

Design and Verify Circuits. Fast.

DOS and Windows & Mac versions available

Electronics Workbench®

NEW Version 3

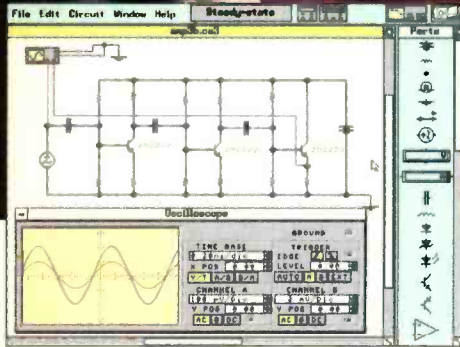

Analog Module includes:

- complete control over all component values
- ideal *and* real-world models for active components
- resistors, capacitors, inductors, transformers, relays, diodes, Zener diodes, LEDs, BJTs, opamps, bulbs, fuses, JFETs, and MOSFETs
- manual, time-delay, voltage-controlled and current-controlled switches
- independent, voltage-controlled and current-controlled sources
- multimeter
- function generator (1 Hz to 1 GHz)
- dual-trace oscilloscope (1 Hz to 1 GHz)
- Bode plotter (1 mHz to 10 GHz)
- SPICE simulation of transient and steady-state response

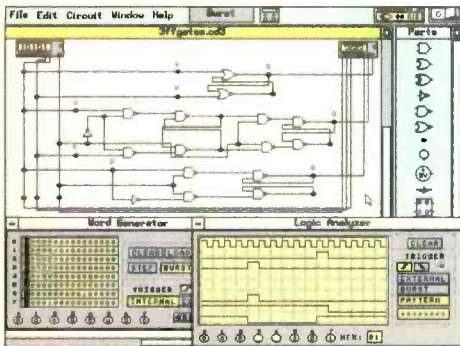

Digital Module includes:

- fast simulation of ideal components
- AND, OR, XOR, NOT, NAND and NOR gates
- RS, JK and D flip-flops
- LED probes, half-adders, switches and seven-segment displays
- word generator (16 eight-bit words)
- logic analyzer (eight-channel)
- logic converter (converts among gates, truth table and Boolean representations)



Complement Your Test Bench

Here's why Electronics Workbench belongs on *your* test bench: Wires route themselves. Connections are always perfect. And the simulated components and test instruments work just like the real thing. The instruments are indestructible and the parts bin holds an unlimited supply of each component. The result: thousands of electronics professionals and hobbyists save precious time and money. **Over 90% would recommend it to their friends and colleagues.** Electronics Workbench: the ideal, affordable tool to design and verify your analog and digital circuits before you breadboard.

And now the best is even better - Electronics Workbench Version 3.0 is here. It simulates more and bigger circuits, and sets the standard for ease of use. Guaranteed!

NEW Features in Version 3

- new components include JFETs, MOSFETs, voltage-controlled and current-controlled sources and manual, time-delay, voltage-controlled and current-controlled switches
- real-world models for opamps, BJTs, JFETs, MOSFETs and diodes - over 100 models available
- MS-DOS version now supports up to 16 MB of RAM for simulation of bigger circuits
- new Microsoft® Windows™ version available
- technical support now also available on CompuServe®

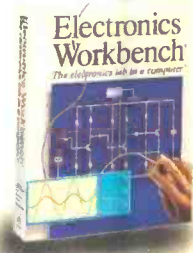

Just \$299!

Electronics Workbench®

The electronics lab in a computer™

Call: 800 263-5552

INTERACTIVE IMAGE TECHNOLOGIES LTD.

908 Niagara Falls Blvd. #068, North Tonawanda, NY 14120-2060
Telephone: (416) 361-0333 FAX: (416) 368-5799

*30-day money-back guarantee.

Prices in U.S. dollars. shipping \$15. Offer valid in U.S. and Canada only.

All trademarks are the property of their respective owners.

CIRCLE 157 ON FREE INFORMATION CARD



Popular Electronics®

THE MAGAZINE FOR THE ELECTRONICS ACTIVIST!

CONSTRUCTION ARTICLES

THE UNIVERSAL NOISE-REDUCTION SYSTEM	Richard Panosh	31
<i>Add the benefits of noise reduction to any audio signal</i>		
BUILD THE VERSATILE DATA LOGGER	Doug Malone	35
<i>This microprocessor-based circuit makes long-term data collection a breeze</i>		
BUILD A DIGITAL CLOCK	Marc Spiwak	61
<i>Explore the intricacies of digital electronics while building this fascinating time piece</i>		
BUILD A PACKET-RADIO TUNING INDICATOR	Brian Pliier	68
<i>Tune packet transmissions dead-on with this simple indicator</i>		
BUILD A DIGITAL COMBINATION LOCK	Jim Stephens	70
<i>Forget about fumbling for your keys with this keyless electronic entry system</i>		

FEATURE ARTICLES

THE WORD ON KITS	Karl T. Thurber, Jr.	43
<i>Learn electronics from the ground up through kit building</i>		

PRODUCT REVIEWS

HANDS-ON-REPORT		18
<i>Elenco Computer-Interface Trainer</i>		
PRODUCT TEST REPORT	Len Feldman	20
<i>McIntosh Laboratories MC7100 Power Amplifier</i>		
GIZMO		49
<i>Including: Tandy Multimedia Personal Computer, Hitachi S-VHS Deck, JVC A/V Selector, and more</i>		

COLUMNS

MULTIMEDIA WATCH	Marc Spiwak	4
<i>Virtual reality by the seat of your pants</i>		
THINK TANK	John Yacono	24
<i>More muscle wire and vehicle projects</i>		
ANTIQUE RADIO	Marc Ellis	73
<i>Testing the NBS set</i>		
COMPUTER BITS	Jeff Holtzman	76
<i>Word 6.0 for Windows</i>		
CIRCUIT CIRCUS	Charles D. Rakes	81
<i>Some igniter circuits to light your fire</i>		
DX LISTENING	Don Jensen	84
<i>Will Ireland return to shortwave?</i>		
HAM RADIO	Joseph J. Carr	86
<i>Antenna topics</i>		
SCANNER SCENE	Marc Saxon	88
<i>Summer sports and games</i>		

DEPARTMENTS

EDITORIAL	Carl Laron	2
LETTERS		3
ELECTRONICS LIBRARY		8
NEW PRODUCTS		12
ELECTRONICS MARKET PLACE		78
POPULAR ELECTRONICS MARKET CENTER		93
ADVERTISER'S INDEX		124
FREE INFORMATION CARD		125

Popular Electronics (ISSN 1042-170X) Published monthly by Gernsback Publications, Inc., 500-B Bi-County Boulevard, Farmingdale, NY 11735. Second-Class postage paid at Farmingdale, NY and at additional mailing offices. One-year, twelve issues, subscription rate U.S. and possessions \$21.95, Canada \$28.84 (includes G.S.T. Canadian Goods and Services Tax Registration No. R125168280), all other countries \$29.45. Subscription orders payable in U.S. funds only. International Postal Money Order, or check drawn on a U.S. bank. U.S. single copy price \$3.50. © 1994 by Gernsback Publications, Inc. All rights reserved. Hands-on Electronics and Gizmo trademarks are registered in U.S. and Canada by Gernsback Publications, Inc. Popular Electronics trademark is registered in U.S. and Canada by Electronic Technology Today, Inc. and is licensed to Gernsback Publications, Inc. Printed in U.S.A.

Postmaster: Please send address changes to Popular Electronics, Subscription Dept., P.O. Box 338, Mount Morris, IL 61054-9932.

A stamped self-addressed envelope must accompany all submitted manuscripts and/or artwork or photographs if their return is desired should they be rejected. We disclaim any responsibility for the loss or damage of manuscripts and/or artwork or photographs while in our possession or otherwise.

As a service to readers, Popular Electronics publishes available plans or information relating to newsworthy products, techniques, and scientific and technological developments. Because of possible variances in the quality and condition of materials and workmanship used by readers, Popular Electronics disclaims any responsibility for the safe and proper functioning of reader-built projects based upon or from plans or information published in this magazine.

Larry Steckler

EHF, CET

Editor-In-Chief and Publisher

EDITORIAL DEPARTMENT

Carl Laron

Editor

Robert A. Young

Associate Editor

John J. Yacono

Associate Editor

Teri Scaduto

Assistant Editor

Evelyn Rose

Editorial Assistant

Marc Spiwak

Editorial Associate

Joseph J. Carr, K4IPV

Marc Ellis

Len Feldman

Jeffrey K. Holtzman

Don Jensen

Charles D. Rakes

Marc Saxon

Contributing Editors

PRODUCTION DEPARTMENT

Ruby M. Yee

Production Director

Karen S. Brown

Production Manager

Kathy Campbell

Production Assistant

ART DEPARTMENT

Andre Duzant

Art Director

Injae Lee

Illustrator

Russell C. Truelson

Illustrator

Jacqueline P. Cheeseboro

Circulation Director

Michele Torrillo

P-E Bookstore

BUSINESS AND EDITORIAL OFFICES

Gernsback Publications, Inc.

500-B Bi-County Blvd.

Farmingdale, NY 11735

1-516-293-3000

Fax: 1-516-293-3115

President: **Larry Steckler**

Subscription

Customer Service/Order Entry

1-800-827-0383

7:30 AM – 8:30 PM EST

Advertising Sales offices listed on page 124

Cover by Loewy Design.
Photo Illustration by David Kahl

Composition by
Mates Graphics



Since some of the equipment and circuitry described in POPULAR ELECTRONICS may relate to or be covered by U.S. patents, POPULAR ELECTRONICS disclaims any liability for the infringement of such patents by the making, using, or selling of any such equipment or circuitry, and suggests that anyone interested in such projects consult a patent attorney.

A SPECIAL ISSUE

If your passion is building, you are going to really enjoy this issue of **Popular Electronics**. It is our annual "Project Builders' Special Issue," and in it we have something for nearly every interest, and every level of ability.

For instance, our *Universal Noise Reduction System* is sure to interest any audio enthusiast. Using National's DNR technology, it lets you add the benefits of noise reduction to any audio-signal source. The story begins on page 31.

If you want to learn more about digital electronics, you'll want to give our *24-Hour Digital Clock* a try. It's a full-featured clock with an alarm and even an electronic pendulum. Building it will give you a fascinating and useful conversation piece, and can teach you a bit about digital electronics in the bargain. That story begins on page 61.

Ham-radio enthusiasts, especially those interested in packet radio, won't want to miss the *Packet Radio Tuning Indicator* on page 68. It is easy to build, requires no modifications to your existing equipment, and can also be used to help tune RTTY signals dead on.

If you are interested in computers and microprocessors, you might just love our *Versatile Data Logger*—a Z80-based microcomputer that's used as a dedicated data-collection device. It can store up to 16,000 measurements, and then download those measurements to your PC for analysis. The story begins on page 35.

Kit building lives, and the proof can be found in *The Word on Kits*. This article covers the state of kit building today, gives you hints and guidelines to ensure your success, and provides a sampling of the type of kits available and where you can get them. The story begins on page 43.

Add to that a *Digital Combination Lock* and our usual compliment of columns and departments and you can see that when we say that this is a special issue, we mean it. We hope you enjoy reading it as much as we enjoyed putting it together!

Carl Laron
Editor

ADDRESS CORRECTION

The wrong address and phone number for Starsight Telecast were inadvertently listed in Gizmo (Popular Electronics, May 1994). The correct address is: Starsight Telecast, 39650 Liberty Street, Third Floor, Fremont, CA 94538. The phone number is 510-657-9620. We're sorry for any inconvenience this may have caused.—Editor

SAFER ROCKET-LAUNCHER

The "Time-Delayed Model-Rocket Launcher" article (Popular Electronics, May 1994) presents a very interesting application for electronics. It is good to know that the design of model-rocketry motors is well standardized so that engine ignition can be performed in a safe manner. There are, however, two minor problems with the circuitry as presented.

First, the rotary switch is not fail-safe, presenting a potential safety problem. Once the fire sequence has begun, if the rotary switch is changed from one delay to another, there will be a period of time where the switch wiper is between taps (break before make). The capacitor will be disconnected from the circuit, U1 pin 6 will be pulled up to the threshold voltage through R3, and engine ignition will occur immediately and unexpectedly.

Also, at the extremely low capacitor currents at the threshold voltage, any oxide build-up on the switch contacts may cause an open circuit between the wiper and the capacitor. If contact oxidation occurs and the fire switch is pressed, there will be no capacitor in the circuit, and engine ignition will occur immediately and unexpectedly.

The circuit could be redesigned so that a single time-delay capacitor is used, with the rotary switch selecting six different resistors. Pins 6 and 7 of U1 should be connected directly to the time-delay capacitor, so if the switch opens the capacitor is not charged and no firing occurs. Gold-plated contacts can be used to prevent the open-contact problem.

The second problem involves capacitor leakage. The long

time-delay ranges may exceed the capabilities of analog circuitry. When electrolytic capacitors are used for time delays, the leakage current of the time-delay capacitor can exceed the current available through the charging resistor. The time-delay capacitor voltage can never reach the LMC555 threshold voltage of $\frac{2}{3} V_{CC}$, or 4VDC in the circuit prepared for the article.

The maximum 25°C leakage current of aluminum electrolytics of the type specified is 0.002CV where C is capacitance and V is rated voltage. For the 47- μ F capacitor used for C8, the maximum leakage is:

$$0.002 \times (47 \times 10^{-6}) \times 16, \text{ or about } 1.5 \mu\text{A}.$$

The current available through R3 at the threshold voltage of 4 VDC is only:

$$I = E/R = 2 \text{ VDC}/(7.5 \times 10^6), \text{ or about } 0.27 \mu\text{A}.$$

Statistically, the capacitor will never charge. In addition, 10 pA of threshold current is required for the IC at pin 6.

The circuit works because most capacitors have leakages lower than the maximum allowed by the specifications. We can see that leakage is definitely a factor by using the 555 time-delay equation. The calculated value for the longest time delay is:

$$t = 1.1 R_3 C_8 = 1.1 \times (7.5 \times 10^6) \times (47 \times 10^{-6}), \text{ or } 388 \text{ seconds}.$$

The design actually produces a time delay of 10 minutes or 600 seconds. The longer time delay is caused by the leakage current "stealing" charge current from the capacitor. Note that the one-minute time delay calculates to be 57 seconds, and is actually 60 seconds. That is because the leakage current is nearly an order of magnitude less for C5/C6. Another disadvantage is that leakage current is very temperature-dependent.

Also, the tolerance of aluminum capacitors can vary from -10% to +50% of nominal. There is an additional tolerance

of 5% in R3. Those tolerances can be compensated for by selecting capacitors, but that presumes that a large selection of capacitors and a capacitance meter are available.

Long analog time delays are a gamble. Digital is much more precise.

C.H.
Tinton Falls, NJ

HAVES & NEEDS

First, I'd like to take this opportunity to let you know how much enjoyment and information I have received through my subscription to Popular Electronics, which I've had for many years. The magazine is wonderful. I have copies dating back to 1972 and refer to them often. I regret that I am only writing to compliment you now when I need something.

I am restoring a working RCA

superheterodyne receiver, Model #6K2 (year unknown), and I need the schematic. I also need either a capacitor, #68597-5, or any technical information on it (only the part number is printed on it). Naturally, I will pay all costs for copying, postage, and handling.

Thank you for any assistance you can provide.

LAWRENCE F. MURRAY
118 Thornton Street
Revere, MA 02151

As a last resort, I'm writing to Popular Electronics. I am repairing an H.H. Scott AM/FM stereo amplifier Model R34S and desperately need servicing information, especially a schematic. I'll gladly pay copying and mailing costs.

REID WHEELER
5910 Boulevard Lp. SE
Olympia, WA 98501-8408

LETTERS

PROTO-BOARD® The breadboard you only buy once.



At Global Specialties® we make one kind of breadboard, the very best, PROTO-BOARD®. American made and Guaranteed for life.

PROTO-BOARD® brand breadboards and the complete Global line of test instruments are in stock at fine electronic distributors everywhere.

 GLOBAL SPECIALTIES

 Can't Wait! Call Toll-Free 1-800-572-1028

70 Fulton Terrace, New Haven, CT 06512
(203) 466-6103 • Fax: (203) 468-0060

 an Interplex Industries company

CIRCLE 13 ON FREE INFORMATION CARD

MULTIMEDIA WATCH

By Marc Spiwak

Virtual Reality By The Seat Of Your Pants

When I first saw a picture of the *ThunderSeat*, I thought that it looked just strange enough to be a lot of fun, and I decided to check one out. This "virtual reality" chair has a built-in subwoofer that enhances all kinds of multimedia fun.

The ThunderSeat is delivered in two large boxes, and takes about 15 minutes to put together. Basically it's a padded, molded-plastic seat that mounts on a sturdy base. The seat is hollow



The ThunderSeat is an excellent compliment to any virtual-reality "play station." For the person who must have it all, it is a double must-have.

with a circular cutout on its underside. A subwoofer speaker mounts on the bottom of the seat over the cutout and, when it is "sub-woofing," it pumps its acoustic energy into the hollow seat. While this unusual chair has a list price of \$299.95, its street price is only about \$200.

Once the seat is assembled, all you have to do is supply it with amplified audio and you're in business—the virtual-reality business that is. Because I didn't have an amplifier suitable for the seat's needs, ThunderSeat Technologies provided me with a demo 35-watt PA amplifier from Radio Shack, which sells for about \$100. The amplifier proved to be more than adequate, as it turned the chair into a regular "rumble seat."

The seat is effective for any kind of audio, but only if you like to "feel" everything you hear. First I tried the ThunderSeat with a couple of hi-fi video tapes. The ThunderSeat puts you right in the action during the motorcycle chase scene in the movie *T2*; you really feel like you're on a motorcycle participating in the chase. The only problem is that you also feel the musical beat—mostly the bass notes—of the movie's soundtrack. Careful adjustment of an equalizer can lessen that effect.

Next I tried the ThunderSeat with my PC. First I fed the output from my sound card through two Y adaptors. Half of the Y's were fed to my left and right amplified speakers as usual, and the other half was fed to the ThunderSeat's PA amplifier. Of all the games I tried with the ThunderSeat, my favorite was a driving game. The game always had some pretty realistic engine sound effects, but with the ThunderSeat it felt

like I was at the wheel of racing car with open headers—real rumbly, and very cool. However, the seat is probably intended more for flight-simulator games, which are also greatly enhanced by the ThunderSeat. Anyone who plays games most of the time will surely want this amazing chair.

If the ThunderSeat was the kind of chair I could also do work in, it would become a permanent part of my multimedia station. Unfortunately, since I have to work in that spot, the seat will have to remain a very fond wish.

THE SOUNDMAN WAVE

While I'm talking about hardware, I might as well mention the *SoundMan Wave* that I am testing out in my PC at work. Logitech sent me a Beta version of the card. So far I really like it. It installed in about 3 minutes and was working only minutes after that. There are no jumpers to set as all configuration is done via software. Also, the card is 100% Sound Blaster, Sound Blaster Pro, and AdLib compatible, so it's guaranteed to be trouble-free and supported.

The SoundMan Wave is a 16-bit stereo card capable of recording and playback at a 44.1-kHz sampling rate. It also uses wave-table synthesis for more realistic sound than the older FM-synthesis sound cards. FM synthesis uses mathematical algorithms to create sound waves while wave-

table synthesis uses short recordings of actual instruments—say a single note—stored in memory to interpolate the rest of the instrument's notes. This leads to far better sound, especially for MIDI stuff. A SCSI interface and audio inputs for a CD-ROM drive let you directly swap this card for the FM-synthesis sound cards present in some older multimedia systems. The card also has a microphone input, line-level inputs, line-level outputs, and a 6-watt amplified output, making it extremely versatile.

Included with the SoundMan Wave is all the software you need to run the card in both DOS and Windows. Among the various utilities is MCS MusicRack that lets you control all Windows 3.1 sound features from what looks like your home stereo. It's very easy and fun to use.

By the time you read this, the SoundMan Wave will no doubt be out of its beta stage and at dealers; it will carry a list price of \$349, although I'm sure it will be available for much less than that. This card gets a thumbs-up from me.

YOU WANT SPEAKERS WITH THAT?

This month I've been playing with some really nice multimedia speakers from Roland. These speakers sound and look great, and are perfect for attaching to the SoundMan Wave. I've tested a few different models including their top-of-the-line MA-20P, which lists for \$320 a pair and sound excellent. For smaller budgets, and work areas, the \$150 CS-30A is a small platform with built-in stereo speakers intended for placing beneath a monitor. It's a neat solution to a small work area. Roland has



Playing computer games while sitting in the ThunderSeat can spoil you to the point where you don't want to play a game without it anymore.

been in the audio business for a long time, and these multimedia speakers add even more feathers to its decorated cap.

CD-ROM RESOURCES

Last month I was talking about CD-ROMs that make doing research easy. This month I'd like to talk about some discs that are valuable resources to have around all the time. Resource discs, while not all that exciting, can be real lifesavers, or at least time savers, in certain situations.

Take, for example, a fascinating set of discs called *ProPhone* from Pro CD, Inc. Contained on its 8 discs is every listed phone number in the *entire country*—business and residential. These discs allow you to type in a name and get a number, a number and get a name, an address and get a name or number, a city and street and get the listings of all families on the block, and so on. Also, searches can be narrowed down using combinations of names, areas, streets, etc. As a matter of fact, I think I've tracked down a long lost friend in upstate New York; all I have to do now is try the two numbers I found that match his name and are in the approximate

Earn Your B.S. Degree in ELECTRONICS or COMPUTERS



By Studying at Home

Grantham College of Engineering, now in our 43rd year, is highly experienced in "distance education"—teaching by correspondence—through printed materials, computer materials, fax, and phone.

No commuting to class. Study at your own pace, while continuing on your present job. Learn from easy-to-understand but complete and thorough lesson materials, with additional help from our instructors.

Our Computer B.S. Degree Program includes courses in BASIC, PASCAL and C languages — as well as Assembly Language, MS DOS, CADD, Robotics, and much more.

Our Electronics B.S. Degree Program includes courses in Solid-State Circuit Analysis and Design, Control Systems, Analog/Digital Communications, Microwave Engr, and much more.

An important part of being prepared to *move up* is holding the right college degree, and the absolutely necessary part is knowing your field. Grantham can help you both ways—to learn more and to earn your degree in the process.

Write or phone for our free catalog. Toll free, 1-800-955-2527, or see mailing address below.

●
Accredited by
the Accrediting Commission of the
National Home Study Council

●
GRANTHAM
College of Engineering
Grantham College Road
Slidell, LA 70460

area where he used to live.

Pro CD has lots of different CD-ROM phone directories at all different prices. All the information on any of the sets can be copied to a hard disk for direct marketing or whatever. While the ProPhone discs certainly won't keep me up late, I'm sure they will come in handy for years to come.

Another disc that I use often is *MapExpert* from DeLorme Mapping—and I just received the latest version (2.0) of it. The new version contains an updated map of the entire United States that you can zoom into and find any street in any neighborhood anywhere in the country. You can search by place, street, zip code, area code, and so on. While this \$495 disc contains the same database as DeLorme's less expensive Street Atlas disc, it has greatly enhanced map-printing options and map-making capabilities, such as custom labeling of your own maps. Users who purchased version 1.0 of *MapExpert* after August 16, 1993 can receive this upgrade free of charge, and for purchases before that, the upgrade is only \$49.

If you do a lot of mailing and shipping, *Mailer's Look-Up* from Mailer's Software is sure to come in handy. This disc lets you quickly locate mailing information such as 9-digit ZIP codes, area code plus prefix, city, state, county, time zones, and local time. This disc is another great time saver.

If semiconductors are your business, you'll be interested in the D.A.T.A. Parametric Access Library, or D.A.T.A./P/A/L for short. This CD-ROM is for serious work only, which is reflected in its price. Up to 10 semiconductor categories can be contained on this single

disc, depending on which categories you need and how much you want to spend. The categories, which cost \$295 each, include Digital, Interface, Linear, Memory, Programmable Logic, Microprocessors, Diodes, Optoelectronics, Thyristors, and

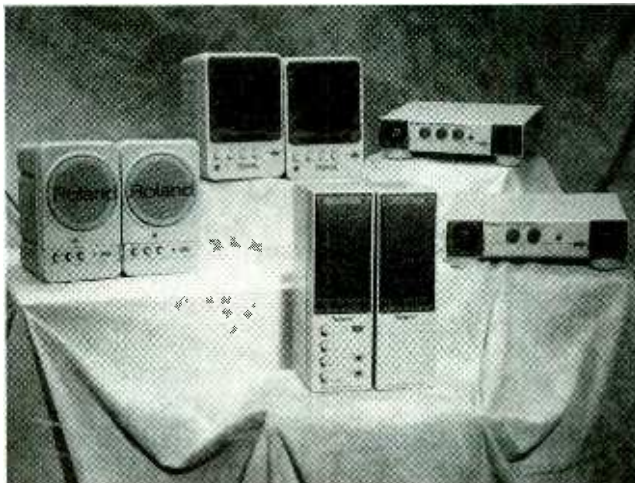

Roland makes a nice line of amplified speakers. Good speakers are the icing on any multimedia cake.

Transistors—all 10 categories can be had on one disc for \$1930. This disc is a gold mine for anyone who can afford it, as up to 25 parameters are included on 1.25-million active and discontinued parts dating back to 1956. That coupled with extensive search capabilities make the CD-Rom disc a must-have for any moderate to large electronics company.

If you need to look up science and engineering information, consider McGraw-Hill's *Science and Technical Reference Set, Release 2.0*. That \$495 disc is chock full of articles, photos, illustrations, definitions, formulas, charts, and tables from the *McGraw-Hill Concise Encyclopedia of Science & Technology*. Any scientific term or topic I could think of is contained on this disc, although I'm sure I'll find it more useful for looking up things I don't already know.

NEW STUFF.

I recently received a copy of *Corel CD PowerPak*, a box of goodies that will surely be useful for any owner of a CD-ROM drive. Included is a CD-ROM driver disk that speeds up your CD-ROM drive with caching software. Other software

utilities provide audio support for CD's, clipart and font-library management, and various multimedia tools. The PowerPak also includes two CD-ROM's; one that contains 100 royalty-free Photo-CD images and screen-saver utilities and another that contains over an hour of royalty-free music clips and sound-effect WAV files. A pair of lightweight Koss stereo headphones completes the package. With a list price of \$99, the Corel CD PowerPak is a great gift idea for anyone you know who has a CD-ROM drive.

Corel also sent me a copy of *CorelDRAW 4* on CD-ROM. While version 5 of this software is due out by the time you read this, version 4 is mighty impressive. Although the software itself is very modern, like old-fashioned software packages *CorelDRAW* comes with loads of paper-based documentation. It includes

two thick books in addition to other manuals and guides. The best word to describe *CorelDRAW* is "complete." The package includes every bit of software you need for any kind of artistic endeavor. You can do page layout, illustration, charting, animation, and more. In addition to the software being on CD-ROM, Corel packs thousands of clipart images, hundreds of fonts, animation, and video onto two CD's—keeping the stuff off your hard drive until you need it. If I could have only one multimedia-intensive software package, this would probably be it, as it can do everything. Version 4 has a new lower price of \$395—a terrific value.

The BookMaker Corporation sent me a copy of its neat utility, *ClickBook*. Although not in the same league as *CorelDRAW*, this \$69 piece of diskette-based software is worthy of mention. It quickly turns Windows 3.1 documents into double-sided booklets. The booklets save paper and are easier to read than ordinary single-sided documents stapled together. A 4-page document can easily be turned into a small booklet printed on one sheet of paper. The software, which automatically reduces page size, instructs you on how to reinsert paper into any laser printer for perfect double-sided printing the first time.

John O'Connor Publishing sent me an assortment of CD-ROM's that sell for the incredible price of \$19.99 a piece. Each disc is loaded with a lifetime's collection of shareware for various applications. *The Megabyte Monster* contains over 625 megabytes of shareware utilities and games. The *Shareware Game Pak for*
(Continued on page 80)

Introducing a New Era In Technical Training.

World College, an affiliate of the Cleveland Institute of Electronics, was created to provide a four year, independent study, technical degree program to individuals seeking a higher education. The Bachelor of Electronics Engineering Technology Degree, offered by World College, prepares students for high-paying careers in electronics, telecommunications, electrical power, computer and control systems. World College's curriculum is taught in an effective, time-proven, independent study environment. With World College's flexible study schedule, students have the opportunity to work or spend time with their family without having to worry about rigid scheduling residential colleges offer.

A Quality Education with a Flexible Schedule.

In a world heavily dependent on electronic equipment, people who understand electronics will have no problem putting their knowledge to work... in high-paying careers. The staff and faculty of World College have invested over ten years developing, what we believe to be, the finest independent-study, baccalaureate degree program available. World College's mission is to instill in each student the knowledge, education, and training that employers are seeking for the many technical positions available today. It's a program created to provide the best education and training possible with a flexible schedule to match your busy lifestyle.



World College is currently seeking approval to confer the Bachelor Degree from the Virginia Council of Higher Education.

Earn A Bachelor of Electronic Engineering Technology Degree from



**WORLD
COLLEGE**
Bringing Technology Home!

Lake Shores Plaza
5193 Shore Drive, Suite 113
Virginia Beach, VA 23455-2500

Send For Your Free Course Catalog.

Take the first step towards a new start in life. Send for World College's Free Independent Course Catalog today and discover how easy and affordable it is to get started on your Bachelor Degree.

World College is affiliated with



Complete the Entire Degree Program Under One Roof. Yours!

Only World College offers an independent study, four year technical degree which can be completed through one school. All lab equipment*, parts, and software are included in your tuition and the program's 300-plus laboratory experiments can be completed in your own home.

You Pay Only For Time Actually Used.

World College not only provides a means to earn a Bachelor Degree while fulfilling current obligations, but there are no restrictions on how fast you can complete the program. At World College, you pay tuition only for the actual upper-level semesters it takes to graduate. The quicker you complete the program, the less you pay in tuition. It's an effective way to keep you motivated in order to complete the course and move on to a better paying position as quickly as possible.

Currently not available in Ohio.

* Student must have access to a personal computer system.

YES! Please send me World College's Free Course Catalog detailing the full curriculum.

Name: _____

Address: _____

Apt: _____

City: _____

State: _____ Zip: _____

Phone: (_____) _____

Age: _____

Return to: WAH10
World College
Lake Shores Plaza
5193 Shore Drive, Suite 113
Virginia Beach, VA 23455-2500

ELECTRONICS LIBRARY

Mastering Oscillator Circuits: Through Projects & Experiments

by Joseph J. Carr

When he's not busy writing his *Ham Radio* column for **Popular Electronics**, Joe Carr puts his efforts into books on electronics, including this one on oscillator circuits. Using a combination of theory, benchtop experiments, and projects, he provides readers with a full working knowledge of component specifications, design standards, and applications for all types of oscillators and other waveform-generator circuits.

The book covers background, theory, operation, design, and

and astable multivibrators; and audio, RF, and voltage-controlled oscillators.

Mastering Oscillator Circuits through Projects & Experiments costs \$17.95 and is published by Tab Books Inc., Blue Ridge Summit, PA 17294-0850; Tel: 800-233-1128.

CIRCLE 98 ON FREE INFORMATION CARD

WORDPERFECT 6 EXPLAINED

by P.R.M. Oliver and N. Kantaris

Intended to help PC users get a handle on WordPerfect as quickly as possible, this book provides practical, hands-on routines for first-time word-processor users as well as those who are switching from another program. To that end, each chapter is a self-contained tutorial unit that builds upon the information presented in previous chapters. Readers can follow the book from beginning to end, or select only those chapters that they need. An emphasis is placed on the most-often used features of the program.

The book explains the hardware requirements and the installation process before familiarizing the reader with the WordPerfect environment and

basic functions. It describes how to enter and edit text, use formatting codes, and setup and use the printer interface. The advanced features covered include document handling, columns, tables, outlines, file management, macros, and the Macro Programming Language. The book also explains how to get up and running with other stand-alone programs—WordPerfect Shell and the Text Editor—that are included with the WordPerfect 6 package.

WordPerfect 6 Explained (order number BP351) is available for \$6.95 plus \$2.50 shipping and handling from *Electronics Technology Today Inc.*, P.O. Box 240, Massapequa Park, NY 11762-0240.

CIRCLE 97 ON FREE INFORMATION CARD

ZEN AND THE ART OF THE INTERNET: A Beginner's Guide, Third Edition

by Brendan P. Kehoe

If you are considering joining the more than 15-million people worldwide who are already connected to the Internet, this book can help you get started. In a straightforward, easy-to-read style, the book makes learning about and traveling through the Internet easier for beginners. No previous knowledge of the Internet is assumed, and the book works for any type of computer operating system.

This third edition of the first user's guide to the Internet has been updated and expanded to reflect the rapidly changing technology and services. New topics covered include Gopher, WAIS; InterNIC; Internet BBS's; how to connect to CompuServe, Genie, and BIX; the Online Career Center; and Internet Talk Radio. The book also includes network basics, electronic mail, anonymous FTP, Usenet News, TELnet, commercial services,

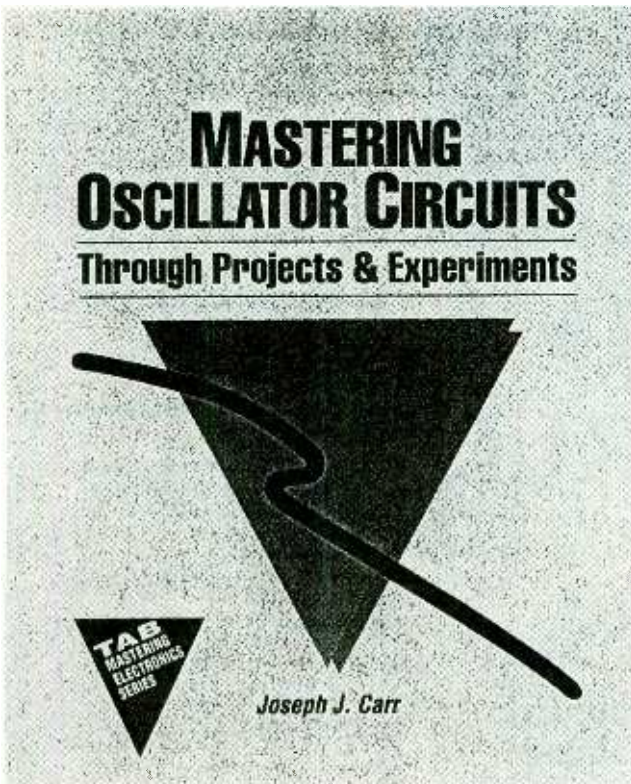

construction. Hundreds of helpful schematics and illustrations accompany several complete projects that readers can build using inexpensive, easy-to-find components. Plans and instructions are included for DC power supplies; relaxation and feedback oscillators; monostable

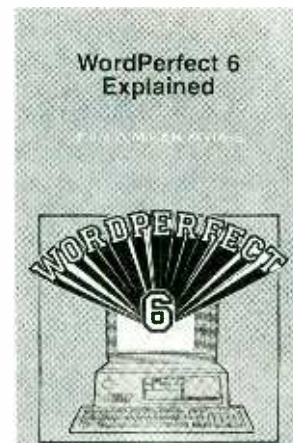



3475P \$10.95

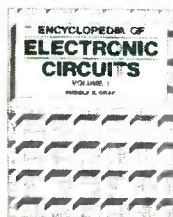

1938H-XXX \$60.00
Counts as 3/Hardcover



3739P \$22.95

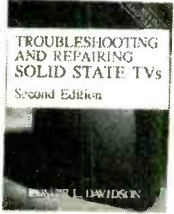

3700H-XX \$36.95
Counts as 2/Hardcover

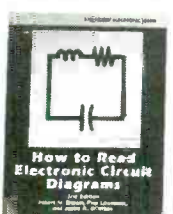

2880P \$15.95

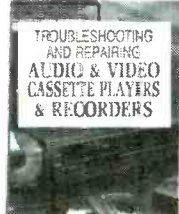

4112H-XX \$29.95
Counts as 2/Hardcover

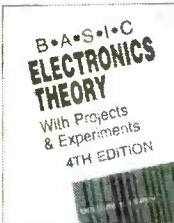

4261H-XX \$35.00
Counts as 2/Hardcover



3438H \$39.95
Hardcover

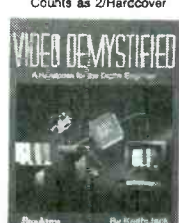

506446H-XX \$29.95
Counts as 2/Hardcover



2813P \$19.95

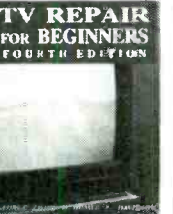

3627P \$19.95

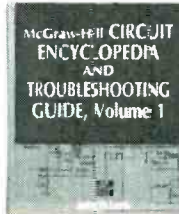

037603H-XXX \$59.50
Counts as 3/Hardcover

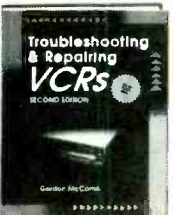

3777H-XX \$32.95
Counts as 2/Hardcover

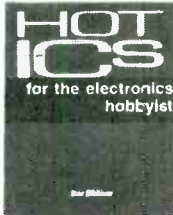

4122H \$36.95
Hardcover

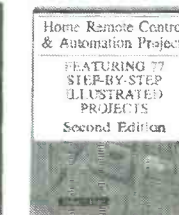

3765P \$19.95



3795P \$19.95

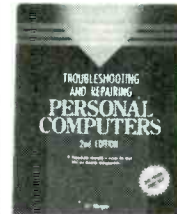

3677H-XX \$34.95
Counts as 2/Hardcover

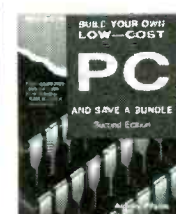

4209P \$19.95

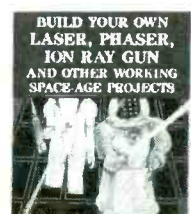

1604P \$17.95

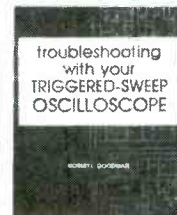

3669P \$19.95



4227P \$14.95



4362P \$16.95



2790P \$17.95

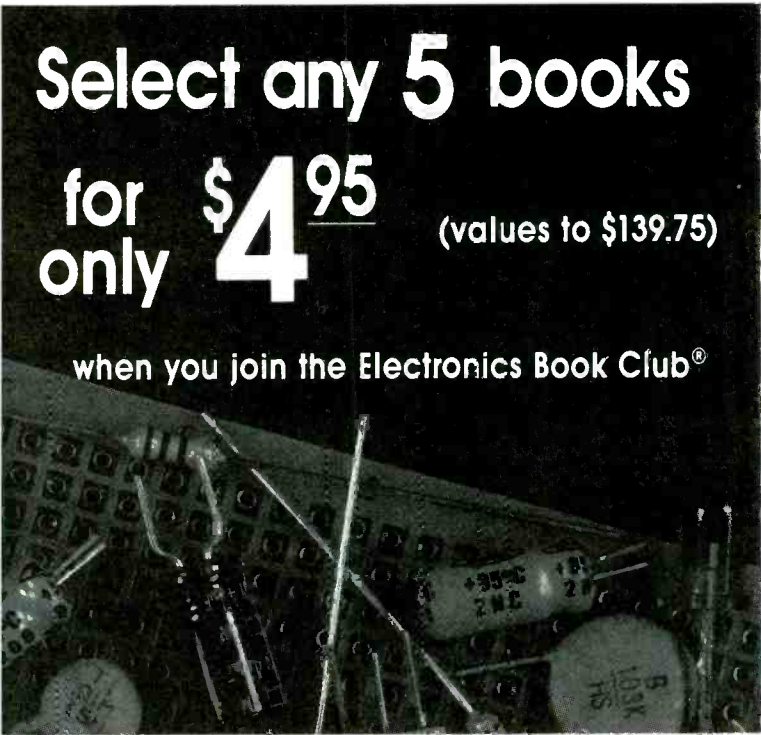

Select any 5 books

for only \$4⁹⁵

(values to \$139.75)

when you join the Electronics Book Club®

As a member of the Electronics Book Club...

You'll enjoy receiving Club bulletins every 3-4 weeks containing exciting offers on the latest books in the field at savings of up to 50% off regular publishers' prices. If you want the Main Selection do nothing and it will be shipped automatically. If you want another book, or no book at all, simply return the reply form to us by the date specified. You'll always have at least 10 days to decide. And you'll be eligible for FREE BOOKS through our Bonus Book Program. Your only obligation is to purchase 3 more books during the next 12 months, after which you may cancel your membership at any time.

Publishers' prices shown. All books are softcover unless otherwise noted. If you select a book that counts as 2 choices, write the book number in one box and XX in the next. If you select a Counts as 3 choice, write the book number in one box and XXX in the next 2 boxes. A shipping/handling charge & sales tax will be added to all orders. ©1994 EBC

If coupon is missing, write to:
Electronics Book Club, Blue Ridge Summit, PA 17294-0810

Your most complete and comprehensive source for the finest electronics books

Electronics Book Club®

Blue Ridge Summit, PA 17294-0810

YES! Please send me the books listed below, billing me for just \$4.95 plus shipping/handling & tax. Enroll me as a member of the Electronics Book Club according to the terms outlined in this ad. If not satisfied, I may return the books within 10 days without obligation and have my membership cancelled.

If you select a book that counts as 2 choices, write the book number in one box and XX in the next.

If you select a Counts as 3 choice, write the book number in one box and XXX in the next 2 boxes.

Name _____

Address _____

City/State _____

Zip _____ Phone _____

Valid for new members only, subject to acceptance by EBC. Canada must remit in U.S. funds drawn on U.S. banks. Applicants outside the U.S. and Canada will receive special ordering instructions. All books are softcover unless otherwise noted. Publishers' prices shown. A shipping/handling charge & sales tax will be added to all orders. PE794

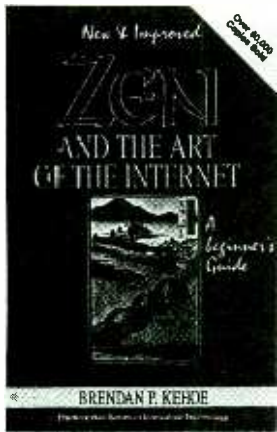

various tools, and country codes. The third edition features a lay-flat binding that makes it easy to read while at your computer.

Zen and the Art of the Internet: A Beginner's Guide, Third Edition is available for \$23.95 from PTR Prentice Hall/Neodata, P. O. Box 11073, Des Moines, IA 50381-1073; Tel: 515-284-6751; Fax: 515-284-2607.

CIRCLE 80 ON FREE INFORMATION CARD

BECOMING AN ELECTRONICS TECHNICIAN: Securing Your High-Tech Future

by Ronald A. Reis

Aimed at would-be electronics technicians, this book offers a complete picture of what the career is like, what preparation and training is required, and how to secure that first electronics-technician position. In a conversational style, the book thoroughly discusses what it means to be an electronics technician in today's high-tech world. It explores the history

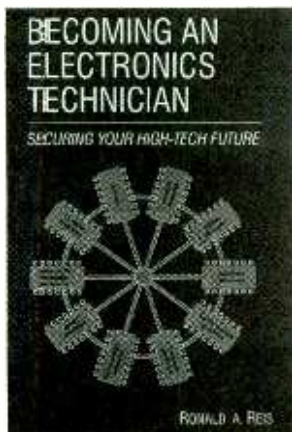

and background of the field, and describes the general occupations and people who make up the industry. The specifics of the electronics technician's job are clearly outlined. The book includes discussions of what it takes to make it through the required course work to obtain a certificate, an associates degree, or a four-year degree. Particular attention is paid to the non-technical, non-electronic skills necessary to completing the course work—reading, listening, calculation, and writing skills. The book also suggests a wealth of activities and interests that students can explore on their own time to supplement and expand their knowledge of electronics.

Becoming an Electronics Technician: Securing Your High-Tech Future costs \$10 and is published by Macmillan Publishing Company, 445 Hutchinson Avenue, Columbus, OH 43235.

CIRCLE 81 ON FREE INFORMATION CARD

ELECTRONIC COMPONENTS CATALOG NUMBER 942

from Digi-Key Corporation

The 300 pages of this catalog are packed with products for electronics hobbyists, students, and professionals. Products featured include batteries, tools,



fuses, stepping motors, power supplies, switches, relays, resistors, capacitors, crystals, oscillators, LED's, LCD's, semiconductor, IC's, transistors, connectors, cable assemblies, buzzers, test equipment, and many more. New products include AMP modular jacks and plugs, Panasonic surface-mount inductors, Raychem resettable fuses, National Semiconductor

IC's, Power One switching and linear power supplies, and Easy Braid desoldering braid.

Electronic Components Catalog Number 942 is free upon request from Digi-Key Corporation, 701 Brooks Avenue South, P. O. Box 677, Thief River Falls, MN 56701-0677; Tel: 800-344-4539.

CIRCLE 82 ON FREE INFORMATION CARD

UPGRADE YOUR COMPUTER PRINTER AND SAVE A BUNDLE

by Horace W. LaBadie, Jr.

This book provides computer users with the practical guidance they need to give their old printers the power and flexibility



of today's best commercial models at the lowest possible price. It describes how to take advantage of inexpensive hardware and software upgrade options for all types of computer printers, including dot matrix, ink jet, daisy wheel, and thermal from all major manufacturers. The step-by-step, illustrated instructions show readers how to get near-letter quality from a draft printer by adding RAM chips to expand the input buffer; ROM chips for font or emulation changes; printer spoolers/buffers; printer-sharing and networking boxes; interface converters; HP PCL, Adobe PostScript, and PostScript emulators; and various software enhancements.

Upgrade Your Computer Printer and Save a Bundle costs \$19.95 and is published by Windcrest/McGraw-Hill, Blue Ridge Summit, PA 17294-0850; Tel: 800-233-1128; Fax: 717-794-2103.

CIRCLE 96 ON FREE INFORMATION CARD

TEXAS RADIO DIRECTORY

by David Stall, N5MKK

Radio enthusiasts in the Lone Star state will find thousands of active listings in more than 40 different categories in this book.

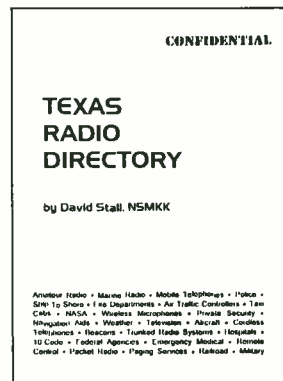

Police, fire, and amateur-radio systems are uniquely sorted by county and frequency for easy reference. Other frequency categories include marine radio, mobile telephones, ship-to-shore, air-traffic controllers, trunked-radio systems, federal agencies, hospitals, emergency medical services, railroad, weather, military, and NASA. It covers the spectrum from 200 kHz to 1.2 GHz; most frequencies listed are between 25 MHz and 950 MHz.

The Texas Radio Directory is available for \$14.95 at Texas electronics shops, or for \$16.00 (postage included) directly from Luna Lumen Press, P. O. Box 58023, Houston, TX 77258-8023.

CIRCLE 83 ON FREE INFORMATION CARD

A BEGINNERS GUIDE TO TTL DIGITAL ICs

by R. A. Penfold

Logic circuits are now part of everyday life, and TTL logic IC's are widely regarded as standard digital devices, used in a wide variety of applications. Because many fundamental concepts of digital design seem abstract and far removed from practical applications, getting started with logic circuits can be difficult. This book covers the basic theory of digital electronics and the use of TTL IC's, but keeps in mind the real-world applications. Along with the basic

A Beginners Guide to TTL Digital ICs

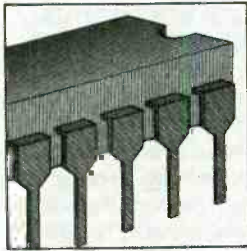

concepts of logic circuits, the book covers the functions of gates, inverters, and other logic building blocks; TTL IC characteristics and their use in circuit design; oscillators and monostables; flipflops, binary dividers, and binary counters; and decoders, data latches, and three-state buffers. The emphasis is on the practical side of the subject matter, and all the circuits presented are based on real TTL IC's.

A *Beginners Guide to TTL Digital ICs* (order number BP332) is available for \$6.50 plus \$2.50 shipping and handling from Electronics Technology Today Inc., P.O. Box 240, Massapequa Park, NY 11762-0240.

CIRCLE 97 ON FREE INFORMATION CARD

1994 EQUIPMENT, TOOLS & SUPPLIES CATALOG

from Print Products International

At 84 pages, this completely revised catalog is 30% larger than last year's edition. It is filled with discounted, brand-name test and measuring equipment, tools, and supplies for use in electronic production, maintenance and service. The catalog includes semiconductors, logic analyzers, signal-strength meters, spectrum analyzers, digital and analog oscilloscopes, and other products used by engineers, technicians, and hobbyists to build, maintain, and test today's advanced electronics. New lines of equipment from Datacom, Goldstar, N.T.E., Yokogawa, and other manufacturers are highlighted in the catalog.

The 1994 *Equipment, Tools & Supplies Catalog* is free upon request from Print Products International, 8931 Brookville Road, Silver Spring, MD 20910; Tel: 800-638-2020 (in Maryland, 301-587-78240); Fax: 800-545-0058 (in Maryland, 301-585-5402).

CIRCLE 84 ON FREE INFORMATION CARD

WINDOWS, WORD & EXCEL OFFICE COMPANION

by Patrick J. Burns

This three-in-one guide to Microsoft's most popular software equips readers with the know-how to work efficiently with Windows and its two top business applications. It combines essential information on the commands and features of each program into a single, easy-to-use resource. The book includes helpful tutorials as well as important tips, techniques, and shortcuts, all organized from the simplest to the most complex. Readers can pace themselves to comfortably learn

to work in Windows versions 3.0 and 3.1, Word versions through 2.0, and Excel versions through 4.0. More advanced users are sure to appreciate the expert, time-saving advice on the three packages that are offered in the book's later chapters.

Windows, Word & Excel Office Companion costs \$21.95 and is available from Ventana Press, P. O. Box 2468, Chapel Hill, NC 27515; Tel: 919-942-0220; Fax: 919-942-1140.

CIRCLE 85 ON FREE INFORMATION CARD

TACTICAL ELECTRONICS

Products for Home & Property Protection

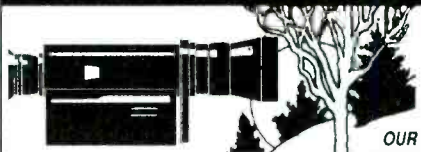

MoonLight Viewer

See in the dark using moonlight or bright starlight. Use our CWL10 laser illuminator for seeing in total darkness. SD90 Ready to Use, with camera adapter \$395.00
CWL10 IR Laser Illuminator \$99.50

3 Mile FM

Wireless Microphone

Subminiature! Crystal clear, ultra-sensitive. Transmits voices & sounds to FM radio. Excellent for security, monitoring of children, etc. Be the local DJ, or go "under cover" with our FM radio sunglasses.
FMV1 Plans \$7.00 FMV1K Kit/Plans \$39.50
SUGL10 Sunglasses with built in FM radio \$29.50

Telephone Transmitter - 3 Miles

Automatically transmits 2 sides of a phone conversation to an FM radio. • Tunable • Undetectable on phone • Easy to build • Up to 3 mi range • Only transmits during phone use.
VWPM7 Plans \$7.00 VWPM7K Kit/Plans \$39.50

Extended (X4) Play Telephone Recording System

Complete with X-4 extended play recorder. Automatically records both sides of phone conversation.
TAP20X Ready to Use System \$129.50

Tel. Line Grabber/Room Monitor

New - The Ultimate in Security & Safety! Call your home or office phone, push a secret tone key to access either: A. On-premise sounds and voices; or B. existing telephone conversation with break-in capability. *Check local laws.*
TELEGRAB Plans \$10.00
TELEGRAB1K Kit/Plans \$99.50

INFORMATION UNLIMITED

Add \$5 P&H • MC, Visa Welcome
Dept PE-15 • Box 716
Amherst, NH 03031-0716
Tel 603-673-4730 Fax 603-672-5406



CATALOG:
Many More Products!
FREE with order.
or Send \$1 P&H

BLITZER STUN GUNS

MADE IN U.S.A.

HARD HITTING • COMPACT UNITS

These compact devices easily fit into a small purse or pocket. Hard hitting with safety switch for prevention of accidental discharges. Crackling and sizzling plasma discourages most attackers without physical contact.

DEFENDER	#STUN1, 80,000 V, curved grip	\$49.50
INTIMIDATOR	#STUN2, 100,000 V	\$59.50
BLITZER	#STUN3, 120,000 V	\$69.50
DEVASTATOR	#STUN4, 150,000 V	\$89.50

Laser Terminator



- Size - 2-7/8" X 7/8"
- Range - 300 yards (night)
- Battery - 20 hours continuous
- Windage & Elevation adjustments
- Warranty - 1 year

Mounts on all popular handguns and rifles
LATR1 - Ready to Use \$174.50

Invisible Pain Field Generator

Pocket size device produces shock waves of intense acoustic energy. Wards off aggressive animals, etc.
IPG7 Plans \$8.00
IPG7K Kit/Plans \$49.50 IPG70 Assembled \$74.50



"Laser Bounce" Listener System

Hear sounds from a distant area using a laser beam reflected from a window or other similar objects. Available as a kit or fully assembled with laser gun site.
LLIST2 Plans \$20.00
LLIST1K Kit of Both Transmitter and Receiver \$199.50
LLIST20 Assembled w/ Laser Gun Site \$299.50

NEW PRODUCTS

Weather Wizard II

You can monitor indoor and outdoor weather at the touch of a button with *Davis Instruments' Weather Wizard II*. The sophisticated, professional-quality weather station measures inside temperature from 32°F to 140°F, outside temperature from -50°F to 140°F, records high and low temperatures, monitors wind direction and wind speed, records high wind speed, calculates wind chill to -134°, and records low wind chill. All highs and lows are recorded with time and date. Alarms can be set to sound when temperature, wind speed, or wind chill fall above or below preset levels.



The Weather Wizard II's functions can be easily expanded with optional add-ons. The Rain Collector allows you to measure daily and accumulated rainfall. Weatherlink allows you to link the Weather Wizard II to an IBM-compatible PC or Macintosh to process, analyze, and store weather data.

The Weather Wizard II, complete with an anemometer with 40 feet of cable, an external temperature sensor with 25 feet of cable, a junction box with eight feet of cable, an AC-power adapter, and detailed instructions, costs \$195. For more information, contact Davis Instruments, 3465 Diablo Avenue, Hayward, CA 94545; Tel: 800-678-3669 or 510-732-9229; Fax: 510-732-9188.

CIRCLE 100 ON FREE INFORMATION CARD

MICROPROCESSOR CALIBRATOR/THERMOMETER

Extech's Model 433201 (115V) and Model 433202 (220V) microprocessor-based calibrator/thermometers can each calibrate and measure thermocouple types J, K, T, E, C, R, S, and N with a maximum accuracy of 0.15% over wide ranges. The high-accuracy calibration function simulates precision thermocouple outputs for use in calibrating thermometers, transmitters, controllers, or recorders. A calibration cable connects the meter to other thermocouple devices. By adjusting the output knob to display the desired temperature, the instrument under test can be calibrated. The device's thermometer function displays temperatures over a wide range and is switchable from °F to °C.



The calibrator/thermometer has a unique "oyster-case" design with large digital displays built into a flip-up cover that can be adjusted for the best viewing angle. Its portable and rugged industrial design is well-suited for field, plant, or benchtop use.

The Models 433201 and 433202 microprocessor-based calibrators/thermometers each cost \$299. For more information, contact Exttech Instruments Corporation, 335 Bear Hill Road, Waltham, MA 02154; Tel: 617-890-7440; Fax: 617-890-7864.

CIRCLE 101 ON FREE INFORMATION CARD

ELECTROCHEMICAL MARKING SYSTEM

The *IMG Electromark SS111*, available from *Jensen Tools*, is an electrochemical marking system that uses a low-voltage, low-amperage electrical current to etch permanent identification marks on metal. The SS111



includes a 115-VAC, 50/60-Hz power supply, a stenciling tool, electrolyte, and neutralizer. When the electrolyte is applied to the stencil, it allows electrical current to pass through and onto the object being marked. Because the metal is etched away from the surface of the object, the mark is permanent. The entire process takes only a few seconds, and is a safe, easy, and economical way to mark metal objects for inventory control or security. Electrolyte will not damage skin, clothing, or surrounding equipment. Stencils can be made on any typewriter. Custom stencils are also available.

The IMG Electromark SS111, including instructions and carrying case, costs \$329. For additional information, contact Jensen Tools Inc., 7815 South 46th Street, Phoenix, AZ 85044; Tel: 800-426-1194; Fax: 602-438-1690.

CIRCLE 102 ON FREE INFORMATION CARD

900-MHz TELEPHONE

According to *BEL-Tronics*, its *Micro 900* cordless phone system features the industry's lightest handset in a multi-handset 900-MHz model. Operating on the 900-MHz frequency, the system provides exceptional clarity and up to three times the range of traditional cordless phones. It is also virtually free of

Be a computer service technician...

5 sure steps to a successful future

1. Choose a complete training program for a secure tomorrow

Jobs for computer service technicians will almost double in the next 10 years according



1994 Good pay, too! 2004

to the latest Department of Labor projections. For you, that means unlimited opportunities for advancement, a new career, or even a

computer service business of your own.

But to succeed in computer service today, you need training — complete, practical training that gives you the confidence to service any brand of computer. You need NRI training.

Only NRI — the leader in career-building, at-home electronics training for 80 years — gives you useful knowledge, hands-on skill, and real-world experience with a powerful 486sx computer you keep. NRI is all you need to succeed in this growing, profitable field.

2. Move beyond "book learning" to try things for yourself

NRI knows that you learn better by doing. That's why we developed the highly effective NRI Discovery Learning Method. You first read about the subject, studying diagrams, schematics, and photos that make the subject even clearer. Then you reinforce each important concept with exciting hands-on projects and experiments. You build, examine, remove, test, repair, replace. So you discover for yourself the feel of the real thing and enjoy a confidence gained only through experience.



3. Get inside a 486sx computer

If you really want to get ahead in computer service, you have to get inside a state-of-the-art computer system. That's why NRI now includes a high-speed 486sx mini-tower computer as the centerpiece of your hands-on training.

As you build this system from the keyboard up, you actually see for yourself how each section of your computer works, especially the powerful, reliable 80486sx Intel CPU. You assemble and test your computer's keyboard, power supply, and 3.5 inch floppy disk drive with your professional multimeter and digital logic probe. But that's not all.

NEW!
Color monitor,
CD-ROM drive,
and 200 meg
hard drive!



You go on to install a 200 meg hard disk drive, Super VGA color monitor, and CD-ROM drive with sound card — today's most wanted computer peripherals. Now not only will you dramatically increase your computer's storage capacity, but you'll also get first-hand experience with today's exciting new multimedia components.

What's more, you train with and keep professional software including MS-DOS 6.2, QBasic, and Microsoft Works. And, using state-of-the-art diagnostic tools from Ultra-X, you learn to quickly identify and service virtually any computer problem on IBM-compatible machines.

4. Make sure you've always got someone to turn to for help

Throughout your NRI training, you've got the full support of your personal NRI instructor and the entire NRI technical staff. Always ready to answer your questions and help you if you should hit a snag, your instructors will make you feel as if you're in a classroom of one, giving you as much time and personal attention as you need.



5. Take a step in the right direction by sending for your FREE catalog today!

Discover for yourself how easy it is to succeed in computer servicing — with the right training. Return the coupon to get a big, full-color catalog describing NRI's incomparable computer training in microcomputer servicing and other high-tech career fields.

If the coupon is missing, write to: NRI Schools, McGraw-Hill Continuing Education Center, 4401 Connecticut Avenue, NW, Washington, DC 20008.



NRI Schools

McGraw-Hill Continuing Education Center
4401 Connecticut Avenue, NW, Washington, DC 20008

For career courses approved under GI Bill
☐ check for details.

<p><input checked="" type="checkbox"/> CHECK ONE CATALOG ONLY</p> <p><input type="checkbox"/> Microcomputer Servicing</p> <p><input type="checkbox"/> TV/Video/Audio Servicing</p> <p><input type="checkbox"/> Telecommunications</p> <p><input type="checkbox"/> Industrial Electronics/Robotics</p> <p><input type="checkbox"/> Basic Electronics</p>	<p><input type="checkbox"/> Computer Programming</p> <p><input type="checkbox"/> PC Applications Specialist</p> <p><input type="checkbox"/> Multimedia Specialist</p> <p><input type="checkbox"/> Programming in C++ with Windows</p> <p><input type="checkbox"/> Bookkeeping & Accounting</p>
---	--

Name _____ Age _____

Address _____

City/State/Zip _____

Accredited Member, National Home Study Council

18-0794



interference from electric motors, fluorescent lights, and other cordless phones. The 7.4-ounce handset is paired with either the stand-up model 900M or the lie-down model 900LX base. A complete Micro 900 system consists of three basic elements: a base-and-handset unit, up to three 900MR remote extension-and-recharger units, and a 900BP battery pack. Each base-and-handset unit has the capacity for up to three remote extension handsets, and can work independently of the extensions; the extensions require a base unit to operate. The extension rechargers can be plugged into any wall outlet in the home with no need for additional telephone jacks.

The 900M base/handset costs \$499.95; the 900LX base/handset costs \$529.95; each 900MR handset/recharger costs \$349.95; and the 900BP battery pack costs \$27.95. For further information, contact BEL-Tronics Limited, 8100 Sagi Parkway, Covington, GA 30209; Tel. 800-341-1401.

CIRCLE 103 ON FREE INFORMATION CARD

HOME/OFFICE SURGE PROTECTION

Designed to protect an average-size home or business, *Intermatic's Home/Office Surge Protection System* takes the guesswork out of selecting surge protectors. The system includes four separate surge protectors to shield a variety of microprocessor-based equipment, ranging from televisions, VCR's, workshop tools, and household appliances to personal computers, telephones, and answering machines. The total system consists of the EG13 microwave surge protector, the EG23T fax/answering machine/modem protector with two modular phone jacks, the

EG63 all-purpose unit with six protected outlets, and the EG634 computer and electronics surge protector with six protected outlets.

Each individual unit continuously monitors the incoming power line, cable-TV, or phone line, operating only when a surge or spike occurs. In that event, the surge protector responds in less than a billionth of a second by absorbing the overload while allowing normal voltage to pass through. After the disruption, it automatically resets to its monitoring mode. Each model features an indicator light to show that it's working properly, noise filtering to eliminate most EMI/RFI interference, and a clamping level of 400 volts. The surge protectors are



UL listed and meet or exceed IEEE specifications for transient voltage surge protection.

The Home/Office Surge Protection System has a suggested list price of less than \$50. For more information, contact Intermatic Inc., Intermatic Plaza, Spring Grove, IL 60081-9698.

CIRCLE 104 ON FREE INFORMATION CARD

VIDEO TITLEMAKER

The broadcast-quality *TitleMaker 2000* video titler, an upgraded version of *Videonics'* popular TitleMaker, offers a host of new features. Intended to bring an added level of convenience and flexibility to home moviemakers who want to give



their productions professional-looking titles and special effects, the TitleMaker 2000 features "preview output," an additional video output that allows a second monitor to be used to create new pages or modify the titles. Other new features include more than 90 font and size combinations, including script fonts; rapid page access without scrolling; advanced scrolling, which allows a title to scroll in from one direction and out from another; and a set of independent pages that can be saved for different jobs or users. Like the original unit, the TitleMaker 2000 offers backgrounds, letters, outlines, and borders that can be created with over a million colors or a wide range of patterns, including animated patterns. The keyboard has accented characters for more than 16 languages and special characters.

The TitleMaker 2000 has a suggested retail price of \$599. For further information, contact Videonics, 1370 Dell Avenue, Campbell, CA 95008-6604; Tel. 708-866-8300; Fax: 408-866-4859.

CIRCLE 105 ON FREE INFORMATION CARD

SOLDERING IRON/TORCH KIT

Philips ECG J-500 soldering iron/torch is now available in a 10-piece kit complete with carrying case, four different tips, and



other accessories. The compact, lightweight, handheld tool features a see-through refillable butane tank, a temperature control for accurate adjustment of tip temperature, and a built-in igniter. The *J-500KT* kit includes the J-500, a solder tip, a blow-torch tip, a hot-knife tip, a heat-blower tip, a metal safety stand, a cleaning pad, spare flints, and a half-ounce of 60/40 rosin-core solder, all packaged in a heavy-duty, fitted carrying case. Additional tips are available

optionally. Applications include electrical/electronic circuit repair, light-gauge welding, jewelry and eyeglass-frame repair, model building, crafts, and thawing frozen locks.

The J-500KT soldering iron/torch kit has a suggested retail price of \$35.50 and is available from participating Philips ECG distributors in the United States and Canada. For more information, contact Philips ECG, 38 State St., Seneca Falls, NY 13148-0730; Tel. 315-568-5875.

CIRCLE 106 ON FREE INFORMATION CARD

COAXIAL-CABLE CHECKER

Designed for testing coaxial cables in common use for network and audio/video applications, *Paladin Tool's Coax-Check 1560* provides a simple pass-or-fail analysis for RG58, 59, and 62 coaxial BNC-type cables. It tests the continuity of both the conductor and the braided



shield, and identifies shorts resulting from contact between the conductor and the shield. A green LED indicates a "pass" diagnosis. One of a group of red LED's lights to indicate the reason for failure. The tester comes in a high-impact case, complete with a 9-volt battery installed.

The Coax-Check 1560 has a suggested retail price of \$35.67. For additional information, contact Paladin Tools, 3543 Old Conejo Road, Suite 101, Newbury Park, CA 91320; Tel. 800-272-8665; Fax: 800-272-5257.

CIRCLE 107 ON FREE INFORMATION CARD

Countersurveillance

Never before has so much professional information on the art of detecting and eliminating electronic snooping devices—and how to defend against experienced information thieves—been placed in one VHS video. If you are a Fortune 500 CEO, an executive in any hi-tech industry, or a novice seeking entry into an honorable, rewarding field of work in countersurveillance, you must view this video presentation again and again.

Wake up! You may be the victim of stolen words—precious ideas that would have made you very wealthy! Yes, professionals, even rank amateurs, may be listening to your most private conversations.

Wake up! If you are not the victim, then you are surrounded by countless victims who need your help if you know how to discover telephone taps, locate bugs, or “sweep” a room clean.

There is a thriving professional service steeped in high-tech techniques that you can become a part of! But first, you must know and understand Countersurveillance Technology. Your very first insight into this highly rewarding field is made possible by a video VHS presentation that you cannot view on broadcast television, satellite, or cable. It presents an informative program prepared by professionals in the field who know their industry, its techniques, kinks and loopholes. Men who can tell you more in 45 minutes in a straightforward, exclusive talk than was ever attempted before.

Foiling Information Thieves

Discover the targets professional snoopers seek out! The prey are stock brokers, arbitrage firms, manufacturers, high-tech companies, any competitive industry, or even small businesses in the same community. The valuable information they filch may be marketing strategies, customer lists, product formulas, manufacturing techniques, even advertising plans. Information thieves eavesdrop on court decisions, bidding information, financial data. The list is unlimited in the mind of man—especially if he is a thief!

You know that the Russians secretly installed countless microphones in the concrete work of the American Embassy building in Moscow. They converted



CALL NOW!

1-516-293-3751

HAVE YOUR VISA or MC CARD AVAILABLE

what was to be an embassy and private residence into the most sophisticated recording studio the world had ever known. The building had to be torn down in order to remove all the bugs.

Stolen Information

The open taps from where the information pours out may be from FAX's, computer communications, telephone calls, and everyday business meetings and lunchtime encounters. Businessmen need counselling on how to eliminate this information drain. Basic telephone use coupled with the user's understanding that someone may be listening or recording vital data and information greatly reduces the opportunity for others to purloin meaningful information.

The professional discussions seen on the TV screen in your home reveals how to detect and disable wiretaps, midget radio-frequency transmitters, and other bugs, plus when to use disinformation to confuse the unwanted listener, and the technique of voice scrambling telephone communications. In fact, do you know how to look for a bug, where to look for a bug, and what to do when you find it?

Bugs of a very small size are easy to build and they can be placed quickly in a matter of seconds, in any object or room. Today you may have used a telephone handset that was bugged. It probably contained three bugs. One was a phony bug to fool you into believing you found a bug and secured the telephone. The second bug placates the investigator when he finds the real thing! And the third bug is found only by the professional, who continued to search just in case there were more bugs.

The professional is not without his tools. Special equipment has been designed so that the professional can sweep a room so that he can detect voice-activated (VOX) and remote-activated bugs. Some of this equipment can be operated by novices, others require a trained countersurveillance professional.

The professionals viewed on your television screen reveal information on the latest technological advances like laser-beam snoopers that are installed hundreds of feet away from the room they snoop on. The professionals disclose that computers yield information too easily.

This advertisement was not written by a countersurveillance professional, but by a beginner whose only experience came from viewing the video tape in the privacy of his home. After you review the video carefully and understand its contents, you have taken the first important step in either acquiring professional help with your surveillance problems, or you may very well consider a career as a countersurveillance professional.

The Dollars You Save

To obtain the information contained in the video VHS cassette, you would attend a professional seminar costing \$350-750 and possibly pay hundreds of dollars more if you had to travel to a distant city to attend. Now, for only \$49.95 (plus \$4.00 P&H) you can view *Countersurveillance Techniques* at home and take refresher views often. To obtain your copy, complete the coupon or call.

PE

CLAGGK INC.
P.O. Box 4099 • Farmingdale, NY 11735

Please rush my copy of the Countersurveillance Techniques Video VHS Cassette for a total cost of \$53.95 each (which includes \$4.00 postage and handling).

No. of Cassettes ordered _____
 Amount of payment \$ _____
 Sales tax (N.Y.S. only) _____
 Total enclosed _____
 Bill me VISA MasterCard
 Card No. _____
 Expire Date ____ / ____

Signature _____
 Name _____
 Address _____
 City _____ State _____ ZIP _____

All payments in U.S.A. funds. Canadians add \$4.00 per VHS cassette. No foreign orders.

July 1994, Popular Electronics



ELENCO COMPUTER INTERFACE TRAINER

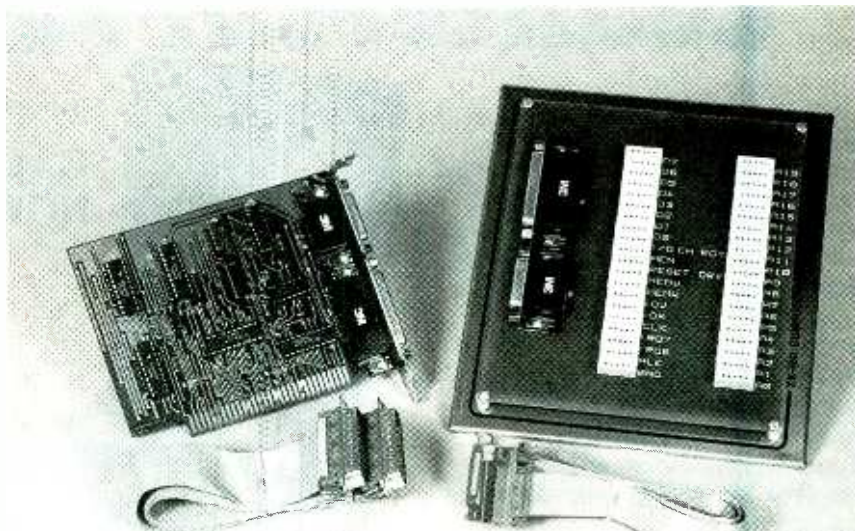

CIRCLE 119 ON FREE INFORMATION CARD

Tap into those useful logic signals on your computer's motherboard with the Elenco XK-450 Computer Interface Trainer.

Learning how logic circuits work is but one "lesson" in the school of electronics. However, given the extent of digital technology today, it is an important lesson; perhaps just as important as learning about radio circuitry was fifty years ago. Logic circuitry is everywhere today, and anyone seriously considering a career in electronics will simply have to learn about it.

However, just understanding the functions of simple logic devices isn't enough. Since computers and microprocessors now control almost everything, a well-rounded education in digital electronics must teach how to interface those components to basic digital circuits.

There are many ways that you can learn about logic. The best place to start is on paper, both by reading vari-

ous textbooks and magazine articles, and by working out the logic expressions with a pencil and pad. Once you're "paper trained" in logic, the next training ground is a workbench, where valuable hands-on experience can be gained. That involves the physical breadboarding of logic circuits, and observing and troubleshooting the outcome of your experiments.

To that end, there are various logic trainers that help one learn particular aspects of digital circuitry. The problem is that most trainers are mission-specific, meaning that once you've completed experiments A through Z there's nothing else you can do with it (except hand it down to someone who hasn't done experiments A through Z). Even a trainer that includes a microcontroller of some kind is still rather limited—once you've learned how to put simple logic circuits under microprocessor control, what then?

That leads me to wonder, is there a more open-ended trainer platform? Personal computers come to mind here, because inside those dull-tan cases are powerful microprocessors and memory arrays that are just waiting to do something intriguing. Getting your hands on a personal computer these days is no problem at

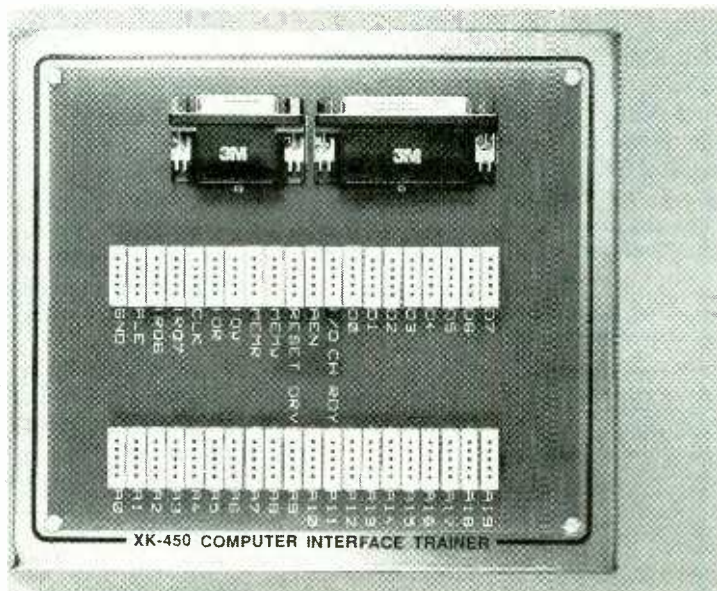

The breadboard area contains 5-point tie blocks for each buffered bus signal. Note that the signals are logically grouped on the board.

all; you shouldn't have to pay more than \$100 bucks for a perfectly good used XT with a hard drive and color monitor. Even though an old PC is not adequate for modern word-processing, spread-sheeting, or even game-playing tasks, they are still more than adequate for generating control signals and recording data.

Provided you know or are ready to learn a little programming, the key difficulty is getting at those signals, which are "buried" in the motherboard. Even with a PC's relatively low cost, one still doesn't want to stick wires into the motherboard slots to pick up signals. What's needed is a card that fits in one of the motherboard slots and safely brings the signals to the outside world. To further protect the motherboard, the card must also buffer those signals.

Fortunately for us, Elenco Electronics (150 W. Carpenter Ave., Wheeling, IL 60090; Tel. 708-541-3800, or 800-533-2441; Fax 708-520-0085) makes exactly that: the Model XK-450 Computer Interface Trainer, that sells for \$165.

What You Get. The XK-450 package consists of an adapter card that fits in an empty slot of any IBM-PC/XT, or compatible, a special breadboard (which rests outside the computer), and two ribbon cables. The expansion card is loaded with five 74LS244 octal buffers that isolate your computer bus from your experiments. Namely, it buffers the address, data, IRQ5 or IRQ6, IRQ7, I/O channel ready, AEN, Reset DRV, MEMW, MEMR, IOW, IOR, Clock, and ALE signals, and provides a signal ground.

The breadboard includes one 5-point tie block for each of the mentioned signals. They give the system great flexibility. The experimenter board is mounted on a sturdy steel base plate equipped with four rubber feet, so it's extremely sure-footed and easy to work with on the bench.

The two ribbon cables (one 15-conductor and one 25-conductor) are simply terminated with IDC DB connectors. The cables connect the adapter card and breadboard together.

Installation. Minutes after taking the XK-450 out of the box, you can convert any old PC/XT or compatible into a

computer-interface trainer. Before installing the XK-450, you must decide if you need to move a jumper on the adapter card from its default position. The jumper allows you to select whether you want access to IRQ5 or IRQ6 (the default) on the breadboard. If you move the jumper to the position for IRQ5, the breadboard tie block labeled IRQ6 will carry the IRQ5 signal instead. This step was not covered in the manual, although it's an option few users would need to exercise.

Next, you plug the adapter card into an empty expansion socket. Once the card is installed, you can put the cover back on the computer. From the back of the computer, you then plug the two ribbon cables into the card. Connect them to the breadboard, and you're done.

Buy it, Try it. Anyone who regularly tinkers with the signals originating from a computer motherboard, as well as anyone who is ready to start doing so, will find the XK-450 extremely useful. The XK-450 is a fine addition to that old PC that's found its final resting place on your electronics workbench. It lets you get at the PC bus signals in an instant, without fear of damaging the computer.

The XK-450 will surely be of interest to any computer buff, or at least the kind interested in hardware as well as software. We know that the Elenco XK-450 Computer Interface Trainer is right up the alley of many readers of this magazine. Its reasonable price, extreme versatility, and uniqueness make it so. For more information on the XK-450, contact Elenco at the address given earlier in this article, or circle No. 119 on the Free Information Card. ■

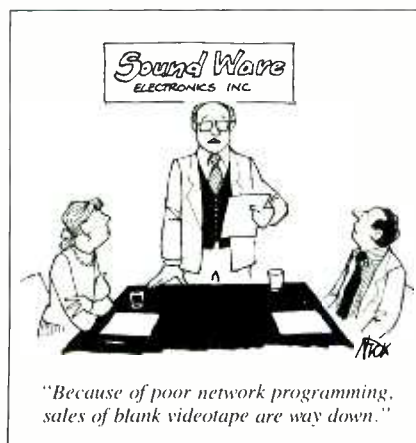

SURVEILLANCE & SECURITY

FM TRANSMITTERS MINIATURE (KITS)

- 3-VOLT FM XMTR, up to 300 ft. indoors, 1500 ft. outdoors
- PHONE XMTR, range to 500 ft., uses phone-line power
- Sound-Activated XMTR, range to 500 ft.
- 2-STAGE XMTR, 9-Volt, very powerful

All above require simple soldering at 2 to 4 places. Broadcast on std FM band. Assemble in less than 5 minutes. Any of the above **\$29.95****

TELE CALL FORWARDER. Transfers incoming calls to any number you select. **\$99.00***

CALLER ID. Registers incoming number and stores to 50 numbers. **\$99.00***

TEL REGISTER WITH PRINTER. Records dialed number, duration, and prints record. 16-digit display with security lock control. Stores up to 40 calls. **\$149.00***

TEL REGISTER W/O PRINTER. Records dialed number and time. 16-digit display. Holds up to 145 numbers in memory. **\$99.00***

12-HOUR LONG-PLAY RECORDER. Modified Panasonic. Records 6 hrs. on each side of 120 tape (supplied). Compatible with VOX and Tel Rec Adapter. **\$119.00***

VOX VOICE-ACTIVATED SWITCH. Makes recorder self-activating with voices or other sounds. Great for radios and scanners. Provisions for external mike and/or patch cord. **\$28.50****

TELEPHONE RECORDING ADAPTER. Records incoming and outgoing calls. Use of handset controls recorder and records both sides of conversation. **\$28.50***

TELEPHONE SCRAMBLERS. Over 51,000 separate codes; impossible to break code. Assures utmost privacy. **\$295.00***

VOICE CHANGER. Changes man's voice to lady's and vice versa. 4 separate settings. Ideal for disguising voice. **\$29.95***

RF BUG DETECTORS, AND MUCH MORE

For Shipping and Handling add *\$5.00 and **\$2.00 per item. Colo. residents add sales tax. Mail Order. VISA, M/C, COD's o.k. Inquire for dealer prices. Free catalog.

TOLL FREE 1-800-926-2488

A.M.C. SALES, INC.

193 Vaquero Drive
Boulder, CO 80303
Tel: (303) 499-5405
Fax: (303) 494-4924

Mon-Fri 8 a.m. - 5 p.m. Mtn. Time

CIRCLE 151 ON FREE INFORMATION CARD

PRODUCT TEST REPORTS

By Len Feldman

McIntosh Laboratories MC7100 Power Amplifier

McIntosh Laboratories is one of the oldest established firms specializing in high-fidelity audio components. The company was formed by Frank McIntosh back in the late 1940's and has remained true to its philosophy of creating audio components that not only perform superbly, but last virtually "indefinitely." I know several audio enthusiasts who bought McIntosh equipment in the 1950's and 1960's and are still using that equipment today. The fact that that equipment was based on vacuum-tube technology makes the longevity of those components even more remarkable.

CIRCLE 120 ON FREE INFORMATION CARD



The McIntosh MC7100 power amplifier.

FEATURES

McIntosh traditionally updates their equipment without necessarily changing model numbers, and that is true in the case of the MC7100 power amplifier that is the subject of this report. The MC7100 includes the "classic McIntosh" black-glass front panel with back lighted nomenclature, and is a perfect match for their Model C712 remote-controlled System Control

Center. The amplifier has been updated with several refinements. A pair of balanced input (XLR) connectors has been added to take advantage of the reduced noise pickup of balanced cables. The addition of a rear-panel AC power switch as well as a DC logic power-control connector (which turns on the amplifier when supplied with 5 volts of DC) provides increased operating flexibility to fit a greater variety of system requirements. All the familiar McIntosh performance circuits such as Power Guard and Sentry Monitor protection (more about those circuits in a moment) are present in this unit.

The amplifier is rated at 100-watts-per-channel into 8-ohm loads, but will also drive 4-ohm speakers. Bridged (mono) operation is also possible, under which the amp can deliver as much as 300 watts into a single speaker. The Power

Guard circuit, referred to above, acts as a waveform comparator, monitoring both the input and output signals. Normally there are no differences between those signals; but there is when an amplifier is overdriven. If the difference exceeds 0.3% (equivalent to 0.3% harmonic distortion), the Power Guard indicator on the front panel will illuminate. If the difference continues to increase, the Power Guard circuit attenuates the input to reduce the gain of the amplifier and prevent any further increase in distortion. Thanks to that circuit, distortion will not exceed 2% even if the amplifier is overdriven by as much as 14 dB.

The MC7100 incorporates seven specific protection circuits to enhance its performance, increase its reliability, and protect loudspeakers. The Sentry Monitor circuit, also referred to earlier, is a good exam-

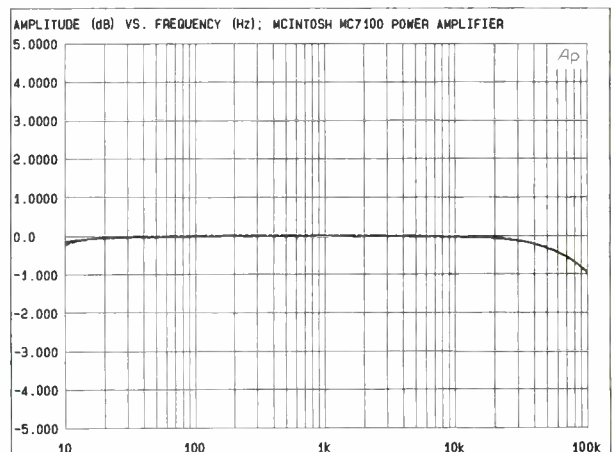

The overall frequency response of the McIntosh MC7100 from 10 Hz to 100 kHz is shown here.

TEST RESULTS—MCINTOSH MC7100 POWER AMPLIFIER

Specification	Mfr's Claim	PE Measured
Frequency response		
20 Hz to 20 kHz	+0, -0.25 dB	+0, -0 dB
10 Hz to 100 kHz	+0, -3.0 dB	+0, -1.0 dB
Stereo power output		
8-ohm loads	100 W/channel	120 W/channel
Mono bridged, 8 ohms	300 watts	315 watts
Rated harmonic distortion	0.005%	0.003% (stereo)
Hum and noise (re: rated output)	115 dB	95 dB (re: 1 watt)
IHF dynamic headroom	1.7 dB	Confirmed
Input sensitivity	1.4 volts	1.48 volts
Damping factor	More than 200	Confirmed
Power requirements	120-volts, 50/60 Hz, 2.5 amps	Confirmed
Dimensions		
(W × H × D, inches)	N/A	17½ × 4¼ × 16½
Weight	24 lbs.	22 lbs.
Suggested retail price:	\$1100.00	

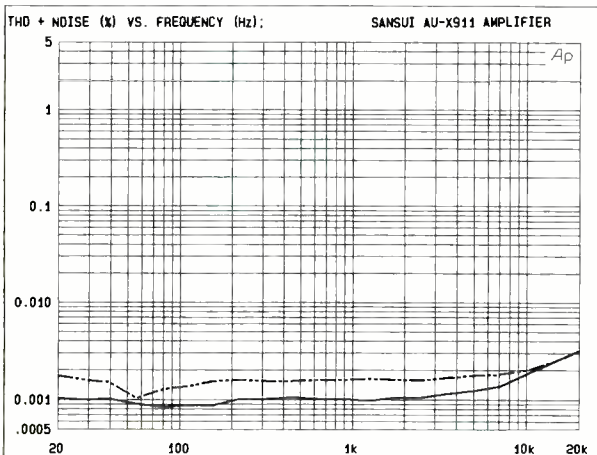

This plot shows how harmonic-distortion-plus-noise varied as a function of the input frequency.

ple. If a short circuit or very low load impedance is connected to the amplifier's outputs, destructive current levels could be reached. The Sentry Monitor circuit senses the dynamic operating time, voltage, and current at the output stages, and keeps them within safe operating limits. The Sentry Monitor circuit does not limit the power output available from the amplifier. Additional protection circuits include thermal protection and direct-current failure protection. The last circuit turns off the speakers if a DC voltage appears at the output terminals. That prevents possible speaker damage.

CONTROLS

There are no operator controls on the front panel of the McIntosh MC7100. Behind the traditional black-glass front panel are a power-on indicator light and the pair of Power Guard indicator lights (one for each channel) described earlier.

The rear panel has a "power on/off-remote" switch at the left, and just below it is a fuse holder equipped with a 6-amp power-line fuse. Nearby is a AC convenience receptacle and above it are a pair of "power control" jacks; those are used with an associated McIntosh control center to turn the amplifier on or off when the control

ATTENTION! ELECTRONICS TECHNICIANS



EARN YOUR B.S.E.E. DEGREE

THROUGH HOME STUDY

Our New and Highly Effective Advanced-Placement Program for experienced Electronic Technicians grants credit for previous Schooling and Professional Experience, and can greatly reduce the time required to complete Program and reach graduation. No residence schooling required for qualified Electronic Technicians. Through this Special Program you can pull all of the loose ends of your electronics background together and earn your B.S.E.E. Degree. Upgrade your status and pay to the Engineering Level. Advance Rapidly! Many finish in 12 months or less. Students and graduates in all 50 States and throughout the World. Established Over 40 Years! Write for free Descriptive Literature.

COOK'S INSTITUTE OF ELECTRONICS ENGINEERING

4251 CYPRESS DRIVE
JACKSON, MISSISSIPPI 39212

CIRCLE 14 ON FREE INFORMATION CARD

Satellite Images On Your PC



PC HF Facsimile 7.0 \$99

SSC has interfaces and software to allow you to receive vivid satellite images on an IBM PC computer. Just plug the interface into the serial port of a PC and into the audio output of a shortwave receiver. The package includes the interface, manuals, schedules and software. SSC also makes systems for reception with VHF scanners. Call or write for our free catalog.

Visa and MASTERCARD accepted

Software Systems Consulting

615 S. El Camino Real, San Clemente, CA 92672
Tel: (714)-498-5784 Fax: (714)-498-0568

center is powered up. Under those conditions, the MC7100's power switch would be left in the "off-remote" position. Further to the right are speaker terminals. The speaker-terminal block is clearly labeled in terms of polarities for either stereo speakers or for a single speaker when bridged (mono) mode is desired. Near the speaker block is a small slide switch that selects either stereo or mono operation. Clear illustrations showing connections for both methods of operation appear in the owner's manual. Two input-level controls come next, followed by unbalanced (standard RCA type) input jacks and three-terminal balanced-input (XLR) connector jacks.

LAB MEASUREMENTS

The frequency response of the McIntosh MC7100 amplifier was flat out to 20 kHz, and even at 100-kHz response was down only 1.0 dB! Harmonic-distortion-plus-noise at a constant rated output of 100-watts-per-channel into 8 ohms was around 0.001% at low and mid-frequencies for the left channel, while the right channel was closer to 0.002%. Even at the 20-kHz extreme, THD plus noise measured no more than about 0.003% for both channels, still well below the published specification of 0.005%. Bear in mind, too, that these measurements take into account distortion plus noise whereas the published specification refers to distortion alone.

In order to "separate" the actual harmonic distortion from the noise contribution we used the FFT spectrum-analysis capability of our Audio Precision test equipment. With a 1-kHz signal applied, the most signifi-

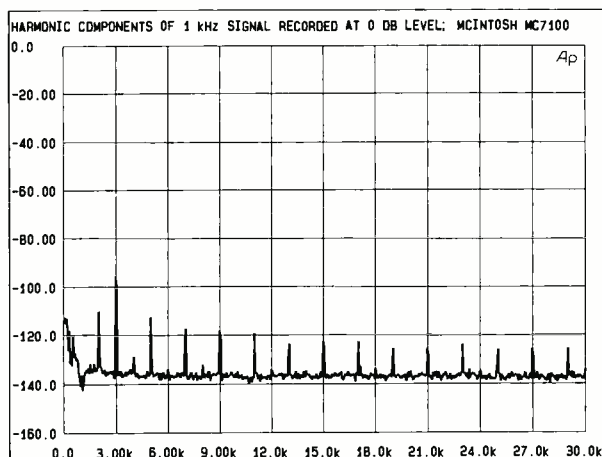

A spectrum analysis showed that even the most significant harmonic-distortion component (at 3 kHz) was down about 96 dB below the reference level.

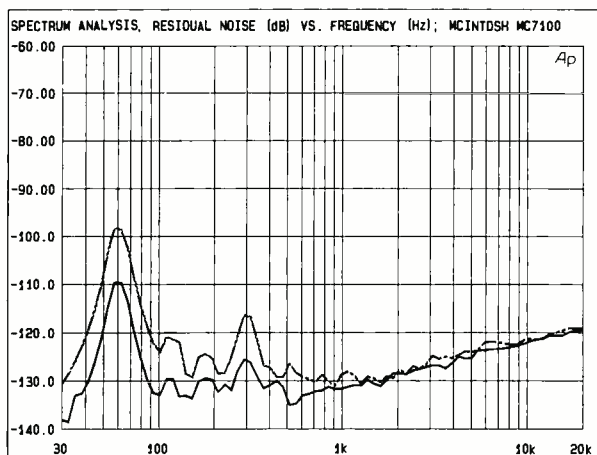

When we looked at residual-noise-versus-frequency using a 1/3-octave band-pass filter we found that even the worst noise peak was down nearly 100 dB.

cant harmonic distortion component occurred at 3 kHz, (the third harmonic of the fundamental test signal) but even it is down some 96 dB below the 100-watt reference level. That corresponds to a distortion percentage of 0.0016%.

We next briefly connected a single load for the bridged (mono) mode and ran another distortion-plus-noise-versus-frequency test, this time maintaining a constant 300-watts of power into the single load. Distortion-plus-noise was less than 0.004% over nearly the entire frequency range, never reaching the McIntosh-published maximum-THD level of 0.005%.

Next, we restored the stereo connections and measured the A-weighted signal-to-noise ratio of the amplifier with input levels adjusted for maximum gain and with an output reference of 100-watts-per-channel into 8-ohm loads. The left-channel S/N ratio was 113.6 dB, while right-channel signal-to-noise ratio measured 112.1 dB.

We also examined the residual-noise-versus-frequency, using a 1/3-octave band-pass filter. We saw peaks at 60 Hz, 120 Hz, 180 Hz, and 300 Hz, which result from the 60-Hz power line, but even the worst of those (60 Hz in the right channel) was down nearly 100 dB

referred to rated output. Note, too, that these measurements were done without any A-weighting and therefore did not take into account the ear's lowered sensitivity to bass sounds at such low levels, which would make this minimal amount of hum totally inaudible, as indeed it was during our subsequent listening tests.

Finally, we measured the SMPTE intermodulation-distortion level of the amplifier when it was fed with a 4:1 ratio of 60-Hz and 7000-Hz signals at a level equivalent to the rated output of 100-watts-per-channel. The SMPTE-IM for the left channel measured 0.001% for either channel.

HANDS-ON TESTS

Hook-up to our reference listening system went smoothly. We listened to the amplifier using KEF Model 105 Mk. 2 speaker systems, which are relatively inefficient and therefore require fairly high power levels. The Power Guard lights never came on during our listening tests, even though we drove the system to fairly loud levels in our listening room.

What can one say about the sound of a McIntosh power amplifier such as this elegantly designed MC7100. If anyone ever tells you that measured lab specifications have nothing to do with the way a product sounds, the MC7100 would be a good component with which to demonstrate the contrary. It not only measured superbly, but sounded magnificent as well.

For more information on the MC7100 power amplifier, contact McIntosh (2 Chambers St., Binghamton, NY 13903) directly, or circle No. 120 on the Free Information Card.

Electronic Paperbacks at Special Prices

BP325—A CONCISE USER'S GUIDE TO WINDOWS 3.1 \$7.95. Come to grips with Windows 3.1 in the shortest and most effective way. Learn how to manipulate Windows screens and DOS by Windows graphics interface. Master its word processor, Paintbrush and data base along with Notepad, Macro Recorder, PIF Editor, and Calculator.

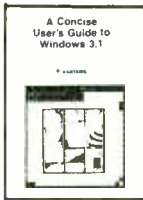

BP311—AN INTRODUCTION TO SCANNERS AND SCANNING \$7.95. Radio scanners have opened a realm of exciting radio listening. Understand radio wave propagation, types of transmissions, antennas, band assignments—the straight dope on what to hear and where to hear it! Comes complete with index, glossary of important terminology.



BP287—A REFERENCE GUIDE TO PRACTICAL ELECTRONICS TERMS \$8.95. More than just a dictionary of practical electronics terms, the book goes a step further in getting down to fundamentals. A reference volume that can be read casually by a reader seeking knowledge.



BP248—TEST EQUIPMENT CONSTRUCTION \$5.95. Details construction of simple, inexpensive, but extremely useful test equipment. AF Gen, Test Bench Ampl, Audio Millivoltmeter, Transistor Tester and six more.



BP267—HOW TO USE OSCILLOSCOPES AND OTHER TEST EQUIPMENT \$6.95. Mastering the oscilloscope is not really too difficult. This book explains all the standard controls and functions. Other equipment is also described.



BP265—MORE ADVANCED USES OF THE MULTI-METER \$5.95. Use these techniques to test and analyze the performance of a variety of components. Also see how to build add-ons to extend multi-meter capabilities.



BP256—INTRO TO LOUDSPEAKERS AND ENCLOSURE DESIGN \$5.95. We explore the variety of enclosure and speaker designs in use today, so the reader can understand the principles involved.

BP298—A CONCISE INTRODUCTION TO THE MACINTOSH SYSTEM AND FINDER. . . \$6.25. If you have one of the popular Macintosh range of computers, this book is designed to help you get the most from it. Although the Mac's WIMP user interface is designed to be easy to use, much of it only becomes clear when it is explained in simple terms. All Macintosh computers are covered including the new "Classic" range.



BP299—PRACTICAL ELECTRONIC FILTERS \$6.95. Presents a dozen filter-based practical projects with applications in and around the home or in the constructor's workshop. Complete construction details are included.



BP249—MORE ADVANCED TEST EQUIPMENT CONSTRUCTION \$6.95. Eleven more test equipment construction projects. They include a digital voltmeter, capacitance meter, current tracer, etc.



BP245—DIGITAL AUDIO PROJECTS \$5.95. Practical circuits to build and experiment with. Includes A/D converter, input amplifier, digital delay line, compander, echo effect and more.



BP247—MORE ADVANCED MIDI PROJECTS \$5.95. Circuits included are a MIDI indicator, THRU box, merge unit, code generator, pedal, programmer, channelizer, and analyzer.



BP257—INTRO TO AMATEUR RADIO \$6.95. Amateur Radio is a unique and fascinating hobby. This book gives the newcomer a comprehensive and easy to understand guide to the subject.



BP309—PREAMPLIFIER AND FILTER CIRCUITS \$6.95. Provides circuits and background info for a range of preamplifiers, plus tone controls, filters, mixers and more. All are high-performance circuits that can be built at a reasonable cost.

BP303—UNDERSTANDING PC SOFTWARE \$6.95. This book will help you understand the basics of various types of business software in common use. Types of software covered include word processors, spelling checkers, graphics programs, desktop publishing, databases, spreadsheets and utilities.



BP251—COMPUTER HOBBYISTS HANDBOOK \$8.95. A wrapup of everything the computer hobbyist needs to know in one easy to use volume. Provides a range of useful reference material in a single source.



PCP115—ELECTRONIC PROJECTS FOR HOME SECURITY . . . \$10.00. 25 projects ranging from a single-door protection circuit that can be completed in an hour or two, to a sophisticated multi-channel security system. Each project is described in detail with circuit diagrams, explanations of how it works, instructions for building and testing, and how to adapt circuits to meet special requirements.



BP180—ADVANCED ELECTRONIC SECURITY PROJECTS. . . . \$5.95. Includes a passive infra-red detector, a fiber-optic loop alarm, computer-based alarms and an unusual form of ultrasonic intruder detector.

BP235—POWER SELECTOR GUIDE \$10.00 Complete guide to semiconductor power devices. More than 1000 power handling devices are included. They are tabulated in alpha-numeric sequence, by technical specs Includes power diodes, Thyristors, Triacs, Power Transistors and FETs.

BP234—TRANSISTOR SELECTOR GUIDE. . . . \$10.00. Companion volume to BP235. Book covers more than 1400 JEDEC, JIS, and brand-specific devices. Also contains listing by case type, and electronic parameters. Includes Darlingtons transistors, high-voltage devices, high-current devices, high power devices.

BP117—PRACTICAL ELECTRONIC BUILDING BLOCKS—Book 1. . . . \$5.75. Oscillators, Timers, Noise Generators, Rectifiers, Comparators, Triggers and more.

BP195—INTRODUCTION TO SATELLITE TV. . . . \$9.95. A definitive introduction to the subject written for the professional engineer, electronics enthusiast, or others who want to know more before they buy. 8 x 10 in.

BP179—ELECTRONIC CIRCUITS FOR THE COMPUTER CONTROL OF ROBOTS \$7.50. Data and circuits for interfacing the computer to the robot's motors and sensors

BP238—GETTING THE MOST FROM YOUR MULTIMETER. . . . \$5.95. Covers basics of analog and digital meters. Methods of component testing includes transistors, thyristors, resistors, capacitors and other active and passive devices.

BP97—IC PROJECTS FOR BEGINNERS. . . . \$5.50. Power supplies, radio and audio circuits, oscillators, timers, switches, and more. If you can use a soldering iron you can build these devices.

RADIO—100 RADIO HOOKUPS. . . . \$3.00. Reprint of 1924 booklet presents radio circuits of the era including regenerative, neutrodyne, reflex & more.

BP42—SIMPLE LED CIRCUITS. . . . \$5.50. A large selection of simple applications for this simple electronic component.

BP122—AUDIO AMPLIFIER CONSTRUCTION \$5.75. Construction details for preamps and power amplifiers up through a 100-watt DC-coupled FET amplifier.

BP92—CRYSTAL SET CONSTRUCTION. . . . \$5.50. Everything you need to know about building crystal radio receivers.

BP255—INTERNATIONAL RADIO STATIONS GUIDE \$7.95. Provides the casual listener, amateur radio DXer and the professional radio monitor with an essential reference work designed to guide him or her around the more than ever complex radio bands

CHECK OFF THE BOOKS YOU WANT

ELECTRONIC TECHNOLOGY TODAY INC.
P.O. Box 240, Massapequa Park, NY 11762-0240

Name _____
Address _____
City _____ State _____ Zip _____

SHIPPING CHARGES IN USA AND CANADA

\$0.01 to \$5.00	\$1.50
\$5.01 to \$10.00	\$2.50
\$10.01 to 20.00	\$3.50
\$20.01 to 30.00	\$4.50
\$30.01 to 40.00	\$5.50
\$40.01 to 50.00	\$6.50
\$50.01 and above	\$8.00

SORRY No orders accepted outside of USA & Canada

Total price of merchandise	\$ _____
Shipping (see chart at left)	\$ _____
Subtotal	\$ _____
Sales Tax (NY State only)	\$ _____
Total Enclosed	\$ _____

Number of books ordered

All payments must be in U.S. funds

PE794

THINK TANK

By John J. Yacono

More Muscle and Vehicle Projects

Last month, we discussed how muscle wires—those miraculous threads that contract when heated—work and reviewed some vehicle-related projects. This month, we'll continue with more of the same. Let me get things started by describing how to design things with muscle wire.

PARAMETERS

One immediately graspable aspect of muscle wire is its diameter. As it turns out,

sectional area, which, in turn, affects its resistance per unit length (or resistivity). The greater the diameter, the lower the resistivity.

The diameter also affects a wire's mass per unit length and surface-per-unit-length. They both conspire to determine how quickly a wire can be cooled; skinnier wires cool quickest. The diameter is also related to the force a wire can exert; the thicker the wire, the more force it can present.

Now for the implications of all that. First, since Joule heating is used to warm a wire into contracting, the higher the resistance, the lower the current needed; so a small diameter is favorable for saving power. Second, if we want the wire to relax quickly, it must cool quickly; again a small diameter is favored. Third, while larger diameter wire has greater pulling force, multiple strands of slim wire can be used to achieve the same strength. So while thin wire has a drawback for heavy-duty applications, it can be easily overcome.

The electrical properties of greatest interest are resistance-per-unit-length and recommended current level. They are important for determining how to power muscle wire. For example, let's say a specimen we wish to use is 10-cm long, has a resistivity of 0.5 ohm/cm, and a current rating of 0.4 amps. First we determine the wire's resistance by multiplying its length and resistivity:

$$R = 10 \times 0.5 = 5 \text{ ohms}$$

Now that we know the wire's resistance as well as

its current rating, we multiply them to determine the appropriate driving voltage:

$$V = 5 \times 0.4 = 2 \text{ volts}$$

So now we know we need a 2-volt, 400-mA supply to drive the 10-cm wire. To summarize, once you decide what wire to use and how much, you determine its resistance and voltage needs to help you design a power supply. That's all there is to it.

It should be mentioned that there are other properties of muscle wire that might help you choose one wire over another, or help you determine how much wire to use. However, they seldom come into play in basic projects and they're too numerous to go into here. They mostly deal with the maximum load, maximum deformation, and key temperatures for a wire. All of those and more can be found in the *Muscle Wires Project Book*, by Roger G. Gilbertson, available from Mondo-tronics, Inc. (524 San Anselmo Ave. #107-20, San Anselmo, CA 94960; Tel. 800-374-5764), for \$17.95. They also have all sorts of neat kits and memory-wire hardware, so I would ask for their catalog.

Let's now muscle-open the mail bag and see what it holds for us.

LIGHTS ON!

Since there's a new law in New York State requiring the use of headlights when wipers are in use, I designed the enclosed circuit to alert drivers to turn the lights on when the wipers are activated. The circuit,

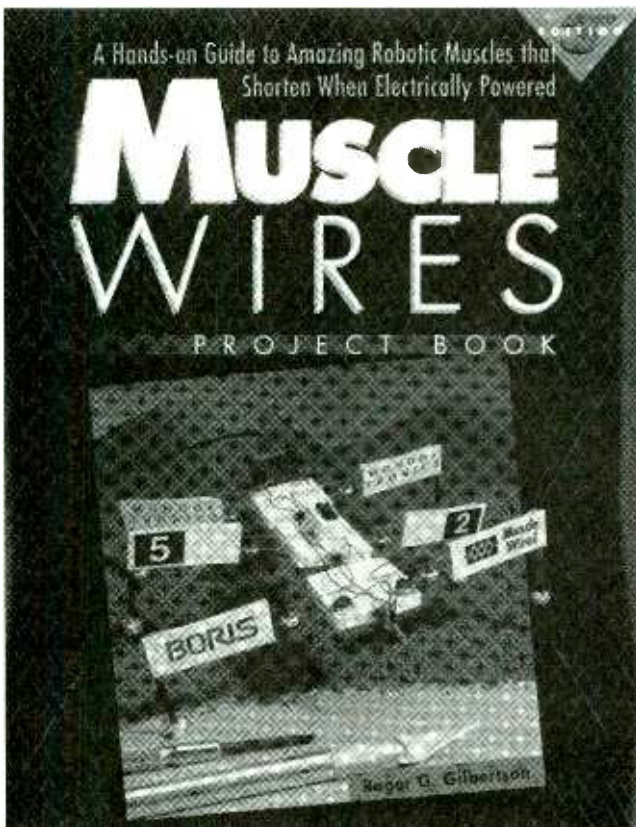

This book is guaranteed to keep you busy for hours. It's crammed with useful historical and technical information on memory wire, not to mention memory-wire projects.

a wire's diameter affects many of its other properties, so it is the most important characteristic of all. A wire's diameter affects its cross-

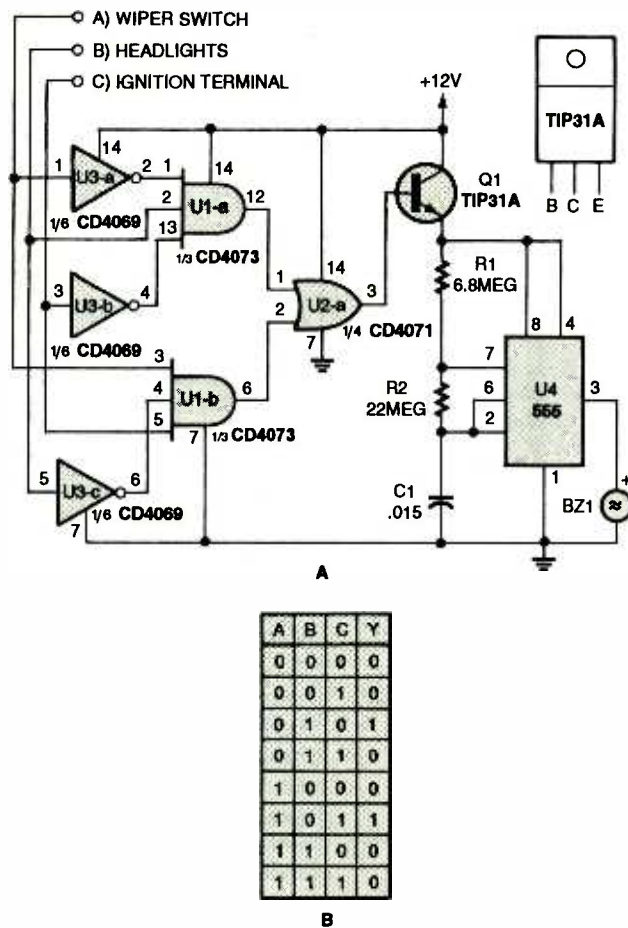

Fig. 1. This handy device buzzes to let you know you're driving with the wipers on but the headlights off. It's a safe way to avoid a nuisance ticket.

shown in Fig. 1A, also advises the driver when the lights are left on and the ignition is off. That should save many from returning to their vehicle to find a dead battery.

The parts for the circuit as shown are available from Jameco Electronics (1355 Shoreway Road, Belmont CA 94002; Tel. 800-831-4242) and Radio Shack. However, it can be made from TTL-logic IC's provided that the car's 12-volt battery source is reduced to 5 volts by a 7805 regulator. Also, if a steady tone is desired, the TIP31A, and the 555 can be eliminated. The circuit's truth table is shown in Fig. 1B to allow readers to further modify the circuit.

For the possible fines

saved by using this circuit, I think it deserves a book.

—Paul C. Pedersen, Cheektowaga, NY
I think it does, too. As I can tell from Paul's thorough notes, the entire project would cost under \$10 including the project case. If you wish to use TTL components as he mentions, U1, U2, and U3 can be replaced by a 7411, 7432, and a 7404, respectively.

WE'VE LOST POWER CAPT'N!

While returning from a trip last June in a nine-ton motorhome towing a car, the engine died (due to a dead battery) while descending a seven-mile long three-percent grade. That meant no boost for steering or brakes. SCARY!! The en-

gine-battery voltmeter, which indicated thirteen volts, had evidently been inoperative for some time.

After having the alternator repaired, I decided to replace the voltmeter with a more reliable voltage indicator (see Fig. 2), using the old meter dial with small light-emitting diodes (LED's) added to indicate each voltage. Total cost: approximately five dollars.

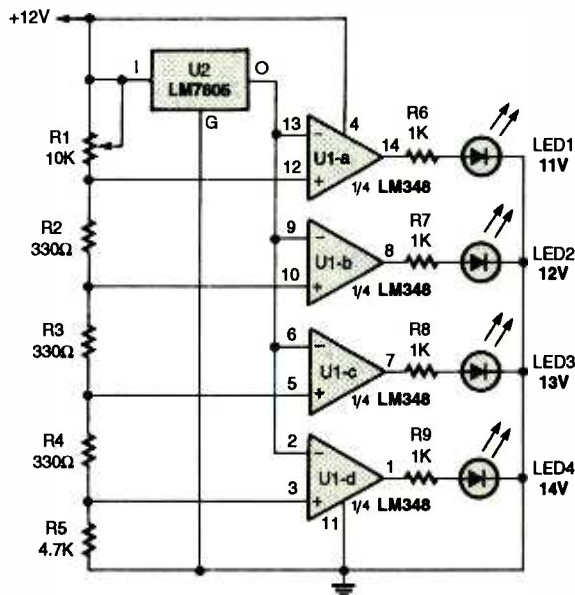

Fig. 2. With a single glance, this car-battery minder can tell you your battery status. It's also a great device for checking the strength your car's charging system.

The circuit could be used to monitor the status of any 12-volt battery.

—Bill McArthur, Torrance, CA

Your heart must have really been pounding when the engine cut out! At least now you've designed a circuit guaranteed to indicate trouble before it grows way out of proportion.

SUPER-SIMPLE CAR ALARM

For those of you who would like to have an alarm system on your car, but don't want to spend \$100 or more for one, the solution is shown in Fig. 3. All of the parts, except the flasher, are available at Radio

Shack. You can get the flasher at any auto-parts store for cheap.

The circuit is very simple. Relay K1 is connected by diodes to the door switches and the switches under the hood and trunk. The diodes keep the switch circuits separate, preventing the alarm wiring from interfering with the interior lights. When 12 volts is sent to K1 from one of the switches, it latches

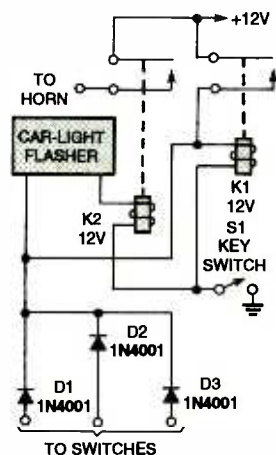

Fig. 3. Car alarms just don't get less expensive than this one. Once a door, the trunk, or the hood has been opened, the circuit beeps the horn repeatedly until the key switch is closed.

closed so that simply closing the door back will not shut off the alarm. Relay K2 is connected to the car's horn and is turned on and off by the flasher that is connected to K1. The key switch that disables the alarm (S1) should be mounted on the door or in any convenient place.

The alarm is not limited to just blowing the horn. Another relay can be used to flash the lights, run a siren, or whatever you want.

—John Clark, Thomasville, GA

Pretty neat. I think a reset circuit to automatically turn off the alarm (and relieve the battery) after a preset time period would be a nice addition. (Any takers?) Anybody building this circuit should remember that car accessories like the horn or headlights require quite a lot of current, so be sure to use heavy-gauge wire to power such things.

AND-GATE CUT-OFF

As a hobbyist new to electronics, I have found that transistors are still quite amazing to me. They are simple to use yet effective. A good example of their versatility is the ignition cut-off circuit in Fig. 4. As you can see, two NPN transistors are arranged in AND-gate fashion. That means the circuit requires three conditions to turn over the car: The keyswitch must be turned to the starting position, Q1 must be in the on state, and Q2 must also be in the on state.

An actual application of this circuit might use the brake-light switch to activate Q1 and the left-turn indicator for Q2. Using that example, you would have to turn the keyswitch to the starting position, turn the left signal on, and touch your brake pedal to start the car. If you add more

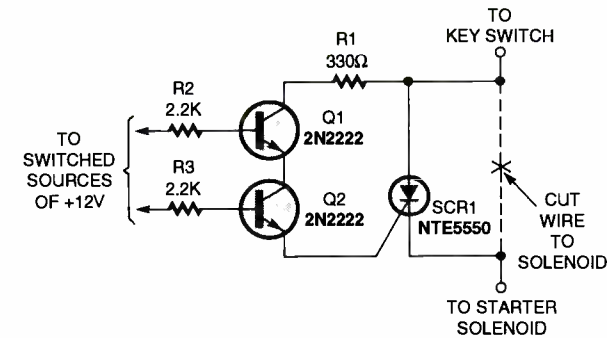
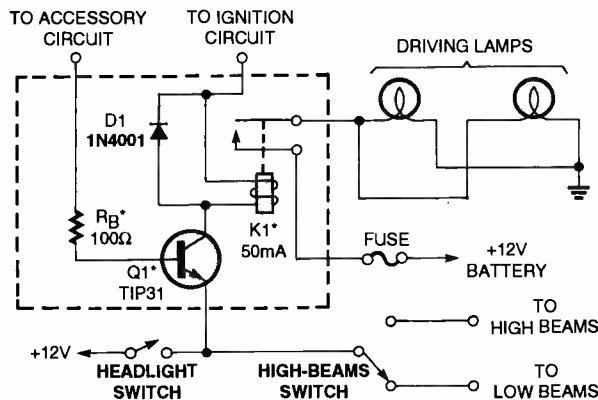

Fig. 4. Defeating this auto-starter cut-off switch is a real brain teaser. The only way to enable the starter solenoid is by using two switched accessories (parking lights, turn signals, breaks, or whatever) in addition to the key switch.



*SEE TEXT

Fig. 5. Living in Canada and tired of turning on your driving lamps? Try this automatic circuit with built-in logic that does the job for you.

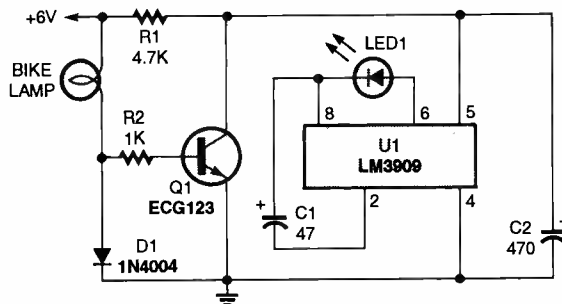

Fig. 6. Driving any two-wheel vehicle a night without lights is crazy. This circuit can prevent you from taking such a risk with a mountain bike by warning you of a burned-out bulb.

transistors to act as AND-gate inputs, then R1 may have to be decreased to allow enough current to trigger the SCR, since this particular SCR requires up to 30 mA for gate activation.

As you can see, with the options for turning the transistors on being numerous

and the combinations adding even more complexity, I think it is a simple but effective circuit.

—Don Bradley,
Owensboro, KY

I like the ingenuity of the circuit. The first thing a car-thief would do if he encountered your device

would be to look for a hidden bypass switch. Meanwhile, the means to starting the car is right under his nose! To make his situation worse, you've further hindered him by giving him too many things to choose from.

AUTO AUTO LAMPS

For Canadian readers of *Popular Electronics*, here's a driving-lamp circuit (in the dashed box of Fig. 5). As you may know, driving lamps are now a requirement on all new cars in Canada.

As you can see, this circuit needs both accessory and ignition voltage to operate. That means the driving lamps will not rob battery current during starting. Accessories (e.g., the radio) can be used while the engine is not running, again, without the driving lamps turning on. By connecting Q1's emitter to the headlamp circuit as shown, the driving lamps will also not operate when the headlamps are on, since the emitter would be at 12 volts, thereby turning the relay off. Any NPN power transistor capable of safely handling the relay coil current may be used. A diode such as a 1N4001 should be connected as shown to protect against the voltage spikes produced when the relay turns off.

The value of R_B may be determined experimentally. For starters, divide the latching current of the relay by the current gain of the transistor. Dividing the result into 12 volts will give an initial value for R_B .

For example, a TIP31 NPN transistor has a current gain of about 40. If the relay requires 50 mA to latch, the result of the first division would yield 1.25 mA. Dividing that into 12 volts gives a

(Continued on page 77)

Just like these Fully Trained Electronics Professionals



"Thanks to CIE I have tripled my previous salary, and I am now in a challenging and rewarding new field where only the sky is the limit."

Daniel Wade Reynolds
Industrial Electrician
Ore-Ida Foods



"CIE was recommended to me by my boss. It was appealing since I could study at my own pace at home and during business travel."

Dan Parks
Marketing Manager/Consumer Products
Analog Devices, Inc.



"I loved the flexibility CIE offered. It was the only way I could continue both school and my demanding job."

Britt A. Hanks
Director of Engineering
Petroleum Helicopters, Inc.



"I liked the way the school was set up with laboratory assignments to enforce conceptual learning. The thing which impressed me the most about CIE's curriculum is the way they show application for all the theory that is presented."

Daniel N. Parkman
Missile Electro-Mechanical Technician
U.S. Air Force



"Completing the course gave me the ability to efficiently troubleshoot modern microprocessor based audio and video systems and enjoy a sense of job security."

Tony Reynolds
Service Manager/Technician
Threshold Audio & Video

Graduate with an Associate Degree from CIE!

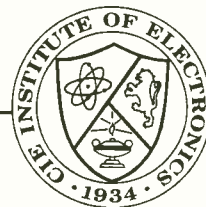

CIE is the best educational value you can receive if you want to learn about electronics, and earn a good income with that knowledge. CIE's reputation as the world leader in home study electronics is based solely on the success of our graduates. And we've earned our reputation with an unconditional commitment to provide our students with the very best electronics training.

Just ask any of the 150,000-plus graduates of the Cleveland Institute of Electronics who are working in high-paying positions with aerospace, computer, medical, automotive and communications firms throughout the world. They'll tell you success didn't come easy...but it did come...thanks to their CIE training. And today, a career in electronics offers more rewards than ever before.

CIE'S COMMITTED TO BEING THE BEST...IN ONE AREA...ELECTRONICS.

CIE isn't another be-everything-to-everyone school. CIE teaches only one subject and we believe we're the best at what we do. Also, CIE is accredited by the National Home Study Council. And with more than 1,000 graduates each year, we're the largest home study school specializing exclusively in electronics. CIE has been training career-minded students for nearly sixty years and we're the best at our subject...
ELECTRONICS... IT'S THE ONLY SUBJECT WE TEACH!

CIE PROVIDES A LEARNING METHOD SO GOOD IT'S PATENTED.

CIE's AUTO-PROGRAMMED® lessons are a proven learning method for building valuable electronics

career skills. Each lesson is designed to take you step-by-step and principle-by-principle. And while all of CIE's lessons are designed for independent study, CIE's instructors are personally available to assist you with just a toll free call. The result is practical training... the kind of experience you can put to work in today's marketplace.

LEARN BY DOING...WITH STATE-OF-THE-ART EQUIPMENT AND TRAINING.

CIE pioneered the first Electronics Laboratory

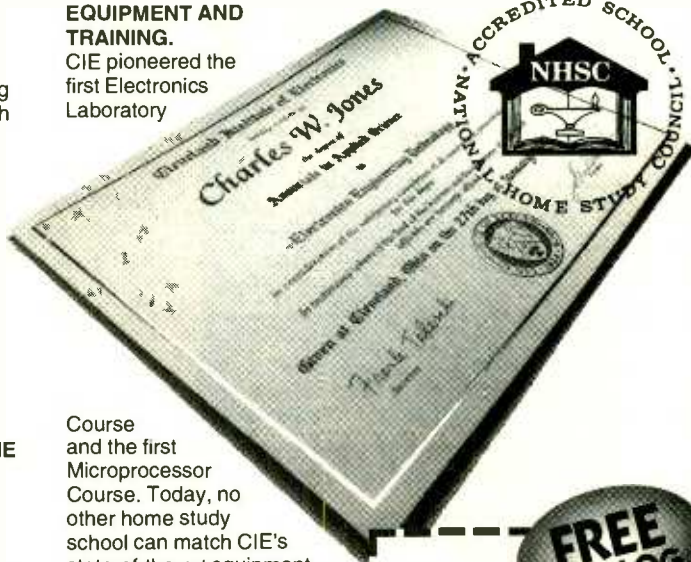

Course and the first Microprocessor Course. Today, no other home study school can match CIE's state-of-the-art equipment and training. And all your laboratory equipment, books and lessons are included in your tuition. It's all yours to use while you study and for on-the-job after you graduate.

PERSONALIZED TRAINING...TO MATCH YOUR BACKGROUND.

While some of our students have a working knowledge of electronics others are just starting out. That's why CIE has developed twelve career courses and an A.A.S. Degree program to choose from. So, even if you're not sure which electronics career is best for you, CIE can get you started with core lessons applicable to all areas in

electronics. And every CIE Course earns credit towards the completion of your Associate in Applied Science Degree. So you can work toward your degree in stages or as fast as you wish. In fact, CIE is the only school that actually rewards you for fast study, which can save you money.



YES! I want to get started. Send me my CIE course catalog including details about the Associate Degree Program. (For your convenience, CIE will have a representative contact you - there is no obligation.)

Please Print Clearly AH55

Name _____

Address _____

City _____

State _____ Zip _____ Age _____

Phone No. _____

Check box for G.I. Bill Benefits.

Veteran

Active Duty

Cleveland Institute of Electronics, Inc.
1776 East 17th Street
Cleveland, OH 44114

A School of Thousands.
A Class of One. Since 1934.

Send for CIE's FREE Course Catalog and See How We Can Help Your Career Too!

GET THE LATEST ADVANCES IN ELECTRONICS

SUBSCRIBE TO—

Electronics NOW[®]



ENJOY THE WORLD OF ELECTRONICS EACH MONTH!

Subscribe to the best informed electronics magazine—the one that brings you the latest high-tech construction projects, feature articles on new technology, practical troubleshooting techniques, circuit design fundamentals, and much more.

Electronics Now looks to the future and shows you what new video, audio and computer products are on the horizon. You'll find helpful, monthly departments such as Video News, Equipment Reports, Hardware Hacker, Audio Update, Drawing Board, Computer Connections, New Products, and more. All designed to give you instruction, tips, and fun.

Electronics Now gives you exciting articles like:

- Buyer's Guide to Digital Oscilloscopes
- Build A Scanner Converter
- Single-Chip Voice Recorder
- Build A MIDI Interface for your PC
- Troubleshoot Microprocessor Circuits
- Build A High-Power Amplifier for your Car
- Add Music On Hold to your Phone
- All About Binaural Recording
- VGA-to-NTSC Converter



FOR FAST SERVICE CALL OUR TOLL-FREE NUMBER!

1-800-999-7139

DON'T DELAY — SUBSCRIBE TODAY!

If you prefer, just fill out the order card in this magazine and mail it in today.

The Universal

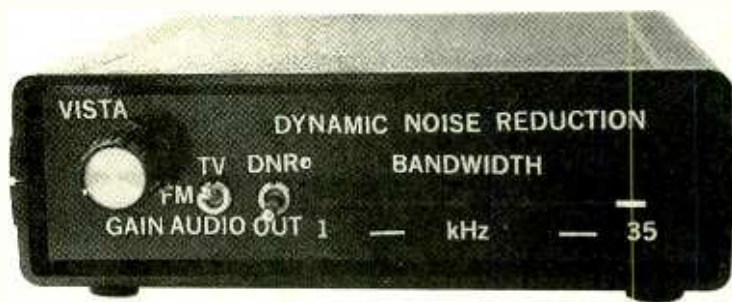

Noise-Reduction System

BY RICHARD PANOSH

Add the benefits of noise reduction to any stereo signal source with this easy-to-build add-on unit.

non-Dolby equipment, or if non-Dolby tapes are played back using Dolby noise reduction, full fidelity will not be achieved.

VHS hi-fi cassettes, with an SNR of over 80 dB, can provide excellent sound quality. However, the SNR on a videotape's conventional audio track (VHS format) will actually be 3–5 dB lower (depending on the recording speed) than that of a normal, non-Dolby cassette tape. If a good hi-fi system is used for audio playback, the familiar tape hiss will be quite evident.

A typical FM receiver can deliver an SNR of between 45 and 75 dB for strong signals. Unfortunately, for weaker stereo signals, the noise will be 20 dB more than for a monaural signal due to the additional noise from the stereo difference signal (L–R). That is why some stereo receivers use blending stereo decoders that decrease the stereo separation when the SNR approaches 45 dB.

If you expect TV audio to be similar to FM, you might be surprised. In reality, the SNR is about the same as a

conventional cassette-tape deck. In addition, the maximum TV audio-frequency deviation in the U.S. is 25 kHz as opposed to 75 kHz for FM radio broadcasts. The poor audio quality has been acceptable up till now because of the limited audio power and frequency response of the audio circuits in a typical TV. However, with the introduction of stereo TV and the growing popularity of home-theater setups, that is no longer the case. Note

that while dbx noise reduction is part of the MTS stereo-TV standard, it is only applied to the stereo difference signal (L–R). The normal audio signal (L+R) is unaltered in order to preserve compatibility; hence the stereo SNR is basically the same as the monaural.

The Dynamic Noise Reduction System. The Dolby and dbx noise-reduction systems both use the principal of companding to achieve their objectives. In companding, a signal's spectrum is compressed at its source and then expanded in a complimentary fashion when received or played back. While that technique can achieve excellent results, it requires the source material to be compressed.

There is another solution. National Semiconductor Corp. has developed a technique called Dynamic Noise Reduction or DNR. National offers the circuitry in its LM1894 DNR integrated circuit. In DNR, an adaptive low-pass filter is placed in the signal path. The filter follows the source material and instantaneously alters the bandwidth to mask any noise.

It is easy to see the benefits of reducing the audio bandwidth from the normal 35 kHz or so, to the DNR minimum bandwidth of 800 Hz. Since the source noise is directly proportional to the square root of the bandwidth, the maximum reduction would improve the SNR by 16 dB. Of course, since the frequency response of neither the human ear nor the noise is flat, weighting factors would have to be used to obtain the actual SNR improvement. Typically, an AM-radio sig-

In the instant following the "big bang," the Universe and noise were created. When man happened upon the scene some time later, he found that he had to shout over the noise to be heard, thereby establishing a signal-to-noise ratio (SNR) greater than one.

The battle to be heard over the noise has been waged ever since. Modern technology, especially digital technology, allows for some impressive signal-to-noise ratios, but there is still room for improvement, especially under less-than-ideal conditions. Let's look at some examples.

Thanks to the digital technology they use, CD players can typically produce S/N ratios on the order of 96 dB. That's great, but before we can listen to the output, we need to feed it to an amplifier. Let's consider a 25-watt IC-based audio amplifier. Typically, such amplifiers have an input reference noise level of 3- μ V RMS. If our amplifier has a gain of 40 dB, the noise output would be 300- μ V RMS, which is a noise level that's about 93 dB below the full output level.

Note that we said *full* output. What if someone politely (or not-so-politely) asks you to turn down the volume? Doing so reduces the output signal level but has little effect on the noise level. If you turn the volume control down so that the output is reduced by 15 dB (to about 0.8 watts), the resulting signal-to-noise ratio is only 78 dB. While that SNR is still respectable, it is a significant reduction.

Next, let's consider an analog cassette-tape deck. A typical unit, without a noise-reduction system and using standard-formulation tape, may achieve an SNR of about 50 dB. Using chromium tape on a deck with a chromium (or metal) equalization setting will improve the SNR by some 4 dB. Using Dolby B noise reduction will improve the SNR by 10 dB, and even greater improvement is available using Dolby C. However, Dolby noise reduction requires special signal processing during recording. If Dolby-encoded tapes are played back on

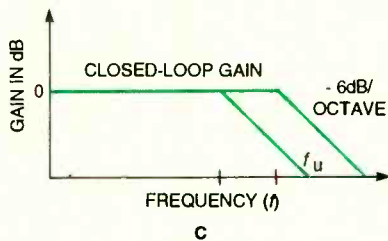
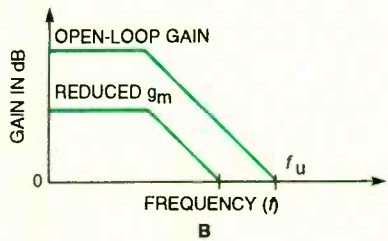
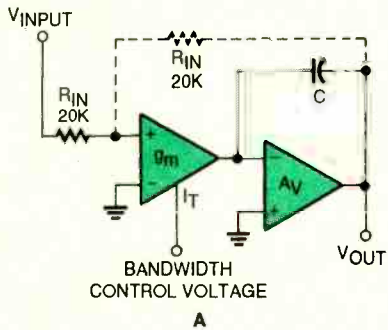

Fig. 1. The low-pass filter used in the DNR system is shown here in A. The open-loop response (with no feedback resistance) is shown in B. With the feedback resistance installed (to provide unity gain), the closed-loop response of the filter is shown in C.

nal with an upper frequency limit of 2 kHz can be improved by 5–7 dB with DNR, while 10–14 dB can be obtained if the source bandwidth is greater than 8 kHz.

A simple experiment can be performed on your present stereo system to hear the effect created by lowering the noise floor by a similar amount. Create a simulated noise source by playing a blank cassette on your audio system's tape deck. When the treble control is adjusted to maximum cut, the noise will be greatly reduced. That's because when the treble is set for maximum cut, the amplifier acts like a single-pole low-pass filter with a cut off near 1 kHz, which is very similar to the effect of DNR at its minimum bandwidth. Of course, in real life that doesn't make for a very effective noise-reduction system since your treble control doesn't open up the bandwidth when a high-frequency signal is present.

The idea behind DNR is based on a basic principle of psychoacoustics known as "auditory masking." It has been known for a long time that when a person listens to one sound, it reduces his ability to hear another sound. In general, wide-bandwidth, low-amplitude noise can mask a signal more effectively than a narrow-bandwidth, high-amplitude signal. Music and speech, with high energy levels around 1 kHz, produce a better noise mask than a single pure tone. That is the reason that tape hiss becomes so annoying during low-ener-

gy music passages: it becomes unmasked.

The design of the DNR system takes advantage of that principle and follows the program material to instantaneously adapt the bandwidth so that the noise is never unmasked. The control signal is derived from the composite sum of the left and right channels to maintain a stable stereo image. That signal is amplified by a multi-pole high-pass filter within the IC; the filter's response is shaped by the external support components. For that reason, the component values

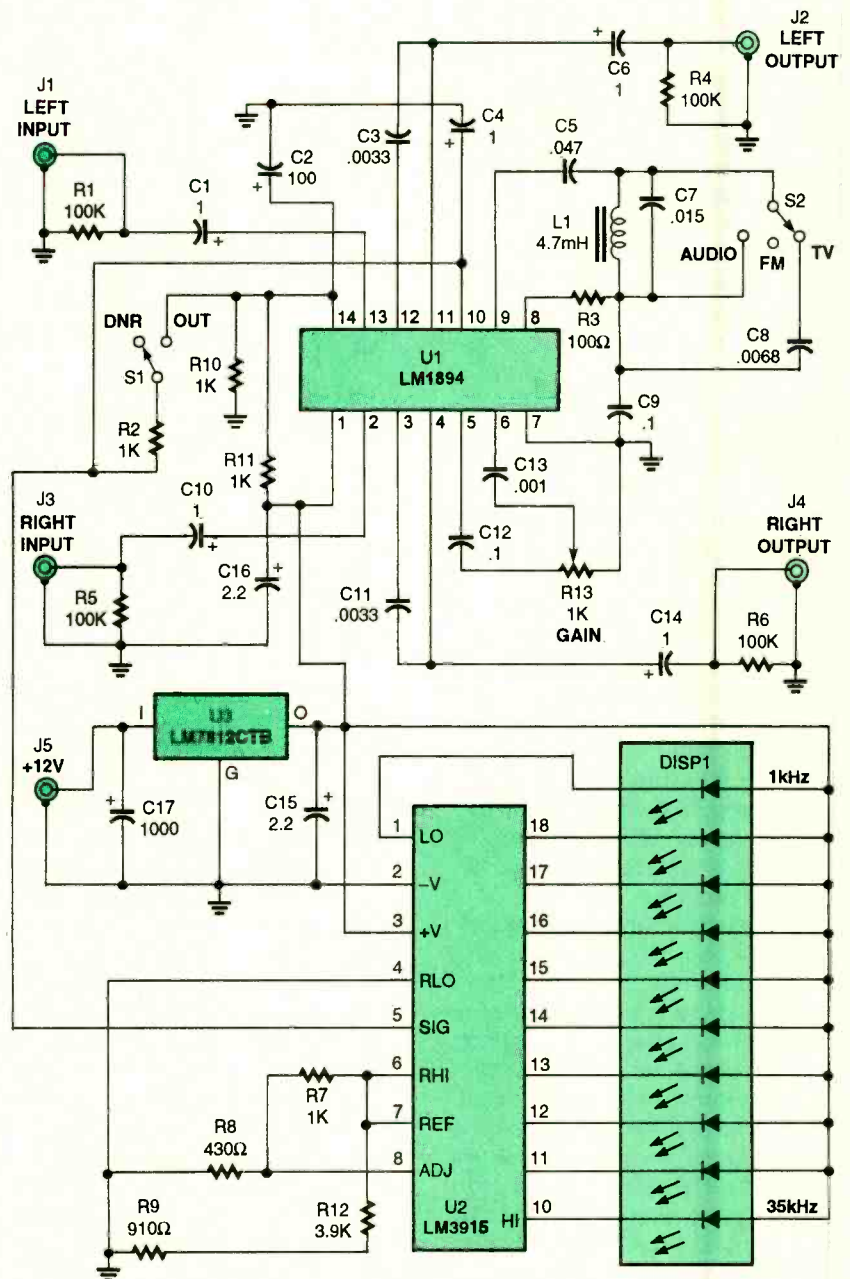

Fig. 2. The Universal Noise Reduction System is built around the National LM1894 integrated circuit. That IC contains the complete DNR circuit.

should not be altered from the manufacturer's specifications.

The last part of the control loop is a peak detector with a fast attack and slow release time. The attack time is adjusted to 500 microseconds, which is faster than the response time of the human ear. The ear has difficulty registering sounds of less than 5 milliseconds duration, or distortion that lasts less than 10 milliseconds. The release time is on the order of 60 milliseconds to maintain reverberation and music ambiance. It takes about 100 milliseconds for the ear to recover from a loud sound so that the bandwidth will be closed down before the noise becomes noticeably unmasked.

The design of the Butterworth voltage-controlled low-pass filter used by the system to control the audio bandwidth is illustrated in Fig. 1A. A voltage-controlled transconductance amplifier stage precedes an op-amp that's configured as an integrator. The integrator bandwidth depends upon the value of C as well as the input current. With C fixed at $0.0033 \mu\text{F}$, the bandwidth and overall gain depend upon the transconductance gain as illustrated in Fig. 1B. Now, if a feedback resistor (shown by the dotted line in Fig. 1A) with the same value as the input resistor is added to provide unity gain, the response of the voltage-controlled low-pass filter is as shown in Fig. 1C. The maximum bandwidth and slew rate occur at the maximum transconductance-stage current, allowing large-bandwidth signals to pass through. When the current is a minimum, the bandwidth is at its minimum.

Circuit Description. A schematic diagram of the *Universal Noise Reduction System* is shown in Fig. 2. The heart of the circuit is U1, an LM1894 DNR integrated circuit. That IC contains the complete DNR circuitry; the balance of the electronics are dedicated to support and user-convenience functions.

Some special attention must be exercised when the DNR sys-

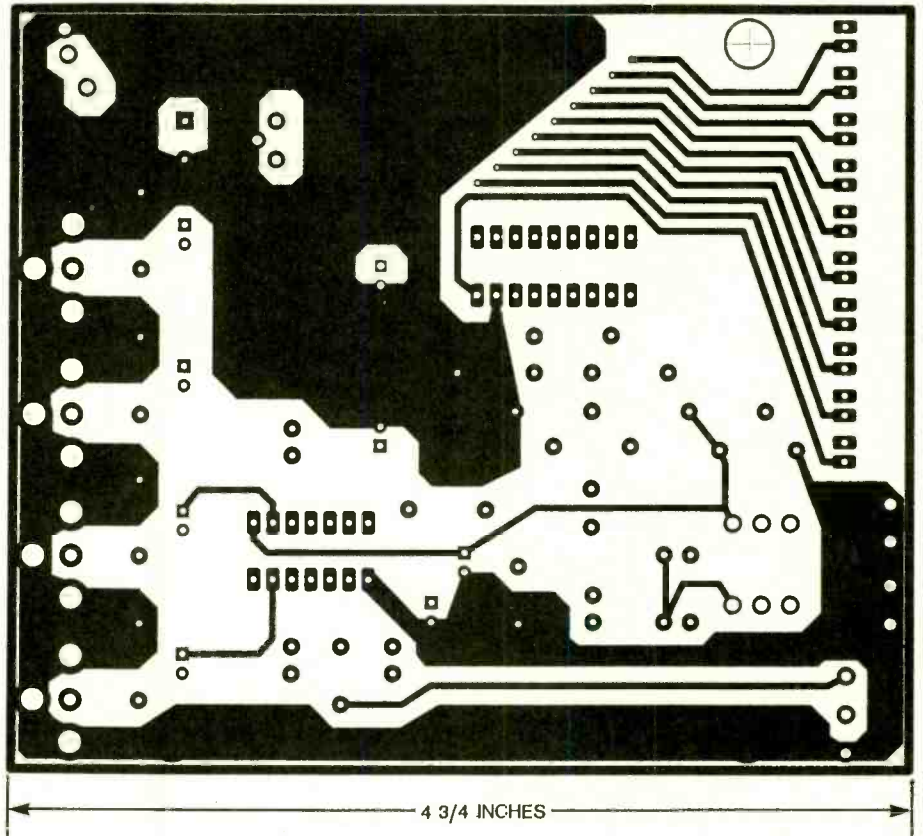

Fig. 3. Here is the component side of the *Universal Noise Reduction System's* double-sided board.

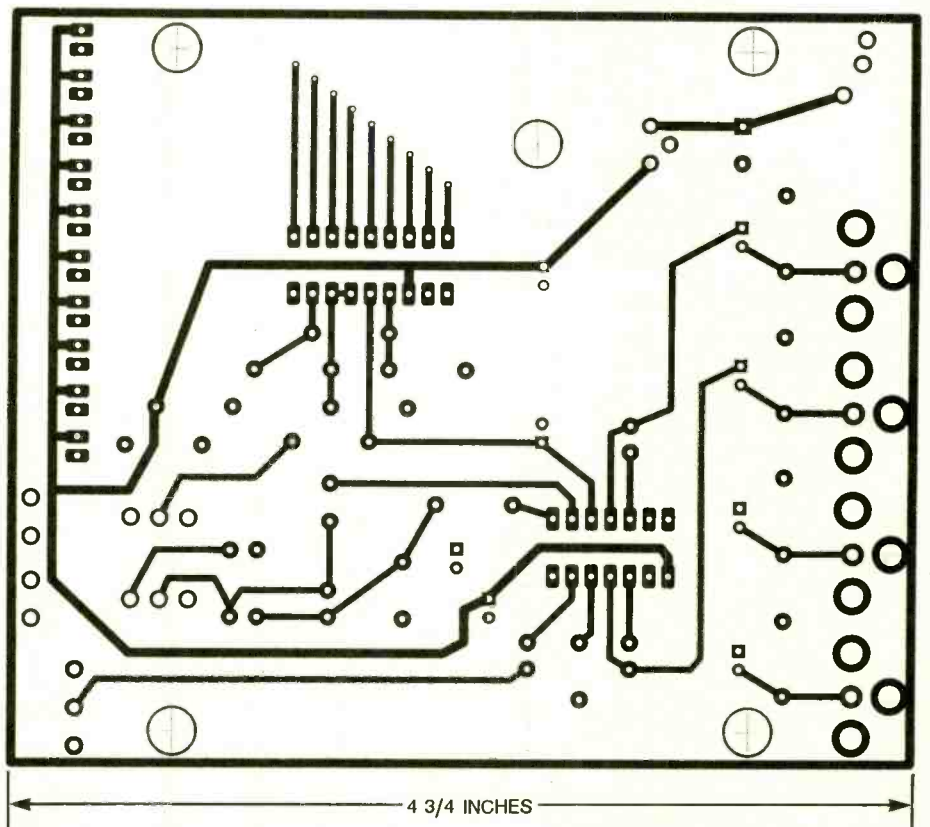

Fig. 4. Here is the solder side of the board. It is shown full size.

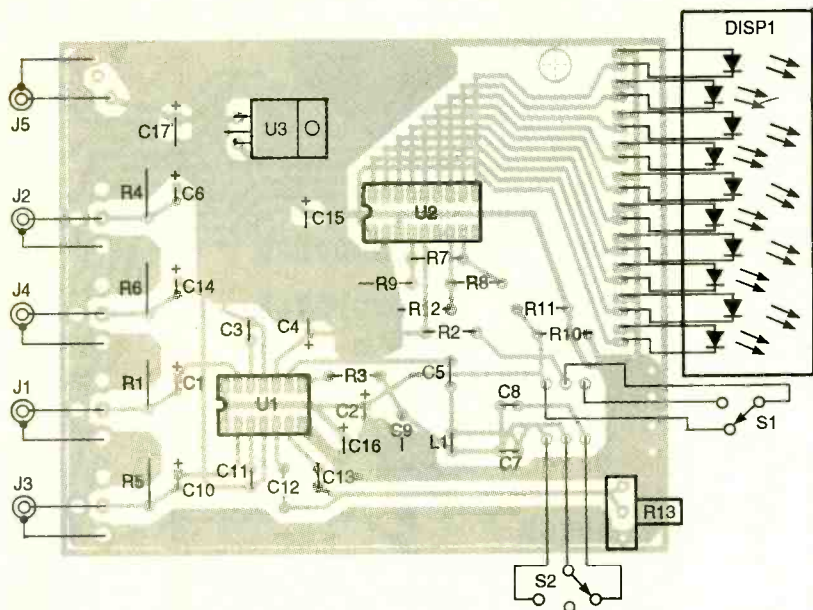

Fig. 5. Use this parts-placement diagram when assembling the Universal Noise Reduction System.

tem is used in FM or TV applications. Because the control-loop gain increases with frequency, the circuit is susceptible to high-frequency signals that are inaudible to the listener. Two sources of such leakage are the FM subcarrier pilot at 19 kHz and the TV horizontal-sweep frequency at 15.750 kHz. Because of that, a switch-selected notch filter has been included in the control path to reduce any problems caused by those signals. The notch filter consists of a switchable LC tank with a Q of 30 to attenuate the appropriate frequencies by 20 dB. The third position of this switch (S2), AUDIO, can be used for disc or tape sources, and newer FM or TV receivers that require no attenuation.

A bypass switch (S1) has also been added so that an A/B comparison can be made of the effectiveness of the unit at any time. Instead of switching the audio around the DNR system, it works by pulling the peak detector located in the control path up to 5.5 volts through R2, thereby forcing the DNR bandwidth to 50 kHz.

An LM3915 logarithmic LED-display driver, U2, has been included in the design to indicate the instantaneous bandwidth of the filter and to facilitate adjustment of the control-loop gain for different source material. The resistor string consisting of R7, R8, and R9 has been selected so that when the peak detector voltage is at minimum bandwidth, the first LED of DISP1

(during a pause or low-signal passage). Since different sources will have different SNR's, each new source should be adjusted using that method. In normal operation, the tenth LED will light during music passages and the bandwidth will close down during pauses to reduce the noise floor and hide the noise.

Power is supplied to the unit via an unregulated 12-VDC/200-mA wall-plug adapter. Select a unit that can supply 14.8 VDC at the Universal Noise Reduction System's load of 60 mA. Approximately 13.5 VDC is required by U3 for proper regulation. A suitable supply is listed in the Parts List.

Construction. The Universal Noise Reduction system is built using a double-sided PC board. The component side of the board is shown in Fig. 3; the solder side is shown in Fig. 4. Once you

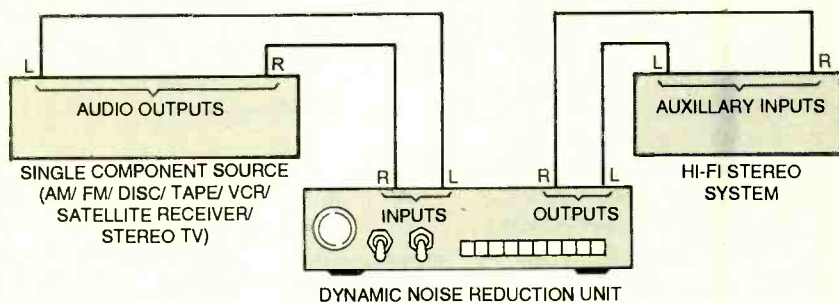

Fig. 6. When using the unit with just a single program source, use this connection scheme.

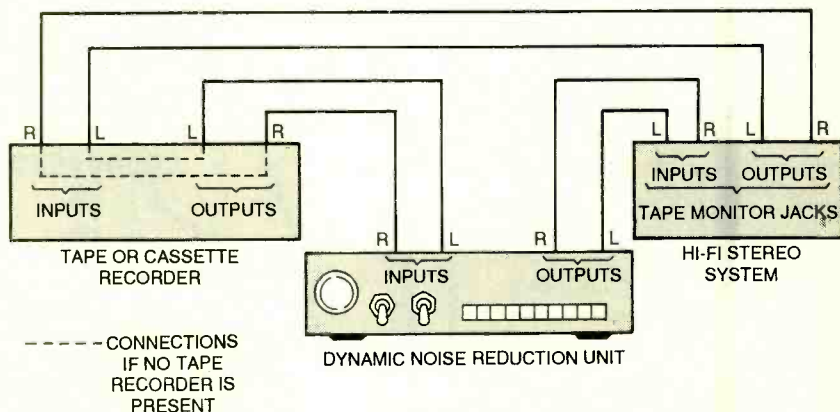

Fig. 7. Place the Universal Noise Reduction System in your receiver's or amplifier's tape loop if you want to use it with multiple signal sources.

(a 10-LED bargraph display) will light, which corresponds to a bandwidth of 1 kHz. The tenth LED of DISP1 corresponds to a bandwidth of 35 kHz and above. The control gain should be carefully adjusted (via R13) to just light the second LED with the signal source connected and no signal present

have etched the board or purchased the kit from the supplier listed in the Parts List, you can begin assembly guided by the parts-placement diagram in Fig. 5.

Note that the LM1894 is a special IC that is not available through hobbyist
(Continued on page 90)

Perform long-term data-collecting task with this dedicated microprocessor-based circuit.

BY DOUG MALONE

Build the Versatile Data Logger

Not long after building the Geiger Counter featured in the July, 1992 issue of **Popular Electronics**, the novelty of searching for radiation from the TV set, smoke detector, granite rocks in the backyard, and camping lantern mantles quickly wore off. What was missing was a permanent use for my newly acquired instrument.

I had, for a long time, wanted to collect background radiation-count data in an attempt to find evidence of solar flares. But that activity was not practical without some way to automatically acquire and store the readings. I also wanted to, at some point, collect long-term air temperature data. The most obvious choice for those operations was to use a PC to collect and analyze the data. However, the thought of dedicating one's computer to long-term data collection is not very attractive. In addition, data collection would have to be interrupted every time that I needed to use the PC for some other purpose. Besides, who wants to have their PC running 24 hours a day?

The solution was to design a low-cost, microprocessor-based, stand-alone unit that could independently collect and store readings. The stored

data could then be transmitted to a PC, and then plotted and analyzed when convenient. That was the inspiration for the *Versatile Data Logger* described in this article.

Features. The Versatile Data Logger supports both analog and digital inputs, is built around readily available Z80-family components, and has switch-selectable, data-acquisition intervals (ranging from 100 measurements/sec to one measurement every 10 minutes). Up to 16,000 measurements can be stored in the unit's memory. ROM-based software provides for easy operation. The circuit can be modified—by eliminating the analog-signal-processing circuitry—to work exclusively with digital inputs.

The Versatile Data Logger can accommodate digital input signals from a variety of sources that produce digital output frequencies that are proportional to the parameter being measured, including the aforementioned Geiger Counter, an anemometer, a light-intensity probe, or a thermal probe. The unit accommodates analog transducers that produce an output voltage that is proportional to the variable being measured, including thermal probes,

pressure transducers, and strain gauges.

The Data Logger has two digital modes: *integrating* and *instantaneous*. The integrating mode is used with transducers such as the Geiger Counter where the total counts during the specified data-collection interval are of interest. For example, radiation intensity can be expressed in counts-per-minute (CPM). Even though the radiation arrives at random intervals, an average figure can be obtained by accumulating (integrating) over a period of one minute. With the Data Logger placed in the integrating mode and the data-collection interval set to one minute, the accumulated radiation count for that interval would be stored in memory once every minute. Figure 1 shows a plot of background radiation readings collected at the authors' location over a 24-hour period.

The instantaneous mode can be used with transducers that provide a frequency that is proportional to, say, wind speed. When in the instantaneous mode, a 1-second accumulation is made at the specified data-collection interval. For example, let's say that with a wind speed of 20

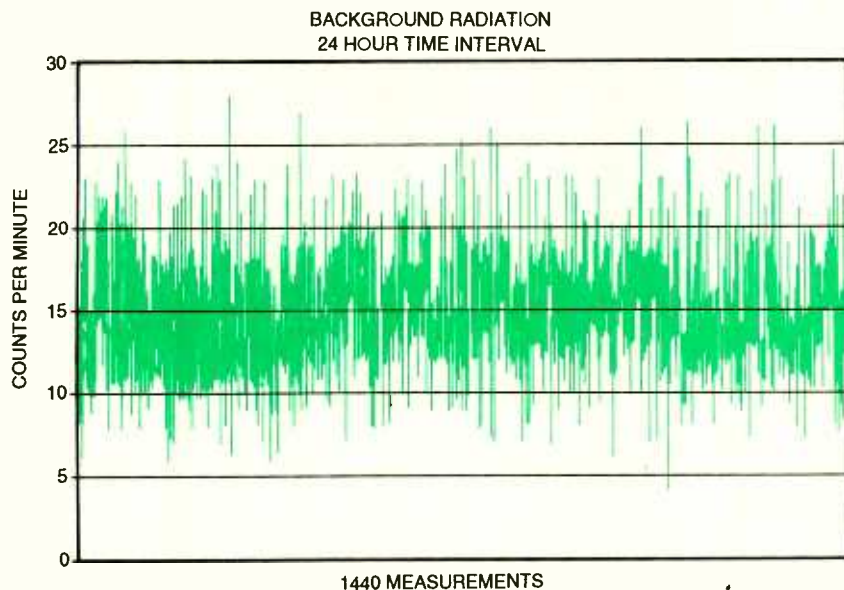

Fig. 1. Here is a plot of background radiation readings collected at the authors' location over a 24-hour period using the Popular Electronics Geiger Counter (July, 1992) and Versatile Data Logger.

mph, your anemometer produces a frequency of 1 kHz. With the Data Logger in instantaneous mode and the data-collection interval set to one minute, a one second accumulation will occur every minute, resulting in a count of 1000 stored in memory.

About the Circuit. A schematic diagram of the Versatile Data Logger is shown in Fig. 2. The circuit is powered from a 5-volt power source that is connected to J2-a and J2-b. If analog inputs are to be used, an additional 9- to 15-volt source must be connected at J2-h. The 9 to 15-volt source connects to the 5-volt regulator, U12, and is used to supply power for the ADC, U6, and for the analog sensors. By using a separate regulator for the ADC, the effects of digital noise on the converter are minimized. Analog transducers with a 0- to 5-volt output are connected to J2-f and J2-e. To allow the circuit to be used with a wide variety of analog transducers, potentiometers R3 and R4 can be used to adjust the ADC-offset and full-scale settings, respectively.

Transducers with digital outputs levels of no more than 12 volts or with NPN open-collector outputs can be directly connected to J2-c. Data collection and storage is controlled by a Z80 microprocessor, U3, which is driven by an Epson America SE1403 2.45-MHz clock oscillator, U1. Power-on reset is accomplished through an RC

network connected to a pair Schmitt-trigger inverters, U2-b and U2-c. Integrated circuit U11 provides two, 8-bit parallel ports, referred to as port A and port B. Two output lines of port A are used to drive two status LED's, LED1 and LED2, while one input line receives the data-ready (AD INTR) signal from U6.

All 8 pins of port B are configured as inputs, and are connected to the switches that control the circuit's operations. Collected data is sent to an external PC via the serial port (U10), the level shifter (U8), and connector J1.

Two counters from U9 (a Z80-CTC counter/timer comprised of four, independent, 8-bit counters) are used to count pulses from external digital transducers. A third counter is used to generate a 100-Hz interrupt to the processor. The fourth counter generates the serial baud-rate clock for the serial port (U10). The Data Logger program is stored in U5 (a TMS2764 8K × 8 EPROM) and data is stored in U4 (a 62256, 32K × 8 SRAM). Outputs from analog transducers are digitized by U6.

Construction. Due to the large number of circuit interconnections, it is recommended that the project be assembled on a printed-circuit board as opposed to other construction methods. Figure 3 shows a full-size template of the component side of

the Data Logger's double-sided, printed-circuit board: Fig. 4 shows the copper side of the board.

Once you have obtained the board (either by etching your own or purchasing one from the supplier listed in the Parts List) for the Data Logger, but before beginning assembly, it is wise for you to answer the following two questions:

1. Do you plan on using both analog and digital transducers? If yes, then you'll need to fully populate the circuit board with components. If, on the other hand, you plan to exclusively use the Data Logger with digital transducers, then you can omit the components in the Analog section shown in dotted lines in the lower left corner of Fig. 2.

2. Is minimum cost more important than power-supply current drain? If the answer is yes, then use low-cost NMOS Z80, PIO, CTC, and SIO components. Also use low-cost upright DIP and pushbutton switches. For a few dollars more, you can buy CMOS parts and the current drain will decrease from approximately 260 mA to 25 mA. That's appropriate if you are considering battery operation. If the board is to be mounted in an enclosure, then right-angle DIP and pushbutton switches are the way to go.

After you have answered the above questions and gathered the parts, assemble the circuit guided by the parts-placement diagram shown in Fig. 5. It is strongly recommended that sockets be used for all IC's. Note from Fig. 5 that the layout is designed to accommodate both straight and right-angle switches for S1-S4. When assembling the board, proceed slowly and use a low-wattage soldering iron to avoid overheating the components. Observe the proper orientation of polarity-sensitive components such as the electrolytic capacitors and diodes.

Checkout. Before applying power to the Data Logger, double-check the component placement and orientation with the layout in Fig. 5. When satisfied that the circuit contains no construction errors, connect a 5-volt power source to J2-a and the ground to J2-b. Set the configuration switches, S1-a-S1-e, to the illegal state (00011, respectively, with 0 meaning closed

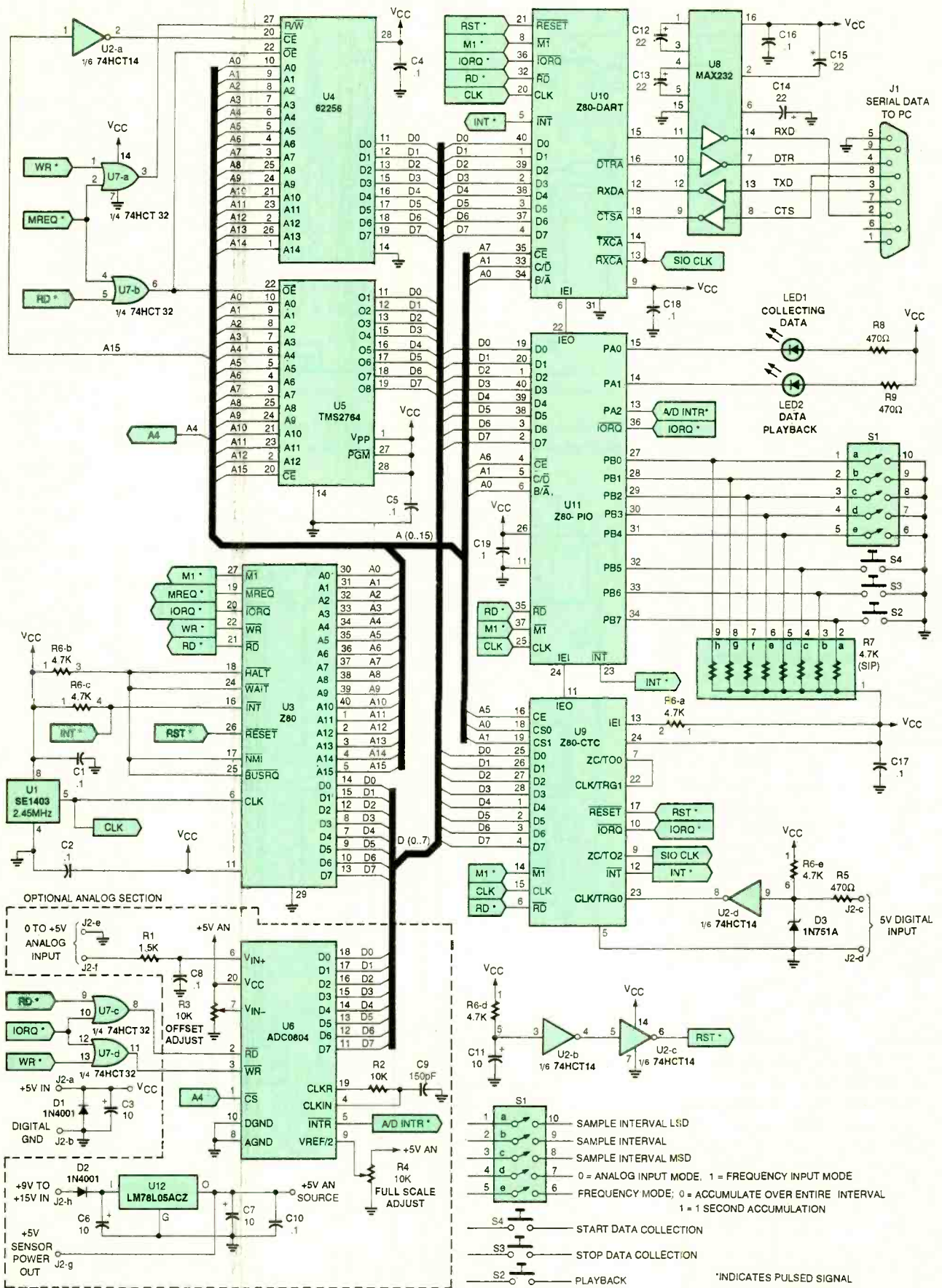

Fig. 2. Here's the schematic for the Versatile Data Logger.

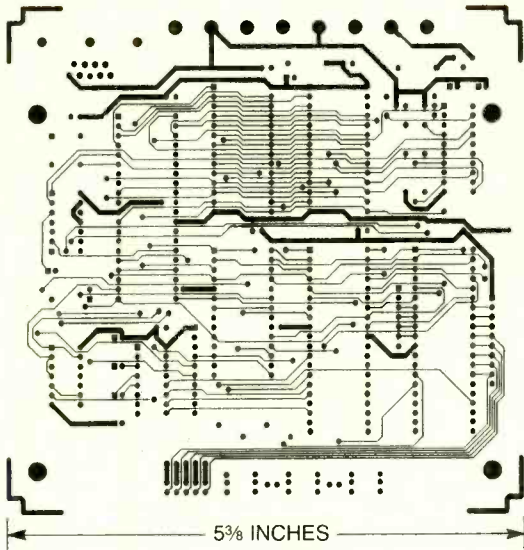

Fig. 3. The Data Logger was assembled on a double-sided, printed-circuit board; a full-scale template of the component side of the board is shown here.

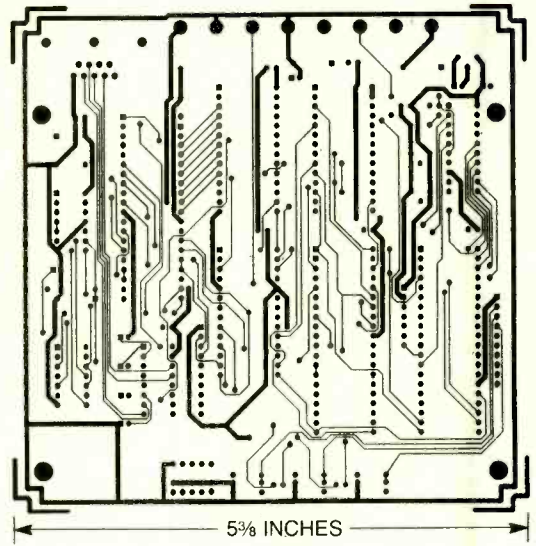

Fig. 4. A full-scale template of the copper side of the Data Logger's double-sided, printed-circuit board is shown here.

and 1 meaning open). Turn on the power and note whether both LED1 and LED2 flash on and off (in unison) at a rate of approximately four times per second (4 Hz).

If that does not occur, measure the supply voltage and make sure it is 5.0 volts \pm 0.30 volts. Also check the orientation of the LED's; they will not light if they are in backwards. Once the LED's are flashing properly, turn the supply off. Set S1-a-S1-e to 00010, respectively. Turn the supply on and push the START pushbutton. Observe that LED1 lights. After a few seconds, push STOP and observe that LED1 turns off. Push the PLAY button and observe that LED2 lights for a few seconds.

If you are unsuccessful with any of those steps, turn off the supply and use an ohmmeter to check the push-button switches for continuity. Place the ohmmeter leads between U11 pin 32 and ground. A high resistance should be measured until the START button is pushed, which should then cause a near-zero reading.

If you have access to an oscilloscope, look at the data exiting the Data Logger at J1 pin 2 while the PLAY button is pushed again. You should see a 9600-baud, \pm 5-volt signal. If you don't have an oscilloscope, follow the instructions in the "Creating a Data File" section to connect the Data Logger to your PC. Push the PLAY button again and observe characters on your screen. If you don't see anything, check the configuration of your PC's

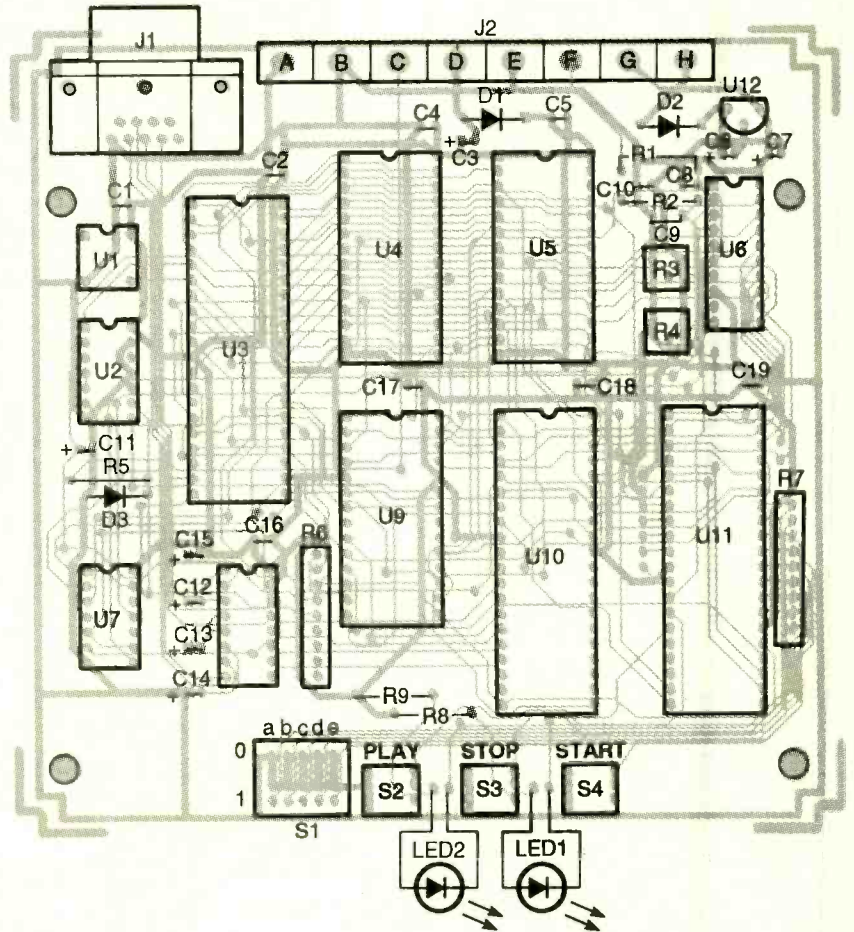

Fig. 5. Once you have gathered the parts, assemble the circuit guided by this parts-placement diagram. It is strongly recommended that sockets be used for all IC's.

serial port and make sure it is set to 9600 baud, no parity, 8 data bits, and 1 stop bit.

If you are using the analog section,

turn off the 5-volt supply and set configuration switches S1-a-S1-e to 00000, respectively. Connect a 9-volt power source to J2-h and the ground

connection to J2-b. Turn the supplies on and push the **START** button. If the **COLLECTING DATA** indicator (LED1) lights, the ADC is in good shape. If, however, the two LED's alternately flash on and off several times per second, check the ADC's supply voltage at U6 pin 20. That should measure 5 volts \pm 0.30 volts.

If your unit passes the above tests, you are ready to proceed with the following sections that explain how use the Data Logger.

Setting the Configuration Switches.

The configuration switches are used to set the operating mode of the Data Logger. Once the DIP switches are set and data collection is in progress, the mode and data-collection interval cannot be altered. The DIP switches are only read once by the processor when power is first applied. If the configuration switches are accidentally changed during the data-collection process, they'll have no effect; *i.e.*, the Data Logger will continue acquiring data in the mode that was selected during power up. That means that the switches must be set while the power is off; then, when power is applied to the circuit, the settings are automatically locked.

Figure 6 shows all possible settings of the configuration switches. Of those 32 combinations, all except 3 are valid. If an illegal setting is selected, the user is alerted to the situation: both LED's will simultaneously flash on/off at approximately 4 Hz.

Switches S1-a, S1-b, and S1-c set the desired data-collection interval. As you can see from Fig. 6, the interval can be set from 100 measurements per second to one measurement every 10 minutes. Switch S1-d allows the Data Logger to accommodate digital- or analog-input signals. With S1-d set to 0 (closed), 0 to 5-volt analog signals connected to J2-f will be digitized and stored. With S1-d set to 1 (open), digital signals connected to J2-c will be stored at the selected collection interval. Switch S1-e determines the specific digital mode. Setting S1-e to 0 makes the Data Logger accumulate counts over the entire interval specified by S1-a, S1-b, and S1-c. With S1-e set to 1, the Data Logger makes a 1-second accumulation at the time interval specified by S1-a, S1-b, and S1-c.

DATA COLLECTION INTERVAL
 0 = ANALOG INPUT MODE; 1 = DIGITAL INPUT MODE
 DIGITAL MODE: 0 = ACCUMULATE OVER ENTIRE INTERVAL (INTEGRATING)
 1 = 1 SECOND ACCUMULATION (INSTANTANEOUS)

S1-a	S1-b	S1-c	S1-d	S1-e	Action
0	0	0	0	X	ADC reading every 0.1 second
1	0	0	0	X	ADC reading every .1 second
0	1	0	0	X	ADC reading every second
1	1	0	0	X	ADC reading every 5 seconds
0	0	1	0	X	ADC reading every 10 seconds
1	0	1	0	X	ADC reading every minute
0	1	1	0	X	ADC reading every 5 minutes
1	1	1	0	X	ADC reading every 10 minutes
0	0	0	1	0	Cumulative count stored every 0.01 second
1	0	0	1	0	Cumulative count stored every 0.1 second
0	1	0	1	0	Cumulative count stored every second
1	1	0	1	0	Cumulative count stored every 5 seconds
0	0	1	1	0	Cumulative count stored every 10 seconds
1	0	1	1	0	Cumulative count stored every minute
0	1	1	1	0	Cumulative count stored every 5 minutes
1	1	1	1	0	Cumulative count stored every 10 minutes
0	0	0	1	1	Illegal; LED's flash on/off
1	0	0	1	1	Illegal; LED's flash on/off
0	1	0	1	1	Illegal; LED's flash on/off
1	1	0	1	1	1 second accumulation every 5 seconds
0	0	1	1	1	1 second accumulation every 10 seconds
1	0	1	1	1	1 second accumulation every minute
0	1	1	1	1	1 second accumulation every 5 minutes
1	1	1	1	1	1 second accumulation every 10 minutes

Fig. 6. All possible settings of the configuration switches (S1-a to S1-e) are shown here. Of the 32 possible combinations, all except 3 are valid.

As an example, let's suppose that you have a transducer that produces a TTL-level signal with an output frequency proportional to wind speed. To get an idea of the wind speed over a time span of one week, a data-collection interval of 10 minutes is selected, as well as the 1-second accumulation (instantaneous) mode (S1-e set to 1). That means that once every 10 minutes, the Data Logger will count the wind-speed transducer pulse train for 1 second and store the results in RAM. The switch settings for that example are shown in the last entry of Fig. 6 (all switches set to 1).

Using the Data Logger. After the configuration switches are properly set and the appropriate transducer is connected to the circuit, you're ready to collect data. Apply power to the Data Logger to lock in the configuration-switch settings. Record the time and date, then push **START** to initiate data collection. Notice that the **COLLECTING DATA** indicator (LED1) lights. That LED will remain lit until either **STOP** (S3) is pressed (halting the data-collection process), the Data Logger's

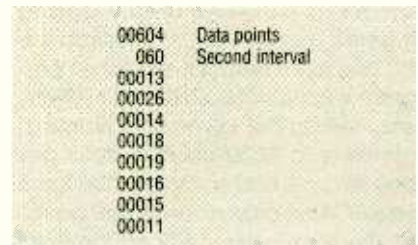

Fig. 7. In the typical Data Logger transmission, the first line tells you how many data points have been stored in the Data Logger, while second line tells you the time interval between data points.

RAM is full (in which case, data collection is automatically terminated), or the data-ready signal (from U6 pin 5) is not asserted within 200 μ s of starting a conversion (causing LED1 and LED2 to alternately flash on/off at approximately 4 Hz, indicating that a hardware failure has occurred—most likely with U6).

If RAM has completely filled, the processor ignores any input from the **START** button; thus, you are protected from accidentally pushing **START** and having the previously collected data overwritten and, thereby, lost. If, during a data-collection run, you decide that

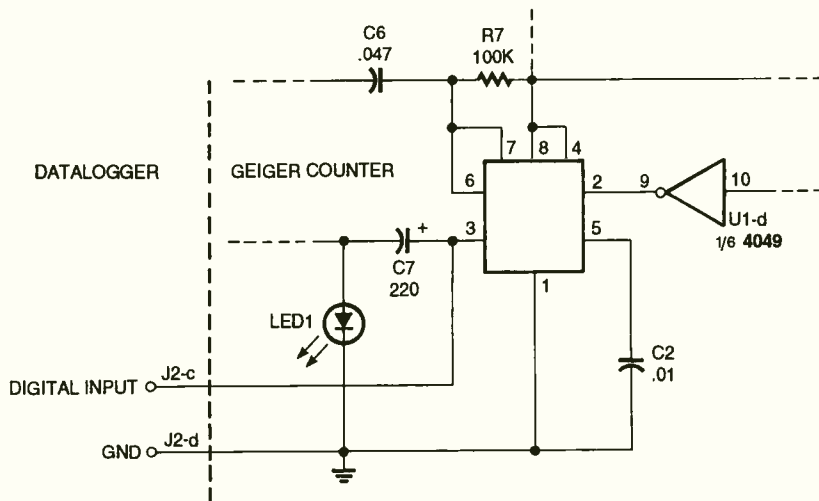

Fig. 8. The Geiger Counter project (from *Popular Electronics*' July, 1992 issue) can be used with the Data Logger's integrating-frequency mode. Here is how the Data Logger's digital input connects to the Geiger Counter.

you want terminate data collection, simply push STOP (S3). Data collection can be resumed by pushing START (S4) a second time. Just make note of the start and stop times so that you can later correlate the data with the time and date.

After data has been collected, you are ready to transfer it to your PC. Connect a serial cable from the 9-pin connector (J1) on the Data Logger to the serial port on your PC. Turn on the PC and run a terminal emulation program such as QMODEM, PROCOMM, etc., setting the communication parameters to 9600 baud, 8 data bits, one stop bit, and no parity. Configure your PC to receive (download) an ASCII file. Push PLAYBACK (S2) on the Data logger to start the data transmission from the Data logger RAM to your PC.

Figure 7 shows a typical Data Logger transmission. The first line of the transmission tells you how many data points have been stored in the Data Logger. The second line tells you the time interval between data points. With that information, you can correlate any data point with a specific time and date. When LED2 lights, close the file that you opened, leave your terminal emulation program, and open your data-plotting program. Import the data from the file that you just created and plot the data.

That procedure may seem cumbersome, but after you've run through it a few times, it becomes child's play (well, almost). The operation of the Versatile Data Logger will be ex-

plained in greater detail in the applications examples that follow.

Applications Examples. A 16-bit word is allocated in Data Logger memory for each reading. That means that to avoid overflow problems, the stored measurement must be less than 65,535. To help understand that restriction, consider the 1-

second accumulation (Instantaneous) mode of the Data Logger (configuration switch S1-e set to 1). The maximum output frequency of the transducer connected to the Data Logger must be less than 65,535 kHz. In the accumulate (integrate) mode (with configuration switch S1-e set to 0), the accumulated count over the selected time interval must be less than 65,535.

Integrating Frequency Example.

The "Geiger Counter" construction article from the July, 1992 issue of *Popular Electronics* can be used to demonstrate the integrating-frequency mode of the Data Logger. Figure 8 shows a portion of the Geiger Counter schematic. The Data Logger's digital input, at J2-c, connects to U3 pin 3 of the Geiger Counter, and its ground connection, at J2-d, connects to the Geiger Counter's U3 at pin 1. The signal amplitude at U3 pin 3 is approximately 9 volts. That relatively high-level signal does no damage to the Data Logger's 5-volt powered, Schmitt-trigger input (U2-d) due to the current-limiting action of R5 and voltage limiting provided by D3.

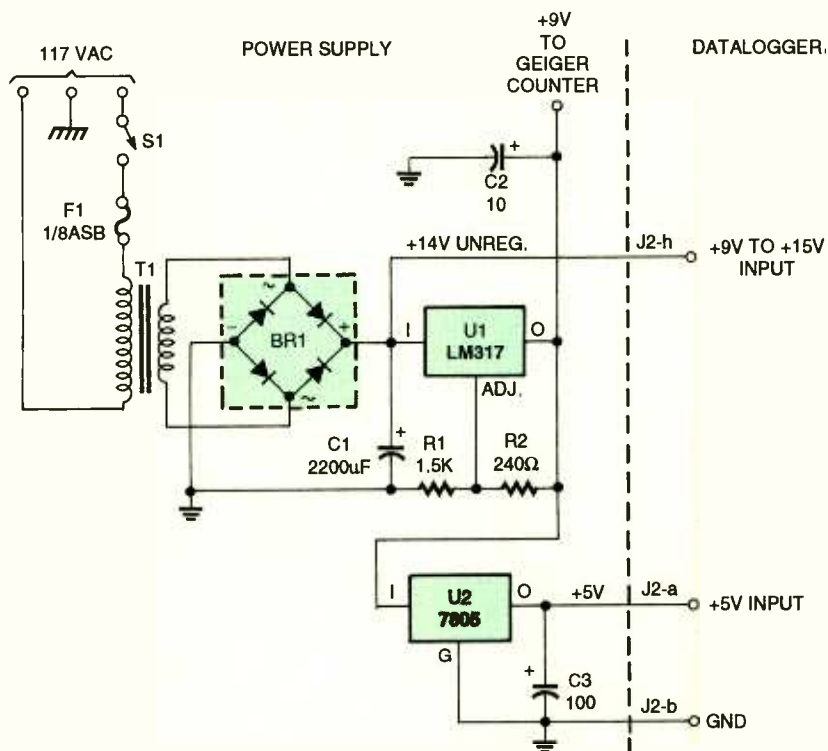

Fig. 9. For long-duration data collection, it is wise to operate the Versatile Data Logger from a well-designed dedicated power supply such as this one, which is designed to serve as a replacement to the original power sources (digital and analog, see text) shown in the schematic diagram.

PARTS LIST FOR THE VERSATILE DATA LOGGER

SEMICONDUCTORS

- U1—SE1403 2.45-MHz crystal oscillator, integrated circuit (Epson America, Digi-key)
 U2—SN74HCT14, hex inverting Schmitt trigger, integrated circuit
 U3—Z80, microprocessor, integrated circuit
 U4—62256, 32K × 8 static RAM, integrated circuit
 U5—TMS2764, 8K × 8 EPROM, 450 ns (or faster), integrated circuit
 U6—ADC0804, 8-bit analog-to-digital converter, integrated circuit
 U7—SN74HCT32, quad 2-input OR, integrated circuit
 U8—MAX232, RS232 dual receiver-transmitter, integrated circuit
 U9—Z80-CTC, counter/timer, integrated circuit
 U10—Z80-DART, serial I/O, integrated circuit
 U11—Z80-PIO, parallel I/O, integrated circuit
 U12—LM78L05ACZ, 5-volt, 150-mA voltage regulator, integrated circuit
 DI, D2—1N4001 1-amp, 50-PIV, silicon rectifier diode

- D3—1N751A 5.1-volt, 400-mW Zener diode
 LED1, LED2—Light-emitting diode, 20-mA

RESISTORS

- (All fixed resistors are ¼-watt, 5% carbon units unless otherwise indicated.)
 R1—1500-ohm
 R2—10,000-ohm
 R3, R4—10,000-ohm PC-mount potentiometer
 R5, R8, R9—470-ohm
 R6, R7—4700-ohm × 9 SIP bus resistor network

CAPACITORS

- C1, C2, C4, C5, C8, C10, C16, C17, C18, C19—0.1-μF, ceramic-disc
 C3, C6, C7, C11—10-μF, 16-WVDC, electrolytic
 C9—150-pF, 50-WVDC, temperature-stable, ceramic-disc
 C12—C15—22-μF, 16-WVDC, electrolytic

ADDITIONAL PARTS AND MATERIALS

- J1—PC-mount DB-9 connector

- (Mouser 152-3209)
 J2—8-position, PC-mount terminal strip (Augau/RDI 6PCR-08-000)
 S1—5-position DIP switch
 S2—S4—PC-mount pushbutton switch
 Printed-circuit materials, enclosure, IC sockets, wire, solder, hardware, etc.

Note: The following items are available from D. Malone, P.O. Box 1542, Battle Ground, WA 98604: Double sided, silk-screened, solder-masked printed-circuit board, \$21.95; programmed 27C64, \$8.00; printed-circuit board with all parts (NMOS), no case, \$70.00; printed-circuit board with all parts (CMOS), \$80.00. Add \$5.00 for right-angle pushbuttons and DIP switch. Painted aluminum case with blank end plates, \$18.95. TSL220, \$8.50. Please add \$3.00 per order for postage and handling. Washington residents please add appropriate sales tax.

PARTS LIST FOR THE OPTIONAL POWER SUPPLY

SEMICONDUCTORS

- U1—LM317T 1.5-amp, adjustable, voltage regulator
 U2—7805 5-volt, 1.5-amp, voltage regulator
 BR1—1-amp, 50-PIV full-wave bridge rectifier

RESISTORS

- (All fixed resistors are ¼-watt, 5% carbon units.)
 R1—1500-ohm
 R2—240-ohm

CAPACITORS

- C1—2200-μF, 25-WVDC, electrolytic

- C2—10-μF, 16-WVDC, electrolytic
 C3—100-μF, 16-WVDC, electrolytic

ADDITIONAL PARTS AND MATERIALS

- T1—10-volt, 600-mA power transformer
 S1—SPDT toggle switch
 F1—0.125-amp slow-blow fuse
 Printed-circuit materials, enclosure, molded AC power plug with line cord, heat sink (Digikey HS112-ND), 4-position barrier strip (Digikey CBB104-ND), fuse clip, wire, solder, hardware, etc.

To prevent inductive spikes from the speaker from reaching the Data Logger and causing extra counts, disconnect the speaker by plugging in the headphone jack. Let's assume that you want to measure the background radiation for your area by storing the accumulated counts once per minute. The appropriate switch settings for S1-a—S1-e would be 10110, respectively. After the connections from the

Geiger Counter to the Data Logger have been made and the configuration switches set, turn on power to the Data Logger. Push the START button and begin collecting count data. Data collection is either manually terminated by pushing the STOP button or automatically when the RAM is completely filled.

If you are going to make background measurements over a long

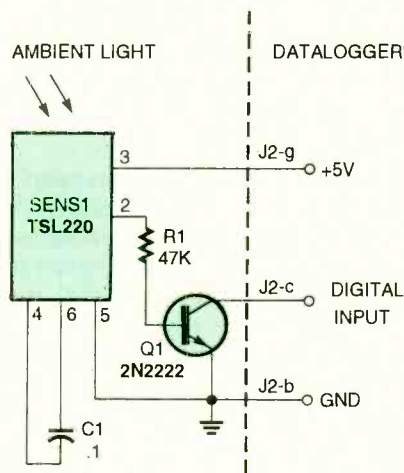

Fig. 10. This setup—which uses a TSL220 light sensor to convert light intensity to frequency—can be used for long-term, ambient light-level monitoring.

period of time, you may want to consider the power supply shown in Fig. 9, which is designed to serve as a replacement to the original power source. In addition, it also provides 5- and 14-volt outputs.

Instantaneous Frequency Example. To operate the Data Logger in

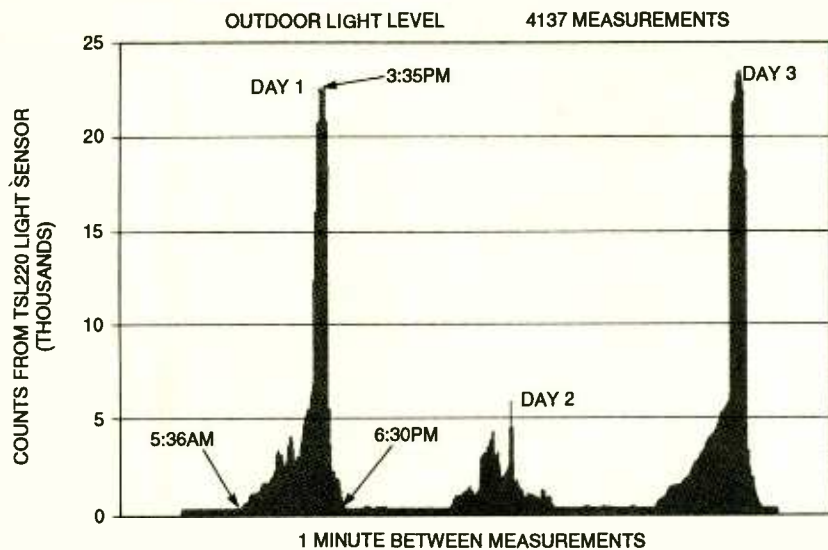

Fig. 11. Here is an example of data collected using the TSL220 circuit and the Data Logger, which was set for a 1-second accumulation taken once per minute. Note the large difference between sunny Days 1 and 3, and cloudy Day 2.

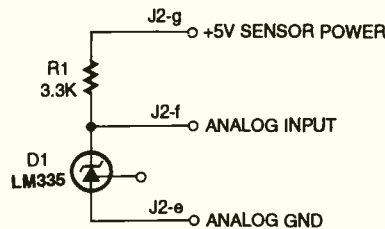

Fig. 12. In this example, an analog-input signal, derived from an LM335 temperature transducer, is applied to the appropriate input of the Data Logger, allowing it to measure temperatures of from 0°C to 100°C.

the instantaneous mode, we need to use a transducer that produces a frequency proportional to the measured quantity. Texas Instruments makes an interesting device, the TSL220, that converts light intensity to frequency. The TSL220 will be used to measure ambient light level with long-term data monitoring provided by the Data Logger.

The TSL220 is packaged in a clear-plastic 8-pin DIP package. Light passes through the plastic and strikes an internal photodiode. The stronger the light the higher the frequency available at pin 2.

Figure 10 shows how to connect the TSL220 to the Data Logger. A 5-volt output at J2-g on the Data Logger supplies power to the circuit. The digital signal at the collector of Q1 connects to the Data Logger's digital input terminal, J2-c. To minimize stray noise pickup, keep the wires to the TSL220 as short as possible and twist

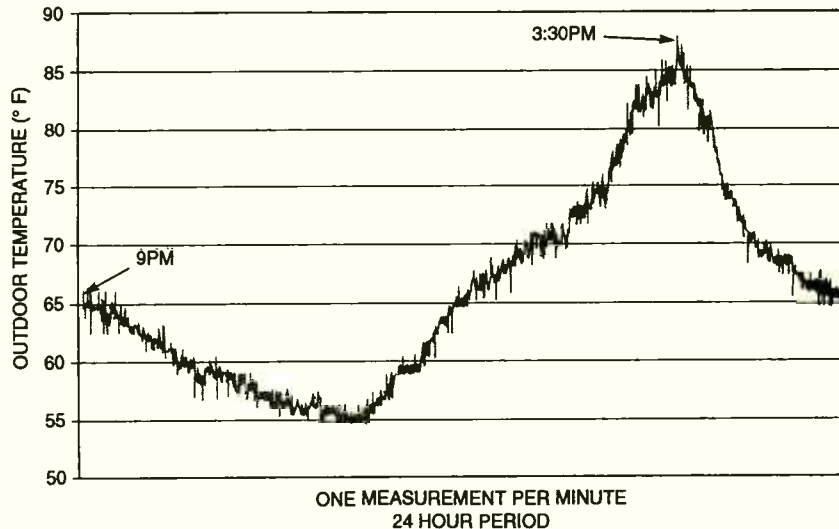

Fig. 13. Here is a plot of temperature data taken using the LM335 temperature sensor and the Data Logger.

them together. The author has successfully used wires up to 3-feet long.

Figure 11 shows the results of storing a 1-second accumulation of frequency pulses taken once per minute. Note the large difference in counts between sunny Days 1 and 3, and cloudy Day 2. The Data Logger configuration switches, S1-a-S1-e were set to 10111, respectively. To avoid saturating the TSL220 in bright sunlight, it was necessary to apply a small amount of black ink from a permanent marker to the light-sensitive face of the device.

If you have access to an oscilloscope, monitor pin 2 of the TSL220, expose it to bright sunlight, and apply black ink until the frequen-

cy is below 65 kHz. Alternatively, you can acquire data, plot the results, and look for spurious plateaus. If they are present, add more ink and try again.

Analog Input Example. Figure 12 shows how to connect an LM335 temperature transducer to the analog input of the Data Logger, allowing it to measure temperatures of from 0°C to 100°C. The LM335 outputs an analog voltage that is proportional to temperature (10mV/°K). That ratio produces 2.73 volts at the freezing point of water (0°C), and 3.73 volts at the boiling point of water (100°C), giving an input-voltage range of 1 volt.

The Data Logger's ADC, U6, (an 8-bit device) divides the input-voltage range of 1-volt (3.73-2.73 volts) into 256 equal steps. To maximize the resolution of the measurements, R3 and

R4 are adjusted to insure that all 256 ADC output values occur within a temperature range of 0 to 100°C. That is accomplished by adjusting R4 for 0.50 volts at pin 9 of U6, which equals half the input voltage span. Potentiometer R3, connected to U6 at pin 7 is adjusted for an input of 2.73 volts, which equals the lowest anticipated voltage from the temperature transducer. If you want better accuracy, place the LM335 in a stirred water/ice bath and measure the voltage from the LM335. Adjust R3 until this voltage is present at U6 pin 7. The conversion between ADC counts and temperature is: °C = ADC counts/2.56. For ex-

(Continued on page 92)

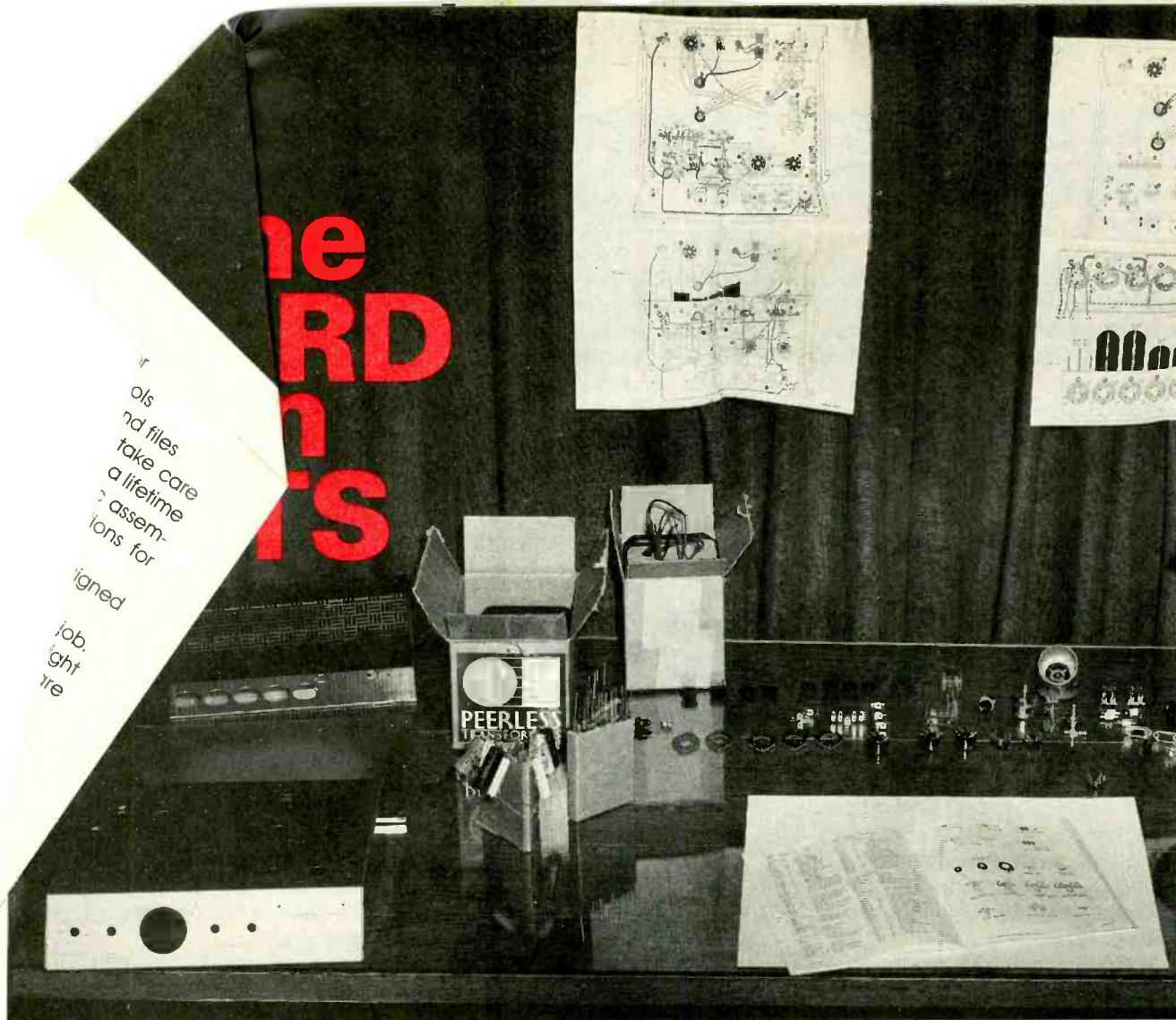

Kit building is still an important part of the electronics hobby, and this primer tells you how to get in on the fun.

BY KARL T. THURBER, JR.

Assembling electronic kits is a rewarding way of augmenting your radio shack and/or workbench. You learn building and troubleshooting techniques while becoming familiar with your equipment. You can also learn about tools, component color codes, schematics, and test equipment. Kits are easier to build than home-brew projects as they usually come with etched and drilled printed-circuit (PC) boards, components, and step-by-step assembly and alignment instructions. Also, a kit can cost less than a comparable factory-assembled unit because of reduced factory labor (although today that advantage is minimal due to factory automation and other advancements).

Many kit suppliers provide instructions that even a beginner can follow. In fact, many kit manufacturers try to ensure that a foolproof kit reaches you. Besides just design engineers, many have at least a modest in-house technical-writing/illustration staff that develop their construction manuals and assembly sequences.

In some cases, the kit may be given to other employees to build using the assembly-manual draft. That reveals how much trouble people with differing technical skills will have building it. A quality-control (QC) or engineering-evaluation team may look at the results and suggest improvements in the assembly manual, pictorial diagrams, components, and basic circuit design.

On the downside, there are only a few firms today whose prime business is electronic kits. (Giants like Knight-kit and EICO exited the business years ago, and even Heath only sells a few educational kits.) So not all kits have the detailed instructions so necessary for immediate success. In some extreme cases, details are limited to providing a schematic and the instruction to "install the parts." So, unless you shop wisely, the initial kit savings may be washed out by return and repair charges.

Also, kits tend to be a shade below factory-made equipment in appearance and design. That's because to engineer a kit for simple construction and adjustment, some performance compromises must be

made. However, there are notable exceptions, such as some logic analyzers and frequency counters. Again, wise shopping will help to overcome this hurdle.

Making a Decision. Today, despite the industry shake-out, attractive kits are still available. However, selecting the right kit is as important as building it. When you need a new piece of equipment, decide on the specifications that are most important to you and balance them against your funds.

Also, make comparisons between competing equipment, giving consideration to both kits and factory assembled gear. Compare factory-made units and kits based on their specifications and price. Don't hinge your choice simply on the fact that one is ready-made and the other has to be assembled.

Be sure to consider the skill level required to successfully build the kit. A small radio accessory, for example, may require only basic electronics skills, while successfully assembling a complete amateur-radio transceiver may require the skills of a highly knowledgeable expert.

You should also evaluate the manufacturer. You must look hard for amenities like intensive engineering, easy-to-follow assembly manuals, pictorial diagrams, technical support, and reasonable repairs. With all those variables, kit quality varies wildly, although some progressive firms are working hard to emulate the high kit documentation and service standards set long ago by Heath and its competitors.

Taking some precautions won't ensure success in dealing with unknown suppliers, but they will help tilt the odds of a successful transaction in your favor. For example, when you see a kit ad, don't immediately rush with your check or plastic. Write or call first. Ask for a catalog, a spec sheet, a sample page of instructions, and the warranty. Inquire as to what repair services are available and at what cost. Also, ask around locally to see if you can find someone who has dealt with the firm, what his experience has been, and whether the kit worked up to expectations or not.

You should look at the supplier's mailing address. Is it a postal box? Is

there a person's name and/or radio amateur call sign listed? Is there a telephone number listed that you can call? See if the ad appears in more than one publication, and for more than a single month. Contact the magazine publisher or editor to see if any complaints have been received.

Finally, be sure to use a credit card or request COD shipment if you're still uncertain about the firm, especially if the amount involved is substantial. Credit cards offer considerable consumer protection.

Basic Tools. It's hard to do a good job of kit construction unless you use the proper tools and know how to use



This Wahl Power Pro cordless soldering iron, with its high-efficiency tips, provides up to 30 minutes of continuous soldering time once fully charged, or, if used intermittently, power for over 200 solder joints. (Photo courtesy Wahl Clipper Corporation.)

them. Usually, very few tools are needed for kits. Being more specific, here are some of the more common hand tools that should prove useful in kit building:

- Adjustable open-end wrench
- Wire cutter/stripper
- Small Allen-wrench set
- Small tweezers
- 4-inch long-nose "needle-nose" pliers
- 4-inch diagonal or side-cutting pliers
- Phillips-head screwdrivers
- Socket wrench sets (nut drivers, hex drivers, and starters, in assorted sizes)
- Pocket knife

- Assorted irons
- 20- to 30-watt soldering-iron, with a chisel tip
- Center punches (for pre-drilling holes)
- Electric drill and bits, in 1/2-inch sizes
- Offset screwdriver
- Small, light hammer
- Circuit-alignment tool
- Assorted nail and rou

Whatever tools you buy, of them, as most can last for a long time. Here are some suggestions for properly taking care of tools:

- Use tools only for their design purposes.
- Use the proper tool for each job.
- Keep tools lubricated with a light film of oil to inhibit rust if they are stored in damp areas.
- Keep cutting edges sharp.
- Keep all tools clean.
- Store tools where you can easily find and use them, such as on a wall or a pegboard.
- Keep soldering-tool tips clean and well-tinned.
- Above all, operate electrical tools safely.

Soldering Equipment. When it comes to building kits, your soldering tool is the most important item in your toolbox. The choice between a gun and an iron is not easy, so most builders end up with at least one of each.

Looking first at the iron, it's usually low in cost, keeps a fairly uniform temperature, and doesn't have to be turned on each time you solder a connection. Soldering irons vary in size and heat capacity from about 15 to 500 or more watts, but an iron of 20-30 watts is all you'll need for most kits. A small pencil iron is good for PC boards and for tight places. A 100-watt-plus iron would be good for heavy-duty electrical work, but can damage PC boards.

One of my favorite soldering tools is a rechargeable cordless soldering iron. Some can make hundreds of connections before recharging and can be fully recharged in 60 minutes or less. While they were primarily designed for portability, they're competitive today with regular irons and guns on the workbench.

Regarding soldering guns, they

have advantages and disadvantages. For instance they don't need stands and some have dual heat levels. With a gun, you depress the trigger and the soldering tip heats up rapidly, although it stays hot only as long as you depress the trigger; an iron is always ready to work. Further, some builders complain that a gun is hard to handle and fatiguing to use. A gun is okay for making repairs and when only a few connections must be made. Bottom line: if you're going to do most of your work building kits on a workbench, consider an iron. If you are going to do mostly repair work, a gun may be the better choice.

Some soldering accessories you'll find useful in kit building are an iron holder, sponge tip-cleaner, clip-on heat sinks (to protect components while soldering), a brush/scrapper, probes, and several spare tips.

For correcting mistakes and for repair work on PC boards, you'll need an illuminated magnifying glass; a low-heat desoldering tool, bulb, station, or wick; and a soft wire brush. Most of what you need is available in complete desoldering tool sets from Radio Shack and other electronic suppliers. An electric mini-drill also is useful for delicate PC-board repairs and rework to clean excess solder from holes. It's worthwhile to have the proper desoldering tools, since an inept repair attempt can ruin a whole project.

Test Equipment. Most electronic kits can be built without any test equipment. Often, a manufacturer provides two adjustment procedures—one requiring test equipment and one not—but cautions that optimum performance is more likely if you use test equipment. Anyway, eventually you'll need some test gear, if for no other reason than to troubleshoot.

Typical items needed in and around the radio shack or workbench for adjusting and testing kits include a multimeter, sometimes called a volt-ohm-milliammeter (VOM) or multi-tester; radio frequency (RF) and audio frequency (AF) signal generators; an oscilloscope; a frequency counter; and RF instruments such as a dummy load, wattmeter, and standing wave ratio (SWR) bridge.

Of those, the most essential general purpose instrument is the multimeter. It

lets you to make voltage, current, and resistance readings, and so is invaluable in troubleshooting kits and making basic repairs. Several electronic test instruments are available from Elenco Electronics in kit form and should make excellent construction projects for the beginner.

Some Notes on Soldering. Some errors beginners make include applying too much or too little heat to PC boards, applying solder to the soldering iron tip rather than to the joint, and moving a connection before it sets. Other errors include using too much solder (creating solder bridges) and working with dirty soldering tools.

Many novice builders don't know what a good solder joint looks like. A properly soldered connection has no ridges or sharp points visible. The solder should flow smoothly over the connection. It's strong and shiny, not grainy, flaky, or blob-like.

Some kit manuals go into extensive detail to describe and illustrate what good soldering is all about. Beginners should read the "how-to-solder" section, if there is one, before digging into a kit.

Some kit manufacturers furnish solder with their kits. Usually the solder is 60/40-type, in which the mixture of tin and lead is in a 60/40 ratio. That is close to the optimum mix of 63/37 that liquefies at about 361°F—a low temperature for solder.

The solder you use should have a rosin-flux core. The flux is normally built into the solder so it's automatically applied when you heat the solder. When it flows over the connection, it removes oxides from the metal surfaces and wets it to facilitate soldering.

Always use rosin-core solder on electronic equipment; never use acid-core solder or paste. Why? Acid fluxes are highly corrosive. If you should use them, the acid flux gradually begins to eat away at the leads of the components. Oxidation builds up around the leads, acting as an insulator.

Acid-core solder can damage PC boards. In fact, kits wired with acid-core solder may not be repaired if you send them back for repair. Many kit warranties specifically exclude responsibility for damage caused by the use of such corrosive solder. So, make sure the solder is for electronic purposes.

Do you need some soldering practice before digging in? The February 1994 issue of **Popular Electronics** reviewed the Elenco Electronics (150 W. Carpenter Ave., Wheeling, IL 60090; Tel. 708-541-3800, or 800-533-2441; Fax 708-520-0085) SP-1 Soldering Practice Kit. Designed for the beginner, it's a simple and inexpensive (\$8.25) project that exposes the builder to various soldering techniques. While the project's warbling alarm and flashing LED's might not be something you really need, it may be the perfect kit for the first-time builder. The kit is like any other electronic kit, but the manual places more emphasis on proper soldering techniques than it does on the circuit itself.

Setting the Stage. Let's review some things to do when you settle down to build a kit. First, find a good place to work. Pick a quiet, well-lit place far from household distractions. It should be a spot where you won't have to put everything away after each session.



Besides its extensive line of accessories, MFJ also offers an inexpensive world band shortwave regenerative receiver kit, the MFJ-8100K. The receiver shown here is also available in assembled form. (Photo courtesy MFJ Enterprises, Inc.)

you have never built a kit, set up workbench and tools first. If you don't have a workbench, a card table is suitable, since you can slide it out of the way after each session. Also, you'll appreciate a comfortable chair after a few hours of soldering.

Ensure you're near some available AC outlets to power your soldering tools, test equipment, and work light. Try to work over a tile or wooden floor. Why? It can be nearly impossible to find tiny components and hardware dropped into a plush carpet.

Check over the kit when it arrives. Open it carefully, retaining all packing material. Before closely handling any parts, read the manual thoroughly—it may identify components that you must treat with special care. It will also give you important details on the kit, how it'll look when finished, show you the construction sequence, what sub-assemblies are involved, how they mesh, and if special tools or equipment are needed.

Now examine the parts list and inventory the components following any special handling precautions mentioned. While that is a time-consuming task with large kits, it's really a time-saver. If the kit is incomplete, you can immediately contact the manufacturer to request any missing parts, rather than waiting till construction has begun to discover that critical components are absent.

Going over the parts list also helps you recognize the parts. Identify, group, and lay out components to save time later. Sort out resistors, capacitors, transistors, integrated circuits (IC's), and hardware. Put small parts in ashtrays, paper cups, saucers, muffin tins, molded egg cartons, or whatever else is convenient. Minimize handling of delicate, static-sensitive transistors and IC's; leave them alone until you're ready to install them.

Ensure that the chassis, cabinet, and PC boards all match up; in other words that the kit is physically buildable. Check all PC boards to see that there are no breaks in the circuit foils. If IC's are to be used, but no IC sockets are provided, consider buying some. You'll be glad you used them if you have to replace a bad IC later on.

Building a Kit. When you build, follow instructions closely. Good manuals tell you exactly what to do and

when to do it. Some manuals go into great detail and have photos showing how leads should be placed, or "dressed." Others leave it up to you. Some include detailed diagrams that show the optimum arrangement of components. The diagrams should be followed closely to avoid instability and other hard-to-trace symptoms and malfunctions.

Experienced builders are more likely to deviate from the instructions than beginners, since they may feel that they can do a better job working directly from the schematic, with only an occasional glance at the manual or pictorial diagrams. In most cases, that results in mistakes, since it's very difficult to work from both a schematic and instructions or pictorials.



This Micronta 10-megohm, FET-input multimeter operates like a solid-state VTVM, letting you troubleshoot and test sensitive circuits with minimal loading. It also has a jumbo 5-inch, tri-color scale. (Photo courtesy Radio Shack)

Always handle and wire a kit with TLC (tender loving care). Be a plodder; it pays to work carefully, methodically, and patiently. If you don't know what good wiring looks like, open up some electronic equipment and see for yourself.

Note that most wiring is "squared-off," each component seems to have its place, most components are laid out parallel to the chassis or circuit boards, and parts aren't stacked one on top of another. Cables are laced and grouped, and the shortest leads possible are used. PC boards are clean looking, with most components mounted on the non-foil side. Lugs and wires are clean and free of wax, frayed insulation, and other foreign substances.

Do the best soldering job you can.

The key to good wiring lies in patience, forethought, common sense, and a winning way with a soldering tool. The biggest problems in building kits lie in soldering. In fact, most kits returned for repair don't have anything wrong with them except bad solder connections. Good soldering is an art, a science, and a craft.

"Heat-sink" delicate components, such as transistors, diodes, and IC's to prevent heat damage. You can do this by holding the component lead near the body with a pair of needle-nose pliers, or by attaching a small alligator clip or clip-on heat sink to it.

Check and recheck your work. Take special care to check that you've selected the right component before you solder it in place. Recheck the circuit when asked to do so by the manual. Even if the assembly instructions don't provide for periodic checks, inspect your handiwork after each session. Inspect and check for solder bridges between components, wrong or missing parts and wiring, loose "pigtailed," and cold solder joints. It's almost impossible to build a large project without making some kind of error, so be cautious.

When completed, give the kit a final QC check before flipping the power switch. Doing so may save considerable frustration and expense should there be a construction error. Now is a good time to cross-check the kit against the schematic, since you may have worked only with pictorial diagrams up to this point.

Carefully follow any check-out procedures outline in the instructions. Don't skip any resistance or voltage checks; they can turn up major assembly errors. Assuming all is okay, power-up the unit and proceed with alignment, calibration, or other adjustments. It's best to follow the final procedures exactly. They're usually carefully worked out and must be performed in a particular sequence if the kit's specifications are to be met.

If it Doesn't Work. Not every kit you build will work the first time it's turned on. Anyone, even highly experienced craftsmen, can make mistakes. What's important is to find the mistakes and get the kit up and running.

Kit manufacturers do occasionally make errors in their manuals, sometimes technical and sometimes ty-

pographical. Usually those errors are soon caught and an errata sheet is prepared. Check for an errata sheet in your kit, and make the page-by-page changes indicated.

Sometimes, a furnished part is bad. Kit makers usually make every effort to furnish reliable components, but occasionally bad or incorrect ones do get in. They can be hard to spot, though resistors and capacitors can be measured, and transistors can be checked for performance with a transistor tester.

If your instruction book has a step-by-step malfunction chart or procedure, use it to discover what's wrong. Usually, it will lead you to the problem. First look for the obvious, though. Is the unit plugged in? Is the fuse inserted and good? Are there any unconnected wires?

Also, even if you followed instructions carefully, go back through every instruction step. It's very easy to misread or omit an instruction.

As mentioned earlier, the most common problem is poor soldering. Often, reapplying heat to all connections and close visual inspections will resolve soldering problems.

Component polarity problems also plague kit builders. Sometimes this is the fault of the manufacturer for not being explicit, and sometimes it rests with the builder for not visually observing polarity. When working with transistors and IC's, be especially careful to properly identify where a "key" or "tab" is to ensure proper insertion.

The importance of checking over a malfunctioning kit can't be overemphasized. It's costly and frustrating to return a kit to find that the solution should have been obvious. Before tearing a troublesome kit apart or sending it for repair, let another more experienced builder check it over. Even the untrained eyes of a non-technical friend or your spouse may help you spot and resolve a problem.

If you're still having problems, bring out your multimeter. Look for the simplest malfunctions first, such as open fuses and shorts. Scan any resistance and voltage charts provided, and make the appropriate resistance and voltage checks called for in the manual.

If your inspection and measurements dictate that you replace a component, use as little heat as possi-

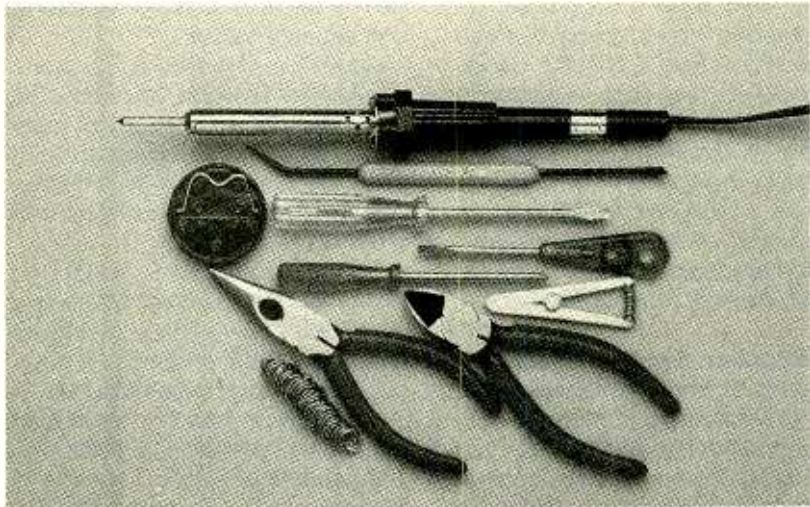

This complete tool set from Radio Shack is designed for kit building, particularly precise light- to medium-duty work. Included are a 30-watt pencil iron, stand, solder, diagonal cutters, three screwdrivers, soldering helper, pliers, and heat sink. (Photo courtesy Radio Shack)

ble in removing it. Excessive heat can damage adjacent components and the PC board; thus, investing in a desoldering tool set is money well spent.

Stuck? Still can't figure out what's wrong? Now's the time to write to, call, or FAX the kit supplier for help and consultation. Most manufacturers are aware that a satisfied customer is their best advertisement and will go to great lengths to satisfy them. Your complaint should be oriented to the objective of getting a helpful response, not criticizing the product. Keep emotions out of your communications, spell out the facts clearly, and be specific in the assistance you're requesting.

Be business like. Do you merely want technical advice? Do you think a new component is needed? Do you want instructions on how to return the unit for repair? Is a refund in order? To get the best results, place yourself in the position of the person receiving the letter, FAX, or phone call.

Most kit manufacturers have a small technical-consulting staff to help solve problems over the phone. Be prepared to give them as many facts as possible. The more specific information you can give, the better. If a part is believed to be the culprit they will usually send a new one out. In uncommonly stubborn cases, several phone calls, FAX's, or letters may be necessary to help you check more than one set of parts.

Only as a last resort should you have

to send your kit back. If you must return the kit, inquire as to whether to return the entire kit or specific subassemblies, and which accessories to return.

Also, read your warranty carefully and ascertain who's responsible for what. Traditional warranties on equipment, usually 90 days or a year, become fuzzy when it comes to kits. In some cases, only the parts themselves are guaranteed, performance being up to you.

Often, the cost of factory repair can't be calculated until you return the kit and it's determined whether the problem was caused by your error or a bad component. Usually, if it's the latter, the repair is free. Most suppliers are liberal in that area.

Sending the kit back for repair will usually cost you something—shipping and insurance charges, at a minimum—and may eat up the savings of buying a kit in the first place. Most manufacturers' repair fees are reasonable. Just don't send back a modified or incompletely assembled kit, or one wired with acid core solder. If you do, you'll likely get it back unrepaired.

For Future Reference. Even if your kit checks out from square one, it's a good idea to record key operating voltages you find are "normal" for your unit, even if a voltage chart is furnished. That is helpful should you have trouble later on in distinguishing between normal and abnormal equipment operation.

Retain the instruction manual, sche-

matic, and even the pictorial diagrams and instruction procedures, regardless of how simple the equipment is. They may very well come in handy in performing repairs, or if you sell the kit. Also fill out and return any warranty-registration cards so you can be notified of equipment updates and problem fixes. Record equipment serial numbers in the assembly manual or instruction book.

Kit-Supplier Sampler. Here is a sampling of firms offering electronic kits, kit-related educational packages, and the like. Also included is a brief listing of the type of kits or other products offered by each. Most of the firms listed offer a free catalog or product-information flyer.

It should be mentioned that due to the number of kit suppliers in existence, this is by no means a complete list. You should look in various electronics-hobbyist publications for the names and addresses of still others that may offer kits of interest to you.

624 Kits (171 Springlake Drive, Spartanburg, SC 29302; Tel. 803-573-6677) supports the QRP (low-power) ham enthusiast with quality RF parts and PC boards for transmitter, receiver, transceiver, and accessory projects. Most kits are based on designs published in the amateur-radio press.

A & A Engineering (2521 W. LaPalma, Unit #K, Anaheim, CA 92801; Tel. 714-952-2114) offers PC boards, kits, and assemblies. His "kits for hams by hams" include QRP CW transceivers, weather FAX and color SSTV adapters, spectrum analyzers, frequency synthesizers, Morse keyers, and more. Most products are offered in kit and assembled form.

Antennaco, Inc. (P.O. Box 218, Milford, NH 03055; Tel. 603-6734347) sells well-engineered, state-of-the-art antenna kits covering HF through microwave. Several Yagi antenna kits are featured.

AntennasWest (Box 50062, Provo, UT 84605; Tel. 801-373-8425) has a wide range of amateur-radio antennas and antenna accessories, kits, and build-it-yourself antenna and radio components.

The C&S Sales, Inc. (1245 Rosewood Ave., Deerfield, IL 60015; Tel. 800-292-7711) catalog offers a wide range of electronic test equipment and components. It also features the

Elenco Electronics line of electronic and educational kits.

Curry Communications (737 North Fairview St., Burbank, CA 91505; Tel. 818-846-0617) has a variety of long-wave-radio kits, including a 1750-meter band receiver, a LF/MF receiving up converter/active antenna, and a CW audio digitizer.

Digiteq (10 Howard St., Buffalo, NY 14206; Tel. 716-852-0449) offers over 30 educational electronics kits, including several short-range FM transceivers and a micro-controller kit.

Elenco Electronics, Inc. (150 W. Carpenter Ave., Wheeling, IL 60090; Tel. 708-541-3800) supplies a number of electronic kits, including the SP-1 Soldering Practice Kit, several analog and digital multimeters, a diode/transistor tester, a combination AM/FM-radio kit and training course, power supplies, and several other educational kits suited to beginners.

FAR Circuits (18N640 Field Court, Dundee, IL 60118; Tel. 708-426-2431) stocks high-quality PC boards for replicating radio-construction projects published in *CQ*, *Communications Quarterly*, *QST*, *73 Amateur Radio Today*, *Ham Radio*, and other communications-electronics magazines and radio handbooks.

Heathkit Educational Services (Heath Company, Benton Harbor, MI 49022; Tel. 800-253-0870) offers electronics and computer-education systems, including individual learning programs, classroom courseware and hardware, test equipment, videos, trainers, and a few kits.

Jayso Electronics Corp. (3210 White Plains Rd., Bronx, NY 10467; Tel. 800-426-4422) sells many basic educational robotics hobby kits and features the OWI, Inc. robotics kit line.

Kanga US (3521 Spring Lake Drive, Findlay, OH 45840; Tel. 419-423-5643) imports QRP amateur-radio kits manufactured by Kanga Products of England. QRP kits from Elktronics also are offered.

Lectrokit (401 W. Bogart Rd., Sandusky, OH 44870) furnishes the Model SP-1 "Spider" QRP transceiver in several versions ranging from a bare PC board to a complete kit. A fully assembled and tested model also is offered.

MFJ Enterprises, Inc. (Box 494, Mississippi State, MS 39762; Tel. 800-647-1800) produces an inexpen-

sive world-band regenerative short-wave-receiver kit, the MFJ-8100K (\$59.95). The receiver is also available assembled for \$79.95. A 2-meter band, repeater-monitor receiver kit also is offered at \$69.95.

Mondo-Tronics, Inc. (524 San Anselmo Ave., #107-22, San Anselmo, CA 94960; Tel. 800-374-5764) offers power devices, or "Muscle Wires," that can create direct linear action in robots, model airplanes, and model-railroad setups. Low-cost sample kits and project books are available.

Oak Hills Research (20879 Madison St., Big Rapids, MI 49307; Tel. 616-796-0920) has a selection of QRP CW transceiver, wattmeter, audio-filter, and keyer kits, along with small radio parts and ham radio application design notes.

OWI Inc. (1160 Mahalo Place, Compton, CA 90220; Tel. 310-6384732) sells the Movit and OWIKit educational robot kits and technology curricula featuring robotics.

PC Build Computers (85 Franklin St., Needham, MA 02194; Tel. 800-798-6363) provides complete computer kits, in both "standard" and "custom" configurations. The PC Build kits include step-by-step manuals and an instructional video.

Radio Adventures Corp. (R.D. 4, Box 240, Franklin, PA 16323; Tel. 814-437-5355) provides a series of crystal-controlled (fixed frequency) receiver kits designed to copy amateur-radio HF code-practice sessions and news bulletins from the American Radio Relay League headquarters station, W1AW.

RadioKit (Box 973, Pelham, NH 03076; Tel. 603-635-2235), a leader in QRP products, offers small parts packs, electronic kits, components, dials, chassis, chokes, toroidal inductors, PC boards, insulators, and other electronic parts and components. They also sell several QRP amateur-transceiver kits.

Ramsey Electronics, Inc. (793 Canning Parkway, Victor, NY 14564; Tel. 800-446-2295) features a large number of construction projects in their 20-page catalog, which describes many inexpensive radio and electronic hobby kits and mini-kits.

Rupp Electronics (5403 Westbreeze Trail, Ft. Wayne, IN 46804; Tel.

(Continued on page 92)

GIZMO®

A CHRONICLE OF CONSUMER ELECTRONICS

The Latest Sensation

TANDY SENSATION! MULTIMEDIA PERSONAL COMPUTER. From Radio Shack, 700 One Tandy Center, Fort Worth, TX 76102. Price: \$1799 (\$1999 with SVGA monitor).

When the personal computer was first introduced back in the mid-70's, it found a niche with technical hobbyists who were considered a bit weird, if not downright nerdy, by the rest of society. That all changed in the 1980's, when it became apparent that the PC was a great tool for business, and a great game platform for the home. Dropping prices and a wealth of new software applications drove the popularity of personal computers sky high. Today, almost as many American households own PC's as CD players. Sure, home offices account for some of those computers, but the fact remains that the PC has transcended its image as a work- or hacker-only tool to become a family-oriented piece of consumer-electronics.

If you don't believe us, survey the people you know who own and use a PC (or more than one). You're likely to find a similar cross-section to the people we know: A neighbor who moonlights from his non-computer day job writing software programs for local businesses and teaching others to use popular software titles. A cousin in Boston who plays chess by modem with his father-in-law in Houston. A friend who keeps her bowling-league scores and schedules on a PC. A musician who uses his computer's MIDI capabilities to compose and score music. A few people who've become hooked on an on-line service, using it to make travel arrangements, do research, or socialize. Several kids who play both learning and just-plain-fun games. A nurse who writes her case reports. Others who keep track of their finances, fill in their own tax returns, inventory their possessions, print out labels for their Christmas cards, create garage-sale



signs, and write letters (e-mail and the old-fashioned kind). And let's not forget all the hours that each of those people logs on computer games.

Today's personal computers are being targeted directly at today's computer-user: the family. How well are manufacturers aiming their products? Pretty close to a

bullseye, judging by the *Tandy Sensation!* multimedia PC (MPC), available at *Radio Shack* stores nationwide. It certainly would meet the computing needs of the friends and family described above.

The 1994 *Sensation!* is an updated version of last year's award-winning model, being marketed at the same price point. The system includes a 33-MHz Intel 80486SX microprocessor, 4 megabytes (MB) of RAM (expandable to 64 MB) and 1 MB video RAM. It offers a 212-MB hard drive and a 3.5-inch, 1.44-MB floppy drive. A double-speed CD-ROM drive is included along with a SoundBlaster 16 sound card. There's room for expansion with three 16-bit slots and one 5.25-inch device bay available. Also included is a 2400-bps data modem with 9600-bps send/receive fax capability.

The system includes a 101-key enhanced keypad and a two-button, PS/2-style mouse. Our test unit came with Tandy's VGM-390 Super-VGA color monitor, which adds \$200 over the price of a system with a standard VGA color monitor. It also came with the Tandy MMS-10 stereo amplifier/speaker, which provides a more impressive sound output than the built-in speaker. Serial, parallel, MIDI, mouse, and joystick ports are provided, along with jacks for stereo line-out and telephone. The front panel features volume controls, speaker, and jacks for attaching a microphone and headphone.

The *Sensation!* meets all the MPC Level II standards set by the MPC Marketing Council for multimedia PC's. Its dual-speed, multi-session CD-ROM drive reads directories and transfers data twice as fast as single-speed drives, and is compatible with Kodak Photo CD. It can also be used to play audio CD's.

However, hardware is only half the story. After all, once everything is connected and plugged in, today's non-technical computer user doesn't want to give it another thought. It's the software that sells the system, and that draws the user back to the PC on a regular basis.

The *Sensation!* comes with Microsoft Windows and MS-DOS 6 pre-installed on the hard disk. (We also received an MS-DOS 6.2 upgrade diskette, which we had to install ourselves.) It is also pre-loaded with a huge array of applications and demo programs, both traditional and multimedia. It includes Lotus Organizer, a personal information manager and a special edition of Intuit's Quicken financial manager (See Gizmo, November, 1993). Microsoft Works for Windows is also supplied, as is the Checkfree electronic bill-payment system. Macromedia Action! allows the creation of interesting multimedia presentations.

Startup kits are supplied for CompuServe, Prodigy, America Online, The

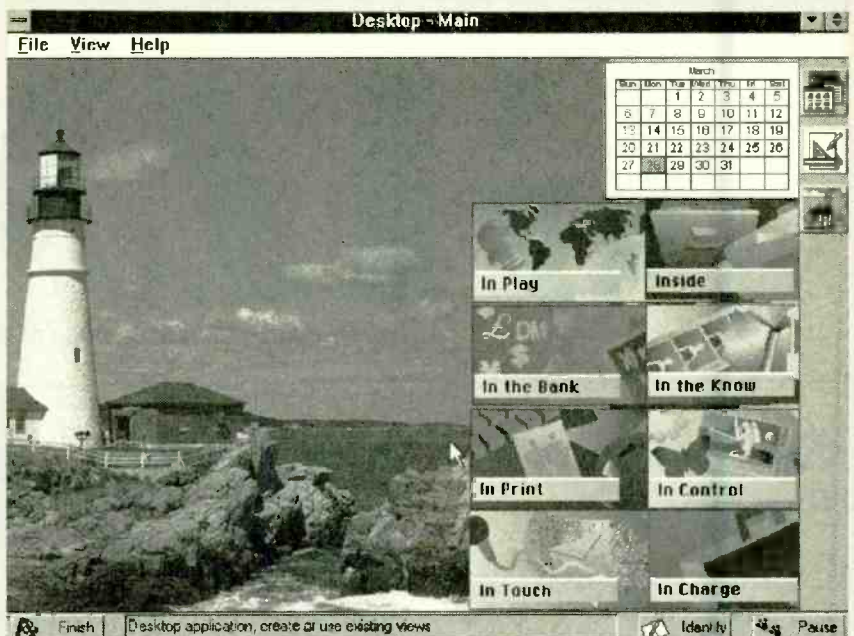

Tandy's WindMate software provides Windows functionality with a different look. Here is one of our customized "desktops."

Sierra Network's *ImagiNation*, and *Worldshop*. The *Sensation!* is also outfitted with Micrografx ClipArt, Mediasource and Autodesk FLIC animations, and the complete AT&T 800-number phone directory. Also included is Microsoft's *Bookshelf* on CD-ROM, which contains a dictionary, encyclopedia, world atlas, thesaurus, almanac, and some other reference works.

Although the computer can be physically hooked up in a matter of minutes, learning to use it—that is, to take advantage of all the bundled applications—is a time-consuming process. Tandy tries to help new users navigate through all those diverse programs with WinMate Desktop, a Windows-like program organizer.

When the system is booted up, the user is greeted first by a musical welcome, and then by the main WinMate screen. Eight categories are displayed on what the manual calls doors (perhaps a play on Windows?): In Print, In Charge, In the Bank, In Control, Inside, In the Know, In Touch, and In Play. A single mouse-click on any door activates an audio introduction to that category; a double click opens the door to reveal another screen with doors, those leading to each of the applications available in that category. (In other words, a submenu or "subdoor.")

We didn't think that WinMate was any improvement over the Windows Program Manager. In fact, we were relieved to be able to click a single icon to call up the Program Manager. We would have preferred if Tandy had provided an easy way to change the default Windows shell. Although we knew how to "get rid" of WinMate, we doubt if many of Tandy's

targeted uses—some of whom might even have experience using Windows at the office—would be able to do so. That, unfortunately, could lead to unnecessary confusion.

For the most part, the applications are logically placed: A standard calculator is located in the same "door" as calculators for loans and savings-and-investment. Quicken and Checkfree are also found in the Bank. The In Play door opens to a dozen different games. Some are aimed at young children. They range from ABC's and a very simple version of Hangman to Solitaire and Mine Sweeper. Multimedia clips are also found under In Play.

Demos and tutorials for *Sensation!*, Windows, and WinMate are found inside the In the Know door, which also provides access to Microsoft Bookshelf. Inserting the Bookshelf CD-ROM is like walking into a reference library. It contains the complete text of *The American Heritage Dictionary*, *Bartlett's Familiar Quotations*, *The Concise Columbia Encyclopedia*, *Roget's II Thesaurus*, *Hammond World Atlas*, *The Concise Columbia Dictionary of Quotations*, and *The World Almanac and Book of Facts 1993*. The text is enhanced by pictures, photographs, video clips, animation, and sound.

We could quibble with the placement of a few of the programs, however. System tools—File Manager, Print Manager, *Sensation* Install, Windows Setup, etc.—are found in Inside. We expected to find those tools in either In Charge or In Control. In Control and In Charge, however, refer not to the computer, but to the user's personal and business life. In Control contains home-inventory, household-maintenance,

vehicle maintenance, and student grade-charting programs. It also offers a demo of Fitness Partner, a workout program that can be customized for each user.

In Charge contains personal-information management programs—a diary, contact manager, clock, and Lotus Organizer—as well as a travel planner. We would have placed Microsoft Works in either that category—after all, word processing, database management, and spreadsheets are the most often used home-business applications—or in In Print, which allows users to make their own greeting cards, signs, name tags, and banners if they wish.

We wouldn't have placed AT&T's 800-number phone book in In Charge, but in In Touch. In Touch is Sensation's link to the outside world. Go through that door to send a fax using Phoenix MicroFAX, or to log on to America Online, Prodigy, ImagiNation, or Worldshop. Also found under In Touch are the Message Center (which allows the various users to leave text or spoken messages for one another) and the Profiler, which allows each user to provide the Sensation! with personal information ranging from height and weight to hobbies and travel preferences.

However it might be organized, the Sensation! comes with an incredible amount of software. As you might imagine, it also comes with a library's worth of manuals and assorted paperwork. There's a 140-page WinMate manual; a 100-page Sensation! manual; a 400+ -page user's guide to Microsoft Windows and MS-DOS 6; an 11 × 17-inch quick-start sheet; user's guides for Quicken, Lotus Organizer, Macromedia Action!, and Phoenix MicroFAX; brochures offering trial subscriptions and/or introductory memberships for CompuServe, CheckFree, and America Online, and assorted other papers.

The manuals leave something to be desired, however, particularly if the owner is not an experienced computer user. We had good intentions of wading through them cover to cover, but good intentions were quickly surpassed by the need to meet a deadline. So we decided to shelve the manuals and navigate using only the on-screen help to guide us.

The on-screen help was also a bit unwieldy and not for the novice. Soon we were just playing by ear, calling upon our past computer experience to guide us. That method was less frustrating, but wouldn't work for a complete computer novice, and it left us wondering what other features the Sensation! might offer that we simply didn't stumble upon in our somewhat haphazard explorations.

We were wishing that Tandy had included a good videotape demonstration, when we stumbled upon the Sensation! demo behind the In The Know door. The

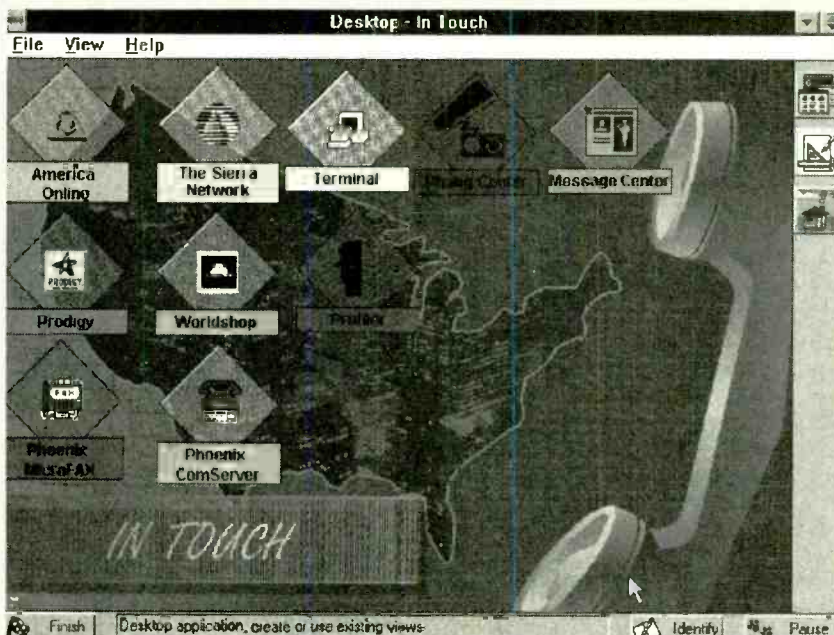

WinMate icons are grouped according to function. Here, the telecommunications applications provided with the Sensation are shown.

demo offered a glimpse at many of the features, but didn't walk new users through all the various functions, nor did it explain how to actually use any of them. It mentioned that we could play CD's on the Sensation!, for instance, but didn't give us a clue how to do so.

We searched the manual for some mention of audio CD's, with no luck. We opened every door, hoping to find a "Play CD" sub-door under one of them. Finally, we called a local Radio Shack store for help. It took the salesperson who answered our call several minutes to find the play-CD application, but she did manage to locate it at last. As it turns out, a custom CD-player application isn't provided. Instead, the somewhat inconvenient Windows Media Player (found under System Tools in the Inside door) is used to access the disc.

We don't want to suggest that the Sensation! is difficult to use. The problems we encountered stemmed from the fact that the system does so much, it's hard to get a handle on it all. Even without following any written or on-screen directions, we figured out how to inventory our household possessions, and even how to import photographs from a Photo CD to accompany each inventoried object. We gave each user an identity, with a "face" to go with it, that the Sensation! could recognize. We opened the door to In the Bank and calculated the monthly payments for a car loan and developed several mortgage refinancing scenarios.

We also managed to design and print our own greeting cards and signs using the Graphics Manager and the applications found under In Print. It's possible to create

original designs by incorporating and manipulating elements from the large library available from the Graphics Manager. Photographs can also be included. A wealth of forms, cards, notices, name tags, and the like are included, ready to be personalized by the user.

Next, we decided to open the In Touch door. The computer's communications features are extensive, and impressive. You've probably heard talk of how computers are crossing over into mainstream consumer electronics. Well, here's a good example: The Sensation! can replace your old answering machine by serving as a sophisticated voice-mail system for the whole family. Each user can record his own outgoing announcement, and have messages routed to his own in-box. If you have Caller-ID service, Sensation can put it to use. A second outgoing message can be recorded; it will be heard by those incoming callers whose numbers you have specified and are recognized by the system. The phone center also stores incoming and forwards outgoing faxes, and provides convenient remote access via a TouchTone phone to the Contact Manager phonebook, the personal-information management files, and the Message Center.

The Message Center is a sort of family bulletin board, replacing all those little notes stuck up on the refrigerator door with magnets in a typical household. Its main screen actually looks like a corkboard. Messages can either be typed in or recorded in your own voice. Even typed messages can be retrieved remotely; Sensation's text-to-voice algorithm translates typed material, and the computer reads

your messages aloud.

The In Touch category also includes the Profiler, which is a more extensive means of identifying each user. Under Profiler, you can input your name, address, work address, and phone and fax numbers; record a password and a "super user password" that supersedes other passwords; create a custom face icon that matches your gender and hair color and style; list your hobbies; note your clothing sizes; input your travel preferences in terms of airline, hotel, and car rental; keep a record of your bank-account and credit-card numbers; and add information about business and your personal contacts.

For the most part, however, addresses and phone numbers would be listed under the Contact Manager, found by opening the In Charge door. For each entry, you can input the standard name, address(es), and phone number(s), along with other fields of your choice, including spouse, children, birthdays, and contact history. It's also possible to add a picture from the Clipboard, or a photograph from a Photo CD. Sensation! can be configured to place phone calls or send faxes to people in your contact list. By activating the Phone Log function, the computer keeps a list of all outgoing calls and faxes; if you have Caller-ID, incoming calls can also be logged. During a call to one of your contacts, you can type notes about the conversation in the "take notes" dialog box and add those notes to the contact history.

Contacts are stored in Lotus Organizer, a personal information manager that uses a day-planner metaphor. Clicking on a section tab turns the pages of the on-screen book to the Calendar, To Do, Address, Notepad, Planner, or Anniversary section.

The In Charge door also provides access to the Diary, Travel Planner, and Phone Book Reader functions. The diary allows users to create and maintain one or several diaries or daily journals. The Travel Planner keeps track of expenses, destinations, and addresses, and allows the user to write in a travel journal and make a detailed packing list. Phone Book Reader is Win-Mate's rather cryptic name for AT&T's 800-number directory on CD-ROM.

We could keep on going—the Sensation! surely does. For personal or home-office use, the bundled applications seem almost unlimited. There really is something for everyone: We can actually envision family members fighting it out for computer time. Of course, it should be easy enough to use the Sensation! to create and print out a schedule . . .

However the family decides to work it out, Tandy's Sensation! is sure to be a popular addition to the household—even before you start buying advanced game controllers and CD-ROM based multimedia games! ■

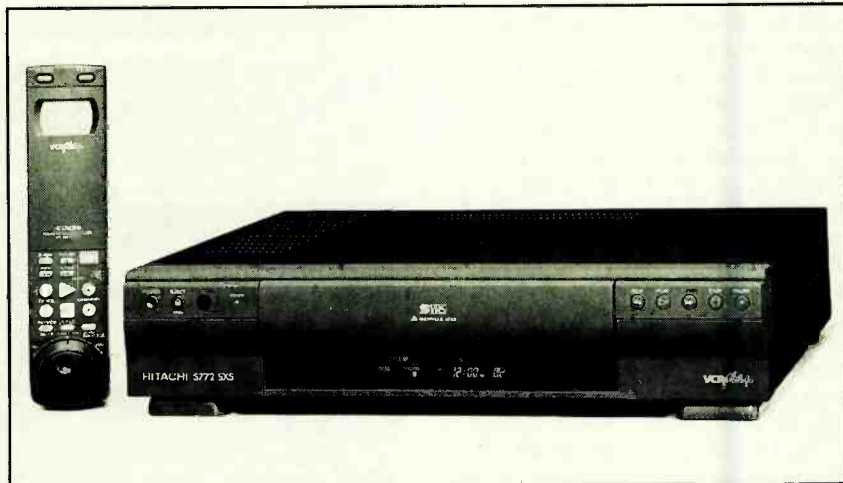

You've Come a Long Way, Baby

VT-S772A S-VHS VIDEO DECK WITH VCR PLUS + . From Hitachi Home Electronics (America), Inc., 3890 Steve Reynolds Blvd., Norcross, GA 30093; Tel. 404-279-5600; Price: \$999.

Take a trip down memory lane and try to visualize the audio and video components that you owned when you brought home your first VCR. Tower speakers, turntable, cassette deck, non-digital tuner, and—located across the room or perhaps in another room altogether—a 19-inch television set. The new videocassette recorder was probably connected only to the TV. It was primarily used to watch prerecorded tapes and, if you managed to decipher the complex procedures, to record and time-shift television programming. Those "simple" early units were anything but simple to use.

Over the past decade, the turntable has been replaced by the CD player, and the distinction between audio and video has blurred. These days, your audio and video components are probably housed—and intricately intertwined—in one catch-all home-entertainment center. The VCR, like the rest of the equipment, is more sophisticated and has become an integral part of the home-theater setup. If you use a camcorder, your VCR might also serve as the heart of your home-video editing system. Sure, you can still find two-head, monaural VCR's (for not much more than you'd pay for two orchestra seats to a Broadway show), but stereo sound and four heads are becoming standard features on trade-up VCR's, most of which are priced in the \$300–\$500 range.

For serious video editors and viewing enthusiasts, today's top-of-the-line VCR's offer an array of advanced features. With

prices starting at around \$800, such decks are expected to have all the latest bells and whistles—flying erase head, jog/shuttle controls, index search, frame-by-frame advance, S-Video inputs and outputs, edit controllers, and the like—but that level of sophistication must not be achieved at the expense of convenience. After all, a high-end VCR must be easy enough for even the least-technically-inclined family member to use.

Hitachi's VT-S772A meets all of those high-end requirements, then adds some extras, such as VCR Plus + circuitry and a host of editing features. It also tacks on a couple of unique features—an automatic, "laser-activated," tape-compartment-door opener and an illuminated universal remote with its own display.

The VCR's complexity is hidden behind a deceptively plain facade. Visible front-panel controls are limited to the basics: POWER, EJECT, REW, PLAY, FFWD, STOP, and PAUSE. The tape well is centrally located, with the display panel just beneath it. Tucked in a compartment to the left of the display are input and output jacks for use during editing, along with knobs used to control recording and headphone levels. An identical compartment on the opposite side houses controls used for editing, tracking, and timer recordings.

Similarly, the remote control keeps the most-used controls out in the open, and hides the rest behind a closed door. The basic VCR controls and channel-up and -down buttons are grouped toward the bottom of the remote, along with the LIGHT button, which activates a red backlight on those frequently used controls. The remote can be programmed to operate a TV and a cable box; a switch on the side selects the device being controlled. Sandwiched between the basic controls and the jog/shuttle dial are the TV/VCR MUTE button, the TITLER/LAST CHANNEL button, used for title making during editing or for last-channel recall during viewing; and the JOG/

SHUTTLE button, used to activate or deactivate the jog/shuttle knob. A window in the door covering the less frequently used controls allows the remote's LCD readout to be seen whether the compartment is open or closed. The display is used during VCR Plus+ timer recording, and also comes in handy for those who cannot make out the writing on the front-panel display from the sofa. Inside the compartment are the VCR Plus+ controls, a numeric keypad, the RECORD button, and controls for various advanced features.

With the "fancy stuff" tucked out of sight, there's nothing at all intimidating about using the VT-S772A to watch a movie. With three ways to time-shift programming, even the most VCR-shy people in your household should be able to record their favorite programs.

The easiest recording method—is simply the initial setup is complete—is simply to input the VCR Plus+ code for the program that you want to tape. (The code for most broadcast and cable programs appears next to each listing in *TV Guide* and in the television listings in many local newspapers.) To prepare the VCR for VCR Plus+ recording, you must first make sure that it understands which channels are which. Say, for example, that your cable system distributes CNN on channel 10 and the Sci-Fi Channel on channel 21. The VCR must be configured to reflect that. (Remember, a neighboring cable system has CNN on Channel 8 and the Sci-Fi Channel on Channel 52. Your local paper might show them on yet another set of channels!)

Unfortunately, the VT-S772A doesn't provide cable-box control, as many VCR Plus+ -equipped VCR's do nowadays. Although it's still possible to use VCR Plus+, it's not as "automatic" as it should be. Let's assume that you want to record a live HBO event. You can't just record it through your VCR's cable-ready input because it is scrambled. Therefore, you must use your cable box to descramble the HBO signal and record it on, for the sake of argument, Channel 3. Then you must program your cable box to come on at the right time, or just leave it on tuned to HBO. In that situation, VCR Plus+ has not really made your recording setup tasks any easier.

It's also possible to set the timer the "old-fashioned" way, using the PROG button on the remote control and following the clear, on-screen programming instructions. Or the Instant Recording Timer front-panel IRT/START and buttons will also do the trick. By setting the VCR to record mode and pressing the REC/LENGTH button once, the next 30 minutes of whatever is playing on the VCR's current channel will be recorded. Each subsequent press of that button adds a half hour of recording time.

The IRT button can also be used in a similar way to delay the start of recording, also in 30-minute increments. The start time can be set at any hour or half-hour during the next 24-hour period. If, for example, at 6:20 you decided to go out to dinner, but wanted to tape *Jeopardy* from 7:00 to 7:30, you would tap the IRT/START button twice (the first tap would bring you to 6:30, the second to 7:00), and then press REC/LENGTH once to record for a half hour.

The VT-S772A also offers several convenient playback features. An index mark is automatically placed at the beginning of each recording that you make, so it's easy to jump to the start of each taped program using the INDEX key. If the show has been recorded on another VCR, and has no index marks, the GO-TO button on the remote control can get you to the right place on the tape. Pressing GO-TO calls up an on-screen prompt that asks you to input the length of the program. A press of the fast-forward or rewind key advances or reverses the tape by the length of time indicated, and automatically starts playing the tape at that point. If you've recorded a commercial-filled TV program, the FADV (frame advance) key can help you get past the ads. Each push results in an automatic one-minute fast-forward to skip forward through the commercial breaks.

When watching rented movies, the artificial intelligence (AI) picture-enhancing mode can be activated to clean up some of the noise. Digital auto tracking also enhances picture quality. You can put the unit's "Spectra Sonic Sound" into movie mode to boost the bass from the audio-out jacks. There's also a Spectra Sonic music mode available. In movie-return mode, when it reaches the end of a tape that has the safety tab removed, the VT-S772A will automatically rewind the tape, eject it, and turn off the power. (It will not, unfortunately, get in the car at 11:45 PM and return the tape to the video store.) Finally, to keep the kids mesmerized long enough so that you can read the entire Sunday paper, you can set the VCR to endless-play mode and insert *Aladdin* or *Barney*. The tape will, hypothetically, keep rewinding and replaying forever.

For videographers, the VT-S772A provides a host of special editing features, including a six-scene edit controller, frame-by-frame advance, audio dub, video dub, insert edit, a built-in character generator and a flying erase head.

The six-scene edit controller is a handy way to assemble an edited video from one tape. The VT-S772A must be set up as the source deck, and it must be connected with a synchro-edit cable to another Hitachi VCR with synchro-edit capability for this edit mode to work. You can jog-and-shuttle around on your source tape, and mark the start and end points of up to

six scenes that you want to include. Errors can be corrected reasonably easily. When you are satisfied that you have the scenes marked properly, you can set the recording VCR to its record-pause mode, and press play on the source VCR. The rest is automatic. As the source VCR searches for the proper scenes, the recording VCR is held in its pause mode. When the desired scene is found, the recording VCR switches to the record mode, and then pauses when the scene is finished.

The audio-dubbing mode allows you to replace the audio recorded on the linear audio track with new audio information without disturbing the video. (Because hi-fi audio is recorded along with the video, it cannot be dubbed over.) To hear the dubbed audio, you must select either the hi-fi or the linear audio track with the AUDIO MONITOR button on the remote control. As an alternative, you might want to turn the audio-mix mode on so that you can hear both the hi-fi and the linear track. That would be useful, perhaps, for post-production narration of a home video.

Manual audio-level controls are available to give better control over what you record. The video dubbing mode allows new video to be recorded without affecting the audio on the linear track.

The built-in character generator won't replace a video titler, but it does a good job of providing a quick-and-dirty way to add simple titles to videos. Unlike most built-in titlers, three character sizes are offered by the VT-S772A.

The VT-S772A also features the "Laser VLS" video-loading system. Translation: The tape-compartment door opens automatically to accept a tape held in front of it. Two sensors on either side of unit's display panel activate the door mechanism whenever the well is empty and any object passes close to the front panel. Laser VLS works even if the power is off, and can be a bit disconcerting when simply walking past the powered-down unit triggers the door to open.

The remote control, however, is definitely convenient. It can control an additional Hitachi VCR, and can be programmed to control more than 30 popular brands of TV's and eight cable-box brands. We liked being able to backlight the basic command keys in a darkened room, and particularly enjoyed having an LCD readout that displayed the time and spectra-mode setting within easy viewing range. VCR Plus+ made recording simply a breeze.

The VT-S772A combines good looks and good performance with a "gee-whiz" automatic tape door and good editing functions. The combination should be attractive to folks looking for a quality step-up deck, particularly if they already own a Hitachi VCR or camcorder. ■

GIZMO NEWS

DIGITAL SATELLITES

The Thomson RCA DSS digital satellite system has been receiving headlines as the first digital direct-to-home satellite service. However, this past March, RCA—along with partners Hughes, DirecTV, and USSB—was beaten to that honor by Primestar Partners. The Primestar service will deliver 77 video channels, plus CD-quality audio programming. (Currently, six audio channels from light-rock to classical are available.) Channel capacity is expected to increase to 100 channels in two to three years as the digital compression used improves.

According to Primestar, the dish required for receiving the signals is only three feet in diameter. That's considerably smaller than the 6- to 10-foot dishes typically used for traditional satellite TV, but larger than the mere 18-inch dish required by the RCA DSS system.

Unlike the RCA DSS service, Primestar is a joint venture of the subsidiaries of six national cable-television companies and G.E. American Communications, Inc., which owns the satellite used by Primestar. (Satellite-system owners might be interested to know that the service is located on the Satcom K-1 Ku-band satellite.) The local Primestar distributors set prices for their area based on "competition, customer preferences and the cost of doing business."

Executives involved in the DSS venture write off Primestar as anything but an alternative to cable-delivered programming, saying that the "whole purpose of Primestar was to confuse the marketplace and throw real DBS (direct broadcasting by satellite) off track."

UPGRADING PC'S

How do you know whether the PC-compatible computer you buy today will still be powerful enough one or two years from now? One way is to buy a computer with an upgradable 486 motherboard, but how do you know that the motherboard can *really* be upgraded to Pentium performance?

Intel Corporation, which makes the lion's share of microprocessors for the PC market, (and various Overdrive processors that allow motherboards to be upgraded) runs the Intel Verification Program to certify that a manufacturer's motherboard can be upgraded down the road. Manufacturers pay \$5000 for their first system submitted for testing, and \$1000 for each additional system. Intel performs mechanical, ther-

PARDON OUR DUST... SYSTEM UNDER CONSTRUCTION

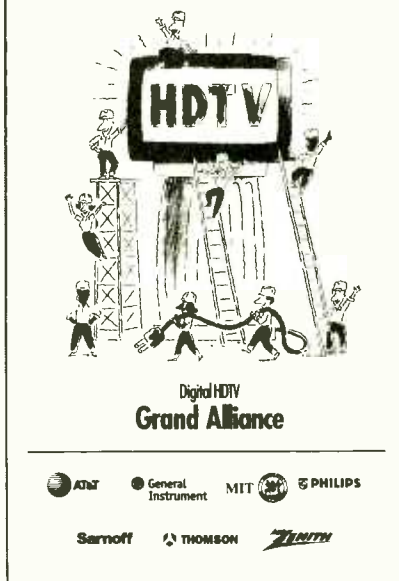

mal, electrical, installation, and functional tests, and verifies the upgradability of the system design.

Consumers can access information on the verification program by calling Intel's FaxBACK service at 800-525-3019. Request document 30335-3039 for a detailed description of the program and for additional instructions.

HDTV UPDATE

Demonstrating that HDTV is coming for sure—and perhaps sooner than we anticipated—the Digital HDTV Grand Alliance released a progress report at the National Association of Broadcasters convention held in late March. The Grand Alliance—made up of members AT&T, David Sarnoff Research Center, General Instrument Corp., Massachusetts Institute of Technology, Philips Consumer Electronics, Thomson Consumer Electronics, and Zenith Electronics Corp.—was one of the sponsors of the 1994 NAB convention.

As it now stands, the subsystems (scanning formats, digital video compression, packetized data, audio, and modulation) have all been approved by the FCC's Advisory Committee on Advanced Television Service. The Grand Alliance stressed the system's interoperability—that is, the way it can work with TV as well as computer and telecommunications technologies.

CONTACT LIST

AT&T
600 Mountain Ave.
Murray Hill, NJ 07974

David Sarnoff Research Center
201 Washington Rd.
Princeton, NJ 08540

DirecTV
P.O. Box 92424
Los Angeles, CA 90009

General Instrument Corp.
181 W. Madison, Suite 4900
Chicago, IL 60608

Intel Corporation
2200 Mission College Blvd.
Santa Clara, CA 95052

Massachusetts Institute of Technology
77 Massachusetts Ave.
Cambridge, MA 02139

Philips Consumer Electronics
One Philips Drive
Knoxville, TN 37914

Primestar Partners
100 North Presidential Blvd.
Bala Cynwyd, PA 19004

Thomson Consumer Electronics
600 North Sherman Drive
Indianapolis, IN 46620

USSB
3415 University Ave.
St. Paul, MN 55414

Zenith Electronics Corp.
1000 Milwaukee Ave.
Glenview, IL 60025

Laboratory testing of the system prototype is on schedule to begin this fall. Two wide-screen pixel arrays will be supported: 1920 pixels × 1080 lines, and 1280 pixels × 720 lines. Square pixels are provided to ensure computer interoperability.

Three different frame rates—60, 30, and 24 Hz—are supported. When combined with the two pixel arrays, a total of six different scanning formats are allowed. The 60- and 30-Hz frame rates are important for video source material, while the 30- and 24-Hz frame rates are important for film. Progressive scanning will be the rule in five of the six scanning formats. The 60-Hz, 1080-line format will not support progressive scanning at the outset.

Video compression will follow the MPEG-2 (Moving Picture Experts Group) international standard. The audio will be provided in the 5-channel, digital Dolby AC-3 surround-sound system. ■

You Called?

M2000 PROGRAMMABLE 2-LINE INTERCOM/SPEAKERPHONE. From TMC Corp., 220 North Center Drive, North Brunswick, NJ 08902. Tel. 908-422-1888. Price: \$199.

Some people we encounter long for a return to simpler days, when every household had but a single phone line—and usually a single telephone as well. These days, however, that is virtually impossible. As telecommuting increases and as more home offices start up, home telephones have no choice but to become more sophisticated to handle the burden.

The m2000 programmable 2-line intercom/speakerphone from TMC Corp. is targeted at small businesses and home offices. Its many advanced features help it to fit in that category perfectly. However, the more we used the phone and its features, the more we realized that it has a valid place in homes without offices as well.

The m2000 is an attractive, modern-looking phone. It is pearl-colored, measures about 7-8½ × 3 inches (not including the receiver), and can be wall-mounted or sit on a desk. Its front panel contains a standard keypad, and another 36 buttons. Despite its sophisticated features and its programmability, the phone is easier to use than most office phones we've encountered. The m2000 is equally at home in either an office with a PBX (private-branch exchange) system or in a home with standard phone service.

Although the m2000 is, by itself, a good stand-alone phone, its real strengths become apparent when it is installed as part of a system with other m2000 models. Up to eight phones can be installed to make up a single system.

When a phone is first installed, it assigns itself an extension number. The first phone that is installed simply sets itself as extension No. 1. It becomes the system's "master" and controls the data flow in the system and controls various system settings including tone or pulse dialing and each extension's access to outgoing lines. Each subsequently installed phone first checks the other phones that are already installed, and then assigns itself the next available number.

Setting up the phone is a relatively easy task thanks to a built-in menu system. The phone's 16-character, one-line, alphanumeric LCD readout prompts the installer through the settings once the SETTINGS button is pushed. The * key scrolls through the possible settings, while the # key changes the settings.

To give an overview of the phone's features, we'll go through the menu settings one at a time as seen from the master

phone (extension 1). The first setting is the extension number. As mentioned previously, the first phone defaults to extension 1. However, the extension number can be changed as long as there is one phone in the system that is set as the master, and as long as each phone has a unique number 1 through 8.

The next menu option sets the phone's line preference; that is, the line that the phone defaults to when you pick up the receiver. Take, for example, a two-person office with two phone lines in which each person has his own line, and gives that phone number out to clients. Person "A" wouldn't normally want person "B" tying up person A's line. Person B's phone could be configured to default to line 2.

In homes with a home office, that same feature could help to keep peace between family members. For example, only the office phone would default to line 2, reducing the chance of the kids accidentally tying up their mother's business line.

The next menu option sets the ringer mode. Each line can be set to ringer on, ringer off, delayed ring, or abbreviated ring. Families with home offices might want to set the phones so that only the

office phone would ring on incoming business calls.

The ringers on the other phones in the house could be set not to ring on incoming business calls, or they could be set to delayed ring, in which they would start ringing only after the first three ring cycles. Delayed ring would probably be more useful for an office in which a secretary usually answers the phone; other office phones would ring only if the secretary couldn't pick up the line within the allotted three rings.

In our hypothetical 2-person office, each person could have his line ring immediately, and have his partner's line on delayed ring.

The abbreviated ring does the opposite of delayed ring—in that mode, the phone will ring only on the first three ring cycles and then stop. It would be useful if you like to occasionally ignore calls if you are finishing up a thought or a project. Even if the incoming call does not ring at your station, you can answer the line—assuming that your line is permitted access to it—by pressing the line-1 or line-2 button.

The next menu option sets how the interstation intercom is handled. If set to auto-



answer, the speakerphone will turn on, and will be connected over the intercom channel. However, if you are currently on an outgoing line, you will have to answer the intercom manually.

Another intercom option is auto answer with standby mute. In that mode, the phone once again automatically answers incoming intercom calls, but your speaker is muted unless you deliberately press the INT button. That permits you to hear voice pages without giving the pager an "ear" into your office.

If auto answer is turned off, you can set the incoming intercom to ring repetitively or with a single ring, and you can answer or choose to ignore the intercom as you wish. You're in control.

The next menu options are for setting the built-in clock and the dial mode (tone or pulse). If the call-privacy setting is turned on, then no other extensions can access a line when it is in use. That not only eliminates deliberate eavesdropping, but also eliminates the more likely occurrence of people disturbing your conversation by accidentally picking up the line. Even when call-privacy is turned on, it is still possible to conference other extensions. Call privacy works only on other m2000 phones—standard phones can access a "private" call even when call privacy is turned on.

The next menu option lets you configure the phone for the type of line it is connected to: standard or PBX. The ring-direct option sets the phone to follow the central-office ringing pattern so that they will be compatible with today's custom-ringing services.

Also set from extension 1 are the outgoing-access and toll-restriction features. Each extension can be allowed to make outgoing calls on both lines, or just line 1 or just line 2. Extensions can also be barred making outgoing calls.

Even if extensions are permitted access to make outgoing calls, they can be restricted from making toll calls. Each extension can be set to either "permitted" or "restricted." Permitted extensions can make calls free from any toll restrictions. Restricted lines, however, will be unable to make calls that start with any of three user-defined, four-digit sequences. For example, a business in Manhattan might want to restrict all toll calls except those to the other New York boroughs and to Long Island. In that case, the system could be programmed to restrict any "1-XXX" sequence, except for the two allowed sequences of 1-718 and 1-516. Regardless of the toll-restriction settings, however, 1-800 and 911 calls are always permitted.

The menu is usually operated only during setup. The m2000 has a host of other interesting features that are operated from discreet buttons.

Another feature is "Line Reserve," which allows you to reserve a line that is currently in use. Say, for example, you want to make an outgoing call but both lines are being used. Pressing the LINE RESERVE button will alert you when the line becomes free while prohibiting other extensions from making outgoing calls.

The m2000 also offers a call timer to help you keep track of the time you spend on the phone. We liked the fact that the phone doesn't reset the call timer when you hang up. If you forget to check the timer before you hang up, you can recall the last elapsed time simply by pressing the call timer button.

A notepad feature lets you store phone numbers in a temporary memory. It's useful if you don't have a notepad handy by the phone but you want to copy down a phone number. We found it especially useful to take down numbers from Information. The temporary memory can be dialed, or it can be transferred to one of the twelve "permanent" memory settings. The twelve memory locations are accessed for speed dialing through six memory buttons and a shift key.

The m2000 has interesting hold features. Music-on-hold is provided by a built-in melody chip. An exclusive-hold feature, accessed by pressing the hold button a second time, allows the call to be released only from the extension where it was placed on hold. Unfortunately, the hold functions work best only with other m2000 phones. For example, if a call is placed on hold and then picked up from a standard extension phone, the hold will not be released and the melody will continue playing in the background.

An auto-hold on intercom allows the user to answer the intercom and automatically places the original outside call on hold. It seems to be a way to eliminate the accidental disconnecting of calls.

Transfer features include a station transfer mode, and all-transfer mode and a distinctive-ring transfer. To transfer to a specific extension, the transfer button is hit, followed by one of the eight extension buttons. Only the targeted extension rings. In the all-transfer mode, which is accessed by hitting the transfer button twice, all stations ring, and the first extension to answer seizes the call. To transfer the call with a distinctive ring, the transfer button is pushed, followed by a numeric key 1-8. All stations ring, but, presumably, only the person indicated by the distinctive ring will pick up. In reality, the distinctive rings are difficult to distinguish from each other.

The m2000 is anything but a simple, basic telephone. Yet its sophistication hasn't rendered it too complex to use. Rather, that sophistication is most evident in the m2000's inherent "smarts," which make it so easy to use. ■

That's a Switch!

JX-S700 A/V SELECTOR. From JVC Company of America, 41 Slater Drive, Elmwood Park, NJ 07407. Tel. 201-794-3900. Price: \$599.

You don't have to be a video enthusiast or a semi-professional videographer to need an audio/video switcher. Even simple setups can cause frustration when you want to copy or edit a videotape. Elaborate setups, however, are becoming more mainstream as more consumers add multiple VCR's (including camcorders), laserdisc players, and audio-processing gear to their systems. Of course, here at Gizmo, our constantly changing array of equipment was begging for a sensible way to route audio and video signals to their proper places. That's where the JX-S700 A/V selector from JVC Company of America came in.

The JX-S700 accepts seven A/V inputs, and routes them to four outputs plus one monitor output. Its most impressive feature is its built-in Y/C separator and mixer circuits. Because of those circuits, the switcher can accept S-video inputs in which the Y (luminance) and C (chrominance or color) signals are separate, and output the signals as conventional composite signals in which the Y and C signals are mixed. The reverse is also true: Conventional composite inputs can be output as S-video. That allows for maximum flexibility when editing videotapes and configuring video-system setups, and it makes hookup simpler. An S-VHS deck, for example, needs to be connected to the system with only the audio and S-video cables and still accept inputs from any composite device.

The A/V selector is an attractive component—it looks quite at home in a video entertainment center, and doesn't have to be hidden behind closed doors. It has a handsome, gold-colored finish and measures about 17¼ × 3½ × 10¾ inches.

The front panel is dominated by a row of seven SOURCE SELECT pushbuttons; the button that is selected lights up green. Below each button is a small indentation for a label. Nine pre-printed and 9 blank labels are supplied with the unit.

Two fold-down doors at the bottom of the front panel conceal an array of jacks and one switch. One set of jacks is simply a set of front-panel inputs and outputs for Source 3. (The rear-panel jacks are for Sources 1, 2, and 4-7.) Another set of jacks are for connecting an audio or video processor. Two front-panel buttons switch the processor into or out of the loop.

The switch located behind the fold-down doors sets the function of the processor when it is first powered up. The

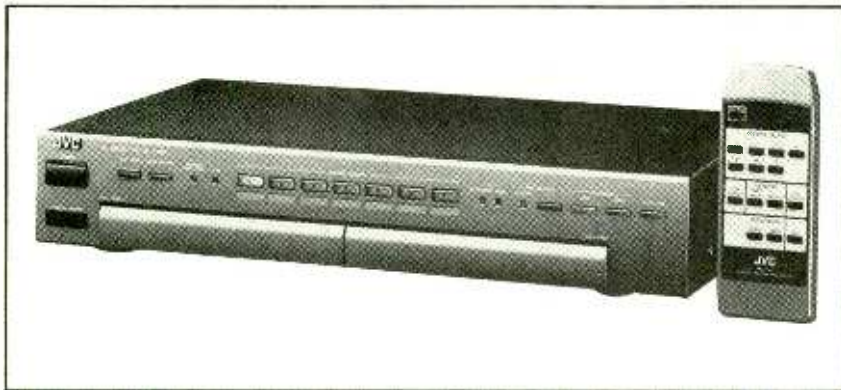

switch has four positions: off, 1, 2, and 7. If it's set to 1, 2, or 7, the source selected at power-up will be 1, 2, or 7, respectively. If set to off, the switcher will not power up when AC is supplied. That function is convenient when the processor is used along with an external timer. In fact, it is useful only with an external timer or other power switch because the POWER INITIAL switch has absolutely no effect if the power switch is used, but only if the AC supply is turned on or off.

Although we found the switch useful when we wanted to record radio programming onto a VCR using a timer, that's not how we used it most often. In our setup, we plugged the switcher into one of the switched power outlets of our A/V receiver, and set the source selector to our most used input (a satellite-TV receiver). Every time we turned on the A/V receiver, we would default to that source.

When the power-initial switch is used, the switcher defaults to its Key Lock mode, in which front-panel key presses have no effect—unless the KEY LOCK button is pushed to toggle out of the mode.

The JX-S700 permits parallel editing, meaning that two sources can be edited simultaneously. The feature isn't very difficult to use—once you get passed the

cryptic description in the manual. The rest of the manual, by the way, isn't much better—we had to play with various settings to see how they worked so we could interpret what the manual was really trying to say.

You would use parallel editing to record two different sources on two VCR's. Say, for example, that you wanted to dub a home video from your camcorder to one VCR while you taped a show off the satellite receiver to a second VCR.

The JX-S700, however, can't switch any input to any output. Instead, the first source—which can be connected to any input from 1 to 6—is output to outputs 1, 2, and 3. The second source must be connected to input 7, and is routed only to output 4.

In our parallel-editing scenario, our first input would be the camcorder (so that we could hook it to input 3, which is on the front panel.) The VCR that we were recording the dubbed camcorder tape to could be connected to any of outputs 1, 2, or 3. The second input would be the satellite receiver, which would have to be connected to input 7, and the second VCR would have to be connected to output 4. To add a little more confusion to the picture, the built-in Y/C separator and mixer cir-

cuits are not effective with the second input in the parallel-editing mode. In other words, both the satellite receiver and second VCR would have to both be either S-video units, or both hooked up with composite-video inputs and outputs.

What would we watch on the monitor? We could watch either, and switch between the sources with the MONITOR SELECT button, which is located only on the remote control.

As we would expect from a quality switcher, the JX-S700 adds nothing of its own to the audio and video signals that it switches. That is, it's transparent. We were unable to detect any differences between video viewed directly or switched through the device. The same was true of the audio that we switched.

The JX-S700 offers a loop-protect mode, in which the input won't be fed to the output of the same channel. In other words, when loop protect is on, the input to source 3 will be fed to all outputs except for output 3. That ensures that feedback loops will not be created, and that the audio and video will not suffer from complete distortion.

An auxiliary audio input permits an audio source that is unrelated to the video source to be fed to the outputs. It allowed us, for example, to replace the audio from a home video with some music. Although that's a handy feature, we would have preferred if the switcher allowed us to combine any audio source with any video source—just like our A/V receiver does. As a specialty device, it's very surprising that the JX-S700 compromised in switching flexibility.

We found ourselves using the switcher in combination with our A/V receiver to get flexibility better than what either one offered by itself. It's ironic (if not humorous), however, that as our A/V setups get more complex, we need even more equipment to keep things manageable. ■

ELECTRONICS WISH LIST

The Big Picture

Long known for its quality three-tube video projectors, *Vidikron of America, Inc.* (150 Bay Street, Jersey City, NJ 07302) has introduced its first *single-lens LCD projector*. The projector features a 200-watt metal halide bulb, which is said to produce a picture that is almost twice as bright as any other LCD projector. The projector has 455 horizontal pixel rows and 479 pixel volumes that are arranged in a delta pattern so that they are less noticeable. It operates with a 32-kHz horizontal scan rate, and uses a line-doubling process called "interlaced double-line addressing" which is said to produce no motion artifacts. A stereo television tuner is built-in, as is a speaker. Price: \$7495.

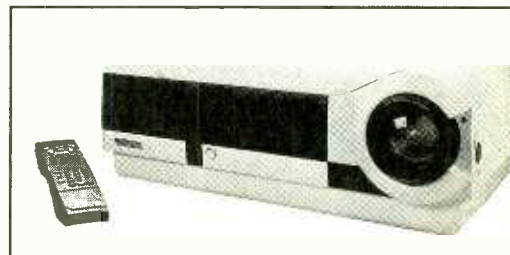

Vidikron LCD Projector

ELECTRONICS WISH LIST

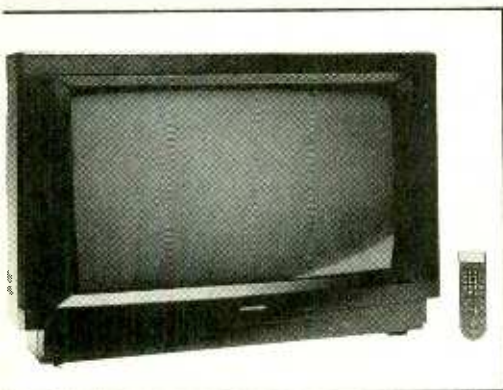

Widescreen TV

Widescreen TV

Proton's (16826 Edwards Road, Cerritos, CA 90701) first entry in the 16:9-television market is the DT-3660 34-inch stereo monitor/receiver. The direct-view set offers four selectable picture formats: standard TV (4:3 aspect ratio); full, which digitally enlarges 70% of the central image of a standard program so that it fills the entire screen; Cinema I for full-screen letterboxed programs; and Cinema II with a 17:9 aspect ratio for even wider movies. Advanced double-scan (non-interlace) extended definition television (EDTV) circuitry is said to provide a theater-like picture with incredible detail. With two 181-channel TV tuners, the DT-3660 provides picture-in-picture and picture-outside-of-picture with no external source. Other features include a video-effects package with still, swap, channel-scan, and strobe options; a high-contrast, square flat tube; two-way bi-amplified speakers; auto programming; and a voice reminder and display that tells the date and time and can be set to remind viewers of special programs, telephone calls, birthdays, or events. Price: N/A.



GameBoy Docking Platform

GameBoy Docking Platform

You can breathe new life into your Nintendo GameBoy with the *Mini-Arcade* from Naki Electronics (Century City North, 10100 Santa Monica Blvd., Suite 1400, Los Angeles, CA 90067). The docking-station design slips around the GameBoy, allowing it to be used as a stationary, table-top game. Its mini-arcade design increases comfort and allows full access to all standard GameBoy controls. The Mini-Arcade includes a high-performance mini-joystick, play buttons, a fold-away magnifying glass with light switch, a concealed storage compartment that holds two cartridges and a set of headphones; and dual stereo amplified speakers. (The speakers and light require an optional AC adapter or four "C" batteries.) Price: \$39.95.

Flat Speaker Cable

One of the challenges facing installers of home-theater or DSP audio systems is how to hide all those speaker cables while optimizing sound quality. Nordost Corporation (58 Peral Street, Framingham, MA 01701) offers a solution with its *Super Flatline* speaker cable, which is both audibly transparent and visually unobtrusive. The bi-wired speaker sends the bass frequencies along a separate cable, magnetic fields generated by the bass signals don't interfere with the upper range of frequencies. Super Flatline is said to be virtually distortion-free, thanks to the use of extruded Teflon construction coupled with the extremely tight tolerances and spacing of the 16 conductors that are separately wrapped in Teflon. Price: \$19.95 per meter.



CD Storage Case

CD Storage Case

The Impressions Model 4325 CD and CD-player carrying case from Micro-Computer Accessories, Inc. (9920 La Cienega Blvd., P.O. Box 17032, Inglewood, CA 90308-7032) has a curved, padded front compartment that can hold a portable CD player and headphones. The main compartment contains an organizer tray for up to 14 compact discs. The bag is made of weather-resistant fabric in two color combinations: black with purple trim and teal with purple trim. An exterior mesh pocket can hold sunglasses, keys, and other personal accessories. Price: \$13.99.

ELECTRONICS WISH LIST

Home-Theater Furniture

Being overwhelmed by a large picture and theater-quality sound is great; having your family room overwhelmed by your home-theater gear is not. *B.I.C. America's* (883-E Hampshire Road, Stow, OH 44224) *Cinema 1 Series* of integrated audio/video furniture puts your home-theater in its place. The *Model AV 1*, pictured here, accommodates a 40- to 60-inch rear-projection TV, and offers two built-in compartments for main speakers and space under the TV for a center-channel speaker. Adjustable shelves hold up to eight A/V components, with ample storage space below for CD's, video tapes, and laser discs. *Model AV 2* features a built-in surround-sound speaker system that includes right-, left-, and center-channel speakers plus two 10-inch subwoofers in the main unit. A pair of satellite speakers is included for rear-channel use. The AV 2 can hold a 27- to 35-inch direct-view TV and up to four other components. Generous storage space is hidden on the sides of the unit. Prices: AV 1, \$899; AV 2, \$999.

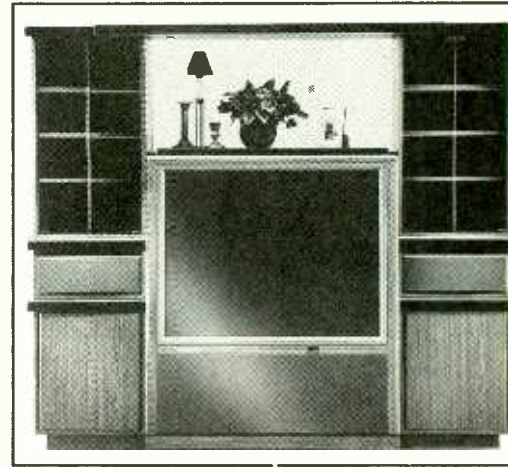

Home-Theater Furniture

Multimedia Speaker System

According to *Bose Corporation* (The Mountain, Framingham, MA 01701-9168), its *Acoustimass-3* is the most powerful and sophisticated sound system yet developed for multimedia use. The system provides professional-quality audio for business presentations, and enhances the audio in such computer applications as CD-ROM and MIDI. The *Acoustimass-3* consists of two small stereo-imaging speaker cubes that are placed near the computer, and a larger bass speaker/amplifier module that can be tucked away out of view. Between them, they create a lifelike, spacious sound stage with the low-frequency response, power handling, and dynamic range of much larger, conventional speaker systems. The bass module contains a bi-amplification system that delivers 50 watts to the bass driver and 20 watts to each imaging cube. The system uses Bose's *Acoustimass* technology, which launches sound waves into a room in the form of a moving air mass, unlike conventional systems that rely on the vibration of a driver cone. Price: \$699.

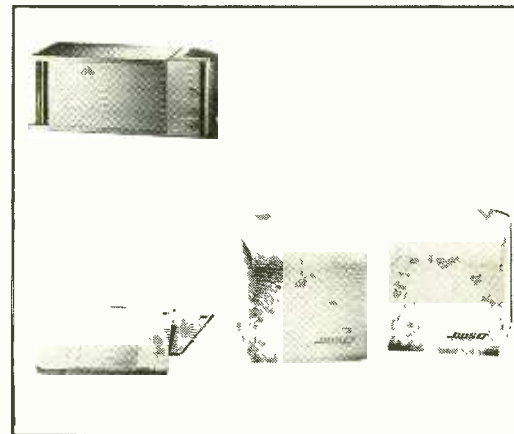

Multimedia Speaker System

Tapeless VCR Cleaning System

Using an automatic brush mechanism instead of the usual ribbon system, the *Memorex Automatic Brush VHS Cleaner* from *Memtek Products* (P.O. Box 901021, Fort Worth, TX 76101) safely and easily cares for video products including VCR's and camcorders. The system, which contains no freon or chlorofluorocarbons, cleans household dust, smoke, and tape-oxide debris from the video drum, video heads, and pinch rollers. A drip-free applicator pen conveniently applies cleaning solution to the non-abrasive brushes, and a timer controls the automatic cleaning cycle. The user simply inserts the cassette into the tape well and presses the cleaning cycle. Price: \$15.99.

Drink to This!

High-tech bartenders will appreciate the *Bartender's Guide* from *Franklin Electronic Publishers, Inc.* (122 Burrs Road, Mt. Holly, NJ 08060). The pocket-sized device contains more than 2200 professional recipes and scores of valuable tips on such bar-related topics as serving and cocktail glassware. Users can search for drinks by ingredient name or through a topic menu. Never again will you suffer the embarrassment of serving a Tom Collins in an old fashioned glass. Price: \$59.95.



Franklin Bartender's Guide

ELECTRONICS WISH LIST



Damiani's AudioPhazer

Phasers on Stun

The *AudioPhazer* is said to create "a literally physical participation in the music" because "it actually moves the stereo experience through the interior of the car." The unit can be incorporated into any car or home stereo system to improve performance and create special effects from any source. As *Damiani's Custom Sounds* (5530 Schaefer Ave, #A, Chino, CA 91710) describes it, the device "broadens the sound with a wind effect and also has a wow feature which dramatically enhances and stimulates listening enjoyment." At least it did in the demonstration car: a Lotus Esprit with 120 speakers and 4000 watts of amplifier power. Price: N/A.

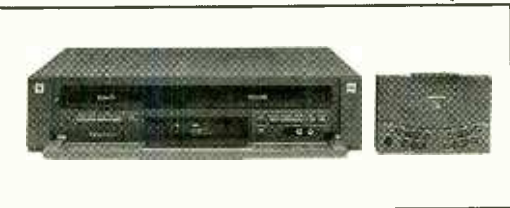

Goldstar VHS/8mm VCR

Dual-Personality VCR

If you can't make up your mind between the VHS and 8mm video formats, consider the *GVR-DDI* from *Goldstar Electronics Int'l, Inc.* (1000 Sylvan Avenue, Englewood Cliffs, NJ 07632). The dual-deck VCR features both an 8mm videocassette player and a 5-head (4 video heads plus a flying erase head) VHS VCR. The deck is targeted toward the 7 to 8 million U.S. households that own 8mm camcorders. The VHS deck's flying erase head eliminates picture noise during editing. The 8mm deck plays normal 8mm or Hi-8 tapes, but only at normal resolution. Front-panel video input jacks make it easy to connect additional audio and video sources. Price: \$899.95.

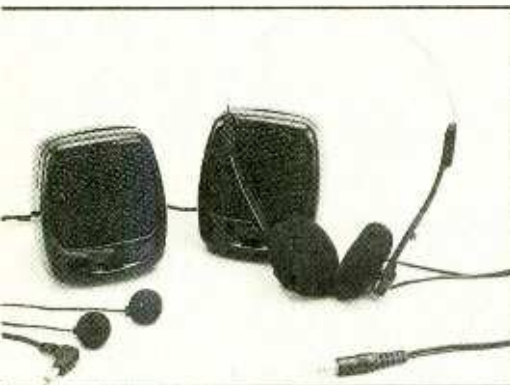

Speaker Assortment Pack

Speaker Assortment Pack

Give your personal radio, cassette player, or CD player a versatility boost with the *Stereo 3 Pack* from *Jasco Products Company, Inc.* (P.O. Box 466, Oklahoma City, OK 73101). The package includes a pair of headphones, a pair of bud-style earphones, and a pair of speakers, allowing you to make your music as public or private as you like. Price: \$9.99.

Shut Up!

What would a 35-mm camera say if it could talk? Now we know. *Polaroid Corp.* (575 Technology Square, Cambridge, MA 02139) has introduced the *Talking Sidekick*. The camera features a built-in pre-programmed integrated circuit that says such supposedly humorous expressions as "Smile and say cheese!", "C'mon look happy!", and "Smile! It'll be over in a flash!" Because the single-use camera is meant to be thrown away after its 24 exposures are taken, you won't have to listen to it for long. Price: \$14.95.

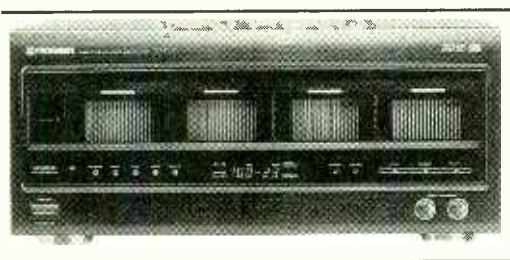

Pioneer 100-Disc Changer

One-Hundred CD's

If you are getting tired of swapping CD's in and out of your system, consider the *PDF-100* from *Pioneer Electronics* (2265 East 220th Street, Long Beach, CA 90801). The changer is equipped with trays that hold up to one hundred of your favorite discs. Four vertical disc trays makes loading easy, and allow the player to be integrated into a stacked home-entertainment system. Discs can be grouped into three different listening categories, and three different play modes allow random sampling of various discs and tracks. An anti-resonant, honeycomb chassis with large insulators helps to eliminate the effects of external shock and vibration. Price: \$715.

Build a Digital Clock

Since Man's earliest days, he has searched for ways to mark the passage of time. One of the first methods used to tell time was to observe the sun's position, at least during daylight hours. At night, the stars were used to tell time. Later on, people figured out better ways of measuring time, such as pouring sand through an hourglass, but that wasn't very accurate. At some point, mechanical clocks were devised; some of those would monitor the passing of time using gravity power, and others would use a steel spring.

More recent technology has given us quartz clocks that keep time by counting the number of oscillations-per-second of a quartz crystal. The crystal has two electrodes attached to it that are used to place a voltage across it. The voltage causes the crystal to oscillate at a high, but very precise frequency. The frequency of a crystal's vibration is determined by its size, shape, and the type of quartz it's made of.

A crystal's oscillation produces a voltage that rises and falls with each oscillation. The frequency of the voltage is measured in cycles per second or "hertz." For example, if a voltage rises and falls ten times a second, we would say that the frequency is 10 hertz. If the voltage rises and falls 100 times a second, then the frequency is 100 hertz. However, when we have a frequency of 1000 hertz, we call it 1 kilohertz (kilo meaning that we multiply by 1000). One million hertz is referred to as 1 megahertz, and one billion hertz is called 1 gigahertz. The abbreviations for those units are Hz, kHz, MHz, and GHz, respectively.

A Quartz-Clock Project. In this article we'll describe a *24-Hour Digital Clock* that you can build. In addition to getting an attractive conversation piece, the advantage of building this project is that it can help you to better understand some of the basic principles of digital electronics. That makes it excellent for someone with limited electronics experience looking to tackle a more advanced project.

Our 24-hour clock uses a 3.579545-

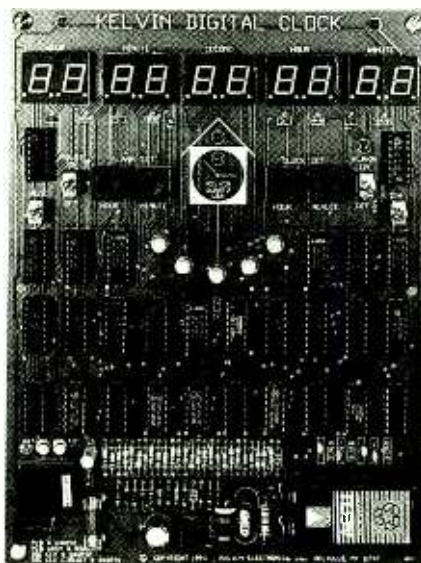

Learn about digital electronics as you build this fascinating and useful conversation piece.

BY MARC SPIWAK

megahertz crystal, which is the standard frequency for time keeping in minutes; we'll see why later on. The clock is available as a kit from the source mentioned in the Parts List. The kit includes a silk-screened PC board that adds to the finished appearance of the clock. Foil patterns for the double-sided board are also provided here if you want to make your own board, but due to space considerations they are shown at half size (more on that later).

The only thing you'll have to master to tell time on this clock is the 24-hour time format, where there is no AM or PM. The day starts at 00:00 (midnight). After it reaches 12:59, it changes to 13:00. It then advances to 14:00, 15:00, and so on, to 23:59 (which is 11:59 PM), and then back to 00:00. You'll quickly get the hang of telling the time on this clock, and the novelty of building it yourself makes it all worthwhile.

The Clock's Features. The clock

shows the time in hours, minutes, and seconds, in the 24-hour format, across the top left of the display on six 7-segment LED's. The clock also has an alarm, and the time that the alarm is set to is constantly displayed on the right side of the display on four 7-segment LED's. Only four digits are needed for the alarm, because you never have to set the seconds for the alarm time. If the alarm switch on the front panel is turned on, and the time display matches the alarm display, the alarm buzzer will sound for exactly one minute.

The clock is powered from a 9-volt AC-to-DC adapter, which also recharges a built-in 9-volt backup battery to maintain time in the event of a power failure. There's also a switch on the front of the clock that turns power on and off.

Two pushbuttons are used to set the time: one advances the hours display and the other advances the minutes display. Another two pushbuttons are used in the same way to set the alarm time. A toggle switch lets you make the display bright or dim.

An unusual feature of this clock is the "electronic pendulum." This circuit uses five bi-color LED's to simulate the effect of a pendulum swinging back and forth. A speaker mounted on the back of the board makes an accompanying tick-tock noise. This feature can be turned off if desired.

One last feature is an external switch output that can be used to trigger something else when the alarm goes off. We'll talk more about it later on.

How it Works. Take a look at the main schematic of the clock in Fig. 1. Power is brought in at jack J1 from the 9-volt AC-to-DC adapter, where it charges 9-volt battery B1. (Note that B1 must be a rechargeable 9-volt battery.) If switch S9 is closed, power is supplied to the rest of the circuitry.

Crystal XTAL1 oscillates at 3.579545 megahertz. Its oscillating voltage is fed into an MM5369 frequency divider, U24, which is set up to generate a 60-Hz signal. It does that by dividing the 3.579545-megahertz signal by

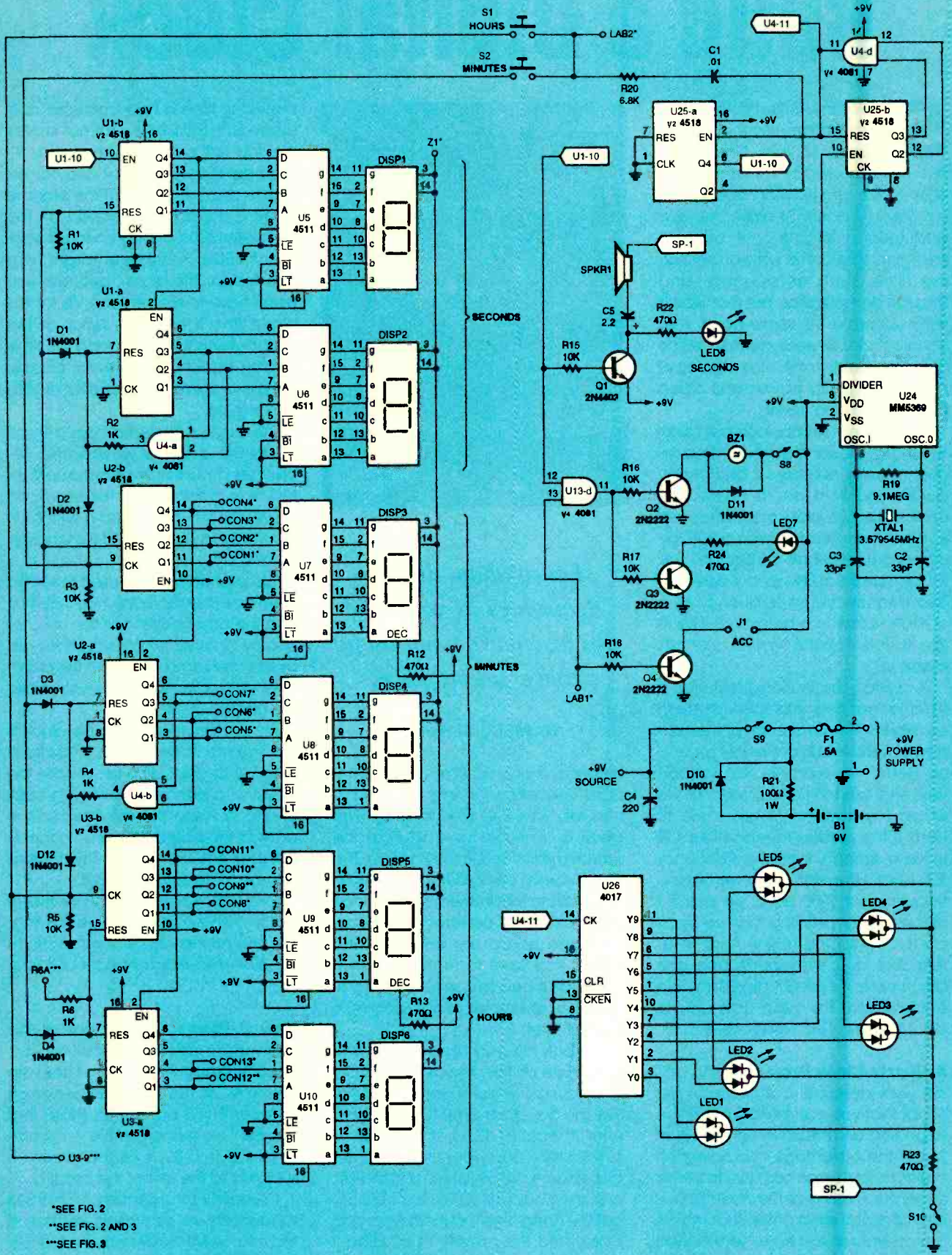

*SEE FIG. 2
 **SEE FIG. 2 AND 3
 ***SEE FIG. 3

Fig. 1. This is the main schematic for the Digital Clock. Note that the clock shows time in the 24-hour format.

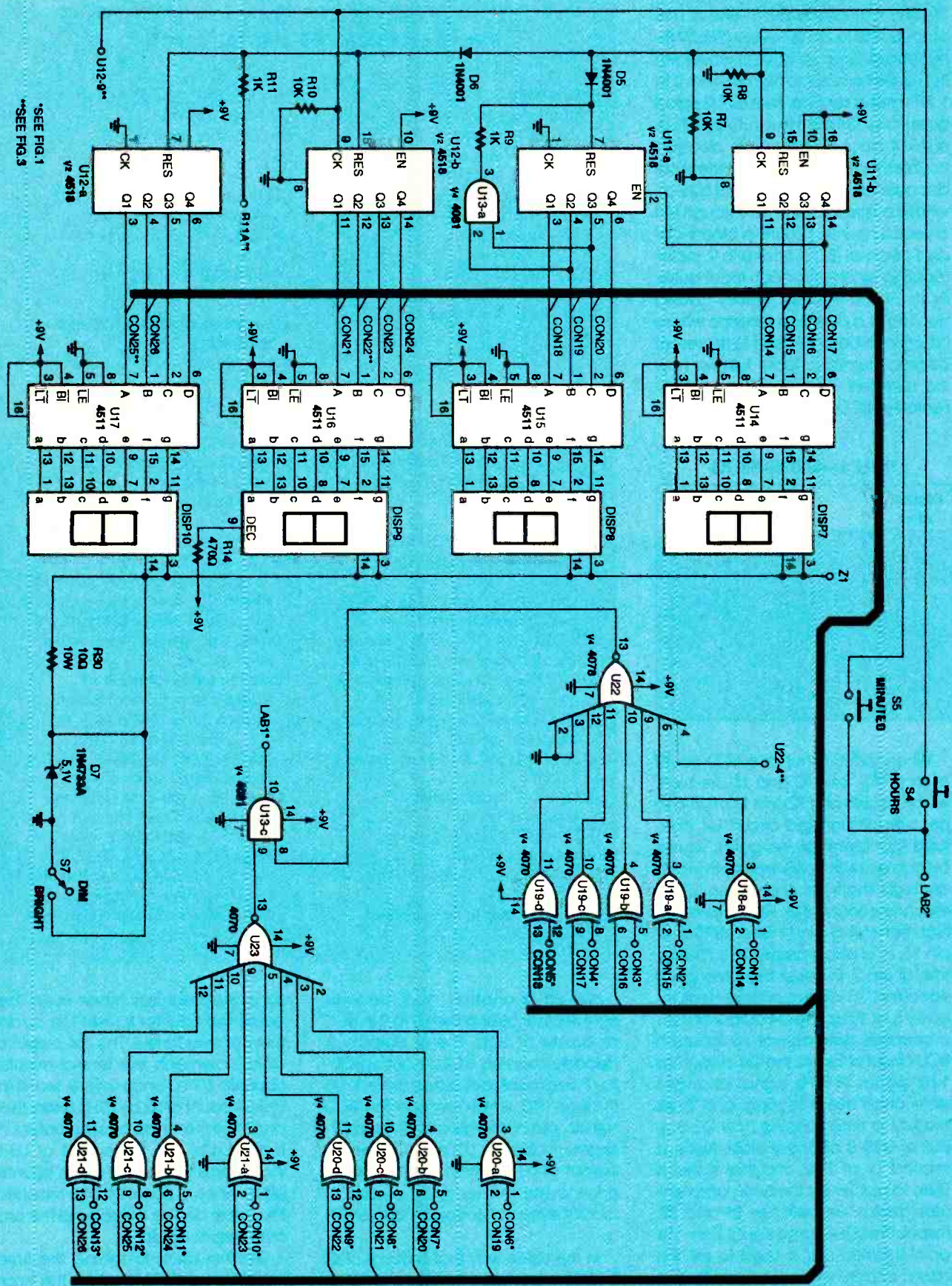

Fig. 2. The alarm circuitry is shown here. When the alarm time matches the actual time, the buzzer sounds for one minute.

*SEE FIG. 1
**SEE FIG. 3

59,659; that equals 60. In effect, U24 outputs one pulse for every 59,659 input pulses. Now we have a waveform that goes from low to high, or from 0 to 1, 60 times a second. That 60-Hz signal goes from U24 pin 1 to pin 10 of U25-b, a 4518 dual synchronous decade counter. That IC contains two identical decade counters (U25-a and U25-b), whose outputs (labeled Q1 through Q4 on each counter) count in binary-coded decimal (BCD) from 0 to 9, incrementing by one for each input pulse. As its name implies, binary-coded decimal is a counting scheme where binary numbers are used to represent decimal numbers. Table 1 shows how the numbers 0 through 9 are represented in BCD.

TABLE 1—BCD NUMBERS

Decimal Value	BCD Number			
0	0	0	0	0
1	0	0	0	1
2	0	0	1	0
3	0	0	1	1
4	0	1	0	0
5	0	1	0	1
6	0	1	1	0
7	0	1	1	1
8	1	0	0	0
9	1	0	0	1

When U25-b reaches a BCD count of six (0110), pins 12 and 13 are high, which causes pins 12 and 13 of U4-d to go high. Integrated-circuit U4 contains four identical AND gates, whose outputs go high only when both inputs are high; that's the case when U25-b reaches a count of six. At that time, the high from U4-d pin 11 resets U25-b at pin 15, and also increments U25-a by one at pin 2. In effect then, the clock signal for U25-a is equal to 60-Hz divided by 6, or 10 Hz. The Q4 output of U25-a changes state only once for each BCD count of ten, so the Q4 output is a 1-Hz signal. A 1-Hz signal changes state once every second, and that's the key to time keeping. The Q2 output of U25-a changes state twice a second, or at 2 Hz, and that signal is used to quickly set the hours and minutes display via switches S1 and S2, respectively. The same signal, from the point labeled LAB2, is used to set the alarm display, which we'll get to in a bit.

The 1-Hz signal from U25-a pin 6 is used to clock the seconds counter, U1-

PARTS LIST FOR THE DIGITAL CLOCK

RESISTORS

(All resistors are 1/4-watt, 5%, unless otherwise noted)

R1, R3, R5, R7, R8, R10, R15–R18—10,000-ohm
 R2, R4, R6, R9, R11—1000-ohm
 R12–R14, R22–R24—470-ohm
 R19—9.1-megohm
 R20—6.800-ohm
 R21—100-ohm, 1-watt
 R25, R27—300-ohm
 R26, R28—2.2-megohm
 R29—not used
 R30—10-ohms, 10-watt

CAPACITORS

C1, C6–C9—0.01- μ F, ceramic-disk
 C2, C3—33-pF, ceramic-disk
 C4—220- μ F, 25-WVDC, electrolytic
 C5—2.2- μ F, 25-WVDC, electrolytic

SEMICONDUCTORS

U1–U3, U11, U12, U25—4518 dual synchronous decade-counter, integrated circuit
 U4, U13—4081 quad, 2-input, AND gate, integrated circuit
 U5–U10, U14–U17—4511 7-segment decoder/driver, integrated circuit
 U18–U21—4070 quad, 2-input, XOR gate, integrated circuit
 U22, U23—4078 8-input, NOR gate, integrated circuit
 U24—MM5369 divider, integrated circuit
 U26—4017 decade-counter, integrated circuit
 U27—4027 dual J-K flip-flop, integrated circuit
 U28—4013 dual D-type flip flop, integrated circuit
 U29—556 dual timer, integrated circuit

D1–D6, D10–D12—1N4001 diode
 D7—1N4733 diode
 D8, D9—not used
 Q1—2N4403 transistor
 Q2–Q4—2N2222 transistor
 LED1–LED5—Bi-color common-cathode light-emitting diode
 LED6–LED10—Red light-emitting diode
 DISP1–DISP10—7-segment LED display

ADDITIONAL COMPONENTS AND MATERIALS

S1, S2, S4, S5—SPST pushbutton switch
 S7–S10—SPST miniature toggle switch
 XTAL1—3.579545-MHz crystal
 P1—Coaxial AC-adaptor socket
 F1—0.5-amp fuse
 BZ1—Miniature, PC-mount DC buzzer
 B1—9-volt rechargeable battery
 SPKR1—8-ohm speaker
 PC board, 9-volt, 500-mA AC-to-DC adapter, IC sockets, PC-mount fuse clips, 9-volt battery holder, double-sided tape, speaker, wire, solder, hardware, etc.
 Note: The following items are available from Kelvin Electronics (10 Hub Drive, Melville, NY 11747; Tel. 800-645-9212 or 516-756-1750; Fax 516-756-1763): Digital Quartz Clock Kit (everything you need including rechargeable 9-volt battery), \$89.95; assembled and tested Digital Quartz Clock, \$139.95. Add 5% for shipping and handling (\$5.00 minimum shipping charge). NY residents add appropriate sales tax.

b, which is another dual decade counter that counts from 0 to 9 in BCD at a rate of 1 Hz. The Q outputs of decade counters U1–U3 control BCD-to-7-segment decoder/drivers U5 through U10, which decode the BCD signals into numerals and drive the 7-segment displays, LCD1–LCD6. The Q4 output of U1-b, which changes state once every ten seconds, is used to clock the tens-of-seconds counter, U1-a.

In the same way that a count of six by U25-b was used to increment U25-a, a count of six by U1-a resets itself and increments the minutes counter, U2-b, via AND-gate U4-a. The count of

six is reached but never seen, because the counter is reset too quickly for your eyes to see. The Q4 output of U2-b increments the tens-of-minutes counter, U2-a, once every ten minutes. A count of six by U2-a resets itself and increments the hours counter, U3-b, via U4-b. The Q4 output of U3-b increments the tens-of-hours counter U3-a. When a count of 24 is reached, the entire display is reset and the process begins again.

Getting back to setting the time, pressing switch S1 provides the hours counter U3-b with a 2-Hz clock signal at pin 9 to quickly advance the hours. Likewise, S2 provides the minutes

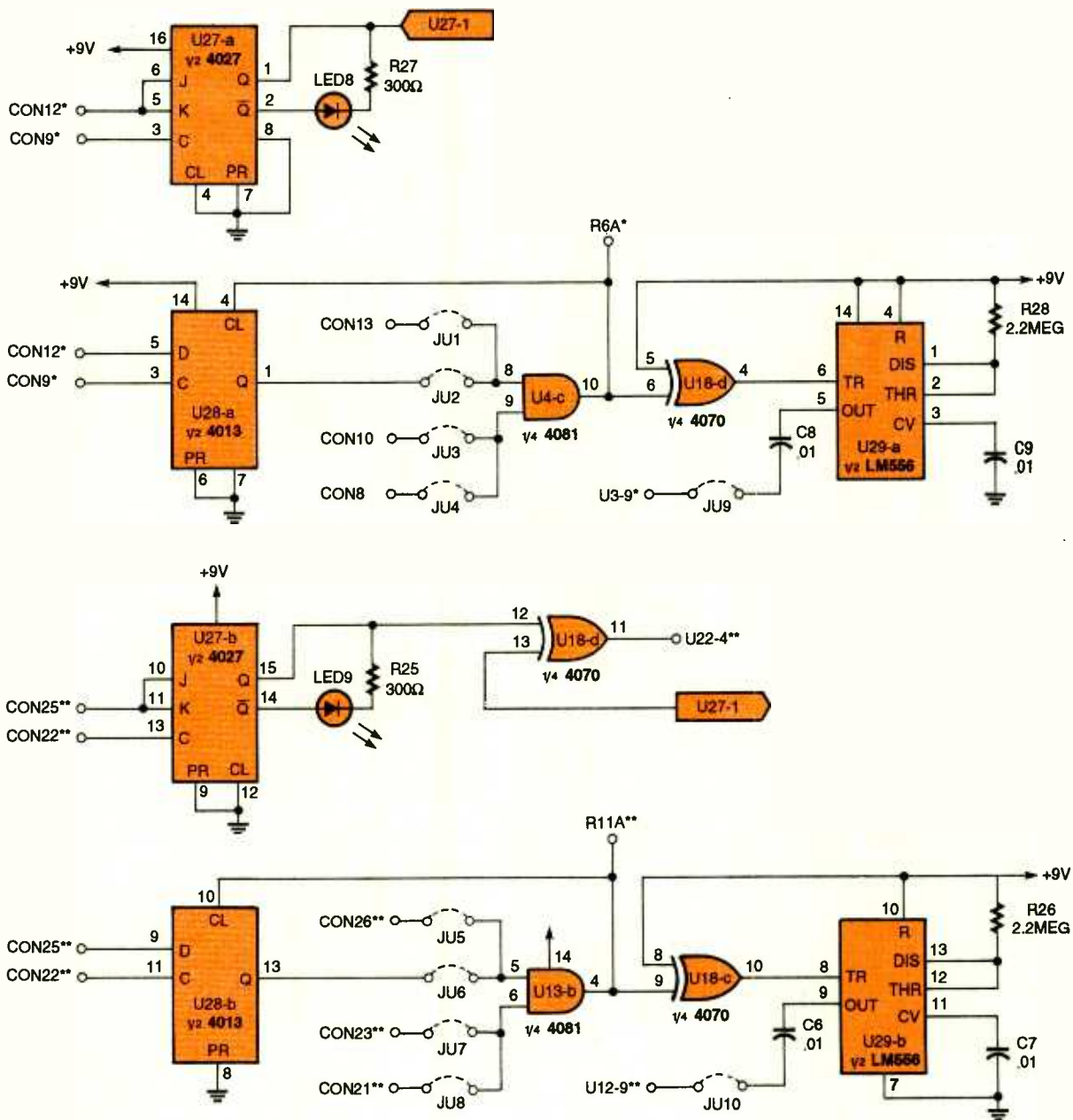

Fig. 3. This is the circuit that enables 24-hour operation. Note that jumpers J1, J3, J5, and J7 must be installed.

counter, U2-b, with the same signal to set the minutes display. Transistor Q1 turns the seconds-indicator, LED6, on and off from the 1-Hz signal at U1-b pin 10. That single LED flashes to indicate seconds.

One input to AND-gate U13-d is tied to the 1-Hz signal from U1-b pin 10, and the other input is tied to a signal that comes from the alarm circuit (which we'll get to in a minute). When the alarm signal at U13-d pin 13 is high, and the 1-Hz signal at pin 12 is high, the output of U13-d at pin 11 goes high. That turns transistors Q2 and Q3 on and off at 1 Hz. Those transistors

drive the alarm buzzer BZ1 (if S8 is closed) and alarm-indicator LED7 on and off at 1 Hz. If S8 is open, LED7 will flash for one minute when the time reaches the alarm setting, but the buzzer will not sound.

Transistor Q4 is used as an external switch output. That output, at J1, can be used to trigger some other device when the alarm goes off. The electronic pendulum consists of U26, which drives five bi-color LED's (LED1-LED5). If S10 is closed, the pendulum will sweep back and forth and the speaker will emit its tick-tocking sound. Because bi-color LED's are

used, the pendulum swings red in one direction and green in the other.

Now take a look at the alarm circuit shown in Fig. 2. The alarm-display circuitry is very similar to the time-display circuitry, except that the seconds are missing and that there is no steady clock signal. The only way to change the alarm display is via switches S4 (hours) and S5 (minutes), which get a 2-Hz signal from LAB2 in Fig. 1.

Notice the exclusive-or (XOR) gates contained within U18, U19, U20, and U21 (each chip contains four gates). An XOR gate's output will go high only when one or the other but not both of

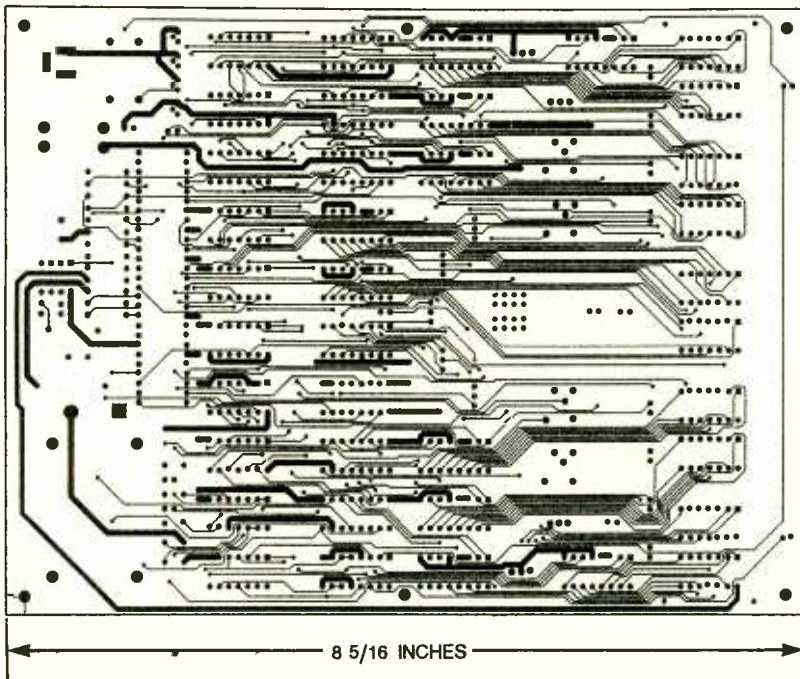

Fig. 4. The component side of the double-sided PC board is shown here half size.

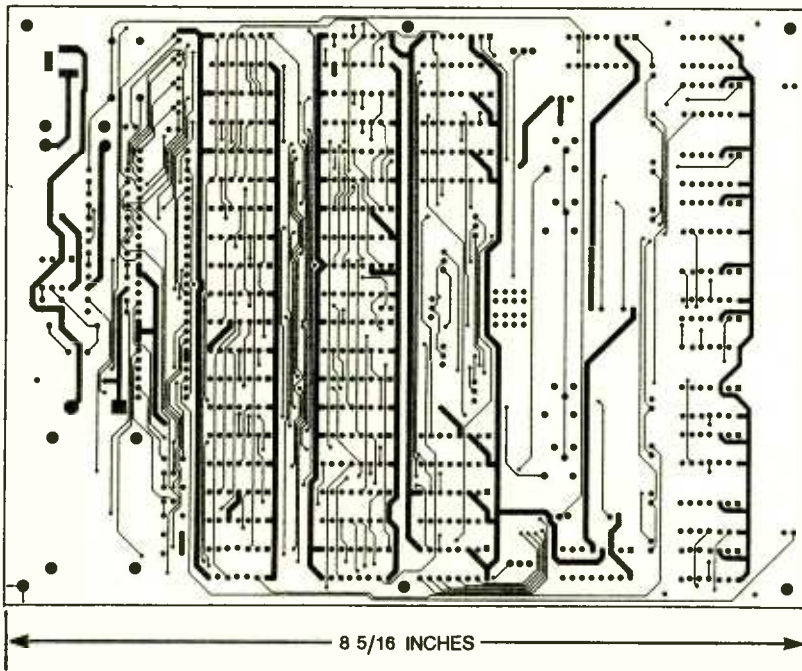

Fig. 5. Here's the solder side of the Digital Clock's PC board. Again, it is shown here half-size for space reasons.

its inputs are high. As such, their output will always be low if the two inputs match, regardless of whether the inputs are high or low. One input of each XOR gate is tied to the time display at points marked CON1–CON13 in Fig. 1. The other input of each gate is tied to the alarm display at points marked CON14–CON26 in Fig. 2. When both the time display and the

alarm display match, the outputs of all of the XOR gates go low.

The outputs of the XOR gates are tied to the inputs of two 8-input NOR gates, U22 and U23. A NOR gate's output will go low if any of its inputs are high, but will be high if all inputs are low. When the time display and alarm display match, all of both NOR gate's inputs are low, and so their outputs are high. The

two high outputs from the NOR gates cause AND-gate U11-c's output to go high at point LAB1, which is used in Fig. 1 to drive the buzzer and alarm LED. The remaining circuitry, shown in Fig. 3, enables 24-hour operation. Note that jumpers J1, J3, J5, and J7 must be installed, as shown.

Construction. Regardless of whether you purchased the clock as a kit or are building it from scratch, the first thing you should do is to identify and account for all of the parts. Check off everything in the Parts List to be sure you've got everything.

The PC pattern for the component side of the board is shown in Fig. 4; the solder side of the board is shown in Fig. 5. Note that for space considerations, those boards are shown half size. Use the parts-placement diagram in Fig. 6 and the silk-screen on the PC board (if you bought the kit) to locate the components. The Parts List is arranged in an order that makes component identification easy, but we'll be installing the parts on the board in an order that makes handling the board and inserting the components as easy as possible.

Install the following 10,000-ohm resistors on the board: R1, R3, R5, R7, R8, R10, and R15–R18. Install 1000-ohm resistors R2, R4, R6, R9, and R11. Install 470-ohm resistors R12–R14 and R22–R24. Install 2.2-megohm resistors R26 and R28, and 300-ohm resistors R25 and R27. Last install a 9.1-megohm resistor at R19, a 6.8K resistor at R20, and a 100-ohm resistor at R21. (If you are looking at the silkscreened board included in the kit, do not install anything at the R29 location.)

Now install the following 1N4001 diodes: D1–D6 and D10–D12. Pay careful attention to the polarity of each diode. Install a 1N4733 diode at the D7 location. (If you're using the board included in the kit, D7 is installed with its banded end opposite the silkscreen marking on the board.)

Install 33-pF ceramic-capacitors C2 and C3, and 0.01- μ F ceramic-capacitors C1 and C6–C9. Install 2.2- μ F electrolytic-capacitor C5 with its positive lead facing the upper edge of the board. Install 220- μ F electrolytic-capacitor C4 with its positive lead on the left.

Install 2N2222 transistors Q2–Q4 and 2N4403 transistor Q1. With the tab

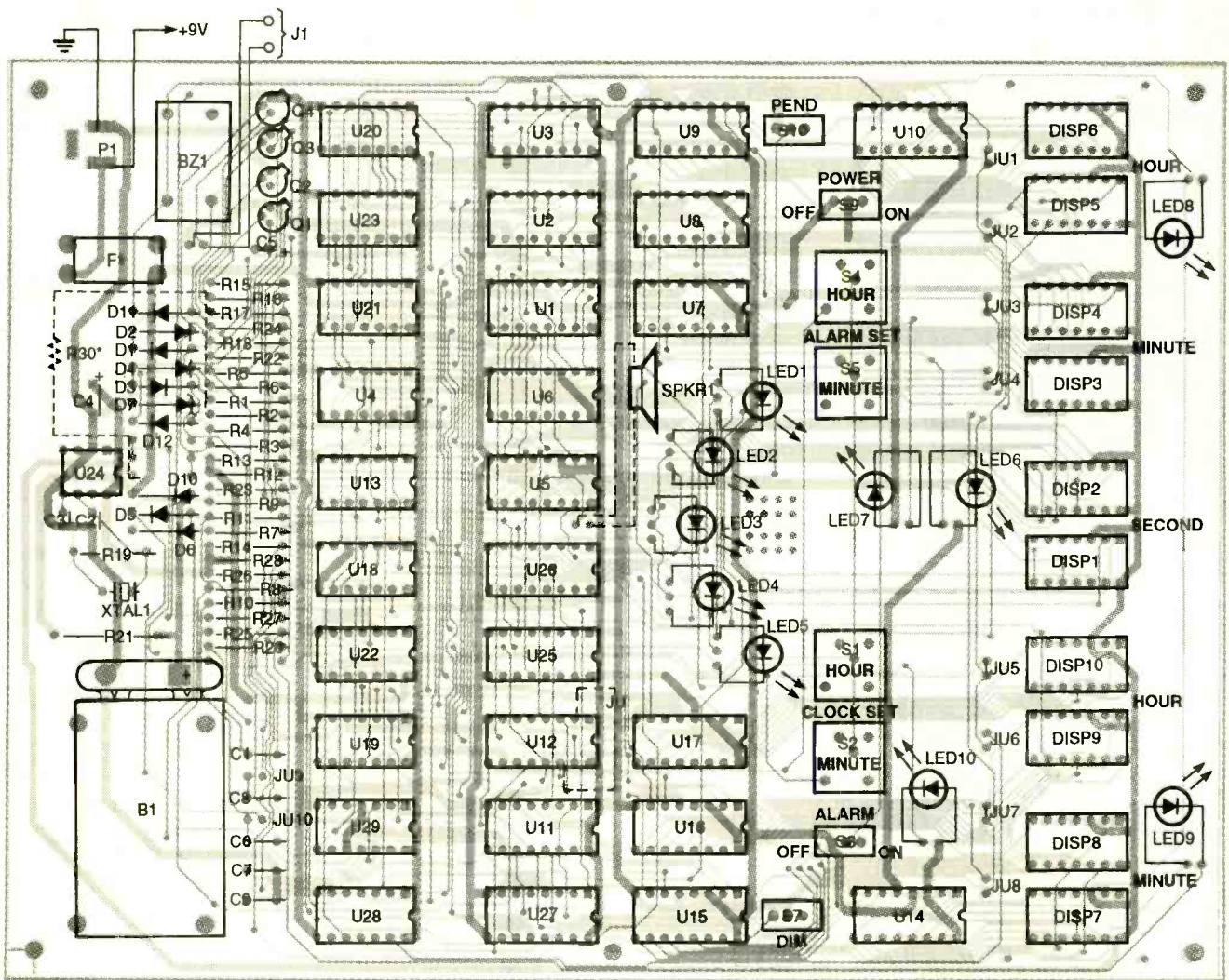

*SEE TEXT

Fig. 6. Use this parts-placement diagram when mounting the parts to the PC board. Pay careful attention to polarized components. Note that R30 and a jumper mount on the back of the board.

on each transistor in the 10-o'clock position, the leads will fit properly into place.

Install two fuse clips at the F1 location. Position the clips so that the fuse can be properly inserted. Insert a 1/2-amp fuse after soldering. Install AC-adaptor socket P1 with the hole facing the circuit-board's edge.

Install the five small red LED's (LED6-LED10). Pay attention to the orientation of each one. Install the five bi-color LED's in the pendulum area. Install buzzer BZ1 with the arrow on its plastic body pointing toward F1.

Install 16-pin IC sockets in the following locations: U1-U3, U5, U7-U12, U14-U17, and U25-U27. Be sure to point the notch on each socket toward the display end of the board. Do not insert the IC's into their sockets yet.

Install 14-pin IC sockets at the following locations: U4, U13, U18-U23, U28, and U29. Be sure to point the notch on each socket toward the display end of the board. Do not insert the IC's into their sockets yet.

Install an 8-pin IC socket at the U24 location. Be sure to point the notch on the socket toward the display end of the board. Do not yet insert the IC.

Install ten 7-segment LED displays along the top of the board at locations DISP1-DISP10. Make sure the decimal points face toward the IC sockets. Install the four pushbutton switches (S1, S2, S4, and S5). They will only fit one way. Also install the four toggle switches for the PENDULUM (S10), POWER (S9), ALARM (S8), and DIM (S7) functions.

Carefully bend crystal XTAL1's leads

to fit the holes in the board and solder it in place. Mount the battery holder to the board with double-sided tape and then solder the leads.

Now insert the following IC's into their proper sockets: a 4511 at U5-U10, U14, U15, and U17; a 4027 at U27; a 4518 at U1-U3, U11, U12, and U25; a 4017 at U26; a 4013 at U28; a 556 at U29; a 4070 at U18-U21; a 4078 at U22 and U23; a 4081 at U4 and U13; and a 5369 at U24. Be sure to match the pin-1 markings (a notch or dot on the chip) to those shown in Fig. 6. Pin 1 of all IC's should face the display end of the board. Be careful not to bend any of the pins under the body of the chip when inserting them into their sockets.

Install a wire jumper at J1, J3, J5, and J7. You can use pieces of scrap

(Continued on page 91)

Build a

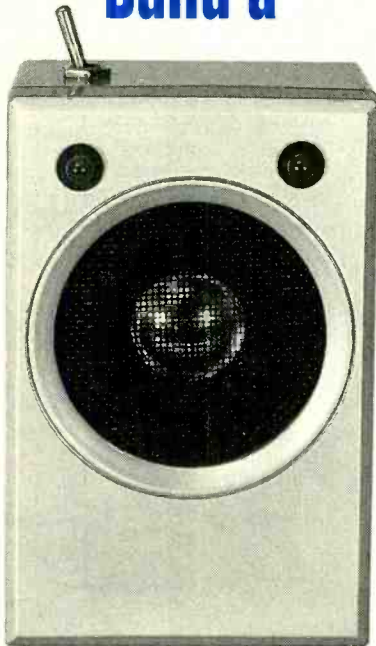

Packet-Radio Tuning Indicator

Tune HF packet transmissions dead-on with this simple and inexpensive indicator.

BY BRIAN PLILER, KF0WD

If your HF packet modem lacks even a simple tuning indicator, and you've wanted to build one, then the tuning indicator described here might be just what you've been waiting for. The unit has two jumbo, red LED's—one representing the "mark" frequency and the other representing the "space" frequency—which blink alternately in the presence of a properly tuned packet signal. All you do to use the tuning indicator is simply tune your receiver until the two LED's blink with equal brightness. That's it! The unit just connects to the receiver's external speaker jack and is powered from 12 volts DC. Therefore, no modifications to the receiver are necessary.

About The Circuit. Looking at the schematic diagram in Fig. 1, you will see that the tuning indicator is based on a pair of common tone-decoder IC's (U1 and U2). One tone decoder is tuned for a frequency of 2025 Hz and the other to 2225 Hz. Respectively, those are the mark and space frequencies for 300-baud amateur packet radio on the HF bands below 30 MHz. Since the operation of both tone decoders is identical except for the operating frequency, only the one based on U1 will be discussed in this article.

Audio is supplied to the circuit via plug PL1, which is inserted into the receiver's external speaker or headphone jack. Panel-mounted jack J1 allows for the connection of a packet modem or external speaker. Switch S1-b (the second half of the power switch) is used to silence the projects

internal speaker when the unit is turned off. However, it does not affect the operation of jack J1.

Receiver audio is coupled to the tone decoder IC, U1, by C1. That capacitor passes audio signals while blocking any DC present, preventing damage to the input stage of the tone decoder. The decoder IC constantly compares the receiver's audio to the decoder's free-running frequency of 2025 Hz. If at any time a 2025-Hz signal is present in the receiver's audio, pin 8 of the tone decoder instantly goes low, lighting LED1.

The free-running frequency of the tone decoder is determined by the following formula:

$$f_o = 1/RC$$

where f_o is the free-running frequency of the tone decoder, R is equal to the resistance between pins 5 and 6, and

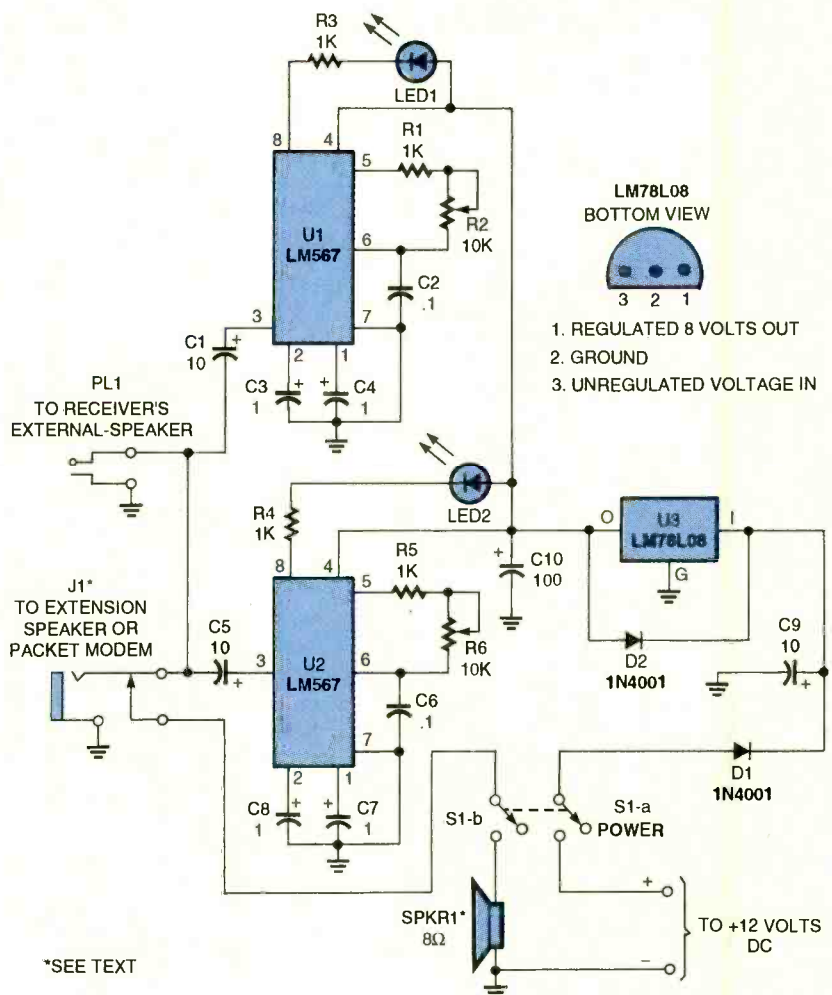
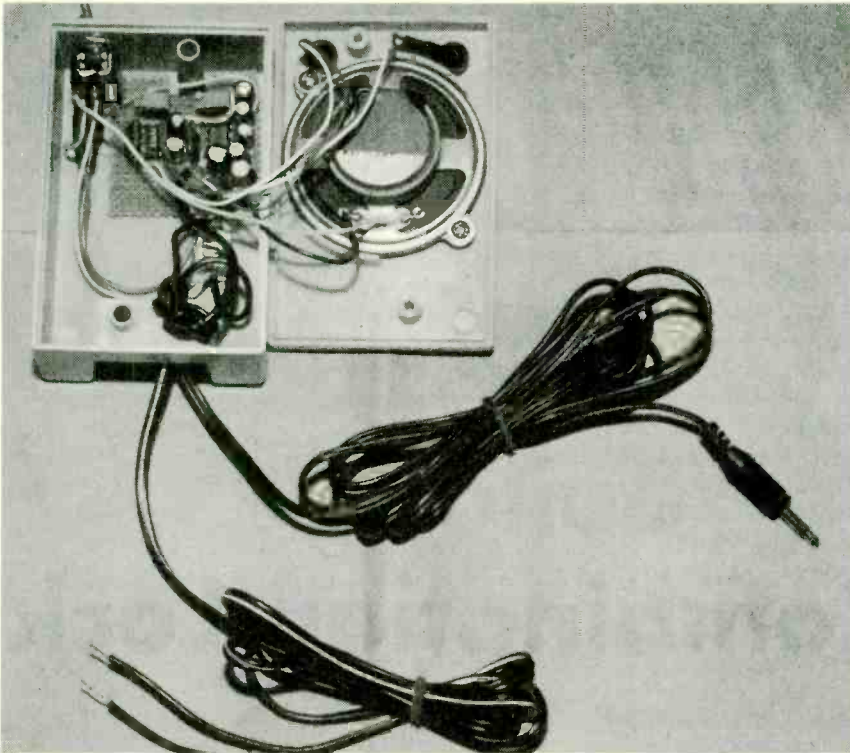

Fig. 1. The Tuning Indicator is simply two identical tone decoders adjusted to different frequencies that share a power supply. When a decoder receives a signal of the right frequency, it lights its LED.



All the circuitry for the Indicator fits in a small personal-stereo extension-speaker enclosure. The speaker driver and wire that came with the extension speaker were incorporated into the project so nothing was wasted.

PARTS LIST FOR THE HF PACKET TUNING INDICATOR

SEMICONDUCTORS

U1, U2—LM567 tone-decoder, integrated circuit
 U3—LM78L08 8-volt, 100-mA, voltage-regulator, integrated circuit
 D1, D2—1N4001 1-amp, 50-PIV, silicon diode
 LED1, LED2—jumbo, red, light-emitting diode

RESISTORS

(All fixed resistors are 1/4-watt, 5% units.)
 R1, R3—R5—1000-ohm
 R2, R6—10,000-ohm, PC-mount, multi-turn trimmer potentiometer

CAPACITORS

C1, C5, C9—10- μ F, 16-WVDC, electrolytic
 C2, C6—0.1- μ F, 16-WVDC, Mylar
 C3, C4, C7, C8—1- μ F, 16-WVDC, electrolytic

ADDITIONAL PARTS AND MATERIALS

S1—DPDT mini toggle switch
 SPKR1—8-ohm, 1/4-watt speaker (see text)
 PL1—plug to fit receiver (see text)
 J1—1/8-inch, normally closed, panel-mount jack
 IC sockets, led bezels, perfboard, wire, solder, enclosure, etc.

C is equal to the value of the capacitor connected between pin 6 and ground in farads. With the values shown in the circuit in Fig. 1, the tone decoder can be adjusted via potentiometer R2 to decode any tone from 1 to 10 kHz.

Capacitor C4 is for output buffering. Its value determines the amount of time the desired tone must be present before pin 8 goes low. Capacitor C3 determines the bandwidth of the tone decoder. If the received tone is outside the bandwidth limits, the tone will be ignored. The bandwidth of the

tone decoder can be approximated by the following formula:

$$BW = 1070 \sqrt{V_{in}/f_o C}$$

where V_{in} is the audio-input level to the tone decoder in volts, f_o equals the free-running frequency of the tone decoder in Hz, and C is equal to the value of the capacitor connected to pin 2 in microfarads.

With the values shown in Fig. 1, each tone decoder has an approximate bandwidth that's 10% of the center frequency with an audio-input level of 200 mV. However, if the audio input is

reduced to 100 mV, the bandwidth decreases to approximately 7 or 8%. Therefore, lower audio input provides the best performance. Never allow the audio to the decoder to exceed 200 mV as that can permanently damage the IC.

Power is supplied to U1 and U2 via U3, an 8-volt regulator IC. That allows the unit to be safely connected to a 12-volt DC supply, since applying more than 9-volts DC can destroy the decoder IC's. Diode D1 prevents damage from reversed power-supply polarity. Diode D2 is included to allow any charge stored in C10 to be safely routed around U3 when power is removed.

Construction. Since the circuit works with such low frequencies, it can be built on perfboard or experimenter's board. The author's prototype was built on a 1.5 x 1.5-inch piece of perfboard and mounted in the enclosure of a personal-stereo extension speaker. Follow the schematic in Fig. 1 to build yours.

After construction, the tone decoders will require calibration. For that you can use either an accurate frequency counter (the preferred method) or a stable function generator. To use a frequency counter, connect it to pin 5 on U1. Adjust R2 to get a reading of 2025 Hz on the frequency counter. Repeat the procedure on U2 using R6 to get a reading of 2225 Hz.

To use a frequency generator instead, connect it to PL1 and adjust it to produce a 2025-Hz, 100-mV signal. Now adjust R2 so LED1 just comes on. Note R2's position and continue rotating it until the LED just turns off. Adjust potentiometer R2 to midway between the points where the LED turned on and turned off. Repeat this procedure for the other tone decoder, setting the function generator to 2225 Hz and adjusting potentiometer R6 while noting the operation of LED2.

While the project was originally intended for use as a tuning aid for an amateur packet modem, by tuning the two decoders to other frequencies, the unit could be used as a RTTY tuning indicator instead. Furthermore, by changing the component values associated with pins 5, 6, and 7, the 567's can be tuned from 0.01 Hz up to 500 kHz!

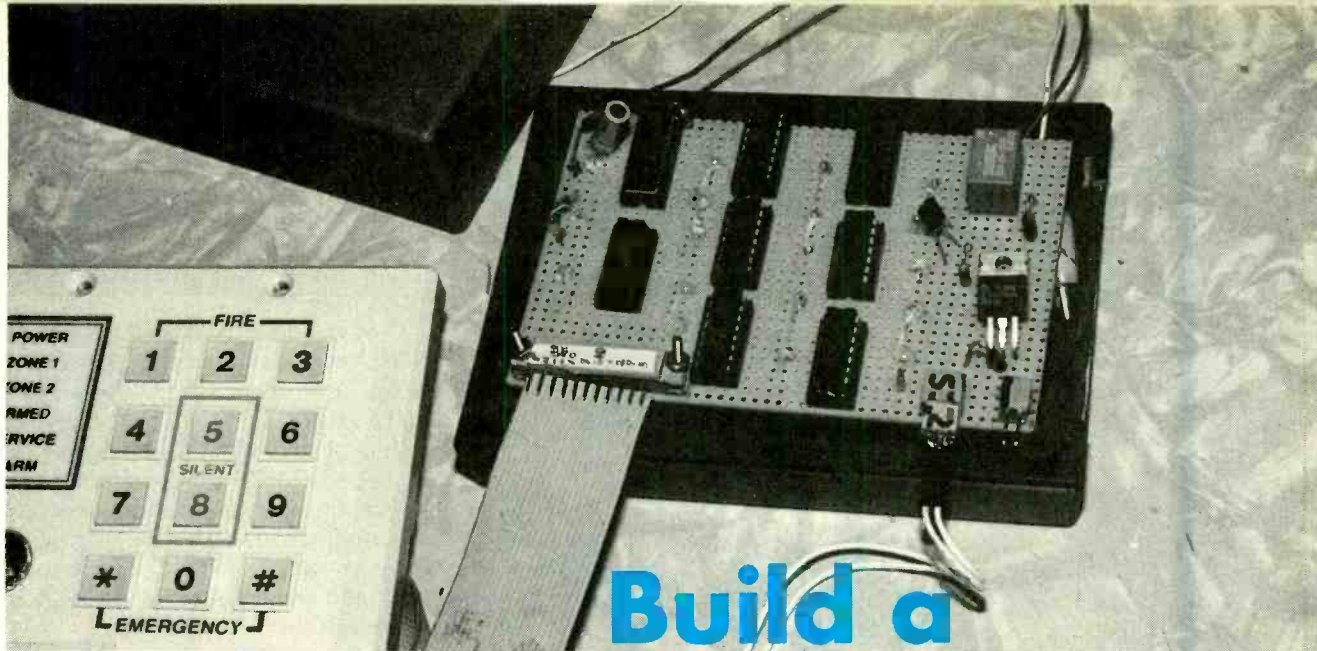

Build a Digital Combination Lock

Forget about fumbling for your keys with this keyless electronic entry system

BY JIM STEPHENS

It seemed that every time I wanted to go into my shop, which is located in a building separate from my house, I always had to go back to get the key. What I needed was either an infallible memory or a good electronic combination lock that would allow me to enter a code number from a keypad to open the door, yet let me unlock the door with a key if needed. The *Digital Combination Lock* described in this article does that.

About the Circuit. The schematic diagram of the Digital Combination Lock—which consists of 11 integrated circuits including a voltage regulator (assuming that you include the optional automatic reset circuit)—is shown in Fig. 1. At the heart of the circuit is U1 (a 74C922 CMOS keyboard encoder), whose job it is to interpret the input from the keyboard (a 16-key matrix keypad) and convert the signal into a 4-bit BCD code. That code is output at pins 14 through 17, and applied to U3–U5 (three 4042 quad clocked D-type latches).

Two other outputs of U1 at pins 12 and 13, the data-available (DA) and output-enable (OE), respectively, are fed to U2—a 4017 decade counter/

divider. Only three of U2's ten available outputs are used, each of which is fed to the clock input of one of the three 4042's (U3–U5). Those U2 outputs act as a sort of chip enable for the latches, so that only one latch at a time can act on the signal applied to its inputs. The latches are sequentially enabled, and each will maintain its output status even after its clock input has been deactivated; thus, it acts as a data retainer (or memory). The outputs of each latch are fed to its own 4-input AND gate (either directly or through an inverter).

The outputs of those AND gates are then fed to another 4-input AND gate (U8-b). Since there are only three D latches in the circuit, one input to U8-b is tied high (remember all inputs to an AND gate must be high in order for the output to go high). The high output from U8-b travels along two paths. In one path, the signal is fed to LED1 through R2, causing it to light. In the other path, the signal is fed to the base of Q1, turning it on. With Q1 turned on, power is applied to 12-volt relay K1, causing its normally open (NO) contacts to close. That feeds 12 volts to the solenoid (SOL1), which in turn opens the lock.

The circuit can be configured for manual reset (using S1) or automatic reset, using the subassembly built around U9 and U10 (a pair of 555 oscillator/timers), which are configured as monostable (one shot) multi-vibrators. The circuit is triggered by the emitter voltage of Q1.

Switch S1 is normally closed, grounded at end, and connected through a 2.2k pull-up resistor (R1) to the +5-volt source. Pressing S1 removes the ground, causing +5V to be applied to the counter reset input. When the switch is released, the counter is reset by the high-to-low transition. Since the reset line is also connected to the polarity pins of U3–U5, the momentary high-to-low transition causes the last number on the data bus to be latched into U3–U5 for security blanking.

The automatic-reset circuit performs in much the same manner as the manual switch. That is, U2 pin 15 is held low, via U10 pin 3. When Q1 turns on, a positive-going pulse is delivered to the base of Q2 (via C3 and R4), briefly turning it on. That causes C4 to quickly discharge through Q2, applying a trigger pulse to pin 2 of U9, causing the timing period ($t = 1.1R7C6$) to

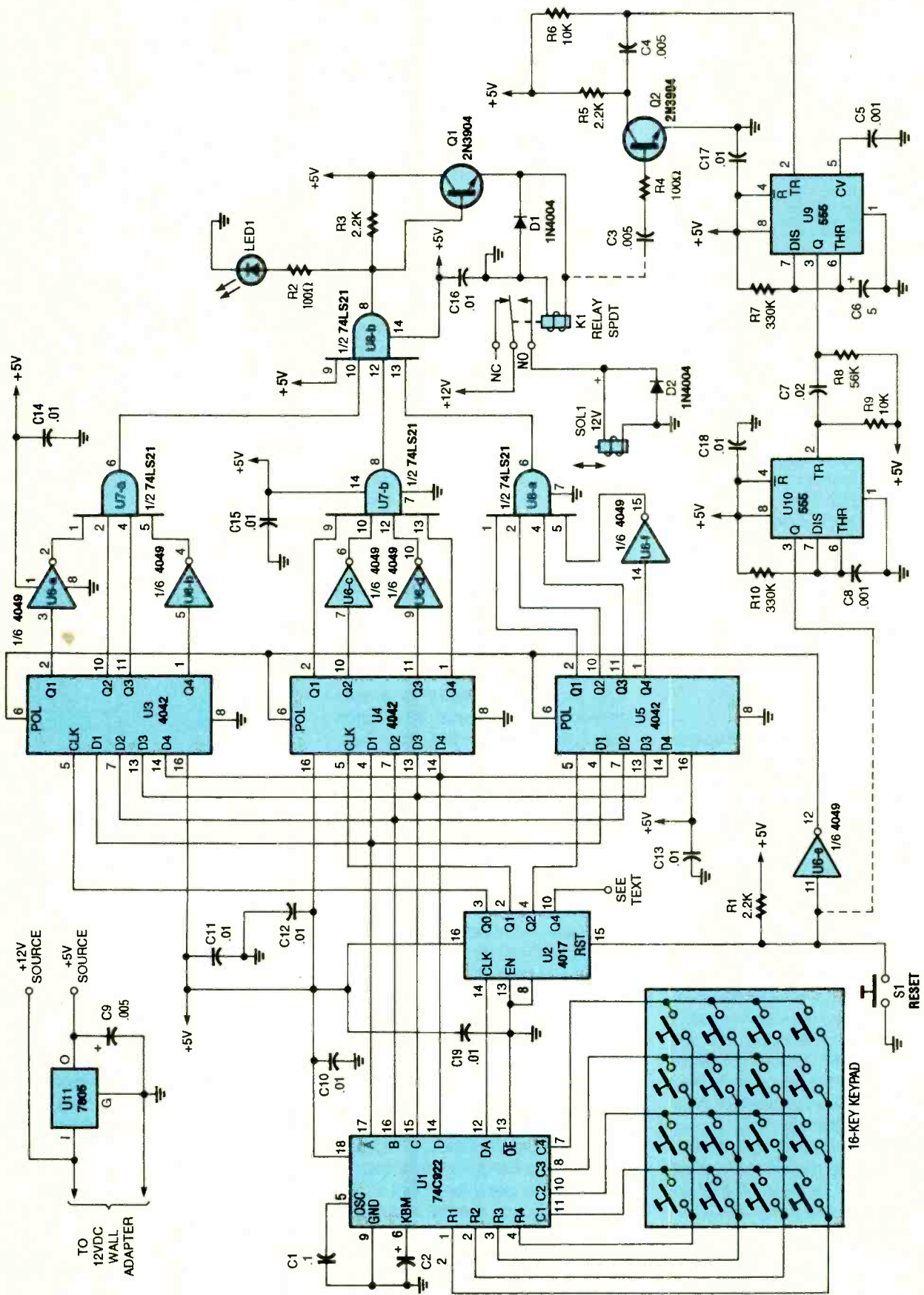

Fig. 1. The Digital Combination Lock—which consists of 11 integrated circuits including the voltage regulator—has at its heart a 74C922 CMOS keyboard encoder (U1), which interprets the input from the keyboard and converts the signal into a 4-bit BCD code.

TABLE 1—DECIMAL TO BINARY EQUIVALENTS

DECIMAL NUMBER	BINARY EQUIVALENTS			
	Q4	Q3	Q2	Q1
0	0	0	0	0
1	0	0	0	1
2	0	0	1	0
3	0	0	1	1
4	0	1	0	0
5	0	1	0	1
6	0	1	1	0
7	0	1	1	1
8	1	0	0	0
9	1	0	0	1

begin. At the end of U9's timing period, its output at pin 3 triggers U10, causing its timing period to begin. At the end of the timing period, its output goes high, resetting U2. If the automatic reset circuit is used, switch S1 can be eliminated.

Power for the circuit is derived from a 12-VDC, 1-amp wall adapter, and a 7805 5-volt three-terminal regulator. The 12-volt input to the regulator is tapped prior to application to U11, and is used to drive the solenoid through relay K1.

Code Selection. The activation code is selected by properly connecting of the latch outputs to the AND gates while the circuit is being wired. After your three-digit code has been chosen, connect the selected digit lines (those that will be at logical high for a valid input) from the latch directly to their associated gate inputs. The remaining unselected binary digits of the latch (those that will be at logical low for a valid input) must be inverted (in our circuit, using 4049 CMOS inverters) before they are connected to their associated gate inputs. That way, only the proper BCD code can create a high at the AND-gate inputs. Table 1 gives the binary equivalents of decimal numbers 1 through 9.

In order to produce a high at an AND gate's output (as mentioned earlier), all inputs must be high. If any unselected binary line is high, the inverters will produce a low, preventing the associated AND-gate output from going high.

As an example, let's take a look at the latch/AND-gate portion of circuit in

Fig. 1. Note that the circuit is wired to respond to an activation code of 697 (0110 1001 0111). Other entry-code numbers could easily be substituted by simply changing the connections as described above. For instance, if you wanted the first digit of your code to be 5 (0101 in binary), the Q1 and Q3 outputs (which represent the binary 1 and binary 4) of U3 would go directly to U7-a, and the Q2 and Q4 outputs (binary 2 and binary 8) would be inverted before going to the same gate. In other words, as pointed out earlier, any 0 output of the latch would have to be inverted. In fact, depending upon the code selected, you may find that you have to add another inverter IC to the circuit to initiate the selected code.

Code Expansion. A three-digit code may seem to some to be too-few digits to provide a truly secure system. After all, if the aspiring malefactor had the patience, he could enter all 1000 possible combinations until the code is broken. For that reason, the circuit is purposely made flexible enough so that it can be easily expanded by increasing the number of latches and associated gates.

For example, if a fourth digit were desired, an additional 4042 latch could be inserted in the circuit, with the data (D) inputs connected in parallel with the others and its clock input connected to the Q4 output of U2 at pin 10. Another AND gate would then be connected to the output of the additional latch, and the output of that AND gate would replace the +5-volt connection of U8-b at pin 9. You'll most likely also need to add an additional inverter IC to the circuit to initiate the selected code.

If you require more than a four-digit code, another dual 4-input AND gate would be needed, and it may be necessary to add non-inverting buffers (such as the 4050) at the output of the 74C922 to drive the data lines harder. Experimenting would quickly indicate if the BCD outputs of the 74C922 start to sag after adding, five, or six latches; you'd start to get intermittent wrong numbers through the latch outputs.

Assembly. The author's prototype of the circuit was assembled on a section of perfboard and wire-wrapped. It is recommended that sockets be pro-

PARTS LIST FOR THE DIGITAL COMBINATION LOCK

SEMICONDUCTORS

- U1—74C922 CMOS 16-key keyboard encoder, integrated circuit
- U2—4017 CMOS decade counter/divider, integrated circuit
- U3-U5—4042 CMOS 4-bit latches
- U6—4049 CMOS hex inverter, integrated circuit
- U7, U8—74LS21 dual 4-input AND gate, integrated circuit
- U9, U10—LM555 oscillator/timer, integrated circuit
- U11—7805 5-volt, 1-amp, voltage-regulator, integrated circuit
- LED1—Miniature light-emitting diode
- Q1, Q2—2N3904 (or 2N2222) general-purpose, NPN silicon transistor
- D1, D2—1N4004 1-amp, 400-PIV silicon rectifier diode

RESISTORS

- (All resistors are 1/4-watt, 5% units.)
- R1, R3, R5—2200-ohm
- R2, R4—100-ohm
- R6, R9—10,000-ohm
- R7, R10—330,000-ohm
- R8—56,000 ohms

CAPACITORS

- C1—0.1-μF ceramic-disc
- C2—2 μF, 16-WVDC, electrolytic
- C3, C4, C9—0.005-μF ceramic-disc
- C5, C8—0.001-μF ceramic-disc
- C6—5 μF, 16-WVDC, electrolytic
- C7—0.02-μF ceramic-disc
- C10-C19—01-μF ceramic-disc

ADDITIONAL PARTS AND MATERIALS

- K1—RD275-423 5-volt miniature relay
- SOL1—12-volt solenoid
- Perfboard materials, enclosure, 12-volt, 1-amp DC, wall adapter, 12-16 key keypad (see text), wire, solder, hardware, etc.

vided for all of the IC's to minimize the chance of heat damage. Sockets also help to make troubleshooting and replacement of defective components easier should that become necessary.

Although most of the components used in the circuit are readily available through local and mail-order suppliers, a few of them—namely U1, the 74C922 16-key encoder; SEN1, the solenoid; and the keypad—might be a little difficult to come by. The en-

(Continued on page 91)

ANTIQUE RADIO

By Marc Ellis

Testing the NBS Set

This month, we'll complete and test the "NBS" crystal set, a project that has been under construction for the last few months. Designed by the National Bureau of Standards in the early 1920's, it was intended to be a practical, easy-to-build, introductory broadcast receiver for the budding radio experimenter.

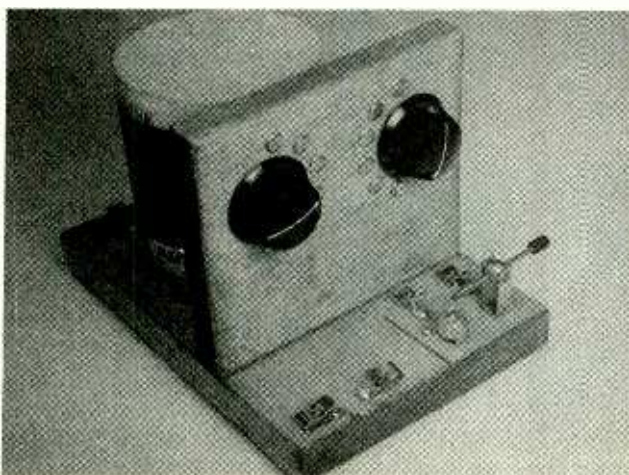

The front view of the completed NBS set. Modern switches are camouflaged with vintage knobs. The position indicators were made from brass-headed upholstery tacks.

In the May, 1994 column, we provided information on winding the NBS set's tapped tuning coil and passed along the original specifications for building the two required tap switches. My own version of this radio, I hastened to point out, would use a couple of rotary switches from Radio Shack.

Last month we completed all of the carpentry work, assembling the receiver's breadboard and front panel. I also mounted my switches and provided the specifications that would be needed by those adventurers desiring to

scratch-build the set's crystal-detector stand as suggested in the original construction article.

TAP TROUBLE

Now all we have to do is mount the few remaining parts and complete the wiring. But first, let's backtrack a bit. In last month's column I had suggested that, after cleaning the enamel coating off its tap connections, the coil could be permanently mounted in place. However, I hadn't yet actually performed those operations myself.

It turns out that removing the enamel is easier said than done. Some of the taps are so close together that it's hard to work between them. And, because the coil wire bends easily, the taps must be supported in some way while cleaning pressure is applied. I used a small wooden ruler to back up each tap as I rubbed or sanded.

I tried sandpaper, steel wool, and even some chemical stripper, but the results, at best, were disappointing. It probably would have been easier to sand off the taps, prior to forming them into loops, as the coil was being wound—although I didn't think it would be at the time.

Eventually, I exposed a reasonable amount of bare copper at each tap—enough so that a solder joint could be made. But because I thought the work might be difficult, I decided to solder the wire leads to the taps prior to mounting the coil. That way, at least, I'd have plenty of room to do the job.

In the end, I was able to make a decent joint at each tap. But in the process I probably burned off more of the enamel than I had been able to remove previously by sanding. And, believe me, the accompanying smell was quite pungent!

The leads were left extra-long, with the intent of cutting them to size as they were being wired to the tap switches. Although I could have mounted and wired the coil at this point, I decided to wait until all of the other set wiring was completed. By the way, the wire used to make all connections was a light gauge of bare, finned bus-bar stock that I happened to have on hand.

THE REMAINING WIRING

Before you can wire the rest of the set, you'll have to decide what kind of terminals to use for the antenna, ground, and headphone connections. I used Fahnestock clips because I had them on hand, they are authentic for the era, and they grip headphone tips very well.

Other options are home-made binding posts made from machine screws and nuts (suggested in the original NBS construction specifications), or commercially made binding posts—either replica or antique. Some of the commercial binding posts have holes in their shafts designed to accept phone tips.

The antenna and ground terminals are mounted at the two rear corners of the breadboard base (see the

plan view printed in last month's column). The antenna terminal is the one on the right as you face the radio. Run a wire from it, under the baseboard to a location just under the right-hand switch. Push the wire up through a small hole drilled in the baseboard at that location and bring it up to the switch.

Make a 180-degree bend in the wire just behind the switch, leaving enough slack prior to the bend so that you can (later) comfortably connect the wire to the switch's movable contact. Next feed the free end of the wire back down under the breadboard through the same hole. It will be connected to the arm ("cat's whisker" holder) of the crystal-detector stand, which you should now mount at the right-hand front corner of the board. If you've made your own stand, as per the "NBS" specs, capture the free end of the wire under the screw securing the arm hardware to the board.

If you're using a commercial stand, drill a hole near the appropriate terminal (usually a Fahnestock clip) on the stand so you can pass the wire up through it and connect it to the terminal. In my case, the wire was too fine to be secured by the clip. So I brought it up under, and through, the hollow rivet that was securing the clip to the stand and then soldered the wire into the rivet.

At this point, if you haven't done it already, you should mount the binding posts or clips you'll be using for the headphone terminals. These (see plan view) are installed at the front left-hand corner of the board. Run a wire under the board (drilling holes as necessary) from the crystal-holder terminal of the detector stand

to the right-hand headphone terminal.

Returning to the back of the breadboard, connect a wire to the ground (left-hand) terminal and run it under the board to a location just under the left-hand switch. Push the wire up through a hole drilled at that location, run the wire up to the switch and, as before, make a 180-degree bend in the wire at a location just behind the switch. Then, run the free end of

left-hand switch selects the taps that are six turns apart, which are numbered 1 through 6 on the same drawing.

As set up in the original specifications, both switches electrically shorten the coil as they are rotated downwards. That means that the right-hand switch, which is connected to the upper taps of the coil, consecutively selects taps lower and lower on the coil (VI through I, in that order) as it

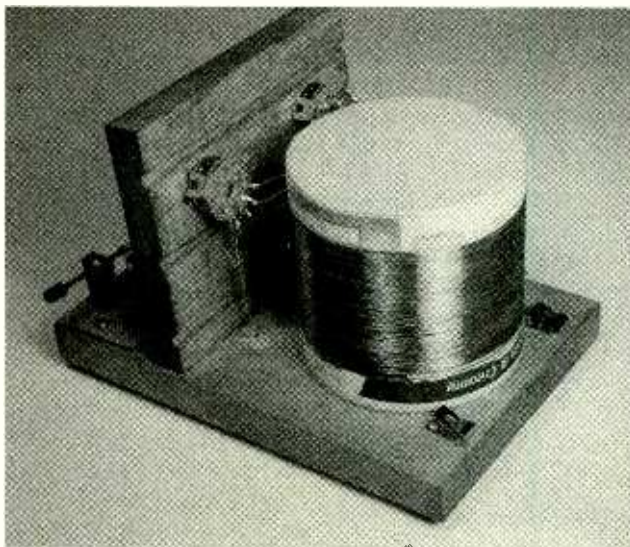

This three-quarter rear view shows some of the connections from the "coarse" tuning switch to the upper taps on the coil. Antenna and ground connections are at rear of baseboard.

the wire down through the same hole and under the breadboard to the remaining (left-hand) headphone terminal.

WIRING THE SWITCHES

The function of the two tap switches is to adjust the electrical length of the coil, thereby making it possible for the listener to tune in signals of different wavelengths. Per the original construction article, the right-hand switch is connected to select the taps that are 12 turns apart (designated by Roman numerals I through VI on the drawing of the coil in the April, 1994 issue). The

is rotated counter-clockwise. The left-hand switch, which is connected to the lower taps of the coil, consecutively selects taps higher and higher on the coil (6 through 1, in that order) as it is rotated clockwise.

If you have scratch-built your switches from the original specs (see May issue), the connections to the movable contacts are made by capturing the bends previously made in the hook-up wire between the spring-loaded washers located just behind the panel on each switch shaft. The connections to the fixed contacts (formed by

the heads of brass brads nailed into the front of the panel) are made by soldering to the points of the brads protruding through the back.

The switches I used were Radio Shack two-pole, six-position jobs (catalog number 275-1386). For those of you who may not be familiar with "switch language," those switches have two individual movable contacts, each of which can be rotated to contact any one of six fixed contacts. In this application, only one of the movable contacts (and its set of six fixed contacts) is required.

Looking at the back of the Radio Shack switch, you'll see that there are two terminals in the center; those connect to the movable contacts. The 12 terminals for the fixed contacts are arranged in a circle around the center terminals. Select one of the center terminals and, using an ohmmeter, identify the six outer terminals to which it connects as the switch shaft is rotated. Turn each of your two switches on the panel so that the terminals for its fixed contacts are conveniently oriented for connection to the proper coil taps in the proper order—as specified earlier in this section—then firmly tighten the switch mounting nuts.

Now cut the wire behind each switch at the bend you made earlier, crimp the free ends to the movable contact terminal you selected, and solder them in place. Complete the wiring by making connections from each coil tap to the appropriate fixed-contact terminal on the proper switch.

As a finishing touch, I dressed up my Radio Shack switches with a pair of large
(Continued on page 89)

Enter A World Of Excitement with a Subscription to

Popular Electronics®

Get the latest electronic technology and information monthly!

Now you can subscribe to the magazine that plugs you into the exciting world of electronics. With every issue of Popular Electronics you'll find a wide variety of electronics projects you can build and enjoy.

Popular Electronics brings you informative new product and literature listings, feature articles on test equipment and tools—all designed to keep you tuned in to the latest developments in electronics. So if you love to build fascinating electronics, just fill out the subscription form below to subscribe to Popular Electronics... It's a power-house of fun for the electronics enthusiast.

EXCITING MONTHLY FEATURES LIKE:

- CONSTRUCTION**—Building projects from crystal sets to electronic roulette
- FEATURES**—Educational training on digital electronics, Ohm's Law, Antennas, Communications, Antique Radio, Simplified Theory
- HANDS-ON-REPORTS**—User test comments on new and unusual consumer products
- SPECIAL COLUMNS**—Think Tank, Circuit Circus, Computer Bits, DX Listening, Antique Radio, Scanner Scene, Amateur Radio

PLUS: ALL OUR GREAT DEPARTMENTS!

You'll get 12 exciting and informative issues of Popular Electronics for only \$18.95. That's a savings of \$23.05 off the regular single copy price. Subscribe to Popular Electronics today! Just fill out the subscription order form below.

MODEL ROCKET LAUNCHER • CES ROUND-UP • TELEPHONE-CALL ROUTER

Popular Electronics MAY 1994

TIME-DELAYED MODEL-ROCKET LAUNCHER
Add a touch of class and safety with this deluxe controller.

CONSUMER ELECTRONICS SHOW ROUND-UP
Satellite TV gets small, multimedia gets big, 380 gets real, and other news direct from the show floor.

Build A Distinctive Ring Switch
It routes your telephone calls to the right person or device.

A Relay Station For Your Remote Control
Remote control

Save 55% Off The Regular NEWSSTAND Rate

FOR FASTER SERVICE CALL TODAY

1-800-827-0383

(7:30AM-8:30PM) EASTERN STANDARD TIME

Popular Electronics® SUBSCRIPTION ORDER FORM

APEG4

P.O. Box 338, Mt. Morris IL. 61054

YES! I want to subscribe to Popular Electronics for 1 Full year (12 Issues) for only \$18.95. That's a savings of \$23.05 off the newstand price.

(Basic Subscription Rate—1 yr/\$21.95)

Payment Enclosed Bill me later

Please charge my: Visa Mastercard

Acct. # | | | | | | | | | | | | | | | | | | | | | |

Signature _____

Exp. Date _____

PLEASE PRINT BELOW:

NAME _____

ADDRESS _____

CITY _____

STATE _____

ZIP _____

Allow 6 to 8 weeks for delivery of first issue. U.S. Funds only.

In Canada add \$6.68 Postage (Includes G.S.T.). All Other Foreign add \$7.50 Postage.

COMPUTER BITS

By Jeff Holtzman

Word 6.0 for Windows

The best just got better. No other mainstream word-processing program even comes close to the power and flexibility provided by Word for Windows. If you take writing seriously—and what student or technical professional can afford not to—there is no choice.

Why is WinWord 6 the best? Mostly because of the same things that made the previous version the best of its generation (styles, templates, outlining, and WordBasic) but also because of literally hundreds of improvements in features small and large throughout the program.



Microsoft's Word 6.0 for Windows is the best. Fully customizable tool bars, a powerful macro language, document templates, document outlining, and literally hundreds of new and improved features push WinWord 6.0 way out ahead of the competition.

If you remember reading about WinWord 2 here in the past, and are wondering what happened to versions 3, 4, and 5, the answer is that Microsoft wanted to synchronize the DOS, Windows, and Macintosh versions of the program. Of course, the fact that WordPerfect is at version 6 might have had a little to do with as well.

OLD FEATURES UPDATED

Styles allow you to specify formatting symbolically, much like variables in a programming language. That way you can change the definition of the symbolic name, and the formatting of all the text associated with that name throughout the document will change accordingly. If you don't use styles, then every bit of formatting must be applied manually, which can make it hard to maintain consistency among elements of a document that are supposed to look the same. With styles, maintaining that consistency becomes a job for the computer, rather than a boring, labor-intensive job for the writer.

In WinWord 2, styles applied only to paragraph-size units. WinWord 6 maintains paragraph styles, but in addition adds character styles, which apply to units of text within a paragraph (typically a word or phrase). On the other hand, if styles seem like more trouble than they're worth, WinWord 6 includes several new features that accelerate the process of formatting your documents manually.

Microsoft's inclusion of both simple and sophisticated ways of applying formatting is indicative of the philosophy that permeates the program. For most tasks, there is more than one way to get things done. At least one will appeal to the beginning or occasional user, and another to the heavy-duty user.

As the name suggests,

templates are documents upon which you can base other documents. You can have different templates for memos, faxes, letters, reports, and so on. A given template can store macros, styles, and boiler-plate text and graphics, all of which would be available to any document based on that template. You can also have a global template, whose contents are available to all documents. The template mechanism in WinWord 6 is much more flexible and efficient than the one in the old version.

Outlining gives you a birds-eye view of your document. With outlining you can structure your document using a hierarchy of headings that can be expanded or contracted to show more or less detail. That allows you to see the forest when you need to see the forest, and the trees when you need to see the trees. Apart from a couple of new display options, outlining works pretty much the same as in version 2.

WordBasic is WinWord's built-in programming language. It's like most modern versions of BASIC, except that it also includes numerous built-in word-processing functions. Although the latest version of Excel conforms to Microsoft's Visual Basic paradigm, known in the applications realm as Visual Basic for Applications, this version of WordBasic does not. Nonetheless, the current version of WordBasic provides numerous small enhancements over the one in WinWord 2, the largest of which is arguably dynamic dialog boxes.

ELECTRONICS MARKET PLACE

FOR SALE

300 Experimenters Circuits — Complete in 6 practical books using diodes, relays, FET's, LEDs, IC 555's, and IC CA3130's for building blocks. Only \$33.00 plus \$5.50 for shipping. USA and Canada only. US funds. ETT, INC., PO Box 240, Massapequa Park, NY 11762-0240.

CABLE test chips. Jerrold, Tocom, S.A., Zenith. Puts cable boxes into full service mode! \$29.95 to \$59.95. 1 (800) 452-7090, (310) 902-0841.

THE Case Against Patents. Thoroughly tested and proven alternatives that work in the real world. \$24.50. SYNERGETICS PRESS, Box 809-C, Thatcher, AZ 85552. (602) 428-4073. Visa/MC.

SECRET cable descramblers! Build your own descrambler for less than \$12.00 in seven easy steps! Radio Shack parts list and free descrambling methods that cost nothing to try, included. Send \$10.00 to: **INFORMATION FACTORY**, PO Box 669, Seabrook, TX 77586. For COD's (713) 922-3512 any time!

CABLE descramblers and test turn-on kits available for most makes and models. We also carry bullet stoppers. No smoke, no mirrors, just low prices! Call others, then compare our prices! Cash paid for cable equipment. No Florida sales. (305) 425-0751.

Look to the Future
With Your Own
Cable Converter & Descrambler!

1-800-228-7404



NU-TEK ELECTRONICS

FREE CATALOG!

3250 Hatch Rd.
Suite 1 C
Cedar Park, TX 78613

ALL MAJOR BRANDS

COD

CABLE equipment! Jerrold, Zenith, Pioneer, Oak, Scientific Atlanta & more! Our prices are below wholesale! **CABLE MASTER**. 1 (800) 480-9888.

GREAT idea! We do documentation right! **PAT DOCUMENT SERVICES**, PO Box 200, Ellisville, MS 39437. (601) 477-3875.

CB RADIO OWNERS!

We specialize in a wide variety of technical information, parts and services for CB radios. 10-Meter and FM conversion kits, repair books, plans, high-performance accessories. Thousands of satisfied customers since 1976! Catalog \$3.

CBC INTERNATIONAL, INC.
P.O. BOX 31500PE, PHOENIX, AZ 85046

PRINTED circuit boards — etched drilled, tin plated. Single sided \$1.25/sq. inch. Free shipping. **CHELCO ELECTRONICS**, 61 Water Street, Mayville, NY 14757. 1 (800) 388-8521.

FOUR simple cable descrambling circuits using Radio Shack RF modulator, instructions \$8.00. **TELCOM**, Box 832P7, Brusly, LA 70719.

UNDETECTABLE cable descrambler will work on all systems guaranteed! Send SASE/info, \$94.95/kit, \$14.95/plans, **MYSTICAL ELECTRONICS**, PO Box 481, Cooper Station, NY, NY 10276.

CLASSIFIED AD ORDER FORM

To run your own classified ad, put one word on each of the lines below and send this form along with your check to:

Popular Electronics Classified Ads, 500-B Bi-County Boulevard, Farmingdale, N.Y. 11735

PLEASE INDICATE in which category of classified advertising you wish your ad to appear. For special headings, there is a surcharge of \$11.00.

() Plans/Kits () Business Opportunities () For Sale
() Education/Instruction () Wanted () Satellite Television

Special Category: \$11.00

PLEASE PRINT EACH WORD SEPARATELY, IN BLOCK LETTERS.

(No refunds or credits for typesetting errors can be made unless you clearly print or type your copy.) Rates indicated are for standard style classified ads only. See below for additional charges for special ads. **Minimum: 15 words.**

1	2	3	4	5
6	7	8	9	10
11	12	13	14	15 (\$23.25)
16 (\$24.80)	17 (\$26.35)	18 (\$27.90)	19 (\$29.45)	20 (\$31.00)
21 (\$32.55)	22 (\$34.10)	23 (\$35.65)	24 (\$37.20)	25 (\$38.75)
26 (\$40.30)	27 (\$41.85)	28 (\$43.40)	29 (\$44.95)	30 (\$46.50)
31 (\$48.05)	32 (\$49.60)	33 (\$51.15)	34 (\$52.70)	35 (\$54.25)

We accept MasterCard and Visa for payment of orders. If you wish to use your credit card to pay for your ad fill in the following additional information (Sorry, no telephone orders can be accepted.):

Card Number

Expiration Date

PRINT NAME

SIGNATURE

IF YOU USE A BOX NUMBER YOU MUST INCLUDE YOUR PERMANENT ADDRESS AND PHONE NUMBER FOR OUR FILES. ADS SUBMITTED WITHOUT THIS INFORMATION WILL NOT BE ACCEPTED.

CLASSIFIED COMMERCIAL RATE: (for firms or individuals offering commercial products or services) \$1.55 per word prepaid (no charge for ZIP code)...**MINIMUM 15 WORDS.** 5% discount for same ad in 6 issues within one year; 10% discount for 12 issues within one year if prepaid not applicable on credit card orders. **NON-COMMERCIAL RATE:** (for individuals who want to buy or sell a personal item) \$1.25 per word, prepaid....no minimum. **ONLY FIRST WORD AND NAME** set in bold caps at no extra charge. Additional bold face (not available as all caps) 30¢ per word additional. Entire ad in boldface, \$1.85 per word. **TINT SCREEN BEHIND ENTIRE AD:** \$1.90 per word. **TINT SCREEN BEHIND ENTIRE AD PLUS ALL BOLD FACE AD:** \$2.25 per word. **EXPANDED TYPE AD:** \$2.05 per word prepaid. Entire ad in boldface, \$2.45 per word. **TINT SCREEN BEHIND ENTIRE EXPANDED TYPE AD:** \$2.55 per word. **TINT SCREEN BEHIND ENTIRE EXPANDED TYPE AD PLUS ALL BOLD FACE AD:** \$2.95 per word. **DISPLAY ADS:** 1" x 2 1/2" — \$205.00; 2" x 2 1/2" — \$410.00; 3" x 2 1/2" — \$615.00. **General Information:** Frequency rates and prepayment discounts are available. **ALL COPY SUBJECT TO PUBLISHERS APPROVAL. ADVERTISEMENTS USING P.O. BOX ADDRESS WILL NOT BE ACCEPTED UNTIL ADVERTISER SUPPLIES PUBLISHER WITH PERMANENT ADDRESS AND PHONE NUMBER. Copy to be in our hands on the 18th of the fourth month preceding the date of issue (i.e.; Sept. issue copy must be received by May 18th). When normal closing date falls on Saturday, Sunday or Holiday, issue closes on preceding work day. Send for the classified brochure. Circle Number 49 on the Free Information Card.**

★ 1994 CATALOG ★
**OF THE WORLD'S MOST FAMOUS
 CB ANTENNAS & ACCESSORIES**
 — FIRESTIK ANTENNA —
 2614 E. Adams · Phoenix, AZ 85034
 Write or Call, 602-273-7151

NEW! Universal descrambler upgrade, improvement, modification, repair parts/instructions. Delivers better picture, performance. \$15.00.
ROBERT SNOW, 22049 Lansdowne, Saint John, Canada E2K4T7.

CABLE TV converters/descramblers 2 year warranties on Jerold, Zenith, Tocom, Scientific Atlanta. We service most converters. Money back guarantee. **NATIONAL CABLE SERVICES** (219) 935-4128.

ACE personal security PRODUCTS, cable converters and accessories. Please have make & model number ready. Call 1 (800) 234-0726.

ELECTRONIC components below wholesale, LEDs 5 cents, EPPROMS 25 cents. Send \$2.00 (refundable on first order) for a catalog: **FINLEY DIGITAL EQUIPMENT**, Department 21, 1010 Columbia Ave., Lancaster, PA 17603.

WIRELESS home security. Intelligent system dials up to 9 phone numbers including pager, upon being triggered. Includes remote arm/disarm, PIR area and magnetic door sensors. Upgrade to: gas, smoke, glass sensors. \$300.00. Call **L.V. SMITH**, (718) 346-2738.

CABLE boxes, converters, descramblers, 25Db line amps, call low pricing, no NY sales. (914) 351-2742.

BEST BY MAIL
 Rates: Write National, Box 5, Sarasota, FL 34230
 OF INTEREST TO ALL

SPORTS FANS: CALL 1-800-PLAY-ISC to see what you are missing!

PROTECT YOURSELF — PEPPER Sprays, Alarms: **GHB SECURITY**, Box 652, Hampstead, MD 21074-0652.

DYNAMIC TECHNIQUES FOR getting the job you want. Guaranteed. 6897-(PE) Serenity Way, San Jose, CA 95120.

CHEESE — SEND FOR Brochure: **CHEESEHAVEN**, P.O. Box 336, Marblehead, Ohio 43440.

CAN GOD HEAL A Nation? Send for Free Bible Studies. Light, St. Maries, ID 83861.

HOLLYWOOD SECRETS EXPOSED! 1-900-776-6397 Pin #8126 \$2.99/Min. 18+ . Innovative 305-537-3003.

INVENTORS

INVENTING? YOU NEED a roadmap to sell your idea. The **INVENTOR'S GUIDE** helps develop a strategy and control costs. Price \$20. **Chevy Chase Engineering**, 2307 Ashboro, Chevy Chase, MD 20815.

INVENT SOMETHING? LAYMAN'S How-To Patent/Market Manual. FREE Details: **INVENT**, 955 Mass Ave., Box 312-(PE), Cambridge, MA 02139.

EDUCATION

HIGH SCHOOL DIPLOMA Fast New Program Credit For Experience 1-800-494-9065.

GED DIPLOMA \$49.00. ULC, PO Box 70096-(PE), Tuscaloosa, AL 35407.

VACATIONS

\$5.00 A DAY VACATION HOTELS!! Save Big \$ With Great Vacation Hotel Specials. 6 Days 5 Nights Waikiki, Hawaii; 5 Days 4 Nights Las Vegas; Freeport, Bahamas; Cancun, Mexico, As Low As \$25.00. Plus Discount Airfares, Cruises And Much Much More! Call Now **1-800-864-8720**.

FINANCIAL

FREE GRANTS TO \$50,000. Personal, Business, Never Pay-back. **KIDKO**, Box 597113-(PE), Chicago, IL 60659.

MONEYMAKING OPPORTUNITIES

EXPLOSIVE NEW 900 Number Home Business Opportunity! Free Details! 508-234-7539.

EARN \$500-\$1000 WEEKLY stuffing envelopes. For details — Rush \$1.00 with SASE to: **KAPPAONE**, PO Box 220, Clarion, PA 16214.

SELL ANTI-THEFT ALARM STICKERS. Information FREE sample \$2.00: **ITS IMPORTS**, POB 62683 N2, Virginia Beach, VA 23466.

FREE SMALL BUSINESS Success Catalog! MSP, 18653 Ventura #321-(PE), Tarzana, CA 91356.

PLANS & KITS

60 Solderless Breadboard Projects in two easy-to-read pocket books. Complete with circuit descriptions, schematics, parts layouts, component listings, etc. Both books (BP107 & BP113) only \$11.90 plus \$3.50 for shipping. USA and Canada only. US funds. **ETT, INC.**, PO Box 240, Massapequa Park, NY 11762-0240.

SCHEMATIC design program. Free brochure. Write Dept. P., **SCHEME-ADDICT**, 8622 W. 44th Place, Wheat Ridge, CO 80033.

FASCINATING kits! Lasers, voice changers, gas sensors, and more! Send \$10.00 for catalog. **LNS TECHNOLOGIES**, 20993 Foothill Blvd., Suite 307P, Hayward, CA 94541-1511.

BUILD your own robot! Complete plans \$12.00, free details. **KEY PUBLICATIONS**, PO Box 971, Eilers, FL 34680.

Telephone Listening & Recording Devices

MA-100 Devices Hidden In Dual Modular Adapters! DMR-20
 FM Transmitter MA-100 Recording Adapter

Crystal clear reception on FM radio up to 1/4 mile
 SnapKit uses phone line for power & antenna

DMR-20
 Starts & stops recorder when phone is used
 Plugs into standard cassette recorder
 Works when any phone in house is used

\$25.95 free Visa/MC (214) 255-7490
 Seymour-Radix Inc. Box 166055 - PE Irving TX 75016

BUSINESS OPPORTUNITIES

MAKE \$75,000.00 to \$250,000.00 yearly. Learn IBM monitors repairs (solutions most brands). New home based business program. Software available. Information: **USA-Canada \$3.00** cash (no checks), Dealers wanted worldwide (\$35.00) US funds. **RANDALL DISPLAY**, PO Box 2168-H, Van Nuys, CA 91404, USA.

GOVERNMENT seized cars, trucks, boats, computers, televisions. Surplus bargains galore! Your area: Information: 1 (800) 601-2212 Ex.SP7930.

EASY work! Excellent pay! Assemble products at home. Call toll free 1 (800) 467-5566 ext. 5730.

START your own technical venture! Don Lancaster's newly updated **Incredible Secret Money Machine II** tells how. We now have autographed copies of the Guru's underground classic for \$18.50. **SYNERGETICS PRESS**, Box 809-C, Thatcher, AZ 85552. (602) 428-4073. Visa/MC.

DISTRIBUTORS needed — big profits. Miniature satellite antennas for homes, RVs, business. \$1,800.00 refundable deposit required. 1 (800) 886-5008.

CB'S AND SCANNERS

SCANNERS, CB's, radar detectors. Call or write for free catalog. (803) 829-3411. **CB DOCTOR**, PO Box 2842, Orangeburg, SC 29116-2842. Toll free order line available.

FULL- OR PART-TIME JOB/BUSINESS:

Learn VCR repair!

Professional-level home study program. Master easy-to-learn, high-profit repairs without investing in costly high-tech instruments. Send or call today.

**Free career kit:
 800-223-4542**

Name _____ Age _____
 Address _____ Phone () _____
 City _____ State _____ Zip _____

The School of VCR Repair, Dept. VVH341
 6065 Roswell Road, Atlanta, GA 30328



Be a computer repair expert!

Professional-level home study. Learn PC repairs, troubleshooting, upgrading, servicing, installation. Open your own business; be a more valuable employee. **Free career literature.**

**Send or call:
 800-223-4542**

Name _____ Age _____
 Address _____ Phone () _____
 City _____ State _____ Zip _____

The School of PC Repair
 PCDI, 6065 Roswell Road
 Dept. JH341, Atlanta, Georgia 30328

EDUCATION/INSTRUCTION

ELECTRONIC engineering. 8 volumes complete. \$109.95. No prior knowledge required. Free brochure. **BANNER TECHNICAL BOOKS**, 1203 Grant Avenue, Rockford, IL 61103.

VCR Repairs You Can Do. Save\$. Make\$. 403-page textbook used by national correspondence schools. \$Back-guarantee. Over 40,000 sold. 704 illustrations + tool. Mail \$24.95 to **WORTHINGTON PUBLISHING**, Box 16691N, Tampa, FL 33687-6691.

PC Power Supplies. What they are. How they work. Safe and easy low voltage test and repair. 96 pages, 37 illus. \$19.95 **WELX TECH**, Box 34, Greenbelt, MD 20768.

BECOME an electronics engineer! Money for college available. Call (609) 266-2887 ext. 112 for recorded message.

"VIDEO Game Secrets of the Orient" — Genesis/Super-Nint, etc...Yes, game recording machines do exist! Any game \$1.00, incredibly accessible to anyone worldwide, described in detail. Also, outrageous savings, products, sources, more! Highly revealing information game companies don't want you to know. 6 years researched. \$15.00. **DEL WORLD PUBLICATIONS**, 2390 Crenshaw Blvd., Dept. 7PE, Torrance, CA 90501.

BECOME an amateur radio operator ham. Information how \$3.00 **D&S INT.**, PO Box 73560, Metairie, LA 70033-3560.

ANTIQUE RADIO CLASSIFIED

Free Sample!

Antique Radio's
 Largest Circulation Monthly.
 Articles, Ads & Classifieds.

6-Month Trial: \$16.95. 1-Yr: \$31.95 (\$47.95-1st Class).
A.R.C., P.O. Box 802-L12, Carlisle, MA 01741

INVENTIONS

INVENTORS: CONCEPT NETWORK offers professional, inexpensive patenting and marketing services. (New product ideas with prototype or schematics preferred; but they are not required.) Free information packet: Call 1 (800) 835-2246 extension 67.

FREE invention package: **DAVISON & ASSOCIATES** offers customized development, patenting, and licensing for new products and ideas. Proven results: 1 (800) 677-6382.

MASTERCARD AND VISA are now accepted for payment of your advertising. Simply complete the Classified Ad order form and we will bill you.

MULTIMEDIA WATCH

(Continued from page 6)

Windows will keep you in fun for months on end with over 250 Windows games. A couple of discs that I thought would be of particular interest to our readers are *The SysOp's Companion* and *The Ham Radio & Scanner Companion*. Other titles include *The Companion for WordPerfect*, *The Companion for Windows, 999 + TrueType Fonts for Windows*, and *999 + .WAV Files for Windows*.

Also from John O'Connor Publishing is *American Street Rods*, a Photo-CD containing 100 high-resolution images of street rods

for \$99.95. Believe it or not, I had never seen a Photo-CD before, and wasn't sure if my CD-ROM drive could read one. I knew my drive (an "old" NEC 2X) was not multisession-capable, but I wasn't sure if it could read photo CD's. Also, I wasn't sure what software would let me view these images. (You can view them with CorelDRAW software, but I didn't have it when I got the *Street Rods* disc.)

Thanks to *HiJaak Pro* from Inset Systems, I was able to check out those neat street rods. *HiJaak Pro* is the best file-conversion software I've ever used, and screen captures couldn't be easier. Anyway, now I know for sure that my CD-ROM drive is Mode-2-compliant (Photo-

CD compatible). Fortunately for me, *American Street Rods* is a single-session disc.

I just set up *Return To Zork*, a wild but very involved fantasy game from Activision, and I sure am glad I recently added a new 500-megabyte hard drive to my system. *Return To Zork* puts about 45 megabytes onto your hard drive, but the payoff is very impressive real-time video. I haven't gotten far yet in this very intricate game, but so far I like it.

Dracula Unleashed from Viacom New Media revives the Dracula legend with a new storyline and new characters. The game contains over an hour and a half of video and is produced much like a feature film. The game is interactive in the sense that items in your possession affect how different video scenes are played out, leading to multiple endings. This game has excellent replay value.

The C.H.A.O.S. Continuum from Creative Multimedia is set in the year 2577. The scientists who created the supercomputer known as Cybergenic Holistic Autonomous Orbiting Server (C.H.A.O.S.) have been trapped in a parallel continuum and have reached back in time to the present in an attempt to free themselves and the colony. Your job is to interact with the future and do battle with the supercomputer. The graphics are excellent and a different combination of events occurs every time the game is played. The disc has a list price of \$79.95.

Media Vision just sent me two versions of their multimedia planner, the *Personal Daily PlanIt*. My favorite of the two, *PlanIt Paradise*, features models from *Swimwear Illustrated*. It

features full-color images of different models for each day, week, and month. The other disc features various action/sports photos. Although I could have left the images on the CD-ROM, a full installation (a month's worth of photos) added 35 megabytes to my hard drive—so how big is a 500 megabyte drive really? These discs certainly are an entertaining way to plan a day. They list for \$59.95.

Last but not least, InterActive Publishing sent me two sample discs. *Supersonic* is a complete multimedia guide to modern military aircraft. It's great fun for any aviation buff. The other title, *1000 of the World's Greatest Sound Effects*, speaks for itself. ■

WHERE TO GET IT

Activision
11440 San Vicente Boulevard
Los Angeles, CA 90049
Tel. 310-207-4500

BookMaker Corporation
625 Emerson Street #200
Palo Alto, CA 94301

Corel Corporation
The Corel Building
1600 Carling Avenue
Ottawa, Ontario, Canada
K1Z 8R7
Tel. 613-728-8200

Creative Multimedia
514 N.W. Eleventh Ave., Ste. 203
Portland, OR 97209
Tel. 503-241-4351

D.A.T.A.
15 Inverness Way East
P.O. Box 6510
Englewood, CO 80155-6510
Tel. 800-447-4666

DeLorme Mapping
P.O. Box 298
Main Street
Freeport, ME 04032
Tel. 207-865-1234

Inset Systems
71 Commerce Drive
Brookfield, CT 06804-3405
Tel. 203-740-2400

InterActive Publishing
Corporation
300 Airport Executive Park
Spring Valley, NY 10977
Tel. 914-426-0400

John O'Connor Publishing Ltd.
1601 S. Black Horse Pike, #5
Turnersville, NJ 08012-2021
Tel. 609-875-8542

Logitech, Inc.
6505 Kaiser Drive
Fremont, CA 94555
Tel. 510-795-8500

Mailier's Software
970 Calle Negocio
San Clemente, CA 92673-6201
Tel. 714-492-7000

McGraw-Hill Inc.
11 W. 19th St.
New York, NY 10114-0144
Tel. 800-262-4729

Media Vision
47300 Bayside Parkway
Fremont, CA 94538
Tel. 510-770-8600

Pro CD, Inc.
8 Doaks Lane
Little Harbor
Marblehead, MA 01945-9866
Tel. 617-631-9200

RolandCorp US
7200 Dominion Circle
Los Angeles, CA 90040-3647
Tel. 213-685-5141

ThunderSeat Technologies
6330 Arizona Circle
Los Angeles, CA 90045
Tel. 800-884-8633

Viacom New Media
1515 Broadway
New York, NY 10036
Tel. 212-258-6000

Ivan Neal has
put out a lot of
fires.



He's not a
firefighter—
he's a teacher.
But to the kids
he's reached,
he's a hero.

**BE A TEACHER.
BE A HERO.**

Call
1-800-45-TEACH.

Adapted from the
book "The Power of
Teach"

Reach for the Power
TEACH
with the Power of
Teach

CIRCUIT CIRCUS

By Charles D. Rakes

Light Your Fire

This get together I'd like to share with you a number of electronic ignitor circuits. A simplified description of an electronic ignitor is an electronic device that generates a spark or an arc to light a fire.

Many of today's gas furnaces are lit with an electronic ignitor. That saves a considerable amount of gas normally used to keep the pilot light on all of the time. When the thermostat calls for heat, the electronic ignitor fires, lighting the pilot and thus the furnace. Many gas stoves also operate in the same manner. Other uses for ignitors include lighters for acetylene gas welders, propane torches, and just about any function that requires a spark to ignite a flame. Possibly the most common ignitor is the spark plug.

AN IGNITOR

Our first ignitor circuit, see Fig. 1, uses only three components to generate a high-voltage spark. At the heart of this circuit (and the majority of the spark generators we'll present) is a high-turns-ratio, step-up transformer, T1. When S1 is closed and released, a current pulse flows through the

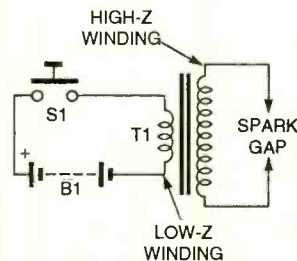

Fig. 1. To activate this ignitor, momentarily depress S1 to release current into T1. The result is a spark across T1's secondary.

transformer's low-voltage primary circuit, producing a high-voltage pulse across the secondary winding.

You may use just about any high-turns-ratio transformer in this circuit or those that follow. For example, an audio, plate-to-speaker, output transformer will do just fine. You can find one of those in just about any old AC, table-top, AM radio from the 1950's or 1960's. Another good choice from the same time period is a low-impedance mike-to-grid transformer. An ignition coil from a small gas engine or car will also work.

THE SPARKER

Our second sparker circuit, see Fig. 2, uses the same step-up transformer as the first circuit with a power transistor, Q2, switch-

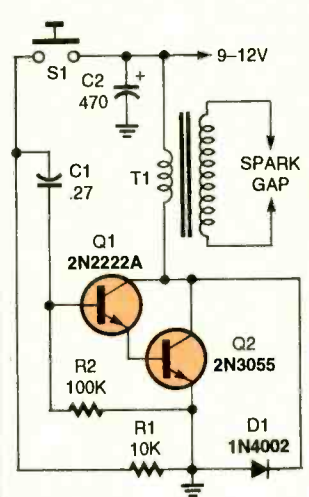

Fig. 2. This circuit uses a transistor switch to pulse T1 with current, creating a high-voltage spark at the output.

ing the current through the transformer's primary circuit. This circuit produces a more consistent output voltage with each pulse and adds

PARTS LIST FOR THE IGNITOR (Fig. 1)

- B1—9- or 12-volt battery
- S1—Normally closed, pushbutton switch
- T1—Step-up transformer (see text)

ADDITIONAL PARTS AND MATERIALS
Perfboard, wire, solder, etc.

PARTS LIST FOR THE SPARKER (Fig. 2)

SEMICONDUCTORS

- D1—1N4002 silicon rectifier diode
- Q1—2N2222A NPN transistor
- Q2—2N3055 NPN power transistor

RESISTORS

- (All fixed resistors are ¼-watt 5% units.)
- R1—10,000-ohm
 - R2—100,000-ohm

CAPACITORS

- C1—0.27-µF, ceramic-disc
- C2—470-µF, 25-WVDC, electrolytic

ADDITIONAL PARTS AND MATERIALS

- S1—Normally open, SPST pushbutton switch
- T1—Step-up transformer (see text) Perfboard, wire, solder, etc.

to the circuit's efficiency by limiting the time that current flows through the transformer's primary circuit.

When S1 is closed, C1 quickly charges up to the positive supply voltage turning Q1 and Q2 on. After C1 charges to near supply level, the power transistor turns off, releasing energy into the transformer's secondary and producing an output spark. When S1 returns to its open position, C1 discharges through R1 and R2, readying the circuit for another cycle. Diode D1 protects Q2 from any reverse-voltage pulses produced by T1.

The pulse-timing current for T1 may be varied by changing the value of C1. Increasing the size of C1 will lengthen the pulse width, while decreasing the value will do the opposite. For the best efficiency and long battery life, use the smallest value capacitor that produces a good spark. The shorter the pulse, the longer the battery life.

A FET-BASED SPARKER

The circuit in Fig. 3 is very

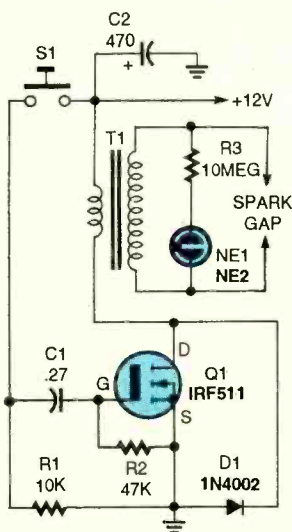

Fig. 3. This FET-based sparker has only one transistor, but needs a 12-volt power source for best operation.

PARTS LIST FOR THE FET-BASED SPARKER (Fig. 3)

SEMICONDUCTORS

D1—1N4002 silicon rectifier diode
Q1—IRF511 field-effect transistor

RESISTORS

(All resistors are 1/4-watt 5% units.)
R1—10,000-ohm
R2—47,000-ohm
R3—10-megohm

CAPACITORS

C1—0.27- μ F, ceramic-disc
C2—470- μ F, 25-WVDC, electrolytic

ADDITIONAL PARTS AND MATERIALS

S1—Normally open, SPST pushbutton switch
NE1—NE2 neon lamp
T1—Transformer, see text
Perfboard, wire, solder, etc.

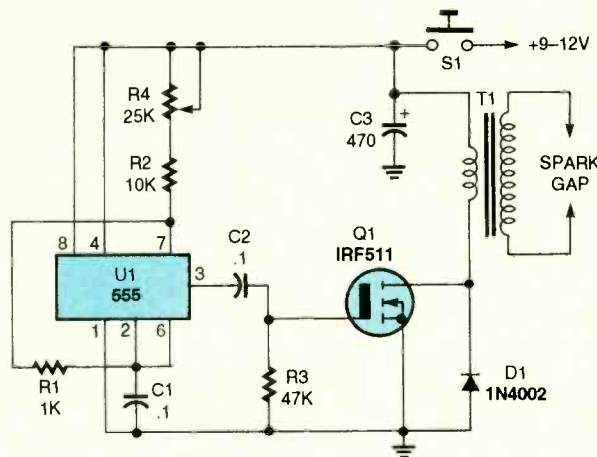

Fig. 4. The 555 timer activates Q1 over and over to produce a series of sparks. This circuit is useful for difficult ignition jobs.

PARTS LIST FOR THE IC-BASED IGNITOR (Fig. 4)

SEMICONDUCTORS

D1—1N4002 silicon rectifier diode
Q1—IRF511 field-effect transistor
U1—555 timer, integrated circuit

RESISTORS

(All fixed resistors are 1/4-watt, 5% units.)
R1—1000-ohm
R2—10,000-ohm
R3—47,000-ohm
R4—25,000-ohm potentiometer

CAPACITORS

C1, C2—0.1- μ F, ceramic-disc
C3—470- μ F, 25-WVDC, electrolytic

ADDITIONAL PARTS AND MATERIALS

T1—Step-up transformer (see text)
S1—Normally open, SPST pushbutton switch
Perfboard, wire, solder, etc.

similar to our last circuit, but it has an IRF511 FET doing the switching. About the only difference is the parts count and the addition of a neon lamp across the transformer's secondary to indicate the presence of high voltage. The pulse timing of this circuit may be varied in the same manner as the previous circuit.

IC-BASED IGNITOR

Our next ignitor circuit, see Fig. 4, takes the previous circuit one step forward with the addition of a 555 oscillator/driver circuit. As long as S1 is closed, the ignitor circuit produces a steady stream of high-voltage output pulses. This circuit would be a good choice to use if you were trying to light a propane torch or a gas welder in a windy area.

Integrated circuit U1, a 555 IC, is connected as a standard astable oscillator with the pulse-repetition rate set by the values of C1, R2, and R4. The IC's output at pin 3 drives the gate of the FET. With each positive pulse, the FET switches current through the primary of T1, inducing high-voltage at the secondary.

The oscillator's frequency should be adjusted to produce the best-looking spark. If a much slower repetition rate is desired, just increase the value of C1.

REPETITIVE SPARKER

Our next ignitor, see Fig. 5, is another simple, repetitive, spark-generator circuit. In it, a unijunction transistor is connected in a free-running pulse-generator circuit with the repetition rate set by the values of C1, R1, and R2. Each time the unijunction fires, C1 is discharged through the primary of T1, producing a high-voltage pulse across T1's secondary.

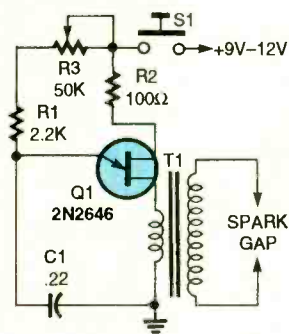

Fig. 5. This repetitive-spark generator requires few parts. That's because its unijunction transistor acts as both an oscillator component and a current switch.

The high-voltage output from this simple circuit is not as great as in the two previous circuits, but it will suffice for lighting a propane torch.

ARC IGNITOR

Our next ignitor circuit is different in that it produces an arc rather than a high-voltage spark. The drawing in Fig. 6 shows the simplicity of the arc-producing ignitor. Before the turn of the century, the arc ignitor was the most popular circuit used to ignite the fuel mixture in internal-combustion engines. The spark plug only became popular after about 1915. Even with the advent of the spark plug, the arc ignitor remained in limited use for many years.

If you would like to see how an arc is produced just

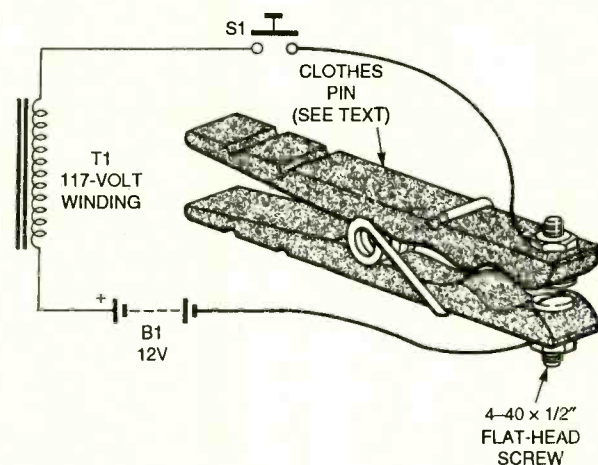

Fig. 6. This arc ignitor works by breaking the current path. This technique was used to ignite car fuel before the turn of the century.

PARTS LIST FOR THE ARC IGNITOR (Fig. 6)

- B1—12-volt battery
- S1—Normally open, SPST pushbutton switch
- T1—Step-up transformer (see text)
- Perfboard, wire, solder, two 4-40 1/2-inch, metal, flat-head screws, nuts, clothes pin, etc.

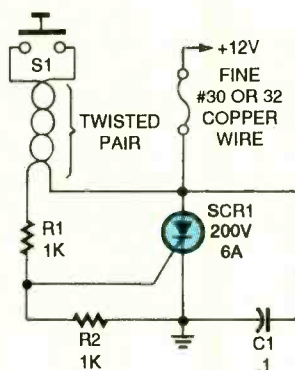

Fig. 7. This flash circuit can be used to ignite solid-fuel model rockets. The fine wire is consumed during each use, so it must be replaced.

PARTS LIST FOR THE REPETITIVE SPARKER (Fig. 5)

RESISTORS

(All fixed resistors are 1/4-watt, 5% units.)

- R1—2200-ohm
- R2—100-ohm
- R3—50,000-ohm potentiometer

ADDITIONAL PARTS AND MATERIALS

- C1—0.22- μ F, 50-WVDC, electrolytic
- Q1—2N2646 unijunction transistor
- S1—Normally open, SPST pushbutton switch
- T1—Step-up transformer (see text)
- Perfboard, wire, solder, etc.

points are two 4-40 flat-head screws mounted in the end of a clothes pin, as shown. A wire from each screw connects the ignitor points to the circuitry. Transformer T1 is just the primary winding of almost any 120-volt power transformer; the larger the transformer, the greater the arc. All other windings must not be connected and should be taped off. To produce an arc, close S1 and open the clothes pin.

FLASH CIRCUIT

Our last entry this visit is neither a spark or an arc ignitor circuit. Take a look at Fig. 7 and you will see a circuit designed to flash a fine copper wire. Solid-fuel model rockets are a popular hobby and this circuit can be used to fire a rocket

PARTS LIST FOR THE FLASH CIRCUIT (Fig. 7)

- R1, R2—1000-ohm, 1/4-watt, 5% resistor
- C1—0.1- μ F, ceramic-disc capacitor
- SCR1—6-amp, silicon, controlled rectifier (Radio Shack No. 276-1067)
- S1—Normally open, SPST pushbutton switch
- Perfboard, twisted-pair wire, hook-up wire, solder, No. 30 or 32 copper wire, etc

take almost any 120-volt AC transformer and connect one lead of the primary to one terminal of a 6 or 12-volt battery. Connect a clip lead to the other battery terminal and wipe the other end of the clip lead across the remaining transformer lead. This should produce a nice, fat, blue arc between the clip lead and transformer wire. **Make sure that the transformer's secondary or any other windings are not connected to anything, and never strike an arc off of a wet-cell battery. Any gases coming from the battery could be ignited!**

Now back to the arc ignitor circuit. The break ignitor

motor. A short length of fine copper wire is positioned in the rocket's motor and connected to the circuit as shown. When S1 is closed, the SCR turns on causing the fine wire to burn and ignite the solid fuel.

That's about it for this month. Hope you enjoyed our ignitor segment. Good circuitry until we meet here next time.

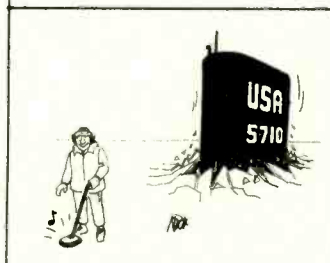

DX LISTENING

By Don Jensen

Will Ireland Return to Shortwave?

There are many who would like to see the return of the worldwide Irish broadcasting service for the first time in nearly a half century. Although, in recent years, there have been a few on-again, off-again SW transmissions by one of several commercial broadcasters in Ireland, those broadcasts have been neither consistent nor

good signals. Most station lists of that era included *Radio Eireann* (as the Irish government's broadcasting arm was called). That station used a low-power, 1.5-kilowatt transmitter located at Athelone that broadcast on a number of SW frequencies, with 17,840 kHz perhaps the most widely noted. The Athelone station was still using that long-outdated equipment at war's end.

In 1947, the "World Radio Handbook" announced plans for a new high-powered Irish SW station. Paddy Clarke in RTE's information office says tests with an experimental transmitter broadcasting to the United States and Australia were actually carried out during that year. But in 1948, there was a major political change in Ireland and the new government had different ideas. The new government concluded that Ireland did not need and could not afford an overseas shortwave service. So, the old SW equipment was retired.

From time to time, over the years, however, there have been reports that RTE, the Irish statutory broadcasting commission, which replaced Radio Eireann, would go on shortwave. That proved to be a baseless rumor. Today, though, pressure for an RTE external SW service seems to be building. An Irish radio columnist suggests that it wouldn't cost that much anyway.

Ciaran McCarthy writes that "there are offers to provide transmitters free." Indeed, that seems to be

the case. There are reports that a North American radio amateur has offered RTE a 10-kilowatt, shortwave broadcast transmitter to be located in eastern Canada. Supposedly, that transmitter could relay RTE programming fed to it by satellite. While 10 kW is puny by today's standards, it might be an interim step, at least bringing Irish programming to many North American listeners.

A better bet, though, is for RTE to lease shortwave facilities from another country for at least a few hours a week. With cutbacks in some nations' broadcasting schedules, notes Radio World Handbook, relatively inexpensive SW air time may be available on existing stations.

Renting transmitter time from other international broadcaster would mean no asset-capital outlay for the RTE, and there certainly is precedence. Denmark, for example, no longer operates its own shortwave transmitters, but instead rents Norwegian SW facilities.

Readers who would like to add their two-cents' worth to these efforts can send their letters to the Director General, Radio Telfis Eireann, Donnybrook, Dublin 4, Ireland.

IAN UPDATER

"The Great white North, here!" Whenever I answered the telephone and heard that familiar tongue-in-cheek identification, I knew immediately it was Ian McFarland on the line. For years, there was probably no better known and



Veteran DX'er, Ron Howard, with 23 years of listening experience, is seen here with his Icom R-71A receiver, and a wall full of attractive station pennants.

easily heard outside of Europe. So supporters—members of the Radio Transmitters Society in Ireland, in addition to a number of expatriates, Irish-Americans, and other friends of Ireland in Canada, Australia, and Germany—have been actively petitioning the Irish government to re-establish a shortwave overseas service after all these years.

Shortwave broadcasting in Ireland dates back to the pre-World War II years when, because of uncrowded frequencies, it didn't take much transmitter power to be heard worldwide with reasonably

liked shortwave personality than Ian, host of *Radio Canada International's* "SWL Digest" and "Listener's Corner." But, three years ago, RCI suffered a massive budget cut. McFarland was offered early retirement and his highly popular "SWL Digest" program became history. Ian, however, went to *Radio Japan* for two years as an English specialist and was frequently heard on its "Media Round-up" program.

Now he's back in Canada (semi-retired but still doing freelance features for *Radio Japan*) writing magazine articles, doing publicity work for both RCI and *Radio Japan*, and working on a number of other SW-related projects. "With all that and some redecorating in my house," Ian says, "I'm keeping fairly busy these days."

MAIL CALL

Your letters, with questions and comments about SW listening, and the stations you're hearing, are always welcome! Why not let the rest of us know about SW programs that you particularly like or dislike. Don't forget to include information on when (preferably in universal UTC time—which is EDT + 4 hours, CDT + 5, MDT + 6, or PDT + 7) and where (giving the frequency in kilohertz) you are hearing them so that other SWLs can tune in. The address is *DX Listening*, **Popular Electronics**, 500-B Bi-County Blvd., Farmingdale, NY 11735.

Bruce Atchison, Edmonton, Alberta, writes to tell us about "a unique broad-

caster and one really nice guy," Sergey Tutov, who for several years has been presenting programs of electronic music on Russian commercial stations. He calls those electronic-music programs, "Tangerine Wave," "Stellar," and "Back to the Universe." Bruce says, "I've actually heard the program "Stellar" broadcast on shortwave and tapes of the "Tangerine Wave" program. I admire the guy because he is earning so little money and yet is doing the shows because of his great love for electronic music."

"Because the program and frequency schedule I have may be out of date by now, readers interested in Tutov's programs can write to Sergey Tutov in care of *Radio Tangerine Wave*, P.O. Box 38, Moscow 11384, Russia for program and frequency information."

Another reader, David Casper of Fort Worth, TX writes, "As a shortwave listener many years ago, I've listened to many of the European shortwave stations. I still remember them very well. But now that I'm listening again, after a long absence from the dial, I can't find some of those European countries that seemed quite easy to hear back then. I suppose I'm not tuning at the right time or place. Can you help? How about Portugal and Monaco?"

Those European countries, Dave, don't seem to be reported by SWLs as often as they once were. I'm not sure why, except that broadcasting hours have been decreased compared to past years. I hope this will help you.

Radio Portugal International is scheduled with English programming at 0230 UTC (but not Sunday night) on 9,570 and 9,705 kHz. A news bulletin is fol-

lowed by feature programming such as "Visitor's Notebook," "Musical Kaleidoscope," "Spotlight on Portugal," "Listeners' Mailbag," or "Collectors Corner."

Trans World Radio station at Monte Carlo, Monaco, has English-language, religious broadcasts from 0740 to 0850 UTC, and until 0920 UTC on Sundays, on 7,385 kHz.

DOWN THE DIAL

Here are some other stations that listeners are logging.

ALBANIA—11,835 kHz. *Radio Tirana's* English transmission to Europe begins with news at 2300 UTC, continuing with commentary and music.

CANADA—6,000 kHz. *Radio Canada International* relays programming of the Canadian Forces network

to military troops overseas from 0300 to 0400 UTC. Look for English news, sports and weather from 0300 UTC, and French-language programs after 0330 UTC.

CZECH REPUBLIC—7,265 kHz. *Radio Prague* can be found on this frequency, and on the parallel channel of 7,345 kHz, from about 2200 UTC with its identification signal and announcement, followed by news and folk music.

LATVIA—5,935 kHz. *Radio Riga's* tri-lingual broadcasting is heard afternoons on this frequency. Besides Latvian programming, you may find English news at 2130 UTC and German news at 2135 UTC.

UGANDA—4,976 kHz. *Radio Uganda* has an English-language newscast shortly after 0400 UTC, followed by their identification and African music. ■

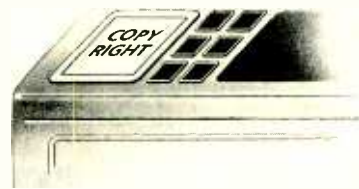

THE MOST
**AN IMPORTANT PART
OF YOUR PHOTOCOPIER
ISN'T PART OF
YOUR PHOTOCOPIER**

Having a machine may not permit you to photocopy books, journals, newsletters and magazines.
The Copyright Clearance Center CAN.
Contact us to find out
how you too can COPY RIGHT!SM

COPYRIGHT CLEARANCE CENTER

222 Rosewood Drive, Danvers, MA 01923 □ Tel. (508) 744-3350 □ Fax (508) 741-2318

© 1993 Copyright Clearance Center

*Credits: Brian Alexander, PA; Rich D'Angelo; Jim Ducharme, MA; Rufus Jordan, PA; Jerry Klinck, NY; Marie Lamb, NY; Errol Urbeis, NY; North American SW Association (45 Wildflower Road, Levittown, PA 19057)

HAM RADIO

By Joseph J. Carr, K4IPV

Antenna Topics

This month we'll return to a topic that is of constant interest and discussion among ham operators: antennas. The reason that this topic is so popular is that the antenna is critical to communications—"getting out" depends heavily on the quality of the antenna that's used. True, you can make yourself louder by using an RF-power amplifier at the output of the transmitter, and you can make received signals louder by using a preselector ahead of the receiver. But those measures are half-baked compared to the benefits of having a good set of "antlers."

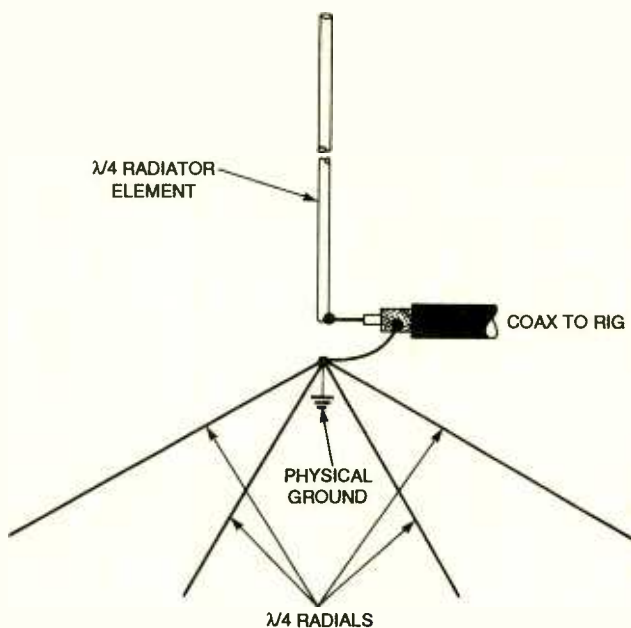

Fig. 1. A typical vertical antenna for use in the HF bands. The radiator element consists of a 1- to 3-inch diameter aluminum tube, cut quarter-wavelength long (length in feet equals 246/frequency in megahertz).

An RF-power amplifier makes you louder, but at the cost of a higher electrical bill (not to mention the expense of having a 220-volt outlet installed in

the shack), while increasing electrical and "RF burn" hazards and producing more TVI. On the other hand, a directional, gain antenna makes you louder without any of those problems and, in some cases, the directivity reduces the amount of TVI by concentrating the signal into a narrow beam that can be directed away from the affected receiver.

A receiver preamplifier has its downside: It amplifies the noise as well as the signal, so the signal-to-noise ratio (SNR), which is what really counts, is not affected in any significant way. Preamplifiers and preselectors have their place, but only after the antenna has done its thing. (Note: preamplifiers are primarily used for VHF/UHF reception.) A preselector, which is literally a tuned preamplifier, is especially useful in the high-frequency (HF) bands, but mostly when used with a low-cost receiver with image rejection problems. In the 1950's, people who used Hallicrafters S-38 or Heathkit AR-3 receivers often used preselectors to boost performance. In general, however, a modern "up-to-snuff" receiver doesn't need a preselector.

EFFECTIVE RADIATED POWER

The effective radiated power (ERP) of a radio station is the transmitter's output power multiplied by the gain of the antenna system. For example, let's say that your transmitter provides 100 watts to the terminals of the antenna (counting losses in the

coaxial cable). If the antenna gain is 6 dB, the ERP will be four times the applied power (note: a 2:1 increase in power is 3 dB, so 6 dB is 2×2 , or 4 times boost), or 400 watts.

A gain antenna doesn't actually "create" power out of thin air, but instead focuses the available power in a limited direction. If the power were measured isotropically, all of the power is distributed over the entire surface of an imaginary sphere (with the antenna at the center). However, in gain antennas, the power is redirected into limited radiation pattern—thus, the same amount of power is available, but the power density (watts-per-unit-area) is greater.

If antenna gain is measured against an isotropic radiator, the gain and directivity are judged relative to that imaginary sphere. However, some ham antennas are measured relative to a dipole. In such cases, for a gain of 6 dB, the actual signal strength would have to be four times as great to produce the same results as the gain antenna. Antenna professionals tend to use the isotropic gain, but since the isotropic gain of a half-wavelength dipole is about 1.9 dB, one can calculate either gain if the other is specified.

THE LAW OF RECIPROCITY

The "law of reciprocity" was recognized for antennas long before the terminology was appropriated by "new agers." Briefly stated, the law says that an antenna works the same for

reception as it does on transmitting. That is, the gain, the directivity, the radiation pattern, the VSWR, the impedance, and all of the attributes normally measured for transmitting are the same for reception. Thus, an antenna that increases the transmitter's apparent power by 6 dB also boosts received signal by 6 dB, while discriminating against directional noise sources. That's one of the reasons why a dollar spent on an antenna is superior to a dollar spent on boosting RF power or receiver preamplifiers.

RADIALS, GROUNDS, AND SIGNAL STRENGTH

Vertical antennas are very popular with hams, especially those with limited space. (A vertical fits nicely on city and suburban lots.) While there are many fine commercial vertical antennas on the market, anyone with access to a few yards of wire and some aluminum tubing from the "do-it-yourself" hardware store, can make an effective vertical antenna.

Figure 1 shows a typical vertical antenna for use in the HF bands. The radiator element consists of a 1- to 3-inch diameter aluminum tube, cut to one quarter wavelength long at the frequency of interest. (Length in feet equals $246/\text{frequency}$ in megahertz.) The center conductor of the coaxial cable is connected to the radiator element, while the shield of the coax is grounded.

When the antenna is mounted at ground level, an ordinary grounding rod driven into the soil close to the antenna base can be used. On the other hand, if the antenna is mounted above ground, an artificial or "counterpoise" ground

must be used. Such a "ground plane" consists of two or more radials (wire), each a quarter wavelength long, that are spread around the base of the antenna. The radials are either mounted horizontal to the ground surface, or are drooped as shown in Fig. 1.

Some people use both radials and a ground rod when operating a vertical mounted at ground level. Why so? Well, it seems that their signal is louder! In tests done in England, and reported in the Radio Society of Great Britain book "HF Antenna Collection" (Erwin David, G4LQL, editor), the signal strength produced by an antenna with just a ground rod was defined as 0 dB (for sake of reference). When four buried quarter wavelength radials were added, the signal strength increased by 2.5 dB, and when 16 radials (the maximum number recommended to amateurs) were used, the signal strength was +3 dB relative to the ground-rod-only results.

Two things are apparent from those test: Note that four radials produced a large increase in signal strength, while quadrupling the number of radials to sixteen resulted in only another 0.5 dB increase. Clearly, radials are effective to a point, but there is a decreasing return on your investment as the number of radials increases.

GETTING THE LEAST VSWR

The standing wave ratio (SWR), or voltage standing wave ratio (VSWR) as it is usually called (the terms can be used synonymously) is a measure of the impedance match between the antenna and transmission line, and the transmission line and the transmitter output. Antennas work best

when matched—in that condition, the SWR/VSWR is 1:1. As the mismatch increases, the SWR/VSWR increases to something greater than 1:1.

Too many amateurs make reducing SWR/VSWR the prime effort in antenna construction. It is believed that tremendous losses occur when SWR/VSWR is high. If you work the mismatch loss equations, however, you will find that the numbers typically are small. Only in some scenarios are losses high. Indeed, some antennas that were popular decades ago intentionally had a high SWR/VSWR.

First, the lowest SWR/VSWR is evidence on most antennas that the antenna is working correctly. Second, the loss is real, even if usually minor. Finally, a high SWR/VSWR implies that power is being reflected back into the transmitter.

Solid-state final amplifiers are notoriously incapable of absorbing that kind of abuse. In the early 1960's, when the first CB sets with 5-watt transistor finals came out, a loose antenna connection could "fry" the output transistor. Today, however, all solid-state rigs have a built-in VSWR sensor circuit that turns down the RF power when the VSWR goes up. Typically, the shutdown starts when the VSWR reaches 1.5:1, and shutdown is total at some point between 2:1 and 3:1.

Once, when working on a new antenna experiment for my book "Practical Antenna Handbook" (TAB Books), I goofed in cutting some wire, and the RF power meter showed no power. It turned out that the VSWR shutdown circuit had turned off the power. When I tested the antenna with an MFJ Enterprises SWR analyzer, the VSWR turned out to be over 10:1.

THE ANTLERS SOFTWARE DISKETTE

The Antlers software package is designed to make antenna length calculations, find the characteristics and resonating capacitance for small loops, and a few other chores on HF antennas. Also provided in the package—which runs on any MS-DOS or Windows machine—are programs for inductance-loaded dipoles, L-C resonance and impedance-matching network (e.g., antenna tuning unit) problems, and inductance and capacitance values.

The disk contains the BASIC programs from my books "Practical Antenna Handbook" and "Secrets of RF Circuit Design," as well as a statistics program and a "game" that teaches statistical thinking and scientific experimentation. The diskette costs \$20, and is available from me, Joe Carr, at P.O. Box 1099, Falls Church, VA, 22041. ■

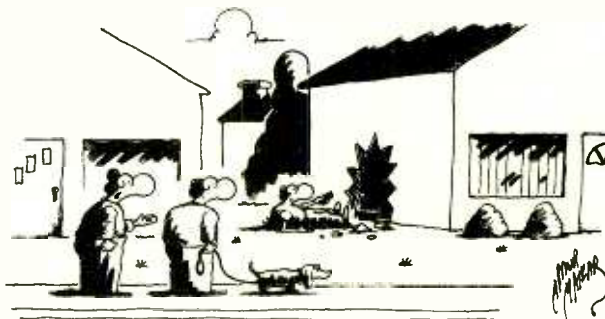

"I've seen it before—remote-control kickback."

SCANNER SCENE

By Marc Saxon

Summer Sports and Games

A fine companion for mid-summer scanning is the new *Uniden Bearcat SC-150XLT SportCat* handheld. The Uniden people told us that they noticed that many people who attend racing and other sporting events bring along handheld scanners. That observation inspired the development of the SportCat, designed for easy adaptability at sports events.



Uniden's SC-150XLT SportCat scanner is specifically designed for use at live sporting events.

Basically, the SC-150XLT is a 12-band scanner with 100 keyboard-programmable memory channels. It covers the VHF low, high, UHF, UHF-T, and even the 800-MHz bands. It has 10 one-touch access keys that you can

preset to easily select your favorite frequencies without multiple keystrokes. That's a great convenience for sporting events, when you want to jump around to several different, pre-determined frequencies.

A full-frequency, illuminated LCD readout makes the SportCat easy to read. The unit also has a "data-skip" feature that helps to eliminate data channels and substantially reduce birdies. It also offers one-touch weather access, turbo scan, and standard scanner features such as channel lockouts.

The SportCat package includes a rechargeable battery pack as standard equipment. SportCats are available in either a traditional charcoal finish or in bright yellow from dealers who carry Uniden Bearcat scanners.

BET YOU'LL LIKE THIS!

Speaking of sporting, the warm weather seems to have some of our readers looking forward to vacationing—and monitoring—in America's newer gambling meccas.

Fred Confer, of Wilkes-Barre, Pennsylvania, wrote to mention that the new Foxwoods Bingo and Casino in Ledyard, Connecticut is said to be the largest gambling casino in the nation. It is located on the Pequot Indian Reservation. Fred is giving odds that we can come up with the frequencies used there in time for his visit to the place.

Our information is: 462.775, 464.425, and 464.925 MHz.

Along the same lines, Jeffrey A. Davis of Horn Lake, Mississippi, tells us that Tunica County (in the north-west corner of the state) is rapidly becoming the Las Vegas of the South. There are five riverboat casinos now operating, and proposals for many more (as well as hotel/casinos) in the area. Other riverboat casinos are operating all along the Mississippi River. Jeffrey would like to see various riverboat-casino frequencies published in this column.

The Isle of Capri (from Biloxi, MS) uses 461.1625, 461.775, 461.95, 463.2375, and 463.2875 MHz. Players Riverboat Casino operates on 154.60 and 464.90 MHz. The Admiral Riverboat Casino can be monitored on 462.875 MHz. The Delta Queen transmits on 461.40 and 464.85 MHz. Jo Davies' Silver Eagle Casino Riverboat uses 463.35 and 464.225 MHz. The President Riverboat Casino operates on 461.025, 463.5125, 463.5375, 463.5875, 463.60, 463.6125, 464.025, 464.36, 464.35, 468.5125, 468.5375, 468.5875, and 468.6125 MHz. Par-A-Dice Riverboat Casino holds down 464.10, 464.35, 464.325, and 464.875 MHz.

Those two-way frequencies are used aboard the riverboat casinos for security and other purposes related to their gambling activities. They would take a

dim view of patrons who wandered through the casino listening to a handheld. No problem listening from a stateroom, however, or from along the shore line. The floating casinos also use regular marine frequencies for navigational and maritime-safety purposes.

LET'S FLY

We received a letter from Francis R. Kessler of Jamesburg, New Jersey, who is a Certified Glider Instructor (Flight and Ground). He mentioned that frequencies 123.3 and 123.35 MHz are commonly used by sailplanes (gliders). The chatter there can be both fascinating and funny, especially during a contest or on a meet day.

Without engines, everyone is checking up on everybody else's status, location, and altitude, and relaying where the thermals are (and aren't). During long flights, those two frequencies are easily as entertaining as they are informative. He advises that if scanner owners are interested in hearing a bunch of pilots drilling holes in the sky without using engines, find out where gliders are flying and tune in on some unusual communications.

Gliders sometimes also turn up on 123.5 MHz. Hot-air balloons have been monitored on 123.3, 123.5, and 151.625 MHz. Many air shows use 122.9 and 123.1 MHz. Summer is a peak time of year for those types of activities, so plug in those frequencies.

Readers have mentioned that the military UHF aeronautics band, which runs from 225 to 400 MHz, has plenty of activity that can't be found anywhere else on a scanner. A few of the favorites include NORAD's 364.2; the USAF's 311.0, 349.4, and 381.3; the FAA's

255.4; and the U.S. Coast Guard's 282.8 and 381.8 MHz. Military weather communications are found on 239.8, 342.5, 344.6, and 375.2 MHz.

Actually, hundreds of frequencies, ground stations, and aircraft are active in the military aeronautics band. You might hear dog-fights, practice bombing runs, air/sea rescues, Air Combat Command, air refueling, AWACS surveillance planes, the Navy's Blue Angels, the Air Force's Thunderbirds, etc. Many of the more sophisticated scanners include that band, and it has many avid devotees.

Some monitors, however, complain that the 225-400-MHz band doesn't come in clearly with standard scanner antennas. Those antennas are intended to provide the best reception on the three most popular "action" bands—for instance, 30-54, 118-174, and 406-512 MHz—where hams, police, fire, and VHF aeronautics stations can be heard. Those antennas don't always do the best possible job in the 225-400-MHz band.

One way around that problem is to use a high-performance antenna designed and peak-tuned specifically for maximum reception in the military UHF aeronautics band. A good example is the MAX-225, a fully assembled, omnidirectional ground-plane antenna. Stainless-steel radials, silver solder, and PVC construction will last a lifetime. Mount it in your attic or on your roof. Just attach your coax feed line to the SO-239 fitting and attach the antenna to any vertical support with tape or hose clamps, and you'll be ready to monitor!

The MAX-225 for the UHF military band is available

for \$25.95, plus \$4 shipping and handling (\$5 to Canada), from CRB Research, P. O. Box 56, Commack, NY 11725. Phone orders can be placed at 800-656-0056 (from Canada, 516-543-9169). New York State residents must add \$2.55 sales tax. Visa and MasterCard are accepted.

COMING ATTRACTIONS

Next month, we will have more frequencies and scanner chatter. We're always looking for your input in the way of questions, loggings, suggestions, and comments. Write to us at *Scanner Scene*, **Popular Electronics**, 500-B Bi-County Blvd., Farmingdale, NY 11735. ■

ANTIQUE RADIO

(Continued from page 74)

1920's pointer knobs. To indicate pointer position, I added a semicircle of six brass upholstery tacks around the periphery of each knob. Their large heads suggest old-fashioned switch contacts and enhance the radio's vintage appearance. Finally, I installed a push-in hemispherical bumper (as used in the original NBS set) under each of the four corners of the board.

TIME FOR A TEST

Now the wiring is complete and the set is ready for try-out. Connect a good outside antenna to the right-hand rear binding post or Fahnestock clip and a good ground to the left-hand one. Connect a pair of high-impedance (2000-ohms or more) headphones to the headphone terminals. Modern low-impedance stereophones won't work.

Touch the cat's whisker to different parts of the crystal

surface, experimenting with various angles and contact pressures, until you hear a station. If there are no sounds, change the switch positions and try again. After you do pull in a station, tune it in for maximum loudness. Try the right-hand switch (which makes coarse frequency adjustments) first. Then make fine tuning adjustments with the left-hand switch.

In the case of my set, the cat's whisker adjustment was very tricky. Signal volume was loudest with a very light pressure on the cat's whisker, a touch that could be easily thrown off by the slightest vibration—even gentle manipulation of the tuning knobs.

That became annoying as I attempted to determine the tuning range of the radio, and I eventually sidestepped the problem by removing the cat's whisker from contact with the crystal and shunting a modern small-signal silicon diode across the detector terminals. Perhaps that wasn't sporting, but now I had greatly increased volume and a stable signal.

In my set, the three topmost positions had no tuning action, bringing in only an unchanging jumble of weak signals. Only the lower three positions brought in individual stations. The topmost of these tunes to about 800 kHz, the next lower to about 1160 kHz, and the lowest to approximately 1600 kHz. In all three positions, the left-hand switch has a very nice vernier action—maximizing the volume of the signal.

But we're out of space for now, so more on this next month! Until then, send your comments and questions to me *c/o Antique Radio*, **Popular Electronics**, 500-B Bi-County Blvd., Farmingdale, NY 11735. ■

NOISE REDUCTION SYSTEM

(Continued from page 34)

nor even most industrial sources. It is available only through DNR licensees. A source for the IC is provided in the Parts List.

Take special care in installing the jacks and switches on the board and make sure that they are firmly seated. Also make sure that the electrolytic capacitors and IC's are properly installed and correctly oriented. The leads of DISP1 should be bent 90 degrees; the proper location of the bend can be obtained by positioning the bar-graph display's leads over a quarter inch thick piece of stock and bending. It is important that the longest lead of the display (used to indicate polarity) lines up with the outside board corner (as indicated by the "+" sign on the parts-placement diagram). When installed properly, DISP1

should line up exactly with the shafts of the two toggle switches (S1 and S2).

Set-Up and Use. The Universal Noise Reduction System should always be placed in the signal path after the signal source pre-amplifier and before any volume or tone controls. The reason for this is that changes in the signal level or its frequency response will alter the control-path gain. For a single-source application, such as a stereo TV connected to your hi-fi system, the connections can be made as shown in Fig. 6. For that type of application, the control gain can be established once and then forgotten since, assuming reasonable picture quality, the signal-to-noise ratio will be essentially constant.

If you want the Universal Noise Reduction System to process signals from multiple sources, you can use the set up shown in Fig. 7. There, the unit is placed in your receiver's or amplifier's

tape loop. That's a good location since the LM1894 can handle line-level signals (from 300-mV RMS to 3-volts RMS). However, because all source material is now processed by the unit, the control gain must be readjusted for each source selection. If there is a tape deck in your set-up's tape loop, the Universal Noise Reduction system should be placed after the deck as shown in Fig. 7.

To test the unit's operation, sit back and listen to a variety of source material with and without DNR processing using the comparison switch. Don't forget that things such as the wrong location in the audio path or an improper control-gain setting can adversely affect performance. Also, the DNR system can not perform feats of magic; if the source material is poor, the amount of improvement will be limited.

Also, note that the DNR attack and release times have been optimized for the best response from music sources and may produce a phenomenon known as pumping when processing speech that is slow with frequent long pauses. During pumping, noise masking is not effective since the bandwidth needed to pass the program material results in the noise becoming audible. In such a situation, it may be helpful to reduce the control gain and thereby reduce the maximum DNR bandwidth.

The ability to sample the source with and without the DNR processing may lead one to believe that the processing reduces the high-frequency content of some sources. That is a false effect because high-frequency noise (for example tape hiss), added to a music source, will seem to reveal high-frequency content to the music. In fact, no extra high-frequency program content is present; just noise. A slightly higher control gain can achieve this effect if desired, but at the expense of noticeable noise when the noise becomes unmasked. ■

PARTS LIST FOR THE UNIVERSAL NOISE REDUCTION SYSTEM

SEMICONDUCTORS

- U1—LM1894 Dynamic Noise Reduction system, integrated circuit
- U2—LM3915 logarithmic LED-display driver, integrated circuit
- U3—LM7812 CTB voltage-regulator, integrated circuit
- DISP1—10-LED bargraph display (Mouser 351-2021 or equivalent)

RESISTORS

(All fixed resistors are 1/4-watt, 5% units unless otherwise indicated)

- R1, R4-R6—100,000-ohm
- R2, R7, R10, R11—1000-ohm
- R3—100-ohm
- R8—430-ohm
- R9—910-ohm
- R12—3900-ohm
- R13—1000-ohm, potentiometer

CAPACITORS

- C1, C4, C6, C10, C14—1- μ F, 16-WVDC, electrolytic
- C2—100- μ F, 16-WVDC, electrolytic
- C3, C11—0.0033- μ F, Mylar
- C5—0.047- μ F, Mylar
- C7—0.015- μ F, Mylar
- C8—0.0068- μ F, Mylar
- C9, C12—0.1- μ F, Mylar
- C13—0.001 μ F, Mylar
- C15, C16—2.2- μ F, 16-WVDC, tantalum
- C17—1000- μ F, 25-WVDC, electrolytic

ADDITIONAL PARTS AND MATERIALS

- L1—4.7-mH ferrite, magnetically shielded (Mouser 434-02-472J or equivalent)
- S1—SPDT switch
- S2—SPDT center-off switch
- J1-J4—Phono jack
- J5—2.5mm coaxial power jack
- PC board, enclosure (PAC-TEC CM5-125 or equivalent), 12-VDC 200-mA wall-plug power supply (Mouser 412-1001 or equivalent), hardware, wire, solder, etc.

Note: The following items are available from Vista (P.O. Box 1425, Bolingbrook, IL 60440; Tel. 708-378-5534): LM1894 DNR integrated circuit, \$6.50; a kit of all parts including etched, drilled, silk-screened, and plated-through PC board with solder mask plus silk screened case and AC power transformer (DNR2KIT), \$95.00; a fully assembled and tested unit (DNR2ASSEM), \$139.00. Please add 5% shipping and handling in the U.S., 12% shipping and handling in Canada. Illinois residents please add 7.5% sales tax. Check or money order only (UPS COD shipping is available in the contiguous U.S. only).



BUILD A COMBINATION LOCK

(Continued from page 72)

coder is available from JDR Micro Devices, Inc. (2233 Samaritan Dr., San Jose, CA 95124), while the solenoid and keypad are available from The Electronic Goldmine (9322 No. 94th Way, Suite 04, Scottsdale, AZ 85258).

Once you have obtained all of the components listed in the Parts List, construction can begin. All of the components—IC's, relays, resistors, capacitors, and transistors—except the solenoid, LED1, S1 (if used), and the keypad, are mounted on the board. The keypad (which in the author's prototype is a 12-key unit) was connected to the board through a ribbon cable. Using color-coded cable simplifies the keypad connections.

Assemble the circuit using Fig. 1 as a guide. Before you begin wiring the circuit, however, it is a good idea to mark the pin 1 terminals of each socket, and label each socket by IC number. Start wiring the sockets by tying all of the power-supply terminals of the sockets together, and then wiring all of the sockets' ground terminals together. Label each of those power-supply bus accordingly.

When installing C10 through C17, those capacitors should be connected as close to the IC power terminals as possible to minimize spikes in the power-supply line caused by solenoid deactivation. Once all of the components have been installed and the interconnections have been made, carefully check your work for misconnected components, before the IC's are installed into their sockets.

If that checks out, before installing the IC's, apply power to the circuit, and carefully check each power connection with a VOM to determine that it is getting the correct voltage and is properly polarized. If a component, such as a transistor or IC, is connected backward, it can easily be ruined. So, checking the power and ground points before the IC's are inserted is very important.

Testing. Once all of the components are in place and you're sure of the power-supply connections, the circuit can be tested for proper operation. However, first you must install the IC's;

in doing so, be absolutely sure that they are properly oriented in their respective sockets.

Apply power to the circuit and press S1. That places a high on the reset lines, which forces all of U2's output lines (Q1 through Q10) low when the switch is released. Now enter your 3- (or more) digit code. If the entered code corresponds to the one that was programmed into the circuit, LED1 will light and the solenoid will activate, indicating that the correct code has been entered, and the circuit is functioning as expected. Next try entering an incorrect code; if all is well, nothing should happen.

Troubleshooting. Rarely will a circuit work perfectly the first time. So some troubleshooting might be required. Problems are usually caused by either incorrect, missing, or bad connections to some point. The search for such problems in digital circuits can be like looking for the proverbial needle in a haystack. To find errors, you'll need a good VOM and a good logic probe.

The best way to find an error if the code number chosen does not produce solenoid activation is to start at the output of Q1, which drives the relay. Place your VOM probe at the emitter of Q1, enter your entry code, and look for +5 volts. If that's okay, you should have heard a slight click as the relay pulled in. If the diode at the relay is reversed, the relay will not operate. If no voltage is read at the emitter of Q1, then place the logic probe on the base of Q1 and enter your code; you should get a high.

If so, transistor Q1 is not operating; Q1 is either bad or biased incorrectly. Try switching transistors or slightly varying the value of R5 in one direction or the other. Some transistors are sensitive enough that only a few ohms difference in one direction can prevent operation. If code numbers are entered and a high is not obtained at the base of Q1, then one or more of the AND gates (the 74LS21's, U7 and U8) are not producing a high, so check the outputs of each as each number is entered.

If the outputs of the gates are not following the numbers as they are entered, place the logic probe on pin 12 of U1. Each time a number is pressed, a pulse should be sent to the CLK input

of U2, causing its Q outputs to switch. If you get good results from the latches irregularly, you may need to either buffer the data lines or add pull-up resistors to the data lines. If all else fails, check the power supply for ripples. That can best be done with a scope. The supply must provide a good steady, ripple-free 5-volts DC to ensure proper operation.

Summary. For those of you who don't have a shop to be locked, the circuit can be adapted to other uses where code numbers are required for security purposes. You can easily adapt the circuit to activate and deactivate a security alarm in your home; or it might be used in conjunction with a relay to prevent unauthorized phone use. Your imagination is the only limit to the uses that the circuit could be put to. Whatever the intended application for the lock, it is sure to give you a certain amount of satisfaction knowing that only you have the secret code that allows access to your property. ■

BUILD A DIGITAL CLOCK

(Continued from page 67)

resistor leads for that. Mount the speaker on the back of the board with double-sided tape over the grill below the clock logo and solder two insulated jumper wires from the speaker terminals to the pads marked "SP"

Solder a jumper on the back of the board between pins 2 and 14 of U12. Install R30 (10-ohms, 10-watts) on the back of the board between the two points shown in Fig. 6.

Power Up. Before applying power to the digital clock, it's a good idea to check your work for proper soldering. If everything looks okay, it's time to install a rechargeable 9-volt battery in the holder, and plug the power pack into P1 and an AC outlet.

The clock should immediately come to life, although the 9-volt battery will take a while to fully charge. When it is properly charged, you will be able to disconnect power and the clock will continue to work. ■

DATA LOGGER

(Continued from page 42)

ample, a reading of 100 equates to 30°C. For those that would rather deal with the Fahrenheit scale, °F = (ADC × 0.703) + 32. Figure 13 shows a plot of temperature measurements made with the LM335.

The above adjustment procedure can be adapted to other analog transducers, but keep in mind that if the voltage span for your transducer is much below 1 volt, you should probably consider amplifying its signal before sending it to the Data Logger. The reason for that is to minimize noise pickup, which would affect your readings. If, for instance, the transducer has a 0.2-volt span, then each of the 256 steps will be only 780µV!

Creating a Data File. Once you have collected your data, the next task is to transfer it from the Data Logger to your PC so it can be analyzed. While the basic procedure was discussed earlier in this article, we will go into it with a little more detail here.

The transfer is accomplished by serially transmitting the data via the Data Logger serial port to the serial port in your PC. There are a myriad of terminal emulation programs available that will allow your PC to communicate with the Data Logger. PRO-COMM and QMODEM are two relatively low-cost programs that have been successfully used with the Data Logger by the author. If you use a modem, you probably already have software that permits serial communications and will be suitable for our purposes.

Set the communication parameters to 9600 baud, no parity, 8 data bits, and one stop bit. Connect a cable from the Data Logger's DB-9 connector (J1) to your PC's serial port. Only 3 wires are needed—two for data and one for ground; to make the interface as simple as possible, no handshaking is used. However, to insure that the receiving PC can keep up with the data being sent by the Data Logger, XON/XOFF protocol is used. That means that if the receiving PC cannot store the data as fast as it is coming in and the PC is in danger of losing characters, it will send the XOFF character (13H) to the Data Logger.

The Data Logger will then sit idle until it receives an XON character (11H), at which time it will start transmitting again. For that reason it is important to enable the XON/XOFF flow control in your terminal emulation program. Set your PC for an ASCII file transfer (download) and open a file. Push the PLAY button on the Data Logger and observe that LED2 lights. If all is well, you should see data on your screen scrolling by, one measurement per line.

When the data transfer is complete (LED2 not lit), close the file. If for some reason the above procedure does not result in a file containing your data, do not despair. After you correct the problem (serial cable not connected, data rate set incorrectly, etc.) just push the PLAY button again to retransmit the data. The data is stored in the Data Logger until the power is turned off.

Plotting Your Data. There are two types of programs to choose from to create printed plots of your data. Technical plotting programs can be used, but they tend to be expensive: One alternative is to explore the relatively low-cost world of shareware offerings. The second alternative is to take advantage of the plotting capabilities provided by spreadsheet programs. If you haven't yet explored that type of program, the Data Logger may provide you with a great reason to do so.

Besides simply graphing your data, spreadsheets can provide you with the ability to perform data averaging to remove noise, statistical functions, and displaying several plots on one graph. Spreadsheets such as Lotus 1-2-3 and Borland's Quattro Pro are examples that can be used with Data Logger files. All of the plots shown in this article were produced by Quattro Pro.

Follow the directions for your particular program to import an ASCII file into your graphing or spreadsheet program. That should result in a single column of data, one data point per line. Next, annotate your graph, adding text to highlight features of interest such as time of day. That results in a more professional looking, interesting, and useful graph. If desired, you can also print a hardcopy of the results for future reference. ■

WORD ON KITS

(Continued from page 48)

219-432-3049) has a peak- and average-power RMS, digital SWR/power meter with LCD display. Called the TR-100, it comes in assembled and kit versions. It sports several novel features making it attractive to the radio amateur.

Tejas RF Technology (17 South Briar Hollow, Suite 101, Houston, TX 77027) sells the "Backpacker" QRP portable CW transceiver kit and other kit-related products.

Townsend Electronics (Box 415, 133 N. 1st St., Pierceton, IN 46562; Tel. 800-944-3661) is a source of a variety of amateur radio transceivers, receivers, transmitters, antenna tuners, active antennas, keyers, and pre-amplifiers. Included are kits from C.M. Howes Communications and Walford Electronics, both of England. Tejas RF Technology kits also are offered.

Tucson Amateur Packet Radio (or TAPR, PO Box 12925, Tucson, AZ 85732-2925; Tel. 602-749-9479), long a pioneer in amateur-radio digital communications, provides specialized packet radio modems and other communications accessories.

Wahl Clipper Corporation (2900 Locust Street, Sterling, IL 61081; Tel. 815-625-6525) stocks a variety of soldering and desoldering tools, featuring the Iso-Tip line of cordless rechargeable soldering irons and accessories.

Summary. This kit building primer examined the factors involved in building electronic kits. It promoted the craftsmanship that you can develop through kit building and presented kit advantages and disadvantages, the rationale for building a kit, selecting the right kit, needed tools and test equipment, building the kit, good soldering practices, what to do in the event the kit doesn't work, and a sampling of what's available from a few of the many kit suppliers.

No one can lay down a set of rules that will absolutely ensure that every kit you build will be successful. But if you follow the guidelines we suggested, chances are good that you'll build kits that work and work right—most of them the first time that the "juice" flows through them. ■

Market CenterTM

Paperback Books

GREAT PAPERBACKS AT SPECIAL PRICES

COMPUTER HOBBYISTS HANDBOOK—BP251—\$8.95

Subjects covered include microprocessors and their register sets; interfacing serial, parallel, monitor, games and MIDI ports; numbering systems, operating systems and computer graphics. While the book is aimed at the computer hobbyist, it should also prove useful to anyone who intends to use a computer to follow their interests.

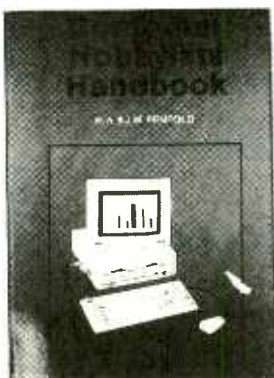

INTERNATIONAL RADIO STATIONS GUIDE—BP255—\$9.95

Provides the casual listener, amateur radio DXer and the professional radio monitor with an essential reference work designed as a guide for the complex radio bands.

Includes coverage on Listening to Short Wave Radio, ITU Country Codes, Worldwide Radio Stations, European Long Wave and Medium Wave Stations, Broadcasts in English and more.

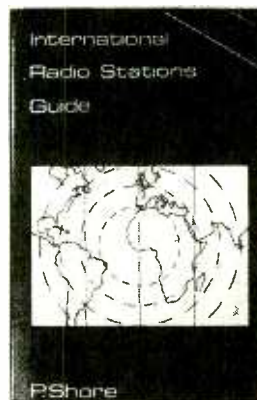

Further Practical Electronics Calculations and Formulae

I. A. WILSON



FURTHER PRACTICAL ELECTRONICS CALCULATIONS—BP144—\$9.00

450 pages crammed full of all the formulae you are likely to need. Covers Electricity, Electrostatics, Electromagnetism, Complex Numbers, Amplifiers, Signal Generation and Processing, Communications, Statistics, Reliability, Audio, Radio Systems, Transmission Lines, Digital Logic, Power Supplies. Then there's an appendix of Conversion Factors, Mathematical Formulae and more.



WIRELESS & ELECTRICAL CYCLOPEDIA—ETT1—\$5.75

A slice of history. This early electronics catalog was issued in 1918. It consists of 176 pages that document the early history of electricity, radio and electronics. It was the "bible" of the electrical experimenter of the period. Take a look at history and see how far we have come. And by the way, don't try to order any of the merchandise shown, it's unlikely that it will be available. And if it is, the prices will be many times higher.

ELECTRONIC TECHNOLOGY TODAY INC.
P.O. Box 240, Massapequa Park, NY 11762-0240

Name _____
Address _____
City _____ State _____ Zip _____

PE794

SHIPPING CHARGES IN USA AND CANADA

\$0.01 to \$5.00	\$1.50
\$5.01 to \$10.00	\$2.50
\$10.01 to \$20.00	\$3.50
\$20.01 to \$30.00	\$4.50
\$30.01 to \$40.00	\$5.50
\$40.01 to \$50.00	\$6.50
\$50.01 and above	\$8.00

SORRY No orders accepted outside of USA & Canada

Total price of merchandise	\$ _____
Shipping (see chart)	\$ _____
Subtotal	\$ _____
Sales Tax (NYS only)	\$ _____
Total Enclosed	\$ _____

All payments must be in U.S. funds

Number of books ordered

ALL ELECTRONICS CORP.

QUALITY PARTS • DISCOUNT PRICES • FAST SHIPPING

12 VOLT, 1.9 A/h RECHARGEABLE GEL CELL BATTERIES

Maintenance free, excellent back-up power source for alarms, communications equipment, lighting or computers. Can be used in any position and can be trickle charged for long periods of time.



Yuasa# NP 1.9-12 or equivalent.
7" X 1.33" X 2.36" high.

CAT# GC-121
\$8.50 each

ELECTRET MIKE WITH VISOR CLIP

Miniature electret condenser microphone designed for use with cellular phones but could be used in other audio applications. Black 0.3" diameter X 0.43" mike and 12 foot flexible cord with 3.5 mm mini-plug. Includes chrome-plated alligator clip which can be used for attachment to auto visor or clothing.

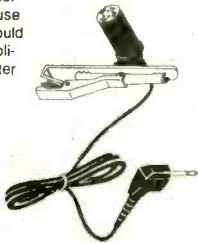

\$4.50 each
CAT# MIKE-14

9 Vdc @ 200 ma. WALL TRANSFORMER

SPECIAL!



Three prong grounded plug. 6 foot long cord terminates to three, color-coded pigtail leads.

\$2.00 each
CAT# DCTX-9200
100 for \$180.00

Futaba # M202SD08GL

Two rows of 20 characters displayed in a 5 X 7 dot matrix. Bright green 5 mm X 3.5mm characters. On board CPU, driver and DC-DC converter simplifies hook-up and interfacing. Operates on 5 Vdc. Displays 215 different characters including alphanumeric and other symbols. ASCII configuration. Module overall dimensions: 6.1" X 1.7" X 0.7" thick.

These displays were modified somewhat from original specifications and we do not know the exact nature of the modifications. They work fine in the test mode, but we don't know if the original interface is the same. We supply a data/hook-up sheet for the pre-modified device which, hopefully, provides most of the information necessary to use the display.

VACUUM FLUORESCENT DISPLAY

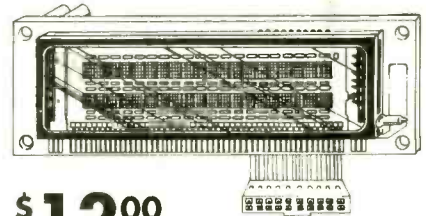

\$12.00 each

CAT# VFM-2

3 1/2 DIGIT LCD DIGITAL PANEL METER

FEATURES:

- 200 MV full scale sensitivity
- Single 9 - 12 Vdc operation
- Decimal point selectable
- 13 mm figure ht.
- Automatic polarity indication
- Guaranteed zero reading for 0 volt input high input impedance (>100 M ohm)
- 1 mA DC power dissipation. LCD size: 1.83" X 0.8". Overall size: 2.67" X 1.73" 0.28" above panel thickness. 0.57" overall thickness. Add resistors and disconnect jumpers for voltage ranges to 500 Vdc. Instructions included.



CAT# PM-128
\$18.00 each

10 AMP SOLID STATE RELAY

Teledyne Relays# 615-8500
Control voltage: 3-32 Vdc
Load: 10 amp, 250 Vac 50/60 Hz
Standard "hockey puck" size: 2.27" X 1.72" X 0.95".
Screw and q/solder terminals.
UL and CSA listed.

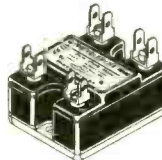

\$10.50 each
CAT# SSRLY-14
10 for \$95.00

5 Volts, 20 Amps POWER SUPPLY

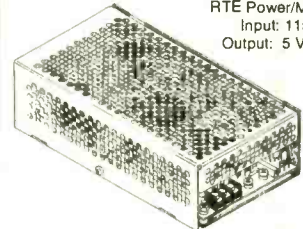

RTE Power/Mate# EVS-5F
Input: 115/230 Vac.
Output: 5 Vdc, 20 amps.

Brand new switching power supply enclosed in vented aluminum cabinet. Over-voltage, over-load, short-circuit protection. Fuse protected. Adjustable output voltage and current limiting. Inrush current limiting. Screw terminals for input and output. UL and CSA listed. 8.5" X 4.9" X 2.45."

\$15.00 each
CAT# PS-520

1 3/4" SPEAKER

8 ohm, 1 watt speaker.
Very heavy magnet for its size.
Speaker o.d. 1.8"
Magnet o.d. 1.35"



CAT# SK-175
\$1.25 each
10 for \$10.00

CALL, WRITE or FAX For A Free 64 Page Catalog
Outside the U.S.A. send \$2.00 postage.

ORDER TOLL FREE **1-800-826-5432**

MAIL ORDERS TO:
ALL ELECTRONICS CORP
P.O. Box 567
Van Nuys, CA 91408

FAX (818) 781-2653
INFO (818) 904-0524

Minimum Order \$10.00 • All Orders Can Be Charged To Visa, Mastercard Or Discover Card • Checks and Money Orders Accepted. By Mail - California, Add Sales Tax • No C.O.D. • Shipping And Handling \$4.00 for the 48 Continental United States - All Others Including Alaska, Hawaii, P.R. And Canada Must Pay Full Shipping • Quantities Limited • Prices Subject to change without notice.



Simply A Superior 1.3 GHz Spectrum Analyzer

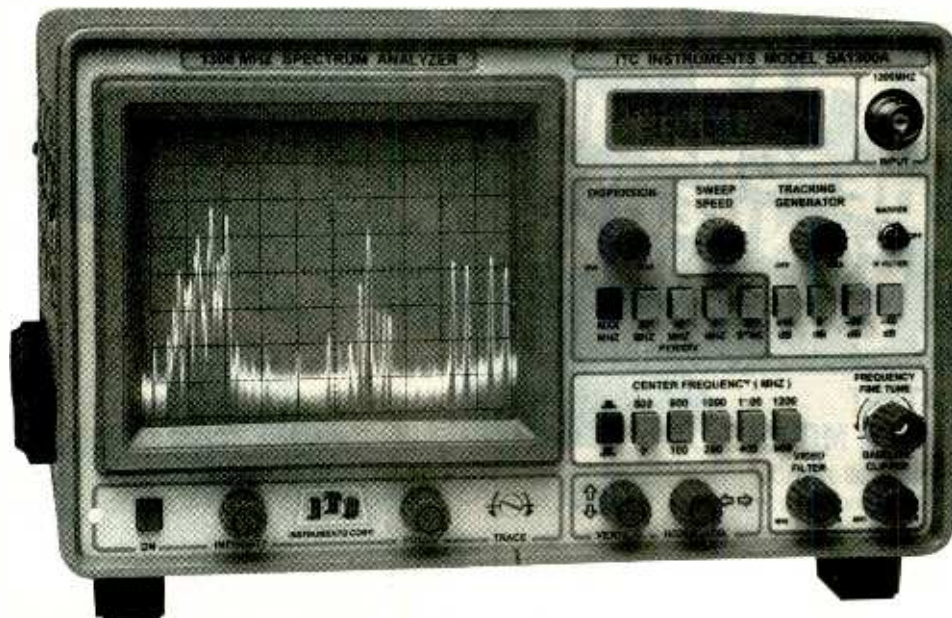

1-1300 MHz *In One Sweep* \$1,895.

MADE IN USA -10KHz Resolution Band Width -7 Digit Center Frequency Display

MARINE, TWO-WAY, HAM, AM FM SW BROADCAST RADIO - CATV, SATELLITE. SYS., SURVEILLANCE
TUNE DUPLEXERS, AMPS, FILTERS, SECURITY TRANS, & RECEIVERS - EMI, RFI, FCC, TESTING

EXCLUSIVE DISPERSION ZOOM
ITC SA Series exclusive Dispersion Zoom lets you zoom in on **any Center Frequency** signal, from any one of five calibrated Dispersion positions. Preset at >140 MHz, 50MHz, 10MHz 1MHz and zero MHz per division. The SA1300A displays greater than 1300 MHz on the screen at one time yet allows instant zoom to any Dispersion Scan Width as low as zero MHz per div. Allowing for total control over all **Dispersion Scan Widths** settings.

80 dB ON SCREEN
130 dB total Dynamic range 110 dBm **Sensitivity**. At Narrow and Wide Band Width settings. Performance you would expect only from a \$10,000 Analyzer.

ULTIMATE *LOW COST* ANALYZER
ITC Spectrum Analyzers are the best performance to price ratio Analyzers on the market today. No other low cost Analyzer comes close to the Superior performance and quality of an ITC Analyzer. **Total flexibility and ease of operation.** SA1300A gives you full control over the Resolution Band Width and Freq. Span widths. Plus Vertical Position, Baseline Clipper, Sweep Speed, Video Filter, 4 Input Attenuator settings, 10 Frequency Select settings.

MODEL SA1800B 1800 MHz
Covers 1-1300 MHz and 850-1850 MHz in one sweep. Ideal for Satellite service. The SA1800B has the same general specifications as the model SA1300A.

INTRODUCTORY OFFER
SA1300A & OPT.s 1, 3, 6

ONLY \$1895.00 note 1

SA1800B & OPT.s 1, 3, 6

ONLY \$2295.00 note 1

\$1995.00 Opt. 1, 6 ONLY

SA1300A	\$1595.00
SA1800B	\$1895.00
OPT. 1 50MHz MARKER	\$200.00
OPT. 3 +/- 5KHz Res B.W	\$350.00
OPT. 5 1000 MHz Tracking Generator	\$250.00
OPT. 6 7 Digit Center Frequency Display	\$300.00

Note 1: Introductory Price for limited time only.

TAKE ADVANTAGE
CALL 1-800-566-1818

To: Order - For Information & Special Intro. Offer Terms MC, VISA, AE, Check, COD, PO (OAC), LC, Transfer

DISTRIBUTED BY: ADVANTAGE INSTRUMENTS CORP.

3817 S. CARSON ST. # 818 CARSON CITY NV. 89701

1-800-566-1818 702-885-0234 FAX 702-885-7600

PRICES & SPECIFICATIONS SUBJECT TO CHANGE WITHOUT NOTICE OR OBLIGATION. F.O.B. CARSON CITY NV. NV. RESIDENTS ADD SALES TAX.

CIRCLE 139 ON FREE INFORMATION CARD

www.americanradiohistory.com

LATEST TECHNOLOGY

- DESCRAMBLERS
- CONVERTERS
- COMBINATION UNITS

WE'LL BEAT ANY PRICE!

LATEST DESCRAMBLER MODELS

Add On Descrambler for all JERROLD Systems (Except Base Band) Guaranteed to Work Anywhere Coast to Coast (Model JD-3)

~~\$125~~
\$89 6-10
 \$119 1-5

Add On Descrambler For All PIONEER Systems. Guaranteed to Work Anywhere Coast to Coast. (Model PD-3)

~~\$125~~
\$89 6-10
 \$119 1-5

Add On Descrambler For All SCIENTIFIC ATLANTA Systems (Except 8570, 8590, 8600). Guaranteed to Work Anywhere Coast to Coast. (Model SAD-3)

~~\$125~~
\$89 6-10
 \$119 1-5



BRAND NEW
1 YEAR
WARRANTY

SCIENTIFIC ATLANTA 8580

- Features
- Wireless Remote Control
 - Favorite Channel Recall
 - Parental Lockout

\$259 6-10

BRAND NEW
1 YEAR
WARRANTY

\$289 1-5

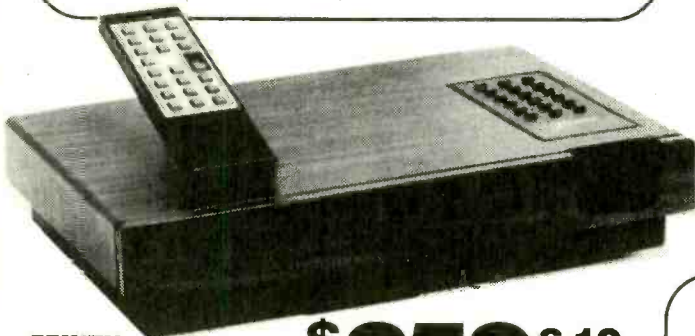

ZENITH

Features

- Wireless Remote Control
- 55cmHz (99 Channel) capacity
- Volume Control
- Parental Lock-Out
- Programmable Favorite Channel Memory

\$259 6-10

\$289 1-5

ADD ON DESCRAMBLERS

	1-5	6-10
FTB-3	49.00	39.00
TVT OR TBI	55.00	47.00
SA-3	59.00	49.00
KN12-3	59.00	49.00
MLD1200-3	49.00	39.00

CONVERTERS

	1-5	6-10
PANASONIC 1453G	79.00	69.00
JERROLD DQN7-3	75.00	65.00
STARGATE 2001	75.00	65.00

Call for other models



**DPV7 & DBB7
8590 & 8600**
Call for availability & prices



1470 OLD COUNTRY ROAD,
SUITE 315 - P.E.
PLAINVIEW, NY 11803
NO NY SALES

FREE COLOR CATALOG!
1-800-950-9145

ELIMINATES SEARCHING, SCANNING, TUNING

INTERCEPTOR™

INTERCEPT, DETECT & CAPTURE
Near Field Transmissions with
Optoelectronics' New
INTERCEPTOR™

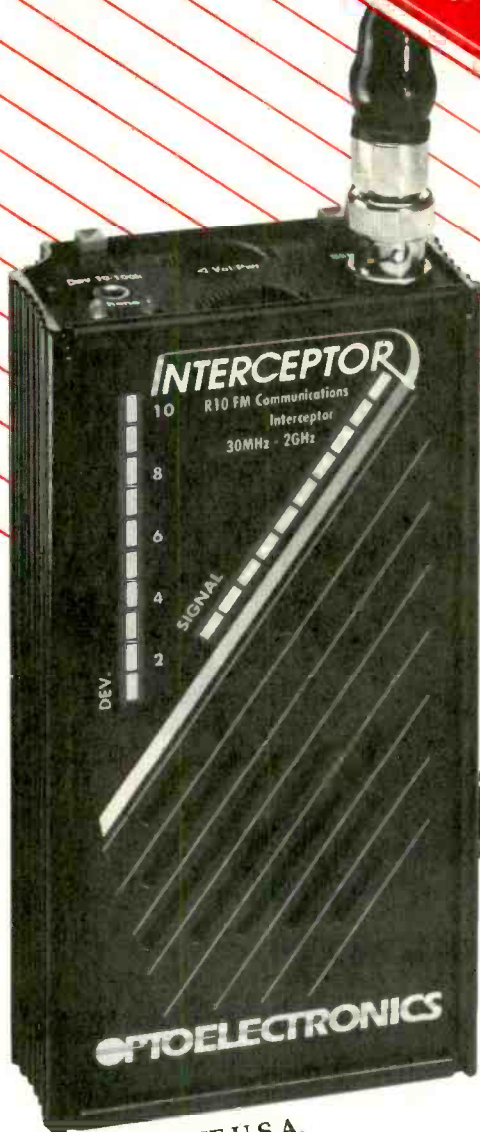

NEW TECHNOLOGY

- Follows & Locks on even when frequency changes.
- Intercepts ALL FM Two-Way Transmissions without gaps in coverage.
- Does Not have to tune through RF Spectrum to find signals.

FCC Classified as Communication Test Instrument for:

- Deviation, FM, FMN
- Relative Signal Strength
- Signaling Tones (CTCSS)
- Modulation Monitor
- Great for testing VHF, UHF & Cellular transmitters

A New Dimension in Recreational Monitoring – Intercept the Two-Way Communication that Surrounds You.

Increase Your RF Security.



Hand Held/Shirt Pocket Size

INTRODUCTORY OFFER

Interceptor™ R10 FM Communications
Interceptor (Includes NiCads, AC/Charger
Adapter, Antenna, Earphone)..... **\$359.**

MADE IN THE U.S.A.

OPTIONS

Headphones (Lightweight personal headphones).....	\$ 15.
Antenna Pak 2 (Five assorted rubber duck antennas – save \$32.).....	\$ 99.
TC200 Tone Counter (CTCSS signalling tones).....	\$ 179.
APS-104 (Extends RF detection distance 10x).....	\$ 995.
CF800 Cellular Band Pass Filter/Amplifier.....	\$ 299.

OPTOELECTRONICS

FACTORY DIRECT ORDER LINE **1-800-327-5912**

305-771-2050 • FAX 305-771-2052 • 5821 NE 14th Ave., Ft. Lauderdale, FL 33334
5% Ship/Handling (Max\$10.) U.S. & Canada. 15% outside continental U.S. Visa & Master Card accepted

CIRCLE 43 ON FREE INFORMATION CARD

CELLULAR SOFTWARE AND MODIFICATION GUIDES

Call Spy Supply for all of your Cellular needs!

We Carry:

CELLULAR SOFTWARE

(We have the software to do New Motorola Phones)

CELLULAR CABLES

(For the Motorola, Panasonic, and Nokia Phones)

CELLULAR MODIFICATION GUIDES

(Covers all cellular manufacturers)

CELLULAR PHONES

(We carry a complete line of cellular phones)



FREE TECHNICAL SUPPORT!

We now offer Cellular Phones cloned with your existing number! Buy a handheld, transportable or car mounted phone ready to go and have only one monthly bill!

Don't Get Ripped Off!

Before you buy our competitor's manual, call and ask if they offer **FREE TECHNICAL SUPPORT**

SPY SUPPLY

Find out why the CIA - FBI - DEA - SECRET SERVICE Have ordered from our catalog To receive yours, send \$5.00 to:

SPY SUPPLY

1212 Boylston St. #120
Chestnut Hill, MA 02167

SPY SUPPLY, 1212 Boylston St. #120, Chestnut Hill, MA 02167

(617) 327-7272

Sold for educational purposes only

KELVIN

ELECTRONICS

10 HUB DRIVE, MELVILLE, NY 11747

RE-ENGINEERED & DESIGNED FOR 1994



150 LE - Student 200 LE - Technician 400 LE - Engineer

Standard Features -

- AC & DC VOLTAGES
- DC CURRENT
- RESISTANCE
- TRANSISTOR
- CONTINUITY TEST - Buzzer
- DIODE TEST
- 3 1/2 Digit LCD
- 10M ohm INPUT IMPEDANCE

BATTERY TEST
TRANSISTOR
DC CURRENT
10 Amp

FREQ COUNTER
up to 20MHz
TRANSISTOR CAPACITANCE
from 1pF to 20uF
AC/DC CURRENT
10 Amp

INDUCTANCE
Resolution 1uH
FREQ COUNTER
up to 20MHz
CAPACITANCE
from 1pF to 200uF
AC/DC CURRENT DUTY %
20 Amp

150 LE
Stock # 990122
\$29.95

200 LE
Stock # 990123
\$49.95

400 LE
Stock # 990124
\$79.95

Designed to meet IEC-348 & UL-1244 safety specifications

2 Year Warranty (Parts & Labor)



"Not only does the Kelvin 94 boast alot of features ... the features go the extra distance."

"If we had to run into a burning building to do some emergency trouble-shooting and could carry in only one piece of equipment, the Kelvin 94 would be it!"

Popular Electronics Reviewed - May 1993

KELVIN 94 The Ultimate Meter

LCR Hz dBm True RMS Logic Probe
The only meter with 0.1% Accuracy on DC Voltages, built-in True RMS, Freq Counter to 20MHz Res: 10 Hz, LCR-Inductance Tester Res: 10 uH, DC/AC Voltages Res: 0.1mV, Ohm Meter Res: 0.1 ohms

TRUE RMS PLUS 12 INSTRUMENTS IN ONE - AC & DC VOLTMETERS, AC & DC CURRENT, dBm, OHMMETER, DIODE TESTER, AUDIBLE CONTINUITY TEST, 20 MHz FREQ COUNTER, CAPACITANCE METER, INDUCTANCE METER, LOGIC PROBE

Model 94
#990111
\$199.95

*See Standard Features Listed below

ENGINE ANALYZER PLUS

Model 95 #990112
\$199.95

A Must For Auto Mechanics

Standard Features - Models 94 & 95

- DC/AC VOLTMETERS
- AC/DC CURRENT
- OHM METER
- DATA HOLD
- RELATIVE MODE
- FREQ COUNTER to 4 MHz (Model 95)
- AUDIBLE CONTINUITY TEST
- DIODE TEST
- MAX/MIN AVERAGE MEMORY RECORD
- 10A HIGH-ENERGY FUSE PROTECTION
- AUTO SLEEP & AUTO POWER OFF

(800) 645-9212
(516) 756-1750
(516) 756-1763/FAX

Established 1945
MIC & VISA ²⁰ Minimum Order
KELVIN CATALOG \$3
Stock No. 650412

KELVIN 100 Basic

990087
\$19.95

- AC & DC VOLTAGES
- DC CURRENT
- RESISTANCE
- CONTINUITY TEST-Buzzer
- 3 1/2 Digit LCD
- LOW BATTERY INDICATOR
- DIODE TEST
- BATTERY TEST

CAPACITANCE METER

KELVIN 250 LE

990126
\$59.95

- ACCURACY: 0.5%
- RANGES: 20mF, 2000uF, 200uF, 20uF, 2uF, 200nF, 20nF, 2000pF, 200pF
- Zero Adjust
- Safety Test Leads
- Test Socket for Plug-in Components

AUTO-RANGE METER

KELVIN 300 LE

990125
\$49.95

AUTO-RANGE

- ACV & DCV
- DC CURRENT
- RESISTANCE
- CONTINUITY TEST
- DIODE TEST
- 3 1/2 Digit LCD
- 10M ohm INPUT IMPEDANCE

INSTRUMENTS

20 MHz SCOPE

Dual Trace 2 Yr Warranty-Parts & Labor
Stock No. 740085 \$385

40 MHz SCOPE

Dual Trace with Delayed Sweep
Stock No. 740086 \$655

TEST ACCESSORIES

SCOPE PROBES

60 MHz, X1 & X10
SPECIAL
700072 \$18.95
150 MHz, X10
700073 \$39.95

IC CLIPS

SOLDER TYPE SPRING LOADED
Stock No. COLOR COST 25+ Qty

990104	BLACK	\$.65 ea.	\$.50 ea
990105	RED	\$.65 ea.	\$.50 ea

DC TOY MOTORS

DC Toy Motor

Stock No. 850647
\$.80 ea

\$.75 ea / 50+ Qty 6V DC High Speed

Solar Motor

Stock No. 850646
\$.60 ea 1.5V DC
\$.55 ea / 50+ Qty

Solar Cells

3 3/4" L x 2 9/16" W
Stock No. 260099 1000mA .45V
\$.5.95 ea
\$.5.50 ea / 3+ Qty

DIGITAL TRAINER

Laptop Digital Trainer comes with 100 page instruction manual, power supply, built-in 1 digit true hexadecimial display, two independent clocks with user adjustable freq & duty cycles, 4 data bit switches and 4 LED displays. Assembled
Stock No. 840460 \$99.95

BINARY QUARTZ CLOCK w/Alarm

ORIGINAL DESIGN - 24 Hr. Binary Quartz Accurate Clock with 2 color LED's. Built-in Alarm and Alarm Display in binary code. **DESIGNED FOR LEARNING** about digital circuitry & binary code. Built with individual IC components. **Battery Memory Loss Prevention.** Comes with rechargeable battery, DC wall transformer and detailed instruction manual. **Advanced Level Kit**
Stock No. 840589 \$79.95

Electronic VOICE PAD

An electronic note pad, able to record your message & replay it later. It has a built-in photo cell & as soon as it senses your presence, it will automatically playback the message left for you. The components are PC mounted. The IC can record a message up to 20 seconds & no mechanical parts or tape - only a digital integrated circuit.
Intermediate Level Kit
Stock No. 840606 \$49.95

BREADBOARDS

Stock No.	Post	Contacts	YOUR COST
680093	0	500	\$ 4.25
680097	0	840	\$ 5.95
680098	2	1380	\$11.75
680100	4	2390	\$22.95

WIRE JUMPER KIT

Pre-cut, Pre-Stripped

330289 140 Piece Set \$ 4.95
330290 350 Piece Set \$ 8.95

COMPONENTS

WHOLESALE PRICES!

Stock No. TYPE (10 Pk. Min.) YOUR COST

600021	555 TIMER	\$.29 ea
600029	556 DUAL TIMER	\$.40 ea
600039	LM566 PPL FUNCTION GENERATOR	\$.60 ea
600018	741C OP-AMP INTERNALLY COMPENSATED	\$.30 ea
600026	1458 OP-AMP DUAL 741C OP-AMP	\$.35 ea
630041	2N2222	\$.20 ea
630383	PN2222	\$.08 ea
600023	7805 Voltage Reg	\$.36 ea

SILICON CONTROLLED RECTIFIER

(Similar to GE C166C1) 4.0 amp, 100V IV
600014 \$.89 ea \$.79 ea/10+

THERMISTOR - 100 ohm

110097 \$1.35 ea \$1.00 ea/20+

THERMISTOR - 10K ohm

110097 \$1.35 ea \$1.00 ea/20+

PROJECT PARTS

Project Speaker

2", 8 Ohm, .1 Watt
Stock No. 350009
59¢

Project BUZZER

3 - 9 Volt DC, 80 db
Stock No. 680089
\$1.59 ea
\$1.39 ea / 10+ Qty

Soldering IRON

with STAND
LONG LIFE TIP
Stock No. 990098
\$3.95 ea

LED T 1 3/4

Stock No.	Color	100+ Qty	1000+ Qty
260020	RED	\$.05 ea	\$.045 ea
260027	GREEN	\$.08 ea	\$.07 ea
260026	YELLOW	\$.08 ea	\$.07 ea
260078	2 COLOR RED/GREEN	\$.32 ea	\$.29 ea

XENON STROBE TUBE

Stock No. 260050
\$3.25 ea
\$2.95 ea / 20+ Qty

TRIGGER COIL

for Xenon Strobe Tube
Stock No. 320037
\$1.25 ea
\$.89 ea / 20+ Qty

INFRARED LED

IR Pair, LED Infrared transmitter and receiver
Stock No. 260061
\$1.95 ea

NEON LAMP

NEZ 2" Long
Stock No. 260003
\$.15 ea
\$.12 ea / 100+ Qty

PHOTO CELL

Photo Cell 450 ohm
Stock No. 260017
\$.65 ea \$.45 ea / 20+ Qty

Photo Cell 1.5K ohm
Stock No. 260018
\$.65 ea \$.45 ea / 20+ Qty

PUSH-BUTTON SWITCH

PUSH-ON, PUSH-OFF
Stock No. 270021
\$.55 ea
\$.49 ea / 100+ Qty

SUB-MINIATURE MOMENTARY SWITCH

Stock No. 990002
\$.35 ea
\$.28 ea / 100+ Qty

MINIATURE TOGGLE SWITCH

Stock No. 270034
\$.90 ea Type-SPST
\$.79 ea / 50+ Qty

CIRCLE 38 ON FREE INFORMATION CARD

ALFA ELECTRONICS

HIGH QUALITY TEST EQUIPMENT
BEST PRICE



DMM 89 \$199.95

Most Advanced DMM
All Purpose & Communication
-80.7 to 81.4 dBm with 4Ω-1200Ω
20 reference impedances
True RMS
Frequency counter: 0.01Hz-10MHz
Capacitance: 1pF-50,000μF
Measure AC volt to 20kHz
5000 counts, 0.1% accuracy
Auto/manual range, fast bar graph
Min/Max/Ave/DH/Relative/Zoom
Auto power off
Input warning
Splash proof
Volt, amp, ohm, logic, diode, continuity
Ruggedized case
Rubber holster included



DMM 2360 \$119.95

DMM-LCR Meter
Very Versatile DMM
Inductance: 1μH-40H
Capacitance: 1pF-40μF
Frequency: 1Hz-4MHz
Temperature: -40-302 °F
TTL Logic Test: 20MHz
Diode, Continuity
Volt, Amp, Ohm
3999 count display
Peak Hold
Auto power off
Ruggedized case.
Rubber Holster \$8.00
Temperature probe \$7.00



DMM 21 \$74.95

Inductance: 1μH-40H
Capacitance: 1pF-200 F
Frequency: 1Hz-1MHz
Volt, amp, ohm, diode, continuity
3999 count display
TTL logic, HFE
Peak hold
Ruggedized case
Rubber holster \$8.00

Full line of DMMs, economy, compact, ruggedized, solar cell, automotive, heavy duty, industrial, starts from \$15.95

Fluke Multimeter
Fluke 12 \$84.95
Holster C-10 \$10
Fluke 70 II \$67.5
Fluke 73 II \$94
Fluke 75 II \$129
Holster C-70 \$16
Fluke 77 II \$149
Fluke 79 II \$169
Fluke 29 II \$169

Fluke 83 \$225
Fluke 85 \$259
Fluke 87 \$287

Fluke 97
Scope Meter \$1785



LCR Meter 131D \$229.95

Most Advanced LCR
Dual display/LQ or C/D
Inductance: 0.1μH-1000H
Capacitance: 0.1pF-10,000μF
Impedance: 1mΩ-10MΩ
0.7% basic accuracy
Dissipation factor & Q factor
Serial & parallel mode
Relative mode for comparison and to remove parasitics
Statistics, tolerance
Best for design, incoming testing & production
SMD and chip component test probe \$25.00



LCR Meter 814 \$189.95

Best Resolution LCR
Inductance: 0.1μH-200H
Capacitance: 0.1pF-20,000μF
Resistance: 1mΩ-20MΩ
1% basic accuracy
Dissipation factor indicates leakage in capacitor and Q factor in inductor
Zero adjustment to reduce parasitics from test fixture
Best for high frequency RF and surface mount components.
SMD and chip component test probe \$25.00, Deluxe carrying case \$5.00

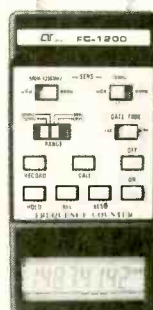

Frequency Counter FC-1200 \$129.95

Frequency: 0.1Hz-1.25GHz
Display: 8 digit LCD
Period: 0.1μs-0.1s
Records Max/Min/Average
Data hold, relative mode
Telescoping antenna \$8.00
Deluxe case \$5.00

Also Available:
AC/DC clamp meter, Light meter, Thermometer, pH meter, High voltage probe, Digital caliper, Anemometer, Electronic scale, Force gauge, Tachometer, Stroboscope, Humidity & EMF adapter, Sound level meter, Frequency counter, SWR/field strength/power meter, Dip meter

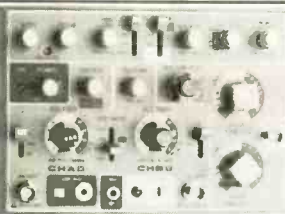

20 MHz Oscilloscope with Delay Sweep PS-205 \$429.95

Dual Trace, Component test, 6" CRT, X-Y Operation, TV Sync, Z-Modulation, CH2 Output, Graticule Illum, 2 probes each has x1, x10 switch. Best price with delay sweep.
PS-200 20 MHz DUAL TRACE \$339.95
PS-400 40 MHz DUAL TRACE \$494.95
PS-405 40 MHz DELAY SWEEP \$589.95
PS-605 60 MHz DELAY SWEEP \$769.95
Scope Probe: 60MHz x1, x10 \$13, 100MHz x1, x10 \$22

20 MHz Digital Storage Oscilloscope DS-203 \$729.95

Switchable between digital and analog modes
2 K word per channel storage
Sampling rate: 10 M sample /sec
8 bit vertical resolution (25 Level/div)
Expanded Timebase 10ms/div - 0.5 s/div.
Refresh, Roll, Save all, Save CH2, Pre-Trig
Plotter Control
250MHz x1, x10 \$29, 250MHz x100 \$39

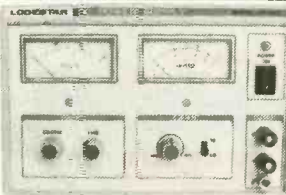

DC Power Supply PS-303 \$159.00

0-30 VDC, 0-3A output
Constant voltage & constant current mode
0.02% + 2mV line regulation
0.02% + 3mV load regulation
1 mVrms noise and ripple
Short circuit and overload protected
PS-8200 with digital voltmeter \$179.00
Also available: 30V/5A, 60V/3A, 60V/5A
16V/10A, 30V/10A

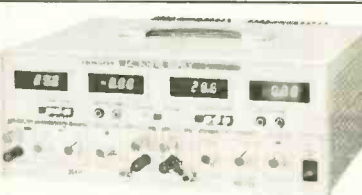

DC Power Supply Triple Output PS-8202 \$499.95

Two 0-30 VDC, 0-3A outputs
One fixed 5VDC, 3A output
Capable of independent or tracking operation
Constant voltage and constant current mode
Four digital meters for volt and current display
Excellent regulation and low ripple
Short circuit and overload protected
Also available: 30V/5A triple output \$549.95
Dual tracking 30V/3A, 30V/5A, 60V/3A, 60V/5A

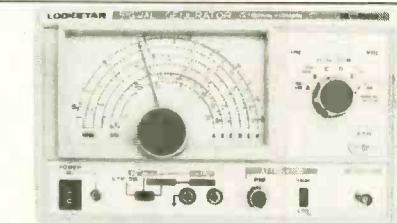

RF SIGNAL GENERATOR SG-4160B \$119.00

100 kHz-150MHz sinewave in 8 ranges
RF Output 100mVrms to 35 MHz
Internal 1kHz, External 50Hz-20kHz
AM modulation
Audio output 1 kHz, 1 Vrms

AUDIO GENERATOR AG-2601A \$119.00

10Hz - 1MHz in 5 ranges
Output: 0-8Vrms sinewave
0-10Vp-p squarewave
Synchronization: ±3% of oscillation frequency per Vrms
Output distortion:
0.05% 500Hz - 50kHz
0.5 % 50Hz - 500kHz
Output impedance: 600 ohm

FUNCTION GENERATOR FG-2100A \$169.95

0.2 Hz - 2 MHz in 7 ranges
Sine, square, triangle, pulse and ramp
Output: 5mV-20Vp-p
1% distortion, DC offset ± 10V
VCF: 0-10V control frequency to 1000:1



RF SIGNAL GEN./COUNTER SG-4162 AD \$229.95

Generates RF signal same as SG-4160B
Frequency counter 1Hz - 150 MHz for internal and external source
Sensitivity <50mV

AUDIO GEN./COUNTER AG-2603AD \$229.95

Generates audio signal same as AG-2601A
Frequency counter 1Hz-150MHz for internal and external sources
Sensitivity <50mV

FUNCTION GEN/COUNTER FG-2102AD \$229.95

Generates signal same as FG-2100A
Frequency counter 4 digits
Feature TTL and CMOS output

SWEEP FUNCTION GEN./COUNTER \$329.95

0.5Hz to 5 MHz in 7 ranges
Sweep: Linear 10:1/Log 10:1 20ms to 2s
AM Modulation
Gated Burst, Voltage Control Generator
Generator Control Voltage & 6 digit counter
1Hz-10MHz for internal & external sources

ALFA ELECTRONICS

741 Alexander Rd., Princeton, NJ 08540

(800) 526-2532/(609) 520-2002 15 DAY MONEY BACK GUARANTEE. 1 YEAR WARRANTY

FAX:(609) 520-2007

CALL OR WRITE FOR FREE CATALOG AND BEST OFFER.

Visa, Master Card, American Express, COD, Purchase Order Welcome

CIRCLE 26 ON FREE INFORMATION CARD

Are Cable Companies Sucking You Dry?



**FREE
Catalog!**

**All Major
Brands!**

Take a Bite out of High Rental Fees
with your own

Converters & Descramblers



Everquest • Panasonic • Jerrold • Zenith • Pioneer
Scientific Atlanta • Oak • Eagle • Hamlin • Tocom



Order
Toll-Free **1 800 624-1150**

Call today for a FREE catalog!

MD Electronics

875 S. 72 Street • Omaha, NE 68114



CALL TOLL FREE
1-800-292-7711
1-800-445-3201 (Can)

C&S SALES

EXCELLENCE IN SERVICE

**WRITE FOR
FREE CATALOG**



**Line Tracker
MV-963**
\$52.95
(Infra-red Sensor)
The robot follows
a black line
on white paper
Preamsembled PCB



**Dual-Display
LCR Meter**
w/ **Stat Functions**
B+K Model 878
\$239.95
Auto/manual range
Many features
with Q factor
High Accuracy

Electronic Tool Kit Model TK-1000
A professional organizer tool kit at affordable prices. No student should be without this unique tool kit that holds all the tools you need.
Including:

- Diagonal Cutter
- Long Nose Pliers
- 6" Wire Stripper
- Solder 60/40
- 6" Screwdriver
- 6" Phillips Driver
- Safety Goggles
- IC Puller
- 3pc Nut Drivers
- Iron 25W
- Iron Stand
- Solder Wick
- Desoldering Pump
- 5 pc Solder Ease Kit
- 6pc Precision Screwdrivers

\$39.95

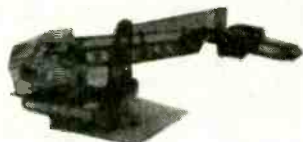

**Robotic Arm
Y-01**
\$49.95
(Wired Control)
Movement grabs
& releases,
lifts & lowers,
pivots from side to side



**Stereo Cassette Player
Kit**
**Model
TR-18K**
\$16.95
Headphones
Included



**Digital
Multimeter
EDM-83B**
\$175.00
Almost every
feature available
Bargain of the
decade



**Digital
Multimeter
DVM-638**
\$39.95
11 Functions
with case



**Digital
Capacitance
Meter**
CM-1555
\$49.95
Measures capacitors
from .1pf to 20,000µf



**Digital
LCR Meter
LCR-680**
\$79.95
3-1/2 Digit
LCD Display
Inductance
1uH to 20MΩ



**Function
Generator
FG-801**
\$149.95
Square,
Triangle
Sine wave
Freq range



**3-3/4 Digit Multimeter
BK-390**
\$139.00
0.1% DCV accy
Analog bar graph
Auto/manual ranging
Capacitance meas
Temperature probe



**Digital
Multimeter Kit
w/ Training Course
M-2665K**
\$49.95
Full function 34 ranges
Ideal school project
M-2661 (Assembled) \$55.00



**Frequency Counter
F-1225**
\$225.00
8 Digit LED display
Wide meas range
High sensitivity
Data hold function
Input impedance 1MΩ or 50Ω
10:1 input attenuation function

**Fluke Multimeters
(All Models Available Call)**

Scopemeters	70 Series
Model 97 \$1,795	Model 7011 \$69.95
10 Series	Model 7311 \$97.50
Model 10 \$62.95	Model 7711 \$149
Model 12 \$84.95	Model 7911 \$175
20 Series	80 Series
Model 2911 \$175	Model 87 \$289



**Triple Power
Supply
XP-620**
By Elenco
\$75.00
3 fully regulated supplies; 1.5-15V @ 1A, -1.5 to -15V @ 1A or 3-30V @ 1A & 5V @ 3A Kit XP-620K \$49.95



**Quad Power
Supply
XP-581**
By Elenco
\$79.95
Four supplies in one unit; 2-20V @ 2.5A, 5V @ 3A, -5V @ .5A and 12V @ 1A. All regulated and short protected



**High Current DC
Power Supply
BK-1686** **\$169.95**
3 to 14 VDC Output
12A @ 13.8V
For servicing high
power car stereos,
camcorders, ham radios, etc.
Connect 2 or more in parallel



**Wide Band
Signal
Generators
SG-9000**
\$124.95
RF Frequency 100K-450MHz
AM modulation of 1KHz Variable
SG-9500 150MHz \$239.00

**Telephone Kit
PT-223K**
\$14.95
Available
Assembled
PT-223
\$15.95



**Function Generator
Blox
#9600**
By
Elenco
\$29.95
Kit \$26.95
Sine, Triangle, Square Wave



**Learn to Build & Program
Computers with this Kit**

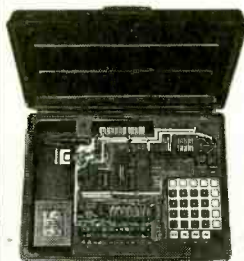

MM-8000
By Elenco
\$129.00

From scratch you build a complete system. Our Micro-Master trainer teaches you to write into RAMs, ROMs and run a 8085 microprocessor, which uses similar machine language as IBM PC.

Digital/Analog Trainer
Complete Mini-Lab For Building,
Testing, Prototyping Analog and Digital



By Elenco
in U.S.A.
XK-525
\$159.95
Kit
XK-525K
\$129.95

Designed for school projects, with 5 built-in power supplies. Includes a function generator with continuously variable, sine, triangular, square wave forms. All power supplies are regulated and protected against shorts.

**AM/FM Transistor
Radio Kit
with Training Course**
Model AM/FM 108
\$27.95
14 Transistor, 5 Diodes
Easy to build because
schematic is printed on the PCB
Makes a great school project
Model AM-550 AM Only \$17.95

**Telephone Line
Analyzer**
Kit **TT-400K \$19.95**
Assembled **TT-400 \$26.95**



WE WILL NOT BE UNDERSOLD
UPS SHIPPING: 48 STATES 5%
IL RES 7.5% TAX (\$3 min \$10 max)
OTHERS CALL

C&S SALES INC.

1245 ROSEWOOD, DEERFIELD, IL 60015
FAX: 708-520-0085 (708) 541-0710



**15 DAY MONEY BACK
GUARANTEE**
FULL FACTORY WARRANTY
PRICES SUBJECT TO CHANGE WITHOUT NOTICE

CIRCLE 32 ON FREE INFORMATION CARD

**FREE PROBES
WITH ALL
SCOPES**

**ELENCO ♦ HITACHI ♦ B+K
SCOPES
AT GUARANTEED LOWEST PRICES**

**WRITE FOR
FREE
CATALOG**

**QUALITY - ELENCO OSCILLOSCOPES
2- YEAR WARRANTY**

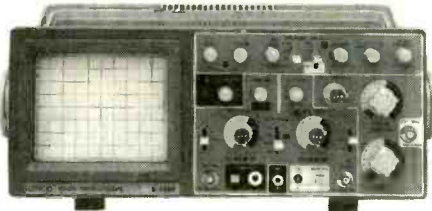

60MHz

S-1360 \$775

Delayed Sweep

S-1365 \$849

Cursor Readout

- ♦ Voltage, Time
- ♦ Frequency differences displayed on CRT

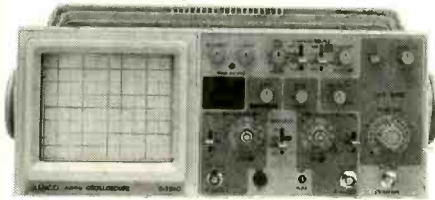

40MHz

S-1340 \$495

2- Channel

S-1345 \$575

Delayed Sweep

- ♦ Beam Find
- ♦ Component Tester



25MHz

S-1325 \$349

2- Channel

S-1330 \$449

Delayed Sweep

- ♦ Beam Find
- ♦ Component Tester

Dependable Equipment at Affordable Prices

B+K 20MHz

2 Channel

Model 2120 \$389.00



Delayed Sweep

Model 2125 \$539.95

40MHz DUAL -TRACE

Model 1541B

\$749.95

- 1mV/div sensitivity
- Video sync separators
- Z axis input
- Single sweep
- V mode-displays 2 signals unrelated in frequency

60MHz DUAL-TRACE

Model 2160

\$949.95

- 1mV/div sensitivity
- Sweep to 5ns/div
- Dual time base
- Signal delay line
- Component tester
- V mode-displays 2 signals unrelated in frequency

100MHz THREE-TRACE

Model 2190

\$1,379.95

- 1mV/div sensitivity
- Sweeps to 2ns/div
- Dual time base
- Signal delay line
- 19kV accelerating voltage
- Calibrated delay time multiplier

**20MHz ANALOG with
DIGITAL STORAGE**

Model 2522A

\$869.95

- 20MHz analog bandwidth
- 20MS/s sampling rate
- 2k memory per channel
- 20MHz equivalent time sampling

HITACHI POPULAR SERIES

V-212 - 20MHz, 2 Channel	\$425.00
V-222 - 20MHz, DC Offset	\$695.00
V-422 - 40MHz, Dual Trace	\$849.00
V-522 - 50MHz, Dual Trace	\$975.00
V-523 - 50MHz, Delayed Sweep	\$995.00
V-525 - 50MHz, w/ Cursor	\$1,069.00

HITACHI COMPACT SERIES SCOPES

V-660 - 60MHz, Dual Trace	\$1,375.00
V-665A - 60MHz, DT, w/cursor	\$1,449.00
V-1060 - 100MHz, Dual Trace	\$1,549.00
V-1065A - 100MHz, DT, w/cursor	\$1,695.00
V-1085 - 100MHz, QT, w/cursor	\$2,125.00
VC-6045A - 100MHz, Digital Stor	CALL
VC-6025A - 50MHz, Digital Stor	CALL

**Elenco DS-203 20MHz, 10MS/s
Digital Storage Oscilloscope**



\$749

2K Word Per Channel • Plotter Output
8 Bit Vert. Resolution • 2048 Pts Hor.
Resolution • Much More.....

FLUKE SCOPEMETERS

A handheld instrument that combines a 50MHz, 25MS/s dual channel digital storage oscilloscope with feature-packed 3000 count digital multimeter.



Model 93 - \$1,225

Model 95 - \$1,549

Model 97 - \$1,795

- Autoset, automatically sets voltage, time & trigger
- Multimeter display;
- 3-2/3 digits (>3000 counts)
- True RMS volts; AC or AC+DC up to 600V

C&S SALES INC.

1245 ROSEWOOD, DEERFIELD, IL 60015
FAX: 708-520-0085 (708) 541-0710

CALL TOLL FREE

1-800-292-7711

1-800-445-3201 (Can)



**15 DAY MONEY BACK GUARANTEE
FULL FACTORY WARRANTY**

ALL PRODUCTS ARE FACTORY NEW

PRICES SUBJECT TO CHANGE WITHOUT NOTICE

CIRCLE 32 ON FREE INFORMATION CARD

B & S SALES

Call(313) 566-7248 • FAX (313) 566-7258 24 hrs.

Hours: Monday through Friday 8 am to 6 pm EST
51756 Van Dyke St. #330, Shelby Township, MI 48316

WE SPECIALIZE IN QUANTITY PRICING 5, 10, 20 LOTS

Make Your Best Deal!

\$ SALE

\$ SALE

Y RENT

Y RENT

<u>JERROLD</u>	<u>SA</u>	<u>PIONEER</u>	<u>HAMLIN</u>	<u>TOCOM</u>	<u>ZENITH</u>
DRX-3-DIC	8590	BA 6110	CR 6600-3M	5507 VIP	1600
DPBB	8580	BA 5135	CR 6000-3M	5503 VIP	
DPV-5,7	8570				
	8550				

NEW PAN
PIONEER
GREEN E LITE
BA 5000 > SERIES
BA 6000

NEW PAN
SA-8500 SERIES
(BUT ALL BASE BAND)
THE PREMIER

NEW PAN
JERROLD
PINK PAN

PANASONIC TZ — PC 1453G2

By far the best basic converter on the market today. 550 MHz (1 to 99) parental control, sleep timer, remote batteries, contrast and remote control range.

Superior to all other converters

NO MICHIGAN SALES

**MINI TVT:
THE 1/4 POUNDER
LITTLE 4x4
SECOND ONLY TO TVT
GOLD IN POPULARITY**

**TVT GOLD ORIGINAL
FOR MOST
JERROLD SYSTEMS,
LEADING SELLER
OF ALL PANS**

OWN YOUR OWN
SA-3
M-80

**TNT
MLD**
OWN YOUR OWN

SAVE \$

SAVE \$

**NEW REMOTE CONTROL AB
SWITCH FOR DUAL SYSTEMS
(WITHOUT LEAVING THE
COMFORT OF YOUR CHAIR)**

**FILTERS
POST & NEG
SUBCONTRACTORS
& DEALERS
ONLY QUANTITY**

We are now offering a 6-month warranty. In order for warranty to be in effect, this form must be signed and returned.
FOR VCR, SECOND, THIRD, ETC. HOOK-UPS.

Yes, I agree all units are to be used or resold in compliance with Federal and State laws.

Signature _____ Date _____

Name _____ Phone No. () _____
Address _____
City _____ State _____ Zip _____

It is not the intent of B & S Sales to defraud any pay television operator and we will not assist any company or individual in doing the same.

CIRCLE 140 ON FREE INFORMATION CARD

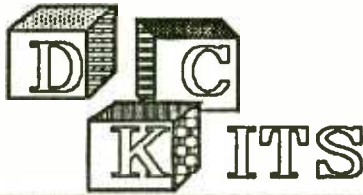

TOLL FREE ORDER
HOT LINE
1-800-423-0070

ALL NEW--IMPROVED STEREO FM TRANSMITTER

LOADED WITH FEATURES

- * RF AMPLIFIER
- * FRONT PANEL FINE TUNING
- * STABLE OPERATION
- * INPUT LEVEL ADJUSTMENTS
- * WORKS WITH DIGITAL TUNED RADIOS
- * 38KHz CRYSTAL MULTIPLEX CIRCUIT

DC'S all new FM Stereo Transmitter Kit based on the unique BA1404 Stereo Broadcaster Integrated Circuit that includes all the complex circuitry to generate the stereo signal. We've added an RF amplifier circuit to provide excellent transmit range. Additional features like electronic fine tuning, voltage regulation, 38KHz multiplex crystal, input level adjustment makes the Stereocaster the top of the line Stereo FM Transmitter.

ORDER STEREOCASTER \$29.95

FUNCTION GENERATOR KIT ORDER FG2 KIT

\$19.95

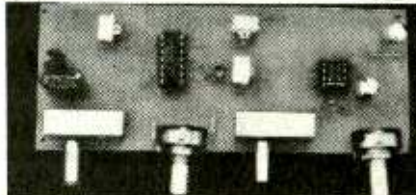

A great project to enhance your bench. This handy little function generator has a built-in buffer amplifier, a 3-decade range selector switch that covers 15 Hz to 25 kHz, output level control and function switch to select sine, square, or triangle.

POWER SUPPLY KIT PS-1 \$16.99

Output of this power supply is continuously adjustable from 1.2 to 25V DC. The LM317T voltage regulator provides excellent regulation and ripple rejection. Includes a 1 A transformer, PC board, LM317T, 2 binding posts, and all small parts.

MORE KITS

3 DIGIT LED DVM ONLY 3" X 3" READS 0 TO 100 V DC ORDER DVM3 \$19.95
FM WIRELESS BROADCASTER FMI \$ 9.95
8038 FUNCTION GEN. KIT FGI \$ 9.50
SEQUENCER PROJECT SEQKIT \$ 9.50

CHRISTMAS TREE PROJECT

Build this unique seasonal project and have an unusual conversation piece. Powered by two D cells, 17 LEDs flash in a seemingly random fashion. Kit includes everything except batteries. ORDER XMASKIT \$16.95

MAKE CIRCUIT BOARDS THE NEW, EASY WAY



WITH TEC-200 FILM

JUST 3 EASY STEPS:

- Copy circuit pattern on TEC-200 film using any plain paper copier
- Iron film on to copper clad board
- Peel off film and etch

convenient 8½ x 11 size
With Complete Instructions

ORDER TEC200-10 (10-SHEETS) \$5.95

UNIVERSAL DECODER IC'S

REFER TO RADIO ELECTRONICS MAY 1990

CD22402E	7.95	CD4040	.65
LM733	.99	CD4053	.59
LM7805	.50	LM7812	.50
CA3126E	1.95	LM7905	.50
74C00	.50	3.58 MHz	1.00
NE564	2.29	18 Uh	.39

DC ELECTRONICS

SEND MAIL ORDERS TO:

PO BOX 3203 SCOTTSDALE, AZ 85271



ADD \$3.50 S&H

CIRCLE 144 ON FREE INFORMATION CARD

CELLULAR TELEPHONES



* **CELLULAR HANDBOOK** \$ 59.95

* **MOTOROLA CELLULAR SOFTWARE** \$199.95

* **MITSUBISHI, PANASONIC, HITACHI, TANDY, NEC & NOKIA SOFTWARE** \$299.95

We also sell new reprogrammed cellular phones (car mount, bag and handheld) or send us your second telephone and we will reprogram it to your current number. We also sell programming cables for all the above phones. Call us for pricing.

CELLULAR LINK

9859 IH-10W, SUITE 257 * SAN ANTONIO, TEXAS 78230

PHONE (210) 697-9544, FAX on demand (210)699-9640

*Unlimited Technical Support * Book and Software sold for Educational purposes only*

CIRCLE 141 ON FREE INFORMATION CARD

Learn MICROCONTROLLERS and EMBEDDED SYSTEMS with the AES-10

The AES-10... a complete learning system, a complete embedded control system. Extensive manuals guide you through your 8051 development project. Assembly, BASIC, and C programming. All hardware details, complete schematics. Learn to program the LCD, keypad, digital and analog I/Os for your applications.



80C32 Computer/Microcontroller board with:

- 32K ROM, 32K RAM
- 2 by 16 Liquid Crystal Display
- 4 by 5 Keypad
- Digital, A/D, D/A, and PWM. I/O
- Built in Logic Probe
- Power supply, (can also be battery operated)
- Extended AES BASIC and AES Monitor in ROM
 - Built-in routines for LCD, Keypad, A/D, D/A and Digital I/O ports
 - See 80C32 registers while you Step
 - See all memory locations and data on LCD
 - See memory contents in dec. hex. and binary
- RS-232 cable to connect to PC for programming
- 8051/52 DOS Cross Assembler
- Program disks with well documented examples
- User's Manual, Language Manual, and Text

\$365, Money Back Guarantee
Free Brochure, M/C Visa
800 - 730-3232
714 - 744-0981
Fax 714 - 744-2693

AES
Advanced Educational Systems

1407 North Batavia Street, Orange, California 92667, USA

PCBoards

PCB Artwork Made Easy!

PRINTED CIRCUIT DESIGN SOFTWARE
for

Layout - Autorouting - Schematic

- Supports all Video Modes including Super VGA
- Copper Flooding for Building Ground Areas
- Gerber and Excellon Output
- Mirror Imaging for Laser Printer Output
- Autorouter and Schematic Programs
- Circuit Simulation Software Available
- **NEW! - WINDOWS™ Versions**
- **NEW! - DOS Versions - PCBoards & PCRoute**
- **FREE - Heat Transfer Film with Order**

Download Demos from BBS (205)933-2954

PCBoards Layout Only \$99

Windows™ Layout starts at \$149

Call or Write for Full Product Line, Prices & Demo Packages

PCBoards
2110 14th Ave. South
Birmingham, AL 35205

(800)473-7227
Fax (205)933-2954
Phone (205)933-1122

AMERICAN RELIANCE

Introducing the AMREL Analog and Digital Power Supplies...

EITHER CHOICE PLACES MORE FEATURES ON YOUR BENCH—SAVES YOU MONEY!

3 YEAR WARRANTY



2 YEAR WARRANTY

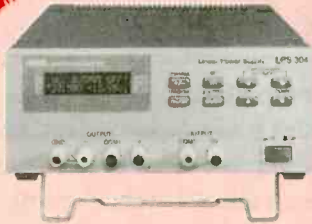

AMREL LPS-100 Series—For Performance That Sets New Industry Standards!

- Low Output noise rating less than 0.3mV.
- Line/load regulation rated at low 0.01% + 1mV.
- Transient response time of 50µ Sec.
- Overload protection.
- Output enable/disable
- Coarse and fine voltage/current adjustment.
- Auto series/parallel operations for triple output supplies.
- 3 year full warranty—not 1 or 2 years.

AMREL LPS-300 Series—Offer Features And Prices That The Competition Can't Beat!

- Microprocessor controlled.
- User friendly keypad data entry.
- Low output noise rating less than 1mV.
- Line/Load regulation rated less than 2mV.
- Output enable/disable and Power—off memory.
- 2 year warranty.
- Optional RS-232 interface capability.

Model	LPS-101	LPS-102	LPS-103	LPS-104	LPS-105	LPS-106	LPS-301	LPS-302	LPS-303	LPS-304	LPS-305
Rating	30V/1A	30V/2A	30V/3A	+30V/1A -30V/1A 3-6.5V/3A	+30V/3A -30V/3A 3-6.5V/3A	60V/1A	15V/2A(H) 30V/1A(L)	15V/4A(H) 30V/2A(L)	30V/3A	+30V/1A -30V/1A 5V/2A	+30V/2.5A -30V/2.5A 3.3-5V/3A
Retail Price	\$195	\$225	\$295	\$395	\$495	\$245	\$249	\$299	\$369	\$399	\$599

PRINT
Product International Inc.



Call For Sale Price: **1-800-638-2020**



8931 Brookville Road • Silver Spring, Maryland 20910 • Fax: 800-545-0058 •

CIRCLE 137 ON FREE INFORMATION CARD

TONY TALLI'S ORIGINAL TELEVIEW DISTRIBUTORS

WHERE OUR VALUED CUSTOMERS'

BUSINESS

IS HONESTLY APPRECIATED

OUR PRICES

1 800 847 3773

Call Us Today

90 DAY + GUARANTEE

SCIENTIFIC ATLANTA

JERROLD PIONEER

OAK HAMLIN



HRS. M - F 9-4 PST NO NV. SALES

AFFORDABLE DATA ACQUISITION

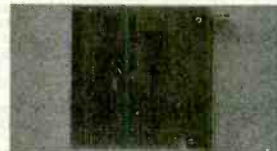

MODEL 30 \$79.00

- PLUGS INTO PC BUS
- 24 LINES DIGITAL I/O
- 8 CHANNEL-8 BIT A/D IN
- 12 BIT COUNTER
- UP TO 14K SMP/SEC



MODEL 45 \$189

- RS-232 INTERFACE
- 8 DIGITAL I/O
- 8 ANALOG INPUTS
- 2 ANALOG OUTPUTS
- 2 COUNTERS-24 BIT

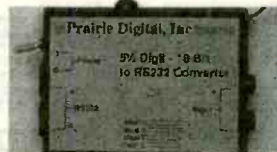

MODEL 70 \$239

- RS-232 INTERFACE
- 18 BIT A/D
- 5.5 DIGIT
- UP TO 60 SMP/SEC



MODEL 150-02 .. \$179

- RS-232 INTERFACE
- TRMS, 20 AMPS
- 12 BIT A/D
- OPTO-ISOLATED
- CHANGE RANGES, AC/DC, VIA RS-232

Prairie Digital, Inc.

846 17th Street • Industrial Park • Prairie du Sac, WI 53578
(608) 643-8599 • FAX: (608) 643-6754

July 1994, Popular Electronics

CIRCLE 47 ON FREE INFORMATION CARD

TOP SECRET



CONSUMERTRONICS
2011 Crescent Dr., P.O. Drawer 537
Alamogordo, NM 88310

Voice: (505) 434-0234, 434-1778;
8AM - 8PM MST, Mon-Sat

Fax: (505) 434-0234 (orders only; if you get
answering machine, any time enter #11)

24-hour, 7 days/week

Free Tech Support (must relate directly to your
order or prospective order): Tues. and Thurs. only.
Add \$5 total \$H (US, Canada). All items in stock. VISA,
MCARD OK (\$29 min.). No CODs or "bill me's". New Catalog
(150+ offers) is \$2 w/order, \$4 w/b (no free catalog).
In business since 1971. As seen on TV, etc. John Williams - former
Lockheed Senior Engineer, NMSU Computer Science Professor,
Navy, Air Force Weapons Engineer, NIH Health Physicist.

*All software supports all IBM-PC compatible
x86 systems (8086 - Pentium)

Off-The-Shelf HARDWARE

Van Eck Systems, Automated Tempst Module, X-Radar
Emitter, Carjacking Follower, Personal Body Alarm,
Voice Disguiser, Hearing Assistant, Shrek Module, EM
Countermeasure, Omnimax TENS, 6th Sense Communicator,
many many Phone Boxes, Bumper Beeper, Subliminal
Mixer/Amp, Super MWD, Rifle Device, Neurophone,
Hieronymus Machine, Magnetometer, Data Card Reader/Writers,
Dwelling Security System, Levitator, Vortex Generator,
Ultrasonic Jammer & Receiver, Long-Range Eavesdropper,
Noise Cancellation System, Unknown Presence Detector,
Electronic Downer, Automatic Pet Feeder, Stealth Palm - more! See our Catalog

CELLPHONE MODIFICATIONS

See our Catalog for our infamous cellphone modification
guide (\$69) - detailed, comprehensive, covers all makes -
10 times more info than competitor's "guides" (Do Special
Projects below) for up-to-date hardware/software.

SPECIAL PROJECTS

We design, build, repair, modify, maintain and/or consult
on any device, system, process or project - electrical,
electronic, computer, phone, mechanical, optical, automotive.
Invention prototyping. Confidentiality guaranteed.
Describe and include \$25 pre-engineering fee (does not
obligate you). Time and cost estimates in 7-10 days.

VOICE MAIL HACKING

How voice Mail Box (VMB) systems are used and the
specific ways they are hacked. Includes ASPEN, MESSAGE
CENTER, BIX, GENESIS, EZ, SYDNEY, PHONE MAIL,
AUDIX, CINDY, CENTRAGRAM, SPERRY LINK, RSVP,
etc. Absolutely required for all users, sysops and
security personnel \$29.

PBX HACKING

How PBXs are hacked to the tune of a Billion\$! While
"VOICE MAIL HACKING" details how VMSs are
hacked for "phun" and profit - including VMS methods
for hacking PBXs themselves - "PBX HACKING" addresses
ALL issues relating to PBX hacking, including
countermeasures! Can your business or agency afford a
\$90,000 phone fraud loss (the average loss due to
hacked PBXs)? As described in Forbes Magazine. \$39

PHREAKING CALLER ID & ANI

Details on how they work and dozens of effective ways
of defeating Caller ID, ANI, *69, *57, and Call Blocking
and *67. Also describes Caller ID, Drange, Beige,
Cheese and CF Boxes, ESS, SS7, E-911, various
CLASS services, CNA, NON PUB DA, CAMA, DNR,
800-ECR, Diverters, LD Extenders, Centrex - more. \$29.

PHONE COLOR BOXES

As designed by Phone Phreaks! 15 phone color boxes
described. Dozens of circuits, simulator programs. Plus
call-forwarding, conferencing, phreak history, 50 useful
and legal phone circuit plans - more. \$29.

ROBOFONE AUTODIALER

Powerful, versatile, menu-driven Wargames autodialer
lets you dial any quantity (up to 10K) or mix of local
long distance numbers in any order, over any length of
time, whether busy or answered (your choice) and log
the times, commands and results to monitor, printer
and/or disk. Quick-dial directory of up to 600 numbers.
BUSY redial options. Direct modem command and control.
All Result Codes, including VOICE and RINGING.
Optional shell to terminal program upon CONNECT. Exit
to menu or DOS (for batching). Manual + Disk* \$29.

COMPUTER PHREAKING

TROJAN HORSES, VIRUSES, WORMS, etc. and
countermeasures. Includes disk with 360K of hacker
text files and utilities, and legendary FLUSHDT+ protection
system (Editor Choice, PC Magazine). Dozens of
computer crime and abuse methods and countermeasures.
How systems are penetrated. BBS advice, password
defaults, glossary - much more! Manuals + Disk* \$39.

BEYOND VAN ECK PHREAKING

Eavesdropping on TV and computer video signals using
an ordinary TV! Includes security industry reports. Range
up to 1 KM. Plans include both the Consumertronics and
the original Top Secret Van Eck designs! \$29.

CRYPTANALYSIS TECHNIQUES

Five powerful menu-driven crypto programs (in COM
and their .BAS sources) to analyze, decrypt "secure" ci-
phertexts. Worked-out examples. Recommended in prestigious
"Computers & Security". Manual + Disk* \$29.

By an ORDER of the MAGNITUDE

The most comprehensive, hard-hitting, hi-tech survival
book ever written! Topics include electronics, computers,
energy, weapons, concealment, revenge, alarms, etc. to
survive today's dangerous world. We all face increasingly
financially and physically brutal times! Field-expert use of
technology in various threat and conflict environments and
scenarios. \$49.

STOPPING POWER METERS

As reported on CBS "60 MINUTES": How certain
devices can slow down - even stop - watt-hour meters -
while loads draw full power! Device simply plugs into
one outlet and normal loads into other outlets. Also
describes meter creep, overload droop, etc. Plans \$29.
I.G. MANUAL: External magnetic ways (applied to the
meter itself) to slow down and stop watt-hour meters
while drawing full loads. Plans. \$19. KW-HR
METERS: How watt-hour meters work, calibration,
error modes (many), ANSI Standards, etc. Demand and
Polyphase Meters. Experimental results to slow and
stop meters by others. \$19. Any 2. \$38. All 3. \$59.

AUTOMATIC TELLER MACHINES

ATM crimes, abuses, vulnerabilities and defeats
exposed! 100+ methods detailed. Include: Physical, Reg.
E, cipher, PIN compromise, card counterfeiting, mag-
netic stripe, false front, TEMPEST, Van Eck, tapping,
spoofing, inside job, super-cool, vibration, pulse, high
voltage - others. Case histories, lab, countermeasures,
detailed security checklist, labeled internal photos, figures.
ATMs contain up to \$250,000 in cash! Recent
\$350,000 ATM crime spree still unsolved! \$39.

CREDIT CARD SCAMS

Cardholders, merchants, banks suffer \$ Billions in
losses annually because of credit card fraud. Describes
every known means of credit card fraud and scams.
Protect yourself! \$29.

CONS & SCAMS

Cons & scams fleece Americans of \$100+ Billion per
year! The most comprehensive survival manual on cons &
scams of all kinds - from the classic to hi-tech. De-
tails on 100s and their many variations. Protect your-
self! \$29.

HIGH VOLTAGE DEVICES

HV devices plans: Stun Gun, Laser, Prod, Cane,
Flasher, Blaster, Zapper, Audio/Radar, Jammer,
Jacob's Ladder, Plasma & Van de Graaf Gens, Fence
Charger, Giger Counter, Ozone Gen, Fish Stunner,
Plant Stim., Killian, more! Shocking! \$29.

UNDER ATTACK!

Electromagnetic Interference and Electronic Weapon
Attacks cause: Cancer, birth defects, and profound psy-
chological, neurological, cardiovascular and immune
system disorders! Electrocute people, animals,
plants. Equipment includes ACTUAL CASES OF EM AT-
TACKS ON PEOPLE (we investigated!) Includes how to
verify and pinpoint EMI and electronic attack sources,
and specific countermeasures. \$29. EM BRAIN-
BLASTER: Tutorial and plans for powerful
ELECTROMAGNETIC WEAPONS and LAB DEVICES.
Optimum circuits, freqs, waveforms, duty cycles, intensi-
ties. Thorough. \$29. Both \$49.

RADIONICS MANUAL

Exciting electrical, electronic and electromagnetic ther-
apeutic, diagnostic and preventive devices (mostly ex-
perimental). History, descriptions, plans (dozens), avail-
abilities of Radionics Devices from early to modern.
While drugs cost \$ Hundreds, electricity costs pennies!
\$29. HEAL THYSELF: Plans for 3 major elec-
tronic therapeutic devices of types approved by FDA.
\$19. Both \$39.

HARD DRIVE MANUAL

Covers all hard drive and controller implementations
(emphasis on PCs). How to select, interface, initialize,
set up, use, maintain, troubleshoot and repair them.
How to protect them from mistakes, sabotage, prying
eyes and sticky fingers. How to recover damaged and
lost files. How to prevent crashes. Includes software re-
views. Loaded with information, advice, tips. \$29.
DISK SERVICE MANUAL: Maintain, trouble-
shoot, repair, adjust, align floppies without special
equipment or software. 3.5/5.25/8". PCXT/AT/386/
486, Apple, Commodore, etc. systems. All floppies need
occasional upkeep. \$29. DISK DRIVE AUTO-
RIAL: Theory, practical facts on floppy drives, disks,
including many tips, recommendations, formatting,
interfacing, FDC, etc. \$24. Any 2. \$49. All 3. \$69.

SOFTWARE PROTECTION SYSTEM

Unique system that highly discourages costly software
piracy while not interfering with legit archival copies. No
passwords to defeat. No special equipment required.
Simple and automatic to install on your distributed soft-
ware. Compatible with all copy-prevention systems.
Manual + Disk* \$59.

STEALTH TECHNOLOGY

Police radar is fascinating! It also has error rates of 10-
20%! Every known error mode - stealth method and ma-
terial used to minimize radar reflections - tactic and
strategy to fight unjust radar tickets (that cost you
\$100s in insurance and risk cancellation) - methods to
detect and jam signals - fully described \$29.

SECRET & SURVIVAL RADIO

Optimum survival and security radio equipment, meth-
ods, freq allocations and voice/data scrambling/encod-
ing. Includes small receivers/transmitters, telemetry, an-
tenna optimizations, remote monitoring and control, se-
curity, surveillance, and ultrasonic, fiber-optic and infra-
red commo. 70+ circuit plans, tables. \$29.

ULTIMATE SUCCESS MANUAL

Underpaid? Harassed or abused? Manipulated?
Taken for granted? Stuck in a dead-end job? Can't find a
good job? Expect to be laid off, fired or transferred
soon? The ultimate no-holds-barred, looking-after-#1
Machiavellian techniques to find, obtain, optimize and
keep top jobs, pay and benefits: THE RULES OF THE
GAME FOR A GAME WITHOUT RULES! From first re-
sume to CEO. \$29.

ROCKET'S RED GLARE

How to design and build solid-propellant amateur and
survival rockets. Emphasis on formulation, manufacture,
installation of propellants, motors, igniters, etc. Includes
list of commonly available materials, and the design of
launch pads and test beds and their electronics.
Please Order Today! (505) 434-0234
Sold for educational purposes only.

Electronics made Easy "Learn by Seeing"



**Complete Course in Basic Electronics
Includes 6 one hour videos and 6 workbooks.**

Everything you need to learn basic electronics. You
will learn about Direct Current, Alternating Current,
Semiconductor devices, Power supplies, Amplifiers,
and Oscillators. These videos are 100% computer
animated, they make learning electronics easy and
fun. Don't waste any more of your valuable time
reading and re-reading the same material to try and
understand these simple concepts when you can
"see it happen." These videos will ... teach you
more in less time ... allow you to learn at your own
pace ... help you remember more of what you learn
... give you years of quality use ... become a valuable
source of reference material ... make your under-
standing of electronics more complete ... and help
you build your future today. Your future is too
important to gamble with, so order your course
in Basic Electronics Today.
Call Now ... ask about these and our other popular
UCANDO videos. These videos are currently being
used by Tech-Schools, CET's, Military branches,
Ham Operators, Industries, and are sold in six
foreign countries. After you have seen your first
UCANDO video you will understand why ...
"UCANDO is Changing The Way The World
Learns Electronics".

- Part 1 DC \$49.95
- Part 2 AC \$49.95
- Part 3 Semiconductors \$49.95
- Part 4 Power Supplies \$49.95
- Part 5 Amplifiers \$49.95
- Part 6 Oscillators \$49.95

SAVE ... buy all six for only \$280

Call toll free 1-800-678-6113

CIRCLE 136 ON FREE INFORMATION CARD

Popular Electronics, July 1994

Professional Electronic Engineering Software

"Best bargain in the country"

Linear AC/DC Circuit Analysis

Active & Passive cks. 50 nodes, 225 elements max. Models for active devices. Calc, Plot & Print AC voltages & currents. Calc DC current, voltage & power. More

Linear Transient Circuit Analysis

10 Input Transients. Active, passive cks. 50 nodes, 225 elements max. Models for active devices. Calc, plot and print output Transient voltages. Calc dc current, voltage, pwr. more.

Active Filters Design & Analysis

Design & Analyze active LPF, BPF, HPF & All pass filters. Calc, plot Mag/Phase. More.

Transient System Analysis

Calc, plot transient response of system H(s). 14 Input Transients. Inverse Laplace. More

New! Circuit Schematic Draw: Both Stand-alone & Integrated

Cut, Copy, Move, Merge, Check, Grid, Label, List, 126 symbols, 300 elements, more...

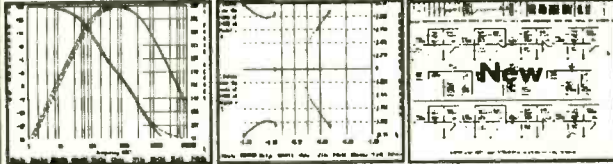

- ◆ Extremely Easy to use PC AT, DOS, EGA/VGA
- ◆ Dot Matrix/Laser/Mouse Support
- ◆ Outstanding Graphics & Menus
- ◆ 200 page User's Manual Included

100% Satisfaction Guaranteed

Introductory Offer: 9-program package (without Schematic Draw) \$79.99

Complete 10-program package (with Schematic Draw) \$129.99

Visa/MC accepted. Add \$5.95 for shipping. CA add 7.25% Tax

To order or info call 1(800)645-6806 or send check or money order to:

Geoban Engineering, PO Box 658, Ridgecrest, CA 93556

Control Systems analysis

Calc and Plot Root Locus, Nyquist, Bode of any H(s). Determine gain and Phase Margins/stability. More

Mag & Phase Graphics

Calc, plot mag/ phase of H(s). more

Function Graphics

Calc, plot, edit any of 87 common math functions as desired. More.

Data Graphics

Plot up to 400 data points in 9 formats. Linear, log, semi, etc. more.

Polynomial Operations

Calc Roots, Product & Coefficients.

Tap into a World of...

FREE ELECTRICITY

Our 150+ page *Self-Reliance Catalog* IS JUST LOADED WITH DC to AC ENERGY INDEPENDENCE ...

We offer:

Solar, Wind & Hydroelectric energy systems. True Sine Wave DC to AC Inverters.

Electric Boat & Car kits.

Portable power packs.

Solar Lighting & Cooling

systems. Solar Pool Heaters.

Solar Battery chargers. Solar

Books & Toys. DC Appliances.

Active & Passive Solar Air & Water Heating Systems.

Composting Toilets. Hydroponic,

Fish-Farming, Solarium & Green-

house Systems. Water Testing,

Treatment, & Pumping Systems.

Emergency Food & H₂O Kits. High

Efficiency AC/DC Refrigeration + More...

A LOT OF INFORMATION FOR ONLY \$5.75 ...

SEND CHECK or MO TO:

Self-Reliance Company Inc.

P.O. Box 306, Florissant, MO 63032

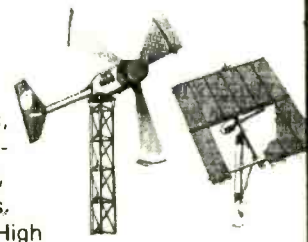

NOW Find the Right Part for Your VCR!



with the

ISCET VCR CROSS REFERENCE

NEW! The Fourth Edition is contained on a diskette for IBM PC AT/XT compatibles, DOS 2.1 or higher. The disk software allows technicians to search by manufacturer for model numbers and description of part numbers. A parts editing sequence gives an on-screen view of all substitutes for parts entered. With the diskette, the technician can update files by adding model and parts

The 320-page, Fourth Edition of the VCR Cross Reference contains both model and part number cross references. Over 1300 new parts and 360 new models have been added.

VCR's are made in a few factories from which hundreds of different brand names and model numbers identify cosmetically-changed identical and near-identical manufactured units. Interchangeable parts are very common. An exact replacement part may be available only a few minutes away from you even though the original brand-name supplier is out of stock. Also, you may be able to cannibalize scrap units at no cost.

crosses of future models. The Fourth Edition can be printed on pages completely from the diskette.

The ISCET VCR Cross Reference, Fourth Edition, is on 8 1/2 x 11-in., pre-punched pages and sells for \$36.00. The 3 1/2 inch diskette sells for \$69.95 and you can view listings from a monitor or printed page.

Only \$36.00 for pages
\$69.95 diskette

Claggk Inc.
VCR CROSS REFERENCE OFFER
P.O. Box 4099
Farmingdale, New York 11735

Name _____
Business _____
Address _____
City _____
State _____ Zip _____
Phone _____

Enclosed \$36.00 for the ISCET VCR Cross Reference, Fourth Edition.

Enclosed \$69.95 for the diskette containing the ISCET VCR Cross Reference, Fourth Edition. Please specify:

5 1/4 Diskettes (2) 3 1/2 Diskette (1)

Include \$3.00 for shipping each Cross Reference (Pages or Diskette)

The total amount of my order is \$ _____

Check enclosed—do not send cash.

Visa MasterCard Exp. Date ___/___/___

Signature _____

New York State residents must add applicable local sales tax to total.

Serving the public since 1981

XANDI Electronics

201 E Southern #111, Tempe AZ 85282



BUY WITH CONFIDENCE FROM XANDI

- 30-DAY REFUND POLICY
- NEW TELEPHONE TECH SUPPORT NUMBER (602-894-0992)

Smallest FM transmitter anywhere!
Tunes 88-108 MHz.
Powerful 2 stage audio amplifier.
Sensitive, picks up sounds at the level of a whisper.
Up to 1 mile range.



XST500 SUPER-MINIATURE FM TRANSMITTER
World's smallest FM voice transmitter. Use with any FM broadcast receiver. Easy to assemble, all chip (SMT) parts are pre-assembled to the circuit board.
XST500(E-Z) Kit \$44.95

Smallest Phone transmitter anywhere!
Tunes 88-108 MHz.
No batteries required, powered by phone line.
Up to 3/4 mile range.
Attach to phone line anywhere in house, even inside phone.



XSP250 SUPER-MINIATURE PHONE TRANSMITTER
World's smallest FM phone transmitter. Use with any FM broadcast receiver. Easy to assemble, all chip (SMT) parts are pre-assembled to the circuit board.
XSP250(E-Z) Kit \$34.95

Digital voice changing: male to female, female to male, adult to child, child to adult.
16 levels of voice masking.
Button for normal operation.
Complete anonymity on all calls



TRANSITION 2000 VOICE CHANGING TELEPHONE
STOP THOSE ANNOYING PHONE CALLS! Sound older and tougher when you want to. Not a kit, fully assembled. Single line phone operation only.
TRANSITION 2000 \$89.95

Digital voice changing: male to female, female to male, adult to child, child to adult.
Use with any modular phone.
Connects between handset and phone.
16 levels of voice masking.



TRANSITION 2001 VOICE CHANGING Accessory
STOP THOSE ANNOYING PHONE CALLS! Sound older and tougher when you want to. Use with single or multi-line phones. Not a kit, full assembled.
TRANSITION 2001 \$59.95

Transmits both sides of phone conversation.
Adjustable from 88-108 MHz.
Works with any FM broadcast receiver.
Up to 1 mile range.
Turns off when phone is not in use to extend battery life.

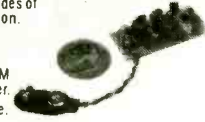

XTT100 LONG RANGE PHONE TRANSMITTER
Similar to our very popular XSP500, the XTT100 is battery powered for maximum range. It plugs into any phone jack and transmits all calls on that line.
XTT100(C) Kit \$32.95

Super sensitive, hear every sound in a house!
Powerful 2 stage audio amp.
Use with any FM broadcast receiver.
Up to 1 mile range.
Powered by 9V battery.



XFM100 MINIATURE FM TRANSMITTER
The XFM100 has a super sensitive microphone and is capable of picking up sounds at the level of a whisper and transmitting them to any FM broadcast receiver.
XFM100(C) Kit \$32.95

Transmits a continuous beeping tone.
Adjustable from 88-108 MHz.
Up to 1 mile range.
Works with any FM broadcast receiver.
Operates at battery voltages of 3 to 18 volts.



XTR100 TRACKING TRANSMITTER
Measuring .7 by 2.4 inches, the XTR100 is ideal for use in locating lost model rockets, bicycles, automobiles, games of hide-and-seek, and contests.
XTR100(C) Kit \$43.95

Uses sensitive microwave transistor amplifier.
Covers 1 to 2000 MHz.
Compact hand held unit.
Uses Miniature loudspeaker (not included) for audio indication of detected signals.



XBD200 SUPER SENSITIVE BUG DETECTOR
When the XBD200 intercepts a signal in the 1 to 2000 MHz range, it emits a growl that increases to a high pitched squeal as the signal strength increases.
XBD200(C) Kit \$49.95

XLC900 800-950 MHz SCANNER CONVERTER KIT
If your scanner can receive 400-550 MHz, just add the XLC900 for uninterrupted 800-950 MHz coverage. It converts all 800-950 MHz signals down to 400-550 MHz so your scanner can receive them! Add our custom case and knob kit for that "professional" look.
XLC900 Kit \$49.95
XLC-Case Kit \$13.95



XLA1000 AMPLIFIER KIT
Designed to help scanners with poor sensitivity pull in those weak signals. Includes off/pass switch for returning to normal operation and front panel gain control. Add our custom case and knob kit for that "professional" look.
XLA1000 Kit \$24.95
XLA-Case Kit \$13.95



WE ACCEPT VISA, MC, MO, COD
ASK FOR FREE CATALOG OF ALL OF OUR PRODUCTS
TOLL FREE ORDER LINE 1-800-336-7389
SEND MAIL ORDERS TO: XANDI ELECTRONICS BOX 25647 TEMPE, AZ 85285-5647

CIRCLE 134 ON FREE INFORMATION CARD

SMALL MIRACLES

NEW MICRO TX2000 KIT
\$59.95
-SMALLEST 120 MW FM VOICE/PHONE TRANSMITTER
-88-110mhz ON ANY BROADCAST RECEIVER
-ROCK SOLID TUNING, DOESN'T DRIFT
-5 MIN. ASSEM., HEAR A WHISPER UP TO 2 MILES
-SMT PARTS PREASSEMBLED
-INCLUDES TXMTR, MIC, ANTENNA, BATTERY CLIP, TUNING TOOL, AND INSTRUCTIONS

VOICE SCRAMBLER/DESCRAMBLER KIT
\$69.95
2 FOR \$129.95
-WORLD'S SMALLEST AUDIO SCRAM/DESCRAM.
-TALK IN PRIVACY ON AUDIO, SPKR, OR MIC LINE
-HEAR THOSE GARBLED SCANNER VOICES
-SMALL SIZE 1"x7/8"x1/4"
-CRYSTAL CONTROLLED DIGITAL SPEECH INVERSION
-7-15 VOLT DC SUPPLY
-LOUD HALF WATT AUDIO AMPLIFIER
-EXCELLENT AUDIO QUALITY
-INCLUDES FULL DOCUMENTATION
-DUPLEX SCRAMBLE & DESCRAMBLE AT THE SAME TIME

MICRO 1.2 VOICE RECORDER
\$69.95
-SMALL SIZE 1-1/4"x15/16"x1/4"
-HUNDREDS OF APPLICATIONS
-EXCELLENT AUDIO QUALITY
-60 SECONDS REC/PLAY
-8 OHM SPEAKER OUTPUT
-7-15 VOLT DC SUPPLY
-100 YEAR MEMORY WITHOUT POWER
-INCLUDES MIC, SWITCHES AND FULL DOCUMENTATION

MICRO 2B VOICE RECORDER
\$109.95
MICRO 2B FEATURES
SAME AS 1.2 PLUS:
-MULTI MESSAGES (UP TO 600 MEM.)
-SMALL SIZE 1-5/16"x1-5/8"x1/8"
-VARIABLE AUTO PLAY TIMER
-5 VOLT KEY OUT DURING PLAYBACK

ORDER BY PHONE OR MAIL
IN U.S.A. ADD \$5 FOR S&H
C.O.D. CHARGES APPLY
NYS RESIDENTS ADD 7% SALES TAX
TECH. SUPPORT: 518-381-1057
TECH. FAX: 518-381-1058

AGRELO ENGINEERING
1145 CATALYN STREET
SCHENECTADY, NY 12303

EPROM+ PROGRAMMING SYSTEM USES PARALLEL PORT

EPROMS (24,28,32 & 40 PIN*) PLUS 27CXXX 1702*, 2708, TMS2716*, 32,32A, 64, 64A, 128, 128A 256, 512, 513, 011, 010, 101, 1001, 1000, 1024, 210, 020 2001, 220, 204R, 4001, 040, 240, 4096, 25XX, 68764/66
FLASH EPROMS 28F256, 28F512, 28F010 28F020, 29C257, 29C010, 29F010
EEPROMS & NVRAMS (18,24 & 28 PIN+CXX) 2210, 2212, 2804, 2816, 2816A, 2817, 2864, 2865, 28256 28C010, DS1220, DS1225, DS1230
SERIAL EPROMS* (8 & 14 PIN PLUS CXX) KR1400, M58657, 2401, 02, 04, 08, 16, 2444, 59C11 9306, 46, 56, 66, 8572, 82, 92
BIPOLAR PROMS* (16 THROUGH 24 PINS). 74SXXX AND 82SXXX FAMILY
MICROCONTROLLERS* 8741, 42, 48, 49, 8751 C51, 8752, 87C52, 87C5XXX, 87C751, 87C752, 68705 68HC705, 68HC711E9, PIC16C5X, TMS7742
*ADAPTER REQ'D - DIAGRAMS INCLUDED



SYSTEM INCLUDES: PROGRAMMING UNIT, PRINTER PORT CABLE, POWER PACK, MANUAL AND SOFTWARE.

\$289

ADD \$5.00 SHIPPING \$5.00 C.O.D.
VISA/MASTERCARD

SOFTWARE - READ, VERIFY, PROGRAM, COPY, DISK FILE LOAD/SAVE, CHECKSUM, FULL SCREEN BUFFER EDITOR, W/20 COMMANDS
READS HEX, S-RECORD AND BINARY FILES
FAST DEVICES PROGRAM IN UNDER 60 SEC
RUGGED (8"X7"X3") ENCLOSURE, W/HANDLE
MADE IN USA - 1 YEAR WARRANTY
ANDROMEDA RESEARCH, P.O. BOX 222, MILFORD, OH 45150
(513) 831-9708 FAX (513) 831-7562

SUPPORT RESEARCH.
It Works Wonders.
American Heart Association

Popular Electronics, July 1994

TO ORDER: CALL 1-(800)-588 4300

TIMELINE INC.

Over 7 years and 22,000 customers and still growing.

LIQUID CRYSTAL DISPLAYS

160 x 128 dot LCD
with Built-in controller. (T6963C)

20 character x 16 line capability. **\$99.00** ~~\$249.00~~

Mfr. Toshiba TLX-1013-EO.

Unit is EL backlit. Dim: 5" 1/16 L x 4" 1/16 H.

The built-in controller allows you to do text and graphics without adding an additional controller card.

Alphanumeric—parallel interface

16 x 1.....	3 for \$25.00	16 x 2.....	\$8.00
20 x 2.....	\$12.00	24 x 2.....	\$12.00
20 x 4.....	\$25.00	40 x 2.....	2 for \$25.00
32 x 4.....	\$20.00	4 x 2.....	\$5.00
40 x 4.....	\$25.00		

5V power required • Built in C-MOS LCD driver & controller • Easy "Microprocessor" interface • 98 ASCII character generator • Certain models are backlit, call for more info.

Graphic and alphanumeric—serial interface

Size	Mfr.	Price
640 x 480.....	Epson	\$50.00
640 x 400 (backlit).....	Panasonic	\$35.00
640 x 200.....	Toshiba	\$19.00
480 x 128.....	Hitachi	\$15.00
256 x 128.....	Epson	\$35.00
240 x 128 (backlit).....	Optrex	\$20.00
160 x 128.....	Optrex	\$15.00

LASER PRODUCTS

HeNe Laser Tube (10mW max. output TEM00, 15.5" long MFG:NEC) **\$99.00**
Laser Power Supply (for HeNe tube) **\$100.00**

LASER SCANNER ASSEMBLY \$39.00
Assembly intended for a laser printer. Includes laser diode, polygon motor (6 sided) and misc. optics and lenses.

LASER DIODE (5mW) with collimator \$20.00

LASER DIODE: Sharp part#: LT022MC
5mW at 780 nm. single transverse mode \$10.00

NETWORK

IRMA BOARD 8 bit \$99.00

Links 3270 mainframe systems to IBM PC

Proteon ProNet-4 Model p1347 Token Ring Board \$79.00

16 bit • 4 Mbps • IEEE 802.2 and 802.5 compatible • twisted pair • interoperable with IBM Token Ring network

POS & BAR CODE

MAGNETIC CARD READER \$25.00

Includes: • 20 character dot matrix display with full alpha-numeric capability • keypad with full alpha-numeric entry • separate 7.5 VDC/0.5 Amp power supply • standard telephone interface extension cord • lithium battery and flat-cone speaker.

HP bar code wand (HBCS 2300).....\$35.00

POWER SUPPLYS

73 WATT SWITCHING \$15.00 or 2 @ \$25.00, (2) 4 pin power connectors attached • 115/230 Volt, Dim: 8.5" L x 4.5" W x 2" H • Output: +5V @ 2-9.75 A, +12V @ 0-1.5 A, -5V @ 0-0.4 A, -12V @ 0-0.5 A

68 WATT SWITCHING \$12.00 or 2 for \$20.00, 115/230 Volt, Dim: 5.5" L x 3.2" W x 1.7" H • Output: 5V @ 4 A, 12V @ 4 A

MISCELLANEOUS

ADAPTEC 4070A (RL) OR 4000A (MFM) SCSI Controller, your choice \$60.00

IBM 370 option XT and AT emulation boards \$50.00

23605 TELO Ave, Torrance, CA 90505

Order desk only: USA: (800) 872-8878 CA: (800) 223-9977

L.A. & Technical Info: (310) 784-5488 Fax: (310) 784-7590

OEM INQUIRIES WELCOME

Minimum Order: \$20.00. Minimum shipping and handling charge \$5.00. We accept cashiers checks, MC or VISA. No personal checks or COD's. CA residents add 8.25% sales tax. We are not responsible for typographical errors. All merchandise subject to prior sale. Phone orders welcome. Foreign orders require special handling. Prices subject to change without notice. 20% restocking fee for returned orders..

MONITORS

Non-Enclosed TTL

Comes with pinout 12V at 1.4 Amp input. Horizontal frequency 15 Khz. Ability to do 40 and 80 column.

5 inch Black & White.....\$35.00
7 inch Amber.....\$39.00
9 inch Amber.....\$29.95
12" Green or B & W.....\$19.95

Enclosed

9" Green BNC composite 115V/230V\$79.00
12" White BNC composite 24V.....\$99.00

Mfr.: Electrohome • For Very High Quality Medical and Industrial Applications

5" COLOR MONITOR \$69.00

- Flat Faceplate • 320 x 200 Dot Resolution • CGA & Hercules Compatible
- 12 VDC Operation • 15.75 Khz Horiz. Freq.
- 60 Hz Vert. Sync. Freq.
- Open Frame Construction
- Standard Interface Connector
- Degaussing Coil Included • Mfg.: Samtron



CHARGE COUPLED DEVICES

MATRIX TYPE



"The Spy In The Sky" \$49.00

Sony CCD Imager - designed for black and white composite video cameras. Picture elements: 384 (H) x 491 (V)

Chip size 10.7 (H) x 9.3 (V) mm² • Unit cell size 23.0 (H) x 13.4 (V) um² • Ceramic 24 pin DIP package. • Mfr: Sony, Part# 016AL

LINEAR TYPE

4096 element CCD \$29.00

2048 element CCD \$15.00 • 1728 element CCD \$15.00

HACKER CORNER

386SX-25 All in one motherboard \$89.00

Great for embedded applications

Includes: Intel 386SX-25 CPU • Built in IDE & floppy controller (cables included) • Built in VGA with 512K video RAM onboard (expandable to 1 Mb) (Will support up to 1280x1024) • 2 serial, 1 parallel port • Mouse and keyboard port (PS2 style) • Award Bios, Real Time Clock • Memory upgradeable to 16 Mb. (0 K on board) • VLSI chip set • Socket for 80387-SX co-processor • Note: there is one 16 bit bus slot on unit • Size: 9 3/4" x 8" • Utility & driver diskettes included

Portable Micro Terminal

Flip up LCD display (9-16 VDC) • Can communicate with any computer having RS 232 port • Can communicate with another Microterminal • Use by itself as electronic notebook • Onboard microprocessor, data RAM (32K) and Video RAM (64K) • Complex built in diagnostics and set up capabilities. • Original intention for POS applications. • display size 40x16 (256 x 128 pixels.) Dimensions: 6.3" W, 11"L, 2"H. (With LCD up height is 7.1")



\$99.00

or 2 for \$149.00

All in one 286 board \$39.00

Includes: • 286-12Mhz CPU (1 wait state) • Built in IDE & floppy controller • 80287 math coprocessor socket • FAST! on board SVGA with 256K RAM • 2 serial ports, 1 printer port, mouse port • EMS-LIM ver 4.0 memory & shadow RAM support • Up to 8 mb memory (256K or 1 Mb SIMMS) • Comes with 0K on board • On board speaker • REAL TIME CLOCK • Phoenix BIOS • Note: There is one long non standard bus connector on board

Double Your Income! Own your own computer repair business or add computer repair to your existing business.

TechServ can put you into your own computer repair business quickly, economically and efficiently. Research indicates that during a recession, computer repair businesses will grow at twice the rate of hardware sales. TechServ's complete support program gives you the opportunity to be a part of this fast growing industry.

• Proven Marketing Plan

• Recognition

Nationally recognized trademarks and logos give you immediate recognition as a professional computer repair specialist in your area.

• Training

- Level 1 286/386/486/586
Troubleshooting, upgrades, advanced diagnostics
- Level 2 Networking/Novel/Unix/Multi-user/
Multi-tasking configuration/Installation/
Maintenance. Prepare for C.N.E.
(Certified Network Engineer) test

• Parts and Board Repair

Single source for OEM/generic parts and board repair. Order 7 days a week/24 hours a day. \$45 million in parts in stock, ready to ship any where, overnight if required.

• Documentation

We provide manuals, documentation and advanced diagnostic software.

• New Hardware

We provide new hardware for IBM, Compaq, Apple and compatibles at huge discounts. Custom build your own systems.

Over 300 dealers worldwide

Find out why the Wall Street Journal and Fortune Magazine call computer repair the business opportunity of the 1990s.

Call TechServ at (212) 967-1865

or fill out coupon below and mail to:

techserv AUTHORIZED DEALER
SM

**America's largest chain of independent,
licensed computer repair centers**

253 West 28th Street, New York, NY 10001

NAME _____

ADDRESS _____

CITY _____

STATE _____

ZIP _____

TELEPHONE _____

[PE 2/93]

CIRCLE 130 ON FREE INFORMATION CARD



Forest Electronics Inc.

**Are you overpaying . . .
. . . your cable company?**

You are if . . .

**. . . you are leasing their
equipment.**

- Forest Electronic, Inc. offers a complete line of New Cable Equipment that is fully Compatible with your cable system.
- All systems come with: Remote Control, & Parental Guidance Feature. Volume Control is also available.
- All Equipment is fully guaranteed & comes with a 30 day money back option.

For More Information Call Us At:

800-332-1996

FAX: 708-860-9048



FOTRONIC

QUALITY ELECTRONIC TEST EQUIPMENT

Sales • Service

- Specialists in - Fluke, Hewlett Packard, Tektronix
- NIST Traceable/Mil Spec 45662A Calibration Available



TECHNICAL SUPPORT

Oscilloscope Specials

Tek 465	100 MHZ	\$489.00
Tek 465B	100 MHZ	\$589.00
Tek 475	200 MHZ	\$649.00
Tek 475A	250 MHZ	\$749.00

ALL EQUIPMENT SOLD WITH WARRANTY

For more GREAT VALUES Call, Write, or FAX
P.O. Box 708, Medford, MA 02155

(617) 391-6858 FAX (617) 391-6903

Model Close Out
Reg. \$59.95
Sale \$24.00*
Item # X3800 ▶

Full Range DMM

- 5 DCV ranges $\pm 0.5\%$
- 5 ACV ranges $\pm 0.8\%$
- 7 DCA ranges $\pm 0.5\%$
- 7 ACA ranges $\pm 1\%$
- 6 OHM ranges $\pm 0.8\%$
- Diode Tester
- Trans. Tester
- Continuity Buzzer
- Highly Visible Yellow Color
- **1 Year Warranty**



Reg. \$105.95
Sale \$89.00*
Item # X3500 ▶

**Auto-Range DMM
w/Capacitance**

- CPU controlled with auto power off function
- 3.75 digit jumbo LCD (max reading 3999)
- 42 segment high speed bar graph
- Full auto-ranging measurement
- Offset adjustment
- Data hold and data memory function
- Auto capacitance measurement 1pF to 40 μ F in 5 ranges
- Auto frequency measurement up to 1 MHz in 5 ranges
- Safety design according to IEC Publication 348
- **1 Year Warranty**

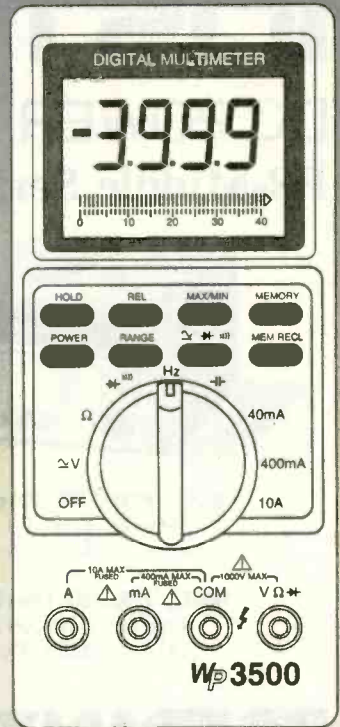

Reg. \$45.95
Sale \$29.00*
Item # X2600



**Affordable
Auto-Ranging**

- Automatic AC/DC Mode Selection
- DC voltage 0.2V to 1000V in 5 ranges
- AC voltage 2V to 700V in 4 ranges
- DC and AC current 200mA and 10A
- Audible continuity check & Diode Tester
- Yellow Case
- **1 Year Warranty**

Reg. \$39.95
Sale \$29.00*
Item # X1000



- Shoreline**
INSTRUMENTS
- 2000 Count Digital Display
 - 11 Ranges - AC/DC V, mA, Ω
 - Diode Tester and Continuity Beeper
 - Auto Shut-off
 - Alligator Clip for Easy Measuring
 - 1 Year Warranty
 - Attractive Gray Case

**Versatile DMM
w/ Capacitance**

- Large LCD Display
- DCV accuracy 0.5%
- Diode test, continuity check with buzzer sound
- Transistor hFE test
- All ranges overload protected
- Rugged case, drop proof
- Capacitance measurement, 1pF-20 μ F in 5 ranges
- Resistance measurement up to 200M
- Auto power off
- Yellow Case
- **1 Year Warranty**



Reg. \$54.95
Sale \$39.00*
Item # X3910 ▶

Orders Only Please
800-597-5929
24 hours a Day

VISA MasterCard or send Check or Money order

* CA customers please add Sales Tax
* Shipping & Handling \$4.00
* Meters are shown about 1/2 Size

Technical/Product Line
408-987-7734
24 Hour Fax Order Line
408-987-7735

* Quick Delivery via Two Day Priority Mail
* All Fax Orders -Free Shipping
Include: Name, Add, Pkts, Cards, Exp. Date, Item #

Don't Pay Out of This World Pricing for
Your Next Voltage Meter..... Call Windward First

Windward
Products

We Stand Behind our Products
Satisfaction Guaranteed

P.O. Box 376, Moffett Field, CA. 94035

INSTEK Test & Measuring Instruments

DC POWER SUPPLIES

PR-Middle Series (Analog/Digital)

ISO 9002
CERTIFICATION
#934163



- Continuous or Dynamic load for internal selectable
- Low ripple and noise
- 0.01% high regulation
- Overload and Reverse polarity protection
- Constant voltage and constant current modes
- 3½ Digits 0.5" LED display (Digital type only)

MODEL #PR6030D (Digital)
Regular \$500.00
Sale \$399.95

MODEL #PR6030 (Analog)
Regular \$379.00
Sale \$299.95

	Model	Output Volts (V)	Output Amps (A)	Weight (kg)
Analog	PR-6030	0~60	0~3	11.5
Digital	PR-6030D	0~60	0~3	11.5

PRINT™

Products International

Test Instruments, Equipment and Tools, Training and Supplies for Electronic Maintenance and Repair
8931 Brookville Road * Silver Spring, Maryland 20910 * 800-638-2020 * Fax 800-545-0058



TOLL FREE
800-638-2020

NEW 84 PAGE CATALOG!!!
Call Today For Your FREE Copy
Of The 1994 Print Test
Equipment Catalog!

CIRCLE 46 ON FREE INFORMATION CARD



CABLE TV Converters & Descramblers

Compatible with
**Jerrold, Scientific Atlanta,
Pioneer, Oak, & Hamlin
Equipment**

BRAND NEW!
90-DAY GUARANTEE
LOWEST PRICES

Volume Control & Parental Lockout Available

Greenleaf Electronics
1-800-742-2567
NO ILLINOIS SALES

It is not the intent of Greenleaf Electronics to defraud any pay television operator and we will not assist any company or individual in doing the same.

DC/CAD

introducing...

THE TERMINATOR

Super High Density Router
(Complete with Schematic & PCB EDITOR)

Features the following powerful algorithm & capability:

- Rip - up and Retry
- Pre-routing of SMT components
- Real-Time via minimization
- Real-Time clean up passes
- User defined strategies
- Window 3.0 capability as DOS Task
- 1-mil Autoplacer and Autopanning
- Two-way Gerber and DXF
- Automatic Ground Plane w/ Cross-Hatching
- Complete w/ Schematic & Dolly Libraries
- Optional simulation capability & protected mode for 386 users

* PCB LAYOUT SERVICE AT LOW COST *

LEASE PROGRAM & SITE LICENSE AVAILABLE

Call for
DC/CAD - \$95
(available for students only)
normal price range
\$295 - \$2500



Design
Computation

1771 State Highway 34
Farmingdale, NJ 07727
(908) 681 - 7700 • (908) 681 - 8733 (FAX)

" DC/CAD . . . The focal point of future CAD market "

Don't Despair...REPAIR!

Here's how to troubleshoot and repair your electronics successfully!



You Can Be Your Own Repair Expert!

For VCRs, camcorders, audio equipment, TV equipment, computer hardware, office equipment, home appliances, automobile electronics, and outdoor equipment.

- Pinpoint and analyze problems quickly.
- Successfully complete repairs with hands-on troubleshooting instructions.
- Become skilled understanding flowcharts and schematic diagrams.
- Confidently use test equipment such as oscilloscopes, frequency counters, and video analyzers.
- Keep your equipment in top condition with effective preventive maintenance techniques.

Continue to Broaden Your Repair Expertise!

You'll receive quarterly supplements, up to 160 pages, with new step-by-step repair and maintenance instructions, valuable schematics and new repair techniques. Learn how to repair a growing variety of appliances with hands-on repair projects that will keep you up-to-date with later models and technology. You'll be thrilled with your ability to repair a growing list of electronic equipment! Supplements may be returned or cancelled at any time.

One Source For All Your Repair Needs!

Better organized than a magazine, more current than a book.

- 900-page manual
- easy-to-follow, detailed instructions
- trouble analysis flowcharts
- safety precaution checklists
- comprehensive replacement parts list
- directory of manufacturers



Order your copy today!

SAVE \$10

Call our toll-free number, pay by credit card, and mention this ad. We'll deduct \$10!

We'll also waive shipping and handling.

Order today for your 30-day, no-risk review of The Electronics Repair Manual.

**For Faster Service Call TOLL-FREE
1-800-222-WEKA
Or Fax To: 1-203-622-4187**

CIRCLE 133 ON FREE INFORMATION CARD

MONEYBACK GUARANTEE

There's no risk in trying the **ELECTRONICS REPAIR MANUAL** to see if it's right for you. If you are not delighted, simply return the manual after the 30-day trial period and receive a prompt refund.



97 Indian Field Rd.
Greenwich, CT 06830

YES! Please rush me a copy of the new Electronics Repair Manual for only \$59.95 + \$5.50 shipping and handling. I understand that if I am not satisfied I may return the manual within 30 days for a complete refund. Supplements are sent quarterly for 25¢ per page (never more than \$30) and may be returned or cancelled at any time.

- My payment is enclosed Bill me later
 Charge my Visa MasterCard

Acct. No. _____ Exp. Date _____

Signature _____

Phone () _____ Signature and phone number are required for all orders.

Name _____

Address _____

City _____ State _____ Zip _____

All payments must be in U.S. funds. Canada add \$10. All other countries add \$15. CT residents add 6% sales tax.

Mail to: WEKA Publishing, 97 Indian Field Rd.,
Greenwich, CT 06830

400075

CABLE TV DESCRAMBLER KITS

"New & Improved Version"
Universal Descrambler
Includes all the parts and an etched & Drilled PC Board. Not included is AC adaptor or enclosure..... **\$69.00**

Tri-Mode Descrambler
Includes all the parts and an etched & drilled PC board & AC adaptor. Not included is the enclosure..... **\$49.00**

SB-3 Descrambler
Includes all the parts & an etched & drilled PC board & AC adaptor. Not included is the enclosure..... **\$29.00**

Call Toll Free 1-800-886-8699

Visa, MasterCard, Discover, AM & COD

M & G Electronics, Inc. 2 Aborn Street, Providence, RI. 02903

It is not the intent of M & G Electronics, Inc. to assist any individual to defraud any pay TV operator or to violate any state or federal laws regarding the use of the descrambler kits. You must understand the kits being purchased for educational and or experimental use only.

PE MARKET CENTER CLASSIFIEDS

MISCELLANEOUS ELECTRONICS FOR SALE

SILENT SAM. Patented vehicle turn signal reminder. Outshines others. Brief, timely alerting signal doesn't bug you. Kits & wired units \$15.00 & up. Visa/MC. 1 (800) 398-5605 literature. Silent Sam, 1627 Basil Dr., Columbus, OH 43227.

NEW! UNIVERSAL descrambler upgrade, improvement, modification, repair parts/instructions. Delivers better picture, performance. \$15.00. Robert Snow, 22049 Lansdowne, Saint John, Canada E2K4T7.

SEE IN the dark. Night vision scopes, goggles, binoculars. Brilliant, razor sharp, high resolution vision at .002 lux. Catalog \$5.00. **MAXTECH**, Box 8086pe, New York, NY 10150.

ADD EXCITING surround sound to your stereo system, **decoder** includes audio patch cables, requires second stereo amplifier. Only \$39.95 plus S&H, fully guaranteed, 1 (800) 768-7530.

Quality Microwave TV Antennas

WIRELESS CABLE - IFTS - MMDS - Amateur TV
 Ultra High Gain 50db(+) • Tuneable 1.9 to 2.7 Ghz.

- 55-Channel Dish System \$199.95
- 36-Channel Dish System \$149.95
- 20-Channel Dish System \$124.95
- Optional Commercial Grid Antenna (not shown) Add \$50.00
- Yagi Antennas, Components, Custom Tuning Available
- Call or write (SASE) for "FREE" Catalog

PHILLIPS-TECH ELECTRONICS
 P.O. Box 8533 • Scottsdale, AZ 85252
 (602) 947-7700 (\$3.00 Credit all phone orders)
 MasterCard • Visa • American Express • COD's • Quantity Pricing

Dish System
 LIFETIME WARRANTY

CABLE TV

"BULLET" BUSTER. Protect your cable box against the infamous cable "bullet." The "Bullet" Buster acts as an electronic shield. Installs in-line in seconds. Don't wait until it's too late! \$19.95 + \$3.00 S&H. **Electroman**, Box 24474, New Orleans, LA 70184. (504) 482-3017.

CBTV DOCTOR Stop the Bullet and ID signal in cable lines. Send \$20.00 to: R.R. Enterprise, PO Box 3532, Easton, PA 18043.

CABLE UNSCRAMBLER. Everything you want to know, but are afraid to ask. \$10.00. **Electroman**, Box 24474, New Orleans, LA 70184. (504) 482-3017.

Satellite-TV

SAVE 40% - 60%
 800-334-6455
 218-739-5231 Int'l
 218-739-4879 Fax

FREE Catalog

Skyvision Inc.
 1048 FRONTIER DRIVE • FERGUS FALLS, MN 56537

CABLE DOCTOR: Attention: All you cable box owners. Want to watch one channel & record another? I have what you need, send \$74.00 to: R. R. Enterprises, PO Box 3535, Easton, PA 18043.

CONVERTERS DRX 3 61 channel remote \$28.00, raw units SA 8500-310 \$50.00, Tocom 5503A \$35.00, RTC56 \$40.00. Call Apex (414) 554-8618.

CABLE — SAFE. Guarantee cable privacy. The one way valve for your cable TV signal. \$29.95, + \$3.00 S&H. **Electroman**, Box 24474, New Orleans, LA 70184. (504) 482-3017.

DESCRAMBLER SCHEMATICS REVEALED. A powerful guide to descrambling schemes. \$10.00. **ELECTROMAN**, Box 24474, New Orleans, LA 70184. (504) 482-3017.

Cable Test Aids

Orders only
 1-800-452-7090 Information
 (310)902-0841

Test chips for **JERROLD, TOCOM, ZENITH, S.A. & more.** Puts cable boxes in full service mode. Easy installation. **Zenith only \$39.95. Most others under \$50ea.** FAX: (310)902-0851. Quantity prices available. No Ch. min. Not for use in cable co. owned equip. For use as a test aid only.

AUDIO-VIDEO-LASERS

HOLOS GAZETTE charter subscription \$15.00. Quarterly publication. **ELECTROPHOTONICS** laser hacker projects: first HOLOGRAM, diode lasers, meters, etc. **FREE HOLOGRAM** with subscription. Send M.O. to: **HOLOS**, 1450 Headdon Road, Box 93113, Burlington, Ontario, L7M4A3 Canada.

SATELLITE EQUIPMENT

VC-2 MODULE \$399.00. Save 10% the big catalog. Our price 10% off their price. Call Satellite TV, 120 W. Centennial, Muncie, IL 47303. Tech hours 11-5E.

VIDEOCIPHER II Descrambling manual. Schematics, video and audio, \$18.95. Software, \$25.00. Videocipher II 032, \$15.00. Videocipher II Plus, \$20.00. VCII Plus software, \$30.00. Cabletronics, Box 30502PE, Bethesda, MD 20824.

BUSINESS OPPORTUNITIES

EASY WORK! Excellent pay! Assemble products at home. Call toll free 1 (800) 467-5566 ext. 5192.

GREAT EXTRA income! Assemble products at home. Easy and fun to do. Guaranteed! 1 (800) 377-6000 ext. 7930.

MAKE \$75,000/year cleaning computers part time! Secure career. Unlimited customers. FREE information. Call (303) 963-1316 Dept PE-2.

MAKE \$93,000/year part time as an independent computer technician! FREE information. Call (303) 963-1316 Dept PE-3.

LEARN COMPUTER maintenance/upgrading. Complete program \$29.95. Details: VCM, 892 Douglas St., Prince George, B.C., Canada, V2M-2M9.

FREE 900#'S. Computerized equipment managers and brokers wanted. Unlimited income potential. For information call (914) 573-2067.

EDUCATION

LEARN COMPUTER REPAIR at home. Make \$90.00/hour! Computer store owner reveals secrets! FREE information. Call (303) 963-1316 Dept PE-4

PUBLICATIONS

CHARTER ISSUES PE Oct 1954 thru 1966. Eight issues missing. Make offer complete set including price this ad and shipping. Charter Issues, 3319 Clay St., San Francisco, CA 94118. (415) 921-3893.

WE'VE GOT IT!

- New Tenma Precision Power Supplies
- Comprehensive Line of Test Equipment
- 288 Page Catalog with Over 20,000 Stocked Items
- 99% of All Orders Shipped within 24 Hours

**Call Today For
Pricing and
Complete
Specifications**



Order # Description
72-2005 0-18V/0-3A
72-2010 0-30V/0-3A
72-2015 0-60V/0-1A

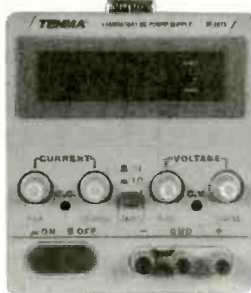

Order # Description
72-2075 0-30V/0-3A



Order # Description
72-2080 Triple Output
Dual 0-30V/0-3A
Single 5V/3A

**MCM is now
an RCA/GE
Premier
Distributor**



MCM ELECTRONICS
650 CONGRESS PARK DR.
CENTERVILLE, OH 45459-4072
A PREMIER Company

Serving you coast to coast. Distribution
facilities in Dayton, OH and Reno, NV!

Free Catalog!
1-800-543-4330

Product questions
1-800-824-TECH(8324)



POP-08

CIRCLE 142 ON FREE INFORMATION CARD

Smart Battery Charger

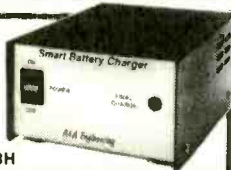

JUN 87 QST

BY WARREN DION N1BBH

FOR GEL-CELLS or LEAD ACID BATTERIES.
Features: Precision temperature tracking voltage
reference & three mode charging sequence.
Standard kit is for 12V @ 1/2 or 1 Amp, user
selectable. Can be connected to the battery
indefinitely, will not overcharge. Weighs 2 pounds
and measures 4"W x 5 1/2"D x 2 1/4"H. Finished
enclosure included in kit.

Complete Kit Only \$59.95
Assembled & Tested \$79.95

CA Residents add 7.75% sales tax. S&H: \$5.00
(Insured). Foreign orders add 20%. For more info
or price list; send legal size SASE (52¢) to:



A&A Engineering



2521 W. La Palma #K · Anaheim, CA 92801
(714) 952-2114 · FAX: (714) 952-3280

CABLE TV DESCRAMBLERS

Best Prices in the U.S.A.! Guaranteed to Work!

WE WILL BEAT ANY PRICE!

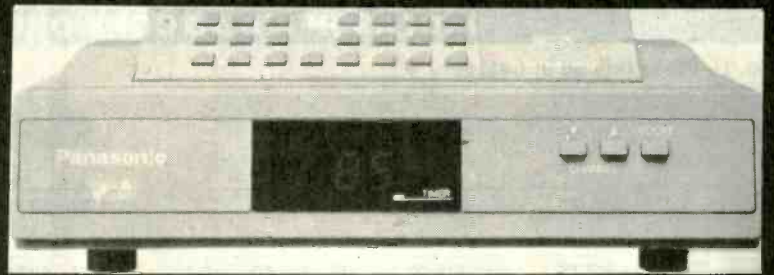

JERROLD PANASONIC SCIENTIFIC ATLANTA PIONEER

The Newest & the Latest

DMTB-A - all Jerrold Impulse & Starcom series
SA3-DFA - all Sci. Atlantas incl. 8536/+, 3580, Drop-field
PN-3A - all Pioneer systems

ALSO FTB3, SA3, TZPC145G

FAST SHIPMENTS FREE CATALOG 30 DAY MONEY BACK GUARANTEE

1-800-772-6244 M-F: 9-6 EST

U.S. Cable TV, Inc. Dept.: KPE074
4100 N. Powerline Rd, Bldg. F-4 Pompano Beach FL 33073

NO FLORIDA SALES!

CABLE TV CHANNELS
EQUIPMENT **GUARANTEED**

➔ The nationwide
source for cable
TV equipment.

**FREE
30 DAY
TRIAL**

"BUY WHERE THE DEALERS BUY."

FREE

TV Cable Descramblers
and Converters Catalog.
Open Every Day!

MEGA ELECTRONICS

VISA • MC
C.O.D.

1-800-676-6342

SAVE
1000's

21 South Main Street, Winter Garden, FL 34787

USE PE MARKET CENTER CLASSIFIEDS

READ BY 87,877 BUYERS OF ELECTRONIC EQUIPMENT ACCESSORIES AND PARTS

INSTRUCTION FOR PLACING YOUR AD!

HOW TO WRITE YOUR AD

TYPE or **PRINT** your classified ad copy **CLEARLY** (not in all capitals) using the form below. If you wish to place more than one ad, use a separate sheet for the additional ads (a photocopy of this form works well). Choose a category from the list below and write that category number into the space at the top of the order form. If you do not specify a category, we will place your ad under Miscellaneous or whatever section we deem most appropriate.

We cannot bill for classified ads. Payment in full must accompany your order. We do permit repeat ad or multiple ads in the same issue, but in all cases, full payment must accompany your order.

WHAT WE DO

The first two words of each ad are set in bold caps at no extra charge. No special positioning, centering, dots, extra space, etc. can be accommodated.

RATES

Our classified ad rate is \$1.00 per word. Minimum charge is \$15.00

per ad per insertion (15 words). Any words that you want set in bold or caps are 20¢ each extra. Bold caps are 40¢ each extra. Indicate bold words by underlining. Words normally written in all caps and accepted abbreviations are not charged as all-caps words. State abbreviations must be Post Office 2-letter abbreviations. A phone number is one word.

CONTENT

All classified advertising in the **PE Market Center** is limited to electronics items only. All ads are subject to the publisher's approval. We reserve the right to reject or edit all ads.

DEADLINES

Ads received by our closing date will run in the next issue. For example, ads received by November 15 will appear in the march, 1994 issue that is on sale January 18. The PE Market Center is published monthly. No cancellations permitted after the closing date. No copy changes can be made after we have typeset your ad. **NO REFUNDS, advertising credit only. No phone orders.**

AD RATES: \$1.00 per word. Minimum \$15.00.

Send your ads with payment to:

Popular Electronics Market Center, 500-B Bi-County Blvd. Farmingdale, NY 11735

CATEGORIES

100 — Antique Electronics	270 — Computer Equipment Wanted	450 — Ham Gear Wanted	630 — Repairs-Services
130 — Audio-Video-Lasers	300 — Computer Hardware	480 — Miscellaneous Electronics For Sale	660 — Satellite Equipment
160 — Business Opportunities	330 — Computer Software	510 — Miscellaneous Electronics Wanted	690 — Security
190 — Cable TV	360 — Education	540 — Music & Accessories	710 — Telephone
210 — CB-Scanners	390 — FAX	570 — Plans-Kits-Schematics	720 — Test Equipment
240 — Components	420 — Ham Gear For Sale	600 — Publications	

CLASSIFIED AD COPY ORDER FORM

Ad No. 1—Place this ad in Category # _____

1 - \$15.00	2 - \$15.00	3 - \$15.00	4 - \$15.00
5 - \$15.00	6 - \$15.00	7 - \$15.00	8 - \$15.00
9 - \$15.00	10 - \$15.00	11 - \$15.00	12 - \$15.00
13 - \$15.00	14 - \$15.00	15 - \$15.00	16 - \$16.00
17 - \$17.00	18 - \$18.00	19 - \$19.00	20 - \$20.00
21 - \$21.00	22 - \$22.00	23 - \$23.00	24 - \$24.00
25 - \$25.00	26 - \$26.00	27 - \$27.00	28 - \$28.00

29 - \$29.00	30 - \$30.00	31 - \$31.00	32 - \$32.00
33 - \$33.00	34 - \$34.00	35 - \$35.00	36 - \$36.00
37 - \$37.00	38 - \$38.00	39 - \$39.00	40 - \$40.00

Ad No 1—Total words _____ × \$1.00 per word = \$ _____
 All Caps words _____ × .20 per word = \$ _____
 Bold words _____ × .20 per word = \$ _____
 Bold Cap words _____ × .40 per word = \$ _____

TOTAL COST OF AD No. 1 \$ _____

Total classified ad Payment \$ _____ enclosed.

Check MasterCard Visa (\$15.00 minimum credit card order)

Name _____ Phone _____

Card # _____

Expiration Date ____ / ____

Signature _____

118 Address _____ City State Zip _____

PE MARKET CENTER CLASSIFIEDS

PLANS-KITS-SCHEMATICS

BUILD — FIVE-digit, ohms, capacitance, frequency, pulse, multimeter. Board and instructions \$9.95. Bagnall Electronics, 179 May, Fairfield, CT 06430.

ALL-IN-ONE catalog. AM/FM/ham/spy, transmitters/amplifiers, voice disguisers, descramblers, audio/TV/science projects. Start your own licensed/unlicensed radio station, books/plans/kits for import and export. 60 mouth-watering pages for \$1.00. **PAN-COM INTERNATIONAL**, PO Box 130-H7, Paradise, CA 95967.

FM STEREO TRANSMITTER kit broadcasts any audio signal to FM stereo radios throughout your home. Uses unique BA1404 IC. Complete kit: PC board/components — \$24.00. Visa/MC. **TENTRONIX**, 3605 Broken Arrow, Coeur d'Alene, ID 83814. (208) 664-2312.

TIRED OF IRONING? Prototype service for hobbyists & engineers. Single/small quantity ss PCB's. No setup fee. \$10.00 minimum, most boards \$25.00. We scan magazine artwork free! Get out your back issues! **FIRST PROTO**, (407) 392-8677.

Prototype it..... FAST!

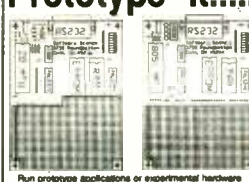

with ProtoQuick 8051 or 28

- Complete single board computers
- Up to 32K EPROMs and 64K RAM
- 12 sq. in. plated-through probe area
- RS232 C serial port w/ DB25 conn.
- 120 pins in EPROM w/ source code
- Assembled ready to run - 5v only
- MS-DOS cross assembler included

ProtoQuick 28 and 8051

\$99.00 each

Software Business
2780 Roundbottom Road
Columbia, OH 43084
(613) 561-2080

Run prototype applications or experimental hardware from the serial port - WITHOUT PROGRAMMING!

HIGH VOLTAGE PROJECT MANUAL II, Tesla, Odin, Spark, Pulsed Induction, Jacobs Ladder, unique high voltage experiments, \$10.00 postpaid, catalog \$1.00. Lambda Publishing Group, Box 1894, Lawrence, KS 66044-8894.

SILENT SAM. Patented vehicle turn signal reminder. Outshines others. Brief, timely alerting signal doesn't bug you. Kit complete w/case \$15.00. Visa/MC. 1 (800) 398-5605 literature. Silent Sam, 1627 Basil Dr., Columbus, OH 43227.

PROJECTS. \$2.00 gets flyer, 100 piece grab bag. Lynn Johnson Electronics, Box 51268, San Jose, CA 95151-1268.

MINI-FM transmitter. Buy parts at Radio Shack. Complete plans \$3.00. Lynn Johnson Electronics, Box 51268, San Jose, CA 95151-1268.

3-D IMAGING plans (surround sound) works with two speakers. Send \$9.95 for booklet and schematic to: Innovative Audio, 114 Smithfield Dr., Endicott, NY 13760.

SURVEILLANCE
A COUNTERSURVEILLANCE Electronic Devices







Bugging/Phone Tapping Detectors • Caller ID • Covert Video
• Phone Scramblers • Voice Changers • Shotgun Mics • Vehicle Tracking • Transmitter Kits • Locksmithing • AND MORE!

7-Hour Telephone Recording System
Tapes phone calls automatically. \$125.00

FOR CATALOG SEND \$5.00 TO...
P.O. Box 337, Buffalo, NY 14226 (716) 691-3476

NINE BAND shortwave receiver kit. See March 1994 Popular Electronics \$59.95 plus \$3.75 shipping ch/mo to Dan's Small Parts and Kits, 1935 So. 3rd. West #1, Missoula, MT 59801. Cat. 2 stamps.

CABLE DESCRAMBLERS Build your own, SSAVI, gated sync, sinewave. \$14.95. Cabletronics, Box 30502PE, Bethesda, MD 20824.

<p>OPTO INPUT</p>  <p>This board has 8 opto isolaters and interfaces to the Parallel I/O boards or the 8748 board via 16 pin dip ribbon cables. It has a screw terminal block to connect to external devices. Input voltage range is 4 to 15 volts AC or DC. Outputs are TTL levels. Size 3.4" by 4.6". Order # 91-3015A \$49.95</p>	<p>RELAY OUTPUT</p>  <p>This board has 8 DIP Relays, and interfaces to the Parallel I/O boards or the 8748 board via 16 pin dip ribbon cables. It has a screw terminal block to connect to external devices. Contacts are 500ma and 10 watts max. Inputs are LS-TTL. Size 3.4" by 4.6". Order # 91-3004A \$69.95</p>	<p>PARALLEL I/O</p>  <p>This board is IBM PC,XT,AT compatible. It has 6 eight bit I/O ports, via two 8255 I/O chips. Ports are programmable for input or output and are TTL level. Will interface with up to 6 Opto input and Relay output boards via ribbon cables. Dip switch sets I/O address. Plugs into bus, uses 1/2 slot. Order # 86-108A \$89.95</p>			
<p>A-D CONVERTER</p>  <p>IBM comp. 8 bit A-D board. 16 channel (0-5 or more volts). Designed to measure temperature, voltage or other slow changing inputs. Connects via 16 pin ribbon cables. Also has 3 TTL inputs & 3 outputs Order # 87-016A \$99.95</p>	<p>UNIVERSAL I/O</p>  <p>This IBM compatible has three 8255's that make 9 eight bit I/O ports and also has 16 analog inputs (0-5 volts) It also has a prototyping area. The I/O ports are designed to work with the Opto input and Relay output boards. Order # 83-064A \$199.95</p>	<p>8748 CONTROLLER</p>  <p>This board is designed to interface with the Opto input & Relay output boards. It uses the 8748 or 8749 single chip controllers (chip is extra). This board has 3 eight bit I/O ports, 6 Mhz crystal, power on reset and a prototype area. Size 3.4" by 4.6". Order # 92-148A \$49.95</p>			
<p>FREE DISK</p> <p>With order of \$89.95 or more, This is a one time offer. Disk has Basic I/O programs, 8748 Assem., Utilities and Text files.</p>		<p>ACCESSORIES</p> <p>8748 Chip \$12.95 8748 Programmer \$CALL Ribbon cable 3 Ft. \$5.00 Disk with Basic I/O programs, 8748 Assembler, Text files & Utilities. \$10.00 or FREE with an order of \$89.95 or more (one time offer).</p>		<p>Thank You !</p> <p>I want to thank all my customers for over 13 years of success.</p> <p>This ad is my new catalog. All boards come with Users Manual. Knowledge of computer workings is necessary.</p>	
<p>HOURS</p> <p>10am to 4pm Pacific time, Monday through Friday. (702) 267-2704</p>		<p>John Bell 1381 Saratoga St. Minden, NV 89423 (702) 267-2704</p> <p>To Order: Send check or money order to John Bell 1381 Saratoga St. Minden, NV 89423. Add \$4.00 for UPS Ground or \$6.00 for UPS Blue shipping. For COD add \$4.00. Include shipping address and phone number. I don't take credit cards. For cash COD, PO's call 702 267-2704 10am to 4pm Pacific time Monday through Friday.</p>			

CIRCLE 138 ON FREE INFORMATION CARD

!!! BROADCAST FARTHER !!!

The model 1525 is a 75-110MHz RF amplifier that connects to mono or stereo FM transmitters and produces a powerful 15-25 watt signal which could broadcast up to 5 miles or more! Requires 75-250 mW drive. Step by step plans complete with part source **ONLY \$14 PLUS \$2 S&H** CHECKS & M.O.'S ONLY

INFORMS. ATTS. & OTHER RF PRODUCTS. SEND \$2 FOR COMPLETE INFO

Progressive Concepts 1434 N. MILLS AVENUE, # B
9081 626-4988 CLAREMONT, CA 91711

BUGGED??

EAVESDROPPING is unbelievably widespread! Electronic Devices with amazing capabilities can be monitoring your telephone and room conversations RIGHT NOW! Are you sure you're safe? **FREE CATALOG** tells you fast! Includes Free Bonus details on fantastic opportunities now open in Counter-Surveillance field. Exciting, immensely interesting and EXTREMELY profitable (up to \$250 hr) full/part-time income. Call Now! **1-800-732-5000**

PHILCO RADIO schematics — 1928 through 40's. \$12.00 each plus \$3.00 S&H. PO Box 531, Dothan, AL 36302.

KERBER KLOCK KIT plays one of twelve melodies on the quarter hour. Six digit display, 12/24 hour mode, date, alarm and accessory outlet. Available completely assembled. Send \$2.00 for construction manual and pricing to **KERBER KLOCK COMPANY**, 36117 Hillcrest, Eastlake, OH 44095.

FREE KIT with purchase of plans, send \$2.95 and SASE. E.A. Hall, Rt. 11, Box 475, Lt. 13, Salisbury, NC 28144.

HOBBYIST CIRCUITS — Remote room monitor, tone decoder, long distance circuit control and more. Simple experiments for the beginner. **CATALOG \$2.00** — Garrett Plans, Box 155, Jamesburg, NJ 08831.

COOL KITS Catalog, Electric dog door, entrancing LED clock, city lights, awesome phones, plans, kits and more. **FREE CATALOG**, **CAMPBELL ENTERPRISES**, 27955 Terrace PE7, North Olmsted, OH 44070.

EVERYTHING YOU EVER WANTED in one catalog! Kits, surveillance, radio, plans, more! Best prices. Send \$1.50 (refundable) Neutronics, 4 Croydon Ct., Englishtown, NJ 07726.

COMPUTER SOFTWARE

AUDIO SPECTRUM ANALYZER: Frequency, time domains. Total harmonic distortion. Large dynamic range. Requires DOS, 386+, Pro AudioSpectrum 16, \$174.95, (512) 329-5859.

Radiotelephone - Radiotelegraph

FCC Commercial License

Why Take Chances?

Discover how easy it is to pass the exams. Study with the most current materials available. Our **Homestudy Guides**, Audio, Video or PC "Q&A" pools make it so fast, easy and inexpensive. No college or experience needed. The new commercial FCC exams have been revised, covering updated Aviation, Marine, Radar, Microwave, New Rules & Regs, Digital Circuitry & more. We feature the Popular "Complete Electronic Career Guide" 1000's of satisfied customers

Guarantee to pass or money back. Send for **FREE DETAILS** or call **1-800-800-7588**

WPT Publications
7015 N.E. 61st Ave Dept. 10
Vancouver, WA 98661

Name _____

Address _____

City _____ St. _____ Zip _____

1-800-800-7588

Dumont Model 190
two channel, 50 MHz
solid state, delayed
timebase, modular
construction, built
to military specs
includes 225 page
manual, 30 money-
back guarantee
Your cost:

\$250

Hewlett-Packard Model 180A two channel
solid state, 50 MHz delayed timebase,
Remanufactured, original cost
was over \$8,000 Your cost:

\$290

Price includes 225 page service
manual with schematics. 30
day unconditional guarantee
80 day parts and labor.
Remanufactured. Two cabinet
styles available.

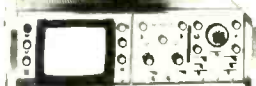

VIDEOSPECTRA
(800) 835-8335

P.O. Box 755
Agoura, CA 91301



DIGI-FIELD FIELD STRENGTH METER

Are you worried about electromagnetic radiation, TV coax distribution loss, poor antenna performance, or EMI/RFI? The DIGI-FIELD field strength meter will put you at ease. With its frequency response of DC up to 12 GHz, it readily detects potential electromagnetic radiation hazards. It is an excellent tool for measuring TV coax distribution loss. In addition DIGI-FIELD can easily find 60-Hz AC-line interference, as well as RFI/EMI instrumentation disrupting set-ups. Sensitivity: @ 100 MHz Model "A" 150 nano Watts. Model "B" 2 nano watts.

\$139.95

Plus \$6.50 s/h



To order call - **(800) FIELD 58 (343-5358)**
I.C. Engineering 16350 Ventura Blvd
Suite 125, Encino, CA 91436 PH.(818) 345-1892 • 818-345-0517 Fax

MARYMAC® The New Realistic® PRO-43 Scanner

Radio Shack®

PHONES

Our 18th year of DISCOUNTS

Toll Free 800-231-3680

PRO-43 List \$349.95

Our Delivered Price \$288.00

IF ON SALE, WE ARE CHEAPER!

We discount everything in the RS catalog

22511 Katy Fwy.

Katy (Houston), TX 77450

1-713-392-0747 FAX 713-574-4567

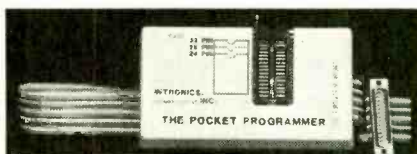

The Pocket Programmer

The portable Eprom programmer that uses the printer port of your PC instead of an internal card. The software has 24 easy to use functions and programs 27/25/28/68764 & Cmos from 16K (2K x 8)—2M (256K x 8) Eproms (32 pin socket, UpGradeable to 8Meg). Adapters available for MCU's, 40-Pin Eproms, 5-Gang and Eprom Emulator to 32K x 8.

\$129.95

INTRONICS, INC.
Box 13723
Edwardsville, KS 66113
(913) 422-2094

Add \$3.00 for shipping.
Add \$3.75 for COD
Visa/Master Charge

PROFESSIONAL SURVEILLANCE EQUIPMENT Used By Law Enforcement Agencies

VHF-FM CRYSTAL CONTROLLED TRANSMITTERS

A - 139MHz, B - 139.970 MHz, C - 149 MHz, D - 149.450 MHz

All kits assemble in less than 5 mins.

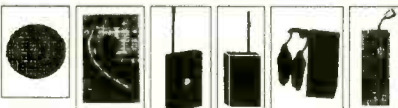

SD-200
Smoke
Detector
Camera
w/Audio
400 lines
03 lux
10-14 VDC
\$330

CX-102
Miniature
Camera
w/Audio
240 lines
2 lux
7-14 VDC
\$235

AD-700
Mic
Range:
up to 5
Mile
Power
750MW
\$247

AD-600
Mic
Range:
up to 5
Mile
Power
15MW
\$125

AD-500
Tel.
Range:
up to 5
Mile
Power
15MW
\$115

AD-400
Mic
Range:
up to 2.5
Mile
Power
400MW
\$155

We sell a variety of cameras, bug detectors, night vision equipment, video transmitters, time lapse recorders, remote video monitoring systems, and many more...

A&D ELECTRONICS

P.O. Box 601, Monsey, NY 10952
914-356-7541 • Fax 914-356-7505
Call for FREE catalog. Credit Cards accepted

\$129* Laser Light Show



This kit displays animation, text, drawings, & music! Includes 2 Galvos, VCO, Computer Interface, Manual & Software listing. Works from parallel printer port.

Computerized Motors \$39*

Includes: 2 Stepper or 4 DC servo motors, Computer interface kit, 32 page training manual & Software listing. Works from parallel printer port.

* Add \$5 for shipping. Computer and Laser not included.

Call for **FREE** Flyer

SVS
Light &
Motion
in kit form

1273 Industrial Pky. W#460
P O Box 55125
Hayward CA 94545-0125
510-582-6602

NEW EASY PC

BRITISH
DESIGN
AWARD

SCHEMATIC and PCB C.A.D.

ONLY

\$195

Includes

- MGA, CGA, EGA & VGA compatible.
- Design large multi layer boards.

- One level pull down menu and quick keys for fast layout.

- Dot matrix, laser, plotter, Gerber & N.C. drill output.

- 6 Month Free update
Free Demo

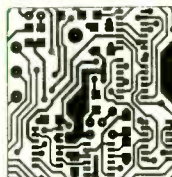

7840 ANGEL RIDGE ROAD
ATHENS, OHIO 45701
(614) 592-1810

Visa & MasterCard Accepted

Home Control Hobbyists:

R.I.B., the Remote Interface Board allows you to...

- Interface ANY REMOTE CONTROL to your COMPUTER!
- Interface Touch Panel Devices (Non remote items)
- Use the computer's standard Parallel Port.
- Complete theory & instructions are included to interface this board to the popular 4 in 1 preprogrammed remote & the Gemini learning remote!
- Inexpensively control electronic devices with your home computer!

Remote Interface Board & Complete Instructions only \$49.99
Quantity Discounts Available. Order Code #RIB-001
Kit Version #RIB002 \$39.99
Authorized Distributor



JAVANCO INC.
501 12th Ave. South
Nashville, TN 37203

(800) 528-2626
(615) 244-4444 Information

Call for our Catalog filled with your electronic needs!

Get the one you missed!

Popular Electronics®



Plans for the world's zaniest plaything—
September 1989



Put together your own Macintosh computer—
September 1991



Build the Tesla Coil that went square!—
August 1989



Take a chance on our Dice-Roulette project—
April 1989

Popular Electronics back issues are available although quantities of some issues are nearly exhausted. Here's an opportunity to complete your collection, or obtain a selected back issue you cannot find elsewhere. This offer is valid only when using the coupon on this page or a photocopy.

Special Back Issue Offer!

Please circle the issue(s) ordered!

	Jan.	Feb.	Mar.	Apr.	May	June	July	Aug.	Sep.	Oct.	Nov.	Dec.	
1987	1	2	3	4	5	6	7	8	9	10	11	12	
1988	1	1987-1988 back issues not available								11	12	23	24
1989	25	26	27	28	29	30	31	32	33	34	35	36	
1990	37	38	39	40	41	42	43	44	45	46	47	48	
1991	—	49	—	50	51	52	53	54	55	56	57	58	
1992	59	60	61	62	63	64	65	66	67	68	69	70	
1993	71	72	73										

Note: Issues prior to November 1988 are "Hands-on Electronics"—the predecessor of Popular Electronics.

How to determine cost!

Quantity	Price per copy		
	United States	Canada	Foreign
1-5	\$6.50 US	\$6.50 US	*
6-11	5.50	5.75	\$8.00 US
12-23	5.00	5.25	7.50
24 and more	4.50	4.75	7.00

Prices include handling and shipping. Prices subject to change. All orders payable in U.S.A. funds only, via international money order, check drawn on a U.S.A. bank, or acceptable credit card (Visa, MasterCard) in U.S.A. funds. Allow 6-8 weeks delivery. Foreign orders may take longer. *Minimum foreign order—6 issues.

Visa MasterCard USA Bank Check US or Int. Money Order

[Note: Credit Card minimum order is \$15.00.]

Credit Card Number _____ Exp. Date _____ / _____

Signature _____

Name _____

Address _____

City _____ State _____ ZIP _____

Send Orders To: CLAGGK, Inc., P.O. Box 4099, Farmingdale, NY 11735. Sorry, no telephone orders.



Model 1010 Synthesized Digital Sweep/Function Generator \$289

- .1 Hz to 8 MHz sawtooth and ramp
- DC to 8 MHz square and sine wave
- AM and FM modulation
- ±25 ppm frequency accuracy
- Log or linear frequency sweeping with automatic or user programmed markers
- Programmable Pulse width and repetition rate. Programmable burst mode
- 10 year nonvolatile memory storage of up to 100 user programmable setups

Options RS-232 remote, ±2 ppm accuracy, rechargeable battery operation 30 day trial 1 year factory parts and labor price and availability subject to change w/o notice

Videospectra
P.O. Box 755 Agoura, CA 91301
(818) 889-9072 (800) 835-8335
FAX (818) 889-9085



Infiniter™
Laser Pointer
Attracts the attention of your audience

\$68 Black or Silver
\$88 Gold
2 "AAA" Batteries included
1 year warranty

FDA APPROVAL
PATENTED

For:
*Conferences
*Presentations
*Marketing Sales
*Lawyers *Doctors
*Real Estate Brokers
*Lectures *Teachers
*Executives *Engineers
*Scientists *Inspections

Please Call 800-520-8435
Quarton USA, LTD. CO.
7042 Alamo Downs Parkway, Suite 250,
San Antonio, Texas 78238-4518
Tel: (210)520-8430 Fax: (210)520-8433



CABLE DIRECT

Now you can tune-in to your favorite cable TV programming and **SAVE 100's—EVEN \$1000's** on premium

CABLE TV EQUIPMENT
Converters • Descramblers • Filters

FREE Cable TV Catalog 

MODERN ELECTRONICS
1-800-906-6664
100% MONEY BACK GUARANTEE! • 30 DAY FREE TRIAL!



Popular Electronics®

WE
**HAVE
THE
RIGHT
ANSWER**

Advertisers who want to place their print ads in a quality publication ask the question: "Is your circulation audited?"

We're very proud to answer "Yes."

We are a member of the Audit Bureau of Circulations because we share ABC's belief that circulation audits are an essential assurance of value.

ABC is the premier circulation auditing organization in the world, and has been since 1914. Each year, ABC auditors test and verify that our circulation figures are facts, not claims. An ABC audit is the sign of a sound investment for advertisers.

Not all publications are audited, but they should be. Because when advertisers ask "Is your circulation audited?" there's only one answer.

"Yes."



Audit Bureau of Circulations

PE MARKET CENTER CLASSIFIEDS

COMPUTER HARDWARE

COMPUTER KITS build your own computer and save. 386/sx \$499.00, 486/sx \$599.00. **FREE CATALOG.** ABI SYSTEMS, 6 Angelacrest Ln., West Seneca, NY 14224. (716) 823-5304.

8031/52 BASIC SINGLE BOARD COMPUTERS: Up to 64K EPROM, 256K bytes NVRAM, RS232, 8255, 36V/O lines, 8 CHANNEL A/D, prototyping area, free basic compiler, assembler. Only **\$16.25** (bare board), **\$29.75** (kit), **\$79.00** (assembled). ProBoard Circuits: (512) 502-1821, 11028 Jollyville Road, Unit 151, Austin, TX 78759.

CB-SCANNERS

RCI-2950 MODIFICATION Manual \$20.00 pre-paid money order, \$25.50 COD. Scott, PO Box 510408, St. Louis, MO 63151-0408. (314) 846-0252.

COMPONENTS

TUBES, COMPONENTS, Sam's, etc. Catalog \$1.00: NRQ Electronics, PO Box 352924-PE, Toledo, OH 43635-2924.

Invest a stamp



Save a bundle

For the price of a stamp, you can get the latest edition of the federal government's free **Consumer Information Catalog.** It lists more than 200 free or low-cost publications on federal benefits, jobs, health, housing, education, cars, and more, to help you save money, make money, and spend it a little more wisely.

So stamp out ignorance with our free Catalog. Send your name and address to:

Consumer Information Center
Department SB
Pueblo, Colorado 81009

PORTABLE SATELLITE ANTENNA



Complete 3' KU Band System

For Free Information Package and Pricing

• Call 219-236-5776 • 

R.C. Distributing • P.O. Box 552 • South Bend, IN 46624

Surface Mount Chip Component Prototyping Kits—



Only
\$49.95

CC-1 Capacitor Kit contains 365 pieces, 5 ea. of every 10% value from 1pf to .33µf. CR-1 Resistor Kit contains 1540 pieces; 10 ea. of every 5% value from 100 to 10 megΩ. Sizes are 0805 and 1206. Each kit is ONLY \$49.95 and available for immediate One Day Delivery!

Order by toll-free phone, FAX, or mail. We accept VISA, MC, COD, or Pre-paid orders. Company PO's accepted with approved credit. Call for free detailed brochure.

 **COMMUNICATIONS SPECIALISTS, INC.**
426 West Taft Ave. • Orange, CA 92665-4296
Local (714) 998-3021 • FAX (714) 974-3420

Entire USA 1-800-854-0547

Universal Programmers

RC Electronics Is Never Undersold!

\$1299 DATA I/O CHIPLABS 4800
\$ 799 DATA I/O CHIPLABS 3200
\$1869 LOGICAL DEVICES 5000
\$ 579 EETOOLS ALLMAX
\$ 479 EETOOLS PROMAX
\$ 549 XELTEK SUPERPRO II
\$ 375 XELTEK SUPERPRO (R)
\$ 499 LOGICAL DEVICES 3000
\$ 499 ADVANTECH PC-UPROG
\$ 779 DATAMAN S4
\$ 499 AMERICAN RELIANCE 9860
\$ 699 NEEDHAMS SA-20 8-GANG
\$ 139 EETOOLS 1 GANG
\$ 199 EETOOLS 4 GANG
\$ 129 XELTEK ROM MAX
\$ 159 SUNSHINE 4 GANG

ASK ABOUT OUR REFURB UNITS!
PC-LAB CARDS 720 725 743 \$99
ADVANTECH 711S \$149

(408) 241-7376 Fax 241-6375



From the Lab
to your
Living Room!

Does your VCR have a "Head Cold?"

Probably not! However, through constant playing and using of degrading dry or wet cleaners, the output of your video tapes has slowly diminished to an unacceptable level and the VCR plays as if it has a head cold! The culprit is most likely clogged and dirty video and/or audio heads.

The **3M Black Watch™ Head Cleaner Videocassette** uses a patented magnetic tape-based cleaning formation to remove head clogging debris. No foreign substances such as cloth, plastics or messy liquids and no harsh abrasive materials are present. The cleaner's usable life is 400 cleanings or more!

It's easy to use. Place the **3M Black Watch™ Head Cleaner Videocassette** in the VCR and press the Play button. A pre-recorded message appears clearly on your screen and an audible tone is heard, telling you that the cleaning process is now completed. No guess work, you never over clean!

3M Black Watch™ Head Cleaner Videocassette SVHS VHS.....\$19.95

Once your VCR's head cold is cured, and the unit plays like new, consider using the finest videocassette you can buy—the **3M Black Watch™ T120 Hi Pro VHS 4410 Videocassette**. The 4410 is the highest performing videocassette available today for use with all standard format VHS recording hardware!

Here's what you hear and see....A sharp, clear picture—brightest colors—freedom from streaks, flashes and snow—outstanding high-fidelity audio reproduction—optimum camcorder performance—maintains recording integrity. **3M Black Watch™** video tape is 100% laser inspected to guarantee surface smoothness and drop-out free performance.

3M Black Watch™ T120 Hi Pro VHS 4410 Videocassette VHS.....\$8.00

CLAGGK INC. — 3M VHS Special Offer
P.O. Box 4099, Farmingdale, New York 11735

Yes, I like your offer and here is my order for 3M Black Watch™ products!

___ 3M Black Watch™ Head Cleaner Videocassette (\$19.95 each) ___ \$

___ 3M Black Watch™ T120 Hi Pro VHS 4410 Videocassette (\$8.00 each) \$ ___

Shipping and handling per order \$ 4.00

Total Amount in U.S. Funds only \$ ___

New York State residents add local sales tax. Canadians add \$6.00 per order. No foreign orders. Do not send cash.

Bill my VISA MasterCard Expire Date ___/___/___

Card No. _____

Signature _____

Name (Please print) _____

Address _____

City _____ State _____ ZIP _____

ADVERTISING INDEX

POPULAR ELECTRONICS magazine does not assume any responsibility for errors that may appear in the index below.

Free Information No.	Page	Free Information No.	Page		
—	A&A Engineering	117	—	M&G Electronics	116
—	A&D Electronics	120	—	Marymac Industries Inc.	120
—	Agrelo Engineering	110	142	MCM Electronics	117
26	Alfa Electronics	100	—	MD Electronics	101
28	All Electronics	94	—	Mega Electronics	117
—	Allen Engineering	106	—	Modern Electronics	122
151	AMC Sales	19	—	NRI Schools	15
—	Andromeda Research	110	—	NuTek	78
—	Antique Radio Classified	79	—	Ohio Automation	120
140	B&S Sales	104	43	Optoelectronics	97
—	C&C Specialties	116	—	PC Boards	106
32	C&S Sales	102	—	Phillips Tech	116
—	CBC International	79	47	Prairie Digital Inc.	107
141	Cellular Link	106	46	Print	107
—	CLAGGK Inc.	109, 123	137	Print	114
—	CLAGGK Video Offer	17	—	Progressive Concepts	119
—	Cleveland Inst. of Electronics	29	—	Quarton USA	122
—	Communication Specialists	123	—	RC Distributing Co.	123
—	CompCo	120	—	RC Electronics	123
—	Consumertronics	108	—	Self-Reliance Co. Inc.	109
14	Cook's Institute of Elec. Eng.	21	—	The School of PC Repair	79
144	DC Electronics	105	—	The School of VCR Repair	79
—	Design Computation	114	—	Seymour-Radix Inc.	79
—	EDE	119	—	Silicon Valley Surplus	120
—	ETT	23	—	Skyvision (Small)	116
—	Firestick II	79	—	Software Science	119
153	Fluke Corporation	CV4	—	Software Systems Consulting	23
—	Forest Electronics	112	—	Spy Supply	98
—	Fotronics	112	—	TAB Books	9
—	GeoBan Engineering	109	130	Tech Serv.	112
13	Global Specialties	3	—	Tele View Distributors	107
—	Grantham College of Engineering	5	143	Timeline	111
—	Great Southern Security	119	136	UCANDO Videos	108
—	Greenleaf Electronics Inc.	114	—	US Cable (Zentek)	117
—	I.C. Engineering	120	—	Video Spectra	120
—	Information Unlimited	11	—	Video Spectra	122
157	Interactive Image Technologies	CV2	158	Voice Powered Technology	CV3
—	Intronics	120	133	Weka Publishing	115
139	ITC Instruments	95	—	Windward Electronics	113
138	John Bell	119	—	World College	7
—	JP Video	96	—	WPT Publishing	120
38	Kelvin Electronics	99	134	Xandi Electronics	110

ADVERTISING SALES OFFICE

Gernsback Publications, Inc.
500-B Bi-County Blvd.
Farmingdale, NY 11735
1-(516) 293-3000

Larry Steckler, EHF/CET
 President

Christina Estrada
 Assistant to the President

For Advertising ONLY
516-293-3000
Fax 1-516-293-3115

Larry Steckler
 publisher

Arline Fishman
 advertising director

Denise Mullen
 advertising assistant

Kelly Twist
 credit manager

**Subscription/
 Customer Service/
 Order Entry**
1-800-827-0383
7:30 AM - 8:30 PM EST

ADVERTISING SALES OFFICES

EAST/SOUTHEAST

Stanley Levitan
 Eastern Sales
 1 Overlook Ave.
 Great Neck, NY 11021
 1-516-487-9357, 1-516-293-3000
 Fax 1-516-487-8402

MIDWEST/Texas/Arkansas/ Oklahoma, Colorado, Arizona

Ralph Bergen
 Midwest Sales
 One Northfield Plaza, Suite 300
 Northfield, IL 60093-1214
 1-708-446-1444
 Fax 1-708-559-0562

PACIFIC COAST/Mountain States

Mike Brooks
 Hutch Looney & Assoc., Inc.
 1800 North Highland Avenue
 Suite 717
 Hollywood, CA 90028
 1-213-462-2700
 Fax 1-213-463-0544

Now You'll Never Forget Anything Ever Again!
Introducing The New Voice Organizer™!

Finally, it's this simple: If you can talk, you can stay organized!

Whether you're in a plane or your car, at home or in a hotel, the amazing *Voice Organizer™* reminds you *who, what, where* and *when*...in your own voice!

Thanks to voice recognition technology, you can throw away your notepads, forget about making tickler files, and stop fumbling with miniature keyboards. All you have to do is talk into your friendly *Voice Organizer* to hold and organize the facts, figures, phone numbers, ideas and appointments you need to remember.

Manage Your Business Day Just By Talking!

The real value of your friendly *Voice Organizer* becomes obvious the first time you use it! Simply tell your easy-to-use *Voice Organizer* what information to keep...then, retrieve it whenever you want it.



Who was I supposed to call?



What was that idea I had for my presentation?



Where was I supposed to pick up those reports?



When did I reschedule that meeting?

With 4-Megabits of memory, the pocket-sized *Voice Organizer* easily remembers:

- Your personal phone directory of up to 400 numbers for up to 100 names. To enter a number, just say: "Bob Jones" and the number...then, when making a call, just say "Bob Jones" and your *Voice Organizer* will display it: "800-555-1212."
- Your personal appointment calendar...All you do is say: "Meeting with George, 12/17, 2 P.M."...then, to review all your events for that day, just say: "12/17."
- 99 individual notes...All you do is say: "Develop New Sales Proposal" and that thought is readily accessible whenever you want to hear it.

- 99 reminders that alert you to every event you schedule -- in your own voice...*even up to a full year later*...and all you do is say: "Staff Meeting, Monday, 9 A.M."

Manufactured by the world leader in voice recognition products, your Voice Organizer holds a charge for 7 days. A plug-in recharging stand is also included!

Take advantage of the easiest way to remember everything instantly. The amazing *Voice Organizer* is not available in any store. To order yours now, have your VISA, MasterCard, Discover or American Express ready and Call Toll-Free Now For Immediate Delivery:

1-800-998-2900, Dept. 62

Or, send a check or money order for \$199.95 (plus \$9 shipping and handling) to:
 Voice Powered Technology International, Inc.
 19725 Sherman Way • Canoga Park, CA 91306.
 California residents please add applicable sales tax.

**Now...Try Your Own Voice Organizer
 RISK FREE For 30 Days!**

Order your friendly *Voice Organizer* now and use it for 30 days with *no obligation*. We'll bill \$199.95 (plus shipping, handling and applicable sales tax) to the credit card of your choice. If you decide to return it within 30 days, you'll receive full credit.



The World Leader In Voice Recognition Products.

There are copies and then there are originals. Only Fluke meters – the original and most copied DMMs in the world – deliver the safety, quality and value they promise. They're built tough enough to achieve C.S.A. and U.L. listings, not to mention the considerable on-the-job punishment they endure. Each meter is loaded with features, of course. But those features are also designed to work together intelligently, so your job is easier. Faster. And safer.

If you're going to spend your hard-earned money on a multimeter, why buy an inferior copy when you can own an original? See Fluke's full line of handheld meters and accessories at your local distributor; or call 1-800-87 FLUKE for the name and number.

O R I G I N A L S



FLUKE®

© Copyright 1993 John Fluke Mfg. Co., Inc. P.O. Box 9090 M/S 250E Everett, WA 98206 U.S.: 206-356-5400
Canada: 416-890-7600 Other Countries: 206-356-5500 All rights reserved. Ad no. 00381

CIRCLE 153 ON FREE INFORMATION CARD