

Electronic Paperbacks at Special Prices

BP325—A CONCISE USER'S GUIDE TO WINDOWS 3.1 . . . \$7.95. Come to grips with Windows 3.1 in the shortest and most effective way. Learn how to manipulate Windows screens and DOS by Windows graphics interface. Master its word processor, Paintbrush and data base along with Notepad, Macro Recorder, PIF Editor, and Calculator.

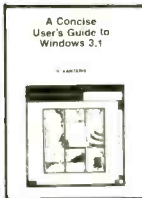

BP311—AN INTRODUCTION TO SCANNERS AND SCANNING . . . \$7.95. Radio scanners have opened a realm of exciting radio listening. Understand radio wave propagation, types of transmissions, antennas, band assignments—the straight dope on what to hear and where to hear it! Comes complete with index, glossary of important terminology.

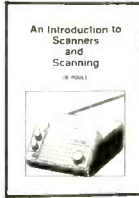

BP287—A REFERENCE GUIDE TO PRACTICAL ELECTRONICS TERMS . . . \$8.95. More than just a dictionary of practical electronics terms, the book goes a step further in getting down to fundamentals. A reference volume that can be read casually by a reader seeking knowledge.



BP248—TEST EQUIPMENT CONSTRUCTION . . . \$5.95. Details construction of simple, inexpensive, but extremely useful test equipment. AF Gen, Test Bench Ampl, Audio Millivoltmeter, Transistor Tester and six more.



BP267—HOW TO USE OSCILLOSCOPES AND OTHER TEST EQUIPMENT . . . \$6.95. Mastering the oscilloscope is not really too difficult. This book explains all the standard controls and functions. Other equipment is also described.



BP265—MORE ADVANCED USES OF THE MULTI-METER . . . \$5.95. Use these techniques to test and analyze the performance of a variety of components. Also see how to build add-ons to extend multi-meter capabilities.



BP256—INTRO TO LOUDSPEAKERS AND ENCLOSURE DESIGN . . . \$5.95. We explore the variety of enclosure and speaker designs in use today so the reader can understand the principles involved.

BP298—A CONCISE INTRODUCTION TO THE MACINTOSH SYSTEM AND FINDER . . . \$6.25. If you have one of the popular Macintosh range of computers, this book is designed to help you get the most from it. Although the Mac's WIMP user interface is designed to be easy to use, much of it only becomes clear when it is explained in simple terms. All Macintosh computers are covered including the new "Classic" range.



BP299—PRACTICAL ELECTRONIC FILTERS . . . \$6.95. Presents a dozen filter-based practical projects with applications in and around the home or in the constructor's workshop. Complete construction details are included.



BP249—MORE ADVANCED TEST EQUIPMENT CONSTRUCTION . . . \$6.95. Eleven more test equipment construction projects. They include a digital voltmeter, capacitance meter, current tracer, etc.



BP245—DIGITAL AUDIO PROJECTS . . . \$5.95. Practical circuits to build and experiment with. Includes A/D converter, input amplifier, digital delay line, compander, echo effect and more.



BP247—MORE ADVANCED MIDI PROJECTS . . . \$5.95. Circuits included are a MIDI indicator, THRU box, merge unit, code generator, pedal, programmer, channelizer, and analyzer.



BP257—INTRO TO AMATEUR RADIO . . . \$6.95. Amateur Radio is a unique and fascinating hobby. This book gives the newcomer a comprehensive and easy to understand guide to the subject.

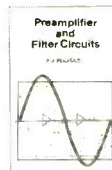

BP309—PREAMPLIFIER AND FILTER CIRCUITS . . . \$6.95. Provides circuits and background info for a range of pre-amplifiers, plus tone controls, filters, mixers and more. All are high-performance circuits that can be built at a reasonable cost.

BP303—UNDERSTANDING PC SOFTWARE . . . \$6.95. This book will help you understand the basics of various types of business software in common use. Types of software covered include word processors, spelling checkers, graphics programs, desktop publishing, databases, spreadsheets and utilities.



BP251—COMPUTER HOBBYISTS HANDBOOK . . . \$8.95. A wrapup of everything the computer hobbyist needs to know in one easy to use volume. Provides a range of useful reference material in a single source.



PCP115—ELECTRONIC PROJECTS FOR HOME SECURITY . . . \$10.00. 25 projects ranging from a single-door protection circuit that can be completed in an hour or two, to a sophisticated multi-channel security system. Each project is described in detail with circuit diagrams, explanations of how it works, instructions for building and testing, and how to adapt circuits to meet special requirements.

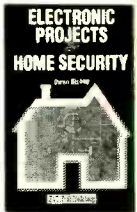

BP190—ADVANCED ELECTRONIC SECURITY PROJECTS . . . \$5.95. Includes a passive infra-red detector, a fiber-optic loop alarm, computer-based alarms and an unusual form of ultrasonic intruder detector.

BP235—POWER SELECTOR GUIDE . . . \$10.00 Complete guide to semiconductor power devices. More than 1000 power handling devices are included. They are tabulated in alpha-numeric sequence, by technical specs Includes power diodes, Thyristors, Triacs, Power Transistors and FET's.

BP234—TRANSISTOR SELECTOR GUIDE . . . \$10.00. Companion volume to BP235. Book covers more than 1400 JEDEC, JIS, and brand-specific devices. Also contains listing by case type, and electronic parameters. Includes Darlingtons transistors, high-voltage devices, high-current devices, high power devices.

BP117—PRACTICAL ELECTRONIC BUILDING BLOCKS—Book 1 . . . \$5.75. Oscillators, Timers, Noise Generators, Rectifiers, Comparators, Triggers and more.

BP195—INTRODUCTION TO SATELLITE TV . . . \$9.95. A definitive introduction to the subject written for the professional engineer, electronics enthusiast, or others who want to know more before they buy. 8 x 10 in.

BP179—ELECTRONIC CIRCUITS FOR THE COMPUTER CONTROL OF ROBOTS . . . \$7.50. Data and circuits for interfacing the computer to the robot's motors and sensors.

BP239—GETTING THE MOST FROM YOUR MULTIMETER . . . \$5.95. Covers basics of analog and digital meters. Methods of component testing includes transistors, thyristors, resistors, capacitors and other active and passive devices.

BP97—IC PROJECTS FOR BEGINNERS . . . \$5.50. Power supplies, radio and audio circuits, oscillators, timers, switches, and more. If you can use a soldering iron you can build these devices.

RADIO—100 RADIO HOOKUPS . . . \$3.00. Reprint of 1924 booklet presents radio circuits of the era including regenerative, neutrodyne, reflex & more.

BP42—SIMPLE LED CIRCUITS . . . \$5.50. A large selection of simple applications for this simple electronic component.

BP122—AUDIO AMPLIFIER CONSTRUCTION . . . \$5.75. Construction details for preamps and power amplifiers up through a 100-watt DC-coupled FET amplifier.

BP92—CRYSTAL SET CONSTRUCTION . . . \$5.50. Everything you need to know about building crystal radio receivers.

BP255—INTERNATIONAL RADIO STATIONS GUIDE . . . \$7.95. Provides the casual listener, amateur radio DXer and the professional radio monitor with an essential reference work designed to guide him or her around the more than ever complex radio bands.

CHECK OFF THE BOOKS YOU WANT

ELECTRONIC TECHNOLOGY TODAY INC.
P.O. Box 240, Massapequa Park, NY 11762-0240

Name _____
Address _____
City _____ State _____ Zip _____

SHIPPING CHARGES IN USA AND CANADA

\$0.01 to \$5.00 \$1.50
\$5.01 to \$10.00 \$2.50
\$10.01 to 20.00 \$3.50
\$20.01 to 30.00 \$4.50
\$30.01 to 40.00 \$5.50
\$40.01 to 50.00 \$6.50
\$50.01 and above \$8.00

SORRY No orders accepted outside of USA & Canada

Total price of merchandise . . . \$ _____
Shipping (see chart at left) . . . \$ _____
Subtotal \$ _____
Sales Tax (NY State only) . . . \$ _____
Total Enclosed \$ _____

Number of books ordered

All payments must be in U.S. funds

PE594

Popular Electronics®

THE MAGAZINE FOR THE ELECTRONICS ACTIVIST!

CONSTRUCTION ARTICLES

BUILD THIS DISTINCTIVE RING SWITCH	Bruce Layne	33
<i>Route your telephone calls to the appropriate person or device</i>		
A TIME-DELAYED MODEL-ROCKET LAUNCH CONTROL	Dan Becker	41
<i>Add a touch of class and safety to your hobby with this deluxe controller</i>		
BUILD A REMOTE-CONTROL RELAY STATION	John Yacono	69
<i>Extend the range and the usefulness of your remote controls</i>		

FEATURE ARTICLES

DOCUMENTATION	Jack Cunkelman	37
<i>Save yourself and others from headaches by properly documenting your projects and designs</i>		
LIGHTNING AND THE RADIO LISTENING POST	Karl T. Thurber	44
<i>Protect your gear and yourself from the fury of nature</i>		
BEYOND OHM'S LAW	Paul Coxwell	66
<i>Use these methods to analyze complex circuits</i>		
ALL ABOUT TRANSISTORS: FET's	Robert A. Young	71
<i>Learn about field-effect transistors and how they work</i>		

PRODUCT REVIEWS

GIZMO		51
<i>Winter Consumer Electronics Show round-up, and more</i>		
HANDS-ON REPORT		22
<i>Media Vision Memphis multimedia upgrade kit</i>		
PRODUCT TEST REPORT	Len Feldman	24
<i>Mitsubishi HS-U57 videocassette recorder</i>		

COLUMNS

MULTIMEDIA WATCH	Marc Spiwak	4
<i>"Terminating" your PC</i>		
THINK TANK	John Yacono	26
<i>Addresses and answers</i>		
ANTIQUÉ RADIO	Marc Ellis	75
<i>The NBS crystal set continued</i>		
COMPUTER BITS	Jeff Holtzman	77
<i>A shell of a dashboard</i>		
CIRCUIT CIRCUS	Charles D. Rakes	79
<i>Some assorted circuits</i>		
DX LISTENING	Don Jensen	84
<i>Shortwave-broadcast funding</i>		
HAM RADIO	Joseph J. Carr	86
<i>Receiver performance today</i>		
SCANNER SCENE	Marc Saxon	88
<i>Scanners under fire</i>		

DEPARTMENTS

EDITORIAL	Carl Laron	2
LETTERS		3
ELECTRONICS LIBRARY		8
NEW PRODUCTS		14
ELECTRONICS MARKET PLACE		81
POPULAR ELECTRONICS MARKET CENTER		97
ADVERTISER'S INDEX		128
FREE INFORMATION CARD		129

Popular Electronics (ISSN 1042-170X) Published monthly by Gernsback Publications, Inc., 500-B Bi-County Boulevard, Farmingdale, NY 11735. Second-Class postage paid at Farmingdale, NY and at additional mailing offices. One-year, twelve issues, subscription rate U.S. and possessions \$21.95, Canada \$28.84 (includes G.S.T. Canadian Goods and Services Tax Registration No. R125166280), all other countries \$29.45. Subscription orders payable in U.S. funds only. International Postal Money Order, or check drawn on a U.S. bank. U.S. single copy price \$3.50. © 1994 by Gernsback Publications, Inc. All rights reserved. Hands-on Electronics and Gizmo trademarks are registered in U.S. and Canada by Gernsback Publications, Inc. Popular Electronics trademark is registered in U.S. and Canada by Electronics Technology Today, Inc. and is licensed to Gernsback Publications, Inc. Printed in U.S.A.

Postmaster: Please send address changes to Popular Electronics, Subscription Dept., P.O. Box 338, Mount Morris, IL 61054-9932.

A stamped self-addressed envelope must accompany all submitted manuscripts and/or artwork or photographs if their return is desired should they be rejected. We disclaim any responsibility for the loss or damage of manuscripts and/or artwork or photographs while in our possession or otherwise.

As a service to readers, Popular Electronics publishes available plans or information relating to newsworthy products, techniques, and scientific and technological developments. Because of possible variances in the quality and condition of materials and workmanship used by readers, Popular Electronics disclaims any responsibility for the safe and proper functioning of reader-built projects based upon or from plans or information published in this magazine.

Larry Steckler

EHF, CET

Editor-In-Chief and Publisher

EDITORIAL DEPARTMENT

Carl Laron

Editor

Robert A. Young

Associate Editor

John J. Yacono

Associate Editor

Teri Scaduto

Assistant Editor

Evelyn Rose

Editorial Assistant

Marc Spiwak

Editorial Associate

Joseph J. Carr, K4IPV

Marc Ellis

Len Feldman

Jeffrey K. Holtzman

Don Jensen

Charles D. Rakes

Marc Saxton

Contributing Editors

PRODUCTION DEPARTMENT

Ruby M. Yee

Production Director

Karen S. Brown

Production Manager

Kathy Campbell

Production Assistant

ART DEPARTMENT

Andre Duzant

Art Director

Injae Lee

Illustrator

Russell C. Truelson

Illustrator

Jacqueline P. Cheeseboro

Circulation Director

Michele Torrillo

P/E Bookstore

BUSINESS AND EDITORIAL OFFICES

Gernsback Publications, Inc.

500-B Bi-County Blvd.

Farmingdale, NY 11735

1-516-293-3000

Fax: 1-516-293-3115

President: **Larry Steckler**

Subscription

Customer Service/Order Entry

1-800-827-0383

7:30 AM - 8:30 PM EST

Advertising Sales offices listed on page 128

Cover by Loewy Design,
Photo illustration by Jeff Berlin

Composition by
Mates Graphics



Since some of the equipment and circuitry described in POPULAR ELECTRONICS may relate to or be covered by U.S. patents, POPULAR ELECTRONICS disclaims any liability for the infringement of such patents by the making, using, or selling of any such equipment or circuitry, and suggests that anyone interested in such projects consult a patent attorney.

FUN AND GAMES

Fortunes are won and lost in Las Vegas all the time, but the stakes are never higher than when the Consumer Electronics Show moves into town each winter. In that respect, the 1994 show wasn't any different, with manufacturers looking for ways to liven up the lackluster sales of the recent past, hoping to find that elusive "must-have" product or device.

Among the clear stars (no pun intended) of the show were digital satellite TV (DSS). Following the successful launch of the Hughes DBS1 satellite this past December, the Thompson/RCA booth was jammed for much of the show. That was not surprising; considering the superior audio and video quality promised, the diversity of programming (as many as 150 channels will be available from two independent suppliers), and user convenience (a tiny 18-inch dish and sophisticated programming guides), DSS could provide cable-TV operators with the stiffest challenge they have ever faced.

Another significant development was the continuing move of multimedia into the mainstream of consumer electronics. Judging from CES, the CD-ROM is rapidly becoming a consumer appliance. Many hardware and software vendors were in attendance, some for the first time. Even chip-maker Intel was present, with its giant "Disney-like" display. What's more, stand-alone multimedia platforms such as the 3DO system and Philips CD-i competed for attention with newcomers from Atari, Commodore, JVC, and others.

There was, of course, much more at the show. For the full story, turn to our Gizmo section, which begins on page 51.

Carl Laron
Editor

ADDRESS CHANGE

Thank you for mentioning Allied Electronics in the article "Where to Find Electronic Parts" (**Popular Electronics**, November 1993). We would like to advise you and your readers of our change of address to: 7410 Pebble, Fort Worth, TX 76118-6997.

Again, we appreciate your comments. Look for our newest release of the "Engineering Manual and Purchasing Guide" in May.

RUTHETTE RAINES
Allied Electronics, Inc.
Fort Worth, TX

MORE ON METRIC CONVERSION

I am writing to endorse the comments of your correspondent from Tulsa regarding the use of the metric system (**Popular Electronics**, *Letters*, January 1994).

Here in England, there has been a gradual change to metric units over the last 20 years or so, and government regulations have repeatedly told various businesses what units must be used for various purposes. Packaged foods are now sold in weights of 500 grams, one kilogram, and so on, with liquids measured by the liter, centiliter, or milliliter. Many packets and bottles do not even show an English equivalent. Postage rates are now based on 10-gram increments, and in the last couple of years all our gasoline pumps have been changed to liters.

About the only officially controlled measurement that has yet to be changed is the use of miles for road distances, although there has been considerable talk about switching to kilometers. We are already seeing warning signs (such as for the end of a lane or a concealed entrance) with distances in meters instead of yards. Even our weather forecasts require the use of a conversion table now, as few announcers seem to give temperatures in anything but centigrade. (I believe that the centigrade scale is not, strictly speaking, part of the metric system, anyway.)

Unfortunately, it appears that

the people in charge of broadcasting, publishing, education, and so on, support the change. I am informed that British schools do not even teach English units any more! A visiting American might be given the impression that we all welcome the change. In fact, I do not know one person who is in favor of the switch to metric, and I can only guess at the expense that has been incurred by businesses to alter packet sizes, change measuring devices, and so on.

The usual "explanation" by official departments is that Britain is being more closely integrated with Europe, and the rest of continental Europe uses metric exclusively. So what? Europeans speak different languages, have different customs, and even use a comma in place of a decimal point when writing numbers. Imagine the ensuing chaos if that crazy idea was introduced! All that aside, the majority of British people have no desire to be integrated with Europe, anyway. I'm sure that the majority of Americans also have no wish to switch to unfamiliar units just because most of the world uses them.

Sure, I'll use metric units when they are appropriate. We all measure radio wavelengths in meters, for example. The fact remains that for normal, everyday measurement American and British people are used to using English units and will continue to do so.

It is a pleasure to visit the United States and see English units in use once again. Don't be pressured into an unwelcome, confusing, and expensive change to satisfy the rest of the world.

P.C.
Sutton-on-Sea, England

HAVES & NEEDS

After getting a couple of great deals on surplus equipment, I

LETTERS

have come back to earth and need to know what to do with it. I would appreciate any information (operation, service, schematics) on either the Philips Type PM3500/Q 16-channel logic analyzer (circa 1980) or the Tektronix Type 611 storage display unit MOD162C (circa 1970). I would be more than happy to cover any reasonable expenses.

Thanks for your help, **Popular Electronics**. Careful with those computer articles: I had to drop my subscription for a while there, but I'm happy we're back together.

MICHAEL C. CORDER
P. O. Box 328754
Columbus, OH 43232

I have a Sencore PS163 oscilloscope that is no longer

made. The trace is to one side of the screen. I need a schematic diagram or information on which potentiometer controls the adjustment for that problem. Thank you in advance for your help with this.

KENNETH YURKOVITCH
23 Roosevelt Ave.
Selden, NY 11784

I've seen other readers get lucky, and now I'm hoping it's my turn. I am looking for an owner's manual as well as a service manual for a Setton Stereophonic Receiver Model RS440. I will gladly pay for copying or postage costs. Thank you.

HUMBERTO MORENO
357 Avenue P, #E3
Brooklyn, NY 11204

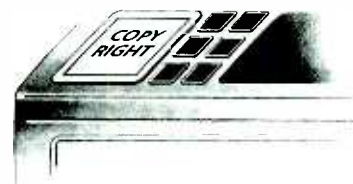

THE MOST
**AN IMPORTANT PART
OF YOUR PHOTOCOPIER
ISN'T PART OF
YOUR PHOTOCOPIER**

Having a machine may not permit you to photocopy books, journals, newsletters and magazines.

The Copyright Clearance Center CAN.

Contact us to find out
how you too can COPY RIGHT!SM

COPYRIGHT CLEARANCE CENTER

222 Rosewood Drive, Danvers, MA 01923 ☐ Tel. (508) 744-3350 ☐ Fax (508) 741-2318

© 1993 Copyright Clearance Center

MULTIMEDIA WATCH

By Marc Spiwak

My PC gets Terminated

The multimedia industry is at full boil right now, and new CD-ROM titles are turning up faster than ever. Today, a multimedia-PC owner can buy a CD-ROM to supplement almost any hobby interest. Buying a CD-ROM is like buying a book—except that it's a huge book with sound, video, and search capabilities thrown in. Many CD-ROM's contain more information than any one owner will

ing for before they buy a computer. A home computer is presently the only key one can use to unlock the vast amounts of information available on CD-ROM.

The PC's ability to display real-time video, and the CD-ROM's ability to hold vast amounts of it—not to mention sound—are surely significant factors in the recent surge in multimedia. Video, or even simple animation, if properly used, can greatly enhance the effect of almost anything. Seeing how an animal walks, how an engine works, or how a certain task is performed can be a lot more informative than a simple photo or diagram.

Today there are many different desktop-video formats. Many require nothing more than a fast computer to view them, and some require special hardware for playback. In comparison, however, very few hardware/software combinations can be used to record video with a PC, especially at an affordable price. Media Vision's *Pro MovieStudio* attempts to fill that void.

THE PRO MOVIESTUDIO

I've been having a lot of fun lately with my *Pro MovieStudio*. An add-in board for PC compatibles, it lets me input, digitize, and compress video signals. The board can handle composite and S-video, in either NTSC, PAL, or SECAM format. Audio is not handled by the board, so a separate sound card is required for making

"talkies" (but anyone playing with a *Pro MovieStudio* most likely has a sound card already). Now, instead of just having my computer (actually Arnold) say "I'll be



If you are an avid videographer or movie buff and own a PC, the Pro MovieStudio is definitely worth taking a look at. It's probably right up your alley.

back," I can have the video clip of Arnold pop up on my screen as well.

The *Pro MovieStudio* includes the board, DOS and Windows software to drive it, a manual, Microsoft's Video for Windows with a complete instruction manual, and Macromedia's Authorware Star with its complete manual. A CD-ROM full of sample video clips is also included, although you don't need the *Pro MovieStudio* to play the clips—only to record new ones.

Video for Windows is the software that lets me capture, edit, and play back my mini movies. VidCap, which is part of the VFW package, can capture single frames, multiple frames, and video sequences, and store them on a hard drive. Video clips are saved to disk in the Audio/Video Interleaved (AVI) file format, which yields

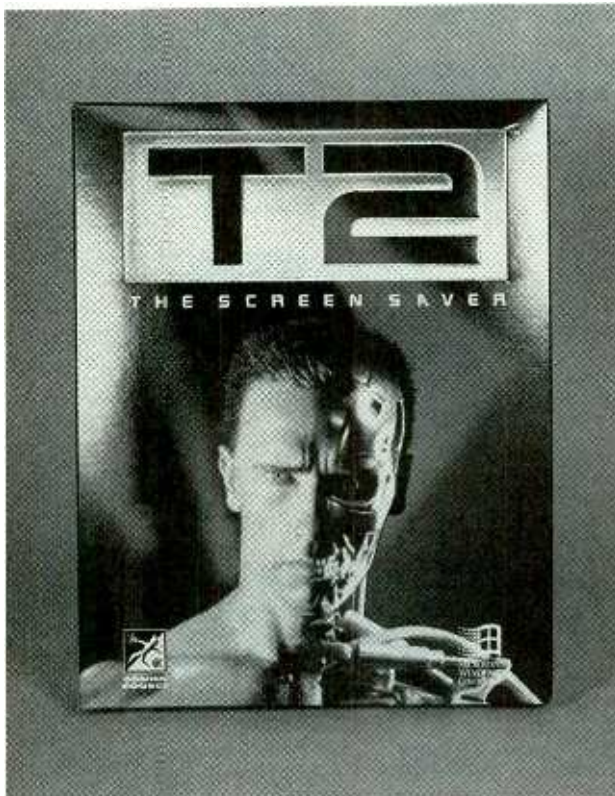

The Terminator is now here to protect monitors from screen burn-in. If you need his services, contact Sound Source Unlimited, Inc.

ever see, but at least the discs don't waste much space. CD-ROM's could actually turn out to be just the thing that everybody's wait-

fully editable video clips in which the audio and video remain synchronized. VFW also includes VidEdit (which allows simple cut-and-paste editing of AVI files) and Media Player (which is used to play back AVI files). A DOS-based utility is also included that allows capture and playback of AVI files in DOS, although the Windows software is a lot easier to use and is far more powerful. One Macintosh disk is also included. That software lets you convert AVI files to QuickTime, the Macintosh video standard, which has also been ported over to the PC. (It does get confusing, doesn't it?) Authorware Star is an object-oriented software-authoring tool, which has now been upgraded to handle digital movies including VFW material.

REQUIREMENTS

The Pro MovieStudio must be installed in an empty 16-bit expansion slot in a 386SX or higher that has at least 2 MEG of RAM (4 recommended) and a color VGA monitor. The card requires one IRQ, one I/O-port address, and a memory range. Software sets those for you automatically. DOS 5.0 or higher and Windows 3.1 are also required.

At least 8 MEG of hard-disk space is required just for all the bundled software, and you'll need a lot more than that for AVI-file storage. AVI files gobble up meg's and meg's of hard-disk space. Some time after experimenting with the Pro MovieStudio, I was cleaning out my hard drive and found about 50 megabytes of "cutting-room-floor stuff"—bits and pieces of video that I meant to discard but forgot about. That 50 meg didn't include the clips I wanted to keep! Even if you don't intend to save

video clips, a lot of free disk space is required just to work with AVI files.

Ideally, AVI files can be recorded at 30 frames per second maximum, with 16-bit audio sampled at 44.1 kHz—but that's only on an ideal (fast) PC. The slower the system, the less frames per second it will be able to record. My DX2/50 had no trouble with 30 frames per second, at least in small windows. Video images can be captured in sizes ranging from 80 × 60 to 640 × 480, but 30 frames per second can only be had in smaller windows. A 240 × 180 image is a nice compromise between size and speed, but note that that is true only on a fast machine.

As hardware installations go, installing the Pro MovieStudio was a breeze. The card pops in an empty slot and, as the software handles its configuration, the card has no jumpers to set. In fact, the software does a pretty good job of configuring the card. The only problem I had was that the installation excludes a section of upper memory for Pro Movie-use only, and

SOURCES

DeLorme Mapping
Lower Main Street, PO Box 298
Freeport, ME 04032
207-865-1234

Dr. T's Music Software
124 Crescent Road
Needham, MA 02194
617-455-1454

LucasArts
PO Box 10307
San Rafael, CA 94912
415-721-3300

Media Vision
3185 Laurelview Court
Fremont, CA 94538
510-770-8600

Sound Source Unlimited
2985 E. Hillcrest Dr. #A
Westlake Village, CA 91362
805-494-9996

SURVEILLANCE & SECURITY

FM TRANSMITTERS MINIATURE (KITS)

- 3-VOLT FM XMTR, up to 300 ft. indoors, 1500 ft. outdoors
- PHONE XMTR, range to 500 ft., uses phone-line power
- Sound-Activated XMTR, range to 500 ft.
- 2-STAGE XMTR, 9-Volt, very powerful

All above require simple soldering at 2 to 4 places. Broadcast on std FM band. Assemble in less than 5 minutes. Any of the above **\$29.95****

TELE CALL FORWARDER. Transfers incoming calls to any number you select. **\$99.00***

CALLER ID. Registers incoming number and stores to 50 numbers. **\$99.00***

TEL REGISTER WITH PRINTER. Records dialed number, duration, and prints record. 16-digit display with security lock control. Stores up to 40 calls. **\$129.00***

TEL REGISTER W/O PRINTER. Records dialed number and time. 16-digit display. Holds up to 145 numbers in memory. **\$99.00***

12-HOUR LONG-PLAY RECORDER. Modified Panasonic. Records 6 hrs. on each side of 120 tape (supplied). Compatible with VOX and Tel Rec Adapter. **\$119.00***

VOX VOICE-ACTIVATED SWITCH. Makes recorder self-activating with voices or other sounds. Great for radios and scanners. Provisions for external mike and/or patch cord. **\$28.50****

TELEPHONE RECORDING ADAPTER. Records incoming and outgoing calls. Use of handset controls recorder and records both sides of conversation. **\$28.50***

TELEPHONE SCRAMBLERS. Over 51,000 separate codes; impossible to break code. Assures utmost privacy. **\$295.00***

VOICE CHANGER. Changes man's voice to lady's and vice versa. 4 separate settings. Ideal for disguising voice. **\$29.95***

RF BUG DETECTORS, AND MUCH MORE

For Shipping and Handling add *\$5.00 and **\$2.00 per item. Colo. residents add sales tax. Mail Order. VISA, M/C, COD's o.k. Inquire for dealer prices. Free catalog.

TOLL FREE 1-800-926-2488

A.M.C. SALES, INC.

193 Vaquero Drive
Boulder, CO 80303
Tel: (303) 499-5405
Fax: (303) 494-4924

Mon-Fri 8 a.m. - 5 p.m. Mtn. Time

CIRCLE 151 ON FREE INFORMATION CARD

that RAM was being used for something else loaded high on my machine. As a result, the other piece of software loaded low, leaving too little conventional memory to run some of my other applications. Such is life—rather, such is a PC! Anyway, with a little bit of upper-memory management, things were back to normal, and the MovieStudio worked right away.

The Pro MovieStudio has a list price of \$449, but I've seen it for sale mail order for just over \$300. Is it worth it? I think so. If you've got a fast multimedia PC, and you're looking for more ways to have fun with it, then the Pro MovieStudio's price is justified, especially if it helps launch a career in film-making.

Fun and games aside, the Pro MovieStudio is an

inexpensive way for anyone with a video camera to get any image into their computer. I've got the Pro MovieStudio hooked up to my VCR, so I can capture bits of any TV program or any video tape. Granted the final image quality is limited by the resolution of the original video format. Even S-video is grainy when compared to a color photo that's been scanned at 1200 dpi, but S-video, or even NTSC quality is sufficient for many non-professional applications, such as making your own catalogs and newsletters, where picture sharpness is not all that important.

NEW STUFF

DeLorme Mapping has recently introduced Version 2.0 of the fantastic *Street Atlas USA* CD-ROM, which includes every street in the

United States. The program is fantastic in that it lets you zoom into any city or town and find any street. The new release includes tens of thousands of new streets built since the first disc was published. In the process, the Street Atlas database has been increased from 480 MB to 640 MB, yet it still fits on one disc. While the program has always run in Windows, only now have built-in printing capabilities been added. Before you'd have to cut maps to the clipboard and process them with some other software. Now you can print clear, sharp maps right from Street Atlas. Priced at \$169 for new customers, and \$49 for upgrade customers, this disc is a winner.

LucasArts' first CD-only title, *Rebel Assault*, is here. The disc is packed with great action, 3D graphics, voice-overs, and a score performed by the London Symphony Orchestra. The CD-ROM is good not only for graphics, but for hard drives as well. The entire game can be played from the CD-ROM, which is a far cry from older games like *X-Wing* that needed 10 meg's of your hard drive. The player assumes the role of Rookie One, a Rebel fighter pilot. Fifteen different levels of game play take Rookie One all the way from training in Beggar's Canyon to the trench run on the Death Star. For \$79.95, this is as close to a galaxy far, far, away as you can get!

Children's CD-ROM titles are becoming more and more popular. Dr. T's Music Software sent me a copy of *Dr. T's Sing-A-Long*. It combines music, animations, and lyrics to make singing a fun and educational experience. The disc contains 26 classic children's songs, including "Twinkle Twinkle Little Star" and "I've Been

Working on the Railroad." In truth, I'm almost looking forward to the next time my 3-year-old nephews visit, just to see how much they like this new disc. It is available for \$39.95.

Another children's title, *Who Wants Arthur?*, is available from Media Vision. This is essentially a children's book with story, pictures, text, and music. Arthur is an ordinary brown dog. A child can take in the story in many forms ranging from having it read to them without seeing the words, to reading the story independently while being able to click on any unknown words. It is a good educational and entertainment value for \$39.95.

While not on CD-ROM, Sound Source Unlimited sent me a sampling of their multimedia software. Most of their stuff consists of movie audio/video clips that are great for use in personal multimedia productions or for attaching unusual sound clips to your desktop functions. I've now got sound and video clips from *Star Trek*, *Star Wars*, *T2*, and the *Wizard of Oz*, and there are many other titles available. I also took a look at their *T2 Screen Saver*. This program just adds modules to your built-in Windows screen saver, so it's easy to use. Now, in addition to keeping my PC from being mediocre, the Terminator protects my monitor from screen burn-in. ■



Be an FCC LICENSED ELECTRONIC TECHNICIAN!

Earn up to \$2000/Week and more!

Learn at home in spare time. No previous experience needed!

No costly school. No commuting to class. The Original Home-Study course prepares you for the "FCC Commercial Radiotelephone License." This valuable license is your professional "ticket" to thousands of exciting jobs in Communications, Radio-TV, Microwave, Maritime, Radar, Avionics and more... even start your own business! You don't need a college degree to qualify, but you do need an FCC License.

No Need to Quit Your Job or Go To School
This proven course is easy, fast and low cost! **GUARANTEED PASS**—You get your FCC License or money refunded. **Send for FREE facts now. MAIL COUPON TODAY!**

COMMAND PRODUCTIONS

FCC LICENSE TRAINING, Dept. 100
P.O. Box 2824, San Francisco, CA 94126
Please rush FREE details immediately!

NAME _____
ADDRESS _____
CITY _____ STATE _____ ZIP _____



"... it reduces operator error by 68 percent."

Take this GIANT CIRCUIT LIBRARY for only \$9.95

when you join the *Electronics Engineers' Book Club*®

THE ENCYCLOPEDIA OF ELECTRONIC CIRCUITS — Vols. 1, 2 & 3 by Rudolf F. Graf

Hundreds of circuit ideas alphabetically arranged — from Alarm circuits to Zero crossing detector circuits!

"... includes schematics for the latest electronics circuits from industry leaders..."

—*Popular Electronics*

Turn to this comprehensive circuit library for hundreds of project ideas . . . valuable troubleshooting and repair tips . . . and concise pinout diagrams and schematics. In each volume you'll find more than 700 electronic and integrated circuits and 100+ circuit categories right at your fingertips to give you ideas you can use on the job or at your workbench.

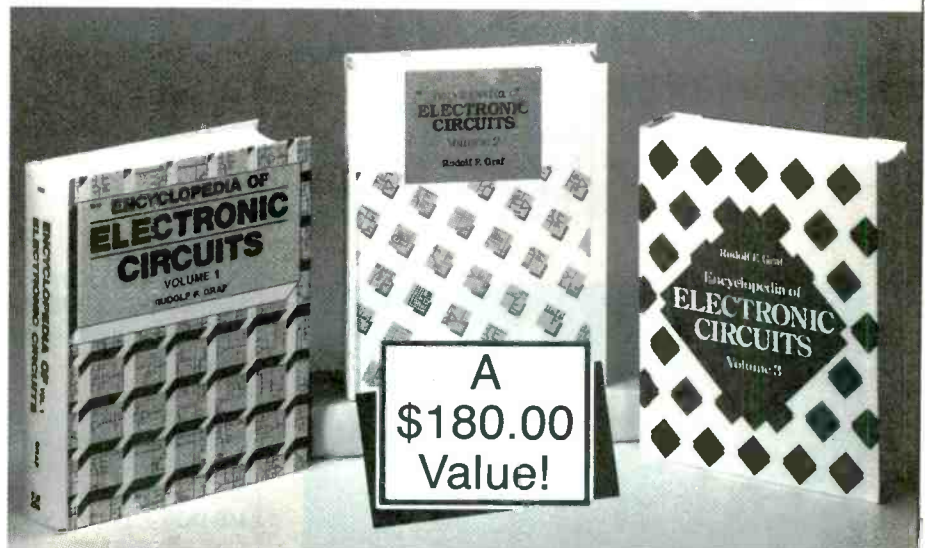

2,344 total pages 3,490 total illustrations

Book No. 5489C Hardcover

If coupon is missing, write to: Electronics Engineers' Book Club, Blue Ridge Summit, PA 17294-0860

As a member of the Electronics Engineers' Book Club . . .

. . . you'll enjoy receiving Club bulletins every 3-4 weeks containing exciting offers on the latest books in the field at savings of up to 50% off of regular publishers' prices. If you want the Main Selection do nothing and it will be shipped automatically. If you want another book, or no book at all, simply return the reply form to us by the date specified. You'll have at least 10 days to decide. And you'll be eligible for *FREE BOOKS* through the Bonus Book Plan. Your only obligation is to purchase 3 more books during the next 2 years, after which you may cancel your membership at any time.

Publisher's price shown. ©1994 EEBC

ELECTRONICS ENGINEERS' BOOK CLUB

Blue Ridge Summit, PA 17294-0860

YES! Please send me *The Encyclopedia of Electronic Circuits— Vols. 1, 2 & 3 (5489C)*, billing me \$9.95 plus shipping/handling & tax. Enroll me as a member of the **Electronics Engineers' Book Club** according to the terms outlined in this ad. If not satisfied, I may return the book within 10 days and have my membership cancelled.

Name _____
 Address _____
 City _____
 State _____
 Zip _____ Phone _____

Valid for new members only, subject to acceptance by EEBC. Canada *must* remit in U.S. funds drawn on U.S. banks. Applicants outside the U.S. and Canada will receive special ordering instructions. A shipping/handling charge & sales tax will be added to all orders.

PIIF594

ELECTRONICS LIBRARY

Kirlian Photography: A Hands-On Guide

by John Iovine

Almost 150 years after its discovery, electrophotography, commonly known as Kirlian photography, remains a subject of speculation and controversy. Some people believe that Kirlian photographs can reveal illnesses in plants and animals before any outward symptoms are evident. Even if those claims were to be proved false, Kirlian photographs would be valued for their colorful aesthetic appeal.

You can make your own Kirlian photographs using just basic photographic or video equipment and the instructions provided in this book. It contains

applications in medicine, industry, and the military. The book offers plans and instructions for building your own Kirlian device for less than \$25, and explores the "phantom leaf" aura that continues to baffle scientists. Full-color Kirlian photographs are included.

Kirlian Photography: A Hands-On Guide costs \$16.95 and is published by Tab Books Inc., Blue Ridge Summit, PA 17294-0850; Tel: 1-800-233-1128.

CIRCLE 98 ON FREE INFORMATION CARD

A CONCISE INTRODUCTION TO MICROSOFT WORKS

by N. Kantaris and P.R.M. Oliver

Written with the busy, non-expert person in mind, this book aims to help the beginner come to grips with Microsoft Works for MS-DOS in the shortest and most effective way. Fully updated to cover the improvements included in version 3.0, the book has an underlying structure that allows the reader to build upon the information presented in each chapter. Experienced Works users need not read the book cover-to-cover, but can start from any of the self-contained sections.

The book explains how to use the word processor to type, edit, print, and save documents. It describes how Works can be used to build up simple spreadsheet examples and then to edit, save, print, and retrieve them. It shows readers how to generate, edit, and print both single and multiple graphs. The book covers setting up, sorting, and searching through a database-management system, and how to use it to create top-

quality printed reports. To simplify long, repetitive tasks, the book explains how to create simple macros and how to customize the program to meet your own needs.

A Concise Introduction to Microsoft Works (order number

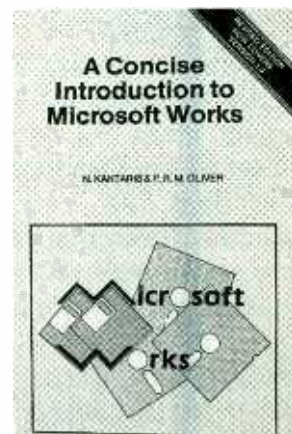

BP294) is available for \$6.95 plus \$2.50 shipping and handling from Electronics Technology Today Inc., P.O. Box 240, Massapequa Park, NY 11762-0240.

CIRCLE 97 ON FREE INFORMATION CARD

OSCILLATOR PROBE CATALOG NO. 90

from Test Probes, Inc.

This 16-page catalog describes TPI's full line of high-performance oscilloscope probes. Highlights include a new differential probe for safe measurement of floating circuits to 700 volts and active FET probes. The catalog also features silicone-rubber multimeter leads designed to meet new industry safety standards, high-voltage probes, coax adapters, and adapter kits for in-series and between-series connection

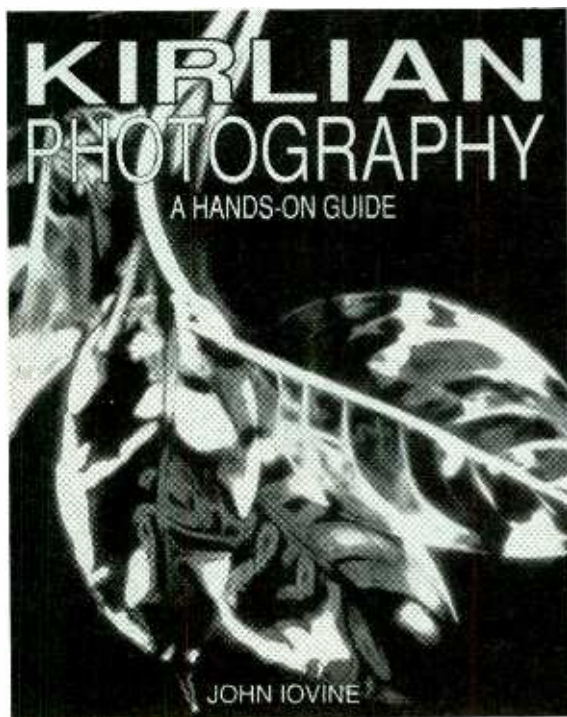

step-by-step instructions on how to shoot all types of subjects, including human. Background material includes a history of electrophotography and a look at its possible ap-

Be a computer programmer!

Only NRI gives you hands-on training with the latest programming tools:

- A 486sx computer with Super VGA color monitor, 200 meg hard drive
- Windows
- Visual Basic
- Power C
- QBasic
- DOS
- And much more!

NEW!
Super VGA
Color Monitor,
200 Meg
Hard Drive!

Only NRI at-home training gives you real-world programming skills in three in-demand languages: QBasic, C, and Visual Basic, today's hot new language designed for writing popular Windows applications. Best of all, you get hands-on training with a powerful Intel-based 486sx computer system, complete with Super VGA color monitor, 200 meg hard drive, Windows, and professional programming software you keep!



NRI, the leader in at-home computer training, shows you how to take advantage of today's newest programming opportunities

Get in on the ground floor of computer programming one of today's fastest-growing career fields. The Bureau of Labor Statistics forecasts that job opportunities for programmers will increase much faster than average over the next 10 years, with as many as 400,000 new jobs opening up by 2005.

And the fastest-growing segment of programming jobs will be PC programming, fueled by the phenomenal popularity of Windows, the efficient power of C, and the ascent of exciting new languages like QBasic and Visual Basic.

Now, with NRI at-home training, you can get the new skills you need to build a top-paying career — even a full- or part-time business of your own — in this high-growth, high-opportunity field.

Get hands-on experience with today's programming tools: a powerful 486sx computer, Super VGA color monitor, 200 meg hard drive, Windows, Visual Basic, and more — all yours to keep!

Right from the start, NRI's unique Discovery Learning Method gets you actively involved in the challenge of real-world programming. Step by step, you learn to create the kinds of full-featured, powerful programs today's employers

and clients demand...including programs designed for use in a Windows environment!

Only NRI gives you first-hand programming experience with a state-of-the-art Intel-based 486sx computer system, complete with Super VGA color monitor, 200 meg hard disk drive, a full megabyte of RAM, 1.44 meg 3.5" floppy drive, mouse, and more — all yours to train with and keep!

Plus you explore the extraordinary capabilities of three in-demand programming languages. You learn to design, code, run, debug, and document programs in QBasic, C, and Visual Basic. Best of all, since Visual Basic is specifically designed for creating Windows applications, you learn to generate fully functioning Windows programs, complete with text boxes, command buttons, and other sophisticated graphical interface elements.

No previous experience necessary

Train with NRI, and immediately start getting the money-making job skills you need to be a computer programmer — no matter what your previous background.

NRI's step-by-step lessons and hands-on programming projects help you first master the design concepts used every day by successful PC programmers. Then, with the support of your experienced NRI instructor, you quickly move on to learn programming in three of today's hottest languages.

By the time you complete your course, you have a clear understanding of programming methods, languages, and techniques... and you're ready to handle any programming task with confidence.

Send today for your FREE catalog

See how NRI at-home training gives you the programming know-how, the computer, and the software you need to get started in this top-paying field. Send today for your FREE catalog!

If the coupon is missing, write to us at the NRI School of Computer Programming, McGraw-Hill Continuing Education Center, 4401 Connecticut Avenue, NW, Washington, DC 20008.

IBM PC/AT is a registered trademark of the IBM Corporation. Windows, QBasic, and Visual Basic are trademarks of Microsoft Corporation. Intel Inside logo is a registered trademark of Intel, Inc.

FREE CATALOG! CALL 1-800-321-4634

NRI Schools

McGraw-Hill Continuing Educator Center
4401 Connecticut Avenue, NW, Washington, DC 20008

- Check one FREE catalog on ly
- COMPUTER PROGRAMMING
- PC Applications Specialist
- Programming in C++ with Windows
- Other Computer Career Courses
- Microcomputer Servicing
- Desktop Publishing
- Bookkeeping and Accounting
- Multimedia Specialist

For career courses approved under GI Bill, check for details

Name _____ (please print) Age _____

Address _____

City/State/Zip _____ Accredited Member, National Home Study Council 5413-0594

BBC Computer Microsoft Windows

Microsoft Visual Basic

Microsoft WINDOWS



of BNC, TNC, SMA, and five other connector types. A cross-reference chart lists economical replacement probes for all makes of oscilloscopes.

TPI Catalog No. 90 is free upon request from Test Probes, Inc., 9178 Brown Deer Road, San Diego, CA 92121; Tel: 800-368-5179; Fax: 619-535-1260.

CIRCLE 90 ON FREE INFORMATION CARD

POWER UP! How to Make Battery Adapters for Portable & Military Radios, and other Military & Non-Military Electronics

by Dave Strom

Readily available on the surplus market, military radios are rugged, versatile, well-designed, and easy to operate. It's no wonder that the surplus sets are used by amateurs, National Guard units, experimenters,

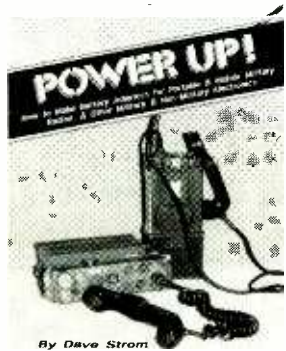

federal agencies, and survival groups. The only problem with them is that almost every type of portable and mobile military set requires a different, usually

hard-to-find, battery, designed particularly for that piece of equipment.

This book solves the problem of powering surplus military radios and electronic equipment. It shows how to easily make battery adapters for the many popular units, allowing the use of standard commercially-available batteries. The fully illustrated book contains detailed instructions and clear wiring diagrams that show exactly how to make adapters that can be used to power a wide variety of popular portable and mobile military radios. In addition, the book covers battery adapters for strobes, night scopes, radiac sets, detection/intrusion sets, and field telephones.

Power Up! is available for \$13.95 plus \$4 shipping and handling (\$5 to Canada) from CRB Research Books, Inc., P.O. Box 56, Commack, NY 11725; Tel: 800-656-0056 in continental U.S., or 516-543-9169. (New York residents please add \$1.53 state sales tax.)

CIRCLE 91 ON FREE INFORMATION CARD

BUILD YOUR OWN HOME THEATER

by Robert Wolenik

Home theater has changed the way we watch TV. Viewers are turning to large-screen sets, accompanied by surround-sound audio systems. If you've been thinking of updating your existing audio/video system or building a complete home theater from the ground up, this book can help you do it without spending a fortune.

The book describes exactly what components go into various home-theater systems—from the simple TV-stereo hook-up to a system complete with Dolby Pro Logic surround sound and even a satellite dish—and then helps you decide what to include in your home theater. It clearly explains the differences between direct-view, rear-projection, and front-projection televisions; Dolby Surround, Dolby Pro Logic, and THX; and other audio and video options.

The book also shows how to

Build Your Own HOME THEATER



fit all the electronics equipment into your home. Beginning with selecting an appropriate room, the book explains how to acoustically insulate it for the best possible performance, how to arrange speakers for true surround sound, how to shop for an entertainment center, how to choose colors and lighting that complement the system, and how to arrange furniture to maximize viewing pleasure. Numerous illustrations as well as photographs of real-life home theaters illustrate the concepts presented in the text.

Build Your Own Home Theater costs \$16.95 and is published by Sams Publishing, 201 West 103rd Street, Indianapolis, IN 46290; Tel: 317-581-3500; Fax: 317-581-3500.

CIRCLE 95 ON FREE INFORMATION CARD

ELECTRONIC HOBBY AND AMATEUR RADIO KITS CATALOG

from Ramsey Electronics

This 20-page catalog contains an assortment of exciting, educational kits for the electronics hobbyist or student. The products range from fast and easy "Mini-Kits"—including a univer-



sal timer, a voice-activated switch, and a light-beam communicator—to VHF/UHF/FM transceiver kits. Other projects include QRP transmitters, active antennas, shortwave gear, a microwave motion detector, a radio direction finder, a TV transmitter, and an FM broadcast-band receiver. The catalog also offers test equipment, antennas, and radio accessories.

The Electronic Hobby and Amateur Radio Kits Catalog is free upon request from Ramsey Electronics, Inc., 793 Canning Parkway, Victor, NY 14564; Tel: 800-446-2295; Fax: 716-924-4555.

CIRCLE 92 ON FREE INFORMATION CARD

SOUTHPAW ELECTRONICS CATALOG 931

from Southpaw Electronics

Electronics hobbyists and technicians alike will find a wide variety of components and parts in this 22-page catalog. Included are LED's, switches, piezo products, capacitors, transistors, replacement semi-



conductors, resistors, rectifiers, diodes, transformers, and more. Special buys are offered on several products, including quartz crystals, oscillators, shorting jumpers, and a jumper-cable assembly. The company offers a "frequent buyer bonus plan" that awards buyers with a bonus point (worth five cents on future purchases) for each dollar of merchandise ordered. Certain products—including grab-bag specials of assorted parts—earn double or triple bonus points.

Catalog 931 is free upon re-

quest from Southpaw Electronics, P. O. Box 886, New Hyde Park, NY 11040-0311; Tel: 800-851-8870; Fax: 516-775-5091.

CIRCLE 93 ON FREE INFORMATION CARD

CONTEMPORARY LOGIC DESIGN

by Randy H. Katz

This textbook offers an innovative approach to logic design that combines a superior introduction to design fundamentals with an in-depth look at today's state-of-the-art design technologies. Recognizing the hardware-design revolution brought about by CAD, rapid prototyping, and PLD's, the book demonstrates how each tool fits

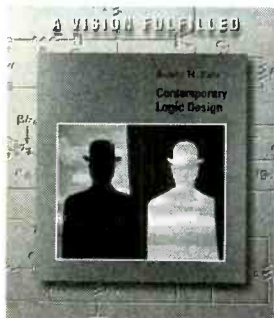

in the design process. Numerous case studies, along with special "Practical Matters" sections, underscore the book's emphasis on the development of practical design knowledge. In addition, an extensive supplements package is available separately. The package includes almost 600 electronic transparencies, a complete instructor's guide, and hardware and software labs.

Contemporary Logic Design costs \$67.75 and is published by The Benjamin/Cummings Publishing Company, Inc., 390 Bridge Parkway, Redwood City, CA 94065; Tel: 800-950-BOOK.

CIRCLE 89 ON FREE INFORMATION CARD

PRACTICAL ELECTRONIC TIMING

by Owen Bishop

This book explores the ways in which electronics is applied to the measurement of time. The

Practical Electronic Timing

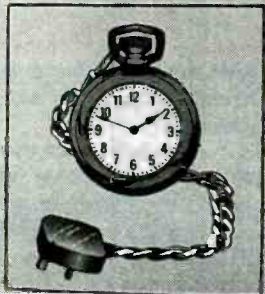

theory that it presents is backed by an array of practical construction projects for the beginning, as well as the advanced, builder. The projects cover many fields of interest, including basic time-keeping, laboratory-data gathering, high-precision timing, sports and games, music, and many other applications in and around the home. Each project includes a detailed circuit diagram and full explanations of how it works, how to build it, and how to troubleshoot it. All of the circuits are battery-powered, making

them safe to build and to use. Several are simple, low-cost projects aimed at the beginner and younger enthusiast. Because the projects make use of all of the more commonly available timing IC's, the book also acts as a reference to practical timing techniques.

Practical Electronic Timing (order number BP317) is available for \$6.95 plus \$2.50 shipping and handling from Electronics Technology Today Inc., P.O. Box 240, Massapequa Park, NY 11762-0240.

CIRCLE 97 ON FREE INFORMATION CARD

TACTICAL ELECTRONICS

Products for Home & Property Protection



MoonLight Viewer

See in the dark using moonlight or bright starlight. Use our CWL10 laser illuminator for seeing in total darkness. SD90 Ready to Use, with camera adapter \$395.00
CWL10 IR Laser Illuminator \$99.50

3 Mile FM

Wireless Microphone

Subminiature! Crystal clear, ultra-sensitive. Transmits voices & sounds to FM radio. Excellent for security, monitoring of children, etc. Be the local DJ, or go "under cover" with our FM radio sunglasses.

FMV1 Plans \$7.00 FMV1K Kit/Plans... \$39.50
SUGL10 Sunglasses with built in FM radio \$29.50

Telephone Transmitter - 3 Miles

Automatically transmits 2 sides of a phone conversation to an FM radio. • Tunable • Undetectable on phone • Easy to build • Up to 3 mi range • Only transmits during phone use.

VWPM7 Plans...\$7.00 VWPM7K Kit/Plans...\$39.50

Extended (X4) Play

Telephone Recording System

Complete with X-4 extended play recorder. Automatically records both sides of phone conversation.

TAP20X Ready to Use System \$129.50

Tel. Line

Grabber/

Room Monitor

New - The Ultimate in Security & Safety! Call your home or office phone, push a secret tone key to access either: A. On-premise sounds and voices; or B. existing telephone conversation with break-in capability. Check local laws.

TELEGRAB Plans \$10.00
TELEGRAB1K Kit/Plans.....\$99.50

INFORMATION UNLIMITED

Add \$5 P&H • MC, Visa Welcome
Dept PE-15 • Box 716
Amherst, NH 03031-0716
Tel 603-673-4730 Fax 603-672-5406

Orders-Only
Phone
800-221-1705

CATALOG!
Many More Products!
FREE with order, or Send \$1 P&H

BLITZER STUN GUNS

MADE IN U.S.A.

HARD HITTING • COMPACT UNITS

These compact devices easily fit into a small purse or pocket. Hard hitting with safety switch for prevention of accidental discharges. Crackling and sizzling plasma discourages most attackers without physical contact.

DEFENDER #STUN1, 80,000 V, curved grip \$49.50
INTIMIDATOR #STUN2, 100,000 V \$59.50
BLITZER #STUN3, 120,000 V \$69.50
DEVASTATOR #STUN4, 150,000 V \$89.50

Laser Terminator



- Size - 2-7/8" X 7/8"
- Range - 300 yards (night)
- Battery - 20 hours continuous
- Windage & Elevation adjustments
- Warranty - 1 year

Mounts on all popular handguns and rifles
LATR1 - Ready to Use \$174.50

DANGER
Laser Radiation
Avoid Direct Exposure
To Beam
Clean Up Laser Product

Invisible Pain Field Generator

Pocket size device produces shock waves of intense acoustic energy. Wards off aggressive animals, etc.

IPG7 Plans \$8.00
IPG7K Kit/Plans \$49.50 IPG70 Assembled...\$74.50

"Laser Bounce" Listener System

Hear sounds from a distant area using a laser beam reflected from a window or other similar objects. Available as a kit or fully assembled with laser gun site.

LLIST2 Plans.....\$20.00
LLIST1K Kit of Both Transmitter and Receiver.....\$199.50
LLIST20 Assembled w/ Laser Gun Site.....\$299.50

NEW PRODUCTS

Electronics Workbench Version 3

Used by electronics professionals and hobbyists to design and verify circuits before breadboarding, *Interactive Image Technologies' Electronics Workbench* is a software tool that simulates analog and digital circuits, as well as test equipment, such as an oscilloscope and a Bode plotter for spectrum analysis. When a circuit is switched on, the waveforms that appear on the simulated instruments are the same as those that would be found on a real test bench.

Version 3 expands the selection of analog and digital parts by adding new components, including JFET's and MOSFET's plus controlled sources and switches. Real-world models

of RAM, and is available for MS-DOS and Windows PC's and Macintosh platforms.

Electronics Workbench costs \$299, including an analog and digital module. Existing customers can upgrade to the new MS-DOS version for \$79 or the Windows version for \$99. For further information, contact Interactive Image Technologies Ltd., 700 King Street W, Suite 815, Ontario, Canada M5V 2Y6; Tel: 416-361-0333 or 800-263-5552; Fax: 416-368-5799.

CIRCLE 101 ON FREE INFORMATION CARD

TEMPERATURE SENSOR SIMULATORS

To ensure their compatibility with a variety of instruments and control systems, *Models 473 and 475* temperature-sensing simulators from *Wavetek* can be adjusted in one-inch and 0.1-inch increments over a wide temperature range. The battery-operated, digital-display simulators offer the ability to measure a 4–20-mA signal while simultaneously outputting the temperature simulation. That makes the instruments well-suited for calibration of temperature transmitters and signal conditioners with a single instrument. Their compact size and long battery life come in handy for calibration of installed instruments and on-site servicing.

The *Models 473 and 475* are multifunction instruments, capable of simulating four sensor types for calibration outputs and measuring them as a digital thermometer/indicator. Model 473 is designed for thermocouple calibration applications. It will directly emulate type K, J, and T thermocouples and will source up to 100 mVDC to simulate other T/C's. Model 475 is designed for RTD installations and will directly simulate platinum 100-ohm RTD's (both 0.00385 and 0.00392 types), and 10-ohm copper RTD's. It will

also source up to 1000 ohms to use as a calibration device for other types of RTD's and even potentiometer settings.

The *Models 473 and 475*



temperature-sensor simulators cost \$795 and \$895, respectively. For more information, contact Wavetek Corporation, 9145 Balboa Avenue, San Diego, CA 92123; Tel: 619-279-2200.

CIRCLE 102 ON FREE INFORMATION CARD

THRU-HOLE/SMT SOLDERING SYSTEM

Designed specifically for production soldering of thru-hole and surface-mount components, the *ST 20* incorporates *Pace's SensaTemp* technology, providing the high-capacity/low-temperature heating needed to safely handle all production applications. The device allows the user to set accurate tip temperatures from 200–900°F. If desired, a specific temperature can be locked in to prevent accidental or unauthorized tampering. An auto-off safety system automatically turns the unit off after 90 minutes of inactivity, increasing tip/heater life and saving energy. *Pace's*

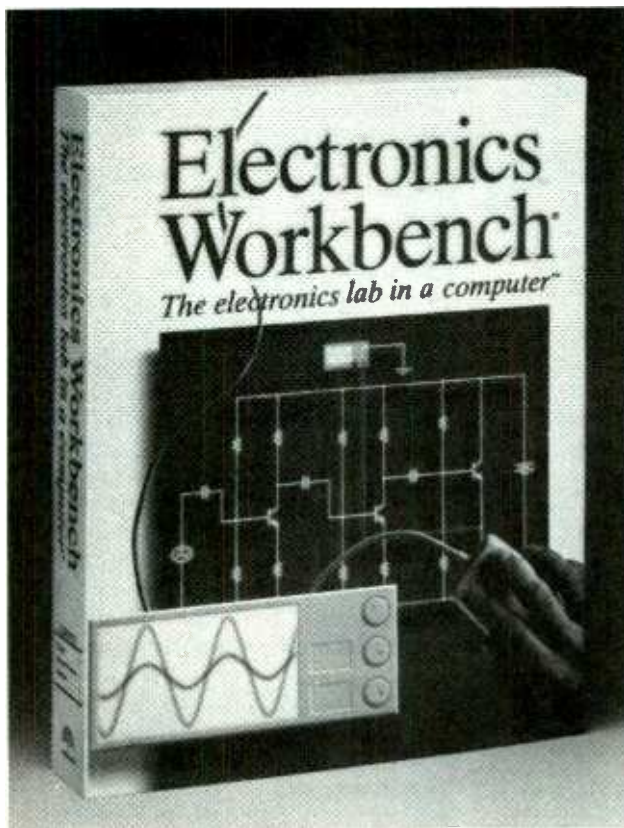

that make all active components selectable by part number, as they are found in data books, have also been added. Version 3 can also support up to 16 MB

Introducing a New Era In Technical Training.

World College, an affiliate of the Cleveland Institute of Electronics, was created to provide a four year, independent study, technical degree program to individuals seeking a higher education. The Bachelor of Electronics Engineering Technology Degree, offered by World College, prepares students for high-paying careers in electronics, telecommunications, electrical power, computer and control systems. World College's curriculum is taught in an effective, time-proven, independent study environment. With World College's flexible study schedule, students have the opportunity to work or spend time with their family without having to worry about rigid scheduling residential colleges offer.

A Quality Education with a Flexible Schedule.

In a world heavily dependent on electronic equipment, people who understand electronics will have no problem putting their knowledge to work... in high-paying careers. The staff and faculty of World College have invested over ten years developing, what we believe to be, the finest independent-study, baccalaureate degree program available. World College's mission is to instill in each student the knowledge, education, and training that employers are seeking for the many technical positions available today. It's a program created to provide the best education and training possible with a flexible schedule to match your busy lifestyle.



World College is currently seeking approval to confer the Bachelor Degree from the Virginia Council of Higher Education.

Earn A Bachelor of Electronic Engineering Technology Degree from



**WORLD
COLLEGE**
Bringing Technology Home!

Lake Shores Plaza
5193 Shore Drive, Suite 113
Virginia Beach, VA 23455-2500

Send For Your Free Course Catalog.

Take the first step towards a new start in life. Send for World College's Free Independent Course Catalog today and discover how easy and affordable it is to get started on your Bachelor Degree.

World College is affiliated with



Complete the Entire Degree Program Under One Roof. Yours!

Only World College offers an independent study, four year technical degree which can be completed through one school. All lab equipment*, parts, and software are included in your tuition and the program's 300-plus laboratory experiments can be completed in your own home.

You Pay Only For Time Actually Used.

World College not only provides a means to earn a Bachelor Degree while fulfilling current obligations, but there are no restrictions on how fast you can complete the program. At World College, you pay tuition only for the actual upper-level semesters it takes to graduate. The quicker you complete the program, the less you pay in tuition. It's an effective way to keep you motivated in order to complete the course and move on to a better paying position as quickly as possible.

Currently not available in Ohio.
* Student must have access to a personal computer system.

YES! Please send me World College's Free Course Catalog detailing the full curriculum.

Name: _____

Address: _____

Apt: _____

City: _____

State: _____ Zip: _____

Phone: (_____) _____

Age: _____

Return to: **WAH08**
World College
Lake Shores Plaza
5193 Shore Drive, Suite 113
Virginia Beach, VA 23455-2500

Soldr-Pen, which provides advanced low-temperature/high-capacity heating in a micro-soldering hand piece, is included. More than 60 surface-mount and thru-hole tips are available to address a wide assortment of soldering problems. The ST 20 can be instantly expanded from production soldering to handle many specialized surface-mount and thru-hole repair tasks by adding other SensaTemp hand pieces.

The ST 20 soldering system costs \$189. For additional information, contact Pace Inc., 9893 Brewers Court, Laurel, MD 20723; Tel: 301-490-9860; Fax: 301-498-3252.

CIRCLE 103 ON FREE INFORMATION CARD

RUGGED CLAMP METER

Designed to meet the rigorous demands of on-site jobs, the *Fluke Model 30* clamp meter has been tested to withstand a six-foot drop. The Model 30 is well-suited for use by commercial, industrial, and residential electricians, as well as HVAC/R service technicians. Its tapered jaws with centered opening make it easy to access conductors in crowded junction boxes. The clamp meter conforms to the tough IEC 1010 safety standards.

The Model 30 measures AC current to 400A, AC voltage to 600V, resistance, and continuity.



It is more accurate and easier to read than similarly priced analog meters. A hold button freezes the display so that values can be read at the user's convenience. The clamp meter's 1.3% accuracy is specified for one year after calibration.

The Model 30 clamp meter costs \$99. For additional information, contact Fluke Corporation, P. O. Box 9090, Everett, WA 98206; Tel: 800-87-FLUKE; Fax: 206-356-5116.

CIRCLE 104 ON FREE INFORMATION CARD

CONVERTIBLE HEADPHONES

Jasco's Model 455 super-bass convertible headphones feature a unique design that allows the basic headphones to be transformed to over-ear design with the easy addition of convertible adaptors. The Model 455 also features an adjustable padded headband for a comfortable fit. Other features include a single



side cord with a gold-plated 1/4-inch adaptor and 40mm samarium cobalt magnets for super-bass sound.

The Model 455 convertible headphones have a suggested retail price of \$31.99. For additional information, contact Jasco Products Company, Inc., P. O. Box 466, Oklahoma City, OK 73101; Tel: 405-752-0710.

CIRCLE 105 ON FREE INFORMATION CARD

MICRO VIDEO CAMERA

According to *Supercircuits*, its *PC-7* is the world's smallest color video camera. Made up of three PC boards interconnected by flexible ribbon-type cables, in its smallest configuration the *PC-7* would be a cube that measured approximately 2 1/4

inches. The CCD pickup and lens are mounted on a sub-board that can be separated. The camera can be left in a flat configuration, "cubed," or rest at a 90° angle from the imager with the lens pointed out the end of the enclosure. The tiny video camera has applications in computer image capture, desktop videoconferencing, live-action sports videography, covert investigations, and sur-



veillance. In addition, the *PC-7* could be mounted in a radio-controlled car or airplane to record live-action R/C video.

With more than 270,000 pixels and 350 lines of resolution, the *PC-7* offers performance superior to standard VHS and 8mm camcorders and approaches the quality of Hi8 and Super VHS (which have 400 lines of resolution). It has a 2-lux low-light rating. Other features include auto gain control, auto white balance, auto black balance, and electronic automatic shutter.

The *PC-7* video camera, fully assembled, costs \$369.95 plus \$7 shipping. For more information, contact Supercircuits, 13552 Research Blvd. #B, Austin, TX 78750; Tel: 512-335-9777.

CIRCLE 106 ON FREE INFORMATION CARD

DIRECT DIGITAL SYNTHESIZER PC CARD

Novatech Instruments' Model DDS3 PC is a 12-MHz synthesized-signal source on a plug-in card for use in PC XT and PC AT or later ISA-bus computers. It provides 5-ppm accuracy and 10-ppm/year stability. The use of modern digital technology allows the *DDS3 PC* to offer spectral purity comparable to that of older instruments



that cost thousands of dollars. For example, the phase noise is less than -90 dBc at 1-kHz offset, spurious signals are below -45 dBc, and harmonics are less than -40 dBc. Output amplitude is 12 V_{pp} into an open circuit and can be attenuated in 10-dB steps to 70 dB.

The *DDS3 PC* can simultaneously generate sine wave and TTL/HCMOS clock signals from 2 Hz to 12 MHz in 2-Hz steps. It comes with a C-language program that runs under DOS and makes it easy for users to set frequency and attenuation or to sweep through a set of frequency, attenuation, and dwell-time settings. A driver is also available for a third-party, Windows-based ATE programming environment.

The *DDS3 PC* 12-MHz direct digital synthesizer card costs \$399. For more information, contact Novatech Instruments, Inc., 1530 Eastlake Ave. E, #303, Seattle, WA 98102; Tel: 206-328-6902; Fax: 206-328-6904.

CIRCLE 107 ON FREE INFORMATION CARD

LED FLASHLIGHTS

Three compact flashlights from *Ledtronics* use special LED lamps to provide color-controlled, low-intensity illumination for a wide variety of industrial and recreational purposes. Each is made with a rugged, splash-proof, anodized-aluminum case and uses AA batteries that will last at least 15 times longer than in incandescent-type flashlights. The LED lamps, with a life of more than 100,000 hours, are available in three intensities (safelight, medium, and full), eight visible colors (ultra-red through blue), and three infrared wavelengths.

The *Stealth-Lite* is a wide-beam flashlight that does not reduce night vision even when the user looks directly at the beam, making it well-suited for

amateur and professional pilots, boaters, or navigators.

The *Specter-Lite* is a narrow-beam flashlight aimed at professional darkroom workers, astronomers, film-processing technicians, radiology technicians, and manufacturers of light-sensitive materials who require illumination while maintaining safelight conditions. Its solid-state LED lamp allows tight control of beam width, illumination intensity, and color-temperature.

The *Phantom-Lite* is a wide-



beam, pen-light style flashlight that can be used by military police, drivers, or theater-goers who need illumination without reflected glare.

For more information on the *Stealth-Lite*, *Specter-Lite*, and *Phantom-Lite* LED flashlights, contact Ledtronics, Inc., 4009 Pacific Coast Highway, Torrance, CA 90505; Tel: 310-534-1505; Fax: 310-534-1424.

CIRCLE 108 ON FREE INFORMATION CARD

MONITOR ANTI-GLARE FILTERS

The *Secure-View* anti-glare filter from *Kantek/Spectrum* combines 99% glare reduction with an innovative design that restricts the peripheral view of material on the screen. That provides a practical means of controlling access to sensitive information in a crowded office environment. The filter is made of high-quality, optically pure glass that contains multiple thin-film anti-radiation coatings on each side. Anti-Radiation versions of the *Secure-View* filter have an additional coating and grounding cord that block up to 99.999% of ELF/VLF E-field ra-

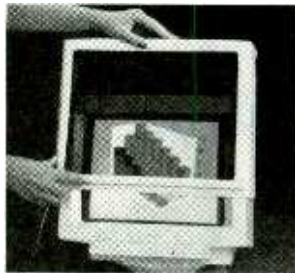

diation, and 100% of static. "Universal" models can be adjusted to fit most 12-15-inch VDT's and installs in seconds without tools. "Spectrum-Contour" models give irregular-shaped and curved VDT's a customized look, fitting snugly around the front of the monitor.

Secure-View filters are priced starting at \$169. For more information, contact Kantek Inc., 15 Main Street, East Rockaway, NY 11518; Tel: 516-593-3212; Fax: 516-593-3295.

CIRCLE 109 ON FREE INFORMATION CARD

DIGITAL CIRCUIT DESIGNER

JPC International's Model TD107 digital circuit designer comes complete with everything needed to design, build, and test digital electronic circuits. It's easy to build, modify, expand, and dismantle circuits without



soldering, by simply inserting the components into the built-in breadboards. Those breadboards accept DIP IC's and virtually all active and passive components. The Model TD107 comes with breadboards that total 1380 tie points, which can accommodate up to 16 14-pin DIP IC's, and can be expanded up to 2020 tie-points, to accommodate up to 24 14-pin DIP IC's. The digital circuit designer is housed in a sturdy high-impact plastic case and includes regulated +5VDC, +12VDC, and -12VDC power supplies; dual-frequency (0.5-

Earn Your B.S. Degree in ELECTRONICS or COMPUTERS



By Studying at Home

Grantham College of Engineering, now in our 43rd year, is highly experienced in "distance education"—teaching by correspondence—through printed materials, computer materials, fax, and phone.

No commuting to class. Study at your own pace, while continuing on your present job. Learn from easy-to-understand but complete and thorough lesson materials, with additional help from our instructors.

Our Computer B.S. Degree Program includes courses in BASIC, PASCAL and C languages — as well as Assembly Language, MS DOS, CADD, Robotics, and much more.

Our Electronics B.S. Degree Program includes courses in Solid-State Circuit Analysis and Design, Control Systems, Analog/Digital Communications, Microwave Engr, and much more.

An important part of being prepared to *move up* is holding the right college degree, and the absolutely necessary part is knowing your field. Grantham can help you both ways—to learn more and to earn your degree in the process.

Write or phone for our free catalog. Toll free, 1-800-955-2527, or see mailing address below.

•
Accredited by
the Accrediting Commission of the
National Home Study Council

•
GRANTHAM
College of Engineering
Grantham College Road
Slidell, LA 70460

Pass the COMMERCIAL RADIO OPERATOR LICENSE EXAM



with this CONFIDENCE BUILDER!

As a reader of *Popular Electronics* you most likely know many of the answers to the FCC General Radiotelephone Operator License exam questions. All it may take to get your license is a quick review of the *Commercial Radio Operator License Educational Package* and taking one or more sample exams—consisting of the actual questions used in the FCC exams! If not, even a novice can bone up using License Exam Preparation software (on a PC disk) and successfully pass the FCC exam. Don't believe it? Buy it! Try it! It's guaranteed to do the job or your money back!

Look at these features:

- All exam questions (*guaranteed word-for-word*) and answers contained in this package are the ones used in the FCC exams. There will be no surprises when you take your examination.
- You will be taking *practice* FCC license examinations right at your personal computer or work from printer copies.
- Question selection formula is the one used in the *actual* FCC examination.
- Computer constructs *unique* written theory tests for you to answer on the screen, or on print out! Program *supports* all dot matrix and laser printers.
- All schematic diagrams *appear* on PC screen.
- Computer *bargraph* scoring by individual sub-element highlights topics requiring further study.
- Software tells you when *you are ready* to take the FCC exam and PASS!
- Change *screen colors*. . .choose *sound effects*. . .and more! *Windows* not required.
- Thousands sold to *satisfied* operators and technicians.

CLAGGK INC. — FCC Commercial Exam Special Offer P.O. Box 4099, Farmingdale, New York 11735

Yes, I like your offer and here is my order for the Commercial Radio Operator License Educational Package!

Complete FCC Radiotelephone Exam Special Offer that includes one 3½-in. and two 5¼-in. disks, Question and Answer booklet containing Elements 1 and 3 and FCC Part 13 Regulations, and Educational Package booklet.

(\$39.95 each) _____ \$ _____
Shipping and handling per order _____ \$4.00
Total Amount in U.S. Funds only _____ \$ _____

New York residents add local sales tax. Canadians add \$6.00 per order. No foreign orders. Do not send cash.

Bill my VISA MasterCard _____ Expire Date ____/____/____

Card No. _____

Signature _____

Name (Please print) _____

Address _____

City _____ State _____ ZIP _____

and 500-Hz) pulse generator with outputs in either high-to-low or low-to-high transitions; complementary clock generator; 60-cycle squarewave; logic probe; eight switchable high or low data switches; eight LED logic indicators; two complementary debounced logic switches; and 1k and 100k potentiometers.

The Model TD107 digital circuit designer costs \$159.95. For further information, contact JPC International, Inc., P.O. Box 55, Agoura Hills, CA 91301; Tel: 818-707-1514; Fax: 818-707-7327.

CIRCLE 110 ON FREE INFORMATION CARD

RS-232 TO RS-485 CONVERTERS

Two plug-in units from *ICS Electronics Corporation* convert RS-232 serial signals into RS-422 or RS-485 compatible signals. The *Models 485M* and *485F* converters are available with male and female connectors, respectively, and are designed to plug directly onto any device with a 25-pin



RS-232 serial port. The units handle baud rates over 114.2 K baud and extension distances greater than 1200 meters. Both converters provide greater noise immunity and longer distances between serial devices than is possible when using standard RS-232 signals. The Model 485M is factory set as a DCE device while the Model 485F is set as a DTE device, but each can be easily configured in the field to operate as either DCE or DTE device. Both units accept +5 to +14 VDC power and are polarity protected.

The Model 485M and 485F converters each cost \$150. A companion +12VDC power supply is available for \$12. For further information, contact ICS Electronics Corporation, 744 South Hillview Drive, Milpitas, CA 95035; Tel: 408-263-5500; Fax: 408-263-5896.

CIRCLE 111 ON FREE INFORMATION CARD

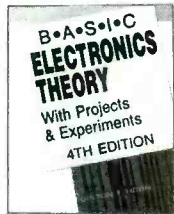

4281H-XX \$35.00
Counts as 2/Hardcover



4362P \$16.95



4110H \$27.95
Hardcover

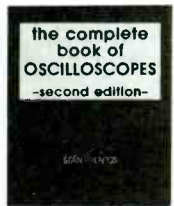

3825P \$17.95



4143P \$14.95

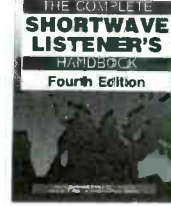

4354P \$19.95

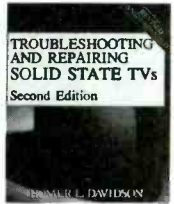

3700H-XX \$36.95
Counts as 2/Hardcover

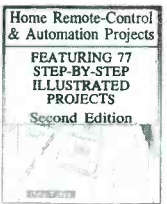

3765P \$19.95



3374P \$16.95

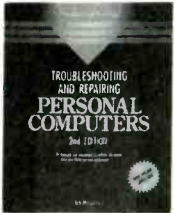

3677H-XX \$34.95
Counts as 2/Hardcover

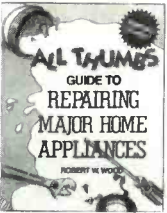

4061P \$9.95

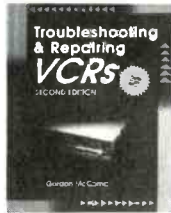

3777H-XX \$32.95
Counts as 2/Hardcover

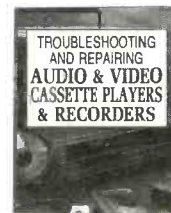

3795P \$19.95

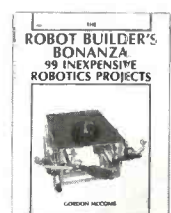

2800P \$17.95



4089P \$18.95

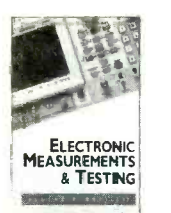

003961H-XX \$40.00
Counts as 2/Hardcover



3711P \$19.95

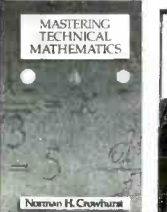

3438H-XX \$39.95
Counts as 2



1604P \$17.95

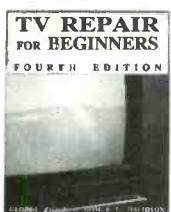

3627P \$19.95



3457P \$19.95



4131H \$27.95
Hardcover

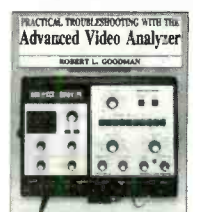

4358P \$24.95

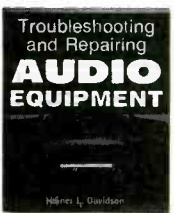

4112H-XX \$29.95
Counts as 2

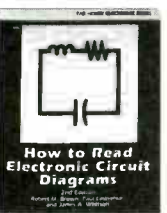

2880P \$15.95



2724P \$17.95

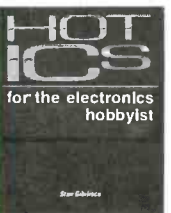

4122H \$36.95
Hardcover

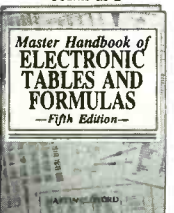

3739P \$22.95

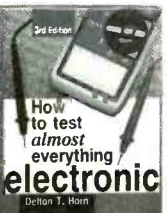

4227P \$14.95

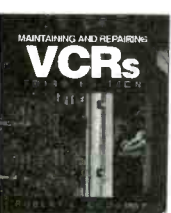

4204H-XX \$39.95
Counts as 2/Hardcover



2790P \$17.95

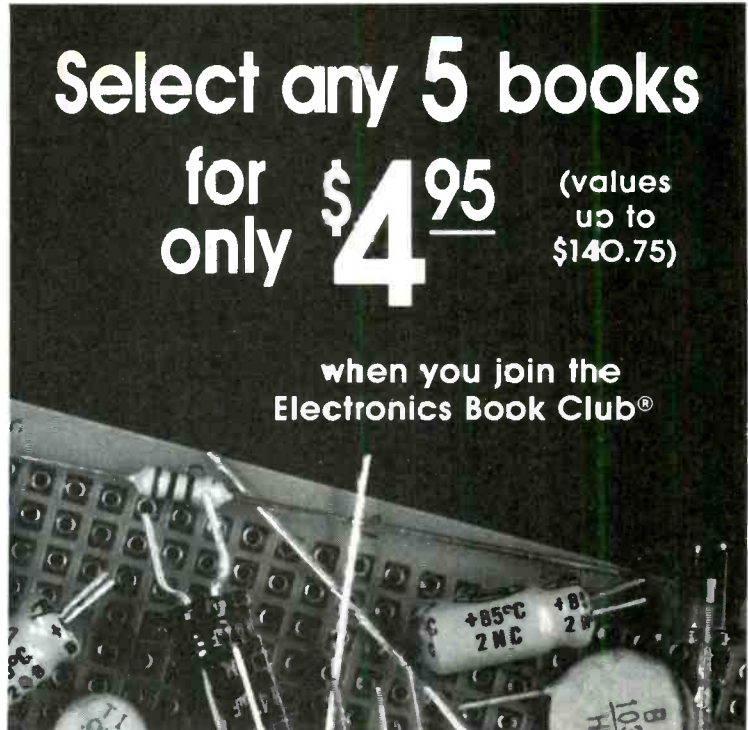

Select any 5 books for only \$4⁹⁵

(values
up to
\$140.75)

when you join the Electronics Book Club®

As a member of the Electronics Book Club . . .

you'll enjoy receiving Club bulletins every 3-4 weeks containing exciting offers on the latest books in the field at savings of up to 50% off of regular publishers' prices. If you want the Main Selection do nothing and it will be shipped automatically. If you want another book, or no book at all, simply return the reply form to us by the date specified. You'll have at least 30 days to decide. And you'll be eligible for FREE Books through the Bonus Book Program. Your only obligation is to purchase 3 more books during the next 12 months, after which you may cancel your membership at any time.

A shipping/handling charge and sales tax will be added to all orders. All books are softcover unless otherwise noted. (Publishers' prices shown) If you select a book that counts as 2 choices, write the book number in one box and XX in the next.
©1994 Electronics Book Club PE594-

If card is missing, write to: Electronics Book Club, Blue Ridge Summit, PA 17294-0813

Your most complete and comprehensive source for the finest electronics books.



MEDIA VISION MEMPHIS MULTIMEDIA UPGRADE KIT

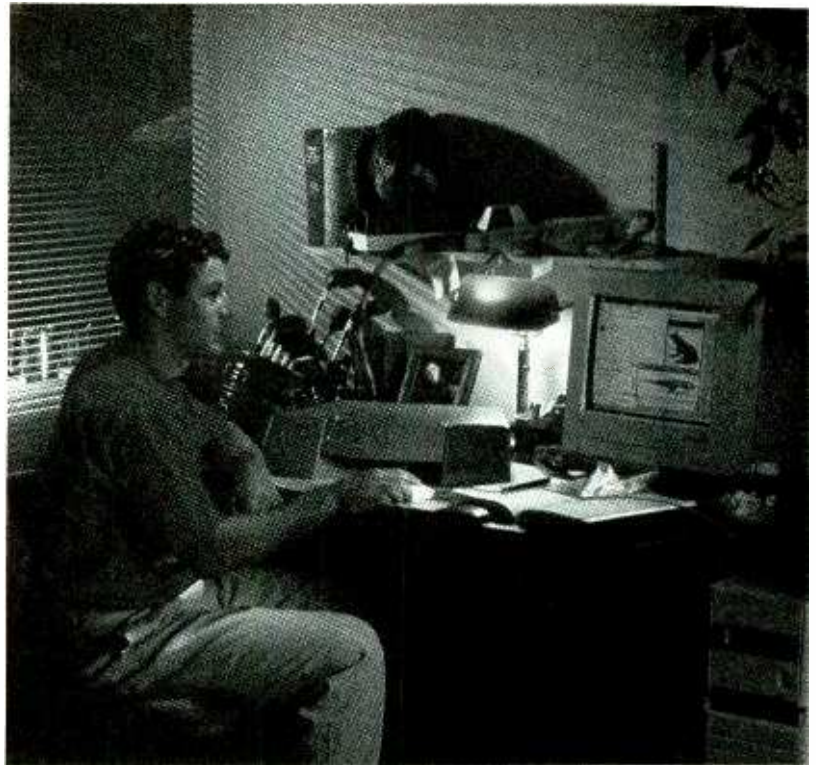

CIRCLE 119 ON FREE INFORMATION CARD

An easy way to add multimedia capabilities to any PC or compatible

Multimedia is currently the hottest topic in personal computing. These days, even low-end PC's are being outfitted with CD-ROM drives. There are a lot of reasons for that: the prices of hardware and software have come down considerably; a number of applications, especially entertainment, education, and research titles, have been optimized for CD-ROM; and the growing size of even non-CD-ROM titles make CD-ROM an ideal distribution medium.

That said, I decided it was time to add a CD-ROM to my own computer. Unfortunately I had a problem: my PC's case has only three external bays, which were taken up by two disk drives and a tape-backup unit. The most practical solution was to add an external CD-ROM, and that's what I did. I installed the *Memphis* from Media Vision (47300 Bayside Parkway, Fremont CA 94538; Tel. 800-845-5870).

The Memphis. The Memphis is a complete, integrated, MPC level-2 multimedia upgrade system. It consists of a double-speed multisession,

NEC CD-ROM drive; a 16-bit sound card (based on Media Vision's popular Pro AudioSpectrum 16); a pair of amplified speakers; all necessary cables and software; two bundled applications (more on that later); and everything else you need to get started right away.

The Memphis is being marketed as a consumer-friendly, multimedia solution. Toward that end, it has a couple of things that set it apart from most other external CD-ROM upgrade kits. For one, it features a higher degree of styling than is usual. It is housed in an attractive gray case with graceful lines. The drive itself is hidden behind a drop-down door.

The matching speakers are designed so that they can be mounted horizontally on the drive case, or detached and placed as much as six feet away for enhanced stereo sound. If detached, they can be placed either horizontally or vertically using included speaker stands.

Also, the unit is designed so that it can be used as an audio-CD player—even with your computer turned off. In fact, the drive does not even have to

be connected to a computer; the power, volume, and drive-transport controls are all located on the front of its case.

The Memphis comes packaged with a suite of DOS and Windows utilities and applications. Among them are programs that allow you to play audio CD's, record WAV (sound) files, play MOD (music) files, and more. Also included is voice-recognition software, a microphone, an installation manual, and a software guide. Rounding-out the package are two popular CD-ROM applications: *Compton's Interactive Encyclopedia* and *Arthur's Teacher Trouble*.

System Requirements and Specifications. The Memphis requires at least a 386SX with 640K of system memory, DOS 5 or higher, a hard disk with at least 12 MB free, 2 available DMA and IRQ settings, and an open 16-bit expansion slot. If you wish to meet minimal MPC level-2 requirements you need a 486SX/25, 4 MB of system memory (8 is recommended), a 160-MB hard drive, and an SVGA video card.

The Memphis CD-ROM drive is a double-speed, multisession SCSI unit with a rated data-transfer rate of 300 K/sec, a 350-ms seek time, and a 64K cache. The sound card is a dedicated version of the Pro AudioSpectrum 16, which is among the more popular sound cards on the market. It features 16-bit PCM recording and playback, a midi interface, a 20-voice FM synthesizer, and more, and is fully Sound Blaster and AdLib compatible. An on-board connector allows you to use the card to interface additional SCSI devices (such as scanners, hard drives, etc.).

Easy Installation. The Memphis is billed as an easy-to-install multimedia solution. In fact, it would be hard to imagine an easier way to add multimedia to a PC-compatible system. The problem is, adding *anything* to a PC can be a pain; we'll explain further in just a moment.

Unlike internal multimedia upgrades, the only thing that goes into your computer is the interface/sound card. Installation is a simple matter of opening your computer, finding an available 16-bit slot, removing its back panel, and inserting and securing the card. While there are on-board jumpers, most users will not need to change them from their factory defaults; interrupt (IRQ) and DMA-channel selections are done with software—a very welcome feature.

Once the card is in place, the balance of the hardware installation should proceed very easily. The card is connected to the drive using a special dedicated cable. Connect the speakers and the small external power supply, and you are done with the hardware installation.

Software installation is done using the Memphis Quick Start Installation disk and the Memphis Installation CD-ROM. The installation programs ask you some questions, selects what it thinks are available IRQ and DMA channels, modifies system files so that your PC will recognize the Memphis, and installs various drivers and multimedia applications.

If all goes well, you are now ready to enter the world of multimedia. If you encounter problems, there is a fairly good troubleshooting guide, and a section of commonly encountered problems, questions, and solutions in

the installation manual. Unfortunately, I needed to find out just how good this section was.

The number-one problem encountered in adding peripherals to a PC is the dreaded interrupt (IRQ) conflict. PC hardware and software vendors are hard at work trying to eliminate that problem, which is caused by the PC's now archaic interrupt structure. Unfortunately, until the promised "Plug-n-Play" standard becomes reality (perhaps by sometime next year), IRQ's will be around to bite us and no PC installation can be considered truly "easy."

In my case, a problem did not become apparent until the next time I went to use my modem—one of the interrupts selected by the Memphis was the same as used by my internal fax/modem. Since the device was not active during the Memphis installation, the program had no way of knowing it was there. (Of course, if I had been paying closer attention during the installation process, and if I had remembered which interrupt the modem used, I could have prevented the conflict then, but such is life.)

With most adapter cards, changing an IRQ setting would involve opening the PC, pulling the offending card, and changing the position of a tiny jumper or switch. Fortunately, as previously mentioned, the Memphis settings are software controlled, making the job as painless as could be. Also, the manual does a good job of helping you diagnose IRQ and DMA problems, and walks you through several ways of solving them.

Summary. I've been using the system for several weeks now, and it, and everything I've run on it, has worked flawlessly. That includes a couple of entertainment titles that have been known to give lesser systems fits. At a suggested list price of \$999 (street prices are, of course, considerably lower), the Memphis is not the least expensive multimedia solution out there, but when you consider its superior performance, ease of installation and use, attractive styling, and versatility, it would be hard to find one that offers a better value.

For more information on the Memphis, contact Media Vision directly, or circle No. 119 on the Free Information Card. ■

FREE

Electronics and Computer Education Catalog

Fast-Track Individual Learning Programs
State-Of-The-Art Classroom Courses
The Best Values in Electronics Education

New
Career-Level Courses
Personal Computer Servicing
TV, VCR, Camcorder Servicing

New
Computer-Aided Instruction
DC & AC Electronics
Semiconductors
Electronic Circuits
Digital Techniques

The stunning animations, hypertext glossary, and easy-to-understand text make learning electronics a breeze...and fun!

Learn the easy and affordable way from the Masters in Electronics Training—Heathkit. From Basic Electricity to Advanced Microprocessors, Heathkit provides you with an unparalleled learning experience at a fraction of the cost of other programs.

Heathkit

Educational Systems

For your FREE Catalog, call
Toll-Free 1-800-44-HEATH

Please mention this code when calling 107-025

CIRCLE 155 ON FREE INFORMATION CARD

Haven't you always wanted a weather station?



The Weather Monitor II makes a state-of-the-art weather monitoring system affordable enough for home use!

FEATURES INCLUDE:

- Inside & Outside Temps
- Wind Speed & Direction
- Barometer
- Time & Date
- Inside Humidity
- Wind Chill
- Alarms
- Highs & Lows
- Rainfall Option
- Instant Metric Conversions
- Outside Hum. & Dew Point Option
- Optional PC Interface

Order today:

1-800-678-3669

M-F 7 a.m. to 5:30 p.m. Pacific Time • PE6411
FAX 1-510-670-0589 • M/C and VISA
One-year warranty • 30-day money-back guarantee

DAVIS INSTRUMENTS
3465 Diablo Ave., Hayward, CA 94545

CIRCLE 162 ON FREE INFORMATION CARD

PRODUCT TEST REPORTS

By Len Feldman

Mitsubishi HS-U57 Video Cassette Recorder

To give you an idea of how feature laden the HS-U57 VCR from Mitsubishi is, let us start by mentioning that the owner's manual accompanying the VCR is 159 pages long, including a 3-page index! In addition to the usual programming capabilities (up to 8 events within a one month period), one-touch recording, and automatic channel programming, this remarkable VHS VCR has a number of special features. What Mitsubishi calls its ViewPoint On-Screen Operating System provides easy access to VCR features with simple on-screen instructions featuring calendar programming.

A "Name The Channels"

"Intelligent Picture Control" automatically sharpens and softens the detail of the picture during playback to create the best possible picture at all times. Edit Search allows you to quickly locate a frame on the tape while recording for more precise editing. "Indexing" magnetically marks program points on a tape while recording, allowing you to quickly find them later. "Quick Program" provides a fast, simple way to program the VCR to record. A "Mix Switch" allows you to add commentary to existing tape soundtracks and to listen to four different audio tracks: stereo, mono, left, and right. S-VHS quasi playback lets you play back

power switch, an eject button, the video-cassette slot, an elaborate front-panel fluorescent display, and a hinged control-panel door that, when lowered, discloses the remaining controls and terminals. They include an "Edit" terminal; video- and audio-input terminals; a VCR A/B remote-control switch; video- and audio-dubbing switches; an input button; an audio-monitor button; a display-mode button; a VCR/TV switch; a recording-speed button; one-touch recording controls; the audio "Mix" switch record-level and balance controls; rewind, play, fast-forward, stop, pause, and record buttons; a channel scanning button; and the one-key program button that allows you to program the VCR right at the control panel instead of via the more elaborate remote control that is supplied with this product.

The rear panel of the VCR contains "Antenna In" and "Antenna Out" terminals, a channel-3/channel-4 switch, an "Edit" terminal, audio- and video-input and -output terminals; and "A/V Network" terminals that enable you to use the remote control with other Mitsubishi components.

In addition to duplicating the main controls found on the front panel of the VCR, the remote control contains the adjust and shuttle rings, index buttons, numbered buttons for directly accessing channels, the one-touch recording button,



CIRCLE 120 ON FREE INFORMATION CARD

The Mitsubishi HS-U57 videocassette recorder is shown here with its supplied remote control.

feature lets you name any channels you have programmed. The name you select appears on-screen when you change channels on the VCR. An adjust dial and shuttle ring allows for precise control for editing and searching functions.

tapes recorded in Super VHS (S-VHS) with standard resolution, even though this machine is not an S-VHS model.

CONTROLS

The front panel of this VCR contains the usual

TEST RESULTS—MITSUBISHI HS-U57 VCR

Specifications	PE Measured
Video frequency response @ 2.0 MHz	-4.33 dB
Video signal-to-noise ratio	
Chroma AM/FM	44.5db/42.7 dB
Luminance (100/50/10 IRE)	47.0db/57.0db/46.5 dB
Hi-fi audio output/THD	2.26 volts/3.0%
Hi-fi flutter (average/peak)	0.01%/0.012%
Conventional audio out/THD	0.47 volts/3.0%
Conventional flutter (average/peak)	0.14%/0.16%
Audio signal/noise ratio	
Hi-fi	87.6db
Conventional	49.6db
Audio response	
Hi-fi	20Hz-20 kHz
Conventional	64Hz-14.2 kHz
Audio THD @1kHz	
Hi-fi	0.15%
Conventional	0.53%
Stereo-decoder signal-to-noise ratio/THD	
Stereo	60.6 db/0.91%
Mono	60.8 db/0.34%
Stereo separation	28.5 dB
Power requirement	27.5 watts
Weight	12.5 lbs.
Fast forward time (T-120 tape)	2 min. 30 sec.
Rewind time (T-120 tape)	3 min. 01 sec.
Dimensions (H x W x D, inches)	3 $\frac{3}{4}$ x 16 $\frac{1}{16}$ x 13 $\frac{1}{2}$
Suggested Retail Price:	\$699.00

and buttons that allow you to control two Mitsubishi VCR's. Also found there are audio and video function buttons used to adjust the sound and picture, a "Cancel" button, a mute button, and a "Quick View" button used to activate the quick search feature.

TEST RESULTS

All tests and performance measurements for this VCR were conducted by the Advanced Product Evaluation Labs (APEL) using the SP speed of the machine. Frequency response was measured using a multiburst test signal. At 2.0 MHz, the video-frequency response was measured at -4.33 dB referenced to a 0 dB reading at 0.5 MHz. The AM red-field chroma (color) signal-to-noise ratio measured 44.5 dB, while the PM (phase modulation) signal-to-noise ratio was 42.7 dB. The luminance signal to noise ratio measured between 47.0 and 46.5 dB, depending upon the lumi-

nance reference level.

The audio tracks for this VCR can be recorded using the VHS-hi-fi mode as well as using conventional edge-track audio recording. In the hi-fi mode, an output of 2.26 volts was measured for a distortion level of 3%. The average and peak flutter in this mode measured 0.01% and 0.012% respectively. The A-weighted signal-to-noise ratio in the hi-fi audio-recording mode was an impressively high 87.6 dB. By contrast, using the conventional audio-recording tracks, signal-to-noise measured only 49.6 dB, which is typical of this type of audio recording for VCR's. Flutter, using the conventional audio-recording mode, measured an average of 0.14%, and had a peak value of 0.16%, while the audio-output voltage measured 0.47 volts for a 3% distortion level.

The audio-frequency response using the hi-fi recording mode extended

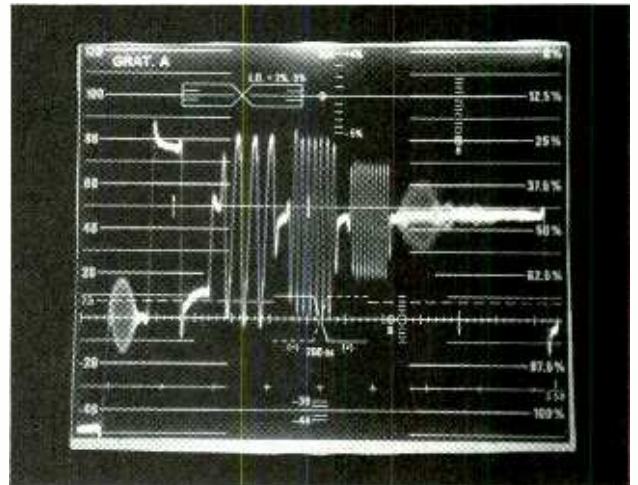

The video frequency response of the unit was measured using a multiburst test signal.

over the full audio spectrum, from 20 Hz to 20 kHz; using the conventional audio recording system, the -3 dB roll-off points occurred at 64 Hz and 14.2 kHz. At a -10-dB record level, harmonic distortion measured 0.15% at 1 kHz when recording audio in the hi-fi mode, while for conventional audio recording, the distortion reading at the same frequency was 0.53%.

Since this VCR records audio stereophonically, it has a built-in stereo-decoder section to take care of recording TV shows that are transmitted with stereo audio. The A-weighted signal-to-noise ratio measured 60.6 dB in the stereo mode and 60.8 dB in the mono mode. Total harmonic distortion in stereo, at a level of -20 dB, measured 0.91%, while total harmonic distortion in mono was 0.34%. The stereo separation at mid-frequencies measured 28.5 dB.

The Mitsubishi HS-U57 consumed 27.5 watts of power and the product weighs approximately 12.5 pounds. Fast-forward winding time for a 2-hour tape was 2 minutes and 30 seconds, while the fast-rewind time was 3 minutes and 1 second. During fast-winding

operations, the counter on the VCR display disappears and reverts to "time remaining" on the cassette.

HANDS-ON TESTS

Despite the length of the owner's manual supplied with this VCR, we found actual operation to be fairly easy, thanks to the "plain-English" on-screen menus. The manual's third and fourth chapters are arranged so that you need only read Chapter 3 for more common VCR operations (including all the programming methods and options). Chapter 4 is devoted to the more advanced features, such as searching techniques, using the adjust and shuttle dials, dubbing and editing, tracking adjustment, and the like. Chapter 5 is devoted to trouble shooting and, happily, in our hands-on use tests of the product we never had to refer to that chapter.

In our opinion, considering its performance and features, the Mitsubishi HS-U57 offers an excellent value at its suggested retail price of \$699.00. For more information, contact Mitsubishi (5757 Plaza Dr., Cypress, CA 90603) directly, or circle No. 120 on the Free Information Card. ■

THINK TANK

By John J. Yacono

Addresses and Questions

As you might remember, our ongoing topic has been IC's; those wonderful black boxes that have become the mainstay of our hobby. I chose that topic to help vacuum-tuber's with renewed interest and newcomers to the electronics hobby as well.

One thing both those groups need, which I couldn't possibly provide in this column, are sales contacts (where they can purchase parts) and data sheets or books. However, what I can do is present the customer-relations addresses for the suppliers of 54xxx and 74xxx series IC's. That way you can contact them yourselves for data and purchasing information.

I would recommend that everyone approach them in a business-like manner for the best results. In other words, type a letter (don't try just calling or scribbling a note) to each company of interest. Each letter should clearly and briefly explain what you need (say, a local distributor or a data sheet). Don't overwhelm them with your technical savvy, personal experiences, or current hobby interests—chances are that the person who reads your letter is not technically inclined anyway. If you are a part of the electronics industry, I suggest using company stationery for impact. If you are more or less just a parts consumer, while you might receive fewer responses to your requests, I'm sure they will be more than satisfactory in scope and number to fill your needs.

74xxxx and 54xxxx Manufacturers

- Advanced Micro Devices, Inc.**
901 Thompson Place
Sunnyvale, CA 94088
- Allegro Micro Systems, Inc.**
363 Plantation St.
Worcester, MA 01605
- Cypress Semiconductor Corp.**
3901 North First St.
San Jose, CA 95134
- GEC Plessey Semiconductors**
1500 Green Hills Rd.
Scotts Valley, CA 95066
- GoldStar Technology, Inc.**
3003 N. First St.
San Jose, CA 95134
- Harris Corp.**
Semiconductor Sector
P.O. Box 883
Melbourne, FL 32902-0883
- Hitachi America, Ltd.**
2000 Sierra Point Parkway
Brisbane, CA 94005
- Ideal Semiconductor**
46721 Fremont Blvd.
Fremont, CA 94538
- Integrated Device Technology, Inc.**
2975 Stender Way
Santa Clara, CA 95054-3090
- Lansdale Semiconductor, Inc.**
2929 South 48th St., Ste. #2
Tempe, AZ 85282
- Maxim Integrated Products**
120 San Gabriel Dr.
Sunnyvale, CA 94086
- Micrel**
1849 Fortune Dr.
San Jose, CA 95131
- Mitsubishi Electronics America**
1050 East Arques Ave.
Sunnyvale, CA 94086
- Motorola Semiconductor Products**
5005 East McDowell Rd.
Phoenix, AZ 85008
- National Semiconductor Corp.**
2900 Semiconductor Dr.
Santa Clara, CA 95051
- NJR Corp.**
Div. of New Japan Radio Co. Ltd.
340-B East Middlefield Rd.
Mountain View, CA 94043
- Panasonic Industrial Co.**
Matsushita Electric Corp. of America
1600 McCandless Dr.
Milpitas, CA 95035
- Performance Semiconductor Corp.**
610 E. Weddell Dr.
Sunnyvale, CA 94089
- Philips Semiconductors**
811 East Arques Ave., POB 3409
Sunnyvale, CA 94088-3409
- Quality Semiconductor**
851 Martin Ave.
Santa Clara, CA 95050
- Rochester Electronics, Inc.**
10 Malcolm Hoyt Dr.
Newburyport, MA 01950
- Rockwell International**
4311 Jamboree Rd., POB C
Newport Beach, CA 92658-8902
- Samsung Semiconductor, Inc.**
3655 North First St.
San Jose, CA 95134
- SGS-Thomson Microelectronics, Inc.**
1000 E. Bell Rd.
Phoenix, AZ 85022
- Sharp Electronics Corp.**
5700 N.W. Pacific Rim Blvd.
Camas, WA 98607
- Siliconix, Inc.**
2201 Laurelwood Rd.
Santa Clara, CA 95054
- STC Components**
Maidstone Rd.
Sidcup, Kent, United Kingdom
DA14 5HT
- Teledyne Components**
1300 Terra Bella Ave.; POB 7267
Mountain View, CA 94039-7267
- Texas Instruments, Inc.**
POB 655303
Dallas, TX 75265
- Toshiba America Electronic Components, Inc.**
9775 Toledo Way
Irvine, CA 92718
- Unicorn Microelectronics Corp.**
3350 Scott Blvd., Building #49
Santa Clara, CA 95054
- Universal Semiconductor, Inc.**
1925 Zanker Rd.
San Jose, CA 95112
- VTC, Inc.**
2800 Old Shakopee Rd
Bloomington, MN 55425

While it's a long shot, I secretly hope that manufacturers will sense enough interest in the hobbyist-level market to become more low-volume purchase friendly. Frankly, I think it would be incredible press for one of those companies to bill themselves as the "Electronics Educator" of America's youth, and distribute data and parts in reasonable quantities at an affordable cost. Surely, if companies can give away parts to potential customers here and abroad, they can sell parts at cost to the potential industry leaders of tomorrow right here at home. Frankly, judging by the amount of correspondence I receive from readers looking for parts from non-volume dealers, I'd say it would be good business sense, too—especially now in the neo cold war where marketing means survival.

Well, that's my pitch for this month. I hope you'll be pleased with the completeness of the list, which was the result of pretty thorough research. Use it wisely, and only for good.

Now let's get to some mail of our own. This month's letters are a combination of requests for help and corrections.

IMAGINARY PROBLEMS

I have enjoyed **Popular Electronics** for many years. I have some back issues from the 50's and 60's that I bought while in high school.

While I enjoyed Charles Hansen's article "Wire!" (in the September, 1993 issue), there is an impedance formula on page 61 with a term that is not defined, a lower case "j." I suspect that that term is frequency dependent even though " Ω " is defined as frequency dependent in the article.

Could you define that

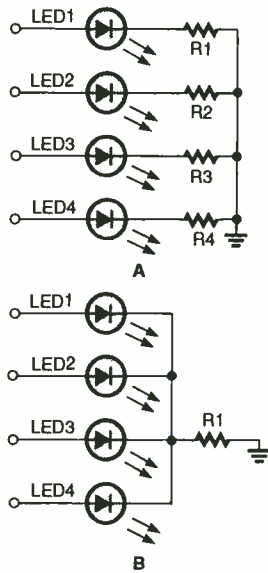

Fig. 1. Are these circuits equivalent? If not, under what conditions are the differences unimportant?

term for me. Thanks for years of good information and great reading.

—Lloyd Hansen, Clinton, MT

I'd be glad to, Lloyd. The letter j stands for the "primary imaginary number," a constant. In most math texts, it is represented as an "i" (which might be more familiar to you). The actual number is the square root of -1 , which cannot be a positive 1 (because a positive 1 times a positive 1 yields a positive 1, not a -1) and it cannot be a negative 1 (because -1 times -1 also yields a positive 1). If it's not positive or negative then it's not what they call a "real" number in math. Thus, the name "imaginary" number.

Like the normal number 1, j is used as the first digit of an entire number system: the imaginary number system. Imaginary numbers are written as regular numbers times j . For example, imaginary 2.3 is written $2.3j$. Imaginary numbers can be combined with real numbers to form "complex"

ATTENTION! ELECTRONICS TECHNICIANS



EARN YOUR B.S.E.E. DEGREE THROUGH HOME STUDY

Our New and Highly Effective Advanced-Placement Program for experienced Electronic Technicians grants credit for previous Schooling and Professional Experience, and can greatly reduce the time required to complete Program and reach graduation. No residence schooling required for qualified Electronic Technicians. Through this Special Program you can pull all of the loose ends of your electronics background together and earn your B.S.E.E. Degree. Upgrade your status and pay to the Engineering Level. Advance Rapidly! Many finish in 12 months or less. Students and graduates in all 50 States and throughout the World. Established Over 40 Years! Write for free Descriptive Literature

COOK'S INSTITUTE OF ELECTRONICS ENGINEERING

CIE 4251 CYPRESS DRIVE JACKSON, MISSISSIPPI 39212

CIRCLE 13 ON FREE INFORMATION CARD

Learn VCR repair at home!

MAKE GOOD MONEY IN YOUR OWN FULL- OR PART-TIME JOB



Professional-level home study course. You will master easy-to-learn, high-profit repairs *without* investing in high-tech instruments or a costly workshop. Want more independence and higher income? Send or call today!

Free career literature: 800-223-4542

Name _____ Age _____
 Address _____ Phone (____) _____
 City _____ State _____ Zip _____

The School of VCR Repair
 6055 Roswell Road
 Dept. VF341, Atlanta, Georgia 30328

CIRCLE 159 ON FREE INFORMATION CARD

May 1994, Popular Electronics

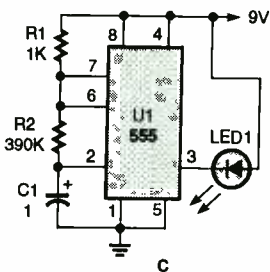
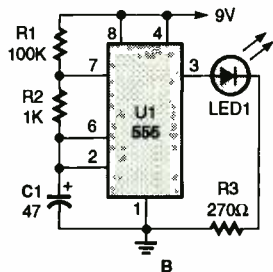
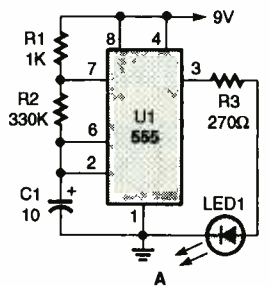
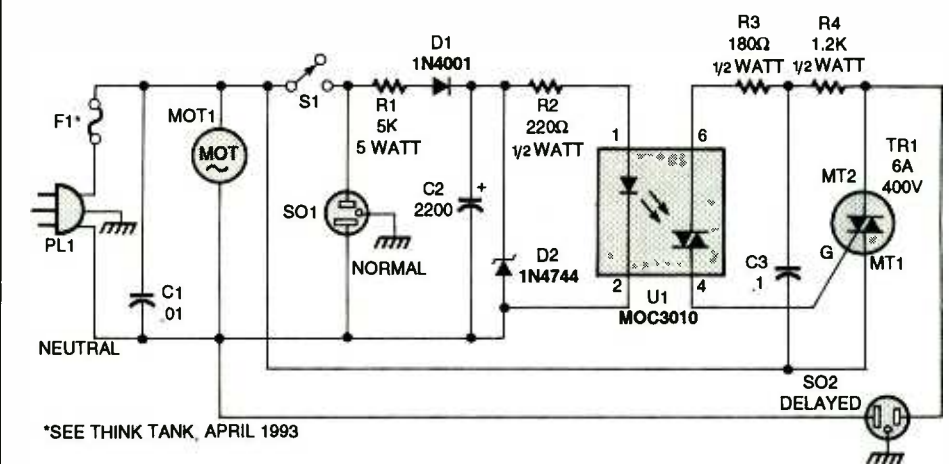

Fig. 2. The circuits in A and B might work okay with a higher value for R1, but the circuit in C is trouble from the get go.

numbers. For example, $4.1 + 2.3j$ is a complex number that has a real component of 4.1 and an imaginary part with a value of 2.3. Actually, adding the numbers 4.1 and 2.3; would have no meaning, because they are from entirely different number systems.

In electronics, complex numbers are used to describe properties that are a combination of directly and indirectly measurable qualities. For example, a part's impedance consists of a resistive component (which can be measured with the part inactive) and a reactive component (which can only be arrived at by measuring the impedance at a given frequency and the resistance at DC,



*SEE THINK TANK, APRIL 1993

Fig. 3. If a fault occurs, the voltage across C2 could rise to the point that that capacitor fails, if it weren't for D1, which is now included in this revised circuit.

and then doing some math). Using complex numbers, we can easily write both portions of such quantities next to one another and yet keep them mathematically separate.

PROPER CONDITION

Regarding the January, 1993 problem with the air-conditioned, split-level house, might I suggest moving the thermostat upstairs, and installing an electric damper on the downstairs duct. Wire the damper to the downstairs thermostat.

When it gets cool downstairs, the damper closes, but the air conditioner continues to cool upstairs, until it is cool as well. I've done this on several split floor-plan houses here in South Florida, and it works well.

By the way, you can also switch the downstairs "zone" off when there is no one downstairs. For example, at night, assuming the bedrooms are upstairs. That would save a large portion of your cooling bill.

—J. Deringer, Lantana, FL
While I don't have central AC, your ideas certainly sound feasible. Thanks for your input.

???

I have been meaning to

send you a letter for quite some time now. I hope that you have a reply for each of my questions. In schematic diagrams like the one in Fig. 1A, would you not be able to rearrange it to look like Fig. 1B? If not, why?

In the June, 1993 issue of *Popular Electronics*, on page 77, is there not a way to make the circuit run 10- to 100-watt fluorescent tubes? Also, is there a Canadian substitute for the TL430C item that is in the same article?

Last, is there any way to convert an unknown waveform into square wave of the same frequency?

—Stephen Joseph, (address withheld)

If each LED is mutually exclusive (only one is lit at any given time), and the resistors and LEDs are all the same and fed with the same voltage, then the circuits in Fig. 1 will operate similarly. If the LEDs have different current requirements or receive different source voltages, then multiple resistors must be used to tailor the current through each LED. However, if the number of LEDs lit at a given time varies, calculating the best value for R1 in Fig. 1B would become diffi-

cult: it would probably permit too much current to flow when only one LED is on, and too little current with more than one on.

I can't answer your second question off the cuff. Try writing to the author of the letter in care of me here at the magazine and I'll forward it to him in case he has any input. With regard to the TL430C, I can't find it in any of my databases. I'll have to assume that it's a discontinued part (again the author of that letter might be able to help).

Last, the easiest way to convert an unknown wave into a square wave is to use a comparator to detect when the unknown wave crosses a given voltage. For that, connect the comparator to an appropriate power source, connect one input to the unknown wave's source, and the other input to the reference voltage. Every time the unknown waveform crosses the reference voltage the comparator output will change state, thus producing a square wave of equal frequency.

555 BLUES

I'm having 555 frustrations in putting together what
(Continued on page 89)

Experience The New Technology Behind Today's Advanced Computer Systems With...

McGraw-Hill's Computer Electronics Series

NEW! Now you have a fast, easy, low-cost way to meet the challenges of today's computer electronics. McGraw-Hill's unique new learning series is as innovative as the technology it explains, as fascinating as the experiments you perform.

From circuit theory to the Pentium chip, you master one subject at a time with the McGraw-Hill Computer Electronics Series. Twelve unique modules, sent to you one every 4-6 weeks, give you a thorough understanding of such subjects as digital logic, microcomputer operation, data storage devices, data communications, PC servicing, local area networks, and more.

Each module goes right to the heart of the matter. You waste no time on extraneous material or dry history. Instead, you get a fast, efficient, and lively learning experience... a nontraditional approach to the most modern of subject matter.

Unique interactive instruction

Your learning experience is reinforced through the integration of vividly illustrated text with actual electronic experiments. In fact, by the time you complete your sixth module, you will have assembled the McGraw-Hill Prototyping Design Lab, a breadboarding lab you'll use long after you complete the series for building up and testing prototype circuits. Your modules also feature indexed binders to preserve your text, backup materials, and notes for convenient referral.

Your adventure begins with Module 1

With your very first module, you'll begin to understand the technology behind today's most advanced computer systems.

You'll be introduced to basic electronics principles and discover the role of key electronic components, including resistors, capacitors, and transistors.

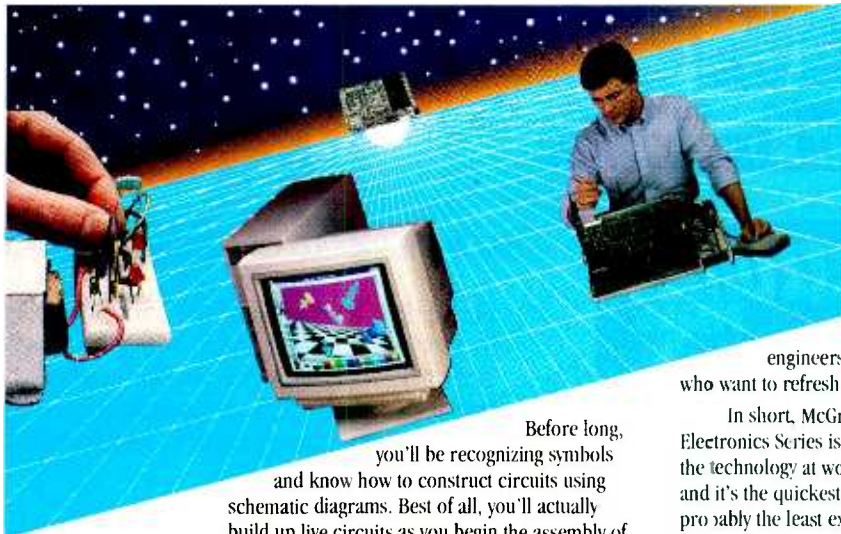

Before long, you'll be recognizing symbols and know how to construct circuits using schematic diagrams. Best of all, you'll actually build up live circuits as you begin the assembly of the McGraw-Hill Prototyping Design Lab.

Each module adds more to your expanding knowledge of computer electronics

Step by step, each module builds your knowledge and confidence. In all, 12 modules take you quickly from the basics to today's sophisticated computer concepts:

- ▶ Electronic Circuits and Components
- ▶ Semiconductors and Linear Applications
- ▶ Digital Logic Fundamentals
- ▶ Flip-Flops, Counters, and Registers
- ▶ Microcomputer Fundamentals
 - ▶ Mass Data Storage Systems
 - ▶ Data Communications
 - ▶ Graphics Display Systems
 - ▶ Embedded Microprocessor Controllers
- ▶ Print Technologies
- ▶ PC Servicing
- ▶ Local Area Networks

For anyone interested in computer electronics

McGraw-Hill's Computer Electronics Series is designed for anyone from hobbyist to professional. It's for

you if you're finding that computers are playing an increasingly important role in your work... if you're a teacher or trainer who wants an update in contemporary computer circuits... or if you're simply fascinated by today's computer technology and want to know more about it.

It's even for electronics engineers or computer technicians who want to refresh their skills.

In short, McGraw-Hill's Computer Electronics Series is an ideal way to understand the technology at work in today's computers... and it's the quickest, most convenient, and probably the least expensive way to do it. And the only one that gives you hands-on experience.

15-day no-risk trial

We invite you to prove to yourself that McGraw-Hill's Computer Electronics Series is all we say it is... without risk and without committing yourself in any way. Order today, and we'll send you your first module — Electronic Circuits and Components — for a free, 15-day examination. If you're not absolutely certain that this is an enjoyable as well as highly effective way to learn, simply return the module to us.

If you wish to continue, we'll ship the remaining modules automatically, about once a month, on the same Free Examination basis.

Send for your first module today! And let McGraw-Hill guide you into the fascinating world of Computer Electronics.



FREE 15-DAY TRIAL! SEND TODAY!

Computer Electronics Series

McGraw-Hill Continuing Education Center
4401 Connecticut Avenue, NW, Washington, DC 20008



YES! I'm interested in learning computer electronics and would like to examine the first module in the series. If I decide to keep it, I will pay just \$24.95 plus \$2.25 shipping and handling. I will then receive future modules automatically, one every 4 to 6 weeks, at the same low price and on the same 15-day Free Examination basis. There is no minimum number of modules I must buy, and I may cancel at any time simply by notifying you.

Name (please print)

Address

City/State/Zip

Telephone () 2002-0994

All orders subject to approval and payable in U.S. funds only. Available in U.S. and Canada only.

GET THE LATEST ADVANCES IN ELECTRONICS

WITH A SUBSCRIPTION TO

Electronics

Radio Combined with
Electronics®

NOW®



Electronics Now gives you exciting articles like:

- Buyer's Guide to Digital Oscilloscopes
- Build A Scanner Converter
- Single-Chip Voice Recorder
- Build A MIDI Interface for your PC
- Troubleshoot Microprocessor Circuits
- Build A High-Power Amplifier for your Car
- Add Music On Hold to your Phone
- All About Binaural Recording
- VGA-to-NTSC Converter

ENJOY THE WORLD OF ELECTRONICS EACH MONTH!

Subscribe to the best electronics magazine—the one that brings you the latest high-tech construction projects, feature articles on new technology, practical troubleshooting techniques, circuit design fundamentals, and much more.

Electronics Now looks to the future and shows you what new video, audio and computer products are on the horizon. What's more you'll find helpful, monthly departments such as Video News, Equipment Reports, Hardware Hacker, Audio Update, Drawing Board, Computer Connections, New Products, and more. All designed to give you instruction, tips, and fun.



FOR FASTER SERVICE CALL TODAY
1-800-999-7139

DON'T DELAY SUBSCRIBE TODAY!

Just fill out the order card in this magazine and mail it in today.

7PE45

Over one hundred years ago, Alexander Graham Bell referred to the infant telephone network as "this grand system." If it seemed like a complex system to him at the time, he would be amazed at how it has developed. It's important to remember the telephone's humble beginnings when trying to understand our modern telecommunications network.

Our phone system is the way it is today because it was based on the technology of 1878 and has evolved from there. Each innovation had to be compatible with the existing system, so many of the limitations of the original technology are still with us today. The modern version of Bell's dream has become a kludged system where technologies that were appropriate for wire, bells, and hand-crank magnetos are mixed with high-speed, electronic-switching systems, geosynchronous communications satellites, and fiber optics.

However, it's difficult to argue with success—the technological mishmash has served us well. The new technologies have added a lot of nice features, most of which are available from your local telephone company for an additional monthly fee. One of those features is a distinctive ring signal that allows you to assign an alternate number to your telephone line. Your original number continues to ring the way it always did, but any call to the new number causes your phone to ring with a distinctly different ring pattern.

Such features are commonly used by roommates who are tired of answering each other's calls. With distinctive rings, they each have a separate telephone number, and the sound of the ring indicates who the call is for before the phone is answered. Much more sophisticated uses for distinctive ringing are possible if a smart device can automatically

Build This



Distinctive Ring Switch

Route incoming telephone calls to the appropriate device with this automatic call-directing circuit

BY BRUCE LAYNE

analyze the ring pattern and switch the phone line.

For example, I recently started a second home-based business. Together, both businesses account for considerably less telephone traffic than the average family with an active teenager, so the cost of a separate phone line was difficult to justify. I requested the distinctive ring service from my local telephone company and had my long-distance carrier assign my new 800-number service to the distinctive-ring number. The only problem was when the answering machine was involved, it would answer either ring, but always played the message as though it was from my original number.

With the *Distinctive Ring Switch* described in this article, the situation has changed—I can now have a second answering machine take all calls for the new company. Adding a fax ma-

chine or a computer BBS to an existing telephone would be a more common use for the Distinctive Ring Switch.

Circuit Description. A schematic diagram of the Distinctive Ring Switch is shown Fig. 1. At the heart of the circuit is a PIC16C54 microcontroller, which packs a lot of power into its tiny 18-pin DIP package. The PIC contains an 8-bit, real-time clock counter (RTCC) that is software configured to increment every 256 internal clock cycles. The internal clock is derived by dividing the oscillator clock by four. A preprogrammed PIC is available from the source given in the Parts List. For those that have the knowledge and ability to do their own programming, the source and object code is also available via the mail or it can be downloaded from this magazine's BBS (516-293-2283).

The PIC's oscillator can be crystal controlled, but our application doesn't warrant such accuracy. Instead, a couple of bits inside the PIC are programmed to use a resistor/capacitor (RC) network as the oscillator. That RC combination (R7 and C1 connected to pin 16) sets the oscillator's frequency to 47 kHz, (PIC's are capable of operating at 20 MHz). That frequency was chosen to enable the RTCC to time all events of interest without overflowing.

Twelve of the PIC's eighteen pins can be software configured as either inputs or outputs. As outputs, those pins can each source 20 mA of current, which is more than sufficient to directly drive the LED's attached to pins 7 and 8. The LED's are used to indicate which device is connected to the incoming phone line. The output pins also provide adequate current to directly drive the relay (K1) connected to pin 9, which switches the devices to the incoming phone line.

To know when to properly switch the

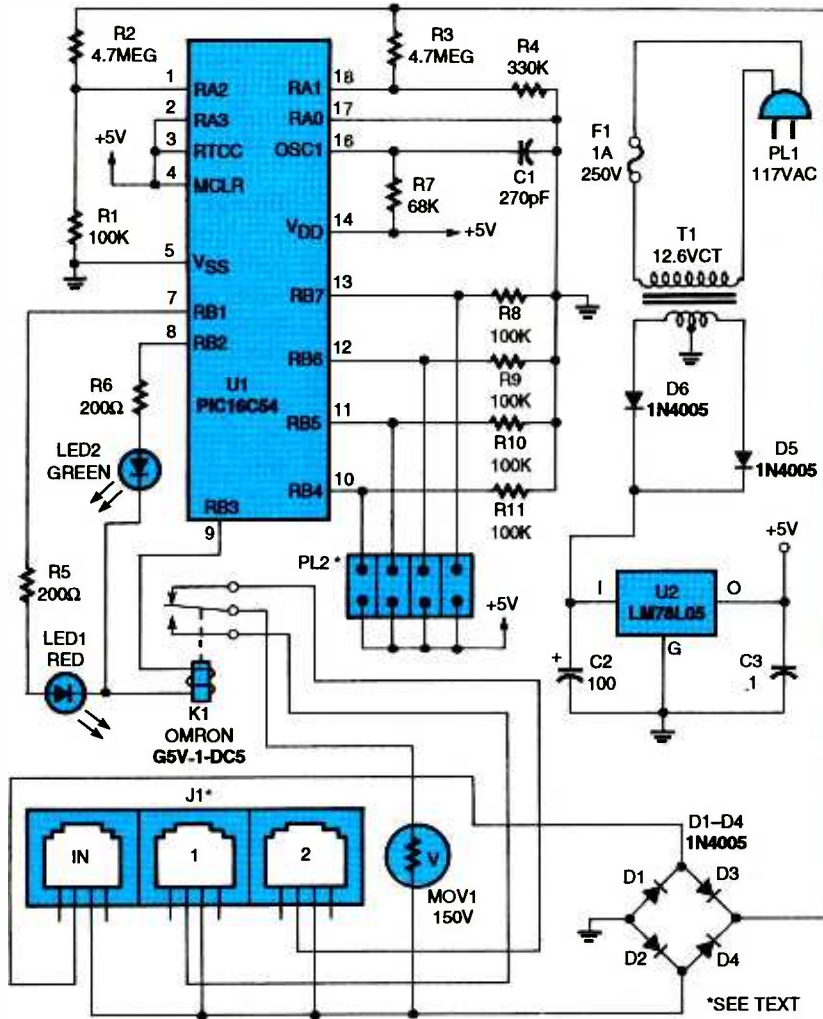

Fig. 1. At the heart of the Distinctive Ring Switch is a PIC16C54 microcontroller (U1), which contains an 8-bit, real-time clock counter (RTCC) that is software configured to increment every 256 internal clock cycles.

devices, the PIC needs to monitor the phone lines for two types of events. It needs to know when the phone is ringing and it needs to know whether the phone is answered or hung up. Technically, when the phone is answered, the condition is called "off hook" and when it is hung up it is called "on hook." Ring status and hook status each use one input pin on the PIC, pins 1 and 18, respectively.

Outwardly, each of those pins seems to be merely connected to a voltage divider, but the important part of the circuit is buried inside the PIC. The input pins have clamping diodes to prevent excessive voltages from damaging the microcontroller. The PIC's clamping diodes are particularly robust, enabling it to be used to clamp the high voltages present on the phone lines. The 4.7-megohm resistors leading to pins 1

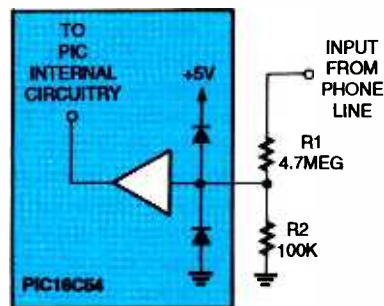

Fig. 2. The ring-detect circuit (which consists of a pair of external resistors, and an internal Schmitt trigger and a pair of diodes) conditions the analog signals from the phone line to produce digital 1's and 0's.

and 18 are used to limit the current to very low levels. They also form the upper legs of voltage dividers that produce signals to indicate the hook and ring status.

Figure 2 shows the ring-detect circuit, including the components that are inside the PIC. The ring and hook status signals are actually very poorly conditioned when they are presented to the microcontroller, but the PIC's internal clamping diodes restrict the signals to within one diode drop (about 0.6 volts) of the power-supply voltage limits. The PIC also has a Schmitt trigger on each input, that further conditions the analog signals from the phone line into a digital highs and lows.

During thunder storms, very high voltages can be induced on the phone lines by nearby lightning strikes. Because of that a 150-volt, metal-oxide varistor (MOV1) is used on the incoming phone line to prevent voltage spikes from damaging the Distinctive Ring Switch. As an added bonus, the connected devices also benefit from that lightning protection.

Basic Telephone Theory. The phone line is really just two wires, called *tip* and *ring*. The origin of both terms dates back to the earliest days of the telephone when operators manually connected calls by plugging a cable into a jack on a panel. One of the wires in the cable connected to the tip of the cable's plug, and the other connected to the ring around the outside of the plug.

Most phones will operate properly even if the tip and ring lines are swapped, although some older phones may not ring properly. Note, however, that the Distinctive Ring Switch requires proper tip and ring wiring, a bridge rectifier in that circuit (diodes D1-D4 in Fig. 1) routes the signals as needed to assure the correct polarity.

The pair of wires that extends from your house is called the local loop, which terminates at the central office. The central office connects - 48 volts DC to your ring line and connects the tip line to ground. A series resistance of 350 to 800 ohms is included to limit the short-circuit current to safe levels. There will also be as much as 1900 ohms on the line due to the resistance of the local loop. The farther you are from the central office, the higher the resistance in the local loop.

When your phone is off hook, its internal resistance is connected across the phone line, allowing current to flow. Most telephones have an inter-

PARTS LIST FOR THE DISTINCTIVE RING SWITCH

SEMICONDUCTORS

- U1—PIC176C54-RC/P
microcontroller, integrated circuit
U2—LM78L05 5-volt, 100-mA,
voltage regulator, integrated circuit
D1—D6—1N4005 1-amp, 600-PIV,
silicon rectifier diode
MOV1—150-volt metal-oxide varistor
LED1—Red light-emitting diode
(T-1-3/4)
LED1—Green light-emitting diode
(T-1-3/4)

RESISTORS

(All fixed resistors are 1/4-watt, 5% units.)

- R1, R8—R11—100,000-ohm
R2, R3—4.7-megohm
R4—330,000-ohm
R5, R6—200-ohm
R7—68,000-ohm

CAPACITORS

- C1—270-pF, ceramic-disc
C2—100- μ F, radial-lead electrolytic
C3—0.1- μ F, ceramic-disc

ADDITIONAL PARTS AND MATERIALS

- F1—1-amp, 250-volt fuse
T1—12.6-volt, center-tapped (Mouser #41PG006, or similar) transformer
PL1—Molded AC power plug with line cord
PL2—4-position PC-mounted, dual header (with shoring jumpers)
K1—Omron G5V-1-DC5 SPDT (Digi-Key #Z773-ND or similar) 5-volt relay
Printed-circuit materials, enclosure, rubber feet, fuse clips, LED-mounting clips, rubber grommet, 18-pin DIP socket, wire, solder, hardware, etc.

Note: The following items are available from Advanced Digital Products, Inc. (300 Bent Bough Place, Lexington, KY 40509-1403; Tel. 606-268-6005); a preprogrammed PIC16C54 microcontroller for \$9.00; printed-circuit board, \$9.00; custom enclosure, \$12.00; complete kit of parts, \$43.00. Please add \$3.50 to all orders for shipping and handling. Kentucky residents, please add appropriate sales tax. Send self-addressed stamped envelope for PIC source and object-code listing. Send SASE and blank 3.5- or 5.25-inch floppy disk for the source and object code on a PC-compatible disk. Code requests do not require shipping and handling charges.

OFF HOOK

ON HOOK

RINGING

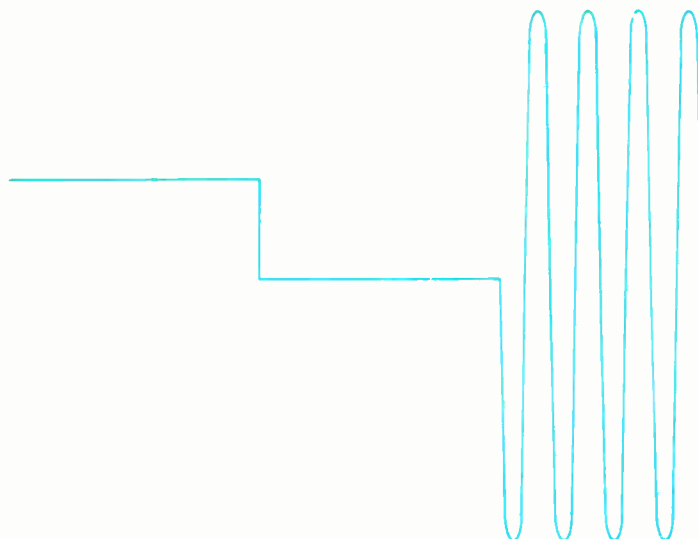

STATUS	PHONE VOLTAGE	PIN 1 (RING)	PIN 18 (ON HOOK)
OFF HOOK	-8VDC	LOW	LOW
ON HOOK	-48VDC	LOW	HIGH
RINGING	-48VDC +86VRMS AT 20Hz	PULSING HIGH AT 20Hz	PULSING HIGH AT 20Hz

Fig. 3. Shown here are some typical telephone-line voltages and their corresponding microcontroller input signals. When someone calls, the phone company superimposes a 86-volt, 20-Hz ring signal onto the -48 volts DC already present on the line.

nal resistance of 100 to 400 ohms. The current varies according to the resistance at the central office, the resistance of the local loop, and the resistance of any phones that are off hook. Multiple off-hook phones are in parallel, so each additional phone that goes off hook increases current flow in the local loop. The central office senses the current flow, provides a dial tone and prepares to receive the number that you dial. The off-hook current is usually 6 to 25 mA. Figure 3 shows some typical telephone line voltages and their corresponding microcontroller input signals.

When someone calls you, the phone company superimposes a 86-volt, 20-Hz ring signal on top the -48 volts DC already present. The ring patterns vary between different locations. The normal ring pattern for the United States is two seconds on and four seconds off. Some parts of the U.S. and Europe have a normal ring of one second on and three seconds off. My distinctive ring is 0.8 seconds on, 0.4 seconds off, 0.8 seconds on and 4 seconds off, however, ring patterns can vary greatly.

Construction. Almost any construction technique (printed-circuit board, wire wrap, or point-to-point solder connections) will work for the Distinctive Ring Switch. However the author's prototype was assembled on a the single-sided, printed-circuit board, measuring about 3 5/8 by 3 inches. Figure 4 shows a full-size printed-circuit template of that layout.

Note the two curved cutouts for the enclosure mounting screws, as well as the rectangular cutout for the transformer. The transformer should be mounted 1/4-inch below the printed-circuit board to accommodate the top of the enclosure. A component-placement diagram is shown in Fig. 5.

With so few components, assembly is quite simple. However, the usual warnings apply concerning the polarity of the diodes, LED's, IC's, and the electrolytic capacitor. Solder all the components to the board, using a socket for the 18-pin microcontroller. Before installing the microcontroller or applying power, use the resistance or continuity setting of a multimeter to verify that the power-supply ground on the middle pin of U2 is connected

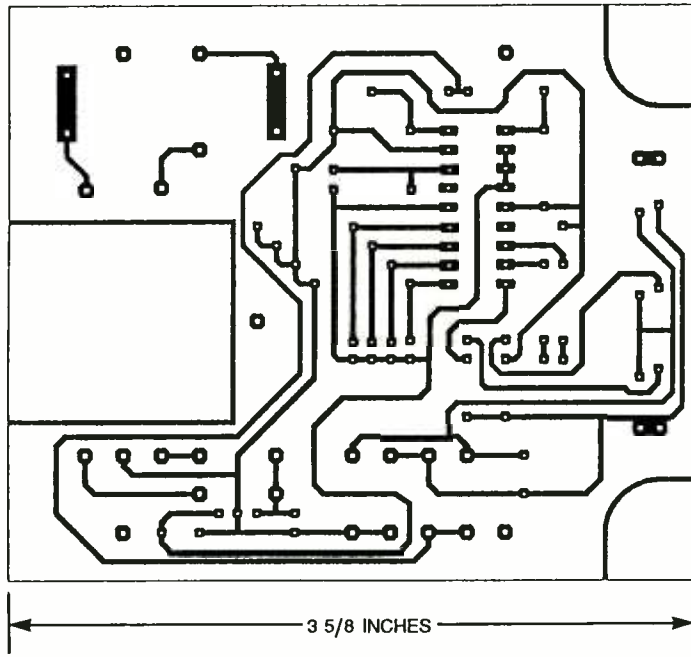

Fig. 4. The author's prototype was assembled on a single-sided, printed-circuit board, measuring about 3 5/8 by 3 inches. A full-size template for that board is shown here.

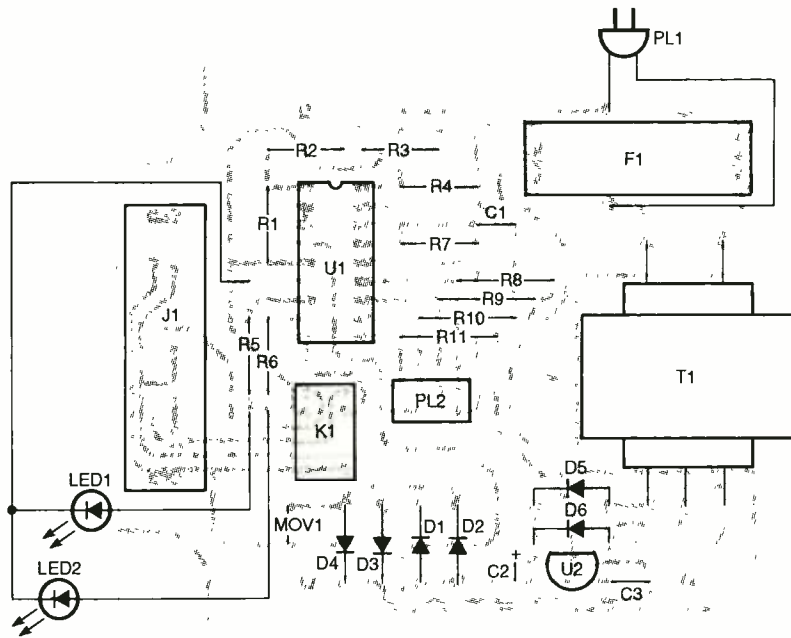

Fig. 5. As shown by this parts-placement diagram, there are very few components in the circuit. When assembling the circuit, however, pay attention to the orientation of the polarized components (diodes, LED's, IC's, and the electrolytic capacitor).

to pin 5 of U1's socket. Using the same technique, check for a good ground every place it appears in the circuit. Also verify that the ground is not shorted to the +5-volt supply line.

If the ground checks out, disconnect the multimeter and plug in the power cord. Select the voltage setting on your multimeter and verify that +5 volts is present at pins 2, 3, 4, and 14 of

U1's socket, as well as on all four of the header pins not directly connected to the microcontroller. If the power supply checks out, unplug the power cord and install the microcontroller into its socket. You should now be ready to attach the incoming phone line, plug in a couple of telephone devices and test the Distinctive Ring Switch.

REFERENCES

Understanding Telephone Electronics
John L. Fike

The Art of Electronics, 2nd Edition
Paul Horowitz and Winfield Hill (p. 935)

PIC16C5x Microcontroller Application Notes (Set two, p. 270)

If you experience any trouble, a good way to check for some sign of life from the microcontroller is to disconnect the incoming phone line and attach an oscilloscope or frequency counter to pin 15 of U1. You should find a good square wave with a frequency of about 11,750 Hz, which is the clock oscillator divided by four. You should always disconnect the incoming phone line before attaching your oscilloscope leads. The ground lead on most AC-powered oscilloscopes is attached to an earth ground via the oscilloscope's power cord. The Distinctive Ring Switch routes the -48-volt ring signal to its ground, so the tip line appears to be +48 volts, making it easier to detect ring and hook status. Connecting a grounded scope lead to the -48-volt circuit ground will ground the ring line and the central office will detect current flowing.

Setup. The Distinctive Ring Switch has four jumpers, one for each of four ring patterns. Each jumper has two positions, one for each device. That allows a great deal of flexibility for unconventional switching functions, as well as accommodating phone systems other than those in the United States. For example, the normal ring cycle for phones in the U.K. consists of 0.4 seconds on, 0.2 seconds off, 0.4 seconds on, and 2 seconds off. The timing is slightly different from my distinctive ring, but it is close enough.

The Distinctive Ring Switch would still count two rings per ring cycle, just like my distinctive ring. The jumpers prevent that problem by allowing you to select either device 1 or device 2 for each of four different ring patterns. When the leftmost jumper is closed, one ring per ring cycle will connect the incoming line to device 1. When open, one ring per ring cycle will connect the incoming line to device 2.

(Continued on page 92)

DOCUMENTATION

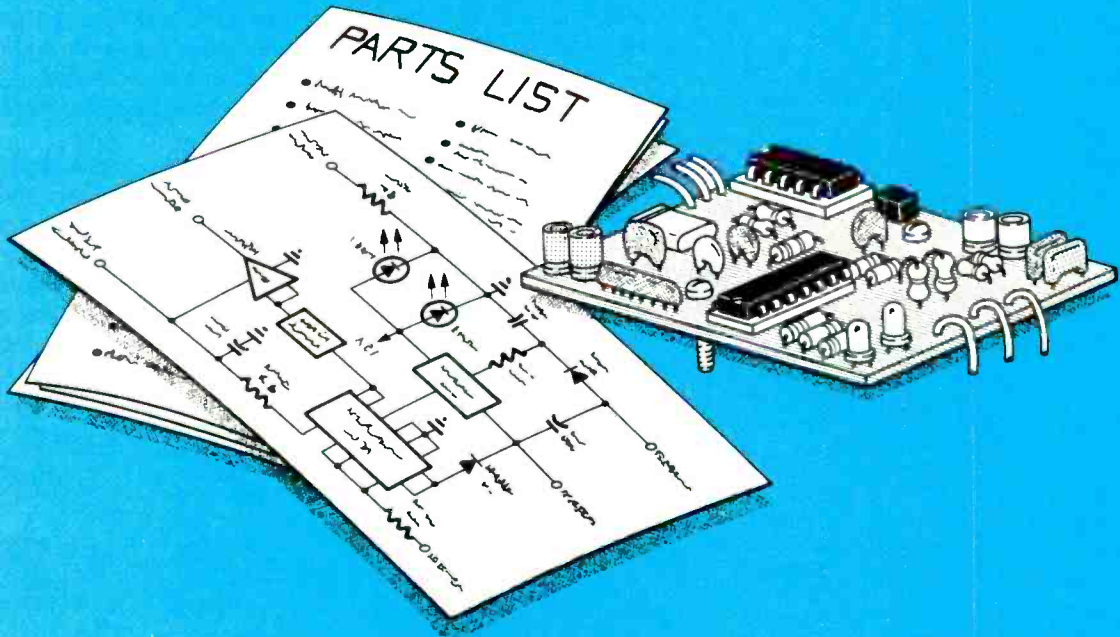

Complete files on projects can save you from hours of head scratching during repairs, and yet most hobbyists are much neater with solder than paper work. We present some hints on how to get your notes in order.

BY JACK CUNKELMAN

When you're caught in the rush to enjoy a newly completed project, its documentation usually falls by the wayside. That's fine until you have to repair the project or want to share it with someone else. Thoughts that were clear at one time are suddenly fuzzy. In the mind, details of changes and fixes made during construction become intermixed with those of other projects.

Working in an environment in which several people were responsible for the maintenance of custom-designed equipment forced me into the habit of documenting everything (well almost everything) I did. I became as proud of the documentation as I was of each project and the information was a lifesaver when a repair was necessary. That discipline spilled over to my home projects and has proved just as helpful.

In this article, I would like to inspire

you to cultivate the same habits. Since a schematic is the road map of any electronic project, what will follow are some tips on how to generate a schematic in a standard, orderly format. Then we will discuss the parts list, layout diagram, and block diagram. The tips that I will be offering are some of the techniques I use in my documentation efforts. For a more detailed look at this subject one of my favorite books is *Electronic Drafting and Design*, by Nicholas M. Raskhodoff, published by Prentice-Hall. With all that in mind, let's proceed.

Notes. Keeping good notes as a project progresses is essential. For that, a notebook, or at least a file folder, about each project is useful. Always write down any changes as you make them, while they are fresh in your mind.

If I am working on a design of my own, I make the notes about compo-

nent changes and design alterations on a working schematic. I later redraw the schematic using all the added information.

On projects from magazines, I usually like to photocopy the schematic, parts layout, and parts list, and then take the copies with me to the workbench. I note any part additions, deletions, and value changes that I make on the copies. Magazine projects that are built without modification need only the material from the magazine article included in its documentation package.

I also take a set of typical voltage and resistance readings at critical points in the working circuit and add them to the notes, and later to the final schematic. That information usually proves invaluable during repair sessions. Oscilloscope-waveform observations at these same critical points may also be appropriate. Sketches of the waveforms indicating

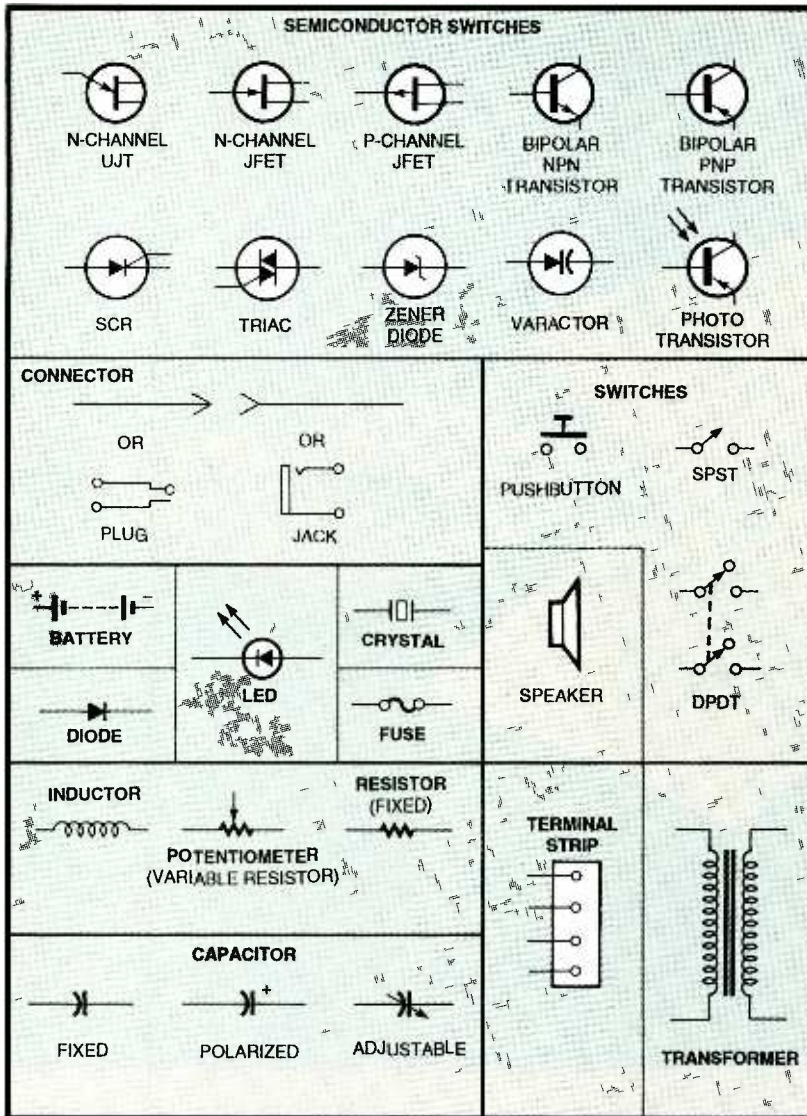

Fig. 1. Here are some of the most commonly used symbols for parts in schematics. You've probably seen all of them in this magazine at one time or other.

the peak voltage values should also be included in the notes.

Symbols and Lines. A schematic diagram is the single most important piece of information about any electronic assembly. Using a set of standard graphic symbols to represent each individual component, the schematic shows how the components are interconnected. Thumbing through this magazine should reveal many example schematics. Some of the more common component symbols are shown in Fig. 1.

Integrated circuits in schematics are represented by blocks or function symbols. A function symbol graphically indicates the function an IC performs, while a block, which is used to represent more complicated logic

functions, specifies only pinouts. Figure 2 shows some commonly used symbols and a block. Next to each pin on the inside of the block is its function label. The number of each pin appears just outside the block. Pin numbers should also be assigned to the function symbols when drawing your own schematics.

Blocks can also be used to represent repeated elements in a drawing. If a stage or section that contains many elements is repeated many times in a schematic, it is acceptable to draw the stage only once and then represent the stage later as a block with only its external connections labeled. Using blocks helps eliminate redundant details.

The symbolic components and blocks in a schematic are intercon-

nected with lines. When two lines cross and should be electrically connected, a dot is placed at their intersection to indicate the electrical junction. Two examples of that are shown in Fig. 3A. When two lines cross with no dot at the intersection, it means the lines are not electrically connected. Figure 3B illustrates that and two other methods used to show that two lines are crossing but not connected.

Following a particular line in a large group of closely spaced, parallel lines is difficult and it is easy to make errors. So there are techniques to group and simplify such bundles (see Fig. 4). In Fig. 4A notice that all the individual lines are grouped into a symbolic "cable" or bus, which spans the drawing.

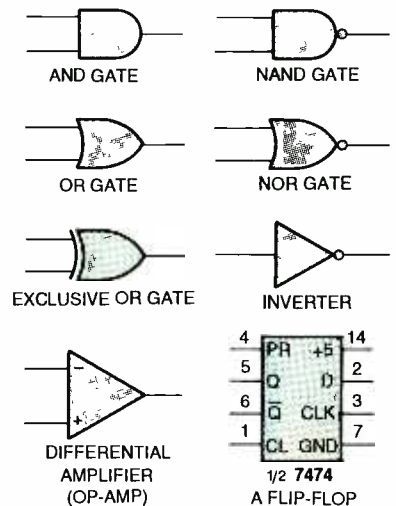

Fig. 2. Logic devices are often represented by a gate symbol or a block. A gate symbol reveals the operation performed by a gate to aid functional comprehension of a schematic.

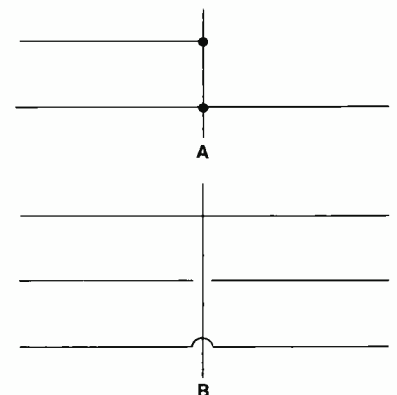

Fig. 3. Dots are used to indicate an electrical connection when two wire cross (A). If there's no dot, or if there's a gap or a hoop (B), it means the wires are not connected.

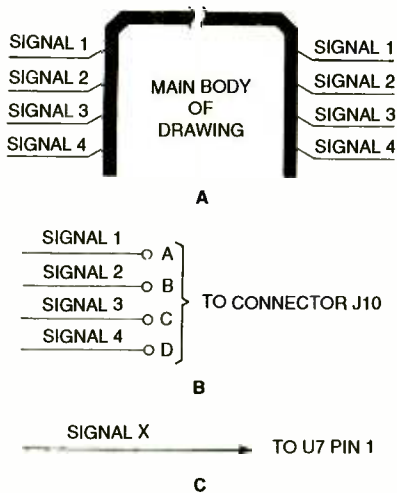

Fig. 4. Multiple wires crossing an entire schematic can look messy. However, they can be bundled in a bus (A), or grouped with a bracket declaring their destination (B). Single wires that have a ways to go can make use of an arrow instead (C).

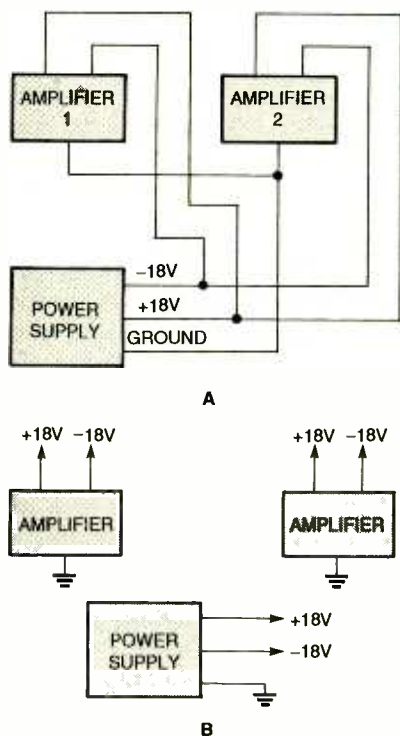

Fig. 5. Wiring power to every point in a circuit can get messy (A). A better method is to use arrows (as presented back in Fig. 4) and ground symbols (B) to avoid routing traces all over.

For clarity, a unique, descriptive label is attached to each line before it enters the bus, and again when it leaves. Multiple lines that run from one side of the drawing to the other can also be interrupted, bracketed, and labeled as shown in Fig. 4B. A method of interrupting a single line that would other-

wise have to be drawn across the whole drawing is shown in Fig. 4C.

Schematic Layout. The schematic as a whole should be clear and understandable. To that end, a little thought on how the symbols will be arranged on paper is worthwhile. The component symbols should be grouped into stages with all the components of a particular stage grouped around the main component of that stage. The main component in a stage may be a transistor, op-amp, digital IC, or whatever. Where possible, main-component symbols should be arranged with input(s) on the left and output(s) on the right (so key signals will flow from left to right).

You should consider breaking complex projects into smaller schematics to aid clarity. The power-supply section is a good place to start. Drawing it in an unused corner of a drawing, or even on a separate piece of paper, will make the main portion of the schematic more comprehensible.

How you route the power-supply lines is also important. Two power-distribution methods for a circuit are shown in Fig. 5. (Note that the power-supply and amplifier stages are represented by blocks.) In Fig. 5A, an interconnect line is drawn between each power-supply terminal and each op-amp block. That method should be avoided in all but the simplest of schematics. Note that the same information is presented in Fig. 5B but the diagram is more readable.

A couple of ground symbols snuck

TABLE 1—POPULAR DESIGNATORS

ITEM	DESIGNATOR
BATTERY	B
CAPACITOR	C
PLUG	P
JACK	J
CRYSTAL	XTAL
DIODE	D
FUSE	F
INDUCTOR	L
INTEGRATED CIRCUIT	U
LIGHT-EMITTING DIODE	LED
METER	M
POTENTIOMETER	R
RELAY	K
RESISTOR	R
SPEAKER	SPKR
SWITCH	S
TRANSFORMER	T
TRANSISTOR	Q
TUBE	V

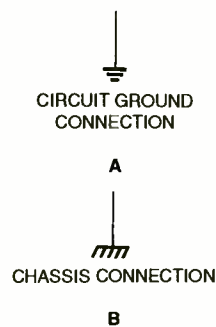

Fig. 6. The most typical ground symbol (A) is the power-supply ground. There is also a chassis-ground symbol (B), which denotes a point in a circuit that should be connected to a cabinet.

into in Fig. 5, so let's discuss them now. The ground bus is often portrayed as line that snakes thru the drawing. Figure 5A is an example of a drawing that uses a continuous line to connect each ground point. In a simple schematic that may be okay, but in larger schematics with many ground points, that would be difficult to follow. So a ground symbol is used at each ground-connection point, as shown in Fig. 5B.

The signal-ground and chassis-ground symbols shown in Figs. 6A and 6B, respectively, actually tell the reader how to route the ground wiring. They show two distinct types of grounds, so they are not interchangeable. A signal ground is usually connected to ground at only one point, the power supply. The chassis symbol tells the reader at which point a circuit connects to the chassis.

Component Identification.

Identifying parts with designations (R1, C2, etc.) and values (10Ω, 0.1-μF, etc.) is the next most important step in drawing a schematic. Attaching a designation to each part allows them to be individually keyed to descriptions in parts lists and any accompanying text. Table 1 lists some standard designation prefixes for components you are most likely to use in your schematics. The numbering for the designations should run from left to right and top to bottom on the schematic. Locate each designation as close to its part as possible. Note that vertical lettering should be avoided.

You should place the value of each component directly below its reference designation. When labeling resistor values, add a 0 to the left of the

decimal point if the value is less than 1 ohm. Values to 1000 ohms are shown as the actual value and the ohm sign (for example, 820Ω). Values above 1000 ohms use a "K" to indicate the 1000 multiplier (4700 ohms is labeled 4.7K). Values above 1,000,000 ohms need the MEG suffix to indicate the 1,000,000 multiplier (1,500,000 ohms is written 1.5MEG).

When labeling capacitors, values to 999 pF are shown in pF. Values above that are given in microfarads or μF's (1,000,000 pF = 1μF). Often times the micro symbol is dropped as it is simply understood, so a 1-μF capacitor is labeled just "1."

A note can be added to the drawing to show any extra labeling con-

ventions you are using. For example: "Unless otherwise specified: 1) Resistance values are in ohms or kilohms (abbreviated K); 2) Capacitance values are in microfarads."

Besides labeling component values, be sure to label all the switch terminals, terminal-block positions, and connector pins on the schematic. All terminations and connections to the outside world should be shown at the outer edges of the drawing.

Component Layout Drawing. Since the schematic drawing does not show the physical placement of components on the completed circuit board or assembly, a component-

layout drawing should be in the documentation. Although most assemblies will follow the schematic signal flow in general, specific component locations may be difficult to find without a layout. Furthermore, the job of stuffing a bare PC board is made much more difficult without it. Besides, taking the time to provide this drawing will pay for itself if troubleshooting becomes necessary later.

Figure 7 shows an example parts layout. Each component is represented by its actual physical shape and not its graphic symbol; for convenience, fixed resistors and capacitors can be shown as straight lines. The components are labeled with just their reference designations (not their electrical values) to reduce clutter.

A completed assembly that has several circuit boards and/or multiple connectors may need an assembly drawing. This is the same type of physical road map as the parts-layout drawing and actually may be a part of the parts layout drawing as is the case in Fig. 7. Shown there are connection points for potentiometers, switches, connectors, and cabling. Assembly drawings should show the physical placement of each sub-assembly and the wiring methods used between them (*i.e.*, cable shielding, ground points, etc.). The sub-assemblies may be shown as blocks with only the terminals that bring signals and power in and out of the boards identified and labeled.

Parts List. The parts list is where you should provide any information about parts that would not realistically fit neatly on a schematic. For example, use it to specify the power and tolerance ratings of the resistors, the types of capacitors that are used at critical points in the circuit, and even manufacturer's part numbers. The various kinds of components (*i.e.*, resistors, capacitors, etc.) should be grouped together and arranged in numerical order. Check out the parts lists in this issue to gain a feel for what they cover.

Block Diagrams. If your design is particularly complicated, a block diagram should be included in your documentation. A block diagram uses blocks as presented earlier to
(Continued on page 94)

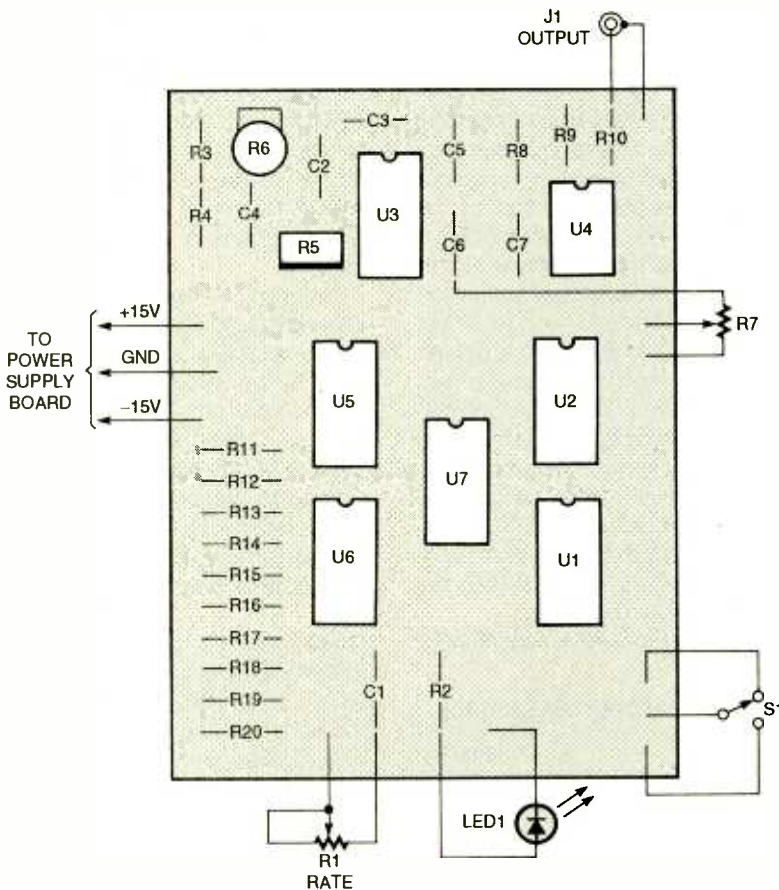

Fig. 7. When preparing a parts layout, it is just as important to indicate all off-board connections as it is to include all on-board parts.

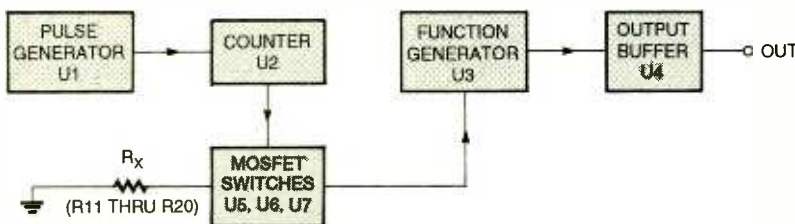

Fig. 8. Block diagrams can help you make instant sense of even the most complex devices.

Since the introduction of low-cost model rocket engines in the 1950's, building and launching small-scale rockets have been popular pastimes. While designing and finishing high-performance models is both interesting and challenging, it is also fun to design and build electronic gadgets to go along with them. One such gadget is the *Time-Delayed Launch Control* described in this article.

With the Time-Delayed Launch Control, you press the fire switch to initiate a launch sequence, then the circuit begins its countdown, giving you plenty of time to step back so that you can view the impending event from a safe distance, record the launch, or prepare to monitor experiments during the flight. At the end of a preset period, the circuit ignites the rocket's engine, sending it skyward.

The circuit has six preset delay intervals: 5, 10, and 30 seconds, and 1, 5, and 10 minutes. The circuit also contains a piezoelectric buzzer that beeps every few seconds as the system counts down to launch. As a safety feature, a launch sequence can be aborted at any time, simply by shutting the system off or by switching to the test mode. The main function of the test mode, however, is to verify, via a front-panel indicator, that the ignition circuit is properly wired. The circuit is powered from its own internal battery pack, which also provides power to the rocket-engine igniter.

Circuit Description. A schematic diagram of the Time-Delayed Launch Control is shown in Fig. 1. The circuit—which gives a choice of 6 delay settings—is comprised of three 555 oscillator/timers (U1–U3), a pair of transistors (Q1 and Q2), four switches (S1–S4), a piezoelectric buzzer (BZ1), and a few support components. Power for both the control circuit and the rocket-engine igniter is provided by a 6-volt power source that is comprised of 4 AA-cell alkaline batteries. Alkaline batteries are specified because other types are incapable of supplying the 1–3 amps required to fire a rocket-engine igniter. Closing switch S1 feeds power to the launch-control circuit, but does not initiate a launch sequence.

A pair of series RC circuits (R4/C9

A Time-Delayed Model-Rocket Launch Control

(C2 through C8). The timing capacitor is selected via DELAY SELECTOR switch S3. Positions 1 through 6 of S3 give intervals of 5, 10, or 30 seconds or 1, 5, or 10, minutes, respectively.

The high output of U1 at pin 3 is fed through current-limiting resistor R12 to the base of Q2, forward biasing it, which causes Q2 to turn on, allowing

the piezoelectric buzzer, BZ1, to turn on when the proper signal is applied to BZ1's negative terminal. Monostable U1's output is also fed to the reset input of U3 (which is configured as an astable multivibrator or oscillator) at pin 4, causing it to oscillate with a duty cycle of about 75% (as determined by C14, R10, and R11). As long as the output of U1 is high and the astable is oscillating, BZ1 beeps once every 4 seconds.

Resistor R5 discharges coupling capacitor C10 whenever U1's output goes high, while R6 maintains the normally high bias voltage required at U2's trigger input (pin 2). At the end of the selected time delay, U1's output goes low. That low is coupled through C10 and D1 to the trigger input (pin 2) of U2, which (like U1) is configured as a monostable multivibrator.

Components R7 and C11 set U2's high-output interval to approximately 3 seconds. During that 3-second interval, U2's high output at pin 3 is fed to Darlington transistor Q1 through R9 (which limits base-bias current to the device to less than 40 mA). With S4 in the LAUNCH position, Q1 grounds one end of the engine igniter, effectively connecting it to the battery's negative terminal. During that 3-second interval, approximately 1–3 amps passes through the engine igniter, causing it to glow and burn.

Construction. To assemble the launch-control circuit, you'll need all of the components listed in the Parts List. You'll probably want to customize the project, so pick out switches, a lamp, and a piezoelectric buzzer that will give your launch control an interesting and personalized appearance.

Start with the enclosure. The enclosure must be large enough to accommodate the printed-circuit board and all of the front-panel controls, and still leave room for the quad AA-cell battery pack. The overall di-



Add a touch of class and safety with this deluxe model-rocket launch-control circuit

BY DAN BECKER

and R8/C12, respectively) are used to debounce the reset inputs (pins 4) of U1 and U2 (a pair of 555 oscillator/timer IC's), thereby, preventing false triggering from occurring during power up or when switching modes. Pull-up resistors R1 and R2 effectively shunt capacitor C1, keeping it discharged until S2 (FIRE) is momentarily closed. When S2 is closed, C1's negative terminal is connected to ground through the switch, momentarily pulling pin 2 of U1 (which is configured as a monostable multivibrator, or one shot) low, activating it.

Once triggered, U1's output goes high for an interval that's determined by R3 and one of six timing capacitors

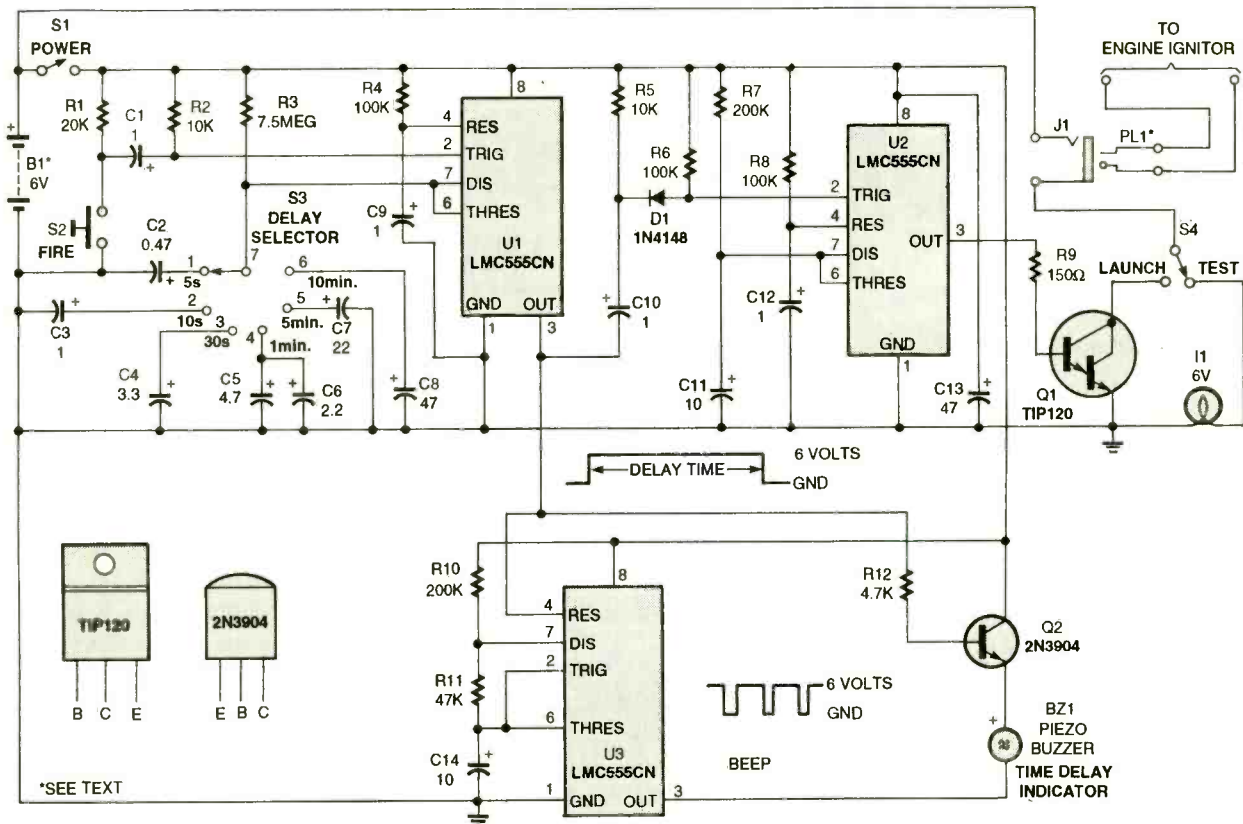

Fig. 1. As shown by this schematic diagram, the Time-Delayed Launch Control circuit—which gives a choice of 6 delay settings—is comprised of three 555 oscillator/timers (U1–U3), a pair of transistors (Q1 and Q2), four switches (S1–S4), a piezoelectric buzzer (BZ1), and a few support components.

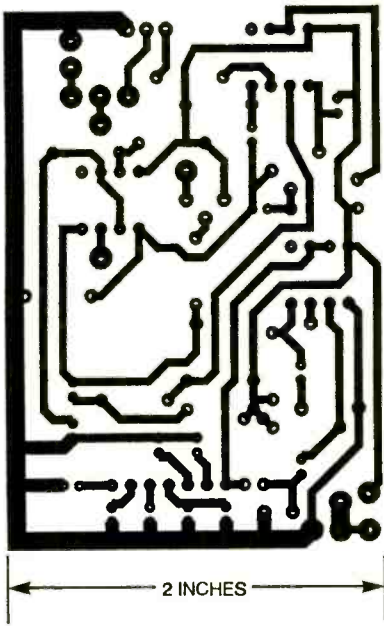

Fig. 2. The author's prototype was assembled on a printed-circuit board, measuring about 2 by 2¹³/₁₆ inches. Here is a full-size template of that printed-circuit layout.

mended that the circuit be housed in an brightly-colored ABS plastic enclosure. A plastic enclosure is recommended because you'll have to drill about ten holes in it, and ABS plastic is much easier to work with than steel or aluminum.

Choose a convenient location on the front panel for the test lamp (I1), the piezoelectric buzzer (BZ1), and the four switches (S1–S4). Mark and drill the mounting holes for those components. Then drill a hole in the side of the enclosure for phono jack J1. It should be located about 2 inches from the end of the enclosure where the battery pack will go. Clean any burrs from the holes and check all front-panel components for a proper fit; but do not mount them yet.

If you are unable to find a brightly colored enclosure, you can spray paint the one you choose after all the mounting holes have been drilled and deburred. If you must paint the enclosure, apply 2 or 3 thin coats of primer (or white), followed by 2 thin coats of a bright-colored paint. Give each coat a couple of hours to dry

before applying the next coat, then let it set overnight.

With that done, use dry-transfer (rub-on) lettering to label each switch position according to its function—the rotary switch with its delay times should be marked at each stop—and the test lamp.

After labelling, protect the dry-transfer lettering by applying one or two coats of clear lacquer. Allow all coats to dry several hours. The front panel is now ready for assembly. Mount BZ1, I1, and S1–S4, and J1 to the enclosure, and don't forget to install a knob on the shaft of S3.

Since the control circuit contains only three IC's and two transistors, you can easily assemble it on a small piece of perboard using wire-wrap or point-to-point wiring techniques. However, the author's prototype was assembled on a printed-circuit board that measures about 2 by 2¹³/₁₆ inches. A full-size template of that printed-circuit layout is shown in Fig. 2. Once you've etched the board, drill all holes with a No. 67 bit. That bit size will accommodate all of the component

PARTS LIST FOR THE TIME-DELAYED LAUNCH CONTROL

SEMICONDUCTORS

- U1-U3—LMC555CM CMOS oscillator/timer, integrated circuit
 Q1—TIP120, SK3180 (or similar) NPN Darlington transistor
 Q2—2N3904 general-purpose NPN silicon transistor
 D1—1N4148 general-purpose silicon diode

RESISTORS

(All fixed resistors are 1/4-watt, 5% carbon-film units.)

- R1—20,000-ohm
 R2, R5—10,000-ohm
 R3—7.5-megohm
 R4, R6, R8—100,000-ohm
 R7, R10—200,000-ohm
 R9—150-ohm
 R11—47,000-ohm
 R12—4,700-ohm

CAPACITORS

- C1, C3, C9, C10, C12—1- μ F, 16-WVDC, radial-lead electrolytic
 C2—0.47- μ F, 16-WVDC, radial-lead electrolytic
 C4—3.3- μ F, 16-WVDC, radial-lead electrolytic
 C5—4.7- μ F, 16-WVDC, radial-lead electrolytic
 C6—2.2- μ F, 16-WVDC, radial-lead electrolytic
 C7—22- μ F, 16-WVDC, radial-lead electrolytic
 C8, C13—47- μ F, 16-WVDC, radial-lead electrolytic
 C11, C14—10- μ F, 16-WVDC, radial-lead electrolytic

ADDITIONAL PARTS AND MATERIALS

- B1—See text
 S1—SPST toggle switch
 S2—Normally-open momentary-contact pushbutton switch
 S3—SP6T rotary switch
 S4—SPDT toggle switch
 J1—Phono jack
 PL1—Phono plug
 BZ1—Piezoelectric buzzer
 I1—6-volt incandescent lamp
 Printed-circuit board materials, enclosure, 7-conductor ribbon cable, quad AA-cell battery holder and connector, micro-alligator clips, knob, 22 AWG and 26 AWG stranded hook-up wire, solder, hardware, etc.

leads and the 22 AWG and 26 AWG stranded hook-up wire that will be used for the interconnections be-

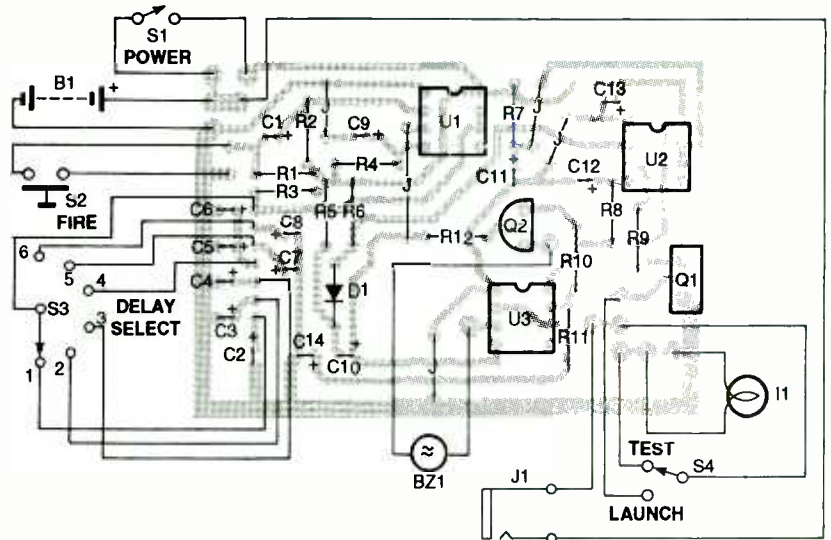

Fig. 3. Following this layout diagram, assemble the Time-Delayed Launch Control, keeping in mind that the polarized components must be installed with the proper orientation.

tween the board and the panel-mounted components.

Following the parts-placement diagram shown in Fig. 3, install the capacitors, making sure that they are all flush to the board, while observing their polarity. Likewise, install the resistors flat against the board. That minimizes lead lengths and gives a neater appearance. Install an 8-pin DIP socket at all IC (U1-U3) locations. That helps to eliminate the possibility of damaging the IC's, which are static sensitive, during soldering. Next, install transistors Q1 and Q2, taking care to properly align the emitter, base, and collector leads. Then, using hookup wire, or the excess leads clipped from the resistors, install the 5 jumper connections in the locations shown.

Cut six 8-inch lengths of 26 AWG stranded hookup wire. Twist pairs of wires together, making 3 pairs in all. Next, cut five 8-inch lengths of 22 AWG stranded hookup wire. Twist three of these wires together to make a 3-lead set for S4, and then twist the remaining pair together for S1. Once that's done, strip about an 1/8th inch of insulation from the ends of all the leads.

Solder one 26 AWG pair to the two printed-circuit pads that are identified as BZ1 in Fig. 3. Being careful to observe the correct polarity, solder the other ends of those leads to BZ1. Similarly, install the other two 26 AWG leads between the printed-circuit board and lamp I1, and the printed-circuit board and S2. Next, install the 3-

conductor 22 AWG wire set between the printed-circuit board and S4. Be careful to identify each of the three printed-circuit pads corresponding to the appropriate terminals of S4. Then solder the remaining 22 AWG pair between the printed-circuit board and S1.

Rotary switch S3 requires a 7-conductor cable. Use either 26 AWG or 28 AWG ribbon cable for S3. Cut an 8-inch length of 7-conductor cable and strip 1/8th inch from all ends. Following that, solder the cable to the appropriate printed-circuit board pads. Next, solder the other end of the cable to the rotary switch, making sure that lead number seven connects to the wiper. Install and solder the two leads coming from the battery holder to the printed-circuit board. Again, be certain to identify the correct polarity of each lead and each printed-circuit pad.

For the engine-igniter leads, cut two 3-foot or more lengths of 22 AWG stranded hookup wire. The actual length of this wire set depends on how far you want to place the control box from the launch pad—mine are about 3 feet. Once you've decided on the length, twist them together and strip about an 1/8th inch of insulation from both ends of each conductor. Solder a micro clip to one end of each lead. Push the other ends of the leads through the phono-plug sleeve, solder the two free ends to the tip and

(Continued on page 91)

Lightning and the Radio Listening Post

Here's the lowdown on lightning and how to protect your valuable equipment from those adverse pulses.

KARL T. THURBER, JR., W8FX

Lightning is real, lightning is dangerous, lightning kills. It's a natural phenomenon that can pack more than 200,000 amperes of raw destructive current in a single bolt. Each year over 100 people in the United States are killed by lightning, 500 people are injured, and over 10,000 fires are started.

So you should be aware of the possibility of damage to your radio and other electrical and electronic equipment, computers, telephones, FAX machines, modems, transmission lines, and antennas. Overvoltage conditions result in costly breakdowns and damage to your valuable equipment, but what can you do about it?

This article tells how to protect your radio listening post from lightning. We'll discuss what lightning is, why it's dangerous, and give examples of its destructive power. We'll also cover protection of AC power and telephone lines, antennas, towers, and transmission lines and proper grounding techniques. Accordingly, we'll cover lightning sensing and equip-

ment protection, and mention publications and equipment dedicated to lightning protection.

The Nature of Lightning. The legendary scientist, Ben Franklin, was the first to identify lightning as an electrical discharge through his famous kite experiment. It showed that lightning was a natural high-voltage discharge or electrical spark that takes place in the lower atmosphere between clouds or a cloud and the Earth.

The movement of air in weather patterns leads to the buildup of huge static electric voltages in clouds by accumulating charges through falling snow or rain. Negatively charged regions generally develop near the cloud bases and positively charged areas near the tops. When the voltage reaches a level where the air between a cloud and either the ground or another cloud can't insulate the charged cloud, an immediate and violent lightning bolt occurs.

The strike begins with a local breakdown of the atmosphere in the form of a "step leader." It steps about 150 feet every 50 microseconds, often over a distance of miles. The lightning-discharge core diameter is only 1-2 inches, while the electrified area surrounding this small core may be several feet in diameter. The intense fields created cause surrounding molecules to ionize.

The power exhibited during a lightning strike is enormous. The currents passing through the air in the discharge path are immense, and they can vaporize many materials. Potential differences of 100 million volts, or sometimes much more, may produce transient currents of up to 200,000 amperes.

Thunder is the audible sound wave generated by the lightning stroke. The sound of thunder appears to lag behind the lightning because of the relatively slow speed of sound compared with that of light; first you see the lightning and then you hear it.

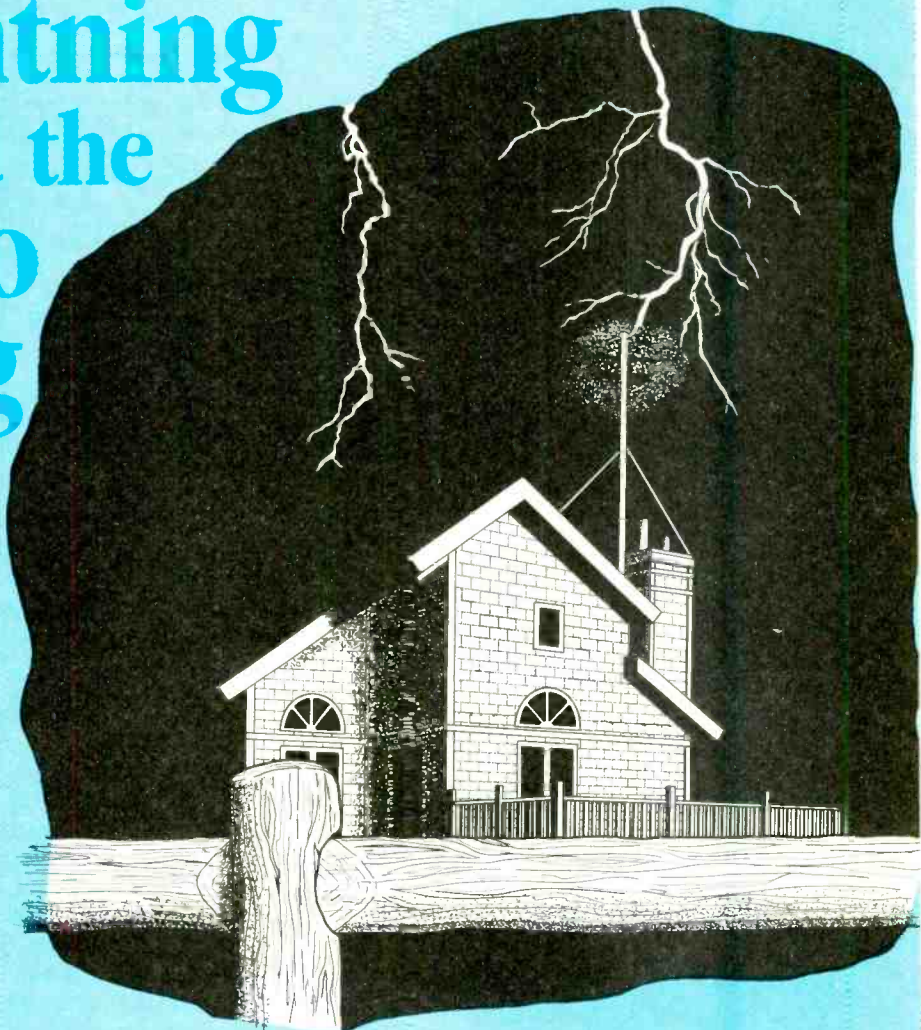

Lightning: Why It's Dangerous.

Ninety percent of lightning discharges are of the harmless intra-cloud type, but when lightning seeks its path through the earth, its power to destroy is awesome, and it's dangerous to you and your equipment.

The lightning discharge's main frequency range is from DC to several MHz. The current, reaches its peak in under 80 microseconds. The discharge declines less rapidly, in 200 microseconds or less. Although the discharge peaks and is over in a fraction of a second, that's long enough to exact a toll on buildings, trees, poles, homes, antennas, power lines, and anything else in its path.

Tall buildings and antenna towers can actually induce lightning discharges. Observers of lightning strikes on towers have noticed that an electrical leader sometimes appears to originate around the top of the tower, traveling upward into the cloud. Its streaked fingers point upward rather than downward.

Some Lightning Tales of Woe.

Besides the potential for physical damage to your home, even a nearby strike can wreak havoc. Transistors and integrated circuits can be destroyed. Capacitors and diodes can blow, receiver and transmitter antenna coils can melt, and contacts on RF switches can fuse. Not infrequently, your antenna rotor and rotor control box can be wiped out, and electrical fixtures and house wiring can be fused and melted.

One radio amateur I know experienced a direct hit on his station. The bolt destroyed the pole supporting his rhombic beam antenna, vaporizing the wire in the antenna itself. The RF stages of his receiver and the transmitter tank circuits weren't damaged since he had disconnected and grounded all his antennas, but the bolt knocked the nearby power-pole transformer to the ground.

All AC supplies left connected to the mains were burned out, unless they were fused on both sides of the line; all the AC power outlets in the home and most of the electrical wiring were damaged. Furthermore, many of the switch and relay contacts in various household appliances were burned or fused. In short, it caused a mess.

You're probably aware of the disastrous effects a direct lightning strike could have on your home and radio shack. But what of the "near miss" where lightning strikes nearby, causing your home to receive some lesser but still nasty and dangerous "induced effects?"

I suffered a nearby lightning strike several years ago, when a wayward



Most baluns place an antenna at DC ground potential and offer a limited degree of built-in protection from lightning-induced effects, though not from a direct hit.

lightning bolt struck somewhere in the neighborhood. While I couldn't find any physical evidence of the strike, its trail of "electronic death and destruction" wasn't hard to discover.

First, the telephones weren't working. The reason was that a new electronic memory phone had shorted out the phone line, apparently due to a surge on the line. I then found that the modems in both computers weren't working. I also found that several plug-in circuit boards on the two PC's had ceased to function, although the PC motherboards weren't damaged.

I also found that the meter in my Cushcraft vertical antenna's control box had shorted out, as had the small, hard-to-replace tuning motor at the

base of the antenna. Household TV sets went unscathed, although two cable TV (CATV) "block converters" also quit—the result of a surge or spike barreling down the CATV coax.

What surge suppression did I have installed? The computers and radio equipment were AC powerline protected, but I didn't have suppressors on the modems, telephones, rotor cables, or cable-TV line. I had erroneously thought surges on buried cable TV and telephone lines would be unlikely.

The AC-line surge suppressors helped that time, but more recently, during an electrical storm, I wasn't so lucky. A surge coming down the AC line was very selective, destroying an expensive VCR's power supply and that of a Bearcat scanner. Both devices were turned on at the time of the surge. They were both surge-protected, but the surge suppressors apparently didn't act fast enough to prevent damage, or the surge may have entered through the antenna.

The moral: buckle up your home and radio shack. While you can't do much about a direct hit, and you can't prevent all damage—as I found out—you can do a great deal to reduce the effects of a near miss. It can happen to you!

Protecting Your AC Power Lines.

While a direct hit by lightning is catastrophic and impossible to fully protect against, they are of low probability. The danger is that lightning strikes may be transmitted for a distance through utility lines as sufficiently large voltages all along the line. Most home lightning damage is caused by longer-duration high-voltage transients, called surges, and shorter-duration transients, or spikes, entering your home via the power mains. In fact, more than 90% of insurance settlements for lightning-related damages to homes and businesses are the result of lightning strikes picked up and carried by power lines.

While buildings themselves can usually survive high-intensity lightning strikes, electronic equipment is much less forgiving. The electronic circuitry in most electrical appliances is highly sensitive to voltage surges. Even relatively low-tech devices like furnaces and clothes dryers may have sensitive microprocessors within them. More

sophisticated devices such as short-wave receivers, scanners, VCR's, TV sets, amateur radio, and CB equipment are even more prone to electrical damage.

Point-of-Use Surge Suppressors.

For lightning strikes, in-line, shunt-type AC transient-voltage surge suppressors offer protection from spikes and momentary but potentially destructive overvoltage conditions. They do this by effectively clamping or limiting voltages to a safe level.

When you select a surge suppressor, whether of the conventional metal oxide varistor (MOV) or other silicon-based types, compare the performance specifications. The level of protection offered varies widely among similar-looking suppressors. Be suspicious of "no-name" suppressors for which specifications are not provided.

The total energy the unit can dissipate without burning out is a key selection criterion. The best models respond to block (without burning out) high-energy surges of at least 200 joules within a few nanoseconds; a 5-nanosecond response time (five billionths of a second) is typical. A joule is a unit of energy: one joule for one second is equal to one watt of power.

Another key spec is the clamping voltage, the voltage where the suppressor begins to block the surge. In practice, on three-wire residential 120/240-volt lines, look for a unit that has a low clamping voltage (around 300 volts or lower). Also, the unit should be capable of withstanding a surge voltage of at least 6500 volts and preferably 10,000 volts or higher.

Some surge suppressors also offer a measure of protection from electrical noise, such as broad-spectrum electromagnetic interference/radio frequency interference (EMI/RFI) reaching your equipment through the power lines. Such units can provide as much as 60 dB of filtering.

Whole-House Surge Protectors.

Ordinary circuit breakers react much too slowly to lightning-induced charges to be useful in protecting equipment and appliances. A so-called "whole-house" surge protector can protect all of the AC wiring circuits in your home from surges. You can mount one on the circuit breaker

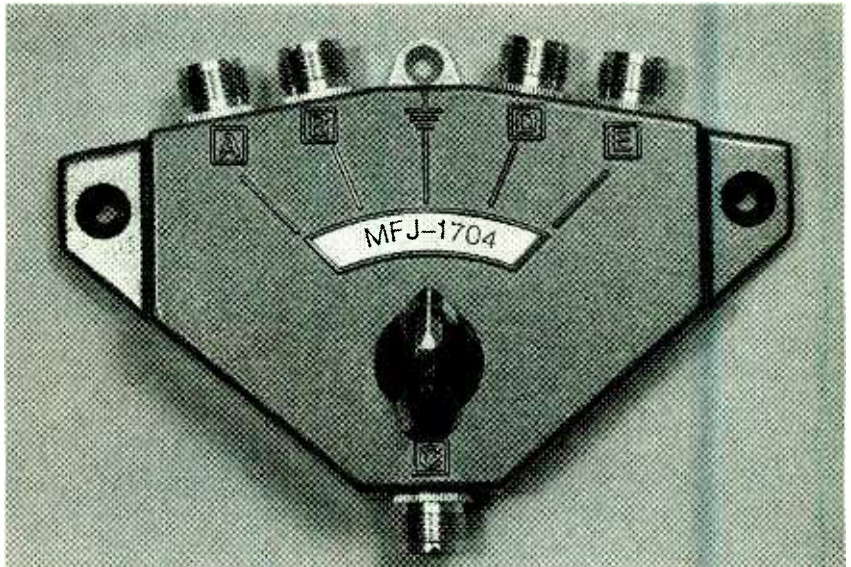

The MFJ-1704 coax switch has a ground position, automatically grounds unused positions, and works to over 500 MHz. A replaceable surge protection device helps protect against lightning-induced surges.

panel, or you can obtain one that's installed as a mounting adapter behind your electric meter.

The newest, least expensive, and easiest to install whole-house surge suppressor is built into a standard double circuit breaker. To install it, you mount it into your electric breaker panel like any other circuit breaker and attach a single wire to ground.

Whole-house surge protectors still can't save your equipment from a direct hit, but they can do wonders protecting your gear from lesser but still damaging electrical perils. The better units can clamp within 10 percent of the rated current entering the home, protecting against lightning-induced surges of up to 15,000 amperes. By the way, you should compare warranties: some manufacturers of whole-house protectors and circuit breakers will replace any damaged electronic appliances up to a specified value.

For protecting radio equipment, a combination of whole-house and plug-in, point-of-use suppressors installed and grounded close to the protected equipment can be highly effective for AC surges.

In some cases you may need a line conditioner to solve chronic high or low voltage conditions. Indeed, power brownouts and sags are much more common disturbances and disruptions than are surges and spikes.

Are You Well Grounded? There's an old radio axiom that says, "When in

doubt, ground it." Nothing could be more true when it comes to effective lightning protection. However, not just any old ground will afford adequate protection.

Lightning behaves like many other natural elements in that it's looking for the path of least resistance or impedance. Should it hit your antenna it's looking for a ground connection. If the best path is through your equipment, you will have disastrous results. When lightning strikes, it's important to quickly divert as much of the strike's energy to ground as possible.

Consequently, the most important single element affecting the effectiveness of most conventional protection equipment and devices is the integrity of the ground to which they are connected. Your first line of defense is to have a good and short connection between your antenna and tower to a good ground.

There are big differences in grounds for RF grounding and RFI (radio-frequency interference) suppression, for power returns, and for lightning protection. A good ground for one purpose may not be so good for another. A ground for RF effectively takes the place of "the other half" of a normal dipole (as in a ground-plane antenna), and often helps improve station efficiency and reduce RFI to nearby TV sets and radios.

A second type of ground is the power return or safety ground for electrical ground faults—your home's

power-line grounding system. This is a good ground for low frequencies (such as 60-Hz AC power) but may not be a good ground for RF or lightning. The third type is the lightning ground, which must be capable of handling high but short-duration currents; it's that type of ground we are most concerned with in this article.

Inside the Radio Shack. There are several things you can do to minimize lightning-related risk within the shack. You should connect all metal cabinets, control boxes, and shielded cables to a common ground bus or wire. The bus should, in turn, be connected to the main station ground system (a cold water pipe and/or outdoor ground rods) and the home electrical ground system. Gas or electrical conduit pipe shouldn't be used for grounding.

Several firms offer means of effecting common-point grounding of all station equipment. J. Martin Systems offers an inexpensive accessory, the Ground It bus, to facilitate common-point grounding. The bus helps protect equipment and makes chassis-ground connections short, with all the benefits good grounding brings. The Ground It system is a 1/8-inch by 1/2-inch solid-copper bus that provides an equipment grounding stud every six inches. The firm recommends a short but heavy gauge wire or grounding strap be used to make connections to a good earth ground, such as a six- to eight-foot ground rod. Four lengths are offered, from two to six feet, from \$11.95 to \$31.95.

Outdoors. Several six to eight-foot ground rods connected together with

heavy-gauge wire will usually provide a satisfactory ground outdoors. The more rods the better.

The main ground conductor should at the very least be a No. 8 wire. While the ground lead may be either insulated or bare, or even heavy copper braid, it should be protected from mechanical injury from lawnmowers, digging, and gardening. It should be connected to the ground rod through the shortest path possible with no sharp bends. Some operators even use small-diameter copper tubing as the connecting wire.

If your soil is dry and sandy, for best protection you should use at least two ground rods spaced at least 6 feet apart and bonded together by heavy wire or copper ground braid. You also can increase soil conductivity and help retain water by "doping" the soil with special salt compounds.

As for materials, inexpensive TV-type grounding hardware is a good value. The heavy No. 8 or 10 aluminum wire sold for grounding TV antennas is good, as are TV-type ground clamps. But be leery of using standard TV ground rods, as they are usually shorter than they should be.

Protecting Your Tower. A high tower or mast doesn't necessarily invite disastrous consequences during electrical storms, despite the fact that the frequency of strikes increases with height. Many radio enthusiasts have operated for years with towers that were the highest objects in the vicinity without suffering damage.

If there's a secret to protecting antennas, towers, transmission lines, and the radio shack, it lies in you—and not Nature—controlling the lightning

strike's energy. That means you must provide a direct path to ground so that the electrical charges picked up from the atmosphere during an electrical storm will be discharged directly and harmlessly to the earth, instead of through expensive equipment or your home. If you do the job right, the worst of the discharge will pass to the earth before blowing your radio shack away.

Ground all towers and masts, including those mounted on roofs. Metal towers are usually well grounded and don't need ground wires run up through the tower, although several ground rods can be attached to the tower legs. With wooden towers, you should run a very heavy ground wire all the way to the hardware on top of the tower.

If you have several coaxial cables coming off a tower, you might want to install cable-grounding blocks. They can help shunt lightning-induced voltages and establish a common-point neutral ground. Also arrange for some distance between the tower itself and the entry point of the transmission line to your home. Doing that will provide an opportunity for the ground to absorb strike energy before it enters the radio shack.

The good news is that a properly grounded tower can create a "cone of protection" over the property lying below it. Thus, the tower offers some protection to nearby lower structures, but only if it has a good, direct, low-impedance ground—one that has low ground resistance and inductance/capacitance values. The cone of protection can be enhanced by a copper, brass, or steel lightning rod at the very top of the tower, clamped to a mast extension above all the antennas. The sharp pointed rod discharges the immediate area around it before a large static buildup occurs.

Protecting Your Antenna.

Generally, all-metal beam antennas are partially self-protecting by their very construction: they are usually at DC ground potential through the mast and tower that support them. That protection assumes good connections, so it's wise to use an antioxidant conductive-grease compound to ensure solid contact and help prevent corrosion.

If you want to use a dipole or other

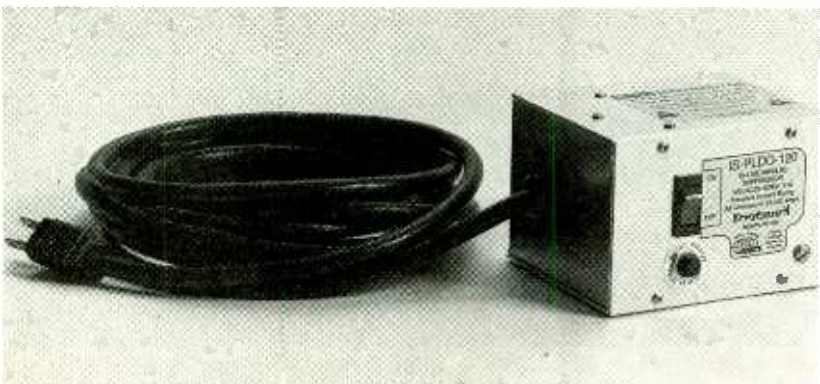

The PolyPhaser Model IS-PLDO-120 inline multistage AC protector has multi-strike capability and is circuit breakered for added protection. The unit can be mounted and grounded to a single-point ground plate. RF1 filtering also is provided.

antenna that normally uses a balanced (open-wire) transmission line, consider placing a balun at the antenna to allow coaxial feedline to be used. The balun, or balanced-to-unbalanced transformer, converts from the unbalanced coax to a balanced output by transformer action. Most baluns put the antenna at DC ground potential, offering a limited degree of built-in static-buildup and lightning protection.

Multiband antenna traps are unprotected from damage during an electrical storm, and induced currents from nearby discharges may cause damage. While it's possible to construct wire spark gaps across the traps, doing so may upset their operation. From a practical standpoint, traps can remain unprotected. Just replace them if they're damaged.

Don't forget to protect the ground-plane antenna. When this type of antenna is elevated above the ground, run a direct ground wire to its radial system. Don't rely on the coax feedline shield alone to provide grounding and lightning protection.

Protection for Your Transmission Line. Although the antenna proper may be well grounded at the business end, the transmission line can cause damage to your home or radio equipment if left unprotected, by acting as a conduit for static discharges. A good place to protect the coax line is where it enters the building.

Radio operators and commercial users often install coaxial bulkhead-adaptor connectors on a sheet metal bracket on the outside of the building where the cable enters, using an air-gap type of lightning protector in the coax line. The bracket is grounded using a length of No. 10 or larger wire to a ground rod.

Bulkhead adapters aren't easy to find these days, though you can purchase commercial bulkhead panels. A popular alternative is to simply install a commercial, preferably hermetically-sealed gas-discharge type plug unit or lightning arrester in the feedline where it enters the building. While nothing can promise protection from a direct strike, such units can head off problems from nearby discharges that might induce high voltages and currents in your equipment by bleeding off the charges.

Such units have a very short turn-on time. They contain a small spark gap that won't arc or short out even if you transmit through them, but will allow all high-voltage discharges to bridge the gap and be blocked and diverted harmlessly to ground. Several manufacturers offer such devices at very reasonable prices. At least one firm (Design Electronics Ohio, or DEO) offers units specifically for receiver protection (these are available from Universal Radio, Inc.).

It's also a good idea to use an antenna-selector switch that automatically grounds all antennas except the one in use and that has enough positions so that you can turn the antenna selector to an unused position when not using the equipment. Putting a couple of loops in your coaxial transmission line, either near the antenna or where the coax enters the radio shack, may also help prevent discharges from entering the shack.

While coaxial cable is the most popular and practical transmission line today, for receiving you can protect a flattop fed with ladderline or twinlead using a TV-type lightning arrester; just don't transmit, which might short out the device. Commercial

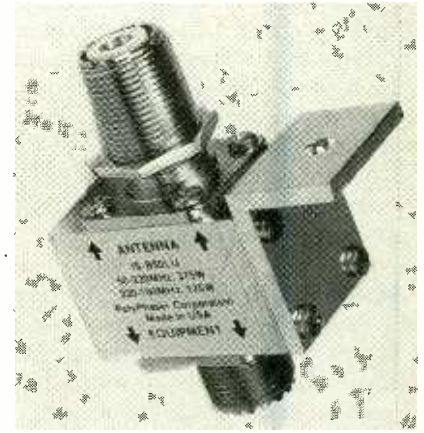

The PolyPhaser IS-B50LU broadband HF/VHF/UHF coaxial transmission-line protector is designed for bulkhead mounting. Available in three different models covering 1.5 MHz to over 1000 MHz, these general-purpose models work on most equipment, including receivers.

balanced-line suppressors are also available, though expensive. However, The Wireman, Inc., offers an inexpensive air-gap lightning arrester (\$26.50) for ladderline, plus a heavy-duty double-pole single-throw knife switch (at \$7.95) to shunt parallel transmission lines to ground when you're not using your gear.

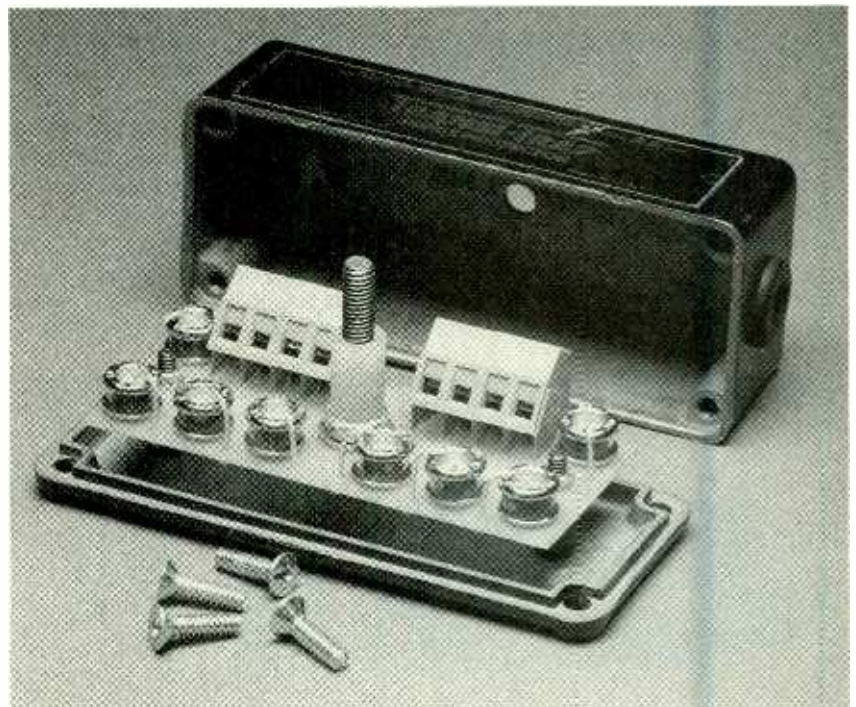

The Alpha Delta Model CLP Lightning Surge Protected Control Line Protector protects control lines to rotors, switches, telephones, and other equipment. The \$49.95 device can protect up to eight wires. Each is protected by a field-replaceable current gas tube Arc-Plug cartridge. During the period of a transient, the cartridges toggle to ground, effectively shunting the spike to ground.

NAMES AND ADDRESSES

Alpha Delta Communications, Inc.

1232 E. Broadway, Suite 210
Tempe, AZ 85282
Tel. (602) 966-2200.

Ameritron

116 Willow Road
Starkville, MS 39759
Tel. (601) 323-8211

Global Computer Supplies

1050 Northbrook Pkwy.
Suwanee, GA 30174
Tel. 1-800-845-6225

Industrial Communications Engineers, Ltd.

P.O. Box 18495
Indianapolis, IN 46218-0495
Tel. 1-800-423-2666.

LPS Enterprises

308 Sterling Dr.
Warner Robins, GA 31088
Tel. (912) 929-9416

MFJ Enterprises, Inc.

P.O. Box 494
Mississippi State, MS 39762
Tel. 1-800-647-1800.

J. Martin Systems

35 Hilltop Ave.
Stamford, CT 06907

McCallie Manufacturing Corp.

P.O. Box 77
Brownsboro, AL 35741-0077
Tel. (205) 776-2633

S.P. McGreevy Productions

45 Elda Drive
San Rafael, CA 94903

PolyPhaser Corporation

2225 Park Place, P.O. Box 9000
Minden, NV 89423-9000
Tel. 1-800-325-7170

Rabun Labs, Inc.

4407 Vineland Rd., Suite D-18
Orlando, FL 32811
Tel. 1-800-788-1824

Radioware Corp.

87 Belmont St.
N. Andover, MA 01845
Tel. 1-800-950-9273

Spi-Ro Manufacturing, Inc.

P.O. Box 5500
Lakeland, FL 33807
Tel. (813) 646-7925

Tytewadd Power Filters

704 W. Battlefield Rd.
Springfield, MO 65807
Tel. (417) 887-3770

Unadilla Manufacturing Co., Inc.

P.O. Box 4215
Andover, MA 01810
Tel. (508) 475-7831

Universal Radio, Inc.

6830 Americana Pkwy.
Reynoldsville, OH 43068
Tel. 1-800-431-3939

The Wireman, Inc.

261 Pittman Road
Landrum, SC 29356
Tel. 1-800-717-9473

In any case, lightning arrestors, of whatever type, installed in the transmission line—especially if located indoors at the back of a receiver or transmitter—should be considered to offer only secondary protection from static buildup, or to divert whatever is left of a nearby lightning strike. The primary protection should be the measures you take with the tower, antenna, and transmission line outdoors.

Protecting Your Modem and Telephone Equipment.

Most of us protect sensitive electronic equipment from potentially damaging powerline surges. But few of us apply similar protection to the telephone line for the well-being of modems, phone patches, telephones, and FAX machines.

The telephone wiring entering your home can route dangerous transients to your equipment. Microprocessors and other solid state devices are

often blown by phone-line spikes that are insufficient to trigger the telephone company's line protector, but which are strong enough to affect individual devices connected to the line.

Theoretically, no damage to electronic equipment should occur if the phone line is properly installed and protected by the telephone company. Most home telephone circuits are protected at the point the phone line enters the home by a device designed to short to ground when the voltage exceeds a preset level. But this voltage is relatively high, and the suppressor may not act fast enough to be effective. It may also be burned out.

While cases of a telephone-line surge passing through the modem to damage the computer itself are rare, it can happen. You can eliminate that possibility by disconnecting the modem and other expensive devices

connected to the telephone line whenever dangerous weather conditions dictate.

Surge suppressors are available to further reduce or eliminate this source of damage. Inexpensive commercial protectors are available from most computer, electronics, and office-supply houses and distributors. The desirable surge ratings of modem and FAX suppressors are similar to those for AC surge protectors. Many AC surge protectors also feature telephone protection as an added feature.

Lightning Sensing. Another old radio saying is that, during a storm, the only safe conductor is a grounded conductor. That means that antennas should be disconnected and grounded whenever a storm develops. You can do that manually, guessing the presence of a storm or relying on special sensors, or it can be done automatically by lightning-detection devices.

To that end, McCallie Manufacturing Corp. offers Stormwise Lightning Alert advance storm warning and lightning sensors. These devices warn that thunderstorms, with the possibility of dangerous lightning, are approaching your area—before you can see the lightning or hear the thunder. The warning gives you time to shut down and disconnect your equipment.

One example of their products is the Model LSU-222A Lightning Storm Detector. It has an omnidirectional sensor that alerts you to approaching cloud-to-ground lightning strikes. The device indicates if the lightning is far or near by the volume of the alarm warning tone, which sounds on each lightning strike detected. A three-way alarm feature lets you choose a loud alarm, hear each unique lightning return-stroke "signature pattern," or have the alarm beep when a "lightning burst" (of 40 or more strokes per second) is detected.

The weatherproof, \$29.95 (plus \$3 S/H) device uses a patented Extremely Low Frequency/Very Low Frequency impulse sensor said to provide accurate warnings over extended ranges, with immunity to manmade or radio-skip static. The sensor, which includes a buzzer alarm, mounts on a TV mast or pole. It draws no power from its

battery unless lightning activity is sensed. When it detects lightning, the sensor drops from an infinite resistance to a level where current flows through it, activating an alarm. (You do have to provide some common parts—a 9-volt battery and connector, cable, ground rod and wire, on/off switch, and other small parts—yourself.)

You can also use the device with a computer for recording and graphing real-time lightning data. The optional computer program records, counts, and graphs over 100 lightning detections per second. The \$39.95 software program includes the software diskette, instructions, and an electrically isolated serial port interface for the LSU-222A detector.

LPS Enterprises offers inexpensive antenna switching and automatic antenna-, modem-, and rotor-disconnect products. Centerpieces of the line are the ASW-series coaxial-antenna switches, that come with or without the automatic antenna-disconnect feature. The devices switch between two or three antennas and protect equipment from discharges when not in use. They operate on 12 VDC, using the same power source as your radio equipment. When power is shut down, the antennas are disconnected and equipment inputs are grounded. Several versions are available starting at \$39.

LPS Enterprises also offers the AMD-1 Automatic Modem Disconnect system. It protects your computer's modem from static discharges and voltage surges; when you shut down, the phone line to your equipment is disconnected. Another device is the ARD-1 Automatic Rotor Disconnect. It protects your rotor control box in a similar manner. When power is shut down, the control box is disconnected and the inputs to the rotor are grounded. The \$39 device handles up to eight lines.

For protective systems that may approach the "ultimate" in equipment protection, Rabun Labs offers several versions of its Incipient Lightning Detection and Protection (ILD/P) System. The Rabun ILD/P system continually monitors the atmosphere and detects the presence of lightning when a storm is two to ten miles away. It looks for specific signal profiles and lightning signatures and filters out fre-

quencies occupied by manmade devices. The system protects equipment by automatically disconnecting everything: AC power, coaxial cables, and telephone lines. The system automatically restores power and other connections after a period of time and when the storm has passed safely out of the local area.

Rabun Labs offers about a dozen ILD/P models for amateur-radio and other two-way communications gear, radio-receiving equipment, satellite-receiving systems, PC's, well-pump motors, air-conditioning compressors, and more. Other models automatically power standby AC-power generators and provide emergency notifications and alarms, detect power surges, or just provide warnings. Prices range from under \$200 to \$1000, depending on the application and features.

Publications and Catalogs.

PolyPhaser Corporation's *Lightning/EMP and Grounding Solutions* catalog is a valuable reference for lightning suppressors and protectors, grounding products, and test equipment. Several pages are devoted to highly instructive lightning-protection and grounding information.

Hundreds of commercial- and military-quality products are offered. They include coaxial-cable impulse, data/telephone-line, power supply, and inline power-mains protectors; copper straps and grounding clamps; ground rods; gas-discharge tubes; bulkhead-entrance panels; test equipment; and more. The company also offers a free newsletter, appropriately titled *Striking News from PolyPhaser*.

Grounding is so important that the company also produced a book about it. They offer Roger R. Block's 95-page, 8½ × 11-inch reference book, *The Grounds for Lightning & EMP Protection*. The Second Edition features very comprehensive information analyzing proper techniques for grounding and protection against lightning. The book's emphasis is on radio communications, telephone, computer, office, local-area network (LAN), CATV, and TVRO use. Though primarily oriented toward commercial installations, the book is written in a non-technical manner. It's available for \$22.95.

Industrial Communication Engineers, Ltd.'s catalog shows a wide range of low-cost antenna-accessories for amateur, commercial, and government applications. RFI filters, signal splitters, RF-tight enclosures, coax lightning suppressors, grounding blocks, ground-rod mounts, tower-leg mounting kits, and rotor-cable voltage suppressors are offered. Also featured are guy-wire grounding kits, cable assemblies, lightning-protected longwire and Beverage-antenna resistive loads and matchers, CATV/TVRO suppressors, chemical-treatment products, and related accessories.

ICE engineers have prepared several one-page technical publications for customer use. They are single-sheet, 8½ × 11-inch reports that cover a variety of subjects related to the use of ICE and competitors' products, station design and construction, and lightning protection. The concise publications are written in easy-to-understand, non-technical language.

Topics in the area of lightning protection and grounding include: lightning protection for radio facilities (publication numbers 30, 30A, and 30B); grounding techniques (numbers 31 and 31A); water-pipe and service-joint grounds (number 32); comparative analyses of coax lightning arrestors (numbers 33, 33A, and 33B); grounding coax-cable shields (number 36); using anti-oxidants for good interconnections (number 60); and DC-grounded antennas (number 80). Industrial Communications Engineers also offers a listing of the free publications and a catalog.

Wirebook II is a very concisely written, 56-page booklet that is billed as a how-to-do-it source manual for coaxial cable and connectors, antenna wire, baluns, lightning protection, grounding, and RF and antenna accessories available from The Wireman, Inc. Not a technical report, it's a highly readable collection of hints, tips, and advice from a variety of sources. The *Wirebook II* is \$2.

In summary, while you can't prevent lightning, learning something of its properties might help you protect yourself and your equipment from at least some of its destructive potential. We hope that this article has helped you do just that. Don't wait for lightning to strike. Protect yourself now. ■

GIZMO®

A CHRONICLE OF CONSUMER ELECTRONICS

Virtually Real

WCES 94: Where's the Hype?

This past January in Las Vegas, something different could be found on the floor of the 1994 Winter Consumer Electronics Show: feet. Manufacturers' feet, to be precise—planted firmly on the ground. That's quite a departure from the usual "head-in-the-clouds, pie-in-the-sky" posturing that's been standard fare at recent Consumer Electronics Shows.

At WCES 94, the emphasis was on product, not prototype. Real products that we could see, feel, hear, and play with on the show floor—and that you can buy in local stores. MiniDiscs, digital compact cassettes (DCC), personal digital assistants (PDA), and 3DO players have been on the shelves since last year. The first satellite for Thomson's Digital Satellite System (DSS) system was launched in late December 1993. DSS will be available in some markets by the time this magazine hits the stands, as will the StarSight on-screen program guide/automatic VCR programmer.

For the most part, progress reports re-

placed promises, but that doesn't mean that the consumer-electronics industry is forsaking the future for immediate profits. There was plenty of talk about the coming information superhighway and what it might mean in terms of new consumer-electronics products and services.

Still, the distinct lack of hype—at least in comparison to past shows—made WCES 94 seem quieter than usual. In reality, that was not the case. In fact, the show set a record for the amount of exhibit space, breaking the 1,000,000-square-foot mark for the first time in CES history. Attendance was up as well, with more than 82,000 attendees registered by noon on day three of the show, compared to a total attendance of 78,500 last year. In general, exhibitors and attendees alike had an upbeat attitude, coming off a good Christmas selling season.

In its physical layout, the Winter Consumer Electronics Show reflected the recent convergence of some technologies, and the entry of other technologies into the realm of consumer electronics. AT&T, for instance, moved from the telephone-exhibit area to the main floor. The company still exhibited phones, but the emphasis at the booth was on interactive networked multimedia in a variety of formats. The computer industry was out in force, with a record number of hardware and software

manufacturers displaying a wealth of multimedia titles and machines, along with more traditional computer products. Apple Computers was on the main floor for the first time, as was Intel.

So, despite the less frenzied atmosphere, there was plenty to see at WCES 94. In this article, we'll provide a status report on the things you can buy now, and a look at what's being touted as the future of consumer and communications electronics. Throughout this article we'll highlight coverage of the more interesting products that made their debuts at the show.

The Here and Now

Multimedia, PDA's, and other computer-related products might be the headline makers, but the bulk of consumer-electronics dollars is still spent in traditional product categories—audio and video, in particular. In both of those categories, recently introduced technologies deserve mention.

Adventures in audio

In the audio world, the MD-versus-DCC battle plods on—albeit leaving the average consumer untouched and unimpressed. Nevertheless, several new Mini-Disc products were introduced, most by Sony, and dramatic price breaks made news on the DCC front.



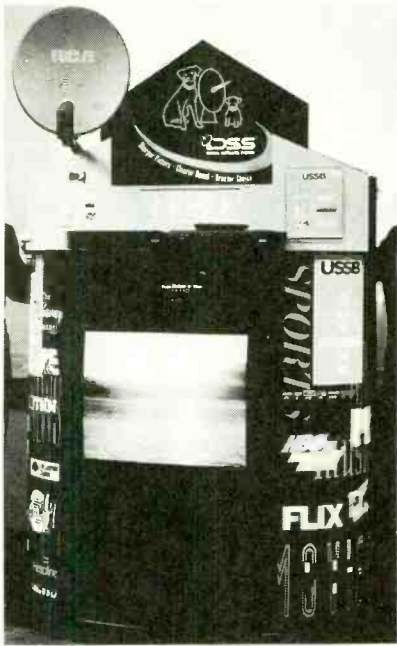

Keep an eye out this spring for Thomson's DSS kiosk in a store near you.

Another audio technology that has yet to touch the lives of most consumers is RBDS: Radio Broadcast Data Service. The roll-out continues, with heavy backing from the Electronic Industries Association Consumer Electronics Group (EIA/CEG).

Although we heard total MiniDisc 1993 sales figures of 70,000 bandied about, Sony was the only company quoting solid numbers. That company shipped some 50,000 units to dealers in U.S. alone last year. That might not sound like much, but it's far higher than the first-year figures for VCR's or CD players.

Newcomers to the MD camp include Clarion and Denon; Kenwood, Sharp, and Sanyo also displayed new products. Clarion's four-disc, in-dash MD changer should be available in April for \$999. Kenwood announced a \$1299 home MD deck, sized to fit mini-component systems. Sharp's first MD portable with record capability will be in stores by May. Designed for low power consumption, it uses a rechargeable lithium battery that provides 2½ hours of playback or 2 hours of recording on a single charge. An optional alkaline battery pack provides up to nine hours of playback time. Sanyo's three-disc, in-dash AM/FM/MD changer with detachable faceplate will be available in June for \$1499.

Sony introduced a full line of second-generation MiniDisc products at the Winter Consumer Electronics Show. It included the company's first MiniDisc in-

Senior Writers: Chris F. O'Brian, Teri Scaduto. ©Gernsback Publications, Inc., 1994. Gizmo is a registered trademark. All rights reserved.

dash car changer/tuner, the four-disc MDX-400 (\$1299.95); the MDX-40 four-disc component MD changer (\$999.95); and the MDX-100 in-dash MD receiver (\$999.95). Although Sony has touted MiniDisc as a portable format, the company introduced a full-size, full-feature home deck, the MDS-501 (\$999.95), with advanced disc-recording and editing capabilities. Sony's portables have become more so: The cassette-case-sized MZ-E2 MD player is half the size of its predecessor, and the MZ-R2 MD Walkman recorder is 60% smaller than the first-generation model. Unfortunately, prices haven't dropped proportionately; suggested retail prices for the MD player and recorder are \$549.95 and \$749.95.

DCC is still alive, if perhaps not kicking as strongly as MD. No new DCC manufacturers were announced at the show, and few new products were introduced. However, those new products—and some 1993 models—featured significantly lower prices than their predecessors. A new home DCC deck from Technics will carry a suggested retail price of \$599 when it ships in June, compared to the \$999 price

tag of the company's previous home deck. Marantz announced similar price cuts on its home DCC decks.

Both camps announced publicity campaigns designed to educate consumers about their products. Sony has teamed with *Rolling Stone* magazine in a promotion that will give one-million magazine subscribers a free MD sampler, which will be attached to the cover of the magazine—a unique way to make "the cover of *Rolling Stone*," as the song goes. On the DCC front, Philips has been offering free DCC cassettes to those who buy the company's portable DCC player.

It remains to be seen which format—if any (or both)—will prevail with consumers. MiniDisc appears to be more robust to date, due in part to its use of optical technology, sure to appeal to those who already appreciate the benefits of CD. DCC's backward compatibility with standard audio cassette tapes sounds like a good idea—but is it realistic to expect those who are still collecting tapes (many of whom haven't even adopted CD's yet) to fuel the introduction of a new digital audio technology?



Sharp introduced its first portable MiniDisc player with record capability, the model MD-M11.



Sanyo's MDR-300 in-dash, 3-disc MiniDisc changer features a detachable face plate.

Also making audio news at WCES 94 was the Radio Broadcast Data System, or RBDS, the technology that allows radio broadcasters to transmit digitally displayed text along with their regular programming. Consumers who own RBDS radios will be able to see displayed radio station call signs and frequencies, traffic and weather alerts, artist or programming information, and advertisements. The RBDS service, which is sometimes misnamed "video radio," is currently being broadcast by more than 80 FM stations in the United States.

The EIA/CEG is actively pushing RBDS with a promotional campaign that targets broadcasters as well as consumers. Plans unveiled at the show include offering the top six stations in ten major markets the chance to test out RBDS technology for free. Stations in Atlanta, Boston, Dallas, Los Angeles, Miami, New York, Philadelphia, San Francisco, Seattle, and Washington, D.C., will receive comprehensive information kits along with an RBDS encoder (model RE-533 from RE America). A print and electronic media campaign will round out the promotion. According to Gary Shapiro, group vice president of the EIA/CEG, "By providing an opportunity for radio stations to sample the benefits of RBDS technology and extend those benefits to consumers, the EIA hopes to build momentum for RBDS demand in the United States."

As that demand grows, several companies—including Denon, Jensen, Delco, Blaupunkt, Panasonic, and Goldstar—will meet it. Denon is also conducting a promotional campaign, offering 40 radio stations the RE-533 encoder in exchange for ad time that will be used to introduce Denon's RBDS gear.

Take control of your video

A group of seemingly disparate video products and technologies displayed at WCES 94 have the empowerment of the viewer in common. An array of devices promises more control over programming and program providers, more channels to choose from, better audio and video quality, easier VCR time-shifting, clever remote controls, and even freedom from commercials.

Perhaps the most exciting development in the video sector is the launch—and we mean that literally—of Thomson's Digital Satellite Service, or DSS. Those of you who already own home satellite systems might have caught the December 16th launch of the high-powered Hughes DBS1 bird from French Guiana. (A second satellite is scheduled for launch in June.) Many more people will now be able to experience some of the benefits of direct satellite broadcasts—superior audio and video quality and greater programming vari-



The second-generation MD line from Sony includes portable, automotive, and home MiniDisc products.



Blaupunkt's Houston RCM84 FM/AM/cassette receiver with CD changer control offers RBDS capability.



The RBDS receiver/cassette player from Delco receives and decodes the digital RBDS signal, and displays text messages.

ety—using a stationary dish that measures only 18 inches in diameter and a set-top DSS IRD (integrated receiver/decoder). The entire system will cost between \$700 and \$900, not including installation (add another \$200 to hire a pro; DIY kits will be available for under \$100).

When both high-powered satellites are transmitting programming, as many as 150 channels will be available. Those will include most major cable services, such as HBO, Encore, Cinemax, ESPN, the Sci-Fi Channel, Discovery, the Disney Channel. Pay-per-view movies and sporting events also will be offered. Because of DSS's

available channel capacity, popular movies will be shown on multiple channels with starting times every half-hour or so. Digital audio and data services are also planned. (To receive basic network services, however, you will still require an antenna or cable box.)

In some ways, the DSS system is actually a cross between satellite systems and cable service, with some of the benefits of the former and drawbacks of the latter. Although it can't compete with the more than 200 channels available to standard TVRO owners, DSS makes up for that in convenience; it offers easy on-screen pro-

NAMES AND ADDRESSES

AMERICA ONLINE, INC.
8619 Westwood Center Drive
Vienna, VA 22182-2285
CIRCLE 50 ON FREE INFORMATION CARD

APPLE COMPUTER, INC.
20525 Miriani Ave.
MS 305 4Q
Cupertino, CA 95014
408-974-9717
CIRCLE 51 ON FREE INFORMATION CARD

ARISTA ENTERPRISES, INC.
125 Commerce Drive
Hauppauge, NY 11788
516-435-0200
CIRCLE 52 ON FREE INFORMATION CARD

AST COMPUTER
16215 Alton Parkway
Irvine, CA 92718
714-727-4141
CIRCLE 53 ON FREE INFORMATION CARD

ATARI CORPORATION
1196 Borregas Avenue
Sunnyvale, CA 94089
408-745-2019
CIRCLE 54 ON FREE INFORMATION CARD

AT&T CONSUMER PRODUCTS
5 Wood Hollow Road, 3L11
Parsippany, NJ 07054
201-581-3000
CIRCLE 55 ON FREE INFORMATION CARD

AT&T INTERACTIVE PRODUCTS
919 East Hillside, Suite 275
Foster City, CA 94404
415-578-1761
CIRCLE 56 ON FREE INFORMATION CARD

BLAUPUNKT
2800 South 25th Avenue
Broadview, IL 60153
708-865-5654
CIRCLE 57 ON FREE INFORMATION CARD

CASIO, INC.
570 Mt. Pleasant Ave.
Dover, NJ 07801
201-361-5400
CIRCLE 58 ON FREE INFORMATION CARD

CLARION SALES CORPORATION
661 W. Redondo Beach Blvd.
Gardena, CA 90247
310-237-9100
CIRCLE 59 ON FREE INFORMATION CARD

COMMODORE INTERNATIONAL LTD.
1200 Wilson Drive
West Chester, PA 19380
CIRCLE 60 ON FREE INFORMATION CARD

COMPAQ COMPUTER CORPORATION
P. O. Box 692000
Houston, TX 77269-2000
713-374-0670
CIRCLE 61 ON FREE INFORMATION CARD

DCC GROUP OF AMERICA
1900 South Sepulveda Blvd. #311
Los Angeles, CA 90025
310-478-3110
CIRCLE 62 ON FREE INFORMATION CARD

DELCO ELECTRONICS CORPORATION
One Corporate Center
Kokomo, IN 46904-9005
317-451-0658
CIRCLE 63 ON FREE INFORMATION CARD

DENON AMERICA, INC.
222 New Road
Parsippany, NJ 07054
201-575-7810
CIRCLE 64 ON FREE INFORMATION CARD

DIRECTV
P. O. Box 92424
Los Angeles, CA 90009
310-535-5062
CIRCLE 65 ON FREE INFORMATION CARD

ECLIPSE MOBILE ELECTRONICS
19600 South Vermont Ave.
Torrance, CA 90502
310-532-3062
CIRCLE 66 ON FREE INFORMATION CARD

EIA/CEG
2001 Pennsylvania Ave. NW
Washington, DC 20006-1813
202-457-8700
CIRCLE 67 ON FREE INFORMATION CARD

GEMSTAR DEVELOPMENT CORPORATION
135 N. Los Robles Avenue
Suite 870
Pasadena, CA 91101
818-792-5700
CIRCLE 68 ON FREE INFORMATION CARD

GOLDSTAR ELECTRONICS INTERNATIONAL, INC.
1000 Sylvan Avenue
Englewood Cliffs, NJ 07632
201-816-2000
CIRCLE 69 ON FREE INFORMATION CARD

INTEL CORPORATION
2200 Mission College Blvd.
San Jose, CA 95052
CIRCLE 70 ON FREE INFORMATION CARD

INTERNATIONAL JENSEN, INC.
25 Tri-State International Office Center
Suite 400
Lincolnshire, IL 60069
800-323-0707
CIRCLE 71 ON FREE INFORMATION CARD

INTUIT
P. O. Box 3014
Menlo Park, CA 94026
CIRCLE 72 ON FREE INFORMATION CARD

JVC COMPANY OF AMERICA
41 Slater Drive
Elmwood Park, NJ 07407
201-794-3900
CIRCLE 73 ON FREE INFORMATION CARD

KENWOOD USA CORPORATION
2201 E. Dominguez
P. O. Box 22745
Long Beach, CA 90801-5745
310-639-9000
CIRCLE 74 ON FREE INFORMATION CARD

MARANTZ USA
1150 Feehanville Drive
Mount Prospect, IL 60056
708-299-4000
CIRCLE 75 ON FREE INFORMATION CARD

MEDIAVISION
47300 Bayside Parkway
Freemont, CA 94538
510-770-8600
CIRCLE 76 ON FREE INFORMATION CARD

gramming guides, does not require repositioning to pick up different satellites, and is easier to install and not as obtrusive as a large dish. And although DSS's quality and programming choices leave today's cable systems in the dust, DSS owners still won't have the myriad package options available to TVRO owners (nor will they be able to pick up the wild feeds and odd-ball shows that make TVRO channel flipping so interesting). Only two suppliers—

USSB and DirecTv—are offering programming packages, but most cable subscribers would agree that two is better than one, and between the two a wide variety of packages will be available. Programming packages from each supplier will cost between \$8 and \$30 a month. Also, when HBO is offered in a DSS package, you won't see one channel but five—HBO East, HBO West, HBO2 East, HBO2 West, and HBO3.

To help viewers decide what to watch (and what *not* to watch), DSS provides such convenience features as an on-screen program schedule and parental lockout based on channel or rating. Parents can also set a time limit on the amount of pay-per-view programming their kids can order.

Even those couch potatoes with the mere 30-or-so channels offered by their local cable companies—or just standard

NAMES AND ADDRESSES

MOTOROLA WIRELESS DATA GROUP
1201 E. Wiley Road
Suite 103
Schaumburg, IL 60173
708-576-0453
CIRCLE 77 ON FREE INFORMATION CARD

PALM COMPUTING
4410 El Camino Real
Suite 108
Los Altos, CA 94002
415-949-9560
CIRCLE 78 ON FREE INFORMATION CARD

PANASONIC COMPANY
One Panasonic Way
Secaucus, NJ 07094
201-348-7000
CIRCLE 79 ON FREE INFORMATION CARD

PHILIPS INTERACTIVE MEDIA
11111 Santa Monica Blvd.
Los Angeles, CA 90025
310-444-6600
CIRCLE 100 ON FREE INFORMATION CARD

SAMSUNG ELECTRONICS AMERICA, INC.
105 Challenger Road
Ridgefield Park, NJ 07660
201-229-4000
CIRCLE 112 ON FREE INFORMATION CARD

SANYO FISHER (USA) CORPORATION
21350 Lassen Street
P. O. Box 2329
Chatsworth, CA 91311-2329
818-998-7322
CIRCLE 113 ON FREE INFORMATION CARD

SEGA OF AMERICA, INC.
130 Shoreline Drive
Redwood City, CA 94065
415-508-2800
CIRCLE 114 ON FREE INFORMATION CARD

SHARP ELECTRONICS CORPORATION
Sharp Plaza
Mahwah, NJ 07430-2135
201-529-8200
CIRCLE 115 ON FREE INFORMATION CARD

SIGMA DESIGNS, INC.
47900 Bayside Parkway
Fremont, CA 94538
510-770-0100
CIRCLE 146 ON FREE INFORMATION CARD

SONY ELECTRONICS, INC.
Consumer Products Group
Sony Drive
Park Ridge, NJ 07656
201-930-1000
CIRCLE 147 ON FREE INFORMATION CARD

STARSIGHT TELECAST
39650 Liberty Street
Third Floor
Southborough, MA 01772
508-460-1100
CIRCLE 148 ON FREE INFORMATION CARD

TANDY CORPORATION
700 One Tandy Way
Fort Worth, TX 76102
817-390-3592
CIRCLE 149 ON FREE INFORMATION CARD

TECHNICS
One Panasonic Way
Secaucus, NJ 07094
201-348-7000
CIRCLE 150 ON FREE INFORMATION CARD

THOMSON CONSUMER ELECTRONICS
6000 North Sherman Drive
MS27-214
Indianapolis, IN 46201
317-267-5000
CIRCLE 152 ON FREE INFORMATION CARD

THE IMAGINATION NETWORK
41486 Old Barn Way
P. O. Box 1550
Oakhurst, CA 93644
209-642-0888
CIRCLE 153 ON FREE INFORMATION CARD

THE 3DO COMPANY
600 Galveston Drive
Redwood City, CA 94063
415-261-3000
CIRCLE 154 ON FREE INFORMATION CARD

UNIDEN AMERICA CORPORATION
4700 Amon Carter Blvd.
Fort Worth, TX 76155
817-858-3300
CIRCLE 156 ON FREE INFORMATION CARD

UNITED STATES SATELLITE BROADCASTING (USSB)
3415 University Avenue
St. Paul/Minneapolis, MN 55114
612-645-4500
CIRCLE 157 ON FREE INFORMATION CARD

network fair—sometimes have trouble deciding what to watch. StarSight Telecast's on-screen, interactive program guide can help them decide, and help them tape programs on their VCR's. Transmitted over the vertical blanking interval of the Public Broadcasting System, StarSight already covers more than 86% of the country. The on-screen guide offers seven days of continually updated schedule information; program selection by title, theme, and

channel number; and one-button VCR recording capability.

At WCES 94, StarSight was shown in real products, including a stand-alone unit and StarSight-equipped televisions, VCR's, cable converters, and satellite decoders. The first company to offer video equipment that incorporates the technology is Zenith, which will introduce StarSight-equipped TV's and cable boxes this spring. Philips plans to market VCR's

with StarSight by the end of the year, and color TV's in 1995 under both the Philips and Magnavox brands. Samsung will begin producing StarSight-capable TV's, VCR's, and TVCR's by the end of this year, and Uniden America will offer StarSight on a new line of satellite receivers early in 1994. StarSight has also licensed the technology to Goldstar, General Instruments, Scientific Atlanta, and PCI Limited.

Should your StarSight on-screen schedule reveal two can't-miss programs aired at the same time, or shows airing when you won't be around to watch, relax. The system also provides a virtually fool-proof way to tape shows. The user simply selects a show from the on-screen menu and pushes a single button. StarSight automatically records the right show at the right time.

Even if you don't buy a StarSight-equipped device, taping has become easier thanks to Gemstar—the creator of VCR Plus+. Two new VCR Plus+ products now feature CallSet technology, which provides instant setup by telephone. One toll-free phone call programs the device for the consumer's exact model of VCR and cable box, the entire cable channel line up, and the correct date and time. VCR Plus+ with CallSet carries a suggested price of \$59.99. The VCR Plus+ Control Tower, the only universal remote control to offer the programming system, also offers CallSet. With CallSet, the universal remote can be continually upgraded by phone as you add new components to your home entertainment system. The Control Tower costs \$79.99.

Recognizing that people who can easily record programs on their VCR's are likely to end up with an unmanageable stack of tapes, Gemstar displayed another new technology at WCES 94. IndexPlus+ is an automatic indexing system that the company hopes to see in use this year. The system will use codes inserted into programming by the broadcasters to identify the taped material on each videocassette. VCR's equipped with Index Plus+ will display an on-screen list of all taped programs, and will allow the user to play back programs from that list in any order desired. The VCR will automatically fast-forward or rewind to the beginning of the selected program.

How will you find the time to watch your rapidly growing library of taped programs? Arista Technologies provides a form of "speed-watching" with their Commercial Brake. A hit at the show, the \$200 stand-alone device, which will be available by the time you read this, automatically senses the presence of commercial clusters and fast-forwards over them. That condenses a commercial-laden hour of television to its actual programming time of perhaps 40 minutes. It also relieves



Consumers who own the 18-inch dish and set-top receiver/decoder required for Thomson's Digital Satellite Service will be able to view up the 150 channels of programming.

commercials, it inserts a timing and identification code onto the videotape. During playback, the device is able to read that "playback map." When commercials are detected, the screen fades to blue and the VCR fast forwards through the break. The process is entirely automatic once the device is connected to a VCR and TV. For commercial-free playback, the viewer simply hits the VCR's play button. (In case someone actually wants to watch the commercials, a bypass switch is provided.)

Even if you no longer need your remote control to fast-forward through commercials, if you're like most of us, you still won't be able to live without one. The remote controls displayed at WCES 94 were smarter and, well, cooler than past models. For instance, Casio's Wrist Controller Model CMD-40 looks like a wrist watch but pulls triple duty as a learning universal remote and a calculator. The CMD-40 can operate a TV, VCR, and cable box. It is priced at \$129.95.

Let the games begin

Housed in three separate pavilions at WCES 94, video games attracted attention not only for their usual mind-boggling, raucous exhibits, but for some newswo-



Gemstar's VCR Plus+ with CallSet provides instant setup with one phone call.

the remote-control handler of the task of fast-forwarding manually (and then re-winding when the resumption of the show is missed), and allows parents to show their kids commercial-free programs.

The Commercial Brake works by noting the indicators that appear at the beginning and end of each commercial, when sound and video are cut off momentarily. As it records the entire program, including



The Control Tower universal remote control from Gemstar features VCR Plus+ programming and CallSet setup.



The Commercial Brake from Arista removes unwanted commercial breaks upon playback of shows that you've taped on your VCR.



Casio's CMD-40 "Wrist Controller" is a watch, a calculator—and a "learning" universal remote control.

thy developments. Several new game systems, both cartridge- and CD-ROM-based, were on display. Reflecting the broadening of the hardware base, software manufacturers whose booths at previous shows fell under the wings of either Nintendo or Sega left the nest at WCES 94. Many displayed multi-platform titles in a pavilion separate from the hardware giants. And while gathered at the show, videogame developers and manufacturers held a series of meetings to discuss the voluntary implementation of an industry-wide ratings system—before the government mandates its own standards. No consensus was reached, however.

Meanwhile, new gaming hardware was introduced by Atari, Commodore, JVC,

and Sega. On the interactive-multimedia front, Panasonic displayed its real-life R.E.A.L. 3DO player. The 3DO Company provided updates on hardware and software developments. Philips' exhibited its CD-i full-motion-video (FMV) add-on cartridge and a host of new titles. Sigma Designs showed off a PC add-on card that will allow full-motion video to be shown on a computer monitor.

Atari—the company that pioneered the video-game industry with its 2600, displayed its new 64-bit Jaguar. The cartridge-based system is said to deliver unprecedented true-color graphics, CD-quality stereo sound, and fast action. Manufactured for Atari by IBM at its Charlotte, North Carolina plant, Jaguar will sell for about \$200, significantly less than many of its competitors' new products. As of January, 35 software companies had

signed licensing agreements with Atari.

Meanwhile, Commodore unveiled its Amiga CD³², a 32-bit CD-based games console that was introduced in Europe and in the United Kingdom last year. Built around the Amiga 4000 computer platform, the system contains special chips that have been "optimized for game and video performance." A true multimedia platform, the Amiga CD³² will also play audio CD's and CD+G (CD plus graphics) discs. A software upgrade is required to make the system compatible with Photo CD, and a \$250 module will enable it to play Video CD's and Philips' CD-i Digital Video releases. When the system is released in late February or early March, it will carry a suggested retail price of \$399, including two to four games. More than 100 titles should be available at introduction, double that by next Christmas.

Sega, which announced at WCES that its 16-bit Genesis system clearly outsold the Super Nintendo Entertainment System during the 1993 Christmas season, knows that 16-bit gaming still has quite a bit of life in it. The company also used the Consumer Electronics Show to launch its Genesis CDX entertainment system, the first to integrate 16-bit cartridge play and CD-ROM multimedia gaming. Genesis CDX is fully compatible with the entire library of nearly 500 available 16-bit Genesis games as well as dozens of Sega CD titles. It also serves as a portable CD player, measuring just 7.8 x 5.5 x 1.8 inches and weighing less than a pound and a half. It will be released in March at a suggested retail price of \$399, including three Sega CD titles: "Sonic CD," "Ecco the Dolphin," and a Sega Classics Arcade Collection CD that contains an assortment of games.

A newcomer to video-gaming—but not



Sega's Genesis CDX can play all cartridge-based Genesis games and all CD-ROM-based Sega CD titles.



JVC's X'EYE "multi-entertainment" system is compatible with audio CD's, CD + G's, CD-ROM's, Sega CD's, and Sega Genesis cartridges.

to digital technology—JVC introduced its X'EYE "multi-entertainment" system, capable of playing audio CD's, CD + G Karaoke, CD-ROM's, both Sega CD and Sega Genesis cartridges, and (with an optional ROM cartridge) Electronic Books. On-screen display menus make it easy to use in any mode. X'EYE will be available in April at a suggested list price of \$499, including three software titles: "Compton's Interactive Encyclopedia," a CD + G Karaoke disc, and a Sega CD game.

CD-i might be an old-timer in the world of interactive multimedia, but it isn't getting stodgy. In fact, Philips has seen dramatic sales increases in recent months due to a series of infomercials that aired on cable TV, and significantly lower prices. At WCES, Philips was showing its CD1220 player, which sells for about \$500, and the Magnavox CD1200 with a street price of about \$400. Both systems play audio CD's, Photo CD's, CD-i interactive discs, and—with the addition of the optional Full Motion Video Cartridge—Digital Video discs.

Several Digital Video interactive titles debuted at WCES, including "Caesar's World of Boxing," "Mad Dog McCree," "Microcosm," "Lilil Divil," and a couple of adult titles: "Joy of Sex" and "Playboy's Complete Massage." Recent and upcoming Digital Video movie titles include *Indecent Proposal*, *The Firm*, *Apocalypse Now*, and *Sliver*. Finally, Philips introduced a new infrared remote that will be shipped with the CD1200 and CD1220, replacing the "thumbstick" controller that came with older models, and the model 22er9017 "touchpad" remote for game playing that will retail for \$29.95.

Sigma Designs showed an add-on card for personal computers that allows full-motion, full-screen video to be displayed on the PC. It provides decompression for video recorded on disc with the MPEG 1 (Moving Picture Experts Group) compression standard. Primarily, the board is used to bring higher quality video to games and other multimedia titles. It will also, however, allow movies recorded in the Video CD standard, including CD-i Digital Video discs, to be played back on the PC.

Most of the hype at the show could be found at the 3DO press conference, where company president Trip Hawkins—in a speech peppered with such phrases as "paradigm shift" and "digital synergy"—made a number of announcements. The 3DO Company is setting up its own rating system (although it will participate in the industry-wide games-ratings debates). An MPEG adaptor that will allow 3DO machines to play Video CD's



The addition of a Full Motion Video (FMV) cartridge allows Philips' CD-i machine to play Digital Video discs.



Paramount Pictures' Star Trek is one of several new Digital Video titles.



This slim infrared remote is now included with CD-i players from Philips and Magnavox.

will be available this spring. Technology advances, particularly the integration of the three ASIC's currently used to a single chip, will result in lower prices for 3DO players.

The most significant news on the 3DO hardware front, however, was that Sanyo, AT&T, and one as-yet-unnamed company will be introducing their own 3DO products this year. Sanyo had a sleek-looking prototype on display in their booth. AT&T expects to have three 3DO products available by the end of 1994: a conventional 3DO multiplayer, a player that will incorporate AT&T's VoiceSpan modem technology, and an add-on VoiceSpan adaptor.

AT&T, whose far-reaching visions for the future of telephone-based interactive multimedia are discussed below, is actively making a name for itself in the game-playing arena. VoiceSpan, which is currently used in AT&T's The Edge 16 product for Sega's Genesis system, allows voice and data to be transmitted simultaneously. That means that game players across the country can talk to each other as they play. AT&T, (along with partners General Atlantic Partners and Sierra Online), also owns The ImagiNation Network (INN), a nationwide entertainment network that offers real-time interaction between groups of people playing games or "chatting" via computer keyboards.

Consumer-electronic newcomers

Audio and video might form the backbone of the industry, but an increasing share of the consumer-electronics market—and the floor space at the Consumer Electronics Show—is occupied by computer-based products. The driving forces behind the upswing are home offices and multimedia. Both categories commanded a strong presence at the show.

PDA updates

Because the entire March issue of

Gizmo was devoted to the first-generation PDA's, we won't provide any further technical background here, but their software and hardware add-ons demonstrated at the Winter Consumer Electronics Show deserve mention.

Most of the newly announced peripherals, particularly in terms of software, were for Apple's MessagePad and other Newton products. A new software publishing and distribution division of Apple, known as the StarCore Group, announced the release of 12 new titles for the MessagePad and plans to publish seven more. StarCore will also distribute titles from third-party software developers. First-quarter 1994 StarCore releases include "Money Magazine Financial Assistant," "The Economist World and Figures 1994," "Solitaire and Other Card Games," "Jig Saw Puzzle Strategy

Game," "Time Out Travel Guide," "DrawPad" (for architects and designers), and "Dell Crossword Puzzles. Third-party titles include "TaxPro," "Fodor's '94 Travel Manager," and "Silicon Casino." All applications are formatted either on PCMCIA cards that slide into the Newton MessagePad, or on Mac- or Windows-based floppy disks that can be transferred from a computer to a Newton PDA using the Newton Connection Kit. Prices will range from \$39 to \$100.

Also on display at the Apple booth was an assortment of communications devices. The Newton Messaging Card provides access MobileComm's wireless messaging service, which allows Newton users to receive postcard-length, alphanumeric pages. The Fax Modem Card, priced at about \$220, is a PCMCIA card that provides all the features of an external fax/

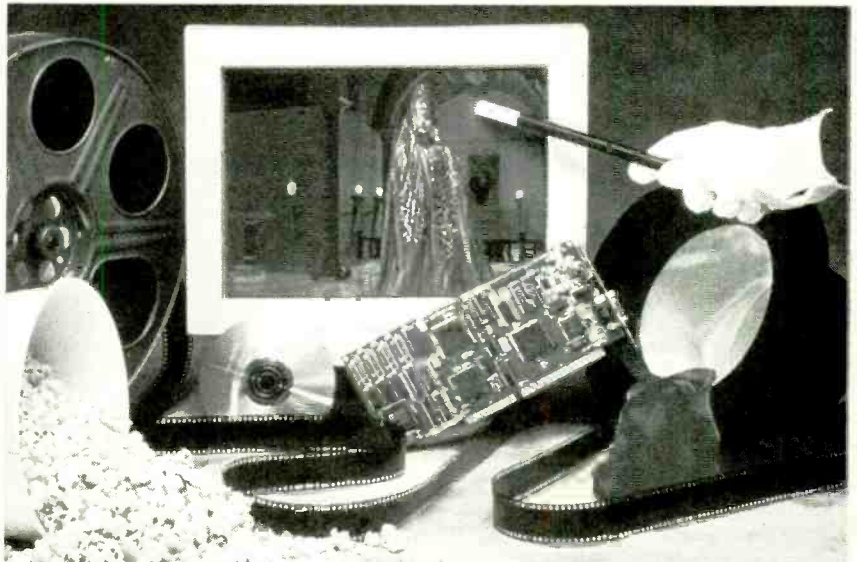

Sigma Designs' ReelMagic card allows PC's to deliver full-screen, full-motion video with CD-quality sound.



Panasonic was the first company to bring a "REAL" 3DO player to market.



An external fax/modem allows Sharp ExpertPad users to send and receive faxes.

modem card—and access to NewtonMail. Charging monthly and hourly fees, NewtonMail links Newton users to each other and to anyone on CompuServe, America Online, MCI Mail, AppleLink, SprintMail, EasyLink, and other Internet-accessible services. It also provides access to Apple's new interactive service called eWorld, a colorful on-line "community" for shopping, entertainment, research, and information.

Communications was also the story for Zoomer products from Casio and Tandy. PalmConnect (see Gizmo, April 1994) links the Zoomer to a PC for about \$129, and IntelliLink for Windows (\$99) will allow information from PC databases to be converted into a usable PDA format. Intuit is offering a transfer disk (\$95) that allows Zoomer users to transfer information from Pocket Quicken to Quicken 3.0 for Windows. Motorola's EMBARC wireless electronic-mail system is available for the Zoomer on PCMCIA NewsCards that carry a suggested retail price of \$249.

While new Zoomer software was notably missing from the show floor, Zoomer collaborators are putting public-domain software on America On-line. Zoomer users can download, at no charge, the names of restaurants in New York City, for instance, or the names, addresses, and phone numbers of the members of Congress.

Casio's president, John McDonald, speaking at a press reception, forecast increased PDA sales for 1994, despite a dramatic drop in sales a few weeks after the product's introduction last year. Blaming that slump on Apple's former CEO, John Sculley, who raised the media's expectations for PDA's before the Newton was even released, McDonald said, "The whole PDA category probably got mired in John Sculley's over-promising and under-delivering." Casio remains optimistic about the future of PDA's, however, and announced plans to introduce two new Zoomers at the Summer Consumer Electronics Show in June.

CD-ROM-inations

As evidenced by the recent developments in the gaming world, CD-ROM truly has become a mass-market consumer commodity. Multimedia PC's—big sellers last Christmas season—were on display at several computer-company booths. Even Intel set up "The Adventure Inside," a theme-park-style exhibit that included a "clean room" microprocessor fabrication plant, a walk-through mock-up of a giant computer, and a most uninformative trip through a Pentium processor chip. Finally, visitors got to play with the latest computer games and educational programs on more than 40 Pentium-based PC's.

MediaVision displayed the first personal CD-ROM player for Macintosh- and IBM-compatible computers. Billed as "Multimedia Unplugged," the Reno is a compact, light-weight, double-speed CD-ROM drive that runs on either nickel-cadmium batteries or AC power. It can be used with desktop or laptop computers, and functions as a stand-alone portable CD player.

On the road again

CD-ROM is also being put to use in the AudioNav vehicle navigation system, premiered at WCES by Eclipse Mobile Electronics and Amerigon. The system, which is also called VAAN for Voice-Activated Audio Navigation, allows drivers to easily find their destination in an unfamiliar city without looking at a map. Because it doesn't depend on global positioning satellites and the associated wheel-mounted sensors, the system is affordable and easy to install.

AudioNav is the electronic equivalent of having a person in the passenger's seat giving you directions. The system's CD-ROM drive, which is connected via the car's CD player, reads data discs produced by Etak. Those discs contain maps and other pertinent information for a certain city. Once the data is loaded, normal CD play is possible. The rest of the system consists of the speaker and microphone required for verbal interaction.

We took a test drive around Las Vegas in a VAAN-equipped RV. To get directions, the driver vocally spelled out the starting position, using either a landmark, an address, or an intersection. In our case, it was the Las Vegas Convention Center. Next, the destination (a house address a few miles away) was indicated in the same manner. AudioNav first let us know how far the destination was and approximately how long it would take to get there. It then provided street-by-street directions, such as: Take Convention Center Drive east for less than one block and make a left turn at the light. Go less than one block to Pacific Street and make a left. The next instruction might be "Travel three miles on Pacific

Street and then make a right turn onto Atlantic." If the first route is blocked by traffic or road closures, AudioNav can provide an alternate path on request.

The user can talk in a normal speaking voice, and AudioNav can even recognize regional and ethnic accents. Because the system will first be released in southern California, AudioNav was "taught" to pick up on Hispanic accents, for instance. In our test drive, however, it had some difficulty with "New Yawk-ese"—we doubt it could find "thoity-toid and toid."

The VAAN system is expected to become available in select locations in the second quarter of 1994, with a retail price of less than \$600. Future enhancements are expected to include a traveler's directory that will make it easy to locate gas stations, restaurants, lodging, etc.

The Great Beyond

Those of us who still have a hard time getting around today's concrete highways and byways—not to mention those who still have trouble operating today's consumer-electronics gear—might not even want to contemplate navigating tomorrow's information superhighway. But the fact is, it's coming. It's hard to open a newspaper these days without reading about it—and you certainly couldn't get through the Winter Consumer Electronics Show without hearing about it.

In fact, the show was opened with a speech from Robert Kavner, AT&T executive VP and CEO of Multimedia Products, in which he addressed the benefits that the consumer-electronics industry could reap—and the pitfalls it could face—in the development of interactive multimedia communications.

Kavner outlined two potential scenarios: the open, competitive, intelligent network being espoused by AT&T, and a closed-access, non-competitive, "gatekeeping" model that would resemble today's cable-TV industry (or the phone company of a decade ago). While it would be hard to argue with his easy-to-use, free-speech, free-trade, and fun telephone-system model, keep in mind that the cable companies were not on hand for a rebuttal.

AT&T envisions that the information superhighway will be built around its PersonaLink Services. The new network service will allow everyone in the "electronic community" to purchase products and services, work, and play. "Intelligent assistants"—customizable software that represents a user's interests—by acting as highly intuitive, trainable personal secretaries, screening and sorting e-mail, scheduling appointments, etc. Intelligent assistants are a key part of making the service useful and appealing to consumers and business users alike. ■

For more information on any product in this section, circle the appropriate number on the Free Information Card.

WCES WISH LIST

Road Radio

Personal portable stereos have revolutionized the way we listen to music—and where we listen. Although they can be used *almost* anywhere, anyone who has ever been pulled over while using a headphone stereo on a bicycle can tell you that there are exceptions. *Emerson Radio Corporation* (9 Entin Road, Parsippany, NJ 07954) has a safe substitute: the *AR2515* AM/FM bicycle radio. The weather-resistant radio is intended to be mounted on the handlebars. It includes an electronic horn and a front-mounted reflector. The radio can be detached from its mount easily, so the chance of theft is reduced. Price: \$29.95.

CIRCLE 116 ON FREE INFORMATION CARD

Cordless Mailbox

Parents who are tired of listening to their teens' seemingly endless phone messages on the family answering machine might appreciate the *Cobra* (6500 West Cortland Street, Chicago, IL 60635) *Intenna model AN-8591* cordless phone/answering machine with four "personal mailboxes." The all-digital answering device prompts callers to enter a user's mailbox code so that they can leave a private message. Alternately, users can leave their messages in the system's general mailbox. Like other *Cobra* cordless telephone products, the device incorporates the exclusive *Intenna* technology, which eliminates the external antennas on both the base and handset pieces. Price: \$249.95.

CIRCLE 117 ON FREE INFORMATION CARD

Satellite Car Security

In an effort to combat car theft, *Audiovox Corp.* (150 Marcus Blvd., Hauppauge, NY 11788) has introduced the *Posse*. The device uses a satellite and a microprocessor to provide security, including a way to recover an automobile after a car-jacking. In such a situation, the driver would give up the car without resisting. He would then phone the *Posse* Communications Center via a toll-free number to report the theft. The Communications Center would then send out a signal to activate the device. Once the signal is received, the car's horn begins to sound and the headlights begin to flash. An optional siren can also be activated. When the thief turns off the engine, the car can't be started. The *Posse* can also be used by absent-minded drivers who lock their keys in the car. A call to the Communications Center can unlock the door (if the car is equipped with power locks.) The *Posse* can even start the car. Imagine using an in-flight telephone to call the service as your plane is approaching for a landing in the middle of winter. Price: N/A.

CIRCLE 118 ON FREE INFORMATION CARD

In the Right Key

Anyone, regardless of musical ability, can play the *Key*, an "intelligent interactive controller" from *Lonestar Technologies* (920 South Oyster Bay Road, Hicksville, NY 11801-3518) that acts like a musical instrument. The *Key* looks something like a guitar, but the neck is outfitted with a keyboard, and the strings are replaced with "strummer veins." The *Key* can be played by itself as a synthesizer. Its real advantage is its ability to accept digital information from specially encoded sources. An encoded music video, for example, allows users to play along in the right key. The intelligence in the *Key* makes sure that everything sounds good. The *Key* conforms to the General MIDI standard, so it can be used with a large library of existing MIDI devices and tracks. Price: \$400.

CIRCLE 121 ON FREE INFORMATION CARD



Emerson AM/FM Bicycle Radio

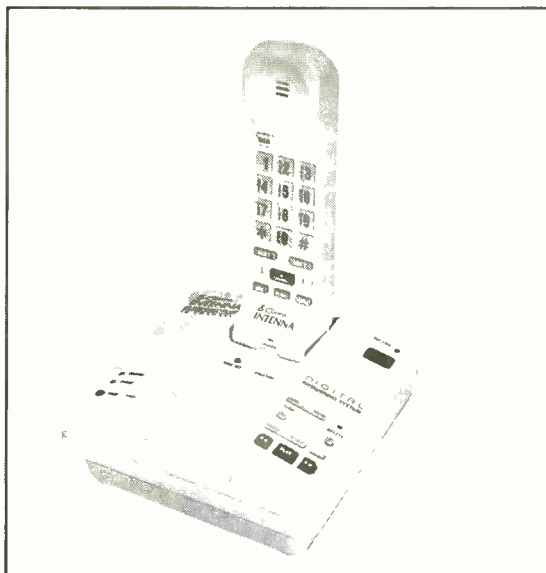

Cobra Cordless Phone/Answering System

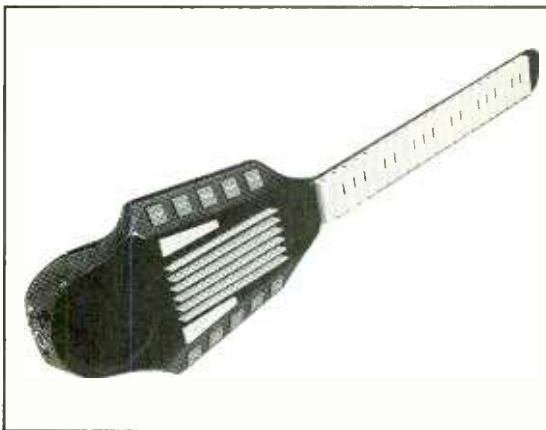

Lonestar's The Key

WCES WISH LIST

For more information on any product in this section, circle the appropriate number on the Free Information Card.



Kawai Pocketband Rehearsal Tool

One-Pocket Band

Called the "world's smallest rehearsal tool," the *Pocketband* from *Kawai America* (2055 East University Drive, Compton, CA 90220) allows practicing musicians to play with accompaniment. The device weighs less than one pound and measures about $4 \times 6\frac{3}{4}$ inches and is intended to hook onto a belt much like a personal portable stereo. It offers several advantages over cassette practice tapes. Players can change the tempo of the music without changing its pitch. Or they can change the key without changing the tempo. Pocketband comes with 20 built-in rhythms from blues to rock to big-band. Song Cards, which contain arrangements of popular music in various styles are also available. Price: \$199.

CIRCLE 122 ON FREE INFORMATION CARD



Triax Joystick

Taking Control

Owners of Sega Genesis and Super Nintendo systems will appreciate a *Multi-Function* joystick from *Triax Technologies* (11 Computer Drive West, Albany, NY 12205). According to Triax, the new "top-of-the-line arcade-style joystick is more like a new game system than a new controller" because it offers capabilities never available before. When games are written to take advantage of the controller, players will be able to vary the speed of on-screen characters or objects, and move them in any direction—even in the "z" direction, into or out from the background. Major companies, including Electronics Arts, Virgin, and Sunsoft are producing games that take advantage of the joystick. Price: \$49.95.

CIRCLE 123 ON FREE INFORMATION CARD



Carver Lightstar Reference Amplifier

Lightstar

A new amplifier from *Carver Research* (20121 48th Ave. West, Lynnwood, WA 98036) is said to represent "a major departure from conventional amplifier design." The *Lightstar Reference* amplifier uses such innovations as a precision digital transformer (whatever that is) and a reactive current-return path architecture that is said to achieve total independence from the effects of reactive loudspeaker loads. According to Carver, traditional amplifiers tend to "fight" the complex reactive loads imposed by loudspeakers. The Lightstar amplifier is unaffected by the load because it recycles reactive energy back into the power supply so as not to disturb the amplified signal. If the digital transformer and peaceful loudspeaker relations don't impress you, perhaps the amplifier's looks will. Innovation usually doesn't come cheap; the Lightstar Reference doesn't either. Price: \$3000.

CIRCLE 124 ON FREE INFORMATION CARD



Videonics Digital Video Mixer

Video Magic

Consumers will be able to turn their amateurish camcorder shots into professional-looking video with the *Digital Video Mixer* from *Videonics* (1370 Dell Avenue, Campbell, CA 95008). The device is virtually an all-in-one video production studio. It allows videographers to mix multiple video sources seamlessly thanks to its dual-field timebase corrector. The device offers a host of broadcast-quality special effects. For example, one scene can dissolve into another. A chroma key is also offered, so that backgrounds can be replaced. (That is the effect used to change weather maps behind the on-air weather forecasters.) Over 200 special effects—including mosaic, strobe, freeze, and zoom—can be added. A built-in audio mixer allows users to combine sound from video sources or separate sound sources. Price: \$1199.

CIRCLE 125 ON FREE INFORMATION CARD

Just like these Fully Trained Electronics Professionals



"Thanks to CIE I have tripled my previous salary, and I am now in a challenging and rewarding new field where only the sky is the limit."

Daniel Wade Reynolds
Industrial Electrician
Ore-Ida Foods



"CIE was recommended to me by my boss. It was appealing since I could study at my own pace at home and during business travel."

Dan Parks
Marketing Manager/Consumer Products
Analog Devices, Inc.



"I loved the flexibility CIE offered. It was the only way I could continue both school and my demanding job."

Britt A. Hanks
Director of Engineering
Petroleum Helicopters, Inc.



"I liked the way the school was set up with laboratory assignments to enforce conceptual learning. The thing which impressed me the most about CIE's curriculum is the way they show application for all the theory that is presented."

Daniel N. Parkman
Missile Electro-Mechanical Technician
U.S. Air Force



"Completing the course gave me the ability to efficiently troubleshoot modern microprocessor based audio and video systems and enjoy a sense of job security."

Tony Reynolds
Service Manager/Technician
Threshold Audio & Video

Graduate with an Associate Degree from CIE!

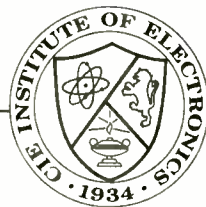

CIE is the best educational value you can receive if you want to learn about electronics, and earn a good income with that knowledge. CIE's reputation as the world leader in home study electronics is based solely on the success of our graduates. And we've earned our reputation with an unconditional commitment to provide our students with the very best electronics training.

Just ask any of the 150,000-plus graduates of the Cleveland Institute of Electronics who are working in high-paying positions with aerospace, computer, medical, automotive and communications firms throughout the world. They'll tell you success didn't come easy...but it did come...thanks to their CIE training. And today, a career in electronics offers more rewards than ever before.

CIE'S COMMITTED TO BEING THE BEST...IN ONE AREA...ELECTRONICS.

CIE isn't another everything-to-everyone school. CIE teaches only one subject and we believe we're the best at what we do. Also, CIE is accredited by the National Home Study Council. And with more than 1,000 graduates each year, we're the largest home study school specializing exclusively in electronics. CIE has been training career-minded students for nearly sixty years and we're the best at our subject...
ELECTRONICS... IT'S THE ONLY SUBJECT WE TEACH!

CIE PROVIDES A LEARNING METHOD SO GOOD IT'S PATENTED.

CIE's AUTO-PROGRAMMED® lessons are a proven learning method for building valuable electronics

career skills. Each lesson is designed to take you step-by-step and principle-by-principle. And while all of CIE's lessons are designed for independent study, CIE's instructors are personally available to assist you with just a toll free call. The result is practical training... the kind of experience you can put to work in today's marketplace.

LEARN BY DOING...WITH STATE-OF-THE-ART EQUIPMENT AND TRAINING.

CIE pioneered the first Electronics Laboratory

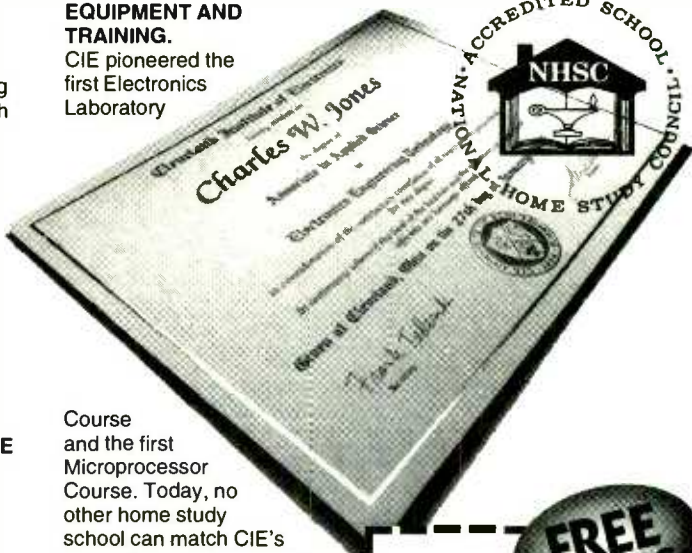

Course and the first Microprocessor Course. Today, no other home study school can match CIE's state-of-the-art equipment and training. And all your laboratory equipment, books and lessons are included in your tuition. It's all yours to use while you study and for on-the-job after you graduate.

PERSONALIZED TRAINING...TO MATCH YOUR BACKGROUND.

While some of our students have a working knowledge of electronics others are just starting out. That's why CIE has developed twelve career courses and an A.A.S. Degree program to choose from. So, even if you're not sure which electronics career is best for you, CIE can get you started with core lessons applicable to all areas in

electronics. And every CIE Course earns credit towards the completion of your Associate in Applied Science Degree. So you can work toward your degree in stages or as fast as you wish. In fact, CIE is the only school that actually rewards you for fast study, which can save you money.



YES! I want to get started. Send me my CIE course catalog including details about the Associate Degree Program. (For your convenience, CIE will have a representative contact you - there is no obligation.)

Please Print Clearly

AH53

Name _____

Address _____

City _____

State _____ Zip _____ Age _____

Phone No. _____

Check box for G.I. Bill Benefits.

Veteran

Active Duty

Cleveland Institute of Electronics, Inc.
1776 East 17th Street
Cleveland, OH 44114

A School of Thousands.
A Class of One. Since 1934.

Send for CIE's FREE Course Catalog and See How We Can Help Your Career Too!

Beyond Ohm's Law

We present an introduction to Kirchoff's Laws, the superposition theorem, and Thevenin's and Norton's equivalents.

BY PAUL COXWELL

Ohm's Law is so fundamental to electronics that it is second nature to all but the very latest newcomer to the field. Ohm's Law can be applied to calculate an unknown quantity for a single component, a section of a circuit, or the entire circuit, no matter how complex.

There are circuits, however, that cannot be easily analyzed using Ohm's Law alone; but they can be handled by using additional methods of analysis. We will examine four such analysis tools: Kirchoff's Laws, the superposition theorem, Thevenin's Theorem, and Norton's Theorem using resistive DC circuits as examples.

Kirchoff's Laws.

Kirchoff's First Law states

that the sum of the currents flowing into a junction must equal the sum of the currents flowing out of that junction. Refer to Fig. 1, in which we have a simple parallel circuit. When given the values of R1, R2, and the source voltage, the application of Ohm's Law shows that I₁ is 4 amps and I₂ is 2 amps. One way to determine the total current drawn from the battery would be to calculate the equivalent resistance of R1 and R2 in parallel and then apply Ohm's Law to the answer; that yields figures of 2 ohms and 6 amps.

The other way to get the answer is to apply Kirchoff's Law at point X or point Y. The total current (I_T) flowing into point X must equal the sum of the two branch currents I₁ and I₂, giving 6 amps. At point Y, the branch currents recombine, again satisfying the Law. The concept, like Ohm's Law, is taken almost for granted, and is often performed without conscious thought of Kirchoff's Laws.

Kirchoff's Second Law states that the sum of the voltage drops in a circuit must equal the sum of the voltage rises, or sources. In the series circuit of Fig. 2A, the total resistance is 24 ohms, giving a current of 0.5 amps. Ohm's Law can be used to determine the voltage dropped across R1; the answer is 9 volts. To comply with Kirchoff's

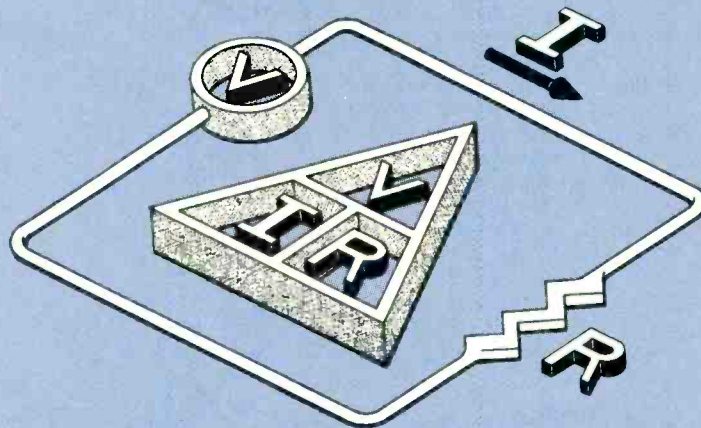

Law, the voltage dropped across R2 must, therefore, be 3 volts. Once again, this principle is so simple that we perform calculations of this type almost subconsciously.

The addition of a second voltage source, as in Fig. 2B, causes no problems; we just add the two battery voltages together:

$$12V + 12V = V_{R1} + V_{R2}$$

Even when the two batteries are separated, as in Fig. 2C, it is still a simple matter to add the voltage rises and voltage drops, since all the components still form a simple series circuit. The results are the same as for the previous example.

Figure 3 shows a more complicated situation. Suppose that we need to calculate the current that flows through each of the three resistors. The two completely separate voltage sources make the task impossible using just Ohm's Law. To solve the problem requires the use of Kirchoff's

Second Law and a little high-school math in the form of simultaneous equations.

Remember that Kirchoff's Law can be applied to any closed loop of a circuit. If we assume that a voltage source is a positive quantity and that a voltage drop across a resistor is a negative quantity, then the algebraic

sum for any closed loop must be zero. There are two complete current loops in the circuit shown. Current I₁ flows through B1, R3, and R1, while I₂ flows through B2, R2, and R3. Note that the current through R3 is the combined current of both I₁ and I₂.

The voltage drop across each resistor can be determined by Ohm's Law. For R1, for example, the voltage is

equal to the value of R1 multiplied by I₁. Starting at the positive pole of B1, trace counterclockwise around the first loop, adding each voltage to the equation as it is encountered. That gives:

$$B1 - R3(I_1 + I_2) - R1I_1 = 0$$

Notice that because both I₁ and I₂ flow through R3, we must use the sum of these two currents to calculate the voltage drop across the resistor. The second loop is written in a similar way, starting at the positive pole of B2 and tracing clockwise around the circuit, giving:

$$B2 - R2I_2 - R3(I_1 + I_2) = 0$$

Next, multiply out the bracketed section of each equation and substitute the known values for B1, B2, and the three resistors:

$$21 - 6I_1 - 6I_2 - 3I_1 = 0$$

Group all the I₁ and I₂ terms together in each equation, and move the con-

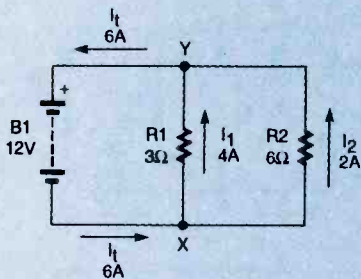

Fig. 1. Kirchoff's First Law states that the sum of the currents flowing into a junction must equal the sum of the currents leaving that junction.

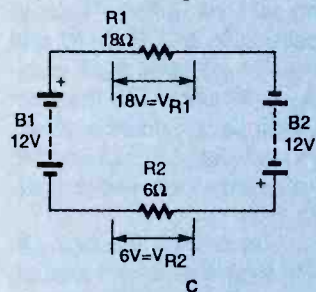
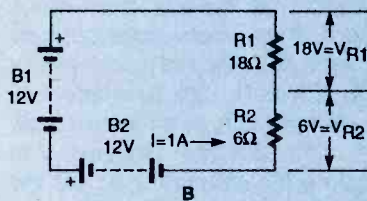
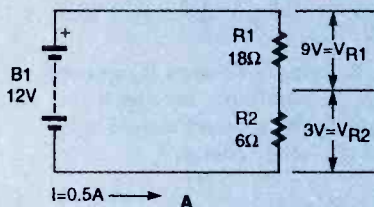

Fig. 2. Kirchoff's Second Law is demonstrated by this simple series circuit.

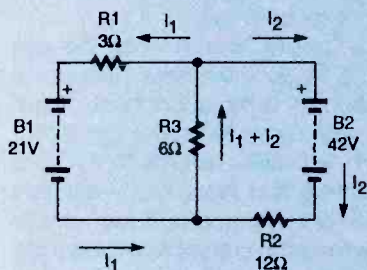

Fig. 3. Kirchoff and simultaneous equations help solve this problem.

starts (the battery voltages) to the opposite side of the equals sign:

$$-9I_1 - 6I_2 = -21 \text{ (Eq. 1)}$$

$$-6I_1 - 18I_2 = -42 \text{ (Eq. 2)}$$

At this point, we need to cancel out either I_1 or I_2 in order to get the result

for one loop. You may multiply both sides of an equation by any factor, so multiplying Eq. 1 by -3 gives:

$$27I_1 + 18I_2 = 63$$

Adding that to Eq. 2 (allowing the I_2 terms to cancel) yields:

$$21I_1 = 21$$

Current I_1 , therefore, is equal to 1 amp.

The value of I_2 can be determined by inserting the now-known value of I_1 in any convenient equation. Substituting in Eq. 1 and simplifying we get:

$$-9 - 6I_2 = -21$$

$$-6I_2 = -21 + 9$$

$$I_2 = 2A$$

Returning to the problem of calculating the current through each resistor, we have already worked out the currents through R_1 and R_2 . The current through R_3 is equal to sum of I_1 and I_2 (by Kirchoff's First Law), which is 3 amps.

If the value for a current is negative, then the direction of current is opposite to that that was assumed when the problem was started. Although the solution may at first look somewhat complicated, once the first two equations have been derived from the circuit, the rest of the problem is purely mathematical.

Superposition Theorem. Unlike the approach just described which analyzes the effects of voltage sources acting simultaneously, the superposition theorem allows us to examine the effect of each source separately and then combine the results. The theorem offers a slightly less mathematical approach to circuit problems, and is probably preferred by people who don't like algebra.

Refer back to the circuit of Fig. 3. To observe the effect of battery B_1 alone, we must remove the second source of power. Taking B_2 out of the circuit gives the diagram shown in Fig. 4A. Notice that the points that previously connected the poles of B_2 have been joined together to keep the loop complete. That is because it is assumed that the internal resistance of the battery is so low as to be of no consequence. However, when using the superposition theorem with voltage sources that have appreciable internal resistance, you should use an equivalent resistance instead of a direct short-circuit.

The current flowing through each part of the circuit in Fig. 4A can now be calculated quite easily, since there is only one power source and a simple series-parallel resistor network. The combined resistance of R_2 and R_3 is 4 ohms, giving a total circuit resistance of 7 ohms and a total current through R_1 and B_1 of 3 amps. That current is split at the parallel resistors, with 1 amp passing through R_2 and 2 amps through R_3 .

Next, we must perform the same procedure with the second voltage source. Figure 4B shows B_2 returned to its correct place in the circuit and B_1 temporarily removed. The parallel resistors R_1 and R_3 have an equivalent resistance of 2 ohms, so the total circuit resistance is 14 ohms and the total current is 3 amps. Resistor R_1 carries 2 amps of that current, with R_3 carrying the remaining 1A, as shown.

The final step is to combine the two sets of values you have calculated. Taking R_3 first, we have 2 amps of current from battery B_1 and 1 amp from B_2 . At this stage you must be very careful to observe the direction of each current. In this case, both arrows are pointing in the same direction, so the total current through R_3 is 3 amps, as shown in Fig. 4C. (Note that the arrows show the direction of electron

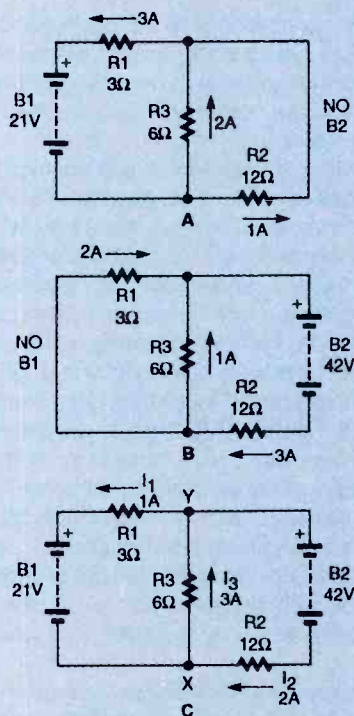

Fig. 4. The superposition theorem examines each voltage source separately and then combines the results.

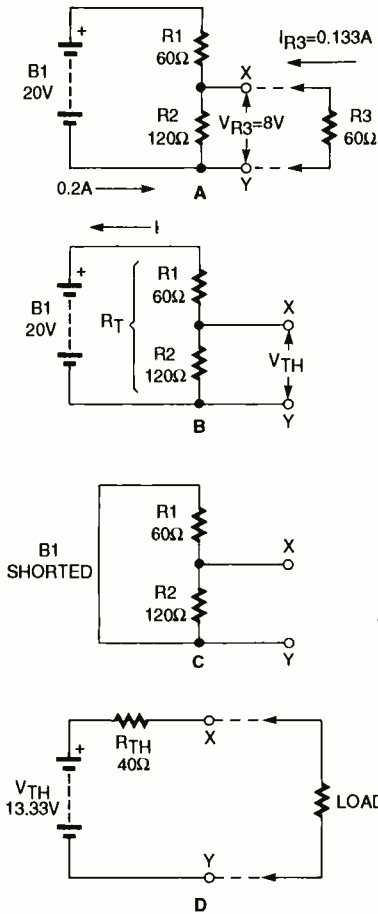

Fig. 5. Thevenin's Theorem allows a circuit to be reduced to a single voltage source and series resistance.

flow, from negative to positive. You could just as easily use conventional flow, from positive to negative, so long as you are consistent throughout your calculations.)

Moving to resistor R1, we have individual currents of 3 amps from B1 and 2 amps from B2. This time, however, the currents are in opposite directions, so the net current with both batteries connected will be equal to the difference, 1 amp. The currents at R2 are also opposing, giving a value of 2 amps overall. Once again, be careful with the polarities: The net current will flow in the same direction as the larger of the two individual currents.

A quick check of the currents flowing to and from points X and Y in Fig. 4C will confirm that the circuit complies with Kirchoff's First Law. That is a convenient way to check your work.

Thevenin's Theorem. Another analytical tool which can simplify certain tasks is Thevenin's Theorem. It states that any combination of resistances

and voltage sources, between any two points in the network, can be replaced by an equivalent circuit consisting of just one voltage source and a series resistance.

Let's take an example to show how Thevenin's Theorem can simplify a problem. Figure 5A shows a simple voltage divider with an output at points X and Y. Let's say that you want to connect various loads (R3) to that output and determine the current and voltage for each load.

The "regular" way to perform the calculation would be to assume a known load, say 60 ohms. Resistors R2 and R3 in parallel give an equivalent resistance of 40 ohms. The overall circuit resistance, is therefore 100 ohms, giving a current of 0.2 amps through R1 and B1, and a drop of 12 volts across R1. That leaves 8 volts across the load, with a current of 0.133 amp. Each of those steps would have to be performed again for each load of interest since all the current and voltage values would change.

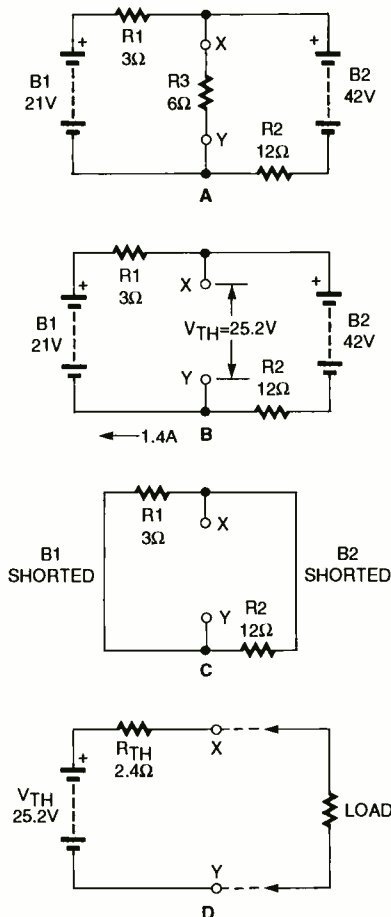

Fig. 6. The benefits of Thevenin's Theorem become clear when applied to a more complex circuit.

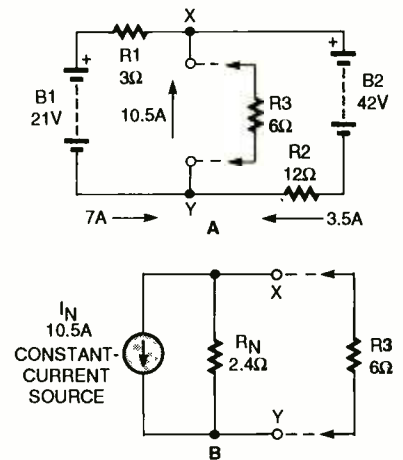

Fig. 7. Norton's Theorem is somewhat similar to Thevenin's, but uses a constant-current source instead of a constant-voltage source.

Two steps are required to convert a network to its Thevenin equivalent. First, determine what voltage appears across the two required points without the load (see Fig. 5B). By simple voltage-divider math, that Thevenin voltage is 13.33 volts. Second, you calculate the resistance across the two points with all voltage sources short-circuited (Fig. 5C). Since R1 and R2 are then in parallel, their combined value is 40 ohms. The Thevenin equivalent circuit can now be drawn, applying the values you calculated to a voltage source and series resistance (Fig. 5D).

You can now use the Thevenin circuit to determine the current through and voltage across each load resistor that you connect to X and Y. The calculations for each load have been reduced to those for a simple two-resistor series circuit.

Far greater benefit can be obtained when Thevenin's Theorem is applied to a more complex circuit. Figure 6A shows the same circuit that was used earlier. Assume that R3 is a load that may have many different values of resistance and you want to determine the current that would flow through each. To perform each calculation with simultaneous equations or the superposition theorem would be lengthy.

Fortunately, we can use Thevenin's Theorem to greatly simplify the task. With R3 removed, the circuit becomes a series network with two opposing voltage sources (see Fig. 6B). It is rela-

(Continued on page 95)

Build a Remote-Control Relay Station

A one-evening project can help your remotes' signals turn corners, or boost their power for well-lit or extra-long rooms.

BY JOHN YACONO

I really think remotes are great. They give you the freedom to control a battery of entertainment units and other equipment from a single location. To some that's a support for laziness, but to me that freedom makes it easier to switch to more enriching programming if what I'm watching or hearing isn't worth the time.

Sometimes though, that freedom extracts an extra price. For example, you might have to draw a blind to keep sunlight from interfering with a remote (a problem in one unfortunately shaped room in my house). Or perhaps you might have to place a couch or easy chair conspicuously in the middle of a very large media room (a problem for a friend of mine). You are also confined to the room containing the equipment—that's hardly full freedom.

Of course, a remote booster may solve the first two problems, but with three provisos: you must deal with added bulk on the remote, the booster must be strong enough to work from the viewing position, and you must swap the booster between remotes or buy more than one. So a booster may be unsightly, tiring to hold, still inadequate for some rooms, and either a pain or expensive for multi-remote use. It is also unlikely to bounce signals around corners.

An alternative is to use an RF universal remote. However, you must find one that is "universal" enough for all your equipment. Furthermore, they

tend to lack buttons for most equipment's special features (commercial skip, alternate channels, a jog shuffle, etc.) which might have played a part in your original purchase decision. Not to mention they're down-right frightening to non-technical family members (believe me, I know)! Besides, most folks are looking to reduce the amount of RF around the home due to the ELF health scare (see "Electromagnetic Fields and Your Health," **Popular Electronics**, March, 1993).

A third possibility is to use an IR-to-RF relay station. They allow you to use your own remotes from any location, but again, only provided your not concerned about RF radiation. Oh yes, and you must plunk-down around \$100 (almost the cost of a play-only VCR with its own remote).

I didn't like any of the mentioned alternatives, so I built the *Remote-Control Relay Station*. It looks for IR signals, demodulates them (to ensure they're from a remote), then re-modulates and broadcasts them at high-power. It can be placed anywhere between the remote user and the equipment (say on a coffee table) to act as an unobtrusive booster, or in a strategic corner to rebroadcast signals from a user down a hallway. Also, the units are so inexpensive to build, it would be more economical to build several to relay signals between rooms than to buy an RF remote or IR-to-RF relay station.

To add to its charm, the circuit is

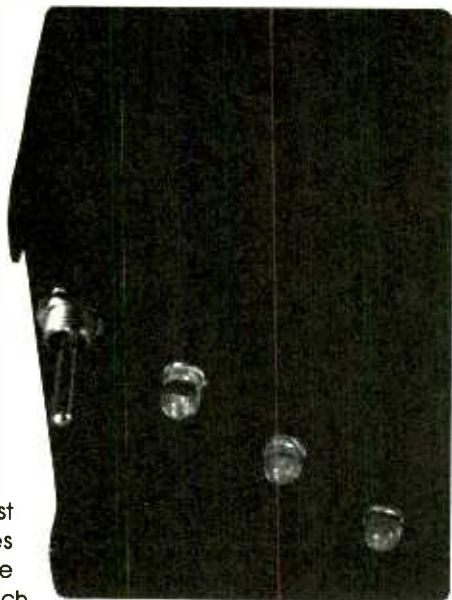

simple to build, and it's a good project for beginners. Its components are readily available, and no special PC board is required. The unit's simplicity is mainly due to the use of an all-in-one IR-demodulator module. Let's discuss its operation and function first.

Demodulating IR. Remote controls basically transmit serial digital information. They encode digital pulses on an IR carrier by turning the carrier on and off. That is known as burst-style data transmission. To see what all that means, take a look at Fig. 1. The top-most waveform represents a series of digital pulses that need to be transmitted by the remote control one at a time. The remote control transmits them by turning on a 40-kHz oscillator for the duration of each pulse. The output of the oscillator (represented by the bottom plot) drives an infrared emitter that pumps those 40-kHz pulses into the room as IR.

As mentioned earlier, the Remote-Control Relay Station uses a special module to detect and convert those 40-kHz IR pulses back into the digital pulses they represent. It is called the GPIU52X infrared-detector module. To help explain its operation, I have broken it down into functional blocks that are shown in Fig. 2. Refer to that figure as I explain further.

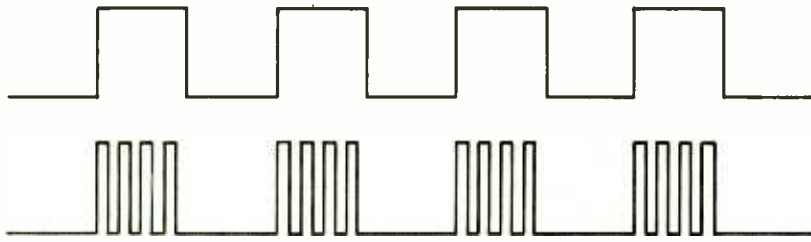

Fig. 1. Some data pulses that must be encoded and transmitted by a remote are shown at the top. The data is transmitted as a series of bursts of infrared as shown in the bottom plot.

All IR is received by the module via an IR photodiode. The diode is operated in its reverse-bias mode. The amount of reverse-bias current it permits depends on the intensity of the received infrared light.

The fluctuations in the reverse-bias current are then amplified by a high-gain stage. The output of the amplifier is then "limited" by the next stage. The limiter chops the extreme highs and lows off the amplified signal and the result is a quasi-digital pulse train.

The simplified wave then passes through a bandwidth filter. It has its center frequency at 40 kHz and a bandwidth of \pm mi4 kHz. The filter cuts out more noise and also prevents sources of infrared operating at the wrong frequency (such as the light bulb) from causing false activation. The filtered signal is then rectified for further processing.

At that point, the circuit has effectively retrieved the 40-kHz remote carrier. The reproduced carrier is then integrated. What that means is that it is

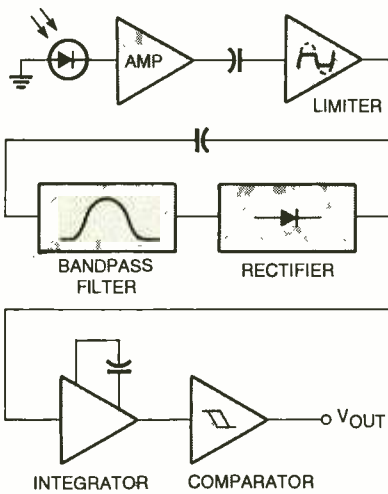

Fig. 2. The module stages look something like this. Together they process infrared light to extract any pertinent waveform and then demodulate it.

sent through a filter that responds slowly to the changing signal—too slowly to follow the 40-kHz carrier pulses, but quick enough to rise and fall significantly with each burst and pause between bursts, respectively.

The next stage takes advantage of those characteristics. It is called an "inverting Schmitt trigger." It will not go low unless the filter's output signal surpasses a certain amplitude, and will not go high again until the signal drops below a certain minimum. Thus the Schmitt trigger only responds to large changes in the filter's output (caused by bursts and pauses) and ignores small changes (caused by the 40-kHz carrier to which the filter can't respond quickly). The Schmitt-trigger's output is thus low when a 40-kHz burst

PARTS LIST FOR THE RELAY STATION

SEMICONDUCTORS

- U1—555 oscillator/timer, integrated circuit
- Q1—2N2222 general-purpose NPN silicon transistor
- Q2—2N3906 general-purpose PNP silicon transistor
- LED1-LED3—SY-IR53L IR-light-emitting diode
- MOD1—GPIU52X IR detector/demodulator module (Radio Shack No. 276-137)
- D1-D2—2.4-volt, 500-mW Zener diode
- D3—1N914 general-purpose small-signal silicon diode

RESISTORS

- (All resistors are 1/4-watt, 5% units unless otherwise indicated)
- R1, R2—18,200-ohm, 1/4-watt, 1%
- R3—47-ohm
- R4—100,000-ohm
- R5, R6—10,000-ohm

ADDITIONAL PARTS AND MATERIALS

- C1—0.001- μ F, NPO ceramic-disc capacitor
- C2—0.1- μ F bypass capacitor
- B1—9-volt transistor-radio battery
- S1—SPST on/off switch
- Project box, double-sided foam, perfboards, wire, solder, etc.

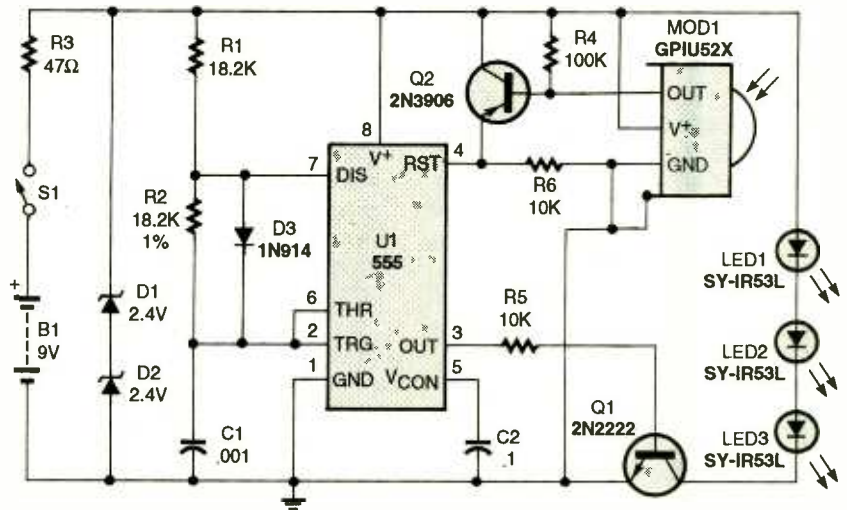

Fig. 3. In the IR-relay circuit, all of the signal processing is performed by the infrared detector/demodulator module, MOD1. The rest of the components regulate power and generate 40-kHz IR pulses.

is received, and high during pauses between bursts. The resulting waveform is an inverted version of the pulses that were modulated and transmitted by the remote. Let's turn our attention to the project to see how those signals are put to use.

The Relay Circuit. A schematic diagram of the Remote-Control Relay Station is shown in Fig. 3. To summarize its pertinent features, it consists of the IR-detector module (MOD1) connected to an inverter (made of Q2,

(Continued from page 96)

All About Transistors: FET's

BY ROBERT A. YOUNG

The lowly transistor evolved from bipolar to JFET to MOSFET to CMOS—which today forms the basis of many industrial and commercial products.

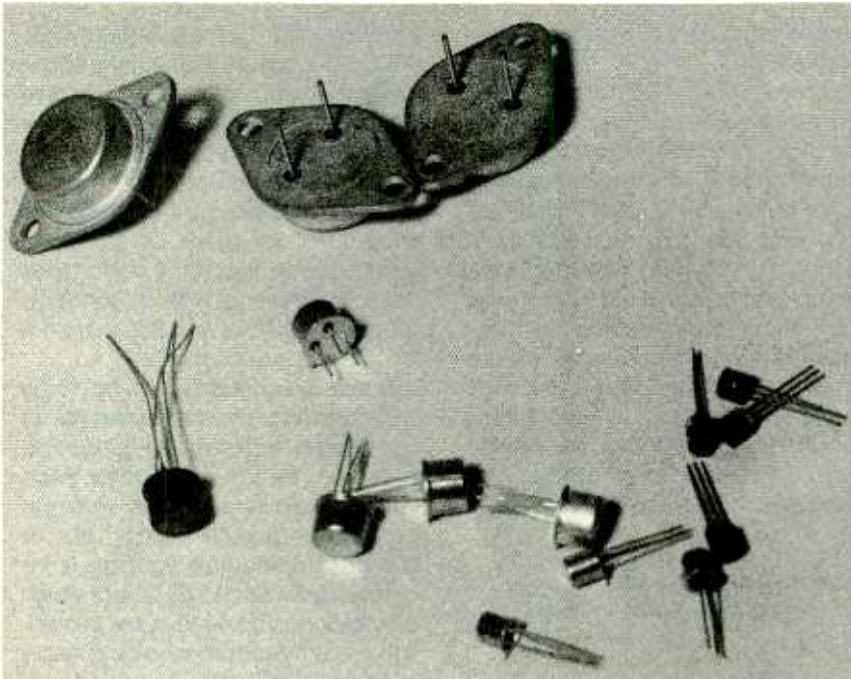

It may seem hard to believe, but it was not too long ago that bipolar transistors began to replace vacuum tubes in mainstream electronic design. Low power, small size, and durability were only a few of the characteristics that propelled those little globs of silicon into the forefront of electronics. However, tube circuits didn't abruptly disappear when transistors hit the scene in part because bipolar transistors have a low input impedance, are noisy, and must be safeguarded against thermal runaway.

When the field-effect transistor (FET) was introduced, it overcame many of the shortcomings of bipolar units. In fact, it combined many of the advantages of bipolar transistors and vacuum tubes into a single package. Thus, several devices that were traditionally vacuum-tube based began to show up in transistorized form. However, before we take a look at the FET, let's take a look again at its forerunner, the bipolar transistor.

Bipolar Transistors. Figure 1 shows the composition of a PNP bipolar transistor. As shown, N-doped semiconductor material is sandwiched between two pieces of P-doped material. The base is comprised of the N-type material, while the collector and emitter of the transistor is made up of P-type material.

In order for a PNP transistor to conduct, its collector must be made more negative than its base, and its base more negative than its emitter. That condition is called "forward biasing." Note that the potential (or voltage) polarity is not specified. That's because bipolar transistors can be operated from either a negative or positive source, as long as they are properly biased.

Current flow between the base-emitter junction causes current flow in the emitter-collector junction. NPN transistors operate in the exact same manner except current flow is in the opposite direction, and their bias voltages are reversed as well; e.g., for an NPN transistor to operate, its collector must be more positive than its base, and its base more positive than its emitter terminal.

It doesn't take a deep understanding of transistor physics to see that the two separate junctions (base-emitter and collector-base) behave much the same as two diodes. The input impedance of a bipolar transistor is consequently very much the same as a forward-biased diode (it's low). That's one of the main reasons that the introduction of the transistor did not totally do away with vacuum tubes. Since vacuum tubes have an inherently high input impedance, it was much easier to use them than to devise additional circuits to provide bipolar

transistors with similar desirable characteristics.

Enter the FET. While bipolar transistors are basically current amplifiers, field-effect transistors (FET's)—which are unipolar rather than bipolar devices—are voltage amplifiers. FET's have certain properties that are superior to those of bipolar transistors. For instance, voltage rather than current operation, extremely high input impedance, virtually constant current with respect to voltage at specified bias levels, current change that is inversely (rather than directly) proportional to temperature, as well as faster switching speeds and thus higher cut-off frequencies. Despite those advantages, the FET has not replaced bipolar transistors in all applications.

There are two major classes of FET: the junction field-effect transistor or JFET, and the metal-oxide semiconductor field-effect transistor or MOSFET (which is sometimes called an "insulated-gate FET" or "IGFET"). FET's are further categorized by channel type (N or P), and as being normally on (depletion) or normally off (enhancement).

Cross sectional views of both N- and P-channel JFET's are shown in Figs 2A and 2B, respectively. As shown in Fig. 2A, an N-channel JFET is formed by embedding (channeling) N-type material in a P-type substrate. The P-type

substrate is referred to as the "gate," while the two regions of embedded N-type material are designated the "source" and the "drain". Respectively speaking, the source, gate, and drain of a FET are analogous to the collector, base, and emitter of a bipolar transistor.

Source and drain terminals are formed directly on the N-channel material and the gate terminal is formed on the P-type area. The symmetrical construction of the JFET permits the drain and source to be interchanged, if necessary. The schematic symbols for both N- and P-channel FET's are shown in Figs. 2C and 2D, respectively.

FET Operation. There are two inter-related factors that control the performance of a FET (*i.e.*, current flow through the embedded channel): the voltage between the gate and source (V_{gs}); and the voltage from drain-to-source (V_{ds}). If the gate-to-source voltage is at ground (zero volts) with the drain connected to a positive voltage and the source tied to ground, the electron shortage in the channel restricts the amount of current that can flow through the channel. The only way to increase current flow is to increase the drain-to-source voltage.

Let's take a look at what happens when a signal source is connected to the gate of a FET and a positive voltage is applied to the drain (refer to Fig. 2A). If a positive voltage is applied to the drain and a negative voltage is applied to the source with the gate terminal open, a drain current flows.

When the gate is biased negative with respect to the source, the PN junction is reverse biased, which causes a depletion region to form. Because the N-channel is more lightly doped than the P-type gate material, the depletion region penetrates into the N-channel. The depletion region, which behaves like an insulator, causes the N-channel to narrow, increasing the channel resistance. If the gate bias is made even more negative, the drain current is eventually cut off completely. The voltage at which that happens is called the "pinch-off" or "gate cut-off" voltage. On the other hand, as the gate bias is made more positive, the depletion region shrinks, reducing the source-to-drain resistance, which in turn causes an in-

crease in current flow through the channel.

For a P-channel JFET (refer to Fig. 2B), if a negative voltage is applied to the drain and a positive voltage to the source with the gate terminal open, a current flows through the channel. When the gate is made positive with respect to the source, the depletion region begins to increase, narrowing the P-channel and causing the channel's resistance to increase. The increased resistance of the channel reduces current flow. If gate bias is made more positive and reaches the pinch-off or gate cut-off voltage, current flow is completely choked off.

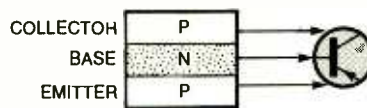

Fig. 1. In essence, a PNP bipolar transistor is comprised of N-doped semiconductor material sandwiched between two pieces of P-doped material.

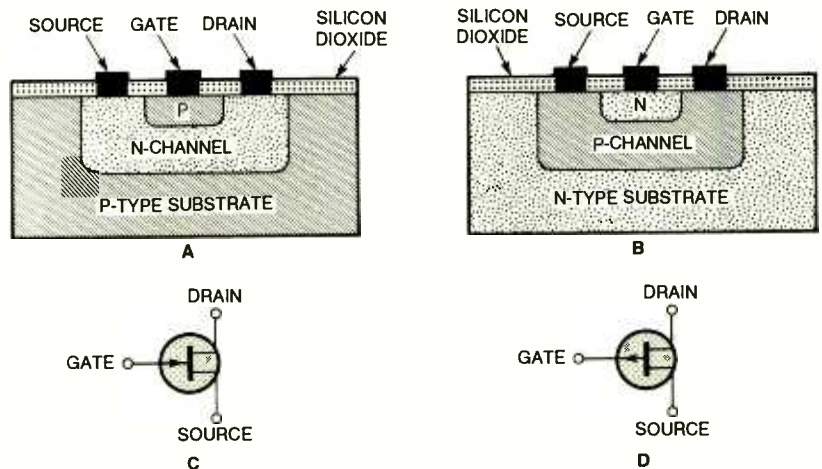

Fig. 2. These cross-sectional views of N- (A) and P-channel (B) JFET structures show that a JFET is formed by embedding either N- or P-doped semiconductor material (the channel) in an N- or P-type substrate (the gate). The schematic symbols for N- and P-channel JFET's are shown in C and D, respectively.

On the other hand, as the bias becomes more negative, the depletion region shrinks, reducing the source-to-drain resistance, increasing current flow. Thus, the gate actually controls current flow through the channel.

The gate-to-source junction of a JFET has the characteristics of a silicon diode; that is, when reverse biased, gate leakage current is in the thousands of microamps at room temperature. Actual gate-signal current is only a fraction of that and the input impedance to the gate is typically

1000 megohms at low frequencies. The gate junction is effectively shunted by a capacitance of a few picofarads, so its input impedance falls as frequency increases.

If the gate-to-source junction of the JFET is forward biased, it conducts like a normal silicon diode, and if it is severely reverse biased, it avalanches like a Zener diode. Neither condition will harm the JFET if the gate current is limited to specified levels.

Figure 3 is a graph showing some JFET-drain characteristic curves (in this case, for an N-channel JFET). It can be seen from that graph that for each value of gate-to-source voltage, drain current rises linearly from zero as the drain-to-source voltage is increased from zero to a value at which a knee occurs on each curve. In addition, drain current remains virtually constant as the drain-to-source voltage is increased beyond the knee.

Therefore, when the drain-to-source voltage for any of the gate-to-

source voltage curves is below its knee value, the drain-to-source terminals of the JFET act like a voltage-variable resistor whose value is determined by the applied gate-to-source voltage. The drain-to-source resistance (R_{ds}) can be varied from several hundred ohms to several thousand megohms. That characteristic permits the JFET to be used as a voltage-controlled switch. The drain's characteristic curve also shows that when the drain-to-source voltage is above the knee value, the drain current is dic-

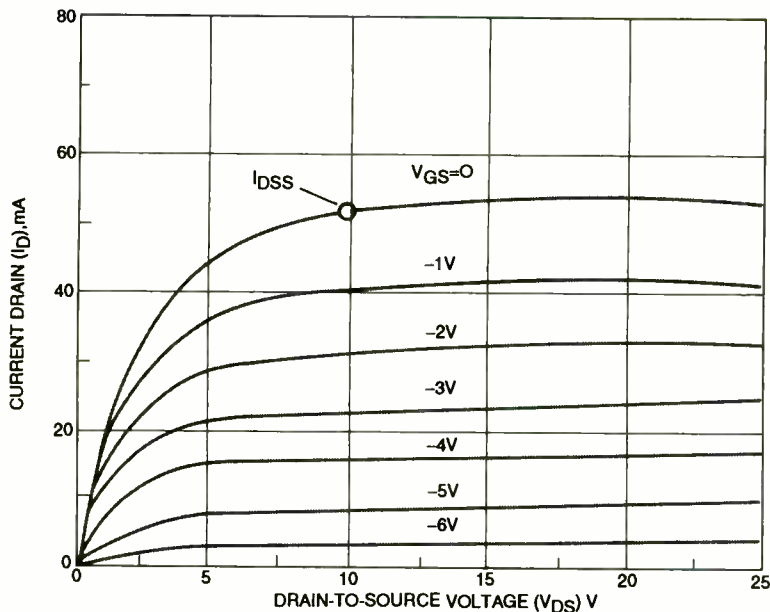

Fig. 3. This graph shows the N-channel JFET's drain-characteristic curve under differing operating conditions. Note that drain current rises linearly from zero as the drain-to-source voltage is increased from zero to a value at which a knee occurs on each curve.

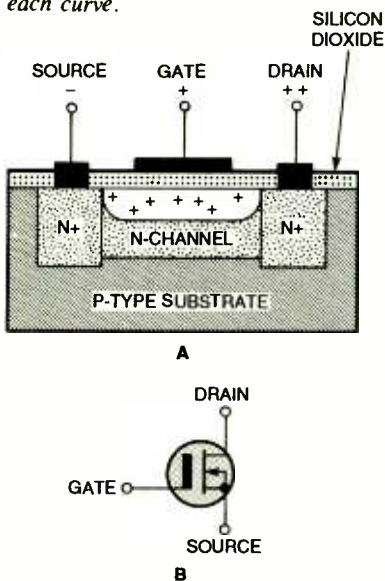

Fig. 4. A cross-sectional view of an N-channel depletion-mode MOSFET is shown in A; its schematic symbol is shown in B. Note that the path or channel between the source and the drain is shown as a solid bar.

tated primarily by the gate-to-source voltage, and is essentially independent of the drain-to-source voltage. That allows the JFET to function as voltage-controlled current generator.

The gain of the JFET is specified as a transconductance (g_m); e.g., the rate of drain-current change with respect to gate voltage. A gain of 5-mA-per-volt indicates that a variation of 1 volt at the gate produces a 5-mA change in drain current.

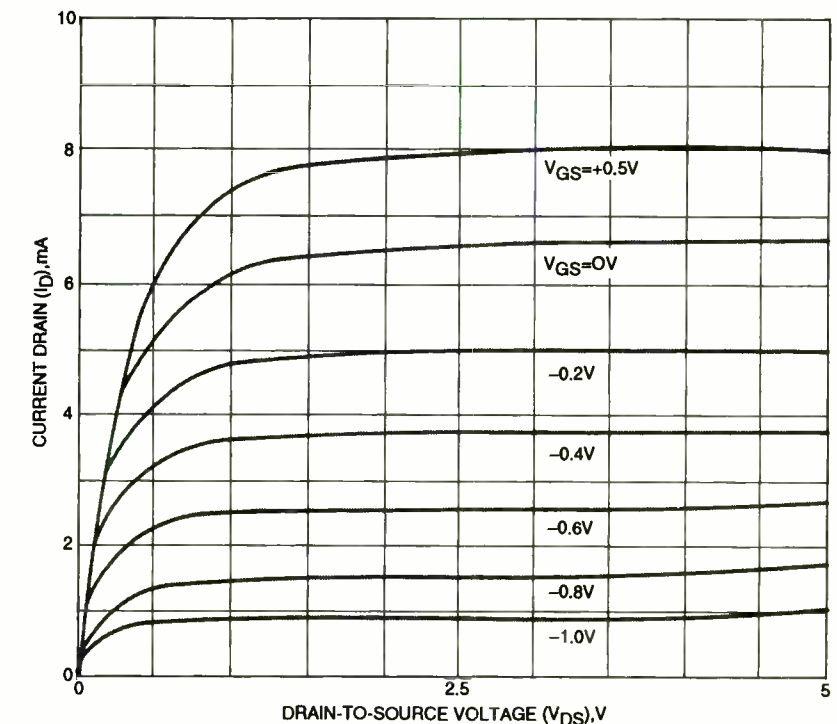

Fig. 5. It can be seen from this source-to-drain characteristic curve for an N-channel depletion-mode MOSFET that the drain current is inversely proportional to the magnitude of any applied negative gate voltage. Note the similarities between the curves for an N-channel JFET and those for an N-channel depletion-mode MOSFET (shown back in Fig. 3).

Note that transistor structures back in Fig. 2A and Fig. 2B, are complimentary to each other: e.g., in Fig. 2A the channel is comprised of N-type material and the gate and the substrate are composed of P-type material, but in Fig. 2B the channel is comprised of

P-type material and the gate and the substrate are composed of N-type material. Thus, the bias voltages for N-channel and P-channel JFET's are opposite each other.

MOSFET's. The metal-oxide semiconductor field-effect transistor (MOSFET), developed as an improved JFET, has become one of the most important forms of FET. A MOSFET is almost the same as a JFET, but instead of having a direct connection between the gate and the substrate, the gate is isolated from the channel by a thin insulator (usually a film of silicon dioxide).

Figure 4A shows a cross-sectional view of an N-channel depletion-mode MOSFET. The gate of the MOSFET is fully insulated from the adjacent channel—which is the most important difference between it and an N-type JFET.

When the drain is positive with respect to the source, a current flows even if the applied gate voltage is zero. However, if the gate is made negative with respect to the substrate, positively charged carriers (holes) induced in the N-channel combine

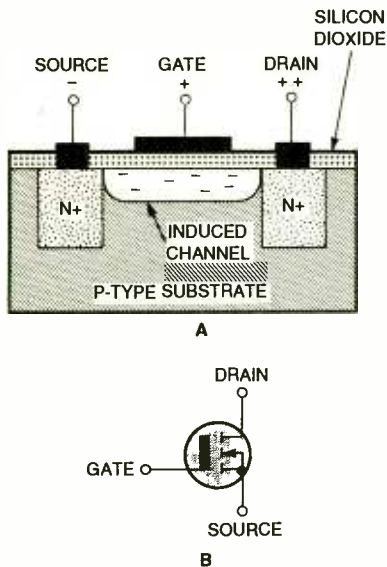

Fig. 6. A shows a cross sectional view of an N-channel Enhancement MOSFET, which is made by using the same process used to manufacture depletion MOSFET's. Its schematic symbol is shown in B.

ever, if the gate is made more positive with respect to the substrate, additional electrons are induced into the channel, increasing the channel current. The schematic symbol for an N-channel depletion-mode MOSFET is shown in Fig. 4B. The path or channel between the source and the drain is shown as a solid bar.

Figure 5 shows the source-to-drain characteristic curve for an N-channel depletion-mode MOSFET. It can be seen that drain current is inversely proportional to the magnitude of the negative gate voltage. Note the similarities between the curves for an N-channel JFET and those for an N-channel depletion-mode MOSFET shown back in Fig. 3.

Enhancement MOSFET's. Figure 6 shows a cross sectional view of an N-channel enhancement MOSFET. Enhancement MOSFET's are manufactured using the same methods used to

MOSFET. Therefore, there is no conduction between the drain and source with no gate bias applied to the device.

To turn on an enhancement MOSFET, a positive gate voltage is needed. The more positive that gate voltage, the more electrons are induced into the channel. They can not flow across the oxide layer, so they accumulate at the substrate surface below the gate oxide. When a sufficient number of electrons have accumulated, the P-type substrate material is converted into an N-channel, and drain-to-source conduction occurs. The magnitude of the drain current depends on the channel resistance, but is controlled by the gate voltage. The schematic symbol for an N-type enhancement MOSFET is shown in Fig. 6B.

In that symbol, the gate does not make direct contact with the channel. The arrow points from the P-type substrate toward the induced N-type channel, which is shown as a dashed line inside the symbol to indicate an intermittent channel. Current flow through both types of enhancement MOSFET is proportional to the voltage applied to their gates, and drain current is directly proportional to the value of any applied positive gate voltage. The P-channel enhancement MOSFET is made the same way as the N-channel type, except that the direction of the arrow is reversed. In the case of the P-type enhancement MOSFET, the drain current is directly proportional to any applied negative gate voltage.

The super-high impedance of MOSFET's is a great design advantage, but it makes them susceptible to damage from even low-energy electro-static discharge (ESD). It doesn't take much static build-up to produce a charge large enough to puncture the insulating oxide of a MOSFET, destroying the component. For that reason, discrete MOSFET's (as well as the IC's that incorporate them) are often protected with internal Zener diodes.

In spite of its susceptibility to ESD, the MOSFET comes very close to bridging the gap between vacuum tubes and semiconductors. Since the gate is totally isolated from the substrate, its input impedance ranges up into the hundreds of megohms.

(Continued on page 94)

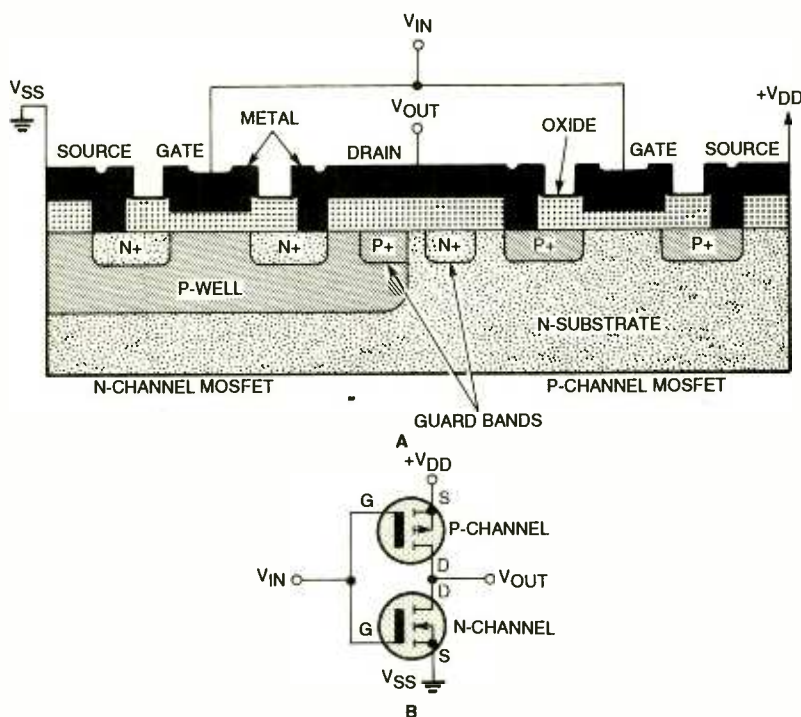

Fig. 7. A cross-sectional view of a complementary pair of MOSFET's implemented on a common substrate is shown in A. The same connection arrangement is shown schematically in B. Note that the two FET's share common gate and drain terminals, and while one source terminal is tied to V_{dd} , the other is tied to V_{ss} .

with the electrons and cause channel resistance to increase. With increasingly negative bias, the drain current diminishes until the pinch-off voltage is reached, at which point current flow ceases altogether. How-

manufacture depletion MOSFET's. However, the enhancement MOSFET (see Fig. 6A) does not have the N-doped drain-to-source channel through the P-type substrate as is the case with the N-channel depletion

ANTIQUÉ RADIO

By Marc Ellis

Getting Started on the NBS Crystal Set

In last month's column, we resumed our discussion of the National Bureau of Standards crystal set, a topic that was opened in the January issue and then set aside for a while in order to provide timely coverage of last September's Antique Wireless Association annual conference. Last month we reviewed the history of the NBS project as well as the radio's circuitry and construction style. At the close of the column, we talked about some of the issues relating to the choice of a form for the tuning coil.



To start the coil winding, turn the canister upside down and secure the end of the wire by threading it through a couple of small holes poked just under the edge of the bottom cap.

The original specifications called for the coil to be wound on a cylindrical cardboard one-pint container of a type no longer manufactured (or at least very rare). In any case, I really had my heart set on using the time-honored Quaker Oats canister as a coil form. The problem was that the diameter of the

Quaker Oats canister—even the smaller one used for the "Quick Oats" product—was too great. As a compromise, I settled on a Quaker "Quick Grits" canister, which does have a diameter close to the required 3½ inches.

Admittedly, "Quick Grits" doesn't have the same romantic ring as "Quick Oats." But at least it is a Quaker Oats product, and, in any case, the artwork on the package is completely covered by the coil windings. If you're still disappointed, all I can do is apologize; this is the closest I can come to keeping the faith!

WINDING THE COIL

After you get your Quick Grits home from the store, open the canister by pulling the string that cuts the paper seal around the cardboard end cap. The cap should now be removed intact, and you have to be careful here because it probably won't come off freely.

Slide a thin knife blade under the side of the cap and carefully work it around the circumference until the cap comes loose. Set it aside for future use and remove the grits from the canister. Now you can begin winding the coil.

I used some No. 22 enamel-covered "magnet wire" that I happened to have on hand, and my completed coil was a bit short of the 2½-inch length called for in the original construction article. The No. 21 size available from Antique Electronic Supply or Antique Audio (see previous column), being slightly

heavier, should work out a little better.

Now turn the canister upside down and poke a couple of holes (using a small finishing nail) about a half an inch apart and just under the ridge formed by the edge of the canister's permanent bottom cap. Turn the canister so that the holes face you, and thread the free end of your coil wire down through the left one and up through the right one.

Form the "tail" emerging from the right-hand hole into a "U" shape, then twist with long-nose pliers to form an eyelet. A finishing nail inserted through the "U" also makes a good twisting tool. That eyelet, and the others you will make as you continue to wind the coil, are the "taps"; they will be used to make electrical connections to the coil later on.

Now that the end of the wire is firmly held in place, you can begin winding. Keeping constant tension on the wire, turn the canister slowly to the right so that the first coil turn falls right under the edge of the cap. Maintain the tension



Here's the coil as it looks when completed. The canister has been cut to size and the top cap (now at the bottom) has been temporarily reinstalled.

and continue winding, keeping each turn as close to the previous one as possible. When you reach the 12th turn, twist another eyelet into the wire, similar to the first one and directly underneath it.

Continue winding, twisting on an eyelet—as above—every twelve turns, until you have wound a total of 60 turns on the coil. You should now have six eyelets, including the one you first installed at the start of the coil. In the completed set, those 12-turn taps will be used to make coarse tuning adjustments on the received signal.

You're now going to wind on a six-turn "spacer winding" followed by five two-turn windings, installing an eyelet (so that you'll have a total of six more) at the end of each one. The two-turn taps will be used to make fine-tuning adjustments on the received signal.

Since the eyelets are now coming very close together, don't continue placing them in a straight vertical line. Add about a half-inch to the last turn of each winding so that the eyelets will be staggered along the circumference of the coil. That will make things a little easier later on, when you'll sand the enamel off the eyelets and solder connections to them.

About half an inch after your last eyelet, poke two holes similar to the ones you made at the start of this coil. Cut off the magnet wire a few inches after the eyelet and secure the free end by threading it through the two holes as before. After the threading, cut off the excess length, leaving a short (perhaps 1/4-inch) "tail" protruding from the second hole. For neatness, bend it over so that it lies flat.

The completed coil should contain 76 turns and

be about 2 1/2 inches long. (A diagram from the original construction article, showing the layout of a completed coil, was included with last month's article.) If you've wound your turns tightly, the winding should be quite stable on its cardboard form. However, if you'd like to be a

mark the canister for trimming so that a stub equivalent to that depth will extend beyond the end of the windings. After trimming with your matte knife, slide the cover onto this stub. (It will be a tight fit, so be careful!) Don't glue it just yet; that will come a bit later.

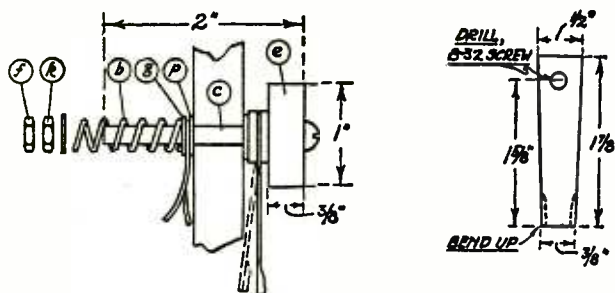

For those adventurers who would like to make authentic tap switches, here are two views showing construction. See the text for more details.

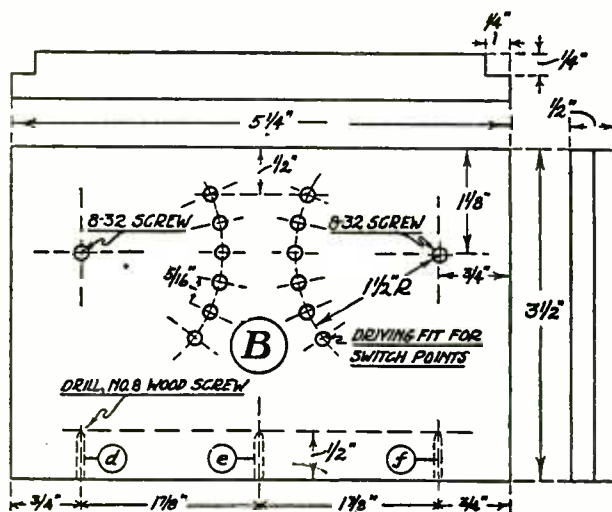

The front-panel layout shows the exact locations of the brass brads used for switch points. Leave these out if you are going to use commercial rotary switches (see text).

little compulsive (as I was), you might want to anchor the turns more securely by spraying the coil with a few thin coats of quick-drying lacquer.

Your final step will be to trim the Quaker Grits canister to size. First, using a matte knife, neatly cut the loose paper from around the edge of the cover you removed at the beginning of this project. Measure the depth of the cover, then

TAP SWITCH CONSTRUCTION

Back in 1924, set builders regularly made items that we wouldn't think of building for ourselves today. For example, the original construction article provided details on how to construct both the two tap switches used with the tuning coil and the stand for the crystal detector.

I've already served notice that that type of fussy me-

chanical construction isn't my bag! I intend to use rotary switches and a commercially available replica crystal stand in my own version of the NBS set. However, for those who want to build a 100% authentic set, I'll conclude this month with some details about the tap switches used in the original project.

A pair of drawings showing parts of the switch-contact assembly is included with this article. You'll need to build two of these assemblies; one for coarse tuning and one for fine. The switch blade is cut and bent, as shown, from No. 24 spring brass sheet "with the grain of the metal running the long way."

The contact assembly parts are assembled on a two-inch 8-32 brass machine screw. First, slide on the knob, which is cut from a fiber rod. Then add the blade, sandwiched between a couple of washers (make one of them a lock washer). Secure the blade by pinning on a brass nut and tightening securely. You might like to back up the nut with another washer to keep it from digging into the wood front panel as the switch is turned.

After giving the blade a slight bend, as shown by the dotted lines, and passing the screw through its hole in the front panel (to be described later), the remaining parts are added to the assembly. Those include brass washers "g" and "p", tension spring "b" (which is formed by wrapping 10 turns of No. 20 piano wire around a 3/16-inch rod clamped in a vise), another brass washer, and a pair of nuts to lock the assembly in place. The twist of wire locked between washers "g" and "p" represents the electrical hookup to the

(Continued on page 78)

COMPUTER BITS

By Jeff Holtzman

Just a Click Away

The Windows Program Manager is one of the most maligned pieces of software in history—and deservedly so. I've been searching for a better interface since the days of Windows 2.0. I've tried numerous commercial and shareware products, and none has ever been able to totally satisfy my needs.

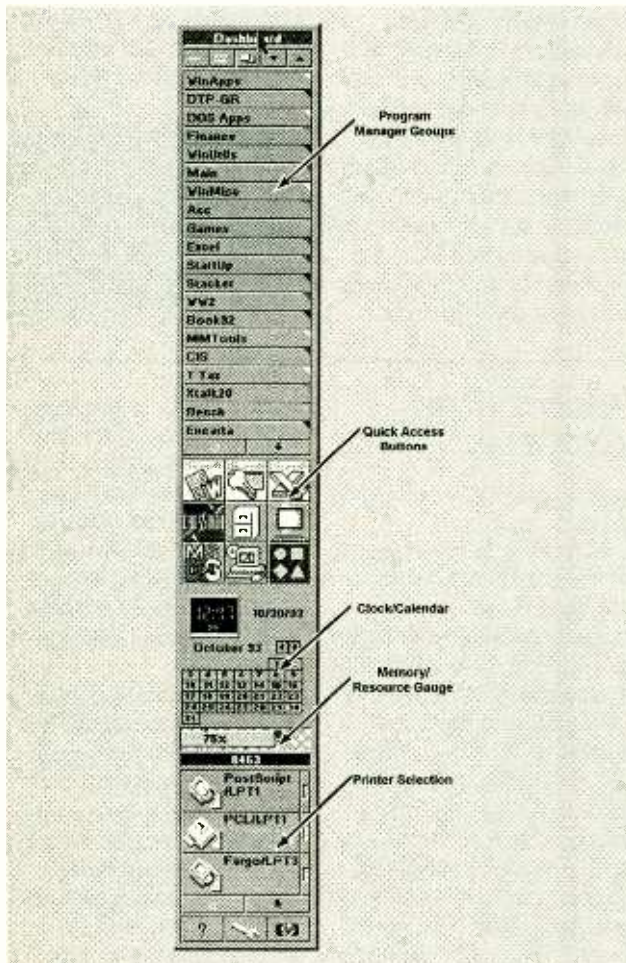

DashBoard, from Hewlett-Packard, is the most economical, effective, and efficient Windows shell available. It allows you to add your own quick access buttons, program groups, printer-selection icons, and more. Then whatever you need is just a click away.

My needs tend to run in cyclical extremes. Most of the time I want a full-blown

package with everything including the kitchen sink. In that category, Norton's Desktop for Windows (NDW) is the best that I've found. But certain things about NDW continue to bother me, like the occasional video instability, the tremendous amount of disk space required, glacially slow start-up time, incompatibility and the lack of synchronization with Program Manager icon groups, occasional incompatibilities with the installation routines of various programs, the lack of icon docking, and the lack of a more object-oriented desktop (like OS/2) that would allow you to clone drive icons and file lists. On the other hand, I really like NDW's file viewing and management system. It's much more efficient than Windows' own File Manager.

However, one day, my copy of NDW broke. It simply refused to load. Faced with the prospect of reloading it from floppies, I decided to go cold turkey. I have missed it—but not as much as I thought I would. What made the biggest difference was a program called Outside In, which can attach itself to the Windows File Manager and give pretty much the effect of NDW's file viewer/manager. But replacing Program Manager took much more effort.

For a short time, I used a program called SideBar, which has a really elegant design, but the early version that I looked at had bugs and was somewhat wasteful of screen real estate.

Then Hewlett-Packard released a program called DashBoard. Although intrigued, I never got around to trying Version 1. Recently, they released Version 2, and have made it widely available for \$30–\$60. At that price, I couldn't afford not to check it out, and it looks like a keeper.

DASHBOARD

DashBoard gives you a highly configurable bar that you can spread horizontally or vertically across your screen. The bar can hold icons for your favorite programs, a clock/calendar, a memory/resource gauge, printer icons for instantly switching among several printers, a virtual screen manager, and more. Click a program icon and the associated program runs. Click a program group, and a list of programs in that group appears. Double click a program group, and a Program Manager-like icon group pops up. The changes that you make to those groups are reflected in Program Manager. For example, you can copy, move, and delete icons, pack them, and optionally sort them alphabetically by title. In addition, you can create nested groups (groups within groups), but those are only good in DashBoard.

DashBoard can work in conjunction with Program Manager or replace it. DashBoard can also replace Task Manager, but this is one area where the competition (e.g., the Metz Task Manager and the Boy-an Task Manager) provide more power. Nonetheless,

DashBoard—as a single-product replacement for both Program Manager and Task Manager—is highly appealing, especially so because DashBoard occupies a mere 1.8MB of disk space. My NDW subdirectory used to occupy nearly ten times that amount!

It's amazing how much HP has been able to pack into 1.8MB. For example, the Clock/Calendar allows you to set alarms, either one-time or recurring. When the specified moment occurs, the program can pop up a reminder, run a program, play a tune (a Windows WAV file), or all of those. However, repetitive alarms can only be set to occur on specific days of the week or every day. Longer time periods (e.g., weekly, bi-weekly, semi-monthly, monthly, quarterly, and yearly) are not supported.

The system-resource monitor keeps track of how

much general memory and system memory you have available, and can sound an alarm if either falls below a specified threshold. DashBoard provides similar resource tracking for your disk drives. All of those items are configurable. If you don't need or want them, you turn them off.

Another useful function is DashBoard's "Run Box." It provides a DOS-like command-line window, complete with a scroll-back buffer, in which you can list directories, copy files, and so forth. You can also launch both DOS and Windows programs—even Windows PIF files—from the Run Box, either by typing the corresponding name, or by double-clicking the name in a directory list.

I have three complaints here. One is the washed out font used in the Run Box. Second is that there doesn't seem to be any way to

access the Run Box directly from the main DashBoard bar. However, you can assign a hot key that will pop the Run Box up over any running application. Third is that you can't copy text (e.g., a directory listing) out of the Run Box.

DashBoard provides you extensive abilities to customize fonts (except in a few places like the Run Box), colors, sort orders, icon titles, icon sizes, and more. You can even save named configurations (called Layouts) and recall them later.

In addition to the customization options, Layouts can also include running programs. For example, you could save a Finance layout with Excel and Quicken, and a document layout with Word and Visio (by the way Version 2 is out—and it's hot! More on that next time). Later, when you reload a layout, all

customization options take effect, and all associated programs are loaded.

However, layouts do not include files loaded by those programs. To compensate, DashBoard allows you to edit the command line that starts each program in a layout. However, it would be better to be able to save a layout and simply have everything appear in the precise state it was in the last time you used that layout.

You may not be in the habit of thinking of HP as a mainstream PC software vendor. DashBoard will change your mind. Byte for byte, it's the most efficient Windows shell out there. ■

VENDOR INFORMATION

DashBoard
Hewlett-Packard Co.
PC Software Division
974 E. Arques Avenue
Sunnyvale, CA 94086
800-752-0900

COMING NEXT MONTH

in the June, 1994 Issue of

Popular Electronics®

Why wait for tomorrow's information superhighway? In June, **Popular Electronics** will be your tour guide to today's fascinating world of on-line information and entertainment. We'll also show you how one of our favorite childhood toys has been updated for the 1990's, how to build a device that will screen out unwanted telephone calls, how to get both positive and negative voltages from a single-sided supply, and more!

On Sale
April 19, 1994

Watch for it!

Pick up **Popular Electronics** at your favorite Newsstand, Bookstore, Convenience Store or Supermarket

ANTIQUE RADIO

(Continued from page 76)

switch, which will be added later.

Now refer to the drawing of the front panel, which is cut from 1/2-inch wood stock. Note the layout of the six contacts for each of the two switches. These should be placed carefully, as shown, so that the blades will contact them properly after assembly. The contacts, or "switch points," are simply 3/4-inch brass brads (approximately 1/8-inch in diameter) driven through the board. Their rounded heads should be flattened out with a file prior to installation. Two 1/2-inch brass brads are installed on the panel at each switch position to act as blade stops.

Electrical connections will later be soldered to the "business ends" of the

switch points, where they protrude through the back of the panel. Of course, you won't be installing those points if, like me, you use commercial rotary switches. Just drill holes big enough to pass the shafts of those switches at the "8-32 screw" locations.

Studying the panel further, you'll also notice that the edges are rabbeted out (I hope that's the correct term) for a cover that will later be added to conceal the coil assembly, which is mounted behind the panel. If you are inclined to duplicate that feature, you should obviously do it before installing the switch points. Also, drill the three holes, as shown, that will accept the screws used to fasten the panel to its wood base. We'll continue construction of the NBS set next month. ■

CIRCUIT CIRCUS

By Charles D. Rakes

Some Assorted Circuits

This month, I want to share a number of circuits, ranging from a single-chip radio receiver to an audible voltmeter. Hopefully, at least one of these circuits will fill a void in an on-going project or a future one. In any event, get ready for some experimenting.

There's no doubt that the popular NE602 double-balanced mixer/oscillator is the star IC of the DC (direct-conversion) receiver. At least that's been the case for the last few years. As popular as the NE602 has become, it's not without its faults. The number one complaint is its limited dynamic range. That means that the NE602 can not handle input-signal levels that vary greatly in strength. To overcome that problem,

PARTS LIST FOR THE ONE-CHIP RECEIVER

SEMICONDUCTORS
 U1—TDA7000 single-chip FM radio, integrated circuit
 U2—LM386 low-voltage audio-power amplifier, integrated circuit

CAPACITORS
 C1—100-pF, ceramic-disc
 C2—C4—0.22- μ F, ceramic-disc
 C5, C6—365-pF variable
 C7, C8—470- μ F, 16-WVDC, electrolytic

ADDITIONAL PARTS AND MATERIALS
 R1—5000-ohm potentiometer
 L1, L2—See text
 S1—SPST switch
 Perfboard materials, T80-2 toroid (D.C. Electronics), #28 magnet wire, IC sockets, 9-volt power source, wire, solder, hardware, etc.

an RF attenuator must be added and constantly adjusted as input levels change.

Another chip to consider for receiver applications is the TDA7000 single-chip FM receiver (originally designed for use in portable radios, TV's, cordless phones, and other receiving equipment), which can be operated from a 4- to 12-volt DC source with a current drain of about 10 mA. The TDA7000's input circuit offers a much wider dynamic range than does the NE602. Furthermore, even though it's designed for FM applications, the TDA7000's oscillator and mixer can be used to build an excellent receiver.

L1 and L2, are each comprised of 100 turns of #28 enamel-covered, copper, magnet wire wound on T80-2 toroid cores (with a tap at the 30th turn on L1). The toroid cores and the TDA7000 are available from D.C. Electronics, P.O. (3203, Scottsdale, AZ 85271-3203;

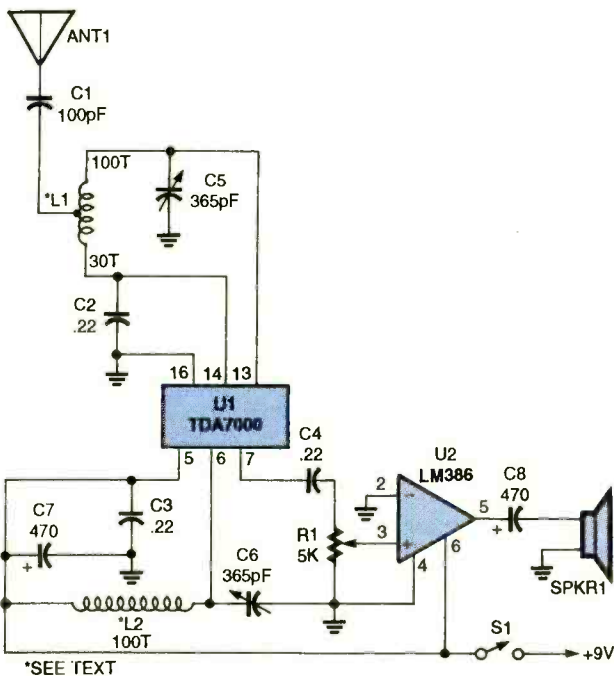

Fig. 1. The DC Receiver is comprised of a TDA7000 single-chip FM receiver (U1), an LM386 low-voltage audio-power amplifier (U2), a pair of hand-wound coils (L1 and L2), and a few additional components.

ONE-CHIP RECEIVER

Take a look at the schematic diagram of the receiver circuit shown Fig. 1. About all you have to do is wind two coils, connect a few components together, tie the input to a simple wire antenna, and a receiver is born. The two coils,

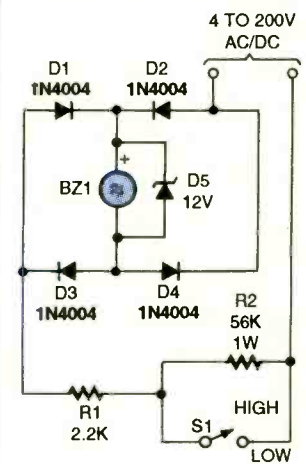

Fig. 2. The Audible Voltmeter can be used to test for AC or DC voltages in a circuit. With S1 closed, the circuit can be used to test for voltages between 4 and 24 volts, and when S1 is open, it can be used to check for the presence voltages of up to 200 volts.

Tel. 800-467-7736).

Although the manufacturer's specifications don't recommend operating the chip below 1.5 MHz, we operated ours in the stan-

standard AM-broadcast band. The 160-meter amateur band can be covered by winding about 70 turns of the same wire (#28) on the T80-2 cores with a tap at

PARTS LIST FOR THE AUDIBLE VOLTMETER

SEMICONDUCTORS

D1-D4—1N4004 1-amp, 200-PIV, silicon rectifier diode
D5—12-volt Zener diode

RESISTORS

(All fixed resistors are 1/4-watt, 5% units unless otherwise noted.)

R1—2200-ohm
R2—56,000-ohm, 1-watt

ADDITIONAL PARTS AND MATERIALS

BZ1—Piezoelectric buzzer
S1—SPST switch
Perfboard materials, enclosure, wire, solder, hardware, etc.

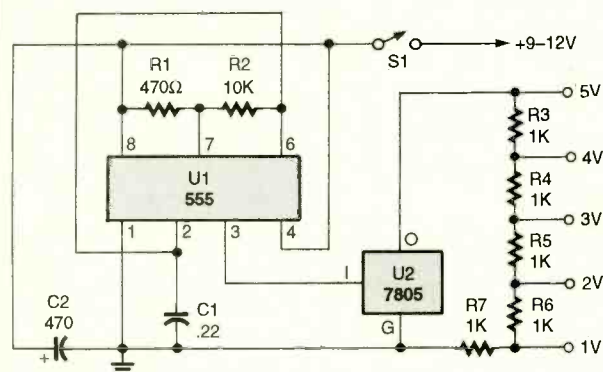

Fig. 3. In the Voltage Calibrator, two low-cost IC's—a 555 oscillator/timer and a 7805 5-volt 1.5-amp voltage regulator—along with a precision voltage divider network are used to provide outputs of 1- to 5-volts peak-to-peak.

PARTS LIST FOR THE VOLTAGE CALIBRATOR

SEMICONDUCTORS

U1—555 oscillator/timer, integrated circuit
U2—7805 5-volt, 1.5-amp, voltage-regulator, integrated circuit

RESISTORS

(All fixed resistors are 1/4-watt, 5% units, unless otherwise noted.)

R1—470-ohm
R2—10,000-ohm
R3-R7—1000-ohm, 1%.

CAPACITORS

C1—0.22- μ F, ceramic-disc
C2—470- μ F, 16-WVDC, electrolytic

ADDITIONAL PARTS AND MATERIALS

S1—SPST switch
Perfboard materials, enclosure, 9-12-volt power source, wire, solder, hardware, etc.

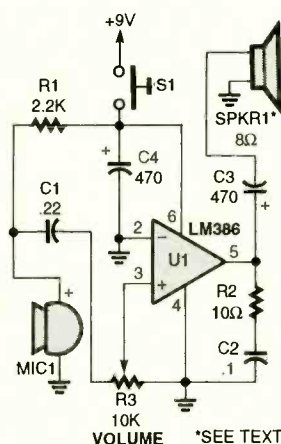

Fig. 4. The Mini-Megaphone is comprised of an electret microphone (MIC1), an LM386 low-voltage audio-power amplifier (U1), a horn speaker (SPKR1), and a few other components.

us a line or two (along with a schematic diagram) explaining your application and how it works. Send them to *Circuit Circus*, c/o Popular Electronics, 500-B Bi-County Blvd., Farmingdale, NY 11735. I'll share the best with our other friends.

AUDIBLE VOLTMETER

Next up is a simple audible voltmeter (see Fig. 2). The circuit can come in handy when you have to make a quick check to see if either an AC or DC voltage is present in a circuit. The tester can also be valuable when checking for voltages in difficult loca-

PARTS LIST FOR THE MINI-MEGAPHONE

RESISTORS

(All fixed resistors are 1/4-watt, 5% units.)

R1—2200-ohm
R2—10-ohm
R3—10,000-ohm potentiometer

CAPACITORS

C1—0.22- μ F, ceramic-disc
C2—0.1- μ F, ceramic-disc
C3, C4—470- μ F, 16-WVDC, electrolytic

ADDITIONAL PARTS AND MATERIALS

MIC1—Electret mike element (Radio Shack #270-090)
SPKR1—4-inch indoor/outdoor horn speaker (Radio Shack #40-1235)
U1—LM386 low-voltage audio-power amplifier, integrated circuit
S1—Normally-closed, pushbutton switch
Perfboard materials, enclosure, IC socket, 9-volt power source, wire, solder, hardware, etc.

the 20th turn on L1. Higher frequency ranges can be covered by using reducing the number of turns on each coil and by reducing the size of the tuning capacitors.

That simple receiver only nibbles at the many uses offered for the TDA7000. Look over the application literature that's furnished with the chip to see how many different uses you can come up with. Once you've got your circuit up and running, why not drop

tions where it's impossible to see what you are doing and read a meter at the same time.

The circuit in Fig. 2 has 2 voltage ranges. With S1 closed, the circuit can be used to test for the presence of voltages between 4 and 24 volts, and when S1 is open, it can be used to check for the presence of voltages of up to 200 volts.

VOLTAGE CALIBRATOR

Our next circuit, see Fig. 3. (Continued on page 90)

ELECTRONICS MARKET PLACE

FOR SALE

MODEMS 2024 AT&T II/Western E. external 110 volt AC — Loc — Adrs — (DC in) (DC out) (CC in) (CC out) (CIU/DBU) etc. Complete untested (\$39.00 each) (\$59.00 X 2) (\$69.00 X 3). **RAY**, (619) 722-2886. (\$10.00 packing & shipping).

SECRET cable descramblers! Build your own descrambler for less than \$12.00 in seven easy steps! Radio Shack parts list and free descrambling methods that cost nothing to try, included. Send \$10.00 to: **INFORMATION FACTORY**, Dept. 5, PO Box 689, Seabrook, TX 77586. For COD's (713) 922-3512 any time!

300 Experimenters Circuits — Complete in 6 practical books using diodes, relays, FET's, LED's, IC 555's, and IC CA3130's for building blocks. Only \$33.00 plus \$5.50 for shipping. USA and Canada only. US funds. **ETT, INC.**, PO Box 240, Massapequa Park, NY 11762-0240.

CABLE descrambler liquidation. Major makes and models available. Industry pricing! (Example: Hamlin Combo's, \$44 each... Minimum 10 orders). Call **WEST COAST ELECTRONICS**, 1 (800) 628-9656.

CLASSIFIED AD ORDER FORM

To run your own classified ad, put one word on each of the lines below and send this form along with your check to:

Popular Electronics Classified Ads, 500-B Bi-County Boulevard, Farmingdale, N.Y. 11735

PLEASE INDICATE in which category of classified advertising you wish your ad to appear. For special headings, there is a surcharge of \$11.00.

() Plans/Kits () Business Opportunities () For Sale
() Education/Instruction () Wanted () Satellite Television

Special Category: \$11.00

PLEASE PRINT EACH WORD SEPARATELY, IN BLOCK LETTERS.

(No refunds or credits for typesetting errors can be made unless you clearly print or type your copy.) Rates indicated are for standard style classified ads only. See below for additional charges for special ads. **Minimum: 15 words.**

1	2	3	4	5
6	7	8	9	10
11	12	13	14	15 (\$23.25)
16 (\$24.80)	17 (\$26.35)	18 (\$27.90)	19 (\$29.45)	20 (\$31.00)
21 (\$32.55)	22 (\$34.10)	23 (\$35.65)	24 (\$37.20)	25 (\$38.75)
26 (\$40.30)	27 (\$41.85)	28 (\$43.40)	29 (\$44.95)	30 (\$46.50)
31 (\$48.05)	32 (\$49.60)	33 (\$51.15)	34 (\$52.70)	35 (\$54.25)

We accept MasterCard and Visa for payment of orders. If you wish to use your credit card to pay for your ad fill in the following additional information (Sorry, no telephone orders can be accepted.):

Card Number

Expiration Date

PRINT NAME

SIGNATURE

IF YOU USE A BOX NUMBER YOU MUST INCLUDE YOUR PERMANENT ADDRESS AND PHONE NUMBER FOR OUR FILES. ADS SUBMITTED WITHOUT THIS INFORMATION WILL NOT BE ACCEPTED.

CLASSIFIED COMMERCIAL RATE: (for firms or individuals offering commercial products or services) \$1.55 per word prepaid (no charge for ZIP code)...**MINIMUM 15 WORDS.** 5% discount for same ad in 6 issues within one year; 10% discount for 12 issues within one year if prepaid not applicable on credit card orders. **NON-COMMERCIAL RATE:** (for individuals who want to buy or sell a personal item) \$1.25 per word, prepaid...no minimum. **ONLY FIRST WORD AND NAME** set in bold caps at no extra charge. Additional bold face (not available as all caps) 30¢ per word additional. Entire ad in boldface, \$1.85 per word. **TINT SCREEN BEHIND ENTIRE AD:** \$1.90 per word. **TINT SCREEN BEHIND ENTIRE AD PLUS ALL BOLD FACE AD:** \$2.25 per word. **EXPANDED TYPE AD:** \$2.05 per word prepaid. Entire ad in boldface, \$2.45 per word. **TINT SCREEN BEHIND ENTIRE EXPANDED TYPE AD:** \$2.55 per word. **TINT SCREEN BEHIND ENTIRE EXPANDED TYPE AD PLUS ALL BOLD FACE AD:** \$2.95 per word. **DISPLAY ADS:** 1" x 2 1/8" — \$205.00; 2" x 2 1/8" — \$410.00; 3" x 2 1/8" — \$615.00. General Information: Frequency rates and prepayment discounts are available. **ALL COPY SUBJECT TO PUBLISHERS APPROVAL. ADVERTISEMENTS USING P.O. BOX ADDRESS WILL NOT BE ACCEPTED UNTIL ADVERTISER SUPPLIES PUBLISHER WITH PERMANENT ADDRESS AND PHONE NUMBER.** Copy to be in our hands on the 18th of the fourth month preceding the date of issue (i.e.; Sept. issue copy must be received by May 18th). When normal closing date falls on Saturday, Sunday or Holiday, issue closes on preceding work day. Send for the classified brochure. Circle Number 49 on the Free Information Card.

Look to the Future

With Your Own

Cable Converter & Descrambler !

1-800-228-7404



NU-TEK ELECTRONICS

FREE CATALOG!

3250 Hatch Rd.
Suite 1 C
Cedar Park, TX 78613

ALL MAJOR BRANDS



CABLE descramblers and test turn-on kits available for most makes and models. We also carry bullet stoppers. No smoke, no mirrors, just low prices! Call others, then compare our prices! Cash paid for cable equipment. No Florida sales. (305) 425-0751.

CABLE TV descramblers. All major brands. Have make/model used in your area when calling. 1 (800) 327-3407. For a free catalog write **KD VIDEO**, PO Box 29538, Minneapolis, MN 55429.

FREE CATALOG

FAMOUS "FIRESTIK" BRAND CB ANTENNAS AND ACCESSORIES. QUALITY PRODUCTS FOR THE SERIOUS CB'er. SINCE 1962

FIRESTIK ANTENNA COMPANY
2614 EAST ADAMS
PHOENIX, ARIZONA 85034

THE Case Against Patents. Thoroughly tested and proven alternatives that work in the real world. \$24.50. **SYNERGETICS PRESS**, Box 809-C, Thatcher, AZ 85552. (602) 428-4073. Visa/MC.

CABLE equipment! Jerrold, Zenith, Pioneer, Oak, Scientific Atlanta & more! Our prices are below wholesale! **CABLE MASTER**. 1 (800) 480-9888.

GREAT idea! We do documentation right! **PAT DOCUMENT SERVICES**, PO Box 200, Ellisville, MS 39437. (601) 477-3875.

PRINTED circuit boards — etched drilled, tin plated. Single sided \$1.25/sq. inch. Free shipping. **HELCO ELECTRONICS**, 61 Water Street, Mayville, NY 14757. 1 (800) 388-8521.

CB RADIO OWNERS!

We specialize in a wide variety of technical information, parts and services for CB radios. 10-Meter and FM conversion kits, repair books, plans, high-performance accessories. Thousands of satisfied customers since 1976! Catalog \$2.

CBC INTERNATIONAL

P.O. BOX 31500PE, PHOENIX, AZ 85046

FOUR simple cable descrambling circuits using Radio Shack RF modulator, instructions \$8.00. TELCOM, Box 832P5, Brusly, LA 70719.

CABLE test chips. Jerrold, Tocom, S.A., Zenith. Puts cable boxes into full service model \$29.95 to \$59.95. 1 (800) 452-7090, (310) 902-0841.

ANTIQUE RADIO CLASSIFIED

Free Sample!

Antique Radio's
Largest Circulation Monthly.
Articles, Ads & Classifieds.



6-Month Trial: \$16.95. 1-Yr: \$29.95 (\$44.95-1st Class).
A.R.C., P.O. Box 802-L10, Carlisle, MA 01741

PLANS & KITS

60 Solderless Breadboard Projects in two easy-to-read pocket books. Complete with circuit descriptions, schematics, parts layouts, component listings, etc. Both books (BP107 & BP113) only \$11.90 plus \$3.50 for shipping. USA and Canada only. US funds. ETT, INC., PO Box 240, Massapequa Park, NY 11762-0240.

SURVEILLANCE kits, hear conversations half a football field away with the National Surveillance Bionic Ear parabolic microphone. Even beginners can build it. Uses common electronics. Easily understood, detailed plans. **Plans \$24.95, kits available. NATIONAL SURVEILLANCE**, PO Box 215, Cleveland, MS 38732.

FASCINATING kits! Lasers, voice changers, gas sensors, and more! Send \$1.00 for catalog. **LNS TECHNOLOGIES**, 20993 Foothill Blvd., Suite 307P, Hayward, CA 94541-1511.

SCHEMATIC design program, Free brochure. Write Dept. P, **SCHEME-ADDICT**, 8622 W. 44th Place, Wheat Ridge, CO 80033.

SECRET revealed, see and/or videotape in total darkness using any video camera. Takes 10 minutes to build. Send \$3.00 for information. \$15.00 plans, \$29.95 complete kit. **A.C.S.**, 4611 S. University Dr. #167, Davie, FL 33328.

Telephone Listening & Recording Devices

MA-100 Devices Hidden in Dual Modular Adapters! DMR-20 FM Transmitter MA-100 Recording Adapter

Crystal clear reception on FM radio up to 1/4 mile
SnapKit uses phone line for power & antenna

DMR-20
Starts & stops recorder when phone is used
Plugs into standard cassette recorder
Works when any phone in house is used

\$25.95 free shipping, Visa/MC (214) 255-7490
Seymour-Radix Inc. Box 166055 - PE Irving, TX 75018

INVENTIONS

INVENTORS: CONCEPT NETWORK offers professional, inexpensive patenting and marketing services. (New product ideas with prototype or schematics preferred; but they are not required.) Free information packet: Call 1 (800) 835-2246 extension 67.

FREE invention package: **DAVISON & ASSOCIATES** offers customized development, patenting, and licensing for new products and ideas. Proven results: 1 (800) 677-6382.

EDUCATION/INSTRUCTION

ELECTRONIC engineering. 8 volumes complete. \$109.95. No prior knowledge required. Free brochure. **BANNER TECHNICAL BOOKS**, 1203 Grant Avenue, Rockford, IL 61103.

PROCESS refunds. Your help is needed immediately to process insurance refunds. Earn up to \$250.00 or more per refund processed. No experience needed. Easy and fun to do. Work in the privacy of your own home. Complete step by step instruction book. Rush \$22.95 to: **POPLAR PUBLISHING**, PO Box 1766, Dept. PE9, Enid, OK 73702.

ELECTRICITY/Electronics training series used by U.S. military. 23 volumes, other courses available. Free info: **FEDERAL TECHNICAL PUBLISHERS**, Box 1061 E. Glen Lake, MN 55345.

VCR repair, do it yourself and save. Illustrated guide shows you how. Mail \$15.00 to **MITCHELL PUBLICATIONS**, Box 81B, Morenci, MI 49256-0081.

VCR Repairs You Can Do. Save\$. Make\$. All brands. Fix difficult problems simply. 403 pages. \$Back-guarantee. Over 38,000 sold. 704 illustrations + tool. Mail \$24.95 to **WORTHINGTON PUBLISHING**, Box 16691M, Tampa, FL 33687-6691.

PC Power Supplies. What they are. How they work. Safe and easy low voltage test and repair. 96 pages, 37 illus. \$19.95 **WELX TECH**, Box 34, Greenbelt, MD 20768.

BUSINESS OPPORTUNITIES

MAKE \$75,000.00 to \$250,000.00 yearly. Learn IBM monitors repairs (solutions most brands). New home based business program. Software available. Information: **USA-Canada** \$3.00 cash (no checks). Dealers wanted worldwide (\$35.00) US funds. **RANDALL DISPLAY**, PO Box 2168-H, Van Nuys, CA 91404, USA.

GOVERNMENT seized cars, trucks, boats, computers, televisions. Surplus bargains galore! Your area: 1 (800) 601-2212 Ex.SP7930.

EASY work! Excellent pay! Assemble products at home. Call toll free 1 (800) 467-5566 ext. 5730.

DISTRIBUTORS needed — high profits, largest selection & lowest prices. Mini-satellite antennas for homes, RV, business, & many new markets. Starting \$296.00. 1 (800) 886-5008.

START your own technical venture! Don Lancaster's newly updated **Incredible Secret Money Machine II** tells how. We now have autographed copies of the Guru's underground classic for \$18.50. **SYNERGETICS PRESS**, Box 809-C, Thatcher, AZ 85552. (602) 428-4073. Visa/MC.

INVENTIONS! New products. You can profit from your ideas! **QUORUM INTERNATIONAL**, a rapidly expanding manufacturing/marketing company is actively seeking consumer products. Send ideas to: **QUORUM INTL**, Product Research Dept., 1550 W. Deer Valley Rd., Phoenix, AZ 85027.

TELEVISION VIDEOS

TELEVISION test patterns on VHS! Computer generated crosshatch, color-bar, etc. 18 patterns, 30 minutes. Only \$23.95 or \$3.00 plus SASE for info. **DL D DISTRIBUTORS**, 429 Cessna Road, Concord, NC 28025.

BEST BY MAIL

Rate: Write National, Box 5, Sarasota, FL 34230

OF INTEREST TO ALL

SPORTS FANS: CALL 1-800-PLAY-ISC to see what you are missing!

AMAZING LOTTERY SECRET of "31". Recorded Message (313)927-0187, Extension 4.

HIGH SCHOOL DIPLOMA Fast New Program Credit For Experience 1-800-494-9065.

PROTECT YOURSELF — PEPPER sprays, more: GHB BE SAFE, Box 652, Hampstead, MD 21074-0652.

1993 **FLORIDA MARLINS** Inaugural Binder And Card Set. \$16.95. 305-741-3355.

NEW DIET PLAN Makes Losing Weight Easy, Fun. Guaranteed: 6897-(PE) Serenity Way, San Jose, CA 95120.

MODERN DAY REVIVAL? Eternal Security? Send for FREE Bible Studies. Light, St. Maries, ID 83861.

MONEYMAKING OPPORTUNITIES

\$HOMES EMPLOYMENT INFORMATION! \$1/SASE: Box 2508-(PE), Ames, IA 50010-2508.

VACATIONS

\$5.00 A DAY VACATION HOTELS! Save Big \$ With Great Vacation Hotel Specials. 6 Days 5 Nights Walkiki, Hawaii; 5 Days 4 Nights Las Vegas; Freeport, Bahamas; Cancun, Mexico, As Low As \$25.00. Plus Discount Airfares, Cruises And Much Much More! Call Now 1-800-864-8720.

"YOUR FREE CATALOG KNOCKED MY SOCKS OFF"

We get that sort of comment all the time. People are impressed that our free Consumer Information Catalog lists so many free and low-cost government booklets. There are more than 200 in all, containing a wealth of valuable information.

Our free Catalog will very likely impress you, too. But first you have to get it. Just send your name and address to:

**Consumer Information Center
Department KO
Pueblo, Colorado 81009**



A public service of this publication and the Consumer Information Center of the U. S. General Services Administration

TODAY'S
THE DAY

Stop Smoking.

American Heart Association



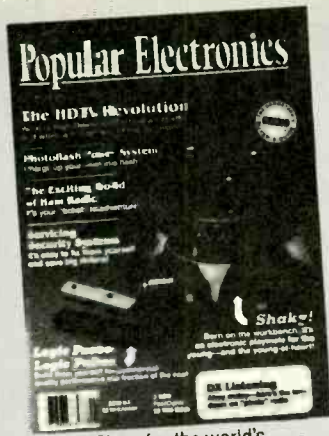

Plans for the world's
zaniest plaything—
September 1989



Put together your own
Macintosh computer—
September 1991



Build the Tesla Coil
that went square!—
August 1989



Take a chance on
our Dice-Roulette project—
April 1989

Get the one you missed!

Popular Electronics®

Popular Electronics back issues are available although quantities of some issues are nearly exhausted. Here's an opportunity to complete your collection, or obtain a selected back issue you cannot find elsewhere. This offer is valid only when using the coupon on this page or a photo copy.

Special Back Issue Offer!

Please circle the issue(s) ordered!

	Jan.	Feb.	Mar.	Apr.	May	June	July	Aug.	Sep.	Oct.	Nov.	Dec.	
1987	1	2	3	4	5	6	7	8	9	10	11	12	
1988	1	1987-1988 back issues not available									11	12	13
1989	25	26	27	28	29	30	31	32	33	34	35	36	
1990	37	38	39	40	41	42	43	44	45	46	47	48	
1991	—	49	—	50	51	52	53	54	55	56	57	58	
1992	59	60	61	62	63	64	65	66	67	68	69	70	
1993	71	72	73										

Note: Issues prior to November 1988 are "Hands-on Electronics"—the predecessor of Popular Electronics.

How to determine cost!

Quantity	Price per copy		
	United States	Canada	Foreign
1-5	\$6.50 US	\$6.50 US	*
6-11	5.50	5.75	\$8.00 US
12-23	5.00	5.25	7.50
24 and more	4.50	4.75	7.00

Prices include handling and shipping. Prices subject to change. All orders payable in U.S.A. funds only, via international money order, check drawn on a U.S.A. bank, or acceptable credit card (Visa, MasterCard) in U.S.A. funds. Allow 6-8 weeks delivery. Foreign orders may take longer. *Minimum foreign order—6 issues.

Visa MasterCard USA Bank Check US or Int. Money Order

[Note: Credit Card minimum order is \$15.00.]

Credit Card Number _____ Exp. Date _____ / _____

Signature _____

Name _____

Address _____

City _____ State _____ ZIP _____

Send Orders To: CLAGGK, Inc., P.O. Box 4099, Farmingdale, NY 11735. Sorry, no telephone orders.

DX LISTENING

By Don Jensen

Shortwave-Broadcast Funding

What makes shortwave different from your hometown broadcast? "The first thing I noticed on shortwave was that there are no commercials," writes 16-year-old Brett Bymaster of Brownsburg, IN. "Why is this? Where do they get their money?"

The major international shortwave stations fall into two basic categories in terms of funding, Brett. Most are owned and operated by foreign governments or quasi-governmental agencies. *The Voice of America*,

voluntary contributions of faithful followers.

Besides those, Brett, there are some U.S. shortwave outlets that are either fully or partly supported by selling blocks of airtime to other program producers, such as the aforementioned preachers or various foreign dissident or exile groups.

What many SWLs don't realize, though, is that in addition, there are many hundreds of commercial stations on shortwave, the sort that regularly air commercial spots, product ads, slogans, jingles, and the rest. If they've escaped your notice, it's probably because they tend to be small and lower powered stations, mostly broadcasting in Spanish or Brazilian Portuguese from Latin America.

Those commercial operations aim their programs and ads at domestic listeners, just as do U.S. AM and FM broadcasters. If you tune in and stick to one of those local Latin SW'ers, you might also hear a "spot" for some less familiar—to *norteamericanos*, at least—soft drink like Inka Kola. Another way your local radio station differs from SW is in the way its signal reaches your receiver. Brett Bymaster has some other interesting questions about that.

"How many watts does a station like the BBC put out?" he continues. "Why can I pick it up a continent away, but I can't hear a local station 100 miles away? Is it just the wattage, or is there something special about the shortwave frequencies?"

In fact, Brett, it's both, al-

though the latter, the very nature of shortwave, that is most important. Major international broadcasters, such as the BBC, today use powerful transmitters that pump out plenty of wattage, typically 100,000 to 500,000 watts (often stated in kilowatts—100 to 500 kW). Not too many years ago, 50,000 watts was considered really high power on shortwave, more than enough to be heard clearly around the world.

But that world has changed. As certain SW stations upgraded to super-power transmitters, the rest (or those stations who could afford it) followed suit, going to higher powers as well. Today, most of the broadcasting "big boys" are "yelling louder," but by and large, because of the increased mutual interference resulting, aren't being heard much better than before. And the small stations that couldn't keep up in the power race are harder to hear than ever.

Consider, next, that small-town medium-wave AM station 100 miles from your home. Its modest transmitter, most likely, runs just 250 or 500 watts. The most powerful big city AM stations in the U.S. and Canada have 50,000-watt transmitters. Transmitter power does help a station punch out its signal. But that doesn't really account for the difference between the range of a shortwave station and that of a local radio broadcaster. That involves, mostly, the way in which radio waves, be they AM medium wave or shortwave, reach us.

When a radio signal

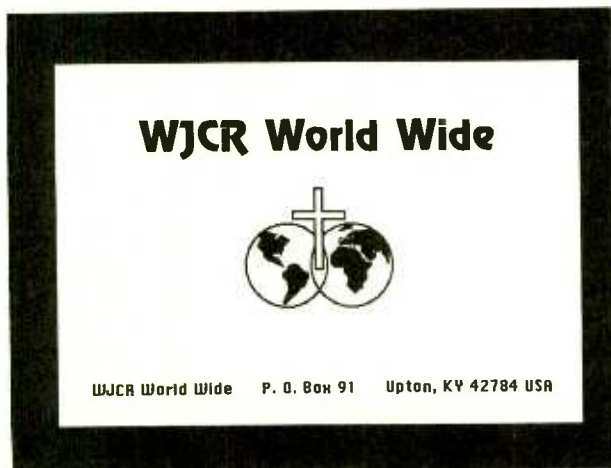

This QSL verification card is sent to listeners by WJCR World Wide, one of the U.S. religious stations that rely on supporters' contributions to finance SW broadcasts.

the British Broadcasting Corp., and Radio Canada International are examples of SW broadcasters financed directly or indirectly by public monies.

A second source of funding for international broadcasting are religious donations. Religious broadcasters—be they major stations like *HCJB* in Quito, Ecuador, or individual preachers who buy airtime for their programs on various SW outlets—get their financial support from the

leaves the station's transmitting antenna, a part of the electromagnetic energy—called the ground wave—hugs the surface of the Earth. The other part of the radiated signal, called the sky wave, heads off into space, and before long, it encounters a series of charged gaseous layers encircling the Earth, 60 to 150 miles overhead in the ionosphere.

Depending on the frequency of the radio signal, the density of those gaseous layers, the time of day, and other factors, some of the outbound energy is reflected back to Earth. It skips in hundreds of miles from the original transmitter site only to bounce skyward again. In that way, multiple skips between the ionospheric layer and the Earth can take a sky-wave signal round the globe.

The sky-wave phenomenon is commonplace for signals on the shortwave frequencies, say, 3,000 to 30,000 kilohertz. It also happens to signals in the regular AM (540 to 1600 kHz.) band, but only during hours of darkness. Probably you have noticed that at night you may hear an AM station a thousand miles away on your car radio, one you can't hear during the day. But reliable day-and-night reception on the AM band, unlike shortwave listening, must rely on the Earth-hugging ground wave portion of the transmitted signal. Here, where electrical brute force does the trick, transmitter power is especially important.

A 50,000-watt, clear-channel AM station in a major U.S. city some 200

miles from your home may be heard quite well at noon, via ground wave, while a 250-watt two countries away cannot be heard at all at that time. However, on shortwave, if propagation conditions are right and the frequency is quiet enough, a sky-wave signal—even from a low-powered 25-watt station in Asia or South America—may come skipping in.

THE UN-THAI-ED KNOT

The BBC and *Radio Nederland* had planned to build a new shared relay station in Thailand, but money problems forced the Dutch to back out of the deal. The British, however, are pushing ahead on their own to build a four-transmitter complex at Nakhon Sawan, 250 kilometers north of the Thai capital, Bangkok.

Engineering studies, reportedly, are completed and, with the strong backing of the British Foreign Office, full funding was anticipated. Construction should be underway shortly, and the new station is expected to be on the air in two and a half to three years, relaying BBC programs throughout China, India, Pakistan, and Bangladesh.

SOUTHERN CAL CALL

West coast SWL's and other radio enthusiasts, attention! An all-band convention called *RADIO COM'94* is scheduled for August 10–14 at the Holiday Inn Bristol Plaza in Costa Mesa, CA. The weekend gathering is sponsored by the "American Shortwave Listeners Club" (ASWLC) and the "Southern California DX'ers" (SCADS).

RADIO COM'94 is open to all radio hobbyists worldwide and should be of interest to those whose in-

terests cover shortwave, medium- and low-frequency listening. VHF/UHF monitors, Morse fans, and those fascinated by all manner of digital modes. Broadcasters, radio vendors, and listening clubs are expected to have displays, and an equipment swap meet is planned.

Further information is available by sending a business-size stamped, self-addressed envelope to *RADIO COM'94*, 6398 Pheasant Drive, Buena Park, CA 90620.

DOWN THE DIAL

What are you hearing these days? Why not share your loggings with the rest of us? Drop a line to *DX Listening*, **Popular Electronics**, 500-B Bi-County Blvd., Farmingdale, NY 11735. Your comments and questions are always welcome!

Here are what others are reporting on SW.

LUXEMBOURG—15,350 kHz. *Radio Luxembourg* has been heard at around 2100 UTC with German-language programming and vintage musical pops. Its longtime English-language programming on 6,090 kHz has been off the air for more than a year, unfortunately.

PAKISTAN—15,550 kHz. *Radio Pakistan* is noted in English at 1730 UTC with a tourist information program and Pakistani music.

SINGAPORE—9,530 kHz. *Singapore Broadcasting Corp.* is expected to become a major regional shortwave voice this year with six new 250-kilowatt transmitters on the air. The Radio One English network is supposed to operate on this frequency and on 6,155 kHz. ■

From Not-Working to Networking!

Troubleshooting Local-Area Networks!

Now, complete for the first time in one detailed booklet!

Gain a fuller knowledge of network fundamentals and how they developed from the early days of main frames, from XNS to Ethernet technology, the OSI stack for interconnecting different computers, basic and specialized test instruments, etc. Several tough LAN case histories bring from theory to the practical side of troubleshooting.



ONLY \$5.00

CLAGGK Inc., Reprint Bookstore
P.O. Box 4099, Farmingdale, NY 11735

Please rush my copy of "From Not-Working to Networking." I enclosed payment of \$5.00 which includes shipping charges.

Name _____

Address _____

City _____ State _____ ZIP _____

Sorry, no orders excepted outside of United States and Canada. All Payments must be in U.S. funds. Send check or money order payable to CLAGGK Inc.—do not send cash or stamps. New York State residents add applicable sales tax.

*Credits: Mark Anderson, MI; Jim Clar, NY; Mike Fern, Australia; William Parks, FL; Robert Tucker, GA; North American SW Association, 45 Wildflower Road, Levittown, PA 19057.

HAM RADIO

By Joseph J. Carr, K4IPV

Receiver Performance Today

With respect to receivers, we hams today are relatively lucky compared to our predecessors of a generation or two ago. Modern ham receivers, often part of a transceiver that also includes the transmitter, are a cut above some (but not all) older models.

Wandering through the display room of a ham-equipment dealer shows all sorts of gleaming cabinets fitted with digital displays.

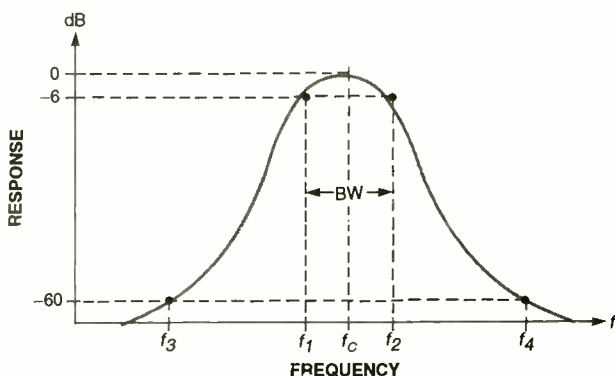

Fig. 1. The shape of the passband plays a major role in determining receiver selectivity. Here the -6dB bandwidth (BW) is $f_2 - f_1$ centered on the design frequency, f_c . Note that the slope are broad and sloppy.

Almost all HF transceivers today contain a general-coverage receiver, even though the transmitter is limited to ham bands only.

Digital readouts are now commonplace on ham rigs. The readouts are basically digital frequency counters designed to measure the local oscillator (a variable-frequency oscillator or VFO) frequency inside the rig, but displays it with a numerical offset equal to the receiver's IF. In most cases, the digital readout is quite accurate, especially when compared to the dreadful calibration of some 1950's

and 1960's vintage receivers. In many of those earlier models, an accurate crystal calibrator was essential in order to avoid going out-of-band.

RECEIVER PARAMETERS

The principal performance indicators for radio receivers are: noise floor, VFO stability, sensitivity, selectivity, dynamic range, and third-order intercept. The noise floor is a measure of the basic noise created by the radio receiver itself. All electronic components, even a simple resistor, produce noise and, in extreme cases, the noise can interfere with the reception of weak signals. Normally, on HF it is not terribly important, while on VHF and up it can be terribly important. The reason for less (but not zero) concern for internal noise on HF is that the external noise (QRN) is so high that it masks any internal noise.

An oddity in the noise department was told to me by shortwave *guru* and author Harry Helms. He owns a number of HF receivers of both old and new designs. He noted that the older receivers, such as his Hammarlund HQ-180, had significantly lower noise floors than a couple of modern receivers. The difference seems to be the trash that can get into the receiver due to the internal digital frequency synthesizer and readout. For the convenience of digital, we apparently pay a noise penalty.

The VFO stability is usually measured in parts-per-million (PPM) or, more

commonly, as the number of hertz that the frequency changes from a cold start in about thirty minutes (more or less), or in terms of drift per hour of operation. Numbers like 50 and 100 Hz are relatively easy to obtain, especially in digitally synthesized units (which use a crystal oscillator as a reference frequency).

Sensitivity is the ability of the receiver to pick up weak signals, and so is a measure of the receiver gain. Generally, sensitivity is expressed in terms of the number of microvolts (μV) needed to achieve some specified signal-to-noise ratio; numbers like $0.15 \mu\text{V}$ or $0.5 \mu\text{V}$ are common. Be careful, though, a large increase in apparent sensitivity is possible by manipulating the numbers or the conditions of the test. Specific attention should be paid to the bandwidth of the receiver during the test.

Another method of specifying sensitivity is to use the power equivalent of the signal-voltage level under similar conditions. It is common to use dBm units, which are decibels relative to 1 mW (0.001 W) in a 50-ohm load.

The selectivity is a measure of the receiver's ability to separate adjacent signals, and is usually measured in frequency units. A typical ham receiver will have a bandwidth of 200 or 500 Hz for CW filters, 1.8 to 2.9 kHz for SSB filters, and 4 to 6 kHz for AM filters. But the bandwidth is not the only thing to worry about. The specified bandwidths are usually

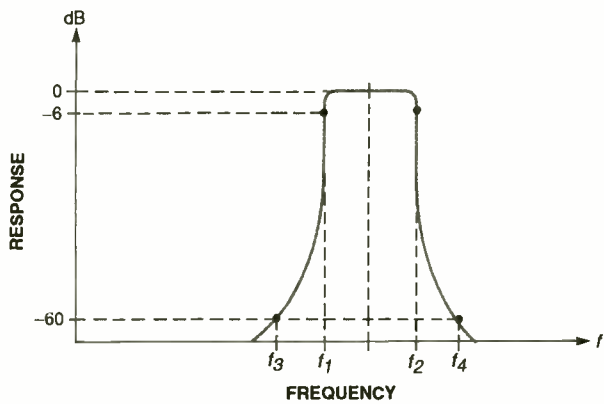

Fig. 2. Here the filter response is sharper, so the -60dB bandwidth is much smaller than before. Because of the -60dB bandwidth difference, this filter will generally outperform the previous filter in Fig. 1.

measured at -6dB on the response curve (see Fig. 1). But the shape of the pass-band response determines a lot of the receiver's selectivity performance. In Fig. 1, the -6dB bandwidth (BW) is $f_2 - f_1$, centered on the design frequency, f_c . But note the slopes—they are broad and sloppy. When you look at the bandwidth at -60dB ($f_4 - f_3$), the numbers are much broader.

In Fig. 2, however, the filter that sets selectivity has a sharper cutoff, so the -60dB bandwidth is much smaller than before. Because of the -60dB bandwidth difference, the filter of Fig. 2 will generally outperform the previous filter (Fig. 1). That attribute of filters is sometimes specified by the filter shape factor, by comparing the -6dB and -60dB bandwidths as a ratio. Receivers with mechanical filters typically more nearly fit the model of Fig. 2, while some cheaper radios with ceramic filters more nearly match Fig. 1. The difference between Fig. 1 and Fig. 2 is also one reason for the difference in price between low-cost crystal filters and higher cost filters. I've seen prices from \$49 to \$210 for 9-MHz SSB and CW crystal filters; it's the shape factors that differ.

The dynamic range and third-order intercept refer to the ability of the receiver to handle large ranges of signals. Having a sensitivity so great that it will pick up a breath of hot air is of no use whatever when the receiver's dynamic range is so poor that it will "mush out" when strong local signals are received. The dynamic range is usually specified in terms of decibels between the minimum detectable signal (MDS) and the largest signal that can be handled. Note: *Dynamic range* is not the same as *automatic-gain control range*.

Some receivers improve dynamic range artificially by placing attenuators in the signal path, either in the front-end or in the IF amplifier. Some are switch selectable, while others kick in automatically. Generally speaking, the attenuator is nice to have, but only if it doesn't mask a lack of true dynamic range.

A preamplifier can be used ahead of the receiver to improve sensitivity; but, if the receiver lacks dynamic range, then there is no preamp that can help. Also, if the noise floor is too high (as it might be above 2-meters), then the preamp must be either low-noise or turned off.

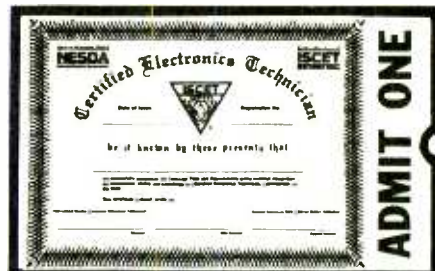

Your Ticket To SUCCESS

Over 28,000 technicians have gained admittance worldwide as certified professionals. Let your ticket start opening doors for you.

ISCT offers Journeyman certification in Consumer Electronics, Industrial, Medical, Communications, Radar, Computer and Video. For more information, contact the International Society of Certified Electronics Technicians, 2708 West Berry Street, Fort Worth, TX 76109; (817) 921-9101.

Name _____

Address _____

City _____

State _____ Zip _____

Send material about ISCT and becoming certified.

Send one "Study Guide for the Associate Level CET Test." Enclosed is \$10 (inc. postage).

Satellite Images On Your PC



PC HF Facsimile 7.0 \$99

SSC has interfaces and software to allow you to receive vivid satellite images on an IBM PC computer. Just plug the interface into the serial port of a PC and into the audio output of a shortwave receiver. The package includes the interface, manuals, schedules and software. SSC also makes systems for reception with VHF scanners. Call or write for our free catalog
Visa and MASTERCARD accepted

Software Systems Consulting

615 S. El Camino Real, San Clemente, CA 92672
 Tel: (714)-498-5784 Fax: (714)-498-0668

SCANNER SCENE

By Marc Saxon

Scanning Under Fire



With 200-channel scanning and wide-spectrum coverage, the Realistic PRO-2032 lets users monitor plenty of activity.

Realistic's PRO-2032 is one of the company's new desktop scanners. It's designed for base or mobile use by the operator interested in keeping track of a lot of activity. The PRO-2032 offers 200-channel scanning and covers a lot of spectrum.

The frequencies that this buckaroo can inhale are 30–54 MHz, 137–174 MHz, 380–512 MHz, and 806–960 MHz (minus the cellular bands). Coverage is also provided in the 109–137-MHz aeronautics band. Those frequencies can be entered in ten 20-channel memory banks, plus ten additional monitor channels. The scanning rate is 25 channels per second, but that can be slowed to eight channels per second. The PRO-2032 will search at 50 channels per second, or the slower speed can be selected.

Peeking inside the cabinet, we found IF's of 455 kHz and 10.7 MHz. The selectivity is -6 dB at ± 10 kHz; -50

dB at ± 20 kHz. The PRO-2032 offers $1.0 \mu\text{V}$ sensitivity on all bands except the aeronautic and the 800-MHz bands, where the sensitivity is $2.0 \mu\text{V}$.

Standard features include priority channel, lockouts, scan delay, direct search, and a headphone jack. The PRO-2032 comes ready to operate on 117 VAC. A 12-VDC power cord is available as an option.

HOT NEWS

The vivid images of the terrible wildfires that roared through areas of southern California not long ago are still fresh in everybody's mind. As we all know, forest fires can (and do) happen in any area of the country. Besides the manpower, water/chemicals, and fire-fighting equipment required to control major forest fires, communications are needed. If you're within monitoring range, you can pick up the action on your scanner.

Obviously, check out all local, county, and state fire and forestry-conservation frequencies that would normally be used in the fire ground area. Also monitor frequencies known to be used by area rescue and ambulance services.

If the fire is large and widespread, or is on federal land (national forest, national park, etc.), the U.S. Department of Agriculture's Forestry Service fire specialists will be on the scene.

Communications are needed to coordinate the

efforts of local agencies and the USDA firefighters. In states west of the Mississippi River, that takes place on 170.425, 170.575, 171.475, 172.225, and 172.375 MHz. In the eastern states, they use 170.475, 171.425, 171.575, and 172.275 MHz. USDA helicopters and fixed-wing fire-fighting aeronautical operations are reported between 118.825 and 120.0 MHz, 122.75, 122.8, 122.85, 122.9, 122.95, 123.05, 123.075, 166.675, 169.15, 169.20, and 170.00 MHz.

For other USDA fire frequencies that might produce activity, we suggest that you scan the band between 168.00 and 168.70 MHz. Also try monitoring 414.65, 415.40, and 415.50 MHz.

A LITTLE OF EVERYTHING

From Reno, Nevada, a note from April Pederson tells of several frequencies in use at John Asquaga's Nugget Casino. It appears that the messages going out are intended to be received by employees moving around in the casino. Jackpots are mentioned, as are reports of amounts being bet at certain tables.

A reader from Tennessee, who requests anonymity, reports that helicopters of the Tennessee Drug Task Force communicate on 154.77 MHz while searching for marijuana patches.

NOAA weather satellites operate on several fre-

quencies. Insofar as scanner users are concerned, 137.50 and 137.62 MHz are the channels of interest. We have run those frequencies here a few times in the past, and several inquiries have come in requesting additional information on the specifications of the satellite transmissions.

Maximum modulation is 4 kHz and the deviation is ± 18 kHz. The Doppler shift is ± 3 kHz, taking into account receiver and transmitter errors. METEOR satellites (on 137.06, 137.12, 137.15, 137.3, 137.33, 137.4, 137.45, 137.8, and 137.85 MHz) are alleged to operate with ± 10 -kHz deviation.

The standard scanners that most people use are designed for only NFM (± 15 -kHz bandwidth) and are sometimes also for WFM (± 150 -kHz bandwidth). Those bandwidths are intended primarily for optimum reception of either two-way communications or FM broadcast signals. Neither bandwidth is suitable for use by diligent satellite experimenters. However, for the casual monitoring hobbyist, a standard scanner with a good outside antenna should be able to produce some sort of gurgle or bleep to acknowledge that a satellite has been received.

SKIP SEASON, AHOY!

The approaching spring/summer season means renewed DX activity on the 30–50-MHz band. Here are some frequencies to watch, based upon the reported experiences of other monitors: Portuguese has been heard on 40.14, 40.16, 40.18, 40.20, 40.22, 40.40, 40.82, and 45.345 MHz; German on 31.25, 32.15, and 38.74 MHz; Turkish on 34.125 and 34.235 MHz;

and Spanish on 41.68, 45.18, 45.21, 45.48, 46.35, 46.50, and 49.50 MHz.

As a general rule of thumb, this type of seasonal Sporadic-E DX follows the sun. That means that it brings in stations east of your location in the morning, south of you during the middle of the day, and it works its way further west as the day wears on into the late afternoon.

This type of DX is characterized by DX stations in a particular area suddenly fading in, staying for a while, and then leaving very abruptly. In ten minutes, they could all return again!

You might be surprised to hear stations in Central and South America blasting through so loudly that they knock out stations in your local area. But remember, Spanish-language stations can just as easily be in the U.S. as anywhere else. Similarly, French-language stations might be coming from Louisiana or Quebec. Take nothing for granted.

You will also hear distant North American stations coming through, which gives you a break. The majority of them speak English, making it easier to identify them.

SEE YOU NEXT MONTH!

We look forward to your letters, questions, loggings, and comments. Our address is *Scanner Scene*, **Popular Electronics**, 500-B Bi-County Blvd., Farmingdale, NY 11735. ■



THINK TANK

(Continued from page 28)

should be a very simple circuit. I just want to make an LED blink on and off. It had been a year since I had used a 555, and I decided I would pull out the breadboard and a few parts and put together an astable multivibrator. Though I'm not great with electronic theory, I can usually put projects together from schematics with a good rate of success. However, at the end of a rather frustrating evening, I had fried three 555's and never got a blink. I used each of the schematics that I have included here (see Fig. 2), each coming from a different source. All three are a bit different in some way. Are any of these correct?

By the way, the circuit in Fig. 2A resembles the one that appeared in the October, 1991 issue of *Think Tank*. Did the various publications that I have make mistakes? Can 555 astable circuits be wired in various ways? What's the scoop on using this chip?

—Garry D. Cook,
Winston-Salem, NC

The third circuit (Fig. 2C) is a guaranteed chip eater because there's no current-limiting resistor for the LED. One thing that bothers me about the other circuits is the low value of their current-limiters; they should be about twice the value that you have indicated. That might be keeping the chip from operating correctly. The last thing that occurs to me is perhaps you miscounted the IC pins (if that's so, don't feel too bad, it often happens). Remember, start at the pin nearest the dot (or to the left of the end-notch with the notch pointed upward) and count counterclockwise.

A CORRECTION

My turn-off delay circuit that you published in *Think Tank* in the April, 1993 issue of **Popular Electronics** had one error in the text. Resistor R1 in the revised circuit is referred to as 500 ohms, 5 watts. It should be 5000 ohms, 5 watts. The schematic, showing 5K ohms, was correct.

Shortly after mailing the circuit to you, I saw the possibility of a problem in that circuit. Because of the lack of a power transformer, the voltage across C2 (see Fig. 3) could rise rather high if there is no load (an open in R2 or between pins 1 and 2 of U2). Because of that, I connected a Zener diode (D2) in parallel with C2 to keep the voltage down. My C2 had a rating of 16 volts, so I used a 15-volt, 1-watt Zener diode.

—William Stiles, Hillsboro, MO

Thanks for the correction. Glad to pass it along.

That's all for this month's Q&A session. Until next month, please send your circuit ideas, questions, and topic ideas to me here at *Think Tank*, **Popular Electronics**, 500-B Bi-County Blvd., Farmingdale, NY 11735. If your letter appears here, you'll receive a *Think Tank II* or other book. ■

When someone in your family gets cancer, everyone in your family needs help.

Among our regular services we provide information and guidance to patients and families, transport patients to and from treatment, supply home care items and assist patients in their return to everyday life.

Life is what concerns us. So you can see we are even more than the research organization we are so well known to be.

No one faces cancer alone.

AMERICAN CANCER SOCIETY

CIRCUIT CIRCUS

(Continued from page 80)

uses two low-cost IC's—a 555 oscillator/timer and a 7805 5-volt 1.5-amp voltage regulator—to produce a voltage calibrator for your oscilloscope. In that circuit, the 555 oscillator/timer (U1)

is configured as a 250-Hz squarewave oscillator. The oscillator's output at pin 3 is fed to the input of a 7805 5-volt regulator (U2). The regulator's squarewave output, in turn, is fed to a voltage divider (comprised of five 1K, 1% resistors). Taps on the divider provide five output-voltage levels, rang-

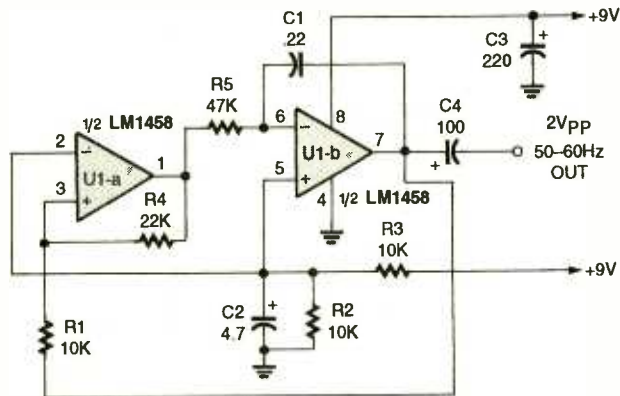

Fig. 5. This oscillator, which is built around a LM1458 dual op-amp and a few inexpensive components, produces a 2-volt peak-to-peak, triangular waveform.

PARTS LIST FOR THE TRIANGULAR WAVEFORM GENERATOR

RESISTORS

(All fixed resistors are ¼-watt, 5% units.)

R1-R3—10,000-ohm

R4—22,000-ohm

R5—47,000-ohm

CAPACITORS

C1—0.22-μF, ceramic-disc

C2—4.7-μF, 16-WVDC, electrolytic

C3—220-μF, 16-WVDC, electrolytic

C4—100-μF, 16-WVDC, electrolytic

ADDITIONAL PARTS AND MATERIALS

U1—LM1458 dual op-amp, integrated circuit

Perfboard materials, enclosure, 9-volt power source, wire, solder, hardware, etc.

ing from 1- to 5-volts peak-to-peak. The circuit can be operated from any DC source of 9 to 12 volts.

MINI-MEGAPHONE

Our next circuit (see Fig. 4) is a mini-megaphone that's comprised of an elec-

tron microphone (MIC1), an LM386 low-voltage audio-power amplifier (U1), a horn speaker (SPKR1) and a few other components. All of the parts (including a suitable plastic enclosure for the circuit) can be purchased from Radio Shack. The circuit is non-critical so just about any construction scheme should work.

TRIANGULAR WAVEFORM GENERATOR

The next circuit came about when a low-frequency triangular-waveform generator was needed to complete a special audio test. A single LM1458 dual op-amp and a few inexpensive components connected as shown in Fig. 5 did the trick.

The output frequency can be varied by changing the value of R5; changing the value of C1 will shift the circuit's frequency range. Increasing the value of C1 will lower the oscillator's frequency and reducing the value will increase the frequency. Resistor R4 can be varied to change the output level. Powered from a 9-volt supply, the circuit produces a 2-volt peak-to-peak, triangular, output waveform.

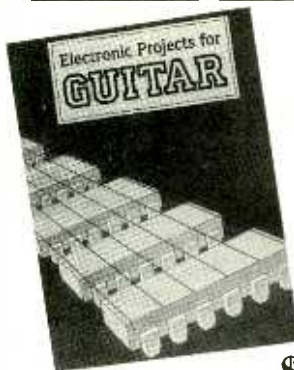

Whether you wish to save money, boldly go where no guitarist has gone before or simply have fun building electronic gadgets designed for your musical pleasure, then read

Electronic Projects for GUITAR

Some of the add-on guitar gadgets you can build are:

\$12.95

Preamplifier • Headphone Amplifier • Soft Distortion Effects Unit • Compressor • Auto-waa • Waa-waa Pedal • Phaser • Dual Tracking Effects • Distortion Unit • Expander • Dynamic Treble Booster • Direct Injection Box • Dynamic Tremelo • Thin Distortion Unit • and Guitar Tuner.

Anyone with some previous electronic project building experience should have no problem assembling the projects.

ELECTRONICS TECHNOLOGY TODAY INC.
P.O. Box 240, Massapequa Park, NY 11762-0240

Yes, send my copy of ELECTRONIC PROJECTS FOR GUITAR by RA Penfold to the address at right. I am enclosing \$12.95 plus \$2.95 for shipping charges in USA and Canada. All payments must be made in US funds. Sorry, no orders accepted outside of USA and Canada. New York State residents add local sales tax. Allow 6-8 weeks for delivery.

Check enclosed.

Please charge my Visa MasterCard

Signature _____

Account No. _____ Expir. Date _____

Name _____

Address _____

City _____ State _____ ZIP _____

LAUNCH CONTROL

(Continued from page 43)

ring terminals of the phono plug, and then install the sleeve.

Finally, fasten the printed-circuit board to the enclosure using a 1-inch length of double-sided foam tape between the bottom of the printed-circuit board and the inside of the enclosure. That is easier than using mounting hardware, and it gives a neater overall appearance.

Test and Use. Set S3 to the 30 s position, S4 to the TEST position, and install 4 AA alkaline batteries in the quad battery holder. Attach an engine igniter to the 2 micro clips and insert phono-plug PL1 into jack J1; the test lamp, I1, should light. Now switch S4 to the LAUNCH position, turn on S1, and press S2, FIRE. The piezoelectric buzzer (BZ1) should begin to beep every few seconds. After about 30 seconds, the beeping stops, and the igniter fires.

Warning: Always pull the phono plug from its jack before attaching the micro clips to a live engine! Also **do not** allow the micro clips to short during a launch or test; otherwise transistor Q1 could be damaged.

Should any of the above tests fail, troubleshoot the circuit using a DC voltmeter. To do so, attach the meter's negative probe to ground, turn S1 on, and measure the voltage at pin 8 of each 555 timer—you should get a reading of approximately 6 volts. If so, check the voltage at pin 3 of U1, and then press S2. The voltage should remain near 6 volts during the time-delay interval and then go to zero. Similarly, at pin 3 of U2, the voltage should be at 6 volts for approximately one out of every 4 seconds. At pin 3 of U3, it should change from zero to 6 volts at the end of the time delay, and then return to zero. If any of those tests fail, recheck all solder connections and component values associated with the defective timer.

The Time-Delayed Launch Control makes a great weekend project. Since all of the parts are inexpensive and come in a variety of shapes and sizes, the control panel can take on a customized look, limited only by your imagination. So heads up and happy flying!

For your Heart's sake get **PULSE STICK II**

Your very own sophisticated pocket health monitor, PULSE STICK II, checks your pulse rate quickly and accurately anywhere. Regular monitoring of your pulse rate during exercise will enable you to plan an exercise regimen suitable for your stage of fitness. Pulse stick II provides an early warning that you may be exceeding your own capabilities.

PULSE STICK II photoelectrically measures the changes

in the pulsed intensity of infrared radiation emitted by superficial blood vessels below the skin of the thumb. The time intervals between pulses are automatically measured and analogued by the micro-processor based circuitry and displayed in a liquid-crystal display (LCD).

Before attempting any exercise program, consult your doctor. Ask for guidance regarding the recommended safe pulse ranges for your exercise program. Follow your doctor's instructions carefully.

Only
\$39⁹⁵

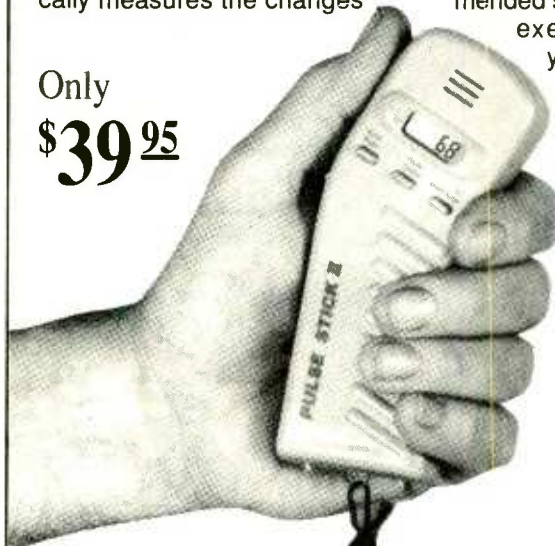

Uses three AA dry cells
supplied with PULSE STICK II



Ideal for running, walking and
aerobic training programs!

PSII-2

YES! Please send me _____ PULSE STICK II at \$39.95 each. Price includes shipping and handling charges.

Total amount of order \$ _____

Check or Money Order enclosed. Make check payable to **CLAGGK Inc. PULSE STICK II Offer**

Charge my Visa MasterCard

Account No. _____

Exp. Date _____ / _____

Credit Card

Signature _____

Print Name _____

Address _____

City _____ State _____ Zip _____

No telephone orders or C.O.D. Signature required on credit card orders. All prices include postage and handling. Payments in U.S.A. funds only. New York residents must include local applicable sales taxes. No foreign orders.

Mail orders to CLAGGK Inc. Pulse Stick II Offer, P.O. Box 4099, Farmingdale, NY 11735.

FAX orders to 1-516-293-3115.

WE HAVE THE RIGHT ANSWER

Advertisers who want to place their print ads in a quality publication ask the question: "Is your circulation audited?"

We're very proud to answer "Yes."

We are a member of the Audit Bureau of Circulations because we share ABC's belief that circulation audits are an essential assurance of value.

ABC is the premier circulation auditing organization in the world, and has been since 1914. Each year, ABC auditors test and verify that our circulation figures are facts, not claims. An ABC audit is the sign of a sound investment for advertisers.

Not all publications are audited, but they should be. Because when advertisers ask "Is your circulation audited?" there's only one answer.

"Yes."



Audit Bureau of Circulations

DISTINCTIVE RING SWITCH

(Continued from page 36)

The other three jumpers work in an identical manner for two rings, three rings, and four or more rings per ring cycle.

Figure 6 shows the jumper settings for a typical setup where the phone is connected as device 1 and a fax machine is connected as device 2. The jumper settings shown will leave the incoming line connected to the telephone if one ring is detected in a ring cycle. For more than one ring per ring cycle, the fax machine will be connected to the incoming line. Consecutive ring cycles are separated by at least one second without any ringing.

When the Distinctive Ring Switch is powered up and attached to the incoming phone line, the red LED for device 1 should be lit. Adjust the jumpers to your desired configuration and have a friend call the phone number for device 2. After the first ring cycle, the green LED for device 2 should indicate that the incoming line has been switched. When you hang up the phone, the LED's should change back to the device-1 display.

Now have your friend call your de-

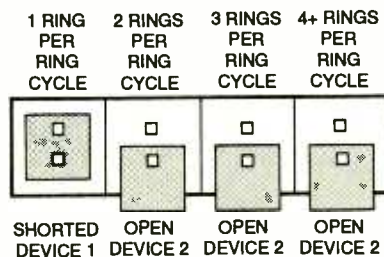

Fig. 6. Shown here are the jumper settings for a typical setup where a phone is connected as device 1 and a fax machine is connected as device 2. The jumper settings shown will leave the incoming line connected to the telephone if one ring is detected in a ring cycle. For more than one ring per ring cycle, the fax machine (device 2) will be connected to the incoming call.

vice 1 number to make sure that device 2 is not selected by a device 1 ring pattern. The red LED for device 1 should remain lit.

Operation. The Distinctive Ring Switch leaves device 1 connected to the incoming phone line when there

is no phone-line activity. That allows a telephone or other device connected as device 1 to make outgoing calls. Note that a telephone connected as device 2 would not have a dial tone. It would only be connected to the incoming line when the proper ring pattern is detected. When the first ring occurs, device 1 receives a ring signal. The first ring always goes to device 1 while the Distinctive Ring Switch analyzes the ring pattern. A phone connected as device 1 will ring to alert you that a call is coming in and you will be able to distinguish between normal and distinctive rings as usual.

Any device connected as device 1 should be set to answer after two or more rings. If a device-2 ring pattern is detected, the incoming line is immediately switched to device 2. If device 2 answers the call, the Distinctive Ring Switch monitors the call status. As soon as device-2 concludes the call by hanging up, the incoming line is switched back to device 1. Sometimes the calling party hangs up before device 2 answers. The Distinctive Ring Switch detects these unanswered calls by looking for 4.5 seconds without a ring signal while device 2 is still on hook. As soon as it senses an unanswered call, it switches the incoming line back to device 1.

By correctly setting the ring-detect jumpers, it's even possible to configure multiple Distinctive Ring Switches to switch to more than two devices. That would only be useful if your local telephone company is one of those that will assign more than one distinctive ring number to a single line.

Whether you are switching between two answering machines, adding a fax machine or BBS to your regular line, or have another application, the Distinctive Ring Switch will give you the ability to automatically route calls. Best of all, you can now add the convenience of a second phone number without spending a fortune on a separate line. ■

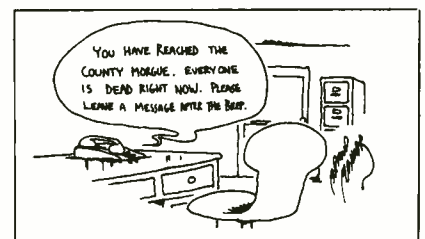

Enter A World Of Excitement with a Subscription to

Popular Electronics®

Get the latest electronic technology and information monthly!

Now you can subscribe to the magazine that plugs you into the exciting world of electronics. With every issue of Popular Electronics you'll find a wide variety of electronics projects you can build and enjoy.

Popular Electronics brings you informative new product and literature listings, feature articles on test equipment and tools—all designed to keep you tuned in to the latest developments in electronics. So if you love to build fascinating electronics, just fill out the subscription form below to subscribe to Popular Electronics... It's a power-house of fun for the electronics enthusiast.

EXCITING MONTHLY FEATURES LIKE:

- CONSTRUCTION**—Building projects from crystal sets to electronic roulette
- FEATURES**—Educational training on digital electronics, Ohm's Law, Antennas, Communications, Antique Radio, Simplified Theory
- HANDS-ON-REPORTS**—User test comments on new and unusual consumer products
- SPECIAL COLUMNS**—Think Tank, Circuit Circus, Computer Bits, DX Listening, Antique Radio, Amateur, Scanner Scene

PLUS: ALL OUR GREAT DEPARTMENTS!

You'll get 12 exciting and informative issues of Popular Electronics for only \$18.95. That's a savings of \$23.05 off the regular single copy price. Subscribe to Popular Electronics today! Just fill out the subscription order form below.

THE FIRST SMART VEHICLES ARE HERE

JANUARY 1994

Popular Electronics®

BUILD A DIGITAL BAROMETER
Be your own weatherman with this easy-to-build forecasting aid

BUILD AN ANEMOMETER
Add this simple-but-accurate wind-speed measuring device to your weather-forecasting arsenal

BUILD A RELATIVE-HUMIDITY GAUGE
Check the humidity at a glance with this digital instrument

COLLISION AND OBSTACLE WARNING SYSTEM FOR YOUR CAR

THE ROBIX ROBOTICS CONSTRUCTION SET
A great learning tool that's lots of fun to build and use



Save **55%** Off The Regular NEWSSTAND Rate

General Agency

GIZMO THE GADGETS BUYER'S GUIDE

\$3.50 U.S.
\$3.95 CANADA



FOR FASTER SERVICE CALL TODAY

1-800-827-0383

(7:30AM-8:30PM)
EASTERN STANDARD TIME

Popular Electronics® SUBSCRIPTION ORDER FORM

APEE4

P.O. Box 338, Mt. Morris IL. 61054

YES! I want to subscribe to Popular Electronics for 1 Full year (12 Issues) for only \$18.95. That's a savings of \$23.05 off the newsstand price.

(Basic Subscription Rate—1 yr/\$21.95)

Payment Enclosed Bill me later

Please charge my: Visa Mastercard

Acct. #

Signature

Exp. Date

PLEASE PRINT BELOW:

NAME

ADDRESS

CITY

STATE

ZIP

Allow 6 to 8 weeks for delivery of first issue. U.S. Funds only.
In Canada add \$6.68 Postage (Includes G.S.T.). All Other Foreign add \$7.50 Postage.

VCR Cross Reference

**NOW Find the right Part
for your VCR**

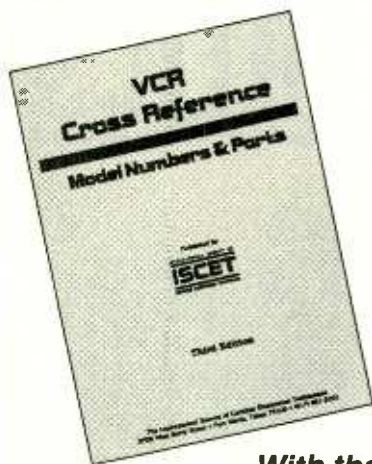

With the ISCET VCR CROSS REFERENCE

This 270-page reference contains both model and part-number cross-references updated to include 1992 units.

VCR's are made in a few factories from which hundreds of different brand names and model numbers identify cosmetically-changed identical and near-identical manufactured units. Interchangeable parts are very common. An exact replacement part may be available only a few minutes away from you even though the manufacturer supplier is out-of-stock. You may be able to cannibalize scrap units at no cost!

The ISCET VCR Cross Reference is pre-punched for standard loose-leaf binding. . . \$38.00 plus \$3.00 for shipping for each Reference.

Clagg Inc.
VCR CROSS REFERENCE OFFER
P.O. Box 4099
Farmingdale, New York 11735

Name _____

Business _____

Address _____

City _____

State _____ Zip _____

Phone _____

Enclose \$38.00 for the Third Edition of the ISCET VCR Cross Reference and \$3.00 for shipping for each Reference.

The total amount of my order is \$ _____

Check enclosed—do not send cash.

or please charge my credit card.

Visa MasterCard Exp. Date ____/____/____

Card No. _____

Signature _____

New York State residents must add applicable local sales tax to total.

DOCUMENTATION

(Continued from page 40)

represent groups of components. The simplified presentation helps one to visualize the relationships between the various stages of a complex circuit. The block diagram for a stepped-waveform generator is shown in Fig. 8. In the block diagram, as in schematics, the signal flow is from left-to-right and top-to-bottom. The blocks are ideally all the same size and the direction of signal flow is shown with arrows on the interconnecting lines. Conventional schematic symbols for the adjustable elements are sometimes shown outside the blocks to add clarity.

As we said at the beginning, this is by no means an in-depth treatment of documentation. My only desire is to inspire you to write down all those details that come up while you are designing and building your projects. There is no absolute right way and wrong way to do it. If you and others you show the documentation to can understand it, you are obviously doing something right. ■

FIELD EFFECT TRANSISTORS

(Continued from page 74)

CMOS Technology. An enhancement MOSFET can act as a switch when it is turned on or off by a voltage applied to its gate; N-channel devices are switched on by a positive gate voltage, but P-channel devices are switched on by a negative gate voltage. That symmetry of operation is known as a "complementary response," and forms the basis for the CMOS (or complimentary MOS) logic family. That IC family is, of course, sensitive to electrostatic discharge.

Figure 7A shows a cross-sectional view of a complementary pair of MOSFET's implemented on a common substrate. The common substrate used for that pair is N-doped silicon material (or "wafer"). Implementing an N-channel MOSFET on an N-type substrate requires the defusing or implanting of a P-doped well in the substrate. The smaller N-type well is then formed in the P-doped region.

Because the substrate is N-doped, fewer steps are required to form the P-channel FET. The P- and N-doped guard bands isolate and insulate the individual FET's to prevent mutual interference. Although not shown, the guard bands are actually N- or P-doped rings formed around the complete FET below the oxide layer.

Two complementary transistors can be connected to form an inverter (the simplest of logic gates). The complementary arrangement is accomplished by connecting the gates of the two MOSFET's together to form a single input (V_{in}) terminal, and taking the output from a common drain. One source (the P-channel) of the complementary pair is connected to V_{dd} while the other source terminal is connected to V_{ss} (as shown in Fig. 7B).

With no gate bias applied to the complementary pair, the inverter offers a very high impedance path from the input to ground, therefore the output voltage rises to V_{dd} . When the input voltage is high (logical 1), the situation is reversed, the P-channel device is cutoff, and the N-channel unit is turned on, so the input voltage drops to zero. Thus, a logical-high input gives a logical-low output, and vice versa. In either logic state, one MOSFET is on, while the other is off. ■

HOME FIRE SAFETY. ACT ON IT!



**FOR FREE HOME FIRE
SAFETY TIPS, WRITE:**

United States

Fire Administration

P.O. Box 70274

Washington, DC 20024



BEYOND OHM'S LAW

(Continued from page 68)

tively easy to calculate the voltage that will appear between points X and Y by using Ohm's Law. First we subtract the voltage sources (which oppose one another) to get the total voltage. Then we divide that voltage by the total series resistance to get the overall current (1.4 amps). Now, using Kirchoff's voltage law, let's write the voltage we want (V_{TH}) in terms of the drops and sources of one of the current loops, say the one with B1 and R1:

$$V_{TH} = B1 + I_1 R1$$

We know I_1 , so:

$$V_{TH} = 21V + 1.4A \times 3 \text{ ohms} = 25.2V$$

With both batteries shorted out, the circuit resistance is simply R1 and R2 in parallel, which comes to 2.4 ohms (see Fig. 6C).

The Thevenin equivalent of the circuit is shown in Fig. 6D. If you are connecting different loads to points X and

Y, the equivalent circuit will behave in exactly the same way as the original. The advantage, of course, is that the calculations for each load resistor are much simpler and quicker to perform. Try the Thevenin circuit with the original R3 value of 6 ohms, and you will get a current of 3 amps.

Norton's Theorem. A network can also be simplified by using Norton's Theorem. The principle involved is very similar to Thevenin's Theorem, but instead of a constant-voltage source and series resistance, the Norton method uses a constant-current source with a parallel resistance.

To keep matters simple, we'll continue to use the same circuit as in Fig. 6A. Recall that to obtain the Thevenin equivalent you must calculate the open-circuit voltage between points X and Y. To determine the value for the constant-current source of the Norton circuit, the short-circuit current must be calculated (Fig. 7A). Shorting X and Y in the example shown results in 7 amps flowing from B1 through R1, and

3.5 amps flowing from B2 through R2, giving a total short-circuit current of 10.5 amps. The Norton parallel resistance is calculated in exactly the same way as for the Thevenin conversion: Just work out the resistance between points X and Y when all voltage sources are shorted out.

The Norton equivalent circuit appears in Fig. 7B. When nothing is connected to points X and Y, the full 10.5 amps from the constant-current source must pass through the 2.4-ohm parallel resistance. Connecting a load to the circuit causes the current to split proportionally.

In the case of the original 6-ohm resistor, the total parallel resistance comes to approximately 1.7 ohms. Since the constant-current source of the Norton circuit always supplies 10.5 amps, no matter what the circuit resistance, the voltage appearing across the load can be calculated with Ohm's Law to be 18 volts. Another application of Ohm's Law will tell you the current through the load, which is 3 amps. ■

FACTCARDS



Jampacked with information at your fingertips

■ ALL YOU NEED to know about electronics from transistor packaging to substitution and replacement guides. FACTCARDS numbers 34 through 66 are now available. These beautifully-printed cards measure a full three-by-five inches and are printed in two colors. They cover a wide range of subjects from Triac circuit/replacement guides to flip-flops, Schmitt triggers, Thyristor circuits, Opto-Isolator/Coupler selection and replacement. All are clearly explained with typical circuit applications.

■ WANT TO EXPAND your knowledge of electronics? Do it the easy way

by studying the Electronics Fact Cards. Do you travel to and from your job each day? Drop a handful of cards in your pocket before you leave, and the bus becomes a schoolroom! At home, you can build some of the projects and not only have fun building and using them, but learn how they work at the same time.

■ YOU'LL BE AMAZED both at how rapidly you learn with these cards, and how easy it is to understand. These new cards are available right now. Don't miss out. Send your check or money order today.

FACTCARDS—Facts at your fingertips for Experimenters and Project Builders!

Please send one copy of FACTCARDS at \$3.50. Shipping \$1.00 (U.S. and Canada only).

Please send _____ copies of FACTCARDS. Total cost is sum of copy price and First Class postage and handling cost multiplied by number of card sets ordered.

New York residents add sales tax to total cost of each order.

Please print

Allow 6-8 weeks for the material to arrive.

(Name) _____

(Street Address) _____

(City) _____

(State) _____

(Zip) _____

Detach and mail today:
CLAGGK Inc.
P.O. Box 4099
Farmingdale, NY 11735

All Payment must be in U.S. Funds!

BUILD THE RELAY STATION

(Continued from page 70)

R4, and R6), a 40-kHz oscillator (the 555 and its timing components), an IR transmitter (R5, Q1, and LED1-LED3), and a power supply (the rest of the circuitry).

Taking the power supply first, the current source is a 9-volt battery that is switched on by S1. Its output is limited by R3, and voltage regulated down to 4.8 volts by D1 and D2. The regulation is necessary to reduce the voltage to a level that MOD1 can handle. It has the added advantage of allowing us to connect the three IR LED's in series without using a dropping resistor, which would dissipate power but do no useful work.

While the oscillator circuit is based on a 555 timer, that IC is used in a non-standard configuration. Normally, D3 would not be present. Without it, C1 (the oscillator's timing capacitor) would charge through R1 and R2, and discharge through only R2. Therefore, it would discharge faster than it would charge. Since the 555's output goes high as the capacitor charges and low as it discharges, the output would not be high for the same amount of time that it is low. In other words, its duty cycle would not be 50%, which is needed for this application.

With D3 in the circuit, R2 is bypassed (or shorted out) while C1 is charging, but is in the current path during discharge. Therefore, by making R1 and R2 equal, the charge time equals the discharge time, yielding an output with a 50% duty cycle. Components R1, R2, and C1 (all precision, drift-free units) have been chosen to provide a 40-kHz output in this configuration. That output strobes the IR LED's via Q1.

However, the oscillator only functions when pin 4 of the 555 is high. Since that pin is connected to the inverter circuit, the oscillator functions when the inverter's input is low. The inverter's input is connected to MOD1's output, which goes low with each remote burst received. So overall, the circuit produces a 40-kHz IR burst when it receives one.

Construction. Building this project is very easy. That's because it uses very few components to do its job, and they can all be purchased from Radio

Shack. My circuit was constructed using point-to-point wiring of three assemblies: the module plus inverter, the IR-LED chain, and the rest of the circuit (which was placed on a "main board").

The assemblies were installed in a metal cabinet to reduce RF interference. If you'll just be using the unit as a repeater for long or well-lit rooms, the IR assembly and the module should face out through opposite surfaces of the cabinet. If you'll use the unit as a repeater to broadcast signals around corners, the IR assembly and the module should be on adjacent surfaces of the cabinet. Keep that in mind when laying out your own unit. One unique way of accommodating both situations would be to make a swivel mount for the module out of an old film canister. It could be attached to a surface adjacent to that of the LED's via a screw in the canister's cap, and rotated to face any desired direction.

The inverter's components (Q2, R4, and R6) were mounted directly onto the module by soldering their leads right to the module's pins. The module's ground pin was also connected to its case. That is a must for reducing RF interference, which would make the unit buggy. Three wires were then attached to pertinent points in the assembly (V+, ground, and the inverter's output) and run to the main board. The module face was then attached to the case with a piece of double sided foam, allowing it to peer through a hole made in the cabinet.

The IR LED's were mounted on a piece of vector board by themselves. They were wired together in series and the two remaining LED leads were attached to wires that connect the assembly to the main board. Another piece of vector board was used as a drilling template to make holes in the case to accommodate the LED's. The LED assembly was pushed into position through the cabinet face. Then a hole was drilled through the board and case to accommodate S1. The switch was passed through the holes and fastened, which holds the LED board in place. The switch was then wired to the battery clip and main board.

The remaining components and battery-clip lead were connected to the main board (a small piece of ex-

perimeter's board). The board and a fresh battery were mounted in the enclosure with double-sided foam. The battery clip was then snapped on the battery and the case was closed.

Since there's nothing to adjust, if you've wired your unit properly it should be ready to work as soon as you switch S1 on. To test the circuit, try to hide your remote control and the detector side of the Relay under some newspapers. Make sure the Relay is off and check to ensure that the remote cannot operate anything from under the paper. If it still controls anything, shuffle the papers around until the equipment no longer receives responses from the remote. Switch the Relay on and activate the remote. If everything is working as it should, all your components should respond normally to the signals being re-broadcast by the Relay.

If something's amiss, disassemble the unit. Fire a remote at the detector and using a multimeter or oscilloscope look for a digital signal at the detector-module's output. If there is none, you've got a faulty module, or you've incorrectly wired it to the inverter. If MOD1 is fine, check the inverter's output. Its output signals should be the compliment of the signals from MOD1. If not, check your inverter's wiring. If that's fine, check pin 3 of U1 for 40-kHz bursts while operating the remote. A lack of signal there indicates an oscillator problem. If all is well, check for pulsed current flow through the IR-LED chain. A lack of current there could only be the result of a bad Q1, a bad LED, or miswiring.

Hopefully this circuit will add more freedom to your use of remotes. Unlike many of the manufactured alternatives, its low-cost, safety, and ease-of-use should make it a really big hit with the family, too. ■

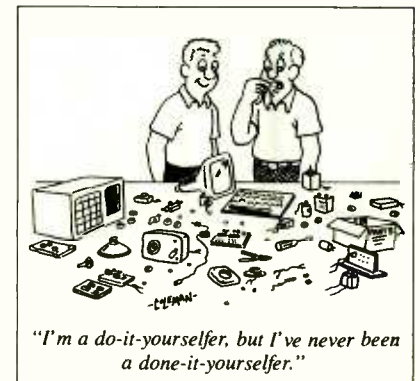

Market Center™

Paperback Books

GREAT PAPERBACKS AT SPECIAL PRICES

**COMPUTER HOBBYISTS
HANDBOOK—BP251—
\$8.95**

Subjects covered include microprocessors and their register sets; interfacing serial, parallel, monitor, games and MIDI ports; numbering systems, operating systems and computer graphics. While the book is aimed at the computer hobbyist, it should also prove useful to anyone who intends to use a computer to follow their interests.

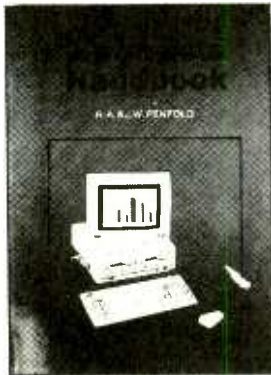

**INTERNATIONAL RADIO
STATIONS GUIDE—
BP255—\$9.95**

Provides the casual listener, amateur radio DXer and the professional radio monitor with an essential reference work designed as a guide for the complex radio bands.

Includes coverage on Listening to Short Wave Radio, ITU Country Codes, Worldwide Radio Stations, European Long Wave and Medium Wave Stations, Broadcasts in English and more.

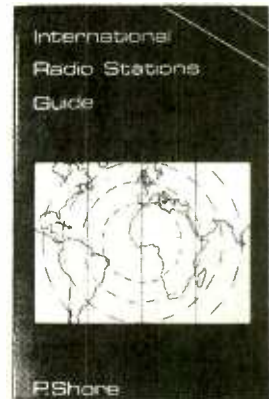

**Further
Practical
Electronics
Calculations and
Formulae**

F. A. WILSON



**FURTHER PRACTICAL
ELECTRONICS
CALCULATIONS—
BP144—\$9.00**

450 pages crammed full of all the formulae you are likely to need. Covers Electricity, Electrostatics, Electromagnetism, Complex Numbers, Amplifiers, Signal Generation and Processing, Communications, Statistics, Reliability, Audio, Radio Systems, Transmission Lines, Digital Logic, Power Supplies. Then there's an appendix of Conversion Factors, Mathematical Formulae and more.



**WIRELESS &
ELECTRICAL
CYCLOPEDIA—ETT1—\$5.75**

A slice of history. This early electronics catalog was issued in 1918. It consists of 176 pages that document the early history of electricity, radio and electronics. It was the "bible" of the electrical experimenter of the period. Take a look at history and see how far we have come. And by the way, don't try to order any of the merchandise shown, it's unlikely that it will be available. And if it is, the prices will be many times higher.

ELECTRONIC TECHNOLOGY TODAY INC.
P.O. Box 240, Massapequa Park, NY 11762-0240

Name _____
Address _____
City _____ State _____ Zip _____

PE594

**SHIPPING CHARGES IN
USA AND CANADA**

\$0.01 to \$5.00	\$1.50
\$5.01 to \$10.00	\$2.50
\$10.01 to 20.00	\$3.50
\$20.01 to 30.00	\$4.50
\$30.01 to 40.00	\$5.50
\$40.01 to 50.00	\$6.50
\$50.01 and above	\$8.00

**SORRY No orders accepted
outside of USA & Canada**

Total price of merchandise	\$ _____
Shipping (see chart)	\$ _____
Subtotal	\$ _____
Sales Tax (NYS only)	\$ _____
Total Enclosed	\$ _____

All payments must be in U.S. funds

Number of books ordered

B & S SALES

Call(313) 566-7248 • FAX (313) 566-7258 24 hrs.

Hours: Monday through Friday 8 am to 6 pm EST
51756 Van Dyke St. #330, Shelby Township, MI 48316

WE SPECIALIZE IN QUANTITY PRICING 5, 10, 20 LOTS

Make Your Best Deal!

\$ SALE

Y RENT

\$ SALE

Y RENT

<u>JERROLD</u>	<u>SA</u>	<u>PIONEER</u>	<u>HAMLIN</u>	<u>TOCOM</u>	<u>ZENITH</u>
DRX-3-DIC	8590	BA 6110	CR 6600-3M	5507 VIP	1600
DPBB	8580	BA 5135	CR 6000-3M	5503 VIP	
DPV-5,7	8570				
	8550				

NEW PAN
PIONEER
GREEN E LITE
BA 5000 > SERIES
BA 6000

NEW PAN
SA-8500 SERIES
(BUT ALL BASE BAND)
THE PREMIER

NEW PAN
JERROLD
PINK PAN

PANASONIC TZ — PC 1453G2

By far the best basic converter on the market today. 550 MHz (1 to 99) parental control, sleep timer, remote batteries, contrast and remote control range.

Superior to all other converters

NO MICHIGAN SALES

MINI TVT:
THE 1/4 POUNDER
LITTLE 4x4
SECOND ONLY TO TVT
GOLD IN POPULARITY

OWN YOUR OWN
SA-3
M-80
SAVE \$

NEW REMOTE CONTROL AB
SWITCH FOR DUAL SYSTEMS
(WITHOUT LEAVING THE
COMFORT OF YOUR CHAIR)

TVT GOLD ORIGINAL
FOR MOST
JERROLD SYSTEMS,
LEADING SELLER
OF ALL PANS

TNT
MLD
OWN YOUR OWN
SAVE \$

FILTERS
POST & NEG
SUBCONTRACTORS
& DEALERS
ONLY QUANTITY

We are now offering a 6-month warranty. In order for warranty to be in effect, this form must be signed and returned.
FOR VCR, SECOND, THIRD, ETC. HOOK-UPS.

Yes, I agree all units are to be used or resold in compliance with Federal and State laws.

Signature _____ Date _____

Name _____ Phone No. () _____
Address _____
City _____ State _____ Zip _____
It is not the intent of B & S Sales to defraud any pay television operator and we will not assist any company or individual in doing the same.

CIRCLE 137 ON FREE INFORMATION CARD

Are Cable Companies Sucking You Dry?



**FREE
Catalog!**

**All Major
Brands!**

Take a Bite out of High Rental Fees
with your own

Converters & Descramblers



Everquest • Panasonic • Jerrold • Zenith • Pioneer
Scientific Atlanta • Oak • Eagle • Hamlin • Tocom

Order
Toll-Free **1 800 624-1150**

Call today for a FREE catalog!

MD Electronics

875 S. 72 Street • Omaha, NE 68114



ALFA ELECTRONICS

HIGH QUALITY TEST EQUIPMENT
BEST PRICE



DMM 2360
\$119.95
DMM + LCR Meter
Most Versatile DMM
Inductance: 1µH-40H
Capacitance: 1pF-40µF
Frequency: 1Hz - 4MHz
Temperature: -40 - 302 °F
TTL Logic Test: 20MHz
Diode, Continuity
Volt, Amp, Ohm
3999 count display
Peak Hold
Auto power off
Ruggedized case.
Rubber Holster \$8.00



DMM 175A \$67.95
DMM with 20 MHz
Frequency Counter
Most Popular DMM
Freq. Counter 1Hz-20MHz
DCV 0.1mV-1000V
ACV 0.1 mV-750V
ACA/DCA 0.1µA-10A
Resistance 0.1Ω-2000MΩ
Capacitance 1pF-20µF
TTL Logic test 20 MHz
Transistor HFE test
Diode test, LED test
3 1/2 digit display
10 MΩ impedance
Soft case \$3.00, deluxe case \$5.00



Fluke Multimeter
Fluke 12 \$79.95
Holster C-10 \$10
Fluke 70 II \$65
Fluke 73 II \$90
Fluke 75 II \$127
Holster C-70 \$15
Fluke 77 II \$147
Fluke 79 II \$167
Fluke 29 II \$167

Fluke 83 \$225
Fluke 85 \$259
Fluke 87 True RMS \$285

Fluke 97 Scope Meter \$1750



LCR Meter 814
\$199.95
The Best Handheld
LCR
Inductance: 0.1µH-200H
Capacitance: 0.1pF-20,000µF
Resistance: 1mΩ-20MΩ
1% basic accuracy
Dissipation factor indicates leakage
in capacitor and Q factor in inductor
Zero adjustment to reduce parasitics
from test fixture
Best for high frequency RF
and surface mount components.
SMD and chip component test probe
\$25.00, Deluxe carrying case \$5.00



LCR Meter 195
\$119.95
Very Popular LCR
Inductance: 1µH-200H
Capacitance: 0.1pF-200 µF
Resistance: 0.01Ω-20MΩ
Basic accuracy: R:1%, C:2%,
L:3%
Test frequency 1 kHz
Soft carrying case \$3.00
Deluxe case \$5.00



Capacitance Meter
7705 \$57.95
0.1 pF-20,000µF in 9 ranges
0.5% basic accuracy
Zero adjustment ± 20pF to compen-
sate parasitics from test fixture

Also Available:
Heavy duty DMM, AC/DC clamp
meter, Thermometer, Light meter
pH meter, High voltage probe
Digital caliper, Anemometer
Electronic scale, Force gauge
Tachometer, Humidity & EMF
adapter, Sound level meter
Frequency counter, SWR/field
strength/power meter, Dip meter

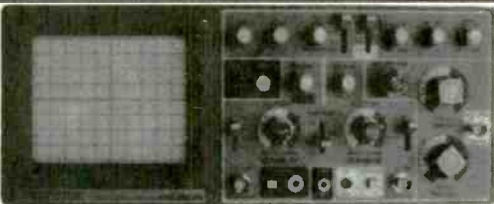

20 MHz Oscilloscope with Delay
Sweep PS-205 \$429.95
Dual Trace, Component test, 6" CRT, X-Y Operation, TV
Sync, Z Modulation, CH2 Output, Graticule Illum, 2 probes
each has x1, x10 switch. Best price with delay sweep.
PS-200 20 MHz DUAL TRACE \$339.95
PS-400 40 MHz DUAL TRACE \$494.95
PS-405 40 MHz DELAY SWEEP \$569.95
PS-605 60 MHz DELAY SWEEP \$769.95

20 MHz Digital Storage
Oscilloscope DS-203 \$729.95
Switchable between digital and analog modes
2 K word per channel storage
Sampling rate: 10 M sample /sec
8 bit vertical resolution (25 Levels/div)
Expanded Timebase 10ms/div - 0.5 s/div
Refresh, Roll, Save all, Save CH2, Pre-Trip
Plotter Control

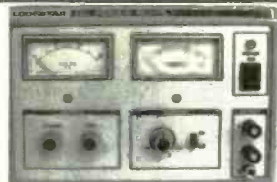

DC Power Supply
PS-303 \$159.00
0-30 VDC, 0-3A output
0.02% + 2mV line regulation
0.02% + 3mV load regulation
1 mVrms noise and ripple
Short circuit and overload protected
PS-8200 with digital voltmeter \$179.00
Also available: 30V/5A, 60V/3A, 60V/5A
16V/10A, 30V/10A

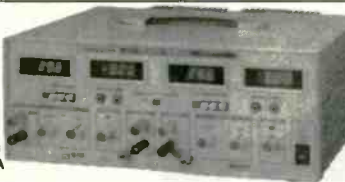

DC Power Supply Triple Output
PS-8202 \$499.95
Two 0-30 VDC, 0-3A outputs
One fixed 5VDC, 3A output
Capable of independent or tracking operation
Constant voltage and constant current mode
Four digital meters for volt and current display
Excellent regulation and low ripple
Short circuit and overload protected
Also available: 30V/5A triple output \$549.95
60V/5A dual tracking \$749.95



RF SIGNAL
GENERATOR
SG-4160B \$119.00
100 kHz-150MHz sine wave in 6
ranges
RF Output 100mVrms to 35 MHz
Internal 1kHz, External 50Hz-20kHz
AM modulation
Audio output 1 kHz, 1 Vrms

AUDIO GENERATOR
AG-2601A \$119.00
10Hz - 1MHz in 5 ranges
Output: 0-8Vrms sine wave
0-10Vp-p square wave
Synchronization: ±3% of oscillation
frequency per Vrms
Output distortion:
0.05% 500Hz - 50kHz
0.5% 50Hz - 500kHz
Output impedance: 600 ohm

FUNCTION GENERATOR
FG-2100A \$169.95
0.2 Hz - 2 MHz in 7 ranges
Sine, square, triangle, pulse and ramp
Output: 5mV-20Vp-p
1% distortion, DC offset ± 10V
VCF: 0-10V control frequency to 1000:1



RF SIGNAL
GEN./COUNTER
SG-4162AD \$229.95
Generates RF signal same as SG-
4160B
Frequency counter 1Hz - 150 MHz
for internal and external source
Sensitivity <50mV

AUDIO
GEN./COUNTER
AG-2603AD \$229.95
Generates audio signal same as AG-
2601A
Frequency counter 1Hz-150MHz
for internal and external sources
Sensitivity <50mV

FUNCTION GEN./COUNTER
FG-2102AD \$229.95
Generates signal same as FG-2100A
Frequency counter 4 digits
Feature TTL and CMOS output
SWEEP FUNCTION
GEN./COUNTER \$329.95
0.5Hz to 5 MHz in 7 ranges
Sweep: Linear 10:1/Log 10:1 20ms to 2s
AM Modulation
Gated Burst, Voltage Control Generator
Generator Control Voltage & 8 digit counter
1Hz-10MHz for internal & external sources

ALFA ELECTRONICS
741 Alexander Rd., Princeton, NJ 08540

(800) 526-2532 / (609) 520-2002 15 DAY MONEY BACK GUARANTEE, 1 YEAR WARRANTY

FAX: (609) 520-2007

CALL OR WRITE FOR FREE CATALOG AND BEST OFFER.

Visa, Master Card, American Express, COD, Purchase Order Welcome

CIRCLE 26 ON FREE INFORMATION CARD

SOUTHPAW ELECTRONICS

SERVING THE ELECTRONICS INDUSTRY FOR OVER 50 YEARS
IMMEDIATE SHIPMENT FROM STOCK • SATISFACTION GUARANTEED

SUPER SPECIAL!

3 Piece NI-CAD BATTERY CHARGER KIT

Buy Kit or Individually • Call for Quantity Prices

1 - 7.2V 1000MAH NI-CAD BATTERY PAK
Brand new—original box—3 1/2" x 2" x 3/4"
\$40.00 Value — Southpaw Special **\$7.50 each**

2 - PLUG-IN POWER SUPPLY
Input 120VAC Hz—Output 8VDC @ 1AMP
6' cord with 2.1mm barrel connector (center positive)
Ideal for charging Ni-Cad Pak
\$12.00 Value — Southpaw Special **\$3.75 each**

3 - IC REGULATED DC ADAPTOR
DC to DC—Input -12VDC/Output 8.5VDC
Cigarette lighter plug to 6' cord with 2.1mm barrel connector
Ideal for charging Ni-Cad Pak
\$7.95 Value — Southpaw Special **\$3.50 each**

"BUY ALL THREE—A \$59.95 VALUE FOR ONLY \$9.95"



SHARP LM 16257

5x7 Dot Matrix Display W/Cursor
Intelligent 16 Characters x 2 Line



Character height .22", Supply voltage +5V,
Dot color - Dark Blue, Background - White,
On-Board CPU, RAM & ASCII, Character
Generator. Dimensions: 3 5/16" x 1 3/8" x
3/8". Full specs supplied.
#LCD002 **\$9.59 each**

12VDC DPDT "ICE CUBE" RELAY

Coil res. 160Ω
Cont. rtg. 10A
OMRON #LY2-DC12
#REL12DC
\$2.99 each
10 Lots/\$2.50 ea.



12VDC MINI POWER RELAY

Potter Brumfield
Part #T90N5D12-12
SPDT Coil Res.
155Ω
#REL13
\$2.49 each
10 Lots/\$2.00 each



GRAB BAG BLOWOUT!!!

\$4.95 each



Part #	Item /Quantity
GB01	Chokes/Inductors - 100
GB02	LEDs - 100
GB03	Ceramic Discs - 500
GB04	Connectors - 50
GB05	IC Sockets - 200
GB06	Trim pots - 100
GB07	Crystals/Oscillators - 20
GB08	Resistors* - 1500
GB09	Wirewound Resistors - 100
GB10	Relays - 20
GB11	Electronic Hardware - 2 lbs.
GB12	Transistors - 100
GB13	Zener Diodes - 200
GB14	Switches - 25
GB15	Fuses - 50
GB16	Volume Controls -50
GB17	Heat Sinks -25
GB18	IF Transformers - 200
GB19	Solderless Terminals - 150
GB20	Plug-in Adapters - 10
GB21	MYSTERY - ?????
GB22	Miniature Motor Asst. - 12 *carbon film/carbon comp

486 COMPUTER SUPER COOLER FAN SYSTEM

Snap on mount -
no tools required!
Spring loaded
heat sink - assures
maximum heat transfer!
Powerful 5500 RPM 12 VDC Fan Dual
power plugs - fits all PC's. Individually
boxed. #F486
\$10.95 each



POWER X'FMER

General Purpose
American Mfr.
Primary: 115V 60Hz
Secondary:
#1 5VAC @ 4.0A
#2 24VAC @ 4.0A
3 1/2" Mounting Centers
H 2 1/2" x L 3" x W 1"
#PTR01 **\$5.75 ea.**

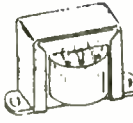

230 WATT CHEROKEE SWITCHING POWER SUPPLY

Input: 115/230 VAC
Outputs: +5V @ 8A, +12V @ 2A
-12V @ 1.5A, 25.5V @ 3A
+18V @ .2A, 18V @ .2A
Size: L 9.5" x H 4.5" x W 1.75"
#PSB02 **\$29.95 ea.**



Standard G.P. Rectifier

IN4004 1A 400V \$3.00/100
IN4006 1A 800V \$4.00/100
IN4007 1A 1000V \$6.00/100

Fully Enclosed 73 Watt Continuous Switching Power Supply

• 91 Watts Surge • Forced Air Output • 4 Outputs
• Full Ranging Input Voltages From 90 to 264 VAC

Will provide the necessary power and cable to run two drives -
one hard drive and one floppy disk drive with a microconnector
Has its own internal fan capable of cooling power supply as well
as the components inside the computer to a safe operating temp.



Output Voltages	Full Load (amp)	UL/CSA Approved
+5V	10.0 A	Size: L 6.5" x W 2.8" x H 3.7"
+12V	1.5 A	
-12V	.3 A	
-5V	.3 A	

#PSB03 **\$24.95 ea.**



COOLING FANS

	Each	10/Lot
115VAC 4.7"	\$6.95	\$65.00
12VDC 4.7"	\$4.75	\$45.00
24VDC 4.7"	\$3.75	\$35.00
12VDC 3.5"	\$4.25	\$40.00
24VDC 3.5"	\$3.75	\$32.00
12VDC 2.25"	\$4.25	\$40.00
24VDC 2.25"	\$3.75	\$32.00
12VDC 1.5/8"	\$4.25	\$40.00

RARE EARTH MAGNETS

Kidney Shaped
Approx 3/4" x 1/2"
Estimated pull 1 1/2 lbs.
You won't believe the power
#REM01 **\$1.49 ea., 10 Lot/\$9.99 ea.**



LED's Standard Jumbo 5MM or 3MM

Red \$.06 ea. 20 piece
Yellow \$.07 ea. minimum
Green \$.07 ea. per item

LED Display Assortment

Half - Single - Dual Digit Units
Common Cathode/Anode
Reds & Greens
25 Piece Assortment **\$9.95**

SNAP-IN LYTICS

220MFD @ 160VDC	.60
220MFD @ 200VCC	.90
220MFD @ 400VDC	1.50
470MFD @ 200VDC	1.75
680MFD @ 200VDC	1.75
820MFD @ 250VDC	1.75
1500MFD @ 200VDC	2.25
2200MFD @ 200VDC	2.25
5600MFD @ 200VDC	1.75

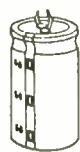

New Rechargeable Sealed Lead Acid Battery

12VDC 15Ah Size: L 7" x H 6.5" x W 3" Name Brand
Leakproof - can be used in any position maintenance free - needs
only charging. High power density - Long service. Will stand up to
tough operating conditions such as overcharge and deep discharge.
Applications - for new equipment or replacement - alarms, medical
equipment, robotics, industrial-equipment, UPS systems and much more!
Weight 13 lbs. "Call For Quantity Pricing" #LAB100 **\$29.95ea.**



PLUG-IN WALL TRANSFORMERS

	Mfg	Each	10/Lot
5.6VAC @ 200MA	T.I.	\$0.95	\$8.00
9.0VDC @ 450MA	G.E.	\$3.25	\$30.00
12VDC @ 100MA	PANA.	\$1.25	\$10.00
12VDC @ 300MA	Import	\$1.75	\$12.50
14VDC @ 450MA	G.E.	\$2.50	\$22.00
14VDC @ 700MA	G.E.	\$3.25	\$30.00
20VAC @ 700MA	Import	\$2.75	\$25.00



Mail Order \$25.00 - VISA - MasterCard - Checks & Money Orders On Mail Orders - Open Account Available To Qualified Firms - No COD
NY, NJ, CT Orders Add Appropriate Sales Tax - Shipping & Handling \$4.75 For Continental U.S. - All Others Pay Full Shipping Charges
Prices Subject To Change Without Notice - Quantities Limited On Some Items - Call/Write For FULL-LINE CATALOG and Quantity Pricing

VISA

ORDER TOLL-FREE • 1-800-851-8870



Mail Orders To: Southpaw Electronics, PO Box 886, New Hyde Park, NY 11040-0311
FREE CATALOG & INFORMATION • (516) 352-7070 • Fax (516) 775-5091

Design and Verify

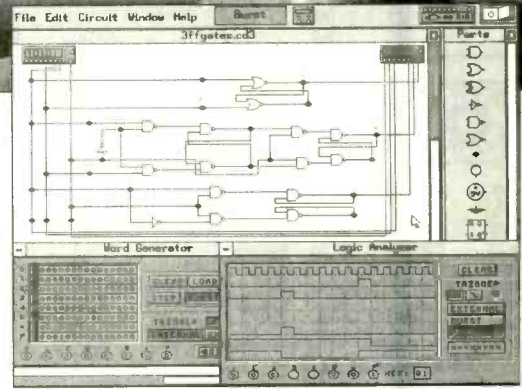
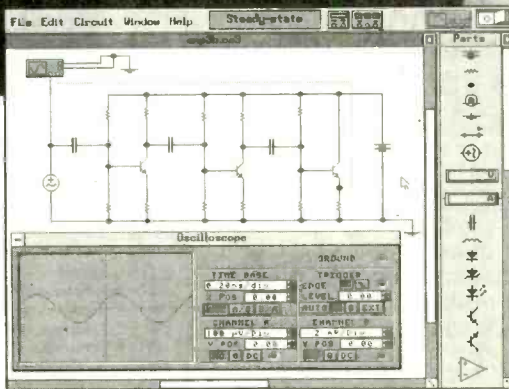
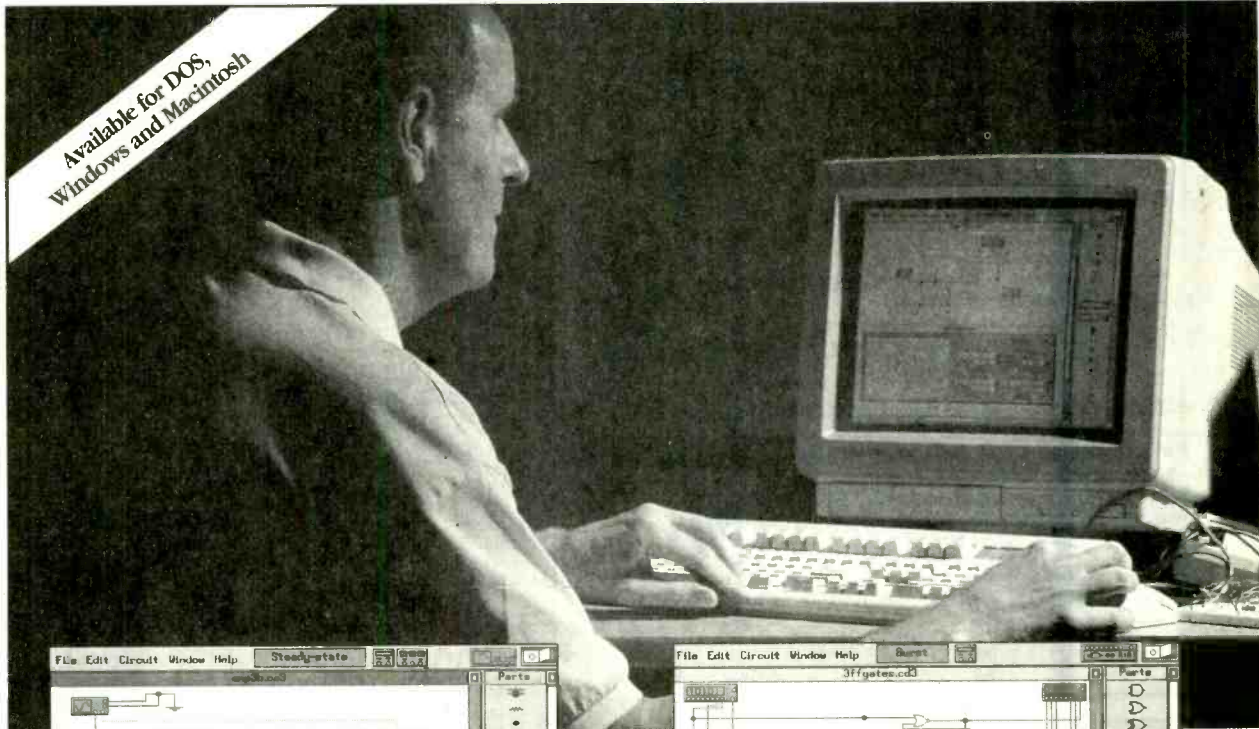

Analog Module includes:

- complete control over all component values
- ideal and real-world models for active components
- resistors, capacitors, inductors, transformers, relays, diodes, Zener diodes, LEDs, BJTs, opamps, bulbs, fuses, JFETs and MOSFETs
- manual, time-delay, voltage-controlled and current-controlled switches
- independent, voltage-controlled and current-controlled sources
- multimeter
- function generator (1 Hz to 1 GHz)
- dual-trace oscilloscope (1 Hz to 1 GHz)
- Bode plotter (1 mHz to 10 GHz)

SYSTEM REQUIREMENTS

MS-DOS version: Requires IBM AT, PS/2 or true compatible with 286 or greater, hard disk, 1 MB RAM, Microsoft-compatible mouse, EGA or VGA display adapter and DOS 3.0 or greater. Supports a math co-processor if available.

Windows version: MS-DOS 5.0 or higher, Microsoft Windows 3.1, 2 MB RAM with suitable pointing device.

Macintosh version: Macintosh Plus or higher, 2 MB RAM, System 6 or 7.

All trademarks are the property of their respective owners.

Digital Module includes:

- fast simulation of ideal components
- AND, OR, XOR, NOT, NAND and NOR gates
- RS, JK and D flip-flops
- LED probes, half-adders, switches, seven-segment displays
- word generator (16 eight-bit words)
- logic analyzer (eight-channel)
- logic converter (converts among gates, truth table and Boolean representations)

Electronics Workbench®

The electronics lab in a computer™

Circuits. Fast.

> An Ideal Test Bench

Here's why Electronics Workbench belongs on *your* test bench: Wires route themselves. Connections are always perfect. And the simulated components and test instruments work just like the real thing. The instruments are indestructible and the parts bin holds an unlimited supply of each component. The result: thousands of electronics professionals and hobbyists save precious time and money. **Over 90% would recommend it to their friends and colleagues.** Electronics Workbench: the ideal, affordable tool to design and verify your circuits before you breadboard.

Now the best is even better!

Version 3.0 simulates more and bigger circuits, and sets the standard for ease of use. Guaranteed!*

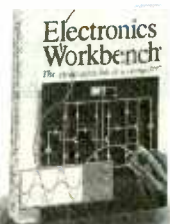

Just \$299!

"Design work is faster and cheaper with Electronics Workbench."

Mark L. Weaver, Production Engineer Technician, Colorado Memory Systems, Loveland, Colorado

"Building a circuit is simple and intuitive."

Jeff Holtzman, Computer Editor, Electronics Now

"I used Electronics Workbench extensively in the design of a six-meter receiver. I got surprisingly good comparison with actual breadboard and end-unit performance, even at 50 MHz. As an affordable tool for performing design tradeoffs, you can't beat it."

M. A. Chapman, Oceanside, California

Call 800 263-5552

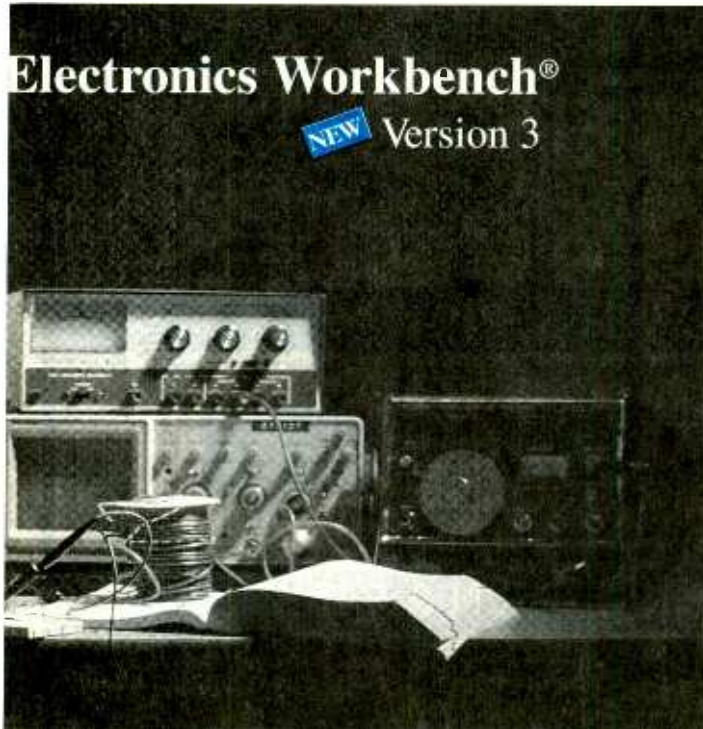

New Features in Version 3

- new components include JFETs; MOSFETs; voltage- and current-controlled sources; and manual, time-delay, voltage-controlled and current-controlled switches
- real-world models for opamps, BJTs, JFETs, MOSFETs and diodes — over 100 models available
- MS-DOS version now supports up to 16 MB of RAM for simulation of bigger circuits
- new Microsoft® Windows™ and Macintosh® versions available
- Technical support now available on CompuServe®

*30-day money back guarantee

Yes, I want Electronics Workbench in my computer!

Version:

- MS DOS 3.5" 5.25"
 Windows 3.5" 5.25"
 Macintosh

Name: _____

Address: _____

City: _____ State: _____ Zip: _____

Tel: () _____ Fax: () _____

MC VISA AMEX # _____

Signature: _____ Exp: _____

INTERACTIVE IMAGE TECHNOLOGIES LTD.
908 Niagara Falls Blvd. #068,
North Tonawanda, NY 14120-2060
Tel: (416) 361-0333 Fax: (416) 368-5799

Order information: Check or Money Order payable to Interactive Image Technologies Ltd.
Call for Canadian prices. All orders add \$15 shipping and handling.



CALL TOLL FREE
1-800-292-7711
1-800-445-3201 (Can.)

TEST EQUIPMENT AT DISCOUNT PRICES

**LOWEST
 PRICES
 GUARANTEED**

DIGITAL METERS



**Dual-Display
 LCR Meter
 w/ Stat Functions
 B+K 878
\$239.95
 Auto / Manual Range
 Many Features
 with Q Factor
 High Accuracy**



**Digital Multimeter
 w/ Inductance
 & Capacitance
\$75.00
 LCM-1850
 Ten Functions
 by Elenco**



**Digital Capacitance Meter
 CM-1550B
\$58.95
 9 Ranges
 1pf-20,000ufd
 .5% basic accy.
 Zero control w/ Case
 Big 1" Display
 by Elenco**



**Digital
 Multimeter
 DVM-638
\$39.95
 11 Functions with
 Case**

Fluke Multimeters
 Model 12 \$84.95
 Model 70II \$67.50
 Model 77II \$149.00
 Model 79II \$169.00
 Model 87 \$289.00
 Model 93 \$1,225.00
 Model 97 \$1,795.00
All Models Available - Call

HIGH QUALITY POWER SUPPLIES

**High Current Power Supply
 Spectrum
 by Elenco
 2.5 - 15VDC
 or 13.8VDC
 Fully regulated, Short circuit protected
 Voltage/Current Analog Meters
 SPL-010 **\$139** SPL-020 **\$199**
 0-10A 0-20A**



**12A DC Power Supply
 B+K 1686
\$169.95
 3-14V @ 12A
 Fully regulated & protected
 Separate Volt & Current Meters
 Current Limiting, Low Ripple**



**Quad Power Supply XP-580
\$79.95
 2-20V @ 2A
 12V @ 1A
 5V @ 3A
 -5V @ .5A
 Fully regulated & short
 circuit protected
 Made in USA by Elenco**



**Triple Power Supply XP-620
 Assembled \$75
 Kit \$49.95
 2 to 15V @ 1A,
 -2 to -15V @ 1A
 (or 4 to 30V @ 1A)
 and 5V @ 3A
 Made in USA by Elenco
 All the desired features for doing experiments.
 Features short circuit protection, all supplies.**



GENERATORS & VIDEO PRODUCTS

**Function Generator
 Blox
 #9600
 by Elenco
\$28.95
 Provides sine, triangle, square wave
 from 1Hz to 1MHz
 AM or FM capability
 Kit **\$26.95****

**Color Convergence Generator
 Elenco SG-250
\$89.95
 Kit **\$69.95**
 Finest in the industry
 10 rock steady patterns
 RF & Video output**

**Wide Band Signal
 Generators
 Elenco
 SG-9000
\$129
 RF Freq 100K-450MHz AM Modulation
 of 1KHz Variable RF output
 SG-9500 w/ Digital Display &
 150MHz built-in counter **\$239****

**Sweep/Function Generator
 with Freq. Counter
\$239
 Elenco GF-8026
 Int/Ext Operation,
 Sine, Square, Triangle, Pulse,
 Ramp, .2 to 2MHz, Freq Counter .1-10MHz**

**ALL PRODUCTS FACTORY NEW
 UPS SHIPPING: 48 STATES 5% OTHERS CALL
 IL RES add 7.75% TAX
 PROBES INCLUDED IN ALL METERS**

EDUCATIONAL KITS - FUN & EASY TO BUILD

**Robotic Arm Kit
 Model Y-01 **\$48.95**
 Teaches basics of robotics. Arm
 grabs & releases, lifts & lowers, &
 pivots from side to side**

**Digital Multimeter Kit
 with Training Course
 Elenco
 M-2665K
\$49.95
 Fun & Easy
 to Build
 Ideal School Project
 Full Function
 34 Ranges
 Includes
 Capacitance, Transistor/Diode Testing
 20Amp AC/DC, Extra Large Display
 M-2661 (assembled) **\$54.95****

**Multi-Function Counter
 Elenco
 F-1200
 1.2GHz
\$229
 Measures Frequency, Period, Totalizer
 8 LED digits, Crystals Oven Oscillator
 .5ppm Accuracy**

**AM/FM Transistor
 Radio Kit
 with 52 page Training Course
 Elenco AM/FM 108
\$27.95
 14 Transistors ♦ 5 Diodes
 Easy to build because
 schematic is
 printed right on the PCB
 Makes a great school project
 Model AM 550 AM Only **\$18.95****

**Power Supplies
\$159.95 Assembled \$129.95 Kit
 ■ Variable Power Supply
 ■ +1.25 to 20VDC @ 5 Amp
 (+1.25 to 15VDC @ 1 Amp)
 ■ -1.25 to -20VDC @ 5 Amp
 (-1.25 to -15VDC @ 1 Amp)
 ■ +12VDC @ 1 Amp
 ■ -12VDC @ 1 Amp
 ■ +5VDC @ 1 Amp
 ■ 30VAC Center tapped
 @ 15VAC at 1 Amp**

Analogue - Section
 ■ Function Generator Sine,
 Triangular, Square wave forms
 ■ Frequency adjustable in five
 ranges from 1 to 100KHz
 ■ Fine frequency adjust
 ■ Amplitude adjust
 ■ DC offset
 ■ Modulation FM-AM
Digital - Section
 ■ Eight data switches
 ■ Two no bounce logic switches
 ■ 8 LED readouts TTL buffered
 ■ Clock frequency 1 to 100KHz
 ■ Clock amplitude 5VPP square wave
Breadboards
 ■ 2 breadboards, each contain:
 840 tie points (total 1,680)

**Learn to Build and Program
 Computers with this kit
 Includes: All Parts,
 Assembly and
 Lesson Manual
 Elenco
 MM-8000
\$129.00
 Starting from scratch you build a complete system.
 Our Micro-Master trainer teaches you to write into
 RAMs, ROMs and run a 8085 microprocessor, which
 uses similar machine language as IBM PC.**

XK-500 Digital / Analog Trainer
 A complete mini-lab for building, testing, prototyping analog and digital circuits
 Elenco's Digital/Analog Trainer is specially designed for school projects, with 5 built-in power
 supplies. Includes a function generator with continuously variable, sine, triangular, square wave
 forms. All power supplies are regulated and protected against shorts.

**15 DAY MONEY BACK GUARANTEE
 FULL FACTORY WARRANTY
 WRITE FOR FREE CATALOG
 PRICES SUBJECT TO CHANGE**

C&S SALES INC.
 1245 ROSEWOOD, DEERFIELD, IL 60015
 FAX: 708-520-0085 • (708) 541-0710



**FREE
PROBES
WITH ALL
SCOPES**

**ELENCO ♦ HITACHI ♦ B&K
SCOPES AT
GUARANTEED LOWEST PRICES**

**24 HOUR
SHIPPING**

B&K 2120

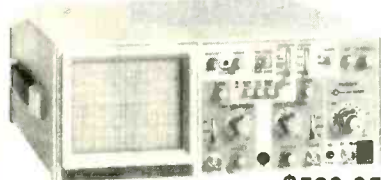

\$539.95

20MHz \$389 Model 2125
2 Channel Delayed Sweep

40MHz DUAL-TRACE

- Model 1541B
- 1mV/div sensitivity
 - Video sync separators
 - Z axis input
 - Single sweep
 - V mode-displays two signals unrelated in frequency

\$695.95

60MHz DUAL-TRACE

- Model 2160
- 1mV/div sensitivity
 - Sweep to 5 ns/div
 - Dual time base
 - Signal delay line
 - V mode-displays two signals unrelated in frequency
 - Component tester

\$949.95

100MHz THREE-TRACE

- Model 2190
- 1mV/division sensitivity
 - Sweeps to 2ns/division
 - Dual time base
 - Calibrated delay time multiplier
 - Signal delay line
 - 19kV accelerating voltage

\$1,395.95

20MHz ANALOG

WITH DIGITAL STORAGE

- Model 2522A
- 20MHz analog bandwidth
 - 20MS/s sampling rate
 - 2k memory per channel
 - 20MHz equivalent time sampling
 - Pre-trigger capture

\$875

**AFFORDABLE - ELENCO OSCILLOSCOPES
2 YEAR WARRANTY**

**S-1360
Delayed Sweep
\$775**

- Automatic Beam Finder
- Built-in Component Tester
- 1mV Sensitivity
- Dual Time Base
- Illuminated Internal Gradicule
- TV Sync

**60MHz
Dual Trace**

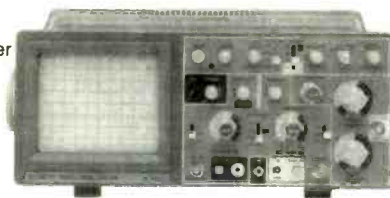

**S-1365
Cursor Readout
\$849**

- Voltage, Time, + Frequency differences displayed on CRT thru the use of cursors.
- 1mV Sensitivity
- TV Sync

**S-1345
Delayed Sweep
\$575**

- Automatic Beam Finder
- Built-in Component Tester
- 1mV Sensitivity
- Dual Time Base
- Illuminated Internal Gradicule
- TV Sync

**40MHz
Dual Trace**



**S-1340
\$495**

- High Luminance 6" CRT
- 1mV Sensitivity
- 12KV Acceleration Voltage
- 9ns Rise Time
- X-Y Operation
- TV Sync

**S-1330
Delayed Sweep
\$449**

- Automatic Beam Finder
- Built-in Component Tester
- 1mV Sensitivity
- Dual Time Base
- Illuminated Internal Gradicule
- TV Sync

**25MHz
Dual Trace**



**S-1325
\$349**

- High luminance 6" CRT
- 1mV Sensitivity
- 2KV Acceleration Voltage
- 18ns Rise Time
- X-Y Operation
- TV Sync

**SPECIAL BUY
HITACHI V-212**



20MHz
2 Channel

\$399

Hitachi Popular Series

V-525 - 50MHz, Cursors	\$995
V-523 - 50MHz, Delayed Sweep	\$949
V-522 - 50MHz, DC Offset	\$895
V-422 - 40MHz, DC Offset	\$795
V-222 - 20MHz, DC Offset	\$649

Hitachi Compact Series Scopes

V-660 - 60MHz, Dual Trace	\$1,149
V-665A - 60MHz,DT, w/cursor	\$1,325
V-1060 - 100MHz, Dual Trace	\$1,395
V-1065A - 100MHz, DT, w/cursor	\$1,649
V-1085 - 100MHz, QT, w/cursor	\$1,995
V-1100A - 100MHz, Quad Trace	\$2,495
V-1150 - 150MHz, Quad Trace	\$2,895

**Elenco DS-203 20MHz, 10MS/s
Digital Storage Oscilloscope**

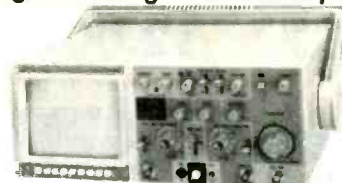

\$775

- 2K Word Per Channel
- Plotter Output
- 8 Bit Vert. Resolution
- 2048 Pts Hor. Resolution
- Much More

C&S SALES INC.
1245 ROSEWOOD, DEERFIELD, IL 60015
FAX: 708-520-0085 • (708) 541-0710



CALL TOLL FREE 1-800-292-7711

1-800-445-3201 (Canada)

ALL PRODUCTS ARE FACTORY NEW

15 DAY MONEY BACK GUARANTEE

FULL FACTORY WARRANTY

WRITE FOR FREE CATALOG

CIRCLE 32 ON FREE INFORMATION CARD

ALL ELECTRONICS CORP.

QUALITY PARTS • DISCOUNT PRICES • FAST SHIPPING

ULTRASONIC PROXIMITY DETECTOR

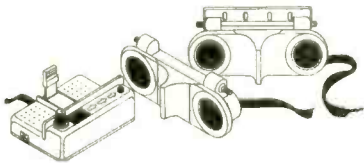

The ED-100 was designed for use as an auto/truck/RV back-up alarm. A digital display and audible beeper inside the vehicle inform the driver of the distance to impact beginning when the vehicle is within 14 feet of another object. Two 40 kHz ultrasonic emitter/detector modules, measuring 5.81" long X 1.9" wide, 2.05" thick, attach to the rear of the vehicle. The device operates on 12 or 24 Vdc.

These units are new, in original cartons and include instructions. The company that marketed this device is no longer in business, and no manufacturer's guarantee is in effect.

We offer these ultrasonic detectors for experimentation only, and in no way wish to promote their usefulness as a driving aid.

Originally sold for over \$100.00. **\$24.95** per set

CAT# ED-100

EXPERIMENTER'S DELIGHT VHF TO UHF BLOCK CONVERTER

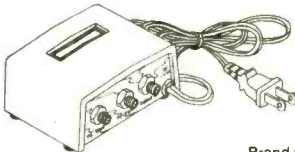

Channel Master # 0746

This is one of those deals that's too good to be true.

Brand new, in the box, Channel Master block converters.

They used to be quite popular back in the early days of cable television, before there were a lot of cable-ready TVs. Somewhere in the world we know there is still a demand for them--especially at this price. Designed to convert television VHF channels 2 through 13 and A through W to UHF channels 36 through 76. The box alone, is a great project box. The 10 ft. AC power cord, the interior components, F connectors and AC receptacles are well worth the price.

CAT# CM-0746

10 pieces for **\$18.50** each **\$2.00**

10 AMP SOLID STATE RELAY

Teledyne Relays# 615-8500
Control voltage: 3-32 Vdc
Load: 10 amp, 250 Vac 50/60 Hz
Standard "hockey puck" size: 2.27" X 1.72" X 0.95"
Screw and q/solder terminals.
UL and CSA listed.

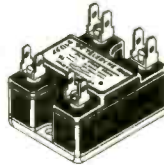

\$10.50 each
10 for **\$95.00**

CAT# SSRLY-14

240 X 128 DOT LCD DISPLAY

Optrex# DMF660N-S
240 X 128 dot LCD module with on-board drivers. Will display graphics, figures and characters.

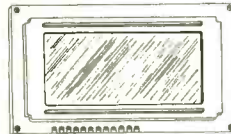

Module size: 5.68" X 4.1" X 0.5" thick.
Viewing area: 4.1" X 2.52".
Dot size: 0.4mm X 0.4mm. High contrast, wide viewing angle. Low voltage drive and low power consumption. Uses fitting controllers LSMSM6255, HD64646, SED1330, SED1351. Includes hook-up instructions and specs.

CAT# LCD-15

\$29.95 each

10 BUTTON MEMBRANE KEYPAD



10 button, matrix encoded keypad. Peel-and-stick backing for easy mounting. Originally designed for use on a satellite TV tuner, the keys have satellite names and related text on them in addition to numerals 0 through 9. Overall dimensions are 9" X 1.625", but half of the strip can be cut off with a knife or scissors, leaving a self-sticking keypad of 4.5" X 1.625". Silver keys with charcoal numerals and background. 6.5" flexible ribbon cable, terminated with 7 pin socket connector - 0.1" spacing.

CAT# KPM-10

\$1.25 each
10 for **\$10.00**

ULTRABRIGHT LED

Toshiba # TLRA180AP
High brightness
T-1 3/4 LED. Water-clear, lights red. 3000 mcd @ 20 mA.
Great for indoor or outdoor displays.



CAT# LED-19

2 for \$1.00
100 for **\$45.00**

11 Vdc @ 500 ma. WALL TRANSFORMER

SUPER SPECIAL!

We have lots of these brand new wall transformers rated 11 Vdc @ 500 ma., but they work fine at 12 volts. With no load they put out 16.2 Vdc. 2.1mm id power plug center positive. White case - U.L listed

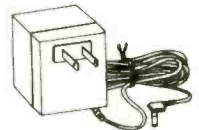

CAT# DCTX-115

\$2.00 each

100 for **\$175.00**

SPECIAL! SPECIAL!

36 PIN SNAPPABLE HEADER



Arklis Corp. # 25MSS2A36GG030
Special purchase of 36 pin, single row 0.1" spacing headers. Snappable to smaller lengths. Sold only in bags of 100 pieces. Our regular price on a 40 pin header is \$120.00 per 100 pieces.

CAT# SHS-36

\$40.00 for 100 piece bag

\$350.00 for 1000 pieces

CALL, WRITE or FAX For A Free 64 Page Catalog
Outside the U.S.A. send \$2.00 postage.

ORDER TOLL FREE **1-800-826-5432**

MAIL ORDERS TO:
ALL ELECTRONICS CORP
P.O. Box 567
Van Nuys, CA 91408

FAX (818) 781-2653
INFO (818) 904-0524

DISCOVER

VISA

MasterCard

Minimum Order \$10.00 • All Orders Can Be Charged To Visa, Mastercard Or Discover Card • Checks and Money Orders Accepted By Mail • California, Add Sales Tax • No C.O.D. • Shipping And Handling \$4.00 for the 48 Continental United States - All Others Including Alaska, Hawaii, P.R. And Canada Must Pay Full Shipping • Quantities Limited • Prices Subject to change without notice.

CIRCLE 28 ON FREE INFORMATION CARD

www.americanradiohistory.com

Simply A Superior 1.3 GHz Spectrum Analyzer

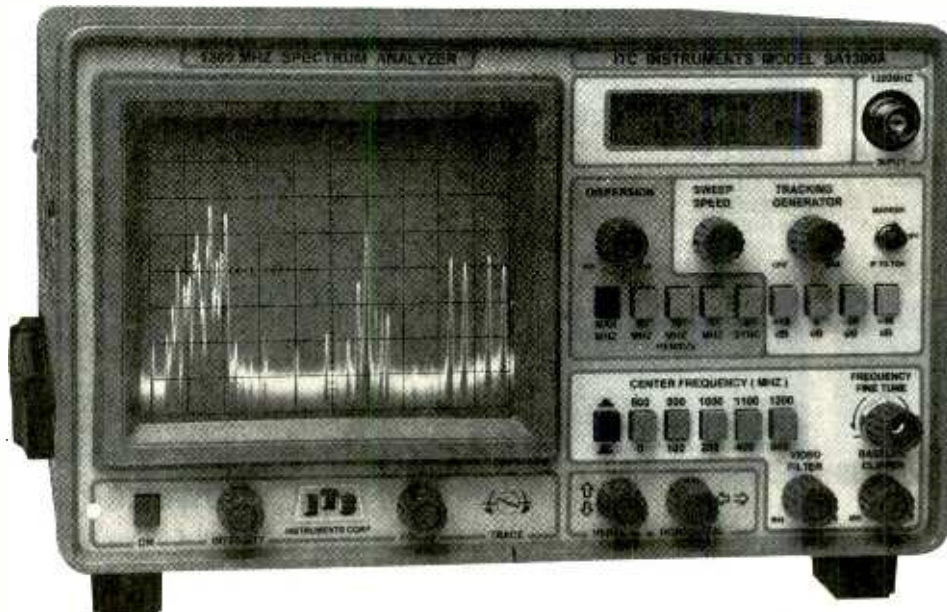

1-1300 MHz *In One Sweep* \$1,895.

MADE IN USA -10KHz Resolution Band Width -7 Digit Center Frequency Display

**MARINE, TWO-WAY, HAM, AM FM SW BROADCAST RADIO - CATV, SATELLITE. SYS., SURVEILLANCE
TUNE DUPLEXERS, AMPS, FILTERS, SECURITY TRANS, & RECEIVERS - EMI, RFI, FCC, TESTING**

EXCLUSIVE DISPERSION ZOOM

ITC SA Series exclusive Dispersion Zoom lets you zoom in on **any Center Frequency** signal, from any one of five calibrated Dispersion positions. Preset at >140 MHz, 50MHz, 10MHz 1MHz and zero MHz per division. The SA1300A displays greater than 1300 MHz on the screen at one time yet allows instant zoom to any Dispersion Scan Width as low as zero MHz per div. Allowing for total control over all **Dispersion Scan Widths** settings.

80 dB ON SCREEN

130 dB total Dynamic range 110 dBm **Sensitivity**. At Narrow and Wide Band Width settings. Performance you would expect only from a \$10,000 Analyzer.

ULTIMATE *LOW COST* ANALYZER

ITC Spectrum Analyzers are the best performance to price ratio Analyzers on the market today. No other low cost Analyzer comes close to the Superior performance and quality of an ITC Analyzer. **Total flexibility and ease of operation.** SA1300A gives you full control over the Resolution Band Width and Freq. Span widths. Plus Vertical Position, Baseline Clipper, Sweep Speed, Video Filter, 4 Input Attenuator settings, 10 Frequency Select settings.

MODEL SA1800B 1800 MHz

Covers 1-1300 MHz and 850-1850 MHz In one sweep. Ideal for Satellite service. The **SA1800B** has the same general specifications as the model SA1300A.

INTRODUCTORY OFFER

SA1300A & OPT.s 1, 3, 6

ONLY \$1895.00 note 1

SA1800B & OPT.s 1, 3, 6

ONLY \$2295.00 note 1

\$1995.00 Opt. 1, 6 ONLY

SA1300A	\$1595.00
SA1800B	\$1895.00
OPT. 1 50MHz MARKER	\$200.00
OPT. 3 +/- 5KHz Res B.W	\$350.00
OPT. 5 1000 MHz Tracking Generator	\$250.00
OPT. 6 7 Digit Center Frequency Display	\$300.00

Note 1: Introductory Price for limited time only.

TAKE **ADVANTAGE**

CALL 1-800-566-1818

To: Order - For Information & Special Intro. Offer
Terms: MC, VISA, AE, Check, COD, PO (OAC), LC, Transfer

DISTRIBUTED BY: **ADVANTAGE** INSTRUMENTS CORP.

3817 S. CARSON ST. # 818 CARSON CITY NV. 89701

1-800-566-1818 702-885-0234 FAX 702-885-7600

PRICES & SPECIFICATIONS SUBJECT TO CHANGE WITHOUT NOTICE OR OBLIGATION. F.O.B. CARSON CITY NV. NV. RESIDENTS ADD SALES TAX.

CIRCLE 139 ON FREE INFORMATION CARD

AFFORDABLE DATA ACQUISITION



MODEL 30 \$79.00

- PLUGS INTO PC BUSS
- 24 LINES DIGITAL I/O
- 8 CHANNEL-8 BIT A/D IN
- 12 BIT COUNTER
- UP TO 14K SMP/SEC



MODEL 45 \$189

- RS-232 INTERFACE
- 8 DIGITAL I/O
- 8 ANALOG INPUTS
- 2 ANALOG OUTPUTS
- 2 COUNTERS-24 BIT



MODEL 70 \$239

- RS-232 INTERFACE
- 18 BIT A/D
- 5.5 DIGIT
- UP TO 60 SMP/SEC



MODEL 150-02 .. \$179

- RS-232 INTERFACE
- TRMS, 20 AMPS
- 12 BIT A/D
- OPTO-ISOLATED
- CHANGE RANGES, AC/DC, VIA RS-232

Prairie Digital, Inc.

846 17th Street • Industrial Park • Prairie du Sac, WI 53578
(608) 643-8599 • FAX: (608) 643-6754

CIRCLE 47 ON FREE INFORMATION CARD



CABLE TV Converters & Descramblers

Compatible with
**Jerrold, Scientific Atlanta,
Pioneer, Oak, & Hamlin
Equipment**

BRAND NEW!

90-DAY GUARANTEE

LOWEST PRICES

Volume Control & Parental Lockout Available

Greenleaf Electronics

1-800-742-2567

NO ILLINOIS SALES

It is not the intent of Greenleaf Electronics to defraud any pay television operator and we will not assist any company or individual in doing the same.

Serving the public since 1981

XANDI Electronics

201 E Southern #111, Tempe AZ 85282

**SATISFACTION
GUARANTEED!**

BUY WITH CONFIDENCE FROM XANDI

- 30-DAY REFUND POLICY
- NEW TELEPHONE TECH SUPPORT NUMBER (602-894-0992)

- Smallest FM transmitter anywhere!
- Tunes 88-108 MHz.
- Powerful 2 stage audio amplifier.
- Sensitive, picks up sounds at the level of a whisper.
- Up to 1 mile range.



XST500 SUPER-MINIATURE FM TRANSMITTER

World's smallest FM voice transmitter. Use with any FM broadcast receiver. Easy to assemble, all chip (SMT) parts are pre-assembled to the circuit board.

XST500(E-Z) Kit \$44.95

- Transmits both sides of phone conversation.
- Adjustable from 88-108MHz.
- Works with any FM broadcast receiver.
- Up to 1 mile range.
- Turns off when phone is not in use to extend battery life.



XTT100 LONG RANGE PHONE TRANSMITTER

Similar to our very popular XSP500, the XTT100 is capable of picking up sounds at the level of a whisper and transmitting them to any FM broadcast receiver.

XTT100(C) Kit \$32.95

- Super sensitive, hear every sound in a house!
- Powerful 2 stage audio amp.
- Use with any FM broadcast receiver.
- Up to 1 mile range.
- Powered by 9V battery.

XFM100 MINIATURE FM TRANSMITTER

The XFM100 has a super sensitive microphone and is capable of picking up sounds at the level of a whisper and transmitting them to any FM broadcast receiver.

XFM100(C) Kit \$32.95



XLC900 800-950 MHz SCANNER CONVERTER KIT
If your scanner can receive 400-550 MHz, just add the XLC900 for uninterrupted 800-950 MHz coverage. It converts all 800-950 MHz signals down to 400-550 MHz so your scanner can receive them! Add our custom case and knob kit for that "professional" look.
XLC900 Kit \$49.95
XLC-Case Kit \$13.95



TRANSITION 2000 VOICE CHANGING TELEPHONE

STOP THOSE ANNOYING PHONE CALLS! Sound older and tougher when you want to. Not a kit, fully assembled. Single line phone operation only.

TRANSITION 2000 \$89.95

- Digital voice changing: male to female, female to male, adult to child, child to adult.
- 16 levels of voice masking.
- Button for normal operation.
- Complete anonymity on all calls

- Digital voice changing: male to female, female to male, adult to child, child to adult.
- 16 levels of voice masking.
- Use with any modular phone.
- Connects between handset and phone.
- 16 levels of voice masking.



TRANSITION 2001 VOICE CHANGING Accessory

STOP THOSE ANNOYING PHONE CALLS! Sound older and tougher when you want to. Use with single or multi-line phones. Not a kit, full assembled.

TRANSITION 2001 \$59.95

- Transmits a continuous beeping tone.
- Adjustable from 88-108 MHz.
- Up to 1 mile range.
- Works with any FM broadcast receiver.
- Operates at battery voltages of 3 to 18 volts.



XTR100 TRACKING TRANSMITTER

Measuring .7 by 2.4 inches, the XTR100 is ideal for use in locating lost model rockets, bicycles, automobiles, games of hide-and-seek, and contests.

XTR100(C) Kit \$43.95

- Uses sensitive microwave transistor amplifier.
- Covers 1 to 2000 MHz.
- Compact hand held unit.
- Uses Miniature loudspeaker (not included) for audio indication of detected signals.

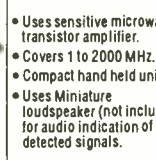

XBD200 SUPER SENSITIVE BUG DETECTOR

When the XBD200 intercepts a signal in the 1 to 2000 MHz range, it emits a growl that increases to a high pitched squeal as the signal strength increases.

XBD200(C) Kit \$49.95

- Designed to help scanners with poor sensitivity pull in those weak signals. Includes off/pass switch for returning to normal operation and front panel gain control. Add our custom case and knob kit for that "professional" look.

XLA1000 AMPLIFIER KIT
Designed to help scanners with poor sensitivity pull in those weak signals. Includes off/pass switch for returning to normal operation and front panel gain control. Add our custom case and knob kit for that "professional" look.
XLA1000 Kit \$24.95
XLA-Case Kit \$13.95



WE ACCEPT VISA, MC, MO, COD
ASK FOR FREE CATALOG OF
ALL OF OUR PRODUCTS

**TOLL FREE ORDER LINE
1-800-336-7389**

SEND MAIL ORDERS TO:
**XANDI ELECTRONICS
BOX 25647
TEMPE, AZ 85285-5647**

Amazing fundamentals method of VCR and computer repair turns you into an electronics "genius."

Here's the practical education you need to earn huge profits.

This is your chance to catch the profit wave of the nineties and cash in on the exciting world of electronics. By learning how to service and repair VCRs, computers and other electronic marvels, you'll be well on your way towards a rewarding and secure financial future.

The secret of the Fundamentals Method.

Chances are, at one time in your life, you've had a flat tire on your car. Solving the problem was a straightforward affair - you simply took off the flat tire and put on one that was filled with air.

The Fundamentals Method of electronics repair is based on the same find-the-problem and replace-the-part procedure. The fact is, almost all electronic equipment failures are caused by the breakdown of simple mechanical or electro-mechanical components. And, just as easily as finding a flat tire and replacing it with a spare, you'll learn how easy it is to identify and replace faulty components with new ones. Yes it's true, it's honestly as simple as that.

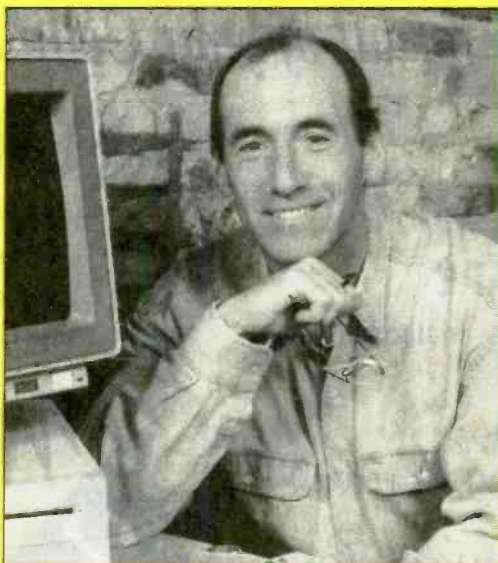

Earn \$80 an hour or more!

The electronics industry has grown at a phenomenal rate. In just the past 10 years we've seen VCRs and computers find their way into virtually every American home and business. Many households have two, even three VCRs, and there are more than 60 million personal computers in service with more than 50,000 new ones being sold every day!



But as the volume of electronic products has grown, the number of qualified technicians to service and repair

them has simply not kept pace. Businesses facing costly losses when their computers are down, will pay almost anything to have them repaired. As a result, qualified electronics technicians can earn up to \$80 an hour for their services. YOU can be one of them.

For just \$1.50 a day, you can become an electronics specialist.

Learning the Fundamentals Method is remarkably inexpensive because we don't require you to pay extra for a new VCR or PC. You'll learn more by working on an old model you can easily find on your own. And once you've earned your diploma from the YOUiversity College of Electronics you can be your own boss, setting your own hours and rates — usually in the range of \$50 to \$80 an hour.

Free information.

Learn more about the high-paying, financially-secure world of VCR or computer service and repair. Simply mail in the coupon below for detailed information. There's no obligation and no salesman will call.

The Future Is Yours!

Foley-Belsaw Institute

5301 Equitable Road, Kansas City, MO 64120-1395

YES! I want more information about how I can learn to make \$80 an hour or more servicing and repairing electronic equipment. Please send me FREE information. I'm interested in: (Check one)

VCR REPAIR
DEPT. 5265B

COMPUTER REPAIR
DEPT. 6446B

NAME (PLEASE PRINT) _____

ADDRESS _____

CITY _____

STATE _____

ZIP _____

the **YOU** niversity

Hands On Training In Your Own Home

CELLULAR SOFTWARE AND MODIFICATION GUIDES

Call Spy Supply for all of your Cellular needs!

We Carry:

CELLULAR SOFTWARE

(We have the software to do New Motorola Phones)

CELLULAR CABLES

(For the Motorola, Panasonic, and Nokia Phones)

CELLULAR MODIFICATION GUIDES

(Covers all cellular manufacturers)

CELLULAR PHONES

(We carry a complete line of cellular phones)



FREE TECHNICAL SUPPORT!

We now offer Cellular Phones cloned with your existing number! Buy a handheld, transportable or car mounted phone ready to go and have only one monthly bill!

Don't Get Ripped Off!

Before you buy our competitor's manual, call and ask if they offer **FREE TECHNICAL SUPPORT**

SPY SUPPLY

Find out why the CIA - FBI - DEA - SECRET SERVICE Have ordered from our catalog To receive yours, send \$5.00 to **SPY SUPPLY** 1212 Boylston St. #120 Chestnut Hill, MA 02167

SPY SUPPLY, 1212 Boylston St. #120, Chestnut Hill, MA 02167

(617) 327-7272

Sold for educational purposes only

AMERICAN
COMMUNICATIONS
TEST & SURVEILLANCE

Setting New Standards

IN THE WORLD OF **Communications, Test & Surveillance** *Further • Better • Faster*

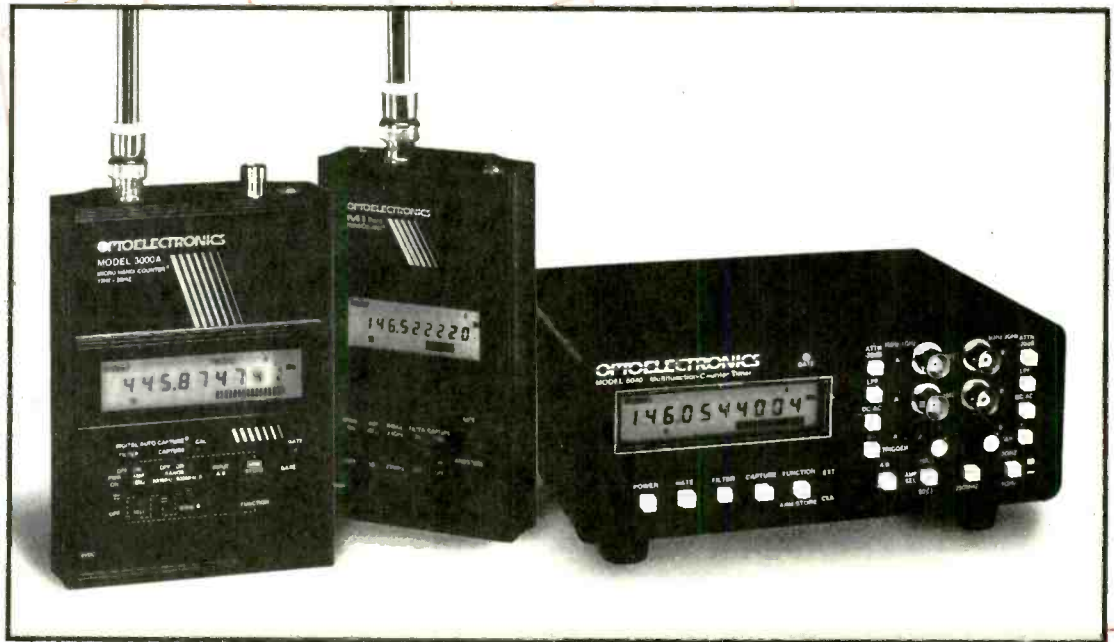

Model 3000A \$329.

World's most highly advanced hand held counter.

- Digital Filter: Reduces false counts - no loss of sensitivity
- Digital Auto Capture - auto hold & store, works even near strong RF Fields
- Stores and recalls frequencies
- 5-6 hour battery operation
- Fast - 250 million counts per second for high resolution - 250 MHz direct count
- 10 Hz to 3 GHz
- Ultra sensitive bargraph w/ 16 segment display
- Multi-Function Counter with Frequency, Period, Ratio and Time Interval
- Optional $\pm .2$ PPM TCXO- \$100.

Model M1 \$229.

Full Range Pocket Sized Counter

- Digital Filter
- Digital Auto Capture - Auto Hold
- Stores & Recalls Frequencies
- 4-5 hr. battery operation
- 10 Hz to 2.8 GHz
- 10 digit LCD with EL backlight

Model 8040 \$679.

Multi-Function Bench/Portable Counter Measures Frequency Period, Ratio, Time Interval and Average.

- Digital Filtering to eliminate false counts
- Auto Capture/Auto Hold
- 16 Segment Signal Strength Bargraph
- Dual 50 OHm and 1 Meg OHm input amplifiers with AC/DC Coupling, \pm Polarity, Triggers Level Adj., Low Pass Filter and Attenuator
- .05PPM, 0-50°C Oversized Time Base Option
- Internal/External Clock Input
- RS-232 Serial Computer Interface

8 0 0 • 3 2 7 • 5 9 1 2

(305) 771-2050 • FAX (305) 771-2052 • 5821 NE 14th Ave. Ft. Lauderdale FL 33334

CIRCLE 43 ON FREE INFORMATION CARD

Electronics made Easy "Learn by Seeing"



Complete Course in Basic Electronics
Includes 6 one hour videos and 6 workbooks. Everything you need to learn basic electronics. You will learn about Direct Current, Alternating Current, Semiconductor devices, Power supplies, Amplifiers, and Oscillators. These videos are **100% computer animated**, they make learning electronics easy and fun. Don't waste any more of your valuable time reading and re-reading the same material to try and understand these simple concepts when you can **"see it happen."** These videos will ... teach you more in less time ... allow you to learn at your own pace ... help you remember more of what you learn ... give you years of quality use ... become a valuable source of reference material ... make your understanding of electronics more complete ... and help you build your future today. **Your future is too important to gamble with, so order your course in Basic Electronics Today.**

Call Now ... ask about these and our other popular UCANDO videos. These videos are currently being used by Tech-Schools, CET's, Military branches, Ham Operators, Industries, and are sold in six foreign countries. After you have seen your first UCANDO video you will understand why ... **"UCANDO is Changing The Way The World Learns Electronics"**.

- Part 1 DC \$49.95
- Part 2 AC \$49.95
- Part 3 Semiconductors \$49.95
- Part 4 Power Supplies \$49.95
- Part 5 Amplifiers \$49.95
- Part 6 Oscillators \$49.95

SAVE ... buy all six for only \$280

Call toll free 1-800-678-6113

CIRCLE 136 ON FREE INFORMATION CARD

Still a little FUZZY on Fuzzy Logic?
Neural Nets
keep you noodling???

fuzzy???

DON'T BE
LEFT
OUT...



Soft-Wear Productions
103 Westward Cove
Austin, TX 78733
1-800-783-8161 Code 5884

These important new technologies are in your future. Find out how they work in this Desk Top Video. Get hands on practice with source code of working models. Call or write now with your order.

- Fuzzy Logic MSDOS Package Includes:
Video Tape
Source Code in C, BASIC, and WK? Spdsht
- Neural Networks MSDOS Package Includes:
Video Tape
Source Code in C for two operating nets

\$29.95 ea + \$5.00 s&h per order. VISA/MC incl number and exp date

Learn MICROCONTROLLERS and EMBEDDED SYSTEMS with the AES-10

The AES-10... a complete learning system, a complete embedded control system. Extensive manuals guide you through your 8051 development project. Assembly, BASIC, and C programming. All hardware details, complete schematics. Learn to program the LCD, keypad, digital and analog I/Os for your applications.



80C32 Computer/Microcontroller board with:

- 32K ROM 32K RAM
- 2 by 16 Liquid Crystal Display
- 4 by 5 Keypad
- Digital, A/D, D/A, and PWM, I/O
- Built in Logic Probe
- Power supply, (can also be battery operated)
- Extended AES BASIC and AES Monitor in ROM
Built-in routines for LCD, Keypad, A/D, D/A and Digital I/O ports
See 80C32 registers while you Step
See all memory locations and data on LCD
See memory contents in dec. hex. and binary
- RS-232 cable to connect to PC for programming
- 8051/52 DOS Cross Assembler
- Program disks with well documented examples
- User's Manual, Language Manual, and Text

AES
Advanced Embedded System

1407 North Batavia Street, Orange, California 92667, USA

\$365, Money Back Guarantee
Free Brochure, M/C Visa
800 - 730-3232
714 - 744-0981
Fax 714 - 744-2693

TOP SECRET



CONSUMERTRONICS

2011 Crescent Dr., P.O. Drawer 537
Alamogordo, NM 88310
(505) 434-0234, 434-1778

FAX: (505) 434-0234 (if you got answering machine press #, then *1 any time)

VOICE LINES: 8 AM - 8 PM MST, Mon-Sat
FAX (orders only): 24-hour, 7 days/week
Add \$5 total \$4 (USA, Canada). All items in stock. VISA, MCARD OK (\$29 min.). No CODs or "bill me's". 150+ unique hi-tech survival books, manuals, programs, hardware services. New Catalog is \$2 w/ order, \$4 w/ no free catalog. In business since 1971. As seen on TV, etc. John Williams - former Lockheed Senior Engineer, NMSU Professor of Computer Science, NIH Health Physicist. Sold for educational purposes only.

*All software supports all IBM-PC compatible systems (8088 - 80486)

Off-The-Shelf HARDWARE

Van Eck systems, Automated Tempest Module, X-Radar Emitter, Carjacking Follower, Personal Body Alarm, Voice Disrupter, Hearing Assistor, Shriek Module, EM Countermeasure, Omnimax TENS, 6th Sense Communicator, many nifty Phone Boxes, Bumper Beeper, Subliminal Mixer/Amp, Super MWD, Rifle Device, Neurophone, Hieronymus Machine, Magnetometer, Data Card Reader/Writers, Dwelling Security System, Levitator, Vortex Generator, Ultrasonic Jammer & Receiver, Long-Range Eavesdropper, Noise Cancellation System, Unknown Presence Detector, Electronic Doozer, Automatic Pet Feeder, Stealth Paint - more! See Our Catalog.

SPECIAL PROJECTS

We design, build, repair, modify, maintain and/or consult on any device, system, process or project - electrical, electronic, computer, phone, mechanical, optical, automotive. Invention prototyping. Confidentiality guaranteed. Describe and include \$25 pre-engineering fee (does not obligate you). Time and cost estimates in 7-10 days.

VOICE MAIL HACKING

How Voice Mail Box (VMB) systems are used and the specific ways they are hacked. Includes ASPEN, MESSAGE CENTER, MIX, GENESIS, EZ, SYDNEY, PHONE MAIL, AUDIX, CINDY, CENTAGRAM, SPERRY LINK, RSVP, etc. Absolutely required for all users and sysops! \$29.

PBX HACKING

Thousands of PBXs are hacked to the tune of about \$3 Billion/yr! While our "VOICE MAIL HACKING" details how VMSs are hacked for "phun" and profit - including VMS methods for hacking PBXs themselves - "PBX HACKING" addresses ALL issues relating to PBX hacking, including countermeasures! Can your business or agency afford a \$30,000 phone fraud loss (the average loss due to hacked PBXs)? As described in Forbes Magazine. \$39

PHREAKING CALLER ID & ANI

Details on how they work and dozens of effective ways of defeating Caller ID, ANI, *69, *57, and Call Blocking and *67. Also describes Caller ID, Orange, Belge, Cheese and CF Boxes, ESS, SS7, E-911, various CLASS services, CWA, NON PUB DA, CAMA, DNR, 800-ECR, Diverters, LD Extenders, Centrix - more. \$29.

PHONE COLOR BOXES

As designed by Phone Phreaks! Is phone color boxes described. Dozens of circuits, simulator programs. Plus call-forwarding, conferencing, phreak history, 50 useful and legal phone circuit plans - more. \$29.

ROBOFONE AUTODIALER

Powerful, versatile, menu-driven "Wargames" autodialer lets you dial any quantity (up to 10K) or mix of location distance numbers in any order, over any length of time, whether busy or answered (your choice) and log the times, commands and results to monitor, printer and/or disk. Quick-dial directory of up to 600 numbers. BUSY redial options. Direct modem command and control. All Result Codes, including VOICE and RINGING. Optional shell to terminal program upon CONNECT. Exit to menu or DOS (for batching). Manual + Disk* \$29.

COMPUTER PHREAKING

TROJAN HORSES, VIRUSES, WORMS, etc. and countermeasures. Includes disk with 360K of hacker text files and utilities, and legendary FLUSHOT+ protection system (Ed. Choice, PC Magazine). Dozens of computer crime and abuse methods and countermeasures. How systems are penetrated. BBS advice, password defeats, glossary - much more! Manuals + Disks* \$39.

BEYOND VAN ECK PHREAKING

Eavesdropping on VDT and TV video signals using an ordinary TV! Documented in security industry literature. Range up to 1 KM. Plans include both the Consumertronics and the original Top Secret Van Eck designs! \$29.

CRYPTANALYSIS TECHNIQUES

The powerful menu-driven crypto programs in COW and their BAS sources) to analyze, decrypt "secure" ciphertexts. Worked-out examples. Recommended in prestigious "Computers & Security". Manual + Disk* \$29.

By an ORDER of the MAGNITUDE

The most comprehensive, hard-hitting, hi-tech survival book ever written! Topics include electronics, computers, energy, weapons, concealment, revenge, alarms, etc to survive today's dangerous world. We all face increasingly financially and physically brutal times! Field-expedient use of technology in various threat and conflict environments and scenarios. \$49.

STOPPING POWER METERS

As reported on CBS "60 MINUTES": How certain devices can slow down - even stop - watt-hour meters - while loads draw full power! Device simply plugs into one outlet and normal loads into other outlets. Also describes meter creep, overload droop, etc. Plans \$29. I.Q. MANUAL: External magnetic ways (applied to the meter itself) to slow down and stop watt-hour meters while drawing full loads. Plans. \$19. KW-HR METERS: How watt-hour meters work, calibration, error modes (many), ANSI Standards, etc. Demand and Polyphase Meters. Experimental results to slow and stop meters by others. \$19. Any 2. \$38. All 3, \$59.

AUTOMATIC TELLER MACHINES

ATM crimes, abuses, vulnerabilities and defeats exposed 100+ methods detailed, include: Physical, Reg. E. slipper, PIN compromise, card counterfeiting, magnetic stripe, false front, TEMPEST, Van Eck, tapping, spoofing, inside job, super-cool vibration pulse, high voltage - others. Case histories, law, countermeasures, detailed security checklist, labeled internal photos, figures. ATMs contain up to \$250,000 in cash! Recent \$350,000 ATM crime spree still unsolved! \$39.

CREDIT CARD SCAMS

Cardholders, merchants, banks suffer \$ Billions in losses annually because of credit card fraud. Describes every known means of credit card fraud and scams. Protect yourself! \$29.

CONS & SCAMS

Cons & scams fleece Americans of \$100+ Billion per year! The most comprehensive survival manual on cons & scams of all kinds - from the classic to hi-tech. Details on 100s and their many variations. Protect yourself! \$29.

HIGH VOLTAGE DEVICES

HV devices plans: Stun Gun, Taser, Prod, Cane, Flasher, Blaster, Zapper, Audio/Radar, Hammer, Jacob's Ladder, Plasma & Van de Graaff Guns, Fence Charger, Gelger Counter, Ozon Gun, Fish Stunner, Plant Stim., Xirlian, more! Shocking! \$29.

UNDER ATTACK!

Electromagnetic Interference and Electronic Weapon Attacks cause: Cancer, birth defects, and profound psychological, neurological, cardiovascular and immune system disorders! Destructive to people, animals, plants, equipment! Includes ACTUAL CASES OF EM ATTACKS ON PEOPLE (we investigated!) Includes how to verify and pinpoint EMI and electronic attack sources, and specific countermeasures. \$29. EM BRAIN-BLASTER! Tutorial and plans for powerful ELECTROMAGNETIC WEAPONS and LAB DEVICES. Optimum circuits, freqs, waveforms, duty cycles, intensities. Thorough. \$29. Both \$49.

RADIONICS MANUAL

Exciting electrical, electronic and electromagnetic therapeutic, diagnostic and preventive devices (mostly experimental). History, descriptions, plans (dozens), availabilities of Radionics devices from early to modern. While drugs cost \$ Hundreds, electricity costs pennies! \$29. HEAL THYSELF! Plans for 3 major electronic therapeutic devices of types approved by FDA. \$19. Both \$39.

HARD DRIVE MANUAL

Covers all hard drive and controller implementations (emphasis on PCs). How to select, interface, initialize, set up, use, maintain, troubleshoot and repair them. How to protect them from mistakes, sabotage, prying eyes and sticky fingers. How to recover damaged and lost files. How to prevent crashes. Includes software reviews. Loaded with information, advice, tips. \$29.

DISK SERVICE MANUAL

Maintain, troubleshoot, repair, adjust, align floppies without special equipment or software. \$3.75/2578", PCXT/AT/386/486, Apple, Commodore, etc systems. All floppies need occasional upkeep. \$29. DISK DRIVE TUTORIAL: Theory, practical facts on floppy drives, disks, including many tips, recommendations, formatting, interfacing, FDC, etc. \$24. Any 2. \$49. All 3, \$69.

SOFTWARE PROTECTION SYSTEM

Unique system that highly discourages costly software piracy while not interfering with legal archival copies. No known way to defeat. No special equipment required. Simple and automatic to install on your distributed software. Compatible with all copy-prevention systems. Manual + Disk* \$59.

STEALTH TECHNOLOGY

Police radar is fascinating! It also has error rates of 10-20%! Every known error mode - stealth method and material used to minimize radar reflections - tactic and strategy to fight unjust radar tickets (that cost you \$100s in insurance and risk cancellation) - methods to detect and jam signals - fully described! \$29.

SECRET & SURVIVAL RADIO

Optimum survival and security radio equipment, methods, freq allocations and voice/data scrambling/encoding. Includes small receivers/transmitters, telemetry, antenna optimizations, remote monitoring and control, security, surveillance, and ultrasonic, fiber-optic and infrared commo. 70+ circuit plans, tables. \$29.

ULTIMATE SUCCESS MANUAL

Underpaid? Harassed or abused? Manipulated? Taken for granted? Stuck in a dead-end job? Can't find a good job? Expect to be laid off, fired or transferred soon? The ultimate no-holds-barred, looking-after-#1 Machiavellian techniques to find, obtain, optimize and keep top jobs, pay and benefits. THE RULES OF THE GAME FOR A GAME WITHOUT RULES! From first resume to CEO. \$29.

ROCKET'S RED GLARE

How to design and build solid-propellant amateur and survival rockets. Emphasis on formulation, manufacture, installation of propellants, motors, igniters, etc. Includes list of commonly available materials, and the design of launch pads and test beds and their electronics. \$29.

Please Order Today! (505) 434-0234

CONTROL ANYTHING FROM YOUR COMPUTER SERIAL PORT!

115200 BAUDS SMART BOARDS DO NOT REQUIRE PROGRAMMING! The I/O-232 boards understand simple commands, e.g. PRA [Enter] reads Port A. Results are sent back to the computer as an ASCII string allowing the use of PROCOMM, MAC240, or your own programs. In addition to interfacing, the I/O-232 boards have the following embedded functions:

- All standard Baud rates (300-115KB) supported.
- Bin, Hex or Dec formats.
- 24 I/O lines configurable individually as Inputs or latched Outputs.
- 8 or 10 bits, 10 channel's Analog to Digital converter.
- 10-10,000 Hz, 0-100% Pulse Width Modulation output.
- 3 EASY to use stepper motor logic interfaces (Muxable to more).
- Relative resistance or capacitance measurements using an RC network (ideal to read temperatures using a thermistor).

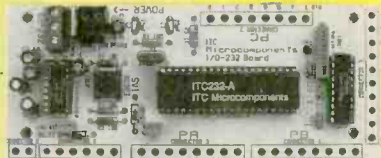

- I/O-232-8A (8 bit ADC) Assemb. Only US\$109
 - I/O-232-8K (8 bit ADC) Kit. Only US\$ 89
 - I/O-232-10A (10 bit ADC) Assemb. Only US\$125
 - I/O-232-10K (10 bit ADC) Kit. Only US\$ 99
- Add \$10 for manuals + Shipping & Handling

ITC MICROCOMPONENTS INC.

18440-57 Ave, Edmonton AB, T6M 1Y2,
Canada. Phone & Fax 1 (403) 486 2377

PCBoards

PCB Artwork Made Easy!

PRINTED CIRCUIT DESIGN SOFTWARE

for

Layout - Autorouting - Schematic

- Supports all Video Modes including Super VGA
- Copper Flooding for Building Ground Areas
- Gerber and Excellon Output
- Mirror Imaging for Laser Printer Output
- Autorouter as Schematic Programs
- Circuit Simulation Software Available
- NEW! - WINDOWS™ Versions
- NEW! - DOS Versions - PCBoards & PCRoute
- FREE - Heat Transfer Film with Order

Download Demos from BBS (205)933-2954

PCBoards Layout Only \$99

Windows™ Layout starts at \$149

Call or Write for Full Product Line, Prices & Demo Packages

PCBoards

2110 14th Ave. South
Birmingham, AL 35205

(800)473-7227

Fax (205)933-2954
Phone (205)933-1122

Enter A World Of Excitement with a Subscription to
Popular Electronics

Get the latest electronic technology and information monthly!

Now you can subscribe to the magazine that plugs you into the exciting world of electronics. With every issue of Popular Electronics you'll find a wide variety of electronics projects you can build and enjoy.

Popular Electronics brings you informative new product and literature listings, feature articles on test equipment and tools—all designed to keep you tuned in to the latest developments in electronics.

So if you love to build fascinating electronics, just call toll free the number below to subscribe to Popular Electronics . . . It's a power-house of fun for the electronics enthusiast.



Save **55%**
 on the Regular
 Newsstand
 Rate

1 yr \$18.95 2 yrs \$36.95

Basic Subscription Rate — 1 yr/\$21.95; 2 yrs/\$42.95

FOR FAST SERVICE CALL TODAY

1-800-827-0383

(7:30 AM-8:30 PM—EASTERN STANDARD TIME)

NEXT MONTH IN

**Electronics
 NOW**

Today's engineers and technicians must understand programmable logic devices to be on the cutting edge of technology. That is why Electronics Now is presenting complete instructions on how to build a low-cost programmer. Even if you aren't doing component-level logic design on a daily basis, you can now experiment with programmable devices and see how PLD's can save PC-board space, reduce costs, and add design flexibility when compared to standard TTL.

☆ Plus. . . How to build an AM Power Loop Antenna and pull in stations you never dreamed possible. Also, IBM OPC I/O Breadboard—get on the PC bus!

The May 1994 Issue is on Sale

APRIL 5, 1994

Watch for it!

Pick Up *Electronics Now* at your favorite Newsstand, Convenience Store, Bookstore or Supermarket

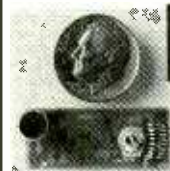

**NEW MICRO TX1000 -
 SMALLEST 100 MILLIWATT FM VOICE TRANSMITTER**

- USE 9-VOLT BATTERY
- STABLE TUNE 88-110mhz ON ANY BROADCAST RECEIVER
- ATTACH 3 WIRES AND HEAR A WHISPER UP TO 2 MILES AWAY!
- USES STANDARD 9-VOLT BATTERY

TX 1000
\$59⁹⁵



MICRO 1.1 VOICE RECORDER

- WORLDS SMALLEST - 7-15 V. OPERATION - EXACT SOUND REPRODUCTION
- 60 SECONDS RECORD TIME - 100 YEAR MEMORY WITHOUT POWER
- NOT A KIT! INCLUDES MICROPHONE, SWITCHES & MANUAL

MICRO 1.1
\$79⁹⁵



1145 CATALYM ST., SCHEMECTADY, NY 12303

ORDERS ONLY
 CALL 1-800-588-4300

TECH. SUPPORT: (518) 381-1057 TECH. FAX: (518) 381-1058

ORDER BY PHONE OR MAIL. IN U.S.A. ADD \$3 FOR S&H. C.O.D. CHARGES APPLY. NYS RESIDENTS ADD 7% SALES TAX.



One tree can make
 3,000,000 matches.



One match can burn
 3,000,000 trees.



A Public Service by This Magazine
 & The Advertising Council

**MEETING TOMORROW'S
 CHALLENGES TODAY**



The men and women in the Navy's Seaman/Airman/Fireman Program are working for America, while learning valuable skills through on-the-job training. They're building solid futures, succeeding in a competitive, high-tech world and advancing as quickly as their abilities and performance allow. Find out more about the Seaman/Airman/Fireman Program, as well as other exciting Navy job opportunities, from your local Navy recruiter. This ad is brought to you as a public service of this newspaper.

Navy. Full Speed Ahead.

KELVIN

ELECTRONICS

10 HUB DRIVE, MELVILLE, NY 11747

RE-ENGINEERED & DESIGNED FOR 1994



150 LE - Student 200 LE - Technician 400 LE - Engineer

- Standard Features -**
- AC & DC VOLTAGES
 - DC CURRENT
 - RESISTANCE
 - TRANSISTOR
 - CONTINUITY TEST - Buzzer
 - DIODE TEST
 - 3 1/2 Digit LCD
 - 10M ohm INPUT IMPEDANCE

BATTERY TEST
TRANSISTOR
DC CURRENT
10 Amp

FREQ COUNTER
up to 20MHz

TRANSISTOR
CAPACITANCE
from 1pF to 20uF
AC/DC CURRENT
10 Amp

INDUCTANCE
Resolution 1uH
FREQ COUNTER
up to 20MHz
CAPACITANCE
from 1pF to 200uF
AC/DC CURRENT
DUTY %
20 Amp

150 LE
Stock # 990122
\$29.95

200 LE
Stock # 990123
\$49.95

400 LE
Stock # 990124
\$79.95

Designed to meet IEC-348 & UL-1244 safety specifications.

2 Year Warranty (Parts & Labor)



"Not only does the Kelvin 94 boast a lot of features ... the features go the extra distance."

"If we had to run into a burning building to do some emergency trouble-shooting and could carry in only one piece of equipment, the Kelvin 94 would be it!"

Popular Electronics
Reviewed - May 1993

KELVIN 94 The Ultimate Meter

LCR Hz dBm True RMS Logic Probe

The only meter with 0.1% Accuracy on DC Voltages, built-in True RMS, Freq Counter to 20MHz Res: 10 Hz, LCR-Inductance Tester Res: 10 uH, DC/AC Voltages Res: 0.1mV, Ohm Meter Res: 0.1 ohms

TRUE RMS PLUS

12 INSTRUMENTS IN ONE - AC & DC VOLTMETERS, AC & DC CURRENT, dBm, OHMMETER, DIODE TESTER, AUDIBLE CONTINUITY TEST, 20 MHz FREQ COUNTER, CAPACITANCE METER, INDUCTANCE METER, LOGIC PROBE

Model 94
#990111
\$199.95

*See Standard Features Listed below

ENGINE ANALYZER PLUS

Model 95 #990112
\$199.95

A Must For Auto Mechanics

Standard Features plus - TEMP, TACHOMETER & DWELL ANGLE TESTER, DUTY CYCLE, 10M OHM IMPEDANCE, ANALOG BAR GRAPH, K-TYPE TEMP PROBE, ALLIGATOR CLIP TEST LEADS, INDUCTIVE PICKUP CLIP, 6' TEST LEADS & DELUXE CARRYING CASE

*Standard Features - Models 94 & 95

- DC/AC VOLTMETERS
- AC/DC CURRENT
- OHM METER
- DATA HOLD
- RELATIVE MODE
- FREQ COUNTER to 4 MHz (Model 95)
- AUDIBLE CONTINUITY TEST
- DIODE TEST
- MAX/MIN AVERAGE MEMORY RECORD
- 10A HIGH-ENERGY FUSE PROTECTION
- AUTO SLEEP & AUTO POWER OFF

(800) 645-9212
(516) 756-1750
(516) 756-1763/FAX

Established 1945

M/C & VISA \$20 Minimum Order

KELVIN CATALOG \$3
Stock No. 650412

KELVIN
100 Basic
990087
\$19.95



- AC & DC VOLTAGES
- DC CURRENT
- RESISTANCE
- CONTINUITY TEST - Buzzer
- 3 1/2 Digit LCD
- LOW BATTERY INDICATOR
- DIODE TEST
- BATTERY TEST

CAPACITANCE METER

KELVIN
250 LE
990126
\$59.95



- ACCURACY: 0.5%
- RANGES: 20mF, 200uF, 200uF, 20uF, 2uF, 200nF, 20nF, 2000pF, 200pF
- Zero Adjust
- Safety Test Leads
- Test Socket for Plug-in Components

AUTO-RANGE METER

KELVIN
300 LE
990125
\$49.95



- AUTO-RANGE
- ACV & DCV
- DC CURRENT
- RESISTANCE
- CONTINUITY TEST
- DIODE TEST
- 3 1/2 Digit LCD
- 10M ohm INPUT IMPEDANCE

INSTRUMENTS



20 MHz SCOPE
Dual Trace 2 Yr Warranty-Parts & Labor
Stock No. 740085 \$385

40 MHz SCOPE 2 Yr Warranty
Dual Trace with Delayed Sweep
Stock No. 740086 \$655

TEST ACCESSORIES

SCOPE PROBES
60 MHz, X1 & X10 SPECIAL
700072 \$18.95
150 MHz, X10
700073 \$39.95



IC CLIPS
SOLDER TYPE
SPRING LOADED
Stock No. COLOR COST 25+ Qty
990104 BLACK \$.65 ea. \$.50 ea.
990105 RED \$.65 ea. \$.50 ea.

DC TOY MOTORS

DC Toy Motor
Stock No. 850647
\$.80 ea.
\$.75 ea / 50+ Qty 6V DC High Speed

Solar Motor Stock No. 850646
\$.60 ea 1.5V DC
\$.55 ea / 50+ Qty

Solar Cells 3 3/4" L x 2 9/16" W
Stock No. 260099 1000mA .45V
\$.95 ea
\$.50 ea / 3+ Qty

DIGITAL TRAINER



Laptop Digital Trainer comes with 100 page instruction manual, power supply, built-in 1 digit true hexadecimel display, two independent clocks with user adjustable freq & duty cycles, 4 data bit switches and 4 LED displays. Assembled
Stock No. 840460 \$99.95

BINARY QUARTZ CLOCK w/Alarm



ORIGINAL DESIGN - 24 Hr. Binary Quartz Accurate Clock with 2 color LED's. Built-In Alarm and Alarm Display in binary code. DESIGNED FOR LEARNING about digital circuitry & binary code. Built with individual IC components. Battery Memory Loss Prevention. Comes with rechargeable battery, DC wall transformer and detailed instruction manual. Advanced Level Kit
Stock No. 840589 \$79.95

Electronic VOICE PAD



An electronic note pad, able to record your message & replay it later. It has a built-in photo cell & as soon as it senses your presence, it will automatically playback the message left for you. The components are PC mounted. The IC can record a message up to 20 seconds & no mechanical parts or tape - only a digital integrated circuit.
Intermediate Level Kit
Stock No. 840606 \$49.95

BREADBOARDS

Stock No. Post Contacts your cost
680093 0 500 \$ 4.25
680097 0 840 \$ 5.95
680098 2 1380 \$11.75
680100 4 2390 \$22.95

WIRE JUMPER KIT
Pre-cut, Pre-Stripped
330289 140 Piece Set \$ 4.95
330290 350 Piece Set \$ 8.95

COMPONENTS

WHOLESALE PRICES!



(10 Pcs. Min.)
YOUR COST

600021	555 TIMER	\$.29 ea
600029	556 DUAL TIMER	\$.40 ea
600039	LM566 PPL FUNCTION GENERATOR	\$.60 ea
600018	741C OP-AMP INTERNALLY COMPENSATED	\$.30 ea
600026	1458 OP-AMP DUAL 741C OP-AMP	\$.35 ea
630041	2N2222	\$.20 ea
630383	PN2222	\$.08 ea
600023	7805 Voltage Reg	\$.36 ea

SILICON CONTROLLED RECTIFIER (Similar to GE C106C1) 4.0 amp, 100PIV
600014 \$.89 ea \$.79 ea/10+

THERMISTOR - 100 ohm
110097 \$1.35 ea \$1.00 ea/20+

THERMISTOR - 10K ohm
110097 \$1.35 ea \$1.00 ea/20+

PROJECT PARTS

Project Speaker
2", 8 Ohm, .1 Watt
Stock No. 350009
59¢

Project BUZZER
3 - 9 Volt DC, 80 db
Stock No. 680089
\$1.59 ea
\$1.39 ea / 10+ Qty



Soldering IRON
with STAND
LONG LIFE TIP
Stock No. 990098
\$3.95 ea



LED T 1 3/4
Stock No. Color 100+ Qty 1000+ Qty
260020 RED \$.05 ea \$.045 ea
260027 GREEN \$.08 ea \$.07 ea
260026 YELLOW \$.08 ea \$.07 ea
260078 2 COLOR RED/GREEN \$.32 ea \$.29 ea

XENON STROBE TUBE

Stock No. 250050
\$3.25 ea
\$2.95 ea / 20+ Qty

TRIGGER COIL for Xenon Strobe Tube
Stock No. 320037
\$1.25 ea
\$.89 ea / 20+ Qty

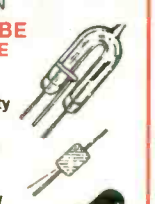

INFRARED LED IR Pair, LED Infrared transmitter and receiver

Stock No. 260061
\$1.95 ea



NEON LAMP NE2, 2" Lead

Stock No. 260003
\$1.15 ea
\$.12 ea / 100+ Qty



PHOTO CELL

Photo Cell - .450 ohm
Stock No. 260017
\$.65 ea \$.45 ea / 20+ Qty

Photo Cell - 1.8K ohm
Stock No. 260018
\$.65 ea \$.45 ea / 20+ Qty



PUSH-BUTTON SWITCH PUSH-ON PUSH-OFF

Stock No. 270021
\$.55 ea
\$.49 ea / 100+ Qty



SUB-MINIATURE MOMENTARY SWITCH

Stock No. 990002
\$.35 ea
\$.28 ea / 100+ Qty



MINIATURE TOGGLE SWITCH

Stock No. 270034
\$.90 ea Type - SPST
\$.79 ea / 50+ Qty



CIRCLE 38 ON FREE INFORMATION CARD

Tap into a World of...

FREE ELECTRICITY

Our 150+ page *Self-Reliance Catalog*
IS JUST LOADED WITH DC to AC
ENERGY INDEPENDENCE ...

We offer:

Solar, Wind & Hydroelectric energy systems. True Sine Wave DC to AC Inverters. Electric Boat & Car kits. Portable power packs. Solar Lighting & Cooling systems. Solar Pool Heaters. Solar Battery chargers. Solar Books & Toys. DC Appliances. Active & Passive Solar Air & Water Heating Systems. Composting Toilets. Hydroponic, Fish-Farming, Solarium & Greenhouse Systems. Water Testing, Treatment, & Pumping Systems. Emergency Food & H₂O Kits. High Efficiency AC/DC Refrigeration + More...

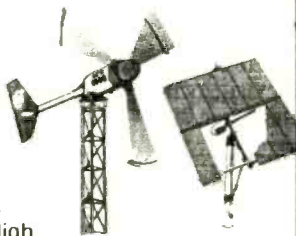

A LOT OF INFORMATION FOR ONLY \$5.75 ...

SEND CHECK or MO TO:

Self-Reliance Company Inc.

P.O. Box 306, Florissant, MO 63032



FOTRONIC

QUALITY ELECTRONIC
TEST EQUIPMENT

Sales • Service

• Specialists in - Fluke,
Hewlett Packard, Tektronix

• NIST Traceable/Mil Spec 45662A
Calibration Available

We buy surplus
Electronic Equipment
FAX your list!!!

TECHNICAL SUPPORT

Oscilloscope Specials

Tek 465	100 MHZ	\$489.00
Tek 465B	100 MHZ	\$589.00
Tek 475	200 MHZ	\$649.00
Tek 475A	250 MHZ	\$749.00

ALL EQUIPMENT SOLD WITH WARRANTY

For more GREAT VALUES Call, Write, or FAX
P.O. Box 708, Medford, MA 02155

(617) 391-6858 FAX (617) 391-6903

LOWEST SCOPE PRICES GUARANTEED!!!

KENWOOD



Model CS-4025
REG. \$559.00
SALE \$389.95



Hitachi



Model V-212
REG. \$560.00
SALE \$409.95



BK PRECISION
MAXTEC INTERNATIONAL CORP.

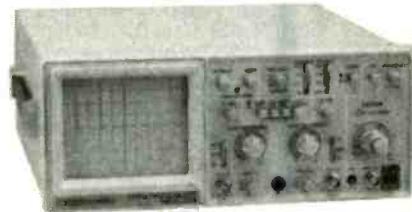

Model 2120
REG. \$549.00
SALE \$CALL

PRINT™

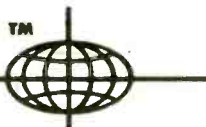

Products International

8931 Brookville Rd, Silver Spring, MD 20910
800-638-2020 * 301-587-7824 * FAX 800-545-0058

Test Instruments, Equipment and Tools, Training and Supplies for Electronic Maintenance and Repair

NEW 84 PAGE CATALOG!!!
Call Today For Your FREE Copy
Of The 1994 Print Test
Equipment Catalog!

TOLL FREE
800-638-2020

WE MAKE ORDERING SIMPLE!



**Powerful Integrated Digital and Analog (Berkeley Compatible Spice)
Circuit Design and Simulation Software for Microsoft Windows™ (network compatible)**

Includes 4 Integrated Modules: LogicDesigner + WinSpice3 + WinProbe3 + SymbolEditor

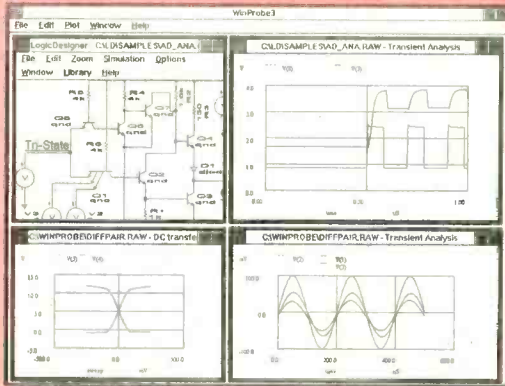

Comes with a Spice library plus 5 more libraries of active digital devices CMOS, 74xx, 74xxx, ALUs, counters, MUX, FFs etc. Plus a passive symbol library of microprocessors and more. Use the symbol library editor to design your own symbols and symbols for subcircuits, true bussing, buss pins can be assigned a unique name, parts billing list, legends, nested subcircuits for hierarchical top down or bottom up design, checks fan out violation and electronic rules, device unit numbers/chip pinouts automatically added as per data books, spice netlist generation, continuous zoom in/out, cut/copy/paste, multiple rotatable fonts, rotatable symbols, multipage zoomed in/out printouts to any windows printer/plotter.

LogicDesigner Digital Simulation/Schematic Capture Module

Interactive digital simulation and schematic capture, with glitch detection, single step mode, variable speed simulation, printable timing diagram output, truth table generation, binary to 7 segment displays, hex keypads, clock sources, logic probes. Built in logic analyzer can be set up to generate breakpoints during simulation from user defined AND/OR combinations of circuit signals and sequential events to help debug circuit timing/logic/race conditions. Simulates tri state, open collector & don't care logic, RAM/ROM, one shot, carry look ahead, shift reg, pull up/down.

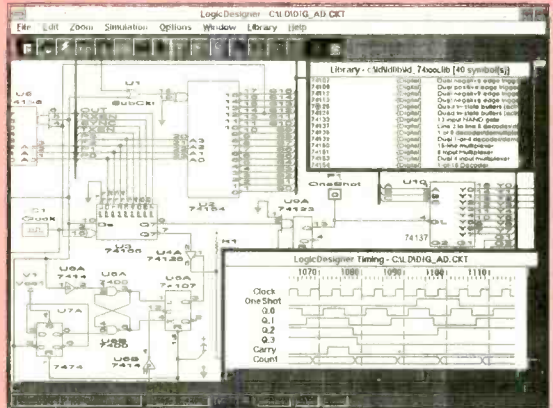

WinSpice3 Simulator & WinProbe3 Data Analyzer Modules

DC, AC, Transient, pole-zero, noise, sensitivity and transfer function analysis. Spice library includes MOSFET, MESFET, GaSFET, BJT, DIODE, controlled, independent, dependent and arbitrary sources, transmission lines, current and voltage controlled switches, more. Each with user modifiable models. Plots linear, logarithmic, smith chart type plots, more. Multiple plot windows. Zoom in/out on plot waveforms. Plots math expressions using plot variables as arguments: Ex: plots $\text{COS}(V(1)/V(2)*10)$, derivatives, + more.

\$69.00 (one month only!!! reg \$179.99)
(Univ & student pricing avail) VISA/Mastercard

ISLAND LOGIX INC.

IRIE MAN
920 South West 95 Terrace
Pembroke Pines, Florida 33025 U.S.A.
PH/FAX: (305) 435-7665



CIRCLE 138 ON FREE INFORMATION CARD

CABLE TV DESCRAMBLERS
Best Prices in the U.S.A.! Guaranteed to Work!

WE WILL BEAT ANY PRICE!

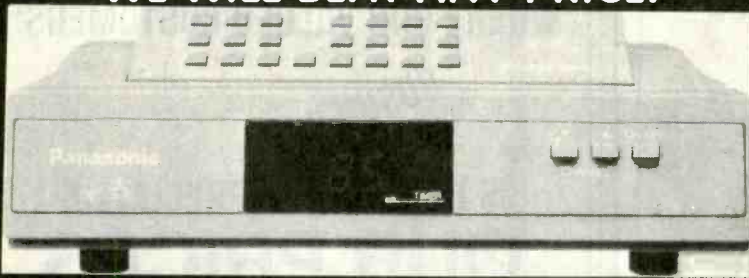

JERROLD PANASONIC SCIENTIFIC ATLANTA PIONEER

The Newest & the Latest

DMTB-A - all Jerrold Impulse & Starcom series
SA3-DFA - all Sci. Atlantas incl. 8536/+, 8580, Drop-field
PN-3A - all Pioneer systems

ALSO **FTB3, SA3, TZPC145G**

FAST SHIPMENTS FREE CATALOG 30 DAY MONEY BACK GUARANTEE

1-800-772-6244 M-F: 9-6 EST

U.S. Cable TV, Inc. Dept.: KPE054
4100 N. Powerline Rd, Bldg. F-4 Pompano Beach FL 33073
NO FLORIDA SALES

CIRCLE 141 ON FREE INFORMATION CARD

Radiotelephone - Radiotelegraph

FCC Commercial License

Why Take Chances?

Discover how easy it is to pass the exams. Study with the most current materials available. Our Homestudy Guides, Audio, Video or PC "Q&A" pools make it so fast, easy and inexpensive. No college or experience needed. The new commercial FCC exams have been revised, covering updated Aviation, Marine, Radar, Microwave, New Rules & Regs, Digital Circuitry & more. We feature the Popular "Complete Electronic Career Guide" 1000's of satisfied customers

Guarantee to pass or money back.
Send for **FREE DETAILS** or call

1-800-800-7588

WPT Publications
7015 N.E. 61st Ave Dept. 10
Vancouver, WA 98661

Name _____

Address _____

City _____ St. _____ Zip _____

1-800-800-7588

May 1994, Popular Electronics

JAN Crystals

FREE 1994 Catalog of General Purpose Crystals Now Available

FOR FREQUENCY CONTROL:

FUNDAMENTAL MODE CRYSTALS
1.001-30.0 MHz *FROM \$11.00*
HC6/U, HC33/U HOLDERS

FUNDAMENTAL MODE CRYSTALS
2.0-30.0 MHz *FROM \$11.00*
HC25/U, HC18/U MINIATURE
HOLDERS

THIRD MODE CRYSTALS
18-75. MHz *FROM \$11.00*
ANY HOLDER

FIFTH MODE CRYSTALS
52-125. MHz *FROM \$13.00*
ANY HOLDER

SEVENTH MODE CRYSTALS
110.5-150. MHz *FROM \$18.00*
ANY HOLDER

*Quantity Prices Available
On Request*

FOR MICROPROCESSORS:

...low E.S.R....close tolerance...long-term stability...
frequency deviation from 0° to 70°C max. ± 100 PPM...
tolerance at 25° ± 50 PPM.

HC49/U	
3.0-3.5 MHz	\$5.00
3.5-18.432 MHz	\$5.00
19.6608-24. MHz	\$5.00

When Ordering Please Specify MP-Crystal

*Your reliable source for a
world of crystal clear communication*

**Order Toll-Free
1-800-JAN-XTAL
FAX ORDERS: 1-813-936-3750**

EXPEDITED ORDER SERVICE AVAILABLE
CALL OR WRITE FOR FREE CATALOG
P.O. Box 60017 Ft. Myers, FL 33906



PRICES SUBJECT TO CHANGE WITHOUT NOTICE



CIRCLE 37 ON FREE INFORMATION CARD

Professional Electronic Engineering Software

"Best bargain in the country"

Linear AC/DC Circuit Analysis

Active & Passive ckts. 50 nodes, 225 elements max. Models for active devices. Calc, Plot & Print AC voltages & currents. Calc DC current, voltage & power. More

Linear Transient Circuit Analysis

10 Input Transients. Active, passive ckts. 50 nodes, 225 elements max. Models for active devices. Calc, plot and print output Transient voltages. Calc dc current, voltage, pwr. more.

Active Filters Design & Analysis

Design & Analyze active LPF, BPF, HPF & All pass filters. Calc, plot Mag/Phase. More.

Transient System Analysis

Calc, plot transient response of system H(s). 14 Input Transients. Inverse Laplace. More

Control Systems analysis

Calc and Plot Root Locus, Nyquist, Bode of any H(s). Determine gain and Phase Margins /stability. More

Mag & Phase Graphics

Calc, plot mag/ phase of H(s). more

Function Graphics

Calc, plot, edit any of 87 common math functions as desired. More.

Data Graphics

Plot up to 400 data points in 9 formats. Linear, log, semi, etc.more

Polynomial Operations

Calc Roots, Product & Coefficients.

New! Circuit Schematic Draw: Both Stand-alone & Integrated
Cut, Copy, Move, Merge, Check, Grid, Label, List, 126 symbols, 300 elements, more...

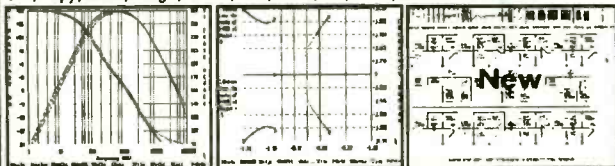

- ◆ Extremely Easy to use PC AT, DOS, EGA/VGA
- ◆ Dot Matrix/Laser/Mouse Support
- ◆ Outstanding Graphics & Menus
- ◆ 200 page User's Manual Included

**100%
Satisfaction
Guaranteed**

Introductory Offer: 9-program package (without Schematic Draw) \$79.99
Complete 10-program package (with Schematic Draw) \$129.99

Visa/MC accepted. Add \$5.95 for shipping. CA add 7.25% Tax
To order or info call 1(800)645-6806 or send check or money order to:
Geoban Engineering, PO Box 658, Ridgecrest, CA 93556

TONY TALLI'S ORIGINAL TELEVIEW DISTRIBUTORS

WHERE OUR VALUED CUSTOMERS'

BUSINESS

IS HONESTLY APPRECIATED
OUR PRICES
1 800 847 3773

Call Us Today

90 DAY + GUARANTEE

SCIENTIFIC ATLANTA

JERROLD PIONEER

OAK HAMLIN



HRS. M - F 9-4 PST NO NV. SALES

Aplab 20 YEARS IN EUROPE NOW IN THE U.S.!

TESTLABS — EUROPEAN DESIGNS — AMERICANS CAN AFFORD



MODEL 3324

3 in 1 TESTLAB

- 25MHz DUAL TRACE OSCILLOSCOPE
1mV/div - 20V, div vert. sensitivity
40nS to 0.2sec timebase/, 5 way trig.
8 cm x 10 cm Rect CRT, Int graticule,
X-Y operation/, Hold off/, Z modulation
- TRIPLE OUTPUT DC POWER SUPPLY
+5V/1A, +12V/0.25A - 12V/0.25A.
- DUAL CHANNEL COMPONENT TESTER
Active/, passive comp. test/, board test

List \$ 525
\$ 365

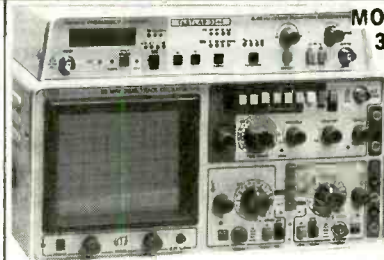

MODEL 3344

5 in 1 TESTLAB

All features of 3324 PLUS

- 100MHz/ 7 DIGIT FREQUENCY COUNTER
Digitally controlled/ /20mV sen to 60 MHz
- 0.02Hz TO 2MHz FUNCTION GENERATOR
Sine/square triangle/DC. - Digital freq. indication
10V pp output, variable DC offset.

List \$ 950
\$ 795



MODEL 3304

25 MHz DUAL TRACE OSCILLOSCOPE

- 1mV to 20V/cm - Vertical Sensitivity
- 40nS to 0.2 sec Time Base/5 Way Trigger
- 8 cm x 10 cm Rect CRT—Int Graticule
- X-Y Operation/Hold off/Z mod.

List \$ 425
\$ 315

DC REGULATED POWER SUPPLIES — DESIGNED TO VDE/UL SAFETY SPECS.

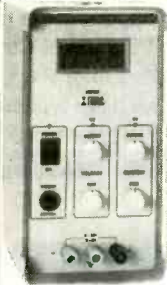

160W DC POWER SUPPLIES

- 3 Digit DPM display output V & A
- CV/CC operation
- + 0.01% + 2mV Line & load regulation
- High efficiency
- VDE approved line components.

OUTPUT	MODEL	CURRENT PRICE	LIST
0.16V/10A	CP1610	\$ 189	\$ 295
0.32V/5A	CP3205	\$ 199	\$ 350

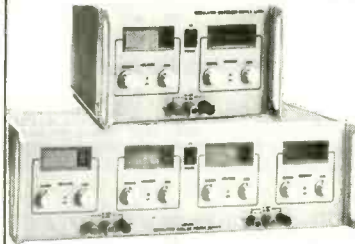

DIGITAL LABs Dual output

- ± 0.01% line & load regulation
- CV/CC operation
- Accurate 3 digit DPM for voltage & current
- 19" Rack, 5.1/4" high.

OUTPUT	MODEL	CURRENT PRICE	LIST
128W 0-32V/2A 0-32V/2A	LD3202	\$ 349	\$ 465
320W 0-16V/10A 0-16V/10A	LD1610	\$ 480	\$ 615

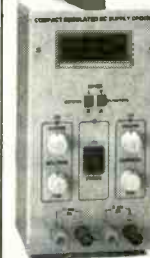

COMPACT 60W DC POWER SUPPLY

- 3 Digit DPM display V&A
- ± 0.02% + 2mV line & load regulation
- Single or multioutput
- CV/CC operation

OUTPUT	MODEL	CURRENT PRICE	LIST
+ 15V/0.2A DUAL OR 0-30V/0-2A	CPD1502	\$ 179	\$ 245
0 + 25V/1A 0 - 25V/1A + 5/2A	CPD2501	\$ 195	\$ 285

POWER LINE CONDITIONERS AND AC SOURCES. — W/W POTS



1KVA 'KLEENLINE' LINE CONDITIONER

Complete 'Brownout' protection for workstations

- Isolation 130dB CMRR
- > 10uA leakage at 4KV
- Output voltage regulation ± 5% for input line + 10% - 20%
- Noise & transient suppression with filters & transorb.

List \$ 375

\$ 275

SHOCKSAFE

Variable Line Supply

- Double wound transformer less than 100 uA leakage
- Continuously adjustable output 0 to 130 V/4A or 0 to 260 V/2A
- 115V, 60 Hz input line.

List \$ 296

\$ 215

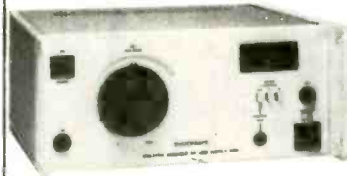

W/W POTENTIOMETERS 2 Watt W/W 1" Dia

- Robust, Industrial type
- 1% linearity
- Stability 100 ppm/°C
- 1% tracking for two section pot



DESCRIPTION	CURRENT PRICE	LIST
SINGLE POT	\$ 2.60	\$ 3.25
DUAL TRACKING POT	\$ 5.80	\$ 7.25

Minimum order 5 Pots

MAIL ORDERS TO

ASHER ENGINEERING CORP.

3001 RED HILL AVENUE, # 5-217 COSTA MESA, CA 92626
FAX: 714-556-7122, INFO: 714-556-6622

ORDER TOLL FREE 1-800-438-0102

WE ACCEPT



1:1/1:10 SWITCHED OSCILLOSCOPE 60MHz PROBES

500V (dc+ac peak)
10 MΩ in 1:10 position

List \$ 28.75

\$ 23 for Two

List \$ 19.95

\$ 13 for One

Call or Write for a Free Catalogue

USE PE MARKET CENTER CLASSIFIEDS

READ BY 87,877 BUYERS OF ELECTRONIC EQUIPMENT ACCESSORIES AND PARTS

INSTRUCTION FOR PLACING YOUR AD!

HOW TO WRITE YOUR AD

TYPE or **PRINT** your classified ad copy **CLEARLY** (not in all capitals) using the form below. If you wish to place more than one ad, use a separate sheet for the additional ads (a photocopy of this form works well). Choose a category from the list below and write that category number into the space at the top of the order form. If you do not specify a category, we will place your ad under Miscellaneous or whatever section we deem most appropriate.

We cannot bill for classified ads. Payment in full must accompany your order. We do permit repeat ad or multiple ads in the same issue, but in all cases, full payment must accompany your order.

WHAT WE DO

The first two words of each ad are set in bold caps at no extra charge. No special positioning, centering, dots, extra space, etc. can be accommodated.

RATES

Our classified ad rate is \$1.00 per word. Minimum charge is \$15.00

per ad per insertion (15 words). Any words that you want set in bold or caps are 20¢ each extra. Bold caps are 40¢ each extra. Indicate bold words by underlining. Words normally written in all caps and accepted abbreviations are not charged as all-caps words. State abbreviations must be Post Office 2-letter abbreviations. A phone number is one word.

CONTENT

All classified advertising in the **PE Market Center** is limited to electronics items only. All ads are subject to the publisher's approval. We reserve the right to reject or edit all ads.

DEADLINES

Ads received by our closing date will run in the next issue. For example, ads received by November 15 will appear in the March 1994 issue that is on sale January 18. The PE Market Center is published monthly. No cancellations permitted after the closing date. No copy changes can be made after we have typeset your ad. **NO REFUNDS, advertising credit only. No phone orders.**

AD RATES: \$1.00 per word, Minimum \$15.00.

Send your ads with payment to:

Popular Electronics Market Center, 500-B Bi-County Blvd. Farmingdale, NY 11735

CATEGORIES

100 — Antique Electronics	270 — Computer Equipment Wanted	450 — Ham Gear Wanted	630 — Repairs-Services
130 — Audio-Video-Lasers	300 — Computer Hardware	480 — Miscellaneous Electronics For Sale	660 — Satellite Equipment
160 — Business Opportunities	330 — Computer Software	510 — Miscellaneous Electronics Wanted	690 — Security
190 — Cable TV	360 — Education	540 — Music & Accessories	710 — Telephone
210 — CB-Scanners	390 — FAX	570 — Plans-Kits-Schematics	720 — Test Equipment
240 — Components	420 — Ham Gear For Sale	600 — Publications	

CLASSIFIED AD COPY ORDER FORM

Ad No. 1—Place this ad in Category # _____

1 - \$15.00	2 - \$15.00	3 - \$15.00	4 - \$15.00
5 - \$15.00	6 - \$15.00	7 - \$15.00	8 - \$15.00
9 - \$15.00	10 - \$15.00	11 - \$15.00	12 - \$15.00
13 - \$15.00	14 - \$15.00	15 - \$15.00	16 - \$16.00
17 - \$17.00	18 - \$18.00	19 - \$19.00	20 - \$20.00
21 - \$21.00	22 - \$22.00	23 - \$23.00	24 - \$24.00
25 - \$25.00	26 - \$26.00	27 - \$27.00	28 - \$28.00

29 - \$29.00	30 - \$30.00	31 - \$31.00	32 - \$32.00
33 - \$33.00	34 - \$34.00	35 - \$35.00	36 - \$36.00
37 - \$37.00	38 - \$38.00	39 - \$39.00	40 - \$40.00

Ad No 1—Total words _____ × \$1.00 per word = \$ _____
 All Caps words _____ × .20 per word = \$ _____
 Bold words _____ × .20 per word = \$ _____
 Bold Cap words _____ × .40 per word = \$ _____

TOTAL COST OF AD No. 1 \$ _____

Card # _____

Expiration Date ____ / ____

Signature _____

Name _____ Phone _____

Address _____ City State Zip _____

Total classified ad Payment \$ _____ enclosed.

Check MasterCharge Visa (\$15.00 minimum credit card order)

Don't Despair...REPAIR!

Here's how to troubleshoot and repair your electronics successfully!

You Can Be Your Own Repair Expert!

For VCRs, camcorders, audio equipment, TV equipment, computer hardware, office equipment, home appliances, automobile electronics, and outdoor equipment.

- Pinpoint and analyze problems quickly.
- Successfully complete repairs with hands-on troubleshooting instructions.
- Become skilled understanding flowcharts and schematic diagrams.
- Confidently use test equipment such as oscilloscopes, frequency counters, and video analyzers.
- Keep your equipment in top condition with effective preventive maintenance techniques.

Continue to Broaden Your Repair Expertise!

You'll receive quarterly supplements, up to 160 pages, with new step-by-step repair and maintenance instructions, valuable schematics and new repair techniques. Learn how to repair a growing variety of appliances with hands-on repair projects that will keep you up-to-date with later models and technology. You'll be thrilled with your ability to repair a growing list of electronic equipment! Supplements may be returned or cancelled at any time.

SAVE \$10

Call our toll-free number, pay by credit card, and mention this ad. We'll deduct \$10!

We'll also waive shipping and handling.

Order today for your 30-day, no-risk review of The Electronics Repair Manual.

For Faster Service Call TOLL-FREE
1-800-222-WEKA

Or Fax To: 1-203-622-4187

CIRCLE 133 ON FREE INFORMATION CARD



One Source For All Your Repair Needs!

Better organized than a magazine, more current than a book.

- 900-page manual
- easy-to-follow, detailed instructions
- trouble analysis flowcharts
- safety precaution checklists
- comprehensive replacement parts list
- directory of manufacturers



Order your copy today!

MONEYBACK GUARANTEE

There's no risk in trying the ELECTRONICS REPAIR MANUAL to see if it's right for you. If you are not delighted, simply return the manual after the 30-day trial period and receive a prompt refund.



97 Indian Field Rd.
Greenwich, CT 06830

YES! Please rush me a copy of the new Electronics Repair Manual for only \$59.95 + \$5.50 shipping and handling. I understand that if I am not satisfied I may return the manual within 30 days for a complete refund. Supplements are sent quarterly for 25¢ per page (never more than \$30) and may be returned or cancelled at any time.

My payment is enclosed Bill me later

Charge my Visa MasterCard

Acct. No. _____ Exp. Date _____

Signature _____

Phone () _____

Name _____

Address _____

City _____ State _____ Zip _____

All payments must be in U.S. funds. Canada add \$10. All other countries add \$15. CT residents add 6% sales tax.

Mail to: WEKA Publishing, 97 Indian Field Rd.,
Greenwich, CT 06830

Signature and phone number are required for all orders.

400070

May 1994, Popular Electronics

121

CABLE TV DESCRAMBLER KITS

"New & Improved Version" Universal Descrambler

Includes all the parts and an etched & Drilled PC Board. Not included is AC adaptor or enclosure.....\$69.00

Tri-Mode Descrambler

Includes all the parts and an etched & drilled PC board & AC adaptor. Not included is the enclosure.....\$49.00

SB-3 Descrambler

Includes all the parts & an etched & drilled PC board & AC adaptor. Not included is the enclosure.....\$29.00

Call Toll Free 1-800-886-8699

Visa, MasterCard, Discover, AM & COD

M & G Electronics, Inc. 2 Aborn Street, Providence, RI. 02903

It is not the intent of M & G Electronics, Inc. to assist any individual to defraud any pay TV operator or to violate any state or federal laws regarding the use of the descrambler kits. You must understand the kits being purchased for educational and or experimental use only.



The New Realistic®
PRO-43 Scanner

Radio Shack®

PHONES

Our 17th year of DISCOUNTS

Toll Free 800-231-3680

PRO-43 List \$349.95

Our Delivered Price \$290.00

We discount everything in the RS catalog

22511 Katy Fwy.

Katy (Houston), TX 77450

1-713-392-0747 FAX 713-574-4567

PE MARKET CENTER CLASSIFIEDS

Prototype it..... FAST!

with ProtoQuick 8051 or 28
Complete single board computers up to 32K EPROMs and 64K RAM! 12 sq. in. plated through hole area. RS232C serial port w/ DB25 conn. Op. sys. in EPROM w/ source code. Assembled, ready to run - Sv. only. MS-DOS cross assembler included.

ProtoQuick 28 and 8051
\$99.00 each

Software Science
3750 Roundbottom Road
Cincinnati, OH 45244 USA
(513) 561-2060

Run prototype applications or experimental hardware from the serial port - WITHOUT PROGRAMMING!

COMPUTER SOFTWARE

AMIGA, MACINTOSH, ATARI Electronics, science, MIDI shareware software \$4.00/disk. Send SASE for catalog. Specify which computer! KDSoftware, Box 1646, Orange Park, FL 32067-1646.

VCR REPAIRMAN. Troubleshoot VCR problems on your PC. Select symptom and the computer will give probable cause. MSDOS \$39.00 + \$5.00 S.H. CBG, 14962 Bear Valley Rd., G-132, Victorville, CA 92392

AUDIO SPECTRUM ANALYZER: Frequency, time domains. Total harmonic distortion. Large dynamic range. Requires DOS, 386+, Pro AudioSpectrum 16, \$174.95, +1(512) 329-5859.

CB-SCANNERS

HI PERFORMANCE CB Manual. Over 1900 CB modifications including power frequency channel mods. The best book available. Also, **Scanner Repair** and modifications for Bearcat Uniden scanners \$29.95 each, includes shipping & handling. (410) 848-6070. Send check or MO to Bumps Electronics, 332-140 Village Road, JCK Center, Suite 6, Westminster, MD 21157.

COMPONENTS

ELECTRONIC FASTENERS. Stainless steel. Kits available. Free catalog. "RUSTY BOLT", Box 708X, North Attleboro, MA 02761.

TUBES, Components, Sam's, etc. Catalog \$1.00: NRQ Electronics, PO Box 352924-PE, Toledo, OH 43635-2924.

SATELLITE EQUIPMENT

VIDEOCIPHER II descrambling manual. Schematics, video and audio, \$18.95. Software, \$25.00. Videocipher II 032, \$15.00. Videocipher II Plus, \$20.00. VCII Plus software, \$30.00. Cabletronics, Box 30502PE, Bethesda, MD 20824.

VC-2 MODULE \$399.00. Save 10% the big catalog. Our price 10% off their price. Call Satellite TV, 120 W. Centennial, Muncie, IL 47303. Tech hours 11-5E.

Satellite-TV

SAVE 40% - 60%
800-334-6455
218-739-5231 Int'l
218-739-4879 Fax

Skyvision Inc.®
1048 FRONTIER DRIVE • FERGUS FALLS, MN 56537

FREE Catalog

BUSINESS OPPORTUNITIES

EASY WORK! Excellent pay! Assemble products at home. Call toll free 1 (800) 467-5566 ext. 5192.

NEED MONEY? Excellent extra income! Assemble easy products at home. Program guaranteed! 1 (800) 377-6000 ext. 7930.

MAKE \$75,000/year cleaning computers part time! Secure career. Unlimited customers. **FREE** information. Call (303) 963-1316 Dept PE-2.

MAKE \$93,000/year part time as an independent computer technician! **FREE** information. Call (303) 963-1316 Dept PE-3.

EDUCATION

LEARN TO EARN: Electronics, robot, radio, others. Free catalog. A&A Products, Rt1 Box 482-L, Rockdale, TX 75657.

LEARN COMPUTER REPAIR at home. Make \$90.00/hour! Computer store owner reveals secrets! Free information. Call (303) 963-1316 Dept PE-4

NEW EASY PC

BRITISH
DESIGN
AWARD

SCHEMATIC and PCB C.A.D.

ONLY **\$195**

Includes

- MGA, CGA, EGA & VGA compatible.
- Design large multi layer boards.
- One level pull down menu and quick keys for fast layout.
- Dot matrix, laser, plotter, Gerber & N.C. drill output.

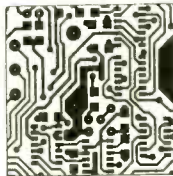

• 6 Month Free update
Free Demo

7840 ANGEL RIDGE ROAD
ATHENS, OHIO 45701
(614) 592-1810

Visa & MasterCard Accepted

LATEST TECHNOLOGY

- DESCRAMBLERS
- CONVERTERS
- COMBINATION UNITS

WE'LL BEAT ANY PRICE!

LATEST DESCRAMBLER MODELS

Add On Descrambler for all JERROLD Systems (Except Base Band) Guaranteed to Work Anywhere Coast to Coast. (Model JD-3)

~~\$125~~
\$89 6-10
 \$119 1-5

Add On Descrambler For All PIONEER Systems. Guaranteed to Work Anywhere Coast to Coast. (Model PD-3)

~~\$125~~
\$89 6-10
 \$119 1-5

Add On Descrambler For All SCIENTIFIC ATLANTA Systems (Except 8570, 8590, 8600). Guaranteed to Work Anywhere Coast to Coast. (Model SAD-3)

~~\$125~~
\$89 6-10
 \$119 1-5



**BRAND NEW
1 YEAR
WARRANTY**



SCIENTIFIC ATLANTA 8580

- Features*
- Wireless Remote Control
 - Favorite Channel Recall
 - Parental Lockout

\$259 6-10

**BRAND NEW
1 YEAR
WARRANTY**

\$289 1-5



ZENITH

Features

- Wireless Remote Control
- 550MHz (99 Channel) capacity
- Volume Control
- Parental Lock-Out
- Programmable Favorite Channel Memory

\$259 6-10

\$289 1-5

ADD ON DESCRAMBLERS

	1-5	6-10
FTB-3	49.00	39.00
TVT OR TBI	55.00	47.00
SA-3	59.00	49.00
KN12-3	59.00	49.00
MLD1200-3	49.00	39.00

CONVERTERS

	1-5	6-10
PANASONIC 1453G	79.00	69.00
JERROLD DQN7-3	75.00	65.00
STARGATE 2001	75.00	65.00

Call for other models



**DPV7 & DBB7
8590 & 8600**
 Call for availability & prices



1470 OLD COUNTRY ROAD,
 SUITE 315 - P.E.
 PLAINVIEW, NY 11803
 NO NY SALES

FREE COLOR CATALOG!
1-800-950-9145



*From the Lab
to your
Living Room!*

Does your VCR have a "Head Cold?"

Probably not! However, through constant playing and using of degrading dry or wet cleaners, the output of your video tapes has slowly diminished to an unacceptable level and the VCR plays as if it has a head cold! The culprit is most likely clogged and dirty video and/or audio heads.

The **3M Black Watch™ Head Cleaner Videocassette** uses a patented magnetic tape-based cleaning formation to remove head clogging debris. No foreign substances such as cloth, plastics or messy liquids and no harsh abrasive materials are present. The cleaner's usable life is 400 cleanings or more! It's easy to use. Place the **3M Black Watch™ Head Cleaner Videocassette** in the VCR and press the Play button. A pre-recorded message appears clearly on your screen and an audible tone is heard, telling you that the cleaning process is now completed. No guess work, you never over clean!

3M Black Watch™ Head Cleaner Videocassette **S**VHS **V**H-S.....\$19.95

Once your VCR's head cold is cured, and the unit plays like new, consider using the finest videocassette you can buy—the **3M Black Watch™ T120 Hi Pro VHS 4410 Videocassette**. The 4410 is the highest performing videocassette available today for use with all standard format VHS recording hardware!

Here's what you hear and see....A sharp, clear picture—brightest colors—freedom from streaks, flashes and snow—outstanding high-fidelity audio reproduction—optimum camcorder performance—maintains recording integrity. **3M Black Watch™** video tape is 100% laser inspected to guarantee surface smoothness and drop-out free performance.

3M Black Watch™ T120 Hi Pro VHS 4410 Videocassette **V**H-S.....\$8.00

CLAGGK INC. — 3M VHS Special Offer
P.O. Box 4099, Farmingdale, New York 11735

Yes, I like your offer and here is my order for 3M Black Watch™ products!

___ 3M Black Watch™ Head Cleaner Videocassette (\$19.95 each) ___ \$
___ 3M Black Watch™ T120 Hi Pro VHS 4410 Videocassette (\$8.00 each) \$ ___
Shipping and handling per order \$ **4.00**
Total Amount in U.S. Funds only \$ ___

New York State residents add local sales tax. Canadians add \$6.00 per order. No foreign orders. Do not send cash.

Bill my VISA MasterCard Expire Date ___/___/___
Card No. _____
Signature _____
Name (Please print) _____
Address _____
City _____ State _____ ZIP _____

PE MARKET CENTER CLASSIFIEDS

MISCELLANEOUS ELECTRONICS FOR SALE

SILENT SAM Turn signal reminder. Patented. Best reminder yet. Doesn't bug you. Sounds briefly at intervals IF you forget to cancel. \$22.00, Hi-Output \$27.00 Visa/MC. 1 (800) 398-5605 free flier. Silent Sam, 1627 Basil Dr., Columbus, OH 43227.

Quality Microwave TV Antennas

WIRELESS CABLE - IFTS - MMDS - Amateur TV
Ultra High Gain 50db(+) • Tuneable 1.9 to 2.7 Ghz.
• 55-Channel Dish System \$199.95
• 36-Channel Dish System \$149.95
• 20-Channel Dish System \$124.95
• Optional Commercial Grid Antenna (not shown) Add \$50.00
• Yagi Antennas, Components, Custom Tuning Available
• Call or write (SASE) for "FREE" Catalog

PHILLIPS-TECH ELECTRONICS
Dish System P.O. Box 8533 • Scottsdale, AZ 85252
LIFETIME (602) 947-7700 (\$3.00 Credit all phone orders)
WARRANTY MasterCard • Visa • American Express • COD's • Quantity Pricing

Cable Test Aids Information
Orders only 1-800-452-7090 (310)902-0841

Test chips for JERROLD, TOCOM, ZENITH, S.A. & more. Puts cable boxes in full service mode. Easy installation. Zenith only \$39.95. Most others under \$50ea. FAX: (310)902-0851 Quantity prices available. No Ch. sales. Not for use in cable co. owned equip. For use as a test aid only.

CABLE TV

"BULLET" BUSTER. Protect your cable box against the infamous cable "bullet." The "Bullet" Buster acts as an electronic shield. Installs in-line in seconds. Don't wait until it's too late! \$19.95 + \$3.00 S&H. **ELECTROMAN**, Box 24474, New Orleans, LA 70184. (504) 482-3017.

CBTV DOCTOR Stop the Bullet and ID signal in cable lines. Send \$20.00 to: R. R. Enterprise, PO Box 3532, Easton, PA 18043.

CABLE UNSCRAMBLED. Everything you wanted to know about cable, but were afraid to ask. \$10.00. **Electroman**, Box 24474, New Orleans, LA 70184. (504) 482-3017.

CABLE DOCTOR: Attention: All you cable box owners. Want to watch one channel & record another? I have what you need, send \$74.00 to: R. R. Enterprises, PO Box 3535, Easton, PA 18043.

**PORTABLE
SATELLITE ANTENNA**

Complete 3' KU Band System

For Free Information Package and Pricing
• Call 219-236-5776 • VISA
R.C. Distributing • PO Box 552 • South Bend, IN 46624

MEMBRANE SWITCH KITS!

These highly durable water resistant flat-panel keypads can be assembled in minutes with YOUR legend! Available in 4, 12, 16, 24 & 40 Key models. Steel "clickdomes" optional. Connector and bezel included.

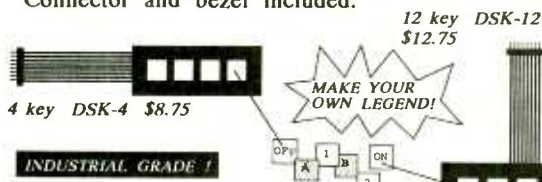

4 key DSK-4 \$8.75

12 key DSK-12 \$12.75

INDUSTRIAL GRADE!

Call for free brochure.

Sil-Walker 880 Calle Plano, Unit N,
Camarillo, CA 93012
(805) 389-8100 FAX (805) 484-3311

EPROM+ PROGRAMMING SYSTEM USES PARALLEL PORT

EPROMS (24,28,32 & 40 PIN*) PLUS 27CXXX 1702*, 2708, TMS2716*, 32,32A, 64, 64A, 128, 128A 256, 512, 513, 011, 010, 101, 1001, 1000, 1024, 210, 020 2001, 220, 2048, 4001, 040, 240, 4096, 25XX, 68764/66
FLASH EPROMS 28F256, 28F512, 28F010 28F020, 29C257, 29C010, 29F010
EEPROMS & NVRAMS (18,24 & 28 PIN+CXX) 2210, 2212, 2804, 2816, 2816A, 2817, 2864, 2865, 28256 28C010, DS1220, DS1225, DS1230
SERIAL EPROMS* (8 & 14 PIN PLUS CXX) ER1400, M58657, 2401, 02, 04, 08, 16, 2444, 59C11 9306, 46, 56, 66, 8572, 82, 92
BIPOLAR PROMS* (16 THROUGH 24 PINS) 74SXXX AND 82SXXX FAMILY
MICROCONTROLLERS* 8741, 42, 48, 49, 8751 C51, 8752, 87C52, 87C5XX, 87C751, 87C752, 68705 68HC705, 68HC711E9, PIC16C5X, TMS7742
*ADAPTER REQ'D - DIAGRAMS INCLUDED
SOFTWARE - READ, VERIFY, PROGRAM, COPY DISK FILE LOAD/SAVE, CHECKSUM, FULL SCREEN BUFFER EDITOR, W/20 COMMANDS
READS HEX, S-RECORD AND BINARY FILES
FAST-DEVICES PROGRAM IN UNDER 60 SEC
RUGGED (8"X7"X3") ENCLOSURE W/HANDLE
MADE IN USA - 1 YEAR WARRANTY



SYSTEM INCLUDES:
PROGRAMMING UNIT
PRINTER PORT CABLE
POWER PACK, MANUAL
AND SOFTWARE.

\$289

ADD \$5.00 SHIPPING
\$5.00 C.O.D.
VISA/MASTERCARD

ANDROMEDA RESEARCH, P.O. BOX 222, MILFORD, OH 45150
(513) 831-9708 FAX (513) 831-7562

PE MARKET CENTER CLASSIFIEDS

PLANS-KITS-SCHEMATICS

BUILD — FIVE-digit, ohms, capacitance, frequency, pulse, multimeter. Board and instructions \$9.95. Bagnall Electronics, 179 May, Fairfield, CT 06430.

ALL-IN-ONE catalog. AM/FM/ham/spy, transmitters/amplifiers, voice disguisers, descramblers, audio/TV/science projects. Start your own licensed/unlicensed radio station, books/plans/kits for import and export. 60 mouth-watering pages for \$1.00. **PAN-COM INTERNATIONAL**, PO Box 130-H5, Paradise, CA 95967.

FM STEREO TRANSMITTER kit broadcasts any audio signal to FM stereo radios throughout your home. Uses unique BA1404 IC. Complete kit: PC board/components — \$24.00. Visa/MC. **TENTRONIX**, 3605 Broken Arrow, Coeur d'Alene, ID 83814. (208) 664-2312.

!!! BROADCAST FARTHER !!!
PLANS ARE SOLD FOR EDUCATIONAL PURPOSES ONLY
The model 1525 is a 75-110MHz RF amplifier that connects to mono or stereo FM transmitters and produces a powerful 15-25 watt signal which could broadcast up to 5 miles or more! Requires 75-250 mW drive. Step by step plans complete with part source information and antenna designs. ONLY \$14 PLUS \$2 S&H (no credit or C.O.D.)
Progressive Concepts 1434 North Mills Avenue, Suite B
1909) 626-4959 Claremont, CA 91711

QUANTUM KITS! Super FM Transmitter — precision varactor tuned, long range \$30.00! Bug Detector — detect and monitor transmitters to 10 GHz. \$39.50! IC Tester — test any integrated circuit \$25.00! Radar Detector — audible, bargraph microwave warning \$23.50! Vocal Truth Detector — determines voice stress levels \$39.50! Add \$10% shipping. Our catalog with many more fascinating kits free with order or \$4.00 (refundable). **QUANTUM RESEARCH**, 17919 — 77th Ave., Edmonton, Alberta, Canada T5T 2S1.

TIRED OF IRONING? Prototype service for hobbyists & engineers. Single/small quantity ss PCB's. No setup fee. \$10.00 minimum, most boards \$25.00. We scan magazine artwork free! Get out your back issues! **FIRST PROTO**, (407) 392-8677.

CABLE DESCRAMBLERS. Build your own, SSAVI, Gated Sync, Sinewave. \$14.95. Cabletronics, Box 30502PE, Bethesda, MD 20824.

BUGGED??

EAVESDROPPING is unbelievably widespread! Electronic Devices with amazing capabilities can be monitoring your telephone and room conversations RIGHT NOW! Are you sure you're safe? **FREE CATALOG** tells you fast! Includes Free Bonus details on fantastic opportunities now open in Counter-Surveillance field. Exciting, immensely interesting and EXTREMELY profitable (up to \$250/hr) full/part-time income. Call Now! **1-800-732-5000**

RADON GAS DETECTOR. Monitors level continuously. Plans, \$19.95. Kit, \$69.95. Assembled and tested unit, \$139.95. **ELECTROMAN**, Box 24474, New Orleans, LA 70184. (504) 482-3017.

TV TECHNICIANS: Zenith TV module repair secrets. Repair hundreds of models, 1984-1993, faster and more profitably to component level. Sym/cure manual pays for itself fast. \$100.00 to: **ZMEX**, 807 Queen Palm Lane, Sarasota, FL 34243.

HIGH VOLTAGE PROJECT MANUAL II, Tesla, Odin, Spark, Pulsed Induction, Jacobs Ladder, unique high voltage experiments, \$10.00 postpaid, catalog \$1.00, Lambda Publishing Group, Box 1894, Lawrence, KS 66044-8894.

FREE HOBBY catalog. Lowest prices components, parts, tools, more! Gallimore Electronics, Box 70150-I, San Diego, CA 92167.

SILENT SAM Turn signal reminder. Patented. Best reminder yet. Doesn't bug you. Sounds briefly at intervals if you forget to cancel. Complete kit \$15.00, Visa/MC. 1 (800) 398-5605 free flier. Silent Sam, 1627 Basil Dr., Columbus, OH 43227.

PROJECTS. \$2.00 gets flyer, 100 piece grab bag. Lynn Johnson Electronics, Box 51268, San Jose, CA 95151-1268.

SURVEILLANCE

& COUNTERSURVEILLANCE Electronic Devices
Bugging/Phone Tapping Detectors • Caller ID • Covert Video
• Phone Scramblers • Voice Changers • Shotgun Mics • Vehicle Tracking • Transmitter Kits • Locksmithing • AND MORE!
7-Hour Telephone Recording System
Tapes phone calls automatically. \$125.00*
FOR CATALOG SEND \$5.00 TO...
EDE P.O. Box 337, Buffalo, NY 14226 (716) 691-3476

CABLE T.V. EQUIPMENT

10 Years Experience
Zenith, Jerrold, Scientific Atlanta
Pioneer, Tocorn
Test Aids Available
30 day money back guarantee
Visa / MC / COD

call for a price
NEWTRONICS
800-256-2880

MINI-FM transmitter. Buy parts at Radio Shack. Complete plans \$3.00. Lynn Johnson Electronics, Box 51268, San Jose, CA 95151-1268.

3-D IMAGING plans (surround sound) works with two speakers. Easy! Free S&H! Send \$14.95 for booklet and schematic to: Innovative Audio, 114 Smithfield Dr., Endicott, NY 13760.

BUILD YOUR own computer with I/O. Many control applications. Inexpensive. For schematics, details, send \$4.00: Philip Palmatier, PO Box 2215, Scotia, NY 12302.

Home Control Hobbyists:

R.I.B., the Remote Interface Board allows you to...

- Interface ANY REMOTE CONTROL to your COMPUTER!
- Interface Touch Panel Devices (Non remote items)
- Use the computer's standard Parallel Port.
- Complete theory & instructions are included to interface this board to the popular 4 in 1 preprogrammed remote & the Gemini learning remote!
- Inexpensively control electronic devices with your home computer!

Remote Interface Board & Complete instructions only \$49.99
Quantity Discounts available. Order Code #RIB-001



Authorized Distributor
JAVANCO INC
201 12 Street
Nashville, TN 37203

(800) 526-2626 sales only
(615) 244-4444 Information



Call for our Catalog filled with your electronic needs!

DIGI-FIELD FIELD STRENGTH METER

Are you worried about electromagnetic radiation, TV coax distribution loss, poor antenna performance, or EMV/RFI? The DIGI-FIELD field strength meter will put you at ease. With its frequency response of DC up to 12 GHz, it readily detects potential electromagnetic radiation hazards. It is an excellent tool for measuring TV coax distribution loss. In addition DIGI-FIELD can easily find 60-Hz AC-line interference, as well as RFI/EMI instrumentation disrupting set-ups. Sensitivity: @ 100 MHz Model "A" 150 nano Watts, Model "B" 2 nano watts.

\$139.95

Plus \$6.50 s/h



To order call - (800) FIELD 58 (343-5358)
I.C. Engineering 16350 Ventura Blvd
Suite 125, Encino, CA 91436 PH.(818) 345-1692 • 818-345-0517 Fax

Universal Programmers

We carry more programmers than anyone!

- \$1299 DATA I/O CHIPLABS 4800
- \$799 DATA I/O CHIPLABS 3200
- \$579 EETOOLS ALLMAX
- \$479 EETOOLS PROMAX
- \$479 XELTEK SUPERPRO
- CALL XELTEK SUPERPRO II
- \$499 ADVANTECH PC-UPROG
- CALL LOGIC DEVICES ALLPRO
- \$699 NEEDHAMS SA-20
- \$569 NEEDHAMS SA-10
- \$149 SUNSHINE 4 GANG
- \$109 SUNSHINE 1 GANG
- \$139 EETOOLS 1 GANG
- \$199 EETOOLS 4 GANG
- \$129 XELTEK ROM MAX

Also Carry Data Acquisition
PC Cards From Advantech

RCElectronics Never Undersold
(408) 241-7376 BBS 241-6375

CABLE DIRECT

Now you can tune-in to your favorite cable TV programming and SAVE 100's—EVEN \$1000's on premium



CABLE TV EQUIPMENT
Converters • Descramblers • Filters

FREE Cable TV Catalog



MODERN ELECTRONICS
1-800-906-6664

100% MONEY BACK GUARANTEE! • 30 DAY FREE TRIAL!

CABLE TV CHANNELS EQUIPMENT GUARANTEED

The nationwide source for cable TV equipment.

FREE 30 DAY TRIAL

"BUY WHERE THE DEALERS BUY."

FREE

TV Cable Descramblers and Converters Catalog. Open Every Day!

MEGA ELECTRONICS

VISA • MC
C.O.D.

1-800-676-6342

SAVE 100's

21 South Main Street, Winter Garden, FL 34787

NEW!!

TELEPHONE THEORY
&
REPAIR

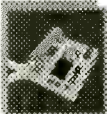

#TEL-001

- Learn how to repair today's electronic telephones and SAVE big \$\$\$\$.
- It's easy with this new 40 minute Telephone Video.
- This well-illustrated video shows you how telephones operate, from its' features down to component level.
- PLUS!!! it contains a list of common problems and troubleshooting tips.

Satisfaction Guaranteed or Money Back
Order Video #TEL-001 Today!
Send only \$29.95 + 4.00 S&H
Check or Money Order

PCW Technical Productions
P.O. Box 1492
Arlington Heights, IL 60006-1492

Surface Mount Chip Component Prototyping Kits



Only
\$49.95



CC-1 Capacitor Kit contains 365 pieces, 5 ea. of every 10% value from 1pf to .33µf. CR-1 Resistor Kit contains 1540 pieces; 10 ea. of every 5% value from 10Ω to 10 megΩ. Sizes are 0805 and 1206. Each kit is ONLY \$49.95 and available for immediate One Day Delivery!

Order by toll-free phone, FAX, or mail. We accept VISA, MC, COD, or Pre-paid orders. Company PO's accepted with approved credit. Call for free detailed brochure.

COMMUNICATIONS SPECIALISTS, INC.
426 West Taft Ave. • Orange, CA 92665-4296
Local (714) 998-3021 • FAX (714) 974-3420

Entire USA 1-800-854-0547

\$129 Laser Light Show



This kit displays animation, text, drawings, & music! Includes 2 Galvos, VCO, Computer Interface, Manual & Software listing. Works from parallel printer port.

Computerized Motors \$39*

Includes: 2 Stepper or 4 DC servo motors, Computer interface kit, 32 page training manual & Software listing. Works from parallel printer port.

* Add \$5 for shipping. Computer and Laser not included.

Call for **FREE** Flyer

SVS

Light &
Motion
in kit form

1273 Industrial Pky. W#460
P O Box 55125
Hayward CA 94545-0125
510-582-6602

PE MARKET CENTER CLASSIFIEDS

ANTIQUE ELECTRONICS

1840, PENNY black, world's first postage stamp, used, very fine condition, send \$300.00 to Rudolph Stamp & Coin, 9838 119th St. SW, Tocomo, WA 98498.

COMPUTER HARDWARE

MAGAZINE SUPPORTING Z80, CP/M, S100, Kaypro, 8031, 6809 and more. The Computer Journal. 10th year of classic computer projects. Hardware, software, forth, assembler. Micro-C Kaypro disks and schematics. 6 issues, \$24.00, free sample. 1 (800) 424-8825. TCJ, PO Box 535, Lincoln, CA 95648.

COMPUTER KITS build your own computer and save. 386/sx \$499.00, 486/sx \$599.00. FREE CATALOG. ABI SYSTEMS, 6 Angelacrest Ln., West Seneca, NY 14224. (716) 823-5304

PROFESSIONAL SURVEILLANCE EQUIPMENT Used by LAW ENFORCEMENT AGENCIES

VHF-FM CRYSTAL CONTROLLED TRANSMITTERS

139.000 MHz — 149.450 MHz

All kits assemble in less than 5 minutes!



#AD-500 Tel
Range: 5 Mile
Power: 11MW

'115

#AD-600 Mic
Range: .5 Mile
Power: 11MW

'125

#AD-700 Mic
Range: 1.5 Mile
Power: 70MW

'150

#AD-400 Mic
Range: 2.5 Mile
Power: 400MW

'155

We also sell: Micro Miniature CCD Cameras; Bug Detectors; and more

A & D ELECTRONICS

P.O. Box 601, Monsey NY 10952

800-356-3480 • In NYS 914-356-7541 • FAX 914-356-7505

Call for FREE Catalog; Credit Cards Accepted



The Pocket Programmer

The portable Eprom programmer that uses the printer port of your PC instead of an internal card. The software has 24 easy to use functions and programs 27/25/28/68764 & Cmos from 16K (2K × 8)—2M (256K × 8) Eproms (32 pin socket, UpGradeable to 8Meg). Adapters available for MCU's, 40-Pin Eproms, 5-Gang and Eprom Emulator to 32K × 8.

INTRONICS, INC.

Box 13723

Edwardsville, KS 66113

(913) 422-2094

\$129.95

Add \$3.00 for shipping.

Add \$3.75 for COD.

Visa/Master Charge

FREE

2 ROLLS

35mm Film



Try this Exciting New Film!
"While (this film) has sharpness and fine grain competitive with other films of its speed, its main forte is color reproduction. Nuances of color are held in the prints; You can see the difference between cherry red and tomato red"
Photographic Magazine



100% Satisfaction Guaranteed

Now you can try the 35mm film *Photographic Magazine* calls the best 200 ASA print film in the World! For Free. To introduce you, we'll send you two rolls Free. Fine grain, rich color, wide exposure latitude — perfect for everyday shots. Shoot in bright or low light — indoors or outdoors. And you can order prints, slides, or both, from the same roll — without the high cost of slide film! Try this remarkable film today.

Prints or Slides from the same roll

SEND ME 2 ROLLS FREE!

Rush me two 20-exposure rolls of your highly acclaimed 35mm film, one each at 200ASA and 400 ASA. Enclosed is \$2.00 for shipping. Limit 2 rolls per household.

FIRST NAME _____ LAST NAME _____

ADDRESS _____

CITY _____ STATE _____ ZIP _____

Mail to: Seattle FilmWorks
1260 16th Ave. W.
P.O. Box 34056
Seattle, WA 98124-1056

©1991 Seattle FilmWorks. Free film offer does not include developing. Process SFW-XL.

ADVERTISING INDEX

POPULAR ELECTRONICS magazine does not assume any responsibility for errors that may appear in the index below.

Free Information No.	Page	Free Information No.	Page		
—	A&D Electronics	126	—	ISCET	87
—	Agrelo Engineering	114	139	ITC Instruments	107
26	Alfa Electronics	100	—	ITC Microcomponents Inc.	113
28	All Electronics	106	37	Jan Crystals	118
—	Allen Engineering	112	—	JP Video	123
—	Amazing Concepts	13	38	Kelvin Electronics	115
151	AMC Sales	5	—	McGraw-Hill CES	31
—	Andromeda Research	125	—	M&G Electronics	122
—	Antique Radio Classified	82	—	Marymac Industries Inc.	122
—	Asher Engineering	119	—	MD Electronics	99
137	B&S Sales	98	—	Mega Electronics	126
—	C&C Specialties	124	—	Modern Electronics	126
32	C&S Sales	104, 105	—	Newtronics	125
—	CBC International	82	—	NRI Schools	11
—	Cellular Link	114	—	NuTek	81
—	CIE	65	—	Ohio Automation	122
—	CLAGGK Inc.	18, 85	43	Optoelectronics	111
—	CLAGGK Inc.	91, 94, 95	—	PC Boards	113
—	CLAGGK Video Offer	CV4	—	PCW Technical Publications	126
—	Command Productions	6	—	Phillips Tech	124
—	Communication Specialists	126	47	Prairie Digital Inc.	108
140	Compco	125	46	Print	116
—	Consumertronics	113	—	Progressive Concepts	125
13	Cook's Institute	27	—	RC Distributing Co.	124
—	Copyright Clearance Center	3	—	RC Electronics	126
162	Davis Instruments	23	—	Seattle Film Works	127
—	EDE	125	—	Self-Reliance Co. Inc.	116
—	EIA	CV3	—	Sil Walker	125
—	Electronics Engineers BC	7	—	Silicon Valley Surplus	126
—	Electronics Technology Today	CV2	—	Skyvision (Small)	122
—	Electronics Technology Today	90	—	Soft-Wear Productions	112
—	Firestik II	81	—	Software Science	122
—	Foley-Belsaw Company	109	—	Software Systems Consulting	87
—	Fotronics	116	127	Southpaw Electronics	101
—	Geoban Engineering	118	—	Spy Supply	110
—	Grantham College	17	—	Tele View Distributors	118
—	Great Southern Security	125	159	The School of VCR Repair	27
—	Greenleaf Electronics Inc.	108	136	Ucando Videos	112
155	Heathkit	23	141	US Cable (Zentek)	117
—	I.C. Engineering	126	133	Weka Publishing	121
—	Information Unlimited	13	—	World College	15
36	Interactive Image Tech.	102, 103	—	WPT Publications	117
—	Intronics	126	134	Xandi Electronics	108
128	138	Island Logix Inc.	117		

ADVERTISING SALES OFFICE

Gernsback Publications, Inc.
500-B Bi-County Blvd.
Farmingdale, NY 11735
1-(516) 293-3000

Larry Steckler, EHF/CET
 President

Christina Estrada
 Assistant to the President

For Advertising ONLY
516-293-3000
Fax 1-516-293-3115

Larry Steckler
 publisher

Arline Fishman
 advertising director

Denise Mullen
 advertising assistant

Kelly Twist
 credit manager

**Subscription/
 Customer Service/
 Order Entry**
1-800-827-0383
7:30 AM - 8:30 PM EST

ADVERTISING SALES OFFICES

EAST/SOUTHEAST

Stanley Levitan
 Eastern Sales
 1 Overlook Ave.
 Great Neck, NY 11021
 1-516-487-9357, 1-516-293-3000
 Fax 1-516-487-8402

MIDWEST/Texas/Arkansas/ Oklahoma, Colorado, Arizona

Ralph Bergen
 Midwest Sales
 One Northfield Plaza, Suite 300
 Northfield, IL 60093-1214
 1-708-446-1444
 Fax 1-708-559-0562

PACIFIC COAST/Mountain States

Mike Brooks
 Patis/3M
 1800 North Highland Avenue
 Suite 717
 Hollywood, CA 90028
 1-213-462-2700
 Fax 1-213-463-0544

What Do These Prestigious Companies Have In Common?

Aerovox®
DC Film and RFI Suppression Capacitors,
AC Oil Capacitors, EMI Filters

AMP
Electrical/Electronic Connectors,
IC Sockets, PCB Switches

AMX CORPORATION
A KYOCERA GROUP COMPANY
MLC, Tantalum and Thin Film
Capacitors, Resistors,
Networks, Trimmers,
Oscillators, Resonators, Filters
and Piezo Devices

BERG
ELECTRONICS
High Density and Industry Standard
Connectors/Subsystems

BURNDY
an FCI Company
Electronic Connectors

CAROL
CAROL CABLE COMPANY INC.
Electronic and Electrical Wire and Cable
and Power Supply Cords

COLE FLEX
Tubing, Conduits, Hose, Sleeveings, Splices,
Insulation and Cable Harness Products

Communications Instruments, Inc.
Relays and Solenoid Relays

COOPER
Belden
Multi Conductor, Paired, Coaxial, Flat,
Fiber Optic, Instrumentation/Process
Control, LAN, Special Application Cables,
Power Supply Cords & Molded Cable
Assemblies

COOPER
Bussmann
Fuses, Fuseholders, Fuse Blocks,
and Fuse Accessories

CORNELL DUBILIER
Capacitors-Aluminum
Electrolytics, Mica, AC Oil, Film,
MICA Paper and Relays

A COMPANY OF
DALE
Dale Electronics, Inc.
Resistors, Networks, Oscillators, Displays,
Inductors & Thermistors

DI DANTONA INDUSTRIES, INC.
BATTERIES: Computer, Cordless
Phone, Scanner & R/C.
ANTENNAS: Cordless Phone (metal &
rubber), Scanner Bumpers,
Grommets and Stik-On Feet

DEARBORN WIRE AND CABLE, L.P.

EATON
Eaton Corporation, Commercial
& Military Controls Operation
Switches, Relays, Displays and Keyboards

A
GERNSBACK
PUBLICATION
Popular Electronics
Electronics Now Magazine

KOA SPEER ELECTRONICS, INC.
Resistors, SMT Tantalum Capacitors Inductors,
Resistor Networks, SMT Thermistors

MALLORY
North American Capacitor Company
Tantalums, Aluminums, Sonalerts®
Ceramics, Films and AC's

M-tron
Quartz Crystal Clock Oscillators
and Special Hybrid Products

MURATA ERIE
MURATA ERIE NORTH AMERICA
Monolithics, Discs, Variable Capacitors,
Oscillators, Potentiometers, RFI/EMI Filters,
Microwave, Surface Mount Capacitors

NTE
NTE ELECTRONICS, INC.
A WORLDWIDE REPUTATION FOR QUALITY, SERVICE AND VALUE
Semiconductors, Resistors,
Capacitors, Relays

Philips ECG
A North American Philips Company
Semiconductors, Test Equipment,
Relays, A/V Parts and
Chemicals

Quam
Loudspeakers and Commercial Sound
Products

ROHM
Rohm Electronics Division
Resistors, Ceramic Capacitors,
Transistors/Diodes,
Opto-Components and IC's

SELECTA
Electrical Electronic Products
Switches, Relays, Terminals,
Indicator/Pilot Lights, LED Indicators,
Test Clips, Test Leads, Cable Ties and
Heat Shrinkable Tubing

A COMPANY OF
SPRAGUE
Tantalum Capacitors, Wet & Foil
Capacitors, Resistor Networks,
Resistor Capacitors Networks, Filters

Switchcraft
A Raytheon Company
Switches, Connectors, Jacks, Plugs,
Jackfields & Audio Accessories

TECH SPRAY
Non-CFC Cleaners/Degreasers,
UV Cured Compounds, Swabs, Wipes,
Brushes, Wick, Cleanroom Supplies, and
Static Control Products.

They sell through distributors.
They belong to the E.I.A.
They belong on your vendor list.

Leadership in electronics is not just a matter of designing products better and manufacturing them better, but also of marketing them better. And the sponsors of this message understand that better service to customers *requires* effectively involving distributors as part of their marketing teams.

Distributor involvement means lower prices, quicker deliveries, better service over-all. The Buyer wins... the Seller wins.

Distributors help achieve marketing leadership. So does the manufacturer's involvement in the Components Group of the Electronic Industries Association. EIA fosters better industry relations, coherent industry standards, and the sharing of ideas, which helps one another *and* serves customers better.

In choosing your component supplier, look for the marks of leadership —

- availability through distribution
- membership in the E.I.A.



Electronic Industries Association/Components Group
2001 Pennsylvania Avenue, N.W. 11th Floor
Washington, D.C. 20006
Phone: (202) 457-4930 Fax: (202) 457-4985

Committed to the competitiveness of the American electronics producer

Countersurveillance

Never before has so much professional information on the art of detecting and eliminating electronic snooping devices—and how to defend against experienced information thieves—been placed in one VHS video. If you are a Fortune 500 CEO, an executive in any hi-tech industry, or a novice seeking entry into an honorable, rewarding field of work in countersurveillance, you must view this video presentation again and again.



CALL NOW!

1-516-293-3751

HAVE YOUR VISA or MC CARD AVAILABLE

Wake up! You may be the victim of stolen words—precious ideas that would have made you very wealthy! Yes, professionals, even rank amateurs, may be listening to your most private conversations.

Wake up! If you are not the victim, then you are surrounded by countless victims who need your help if you know how to discover telephone taps, locate bugs, or “sweep” a room clean.

There is a thriving professional service steeped in high-tech techniques that you can become a part of! But first, you must know and understand Countersurveillance Technology. Your very first insight into this highly rewarding field is made possible by a video VHS presentation that you cannot view on broadcast television, satellite, or cable. It presents an informative program prepared by professionals in the field who know their industry, its techniques, kinks and loopholes. Men who can tell you more in 45 minutes in a straightforward, exclusive talk than was ever attempted before.

Foiling Information Thieves

Discover the targets professional snoopers seek out! The prey are stock brokers, arbitrage firms, manufacturers, high-tech companies, any competitive industry, or even small businesses in the same community. The valuable information they filch may be marketing strategies, customer lists, product formulas, manufacturing techniques, even advertising plans. Information thieves eavesdrop on court decisions, bidding information, financial data. The list is unlimited in the mind of man—especially if he is a thief!

You know that the Russians secretly installed countless microphones in the concrete work of the American Embassy building in Moscow. They converted

what was to be an embassy and private residence into the most sophisticated recording studio the world had ever known. The building had to be torn down in order to remove all the bugs.

Stolen Information

The open taps from where the information pours out may be from FAX's, computer communications, telephone calls, and everyday business meetings and lunchtime encounters. Businessmen need counselling on how to eliminate this information drain. Basic telephone use coupled with the user's understanding that someone may be listening or recording vital data and information greatly reduces the opportunity for others to purloin meaningful information.

The professional discussions seen on the TV screen in your home reveals how to detect and disable wiretaps, midget radio-frequency transmitters, and other bugs, plus when to use disinformation to confuse the unwanted listener, and the technique of voice scrambling telephone communications. In fact, do you know how to look for a bug, where to look for a bug, and what to do when you find it?

Bugs of a very small size are easy to build and they can be placed quickly in a matter of seconds, in any object or room. Today you may have used a telephone handset that was bugged. It probably contained three bugs. One was a phony bug to fool you into believing you found a bug and secured the telephone. The second bug placates the investigator when he finds the real thing! And the third bug is found only by the professional, who continued to search just in case there were more bugs.

The professional is not without his tools. Special equipment has been designed so that the professional can sweep a room so that he can detect voice-activated (VOX) and remote-activated bugs. Some of this equipment can be operated by novices, others require a trained countersurveillance professional.

The professionals viewed on your television screen reveal information on the latest technological advances like laser-beam snoopers that are installed hundreds of feet away from the room they snoop on. The professionals disclose that computers yield information too easily.

This advertisement was not written by a countersurveillance professional, but by a beginner whose only experience came from viewing the video tape in the privacy of his home. After you review the video carefully and understand its contents, you have taken the first important step in either acquiring professional help with your surveillance problems, or you may very well consider a career as a countersurveillance professional.

The Dollars You Save

To obtain the information contained in the video VHS cassette, you would attend a professional seminar costing \$350-750 and possibly pay hundreds of dollars more if you had to travel to a distant city to attend. Now, for only \$49.95 (plus \$4.00 P&H) you can view *Countersurveillance Techniques* at home and take refresher views often. To obtain your coupon, complete the coupon or call.

CLAGGK INC. PE
P.O. Box 4099 • Farmingdale, NY 11735

Please rush my copy of the Countersurveillance Techniques Video VHS Cassette for a total cost of \$53.95 each (which includes \$4.00 postage and handling)

No. of Cassettes ordered _____
 Amount of payment \$ _____
 Sales tax (N.Y.S. only) _____
 Total enclosed _____
 Bill my VISA MasterCard
 Card No. _____
 Expire Date _____ / _____

Signature _____
 Name _____
 Address _____
 City _____ State _____ ZIP _____

All payments in U.S.A. funds. Canadians add \$4.00 per VHS cassette. No foreign orders.