

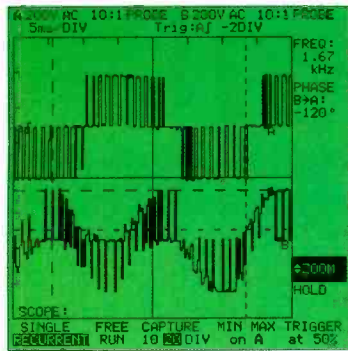



# A DAY IN THE LIFE OF SCOPEMETER®

6:42 AM, Motor in #2 shaft overheating. Dual channel shows incorrect drive signal.



8:23 AM, Security Monitor not working. 3-1/2-digit DMM indicates bad ground.

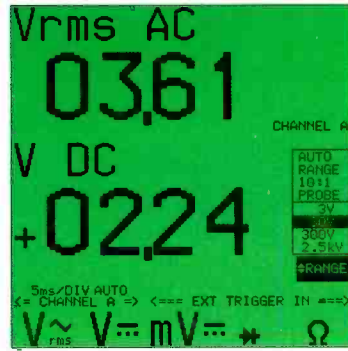

9:25 AM, Conveyor Stepper Motor fails. Cursors help find broken sync connection.

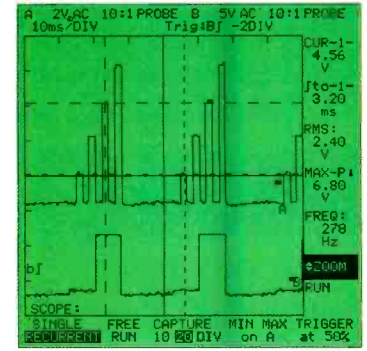

10:57 AM, Intermittent Auditorium lighting. Waveform shows too much noise.

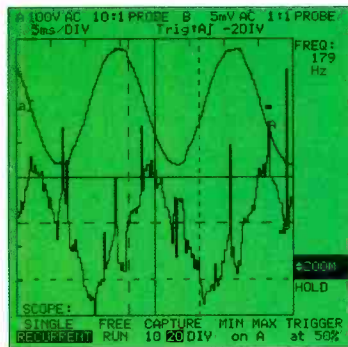

11:17 AM, 5V Control Signal is bad. Scope display reveals -DC offset.

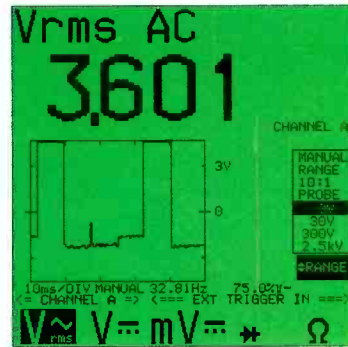

12:58 PM, Air Conditioner overheating. Resistance shows corroded connection.

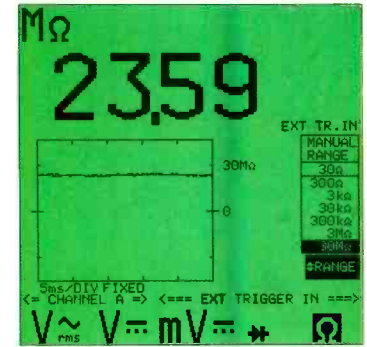

1:22 PM, Copier toning uneven. Counter finds clock off frequency.

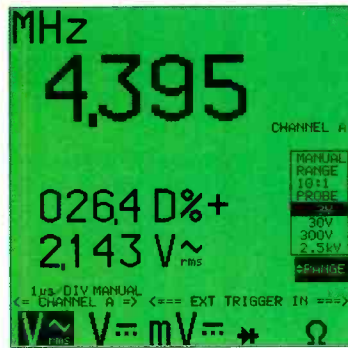

2:14 PM, Testing Power Inverter loads. Save reference waveform to memory.

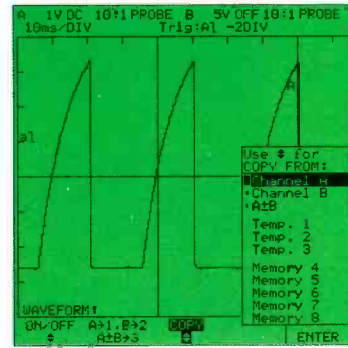

3:12 PM, Copier fails, again! The ns rise time helps find broken shield.

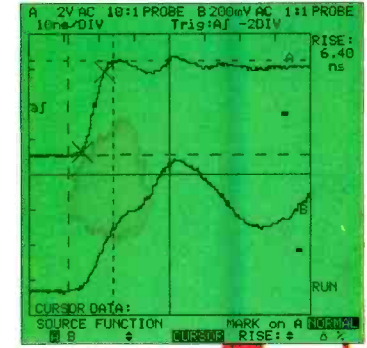

4:05 PM, Salesman presents demo board. 25MS/s finds 40ns glitches.

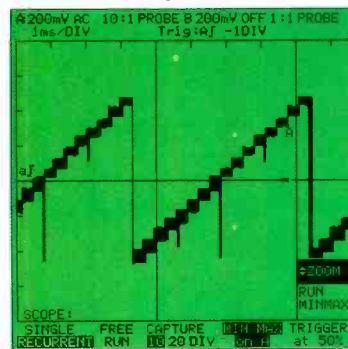

From the roof top to the basement, indoors and out, the ScopeMeter test tool works wherever you work. The sealed, ruggedized case is designed for hand-held use. The backlit screen works in both bright sun and low light conditions. And the logical control panel makes operation simple. So, make your day a little easier. Call 1-800-44-FLUKE and ask how the ScopeMeter test tool can help you save time and frustration with electrical problems, on the go.

©1993, John Fluke Mfg Co., Inc., P.O. Box 9090, M/S 250C, Everett, WA 98206-9090, U.S. (206) 356-5400. Canada (416) 890-7600. Other countries (206) 356-5500. All rights reserved. ScopeMeter is a registered trademark of John Fluke Mfg Co., Inc. Ad No. 00387

## FLUKE®

CIRCLE 153 ON FREE INFORMATION CARD

www.americanradiohistory.com



# Popular Electronics®

THE MAGAZINE FOR THE ELECTRONICS ACTIVIST!

## CONSTRUCTION ARTICLES

<b>BUILD AN EXPLOSIVE GAS DETECTOR</b> .....	Anthony Charlton	31
<i>Safeguard your family and property by detecting dangerous-gas concentrations before they reach combustible levels</i>		
<b>BUILD THE PHONE PAGER</b> .....	Jim Cooke	37
<i>Summon family members or co-workers without straining your vocal cords</i>		
<b>ADD A DVM TO YOUR PC</b> .....	Scott Hendershot	41
<i>Turn your PC into a digital voltmeter for automated testing, to record readings over time, and more</i>		
<b>PIPE AND TUBING ANTENNAS</b> .....	Joseph J. Carr	44
<i>Design and build your own communications antennas and save a bundle in the process</i>		
<b>BUILD THE DOOR MINDER</b> .....	Brian Pillar	53
<i>It keeps an eye on the door even when you can not</i>		
<b>BUILD A KEYHOLE ILLUMINATOR</b> .....	Marc Spiwak	55
<i>Get a spot of light when, and where you need it most</i>		

## FEATURE ARTICLES

<b>CHARLES PROTEUS STEINMETZ</b> .....	James P. Rybak	56
<i>Learn about the genius who overcame physical disability to change the science of electronics</i>		
<b>WHERE TO FIND ELECTRONICS PARTS</b> .....	Neil W. Heckt	62
<i>We make the hardest part of project building—finding parts—a little easier</i>		

## PRODUCT REVIEWS

<b>GIZMO</b> .....		5
<i>Panasonic's Check Printing Accountant; Intuit's Quicken for Windows; Videonics' Home Video Editor; and much more!</i>		
<b>HANDS-ON REPORT</b> .....		24
<i>Kelvin-95 digital multimeter/engine analyzer</i>		
<b>PRODUCT TEST REPORT</b> .....	Len Feldman	26
<i>Toshiba M-758 videocassette recorder</i>		

## COLUMNS

<b>ANTIQUE RADIO</b> .....	Marc Ellis	66
<i>Behind the scenes at the Motorola Museum</i>		
<b>COMPUTER BITS</b> .....	Jeff Holtzman	68
<i>Visual programming II: Access</i>		
<b>CIRCUIT CIRCUS</b> .....	Charles D. Rakes	71
<i>Something for just about everyone</i>		
<b>THINK TANK</b> .....	John Yacono	74
<i>Derby stuff</i>		
<b>DX LISTENING</b> .....	Don Jensen	78
<i>Getting two for one</i>		
<b>HAM RADIO</b> .....	Joseph J. Carr	80
<i>Ham-radio potpourri</i>		
<b>SCANNER SCENE</b> .....	Marc Saxon	82
<i>A look at trunked systems</i>		

## DEPARTMENTS

<b>EDITORIAL</b> .....	Carl Laron	2
<b>LETTERS</b> .....		3
<b>FACTCARDS</b> .....		49
<b>POPULAR ELECTRONICS MARKET CENTER</b> .....		50A
<b>FREE INFORMATION CARD</b> .....		51
<b>ELECTRONICS LIBRARY</b> .....		84
<b>NEW PRODUCTS</b> .....		89
<b>ELECTRONICS MARKET PLACE</b> .....		95
<b>ADVERTISER'S INDEX</b> .....		98

Popular Electronics (ISSN 1042-170X) Published monthly by Gernsback Publications, Inc., 500-B Bi-County Boulevard, Farmingdale, NY 11735. Second-Class postage paid at Farmingdale, NY and at additional mailing offices. One-year, twelve issues, subscription rate U.S. and possessions \$21.95, Canada \$28.04 (includes G.S.T., Canadian Goods and Services Tax Registration No. R125166260), all other countries \$29.45. Subscription orders payable in U.S. funds only. International Postal Money Order, or check drawn on a U.S. bank. U.S. single copy price \$3.50. © 1993 by Gernsback Publications, Inc. All rights reserved. Hands-on Electronics and Gizmo trademarks are registered in U.S. and Canada by Gernsback Publications, Inc. Popular Electronics trademark is registered in U.S. and Canada by Electronics Technology Today, Inc. and is licensed to Gernsback Publications, Inc. Printed in U.S.A.

Postmaster: Please send address changes to Popular Electronics, Subscription Dept., P.O. Box 338, Mount Morris, IL 61054-9932.

A stamped self-addressed envelope must accompany all submitted manuscripts and/or artwork or photographs if their return is desired should they be rejected. We disclaim any responsibility for the loss or damage of manuscripts and/or artwork or photographs while in our possession or otherwise.

As a service to readers, Popular Electronics publishes available plans or information relating to newsworthy products, techniques, and scientific and technological developments. Because of possible variances in the quality and condition of materials and workmanship used by readers, Popular Electronics disclaims any responsibility for the safe and proper functioning of reader-built projects based upon or from plans or information published in this magazine.

**Larry Steckler**

*EHF, CET*

*Editor-In-Chief and Publisher*

## EDITORIAL DEPARTMENT

**Carl Laron**

*Editor*

**Robert A. Young**

*Associate Editor*

**John J. Yacono**

*Associate Editor*

**Byron G. Wels, K2AVB**

*Associate Editor*

**Teri Scaduto**

*Assistant Editor*

**Evelyn Rose**

*Editorial Assistant*

**Marc Spiwak**

*Editorial Associate*

**Joseph J. Carr, K4IPV**

**Marc Ellis**

**Len Feldman**

**Jeffrey K. Holtzman**

**Don Jensen**

**Charles D. Rakes**

**Marc Saxon**

*Contributing Editors*

## PRODUCTION DEPARTMENT

**Ruby M. Yee**

*Production Director*

**Karen S. Brown**

*Production Manager*

**Marcella Amoroso**

*Production Assistant*

**Lisa Rachowitz**

*Editorial Production*

## ART DEPARTMENT

**Andre Duzant**

*Art Director*

**Injae Lee**

*Illustrator*

**Russell C. Truelson**

*Illustrator*

**Jacqueline P. Cheeseboro**

*Circulation Director*

**Michele Torrillo**

*P-E Bookstore*

## BUSINESS AND EDITORIAL OFFICES

Gernsback Publications, Inc.

500-B Bi-County Blvd.

Farmingdale, NY 11735

1-516-293-3000

Fax: 1-516-293-3115

President: **Larry Steckler**

**Subscription**

**Customer Service/Order Entry**

1-800-827-0383

7:30 AM - 8:30 PM EST

Advertising Sales offices listed on page 98

Cover Photography by Diversified Photo Services

Composition by  
Mates Graphics



## A POTPOURRI OF PROJECTS

Our mission at Popular Electronics is to present comprehensive coverage of the electronics hobby. That means providing articles about such diverse areas as consumer electronics, ham radio, shortwave listening, antique-radio collecting and restoration, computers, automotive electronics, new technologies, and more. In past months, specific issues have highlighted new consumer products, satellite TV, the future of electric cars, and computers.

But we have never forgotten that the cornerstone of our popularity is project building. In this month's issue we present a new potpourri of projects and articles sure to please even the most jaded builder. The projects revolve around convenience (a phone pager), safety (an explosive-gas detector), security (a door minder and a keyhole illuminator), radio (pipe and tubing antennas), and computers (add a DVM to your PC). Further, Think Tank, Circuit Circus, and Ham Radio all feature even more circuits and small projects for builders.

We even have an article that attempts to minimize the biggest hurdle most builders face in completing their projects: finding parts. In the article Where to Find Electronics Parts, we provide a list of many major, and some not-so-major parts and resource suppliers and their primary product lines.

No matter whether you like to build, tinker, or experiment, you are sure to find something that catches your interest in this issue. We hope you enjoy it. The projects start on page 31.

Carl Laron  
Editor



## ERROR REPORTS

Two errors appeared in the schematic diagram of the "Super Simple Shortwave Receiver" (**Popular Electronics**, August 1993). First, the positive end of C17 should connect to the junction formed by U2-a pin 1, R12, and R14. Second, C13 should be taken out of the signal path, between D2 and pin 3 of U2-a, and instead be connected between the signal path (at that same point) and ground; the way that it is shown in the schematic diagram grounds the signal path. We are sorry for any inconvenience this might have caused.—Editor

After receiving a considerable amount of feedback on my "Battery Butler" article (May 1993), it has been determined that there are two known errors in the published article.

The first error is on the top of page 36. The text reads: "Measure the voltage at pin 3 of U5. That voltage should be at or near 5.0 VDC." The actual text should have read: "Measure the voltage at pin 3 of U5. This voltage should be between 11.5 and 15.0 VDC, with respect to ground. Measure the voltage at pin 14 of U1. This voltage should be at, or near, 5.0 VDC."

The second error appears at the bottom of page 36. The text reads: "The recommended voltage [at pin 9 of U5] can be determined by subtracting 0.10 VDC from the voltage noted earlier at pin 4 of U5." The actual text should have read, "The recommended voltage at pin 9 of U5 can be determined by subtracting 0.10 VDC from the voltage noted earlier at pin 5 of U5." The text continues discussing pin 5 (as opposed to pin 4) of U5, and most of the readers have been able to figure it out.—Larry Lanpher

## CROWBAR CIRCUIT

My filament crowbar circuit was published in *Antique Radio* in the July, 1993 issue of **Popular Electronics**. Before someone comes to grief, I feel I should point out a typo in the text of the article. The 1.1 volts printed should actually be 1.4 volts, as the circuit was designed for

tubes such as the 1A7, 1U5, etc., which require 1.4 volts. As shown, the circuit would be unlikely to protect 1.1-volt tubes as mentioned. If protection of these tube types is required, remove one of the diodes and reduce the input voltage accordingly.

*Antique Radio* is the first column I turn to each month—keep the great stories coming! C.R. ZINCK  
Halifax, Nova Scotia  
Canada B3N 1Y9

## AUTOMOTIVE ALTERNATORS

I found Gary Eggleston's article, "Fighting Interference" (**Popular Electronics**, August 1993) to be a good overview on EMI. He offered practical solutions to making equipment less susceptible to interference. However, his article contains one error in the description of the automotive alternator.

The article states that slip rings connect the rectifying diodes to the coils of the rotating armature. Actually, the rotating element of the alternator is the field. The stator is the armature and it contains the diodes that are directly connected to its AC windings. The current for the field is supplied via the voltage regulator from the battery contacts of the ignition switch. The voltage regulator, which is often contained in the alternator housing, monitors the battery voltage and supplies excitation current to the rotor field through the slip rings. The regulator adjusts the excitation current with the varying electrical load and engine speed to the value required to maintain a constant battery-charging voltage (around 14 VDC). The voltage is varied with temperature, however, to provide more charging current during cold weather.

The description in the article more resembles that of the old-style automotive generator. The rotating element of the generator is the armature, and the stator is the field. The generator-voltage regulator provides

excitation current to the stator field, and battery-charging current is obtained from the rotor armature via brushes that ride on a segmented commutator. "Rectification" is obtained by rapidly switching the polarity of the generator armature winding with the brushes so that a DC output current results. Because the alternator is a more efficient machine than the generator, charging current can be obtained at a lower engine RPM. Generators were sometimes unable to charge the battery at idle speed, which is one of the reasons why the generator is no longer widely used.

The brushes in an alternator also last much longer than the brushes in a generator, for three reasons. First, the alternator brushes only carry the field current (less than 10 amps), while the generator brushes must carry the entire output current (50 to 100 amps, depending on the generator rating). Second, the alternator slip-ring surface is a smooth continuous band, while the generator commutator is segmented, causing more mechanical wear. Finally, the generator brushes have to continuously switch the polarity of the highly inductive output windings to obtain the DC charging current. This causes high-temperature arcing, which adds to the brush wear.

C.H.  
Tinton Falls, NJ

## FUEL MISER STATS

I've built three Fuel Misers using the information that appeared in the March 1993 issue of **Popular Electronics**. Two are installed on gas furnaces (one older, one fairly new) and the third on a brand-new electric furnace. The first board was hard-wired, the second etched by hand, and the third etched using the photocopy method. All three are working with furnace fans on continuously. The two gas furnaces are operating at 40%, and the electric had to settle for 70%. We started, as

suggested, at 70% and decreased to the best comfort level. The electric furnace is more efficient, so the Miser serves there as a fine-tuning device (or at least that's the way I'm looking at it).

I've kept records on gas costs and consumption since 1982 on my own gas furnace (I have now also begun keeping records on the other furnaces). I installed my first Fuel Miser in mid-April and found a 30% reduction in fuel consumption for that month over last year. May, the first full month of operation, was even better—a 42% reduction. The weather was very similar to last year in both April and May. Previous years were warmer, but still show up with higher gas consumption than this year. I know it's too early for a good statistical comparison, but I'll keep you informed of future results.

M.L.  
Gatineau, Quebec, Canada

## FULFILLING NEEDS

I am writing to thank you for putting my request for an operator's manual in the "Haves & Needs" sections of the *Letters* column. I am glad to report that a gentleman in South Dakota sent me the manual—in fact, it arrived in my mail one day after I received the issue of **Popular Electronics** that included my request! I was very pleased, and sent the gentleman a thank-you note. **Popular Electronics** is a great magazine, and I really enjoy it. Keep up the good work. David Bjorkman  
Elk Point, Alberta, Canada

## HAVES & NEEDS

I am searching for the manual or circuit diagram for a Hallicrafters SW500 receiver. I would gladly pay for any copying and postage costs. Thanks! LEWIS FISHER  
14 Redford Drive  
Exeter, Ontario N0M 1S3  
Canada

# LETTERS

# There's Big Profits In Electronics If you have the Proper Training

Foley-Belsaw can give you that training. Training that will provide high income potential in the 90's and on into the twenty-first century. The right training can give you the potential for a bright, economically, rewarding and fascinating future. You can take control of your future by choosing one of these highly profitable career fields. Our experience proves when you're in a field you're interested in you'll earn more and advance farther than you ever will in a field where you lack interest.

If you're unhappy with your present job, not satisfied with your income, or if you feel you can't reach your full potential, now is the time to act. There is no obligation to get a free Career Kit from Foley-Belsaw. Just check the coupon - mail it to us - we'll send your Career Kit free.

## VCR Repair



## VCR Technician

VCR Technicians report earning \$80.00 and more per hour. That's because this career field lacks the qualified technicians to handle the demand. We use the Viejo Method by Foley-Belsaw to quickly teach you VCR Repair without all the unnecessary basic electronics. The Viejo Method has been proven best right in the VCR repair shop.

The vast majority of VCR repairs are mechanical or electromechanical.

You learn these simple repairs first so you start earning right away. These basic repairs become the foundation on which you build your career.

## Personal Computer Repair



If you have used a computer or are interested in how computers work you've probably got what it takes to become a computer repair specialist. This field continues to grow as personal computers are being used in almost every office and many homes.

You can cash in on this big demand quickly when you learn personal computer repair by the Foley-

Belsaw method. This quick learning method teaches you the basics of computer repair so you start earning quickly as you continue to learn more complicated procedures. In a short time you'll be earning \$80, \$100 or more an hour.

Beside VCR and Computer Repair Foley-Belsaw can offer you specialized training in other high paying electronic fields. These courses all provide the knowledge you need to start a business of your own. A business where you're the boss. A business that provides both financial and personal security.

Foley-Belsaw can also provide you with nationally acclaimed training in several high paying mechanical career fields. Just check the coupon for your area of interest. We'll rush you a free career kit with all the exciting details.

## FREE Kit

For a free information kit in one of these high paying career fields, contact:

Foley-Belsaw Institute  
6301 Equitable Road  
Kansas City, MO 64120



Since 1926

Foley-Belsaw Institute, 6301 Equitable Road  
Kansas City, MO 64120

Check One Box Only, Please.

### Electronic Courses

- VCR Repair, Dept. 62083
- Computer Repair, Dept. 64013
- Basic Digital Electronics, Dept. 69012
- Fax Machine Repair, Dept. 67012
- Printer Repair, Dept. 68012
- Camcorder Repair, Dept. 66012

### Mechanical Courses

- Locksmithing, Dept. 12363
- Small Engine Repair, Dept. 52307
- Saw and Tool Maintenance, Dept. 21263
- Upholstery, Dept. 80895
- Woodworking, Dept. 43230

Name \_\_\_\_\_

Address \_\_\_\_\_

City \_\_\_\_\_

State \_\_\_\_\_ Zip \_\_\_\_\_



# GIZMO

A CHRONICLE OF CONSUMER ELECTRONICS

VOLUME 6,  
NUMBER 11

## Checks and Balances

**CHECK PRINTING ACCOUNTANT MODEL KX-RC100.** Manufactured by Panasonic Company, One Panasonic Way, Secaucus, New Jersey 07094. Price: \$349.95.

Money might not be the root of all evil, but it certainly can be the root of marital discord when two different "money types" attempt to join their checking and savings accounts, as well as their hearts and souls. Everyone has a different way of handling personal finances. At one extreme is our friend who, back in the days when banks actively courted customers with free checking accounts, would switch banks everytime she received a bank statement that was more than \$500 off the "guesstimate" she had made from her haphazard ledger entries. At the other extreme is a neighbor who keeps computerized records of every expense, charge account, bank statement, and the like, makes extra payments on his mortgage principle at regular intervals, and makes monthly contributions to savings, retirement, college, and investment accounts.

There are those who get their kicks from spending every cent they earn and then some, and others who find satisfaction and security in sticking to a budget and squirreling away every available dollar into savings and long-term investments; those who keep a wallet-full of credit cards charged to their limits, and others who promptly pay the full balance to avoid paying interest. When you try to picture such disparate types trying to get along—even leaving out the power struggle that underlies most fights over money—it's no wonder that money trouble tops of the list of reasons for divorce.

Money, power, and control are intertwined not only in interpersonal relationships, but also in all levels of government and social structures—and in the relationship that each person has with



CIRCLE 50 ON FREE INFORMATION CARD

his or her own funds. The one principle on which every financial advisor can agree is that no matter what you want to do with your income, to do it well you must take control by learning precisely where your money goes. If you don't control it, then your money will control you.

Most of us can rattle off the exact amounts of our weekly paychecks and our monthly mortgage or rent payments. Some of us can make a good estimate of our utility, phone, food, gas, medical, and insurance bills. But very few can account for the rest, those dollars that are frittered away in big or little chunks on coffee and a donut each morning, entertainment, impulse shopping, dining out, paying the paper boy. "I just don't know where my money disappears to!" "Cash just slips through my fingers." "No matter how much I earn, I seem to need/spend more." All are familiar refrains. Even our computerized neighbor has a category called miscellaneous that he can't account for.

Financial experts know that if you can discover where your money is disappearing to, you can stop it from slipping through your fingers. In other words,

whether you're a spender or a saver, you can take control over your finances—if you're willing to take the time to track and analyze your spending habits. That goes well beyond the unpleasant, time-consuming chore of keeping your checkbook up-to-date and balanced. They suggest that you carry a little notepad around and jot down such expenditures as "35-cents: newspaper," "\$2: lottery tickets," "MasterCard: \$56.50: dinner at Siam Lotus," and so on.

Sounds like a lot of work, doesn't it? Panasonic must have thought so too. They came up with a device to make it easier—and even fun, if you're a gizmo-lover. The *Model KX-RC100 Check Printing Accountant*, or CPA (pun intended, we're sure), provides a portable, electronic means to keep two checking accounts balanced and to print out the checks. In addition, the unit can be used to maintain records of credit-card and cash expenditures, as a calculator, and as a 50-number telephone directory.

At about the size of one of those checkbook/wallet/calculator combinations ( $7\frac{1}{4} \times 3\frac{1}{2} \times 1\frac{3}{16}$  inches), the CPA can be

TURN PAGE FOR CONTENTS



# This month in GIZMO<sup>®</sup>

Panasonic Model KX-RC100 Check Printing Accountant .....	pg. 5
Intuit Quicken Version 2.0 for Windows .....	pg. 10
Videonics Thumbs Up Home Video Editor .....	pg. 12
Sanyo Sportable Personal AM/FM Cassette Player.....	pg. 14
Cobra Lloyd's Model CR400 Wireless Intercom and Clock Radio ..	pg. 18
Samsung Model XD3500 8mm VCR .....	pg. 19
Franklin Electronic Word Games.....	pg. 20
Samsung Home Fax Machine ..	pg. 20
AudioSource Screen Cleaner ..	pg. 22
Bel-Tronics Cordless Phone... ..	pg. 22
Center-Channel Speaker .....	pg. 22
Radio Shack Talking Calculator .....	pg. 22
In-Wall TV .....	pg. 23
Quasar VHS-C Camcorder....	pg. 23
Sima Editing Microphone and Headset.....	pg. 23
Thomson Laserdisc Player....	pg. 23

Gizmo is published by Gernsback Publications, Inc., 500-B Bi-County Blvd., Farmingdale, NY 11735. Senior Writers: Chris F. O'Brian and Teri Scaduto. ©Copyright 1993 by Gernsback Publications, Inc. Gizmo is a registered trademark. All rights reserved.

considered purse- or briefcase- (but not quite pocket-) sized. The top of the unit features a 2-line LCD readout with seven function buttons arrayed below it (five display icons of a check, a credit card, a coin, a calculator, and a telephone, and two are labeled PRINT and ENTER) on the upper left side. The right side of the unit features a calculator and four cursor arrow keys. When the top cover is lifted, a QWERTY keyboard is revealed, along with additional function keys. Printed on the lid's underside is a quick-check summary of the CPA's basic functions. The bottom of the unit also flips open. The bottom compart-

ment contains a dot-matrix check printer, a check-storage area, and the battery compartment. The CPA runs on a rechargeable Ni-Cad battery; an AC adapter/charger plugs into a jack on the left side of the unit, next to the power switch and an interface connector jack that's used for communications with other CPA units or with a PC (using optional connectors).

Before you can begin using the Check Printing Accountant, you have to set the date and tell it about your finances. We began using the CPA on the first of the month, when we regularly balance our checkbooks and pay our bills. We cleared our desk of everything but a small mountain of bills, two checkbooks, two current bank statements, the CPA, and its 125-page main manual. (Fortunately, that manual is clearly written, detailed, and quite easy to follow. For less patient folks, a 6-page quick-start manual is also included.)

Once both accounts were reconciled (the old-fashioned, pencil-and-paper way), we pressed the CPA's SETUP key, which calls up a function menu from which we selected "check." The CPA prompted us to fill in the bank name and balance for first the primary and then the secondary account. A press of the DONE key brought back the initial display of date and time.

Next, we used the included template to set the print positions to match our checks (done by selecting "print" from the setup menu). We discovered that neither the "A" or "B" positions printed on the template was an exact fit, and we had to use the rulers on the left and bottom sides of the template to determine the x- and y-coordinates of the starting point for each line to be printed on the check.

The most time-consuming step—but one that ends up saving a lot of time later—was entering the payroll data, information about those people and institutions whose names repeatedly appear in the payee line of our checks. Unfortunately, we have a lot of payees! For each payee, we entered the name and any information we wanted to appear on the check's memo line (for instance, "Acct. #123456"). That information then can be recalled at the press of a button and automatically printed on every check issued to that payee. We took Panasonic's advice and kept a written list of our payees on the back of the CPA unit for future reference.

At that point, we could have gone on to enter similar data about our credit cards, but we decided to dive right in and start writing and printing out checks. One press of the CHECK button is used to access the primary account (a second press brings up the secondary account). At the "pay to" prompt, we could either type in the name to appear on the check—or, since we had completed our payroll, we simply hit the

LIST # key and entered the proper number. The payee's name and the memo data appear on the LCD for confirmation. For the first check only, we had to input the check number (the CPA automatically numbers all subsequent checks).

To help the user keep more accurate records, the CPA asks for some additional information: Is the check a business, personal, or "other" expense; is it tax-related; and into which category does it fall? A list of 50 categories appears in the manual and includes such areas as groceries, utilities, household, tax, charity, insurance, mortgage, and auto service. (It was missing a few that we needed, however, such as pets and books.) Finally, we entered the amount, confirmed each item, and were almost ready to print.

Before printing, a check must be inserted under the guide tabs in the unit's flip-open bottom compartment. Several checks can be stored in a separate storage area in that compartment. Once the compartment was snapped shut again, we pressed the PRINT key and—lo and behold—a perfectly printed check came out. In the LCD readout was a reminder to sign the check.

If that sounds like a lot to go through to get one perfect check, it is! At that point, we had our doubts about the Check Printing Accountant, despite the "neat" factor (neat as in "wow" as well as in "legible"). After printing one check, we'd already spent more time than it usually takes to pay our bills by writing them all out by hand, licking the stamps, and sealing the envelopes.

As we continued to pay our monthly bills, however, it became clear that all our prep work had paid off. The input process quickly became so familiar as to be almost intuitive, and took virtually no time at all. (Even with practice, though, inserting the check in the bottom compartment remained a somewhat clumsy procedure. It would be much more convenient if a stack of checks could be stored in print position at all times.) The CPA automatically deducted the amount of the check from the account and displayed the new balance, saving us time previously spent with pencil, paper, and calculator—which often resulted in careless mistakes. (If we still managed to make a mistake, however, the CPA would allow us to void that check.) Rather than manually entering the information into a check register, we used the CPA's report function to get a printout of the entire check-printing session.

And, when it came time to pay the following month's bills (all too quickly, as always), all the data was already in place, ready to be printed automatically in the correct places on our checks. We simply input the payee's numeric code and the amount, and the CPA presented a printed



## Just like these Fully Trained Electronics Professionals



"Thanks to CIE I have tripled my previous salary, and I am now in a challenging and rewarding new field where only the sky is the limit."

Daniel Wade Reynolds  
Industrial Electrician  
Ore-Ida Foods



"CIE was recommended to me by my boss. It was appealing since I could study at my own pace at home and during business travel."

Dan Parks  
Marketing Manager/Consumer Products  
Analog Devices, Inc.



"I loved the flexibility CIE offered. It was the only way I could continue both school and my demanding job."

Britt A. Hanks  
Director of Engineering  
Petroleum Helicopters, Inc.



"I liked the way the school was set up with laboratory assignments to enforce conceptual learning. The thing which impressed me the most about CIE's curriculum is the way they show application for all the theory that is presented."

Daniel N. Parkman  
Missile Electro-Mechanical Technician  
U.S. Air Force



"Completing the course gave me the ability to efficiently troubleshoot modern microprocessor based audio and video systems and enjoy a sense of job security."

Tony Reynolds  
Service Manager/Technician  
Threshold Audio & Video

# Graduate with an Associate Degree from CIE!

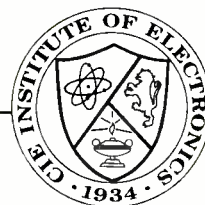

CIE is the best educational value you can receive if you want to learn about electronics, and earn a good income with that knowledge. CIE's reputation as the world leader in home study electronics is based solely on the success of our graduates. And we've earned our reputation with an unconditional commitment to provide our students with the very best electronics training.

Just ask any of the 150,000-plus graduates of the Cleveland Institute of Electronics who are working in high-paying positions with aerospace, computer, medical, automotive and communications firms throughout the world. They'll tell you success didn't come easy...but it did come...thanks to their CIE training. And today, a career in electronics offers more rewards than ever before.

### CIE'S COMMITTED TO BEING THE BEST...IN ONE AREA...ELECTRONICS.

CIE isn't another be-everything-to-everyone school. CIE teaches only one subject and we believe we're the best at what we do. Also, CIE is accredited by the National Home Study Council. And with more than 1,000 graduates each year, we're the largest home study school specializing exclusively in electronics. CIE has been training career-minded students for nearly sixty years and we're the best at our subject...  
**ELECTRONICS... IT'S THE ONLY SUBJECT WE TEACH!**

### CIE PROVIDES A LEARNING METHOD SO GOOD IT'S PATENTED.

CIE's AUTO-PRO-GRAMMED® lessons are a proven learning method for building valuable electronics

career skills. Each lesson is designed to take you step-by-step and principle-by-principle. And while all of CIE's lessons are designed for independent study, CIE's instructors are personally available to assist you with just a toll free call. The result is practical training... the kind of experience you can put to work in today's marketplace.

### LEARN BY DOING...WITH STATE-OF-THE-ART EQUIPMENT AND TRAINING.

CIE pioneered the first Electronics Laboratory



Course and the first Microprocessor Course. Today, no other home study school can match CIE's state-of-the-art equipment and training. And all your laboratory equipment, books and lessons are included in your tuition. It's all yours to use while you study and for on-the-job after you graduate.

### PERSONALIZED TRAINING...TO MATCH YOUR BACKGROUND.

While some of our students have a working knowledge of electronics others are just starting out. That's why CIE has developed twelve career courses and an A.A.S. Degree program to choose from. So, even if you're not sure which electronics career is best for you, CIE can get you started with core lessons applicable to all areas in

electronics. And every CIE Course earns credit towards the completion of your Associate in Applied Science Degree. So you can work toward your degree in stages or as fast as you wish. In fact, CIE is the only school that actually rewards you for fast study, which can save you money.



**YES!**

I want to get started. Send me my CIE course catalog including details about the Associate Degree Program. (For your convenience, CIE will have a representative contact you - there is no obligation.)

Please Print Clearly

**AH46**

Name \_\_\_\_\_

Address \_\_\_\_\_

City \_\_\_\_\_

State \_\_\_\_\_ Zip \_\_\_\_\_ Age \_\_\_\_\_

Phone No. \_\_\_\_\_

Check box for G.I. Bill Benefits.

Veteran  
 Active Duty

Cleveland Institute of Electronics, Inc.  
1776 East 17th Street  
Cleveland, OH 44114

A School of Thousands.  
A Class of One. Since 1934.

Send for CIE's FREE Course Catalog and See How We Can Help Your Career Too!

check in about 20 seconds—and simultaneously deducted the amount and calculated the new balance.

Between one monthly bill-paying marathon and the next, the CPA didn't sit unused in a desk drawer, although we did tend to leave it in our home office. We really do prefer to travel lightly, and are unlikely to carry a purse or briefcase to the supermarket or doctor's office, so we found the unit a bit bulky to carry around at all times. But we had no trouble entering information about our financial activities at the end of the day.

We used the CPA to update our checking accounts—recording all deposits, ATM withdrawals, and check activity. (Deposits can be categorized as salary, bonus, commission, gift, dividend, or other income.) Cash withdrawals and service fees are entered as if they were checks, but "0" is entered for the check number. When our bank statements arrived, we used the CPA to quickly reconcile the accounts with the records stored in the CPA's memory. Unfortunately, there is no way to have the CPA "remember" to deduct banking fees and electronic payments on a monthly basis; those have to be input manually, although using the payee list speeds up the process a bit.

We also put the CPA to work recording our day-to-day cash and credit-card expenditures. The cash function allows users to input the date, amount, a memo notation, whether it's a business or personal expense, whether or not it's tax related, and the category. To go back and check your cash records, you can scroll through them or search by date. The credit-card function demands a bit of setup time, during which the user must input the card name, account number, balance, and credit limit for up to ten cards. Once the card list is complete, however, recording purchases is done in the same manner as for cash. To safeguard that information, we took advantage of the CPA's password protection.

Finally, we used the CPA as a calculator—there were no surprises there—and as a phone directory. Users can enter up to 50 names and phone numbers. The CPA sorts them alphabetically by first name (unless you enter first name last), and you can search for numbers by inputting the name or by scrolling through the entire directory.

You can also get printouts of check, credit-card, and cash transactions. Pressing the REPORT key calls up a menu from which you can choose what to print. For checking account reports, you can select "all" to see a full accounting of all activity, or you can request printouts by date, check numbers, payee name, category, tax-related, business, or personal. The report can be viewed on screen before printing. Credit-card and cash reports can be

sorted by the same categories, with the exceptions of payee name and check number.

Printing is intended to be done at a desk, not on the road. The CPA comes with a paper feeder that attaches to the left side of the unit and a roll of calculator-type paper (interestingly, you can't print out calculations). The paper feeds through the bottom compartment and out the left side. There is no paper cutter.

The CPA can store up to 1000 check entries, 600 credit-card or cash entries, and 50 phone numbers in its 128K, lithium-battery-backed memory. People who write a lot of checks (or wear out their charge cards) might want to keep printed records of older transactions and then delete them from memory. To keep permanent electronic records, an optional interface box allows data to be transferred to a personal computer. The CPA is compatible with the popular Quicken financial-management program. (A review of Quicken 2.0 for Windows follows this review.)

Unfortunately, we were not able to test Panasonic's interface package, which missed its scheduled release date (and our deadline). From what we could garner from a faxed copy of the manual, the software is a rather straightforward communications package. The menu-driven program, CPALink, lets you receive files from the CPA, send files to it, create an ASCII or QIF (Quicken data), merge data, view information on screen, and set up communications parameters.

Faithfully recording all your transactions in the CPA is a good first step toward taking control of your money. You can take a giant leap toward that goal, however, by linking the CPA to a personal computer equipped with Quicken. Carry the CPA around with you to be sure that you capture every transaction electronically. Then transfer that data to Quicken, which can handle virtually all your personal and small-business financial planning needs.

The Check Printing Accountant has one major "flaw": It's only as good as its user. It can't keep an accurate running balance of your checking account if you forget to tell it that you took out \$200 last Friday night. It can't let you know that you're approaching the limit on your Visa card if you forget to mention that you charged a \$650 television and \$200 worth of clothing. As with any financial-management program, commitment is required. We doubt that our bank-switching friend would have the patience to keep up with the CPA; our neighbor with the computer (and Quicken) would be an ideal CPA user, however. As for us—well, we're not financially independent yet, but at least both checking accounts are balanced to the penny for a change! ■

## Money Matters

**QUICKEN VERSION 2.0 FOR WINDOWS.** From Intuit, P. O. Box 3014, Menlo Park, CA 94026. Price: \$69.95.

We originally requested a copy of *Intuit's Quicken 2.0 for Windows* personal finance software to supplement our review of the Panasonic Check Printing Accountant (CPA). After using the program for a month, however, we realized that it deserved more than a mere mention within another review.

Most of us lead more complicated financial lives than the day-to-day activities of checking, credit-card, and cash accounts tracked by the CPA. We have assets—savings, homes, cars—and we have liabilities—credit-card debt, mortgages, car loans. We have various investments—retirement accounts, mutual funds, stock and bonds. Many of us would like to come up with some kind of budget that we could stick to. (Unfortunately, budgeting is about as easy as finding a diet that works.) And we all have to pay taxes. Quicken can help you take charge of every aspect of your personal and small-business finances.

The most basic Quicken functions parallel those of the CPA—it provides check registers, reconciles bank statements, tracks credit-card and cash expenditures, prints checks, and categorizes expenditures and income—but with several advantages. Obviously, entering information with a full-sized keyboard and by pointing and clicking a mouse is much faster and easier than trying to type on the CPA's miniature keyboard. Even sticking only to the basics, Quicken is immeasurably more powerful, allowing up to 225 separate checking, savings, credit-card, cash, investment, and other accounts to be tracked. And, if you write a check to pay your MasterCard or add funds to your savings account, Quicken automatically "transfers" the correct amount (deducts it from checking and deposits it to the appropriate account) in one seamless transaction. The Quicken category list is quite extensive, and can be customized with subcategories and new categories to match your lifestyle. (For example, we were able to add "pets" and "books" to our expense categories—something the CPA didn't allow.) When categorizing expenses, a feature called "split" allows one item to be placed into two or more categories—for instance, to divide your mortgage payment into principle and interest—for more accurate tracking. And printing checks with Quicken is a breeze, when using special Quicken checks, thanks to Intuit's patented check-alignment technology.



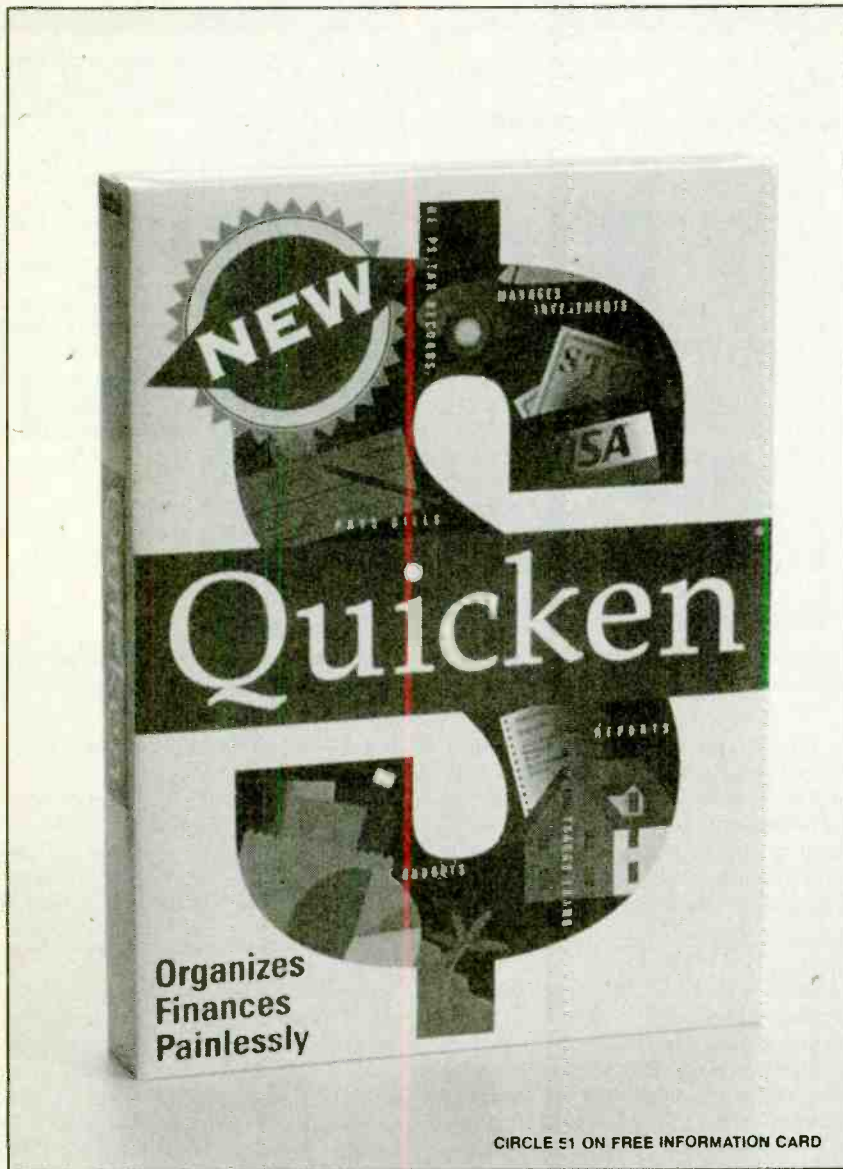

allows you to postulate your status years from now, using what it calls "financial-planning calculators" to create "what if?" scenarios. The loan planner lets you figure out payment schedules and remaining principle by specifying the amount borrowed, length of term, periods per year, and interest rate. The retirement planner asks for your current savings, annual yield, annual contribution, your age now, retirement age, how long you plan to stick around after that, and other retirement income. It then lets you know what your annual retirement income would be. Similar planners are included for investment accounts and college savings.

For small businesses—which represent more than half of all Quicken users—Quicken 2.0 for Windows provides a wealth of bookkeeping services. It can generate income statements, balance sheets, and cash-flow reports, and can manage income and expenses for individual clients, jobs, and properties. It can link to *QuickInvoice for Windows* to produce invoices and to *QuickPay for Windows* to calculate deductions and withholdings from the payroll checks that it can print.

Taxes are a major headache for businesses and individuals alike, but Quicken can make things a bit easier when April 15 rolls around. You can tag every tax-related transaction, print out tax summaries, and even export that data to tax-preparation programs such as TurboTax.

Finally, Quicken offers automation. According to Intuit president Scott Cook, "We're working toward the day when users receive and act on all financial matters electronically—without paper transactions." As it now stands, Quicken allows you pay your bills electronically by setting up a special account with Check-Free Corporation, which offers Quicken users a free one-month trial subscription. Quicken also offers its own "electronic" credit card. The IntelliCharge provides monthly statements on diskette; that information can also be downloaded by modem. IntelliCharge assigns categories as it automatically updates your charge-card account register, and then writes a check to pay the bill.

Quicken's tremendous popularity (it holds a 70% market share and has been gaining more than a million new users every year) stems not only from its immense capabilities but also from its highly-touted ease of use. We selected a product tester who avoids using a PC outside the office, has never used an electronic financial planner, and has little experience with Windows—or with financial planning, for that matter.

The task of gaining even basic proficiency seemed daunting—until the program was loaded. Intuit certainly lives up to its name with Quicken; learning the program

But those functions just hint at the power and scope of Quicken. The program also allows you to set up a budget, in which you enter your estimates of how much you are likely to earn and spend each month, broken into categories that you've selected. Budgets can be as precise as you like. For instance, you might divide your car expenses into fuel, maintenance, repairs, insurance, and loan payments—or you might lump all that together under the single heading, "auto." How well are you doing on your budget? If you are accurately tracking your spending (using the CPA or directly entering the information into Quicken), then you can automatically print a report that compares your ideal budget with the actual amounts you've brought in and laid out. Those reports can be customized in all sorts of ways, and can be colorfully depicted in bar and pie graphs.

Quicken's report and graph functions

are not only visually impressive and informative, but also inspiring. Just as a dieter seeks confirmation of success with scales and tape measures, a financial planner can see graphic evidence of the budget program's success via Quicken's reports and charts.

We've still only skimmed the surface. Quicken can also track all of your investment accounts—stocks, bonds, mutual funds, IRA's, and CD's. It provides reports and graphs that show price history, performance, and portfolio value—and prices can be imported from on-line services such as Prodigy. It can also track your assets, including the value of your home and any improvements that you make. It can also track your loans, calculating the interest on fixed and variable loans and even handling prepayments and late fees.

Because financial planning concerns the future as much as the present, Quicken



is an intuitive process. A printed *Getting Started Guide* is included along with the 320-page *User's Guide*. There also are on-screen tutorials on both Quicken and Windows, and pull-down help for virtually every function. And messages called "QCards" pop up at any stage in the game where the programmers thought you might need more information. The program makes full use of the easy-to-manuever Windows environment—all it takes to access any function (including the help function) is a quick mouse click on the icon bar.

Our tester actually used Quicken for several sessions before opening either printed manual—not recommended procedure, but an endorsement of the thoroughness of the on-screen help. She first consulted the manual not for clarification of the program, but for suggestions on setting up a budget. With no outside help—although Intuit is renowned for its helpful technical-assistance hotline—she managed to tally a month's worth of a family's financial activities, create retirement and investment scenarios, print checks and reports, and analyze the family's financial picture. She didn't have a stock portfolio to track, but she expressed interest in the IntelliCharge and the CheckFree service—quite an about-face for a non-computer type. In fact, she's hooked.

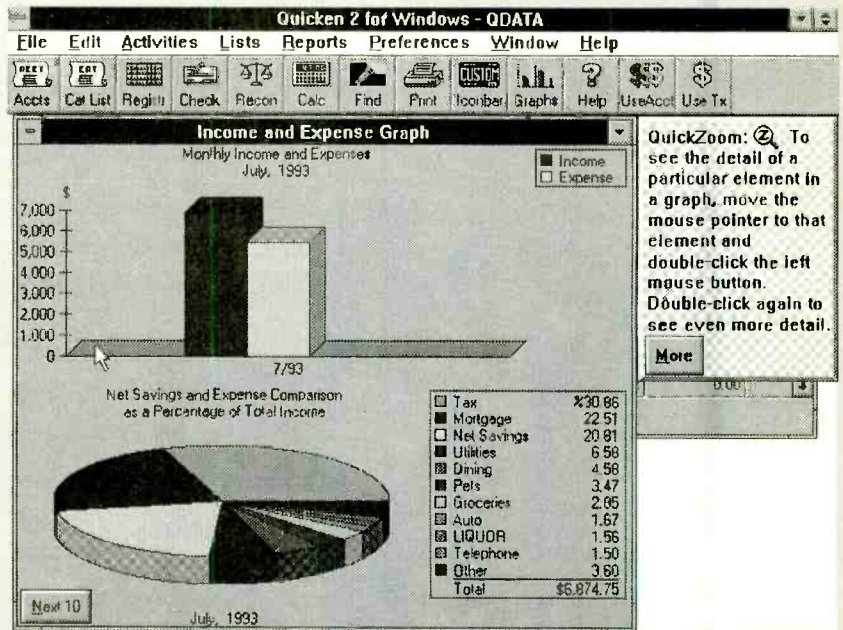

Quicken makes it easy to generate charts and graphs depicting your net worth, how well you're sticking to your budget, and other pertinent financial information.

Together, the CPA and Quicken could make a pretty good team—after all, unless you're hooked on the Home Shopping Network, most of your spending is done away from your desk. But most people would do just as well simply jotting down all expenses on a notepad, and then input-

ting them each evening, or once a week, into Quicken.

We, however, are looking forward to the introduction of the pen-based Zoomer personal digital assistant from Casio and Tandy, which will include *Pocket Quicken* for tracking all of our on-the-go spending! ■

## Two Thumbs Up!

**THUMBS UP VIDEO EDITOR.** Manufactured by: Videonics, 1370 Dell Avenue, Campbell, CA 95008. Price: \$199.

Close to twenty-million Americans now own camcorders. But only a small fraction of those home videographers really strive for professional results. Let's face it: Not many folks have the talent, or even the desire, to be the next Fellini or Spielberg. Most of them just want to record the important moments in their kids' lives—from birth through college graduation—and capture for posterity a few family vacations, weddings, surprise parties, and reunions.

Even those who are aware of the drastic improvement that can be achieved by post-production editing are often unwilling to buy expensive video-editing devices or spend the time needed to master their complex controls. It's easier to take the low-tech road and merely fast-forward through the dull parts.

But that's not true any more. Now even people who are all thumbs can edit their home videos easily with the *Thumbs Up* video editor from Videonics. With just two

main editing controls, the device was designed for simplicity.

Fans of Siskell and Ebert won't need the manual to explain the controls: If you like what you're watching, press the thumb-up button to copy it; if you don't like it, pressing the thumb-down button will edit the boring parts out.

A simple editor isn't of much use if it's not simple to hook up. Fortunately, getting *Thumbs Up* up and running is an easy process. It accepts a video (or an S-video) input from a camcorder (or source VCR) and provides a video (or an S-video) output for the recording VCR. (There are no audio connections on *Thumbs Up*—the source and recording VCR's are connected together directly.) Unfortunately, only a single, too-short cable is included with *Thumbs Up*—something that could frustrate the unprepared.

After the cables are connected, the *Thumbs Up* unit must be configured so that it can control the recording VCR with its infrared signals. It's not necessary to look up a manufacturer code for your VCR. Instead, you manually scan through VCR codes until the *Thumbs Up* operates your VCR.

The complete process requires that you set the recording VCR to its recording mode, and then hold a button down as

*Thumbs Up* scans through as many as 67 codes. When the recording VCR enters its pause mode, you release the button. We found it to be a quick and easy way to set up the unit. One test subject—an admitted technophobe (and proud of it)—had a little trouble: Because she didn't release the button quickly enough, *Thumbs Up* had already scanned to the next code. But that problem was the exception to the rule.

In its simplest mode, called "instant editing," *Thumbs Up* functions merely as a play/pause control. The source VCR is started, and when scenes that you want to include in your edited tape appear on screen, you press the thumb-up button. When the scene is over, you press the thumb-down button. The same results, of course, could be obtained by pressing the record and pause controls on the recording VCR. The one value-added feature with *Thumbs Up* instant editing, however, is that a fade to black can be added between scenes. That's especially helpful for recording VCR's that don't have a flying erase head, because the distortion and picture jitter that accompany the start of scenes are masked.

As you might expect, *Thumbs Up* is more than a pause control. Instead of the simple instant-editing mode, it can perform automatic editing with edit control.



In the automatic-edit mode, you watch the camcorder video and use the thumb buttons to mark where the good segments start and where they end. When you've marked all of the scenes you want to include, you rewind the source tape and press the Edit button. Then Thumbs Up automatically controls the recording VCR, starting and pausing it as the desired scenes roll by. (We should note here that the editing "markers" are not recorded on the tape. Instead, Thumbs Up memorizes the times of the scenes, and starts the recording VCR at the appropriate times.)

Automatic editing won't work with all camcorders. In the best case, the camcorder will have a real-time counter and will feature edit control. Thumbs Up is compatible with two kinds of edit control. First is Control-L or LANC, which is provided on many camcorders made by Sony and Canon. (Sony also manufactures some editing VCR's with Control-L capability, and manufactures camcorders for Ricoh, Nikon, Kyocera, and Yashika.) Second is a Panasonic 5-pin control found on some Matsushita-manufactured camcorders (including Panasonic, National, Quasar, and others). Thumbs Up will not work with Synchro-edit or Control-S. Cables to interface the Control-L or Panasonic 5-pin connectors to Thumbs Up are available but, unfortunately, they are not included with the unit.

If your camcorder supports it, automatic editing offers tremendous advantages over instant editing. After marking the scenes—up to 62 of them—you can preview them and make changes if you wish. In preview mode, the camcorder fast-forwards past the "thumbs down" portions. Another advantage of automatic editing is that when Thumbs Up and the camcorder are connected with an edit-control cable, the play, rewind, fast-forward, pause, and stop buttons on Thumbs Up can control the camcorder.

Thumbs Up also supports the timecodes that some more advanced camcorders add to tapes. The timecodes help to eliminate problems caused by inaccurate real-time counters. The two consumer camcorder timecode formats are supported. First is the Sony RC format. Second is the VITC (vertical-interval timecode) developed by the SMPTE (Society of Motion Picture and Television Engineers).

Even if your camcorder lacks edit control and timecode generation, you don't have to be limited to instant editing. Instead, Thumbs Up can make a timecoded copy of any tape! The copy will have the accuracy advantage that timecode provides. The disadvantage of this method is that your final production will be a copy of a copy, that is, a third-generation copy. Thumbs Up does include a video enhancer that can counteract some of the adverse effects of tape copying. With reasonably good equipment, a third-generation tape can be more than adequate. And the improved editing accuracy is easy to see.

Another potential disadvantage of making a timecoded copy is that you need another VCR or camcorder of the same format, or you'll have to switch your source VCR. For example, if your original source tape is from an 8mm camcorder, you'll want to record it on another 8mm tape so that you can continue to use your camcorder as a source. If you have two VHS VCR's, you might prefer to make the timecoded copy on a VHS tape, and then use one VHS VCR as the source, and the other for the recorder. (Since most VHS VCR's lack any edit control, it's not necessarily an attractive option.)

After the desired scenes are stored in the Thumbs Up memory, you're ready to preview the scenes or create the edited copy. (Pressing the PREVIEW button instead of the EDIT button plays the source tape without putting the recording VCR into the record mode.) If the source camcorder of-

fers edit control, then it fast-forwards through the "thumbs down" segments.

To edit a tape with timecodes on a VCR or camcorder without edit control, you simply place the recording VCR in its record-pause mode, and start the source tape. When the desired scenes occur, the recording VCR will enter the record mode, and it will return to its record-pause mode. A potential problem can occur if your source tape has long gaps between desired scenes. That's because most VCR's will not stay in their pause modes for more than a few minutes. You can either return the recording VCR to its record-pause mode before the desired scene comes by, or you can help things along by manually fast-forwarding the source camcorder.

It is possible to assemble scenes from more than one tape. In the instant edit mode, all that's required is that you swap tapes, of course. For automatic, however, editing, you can assign each tape a number, mark scenes for each tape, and then edit them one by one. You must tell Thumbs Up which tape you're inserting, and you must rewind the tapes and zero the real-time counter when they're inserted. (That's not necessary for timecoded tapes, which contain the timing information on the tape itself.)

Rearranging scenes can also be done, but not automatically. You can fast-forward past scenes that you want to insert at a point later in your edited tape, and Thumbs Up will still stop at the desired subsequent scenes that were marked. You can then rewind to the earlier scenes and transfer them to your edited copy. That process required a little too much paperwork and attention to detail. We preferred a "trick" suggested in the reference manual. We marked the scenes that we wanted to record first as being on "tape 1," and the scenes we wanted to record after as being on tape 2 and tape 3.

Owners of Videonics' Video TitleMaker will appreciate the ability of Thumbs Up to control the TitleMaker and insert titles in the right spots. And users who edit on the run will appreciate that Thumbs Up can be powered by four "AA" batteries.

We are impressed by the design of Thumbs Up. Thumbs Up can be embarrassingly simple, as in its instant-edit mode, but its more sophisticated features actually make it *easier* to use. Thumbs Up's ability to work with virtually any camcorder and VCR is noteworthy, and its ability to use timecodes is significant.

Videonics has come up with a video editor that would serve the great majority of camcorder owners perfectly. It won't satisfy pro or semi-pro camcorder users nor high-end videophiles, but Thumbs Up contains the features that are most needed in a video editor, and at a price that is hard to pass up.



CIRCLE 52 ON FREE INFORMATION CARD



## Step by Step

**MODEL SPT-1500 SPORTABLE PERSONAL AM/FM CASSETTE PLAYER WITH BUILT-IN Pedometer AND CALORIE COUNTER.** Manufactured by Sanyo, 21350 Lassen Street, Chatsworth, CA 91311-2329. Price: \$69.99.

It's getting harder all the time to ignore the obvious truth: Sitting on the couch watching TV, eating buttered popcorn, and drinking beer makes you fat. Swimming, biking, hiking, jogging, stepping, or plain old walking can go a long way toward countering the effects of too many hours on the couch, if—to paraphrase a popular athletic-shoe ad—you actually make yourself get up and do it. A lot of us are doing just that.

Despite the fact that record numbers of folks are out there working out, many people find exercise for the sake of exercise (as opposed to a friendly game of softball or going out dancing, both of which are often accompanied by fattening alcoholic beverages) to be deadly dull. Those who are dedicated to keeping up a fitness routine find ways to lessen the boredom, perhaps by involving a friend (misery loves company), but most often with music. A personal stereo seems as integral a part of the jogger's equipment as a good pair of running shoes.

Sanyo has come up with a way to combine the entertainment provided by a personal AM/FM stereo cassette player with an added incentive to joggers and walkers—a built-in pedometer and calorie counter. The *Sportable Model SPT-1500* lets users set up a customized exercise program that takes into account their current weight, pace, stride length, and goals.

The Sportable looks like a digital AM/FM personal stereo—but looks can be deceiving. The LCD doesn't display the station frequency; tuning is done on an analog sliderule dial. The display keeps the user posted on workout information, and is used during programming.

Programming is a straightforward affair, in spite of the "manual" included with the unit—actually, a 14 × 20-inch sheet of paper folded to 3 × 5-inch size, tightly printed on both sides in a confusing mixture of English and Spanish, with directions read left to right, or sometimes right to left. (Don't get us started on trying to *refold* it!)

In any case, before beginning to exercise you must provide the Sportable with some basic data about yourself and your workout routine. A press of the PROG button begins each stage of the programming process, during which you use the SEL button to enter your exercise style



CIRCLE 53 ON FREE INFORMATION CARD

(choosing between walking, speed walking, or jogging), the length of your stride (from 10 to 100 inches), the distance you plan to cover (between 1 and 50 miles, no fractions allowed), your pace (between 70 and 220 strides per minute, and your weight (between 60 and 260 pounds—don't cheat!). A final press of the PROG button completes the process.

After we programmed the Sportable, we were ready to start moving. We slipped in a tape, put on the headphones, and pressed the START/STOP button. A pace tone sounded for about 30 seconds, allowing us to match our stride to the pace we'd selected during programming. (We had to stop and reprogram at that point. The first pace that we had set—aiming low, since we don't do much walking ordinarily—resembled the stately march down the aisle at a wedding. We had to scroll through each step in the process to change the pace setting.) The volume of the pace tone cannot be changed, but you can turn it off by pressing the PACE button. You can also turn it back on at any time during your workout, if you suspect you might be lagging behind

your projected pace. With the pace properly reset, we began our walk, keeping an eye on the display to see how many calories we were burning off.

When, after ten minutes or so, nothing seemed to be happening, we went back and read the *back* of the instruction paper, titled "Helpful Hints Before Beginning to Exercise." The first "hint" was to wear the Sportable at your waist, clipping it to your belt or waistband, or to the bright-yellow nylon belt that's included with the unit. Accurate measurement depends on the proper position of the Sportable. The unit counts every step you take by detecting your up and down motions, so it won't work properly if you drag your feet, are walking up or down a steep incline, or bounce while standing in place. The instructions also provide helpful hints on the correct form to use when exercise walking—back straight, come down heel first, swing your arms, breath steadily, and the like.

With the unit properly in place, we began our walk again, keeping time with the beeping pace tone, and listening to a favor-



# “Last February my company was in a slow period. One after another, my co-workers were being laid off ...



...I was seriously worried I would be next. One day I was asked to go to the main office. I never imagined the NRI course I took in Microcomputer Servicing would help me keep my job — but that day I wasn't given a pink slip. Instead, I got a desk with a computer and a new position! Thanks to my NRI training, I am still working today — training field personnel in computer operation. Aside from keeping me employed, it made my ego soar! Because of my new-found skills and my company's computer sophistication, we have done well in a recessed market — and I have more job stability than I ever thought possible.”

— John Ricca, Falls Church, VA

Even though NRI graduate John Ricca says he began his course to elevate himself from a “very early stage hacker” to a “late stage hacker,” and not specifically to enhance his career or job stability, having the NRI course under his belt made him that much more indispensable to his company in uncertain times. NRI's course in microcomputers helped John Ricca and thousands of others, and we can help you, too. Here's how:

## The NRI Difference

When you train with NRI, you're completely prepared for a high-paying position as a computer service technician, even a computer service business of your own! Regardless of your previous electronics background, you can succeed with NRI, the leader in career-building at-home electronics training for over 78 years. You begin with the basics, rapidly building on the fundamentals of electronics to master today's advanced microcomputer concepts

through detailed, yet easy-to-understand lessons and Action Learning Kits.

## NRI's Learn-By-Doing Approach

NRI's highly acclaimed learn-by-doing approach gives you a complete understanding of the intricate electronics behind the 1 meg RAM, 32-bit CPU computer system included in your course. You perform hands-on electronics experiments with your NRI Discovery Lab and digital multimeter, then build and test the powerful 486sx/25 MHz

Now NRI offers hands-on training with a powerful 486sx/25 MHz computer!

computer you train with and keep. You install the 1.2 meg, 5-1/4" floppy disk drive, learning disk drive operation and adjustment. Later, you dramatically improve your computer's data storage capacity by installing a powerful 80 meg IDE hard drive. You even learn to diagnose and service virtually any com-

puter problem with the extraordinary R.A.C.E.R. plug-in diagnostic card and QuickTech diagnostic software included in your course.

## NRI's At-Home Advantage

With NRI, you study in the privacy and convenience of your own home — with your personal instructor and NRI's team of technical professionals behind you every step of the way. You learn at your own pace — no classroom pressures, no night school, no need to quit your present job until you're ready to make your move.

Step by step you're guided through the assembly of a powerful 486sx-based computer system — the centerpiece of your coursework — complete with monitor, floppy drive, 80 meg hard drive, operating and applications software. You get the hands-on experience you need to work with, troubleshoot, and service any IBM PC/AT-compatible computer, plus the confidence to tackle any job you take on.

What's more, you work with today's most popular integrated software package, Microsoft Works, learning to use its word processing, spreadsheet, database, and communications utilities for your own personal and professional applications.

## Learn More About NRI Today

You can be NRI's next success story. Send today for NRI's free, full-color catalog which describes every aspect of NRI's innovative computer training, as well as hands-on training in other growing high-tech fields. If the coupon is missing, write to NRI Schools, 4401 Connecticut Avenue, NW, Washington, DC 20008.

**SEND FOR FREE CATALOG!**

**NRI Schools**



McGraw-Hill Continuing Education Center  
4401 Connecticut Avenue, NW, Washington, DC 20008

Check one FREE catalog only:

- |  |  |
|--|--|
| <input type="checkbox"/> MICROCOMPUTER SERVICING           | <input type="checkbox"/> Computer Programming            |
| <input type="checkbox"/> TV/Video/Audio Servicing          | <input type="checkbox"/> Desktop Publishing & Design     |
| <input type="checkbox"/> Industrial Electronics & Robotics | <input type="checkbox"/> PC Applications Specialist      |
| <input type="checkbox"/> Basic Electronics                 | <input type="checkbox"/> Programming in C++ with Windows |
| <input type="checkbox"/> Computer-Aided Drafting           |  |

Name	Age
Address	
City	State Zip

18-1193



ite, up-beat tape. Music does make exercise walking more enjoyable, and occasionally activating the pace tone ensured that we kept in step. This time, the Sportable kept accurate tabs of our activity and the energy expended in calories. (We don't exercise by walking around a track, so keeping track of the distance we've covered is usually difficult.) It was nice to know when we had reached the one-mile mark in our rambles around the neighborhood; then we could turn around and walk back to complete a two-mile workout. We also appreciated learning how many calories we'd burned off while walking.

Our other favorite walking spot, at least in the summer months, is the beach. But we didn't take the Sportable down to the shore, for fear of getting sand or water inside it. We'd have liked to see a more rugged, weatherized case on a personal stereo that is specifically designed for outdoor use.

The Sportable, however, is actually a low-end personal stereo with some neat high-tech features tacked on. The tape player and radio are nothing to write home about, despite the addition of BassXpander bass-boosting circuitry and a feature called PVSS (peak-volume select switch). According to the manual, when using the Sportable for a long time, switching on the PVSS feature will "automatically set a comfortable listening level." According to the press kit, PVSS "allows the user to cut down volume quickly and easily." According to our tests, activating PVSS slightly reduced the volume—but it's easier to use the larger, more accessible volume control.

The Sportable's weakest point is its tuning capability. We don't live in a poor-reception area, yet we were unable to tune in any of the FM stations that we regularly enjoy while walking. In fact, one classic-rock station and one easy-listening station (both of which broadcast locally) were all that we could receive with reliable stereo. We did better on the AM band but, not surprisingly, we tended to use the tape player more than the radio.

The Sportable's sound quality is adequate for its intended purposes—after all, most people aren't that acoustically discriminating while they're huffing and puffing through a workout. The bass-boosting circuitry allows the sound to be tailored by an adequate amount.

Sure, Sanyo could have put a better radio in the Sportable. But if you're looking for high-fidelity sound and digital tuning, there are plenty of models on the market (including a few from Sanyo) that you can choose from. If, however, you're looking for a personal stereo with built-in pedometer and calorie-counter, the Sportable is one of a kind. ■

## You Rang?

**LLOYD'S MODEL CR400 WIRELESS INTERCOM AND CLOCK RADIO.** Manufactured by Cobra Electronics Corporation, 6500 West Cortland St., Chicago, IL 60635. Price: \$54.95.

The average sizes of our homes and our families are getting smaller, according to recent demographic studies. However, the noise level within those homes is on the rise—particularly if any members of those shrinking families happen to be children. Kids have never been quiet, but these days, added to the traditional laughs, shouts, fights, and other kid-generated din, are the sounds of video games, "kid-vids" watched over and over at high volume, and computer games. Children aside, consider bookshelf stereos in almost every room, stereo TV's with surround sound, gas-powered lawnmowers and snow blowers, power tools, coffee grinders, food processors . . . it's a wonder we can hear ourselves think.

If you're having trouble making yourself heard over the cacophony of electronic and human sounds filling your home, an intercom system might ease communications and save your vocal cords. If you're not put off by the thought of an intercom that doubles as a clock radio (thus, adding the sounds of a radio and alarm!) Lloyd's Model CR400 could do the trick.

The basic package includes two pieces: a clock/radio base station and a remote intercom station. Additional remote intercoms can be purchased separately (Model IN400, \$24.96 each) to link up the whole house. The attractive base unit is a full-featured clock radio (digital clock, analog-tuned radio), with a snooze bar, battery backup, and a display-dimmer control—and, of course, intercom controls. The remote unit resembles a small, stand-alone speaker, with the addition of intercom

controls. Both units can either sit on a table top or be mounted on a wall.

The system requires no fancy installation. Voice and radio programming are transmitted over standard household AC wiring, so the entire setup process consists of plugging in each unit and setting the time and alarm-time on the clock radio.

As a clock radio, the CR400 offers no surprises. A 9-volt backup battery stores the time and alarm settings so that a power interruption doesn't result in an annoying flashing display. You wake up to either the alarm's buzzer or the AM/FM radio. By pressing the SLEEP button, you can fall asleep to the radio; it will automatically shut off 59 minutes after the button is pressed unless you program a different shut-off time. Pressing the snooze bar gives you an extra nine minutes of sleep time before the alarm sounds again.

As an intercom, the remote station can be placed in any room of the house, or even out in the garage. For basic intercom use, the radio is first turned off at the base station, and the intercom-function switches on both units are placed in the "on" position. Depressing the TALK button, you speak into either the base unit or a remote station. (Only one person can talk at a time.) To let everyone know that you have something to say, you can press the call alert button, which sends a tone to all stations that are turned on, before speaking.

It's not actually necessary to turn off the radio before using the intercom. In fact, you can send the radio signal (FM only) to the remote stations in other rooms simply by sliding the intercom function switch to the "music" position while the radio is on. Then, to send an intercom message, the function switch on the base unit must be slid back to the "on" position.

Without putting the function switch in the music position, the radio will be heard only at the base station. Pressing the TALK button on either the base or any remote



CIRCLE 54 ON FREE INFORMATION CARD



unit automatically mutes the radio to allow the conversation to be clearly heard. The radio comes back on six seconds after the TALK button is released, allowing time for a response. Unfortunately, when the base stations are used to listen to the radio, they cannot function as intercoms; they can't "call" the base station, for example.

We were in the midst of our annual garage cleaning (a task that took several weekends and evenings since we skipped it the last several years!) when the Lloyd's intercom system arrived. We set up the remote station in the garage, which is located at least 50 feet from the kitchen where we had set up the clock radio. The system got a lot of use, both for sending radio signals out to the garage, and for saving our voices from screaming "Dinner's ready!" or "Can you come out and give me a hand with this?"

Cobra recommends using the system as a baby monitor. By sliding the TALK button to the right, the base or any intercom station can continually pick up sounds in the nursery. Any (or all) other station(s) can be used to monitor those sounds.

We have no babies or other children in the house, but we can imagine that speaking softly into an intercom would be highly preferable to yelling from another part of the house: "Turn off that Nintendo and do your homework!" or "Lower that music!" We also found that the intercom came in handy when trying to communicate with someone working in an air-conditioned room with the door closed, who wouldn't otherwise have been able to here us no matter how loud we yelled.

We experienced no problem with reception of either voice or radio signals on the wireless intercom system, even with the remote station out in the garage. Lloyd's plug-in intercom also has the advantage of being private—unlike most baby monitors and intercoms that broadcast your conversations to anyone with a scanner, or even another baby monitor.

Lloyd's CR400 wireless intercom and clock radio is not a high-tech, high-ticket item. It is, however, an attractive, low-profile, common-sense system that does just what it promises. ■

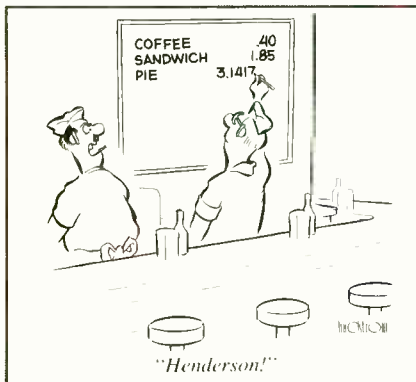

## Eight(mm) is Enough

**MODEL XD3500 8mm VCR. Manufactured by Samsung Electronics America, Inc., 105 Challenger Road, Ridgefield Park, NJ 07660. Price: \$749.95.**

The more we use the 8mm video format, the more we like it. For portable applications, its attraction is obvious: The small cassette makes for compact equipment and convenience. However, we're not using it only for camcorders any more. In home VCR decks, the 8mm format becomes more attractive as our equipment racks get more crowded. A typical 8mm deck is about a quarter of the size of a VHS model. Further, as we accumulate more camcorder-recorded tapes, we appreciate the convenience of being able to play them

control, which could be programmed to control many TV's. The programming was reasonably straightforward, and required holding the remote's TV button down while entering a number between one and fourteen. As you might expect, not all of the TV's functions can be accessed, but the basics—power, channel selection, channel scan, volume, mute, previous-channel, and screen display—can be controlled.

Because the XD3500 has a cable-capable 181-channel tuner, an automatic channel-programming feature is a welcome convenience. Simply pressing the A.PROG button on the remote control causes the VCR to scan through all channels. It "memorizes" all active channels, so that it will not stop at unused channels when the up and down channel-scan buttons are used. The ADD and ERASE buttons can be used to manually include or remove specific channels. For example, we added Channel 3 so that we could watch the output of a second VCR, and we deleted

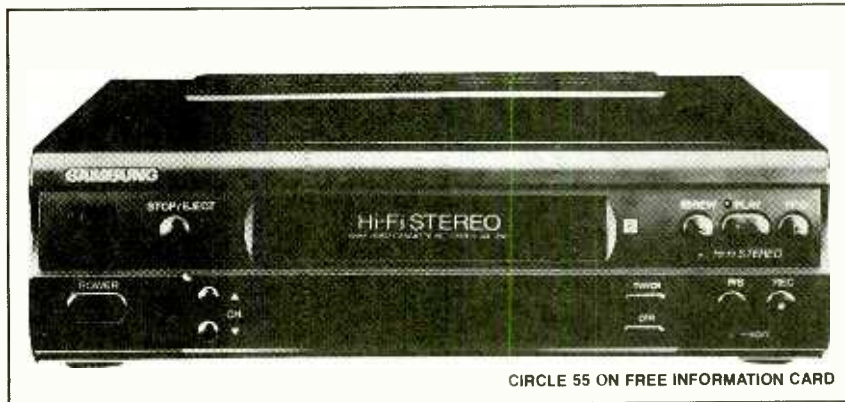

CIRCLE 55 ON FREE INFORMATION CARD

back on a VCR rather than having to hook up the camcorder. Of course, using an 8mm VCR also saves wear and tear on the camcorder.

Samsung's Model XD3500 8mm VCR is a good example of today's home 8mm decks. It measures a petite  $8\frac{7}{8} \times 2\frac{1}{2} \times 8\frac{3}{8}$ , weighs less than  $4\frac{1}{2}$  pounds, and offers a rather standard set of VCR features. The XD3500 offers both SP and LP speeds. The latter speed permits recording up to five hours on a P6-150 8mm tape. With only eleven buttons on the front panel of the unit, most of the functions are controlled with the handheld infrared remote control and a couple of on-screen menus. (The rear panel of the VCR is even more sparse than the front. One F-type connector is provided for antenna or cable input, and a second for an RF output to a TV. A switch permits either Channel 3 or 4 to be selected as the output channel. A set of six RCA-type phono plugs are provided for video and stereo-audio inputs and outputs.)

We liked the convenience of the remote

Channel 67—a home-shopping channel that we simply detest. One thing we didn't like about the automatic channel-programming feature was that the button—directly below that for calling up the on-screen programming menu—was too easy to accidentally push. Since we would expect to use the feature only when the VCR was set up the first time, we would have preferred to see the button either removed from the more commonly used buttons, or perhaps behind a door of some sort.

The on-screen programming features are rather standard. Pushing the PROG key brings up a menu with three choices. The first allows the clock to be set; the time and date are entered directly by using the numeric keys.

The second menu choice is for setting timer recordings. Up to eight programs can be entered, over a period of one year. In the program mode, the VCR prompts the user to enter the number, one through eight, of the desired program. It then prompts the user to select the desired program mode—normal, daily, or weekly—

by pressing either 1, 2, or 3, respectively, on the remote. The normal program mode is for single-event taping. The daily program mode is for recording shows that are on at the same time Monday through Friday. The weekly program is for shows that are on seven days a week. The VCR then prompts for the tape speed, and for the starting and ending times, which are entered directly with the keypad. (AM or PM is selected by pressing 1 or 2, respectively.)

Like most VCR's these days, the on-screen programming is simple, intuitively obvious, and convenient. What we didn't like, however, is that it's virtually impossible to program the VCR without turning on the TV—the VCR's front-panel display does not show any indication of the program mode or settings.

The third selection on the main program menu is for setting the operating mode of the VCR. When selected, a "Model Set" submenu is displayed. The first choice,

accessed by pressing the 1 key on the remote, sets the audio line-in mode between stereo and dual (for a second audio track, which is selected during playback with the OUTPUT button on the remote). The second choice, accessed by pressing the 2 key, toggles the tuner between broadcast and cable modes. The third, accessed with the 3 key, switches the audio mode between stereo, mono, and SAP (secondary audio programming) modes.

To accommodate people for whom even the on-screen programming is confusing, a one-touch recording mode is provided. Pressing OTR on the remote brings up a message on the TV screen and on the display. On the first press, the length of the recording is zero. Additional presses increase the OTR time by a half hour; the maximum OTR recording time is four hours.

The XD3500 offers a slow-motion playback mode. A single-frame advance is

also available. An additional feature, for dubbing tapes, is an edit mode, which compensates for the usual degradation caused by making copies of tapes.

For people who are looking for an editing deck to trim the fat out of their raw videotapes, however, the XD3500 is not an adequate solution, because it doesn't offer a LANC or other edit-control connector, which we feel is essential for anything above rough edits.

Our only other complaint, albeit a minor one—is that the front-panel display doesn't present enough information. (That's not only for programming, as mentioned earlier; it doesn't provide an indication of fast-forward or reverse functions, either.)

On the whole, however, the XD3500 performed without a hitch during our tests. We feel that it could easily serve as the main VCR for many families, even those who don't make 8mm camcorder tapes. ■

## ELECTRONICS WISH LIST

For more information on any product in this section, circle the appropriate number on the Free Information Card.



Franklin Pocket Word Games

### Pocket Word Games

Looking for something to keep boredom at bay on a long flight, or the kids occupied on a car trip? Don't want to add another pound to your luggage? Check out the credit-card-sized *Word Games* from *Franklin Electronic Publishers, Inc.* (122 Burrs Road, Mt. Holly, NJ 08060). Weighing in at a feather-light 1.9 ounces, the pint-sized unit offers ten exiting word games: Hangman, Anagrams, Jumble, Word Train, Memory Challenge, Spelling Bee, Word Blaster, Deduction, Word Builder, and Flashcards. Games can be played at five skill levels, making it suitable for children (at least those willing to overlook the absence of videogame-style graphics and sound effects) yet still challenging for adults. A SCORE key helps players track points, while "hint" and "help" messages make it easy to play. Price: \$29.95.

CIRCLE 56 ON FREE INFORMATION CARD



Samsung Home Fax Machine

### Fax Home

The fax machine became standard office and home-office equipment in the 1980's, and now manufacturers are turning to a new, largely untapped market—the home. *Samsung Electronics'* (105 Challenger Road, Ridgefield Park, NJ 07660) entry is the *Model FX40 Home Facsimile*, which can be used for such non-business purposes as ordering a pizza, requesting more money while at college, and faxing instant birthday greetings. The telephone/fax combination takes up less than one square foot of desk (or kitchen-counter) space, and has a soft, curved design to fit in with home decor. It automatically distinguishes between incoming phone and fax calls, and can be connected to an answering machine. When not in use, the FX40 can be shut off without affecting regular telephone operation. The unit offers one-touch speed dialing of 10 numbers, last-number redial, polling, and it doubles as a home copier. Price: \$399.

CIRCLE 57 ON FREE INFORMATION CARD



# Get 3 PROFESSIONAL BOOKS for only \$9.95

when you join the **ELECTRONICS ENGINEERS' BOOK CLUB®**

Values to \$149.50

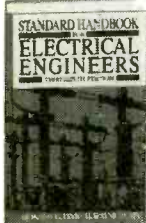

020984H-XXX \$110.50  
Counts as 3

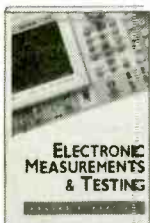

003961H \$40.00

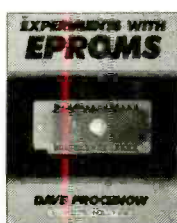

2962P \$18.95  
Softcover

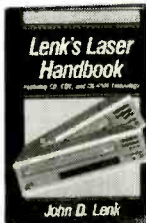

037505H \$39.50



070439H-XX \$60.00  
Counts as 2

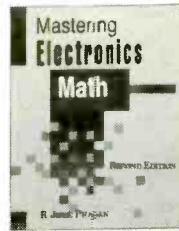

3589H \$27.95



3212H-XX \$41.95  
Counts as 2



3837H \$27.95



031716H \$50.00

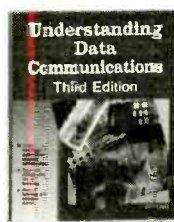

5B6312H \$24.95

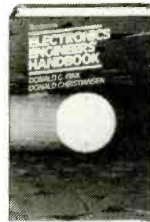

9255H-XXX \$105.50  
Counts as 3



011200H \$45.00



044847H-XX \$39.95  
Counts as 2



3279P \$24.95  
Softcover

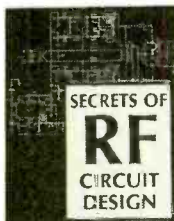

3710H \$32.95



070964H-XX \$70.00  
Counts as 2

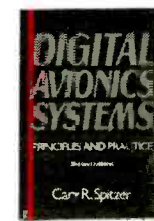

040333H \$50.00

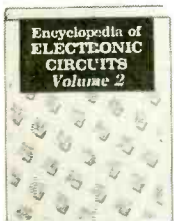

3138H-XX \$60.00  
Counts as 2



3991H \$39.95



032281H-XXX \$119.50  
Counts as 3

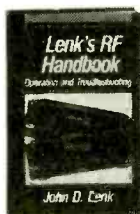

037504H \$39.50



4228H \$32.95



040769H-XX \$60.59  
Counts as 2



050806H-XX \$58.00  
Counts as 2



2627H \$49.50



3436H \$39.95

## As a member of the Electronics Engineers' Book Club . . .

. . . you'll enjoy receiving Club bulletins every 3-4 weeks containing exciting offers on the latest books in the field at savings of up to 50% off of regular publishers' prices. If you want the Main Selection do nothing and it will be shipped automatically. If you want another book, or no book at all, simply return the reply form to us by the date specified. You'll have at least 10 days to decide. And you'll be eligible for **FREE BOOKS** through the Bonus Book Program. Your only obligation is to purchase 3 more books during the next 2 years, after which you may cancel your membership at any time.

All books are hardcover unless otherwise noted. Publishers' prices shown. ©1993 EEBC  
A shipping/handling charge & sales tax will be added to all orders.  
If you select a book that counts as 2 choices, write the book number in one box and XX in the next. If you select a Counts as 3 choice, write the book number in one box and XXX in the next 2 boxes.

If coupon is missing, write to:  
Electronics Engineers' Book Club, Blue Ridge Summit, PA 17294-0860

## ELECTRONICS ENGINEERS' BOOK CLUB

Blue Ridge Summit, PA 17294-0860

**YES!** Please send me the book(s) listed below for just \$9.95, plus shipping/handling & tax. Enroll me as a member of the **Electronics Engineers' Book Club** according to the terms outlined in this ad. If not satisfied, I may return the book(s) within ten days and have my membership cancelled.

--	--	--

If you select a book that counts as 2 choices, write the book number in one box and XX in the next.  
If you select a Counts as 3 choice, write the book number in one box and XXX in the next 2 boxes.

Name \_\_\_\_\_  
Address \_\_\_\_\_  
City/State \_\_\_\_\_  
Zip \_\_\_\_\_ Phone \_\_\_\_\_

Valid for new members only, subject to acceptance by EEBC. Canada *must* remit in U.S. funds drawn on U.S. banks. Applicants outside the U.S. and Canada will receive special ordering instructions. A shipping/handling charge & sales tax will be added to all orders.

PPF1193

# ELECTRONICS WISH LIST

For more information on any product in this section, circle the appropriate number on the Free Information Card.



Bel-Tronics Cordless Telephone

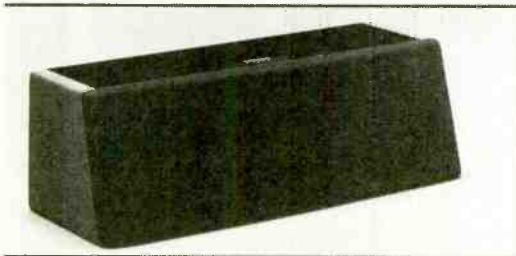

Center-Channel Speaker



Radio Shack Talking Calculator

## Cordless Conversations

*Bel-Tronics Limited* (8100 Sagi Parkway, Covington, GA 30209) is branching out from the radar-detector field and expanding into cordless telephones. The top of their 46/49-MHz phone line is the *Model C2140*, which offers 10-channel auto or manual scanning, compander circuitry for noise reduction, one-million digital security codes, last-number redial, and 10-number memory. The C2140 provides a two-way intercom function, speakerphone capability, and dual keypads. Standard features include volume controls for handset and ringer, out-of-range and low-battery warning tones, and LED indicators for talk and charge modes. Price: \$129.95.

CIRCLE 58 ON FREE INFORMATION CARD

## Keep it Clean!

TV and computer-monitor screens are natural dust-collectors, but *AudioSource's* (1327 North Carolan Avenue, Burlingame, CA 94010) *KleenScreen* can help remedy that situation. *KleenScreen* safely and effectively removes dust and debris from any laptop, computer, and television screens while preventing static buildup. *KleenScreen* includes 20 sheets of "laboratory-grade," non-woven material that are used to apply a "specially formulated" cleaner-protectant that comes in an environmentally friendly pump-spray bottle. The liquid is non-abrasive and contains a special glare-reducing agent. It is also safe for use on plastic, metal, or painted housings. This screen cleaner doesn't come cheap. Price: \$29.95.

CIRCLE 59 ON FREE INFORMATION CARD

## Center-Channel Speaker

Designed for use with Dolby Pro-Logic home-theater systems, the *NS-C110* is the first two-way center-channel system from *Yamaha Electronics Corporation, USA* (6660 Orangethorpe Avenue, Buena Park, CA 90620), and is capable of handling up to 120 watts. The magnetically-shielded speaker uses two ¾-inch cone woofers and a single one-inch soft-dome tweeter. The crossover point is at 3000 Hz, and the frequency range is 60–20,000 Hz. Price: \$199.

CIRCLE 60 ON FREE INFORMATION CARD

## Talking Calculator

How do you bargain over prices in a Mexican or Arab bazaar, an Italian leather-goods shop, or a French perfumery if your linguistic skills are limited to English? You could take along the *Radio Shack* (700 One Tandy Center, Fort Worth, TX 76102) *EC-210 8-Digit Talking Calculator*, which acts as a full-function calculator and then pronounces the calculation answers in any of nine languages: English, German, French, Italian, Spanish, Arabic, Mandarin and Cantonese Chinese, and Russian. The calculator's talking feature provides voice announcements for every key entry made and calculation result displayed. The result can be repeated at the press of a button. Front-panel slide switches are used to select the desired language and voice announcements. The pocket-sized device also features a large, 8-digit LCD readout, a digital clock that chimes on the hour (unless the alarm has been set to chime at a specific time), and a volume control. (Perhaps we can come up with a real-world use for it before the next hourly chime!) Price: \$29.95.

CIRCLE 61 ON FREE INFORMATION CARD



For more information on any product in this section, circle the appropriate number on the Free Information Card.

# ELECTRONICS WISH LIST

## Look Ma, No Hands!

It isn't easy trying to juggle a microphone while manning the controls on a home video editor. The *EditMike Pro* editing microphone and headset from *Sima Products Corporation* (8707 North Skokie Blvd., Skokie, IL 60077) eliminates that hassle by providing hands-free video narration. The *EditMike Pro* works with all video editors on the market today. It plugs into the video editor's microphone input, or, for adding narration while taping, plugs into your camcorder. The microphone has a frequency response of 50–150 kHz. It weighs just 3.5 ounces, and the headset is designed to fit comfortably and securely. Price: \$39.95.

CIRCLE 62 ON FREE INFORMATION CARD

## In-Wall Television

Designed exclusively for in-wall applications, the *WallVision2* from *Philips Consumer Electronics* (One Philips Drive, P.O. Box 14810, Knoxville, TN 37914-1810) is an all-in-one home-theater solution. Available in 52- and 61-inch versions, the package includes two equipment cabinets, a multi-disc combi-player, a 100-watt amplifier, an auto-reverse cassette deck, an AM/FM tuner, a hi-fi VCR, six in-wall speakers, and an in-wall subwoofer. It also includes a component that's not offered in any other home-theater setup—the DCC900 Digital Compact Cassette Deck. Other items include a six-outlet surge protector, a vented front panel, an audio/video coupler, RF cable, a heat-dissipation fan, and both printed and video instructions. The TV set is only 22½ inches deep. Price: 61-inch *Model T6185WV1*, \$9499; 52-inch *Model T5280WV1*, \$8999.

CIRCLE 63 ON FREE INFORMATION CARD

## Laserdisc Player

The growing popularity of home-theater systems is spurring the demand for the high-quality video offered by laserdiscs. *Thomson Consumer Electronics'* (600 North Sherman Drive, Indianapolis, IN 46201-2598) *Model LDR307* plays all sizes of laserdiscs and CD's and features dual audio outputs for simple, direct connection to an external audio system. The unit also features a one-bit digital/analog converter, 32-track programmable playback, a headphone jack for private listening, and a full-function remote control. Price: \$549.

CIRCLE 64 ON FREE INFORMATION CARD

## QuarterBack Camcorder

*Quasar Company* (1707 North Randall Road, Elgin, IL 60123-7847) offers consumers high-end options in an affordably priced VHS-C camcorder: the *VM538/539 QuarterBack*. Its features include a full-color viewfinder, digital electronic image stabilization (EIS), and 16:9 wide-screen recording capability. In addition the *QuarterBack* has a compact lens (49mm-diameter) capable of 10:1 power zoom and one of the industry's first 100:1 digital zoom lenses, allowing close-up shots (albeit grainy ones) from thousands of feet away. A four-head, double-azimuth system ensures jitter-free, clear picture quality, and color digital fade lets users customize their video presentations. But can it throw a touchdown pass? Price: \$1399.

CIRCLE 65 ON FREE INFORMATION CARD



Sima EditMike Pro

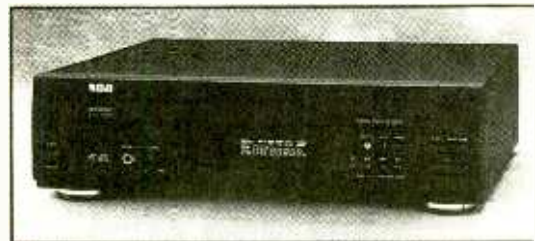

Thomson Laserdisc Player



Quasar QuarterBack Camcorder



## KELVIN-95 MULTIMETER/ ENGINE ANALYZER



CIRCLE 119 ON FREE INFORMATION CARD

*Keep your car in tune with this combination multimeter/engine analyzer.*

**T**here are lots of electronics enthusiasts who like to play weekend auto mechanic from time-to-time, at least with the older cars where there is no computer on board. In fact, a car that uses points in its electrical system generally needs more maintenance than a more modern car for it to run efficiently. However, even cars that have a computer-controlled engine require electrical adjustments and repairs every now and then. That's why a DMM that includes both standard features and automotive-troubleshooting amenities is a valuable tool indeed. And that's what you get with a Kelvin-95 Digital Engine Analyzer for \$199.95.

Besides being very useful for automotive work, the Kelvin-95 won't let you down when it comes to standard DMM applications. That's because it includes all of the features you'd expect in a multimeter, in addition to some fancier features that you wouldn't expect. So the Kelvin-95 is not only a great tool for working on the car, it's also a great DMM for anyone who either doesn't have one or has been thinking about upgrading from a less-capable model.

**Features.** Any tool that's intended for use under the hood of a car should be

of rugged construction, and the Kelvin-95 is rugged, as it's drop resistant at up to 3 feet. The meter is given further crash protection by an included yellow rubber holster. That makes it perfect for use in a garage or any other harsh environment or even by a harsh user! There is a tilt stand built into the back of the meter and a pair of ribbed rubber feet that keep the meter from sliding, even under the hood of a car. A 9-volt-battery compartment and spare-fuse holder (complete with a spare fuse) are molded inside the tough case.

The Kelvin-95 has a 3¾-digit display, which makes it a lot more "friendly" to work with than a meter with a 3½-digit display. The meter's display can show a maximum of 3999 in any given range, whereas a 3½-digit display is limited to a maximum of 1999. Beneath the 3¾-digit display is a 40-segment analog bargraph that makes it easy to get a quick visual indication of a signal's level relative to the range.

Since the Kelvin-95 is intended for automotive use, it can check engine RPM, dwell angle, duty cycle, and temperature. But the Kelvin-95 doesn't fall short on the electronics workbench either. With any multimeter one would expect to be able to measure AC and DC voltage, alternating and direct current, and resistance. A

pickier customer would want to be able to measure frequency, check diodes, and have an audible continuity test. The Kelvin-95 also includes data-hold and minimum/maximum/average recording capabilities.

**A Closer Look.** The meter can measure engine rotational speed from 150 to 10,000 RPM simply by connecting a supplied inductive pickup to any spark-plug wire. The dwell angle and duty cycle can be checked on any 3-, 4-, 5-, 6-, and 8-cylinder engine, where applicable. A pair of 6-foot alligator-type test leads are included to make these engine checks easier. Temperature can be measured using a supplied thermocouple and the meter can display from -18 to 1100°C or 0 to 2000°F.

Voltages can be measured in five ranges to a maximum of 1000 volts DC and 750 volts AC. Up to 20 amps of current can be measured in two ranges for both AC and DC. Resistance can be measured up to 40 megohms in six ranges, and frequency up to 4 megahertz in four ranges.

A data-hold function, which freezes the display, is useful on the workbench as well as in the garage. For example, a reading taken under the hood of a car outdoors can easily be brought inside and compared to a chart in a



shop manual. When the meter is set to record minimum, maximum, and average readings, a beep is heard each time a new maximum or minimum is recorded. The results can then be scrolled through on the display.

The meter enters a sleep mode if it has been inactive for 30 minutes. Then it displays a blinking symbol for an additional 60 minutes after which it shuts off completely. If desired, the automatic power-off feature can be disabled to preserve any recorded minimum or maximum values, which would be normally erased when the meter enters the sleep mode. The meter's display also has a low-battery indicator.

The Kelvin-95 comes with a zippered pouch with a separate pocket for all of the accessories we've mentioned including a pair of regular test leads. The unit's rugged construction, wide range of features, and full assortment of test accessories make it quite useful and a good value. To learn more, contact Kelvin Electronics (10 Hub Drive, Melville, NY, 11747; Tel. 516-756-1750) directly, or circle No. 119 on the Free Information Card. ■

In case of weather,  
push button.



Now you can have complete weather information literally at your fingertips with the Weather Wizard II. Easy to operate and incredibly affordable, it's as miraculous as the weather itself. All for only \$250.

**FEATURES INCLUDE:**

- Inside & Outside Temps
- Wind Speed & Direction
- Wind Chill
- Time & Date
- Alarms
- Highs & Lows
- Instant Metric Conversions
- Rainfall Option
- Optional PC Interface



**WEATHER WIZARD II**

THE PROFESSIONAL HOME WEATHER STATION

Only \$250. Add \$50 for self-emptying rain collector. Order today: 1-800-678-3669 • PEG35P  
M-F 7 a.m. to 5:30 p.m. Pacific Time • FAX 1-510-670-0589  
M/C and VISA • Add \$5 for shipping. CA residents add sales tax.  
One-year warranty • 30-day money-back guarantee

DAVIS INSTRUMENTS 3465 DIABLO AVE., HAYWARD, CA 94545

CIRCLE 162 ON FREE INFORMATION CARD

**Be an FCC LICENSED ELECTRONIC TECHNICIAN!**



Earn up to \$2000/Week and more!

Learn at home in spare time. No previous experience needed!

No costly school. No commuting to class. The Original Home-Study course prepares you for the "FCC Commercial Radiotelephone License." This valuable license is your professional "ticket" to thousands of exciting jobs in Communications, Radio-TV, Microwave, Maritime, Radar, Avionics and more...even start your own business! You don't need a college degree to qualify, but you do need an FCC license.

**No Need to Quit Your Job or Go To School** This proven course is easy, fast and low cost! **GUARANTEED PASS**—You get your FCC License or money refunded. **Send for FREE facts now. MAIL COUPON TODAY!**

**COMMAND PRODUCTIONS**

FCC LICENSE TRAINING, Dept. 100  
P.O. Box 2824, San Francisco, CA 94126  
Please rush FREE details immediately!

NAME \_\_\_\_\_  
ADDRESS \_\_\_\_\_  
CITY \_\_\_\_\_ STATE \_\_\_\_\_ ZIP \_\_\_\_\_

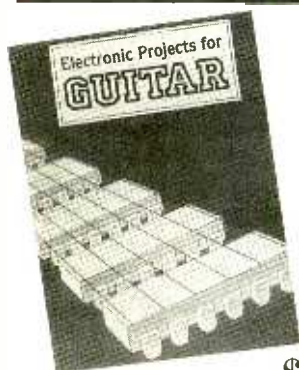

Whether you wish to save money, boldly go where no guitarist has gone before or simply have fun building electronic gadgets designed for your musical pleasure, then read

**Electronic Projects for GUITAR**

\$12.95

Some of the add-on guitar gadgets you can build are:

- Preamplifier • Headphone Amplifier • Soft Distortion Effects Unit • Compressor • Auto-waa • Waa-waa Pedal • Phaser • Dual Tracking Effects • Distortion Unit • Expander • Dynamic Treble Booster • Direct Injection Box • Dynamic Tremelo • Thin Distortion Unit • and Guitar Tuner.**

Anyone with some previous electronic project building experience should have no problem assembling the projects.

ELECTRONICS TECHNOLOGY TODAY INC.  
P.O. Box 240, Massapequa Park, NY 11762-0240

Yes, send my copy of ELECTRONIC PROJECTS FOR GUITAR by RA Pentfold to the address at right. I am enclosing \$12.95 plus \$2.95 for shipping charges in USA and Canada. All payments must be made in US funds. Sorry, no orders accepted outside of USA and Canada. New York State residents add local sales tax. Allow 6-8 weeks for delivery.

Check enclosed

Please charge my  Visa  MasterCard

Signature \_\_\_\_\_

Account No. \_\_\_\_\_ Expir. Date \_\_\_\_\_

Name \_\_\_\_\_

Address \_\_\_\_\_

City \_\_\_\_\_ State \_\_\_\_\_ ZIP \_\_\_\_\_

**Learn VCR repair at home!**

MAKE GOOD MONEY IN YOUR OWN FULL- OR PART-TIME JOB



Professional-level home study course. You will master easy-to-learn, high-profit repairs *without* investing in high-tech instruments or a costly workshop.

Want more independence and higher income? Send or call today!

Free career literature:  
**800-223-4542**

Name \_\_\_\_\_ Age \_\_\_\_\_  
Address \_\_\_\_\_ Phone ( ) \_\_\_\_\_  
City \_\_\_\_\_ State \_\_\_\_\_ Zip \_\_\_\_\_

**The School of VCR Repair**  
6065 Roswell Road  
Dept. VM341, Atlanta, Georgia 30328

CIRCLE 15 ON FREE INFORMATION CARD

# PRODUCT TEST REPORTS

By Len Feldman

## Toshiba M-758 Video Cassette Recorder



CIRCLE 120 ON FREE INFORMATION CARD

*The Toshiba M-758 hi-fi video cassette recorder.*

If you've begun to think that all VCR's are pretty much alike these days, you're in for a surprise when you check out this top-performing Toshiba model. As you would expect in a high-quality machine, it uses HQ circuitry for better VHS pictures, offers hi-fi stereo-sound capability that yields as much as 90 dB of dynamic range, and has a

built-in MTS stereo decoder. But the M-758 has so many other features that we'd best divide them into three categories: convenience, special effects, and "others."

As for convenience features, perhaps the most important one is the incorporation of "VCR Plus" programming. That's the system that lets you program the VCR for unattended recording simply by entering a TV program's code number, which can be found in *TV Guide* as well as many newspaper TV listings. As many as 8 broadcast or cable programs can be programmed in this man-

ner. In addition, on-screen programming lets you set the unit's clock and also lets you check the accuracy of normal timer recording as well VCR Plus programming. One touch recording to a maximum of 4½ hours, in 30-minute increments, is also possible.

You can easily locate a desired scene using either an index-search or skip-search function. The on-screen counter display operates either as a linear time-counter or as a remaining-time display. When a cassette without its safety tab is loaded, playback and auto-rewind occur automatically. A repeat-play function allows the tape to be repeatedly played up to ten times. The VCR is also able to check remaining tape-time and, if it is insufficient to record the programmed event at the higher SP speed, the machine will automatically switch to the EP (SLP) long-play mode.

As for special-effects features, they include the now-popular jog/shuttle dial that allows variable-speed playback from still picture to search speed. Picture search, accelerated search, still-frame viewing, and slow playback are all possible using the fast-forward, rewind, still, and slow buttons found on the unit. Finally, if you connect an external FM receiver to the external-audio inputs, you can record an FM-simulcast program.

Other, miscellaneous fea-

tures include a 181-channel, frequency-synthesized TV tuner; an included remote control unit that is compatible with 16 TV brands (including RCA, Magnavox, etc.); high-speed rewind and fast-forward; and a flying erase head that allows continuous editing of two recordings without distortion or noise at the editing points.

### CONTROL LAYOUT

The power and eject/stop buttons are found at the left end of the front panel of this VCR. Just below them are video and stereo-audio input jacks, so you don't have to go around to the back to connect a camcorder to this VCR. The cassette compartment is centered on the front panel, and below it is a multi-function display. To the right of the display are channel-"up" and "-down" buttons; to the right of the cassette slot are rewind, record, play, and fast-forward buttons.

Keeping the front panel this simple meant that most of the special features discussed earlier are activated by buttons on the much more elaborately configured remote control. That remote, in addition to duplicating the front-panel controls, houses number buttons, an input-selector button; a TV/CATV-selector button; a TV/VCR button; buttons that control tape speed and counter mode; buttons relating to the VCR Plus programming feature;



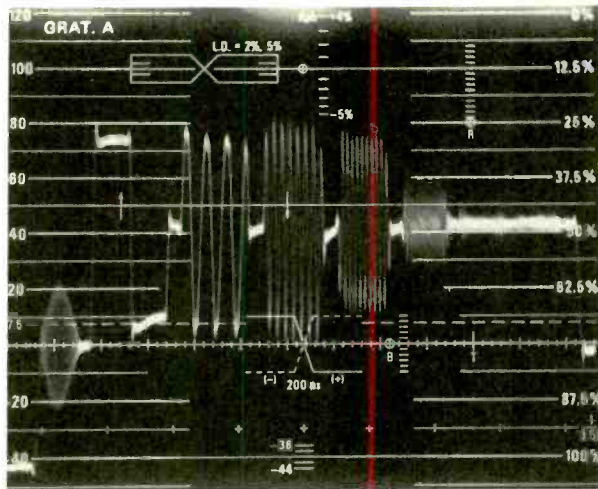

The video frequency response was better than average for a conventional (non-S-VHS) VHS VCR.

one-touch recording, display on/off, and tape-tracking buttons; the slow-motion button; and a timer button used as the last step in setting up for timer recording. In addition, the remote houses the previously mentioned shuttle ring and jog dial.

The multifunction display on the front panel provides no less than 14 useful status indicators. Those range from a clock/remaining-time/linear-counter display to indicators for such less-often used functions as digital tracking, stereo mode, and repeat play. Of course, the display also has the more commonly expected status indicators found on every VCR.

The rear panel of the VCR houses the usual RF input and output connectors, an output Channel-3/4 selector, and video and stereo-audio input and output jacks.

### TEST RESULTS

All of the recordings and measurements made by APEL (the Advanced Product Evaluation Laboratories) for this test report were made at the faster, SP tape-speed. Under those conditions, the video frequency-response was better than

average for a VHS-format VCR, with an attenuation of only  $-1.79$  dB at 2.0 MHz and  $-6.0$  dB at 3.0 MHz. The luminance signal-to-noise ratio ranged from a very acceptable 43.8 dB to an even higher 44.8 dB, depending upon the reference luminance level used by APEL in making the measurements. Chroma (color) AM signal-to-noise ratio was also far better than average, measuring 46.5 dB.

In the hi-fi audio-recording mode, a 0-dB reference output-level measured 2.57 volts; at that level, harmonic distortion measured 1.26%. In that preferred audio mode, wow-and-flutter was virtually negligible, with average readings of only 0.007%, and peak readings of 0.009%. The audio signal-to-noise ratio rivaled that of digital audio recordings, with a reading of  $-89.5$  dB!

As might be expected, the conventional audio-recording mode yielded results that were considerably inferior to those observed in the hi-fi mode. In that mode, the output voltage was only 0.31 volts for a distortion level of 1.74%, while average wow-and-flutter measured a rather high 0.22%, with

# FROM HOOKING IT UP TO FIXING IT UP, WE'RE THE PLACE TO GO

**Radio Shack®**

America trusts Radio Shack for the products and advice needed to hook up nearly anything electronic. You've made us number one in adapters, cables and connectors, and we're second to none in multimeters. We offer 18 different models, from analog "basics" to our advanced PC-compatible digital multimeter complete with software. At Radio Shack, you can see and try before you buy. With more than 6600 convenient locations, we'll fix you up in a hurry!

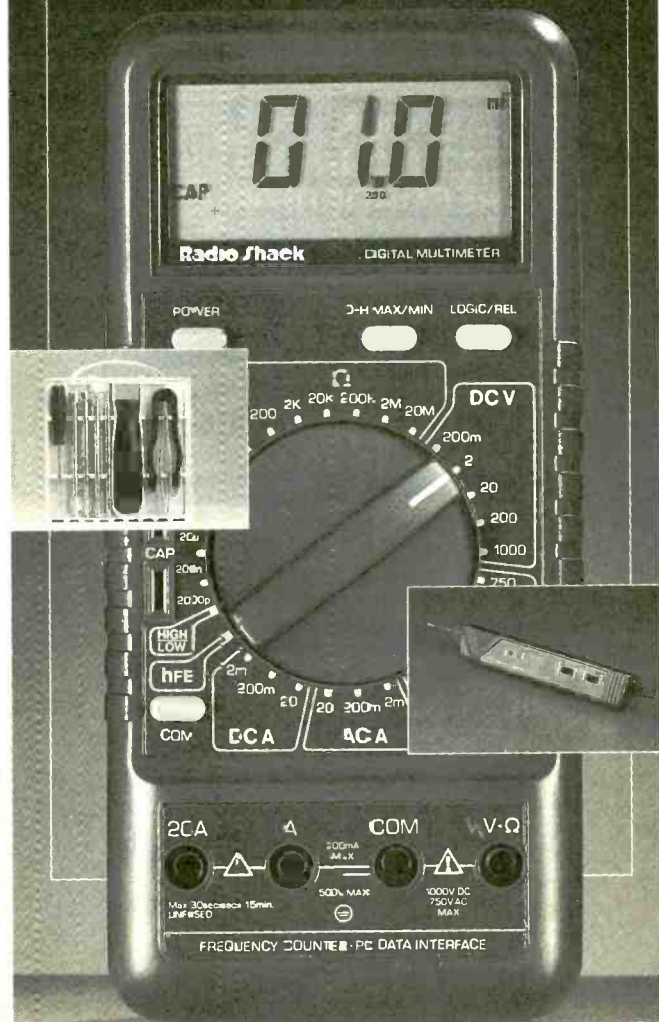

peak wow-and-flutter readings of 0.24%. Further, the signal-to-noise ratio using that mode was only 48.8 dB.

The frequency response using the hi-fi recording mode extended from 20 Hz to 20 kHz, while in the conventional audio-recording mode, the -3 dB points were reached at 98 Hz and at 8.8 kHz. At -10-dB recording levels, the hi-fi recording mode yielded distortion levels of only 0.06% at 100 Hz, 0.17% at 1 kHz, and 0.96% at 5 kHz. By contrast, using the conventional recording mode, distortion levels at -10 dB were 0.48% at 100 Hz and 0.60% at 1 kHz.

APEL measured the performance of the broadcast-stereo decoder (MTS) section of the VCR and noted an A-weighted signal-to-noise ratio in the stereo

mode of 63.5 dB, while the total harmonic distortion at -20-dB levels was an acceptably low 0.12%. Stereo separation at 1 kHz measured 25 dB and was better than 20 dB even at higher, treble frequencies where many stereo decoders tend to lose separation capability. In the mono mode, the stereo-decoder section yielded an almost identical signal-to-noise ratio (63.6 dB) and a slightly higher distortion level (0.24%). Additional test data can be found in the Test Results table located elsewhere in this report.

### HANDS-ON TESTS

As usual, we recorded several off-air programs using this VCR, as well as some "live" recordings using our S-VHS hi-fi reference camcorder, which was connected to the front-panel

### TEST RESULTS—TOSHIBA M-758 HI-FI VCR

Specification	Video Section	PE Measured
Frequency response		-1.79 dB @2.0 MHz -6.0 dB @6.0 MHz
Signal-to-noise ratio		
Luminance level		
100 IRE/50 IRE/10 IRE		43.8/44.7/44.8 dB
Chroma AM/PM		46.5/39.5 dB
	Hi-Fi Audio Section	
0-dB output reference level		2.57 volts*
Total harmonic distortion		1.26%
Flutter (average/peak)		0.007%/0.009%
Signal-to-noise ratio		89.5 dB
Playback frequency response (-3 dB)		20 Hz to 20 kHz
THD at -10 dB (100 Hz/1 kHz/5 kHz)		0.06%/0.17%/0.96%
	Conventional Audio Section	
0-dB output reference level		0.31 volts
Total harmonic distortion		1.74%
Flutter (average/peak)		0.22%/0.24%
Signal-to-noise ratio		48.8 dB
Playback frequency response (-3 dB)		98 Hz to 8 kHz
THD at -10 dB (100 Hz/1 kHz)		0.48%/0.60%
	Stereo-TV Decode Section	
Signal-to-noise ratio (stereo/mono)		63.5 dB/3.6 dB
THD at -20 dB, 1 kHz (stereo/mono)		0.12%/0.24%
	Additional Data	
Power requirements		19.0 watts
Weight		11.5 lbs
Fast-forward/rewind time		1 min, 38 sec/ 1 min, 46 sec
Dimensions (H x W x D, inches)		3 <sup>7</sup> / <sub>16</sub> x 14 <sup>9</sup> / <sub>16</sub> x 12 <sup>3</sup> / <sub>4</sub>
Suggested Price: \$600.00		

## SUPER 12 HOUR RECORDER

CALL TOLL FREE

Modified Panasonic Slimline. 6 hrs per side. 120 TDK tape furnished. AC/DC Operation. Quality Playback. Digital Counter. Durable Lightweight Plastic.



**\$119.00\***

### PHONE RECORDING ADAPTER

Starts & Stops Recorder Automatically When Hand Set is Used. Solid State!

FCC APPROVED



**\$28.50\***

### VOX VOICE ACTIVATED CONTROL

Solidstate Adjustable Sensitivity. Voices & Sounds Activate Recorder. Adjustable Sensitivity. Provisions for Remote Mike.



**\$28.50\***

\*Add for ship. & handling. Phone Adapter & Vox \$2.00 each. Recorders \$5.00 each. Colo. Res. add tax. Mail Order, VISA, M/C, COD's OK. Money Back Guar. Qty Disc. available. Dealer inquiries invited. Free data on other products

ALL MAIL TO: Box 20100, Boulder, CO 80308  
AMC SALES INC., 193 Vaquero Dr.,  
Boulder, CO 80303

Phones (303) 499-5405 • 1-800-926-2488  
FAX (303) 494-4924 • Mon-Fri 8-5 MTN. TIME

CIRCLE 151 ON FREE INFORMATION CARD

audio and video jacks. Incidentally, when the front-panel jacks are used, the rear-panel audio and video input jacks are automatically disconnected. The picture quality, we felt, was better than that found on most standard VHS machines, and was, in fact, just about as good as the picture quality obtained from broadcast TV.

According to some surveys, fully 80% of VCR owners are unable (or unwilling) to program their VCR's for timer recording. In the light of that, perhaps the best thing about this VCR is its incorporation of the VCR Plus programming system. It really works and its accuracy is verifiable in the on-screen display. Of course, even for those of us who have no trouble "doing it the old fashioned way," the on-screen display is very helpful.

To be sure, you can purchase perfectly serviceable

VCR's for considerably less than the price of this Toshiba model. But we doubt that you'll find many conventional VCR's that are as feature-laden as this excellent unit.

For more information on the Toshiba M-758 VCR, contact Toshiba (82 Totowa Rd., Wayne, NJ 07470), or circle No. 120 on the Free Information Card. ■

## When someone in your family gets cancer, everyone in your family needs help.

Nobody knows better than we do how much help and understanding is needed. That's why our service and rehabilitation programs emphasize the whole family, not just the cancer patient.

Among our regular services we provide information and guidance to patients and families, transport patients to and from treatment, supply home care items and assist patients in their return to everyday life.

Life is what concerns us. So you can see we are even more than the research organization we are so well known to be.

No one faces cancer alone.

AMERICAN CANCER SOCIETY



# How to Get a High-Paying Job In Electronics

## Launch your career as an electronics professional.

Your key to career success and personal happiness can be summed up in one word. . .  
**EDUCATION!**

Thousands of great jobs become available in electronics every year. To land one of those great jobs, you must have the educational credentials, knowledge and skills that employers not only want and need, but also demand.

**Let Peoples College prepare you for an exciting job and a secure future in electronics.**

Peoples College offers Specialized Associate Degree and Diploma programs by distance education to prepare you for one of the many high-paying electronics jobs. As a graduate of one of our programs you can qualify for jobs such as field service engineer, electronics technician, laboratory assistant, PC specialist and many others.

Peoples College offers you an outstanding educational alternative. Our programs are equivalent to what you would get in a technical school or community college. In addition to providing you with a rock-solid foundation in electrical and electronic fundamentals and computer concepts, we offer in-depth training in these specialties:

- Personal computer servicing
- Communications electronics
- Industrial control



**Distance learning—Peoples College comes to you.**

With distance education, you learn in your own home at your convenience. There are no classes to prepare for, no commuting, no parking problems. You can complete our programs in your spare time without giving up your present job. Learn while you earn. You go as fast as you want. Our instructors are standing by to answer your questions if you need help.

**What makes Peoples College programs so special?**

While there are other schools offering similar training, ours is unique! Here are just a few reasons why Peoples College programs give you more:

- Standard college texts, not lessons
- Video training which makes critical subjects come alive
- Accelerated Learning System—a scientifically proven study system that lets you learn faster and easier than ever before
- Computer-based training software for selected software subjects
- Industry certification preparation

Here is a partial list of some of the hardware you receive with a Peoples College program:

- 486sx 25 MHz PC with 80 MB hard drive, 3.5" 1.44 MB floppy drive, VGA color monitor and mouse in selected programs
- Microprocessor trainer (8-bit CPU), digital multimeter, breadboard with function generator, power supplies and logic probe
- Oscilloscope included in some programs
- Portable cellular telephone in the communications programs
- All programs include Electronics Experience Labs for hands-on training

**Don't delay—Your future starts today! For more information fill out and mail the attached coupon.**

We'll send you our color brochure, catalog and our new booklet "How to Get a High-Paying Job in Electronics." Get your career started today. Do yourself a big favor and send for this information now!

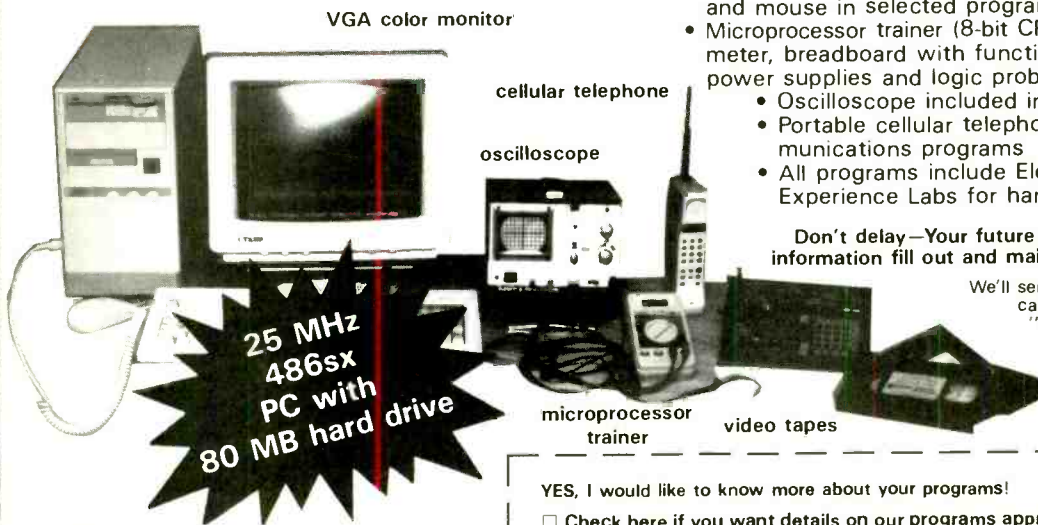

VGA color monitor

cellular telephone

oscilloscope

microprocessor trainer

video tapes

**25 MHz  
486sx  
PC with  
80 MB hard drive**



233 Academy Drive • P.O. Box 421768  
Kissimmee, FL 34742-1768

Accredited member, National Home Study Council  
Member, D.L. Peoples Group

YES, I would like to know more about your programs!

Check here if you want details on our programs approved under the GI Bill.

Name \_\_\_\_\_

Address \_\_\_\_\_

City \_\_\_\_\_

State \_\_\_\_\_ Zip \_\_\_\_\_

Phone (\_\_\_\_) \_\_\_\_\_

E1193

CIRCLE 158 ON FREE INFORMATION CARD

# 1-800-831-4242

Your Resource for Value. Only a Phone Call Away.

**20**  
YEARS OF  
EXCELLENCE  
1973-1993

## Metex Digital Multimeters

- Handheld high accuracy
- Measures AC/DC voltage, AC/DC current, resistance, diodes, audible continuity test, transistor hFE
- Manual ranging w/overload protection
- Comes with probes, batteries, case and manual
- One-year warranty



NP27158

NP27086 & NP27158 only:  
• Also measures frequency and capacitance

Part No.	Description	Price
NP27078	3.5 digit multimeter	\$59.95
NP27086	3.5 digit multimeter, w/frequency & capacitance	74.95
NP27115	3.5 digit multimeter	39.95
NP27140	4.5 digit multimeter, w/tach/dwell	69.95
NP27158	4.5 digit w/frequency & capacitance & data hold switch	99.95

## Jameco Solderless Breadboards

Our long-lasting breadboards feature screen printed color coordinates and are suitable for many kinds of prototyping and circuit design. Larger models feature heavy-duty aluminum backing with voltage and grounding posts.



NP20757

Part No.	Terminal Strips		Contact Points	Price
	Bus Strips	Strips		
NP20343	0	2	200	\$3.95
NP20600	1	2	400	4.95
NP20669	1	0	630	5.49
NP20722	1	2	830	6.95
NP20757	2	1	1,360	12.95
NP20773	2	4	1,660	17.95
NP20790	3	5	2,390	24.95
NP20811	4	7	3,220	32.95

## Regulated Power Supply Kits

Build the power supply you've been needing for years. Ideal for home or instructional use. Select from three different versions. Each kit is complete with printed circuit board, electronic components and user assembly instructions.

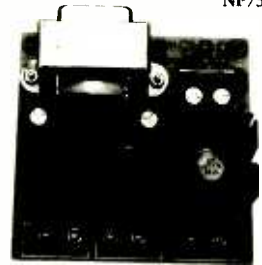

NP73613

Part No.	Product No.	Input Voltage (VAC)	Output Voltage (VDC)	Current (mA)	Dimensions (L x W x H inches)	Price
NP20360	JE200	120	+5	1000	3.5 x 5.0 x 2.0	\$14.95
NP20626	JE215	120	+5 to +15 -5 to -15	750 to 175 750 to 175	3.5 x 5.0 x 2.0	19.95
NP73613	JE225	120	+5 fixed +3 to +12 -3 to -12	1000 100 100	5.12 x 5.12 x 2.25	29.95

See our Catalog for more kits

## EPROMS

Part No.	Product No.	Price
NP33611	TMS2716	\$5.95
NP39909	2708	4.95
NP40002	2716	4.49
NP40125	2732A-25	4.49
NP40230	2764A-20	4.75
NP39829	27C64-15	4.49
NP39933	27128-25	7.75
NP39968	27128A-20	4.95
NP39984	27128A-25	3.95
NP39677	27C128-15	5.75
NP40037	27256-15	5.49
NP40061	27256-25	4.75
NP39714	27C256-15	5.25
NP39722	27C256-20	4.95
NP40150	27512-20	6.95
NP39781	27C512-15	6.49
NP65699	27C020-15	10.95
NP43692	68766-35	4.95

## Integrated Circuits\*

Part No.	Product No.	Price
NP48979	7400	\$3.29
NP49015	7402	.39
NP49040	7404	.39
NP49091	7406	.39
NP49120	7407	.39
NP49146	7408	.39
NP49189	7410	.29
NP49728	7417	.35
NP50008	7420	.35
NP50235	7432	.39
NP50420	7447	.89
NP50551	7474	.39
NP50593	7476	.59
NP50665	7486	.39
NP50681	7489	2.95
NP50690	7490	.79
NP49322	74121	.49
NP49912	74192	.99
NP49939	74193	.99

\*Name brand IC's in stock



NP26622

NP21936

## Switches

Part No.	Product No.	Description	Price
NP21936	JMT123	SPDT, on-on (toggle)	\$11.15
NP38842	206-8	SPST, 16-pin (DIP)	1.09
NP26622	MS102	SPST, momentary (push-button)	.39

\*Additional components available



## National, Intel & TI Databooks

Part No.	Product No.	Description	Price
NP79071	400061	National Operational Amplifier Linear Devices Databook	\$17.95
NP79089	400060	National Linear Application Specific IC's Databook	14.95
NP41208	400015	National Data Acquisition Linear Devices Databook	14.95
NP79062	400062	National Power IC's Linear Devices Databook	13.95
NP88225	—	Texas Instrument LS/S/TTL Databook	24.95
NP39280	230843	Intel Memory Databook	24.95
NP39870	270645	Intel Embedded Controller Processors Databook	24.95

## 3/4 Watt Linear Taper-15 Turn Cermet Potentiometers

Part No.	Ohms	Price
NP41785	1K	\$ .99
NP41822	10K	.99
NP41849	100K	.99
NP41806	1MEG	.99



## 1/2 Watt Linear Taper- Single Turn Cermet Potentiometers

Part No.	Ohms	Price
NP42964	1K	\$ .85
NP43001	10K	.85
NP43027	100K	.85
NP42981	1MEG	.85



**SMT product now available!**  
Call for price and availability

## Other Jameco Resources

- Test/Masurement and Prototyping Equipment
- Full line of Integrated Circuits and Electronic Components
- Call for computer parts

Order toll-free 1-800-831-4242

Call or write for your FREE Component Catalog:  
1-800-637-8471

**JAMECO™**  
ELECTRONIC COMPONENTS  
COMPUTER PRODUCTS

1355 Shoreway Road  
Belmont, CA 94002  
FAX: 1-800-237-6948 (Domestic)  
FAX: 415-592-2503 (International)

For International Sales, Customer Service, Credit Department and all other inquiries: Call 415-592-8097 between 7AM-5PM P.S.T.

CA Residents please add applicable sales tax.

\$30.00 Minimum Order

Terms: Prices subject to change without notice. Items subject to availability and prior sale. Complete list of terms/warranties is available upon request.

© 1993 Jameco 11/93 All trademarks are registered trademarks of their respective companies.

CIRCLE 156 ON FREE INFORMATION CARD



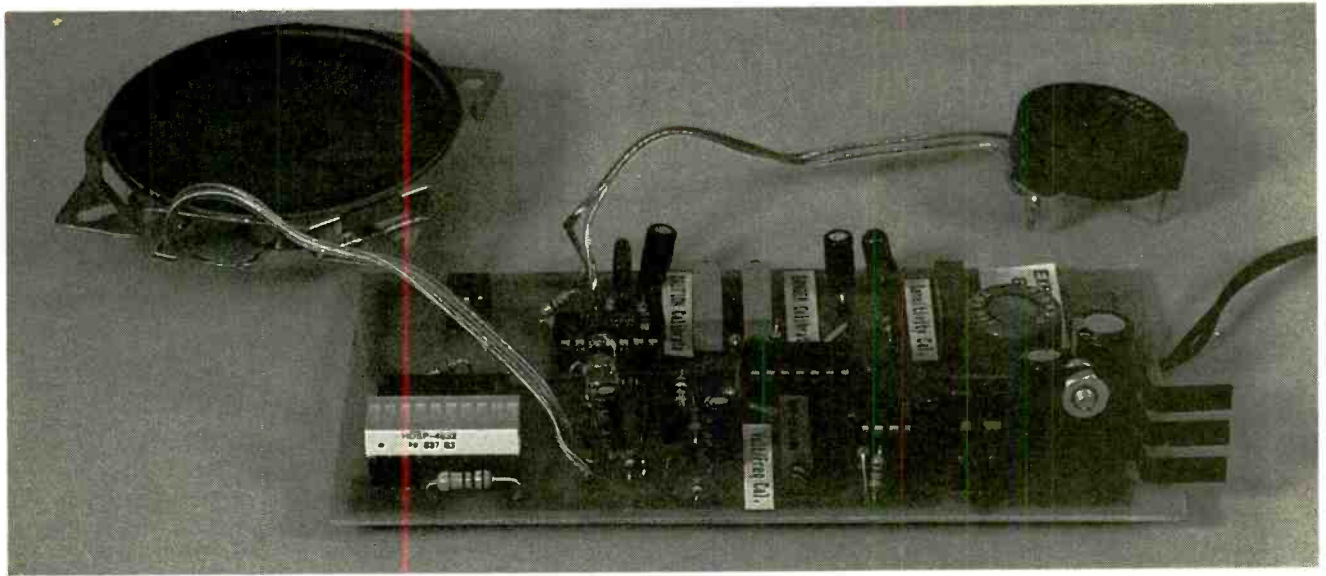

# Build an Explosive Gas Detector

*Protect your family and property from dangerous gas concentrations by detecting them before they reach combustible levels.*

BY ANTHONY CHARLTON

**G**as! To many, that very word is synonymous with explosion. Thankfully, modern gas appliances and their delivery systems (supply lines) are cause for much less concern now than in the past—although one still hears about the occasional catastrophe where an explosion has caused misery, property damage, and/or death. Fortunately, such catastrophes are now preventable. Using today's electronic circuitry, you can detect and dissipate hazardous gases before they can accumulate to the ignition level.

The *Explosive Gas Detector* described in this article can identify a whole range of potentially explosive gaseous materials (including invisible, odorless, and highly poisonous carbon monoxide)—making it essentially an all-purpose vapor sensor.

The Explosive Gas Detector offers four types of output; an audible tone that rises in pitch as gas concentration increases; a bargraph display that visually shows relative concentration; an alarm that's activated when the user-set threshold is exceeded; and an optoelectronic (triac driver) output that can be used to trigger a range of AC operated de-

vices (a fan, for instance, to bring fresh air).

**The Sensor.** At the heart of the circuit is a TGS822 gas sensor (see Fig. 1), which contains a miniature nichrome wire heater (that has a nominal resistance of 38 ohms), which is used to keep the surface of the tin dioxide ( $\text{SnO}_2$ )

**WARNING!!** This article deals with and involves subject matter and the use of materials and substances that may be hazardous to health and life. Do not attempt to implement or use the information contained herein unless you are experienced and skilled with respect to such subject matter, materials and substances. Furthermore, the information contained in this article is being provided solely to readers for educational purposes. Nothing contained herein suggests that the monitoring system described herein can be or should be used by the assembler or anyone else in place of or as an adjunct to professional advice regarding the presence of gas. Neither the publisher nor the author make any representations as for the completeness or the accuracy of the information contained herein and disclaim any liability for damages or injuries, whether caused by or arising from the lack of completeness, inaccuracies of the information, misinterpretations of the directions, misapplication of the information or otherwise.

semiconductor element at a temperature of between 400 and 750°F. Heating that semiconductor element has two effects: It allows greater molecular activity (and hence a more rapid response) and it creates a small convective air current, which draws the monitored air through the unit, thereby eliminating the need for a forced-air system. The sensor also has a double layer of stainless steel gauze at the bottom and top that arrests any flame that may begin inside the sensor due to the hot heater contacting concentrated gas.

Although the TGS822 is highly sensitive, it cannot differentiate between vapors without an external chemical filter, which is beyond the scope of this article. The TGS822's operation is really simple; gas molecules touching the sensing surface causes the unit's internal resistance, depending on the level of concentration, to decrease. (Note that different gases at the same concentration produce vastly different resistance changes. That's because, generally speaking, the higher the molecular weight of the gas, the greater a change in sensor resistance for a given concentration.) The reduction in resistance allows a correspon-

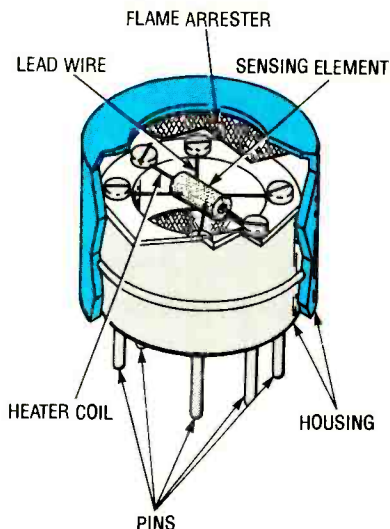

Fig. 1. At the heart of the Explosive Gas Detector is a TGS822 gas sensor.

dingly greater amount of current to pass through the sensor, which can then be interpreted by monitoring/level-detection circuitry.

**About the Circuit.** Figure 2 shows a complete schematic diagram of the Explosive Gas Detector. The circuit is built around seven integrated circuits (of various types), along with a few additional semiconductors and support components.

The circuit is broken down into several subassemblies, each with its own alarm enunciator, and performing slightly different monitoring functions. Let's examine those subassemblies individually, starting with the sensory portion of the circuit.

At the heart of the sensory portion of the circuit is the aforementioned TGS822 gas sensor (SEN1), which acts as a gas-variable resistor. A regulated +5-volt source is applied to SEN1's heater terminal at pin 5 to keep its semiconductor sensory element at between 400 and 750°F.

Another regulated source, this one +8 volts, is applied to SEN1 at pins 4 and 6 (the input to the gas-variable resistor). The output of the sensor, taken from pins 1 and 3 is fed to R1 (a 10k, 15-turn, trimmer potentiometer), which serves as the circuit's SENSITIVITY ADJUST, allowing the circuit to be set to a user-determined trigger threshold. The output of the sensory circuit, taken from the wiper of R1, divides along several circuit paths.

In one of those paths, the sensor output is fed to U5 (an LM331N volt-

## PARTS LIST FOR THE EXPLOSIVE GAS DETECTOR

### SEMICONDUCTORS

- U1—MOC3042IS-ND, zero-crossing optoisolator/coupler Triac-driver, integrated circuit
- U2—AN7805, 5-volt, 1.5-amp, voltage regulator, integrated circuit
- UC3—AN7808, 8-volt, 1.5-amp, voltage regulator, integrated circuit
- U4—LM324N, general-purpose, quad op-amp, integrated circuit
- U5—LM331N, precision voltage-to-frequency converter, integrated circuit
- U6—74C14N, hex inverting Schmitt trigger, integrated circuit
- U7—LM3914N, dot/bargraph display driver, integrated circuit
- Q1—PN2222 or similar general-purpose NPN silicon transistor
- SEN1—TGS822 gas sensor
- D1, D2—1N4148 or similar general-purpose small-signal silicon diode
- LED1—Light-emitting diode
- LED2, LED3—High-brightness, light-emitting diode
- DISP1—LED bargraph display (Hosfelt Electronics #25-116 or similar)
- BR1—1-amp, 50-PIV, full-wave bridge rectifier

### RESISTORS

- (All fixed resistors are 1/4-watt, 5% units unless otherwise indicated.)
- R1—10,000-ohm, 15-turn, trimmer potentiometer
  - R2, R12, R18, R22—1000-ohm
  - R3, R8—100,000-ohm, 1% metal-film
  - R4—6810-ohm, 1% metal-film
  - R5, R15, R16, R19, R20—10,000-ohm
  - R6—12,100-ohm, 1% metal-film
  - R7—5,000-ohm, 15-turn, trimmer potentiometer
  - R9—47.5-ohm, 1% metal-film
  - R10—22,000-ohm
  - R11—27,000-ohm
  - R13, R14—100,000-ohm, 15-turn,

- trimmer potentiometer
- R17, R21—10-megohm
- R23—560-ohm
- R24—47,000-ohm
- R25—4700-ohm
- R26—100-ohm, 1/2-watt
- R27—1210-ohm, 1% metal-film
- R28—3830-ohm, 1% metal-film

### CAPACITORS

- C1—1000- $\mu$ F, 16-WVDC, electrolytic
- C2, C3, C10—0.1- $\mu$ F, ceramic-disc
- C4—22- $\mu$ F, 16-WVDC, electrolytic
- C5—100- $\mu$ F, 16-WVDC, electrolytic
- C6—0.1- $\mu$ F, polyester or Mylar
- C7—0.01- $\mu$ F, polyester or Mylar
- C8—0.47- $\mu$ F, 50-WVDC, electrolytic
- C9—1- $\mu$ F, polyester or Mylar
- C11, C12—10- $\mu$ F, 16-WVDC, electrolytic
- C13—0.047- $\mu$ F, polyester or Mylar
- C14—1- $\mu$ F, 50-WVDC, electrolytic

### ADDITIONAL PARTS AND MATERIALS

- SPKR1—8-32-ohm speaker
- BZ1—Piezo buzzer
- T1—12-volt, 250-mA (or more) transformer
- PL1—AC molded power plug with line cord
- S1—SPDT toggle switch
- B1—12-volt Gel-cell battery
- Printed-circuit materials, enclosure, battery charger (see text), TO-220 heat sink, IC sockets, wire, solder, hardware, etc.

**Note:** The following parts are available from Allegro Electronic Systems, Dept-GS, 3 Mine Mountain Road, Cornwall Bridge, CT 06754: The TGS822 toxic-gas sensor with special socket—\$23 postpaid. For C.O.D. orders, free catalog of gas sensors, and circuitry call 203-672-0123.

age-to-frequency converter), which produces an output frequency that is proportional to the magnitude of the input voltage. At zero gas concentration, SEN1 has a high resistance, so the output voltage delivered to U5 is low, thus the output frequency of U5 is low (roughly, as low 100 Hz in clean air). That low-frequency signal quickly rises (to around 8 kHz in an atmo-

sphere contaminated with a near-explosive level of gas) as gas concentrations rise. Trimmer potentiometer, R7, is used to cancel out component tolerances for accuracy.

The output of U5 at pin 3 is fed through C8 to a simple single-transistor audio amplifier (built around Q1), which is used to drive an 8- to 32-ohm speaker (SPKR1). As gas con-



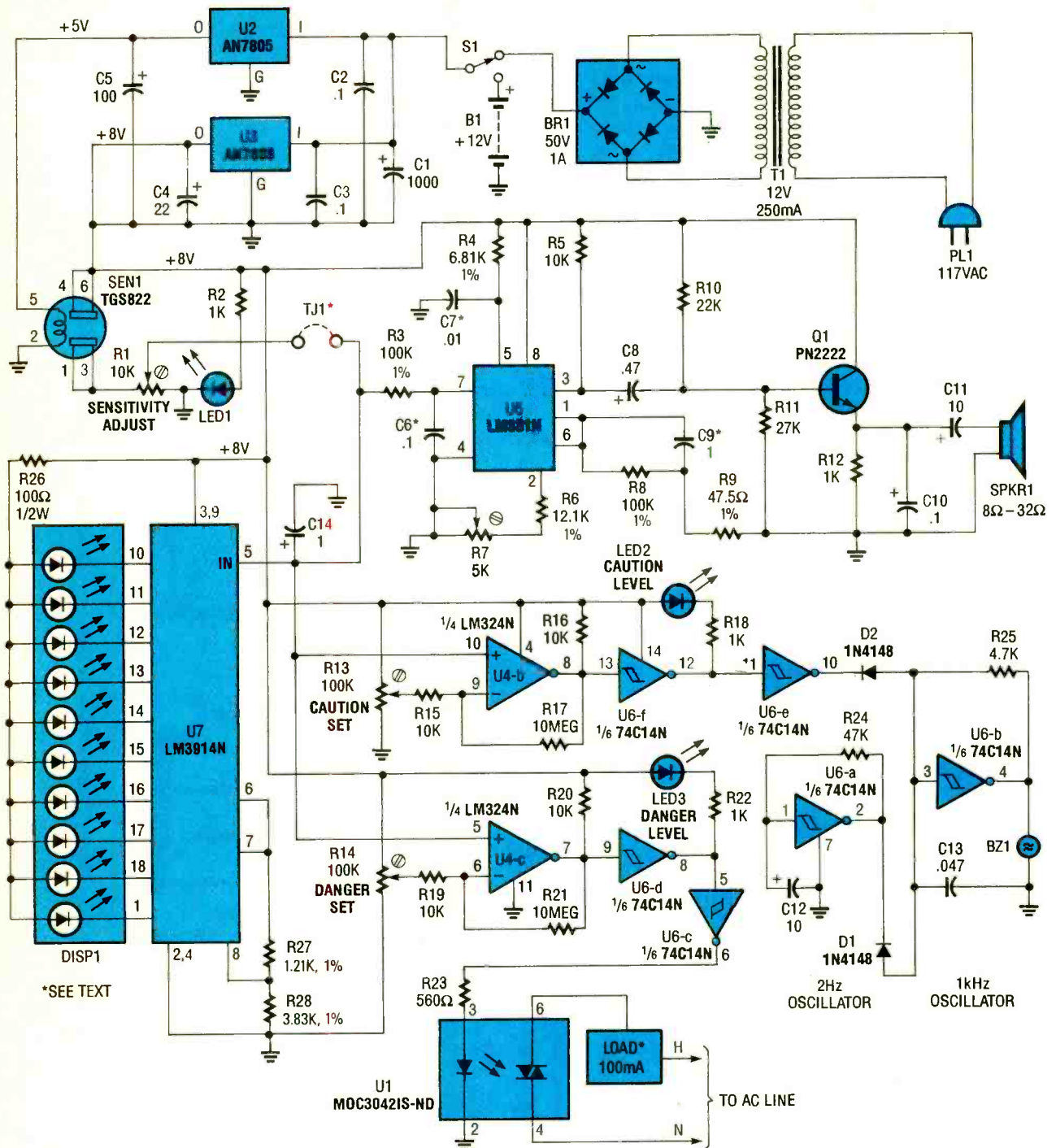

Fig. 2. The Explosive Gas Detector is built around seven integrated circuits (of various types), along with a few additional semiconductors and support components, that comprise several subassemblies, each, with its own alarm enunciator, and performing slightly different monitoring functions.

tamination rises from zero, the tone produced in the speaker goes from a low buzzing to a rather shrill sound.

In the next circuit path, the signal is fed to the alarm section of the circuit—a two-part circuit, which is comprised of half of an LM324 quad op-amp (U4); a 74C14 inverting Schmitt trigger (U6); an MOC3042IS-ND Triac

driver, optoisolator/coupler (U1); a buzzer (BZ1); and assorted support components.

In this two-fold section of the Explosive Gas Detector, the output voltage of the sensor circuit is fed to identical comparator circuits (built around U4-b and U4-c), with each comparator circuit feeding identical

double-inversion circuits, which we'll refer to as the "caution" and "danger" circuits. Each comparator circuit has a 10k and 10-megohm resistor on the input and feedback, respectively, which provides some degree of hysteresis, so each comparator trips fully on when activated rather than oscillate a little initially. The only real dif-

ference between those two circuit lies in their output circuitry.

In the caution circuit, comparator U4-b feeds a double inverter, consisting of U6-e and U6-f (each  $\frac{1}{2}$  of a 74C14 hex inverting Schmitt trigger). A 100k 15-turn trimmer potentiometer, connected to the inverting input (pin 9) of U4-b is used to establish the trip point for the comparator. The output of SEN1 is applied to the non-inverting input of U4-b at pin 10. In the absence of explosive gas, the voltage applied to the non-inverting input of U4-b at pin 10 is low. The low input forces the output of U4-b low. The output of U4-b is applied the input of U6-f, causing its output to go high. That high has two effects on the following circuitry. First the high output of U6-f reverse biases LED2 so it does not light, and second, it forces the output of the second inverter low. The low is fed to a pair of oscillator circuits (built around U6-a and U6-b), disabling them.

As the gas level detected by SEN1 rises, the voltage delivered to U4-b also rises. When the voltage applied to U4-b at pin 10 exceeds the reference established at pin 9, the output of the comparator switches high. That high forces the output of U6-f low, lighting the LED and forcing the output of U6-e high. The high output of U6-e enables the double-oscillator circuit, with the output of one oscillator (the one built around U6-a) turning the other (built around U6-b) off and on. The output of the second oscillator (U6-b) feeds BZ1, turning it on and off in accordance with the output of the U6-a.

The other comparator/double-inverter circuit (U4-c/U6-d and U6-c) performs in an identical fashion, so we won't go into its operation, but instead will skip to the operation of its output element (the Triac-driver optoisolator/coupler, U1). When the gas concentration detected by the sensory circuit causes the voltage applied to comparator U4-c at pin 5 to exceed the reference established at pin 6 via R14, U1's internal LED lights, turning on its Triac-driver output. With the output turned on, an AC voltage is delivered to the load device, causing it to turn on. The Triac driver can handle low-current, 117-volt AC loads of up to 100 mA. For higher load capacities, the Triac driver can be used to trigger a Triac into conduction, which can then

be used to power the load.

The Triac driver can be used to power a fan to bring fresh air into the area to dilute the gas. But beware: If the level of gas/vapor contamination is high enough, turning on said device could precipitate an explosion! For example, imagine U1 is used to turn on a old-style fan with motor-contact brushes in say, a gasoline-saturated atmosphere. The likelihood of a spark is so high that you might as well strike a match. (So, be aware of your equipment, your application, and your own level of expertise to avoid problems!)

The final section of the Explosive Gas Detector is comprised of an LM3914 dot/bargraph display driver

and a 10-segment bargraph display (DISP1), which is available from Hosfelt Electronics, Inc. (2700 Sunset Blvd., Steubenville, OH 43952-1158; Tel. 800-524-6464) and is used to show at a glance the relative level of explosive gas. The LM3914 dot/bar display driver simplifies the task, since it contains nearly all the circuitry needed to drive the 10-segment display.

In this section of the circuit, as gas concentration increases, more LED's light up. **Note:** The bargraph is not likely to light to the 10th LED if the SENSITIVITY ADJUST (R1) is not set to maximum.

The voltage applied to U7 at pin 5 is compared to internal references. With the values shown, the display re-

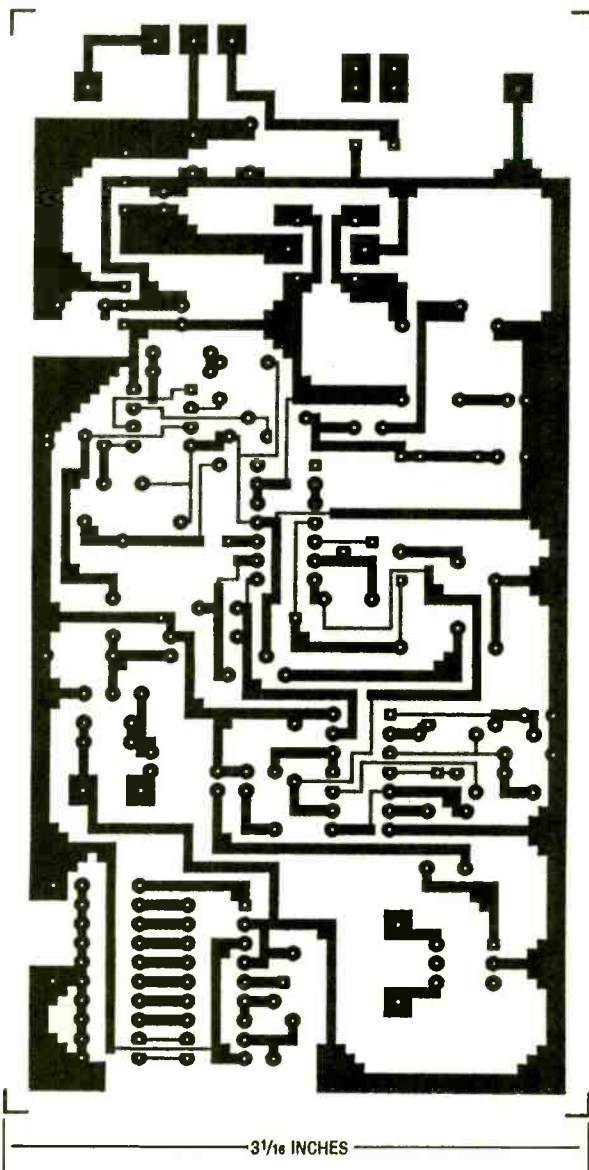

Fig. 3. The Explosive Gas Detector was assembled on a printed-circuit board measuring about  $3\frac{1}{16}$  by  $5\frac{5}{16}$  inches. A template for that printed-circuit pattern is shown here.



sponds to 0.5-volt increments from 0 to 5 (and over) volts. Normally, one LED (the first one, which is connected to pin 1 of U7) will be lit at all times. As the gas concentration rises, each successive LED lights. Resistor R26 is used to reduce power consumption at a slight sacrifice in brightness when several LED's are lit.

Note that the circuit is designed to be operated either as a stationary device, drawing power from an AC-line derived power source, or as a portable unit, powered from a 12-volt battery. An SPDT switch (S1) is used to select between power sources. The AC-derived, power-supply portion of the circuit is comprised of PL1 (a 117-volt AC power plug with line cord), a 12-volt step-down transformer (T1), a fullwave-bridge rectifier (BR1), and a pair of 3-terminal regulators (U2 and U3). The output of U2 (an AN7805, 5-volt, 1.5-amp regulator) serves only to provide the necessary heater voltage for SEN1. The other regulator (U3, an AN7808 8-volt, 1.5-amp regulator), in conjunction with several dropping resistors, provides all the additional voltages required by the circuit.

In the case of battery operation, the circuit is powered from a 12-volt gel-cell. If you opt for battery operation, it will be necessary to acquire a special charger (sold separately by gel-cell vendors, such as Digi-Key). In addition, be aware that the heating element of SEN1 uses about 130 mA; so if you use a battery, purchase one with several amp/hours capacity for a reasonable running time between charges.

**Assembly.** The Explosive Gas Detector was assembled on a printed-circuit board measuring about 3 1/16 by 5 1/16 inches. A template for that printed-circuit pattern is shown in Fig. 3, with the corresponding parts-placement diagram appearing in Fig. 4. Since space is at a premium, it is recommended that miniature parts be used to facilitate assembly. Remember that the bargraph display (DISP1) and alarms section are optional, and can be omitted as desired.

Once you've obtained all of the parts (all of which, except DISP1 and SEN1, are available from Digi-Key Corp., P.O. Box 677, 701 Brooks Ave. South, Thief River Falls, MN 56701-0677; Tel. 800-344-4539) listed

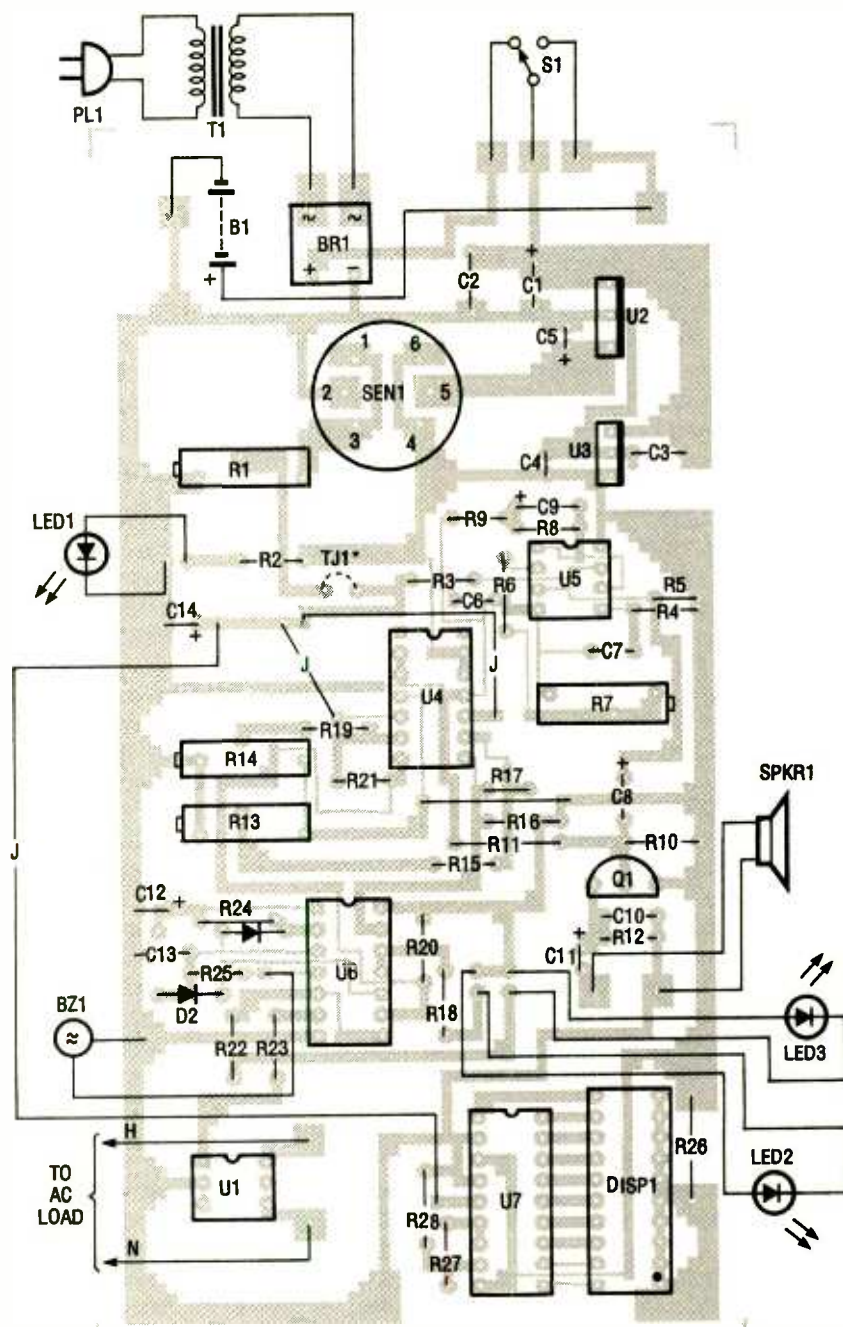

\*SEE TEXT

Fig. 4. Assemble the circuit using this parts-placement diagram as a guide. Since space is at a premium, it is recommended that miniature parts be used. Remember that the bargraph display (DISP1) and alarm section are optional, and can be omitted as desired.

in the Parts List (or those necessary for your version of the circuit) and etched a printed-circuit from the pattern provided, construction can begin. Note from Fig. 4 that the board contains several jumper connections; those jumpers should be installed near the end of the assembly process, since some of them must be routed around some board-mounted components. While we're on the subject of jumpers, be sure not to install the \*test jumper

(TJ1) until instructed to do so.

A special socket for SEN1 is available from the sensor supplier. The socket can then be wired to the board, allowing the sensor to be located in the open and exposed to free air. The sensor should be mounted vertically with space underneath to allow convection of air through the sensor's case. If the sensor is located a significant distance from the power supply (more than a few

feet), use fairly heavy wire in order to supply sufficient current to the internal heater. And sockets should be provided for all of the IC's; that includes DISP1, which can be accommodated by a 20-pin socket.

Install the passive components first (IC sockets, resistors, and capacitors), followed by the non-socketed semi-conductors (the bridge rectifier, the diodes, the transistor, and the voltage regulators). Be sure to heat sink U2. When assembling the board, pay special attention to the orientation of the polarized components—electrolytic capacitors, transistors, diodes, and IC's—as one misoriented part will cause the project to fail.

Once all of those components have been installed, check your work for defects such as cold solder joints, solder bridges, misoriented components, etc. If all is well, move to the power-supply section of the circuit. If the unit is to be operated exclusively from the AC line, connect T1 (see Parts List for specifications) to the circuit-board as shown in Fig. 4. If, on the other hand, the unit will be for portable use only, connect the battery as shown. If you intend to use the unit for both portable and fixed applications, connect both supply options. In any event, don't forget to install S1, which either serves as a power-source selector, or an on/off switch, depending on how you decide to configure your unit.

Do not install the gas sensor or the socketed IC's yet; the circuit must be checked out first. When the board has passed inspection, apply power to the circuit. Check the output of both voltage regulators; U2 (+5-volts) and U3 (+8 volts). Once the proper voltages are verified, power-down the circuit and insert the IC's, making sure that they are properly oriented. Also, take precautions against electrostatic discharge when handling U6 (the MM74C14N inverting Schmitt trigger). Using insulated wire, attach a small speaker (8 to 32 ohms) to the board at the points indicated in the parts-placement diagram. The piezo buzzer, BZ1, is also located off-board to save space. Attach its positive (+) lead to the point shown and the ground wire to any point on the ground (-) buss.

Now turn the power on, and adjust R1 and R7 to their approximate mid-

points. Initially, new gas sensors require a "conditioning" period while their impurities are baked off by the internal heater. The process should take about 15 minutes the first time the project is turned on. So expect the alarm to initially sound off. After the first "baking," the sensor should reach stability more quickly, 2 or so minutes after applying power. The readings may be regarded as accurate after those time intervals have elapsed and the circuit is calibrated.

If you don't like the alarm going off when the circuit is first powered up, insert a small switch in series with the piezo buzzer and/or speaker and set it to the off position until the unit has warmed up. Ideally, the LED bargraph (DISP1) should have none or just the first LED lit after warm-up. The speaker should emit a low-pitch whine or buzz.

**Calibration.** The care you take in calibrating the circuit determines the ultimate accuracy of the project. Calibration is made simpler if a frequency counter is used. Start by measuring the exact output of U2. Temporarily connect a jumper wire between the +5 volt line and the point marked TJ1 in the parts-placement diagram. That sends a +5 signal to U5 (the voltage-to-frequency converter) and the rest of the circuit (see the schematic diagram in Fig. 2).

Using the counter, measure the output frequency of U5 at pin 3. Adjust R7 so that the output frequency is 1000 times the exact output voltage of U2; e.g., if U2's output is 4.95 volts, the output frequency of U5 should be 4950 Hz. Remove the +5-volt jumper and permanently solder a wire across the test-jumper pads (a piece of discarded resistor lead will do). Now the voltage-to-frequency circuit is calibrated.

Another approach can be used by those who do not have access to a frequency counter. First you must find a way to produce a stable 0.44 volts DC; to accomplish that, a potentiometer wired to one of the on-board voltage regulators can be used as a voltage divider. Connect the 0.44-volt output of the divider to the test-jumper pad on the R3 side. Adjust R7 until the tone at the speaker is about middle "A" (440 Hz). The circuit can be tuned by ear, using an A-440 tuning fork (a common item in a musician's

toolbox) or by comparing it to an instrument or audio generator that will play A-440.

The SENSITIVITY-ADJUST (R1) calibration is a user-specific one. For example, if you want to detect carbon monoxide, as discussed earlier, set the sensitivity to maximum by turning the knob fully counter-clockwise. Note that if you have the sensitivity control turned down too far it will take a large concentration of gas to activate the warning portions of the circuit—avoid turning it too far down at all costs. That feature was designed with a large dynamic range so industrial users who want to scientifically measure high concentrations of explosive gas have the option to do so; users should be very conservative when setting this function.

For example, if your application is precise and you need to detect a specific level of, say, lacquer thinner (as set by OSHA standards for the workplace), you might not want maximum sensitivity so as to eliminate nuisance alarms, but would instead balance the setting of the control along with the CAUTION SET and DANGER SET controls (R13 and R14, respectively). You could also borrow or rent an industrial meter to calibrate the Explosive Gas Detector, perhaps for a specific application and gas.

Builders should be cautioned that large swings in temperature and relative humidity (RH) will affect the sensitivity of the gas sensor. Once you have exactly calibrated your unit for, say, 60% RH at 72°F, you would have to re-calibrate it if the environment changes to, say, 90°F at 40% RH. However, most builders need not be concerned by the changes in temperature and RH on the sensor, since (as we discussed) the object is to detect explosive gas long before it has reached a flammable level.

The final calibration is to adjust the circuit so that nuisance alarms do not occur, while keeping it sensitive enough to sound-off immediately if a bad situation arises. Again, your application will determine the settings. In the case of propane or cooking gas (which has a chemical odor added so you can smell it at low concentrations), I suggest the following: Set R1 at maximum sensitivity, set R13 so that the alarm comes on as LED2

*(Continued on page 94)*



*Here is a way to signal family members or co-workers that their presence is requested or that there is a phone call for them without putting a strain on you vocal cords*

BY JIM COOKE

If your business or home has lots of telephone activity, the *Phone-Pager* project described in this article may be of interest to you. The Phone-Pager has an adjustable beeper, a seven-segment display, an easy-to-customize graphics overlay, and connectors for access to the phone line. The unit also has its own DC power supply, so it does not have to draw power from the phone line.

Working in conjunction with standard touch-tone phones, the Phone-Pager allows you to non-verbally notify others of phone calls, dinner, business meetings, etc. You simply use your existing touch-tone phone as the sender, while the Phone-Pager listens for communications directed to it. The Phone Pager, which also works well with cordless phones, is a must for families with teenagers or for small businesses where rapid communication is needed.

In addition, its operation is simple. For example, let's say that you have two teenage children, and they each have an extension phone in their rooms; on top of that, there are extension phones in the kitchen and family room. Further, let's assume that each phone has a Phone-Pager connected to it.

In addition to being individually addressable, the Phone-Pager also has the ability to accept "wildcard" addressing as well as global addressing; i.e., a unit can respond to more than one number. Now let's assume that child 1's unit is programmed to recognize numbers 1 and 2, and child 2's unit is set to recognize 4 and 5. Since both children use the family room, the Phone Pager there is set to recognize 1, 2, 4, or 5. Now, when a call comes in for child 1, you simply press the asterisk (\*) key followed by 1 on your touch-tone phone. The purpose of the asterisk key is to inform all Phone-Pagers to "watch" for the next key press



(number) to see if it matches what it's programmed for.

After pressing the asterisk key followed by the 1 key, the unit in child 1's room as well as the one in the family room is activated, causing them to sound a 2-second beeper as well as display the number (in this case 1) sent for 10 seconds. (Units not specifically addressed remain idle.) The number is used in our family room example to see exactly who the call is for.

With regard to global or wildcard addressing, in our example, child 1's unit was set to recognize numbers 1 or 2, so 1 could be a code meaning that there is a phone call for child 1; a 2 could mean come to dinner.

To make the Phone-Pager even more useful, pressing the asterisk key twice followed by the number is used to page all units, which then display the number entered. That basically overrides the specific address of the unit. That feature could be used if the person being paged has not answered the first page, or it could be used as a "calling-all-persons" message.

**Theory of Operation.** A complete schematic diagram of the Phone-Pager is shown in Fig. 1. The input to the circuit is fed through one of two telephone jacks (J1 or J2), which are parallel-connected to one another to allow the phone line to be daisy-chained between the wall jack and the telephone. Note the two jumpers (labeled JP1, JP2), which, if installed,

would allow a single power supply to be shared between several units. By installing those jumpers, power is distributed between all connected units via pins 1 and 6 of J1 and J2. (To support two line-phone setups, pins 3 and 4 of J1 and J2 are tied together.)

The input signal is picked off pin 3 of the input jack and coupled to pin 2 of U3 (an SC11270 DTMF—Dual-Tone Multi-Frequency-decoder) through the C2/R2 combination. The other leg of the input (at pin 4) is coupled to ground via C3. Using two capacitors at the input provides AC coupling, while blocking any DC that might interfere with the operation of the circuit. Zener diode D1 clamps the input applied to pin 2 of U3 so that it does not exceed 5.1 volts, preventing very high ring voltages from reaching U3 and damaging the IC. Timing for U3 is provided by a 3.58 MHz crystal (XTAL1) that is connected through pins 7 and 8 to the unit's internal oscillator. Components C1 and R1 determine the response time of the chip.

When a valid DTMF signal—which consists of a low tone and a high tone mixed together—is delivered to U3, the signal is fed to U3's internal dial-tone filter. The signal is then separated into high and low tones, which are, in turn, fed to digital-detection-algorithm and code-convert/latch circuits. Table 1 gives high and low frequencies and the decoded logic outputs of U3 associated with each key. Note that only four different low tones (labeled f<sub>low</sub>) and four different

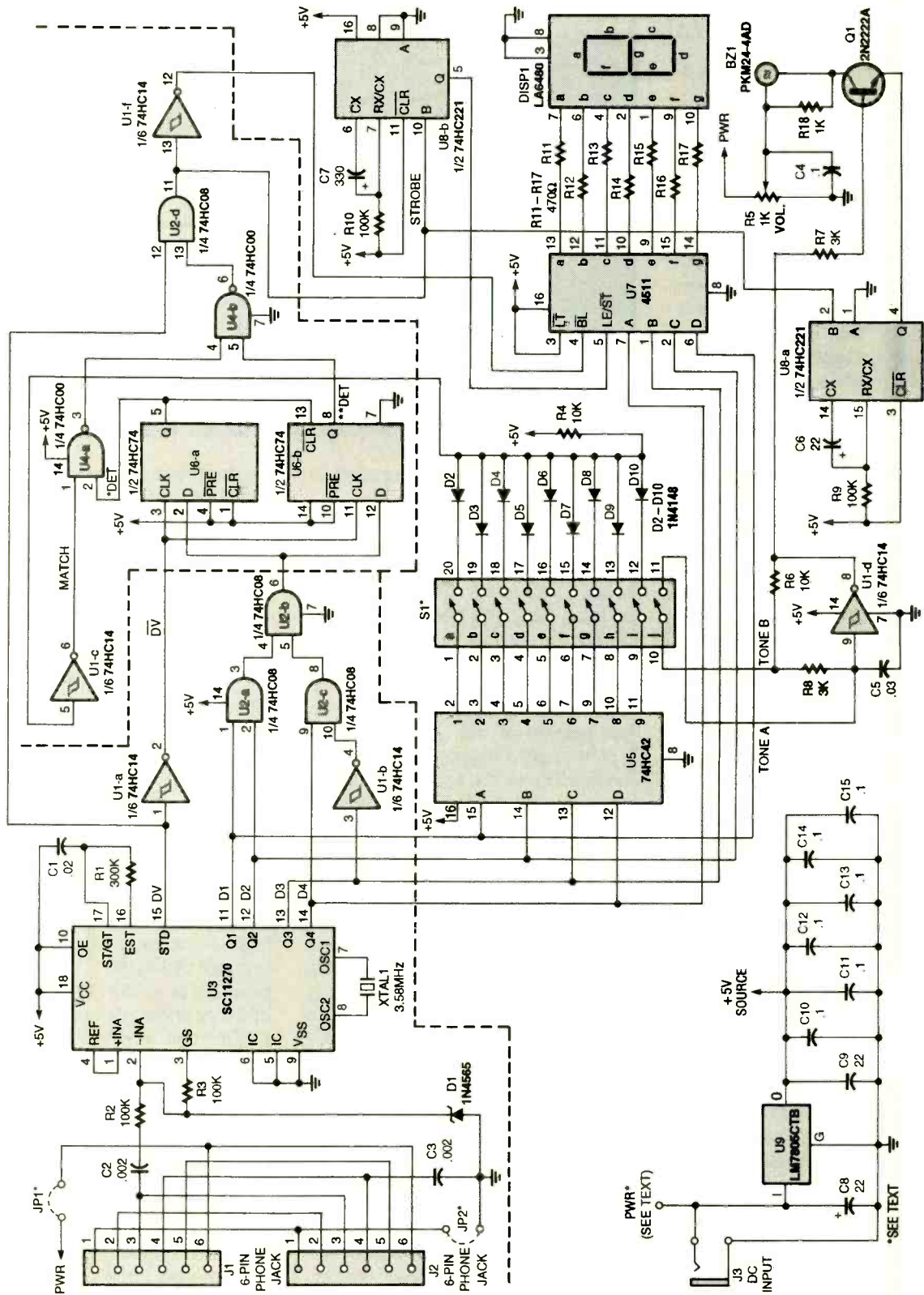

Fig. 1. The input to the Phone-Pager is fed through one of two telephone jacks (J1 or J2) to pin 2 of U3 (an SC11270 DTMF—Dual-Tone Multi-Frequency decoder) through the C2/R2 combination.



**TABLE 1—DTMF DECODER OUTPUT**

<i>f</i> <sub>low</sub>	<i>f</i> <sub>high</sub>	Key	Q4	Q3	Q2	Q1
697	1209	1	0	0	0	1
697	1336	2	0	0	1	0
697	1477	3	0	0	1	1
770	1209	4	0	1	0	0
770	1336	5	0	1	0	1
770	1477	6	0	1	1	0
852	1209	7	0	1	1	1
852	1336	8	1	0	0	0
852	1477	9	1	0	0	1
941	1336	0	1	0	1	0
941	1209	*	1	0	1	1
941	1477	#	1	1	0	0
697	1633	A	1	1	0	1**
770	1633	B	1	1	1	0**
852	1633	C	1	1	1	1**
941	1633	D	0	0	0	0**

\*\*Not supported by normal phones

high tones (labeled *f* high) combine to yield the 16 encoded outputs.

A valid DTMF signal causes the chip to generate two types of signals: a four-bit BCD output, Q1–Q4 at pins 11–14, respectively (which are internally latched to retain the last valid DTMF signal) and a DV (Data Valid) output at pin 15 (which acts as a sort of enable signal for U2-d). The DV signal is also inverted by U1-a (providing a negative-going trigger signal) and fed to U6-a and U6-b (the two halves of a 74HC74 dual D-type flip-flop) at pins 3 and 11, respectively, to clock those devices. The DV output at pin 15 of U3 is normally low, and goes high when a valid signal is delivered to U3's input.

The BCD outputs of U3 are fed along three paths. In the first path, U3's outputs are fed to a pair of AND gates (Q1 and Q2 to U2-a and Q3 and Q4 to U2-c) whose outputs are then AND'ed together via U2-b, the output of which is fed to the D-inputs of flip-flops U6-a and U6-b, which are both clocked by the negative edge of the inverted Data Valid (DV) signal (pin 15 of U3). Flip-flop (U6-a) simply remembers if the previous keystroke was an asterisk. The timing diagram in Fig. 2 shows that in more detail. Flip-flop U6-b is used to detect the occurrence of a two-asterisk keystroke. That flip-flop is held reset (by feeding the output of U6-a to U6-b's clear input at pin 13) until a second asterisk keystroke is detected; once a second asterisk is detected, the flip-flop is set and remains set until a non-asterisk key is depressed. The output of U6-b is then fed to pin 5 of U4-b.

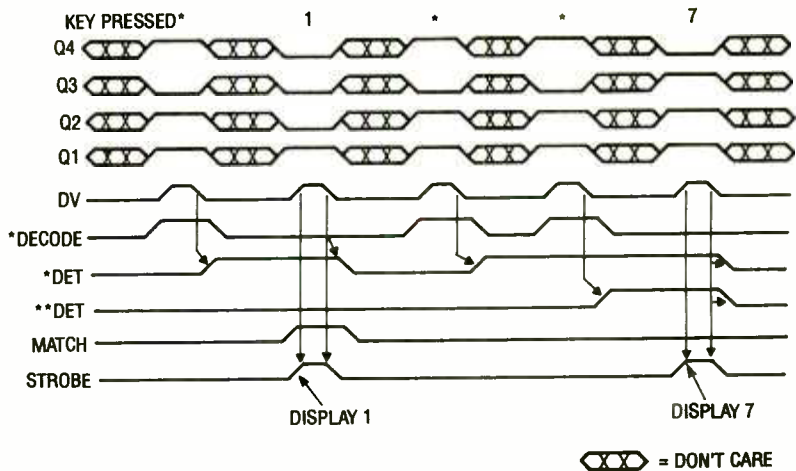

Fig. 2. This timing diagram in Fig. 2 shows the sequence that occur when a valid DTMF signal is detected.

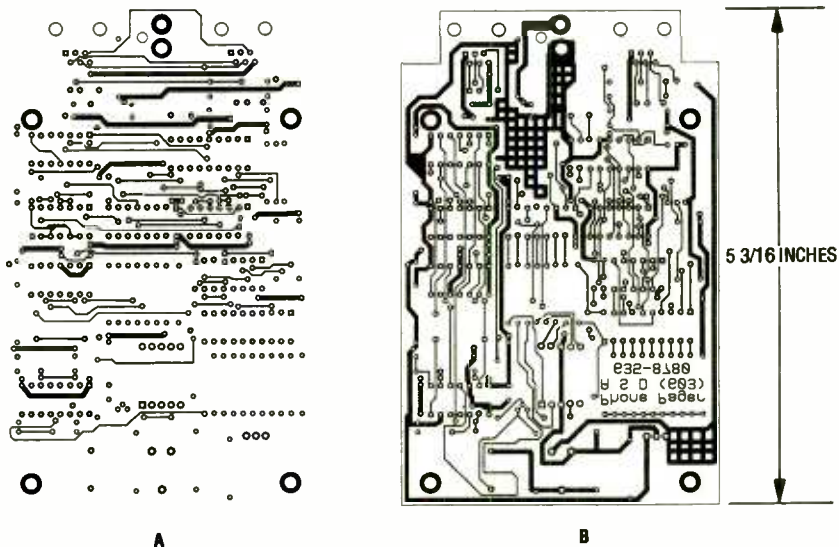

Fig. 3. The Phone-Pager was assembled on a double-sided printed-circuit board, measuring about 5<sup>3</sup>/<sub>16</sub> by 3<sup>5</sup>/<sub>16</sub> inches; templates for both sides of the board are shown here at half size (50%). The template in A is the component side of the board while B shows the foil side of the board.

The output of U6-a is also fed to one leg of U4-a (pin 2) and acts as an enable signal for that gate. The output of U4-a is then fed to U4-b, where it is inverted and AND'ed with the output of U6-b. The output of U4-b is then fed to pin 12 of U2-d, where it is AND'ed with the DV output (pin 15) of U3. The output of U2-d serves as a strobe signal for other subcircuits in the assembly. The strobe signal provided by U2-d at pin 11—which pulses high after a valid address has been decoded, or after double-asterisk keystrokes are followed by any number key—is fed to both halves of U8 (a 74HC221 dual monostable multivibrator).

Normally, when U8-a has not been triggered, the emitter of Q1 (which is tied to the output of U8-a) is held high,

preventing it from turning on regardless of its base input signal. When monostable U8-a is triggered by the strobe signal, it brings Q low for 2 seconds. The low output of U8-a pulls the emitter of Q1 low, thereby enabling it. That allows BZ1 to be activated by the output of U1-d (½ of a 74HC14 hex inverting Schmitt trigger), which is configured as a free-running oscillator, and has a frequency of about 2000 Hz. The length of time that BZ1 sounds is determined by the value of C6, which can be increased if a longer tone is desired. Potentiometer R5 (the vol control) determines how much power is delivered to BZ1.

Switch S1-j is used to optionally add or remove the 3k resistor (R8) from the feedback of the oscillator. That allows the output of BZ1 to be set as a 2500-

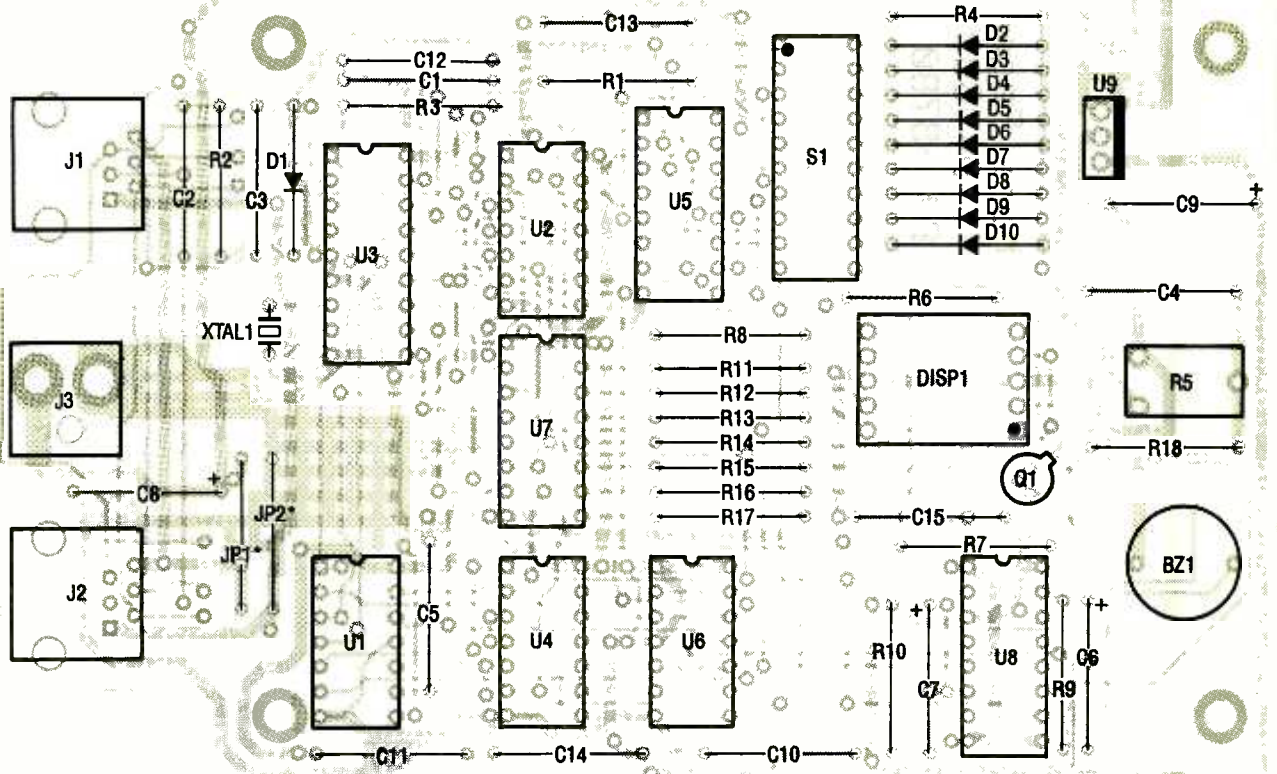

Fig. 4. All of the components for the Phone-Pager, as shown here, were mounted on the printed-circuit board, including DISP1, which was mounted in double rows of SIP sockets.

Hz or a 2000-Hz tone—an option that can be used to ascertain which unit is being paged when two units are located physically close to one another.

In the second path, the decoded outputs of U3 are fed to U5 (a 74HC42 BCD-to-decimal decoder), which in combination with diodes D2 through D10 and DIP switch positions S1-a—S1-i allows us to provide a match on any combination of the decoded numbers one through nine. The diodes constitute a “wired-or” output that allows the user to configure the Phone-Pager to answer to only one address or all addresses. The DIP switch can be omitted, and the circuit can be programmed by simply soldering a jumper across the appropriate switch position. The or’ed decimal output of U5 is inverted by U1-c and fed to the second leg of U4-a, and on to U4-b (as mentioned earlier in connection with the strobe signal output by U2-d).

In the third path, the decoded outputs of U3 are fed to U7 (a 74HC4511 BCD-to-7 segment decoder/display driver), which is connected to seven-segment display DISP1 through seven 470-ohm resistors, causing the appropriate segments of DISP1 to light,

showing the number that was entered. In this section of the circuit, the strobe output of U2-d is inverted by U1-f and used to latch data into the decoder. As with the buzzer circuit, U8-b is used determine how long the display remains active. In this case, U8-b and its associated components keep DISP1 lit for about 10 seconds. By increasing the value of C7, the display’s on-time can be increased.

**Construction.** The Phone-Pager was assembled on a double-sided printed-circuit board, measuring about 5 $\frac{3}{16}$  by 3 $\frac{3}{16}$  inches; full-size templates for both sides of the board are shown in Fig. 3; the template in A is the component side of the board while B shows the foil side of the board. Those unable to produce their own double-sided boards or to find assembled units from the supplier listed in the Parts List.

All of the components for the Phone-Pager are mounted on the printed-circuit board, including DISP1, which was mounted in double rows of SIP sockets. That was done to raise the

height of the display, placing it very close to the graphics overlay. A parts-placement diagram for the unit’s printed-circuit board is shown in Fig. 4.

If you do not plan to use DIP switch S1, you need to give some thought to the address(es) you want to set the unit for. By referring to Fig. 1, you will see that the address decoding is very straightforward. Diodes D2 through D10 are used to decode number keys 1 through 9 respectively. If the DIP switch is not installed, you must wire a jumper across the switch for the numbers that you wish to decode. Once all components are soldered in place, check your work for the usual construction errors.

Once you are satisfied that the circuit contains no defects, plug the wall-mount power supply into the Pager and apply power to the unit. Initially, the beeper will sound for 2 second and the display will light for about 10 seconds. If that does not happen, check the output of voltage-regulator U9 for + 5 volts. If the voltage is okay, check the board for other defects of the sort mentioned above. Also remember that since the circuit

(Continued on page 94)



# Add a DVM

BY SCOTT HENDERSHOT

**P**C-based analog-to-digital (A/D) conversion is a hot topic these days. So there are numerous A/D adapter boards available for PC's. However, most of them seem to be geared toward digitizing waveforms in the megahertz frequency range and, as a result, cost megabucks. However, for many types of signals, high-speed, high-cost conversion is not necessary. For example, unless you are doing some special, research you probably do not need to take temperature measurements at 50,000 samples per second even if high resolution is a must.

So what data-acquisition technique will yield a cost savings by permitting slow, high-resolution analog-to-digital conversion? Voltage-to-frequency (or V/F) conversion, which is very useful for digitizing steady-state or slowly changing DC signals. Voltage-to-frequency conversion is seldom discussed in texts on analog-to-digital conversion, probably because of its generally slow conversion speed. However, it offers some important advantages over other techniques. For example, its inherent integration of the input signal makes it more immune to noise. Also, high-resolution is more easily obtainable with this form of conversion.

You can take advantage of all that by building the project presented in this article. It is a 0- to 12-volt analog-input adapter that uses the Analog Devices AD654 voltage-to-frequency converter IC. That IC has several features that make it very attractive to the experimenter including extremely low cost, low support-component count, and the ability to be powered by a single 5-volt supply. The circuit uses a PC's game port as the interface, has a resolution of 1 part in 12,000, and can be built for about 15 dollars.

As you read through this article you will probably see opportunities to



## to your PC

*Turn your PC into a digital voltmeter for automated testing, to record readings over time, and more.*

customize this project for your own needs. Fortunately, there are many parameters that can be changed (which we'll explore in moderate detail) once you understand how each affects the overall system. The intent here is not to fully illustrate the AD654, but to present the basics of a complete A/D converter project and allow the experimenter to use it as a starting point for other designs.

**The Circuit.** Looking at the schematic diagram in Fig. 1, you will notice that there are only two active components: U1 and U2. Taking U1 first, it is an Analog Devices AD654, which is the actual analog-to-digital converter. More accurately, it is a voltage-to-frequency converter; it accepts an analog input voltage (the difference between its  $-V_{in}$  and  $+V_{in}$  inputs)

and generates a squarewave. The chip was chosen for its ease of implementation. For example, it can be powered from a single supply such as the 5 volts available from a PC's game port. The full-scale input range can be set by a single resistor, and it has a linearity of 0.1% or better.

Integrated circuit U2 is an LM324 single-supply general-purpose op-amp with an input impedance of 250-megohms set up as a voltage follower. It provides input protection and bias-current compensation for the AD654. Other single-supply op-amps will also work, however the LM324 is readily available while others might be difficult to find.

As mentioned, the output of U1, and therefore the circuit, can be connected to any digital input on the PC. For example, one of the parallel-port



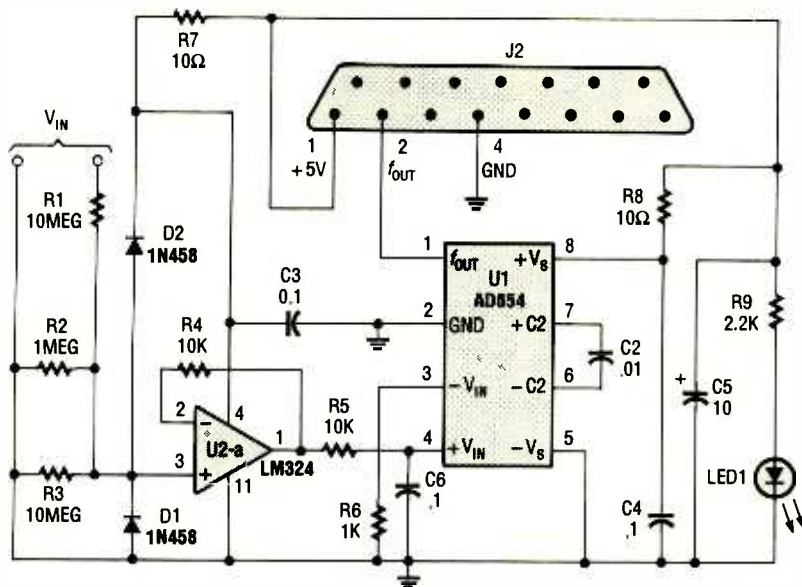

Fig. 1. Effectively, the adapter can be broken down into a voltage-to-frequency adapter with a signal-conditioner/protection-circuit at the front end.

handshaking inputs or one of the button inputs on the game port. We decided to use the game port (via J2) because of its 5-volt outputs. Bear in mind that the AD654 has an open-collector output capable of sinking about 10-mA. So the input of the computer port you use must be tied to 5 volts through a pull-up resistor residing either inside the computer or the adapter circuit. The inputs on the game port are tied high within the computer, so we don't need to worry about this. If you decide to use another input port (such as the parallel port), you will need to deliberately pull the signal line high.

The AD654 can accept input voltages of up to 4 volts less than the power supply. Since we will be using the PC's 5-volt supply, our maximum input voltage will be 1 volt. In order to extend this range to 12 volts, a voltage divider is used ahead of both U1 and U2 to scale the input down to 1 volt. Looking at the schematic you will see the divider is made up of R1, R2, and R3. Resistors R2 and R3 are in parallel and have a total resistance of 909,000 ohms. In series with the 10-megohm resistor that provides a 12:1 attenuation of the input signal. Component values are not critical and 5% types are okay to use. Any accuracy problems will be compensated for in software. Using the attenuator will reduce the input impedance to 10 megohms. This is about the same as most digital volt meters and should not be a prob-

lem for most applications.

Once supplied with appropriate input, the AD654 requires the addition of only two passive components in order to operate. These are a timing capacitor (C2) and a scaling resistor (R6). The scaling resistor sets the overall input-voltage range and the capacitor sets the full-scale frequency.

The scaling resistor converts the IC's input voltage to a current. That resistor must be selected to provide 1 mA of input current at the full-scale input voltage. For example, our full-scale input voltage will be 1 volt, so by Ohms law, the resistor needs to be 1k. You might be tempted to substitute another resistor to achieve some other full-scale voltage. That is fine as long as you observe the design parameters that follow.

The timing capacitor should be selected by using the following formula:

$$C = V/(10Rf)$$

where  $f$  is the full-scale frequency (10 kHz for our design),  $R$  is the scaling resistor, and  $V$  is the full-scale input voltage, which is 1 volt for our circuit. This sets the value of our timing capacitor, C2, at 0.01- $\mu$ F. It is possible to design the circuit to operate at a higher frequency, but most PC's will not be able to keep up with the signal. This frequency is suitable for PC/XT and later machines.

The only other criteria for the capacitor is a stable temperature coefficient. The following types are recom-

## PARTS LIST FOR THE ANALOG-INPUT ADAPTER

### SEMICONDUCTORS

- U1—AD654 voltage-to-frequency converter, integrated circuit
- U2—LM324 operational amplifier, integrated circuit
- D1, D2—1N458, or 2N5089 diode
- LED1—light-emitting diode

### CAPACITORS

- C1—not used
- C2—0.01- $\mu$ F polypropylene
- C3, C4, C6—0.1- $\mu$ F monolithic bypass
- C5—10 $\mu$ F, 6-WVDC, Tantalum

### RESISTORS

- (All fixed resistors are 1/4-watt, 5% units unless otherwise indicated.)
- R1, R3—10-megohm
  - R2—1-megohm
  - R4, R5—10,000-ohm
  - R6—1000-ohm
  - R7, R8—10-ohm, 1/4-watt
  - R9—2200-ohm

### ADDITIONAL PARTS AND MATERIALS

- J1—not used
- J2—Male DB-15 connector

Printed-circuit board or perfboard, 14-pin IC socket, 8-pin IC socket, connector hood, binding posts, hardware, solder, wire, etc.

The following are available from SCOTTECH (485 Old Ridge Road, Webster, NY 14580; Tel. 716-671-8783, FAX 716-787-2788): Software, \$5.00; printed-circuit board, \$12.00; a kit including software, circuit board, U1, C2, and the IC sockets, \$25.00. Add \$3.00 shipping with your order, and NY State residents must add 8 1/2% sales tax.

The AD654 voltage to frequency converter is available from Newark Electronics (N. Ravenswood Ave., Chicago, IL 60640-4496; Tel. 312-784-5100)

mended: polystyrene, NPO ceramic, and polypropylene. Other types are not recommended due to their poor temperature stability.

With the output of the AD654 connected to a TTL-input port and tied to 5 volts, it will generate a 0-5-volt square-wave. The frequency of the square-wave will be linearly proportional to the input voltage. The component values chosen will give us a 10-kHz square-wave at full scale. That



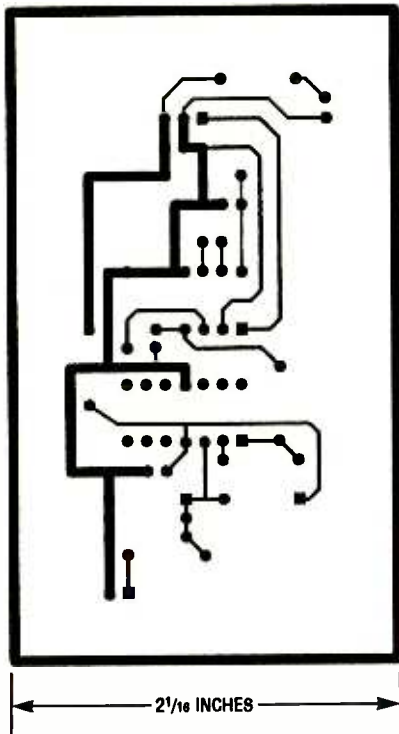

Fig. 2. It is recommended that you use this foil pattern for making your own adapter circuit board.

translates to 10 Hz per millivolt. Actually, because of the voltage divider, our scaling will be 0.833 Hz per millivolt. However, because of the way the software measures the voltage, it is not necessary to have a 1-to-1 correlation of Hz to millivolts.

Diodes D2 and D1 provide input protection in case of polarity reversal or over-voltage. These should be Schottky or low-leakage type diodes.

Resistor R5 provides bias current compensation to the AD654. Together with C6 they form a single-pole filter with a time constant of 1 millisecond. That helps suppress noise at the input to prevent false readings. Remember we are measuring voltage changes of only 100 microvolts.

A 10- $\mu$ F tantalum capacitor (C5) at the point where the supply voltage enters the circuit quiets any power-supply noise to produce a clean square-wave output. The additional resistors and 0.1- $\mu$ F monolithic capacitors shown in the schematic just decouple the IC's.

**Software.** Precise timing software is the key ingredient to using this technique on a PC. Most high-level languages are inadequate for microsecond timing so the software must be

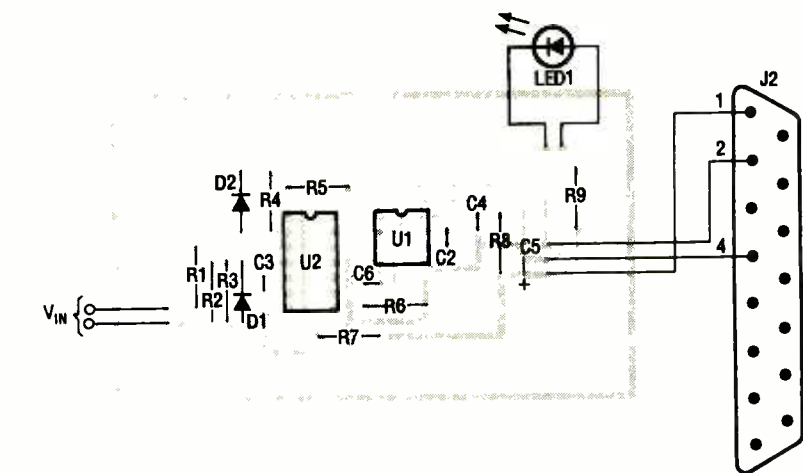

Fig. 3. If using a PC board based on the author's foil pattern, stuff it as shown here. Note the polarity of the diodes, C5, and LED1 as you proceed.

written in machine language. To spare you the agony of assembly-language programming, all of the necessary interface routines complete with manuals have been made available by the author (see Parts List). There are demo programs that show you how to call the data-acquisition routines from C and BASIC, and linkable object modules for both languages. There is also a quick library that can be loaded into the QuickBASIC environment.

A single call is all that is necessary to acquire a sample from the adapter. The functions return a floating point value that is already adjusted for the current calibration. The supplied functions have a conversion time of about 17 ms. That will provide about 60 samples per second. This sample rate was chosen to reduce the effects of 60-cycle noise. Each sample will last exactly as long as one cycle of a 60-Hz sine wave, therefore fully integrating any noise. The functions have been tested with Microsoft BASIC and QuickBASIC, Microsoft C and Quick C. I cannot guarantee their compatibility with other compilers.

Along with the sample programs, there is a program called DVM.EXE. This program is a digital voltmeter application. When run, it expects to find a square-wave signal on the button-0 input of the game port. If the signal is there, the program reads the frequency and displays the calculated voltage. Complete instructions for using DVM are provided with the software.

For convenience, all this software

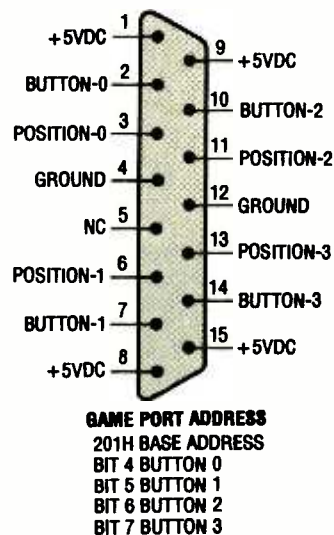

Fig. 4. You can use the additional button inputs on your PC's joystick port to receive data from multiple adapters.

has been posted on this magazine's bulletin board. The telephone number is 516-293-2283 and the protocol is no parity, 8 data bits, and 1 stop bit. However, if you go this route you'll have to do without the manuals. [At the time this was being prepared for publication a Windows version of the software was due to be released. Contact Scottech for further information—*Editor*]

**Construction.** The circuit should be constructed using a printed-circuit board. You can obtain one from the author (see Parts List for ordering information), etch your own using the pattern in Fig. 2, or design your own.

If you design your own PC board consider the following precautions.

(Continued on page 92)

# Pipe and Tubing Antennas

*Design and build a communications antenna, and save a bundle in the process.*

BY JOSEPH J. CARR

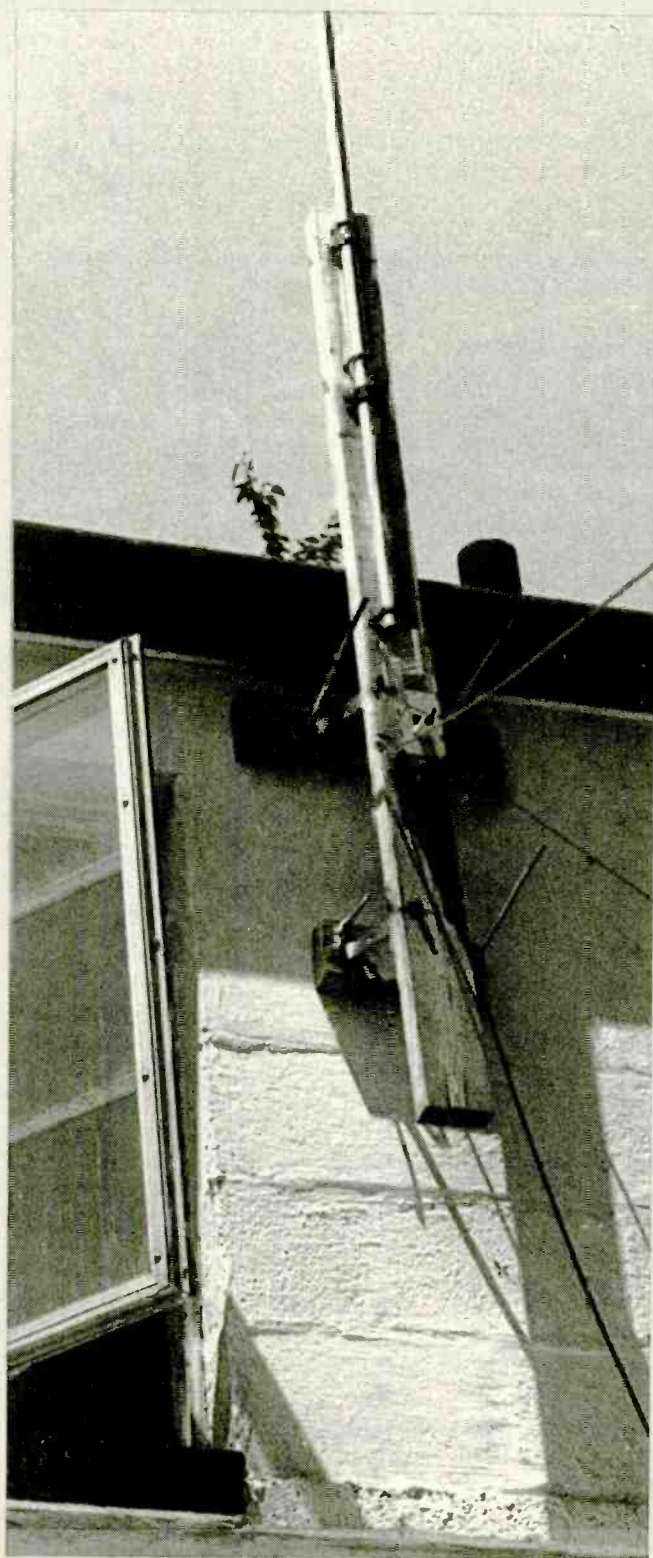

**A**ntennas can be made from a variety of materials. The most common materials used in antenna construction are wire and aluminum tubing or copper pipes. In this article, we'll discuss the basic methods used to process aluminum tubing and copper pipes into functioning antenna systems.

Aluminum tubing is available at almost all hardware stores in any diameter. Even small operations carry aluminum tubing in at least three diameters: 1/2 inch, 3/4 inch, and 1 inch. Larger hardware stores may have a substantially more impressive display of aluminum tubing in diameters ranging from 1/2 to 1 1/2 inches, and in various lengths. While small stores may stock aluminum tubing in six- and eight-foot lengths, larger stores might also carry four-foot and twelve-foot lengths. Specialty metal distributors also have a wide variety of aluminum tubing, but they are a bit harder to find and often require a minimum purchase of \$50 to \$100.

Regardless of where you obtain the required materials, there's a little secret that you should know about aluminum tubing: adjacent sizes form a slip fit with each other. That is, the smaller outside diameter pipe fits snugly inside larger diameter pipe. When purchasing aluminum-tubing for antenna construction, be sure to buy adjacent sizes, and check them by slipping the smaller pipe into the larger one before leaving the store.

Unfortunately, copper pipe in convenient lengths for antenna construction is quite expensive! Although copper pipe is available in sizes ranging up to two inches in diameter, 1/2-inch and 1-inch diameter pipes are easier to find. Copper solders well (aluminum doesn't solder with plain solder at all) and is easy to work with ordinary tools (as is aluminum). And although there may be situations where you might prefer copper over aluminum, most of the time aluminum is the way to go. (Copper antennas look great on the day that they are installed, but soon corrode, turning a yucky green in a few months.)

**Pipe Joints.** Longer lengths of tubing can be made by joining two or more shorter pieces together. There are benefits to working with shorter lengths of pipe or tubing. Because antennas are tuned by adjusting the length, using two sections makes it easier to custom tune the antenna to a specific frequency.

There are several different ways to join sections of tubing. Figure 1 shows four jointing schemes. Figure 1A shows an ordinary slip-joint made by feeding the smaller-diameter tubing six to twelve inches into the larger tubing. The longer the overlap between the two sections, the greater the mechanical strength of the assembly.

Figure 1B shows another jointing scheme, which is used when identical pipe sections are used. The flared end of one section of tubing accepts the non-flared end of the second section of tubing. Note that in that illustration both sections have the same diameter (designated *d*) for most of their



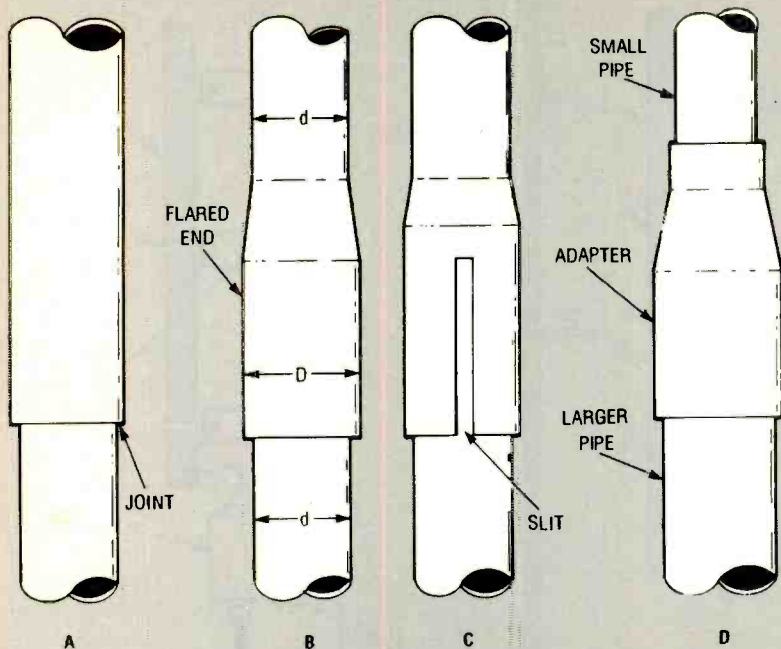

Fig. 1. There are several ways to join lengths of tubing to form an antenna; A shows a slip-fit joint; B is a flanged joint; C is a slotted flanged joint; and D uses a step-down adapter joint.

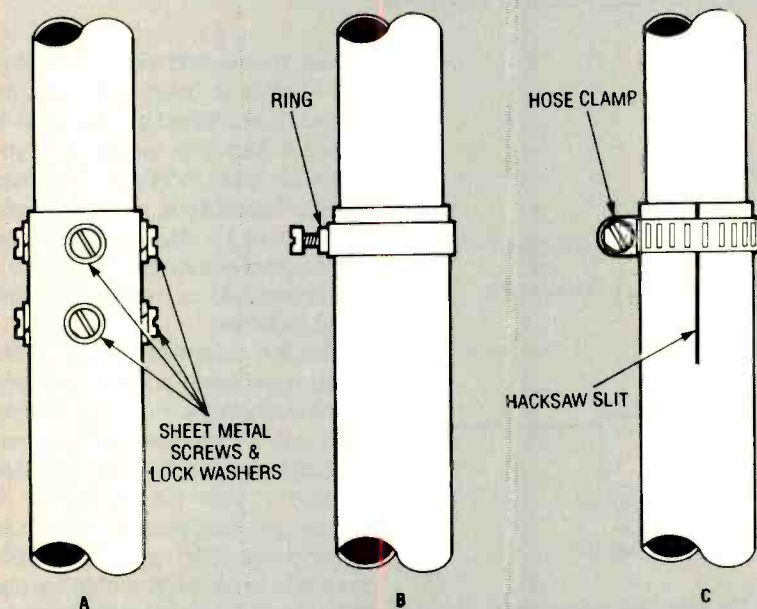

Fig. 2. Putting two pieces of pipe or tubing together is one thing, keeping them together is quite another. Several approaches can be used to secure a joint: in A, several sets of sheet metal screws are used; in B a ring collar with a set screw is used; and in C an automotive hose clamp keeps the joint secure.

length, but flare to a larger diameter (designated D) at one end. In some cases, the small end must be pinched a little bit in order to permit the two sections to be joined. That type of construction is used for steel TV-antenna masts.

Another flared joint is shown in Fig. 1C. In that case, a slot is cut into the flared end to permit an easier slip-fit

between the two sections. Some people also use that method for joining two identical diameter pipes, but that scheme considerably weakens the joint.

Figure 1D shows a scheme wherein a reducing (graduated) adapter is used to bridge the two different diameter sections. That scheme might be used to join 1-inch pipe with a 1/2-inch

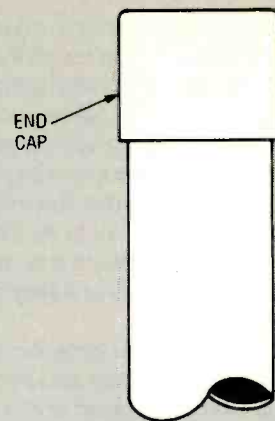

Fig. 3. Once the antenna has been completed, end caps should be placed on the tubing or pipe ends to prevent rain and insects from entering the antenna.

pipe. Such adapters are very difficult to find for aluminum tubing, but are readily available for most sizes of copper pipe. Sweat soldering the ends of the pipes to the adapter produces an excellent bond between the two sections.

Putting two pieces of pipe or tubing together is one thing, keeping them together is quite another. Figure 2 shows three methods that can be used to secure the joints. In Fig. 2A several sets of sheet-metal screws (use #8, #10 or #12 screws) are used to anchor the joint. The number of screw sets used to secure the joint depends on the size of tubing. It is best to use at least two sets of three or four screws. Unfortunately, sheet-metal screws have one less-than-endearing quality; wind and vibration can cause them to work loose. Unless the antenna is supported above and below the joint, it is probably best to use one of the other methods.

The ring and set-screw assembly, shown in Fig. 2B, is used by some commercial antenna makers. In that method, a special ring collar with a #10 or #12 machine screw is slipped over the joint and then the screw is tightened. That method is reliable, but such ring-collar assemblies are hard to find. In addition, tightening the set screw puts a "dimple" in the metal, making it difficult to disassemble for maintenance or adjustment. In such installations, it is best not to tighten the screw until you are finished tuning, since the antenna is tuned by adjusting the physical length of the element.

Similarly, an automotive hose clamp can also be used to fasten the joint, as shown in Fig. 2C. Automotive hose clamps have a wide adjustment range, and hose-clamp set screw does not dimple the metal, making it easy to readjust the joint later. In some cases, it may be necessary to slit the larger pipe in order to allow the outer pipe to be compressed, ensuring a good tight-fitting joint.

In any event, once the antenna is complete and the joints are secured, it is wise to close off the open ends of the pipe(s) to prevent water, debris, and insects from getting into the antenna system. Figure 3 shows an end-cap placed over the open end of the antenna. For copper pipes, metal caps can be sweat soldered in place. Alternatively slip-fit or plastic caps can be used, or you can simply wrap the end with black electrical or nylon-filament tape. But if tape is used, be prepared to replace the tape once in a while—tape takes a beating (cracks and loses adhesion) when left to the elements.

### Mounting Pipe/Tubing Antennas.

The typical method for mounting a pipe antenna is, as shown in Fig. 4A, with beehive insulators. The base of each insulator is mounted to a wall or to a piece of lumber (2 × 4 studding stock, for instance). The top of each insulator is outfitted with a bolt that accepts a hex nut or designed to accept a machine screw. The insulator selected should have a ¼–20 bolt, as smaller sizes will shear off in the wind; over time, even gentle breezes can shear smaller bolts.

Unfortunately, though once commonplace in electronic parts and radio stores only a couple of decades ago, beehive insulators, especially in sizes appropriate for vertical antennas are becoming hard to find. Your best bet is to try some highly specialized stores, or at hamfests and other tailgating events. And, if you manage to locate a dealer, don't be shocked at the price!

An alternate method for mounting the antenna is shown in Fig. 4B. In that scheme, the antenna is mounted to 6- or 8-inch TV-antenna standoffs that are, in turn, mounted to a wall or attached to piece of 2 × 4 lumber, which is, in turn, mounted to the wall. If an antenna tuner or broadband

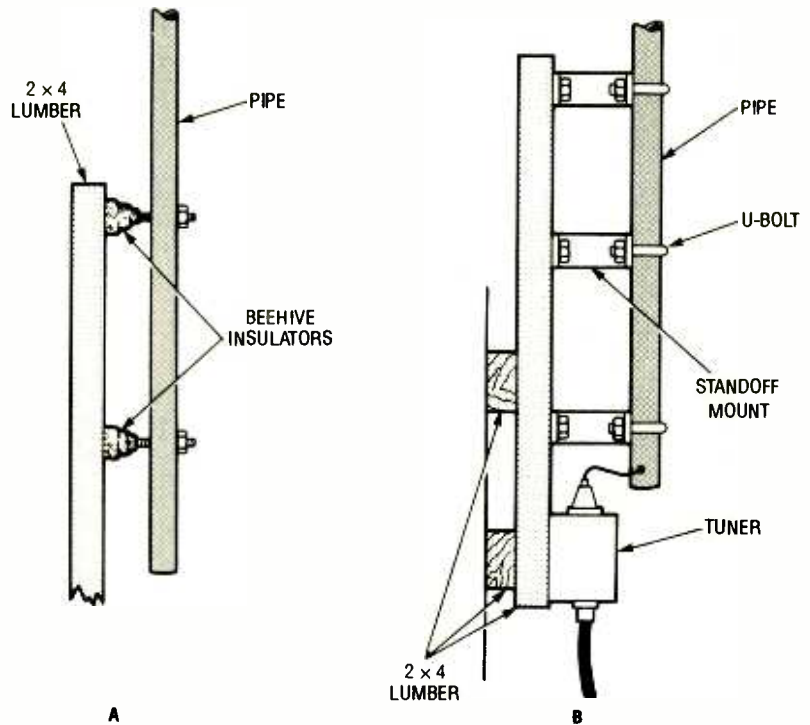

Fig. 4. The antenna should be mounted with beehive stand-off insulators, as shown in A or using TV stand-off mounts as shown in B.

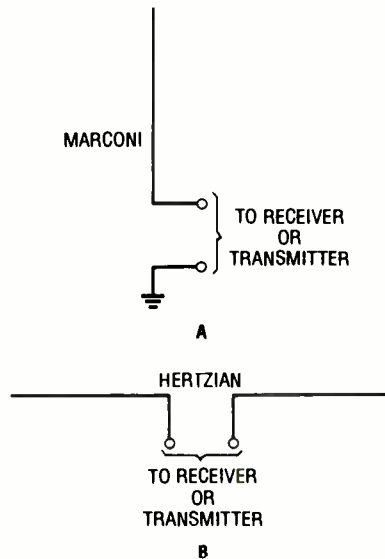

Fig. 5. The Marconi-style vertical antenna (A) is an end-fed (bottom) antenna, and is unbalanced with respect to ground. The Hertzian antenna (B) is balanced with respect to ground: A dipole is a Hertzian antenna regardless of whether it is vertically or horizontally mounted.

transformer is used in your antenna system, it should be mounted with the antenna on the 2 × 4.

The lumber (if that's the type of installation you choose) should be pressure-treated weatherized material, which is the type normally used for

outdoor decks and patios. If untreated lumber is used, it should be painted or varnished beforehand to protect it from the weather; if you don't, it will rot in short order. For most antenna installations, a single eight-foot length of 2 × 4 lumber will suffice. Lengths greater than that are not advised unless two or more pieces are bolted together.

So far, the antennas that we've discussed have been end-fed (bottom) Marconi-style vertical antennas, which are unbalanced with respect to ground (see Fig. 5A). Marconi-style verticals can be ¼, ½, or ¾ wavelengths depending on the design and intended application. Bottom-fed ½-wavelength antennas also exist, but require an impedance transformation tuner at the feedpoint. For the standard ¼-wavelength antenna, the starting length for tuning is found from:

$$L_{\text{feet}} = 234/f_{\text{MHz}} \quad [\text{Eq. 1}]$$

Keep in mind that the length calculated from Eq. 1 is merely an approximation; the actual length will vary a small amount from the calculated value. The antenna is tuned for minimum voltage standing-wave ratio (VSWR) by adjusting the actual physical length of the antenna up or down



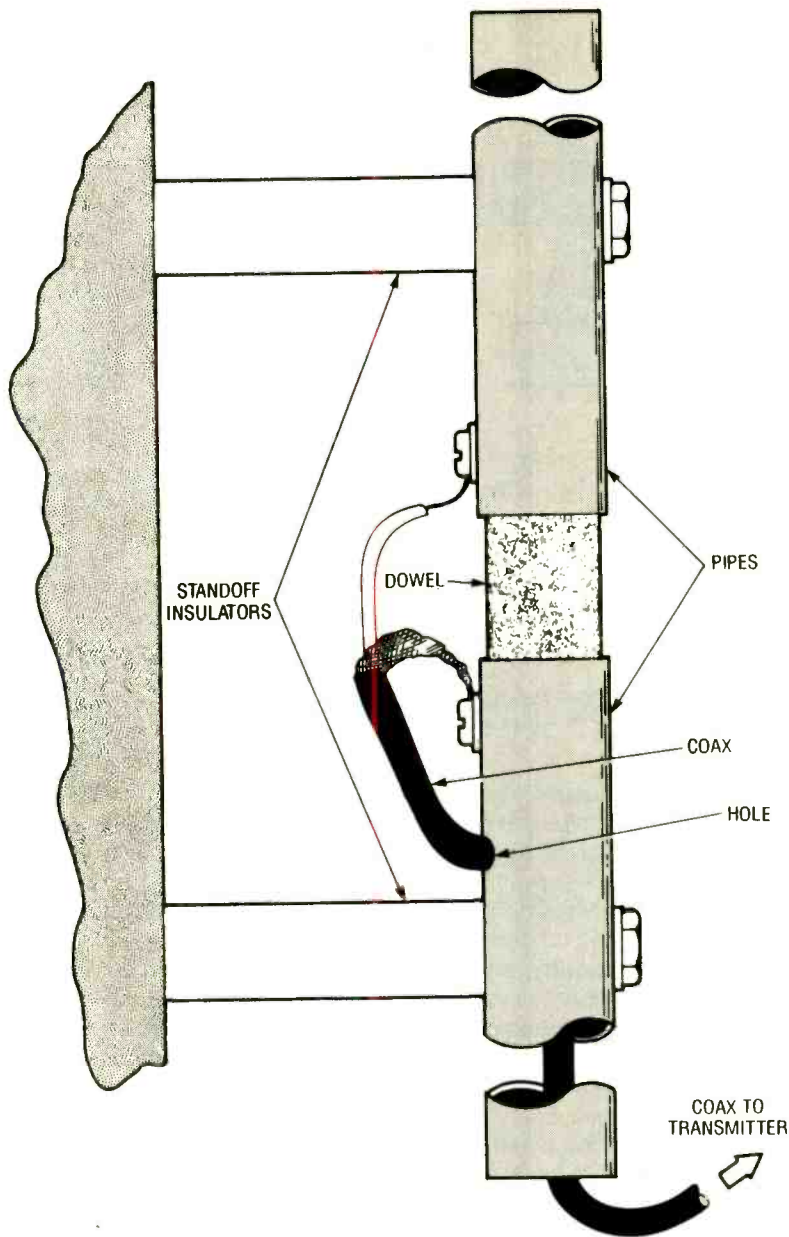

Fig. 6. The transmission line can be connected to the feedpoint of the antenna in the manner shown here. The coaxial cable is routed through the hollow pipe to a hole on the side. That method only works when sufficient standoff insulators are used so that the antenna assembly does not need a long dowel.

from the calculated point. The actual length is also a function of mounting style, local conducting objects in the field, and several other factors (hence, the equation can not produce absolute values).

A different form of antenna—a 1/2-wavelength Hertzian (balanced with respect to ground) dipole—is shown in Fig. 5B. A dipole is a Hertzian antenna regardless of whether it is mounted vertically or horizontally. If mounted horizontally, the two elements (top and bottom) are equal in length. The length of the elements can be found

using Eq. 1. That is, the overall length is twice the length derived from Eq. 1, or:

$$L_{\text{feet}} = 468/f_{\text{MHz}} \quad [\text{Eq. 2}]$$

Each element is mounted to a wall or 2 x 4 lumber using at least one stand-off/insulator per pipe section as shown in Fig. 6, although two or more per section is probably wiser. A wooden, plexiglass, or Lucite dowel is placed in between the two sections when the antenna is self-supporting or when only one insulator per section is used. The pipe sections should be mounted about 3-inches apart with a

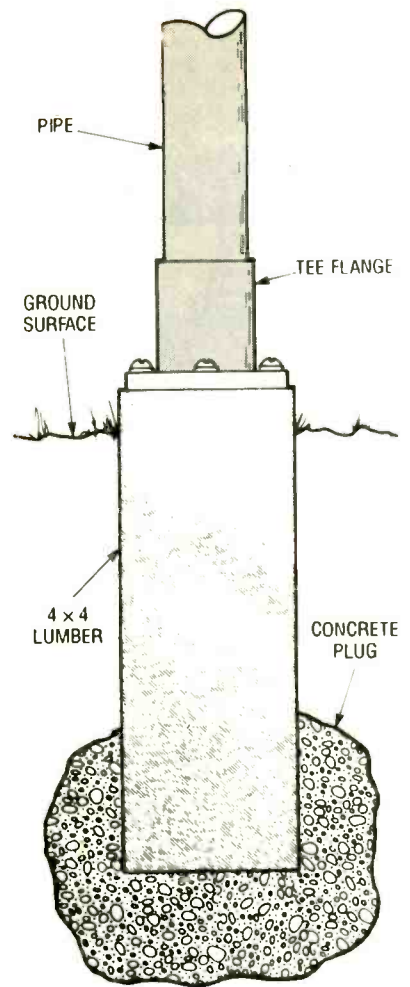

Fig. 7. In this ground mounting system, a tee-flange is mounted to a section of 4 x 4 lumber that is, in turn, mounted in a fence-post hole, and set in concrete.

single dowel (of at least two feet in length) fed in to the ends of the two pipes. The dowel should then be fastened to the two pipe sections with several sets of three or four sheet-metal screws.

The coaxial transmission line can be connected to the feedpoint of the antenna in the manner shown in Fig. 6. In that system, the coaxial cable is routed through the hollow pipe to a hole on the side. That method only works when enough standoff insulators are used so as not to need a long dowel.

Another mounting scheme—a ground mounting system—is shown in Fig. 7. In that system, a tee-flange is mounted to a pedestal made of 4 x 4 lumber that is, in turn, set in a fence-post hole and surrounded at the base by concrete. The pedestal should be made from the treated lumber of the

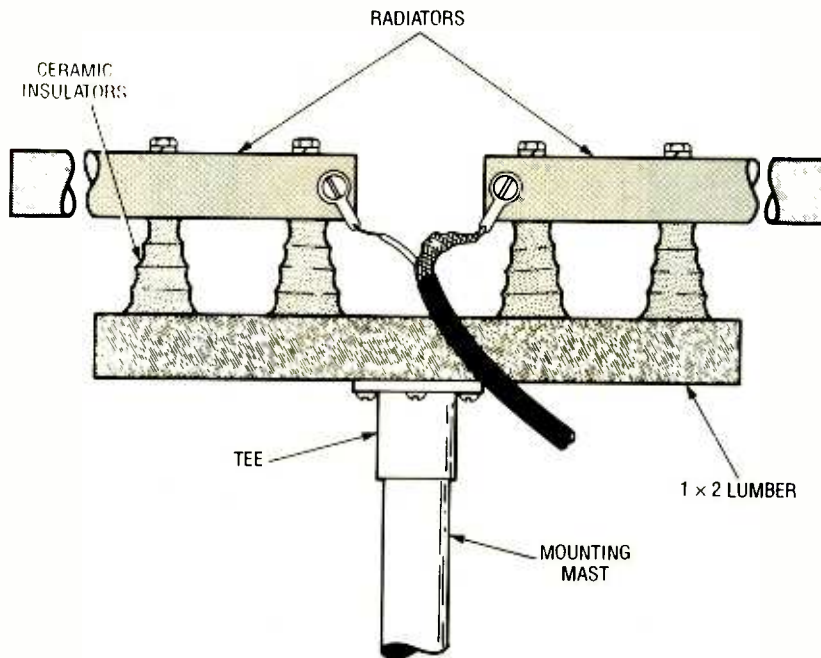

Fig. 8. The horizontal half-wavelength rotatable dipole made from pipes is practical at frequencies higher than about 18 MHz; at lower frequencies, the size becomes too large and bulky for easy construction.



This multi-impedance transformer, which is especially made for vertical antennas, can be placed at the feedpoint of your antenna to transform its impedance to 50 ohms.

type that is used for fence posts; if the treated type is not used, bugs and rot will destroy it very quickly! It is also possible to combine mounting schemes. For instance, you could use a 2 x 4 or 4 x 4 lumber to form the pedestal portion of the mount in Fig. 7, and then attach the antenna using the method outlined in Fig. 4.

Finally, Fig. 8 shows a horizontally mounted dipole antenna. That type of antenna is practical at frequencies higher than about 18 MHz; at lower frequencies, the size becomes too large and bulky for easy construction. The antenna provides a bidirectional receiving or transmitting pattern. It

can be rotated either using a regular antenna rotator, or if you are healthy and fit, the "arm-strong" rotator, i.e., old-fashioned muscle power!

The antenna elements in Fig. 8 are metal pipes mounted on ceramic insulators that are, in turn, mounted to a length of 1 x 2 lumber. A tee-joint is used to attach the antenna array to the mounting mast. For smaller antennas, ordinary television-antenna hardware will suffice.

The feed line for the antenna can be a straight piece of coaxial cable (as illustrated). In that installation, the coaxial shield is connected to one element, while the center conductor is connected to the other. For the best radiation pattern for that installation, connect a 1:1 BALUN transformer to the feedpoint, and connect the coax to the BALUN.

**Impedance Transformers.** The feedpoint impedance of a vertical is 50 ohms, while for a dipole it is 75 ohms, right? Nope! Some 1/4-wave verticals have a feedpoint impedance of 37 ohms, which is a reasonable match to 52 ohm coaxial cable. However, most antennas have a feedpoint impedance that is a lot less, perhaps as low as about 5 ohms. A multi-impedance transformer especially made for vertical antennas can be placed at the feedpoint to transform

the impedance to 50 ohms. Palomar Engineers (P.O. Box 455, Escondido, CA 92025; 619-747-3343) makes transformers suitable for this application.

**Antenna Safety.** Antenna construction looks easy and safe, but there are some terrible dangers to guard against. First and foremost is the matter of electrical safety. It should go without saying (but I'll say it anyway) that the transmission line should not be connected to the antenna while you are working on it. And under no circumstance should the transmission line be connected to your receiver or transmitter while you are working on the antenna. A short circuit, or an inadvertent excitation of the transmitter, could make for a very dangerous and nasty surprise!

Perhaps the most important aspect of electrical safety for antenna builders is the proximity of any AC power lines to the antenna site. Look around in all directions from the mounting location, and note the proximity of the power lines. The mounting location should be far enough away from power lines so that if the antenna should fall (while you're building it or later when the wind gives it a shove), it won't fall onto the power line.

You must consider the travel (the length) of the antenna once built. That is, a power line that appears to be safely out of the way when the proposed antenna site is surveyed may well be within striking range during and after its erection! In addition, you'll probably have to move the antenna around a little bit when installing it. So allow yourself plenty of leeway. Although a power line may be insulated, after a short time out in the weather that insulation becomes weakened and brittle. If the antenna touches it, the insulation may crumble, exposing the current-carrying conductor inside.

Another precaution is to make sure that you are physically able to do the job. Pipe antennas are very light, or so it may seem, but they are also very long. Because of its length, the antenna can put a great physical strain on you, especially if there is a slight breeze (don't build an antenna in a wind!). I've thrown out my back building verticals alone. So get help; it's a two-person job.

(Continued on page 93)



# BUILD THE DOOR MINDER

BY BRIAN PLILER



*This entry-way monitoring circuit can effectively guard the various accesses to your home or business.*

**D**o you have a frequently used door in your home or business that needs to be closed when not in use? If so, then maybe you need the *Door Minder* described in this article. The Door Minder is a device that uses a magnetic reed switch to determine if the monitored door is open or closed. The unit has a built-in delay period that keeps it silent for up to about 24 seconds after the door has been opened to allow normal use of the monitored door. But if the door is not closed within the 24-second period, the alert tone sounds until the door is closed. The alert signal emitted by the Door Minder sounds like an electronic chime, and is struck once per second. That sound was chosen because it is too annoying to ignore, but not harsh enough to startle anyone. The prototype was assembled on a small section of perfboard using point to point wiring and was installed in a small speaker enclosure that was originally used with a personal stereo. The speaker in the enclosure was used as the project's speaker.

**How It Works.** A schematic diagram of the Door Minder is shown in Fig. 1. While the circuit may look complicated at first glance, a closer inspection reveals that it is actually comprised of several smaller circuits. Integrated circuit U1-a along with R1 and C1 form a simple delay timer. When C1 is discharged through the closing of door switch S1, the output at pin 1 goes high. That turns on transistor Q1 and prevents transistor Q2 from receiving any base drive. But, as soon as S1 is opened, C1 begins to charge through R1. When the voltage on C1 exceeds the reference voltage at pin 3 of U1-a (approximately 4 volts as established by R4 and R5), the output at pin 1 goes low, turning off Q1, which now allows Q2 to be activated by the striker signal. Since the reference volt-

age is roughly half of the supply voltage, the formula for determining the delay time is:

$$(R1 \times C1)/2 = \text{time}$$

where R1 is resistance in ohms and C1 is capacitance in farads. For example:  $470,000 \times .000100 = 47/2 = 23.5$  seconds.

The "striker" oscillator, which is built around U1-b and configured as an astable multivibrator, outputs a narrow positive-going pulse once a second. Resistor R3 provides just enough gain for the op-amp to oscillate. The reference voltage at pin 5 of U1-b is also set to approximately 4 volts through R4 and R5. Capacitor C2 is tied directly to the inverting input of U1-b and to that IC's output through R2 and D1. When the voltage on C2 is below the reference voltage at pin 5, pin 7 is forced high and immediately charges C2 through D1. Since the voltage at C2 is now higher than the reference voltage, pin 7 switches low and begins discharging C2 through resistor R2. As soon as the voltage on C2 dips below the reference voltage, the cycle repeats.

Op-amp U1-c is configured as a voltage follower. It simply prevents C3 and other associated components from affecting the operation of the striker oscillator. Capacitor C3 changes the narrow positive-going pulse generated by the striker oscillator into somewhat of a spike pulse to imitate the abrupt striking of a real chime.

When transistor Q2 is turned on, its collector is pulled low, thereby pulling the base of Q3 low through resistor R7. That activates Q3 and causes it to output almost 8 volts on its collector lead. Resistor R6 is included in the circuit to ensure that Q3 turns off when Q2 does. The voltage output from the collector of Q3 is fed to C4 and R8. Their values determine the decay rate of the chime, which as configured is 0.47 second. Resistor R9 is used to buffer the voltage and limits the current to Q4.

Op-amp U1-d is configured as a phase-shift oscillator, which produces a sinewave-output signal of approximately 1200 hertz, but only when Q4 is on. To make the audio tone as stable as possible, a second voltage divider—comprised of R13, R14, and filtered by C8—was added to help isolate the audio-tone oscillator from possible voltage fluctuations created by the striker oscillator. The audio-tone output at pin 14 of U1-d is capacitively coupled to an LM386 audio amplifier (U2), which is configured for a voltage gain of 20.

With the exception of U2—which is powered directly from an unregulated 12-volt source—the entire circuit is powered from a well regulated 8-volt supply built around an LM78L08 (100 mA) or LM7808 (1-amp) 8-volt regulator. Pinouts for those two devices are shown in Fig. 2.

If an 8-volt regulator is unavailable, a 5-volt unit, such as the LM78L05 or LM7805 5-volt regulators may be

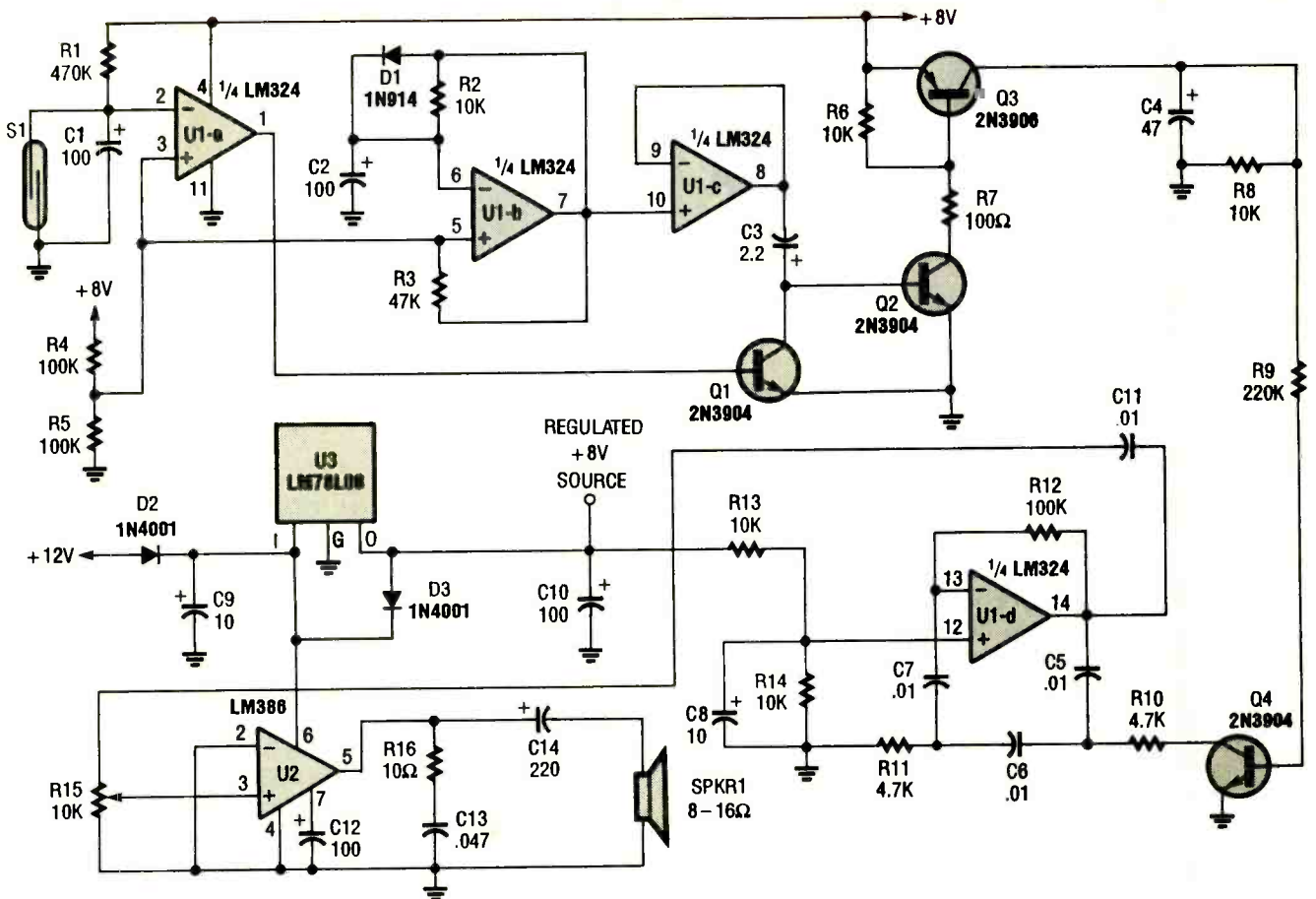

Fig. 1. The Door Minder is built around three integrated circuits: U1, an LM324 quad op-amp; U2, an LM386 low-voltage audio amplifier; and U3, a 78L08 8-volt, low-power, voltage regulator.

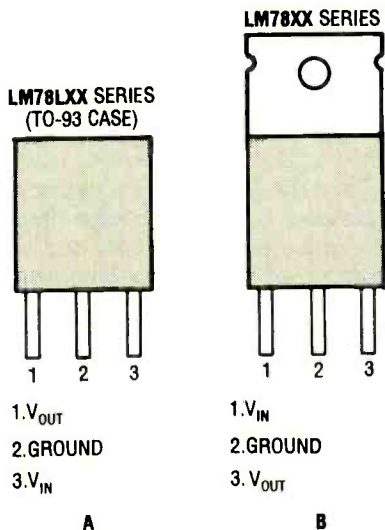

Fig. 2. To aid you in assembling the power-supply section of the circuit, we present the pinout diagrams for both the 78LXX and 78XX series of regulators.

used. Figure 3 shows how to configure the 5-volt regulators to produce an 8-volt output.

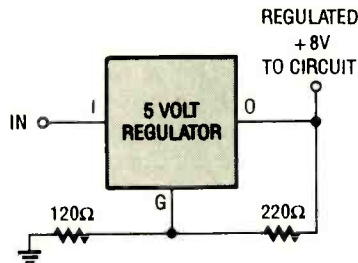

Fig. 3. If you have trouble locating an 8-volt regulator, although they are commonly available, a 5-volt unit can take its place by connecting the regulator as shown here.

prototype of the Door Minder circuit was assembled in a small section of perfboard, measuring about 2 inches square. When assembling the circuit it is recommended that sockets be provided for U1 and U2. Aside from serving as a convenient marker around which to wire the other components, the sockets also prevent possible damage due to excessive heat during soldering.

In any event, once the sockets are in place, install the support compo-

nents, connecting them to the pins of the IC sockets, as you would connect them to the IC's themselves. Check the orientation of the polarized components and semiconductors—especially the transistors—as they are installed. Once all of the components have been installed, double check your work for misoriented or misconnected components. Pay particular attention to the two transistor types (2N3906 and 2N3904) used in the circuit, as on the surface they appear to be identical. Also check for solder bridges and cold solder joints.

After double-checking your work for possible construction errors, it is time to apply power to the circuit and make sure that the project works correctly before installing it in an enclosure.

### Checkout and Troubleshooting.

Apply power to the circuit, and wait awhile. If, after a delay period, nothing is heard, there are several tests that can be done to determine which section isn't working.

First take a small jumper and place it from the collector of Q4 to ground.

(Continued on page 91)



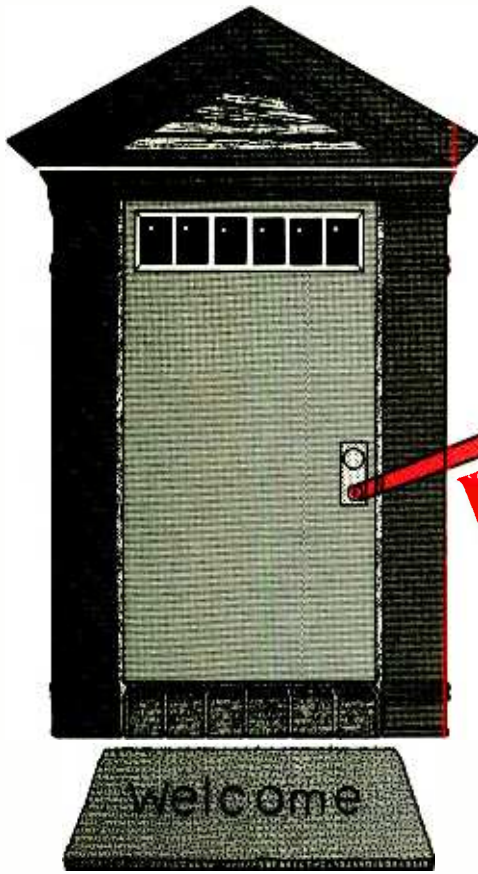

# Build a KEYHOLE ILLUMINATOR



BY MARC SPIWAK

*Fumbling in the dark with your keys is not only a nuisance, it can be downright dangerous*

**H**ave you ever been the first one to come home after dark and find that no one has bothered to leave the porch light on? Well we have, and our block is dark—so dark that it's hard to find the right key, and even harder to get it in the lock! In our neighborhood, it's hardly considered dangerous to fumble in your own doorway, but sadly that's not the case for everyone. And, unfortunately, in today's society women have even more to worry about. Since it's in your best interest to get into your house as quickly as possible, anything that can hasten your entry would be considered a plus.

What's needed is something that can shed some light on a keyhole. It has to be easy to turn on, small enough to be inconspicuous, and be able to turn itself off. In addition, it should be very inexpensive, and take very little time to build. Fortunately for everyone with dark doorways, I found a circuit that fits the bill—the *DoorLite* keyhole illuminator, which can be built for under ten dollars.

**The Circuit.** The schematic for the *DoorLite* is shown in Fig. 1. As you can

see, there's very little to the circuit, and in addition, the values of all of components are very flexible. With the values shown, LED1 lights and stays lit for about ten seconds after S1 (a miniature, momentary contact, pushbutton switch) is pressed.

Many of you are probably wondering how on Earth can a single LED produce enough light to be of any use; so before we get into how the circuit works, let's address that question. The answer is that LED1 is no ordinary LED. As a matter of fact, LED1 is one of a recent breed of high-intensity LED's, that not only output a lot of light, but also use a focusing lens to create a more intense light beam, rather than a diffusing lens that makes an LED more suitable for use as an indicator.

The normal-size, high-intensity LED

can be purchased from Radio Shack (as part number 276-087) for less than two dollars. The high-intensity LED outputs 2000 millicandelas (mcd) of red light; that's over a hundred times the light output of ordinary LED's. And the 2000-mcd LED is hardly the brightest of the high-intensity LED's; Radio Shack also carries a 5000-mcd LED, and Hewlett Packard makes a 15,000-mcd LED (their HLMP-8150).

Any of those units—as well as a small incandescent lamp—can easily be substituted into our circuit. But because 2000 mcd's is more than enough light to illuminate a door lock, and because the more powerful LED's are much larger in size (the HLMP-8150 is about a half-inch in diameter) and a lot more costly, we went with the 2000-mcd unit. Now let's discuss the circuit.

The circuit should be powered from at least 3-volts DC, but 5 is probably better. We used a 6-volt camera battery, because of its small size (about the size of an N-cell), and because one only cost about four dollars. Switch S1 is a simple momentary-contact pushbutton that we had in our junkbox; we used it, too, because of its small size.

With S1 normally open, there is no charge on C1, Q1 is off, and the LED is dark. When S1 is pressed, a bias voltage is applied to the base of Q1 via R1, causing it to immediately turn on. Turning on Q1 completes LED1's

*(Continued on page 93)*

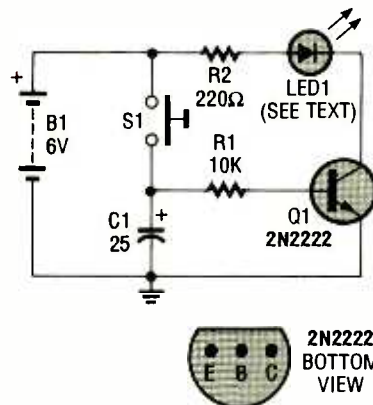

Fig. 1. This circuit will keep the LED illuminated for about ten seconds.



The officials at the Castle Garden Immigration center in New York City probably looked at Steinmetz with feelings of both frustration and sympathy. Standing before the officials was a person who likely already had faced rejection many times in his life. More rejection appeared imminent.

This would-be immigrant was a twenty-four year old hunchbacked dwarf who walked with a very pronounced limp. His face was swollen due to his infected teeth and his eyes were red as a result of the cold he had gotten on the steerage-class ocean voyage from Europe. To make matters worse, his clothes clearly indicated poverty. Karl Steinmetz's appearance did not make a good first impression.

The year was 1889 and immigrants from Europe were flocking to the United States by the thousands. Those seeking admittance were expected to be strong and in good health as the jobs available to immigrants virtually always required manual labor. It also would be helpful if the applicants had a basic knowledge of English.

The new arrivals were required to have some means to support themselves until they found jobs. Like most nations, the United States would not admit persons who were indigent, seriously ill, or who otherwise would become a burden to society.

In addition to his obvious physical disabilities, Steinmetz appeared destitute, spoke very little English, and had no immediate prospects for a job. He seemed to meet none of the criteria for entry to the United States. There would be no option for the immigration officials but to refuse admission to this pathetic individual and send him back to Europe.

One could not fault the officials for reaching this conclusion. They had no way of knowing that soon Steinmetz's experimentation and mathematical analyses would at last make the design of electrical equipment a mathematically precise science.



# CHARLES PROTEUS STEINMETZ

BY JAMES P. RYBAK

No one on that June 1 date in 1889 could possibly have predicted that within twenty-five years, the name "Steinmetz" would be a household word in America. It was simply inconceivable that this impoverished-looking man occupying a twisted body barely four feet in height would soon associate with scientific celebrities such as Edison, Marconi, and Einstein on an equal basis.

The senior official was about to stamp "Refused Entry" on the papers and send Steinmetz to a holding area to await being sent back to Europe when Oscar Asmussen stepped forward. Asmussen, whom Steinmetz had

known for only a few months, had already come to the latter's aid on more than one occasion.

This young man who had befriended Steinmetz immigrated to the United States from Denmark some years earlier and lived with an uncle who was a successful San Francisco businessman. The uncle had sent Asmussen back to Europe for a university education and supplied him with a monthly living stipend. Graciously and repeatedly, Asmussen had shared his stipend with Steinmetz. His generosity even extended to taking the money his uncle had sent for purchasing a single first-class boat ticket back to America and buying steerage-class tickets for Steinmetz and himself.

Now, Asmussen would attempt to do an even greater favor for Steinmetz. Pulling a rather substantial sum of money from his pocket, Asmussen told the immigration

officials that the money belonged to both Steinmetz and himself. Carrying the hopefully convincing, albeit exaggerated, argument a bit further, Asmussen assured the immigration officials that Steinmetz already was a renowned European scientist who would learn English quickly. Asmussen pledged that he would be responsible for making sure that Steinmetz did not become a public burden.

Asmussen's self-assured demeanor, good command of the English language, apparent financial resources, and familiarity with America caused the senior immigration officer to change his mind. With a sweep of his hand, the officer indicated to Steinmetz that he was allowed to enter the United States.

**An Unauspicious Beginning.** Karl August Rudolf Steinmetz was born on April 9, 1865, in the city of Breslau in what is called Germany today. He inherited the pronounced physical disabilities with which many of the males in the Steinmetz family, including his father, had been afflicted. What Karl



lost to dwarfism and a hunched back in terms of physical abilities, however, he later would more than offset with his superior intellectual achievements.

Young Karl's early school experiences led no one to suspect he possessed the brilliant mind he later would demonstrate. He complained so bitterly and convincingly about having to go to kindergarten at the age of four that the beginning of his formal schooling was delayed for a year.

Once he finally entered school, Karl very quickly began to enjoy both learning and the school environment. Nonetheless, until he was almost nine years old, Karl Steinmetz was an undistinguished student. So mediocre was his performance at learning basic arithmetic, the teachers considered him intellectually dull. No one at that time would have ever suspected that Karl one day would develop into an exceptionally brilliant mathematician.

Looking back years later on his early school days, Steinmetz observed that his early difficulties with arithmetic arose because he never before had been required to put forth the effort and self-discipline that learning the multiplication tables required. Soon, however, Karl Steinmetz was excelling at not only arithmetic, but Latin, French, Greek, philosophy, algebra, and geometry as well. Mathematics was now his favorite subject and one at which he demonstrated the greatest ability.

### **Steinmetz Questions Everything.**

Early on, Karl learned to question everything, including (and especially) the commonly accepted laws of science and mathematics, before accepting anything as fact. His questioning was not done out of an attitude of audacity. Rather, he questioned so that he might develop a more complete understanding of basic scientific and mathematical principles. It was on this basis Steinmetz would later develop what to others seemed like unbelievably insightful breakthroughs.

Steinmetz completed his "gymnasium" or high school studies at the head of his class and entered the Uni-

versity of Breslau in 1882. His university studies consisted of mathematics, astronomy, physics, chemistry, philosophy, and classical literature.

Attendance at the lectures was totally voluntary with the exception of one at the beginning of the term and another at the end. Examinations were not a part of the courses. After a student had been at the university for at least four years, a diploma could be earned by passing an examination covering all the courses the student claimed to have attended. Steinmetz wanted more than a diploma. He intended to perform the research and write the dissertation required for a doctoral degree.

The lax policy toward attendance resulted in many students attending few lectures. Not so with Steinmetz. Every lecture was important to him and he studied late into the night. Often the attendance at lectures dwindled to the point where they became virtually private dialogues between Karl and the professor. Steinmetz could discuss topics with his

*Learn about a mildly eccentric but affable genius who changed the process of designing electrical equipment from a chaotic art into an orderly science.*

professors to a depth few other students could or even wanted to approach.

### **The Origin of "Proteus."**

Although Karl was a diligent student, he also took an active part in several of the student societies that were an integral part of university life. Initially, his favorite was the mathematical society whose weekly meetings combined a business session and a technical session with several intervals of singing, drinking beer, and storytelling.

New members, or "foxes" as they were called, were required to entertain the more senior students by providing an unrehearsed lecture on an academic topic when ordered to do so. To make things more interesting, a fox would have to stop on com-

mand and change the topic of the lecture to something totally different.

The mathematical society followed the practice of conferring on each new member a "student name" that supposedly fit his personality and by which the student was then known to the other members. Steinmetz was so proficient at changing lecture topics on command that he was given the name "Proteus" after the Greek sea god who allegedly could change his shape at will. When Steinmetz later immigrated to America, he adopted Proteus as his middle name.

### **Politics Leads to Trouble.**

Karl Steinmetz soon also became interested in politics. The government of Chancellor Bismarck granted numerous privileges to the aristocracy, but virtually none to the millions of common people. For years, university students throughout Germany had agitated for social and political reform. Bismarck had retaliated by outlawing all opposing political organizations. The university students persisted in their political activities but had to do so in secrecy.

The Socialist movement's goals of a more democratic government attracted Steinmetz. Karl always worked for peaceful political change. He never used or advocated violence. When Karl temporarily became the editor of that organization's newspaper, he could not escape the scrutiny of the police.

In June of 1888, Steinmetz's doctoral thesis on a topic in synthetic geometry was nearly finished. The awarding of his doctoral degree was not far off. However, that degree would never be conferred on him. Karl's political writings had become increasingly more offensive to the government and his activities were under constant police surveillance.

### **Goodbye to Germany.**

Karl learned that the police had a warrant for his arrest. It became obvious to him that he must leave Germany immediately. His plans for the future, which had included a university professorship, now were in total disarray.

Steinmetz secretly left Breslau by train and headed for Switzerland. Al-



though he had little money, his plan now was to study the theoretical principles of mechanical engineering, with emphasis on the technology of motors and generators, at the famous Polytechnic School in Zurich. Karl avidly read all the available textbooks and journals on the latest developments in electrical science.

The Polytechnic at first refused to admit Steinmetz because he was a non-resident of Zurich and lacked the necessary papers from his hometown police certifying that he was a person of good character. There was no chance that the Breslau police would provide him with that certification! To make matters worse, supporting himself in Zurich also turned out to be more difficult than Karl had anticipated.

The first problem was solved when Steinmetz was introduced to a prominent local political figure. The politician liked Karl and used his influence to get Steinmetz admitted to the Polytechnic.

Supporting himself remained a chronic problem. Steinmetz wrote scientific articles and tutored other students, but neither of these activities provided a reliable source of income.

Soon Karl met Oscar Asmussen and the two quickly became good friends. Asmussen was more than willing to share the modest stipend his uncle was providing. The stipend was cut off, however, and his uncle ordered him to return to the United States when Oscar announced that he planned to marry a Swiss girl.

**Off to America!** Steinmetz had heard many stories of the opportunities that were available to even the most common people in America and wanted to accompany Asmussen. Karl, however, still had very little money of his own. Oscar Asmussen again helped out his new friend. This time he used the money his uncle had sent him for buying a first-class return ticket to America to buy steerage-class tickets for both himself and Steinmetz.

As mentioned before, Steinmetz would have been denied permission to enter the United States had it not been for Oscar Asmussen. Not only did Asmussen convince the immigration officials that Steinmetz would not become a public burden, he made

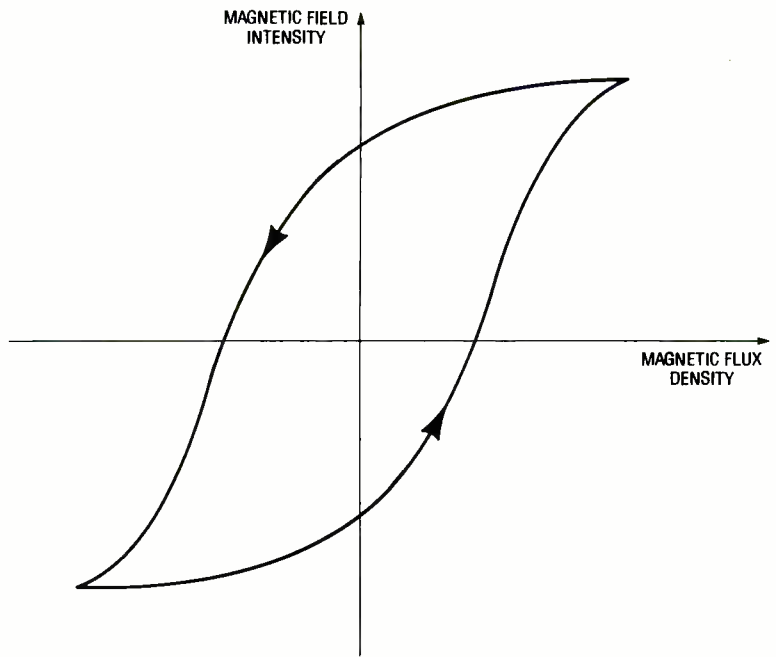

Fig. 1. Each magnetic material has a unique "hysteresis loop" that indicates that material's suitability for use in magnetic circuits.

good on that promise by arranging for his own relatives in Brooklyn to house and feed his friend until Karl could find a job.

Steinmetz went to the Edison Machine Works in Manhattan to seek a job with the famous electrical inventor. The person with whom he talked there made it very clear that no more "electricians," as electrical engineers then were called, were needed.

**A Lucky Letter.** Before leaving Zurich, Steinmetz had received a letter of introduction to a Rudolf Eickemeyer in Yonkers who manufactured machines to make hats. Karl had no idea who Eickemeyer was, but decided it could not hurt to pay him a visit.

Eickemeyer, also an immigrant from Germany, was impressed with Steinmetz's keen intellect and desire to work. However, he had no positions available. Karl returned a week later to inquire again. Impressed now also with his persistence, Eickemeyer hired Steinmetz to do drafting for two dollars a day.

Steinmetz began his new job making drawings of the DC motors and generators Eickemeyer had also recently begun to manufacture. The design of all electrical devices at that time was done solely by trial-and-error experimentation. No one had yet

been able to use mathematics to describe the operation of any but the most simple electrical circuits. Steinmetz, however, was confident that mathematics would provide the key to understanding how best to design complicated electrical equipment.

**The New American.** Immediately

#### BOOKS AND ARTICLES

*Charles Proteus Steinmetz—A Biography.* John Winthrop Hammond. The Century Company, New York, NY, 1924.

*Steinmetz—Engineer and Socialist.* Ronald R. Kline, The Johns Hopkins University Press, Baltimore, MD, 1992.

*Loki—the Life of Charles Proteus Steinmetz.* Jonathan N. Leonard, Doubleday, Doran & Co., Garden City, NY, 1929.

"Charles Proteus Steinmetz—His Scientific Attainments and Their Meaning to the World," E.W. Rice, Jr., *General Electric Review*, December, 1923, pp. 796-799.

"Dr. Charles Proteus Steinmetz," Martin P. Rice, *General Electric Review*, December, 1923, pp. 800-801.

"You Will Think This a Dream," Charles P. Steinmetz, *Ladies' Home Journal*, September, 1915, page 12.

"Steinmetz Revisited: The Myth and the Man," C.D. Wagoner, *General Electric Review*, July, 1957, pp. 16-21.



after obtaining a job, Steinmetz began the process of applying for American citizenship. Everything about America fascinated him and he wanted to be an integral part of this nation. He even felt that Karl August Rudolf Steinmetz was not an appropriate name for him in America.

Since "Charles" was the American equivalent of "Karl," he would call himself, simply, Charles Steinmetz. Later, Steinmetz became convinced that he had to have a middle name. As neither of his two German middle names had an American equivalent, a new middle name would have to be found. Steinmetz soon decided that his school name, "Proteus," would make a fine middle name. From that time on, he was known as Charles Proteus Steinmetz.

**Steinmetz Becomes Noticed.** As soon as Steinmetz learned some basic English, he began attending meetings of the American Institute of Electrical Engineers (AIEE) in New York. The electrical experts of the day presented the results of their latest experiments and research at these meetings. Steinmetz was becoming more and more fascinated by the study of electricity and wanted to be in on the forefront of electrical development.

Thorburn Reid presented a talk on "The Armature Reaction of Alternators" at one of these meetings but Steinmetz was not pleased with what he heard. Reid had not taken into account the effects of the third harmonic terms in his analysis. When questioned about this by Steinmetz, Reid pointed out that to include these effects would cause the mathematics to become extremely complicated and would serve no useful purpose.

Steinmetz was appalled at Reid's response. He was sure that the third harmonic effects were not insignificant and that workable mathematical formulas could be developed.

In a month's time, Steinmetz developed the necessary mathematical analysis and reduced it to a workable form. When he reported his results at the next AIEE meeting, Steinmetz won the respect and admiration of the membership, including Thorburn Reid, for having solved a particularly complicated problem. When Eickemeyer heard of his employee's success with the third-harmonic prob-

lem, he immediately set Steinmetz to work on solving the "hysteresis" problem, which was making the design of alternating-current motors, generators, and transformers very difficult.

**Hysteresis.** A current flowing in a coil wound around a soft iron core produces a magnetic field in the iron. A substantial part of the total magnetic field in the bar, however, is due to microscopic magnetic elements in the iron that become aligned with the magnetic field produced by the current in the coil.

When the direction of the current in the coil is reversed, the magnetic field in the iron also tries to reverse itself. Effects similar to friction tend to keep the magnetic particles in the iron from reversing direction easily. This resulted in the production of heat in the iron. Hysteresis effects, while moderately troublesome in the design of DC motors and generators, were holding the development of AC machines at a virtual standstill.

An alternating current flowing in the coil changes direction rapidly and repeatedly. The resulting heat from the hysteresis effects can cause the iron to become very hot. At best, the motor, generator, or transformer then exhibits low efficiency. In the worst cases, the device is destroyed by the heat. At the time, attempts by engineers to understand how to predict and minimize the losses due to hysteresis had met with very little success.

Back then, building electrical devices that operated well was more the result of luck than of design. Steinmetz himself later said: "The designer of electrical apparatus simply built it, then tested it, and when the loss was too high and the efficiency too low, or the machine too hot, he tried again. This obviously was not a satisfactory way."

Steinmetz carefully studied all the published information on hysteresis effects. Because the existing data was inconsistent and incomplete, he made numerous measurements of his own using a magnetic-bridge circuit Eickemeyer had developed. Steinmetz elegantly combined careful experimental measurements with sophisticated mathematical analysis.

The "law of hysteresis" developed by Steinmetz allowed engineers to predict the magnitude of hysteresis

losses with excellent accuracy. Steinmetz was able to show which types of iron were suitable for use in alternating-current devices and which were not. His work provided a means for determining how much magnetizing current is required to produce the desired amount of magnetization in a particular piece of iron.

When Steinmetz presented his work on hysteresis to the AIEE in 1892, engineers around the world hailed it with great acclaim. The successful design of alternating-current devices was no longer a matter of luck. It now was a logical process thanks to Steinmetz. He had brought forth scientific order from chaos.

**More Obstacles to Hurdle.** As early as 1890, Steinmetz had realized that the understanding of how to predict and calculate hysteresis effects was not the only obstacle that was hindering the development of efficient AC equipment. Engineers at that time had no straightforward and accurate way to predict the various voltages and currents that would occur in AC networks.

The application of Ohm's law to AC circuits with inductance and capacitance as well as resistance was not well understood. The graphical techniques then in use were extremely cumbersome and provided only limited information concerning the steady-state operation of AC circuits.

A second problem was that no way existed to predict with accuracy the transient voltages and currents that occur whenever motors or generators are switched on or off. The most damaging transients, however, are caused when lightning strikes a power system and creates a brief but abnormal path to ground that permits dangerously large currents to flow.

Steinmetz believed that mathematics could provide solutions to both these problems. Few engineers at that time, however, possessed the mathematical knowledge to develop the needed techniques. Scientists who had the required mathematical ability, generally lacked a practical understanding of electrical systems. Steinmetz had both the mathematical and practical knowledge needed. Because of that, he would develop the necessary mathematical techniques himself.

### Steinmetz Finds the Solutions.

Complex numbers provided Steinmetz with the means needed to develop what he called his "symbolic" method for calculating steady-state AC voltage and current values. Consisting of both "real" and "imaginary" numbers, complex numbers allow not only for the calculation of the magnitudes of AC voltages and currents but also for determining how much these quantities differ in phase from other voltages and currents in the same circuit.

Steinmetz did not invent or discover complex numbers. Others before him had attempted to use these numbers to analyze circuits, but their methods lacked the clarity, elegance, and broad applicability of Steinmetz's work.

When Steinmetz presented a paper to the International Electrical Congress (IEC) in 1893 describing his use of complex numbers to solve alternating-current problems, virtually no one had the mathematical background necessary to immediately understand the importance of what he was proposing. The IEC had severe financial problems at that time and could not afford to publish Steinmetz's lengthy paper so people could study the details of his work. The significance of his work, therefore, lay unrecognized for several years. Once engineers finally understood Steinmetz's techniques, his method was universally adopted and greatly respected.

Steinmetz later addressed the problem of predicting transient voltages and currents in circuits that plagued engineers at the time. Although lasting for only small fractions of a second, these voltage and current spikes or surges could attain values of thousands of volts or amperes, respectively.

Because the magnitude of a transient changes rapidly with time, differential equations are needed to describe and predict the effects. Steinmetz solved the equations with ease but, again, few others had the mathematical background to understand his techniques and apply them to their own engineering problems.

Steinmetz now knew he needed to help educate engineers concerning the practical use of what was then considered to be advanced mathematics. To achieve this, Steinmetz

wrote a series of books that became the standard texts used in most college electrical-engineering programs for many years.

**Joining the G.E. Team.** Shortly after Steinmetz had completed his work on hysteresis, Eickemeyer sold the electrical-equipment part of his business, which by that time had grown substantially. The newly formed General Electric Company was seeking to solidify its position in the manufacture of both AC and DC motors and generators. G.E. wanted Eickemeyer's valuable patents for electric railroad and streetcar motors, together with Steinmetz's equally valuable applied-mathematics skill. Steinmetz and the patents would go a long way toward helping G.E. achieve its goal.

Steinmetz realized that the considerable resources of G.E. would provide him with even more professional opportunities for research. He gladly joined this new corporation in 1893 and was one of those chiefly responsible for enabling G.E. to become an American industrial giant.

Initially, Steinmetz was sent to Lynn, Massachusetts to work in G.E.'s calculating department, which did all the mathematical computations for new equipment designs. Soon, however, that department was transferred to Schenectady, New York and Steinmetz was made its head.

The calculations were easy for Steinmetz but not so for those he directed. As a result, Steinmetz spent

much of his time teaching others the details of his mathematical techniques.

Steinmetz quickly won the admiration and respect of the engineers at G.E. as one who was both exceptionally brilliant and modest at the same time. He never considered himself superior to others and never became impatient with or discourteous toward those who needed to be helped repeatedly in mastering the mathematics. The diminutive and genial Steinmetz, together with the cigars he constantly smoked and the poorly fitting, mismatched clothes he wore, soon became legendary both at G.E. and in Schenectady.

Science and engineering, not the administration of a corporate department, were Steinmetz's interests. Soon, General Electric realized this. The Company then made Steinmetz its "Senior Consulting Engineer," allowing him to choose the projects on which he would work, and to come and go on his own schedule.

### Relaxations and Hobbies.

Steinmetz loved to canoe along the Mohawk River, which flows through Schenectady. He leased a piece of property on one of that river's tributaries and had a one-room shelter built. Steinmetz spent nearly every summer weekend entertaining his numerous friends at his "camp." During the week, his canoe was often his "office." It was here that he often got his best scientific ideas. Thinking about



Steinmetz at work in his "office" on the Mohawk River. (Photograph courtesy of the General Electric Company)



science and mathematics was Steinmetz's favorite form of relaxation.

Keeping rare varieties of live exotic animals and plants at home was a lifelong hobby for Steinmetz. In his conservatory were orchids and cacti together with crows, eagles, owls, raccoons, a gila monster, and a three-foot long alligator. This menagerie made visiting his home a fascinating adventure for his friends and for the neighborhood children, whom he especially enjoyed.

Home also was the place where Steinmetz maintained a laboratory for performing scientific experiments late into the night. In 1901, he decided that living in rent was not compatible with keeping a plant and animal conservatory as well as a laboratory.

Steinmetz then purchased some land and built a house of his own. General Electric gladly made available to him the funds for building and equipping a first-rate laboratory in his back yard. The company knew that this was a good investment. Steinmetz came up with valuable ideas virtually twenty-four hours a day.

Most neighbors would be up-in-arms if strange animal and bird noises together with odors from chemical experiments emanated from a nearby house at all hours of the day and night. The neighbors found Steinmetz to be such a genial person and such a good friend to their children that they accepted the noises and odors without serious complaint.

**A Better Arc Lamp.** Electric street lighting was rapidly becoming popular at the turn of the century. The carbon arc-lamps commonly used, however, were not efficient and required too frequent adjustment of the electrodes to keep them operating properly. Steinmetz was asked to study this situation.

Soon, Steinmetz discovered that electrodes made of magnetite, an iron oxide, were much more efficient at producing light. Furthermore, these new electrodes did not burn away rapidly during operation and, hence, did not require frequent adjustment.

The only drawback was that magnetite electrodes, unlike carbon, could operate only from DC voltage. Since inexpensive rectifiers capable of handling high power were not available, the magnetite arc-lamps

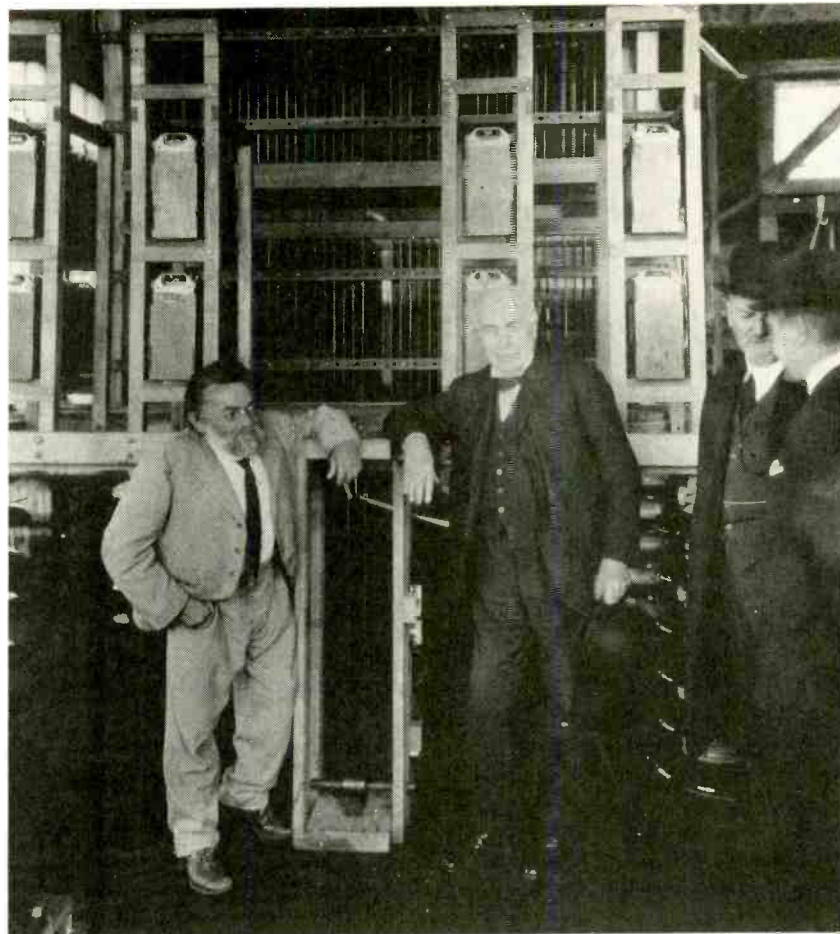

Steinmetz discussing his lightning generator with Thomas Alva Edison. (Photograph courtesy of the General Electric Company.)

had to be powered by DC generators. That was a distinct disadvantage. Soon, however, Steinmetz aided in the commercial development of mercury-arc rectifiers, which allowed the magnetite lamps to be operated from AC power.

**Academic Honors.** Harvard College awarded Steinmetz an M.A. degree in 1902 calling him the "foremost expert in applied electricity of this country and therefore the world." The following year Union College in Schenectady awarded Steinmetz an honorary doctoral degree completing the formal recognition of his academic achievement that was denied him when he hurriedly left Breslau fourteen years earlier. Few before or afterward have been more deserving of an honorary degree than was Steinmetz.

Union College also invited him to join the faculty as a professor of electrical engineering. This he did on a part-time basis without pay for ten

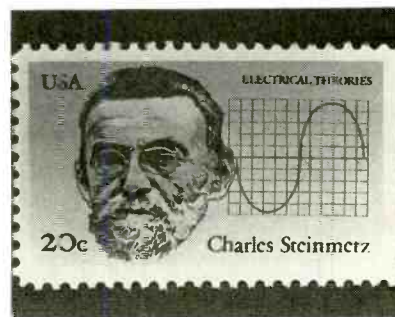

The United States honored Steinmetz in 1983 with this stamp.

years. Steinmetz earned the respect and friendship of virtually all the students despite the fact that he was exceedingly demanding in the classroom. He always emphasized the importance of liberal-arts studies as part of a sound engineering curriculum and constantly reminded students that they were merely beginning the lifelong process of learning.

**Public Recognition.** It did not take  
(Continued on page 92)

# WHERE TO FIND ELECTRONICS PARTS

*Finding those hard-to-get components can be a challenge, unless you know where to look!*

BY NEIL W. HECKT

Once, getting parts for virtually any type of electronic project or circuit was a simple matter. You merely had to make a (usually) short trip to your local parts retailer, make your purchase, and go home.

Unfortunately, those days are long gone. Decent parts houses are few and far between, few carry "everything," and some are less-than-friendly to hobbyists or those making relatively small purchases. Don't get me wrong. There are still a number of places that offer good service, selection, prices, etc. The problem is that they are scattered from coast-to-coast across the country.

Fortunately, all is not lost. Most, if not

all, do much of their business via mail or phone orders. So while you have to contend with minimum orders, the loss of the "instant" gratification of taking your purchases home with you, etc., it is still possible to get virtually any electronic component in short order. You just have to work harder to do it.

Tired of the frustration that is inevitable when you look for something after you need it instead of before, I put together a list of over 100 suppliers that either I or others were aware of and sent for their catalogs, lists, flyers, etc. Some did not respond, others had little to offer the electronics hobbyist. The offerings of the remainder are listed in this article.

Note, however, that while extensive research was done to compile the listing that appears here, it is inevitable that some very fine suppliers have inadvertently been omitted. Further, while the information provided is accurate as of my last contact with the companies listed, telephone numbers, addresses, and product lines do change, and sometimes suddenly. We apologize in advance to anyone we have missed or for any errors that appear. We will publish any corrections we receive in future issues. Send updates to "Parts Suppliers," **Popular Electronics**, 500-b Bi-County Blvd., Farmingdale, NY 11735.

Now, on to the listing! ■

## 624 Kits

171 Springlake Dr.  
Spartanburg, SC 29302  
Tel. 803-583-1304

A line of kits based on ARRL publications. Kits include PC boards and all needed parts unless stated otherwise. Included are QRP receivers, transmitters, transceivers, and accessories. Prices are typically in the \$20 to \$30 range.

**CIRCLE 137 ON FREE INFORMATION CARD**

## A&A Engineering

2531 W. LaPalma, Unit K  
Anaheim, CA 92801  
Tel. 714-952-2114

Send large S.A.S.E. for catalog

A&A specializes in assembled units, kits, PC boards and parts for designs which appeared in *QST* and other amateur-radio magazines. Included are a 450-MHz spectrum analyzer, some WEFAX receivers, QRP transceivers as well as several other kits of interest to amateurs.

**CIRCLE 138 ON FREE INFORMATION CARD**

## Accord Electronics

1001 NW 62nd SE #306-F  
Ft. Lauderdale, FL 33309  
Tel. 800-998-2242

Components of all sorts. I've bought a collection of transistors, 50 each of 6 different (a total of 300 transistors) for \$18 and 14 different electrolytic capacitors (a total of 350 caps) for \$30. An inexpensive way to stock up.

**CIRCLE 139 ON FREE INFORMATION CARD**

## ALFA Electronics

Box 8089  
Princeton, NJ 08540  
Tel. 609-275-0220

A nice illustrated catalog of test equipment. Worth checking out if you're in line for some new test instruments.

**CIRCLE 140 ON FREE INFORMATION CARD**

## All Electronics

Box 567  
Van Nuys, CA 91408  
Tel. 800-826-5432  
Min. order: \$10.00

They have some "smart" LCD displays, quite a few switches and relays, small list of capacitors and resistors, power supplies, fans, and motors. A small list of IC's and semiconductors and the usual tools and connectors. Some nice bargains in there.

**CIRCLE 141 ON FREE INFORMATION CARD**

## Allied Electronics

401 E. 8th St.  
Ft. Worth, TX 76102  
Tel. 800-433-5700  
Min. order: \$25.00.

A gigantic B20-page catalog from a full-line supplier with everything imaginable in electronics. Of special interest to me, they stock the "Siemens" line of transistors (Bxxx part numbers) frequently called-out in European-magazine articles.

**CIRCLE 142 ON FREE INFORMATION CARD**

## Alltronics

2300 Zanker Rd.  
San Jose, CA 95131  
Tel. 408-943-9773

Alltronics has a small catalog of assorted items that seem to change continuously. I've bought several things from them and their catalog is well worth having although most of their items are featured in their monthly ads.

**CIRCLE 143 ON FREE INFORMATION CARD**

## American Design Components

Box 220  
Fairview, NJ 07022  
Tel. 201-601-8999  
Min. order: \$15.00

Line of PC-compatible computers, including lap-tops, motherboards, monitors, and accessories; TSM kits; a good selection of IC's, transistors, capacitors, and resistors at moderate prices; a nice list of power supplies; large selection of motors and fans; and some obsolete surplus home-computer and game circuit boards. Components lean toward digital and computer electronics.

**CIRCLE 144 ON FREE INFORMATION CARD**

## Arrow Electronics, Inc.

Catalog Division  
25 Hub Drive  
Melville, NY 11747-9828  
Min. order: \$25.00

A full-line supplier with a mammoth catalog of every conceivable part.

**CIRCLE 145 ON FREE INFORMATION CARD**



**B.G. Micro**

Box 280298  
Dallas, TX 75228  
Tel. 214-271-5546  
Min. order: \$10.00

Mostly moderate list of IC's including microprocessors, RAM's, and EPROM's. A few other things of interest.

**CIRCLE 146 ON FREE INFORMATION CARD**

**BNF Enterprises**

119 Foster St.  
Peabody, MA 01960  
Large S.A.S.E. for list

A six-page list containing a selection of 286/386 PC-compatible systems and accessories. They have itemized lists of assorted surplus parts and assemblies and a large inventory of solar panels and solar-powered devices.

**CIRCLE 147 ON FREE INFORMATION CARD**

**Brigar Electronics**

7-9 Alice St.  
Binghamton, NY 13904  
Tel. 607-723-3111  
Min. order: \$30

A small illustrated catalog of surplus power supplies, a few relays and switches, a selection of electrolytic capacitors, and other assorted goodies. Of special interest are several IC sockets including PLCC and pin grid at nice prices.

**CIRCLE 148 ON FREE INFORMATION CARD**

**C&H Sales**

2176 E. Colorado Blvd.  
Pasadena, CA 91107  
Tel. 800-325-9465  
Min. order: \$30

A 120-page catalog featuring lots of motors, lots of blowers, and mechanical parts such as clutches and differentials. Big selection of hydraulic cylinders, valves, and pumps. Quite a few transformers, relays, and power supplies. An excellent list for the electromechanical and robotics types.

**CIRCLE 149 ON FREE INFORMATION CARD**

**C&S Electronics**

Box 2142 Belden Station  
Norwalk, CT 06852-2142  
Tel. 203-866-3208

C&S offers two or three kits designed to teach radio theory through the construction of radio receivers. Prices are \$20-\$30. They have a short list of exotic IC's and also offer a software program, "Quick Plot," for the PC.

**CIRCLE 150 ON FREE INFORMATION CARD**

**C&S Sales Inc.**

1245 Rosewood  
Dearfield, IL 60015  
Tel. 708-541-0710

A nice illustrated catalog of test equipment including what must be the whole B&K line, some unique educational digital/analog kits, and amateur-radio handheld transceivers. They also have a limited list of parts including resistors, capacitors, and semiconductors.

**CIRCLE 71 ON FREE INFORMATION CARD**

**Cal West Supply Inc.**

31320 Via Colinas #105  
Westlake Village, CA 91362  
Tel. 800-892-8000

Cal West offers several kits of interest to experimenters. Most are small fun-type kits. They also offer a list of parts, presumably those used in their kits. They were kind enough to supply me with a sample and the quality of their kits is excellent.

**CIRCLE 66 ON FREE INFORMATION CARD**

**Circuit Specialists**

PO Box 3047  
Scottsdale, AZ 85271  
Tel. 602-464-2485

A line of PC-compatible computer systems and accessories. They concentrate on industrial applications of PC's and stock a number of PC-compatible data-acquisition adapter boards and scientific software. Large selection of IC's and semiconductors including NTE replacements. They have a good selection of hard-to-get IC's and are the only source I know of for Motorola MPN3404 PIN diodes.

**CIRCLE 67 ON FREE INFORMATION CARD**

**Communications Specialists, Inc.**

426 West Taft Ave.  
Orange, CA 92665-3420  
Tel. 800-854-0547

Source for chip capacitors and resistors. Sells chip resistor and capacitor kits for \$49.95 each.

**CIRCLE 68 ON FREE INFORMATION CARD**

**Digi-Key**

Box 677  
Thief River Falls, MN 56701  
Tel. 800-344-4539

A near full-line distributor. Heavy on connectors, IC's, semiconductors, capacitors, and resistors. The only source I know for TOKO coils and chokes. They stock the Microchip PIC 16C5x series of inexpensive EPROM microcontrollers, and programmers. Largest selection of off-the-shelf microprocessor crystals and crystal oscillators I've seen. Also an excellent source of LCD and LED displays. They feature quantity discounts and free shipping. One of my favorite suppliers.

**CIRCLE 69 ON FREE INFORMATION CARD**

**Digitronics Surplus**

P.O. Box 933  
Olalla, WA 98359  
Large S.A.S.E.

They have a small list of surplus items that changes as items are available. Should be of interest to experimenters.

**CIRCLE 70 ON FREE INFORMATION CARD**

**Electronic GoldMine**

Box 5408  
Scottsdale, AZ 85261  
Tel. 602-451-7454  
Min. order: \$10.00

A nice little catalog of miscellaneous items. Good selection of electrolytic capacitors at good prices. Generally a smattering of everything surplus. A good source for most sizes of

drill bits for PC boards. They also have a large selection of PC-board stock.

**CIRCLE 72 ON FREE INFORMATION CARD**

**Fair Radio Sales**

PO Box 1105  
Lima, OH 45802  
Tel. 419-227-6573  
Min. order: \$10.00.

Fair Radio is a good, old-fashioned military-surplus dealer. If you are looking for an R-390 receiver, or spare parts for one, this is the place. They have many military-surplus receivers, transmitters, and test equipment. As a collector of antique tubes, I find them an excellent source for weird oldies including most of the small CRT's such as 2BP1's, etc. They also have many manuals for surplus gear. Prices seem a little high, but then where else can you find this stuff?

**CIRCLE 73 ON FREE INFORMATION CARD**

**FAR Circuits**

18N640 Field Ct.  
Dundee, IL 60118  
Tel. 708-426-2431

FAR offers PC boards from construction articles in *QST*, *CQ*, *QEX*, *Communications Quarterly*, Motorola applications notes, *W1FB Design Notebook*, *W1FB QR Notebook*, and *Ham Radio* magazine. It is an extensive list of over 200 PC boards at very reasonable prices. If your planning on building from an article in one of these magazines, FAR probably has the PC board.

**CIRCLE 74 ON FREE INFORMATION CARD**

**Ft. Apache Electronics**

31902 Hayman St.  
Hayward, CA 94544  
Tel. 510-429-1060

A small catalog mostly of manufacturing equipment. If your looking for a 190-ton plastic molding press, they have one. They also have some laser devices, stepper motors, etc. Catalog should be of interest if you are an electronics manufacturer.

**CIRCLE 75 ON FREE INFORMATION CARD**

**Herbach and Rademan**

18 Canal St.  
Bristol, PA 19007  
Tel. 215-708-5583  
Min. order: \$15.00.

Tools, Siemens laser tubes and modules, as well as other laser supplies. Also test equipment, power supplies and transformers, mechanical components, timers, switches, and motors (lots of motors).

**CIRCLE 76 ON FREE INFORMATION CARD**

**Hosfelt Electronics**

2700 Sunset Blvd.  
Stuebenville, OH 43952  
Tel. 800-524-6464

NTE replacement semiconductors. Excellent selection of relays at good prices. Small list of IC's and transistors. Motors, blowers, meters, hardware, switches, wall transformers, tools, PC-board supplies, and fuses. Nice list of capacitors. Good source for ceramic filters. 120 page catalog.

**CIRCLE 77 ON FREE INFORMATION CARD**

**IME**

P.O. Box 170415  
Arlington, TX 76003  
Tel. 817-561-2244

International Micro Electronics has a small catalog of surplus parts including some RF chokes, capacitors, transformers (including IF transformers), switches, a few ICs, quite a few potentiometers, and a moderate list of transistors.

**CIRCLE 78 ON FREE INFORMATION CARD**

**JAMECO**

1355 Shoreway Road  
Belmont, CA 94002  
Tel. 800-831-4242  
Min. order: \$30.00.

PC-compatible computers, motherboards, monitors, and accessories. Large selection of ICs and connectors. Tools and test equipment.

**CIRCLE 79 ON FREE INFORMATION CARD**

**JAN Crystals**

BOX 06017  
Ft. Myers, FL 33906  
Tel. 800-526-9825

Crystals made to your specifications as well as off-the-shelf. Crystals are their only products. Reasonable prices.

**CIRCLE 165 ON FREE INFORMATION CARD**

**Javanco**

501 12th Ave. S.  
Nashville, TN 37203  
Tel. 615-244-4444  
Min. order: \$10.

A giant 3/4-inch stack of illustrated and itemized surplus lists. There is a computer/test-equipment/tools/telephone list, a switches list, an optical list, an audio/video/radio list, a resistor list, an inductor/crystal/ceramic filter list, a connector list, a hardware list, a wire list, a power supply/blower list, a capacitor list, and a couple of general lists. Lots of items of interest to everyone, including TV replacement parts.

**CIRCLE 166 ON FREE INFORMATION CARD**

**JDR Microdevices**

2233 Samaritan Dr.  
San Jose, CA 95124  
Tel. 800-538-5000

A line of PC-compatible computers, motherboards, power supplies, and accessories. Nice selection of ICs. Usual selection of tools and test equipment.

**CIRCLE 167 ON FREE INFORMATION CARD**

**Jensen**

7815 S. 46th St.  
Phoenix, AZ 85004-5399  
Tel. 800-426-1194

Tools and test equipment, particularly for the professional TV- and computer-service industries.

**CIRCLE 168 ON FREE INFORMATION CARD**

**Johnson Shop Products**

Box 160113  
Cupertino, CA 95016  
Tel. 408-257-8614  
Catalog price: \$1.00

Excellent source of RF inductors and ferrite products. Nice selection of ICs and semiconductors at reasonable prices. Good selection of capacitors. Some good deals on resistor assortments. Other interesting RF products such as copper tape. A must list for hams and RF designers.

**CIRCLE 169 ON FREE INFORMATION CARD**

**Joseph Electronics**

8830 N. Milwaukee Ave.  
Niles, IL 60648  
Tel. 708-297-4200

Test gear, tools, chemicals, custom cases, soldering equipment, accessories, and more.

**CIRCLE 170 ON FREE INFORMATION CARD**

**KA7QJY Components**

Box 7970  
Jackson, WY 83001  
Tel. 801-753-5691

Send a Large S.A.S.E. for list

A must list for radio amateurs and RF experimenters. Several hard-to-find RF transistors including dual gate MOSFETs. A few linear ICs, capacitors, and inductors. They also have several air-variable capacitors and Jackson Bros. reduction drives that are hard to find. Lots of good specials. One of my favorite lists.

**CIRCLE 171 ON FREE INFORMATION CARD**

**Kelvin Electronics**

7 Fairchild Ave.  
Plainview, NY 11803  
Tel. 516-349-7620

Good selection of test equipment, PC-board etching supplies and equipment, a gigantic selection of tools, and a moderate selection of ICs and semiconductors. Many kits including robotics.

**CIRCLE 172 ON FREE INFORMATION CARD**

**Kirby Tubes**

298 W. Carmel Dr.  
Carmel, IN 46032  
Send a large S.A.S.E. for list

A nice list of general-purpose receiving tubes of interest to TV technicians.

**CIRCLE 173 ON FREE INFORMATION CARD**

**Liolaemus Designs**

Box 360866  
Milpitas, CA 95036  
Tel. 408-263-8944

Liolaemus offers dipole and loop antenna kits for the amateur bands and three or four code-practice kits.

**CIRCLE 174 ON FREE INFORMATION CARD**

**LNS Technologies**

20993 Foothill Blvd., Suite 307N  
Hayward, CA 94541-7150  
Tel. 800-886-7150

A small illustrated catalog of kits such as a digital voice-message recorder and an 8085-based microcontroller board with matching software for program development.

**CIRCLE 175 ON FREE INFORMATION CARD**

**Mark V Electronics**

8019 E. Slauson Ave.  
Montebello, CA 90640  
Tel. 213-888-8988

Mark V has a line of kits mainly in the audio/stereo arena. They have several amplifier kits (up to 300 watts) as well as preamplifiers, graphic equalizers, stereo simulators, etc. They have several other kits including power supplies, light controllers, and digital panel meters and counters.

**CIRCLE 176 ON FREE INFORMATION CARD**

**Marlin P Jones & Associates**

PO Box 12685  
Lake Park, FL 33403  
Tel. 407-848-8236

A nice little catalog filled with interesting bargains. Over 100 different power supplies are listed. Also offers the usual assortment of switches, motors, fans, and relays. A few semiconductors, but a nice list of "smart" LCD displays including laptop graphics displays. A moderate assortment of tools, hardware, test equipment, and components.

**CIRCLE 177 ON FREE INFORMATION CARD**

**MCM Electronics**

650 Congress Park Dr.  
Centerville, OH 45459-4072  
Tel. 513-434-0031

Source for assorted components and parts including TV/VCR parts, speaker components, computer parts and accessories, and more. Excellent selection of standard components including semiconductors, resistors, capacitors, switches, etc. Stocks RCA/GE original replacement parts and SK replacement semiconductors.

**CIRCLE 178 ON FREE INFORMATION CARD**

**MECI**

3340 1st St.  
Dayton, OH 45402  
Tel. 800-344-4465  
Min. order: \$20

Mendelson Electronics Co., Inc. has a small catalog of select surplus items. They stock fans, connectors, wall transformers, and stepper and other motors. They have a moderate selection of capacitors, including the older, multiple high-voltage electrolytics needed for replacement in older TVs. They also have a number of PC-compatible accessories.

**CIRCLE 179 ON FREE INFORMATION CARD**

**Meredith Instruments**

PO Box 1724  
Glendale, AZ 85301  
Tel. 602-934-9387

Specializing in laser kits, tubes, power supplies, and optics.

**CIRCLE 180 ON FREE INFORMATION CARD**

**Mouser Electronics**

2401 Hwy 287N  
Mansfield, TX 76063-4827  
Tel. 800-346-6873  
Min. order: \$20.00

Mouser is a near full-line distributor with an extensive list of ICs and semiconductors, including NTE replacement devices. They stock SGS-Thompson semiconductors,



which are quite a bit less expensive than other brands. They also have an excellent selection of house-brand capacitors, inductors, and resistors at good prices. One of my favorite suppliers.

**CIRCLE 85 ON FREE INFORMATION CARD**

#### **Newark Electronics**

4801 N. Ravenswood Ave.  
Chicago, IL 60640-4496  
Min. order: \$25

A full-line electronics supplier with a mammoth catalog of every conceivable part. Branch offices nationwide.

**CIRCLE 84 ON FREE INFORMATION CARD**

#### **Oak Hills Research**

20879 Madison St.  
Big Rapids, MI 49307  
Tel. 616-796-0920

Send a large S.A.S.E. for catalog

Some nice QRP kits, as well as wired and tested units. Also listed is a select list of components typically used in QRP receivers and transmitters.

**CIRCLE 83 ON FREE INFORMATION CARD**

#### **Oak Ridge Electronics**

P.O. Box 93  
Paragould, AR 72451-0093  
Tel. 501-236-2179

Manufacturers of PC boards for hobbyists and small manufacturers. Very reasonable rates: \$3.50 to \$45.50 setup charge and a \$0.25 to \$0.35 per-square-inch processing charge. Double-sided boards are **not** plated through.

**CIRCLE 82 ON FREE INFORMATION CARD**

#### **Ocean State Electronics**

Box 1458  
Westerly, RI 02891  
Tel. 800-866-6626  
Min. order: \$5.00.

A large selection of IC's and semiconductors including NTE replacements. They list tubes including those for amateur transmitting. A very complete listing of toroid cores, J.W. Miller inductors, and a source for B&W Miniductor and Airdux air-wound coils. They also have roller inductors and air-variable capacitors for transmitting applications. They stock magnet wire in sizes from 14 to 40 gauge in 1/4-pound spools. Ocean States is a must for amateurs and RF designers.

**CIRCLE 81 ON FREE INFORMATION CARD**

#### **ORA Electronics**

9410 Owensmouth Ave.  
Chatsworth, CA 91311  
Tel. 800-423-5336

Accessories for cellular telephones including battery packs and chargers, antennas, and mounting hardware. They also carry connectors, cables, and adapters including RF, telephone, and computer. A very extensive illustrated catalog.

**CIRCLE 109 ON FREE INFORMATION CARD**

#### **Pak Rat Electronics**

Box 690073  
Houston, TX 77269  
Tel. 713-893-0313

Pak Rat has a small catalog of solar cells, power inverters, and a few other items. If you're into solar cells, you will want this list.

**CIRCLE 110 ON FREE INFORMATION CARD**

#### **Pan-Com Int'l**

Box 130-V9  
Paradise, CA 95967  
Tel. 916-534-0417

An extensive list of kits, plans, and books. Some items are "plans only," some are plans and PC boards, some are kits, and some are available assembled. Prices range up to about \$30 for a kit. Covers amateur, cable-TV, general hobby, and low-power broadcast kits. A good list for general electronics experimenters.

**CIRCLE 111 ON FREE INFORMATION CARD**

#### **Parts Express**

340 E. First St.  
Dayton, OH 45402-1257  
Tel. 513-222-0173  
Min. order: \$20

Source for assorted components and parts including TV/VCR parts, arcade- and pinball-game parts, alarm-system parts, and speaker components including crossovers, L-pads, drivers, accessories, and more. Decent selection of standard components including semiconductors, resistors, capacitors, switches, etc.

**CIRCLE 112 ON FREE INFORMATION CARD**

#### **PEM Tubes**

7392 French Rd.  
Sacramento, CA 95828  
Tel. 916-383-9107

A 16-page list of receiving and some special-purpose tubes. They have over 100,000 tubes in stock.

**CIRCLE 113 ON FREE INFORMATION CARD**

#### **PCB Prototypes**

8195 South 2660 East  
Sandy, UT 84093

Of interest to product developers, PCB Prototypes will build you one double-sided, plated-through-hole PCB for a cost of \$1.25 per square inch (minimum \$20). All you do is send them a "plot" file from an IBM-compatible PC-layout program. If you don't have one, they will supply you a PC layout program free if you send them a blank disk in a disk mailer.

**CIRCLE 114 ON FREE INFORMATION CARD**

#### **Premium Parts**

Box 28  
Whitewater, WI 53190  
Tel. 800-558-9572

Replacement parts for TV's and VCR's. They also have a large listing of Japanese transistors (2SCxxx). A must catalog for TV and VCR repairmen.

**CIRCLE 115 ON FREE INFORMATION CARD**

#### **PS Technology Inc.**

715 Warren Rd.  
Cockeysville, MD 21030  
Tel. 410-667-4889  
Send a large S.A.S.E. for list

A select list of components of all kinds.

Quantity of any one item appears to be limited to stock on hand. Should be some bargains in there if you can match your needs to their supply.

**CIRCLE 116 ON FREE INFORMATION CARD**

#### **R&D Electronics**

1224 Prospect Ave.  
Cleveland, OH 44115  
Tel. 216-621-1121  
Min. order: \$10.00.

Small selection of semiconductors and some exotic IC's such as flash A/D converters. Also switches, power transformers, motors, relays, and fans.

**CIRCLE 117 ON FREE INFORMATION CARD**

#### **Radio Shack**

One Tandy Center  
Fort Worth, TX 76102

Well known chain of electronics stores. Carries a wide assortment of consumer-electronics, computers, test gear, components, and more. Stores and dealers nationwide.

**CIRCLE 118 ON FREE INFORMATION CARD**

#### **Ramsey Electronics, Inc.**

793 Canning Parkway  
Victor, NY 14564  
Tel. 716-924-4560

Kit and assembled test equipment, transmitters, and receivers, as well as some other interesting devices. I have had one of their frequency counters for several years and am completely satisfied with it. Some nice QRP rigs and shortwave receivers.

**CIRCLE 80 ON FREE INFORMATION CARD**

#### **S&J Electronics**

1900 Beld St.  
Madison, WI 53713  
Tel. 608-255-7400

Small catalog containing some test equipment, miscellaneous IC's and semiconductors, computer-peripheral cards, connectors, and a few other items.

**CIRCLE 107 ON FREE INFORMATION CARD**

#### **Science Workshop**

Box 310NV  
Bethpage, NY 11714

Home of the "Poor Man's Spectrum Analyzer," kits, tuners, tracking generator, and parts to make your own 1-1000-MHz spectrum analyzer/monitor receiver.

**CIRCLE 108 ON FREE INFORMATION CARD**

#### **Small Parts Inc.**

P.O. Box 4650  
Miami Lakes, FL 33014-0650  
Tel. 305-751-0856  
Min. order: \$15.00.

A 270-page illustrated catalog of every conceivable nut, bolt, and screw. Plastic, brass, aluminum, steel, bronze, or copper rod, tube bar, channel, square, sheet, or ball stock. Bearings, springs, pulleys, gears, and a large selection of specialized hand tools. Of special interest to machinists and others mechanically inclined.

**CIRCLE 18 ON FREE INFORMATION CARD**

*(Continued on page 97)*

# ANTIQUÉ RADIO

By Marc Ellis

## Behind the Scenes at Motorola's Museum



Terry Sinnott, Manager, Museum Collections and Exhibits, shows off some of the collection's early auto radios.

Last month, I had the opportunity to visit the Motorola Museum of Electronics and use its resources to tell you a little bit about that company's colorful history. In the process, I met Terri Sinnott, the museum's manager of collections and exhibits, who gave me a tour through the "back-stage" part of the operation. I thought that

the behind-the-scenes activities were at least as interesting as the public exhibits, so I asked Terri if I could come back and do a follow-up column on how the museum's collections were acquired, catalogued, and stored. She graciously agreed.

Probably the best way to understand what happens behind the scenes is to trace the steps of the museum's acquisition process and observe how objects are added to the collection. But before we can do that, you have to know a little bit about the philosophy of this institution. Here's the museum's official mission statement:

*The purpose of the Motorola Museum of Electronics is to serve as the corporation's institutional memory and to encourage employees and other visitors to explore electronics technologies through examples drawn from the company's history and product applications. The museum's exhibits, archives, and related programs are part of a larger endeavor to promote public interest in science and technology and to show the vital role these play in improving the quality of life.*

In its role as Motorola's institutional memory, the museum acquires many items of interest to us as collectors—including samples of products, packaging, and promotional materials. However, items relating to the company's internal history are also sought, including service awards, company uniforms, and early equipment. On my tour through the facility, I spotted an old, straight-backed, wooden chair carefully stored on a shelf. Closer inspection showed that it carried a property tag bearing the original (Galvin Manufacturing Corporation) company name.

### **SIZING UP A PROSPECTIVE DONATION**

When it comes to company products, the museum staff does not collect every variation of every model of every piece of equipment ever manufactured by Motorola. A couple of huge warehouses would be required to achieve that goal.

Judgment on whether to

add an item to the collection depends on a mix of factors, including the rarity of the piece, its condition, and its significance in Motorola's history. Of special interest are products, such as the low-cost Golden View table-model TV of 1947, that represent Motorola's entry into a new product arena.

Pieces for the collection come from both inside and outside Motorola. As a matter of fact, Terri is still cataloguing a backlog of material that was put aside by the historically-minded company over the years.

When material is offered to the museum, all of the information available about the prospective donation is written out on a standard form to make evaluation as easy as possible. And the first step is to check the model number, if known, against a computer database (if you're curious about the software, the museum uses Q&A) to see if there's already an example in the collection.

Should the museum already own an example in good condition, the piece probably won't be accepted unless it's a real rarity or is in demand for special exhibitions. Certain items are considered "hot" because they are frequently requested for inclusion in artifact loans that are made available to other Motorola facilities or other museums.

### **THE FATE OF THE DIRTY TAXI SETS**

I had a chance to participate in the selection process first-hand because I



happened to have some Motorola items to offer the museum. For many years my garage has harbored a group of taxi transceivers acquired during the era when these sets were still popular with the amateur-radio fraternity.

I'd left a voice-mail message for Terri in advance of my visit, offering the items and listing the model numbers. She responded with a message ruling a couple of the units out because they were definite duplicates and asking that I bring a couple with me for closer inspection. Actually, I was quite embarrassed when I got around to loading them into the van. They'd become quite rusty and dirty since I'd last really looked at them a decade or so earlier.

If Terri was revolted by the sorry-looking equipment I'd dragged in, she hid it well. In fact, she assured me that the museum has occasionally had to remove disreputable items such as mummified mice from donated items during clean-up. However, I was definitely *not* invited to move any of my material into the building.

The museum's database had indicated that there appeared to be a model similar to one of my sets in stock and we went into the storage area to look at it just to make sure. Except for being free of rust and quite a bit cleaner, it certainly looked like mine. So much for that prospective donation!

The fate of the other candidate for adoption is still being decided. Its model number did not appear in the database, so Terri has begun a search of the company's archives (her standard procedure in such cases) to find out more about the equipment. If its



*The Motorola museum's massive storage cabinets would be at home on a battleship.*



*Handie-Talkie radios manufactured during World War II made an important contribution to the war effort.*

characteristics are sufficiently different from those of the models already in the collection, the set may yet be accepted in spite of its unpromising appearance.

#### **AFTER ACCEPTANCE**

At the time of my visit, several items recently accepted by the museum were arrayed on tables in the collection's workroom. Those included a couple of Bakelite-cased broadcast receivers, a toy Japanese cellular phone modeled after a Motorola product, a commemorative brick from an old company building, a knocked-down retail store display, and a small enameled company service-award pin. Prior to being

be removed, if necessary, without any damage to the piece.

Except in special cases, though, no attempt is made to restore an item to working order. The museum's aim is to stabilize each piece in the condition that it was received. To that end, the collection is kept in a storage room maintained at a temperature of 70° Fahrenheit and a relative humidity of 55 percent. That environment is considered optimum for the variety of



*Equipment too large for the cabinets, such as this group of Golden View TV sets, is stored on shelf systems that are installed around periphery of the storage room. Advertising items, test gear, and other TV sets are also located on these shelves.*

stored, each piece would be assigned a catalog number, cleaned (if necessary), photographed, and added to the database.

I was quite impressed with the meticulous handling received by each item. For example, individual catalog numbers were applied to both the service pin and its tiny spring retaining clip—just in case they might become accidentally separated. As a person who can hardly write his name legibly without a struggle, I was astonished at the perfection of the impossibly minute numbers that had been applied to the retaining clip. By the way, all catalog numbers are applied in a reversible manner—so that they can

metal, fabric, and wood materials contained in the collection.

The room contains rows of heavy-duty metal storage cabinets that would be at home on a battleship. As one walks between the rows, glass windows in the massive sliding access doors provide tantalizing glimpses of the treasures housed within. Galaxies of employee-recognition pins from all eras of the company's history, Handie-Talkie radios from World War II, examples of various stages in the development of the automobile radio, and company uniforms from facilities on the Pacific rim.

What won't fit inside the cabinets is shelved on a  
*(Continued on page 83)*

# COMPUTER BITS

By Jeff Holtzman

## Visual Programming II: Access

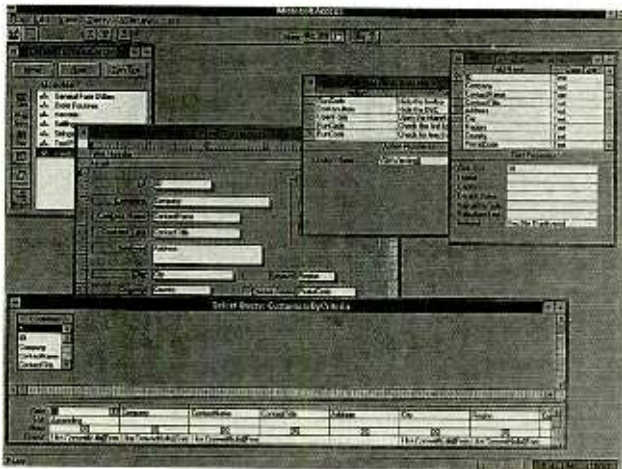

*Through an intuitive process of building tables, forms, reports, macros, queries, and Access Basic modules, Microsoft's Access brings the power of the relational database to the average user.*

Several months ago, we began a discussion of visual-programming environments. I gave a very brief overview of Microsoft's Visual Basic, version 2.0, and concluded that it is one heck of a programming tool. We then went on to discuss the importance of databases in today's world.

Our conclusion was that success in this world by both technical and non-technical professionals depends on a basic understanding of database concepts. That understanding will allow you to both access myriad commercial and non-commercial databases, and create your own.

Our topic this month combines both themes: visual programming and databases.

Until very recently, creating a personal database was a difficult task, much more so than creating a spreadsheet or a word-processed document. Tools like 1-2-3 and Word for Win-

dows have improved 1000% during the past decade. But during that same period of time, database tools barely budged an inch.

There were and are lots of pretty good "flat file" products—e.g., Symantec's Q&A—that allow you to create single-table databases and get information into and out of them fairly easily. However, those types of products sacrificed important features for the sake of ease-of-use.

At the other end of the scale, you could use products like dBASE and Paradox (not to mention their siblings on larger systems) to create complex databases. However, doing so involved extensive coding in proprietary languages and hostile environments. There was almost nothing available at either end of the scale for the Windows environment.

That all changed at around the end of 1992, when Microsoft released Access and Borland released Paradox for Windows (PW). Both are fully Windows-based database managers that can read and write data in multiple formats, and that have easy-to-use screen and report generators. In addition, both package many of the high-end capabilities formerly associated with dBASE and Paradox for DOS in a much easier-to-use format. Both fit in the middle of the spectrum from easy to hard; Access a little closer to easy, and PW a little closer to hard. Both allow the user much greater focus on problem solving

rather than tool usage. Currently I would recommend Access over PW to beginners and occasional users, mainly because programming in Access is more accessible than in PW.

### INSIDE ACCESS

An Access database consists of one or more tables, forms, queries, reports, macros, and modules. All components are stored in a single file, and are referenced with long file names, an arrangement that makes managing a project much easier than, for example, dBASE's, where every component is stored in a different file, each of which is limited to DOS's 8/3 format.

The basic unit of a database is the table. A table consists of rows (records) and columns (fields). Using a spreadsheet-like grid, creating a table is simple. In addition, you can update a table's structure as needed without jumping through hoops. To help ensure that data gets entered correctly, you can specify format criteria directly at the table level, in which case Access will not let you enter incorrect data. Performing lookups is trivial; sophisticated data verification will require writing code.

Entering data into tables can be awkward; you'll probably want to create forms to do so. Access is a big help here. After defining a table, an Access "Wizard" can create a serviceable form for you automatically, or you can create it manually. The latter involves dragging and





# Give a Friend a Year of Electronics Fun this Christmas...

Does fighting the crowds at Christmas short-circuit your holiday fun? Don't blow a fuse this year. . . for the friend who shares your love of project-oriented electronics — or a youngster who may need only a spark to ignite a life-long interest — give a gift subscription to Popular Electronics.

Popular Electronics readers get the know how they need to build exciting, educational, and useful projects like these . . . a touch light dimmer. . . a traveler's theft alarm . . . an economy NiCd battery charger. . . a voice synthesizer. . . a portable frequency counter. . . a shortwave converter. . . a stereo graphic equalizer. . . even a robot!

PLUS. . . Gizmo, our honest and straight-shooting review of the latest consumer-electronics gear. . . Market Center, featuring mail-order merchants that are ready to help you in all your hobby activities. . . articles and columns covering every aspect of the electronics hobby — including antique radio, shortwave listening, ham radio, computers, scanners, circuit design, and more!

SAVE MONEY. . . A great gift to receive, Popular Electronics is also a great gift for *you* to give! The Special Holiday Rate saves you \$23.05\* off the newsstand price on each gift. You can save another \$23.05\* when you start or extend your own subscription at the same time. It's our "thank-you" for sharing Popular Electronics with a friend this Christmas.

Send no money, unless you prefer. We'll be glad to bill you in January, 1994. Just take a brief moment to go over your gift list and make sure you haven't forgotten anyone who might appreciate the many benefits of Popular Electronics. Then write the names on the attached Gift Certificate and mail it back in the postage-paid reply envelope. . . we'll take it from there!

Your friends will receive a handsome gift announcement card signed with your name just before Christmas. And all through the new year they'll remember and appreciate your thoughtful gift! So don't blow a fuse. . . take it easy and enjoy the holidays. Give Christmas gifts of Popular Electronics!

## Popular Electronics<sup>®</sup>

\*Basic sub rate—1 yr/\$21.95



# Earn Your B.S. Degree in ELECTRONICS or COMPUTERS



## By Studying at Home

Grantham College of Engineering, now in our 43rd year, is highly experienced in "distance education"—teaching by correspondence—through printed materials, computer materials, fax, and phone.

No commuting to class. Study at your own pace, while continuing on your present job. Learn from easy-to-understand but complete and thorough lesson materials, with additional help from our instructors.

Our Computer B.S. Degree Program includes courses in BASIC, PASCAL and C languages — as well as Assembly Language, MS DOS, CADD, Robotics, and much more.

Our Electronics B.S. Degree Program includes courses in Solid-State Circuit Analysis and Design, Control Systems, Analog/Digital Communications, Microwave Engr, and much more.

An important part of being prepared to *move up* is holding the right college degree, and the absolutely necessary part is knowing your field. Grantham can help you both ways—to learn more and to earn your degree in the process.

Write or phone for our free catalog. Toll free, 1-800-955-2527, or see mailing address below.

Accredited by  
the Accrediting Commission of the  
National Home Study Council

**GRANTHAM**  
**College of Engineering**  
Grantham College Road  
Slidell, LA 70460

dropping field names from a list, and aligning input-field controls (text boxes, check boxes, radio buttons, etc.) to a grid. Each Access control has numerous properties that specify how it looks and which event(s) it responds to. As for appearance, you can create snazzy 256-color screens with 3D effects, buttons with bitmaps, and more. The range of events (e.g., click, double-click, entering a field, changing a field, etc.) is limited, but sufficient for most cases. However, I do wish that Microsoft would provide a "MouseOver" event.

Creating reports is very similar to creating forms: drag and drop fields from a list, arrange them as desired, specify font and color, and you're done. A zoomable print-preview mode allows you to see exactly how your report will print without wasting paper.

Queries allow you to extract and modify subsets of your data (e.g., all records with a specific area code). Learning how to use queries effectively is the key to database power.

Access allows two kinds of programming: one using macros, and the other using an extended language that's very similar to BASIC. The macro language is powerful but has curious limitations. For example, it's easy to create buttons to help navigate through your database (first, last, next, and previous). However, using the macro language, if you press a button and try to go beyond the first or last record, Access generates a

nasty error message and dialog box the user must close before continuing. Performing the same actions in Access Basic allows you to avoid the error message, but only by telling Access to ignore errors! That kind of error handling is simply inelegant and a pain to get around. In addition, the distribution of functions among macros and Access Basic is confusing at first and arbitrary even after you get the hang of it.

An interesting feature of Access Basic is that it has a significant number of object-oriented methods and data structures. If you're familiar with BASIC or some other traditional procedural language, gradually adopting Access Basic's object-oriented features is a smooth way to get up to speed.

## CONCLUSIONS

Access is a powerful, innovative product. It has helped me get a handle on data-handling chores that have bugged me for years. I did have to spend a significant amount of time coming up to speed on some advanced features. But I don't believe that that time was wasted.

Accomplishing those things in dBASE or Paradox would have taken much longer, and it's doubtful that the results would have been as pleasing. In addition, with just a little planning, you can create code and command buttons that you can use over and over again.

Today's world requires some understanding of data management. Armed with that knowledge and a tool like Access, you'll be unbeatable. Although the program lists for \$495, it's often available for \$100-\$150.

## VENDOR INFORMATION

Access (\$495, list price)  
Microsoft Corp.  
One Microsoft Way,  
Redmond, WA 98052-6399.  
800-426-9400 or 206-882-8080



# CIRCUIT CIRCUS

By Charles D. Rakes

## Something for Just About Everyone

This month I've worked up a number of assorted circuits to share with you that, with any luck, are bound to inspire you to create your own electronic project. The first of this month's circuits came about when a friend asked if there was any way that he could generate about 30 to 36 volts DC from a 12-volt transformer without spending a bundle on parts.

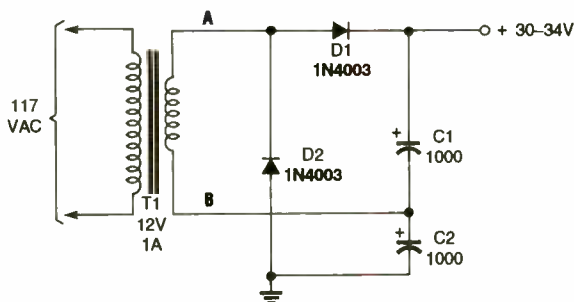

Fig. 1. The voltage doubler is built around a pair of diodes (D1 and D2) and a pair of capacitors (C1 and C2) that are fed from, in this case, a 12-volt, 1-amp step-down transformer (T1).

Since he didn't need a regulated source, I figured that a full-wave voltage doubler would fill the bill.

### VOLTAGE DOUBLER

The voltage doubler (see Fig. 1) is built around a pair of diodes (D1 and D2) and a pair of capacitors (C1 and C2) that are fed from the aforementioned 12-volt transformer (T1, a 1-amp unit). One leg of T1's secondary winding is

connected between the anode/cathode junction of D1 and D2. The other leg is connected at the junction of C1 and C2. When the transformer's "A" lead goes positive, D1 conducts, charging C1 to about 16 volts; that's about equal to the peak AC voltage minus the diode's forward drop.

During the following half-cycle, the polarity is reversed with the "A" lead going negative, charging C2 through D2 to about 16 volts. Since the two capacitors are in series, the voltage across the two units add, providing about 30-34 volts at the output of the circuit. The actual DC out-

put voltage depends on the AC input voltage and the load connected to the output of the power supply.

### STEPPED-UP DUAL-VOLTAGE SUPPLY

Our next circuit, see Fig. 2, follows a similar course to produce a simple dual ( $\pm$ ) 15-volt unregulated power supply. Diodes D1 and D2 are connected to the output of the 24-volt, center-tapped transformer to produce a positive output across capacitor C1. Diodes D3 and D4 are connected to the transformer's output in the reverse direction, producing a negative output across C2.

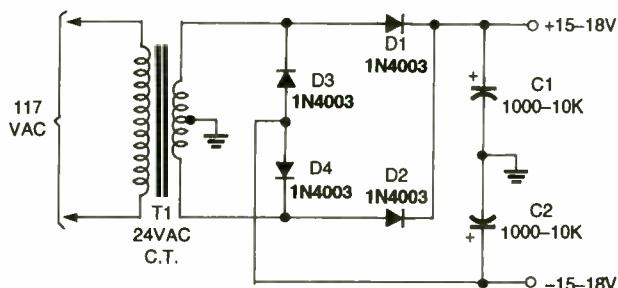

Fig. 2. The stepped-up dual-voltage supply follows a similar course to that in Fig. 1 to produce a  $\pm$ 15-volt unregulated power supply.

### PARTS LIST FOR THE STEPPED-UP DUAL VOLTAGE SUPPLY

D1-D4—1N4003 1-amp, 200-PIV, general-purpose, silicon rectifier diode  
 C1, C2—1000- to 10,000- $\mu$ F, 35-WVDC, electrolytic capacitor  
 T1—24-volt, center-tapped power transformer  
 Perfboard materials, enclosure, molded AC power plug with line cord, wire, solder, hardware, etc.

### PARTS LIST FOR THE VOLTAGE DOUBLER

D1, D2—1N4003 1-amp, 200-PIV, general-purpose, silicon rectifier diode  
 C1, C2—1000- $\mu$ F, 35-WVDC, electrolytic capacitor  
 T1—12-volt, 1-amp power transformer  
 Perfboard materials, molded AC power plug with line cord, wire, solder, hardware, etc.

The supply's unloaded output voltages will be somewhere between  $\pm$  15 and  $\pm$  18 volts DC. For light loads, the two filter capacitors may be as small as 1000  $\mu$ F, but for heavy loads, the capacitors should be as large as possible.

## TELEPHONE-LINE TESTER

If you have ever had problems with your telephone and ended up paying an exorbitant price for a service call, then look at the simple phone-line tester shown in Fig. 3.

The line tester consists of a meter that is used to measure the line voltage with the telephone in the on-hook or off-hook state. Those two simple checks can, in most cases, tell you where your phone problem lies. The tester—with its built-in off-hook load resistor—is wired to a modular telephone connector, which has become the phone standard in just about all locations.

The standard phone system usually uses a four-wire cable; in most cases, only the green and red wires (respectively, designated as the positive and negative sides of the line) are used. Often you find that some-

one has wired the line backwards (the red positive, and the green to negative). If the meter's needle pegs to the left (reverse), check the wiring at the wall jack to see if some misguided soul has been tampering with the phone line.

The line tester requires only one simple calibration; the meter must be calibrated for a full-scale reading of 50 volts. For that, you'll need a digital multimeter set to read 50 or more DC volts. Connect the DMM to the red and green wires of the tester, and then plug the tester into a phone jack; the meter should read about 48 volts. If the voltage is much lower than 48 volts, check to see that all the extension phones on the line are in the on-hook condition. Once that is done, adjust R2 for a meter reading that's slightly less than full scale.

Playing telephone detective is easy. If your phone

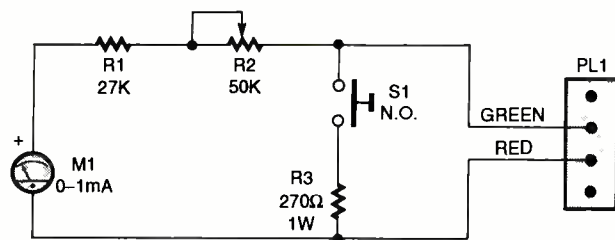

Fig. 3. The telephone-line tester consists of nothing more than a meter (that's used to measure line voltage in the on- or off-hook state), three resistors (one of which is variable), a pushbutton switch, and a modular telephone connector. When the circuit is connected to the telephone line, a meter reading of 5 to 10 volts when S1 is pressed indicates that the line is okay.

### PARTS LIST FOR THE TELEPHONE-LINE TESTER

#### RESISTORS

(All fixed resistors are 1/4-watt, 5% units unless otherwise indicated.)

R1—27,000-ohm

R2—50,000-ohm, potentiometer

R3—270-ohm, 1-watt

#### ADDITIONAL PARTS AND MATERIALS

M1—0-to 1-mA D'Arsonval meter movement

S1—Normally open pushbutton switch

PL1—Modular telephone plug

Perfboard materials, enclosure, wire, solder, hardware, etc.

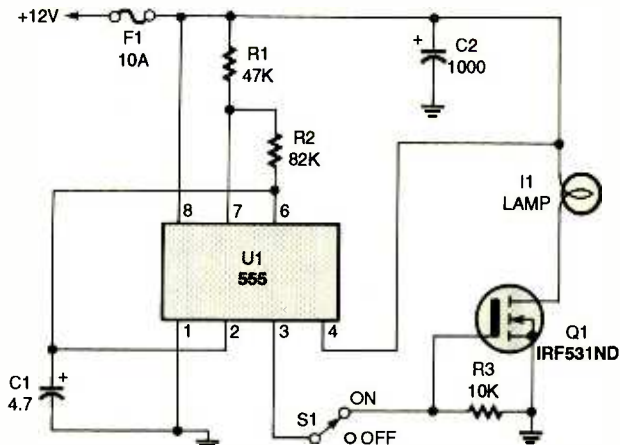

Fig. 4. The headlight flasher is nothing more than a 555 oscillator/timer that's configured as an astable multivibrator (oscillator), whose output is used to drive the gate of an IRF531ND hexFET, which, in turn, acts like an on/off switch, turning the lamp on and off at the oscillating frequency (1 Hz).

appears dead (no dial tone), unplug the phone and plug in the tester in its place. If the meter reads near full scale and drops to about 5 to 10 volts when S1 is pressed, there is a good chance that the phone line is okay. The problem is most likely in the phone itself. If the meter reading is low or you get no reading at all and all phones on the line are unplugged, the problem is probably located in the central office or in the phone line between your location and the central office (although it is also possible that the problem is with the wiring inside your home).

Believe me, I've saved a bundle in service charges over the years by making the same simple tests before contacting the phone company.

## HEADLIGHT FLASHER

Our next circuit came about when an outdoors buddy of mine ask if I could come up with an inexpensive circuit to make the add-on headlights for his off-road four-wheeler flash. That request was easily handled by the simple 555 oscillator/timer-based circuit (U1) shown in Fig. 4.

In the headlight flasher, U1 is configured as an astable multivibrator (oscillator) with an operating frequency of about 1 Hz. The duty cycle of the oscillator is set by the values of R1, R2, and C1. The oscillator's output at pin 3 drives the gate of an IRF531ND hexFET, which, in turn, acts like an on/off switch, turning the lamp on and off at the oscillating frequency (1 Hz).

Switch S1 is used to turn the circuit on or off without breacking the high-current lamp circuit, allowing the circuit to be controlled with a low-current, low-cost switch.

## FIELD-STRENGTH METER

Our next circuit, a field-strength meter (see Fig. 5), provides a cheap and fast way to monitor an amateur-radio or CB transmitter for maximum output; it can also be used to check out a new antenna system.

The circuit is no more than a simple untuned, crystal radio receiver that feeds a metering circuit. A 19-inch pull-up antenna is connected between a 2-mH choke and the anode of a 1N34A germanium diode. Capacitor C1 removes





# THINK TANK

By John J. Yacono

## Derby Stuff

We are still in the midst of our pinewood-derby exploration, and there is a little more to go. So this month, like last, we'll skip our usual tutorial and present only some reader's circuits, as those circuits will take up a lot of space by themselves. The contributors will be rewarded with a "Think Tank II" book and, as a bonus for taking part in the derby round-up, an MCL1010 chip. For now, let's take the day . . .

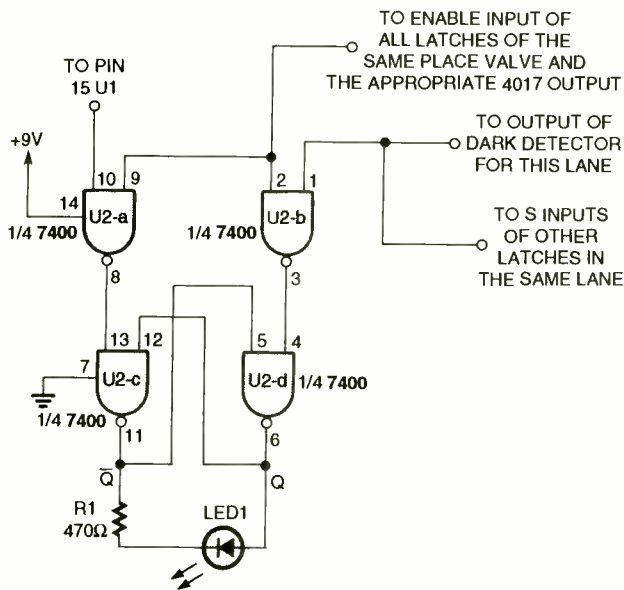

Fig. 1. This is one of 36 latch circuits ready to light its LED when triggered by a detector circuit (not shown here).

### LATCHES GALORE

With regard to Stephen Guye's problem of which pinewood derby car finishes first, second, third, fourth, fifth, and sixth, here's my solution: An array of (six rows of six) subcircuits made from super-bright LED indicators that are each connected to a 7400 quad two-input NAND gate that is configured as an RS (set/reset) latch (see Fig. 1). Each subcircuit is connected to

the five others in its lane, and the five others in the other lanes that hold the other place values (as you can see by the terminal circles).

Arranged to form a matrix like the one in Fig. 2, each column of subcircuits forms the display for a lane, and each row represents a finishing place. Each row of RS latches (representing a place value) is enabled by a 4017 CMOS decade counter (see Fig. 3).

As a car passes over the finish line, it interrupts the light to a phototransistor embedded in the center of its lane at the finish line. The phototransistors are used to form six dark-detector circuits, one for each lane as shown in Fig. 4. The light interruption causes the circuit to produce a positive-going pulse that causes pin 6 on whichever RS latch is enabled by the 4017 to go high, turning that subcircuit's particular LED on.

At the same instant that a particular car has been registered at a place (let's say that the sixth car passes the finish line first, the sixth LED lights in the first row to indicate a first place winner), a pulse is also

received at pin 14, of U1 (4017), causing the first row (first place) to be disabled, and the next row of latches (second place), to be enabled and ready for the next car to trigger one of the sensors in the remaining lanes and, in turn, register the second place winner, and so on. The detection is so accurate that there cannot be any ties. An SPDT reset switch is connected to pin 15 of U1 (4017) and pin

10 of U2 through U37 to reset the decade counter and the RS latches so you're ready for a new race!

PS. I didn't seem to have any problem using a 9-volt power source for both the CMOS IC and the TTL IC's. The circuit worked fine without providing a special 5-volt source for the TTL's.

—Denny Gregg, Oroville, CA

*It might not work without the extra voltage! If the 7400 IC's aren't the special 7400-S6 variety (which can handle up to 15-volts), they are likely to burn out. Further, a straight TTL chip is not designed to source the current needed to light an LED. That's why the extra voltage has worked to your advantage thus far; it's forcing excessive current through the 7400's outputs.*

*I would recommend replacing the 7400 IC's with CMOS equivalents. Otherwise, drop the voltage to 5 volts, re-calculate the current-limiting resistor values, and disconnect the anodes of the LED's from pins 6 and 12 of the latches, and connect them directly to the 5-volt source instead.*

### HYBRID DERBY

Since some sections of this circuit are reproduced six times, the explanation will be confined to the circuitry used by track one. Each track uses a 74373 transparent latch with six LED's at its outputs to indicate which "place" its car held when it crossed the finish line (see Fig. 5). The first six inputs of all the latches are tied to the six least-significant outputs of a CMOS 4017 decade coun-



## Introducing a New Era In Technical Training.

World College, an affiliate of the Cleveland Institute of Electronics, was created to provide a four year, independent study, technical degree program to individuals seeking a higher education. The Bachelor of Electronics Engineering Technology Degree, offered by World College, prepares students for high-paying careers in electronics, telecommunications, electrical power, computer and control systems. World College's curriculum is taught in an effective, time-proven, independent study environment. With World College's flexible study schedule, students have the opportunity to work or spend time with their family without having to worry about rigid scheduling residential colleges offer.

## A Quality Education with a Flexible Schedule.

In a world heavily dependent on electronic equipment, people who understand electronics will have no problem putting their knowledge to work... in high-paying careers. The staff and faculty of World College have invested over ten years developing, what we believe to be, the finest independent-study, baccalaureate degree program available. World College's mission is to instill in each student the knowledge, education, and training that employers are seeking for the many technical positions available today. It's a program created to provide the best education and training possible with a flexible schedule to match your busy lifestyle.



World College is currently seeking approval to confer the Bachelor Degree from the Virginia Council of Higher Education.

# Earn A Bachelor of Electronic Engineering Technology Degree from



**WORLD  
COLLEGE**  
*Bringing Technology Home!*

Lake Shores Plaza  
5193 Shore Drive, Suite 113  
Virginia Beach, VA 23455-2500

## Send For Your Free Course Catalog.

Take the first step towards a new start in life. Send for World College's Free Independent Course Catalog today and discover how easy and affordable it is to get started on your Bachelor Degree.

World College is affiliated with



## Complete the Entire Degree Program Under One Roof. Yours!

Only World College offers an independent study, four year technical degree which can be completed through one school. All lab equipment\*, parts, and software are included in your tuition and the program's 300-plus laboratory experiments can be completed in your own home.

## You Pay Only For Time Actually Used.

World College not only provides a means to earn a Bachelor Degree while fulfilling current obligations, but there are no restrictions on how fast you can complete the program. At World College, you pay tuition only for the actual upper-level semesters it takes to graduate. The quicker you complete the program, the less you pay in tuition. It's an effective way to keep you motivated in order to complete the course and move on to a better paying position as quickly as possible.

Currently not available in Ohio.

\* Student must have access to a personal computer system.

**YES!** Please send me World College's Free Course Catalog detailing the full curriculum.

Name: \_\_\_\_\_

Address: \_\_\_\_\_

Apt: \_\_\_\_\_

City: \_\_\_\_\_

State: \_\_\_\_\_ Zip: \_\_\_\_\_

Phone: ( \_\_\_\_\_ ) \_\_\_\_\_

Age: \_\_\_\_\_

Return to: WAH02  
World College  
Lake Shores Plaza  
5193 Shore Drive, Suite 113  
Virginia Beach, VA 23455-2500





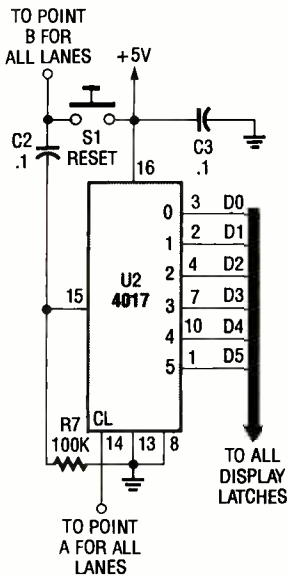

Fig. 6. The decade counter/divider is responsible for counting the cars as they finish, thus providing the place of each car to its latched display (look back at Fig. 5).

clocking the 4017. All increment circuits are isolated from each other by a diode to prevent damping of the pulses.

For proper operation, the appropriate latch must be set before the 4017 advances. That is not a problem as the TTL device is inherently faster and the pulse to the 4017 is delayed by the increment circuit.

When the reset button is pressed and released all six SCR's are left nonconducting due to the interruption of their holding current. The large-value base resistor on the increment circuit will not pass enough current to hold the SCR on. The reset button also resets the 4017 via C2 and R7. Since all of the SCR anodes are now high, all of the latches are transparent, causing them

output. The 4017 will advance one count, as will all latches except for the one that is latched.

As the second car crosses the line, its latch will hold Q1 high and all other latches will advance one place. After all six cars have crossed the finish line, the LED display will graphically show the relative position of each car as the finish line was crossed.

—Jay Stevens, Columbus, OH

Nice blend of CMOS and TTL logic. Note that Jay kept the supply at 5 volts to accommodate the TTL IC's in the circuit.

Well, we've run out of space for this month. Until next month, be sure to send your creations (in letter form anyway) here to *Think Tank*, Popular Electronics, 500-B Bi-County Blvd., Farmingdale, NY 11735.



One tree can make 3,000,000 matches.



One match can burn 3,000,000 trees.



A Public Service of This Magazine & The Advertising Council

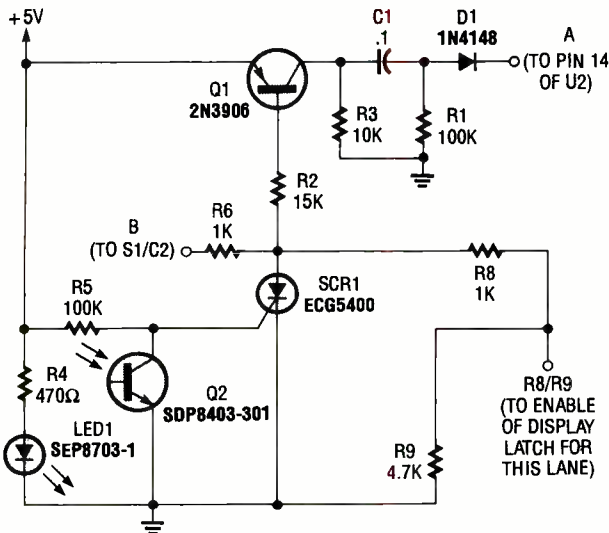

Fig. 7. This circuit detects a passing car, clocks the 4017 (back in Fig. 6), and activates the latch for its lane.

clocked, causing it to advance by one count.

Transistor Q1 has its base tied to the anode of its respective SCR and, so, it is turned on when the SCR is fired. When Q1 switches on, a rising pulse is generated at the junction of C1 and R1, which lasts as long as it takes C1 to charge. That pulse forward biases D1,

to pass data from their inputs to their outputs.

When the circuit is reset and in the standby mode at the beginning of a race, all latches will have a logic high on their  $Q_n$  (first place) outputs and so the corresponding LED will be lit. As the first car breaks the light path, the latch for its track will hold the high on its  $Q_n$

**FREE**  
 Electronics & Computer Software  
 Education Catalog

\*Fast-Track Individual Learning Programs  
 \*State-of-the-Art Classroom Courses  
 \*The Best Values in Electronics Education

**New**  
 Career-Level Courses  
 Personal Computer Servicing  
 TV and VCR Servicing

**New**  
 Computer-Aided Instruction  
 DC & AC Electronics  
 Semiconductors  
 Electronic Circuits

The stunning animations, hypertext glossary, and easy-to-understand text make learning electronics a breeze...and fun!

Learn the easy and affordable way from the Masters in Electronics Training - **Heathkit**. From Basic Electricity to Advanced Microprocessor Applications and more, Heathkit will provide you with an unparalleled learning experience at a fraction of the cost of other programs.

**Heathkit**<sup>®</sup>  
 Educational Systems  
 For your FREE Catalog, call  
**Toll-Free 1-800-44-HEATH**  
 please mention this code when calling 107-017

CIRCLE 155 ON FREE INFORMATION CARD

# DX LISTENING

By Don Jensen

## Getting Two For One

**M**aps, these days, seem to go out of date as quickly as they are published. Countries come, countries go! For example, consider Czechoslovakia, which disappeared early this year. In place of that central European country we'd all come to know from our grade-school geography class, we now have separate Czech and Slovak Republics.

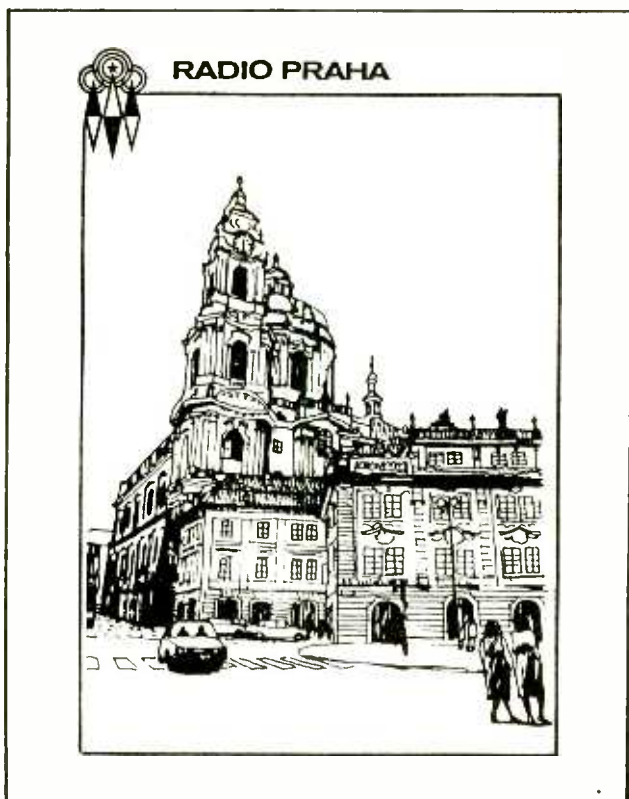

This is one of the many QSL verification cards issued by Radio Prague (Praha) during the days when it was the shortwave voice of a united Czechoslovakia.

Czechoslovakia, created in 1918 after World War I, was pieced together from parts of the old Austro-Hungarian Empire. But things went bad when, decades later, the Nazis invaded Czechoslovakia. And, following World War II, it was a

Soviet-dominated communist regime that ruled the country.

Democracy returned with the collapse of communism and, then, the two ethnic groups opted to go their own separate ways. That split, happily, was peaceful, with the western portion of old Czechoslovakia, Moravia and Bohemia, comprising the Czech Republic, and the eastern part making up the Slovak Republic.

Radio broadcasting in what was Czechoslovakia dates back 70 years, to 1923. In more recent years, most SWLs recognized *Radio Prague* as one of the more progressive shortwave voices from the eastern bloc. After Czechoslovakia split apart in January, those shortwave broadcasts were announced, at least for several months, as Czech and Slovak Radio. Then the two radio operations, in fact, separated, too.

As this is written, *Radio Slovakia International*, with studios in Bratislava and transmitters at Velke Kostolany/Rimavska Sobota, broadcasts in English at 0100 UTC on 5,930, 7,310, and 9,810 kHz. Radio Prague, transmitting from Litomyseľ in the Czech Republic, operates simultaneously at 0100 UTC, with English to North America, on its longtime 7,345 kHz frequency, and on 11,990 kHz.

Both stations verify reception reports. The addresses are: Radio Slovakia International, Slovensky Rozhlas, Director of Elektro-Technical Services, Podatelna, 81290 Bratislava, Mytna 1, Slovak

Republic; and Radio Prague, External Programs Department, Vinohradska 12, 12099 Prague 2, Czech Republic.

### SOLAR WINDS

The crew of the *Discovery*, during the space shuttle's April flight, released a mini-spacecraft designed to study solar winds. The Associated Press reported that astronaut Dr. Ellen Ochoa used the shuttle's robotic arm to lift the \$6 million satellite, which was the size of an air conditioner, from the *Discovery's* cargo bay for a two-day deployment.

Among its several experiments, the little satellite, called *Spartan*, was designed to investigate how the so-called solar wind, a stream of electrons, heavy protons, and heavy ions, is generated by the sun's blazing halo, called the corona. The solar wind, which blasts by our planet at about a million miles an hour, disrupts communications and electrical systems on Earth.

During future shuttle flights, you might wish to tune in on communications between NASA's Mission Control Center in Houston and the spacecraft. Two frequencies to try for the lower side-band voice traffic are 7,185 and 20,192 kHz, reports David Ross in his "Monitoring Services" column in *DX Ontario*, the monthly bulletin of the Ontario DX Association.

### IT'S THAT TIME AGAIN

For those of you who, like one Long Island reader who asks to remain unidentified, still may have a bit of



trouble converting your local time to UTC (Universal Coordinated Time)—the shortwave world's recognized standard reference—Reader Billy R. Pogue, Lake Havasu City, AZ, offers this tip. "The hassle of keeping track of time zones can be easily and cheaply solved by setting a cheap digital watch (you can get them for as little as a dollar) to UTC and stick it to the front panel of your receiver with a little rubber cement."

Good idea! UTC, of course, is equal to Eastern Standard Time plus 5 hours, CDT + 6, MDT + 7 or PDT + 8. (With the coming change of seasons and the end of daylight savings time, the conversion factors will be: EST + 5, CST + 6, MST + 7 or PST + 8 hours).

And remember, since those cheapie watches tell time using the AM-PM 12-hour system, you'll also have to mentally add 12 to the UTC-PM times. For example, 1 PM is 1300, 4 PM is 1600, 9 PM is 2100, and so on.

## PEN PAL

The next letter is from a reader named Bernard, who writes from Columbus, GA, with a different sort of time problem. "I'm temporarily confined to a dismal Georgia state prison. Here the highly paranoid authorities carefully control the type of radios we may have, and recently denied me the use of a cheap, made-in-China DAK MR-101-S shortwave, AM, and FM-stereo receiver.

"It was a digitally tuned,

\*Credits: Chuck Rippel, VA; Marie Lamb, NY; Ed Newbury, NE; Mike Wolfson, OH; John Lyon, MI; Mike Westdal, CA; Giovanni Serra, Italy; Don Moore, IA; Ontario DX Association, P.O. Box 161 Station A, J Willowdale, Ont., M2N 5S8, Canada; North American SW Association, 45 Wildflower Road, Levittown, PA 19057

autoscan, 5-pushbutton radio. But I was banned from using it because it had a clock, an alarm, and a sleep timer. I've searched high and low and can't find any small sized, digitally-tuned receiver that covers AM, FM, and at least the 49-, 31-, and 25-meter shortwave bands, but without the clock features.

"I'm 62 years old and have five more years of prison ahead of me. A receiver with the old fashioned analog dial is just too tough on my old eyes!"

I'll tell you, frankly, Bernie, I've never before had a question quite like this one! And while I sympathize with your problem, unfortunately, I don't have an easy solution. But, I can say this: For equipment questions, I generally look for answers in the annual "Passport To World-Band Radio" (Box 300, Penn's Park, PA 18943). But I cannot find listed any modestly priced digital-readout SW receiver without clock, alarm, or sleep timer.

You see, adding a clock-alarm to the design of a portable costs only pennies more, so receiver manufacturers invariably include it as a cheap extra on all of their digital-readout models. But here's a suggestion: Some mail-order SW receiver dealers will, upon request and for a reasonable price, make custom modifications to the off-the-shelf receivers they sell. Perhaps prison authorities might make an exception for a digitally-tuned radio whose clock features had been professionally deactivated or removed from the circuitry.

## MORE MAIL

Edward Fabbri, New York City, checks in with a quick question about where to send his reception reports. "What are the addresses of *Radio Ukraine International*

and *Radio Nacional* in Brasilia, Brazil?"

Here they are, Edward: *Radio Ukraine International*, ul. Kreshchatik 26, 252001 Kiev, Ukraine. *Radio Nacional da Amazonia*, Radiobras, Caixa Postal 08840, 70323 Brasilia, Brazil.

Have you a question, a comment or observation about SLW'ing? Would you like to see your photo, showing you and your listening setup, in this column? Want to let others know what you've been hearing on shortwave, or some SW programming you especially enjoy? Then drop me a line. Send your letters and photographs to *DX Listening*, **Popular Electronics**, 500-B Bi-County Blvd., Farmingdale, NY 11735.

## DOWN THE DIAL

Let's focus this month on the African continent and off-shore islands. Here are some of the stations being heard lately.

**ASCENSION ISLAND**—15,400 and 17,880 kHz. The *British Broadcasting Corporation's* relay station on this south Atlantic island is noted at 1700 UTC with a program called "Focus on Africa."

**CONGO**—9,610 kHz. *Radio TV Congolaise* broadcasts here at around 0600 UTC. It has been heard on this frequency with news in French and in one of the African languages.

**CHAD**—4,904 kHz. *Radio Nationale Tchadienne* is another West African voice noted here in the 60-meter band, with French programming and local high-life rhythms at around 0430 UTC.

**GABON**—9,580 kHz. *Africa No. 1* is one of the most popular of the popular stations of West Africa. Look for this one with a French-lan-

guage disc-jockey program, including call-in musical requests at around 1900 UTC.

**INDIA**—7,412 kHz. *All India Radio* has some interesting listening, especially in the musical department. You can find this one from around 2100 UTC onward with Indian music and English-language features. Or look for it on the parallel frequency of 11,620 kHz.

**MADAGASCAR**—9,605 kHz. The *Radio Nederland* relay station located here can be tuned at 1800 UTC, with English-language programming.

**MUARITANIA**—4,845 kHz. *Radio Mauritanie* is another of the numerous West African SW'ers. It has been heard at around 2255 UTC, with Arabic-language programming and identification.

**SIERRA LEONE**—3,316 kHz. The *Sierra Leone Broadcasting Service* operates on this 90-meter band channel. Look for English announcements at close down at 2230 UTC.

**SOUTH AFRICA**—7,270 kHz. *Channel Africa*, South Africa's foreign shortwave service, has been heard here in English at 0400 UTC. Another frequency to check is 15,430 kHz. Since the restructuring of the RSA operation, this station's programming has focused on the African continent.

**SOUTH AFRICA**—11,745 kHz. *Channel Africa*, the South African shortwave service to the rest of the continent, is noted at 0500 UTC in English, with identification, news, a mailbag program, and African music.

**TUNISIA**—7,475 kHz. *Radio TV Tunisienne*, one of the voices of northern Africa on shortwave, is heard on this frequency in Arabic, with news, Islamic programming, and music. ■

# HAM RADIO

By Joseph J. Carr, K4IPV

## Ham-Radio Potpourri

Every few months or so, I try to tie up a few loose ends or answer some of my mail, making for a "pot-pourri" column. Well it's that time again, so this month, we will take a look at a couple topics, including hum in direct conversion receivers and I'll provide a printed-circuit board pattern for the popular MAR-1 MMIC chip, which can be used for receiver, monitor, and scanner preamplifiers suitable for the VLF through UHF region.

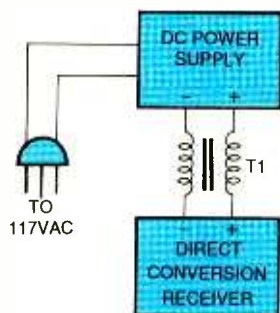

Fig. 1. One cure for AC power line hum and ripple (caused by leakage current) is to use a well regulated and filtered 9- to 18-volt DC power supply with a balancing choke (T1 in this illustration) between the power supply and the DCR.

### DIRECT CONVERSION RECEIVERS

The first topic this month involves direct conversion receivers (DCR's). These simple receivers are popular with amateur builders because they are very easy to build and, if done correctly, the DCR will perform rather well. Amateur radio operators who do "QRP" (very low power) operating often use the DCR as the basis for a QRP transceiver.

The DCR uses a local oscillator on a frequency

near the desired radio frequency (RF). If CW is being received, the offset is the frequency of the tone you prefer. For example, if you are receiving 3,600 kHz, and prefer an 800-Hz CW beatnote, then you would set the local oscillator to either 3,600.8 or 3,599.2 kHz. For SSB, set the local oscillator to a frequency that is  $\pm 2.7$  kHz from the desired RF. Most DCR's are probably battery operated. They draw modest current, so batteries won't be depleted as rapidly as they would with more complex receivers.

When the DCR is operated from AC power lines, a hum problem often pops up. Figure 1 shows a cure for that problem (which is derived from *The ARRL Handbook for Radio Amateurs*—a book that ought to be in every ham's personal library). In that arrangement, the DC power supply converts the 117-volt AC line voltage into 9 to 18 volts of filtered DC to operate the DCR. In many cases, the use of such power supplies cause a massive amount of hum due to leakage currents and ripple.

The ripple problem can be taken care of by using a well filtered and regulated (voltage regulation reduces ripple much more than filtering alone) DC power supply. The leakage-current problem can be taken care of by connecting a balancing choke (T1 in our illustration) between the power supply and the DCR. In Fig. 1, the balancing transformer is wound on a powdered-iron toroid core. For small receivers, drawing

less than 100 mA, use a T-50-6 choke wound with 12 bifilar turns of #24 enameled wire. A "bifilar" turn is one in which both wires are kept close together. One way to accomplish that type of winding is to twist the wires together (5 to 10 twists per inch), and then wind them onto the toroidal core.

Winding 12 bifilar turns onto a half-inch (T-50-xx) core crowds things a bit, so if you are uncomfortable doing it, then try a T-68-6 or T-80-6 core. The latter cores can also be used for higher powered DCR's when #22 or #24 wire is needed to accommodate larger current drains. All of those cores can be purchased from Ocean State Electronics (P.O. Box 1458, 6 Industrial Drive, Westerly, RI, 02891; Tel. 401-596-3080; fax 401-596-3590 or 800-866-6626, for orders only). And if you're interested in amateur-radio and electronic construction, ask for the Ocean State catalog. Ocean State carries lots of parts—e.g., toroid cores and variable capacitors—that are hard to obtain elsewhere. They also offer a couple kits of ferrite and powdered-iron toroid cores for people who do a lot of RF experimenting.

### MAR-1 RECEIVER/SCANNER PREAMPLIFIER

Building a wideband preamplifier that works for a wide variety of receivers has always been a real torturous chore—at least that was the case until recently. In this column, and in other **Popular Electronics**



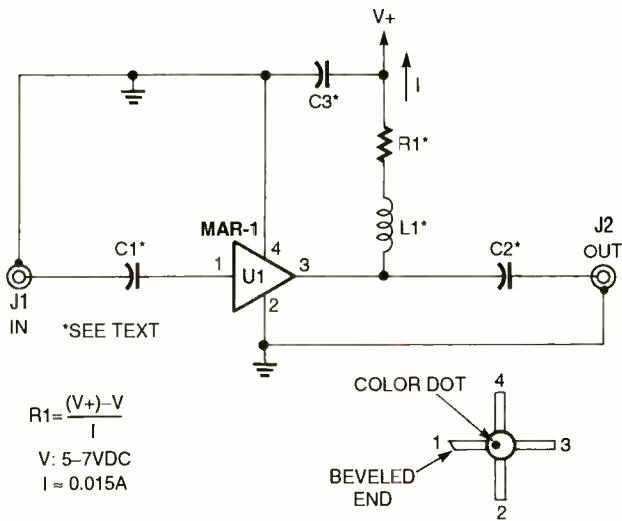

Fig. 2. The low-cost Mini-Circuits MAR-x series of chips offer the RF builder a real advantage, with their inherent 50-ohm input and output impedances (needed for RF systems). Shown here is an MAR-1-based receiver/scanner preamplifier

articles, I covered the Mini-Circuits MAR-x series of wideband chips. Those low-cost devices offer the RF builder a real advantage, with their inherent 50-ohm input and output impedances (needed for RF systems).

We previously covered the preamplifier circuit shown in Fig. 2 (see "Receiver Preamplifiers That You Can Build," June 1993, and *Ham Radio*, October 1993), but this month we'll provide a slightly different printed-circuit pattern than the one shown last time, and go into more details regarding the circuit and its construction, and use.

The circuit in Fig. 2, built around the MAR-1 device (a member of the MAR-x family), offers >13 dB gain from near-DC to 1000 MHz, so it will work throughout the HF-shortwave, VHF, and UHF bands. Using the MAR-1 is simplicity itself, for there are only four terminals: input (pin 1), output (pin 3) and two grounds (pins 2 and 4). Figure 2 also shows a combination pinout/package outline (which resembles a small-signal UHF/microwave transistor) for the MAR-1. Note that pin 1 is identified

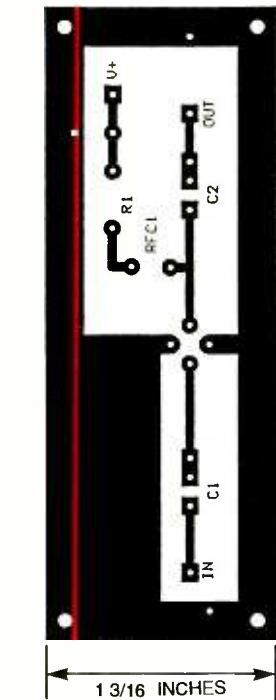

Fig. 3. Here is a printed-circuit template for the Fig. 2 circuit.

in two ways: its lead is beveled (the other leads are rounded on the ends) and there is a brown dot at pin 1.

The V+ DC power is applied to the output terminal (pin 2) through a current limiting resistor (R1) and an optional RF choke (L1). The value of R1 is set by Ohms law, and by setting the ap-

plied voltage (V+) to a value between 5 and 7 volts (higher voltages will harm the device). The value of R1 is given by:

$$R1 = \frac{V+ - V}{I}$$

That equation assumes a current (I) of 15 mA (0.015 A), which is proper for the MAR-1 (other MAR-x devices may use different optimum currents). If V+ is +9 volts DC, and the voltage applied to U1 is +6 volts DC, then R1 would have to be 200 ohms.

The input and output capacitors, C1 and C2, should be 1000-pF (0.001-μF) units for frequencies under 50

tween the ends of the printed-circuit traces is set to accommodate chip capacitors. Chip capacitors would be soldered directly to the foil side of the board. On one side of each capacitor site, there are two holes to accommodate, ceramic-disc or other high-frequency capacitors.

The MAR-1 device can be mounted in either of two ways. First, you can mount the MAR-1 directly to the foil side of the board; note placement of pin 1. That approach (which is the one shown in the parts-placement diagram) is recommended for upper-UHF

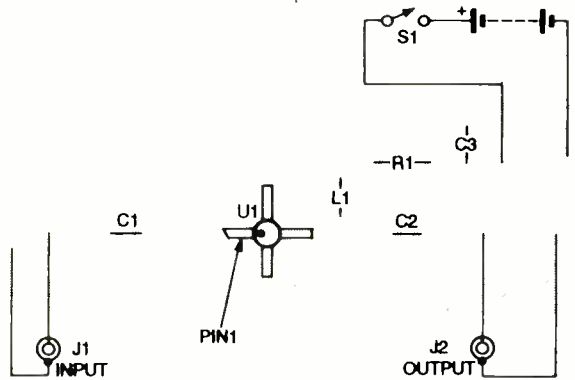

Fig. 4. This is a parts-placement diagram for the Fig. 3 printed-circuit template. (See text for assembly options).

MHz (some say under 100 MHz) and 100 pF for frequencies above that. When VHF/UHF operation is desired, C1 and C2 should be chip capacitors, otherwise, ceramic-disc capacitors are satisfactory. Capacitor C3, which is used for power-supply decoupling, should be a ceramic-disc unit; 0.01 μF for HF and low VHF and 0.001 μF for frequencies above 50 MHz.

### MAKING YOUR OWN

Figure 3 shows a printed-circuit template for the Fig. 2 circuit, while Fig. 4 is the parts-placement diagram for the template in Fig. 3. The sites for C1 and C2 are designed to accommodate several different capacitor types. The spacing be-

scanner operation, or in the VHF ham bands above 220 MHz. Second, you can bend the leads 90 degrees, and insert them through the holes provided from the component (non-foil) side of the board. The second method of mounting the device works well into the VHF/UHF region.

For a limited time, I can offer the printed-circuit board for \$7.00 postpaid, and the MAR-1, plus two each of either 100 pF or 1000 pF (you select) chip capacitors for \$6.00. If you want both offers, then the entire set (printed-circuit board, MAR-1, and two capacitors of your choice) is \$10.00. Order from me at P.O. Box 1099, Falls Church, VA 22041.

# SCANNER SCENE

By Marc Saxon

## Let's Look at Trunked Systems

Uniden Bearcat's BC-305A mobile/base scanner certainly looks different than anything the company has produced in the past. The unit has 50 programmable memory channels, offering coverage of 29–50-, 137–174-, and 406–512-MHz public-service bands, plus the 108–137-MHz aeronautics band. That might not sound like much in the

BC-305A is a completely new design, not merely a reworking of an old model. Uniden Bearcat dealers carry this easy-to-use unit, and we think that it's a fine addition to the line.

### TRUNKED

We often receive letters asking if we could spare a few lines in this column to provide a general explanation of what "trunked" systems are, as that term often turns up in descriptions of newly modernized communications facilities.

For starters, it has nothing to do with either elephants or luggage. Trunked systems presently operate only in the 800-MHz band, and various equipment manufacturers deal with them slightly differently. Yet, every system authorized for a trunked system has the same type of basic operational mode, requiring the use of a sequence of several frequencies spaced at 1-MHz intervals.

Here's a typical (but hypothetical) example. A city has six police frequencies, three fire frequencies, and six other frequencies used for city hall, sanitation, public works, parks, animal control, and municipal transit. Although 15 frequencies are licensed, a survey shows that 75% of the time no more than eight frequencies are in use at the exact same moment. That represents a lot of wasted frequency spectrum.

Suppose that a trunk system is designed for this city

that operates on eight UHF frequencies and combines all of the agencies to give them access to each of those frequencies. All agencies operate through the same transmitting facilities. Dispatchers for the individual agencies don't select a frequency; a computer selects any available channel. Communications are received only by each particular agency's mobile units. Their vehicles scan all eight channels for the tone-coded signals that activate their radios. An exchange of communications might conceivably take place on a series of different channels.

This is a simplified, capsule explanation of trunking to provide a general idea of what it is. Each trunked system is set up with the number of frequencies geared to meet its own particular needs. Although trunked systems save spectrum usage, they give fits to scanner owners. To the scanner listener, it's often as if all of the communications from a city's various agencies were put into a blender, and then fed out in equal parts over several frequencies.

### SPACED OUT

Jerry, the Sultan of Santee as he is known to one and all, sent information on Russian cosmonaut frequencies. He likes 143.625 MHz, which is popularly used for manned space activities. The 142.40–143.625-MHz band



The easy-to-use Uniden Bearcat BC-305A is factory programmed with hundreds of police, fire, EMS, aeronautics, maritime, and NOAA-weather stations.

way of capabilities, but don't fret—there's more. The BC-305A has Service Search that is preprogrammed with 739 police frequencies, 197 fire and EMS frequencies, 1160 aeronautics frequencies, all NOAA weather channels, plus 20 additional frequencies of the user's choice. The unit's Turbo Scan feature flips through its channels at nearly 100 channels per second. There are 11 separate scan/search bands.

As you can see, the





The 2.5-watt, 800-MHz LTR 8565 from E.F. Johnson Company is an example of a trunked handheld.

has turned up on several frequencies used in the Russian space program. The main problem is that everything they say is in a language that most of us don't understand. Yet you still get a lift from pulling in a signal on your scanner that comes directly from a Russian cosmonaut in a spaceship.

The chatter from American satellites doesn't sound any more coherent to the casual monitor because they send only data. Listen between 136 and 144 MHz. Jerry specifically mentions 137.10, 137.11, 139.056, 140.056, and 141.056 MHz.

### MAIL CALL

Cory Woodrow, of Edmonton, Alberta, Canada, wrote to say that he does all of his scanning from a basement. He wants to know if being below ground reduces scanner performance, and if getting a new scanner would improve reception.

Cory, in the event that you are trying to hear stations either in Australia or the lost continent of Atlantis via the most direct route possible, you might have hit upon a novel approach. For any other purpose, the

below-ground idea doesn't hold much promise. You probably don't need a new receiver. If you can just get a scanner antenna even 10 feet above ground, you'll be pleased with the improvement in your reception. The higher you can mount it, the better.

Eddie wrote to us from Florida to advise that the Ringling Brothers Barnum and Bailey Circus uses several frequencies, most notably 151.625, 153.02, and 151.995 MHz. He tells us he's not lion!

Darlene Seligson, from Los Angeles, California, passes along some frequencies of interest. Monitor Del Mar Racetrack on 151.715, 151.745, and 151.865 MHz. The San Diego Zoo uses 151.49, 151.895, 453.20, 453.80, and 464.425 MHz, while the San Diego Stadium uses 461.6375, 461.8875, and 462.05 MHz.

Another Californian, Dan Baldassari of San Anselmo, wants to know if the Regency HX-1000 that he was given is so old by today's standards that it should be regarded as obsolete. That is, would it be a good learning tool, or should it be trashed and replaced?

That scanner is several years old now, but as long as it works and is bringing in stations, I wouldn't toss it in the dumpster. Because you mention using it as a learning tool, you might not be fussy enough yet to demand a newer and more elegant unit. When you find that the HX-1000 no longer satisfies your needs, then pick up something fancy.

### KEEP IN TOUCH

Send your questions, frequencies, scanner-related news clippings, and suggestions to *Scanner Scene*, **Popular Electronics**, 500-B Bi-County Blvd., Farmingdale, NY 11735. ■

### ANTIQUE RADIO

(Continued from page 67)

system of open racks installed around the periphery of the room. Walking past those, I glimpsed a two-way radio base-station transmitter, laboratory test equipment of all kinds, advertising signs, shipping cartons for 1930's and 1940's broadcast receivers, a large collection of identical *Golden View* TV's, other TV's in exotic corner cabinetry, living-room console radios, and ... well I really can't begin do justice to the scope of the collection in the space I have available!

As you might expect, donations come to the museum in a variety of ways, some straightforward, some a little more unusual. Most frequently, people who are familiar with the work of the museum approach Terri via phone or mail and offer material they think might be useful. But folks sometimes drive up unannounced with a load of relics. When some, or all, of the artifacts are turned down, the prospective donor will often counter by asking the way to the nearest dump!

This is really an unfair tactic to use on museum personnel who, being in the preservation field, are understandably uncomfortable with the notion that such material might be trashed. Not that the approach works, because the staff really has to be selective about what is accepted. However, Terri and her assistant have developed a list of institutions that might be seeking various types of donations and will try to make appropriate suggestions.

Thinking that some *Antique Radio* readers

might be able to make valuable contributions to the museum, I asked Terri if there were any items she was especially looking for. She replied that although there is no "wish list," the museum would be interested in hearing about any Motorola-related material that might be available. Write to Terri Sinnott, Manager, Museum Collections and Exhibits, Motorola Museum of Electronics, 1297 East Algonquin Road, Schaumburg, IL 60196. You could also call Terri at 708-576-7814 or 708-538-2945; if you prefer faxing, the number is 708-576-6401.

Be prepared to tell Terri what the item is (broadcast receiver, 2-way radio, advertising piece, service award, etc.) and provide the model number, if appropriate. Describe the piece as carefully as possible. If it's a broadcast receiver, for example, indicate whether it's a table or a floor model, whether the cabinet is wood or plastic, etc. Also do the best you can to date the object.

Terri will respond in a timely fashion and, if the piece is suitable for the collection, will discuss acquiring it for the museum.

The museum would be pleased to answer queries regarding Motorola equipment in your own collection. They can often help to date pieces and/or provide schematics and technical information. When you contact Terri with your query, be ready to describe your equipment in detail just as you would if proposing a donation.

That wraps things up for now. As always, I look forward to hearing from you. Write me at *Antique Radio*, **Popular Electronics**, 500-B Bi-County Blvd., Farmingdale, NY 11735. ■

# ELECTRONICS LIBRARY

## Mobile 2-Way Radio Communications

by Gordon West, WB6NOA

Mobile 2-way radios are used by small businesses, boaters, campers, RV owners, and many others, for both work and play. Whatever use you might have for such communications, this book strives to answer every question that might arise. It concisely explains the difference between business, personal, marine, and amateur-radio services, and covers frequencies,

service, citizens band, marine radio, and amateur radio.

With an emphasis on practical information, the book helps readers get on the air, with advice on filling out license applications, choosing the correct gear for various purposes, and installing mobile antennas and other equipment. Easy-to-read, two-color frequency and channel charts are included. The book also explains how to obtain VHF and SSB marine and shore licenses and how to install properly grounded short-range/long-range radio equipment and antennas aboard boats.

*Mobile 2-Way Radio Communications* is published by Master Publishing costs \$6.95 at Radio Shack stores nationwide.

**CIRCLE 88 ON FREE INFORMATION CARD**

## ELECTRONIC MUSIC LEARNING PROJECTS

by R. Bebbington

Aimed at electronics enthusiasts who are new to music, and musicians who are new to electronics, this book presents a series of unusual projects designed to unite both camps while teaching about electronic music and providing hours of entertainment. Elementary music and electronics theory is presented on a need-to-know basis as practical aspects are explored. The projects include some that are intended to smooth out common stumbling blocks in music—a rhythm setter audio-video metronome, an instrument that gives true glissando and vibrato, and an electronic sol-fa machine—and others are musical instruments with strange-sounding names—the Elexylophone, the Glidaphone, the Melody Flanger, Appealing Handbells, and the Chordmaker. The projects are

## Electronic Music Learning Projects

R. BEBBINGTON

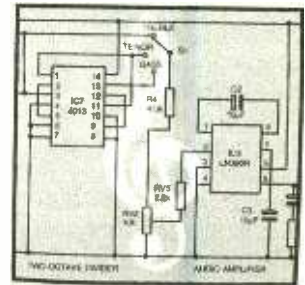

arranged by level of difficulty, with the earlier, easier projects serving as learning stepping stones.

*Electronic Music Learning Projects* (order no. BP329) is available for \$6.25 plus \$2.50 shipping and handling from Electronics Technology Today Inc., P.O. Box 240, Massapequa Park, NY 11762-0240.

**CIRCLE 97 ON FREE INFORMATION CARD**

## WIHA TOOLS CATALOG

from Willi Hahn Corporation

This 24-page, full-color catalog details the Wiha line of high-quality hand tools. The line includes screwdrivers, T-handles, bit selectors, magnetizer/demagnetizers, dead-blow hammers, awls, screw-holding screwdrivers, and a complete line of Torx tools. The catalog also includes the Precision series of fastening tools and tool sets, as well as insulated tools that meet all necessary standards and are certified to 1000 VAC/1500 VDC. New products include 6mm reversible blades that fit either the ratcheting Topra handle or the Precision handle.

*The Wiha Tools Catalog is*

## MOBILE 2-WAY RADIO COMMUNICATIONS

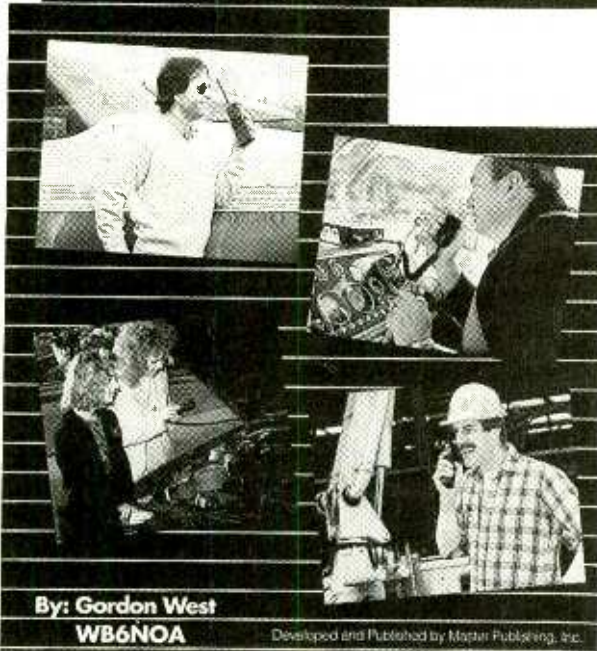

licensing requirements, and operating procedures for each. Opening chapters cover the mobile-radio frequency spectrum, modes and emissions, and mobile transceivers. Subsequent chapters are devoted to various mobile services, including the business radio, mobile telephone, general mobile-radio





1367P \$29.95



3671P \$18.95



2790P \$15.95

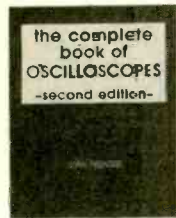

3825P \$16.95



2613P \$18.95



2800P \$17.95

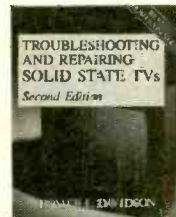

3700H-XX \$36.95  
Counts as 2/Hardcover



4179H \$27.95  
Hardcover

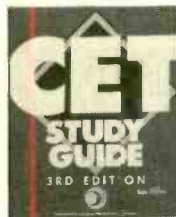

4076H \$27.95  
Hardcover

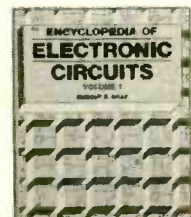

1938H-XXX \$60.00  
Counts as 3/Hardcover

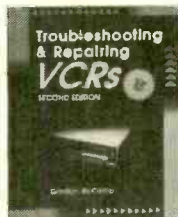

3777H-XX \$32.95  
Counts as 2/Hardcover

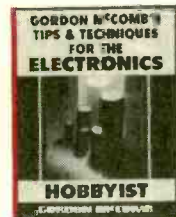

3485H \$27.95  
Hardcover



3258P \$19.95



10018H-XX \$35.50  
Counts as 2/Hardcover



4259H \$29.95  
Hardcover



4089P \$18.95



3677H-XX \$34.95  
Counts as 2/Hardcover

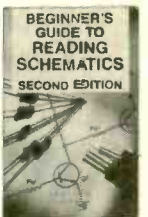

3632P \$10.95

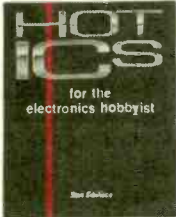

4122H-XX \$36.95  
Counts as 2/Hardcover



3627P \$19.95

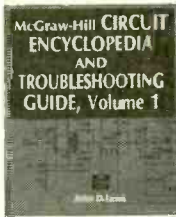

037603H-XXX \$59.50  
Counts as 3/Hardcover



4061P \$9.95

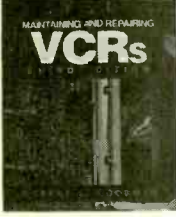

4204P \$19.95

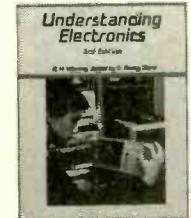

3044P \$12.95

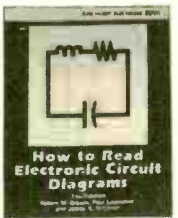

2880P \$15.95



4111H \$27.95  
Hardcover



3457P \$19.95

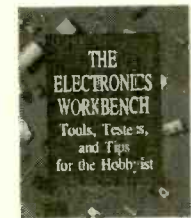

3672P \$18.95

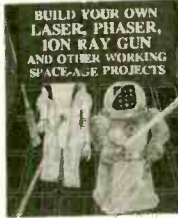

1604P \$17.95

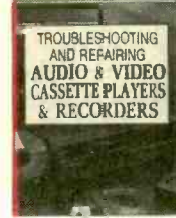

3795P \$19.95



3922P \$16.95

# Select any 5 books

## for only \$4<sup>95</sup>

(values up to \$171.70)

### plus 1 book FREE upon prepayment

when you join the Electronics Book Club®

**As a member of the Electronics Book Club . . .**

. . . you'll enjoy receiving Club bulletins every 3-4 weeks containing exciting offers on the latest books in the field at savings of up to 50% off of regular publishers' prices. If you want the Main Selection do nothing and it will be shipped automatically. If you want another book, or no book at all, simply return the reply form to us by the date specified. You'll have at least 10 days to decide. And you'll be eligible for FREE Books through the Bonus Book Program. Your only obligation is to purchase 3 more books during the next 12 months, after which you may cancel your membership at any time.

A shipping/handling charge and sales tax will be added to all orders. All books are softcover unless otherwise noted. (Publishers' prices shown) If you select a book that counts as 2 choices, write the book number in one box and XX in the next. If you select a counts as 3 choice, write the book number in one box and XXX in the next two boxes.

©1993 Electronics Book Club PE1193  
If card is missing, write to: Electronics Book Club, Blue Ridge Summit, PA 17294-0810

**Your most complete and comprehensive source for the finest electronic books.**



free upon request from Willi Hahn Corporation, 1400 East Broadway, Monticello, MN 55362; Tel: 612-295-2162; Fax: 612-295-4440 (in Canada, Bondhus Tool Ltd., 190 Highway 7, West Unit 29, Brampton, Ontario L7A 1A2; Tel: 800-361-1606 or 416-453-7470; Fax: 416-453-5551).

**CIRCLE 89 ON FREE INFORMATION CARD**

## UPGRADE OR REPAIR YOUR PC AND SAVE A BUNDLE

**Third Edition**

by Aubrey Pilgrim

Whether your computer is a real dinosaur that can't keep up with your current needs, or you're just one of those folks who must always have the latest and greatest models, this book will tell you how to get a state-of-the-art PC without breaking the bank. It focuses on the hardware and components—motherboards, disk drives, memory, backup units, input devices, telecommunications, monitors, software, and more—that can be added to computers to bring them up to date. The third edition also includes information on upgrading and



repairing PS/1's and PS/2's.

Written in plain English, the book uses a step-by-step approach that will appeal to beginners and advanced users, tinkerers, and all-thumbs "klutzes" alike. One chapter is devoted to basic descriptions of each separate computer component and peripheral and the tools required to service them. Following chapters each begin with a simple, clear outline of various upgrading options, and then offer more technical details

for those who require such information. Computer jargon is avoided wherever possible and a glossary provides definitions for unfamiliar terms. Plenty of photos illustrate components and installation techniques. In addition, the book includes listings of swap meets, local stores, mail-order companies, and other sources of computer gear, along with listings of on-line services, computer books and magazines, and public-domain and shareware.

*Upgrade or Repair Your Computer and Save a Bundle, Third Edition costs \$19.95 and is published by Windcrest/McGraw-Hill, Blue Ridge Summit, PA 17294-0850; Tel: 1-800-233-1128; Fax: 717-794-2103.*

**CIRCLE 98 ON FREE INFORMATION CARD**

## MCM ELECTRONICS CATALOG

from MCM Electronics

This 236-page catalog contains more than 20,000 high-demand parts and components, more than 1400 of which are new to this edition. Product categories include semiconductors, TV parts, power supplies, home-security alarms, telephone parts and accessories, connectors, tools, batteries, speakers, VCR parts, and MCM's value-priced line of Tenma test equipment.



Also featured are expanded lines of computer and cellular products.

*The MCM Electronics Catalog is free upon request from MCM Electronics, 650 Congress Park Drive, Centerville, OH 45459-4072; Tel: 800-543-4330.*

**CIRCLE 90 ON FREE INFORMATION CARD**

## LENK'S LASER HANDBOOK Featuring CD, CDV, and CD-ROM

by John D. Lenk

This book provides all the practical information that technicians, field engineers, and skilled hobbyists need to troubleshoot and repair today's laser-based audio and video equipment. While its focus is on compact-disc and laserdisc players, its coverage isn't limited to those devices. Many of the CD servicing procedures can be applied to CD-Interactive, CD-ROM, and other laser-based devices. The book takes a general approach so that its

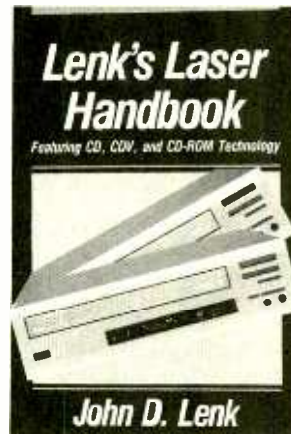

information won't become dated with the introduction of new models. Making liberal use of schematics, block diagrams, and discussions of the theory behind laser operation, the book describes professional diagnostic and repair techniques. Circuit-by-circuit, component-by-component examples show how laser equipment works, including a concise description of the encoding/decoding processes involved in CD's and the optical readout principles used in all CD systems; how to pinpoint and eliminate malfunctions; how to perform routine maintenance; and even how to install laser modules using modern test instruments and tools.

*Lenk's Laser Handbook costs \$22.95 and is published by Tab Books Inc., Blue Ridge Summit, PA 17294-0850; Tel: 1-800-233-1128.*

**CIRCLE 98 ON FREE INFORMATION CARD**

## AUTOCAD: A CONCISE GUIDE TO COMMANDS AND FEATURES: Third Edition for Release 12

by Ronald W. Leigh

AutoCAD Release 12 makes the design program richer and more versatile than ever before, and this book opens the doors to greater productivity for its users. Providing a brief yet thorough overview of terms and procedures required to effectively use AutoCAD, the book serves as both a tutorial and a reference. Suitable for both beginners and experienced AutoCAD users, it opens with the basics and progresses through more difficult concepts in subsequent chapters. The book covers drawing and editing commands and presents techniques for effective CAD drafting and design, including AutoCAD startup procedure, using Release 12 RENDER commands, modifying drawings using GRIPS, creating a custom menu, and advanced plotting procedures. Appendices include exercises designed to reinforce the skills taught, as well as a custom menu and tablet overlay and a chart for estimating personal AutoCAD skills. The "AutoCAD Concise Guide Diskette," available separately, allows users to directly enter the programs and drawings featured throughout the book.

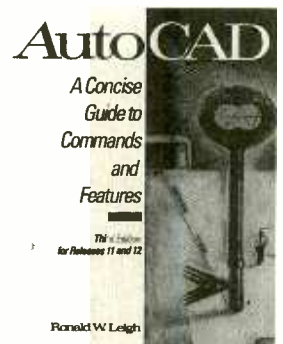

*AutoCAD: A Concise Guide to Commands and Features, Third Edition costs \$24.95 (the companion diskette costs \$19.95) and is published by Ventana Press, P. O. Box 2468, Chapel Hill, NC 27515; Tel: 919-942-0220; Fax: 919-942-1140.*

**CIRCLE 91 ON FREE INFORMATION CARD**



# NEW PRODUCTS

## Workin' on the Realroad

Model-train buffs can have their setups simulate the operation of real trains using *Digital Power, Inc.'s* line of *Realroad Digital Throttle Systems*, which put the power of your IBM-compatible PC behind your model trains. The system consists of two parts: a Digital Throttle add-in card and the Realroad Digital Simulation software. Three card models are available: single-

freight- and passenger-car data is also included. You can combine multiple locomotives on the same train with varying numbers of cars, providing the user virtually endless simulation possibilities.

During an interactive "calibration" procedure, the Realroad system learns about each model locomotive, including its starting voltage, stopping voltage, pulse-power characteristics, and actual scale speed. It uses that information to calculate locomotive power, adhesion factor, acceleration rate, track speed, and wheel slip many times per second. That information is stored in the computer for use in future operating sessions. Once you've supplied information about both the prototype and model locomotives and trains, the Realroad system monitors throttle, brake, sand switch, direction switch, and other user settings to control the model train, making it perform just as a real train of the same type would.

Prices for the Realroad Digital Throttle System start at \$279.95 for a small-scale starter set; optional upgrades and accessories are available. For more information, contact Digital Power, Inc., Department F, P. O. Box 130472, St. Paul, MN 55113; Tel: 612-698-7679; Fax: 612-595-9772.

**CIRCLE 101 ON FREE INFORMATION CARD**

### DMM CASES

Providing added storage and protection in a lightweight package, *Fluke's C17 and C28 DuraCases* are rugged digital-multimeter cases with vinyl covers that are intended for field-service applications. The C17 can be used with the Fluke Series 10, all 70 series, and the Fluke 21, 23, and 29 DMM's as well as the 50 Series digital thermometers. The C28 is designed for use with the Fluke 25/27 and 80 Series meters.



The *DuraCases* securely hold meters while in transit, and the meter can be used while installed in the case. The case cover converts to a tilt-stand for easy viewing of the meter's display. The *DuraCases* allow right-angle test leads to remain connected to the DMM at all times, eliminating the need to continually disconnect and reconnect the leads. Separate internal compartments keep accessories such as current clamps and test leads organized neatly, and a slip pocket for storage of a quick-reference card is also included. A versatile strap adjusts for hand or shoulder carrying.

The *Fluke C17 and C28 DuraCases* each has a suggested list price of \$39.00. For additional information, contact *John Fluke Mfg. Co., Inc.*, P. O. Box 9090, Everett, WA 98206; Tel: 800-87-FLUKE; Fax: 206-356-5116.

**CIRCLE 102 ON FREE INFORMATION CARD**

### SURROUND-SOUND PROCESSOR

*NAD's* first entry into the home-theater market is the *Model 910 A/V Surround-Sound Processor*, designed to integrate video functions with an audio system, blending sound and images into a true home theater, and to complement conventional stereo systems with multi-channel sound. The processor provides *Dolby Pro Logic* decoding as



channel, dual-channel and high-power single-channel. The software is designed for those who prefer to spend their leisure time with trains, not computers, and is easy to use with on-line help. The system works with existing 8-20-VDC model locomotives and track wiring with no modifications to the train or wiring required.

The Realroad system allows you to enter information about the type of locomotives and the size of the trains you'd like to simulate. The basic Realroad software can simulate 150 prototype locomotives; prototype

well as several additional modes to enhance both video surround sound and stereo music listening. Three Sound Space modes—club, hall, and stadium—use NAD-designed matrixing and delay algorithms to deliver subtle enrichment of musical acoustics. Super-Stereo mode adds carefully calculated center-channel fill to stereo listening.



Although the unit is unusually easy to set up and use, it provides reference-quality decoding of the thousands of videotaped films and music CD's endowed with Dolby Surround Sound. It accepts and selects stereo audio and video signals from three A/V sources as well as stereo from an associated receiver or preamplifier. Line-level outputs are provided for the required Pro-Logic channels and for a subwoofer, allowing the Model 910 to be used in various system configurations.

The Model 910 A/V Surround Sound Processor has a suggested retail price of \$599. For more information, contact NAD, 633 Granite Court, Pickering, Ontario, Canada L1W 3K1; Tel: 416-831-6333; Fax: 416-831-6936.

**CIRCLE 103 ON FREE INFORMATION CARD**

## SURGE SUPPRESSOR

Tripp Lite's Spike Bar Super 7 surge suppressor features three diagnostic indicators that light to show the presence of wiring faults, status of protection circuitry, and loss of AC power. The indicators warn of any abnormalities before equipment is turned on, assuring complete protection of connected equipment. The UL-listed Spike Bar Super 7 also has seven spike-and-noise-filtered AC outlets, a seven-foot AC line cord, and a safety circuit breaker. In addition, "Ultimate Lifetime Insurance" protects both the surge suppressor and any connected equipment from surge



damage, including direct lightning strikes, for up to \$5000.

The Spike Bar Super 7 has a suggested retail price of \$49.95. For additional information, contact Tripp Lite, 500 North Orleans, Chicago, IL 60610-4188; Tel: 312-329-1777; Fax: 312-644-6505.

**CIRCLE 104 ON FREE INFORMATION CARD**

## HIDDEN WIRE TAPE

Today's speakers are getting smaller and less conspicuous, but there's still the problem of unsightly wire runs between the speakers and the audio or video components. *Wire Tape*, designed to replace any 18-gauge wire for speakers or burglar alarms, is just ten thousandths of an inch thick. Its resemblance to a strip of tape is compounded by its pre-applied adhesive backing that allows you to sim-



ply "peel-and-stick" Wire Tape to drywall or plaster walls. Covered with a coat of paint or wallpaper, the Wire Tape is virtually invisible, particularly when installed in room corners. Each package comes with enough Wire Tape to connect two speakers on the average eight-foot wall as well as end connectors for attaching the tape to standard speaker wire.

Wire Tape has a suggested price of \$19.95. For further information, contact Wire Tape, 640 North Cypress, Orange, CA 92667; Tel: 714-771-4063. ■

**CIRCLE 105 ON FREE INFORMATION CARD**

## CIRCUIT CIRCUS

*(Continued from page 73)*

In that circuit, a FET input op-amp is configured as a voltage follower, and its output is connected to a digital voltmeter. The op-amp's positive input is tied to a .05- $\mu$ F, high-quality, low-loss polystyrene capacitor and to the wiper of a three-position switch.

With S1 in the reset position, the op-amp's input is taken to ground and the meter reads zero. When the switch is moved to the sample position, the capacitor charges to the input voltage level and the op-amp produces the same voltage at its output, which is then applied to the meter.

When the switch is returned to the hold position, the charge on the capacitor remains and the op-amp supplies the same voltage to the meter. A quality capacitor will hold the charge for a long time, and with the high input impedance of the FET-input op-amp, the circuit will hold the reading for several minutes with little loss.

## CMOS LAMP DRIVER

The majority of CMOS IC's are capable of sinking enough current to light a single LED indicator. But, if you need a bright light, CMOS IC's just aren't designed to handle that much current.

With the aid of the circuit in Fig. 7, a CMOS chip can

## PARTS LIST FOR THE FIELD-STRENGTH METER

D1—1N34A general-purpose germanium diode  
R1—20,000-ohm, potentiometer  
C1—0.005- $\mu$ F, 50-volt, ceramic-disc capacitor  
L1—2-mH RF choke  
M1—50- $\mu$ A D'Arsonval meter movement  
ANTI—19-inch telescoping antenna  
Perfboard materials, metal enclosure, wire, solder, hardware, etc.

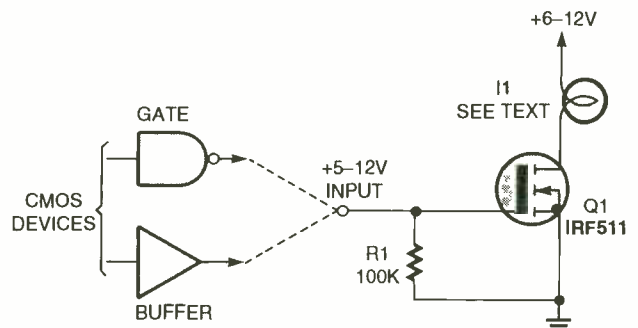

Fig. 7. The lamp-driver circuit allows an incandescent lamp to be controlled by CMOS logic gates, which aren't designed to handle that much current.

## PARTS LIST FOR THE CMOS LAMP DRIVER

Q1—IRF511IND hexFET  
R1—100,000-ohm, 1/4-watt, 5% resistor  
I1—See text  
Perfboard materials, enclosure, 6-12-volt power source, wire, solder, hardware, etc. ■

be used to control an incandescent lamp. The input drive power required by the gate of the hexFET is almost zero, so the circuit can be used to control just about any lamp (or another load, like a motor) as long as the current and voltage limits of the hexFET are not exceeded. ■



## KEYHOLE ILLUMINATOR

(Continued from page 55)

ground path, causing it to light. While that is happening, C1 charges toward the positive supply rail. When S1 is released, the charge on C1 maintains Q1's base bias, keeping it and LED1 turned on.

Because resistor R1 is a 10k unit, the charge on capacitor C1 takes about ten seconds to discharge through R1 and the base of transistor Q1. Actually it takes a bit longer than ten seconds

### PARTS LIST FOR THE DOORLITE KEYHOLE ILLUMINATOR

- Q1—2N2222, 2N3904, or similar general-purpose NPN silicon transistor  
LED1—High-intensity LED (Radio Shack part number 276-087, or substitute, see text)  
R1—10,000-ohm, ¼-watt, 5% resistor  
R2—220-ohm, ¼-watt, 5% resistor  
C1—25-µF, 10-WVDC, electrolytic capacitor  
B1—6-volt camera battery (see text)  
S1—Miniature, normally open, momentary-contact, pushbutton switch

### ADDITIONAL PARTS AND MATERIALS

Perfboard materials, enclosure, wire, solder, hardware, etc.

for C1 to completely discharge, but after ten seconds, the bias on Q1 is no longer sufficient for that transistor to pass enough current for LED1 to produce a useful light.

For most people, ten seconds should be plenty of time to get a key in the lock. But, for those who may need more time (for instance, those suffering from arthritis or some other debilitating joint condition), the time can be increased by increasing the value of C1. On the other hand, the LED's on time can be decreased by decreasing the value of C1. The same effect can be achieved by varying the value of R1, but it's possible to increase the value of R1 to the point where Q1 will no longer turn on. So, to vary the time that the LED stays on, it's best to vary the value of C1.

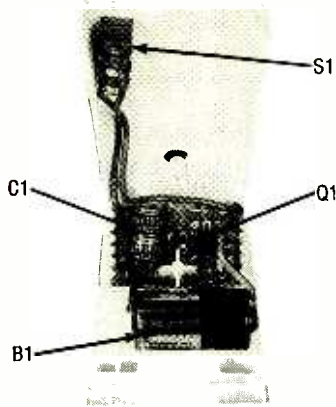

*With some carefully chosen parts, the DoorLite fits neatly into an old dental-floss case.*

Resistor R2 is included in the circuit only to limit the current flow through LED1. At the specified value (220 ohms), it's enough to effectively limit current through LED1, while still allowing the LED to glow brightly. The lower R2's resistance, the brighter LED1 will be, and the higher the resistance, the dimmer LED1 will be.

We've specified a 2N2222 NPN transistor for Q1 because that's perhaps the most common transistor in the industry. However, we actually used a 2N4410—another NPN transistor—in our prototype because that's what we had on hand. The point we're trying to get across here is that the DoorLite circuit is so non-critical that nearly any NPN transistor that you happen to have on hand should work properly.

**Construction.** Once we had a simple circuit down on paper and had successfully breadboarded it, the next thing was to find a suitable enclosure for the project. Size was definitely a consideration, since we didn't want to install a large, unsightly device at our front door. Store-bought cases don't really come in sizes as small as we wanted, but fortunately the perfect case—at least for this project—was right in our medicine cabinet: a dental-floss container.

True, it sounds silly, but the finished design looks good and certainly is small. And the floss case seemed to be specially designed to accommodate the parts that we had chosen. We simply opened the case, removed the spool of floss (we saved it

in an old film canister), and started our measuring, fitting, and drilling to create the enclosure.

The N-cell battery fit perfectly in a place already molded in the case, the switch also fit perfectly. We cut a piece of perfboard to fit in the case to mount the rest of the components on. Naturally, all wiring was done point-to-point, as there were only a few connections to make. Some double-sided tape can be applied to the back of the case to make it easy to mount the device wherever it is needed. However, the finished unit is so small that you might want to forget the double-sided tape, and suspend it from a keychain.

The floss case was the perfect choice for this project—in our opinion anyway. But if size is not a consideration to you, then you can use any size case, battery, or LED you like. The circuit will work just the same.

That's all there is to it. The DoorLite is a simple, yet useful project that anyone could use. Why not build one today! ■

## Be a computer repair expert!

CAREER-LEVEL HOME STUDY



Learn PC repairs, troubleshooting, servicing, upgrading, installation. Increase your value as an employee or open your own business.

No expensive instruments, no high-tech electronics.

Over 90% of PC repairs and service involve easy mechanical procedures or parts replacements. Send or call for free literature.

# 800-223-4542

Name \_\_\_\_\_ Age \_\_\_\_\_

Address \_\_\_\_\_ Phone (\_\_\_\_) \_\_\_\_\_

City \_\_\_\_\_ State \_\_\_\_\_ Zip \_\_\_\_\_

### The School of PC Repair

6065 Roswell Road  
Dept. JM341, Atlanta, Georgia 30328

CIRCLE 159 ON FREE INFORMATION CARD

---

## CHARLES PROTEUS STEINMETZ

(Continued from page 61)

---

newspaper reporters long to recognize Steinmetz as an excellent source of good copy despite the fact that most of his scientific achievements were not understandable to the average person. What made Steinmetz intriguing to newspaper readers was the man himself.

The combination of his wizard-like mind and small, twisted body together with his engaging personality and amusingly eccentric activities made Steinmetz a popular folk-hero. The rapidity with which this disabled and destitute immigrant had achieved scientific greatness while still maintaining his personal charm had won him the respect and admiration of the public.

In an article appearing in *Ladies' Home Journal* in 1915, Steinmetz fascinated his readers by describing how electricity soon would be used to cook meals, heat and cool homes, provide various new forms of entertainment at home, as well as supply power for all factory and transportation needs.

Repeatedly in talks and articles, Steinmetz urged the development of hydroelectric power-generating stations as well as other, yet unknown, energy sources because he realized that coal supplies were limited and that the burning of coal was polluting our air. He also urged the development of crops that could store the sun's energy for later conversion into alcohol-based fuels for the sake of efficiency. It wouldn't be until the 1970's (over fifty years later) that these ideas would gain popular support.

**Maker of Lightning.** Steinmetz's greatest public acclaim came as the result of the laboratory lightning generator he created in 1921 to test improved insulators for electric power systems. As electric power networks were growing in size, the problems caused by lightning discharges were becoming more troublesome.

Artificial lightning discharges of 120,000 volts at 10,000 amperes literally exploded around Steinmetz's laboratory. Higher voltage discharges had been produced previously by others, but not at the high current lev-

els achieved by Steinmetz. High current is critically important if one is to truly simulate lightning's devastating effects.

Not only was Steinmetz's lightning generator successful in providing the discharges needed to develop better lightning arresters, it also provided newspaper reporters and photographers with material that captured the astonished attention of the nation. People could not believe that energy was being released at the rate of over one million horsepower, even if it were for only a hundred-thousandth of a second.

Photographs of the devastation dealt to large blocks of wood and sections of tree limbs made firm believers of everyone concerning the power of these laboratory discharges. Steinmetz was controlling energy in a manner heretofore done only by nature.

**A Great Loss.** In the fall of 1923, Steinmetz combined business with pleasure as he travelled for six weeks by railroad from Schenectady to California and back with numerous stops along the way. Besides visiting the Grand Canyon, Yosemite, and Hollywood, Steinmetz made personal appearances before many professional and civic groups.

Steinmetz had known for some time that his heart was weak. While he had enjoyed his trip, the schedule had been exceedingly demanding and he was exhausted. When he returned to Schenectady in mid-October, a period of rest was ordered but nothing more serious was suspected. He awoke on October 23 and asked that his breakfast be brought to him in bed. The 58 year old Steinmetz died with a physics book clutched in his hand before his breakfast arrived.

The thousands of eulogies from around the world attested to the widespread loss felt as the result of Steinmetz's death. The president of the Westinghouse Electric and Manufacturing Company, G.E.'s largest competitor, summed up the feelings of many when he stated: "He (Steinmetz) has been such an outstanding figure in engineering work for so many years and is so well known to the public that his death will be a great loss not only to the profession but to people generally." Indeed it was. ■

---

## ADD A DVM

(Continued from page 43)

---

Analog devices recommends a guard ring around the timing capacitor for demanding applications. For this project, careful placement should be enough. Make sure the timing capacitor is placed as close to the AD654 as possible. They also recommend that you do *not* use a ground plane.

To stuff the board of Fig. 2, look at Fig. 3 and begin by installing the passive components. Then add the IC sockets. You may wish to hold off from soldering LED1 to the board until the case is prepared. This way you will be sure to cut the leads to the proper length. While that LED is optional, it indicates that power is present. If power is not present, you should not connect a signal to the inputs. Therefore, LED1 also provides an indication that it is safe to use the adapter.

After you have prepared a circuit board, you should build the interface cable. The cable should be constructed from a length of three-conductor cable. Keep the length to about six feet or less. Strip one inch of jacket from each end of the cable exposing the three wires. Strip one sixteenth inch from the ends of each of the wires. Solder the conductors to pins 1, 2, and 4 of the DB15 connector.

Cut two lengths of wire to about two inches in length. Strip  $\frac{1}{16}$  inch from each of the ends. These will connect the input terminals to the board. Drill two  $\frac{1}{8}$ -inch holes in one end of the case about one inch apart for mounting the terminals. Drill a  $\frac{1}{4}$ -inch hole in the opposite end for the interface cable. Feed the interface cable through the  $\frac{1}{4}$ -inch hole and solder the conductors to the appropriate pads on the circuit board. I like to drill holes in the board on either side of the cable so I can use a cable tie to secure the cable to the board.

Once everything is in place, I recommend using a flux stripper on the solder side of the board to be sure it is clean and free of contamination. Residual flux can cause shorts and problems that are difficult to debug at a later time.

With the power off, plug the interface cable into the game port. Turn the computer on. Check for the prop-



er voltage and polarity on the board. Remember the button-0 input of the game port has a pull-up resistor on it, so there will be +5 volts present on that signal line. If the voltages check out turn the computer off, unplug the interface cable and insert the AD654 and LM324 into their sockets. Plug the interface cable in and turn on the computer. If you have an oscilloscope, check for a square-wave on pin 1 of the AD654. If you do not have a scope, you can use a logic probe or frequency meter. If there is no signal on pin 1 then there is a problem with the board or perhaps the interface cable. Turn the computer off and double check the circuit against the schematic and then check the wiring of the interface cable to find any errors.

If the circuit checks out then run the DVM program. If the program finds a square-wave on the button-0 input, it will begin to display values on the screen. If the signal is not present, the program will display a message and abort.

Once the circuit is functioning correctly you can secure the circuit board in the case and connect the input wires to the terminals. That's all there is to it; your circuit is now ready for use.

**Going Further.** There are 4 digital inputs on the game port so you can have up to 4 Analog Input Adapters connected at the same time. You can easily construct a circuit board that distributes power and ground to the attached adapters. Remember to connect the signal lines to different button inputs on the port. Refer to the pinouts in Fig. 4 for the proper connections and input addresses for the game sport connector. ■



## DOOR MINDER

(Continued from page 54)

### PARTS LIST FOR THE DOOR MINDER

#### SEMICONDUCTORS

- U1—LM324 quad op-amp, integrated circuit
- U2—LM386 low-volt audio-amplifier, integrated circuit
- U3—LM78L08 8-volt, 100-mA voltage regulator (see text)
- Q1, Q2, Q4—2N3904 NPN general-purpose silicon switching transistor
- Q3—2N3906 PNP general-purpose silicon switching transistor
- D1—1N914 small-signal silicon diode
- D2, D3—1N4001 1-amp, 50-PIV, silicon rectifier diode

#### RESISTORS

- (All fixed resistors are 1/4-watt, 5% units.)
- R1—470,000-ohm
  - R2, R6, R8, R13, R14—10,000-ohm
  - R3—47,000-ohm
  - R4, R5, R12—100,000-ohm
  - R7—100-ohm
  - R9—220,000-ohm
  - R10, R11—4700-ohm
  - R15—10,000-ohm PC-mount trimmer potentiometer
  - R16—10-ohm

#### CAPACITORS

- C1, C2, C10, C12—100- $\mu$ F, 16-WVDC, electrolytic
- C3—2.2- $\mu$ F, 16-WVDC, electrolytic
- C4—47- $\mu$ F, 16-WVDC, electrolytic
- C5—C7, C11—0.01- $\mu$ F, 50-WVDC, Mylar
- C8, C9—10- $\mu$ F, 16-WVDC, electrolytic
- C13—0.047- $\mu$ F, 50-WVDC, Mylar
- C14—220- $\mu$ F, 16-WVDC, electrolytic

#### ADDITIONAL PARTS AND MATERIALS

- SPKR1—8- to 16-ohm, 1/2-watt speaker
- SI—Magnetic reed switch (closed when near a magnet)
- Perfboard materials, enclosure, IC sockets, 12-volt power source, wire, solder, hardware, etc.

The 1200-Hz tone should now be heard continuously. Remove the jumper and place one end on the collector of Q2, while tapping the opposite end to ground. The "chime" should "ring" each time the jumper is

grounded. If the unit doesn't work correctly, disconnect the collector of Q1 from the base of Q2. The unit should now be "ringing" on its own. If not, place a jumper wire from the positive (+) side of C2 to ground. The unit should "ring" once each time the jumper is grounded.

Once you have isolated the faulty section, it is easier to locate and correct your error. After everything is working correctly, mount the unit in a suitable enclosure and set the volume to a level that can't be ignored, but not loud enough to startle anyone. A bit louder than normal speech works best.

**Use.** It would be a good idea to install a hidden bypass switch so that the unit could be silenced when necessary. I have found that the circuit tends to get better response than simply having a sign posted nearby with the words *Please keep door closed*. Perhaps that's due to its pulsing alert tone. When choosing a suitable mounting position for the project, be sure the speaker is mounted up high so that it cannot be obstructed. ■

## PIPE ANTENNA

(Continued from page 48)

Finally, be sure to obey all local electrical and mechanical codes for antenna construction. The codes are a pain in the neck, or so it seems, but they also represent good engineering practice. While rugged individualists may disdain having some "bureaucrat" tell them how to install the antenna, the codes actually represent someone's experience—bad experience—so the codes should be followed closely.

There is one real good reason to follow the electrical codes, even if you are unconvinced of their inherent wisdom. In the event of an accident, your homeowner's insurance might not pay off if the antenna was installed *ad hoc* without the advice and consent (which means a permit and inspection) of the local building and mechanical authorities.

Antennas made from pipe and tubing are low cost, are easy to design, and are not overly complex or difficult to install. Try one! ■

## BUILD THE PHONE PAGER

(Continued from page 40)

### PARTS LIST FOR THE PHONE-PAGER

#### SEMICONDUCTORS

- U1—74HC14 hex Schmitt trigger, integrated circuit
- U2—74HC08 quad two-input AND gate, integrated circuit
- U3—SC11270 DTMF decoder (Sierra), integrated circuit
- U4—74HC00 quad two-input NAND gate, integrated circuit
- U5—74HC42 BCD-to-decimal decoder, integrated circuit
- U6—74HC74 dual D-type flip-flop with preset and clear, integrated circuit
- U7—74HC4511 BCD-to-7 segment latch/decoder/driver, integrated circuit
- U8—74HC221 dual monostable multivibrator with Schmitt-trigger input and clear, integrated circuit
- U9—LM7805CTB positive 5-volt, 1-amp voltage regulator, integrated circuit
- Q1—2N2222A general-purpose NPN silicon transistor
- DI—1N4565 5.1-volt Zener diode
- D2—D10—1N4148 general-purpose small-signal silicon diode
- DISP1—LA6480 (ROHM) seven-segment LED display (or HP HDPS-5803)

#### RESISTORS

(All fixed resistors are 1/4-watt, 5% units.)

- R1—300,000-ohm
- R2, R3, R9, R10—100,000-ohm
- R4, R6—10,000-ohm
- R5—1000-ohm potentiometer
- R7, R8—3000-ohm
- R11—R17—470-ohm
- R18—1000-ohm

#### CAPACITORS

- C1—0.02- $\mu$ F, ceramic-disc
- C2, C3—0.002- $\mu$ F, 200-WVDC, ceramic-disc
- C4, C10—C15—0.1- $\mu$ F, 10- to 100-WVDC, ceramic-disc
- C5—0.03- $\mu$ F, ceramic-disc
- C6, C8, C9—22- $\mu$ F, 16-WVDC, electrolytic
- C7—330- $\mu$ F, 10-WVDC, electrolytic

#### ADDITIONAL PARTS AND MATERIALS

- BZ1—Murata PKM24-4A0 buzzer
- J1, J2—4-pin telephone jack (MT6G)
- J3—Powerjack (Mouser 16JP031 or similar)
- SI—10-position DIP switch (optional, see text)
- XTAL1—3.58 MHz crystal (HC-49 case)
- Printed-circuit materials, enclosure, 12-volt, 200-mA DC, wall adapter, wire, solder, hardware, etc.

**Note:** The following are available from Jim Cooke (PO Box 834 Pelham, NH 03076; Tel. 603-635-8780): A complete kits with all the components, including the case, and the power supply, \$49.00 each in single-unit quantities; two kits for \$45.00 each; and \$39.00 for three or more. Assembled units are available for \$59.00 each in single-unit quantities; \$55.00 each for 2; and \$49.00 each for three or more. Add 5% to total for shipping and handling. MC and Visa accepted. New Hampshire residents please add appropriate sales tax.

has an adjustable volume control, there is a possibility that the volume is turned all the way down.

**Final Checkout.** Once you have completed the initial checkout, you can proceed to plug the Phone-Pager into the telephone line. For a quick test, simply lift the receiver of a nearby phone and dial 1. That will clear the dial tone from the line. Then press the asterisk (\*) key followed by the number that the Phone-Pager has been set to respond to. That should cause the Phone-Pager to beep and display the number entered. You can repeat that

last step to verify any additional numbers if the unit has been configured to decode more than one number. Once you've verified the units operation, you can place the printed-circuit board into its enclosure, anchor it in place with screws, and attach the enclosure's cover. The enclosure provided with the kit offered in the Parts List has a graphic overlay that has space so that you can write the meanings assigned to the various numbers. If wall mounting is desired, that can easily be done using Velcro (which is available at most hardware stores). That's all there is to it. ■

## EXPLOSIVE GAS DETECTOR

(Continued from page 36)

lights, set R14 so that the alarm goes off when LED3 lights. Those settings are for concentrations way below an explosive amount of gas.

### Gas Sensing in the Real World.

There are two basic kinds of potentially dangerous gas situations. One is a *localized* concentration of gas, such as a leak from a pipe or container holding a flammable liquid, which can cause a fire if ignited or an explosion if the area is leaked into for a long period without incoming fresh air. The second is a *general* concentration, such as might fill a room, building, or the hold of a boat with explosive fumes, perhaps periodically.

I recollect a weekend home whose damp basement contained a large deposit of old coal that generated enough carbon monoxide and other gases via decomposition to give its busy owners painful headaches. Their relaxing "getaway" home had become a nightmare until I identified the antagonist as odorless gas. Ventilation and eventual removal of the coal solved their problem. Even barn silos can accumulate flammable gas from the byproducts of organic decomposition. Such situations pose a real threat for violent explosions, or at least can cause serious health problems after prolonged exposure.

You can use this project to "sniff" out gas by mounting the sensor to a flexible cable, and following the pipe or whatever to find a leak. Just remember if the detector sounds off or you begin feeling ill, the gas concentration is likely high—so get out of that area fast! Peace of mind may be had by permanently mounting the project in an area at risk such as a storage shed for flammable liquid.

Another, heavier Triac may be turned on by the Triac-driver to handle a higher current load if needed. Just remember to exercise utmost caution when dealing with any external device that could heat up or spark around explosive gas.

**Conclusion.** Well, that's it! Now you can protect yourself, your loved ones, and your property from the hazards of invisible explosive gas. ■



# ELECTRONICS MARKET PLACE

## FOR SALE

**SECRET cable descramblers!** Build your own descrambler for less than \$12.00 in seven easy steps. Radio Shack parts list and free descrambling methods that cost nothing to try, included. Send \$10.00 to: **INFORMATION FACTORY, Dept. 5, PO Box 1790, Baytown, TX 77522.**

**CABLE test chips. Jerrold, Tocom, S.A., Zenith. Puts cable boxes into full service mode! \$29.95 to \$59.95. 1 (800) 452-7090, (310) 867-0081.**

**DESCRAMBLERS** for cable and satellite. Kits and assembled units. All types. Guaranteed. From \$19.95. Free catalog. (212) 330-8035.

**300 Experimenters Circuits** — Complete in 6 practical books using diodes, relays, FET's, LED's, IC 555's, and IC CA3130's for building blocks. Only \$33.00 plus \$5.50 for shipping. USA and Canada only. US funds. **ETT, INC.,** PO Box 240, Massapequa Park, NY 11762-0240.

**CABLE descrambler liquidation.** Major makes and models available. Industry pricing! (Example: Hamlin Combo's, \$44 each... Minimum 10 orders). Call **WEST COAST ELECTRONICS, 1 (800) 628-9656.**

## CLASSIFIED AD ORDER FORM

To run your own classified ad, put one word on each of the lines below and send this form along with your check to:

**Popular Electronics Classified Ads, 500-B Bi-County Boulevard, Farmingdale, N.Y. 11735**

**PLEASE INDICATE** in which category of classified advertising you wish your ad to appear. For special headings, there is a surcharge of \$11.00.

Plans/Kits     Business Opportunities     For Sale  
 Education/Instruction     Wanted     Satellite Television

Special Category: \$11.00

**PLEASE PRINT EACH WORD SEPARATELY, IN BLOCK LETTERS.**

(No refunds or credits for typesetting errors can be made unless you clearly print or type your copy.) Rates indicated are for standard style classified ads only. See below for additional charges for special ads. **Minimum: 15 words.**

1	2	3	4	5
6	7	8	9	10
11	12	13	14	15 (\$23.25)
16 (\$24.80)	17 (\$26.35)	18 (\$27.90)	19 (\$29.45)	20 (\$31.00)
21 (\$32.55)	22 (\$34.10)	23 (\$35.65)	24 (\$37.20)	25 (\$38.75)
26 (\$40.30)	27 (\$41.85)	28 (\$43.40)	29 (\$44.95)	30 (\$46.50)
31 (\$48.05)	32 (\$49.60)	33 (\$51.15)	34 (\$52.70)	35 (\$54.25)

We accept MasterCard and Visa for payment of orders. If you wish to use your credit card to pay for your ad fill in the following additional information (Sorry, no telephone orders can be accepted.):

Card Number

Expiration Date

PRINT NAME

SIGNATURE

**IF YOU USE A BOX NUMBER YOU MUST INCLUDE YOUR PERMANENT ADDRESS AND PHONE NUMBER FOR OUR FILES. ADS SUBMITTED WITHOUT THIS INFORMATION WILL NOT BE ACCEPTED.**

**CLASSIFIED COMMERCIAL RATE:** (for firms or individuals offering commercial products or services) \$1.55 per word prepaid (no charge for ZIP code)...**MINIMUM 15 WORDS.** 5% discount for same ad in 6 issues within one year; 10% discount for 12 issues within one year if prepaid not applicable on credit card orders. **NON-COMMERCIAL RATE:** (for individuals who want to buy or sell a personal item) \$1.25 per word, prepaid...no minimum. **ONLY FIRST WORD AND NAME** set in bold caps at no extra charge. Additional bold face (not available as all caps) 30¢ per word additional. Entire ad in boldface, \$1.85 per word. **TINT SCREEN BEHIND ENTIRE AD:** \$1.90 per word. **TINT SCREEN BEHIND ENTIRE AD PLUS ALL BOLD FACE AD:** \$2.25 per word. **EXPANDED TYPE AD:** \$2.05 per word prepaid. Entire ad in boldface, \$2.45 per word. **TINT SCREEN BEHIND ENTIRE EXPANDED TYPE AD:** \$2.55 per word. **TINT SCREEN BEHIND ENTIRE EXPANDED TYPE AD PLUS ALL BOLD FACE AD:** \$2.95 per word. **DISPLAY ADS:** 1" x 2 1/2" — \$205.00; 2" x 2 1/2" — \$410.00; 3" x 2 1/2" — \$615.00. **General Information:** Frequency rates and prepayment discounts are available. **ALL COPY SUBJECT TO PUBLISHERS APPROVAL. ADVERTISEMENTS USING P.O. BOX ADDRESS WILL NOT BE ACCEPTED UNTIL ADVERTISER SUPPLIES PUBLISHER WITH PERMANENT ADDRESS AND PHONE NUMBER.** Copy to be in our hands on the 18th of the fourth month preceding the date of issue (i.e., Sept. issue copy must be received by May 18th). When normal closing date falls on Saturday, Sunday or Holiday, issue closes on preceding work day. Send for the classified brochure. Circle Number 49 on the Free Information Card.

**Look to the Future**  
*With Your Own*  
**Cable Converter & Descrambler!**

**1-800-228-7404**



**NU-TEK ELECTRONICS**

**FREE CATALOG!**

3250 Hatch Rd.  
 Suite 1 C  
 Cedar Park, TX 78613

**ALL MAJOR BRANDS**



**TUBES.** (Thousands in stock). Send SASE for list. **FALA ELECTRONICS, PO Box 1376-2, Milw., WI 53201.**

**CABLE test-chips** as low as \$9.95, for testing cable boxes in full service mode. Jerrold: 400, 450, DL4, Starcom VI & VII; Pioneer, clears E2 thru E5; Pioneer cubes: BA-5000 thru BA-6700; Tocom 5503/5507; Scientific Atlanta: 8500 thru 8600; Zenith: all but PZ1; remotes \$10.00; money back guarantee **N.E. ENGINEERING, 1 (800) 926-4030, fax (617) 770-2305.**

**GET CONTROL!**

**CABLE TV DESCRAMBLERS AND CONVERTERS**

Top Brands Available

**SATISFACTION GUARANTEED! NER**

**1-800-775-0444**

**T.C. ELECTRONICS**

Descramblers and Converters must be used with a third party approved by your local cable operator. No first pass sales.

**GEIGER** counter for sale, new, \$30.00, C.O.D., cash, great instrument. Please call (408) 988-4641, leave message.

**ELECTRONICS grab bag!** 500 pieces of new components: inductors, capacitors, diodes, resistors. \$5.00 postpaid. **ALLTRONICS, 2300 Zanker Rd., San Jose, CA 95131.**

**CABLE TV descramblers/converters** bargain headquarters. Buy direct from wholesale outlet — open to all. Absolutely the lowest prices. All major brands. Nobody beats our prices! Cable hotline 1 (800) 497-6273.

## FREE CATALOG

FAMOUS "FIRESTIK" BRAND CB ANTENNAS AND ACCESSORIES. QUALITY PRODUCTS FOR THE SERIOUS CB'er. SINCE 1962

FIRESTIK ANTENNA COMPANY  
2614 EAST ADAMS  
PHOENIX, ARIZONA 85034

**CABLE descramblers**, test turn-on kits, bullet stoppers. We have the lowest prices in the industry, because we have no catalog, and no 800 number! Call everyone else, then call us for the best price. We buy, sell and trade. (305) 425-0751. No Florida sales.

**PROTOTYPE service** for hobbyists & engineers. Single quantity ss PCBs. \$10.00 minimum. No setup fee. We also scan magazine artwork. Get out your back issues! **FIRST PROTO**, (407) 392-8677.

## CB RADIO OWNERS!

We specialize in a wide variety of technical information, parts and services for CB radios. 10-Meter and FM conversion kits, repair books, plans, high-performance accessories. Thousands of satisfied customers since 1976! Catalog \$2

**CBC INTERNATIONAL**

P.O. BOX 31500PE, PHOENIX, AZ 85046

**DESCRAMBLING secrets revealed.** Free 24 hour hotline reveals secret satellite and cable descrambling information. (718) 390-7130.

**CABLE TV descramblers, converters, lowest prices, guaranteed, best quality, free catalog.** **CNC CONCEPTS INC.**, Box 49503, Minneapolis, MN 55449. 1 (800) 535-1843.

## SATELLITE TV

**SUPER low satellite prices.** Free U.S. and International catalog. **SATMAN**, (309) 692-4140 (Int'l.), 1 (800) 472-8626 in U.S.

## EDUCATION/INSTRUCTION

**VCR Repairs You Can Do. Save\$. Make\$.** Simple solutions to difficult problems. 403-pages. \$Back-guarantee. Over 36,100 sold. 704 illustrations + tool. Mail \$24.95 to **WORTHINGTON PUBLISHING**, Box 16691M, Tampa, FL 33687-6691.

**ELECTRICITY/Electronics training series** used by U.S. military. 23 volumes, other courses available. **Free info:** **FEDERAL TECHNICAL PUBLISHERS**, Box 1061 E, Glen Lake, MN 55345.

## MAKE \$\$ IN PC REPAIR

NEI's PC Servicing course prepares you for a high-paying career in computer repair. Be the boss of your own PC repair business, advance in your present job, or start a new career. The opportunities are unlimited!

**Set Your Own Schedule!** Master the skills you need for success at home in your spare time. No rigid course schedules, no wasted commuting time.

**The Best Training Value Available!** NEI gives you the best possible training at the lowest possible cost. No hidden fees. Sound instruction, personal service, and low tuition. Guaranteed!

**FREE CATALOG!**  
**1-800-552-0782**

Name \_\_\_\_\_ Age \_\_\_\_\_  
Address \_\_\_\_\_  
City/State/Zip \_\_\_\_\_

**NEI** NEI Schools  
2929 Windom Place, NW  
Washington, DC 20008  
Dept. 7020-1193



**MAC users.** Learn HyperCard 2.0 in minutes. Manual, free stacks. 800k disk \$13.00. **CUT & PASTE**, PO Box 846, Bellmore, NY 11710.

## FREE INFO!

**BECOME A HAM RADIO OPERATOR THE FAST, EASY, FUN WAY — NO MORSE CODE REQ'D!**

You'll be on the air in no time—making new friends—with the ARRL's all-new Technician Class Video Course.

It's everything you need to start exploring your new, exciting world of Amateur Radio: 3 full-length video tapes, 164-page course book, 6 practice exams, even optional review software—all with an iron-clad money-back guarantee.

We've been helping people become hams for more than 75 years—we won't let you fail!

Get in on the fun of ham radio. Call the toll-free number and ask for our free video course info kit. **Call Today!**

**ARRL** • 225 Main St • Newington, CT 06111

**1-800-32-NEW HAM**



## PLANS & KITS

**SURVEILLANCE transmitter kits** tune from 65 to 305 MHz. Mains powered duplex, telephone, room, combination telephone/room. Catalog with **Popular Communications**, **Popular Electronics** and **Radio-Electronics** book reviews of "Electronic Eavesdropping Equipment Design," \$2.00. **SHEFFIELD ELECTRONICS**, PO Box 377785-A, Chicago, IL 60637-7785.

**60 Solderless Breadboard Projects** in two easy-to-read pocket books. Complete with circuit descriptions, schematics, parts layouts, component listings, etc. Both books (BP107 & BP113) only \$11.90 plus \$3.50 for shipping. USA and Canada only. US funds. **ETT, INC.**, PO Box 240, Massapequa Park, NY 11762-0240.

**BUGGED?** Telephone tapped? Find out fast! Free catalog of fantastic counter-surveillance equipment! 1 (800) 732-5000.

**ANNOUNCING OmniAlert!** (pat.pend) Designed by F-18 tactical radar engineer. Revolutionary photosensitive alarm safeguards your home, office, car, & valuables. Professionally engineered board & plans, guaranteed foolproof! \$11.95. **DRALIN DESIGNS**, PO Box 04, Ellenburg Depot, NY 12935.

**SYNTHESIZER** kits digitally generate low-distortion signals. Model DDS-3: 2Hz steps to 12MHz, \$149.95. Model DDS-1: 1Hz steps to 524kHz, \$89.95. \$5.00 S/H. SASE for specifications. **NOVATECH INSTRUMENTS**, 1530 Eastlake East, Suite 303, Seattle, WA 98102.

**FOUR** simple cable descrambling circuits using Radio Shack R.F. modulator. Instructions \$8.00. **TELCOM**, Box 832P, Brusly, LA 70719.

**INDUCTION** heating project you can build. Fundamentals and applications. Description of amazing effects. Schematic and instructions fully illustrated. \$12.00 check or money order to **MARITIME ELECTRONIC DEVICES**, 2103-M Cobblestone Lane, New Orleans, LA 70114.

## GET CONTROL!

with **CABLE TV DESCRAMBLERS AND CONVERTERS**

Top Brands Available

**SATISFACTION GUARANTEED! NECA**

**1-800-775-0444**

**T.C. ELECTRONICS**

Decoders and Descramblers must be not used without authorization by your local cable operator. An Tennessee sales.

**SHOCK** box! F.M. bug! T.V. jammer! 3 sets of plans, \$3.00 **DESERT ELECTRONICS**, PO Box 1642-U, El Centro, CA 92243-4361.

**HARNESS** solar energy, solar collector plans \$24.95, send check or money order to **PROTRONICS**, PO Box 2, Alvada, OH 44802.

**STEREO** amplifiers to 500WRMS/CH, pre-amps, etc. Build yourself. Call for custom plans. **ELECTRONICS HOSPITAL**, (407) 952-3838.

**BUILD** 0-50 volt regulated dual tracking power supply. Complete schematics and instructions. \$5.95. **SMS ENGINEERING**, 5932 West Bell Road, Suite D106, Glendale, AZ 85308.

**FASCINATING** Electronic devices! Voice disguiser! Vocal truth indicator! Lasers! Transmitters! Detectors! Free energy! High voltage! More! Kits/ assembled! Catalog \$4.00 (refundable). **QUANTUM RESEARCH**, 17919 — 77th Ave., Edmonton, Alberta, Canada, T5T 2S1.

**DESCRAMBLER** built right into your TV. Complete plans & instructions. Send \$15.00 to **BERGER ENTERPRISES**, Route 6, Box 209T, Murphy, NC 28906.

## BEST BY MAIL

Rates: Write National, Box 5, Sarasota, FL 34230

OF INTEREST TO ALL

**LONG-RANGE CORDLESS PHONES.** Non-cellular. 60-mile range. Base connected to home line. Morningstar, 307 E. Ash, S47, Columbia, MO 65201.

**LOTTERY RESEARCHERS INVITED** Send \$2 SASE: LMT, Box 37645-(PE), Jacksonville, FL 32205.

**BUY \$200 IN Groceries For Under \$25, GUARANTEED!** CALL 1-800-358-2962.

### PLANS

**CONFUSE LIDAR!** PLANS, parts, sources to construct laser speed gun confuser. Info pack \$3.00, plans \$20. Send Check/ MO to: M. Wallace & Assoc., POB 267-Paul, Morrison, CO 80465.

### MONEYMAKING OPPORTUNITIES

**EARN \$50-\$300 DAILY** Using Your Camcorder. Free Information: WCE, Box 9803E, Fountain Valley, CA 92728.

## BUSINESS OPPORTUNITIES

**MAKE \$75,000.00 to \$250,000.00 yearly.** Learn IBM monitors repairs (solutions most brands). New home based business program. Software available. Information: **USA-Canada** \$3.00 cash (no checks). Dealers wanted worldwide (\$35.00) US funds. **RANDALL DISPLAY**, PO Box 2168-H, Van Nuys, CA 91404, USA.

**EASY** work! Excellent pay! Assemble products at home. Call toll free 1 (800) 467-5566 ext. 5730.

**NEED** money? Guaranteed employment! Assemble simple products at home. Easy work! Excellent income! 1 (800) 377-6000, ex7930.

**FEDERAL** loans for small businesses now available. 1 (800) 777-6342 for free details.

**FREE** information — research engineer earns living safely with stocks! **HILL**, Box 48194P, Niles, IL 60714.

**\$600.00** weekly, assembling PC boards at home. Free information: **TECHNIX**, 4141 Main Street, Bridgeport, CT 06606.

**WANTED:** Distributors! Top quality mini-satellite systems for RV, home, office and more. 5'9" C/Ku remote demo included. Unlimited profit potential. **STRATAVISION**, (24 hrs.) 1 (800) 960-9656.

## SPEAKER BUILDERS

**BUILD** your own speaker systems using our first class speaker cabinets. Solid MDF cabinets beautifully finished in textured black or with base-coat to paint own color. Call or write for product info and pricelist. **VIRGIN CABINETS, R.R. #1**, Desbarats, Ontario, Canada P0R 1E0 (705) 736-2826.

## INVENTIONS

**INVENTORS: CONCEPT NETWORK** offers professional, inexpensive patenting and marketing services. (New product ideas with prototype or schematics preferred; but they are not required.) Free information packet: Call 1 (800) 835-2246 extension 67.



# GET CONTROL!

## with CABLE TV DESCRAMBLERS AND CONVERTERS

Gain complete control of your TV, and save money on monthly rental charges by owning your cable equipment!

### TOP BRANDS AVAILABLE

Everquest • Panasonic • Jerrold • Zenith • Pioneer • Scientific Atlanta • Tocom • and many more!

### SATISFACTION GUARANTEED!

#### Quantity Pricing Available

Orders can be placed 24 hours a day  
7 days a week!

Same day shipment if order placed  
before 5 pm EST M-F



Call Toll-Free

# 1-800-775-0444

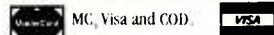

## T.C. ELECTRONICS

Special Note: Decoders and Descramblers must not be used without authorization by your local cable operator  
Sorry, no Tennessee sales

CIRCLE 164 ON FREE INFORMATION CARD

## ANTIQUE RADIO CLASSIFIED

### Free Sample!

Antique Radio's

Largest Circulation Monthly,  
Articles, Ads & Classifieds.

6-Month Trial: \$16.95. 1-Yr: \$29.95 (\$44.95-1st Class).  
A.R.C., P.O. Box 802-L10, Carlisle, MA 01741



## Learn to fix computers!

Home study. Earn great money repairing troubleshooting, upgrading, and installing PCs. Free literature: 800-223-4542.

Name \_\_\_\_\_ Age \_\_\_\_\_

Address \_\_\_\_\_

City \_\_\_\_\_ State \_\_\_\_\_ Zip \_\_\_\_\_

The School of PC Repair, Dept. KM341  
6065 Roswell Road, Atlanta, Georgia 30328

MASTERCARD AND VISA are now accepted for payment of your advertising. Simply complete the form on this page of the Market Center and we will bill you.

## ELECTRONIC PARTS (Continued from page 65)

### Startronics

Box 603  
McMinnville, OR 97128  
Tel. 503-472-9716

A nice 16-page illustrated list of surplus goodies including resistors, capacitors, a few IC's, switches, and meters. Of special interest are some PLCC and pin-grid array sockets at reasonable prices.

CIRCLE 19 ON FREE INFORMATION CARD

### Surplus Sales of Nebraska

1315 Jones St.  
Omaha, NE 68102  
Tel. 402-346-4750  
Catalog price: \$3.00

Tons of RF and other connectors, panel meters, RF inductors (from Collins, JW Miller and Barker & Williamson), capacitors, tube sockets, transmitting and receiving tubes, and lots of relays. Also ceramic and ferrite coil forms. Lots of parts for Collins radio equipment (a must catalog for any amateur using Collins equipment). Gigantic selection of Collins crystals and mechanical filters. Many crystal filters as well. Gigantic listing of semiconductors including many hard-to-find ones. Prices seem rather high, but where else can you get some of this stuff?

CIRCLE 20 ON FREE INFORMATION CARD

### Surplus Traders

Box 276  
Alburt, VT 05440  
Catalog price: \$3.00 (free to dealers)

Surplus Traders is a unique publication offering items usually in large quantity. They also have newsletters that you can subscribe to. The items are varied and change continuously. Most are available only in large quantity. A few are available in small quantity and single lots that might be of interest to experimenters, but the majority are mainly of interest to retail-surplus dealers and manufacturers. Of special interest is an offering of 3 gigabytes of PC public-domain software on 3 CD-ROM's for under \$100 (also available in quantity at a substantial discount).

CIRCLE 21 ON FREE INFORMATION CARD

### Tanner Electronics

1301 W. Beltline Rd. #105  
Carrollton, TX 75006  
Tel. 214-242-8702

A short but very interesting list at very nice prices. I've purchased some interesting dual-gate FET's, RF AM-receiver chips, and 455-kHz IF transformers and ceramic filters. Content probably changes quite a bit from one list to another.

CIRCLE 22 ON FREE INFORMATION CARD

### Techni-Tool

5 Apollo Rd., P.O. Box 368  
Plymouth Meeting, PA 19462  
Tel. 215-941-2400

One of the most complete illustrated catalogs on the subject of electronics tools, test equipment, chemicals, soldering equipment,

and much more that I've seen. Many hard-to-find items.

CIRCLE 23 ON FREE INFORMATION CARD

### Tucker Electronics and Computers

Box 551419  
Dallas, TX 75335-1419  
Tel. 800-527-4642

A bargain list of used test equipment. A line of 286/386/486-based PC's and printers. They list the "Sangean" series of portable shortwave receivers. They also have the Tucker Electronics test-equipment catalog, a large illustrated catalog of just about everything there is in test equipment. Prices are high but this is not just surplus stuff, they are completely reconditioned, top-quality items.

CIRCLE 24 ON FREE INFORMATION CARD

### U.S. Cyberlab Inc.

Rt. 2 Box 284 Cyber Rd.  
West Fork, AR 72774  
Tel. 501-839-8293

The CYANCE KIT division of U.S. Cyberlab Inc. offers a large selection of kits ranging from VHF transmitters, receivers, and accessories to robotics actuators. There is probably a kit for you regardless of your special interests. They also have a list of hard-to-find components.

CIRCLE 121 ON FREE INFORMATION CARD

### Unicom Electronics

10010 Canoga Ave. Unit B-8  
Chatsworth, CA 91311  
Tel. 800-824-34342

Unicom is my favorite supplier of IC's and semiconductors with a very extensive list at excellent prices. They also have some robotics kits, and laser modules and supplies. Their list is a must if you like to stock up on IC's at low prices.

CIRCLE 122 ON FREE INFORMATION CARD

### Universal Radio

1280 Aida Dr.  
Reynoldsburg, OH 43068  
Tel. 800-431-3939

A complete line of shortwave receivers, amateur transceivers, scanners, and accessories, as well as books of interest to amateurs and SWL's. Discount prices are listed.

CIRCLE 123 ON FREE INFORMATION CARD

### Wyman Research Inc.

Box 95, RR1  
Waldron, IN 46182  
Tel. 317-525-6452

Wyman specializes in units for the transmission and reception of amateur-television signals in the 450- to 1280-MHz bands. Very interesting if you're into ham TV.

CIRCLE 124 ON FREE INFORMATION CARD

# BUY BONDS

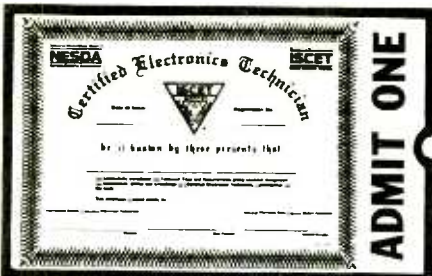

## Your Ticket To SUCCESS

Over 28,000 technicians have gained admittance worldwide as certified professionals. Let your ticket start opening doors for you.

ISCET offers Journeyman certification in Consumer Electronics, Industrial, Medical, Communications, Radar, Computer and Video. For more information, contact the International Society of Certified Electronics Technicians, 2708 West Berry Street, Fort Worth, TX 76109; (817) 921-9101.

Name \_\_\_\_\_  
 Address \_\_\_\_\_  
 City \_\_\_\_\_  
 State \_\_\_\_\_ Zip \_\_\_\_\_

\_\_\_\_ Send material about ISCET and becoming certified.

\_\_\_\_ Send one "Study Guide for the Associate Level CET Test." Enclosed is \$10 (inc. postage).

## HOME FIRE SAFETY. ACT ON IT!



FOR FREE HOME FIRE SAFETY TIPS, WRITE:

United States  
 Fire Administration  
 P.O. Box 70274  
 Washington, DC 20024



## ADVERTISING INDEX

POPULAR ELECTRONICS magazine does not assume any responsibility for errors that may appear in the index below.

Free Information No.	Page
151	AMC Sales ..... 28
—	American Radio Relay League ... 96
—	Antique Radio Classified ..... 96
—	CBC International ..... 96
—	CIE ..... 9
—	CLAGGK Video Offer ..... CV5
—	Command Productions ..... 25
—	Copyright Clearance Center, Inc. 73
162	Davis Instruments ..... 25
—	EIA ..... CV4
—	Electronics Book Club ..... 21, 87
—	Firestik II ..... 96
153	Fluke Manufacturing ..... CV2
154	Foley-Belsaw Company ..... 4
—	Grantham College ..... 70
155	Heathkit ..... 77
—	ISCET ..... 98
156	Jameco ..... 30
—	NRI Schools ..... 17, 96
158	People's College of Indep. Study . 29
14	Radio Shack ..... 27
159	The School Of PC Repair ..... 91
15	The School Of VCR Repair ..... 25
164	U.S. Cable Supply, Inc. .... 95, 97
—	World College ..... 75

## ADVERTISING SALES OFFICE

Gernsback Publications, Inc.  
 500-B Bi-County Blvd.  
 Farmingdale, NY 11735  
 1-(516) 293-3000

**Larry Steckler**  
 President  
**Christina Estrada**  
 Assistant to the President

**For Advertising ONLY**  
 516-293-3000  
 Fax 1-516-293-3115

**Larry Steckler**  
 publisher

**Arline Fishman**  
 advertising director

**Denise Mullen**  
 advertising assistant

**Kelly Twist**  
 credit manager

**Subscription/  
 Customer Service/  
 Order Entry**  
 1-800-827-0383  
 7:30 AM - 8:30 PM EST

## ADVERTISING SALES OFFICES EAST/SOUTHEAST

**Stanley Levitan**  
 Eastern Sales  
 1 Overlook Ave.  
 Great Neck, NY 11021  
 1-516-487-9357, 1-516-293-3000  
 Fax 1-516-487-8402

## MIDWEST/Texas/Arkansas/ Oklahoma, Colorado, Arizona

**Ralph Bergen**  
 Midwest Sales  
 One Northfield Plaza, Suite 300  
 Northfield, IL 60093-1214  
 1-708-446-1444  
 Fax 1-708-559-0562

## PACIFIC COAST/Mountain States

**Mike Brooks**  
 Pattis/3M  
 1800 North Highland Avenue  
 Suite 717  
 Hollywood, CA 90028  
 1-213-462-2700  
 Fax 1-213-463-0544



# Countersurveillance

**Never before has so much professional information on the art of detecting and eliminating electronic snooping devices—and how to defend against experienced information thieves—been placed in one VHS video. If you are a Fortune 500 CEO, an executive in any hi-tech industry, or a novice seeking entry into an honorable, rewarding field of work in countersurveillance, you must view this video presentation again and again.**

*Wake up!* You may be the victim of stolen words—precious ideas that would have made you very wealthy! Yes, professionals, even rank amateurs, may be listening to your most private conversations.

*Wake up!* If you are not the victim, then you are surrounded by countless victims who need your help if you know how to discover telephone taps, locate bugs, or “sweep” a room clean.

There is a thriving professional service steeped in high-tech techniques that you can become a part of! But first, you must know and understand Countersurveillance Technology. Your very first insight into this highly rewarding field is made possible by a video VHS presentation that you cannot view on broadcast television, satellite, or cable. It presents an informative program prepared by professionals in the field who know their industry, its techniques, kinks and loopholes. Men who can tell you more in 45 minutes in a straightforward, exclusive talk than was ever attempted before.

## Foiling Information Thieves

Discover the targets professional snoopers seek out! The prey are stock brokers, arbitrage firms, manufacturers, high-tech companies, any competitive industry, or even small businesses in the same community. The valuable information they filch may be marketing strategies, customer lists, product formulas, manufacturing techniques, even advertising plans. Information thieves eavesdrop on court decisions, bidding information, financial data. The list is unlimited in the mind of man—especially if he is a thief!

You know that the Russians secretly installed countless microphones in the concrete work of the American Embassy building in Moscow. They converted



**CALL NOW!**

**1-516-293-3751**

**HAVE YOUR VISA or MC CARD AVAILABLE**

what was to be an embassy and private residence into the most sophisticated recording studio the world had ever known. The building had to be torn down in order to remove all the bugs.

## Stolen Information

The open taps from where the information pours out may be from FAX's, computer communications, telephone calls, and everyday business meetings and lunchtime encounters. Businessmen need counselling on how to eliminate this information drain. Basic telephone use coupled with the user's understanding that someone may be listening or recording vital data and information greatly reduces the opportunity for others to purloin meaningful information.

The professional discussions seen on the TV screen in your home reveals how to detect and disable wiretaps, midget radio-frequency transmitters, and other bugs, plus when to use disinformation to confuse the unwanted listener, and the technique of voice scrambling telephone communications. In fact, do you know how to look for a bug, where to look for a bug, and what to do when you find it?

Bugs of a very small size are easy to build and they can be placed quickly in a matter of seconds, in any object or room. Today you may have used a telephone handset that was bugged. It probably contained three bugs. One was a phony bug to fool you into believing you found a bug and secured the telephone. The second bug placates the investigator when he finds the real thing! And the third bug is found only by the professional, who continued to search just in case there were more bugs.

The professional is not without his tools. Special equipment has been designed so that the professional can sweep a room so that he can detect voice-activated (VOX) and remote-activated bugs. Some of this equipment can be operated by novices, others require a trained countersurveillance professional.

The professionals viewed on your television screen reveal information on the latest technological advances like laser-beam snoopers that are installed hundreds of feet away from the room they snoop on. The professionals disclose that computers yield information too easily.

This advertisement was not written by a countersurveillance professional, but by a beginner whose only experience came from viewing the video tape in the privacy of his home. After you review the video carefully and understand its contents, you have taken the first important step in either acquiring professional help with your surveillance problems, or you may very well consider a career as a countersurveillance professional.

## The Dollars You Save

To obtain the information contained in the video VHS cassette, you would attend a professional seminar costing \$350-750 and possibly pay hundreds of dollars more if you had to travel to a distant city to attend. Now, for only \$49.95 (plus \$4.00 P&H) you can view *Countersurveillance Techniques* at home and take refresher views often. To obtain your copy, complete the coupon or call.

**PE**

**CLAGGK INC.**  
**P.O. Box 4099 • Farmingdale, NY 11735**

Please rush my copy of the Countersurveillance Techniques Video VHS Cassette for a total cost of \$54.95 each (which includes \$4.00 postage and handling)

No. of Cassettes ordered \_\_\_\_\_  
 Amount of payment \$ \_\_\_\_\_  
 Sales tax (N.Y.S. only) \_\_\_\_\_  
 Total enclosed \_\_\_\_\_  
 Bill me  VISA  MasterCard  
 Card No. \_\_\_\_\_  
 Expire Date \_\_\_\_/\_\_\_\_/\_\_\_\_  
 Signature \_\_\_\_\_  
 Name \_\_\_\_\_  
 Address \_\_\_\_\_  
 City \_\_\_\_\_ State \_\_\_\_\_ ZIP \_\_\_\_\_

All payments in U.S.A. funds. Canadians add \$4.00 per VHS cassette. No foreign orders.

# MULTIMEDIA TOOLCHEST

Want to learn more about multimedia communications and production? SIGHTS & SOUNDS, the only video magazine dedicated to innovative technology, will show you how.

Every week we feature reports on the latest market trends, product reviews and insightful interviews with industry experts.

Check us out on October 16th as we feature the latest in desktop multimedia equipment, the **GVP G-Lock VGA+** for high quality desktop video special effects. The VGA+ is a plug-in card for the PC using technology that won an Emmy Award in 1991. The G-Lock VGA+ accepts live or prerecorded video, and allows you to mix, dissolve, fade and color-key your video with PC graphics that you create and control. Applications include titling, overlays, dissolves, and much more. It offers Composite & Y/C video input and output.

215-337-8770  
ext. 242



If you think that multimedia production is expensive and complicated, take a look at **Multimedia Works** from software developer **Level Systems International**.

With MultiMedia Works, anyone can create professional-quality presentation packages from a variety of source materials, such as audio clips, animation, graphics, analog and digital video, and documents. And you can easily add multimedia features to other programs such as word processing, spreadsheets and graphics software.

This powerful yet affordable product is Windows-based, so you can be up and running in no time, increasing the effectiveness of your message!

Check it out October 16th on SIGHTS & SOUNDS.

761-248-9720

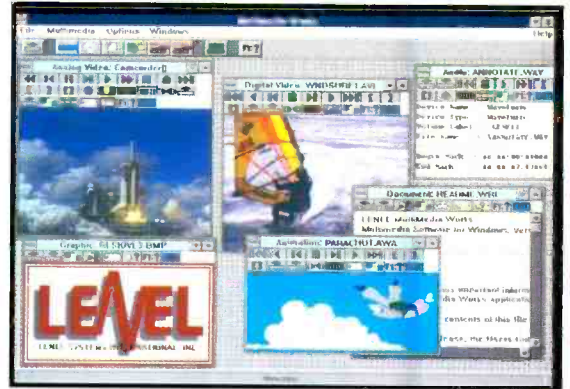

A state-of-the-art video editing system, **Media SuitePro** from **Avid Technology**, interfaces with your existing Macintosh computer to create and manipulate professional-quality video effects. Tune in to SIGHTS & SOUNDS on November 27 and see for yourself.

800-949-AVID ext. 2

See and hear the newest products for your desktop system, home theater or mobile office. Tune in to....

# SIGHTS & SOUNDS

Saturdays at 4:30 (et) on CNBC.

