

There are copies and then there are originals. Only Fluke meters – the original and most copied DMMs in the world – deliver the safety, quality and value they promise. They're built tough enough to achieve C.S.A. and U.L. listings, not to mention the considerable on-the-job punishment they endure. Each meter is loaded with features, of course. But those features are also designed to work together intelligently, so your job is easier. Faster. And safer.

If you're going to spend your hard-earned money on a multimeter, why buy an inferior copy when you can own an original? See Fluke's full line of handheld meters and accessories at your local distributor; or call 1-800-87 FLUKE for the name and number.

O R I G I N A L S



FLUKE®

© Copyright 1993 John Fluke Mfg. Co., Inc. P.O. Box 9090 M/S 250E Everett, WA 98206 U.S.: 206-356-5400
Canada: 416-890-7600 Other Countries: 206-356-5500 All rights reserved. Ad no. 00381

CIRCLE 153 ON FREE INFORMATION CARD

www.americanradiohistory.com

Popular Electronics®

THE MAGAZINE FOR THE ELECTRONICS ACTIVIST!

CONSTRUCTION ARTICLES

BUILD THIS MICROWAVE MOTION DETECTOR	Fred Blechman	31
<i>A security-system add-on that works just like police radar</i>		
BUILD A COMPUTER-CONTROLLED A/B SWITCH	John Yacono and Marc Spiwak	43
<i>Teach your computer how to share with this easy-to-build accessory</i>		
BUILD A SIDESWIPER	Larry Lisle	48
<i>Build the first of the high-speed Morse-code keys</i>		
BUILD A TIME-DELAYED KILL SWITCH FOR YOUR CAR	Walter W. Schopp	64
<i>Put one in your car to foil carjackers and other car thieves</i>		

FEATURE ARTICLES

A FLEA MARKET SURVIVAL GUIDE	Karl T. Thurber Jr.	36
<i>These tips can make your next radio flea-market visit more pleasurable</i>		
VACUUM-TUBE BASICS	Paul Coxwell	53
<i>Learn about the different types of tubes, how they work, and how they are used</i>		

PRODUCT REVIEWS

GIZMO		5
<i>Report from the Summer Consumer Electronics Show, Innovations 1993, and more</i>		
HANDS-ON REPORT		20
<i>DynaArt Designs Toner Transfer System</i>		
PRODUCT TEST REPORT	Len Feldman	26
<i>Carver CT3 Preamp/ifier/Tuner</i>		

COLUMNS

ANTIQUÉ RADIO	Marc Ellis	68
<i>The Motorola story</i>		
COMPUTER BITS	Jeff Holtzman	70
<i>Amber waves of data</i>		
CIRCUIT CIRCUS	Charles D. Rakes	72
<i>Nothing but amplifiers</i>		
THINK TANK	John Yacono	75
<i>More "Derby"</i>		
DX LISTENING	Don Jensen	78
<i>Shortwave contests and quizzes</i>		
HAM RADIO	Joseph J. Carr	80
<i>Wanna be a CAD?</i>		
SCANNER SCENE	Marc Saxon	82
<i>An FM interceptor</i>		

DEPARTMENTS

EDITORIAL	Carl Laron	2
LETTERS		3
FACTCARDS		49
POPULAR ELECTRONICS MARKET CENTER		50A
FREE INFORMATION CARD		51
ELECTRONICS LIBRARY		84
NEW PRODUCTS		89
ELECTRONICS MARKET PLACE		95
ADVERTISER'S INDEX		98

Popular Electronics (ISSN 1043-170X) Published monthly by Gernsback Publications, Inc., 500-B Bi-County Boulevard, Farmingdale, NY 11735. Second-Class postage paid at Farmingdale, NY and at additional mailing offices. One-year, twelve issues, subscription rate U.S. and possessions \$21.95, Canada \$26.64 (includes G.S.T. Canadian Goods and Services Tax Registration No. R125168280), all other countries \$29.45. Subscription orders payable in U.S. funds only. International Postal Money Order, or check drawn on a U.S. bank. U.S. single copy price \$3.50. © 1993 by Gernsback Publications, Inc. All rights reserved. Hands-on Electronics and Gizmo trademarks are registered in U.S. and Canada by Gernsback Publications, Inc. Popular Electronics trademark is registered in U.S. and Canada by Electronic Technology Today, Inc. and is licensed to Gernsback Publications, Inc. Printed in U.S.A.

Postmaster: Please send address changes to Popular Electronics, Subscription Dept., P.O. Box 338, Mount Morris, IL 61054-9932.

A stamped self-addressed envelope must accompany all submitted manuscripts and/or artwork or photographs if their return is desired should they be rejected. We disclaim any responsibility for the loss or damage of manuscripts and/or artwork or photographs while in our possession or otherwise.

As a service to readers, Popular Electronics publishes available plans or information relating to newsworthy products, techniques, and scientific and technological developments. Because of possible variances in the quality and condition of materials and workmanship used by readers, Popular Electronics disclaims any responsibility for the safe and proper functioning of reader-built projects based upon or from plans or information published in this magazine.

Larry Steckler

EHF, CET

Editor-In-Chief and Publisher

EDITORIAL DEPARTMENT

Carl Laron

Editor

Robert A. Young

Associate Editor

John J. Yacono

Associate Editor

Byron G. Wels, K2AVB

Associate Editor

Teri Scaduto

Assistant Editor

Evelyn Rose

Editorial Assistant

Marc Spiwak

Editorial Associate

Joseph J. Carr, K4IPV

Marc Ellis

Len Feldman

Jeffrey K. Holtzman

Don Jensen

Charles D. Rakes

Marc Saxon

Contributing Editors

PRODUCTION DEPARTMENT

Ruby M. Yee

Production Director

Karen S. Brown

Production Manager

Marcella Amoroso

Production Assistant

Lisa Rachowitz

Editorial Production

ART DEPARTMENT

Andre Duzant

Art Director

Injae Lee

Illustrator

Russell C. Truelson

Illustrator

Jacqueline P. Cheeseboro

Circulation Director

Michele Torrillo

P-E Bookstore

BUSINESS AND EDITORIAL OFFICES

Gemsback Publications, Inc.

500-B Bi-County Blvd.

Farmingdale, NY 11735

1-516-293-3000

Fax: 1-516-293-3115

President: **Larry Steckler**

Subscription

Customer Service/Order Entry

1-800-827-0383

7:30 AM - 8:30 PM EST

Advertising Sales offices listed on page 98

ABC
AUDITED

Composition by
Mates Graphics



Since some of the equipment and circuitry described in POPULAR ELECTRONICS may relate to or be covered by U.S. patents, POPULAR ELECTRONICS disclaims any liability for the infringement of such patents by the making, using, or selling of any such equipment or circuitry, and suggests that anyone interested in such projects consult a patent attorney.

INTERACTING WITH TOMORROW

While this summer's Consumer Electronics Show was largely billed as devoid of excitement, the trends that were established or better-defined there will likely determine the shape of the consumer-electronics industry, and more, for the next decade. Those trends revolve around the concepts of "interactivity" and "multimedia."

Interactivity, in particular, was pervasive. Most of us have seen those catchy AT&T television ads highlighting future technology. However, in some cases the future may be closer than you realize. Do you want to jot down a note, have it turn into typewritten text, and fax it to your office, all while relaxing on a pristine beach? You can do that today, courtesy of AT&T's EO Personal Communicator. Casio, Tandy, Apple, and others are not far behind with similar products expected either by the time you read this or by the end of the year. In fact, the EIA, recognizing the importance of the budding industry, set-up a separate Personal Communications and Computing Show within CES.

Then there's interactive multimedia. Don't like the way a movie ends? Then change it. Need an exercise video that tailors itself to your goals and preferences? No problem. You can do all of that and more with the 3DO Multiplayer and the Full Motion Video (FMV) add-on for the Philips CD-I machine, both available by the end of the year.

Add to that Thompson's digital direct-broadcast satellite service (the first satellite is scheduled for a December launch), more widescreen TV's, the on-going battle between Mini-Disc and DCC, the Innovations exhibition, and more, and you can see that there really was quite a bit of excitement at CES. For the whole story, turn to Gizmo, which begins on page 5.

Carl Laron
Editor

ADDRESS OMISSIONS

Due to oversights, two addresses were omitted from recent issues of **Popular Electronics**. In the May 1993 Gizmo section, the address for 50/50 Micro Electronics, Inc. should have appeared in the manufacturers box. The address is 1249 Innsbruck Drive, Sunnyvale, CA 94089; the phone number is 408-730-5050.

The address for Advanced Electronic Applications (AEA) was left out of the article "Computer Software for Hams and SWLs," which appeared in the July 1993 issue. Their address is P. O. Box C2160, 2006 196th St. S.W., Lynnwood, WA 98036; phone 800-432-8873.

We are sorry for any inconvenience this might have caused.—Editor

KEEP PC'S IN THEIR PLACE!

When I read the cover of my just-received (July 1993) **Popular Electronics**, I thought I had mistakenly received *Byte*, but with the **Popular Electronics** masthead. The editorial pointed out, however, that the July issue was a "dedicated issue"—to PC's. Good. Don't fall into the trap that the old **Popular Electronics** did. There are dozens of PC magazines out there. Keep the emphasis on hobby electronics. (I like RF and radio circuits.)

L.C.
Kissimmee, FL

You're doing it again! Why all the computer articles? Aren't there enough computer rags out there without you deserting us electronics hobbyists to pander to the computaholics?

As this letter was done on a Commodore 128D, it is not that we are against computers. We just want more radio, TV, and many more hobby projects. How about some tube projects for nostalgia's sake? What will it take to convince you that some of use still like simple, useful projects?

G.W.
Evergreen Park, IL

No, we're not! Simple, useful projects remain the backbone of this magazine. But we also

strive to provide balanced coverage of all areas of the electronics hobby, including computers. However, if you like projects and project building, you'll love next month's edition of **Popular Electronics**, and if you're nostalgic about tubes, check out "Vacuum-Tube Basics" in this issue.—Editor.

METRIC: JUST DO IT!

Thanks for John Iovine's article "Experimenting with Shaped Memory Alloys" (**Popular Electronics**, June 1993). He did a great job of explaining a subject that, although around since the 1930's, has received little coverage of practical use to the hobbyist and home experimenter.

But the article brings up an issue that has been growing in the back of my mind. In the "Parts" side bar, Flexinol 150 wire is listed as being "40 inches" long—but all our literature says "1 meter." Sure, one meter and 40 inches are almost exactly the same, but there is a greater difference here. Don't you expect your readers to be metric literate?

Those in scientific and medical fields probably use metric every day. Engineers, especially recent graduates, also have experience with kilograms, newtons, and meters. But consider this: The U.S. is the *only* country on the planet that does not use the metric system; phone, fax, and television systems bring that all-metric world into our living rooms every day; all science and most medicine is performed in metric; and breakthroughs still do come from hobbyists and garage experimenters. Your readers (and technically inclined people across the U.S.) should have complete familiarity with metric measures, not protection from them!

I asked a friend who teaches grade school if kids in the U.S. learn metric today. Her answer

was positive: "I think the sixth grade curriculum spends a whole week on metric." One whole week? Watch out, Japan! We worry about our world competitiveness today, yet we're bringing up our next generation of scientists, engineers, and consumers on a system that will only be more out of date, and further from the world standard, when they graduate in the 21st century.

Put aside metric's ease of use (try to figure out how many tablespoons are in two gallons versus how many milliliters in two liters), and the fact that all our scientists and medical practitioners use it regularly. What can the interested layperson do to make it their standard?

Start using and "feeling" metric every day, and notice where we use it already. Cars and motorcycle engines are measured in cubic centimeters, and you intuitively know the size and feel of a two-liter bottle of your favorite soda. A hair on your head is probably 50–100 microns in diameter. An average male stands around 1.8 meters tall; a basketball player, 2 meters or more. 20°C is a nice day, but when it gets to 32°C, it's time to head for the beach! Drive 88 kilometers per hour on the freeway and you're legal, but go 130 KPH and you'd better watch out for flashing red lights! Incidentally, most new cars from Detroit with electronic instrument panels can switch to metric at the press of a button. Start using it now. To borrow a marketing phrase: Just do it!

After selling over 3000 copies of our *Muscle Wires Project Book* (it's completely in metric), I've heard only one complaint about the "funny numbers." Maybe the fact that the caller lived just outside Washington D.C. indicates where we most need metric education!

I look forward to hearing what other hobbyists think. I invite interested readers to write to me for a free metric-U.S. conversion chart.

Roger G. Gilbertson
Mondo-tronics, Inc.
524 San Anselmo Ave.,
#107-18
San Anselmo, CA 94960

HAVES & NEEDS

Being a technician, I own two oscilloscopes—unfortunately, they are both out of order. They are a Unilab Model Q32-601 and a Tektronix Model 465. I will be grateful to any **Popular Electronics** reader who can help me obtain the schematics.

JOSEPH ANIE
Fire Service Box 383
Tema, Ghana, West Africa

I am looking for schematics for several pieces of test equipment: RCA Model #WR-61A color bar generator and Model #WR-46A video dot/crosshatch generator; Philco Model # 7100 color bar and dot bar generator and Model #7170 FM/AM generator; and EICO Model #950-B RCL bridge and comparator. CRAIG K. SELLEN
Box 1038, RR-1 58-B
Waymart, PA 18472

I am searching for the schematic diagrams and alignment instructions for two pieces of test equipment from EICO. They are the Model 565 multi-meter and the Model 320 signal generator. I'm hoping that a fellow **Popular Electronics** reader might have the manuals. I would gladly pay for copying and postage costs.

I am also interested in building an interface box for use with a PC to display the diagnostic codes provided from car-engine computers with a diagnostic connector. I have the factory service manuals for GM and Chrysler minivans, which describe how to use the displayed codes. The units that I have found are not economical for a do-it-yourself person. TED MARTIN
3800 S. Ceylon Way
Aurora, CO 80013

LETTERS

ATTENTION

PUBLIC SAFETY ANNOUNCEMENT

Tampering with Motorola's Communication Technology is Nothing Short of a Crime.

Motorola has been at the forefront of communications technology for more than 60 years. Today, we offer a greater array of communications products than ever before. We are proud of our products and the vital services they bring to our customers which are of unparalleled public importance.

Theft of communications services and so-called High-Tech piracy threaten the entire communication industry's reputation for reliability. This conduct

not only damages the reputation of Motorola, Inc. and the communications industry, but undermines the very integrity of America's public and private communications services.

Motorola intends to combat this conduct by aggressively maintaining and enforcing its proprietary rights to its hardware and software technology. Anyone who has knowledge of illegal activities or has questions concerning such activities is urged to contact Motorola Inc. immediately at 1-800-325-4036. Contacts will be kept confidential and may be made anonymously.



 and Motorola are trademarks of Motorola, Inc., © 1993 Motorola, Inc.



GIZMO

OCTOBER 1993

VOLUME 6,
NUMBER 10

A CHRONICLE OF CONSUMER ELECTRONICS



Highlights of the Summer Consumer Electronics Show

The Summer Consumer Electronics Show, held for four days each June in Chicago, is more than just a trade show. Of course, its main purpose is the buying and selling of consumer-electronic gear to fill the shelves of stores in the next few months; after all, that's the backbone of any industry. But in a field as fast-changing as consumer electronics, such a gathering also provides a showcase for new technologies, foreshadowing the products that will be filling the shelves in years to come. At SCES, buyers, dealers, retailers, the media, and—for one day only—the general public, can meet with industry trendsetters, browse through this year's Innovations Award-winning products, learn about new technologies, and perhaps catch a glimpse of the future.

SCES 1993 fulfilled those expectations. Alongside today's staples—TV's, VCR's, audio gear, and telephones—were exhibited a host of products that just might change the way we will work, play, and interact in the years to come. Reflecting the merging of telecommunications and computers, a separate pavilion was set up on the main floor to house a show-within-a-show: the Personal Computing and Communications (PCC) show. Interactive devices were prominently displayed, with Philips debuting full-motion video for their CD-I machine, and 3DO and Panasonic regaling show-goers with their soon-to-be-released interactive multi-players.

ACTIVATING INTERACTIVITY

"Interact" is the key word here. The highlights of the Summer Consumer Electronics show were new devices and technologies that promise to open new avenues of interactivity: people interacting with people, people interacting with machines, and machines interacting with machines, and "interactive" strategic alliances

formed between companies that might previously have been considered strange bedfellows.

The past decade has brought about the beginnings of a communications revolution. Cellular phones and pagers have allowed people to be accessible wherever they may be—at home, at work, commuting, or even out jogging. Mobile electronics have fostered the concept of the go-anywhere office, with laptop computers, modems, and portable fax machines and printers. But all of that—impressive as it is—is just the tip of the iceberg. The EIA recognized the future impact the budding industry could have, and decided to create the Personal Communications and Computing Show, at which the first generation of handheld personal communicators were demonstrated.

INTRODUCING THE PCC SHOW

At the keynote address for the Personal Communications and Computing show, AT&T's Gordon Bridge, citing the "awesome" advances that have already been achieved in signal compression, real-time

TURN PAGE FOR CONTENTS

This month in GIZMO

Report from the Summer Consumer Electronics Show pg. 5
 Innovations Award-Winning Product Round-Up pg. 10
 Motorola Bravo Express Pager pg. 17

Gizmo is published by Gernsback Publications, Inc., 500-B Bi-County Blvd., Farmingdale, NY 11735. Senior Writers: Chris F. O'Brian and Teri Scaduto. ©Copyright 1993 by Gernsback Publications, Inc. Gizmo is a registered trademark. All rights reserved.

language translation, fast data transmission, and intelligent networks, heralded the dawning of a new era. "an era in which the exchange of data using wireless voice-data devices will become more and more abundant—even common place." Bridge noted that, "the marriage of communications and computer technology . . . has created a paradigm shift that has forever changed the way we do business and is changing the very fabric of our society." Alain Rossman, president and CEO of EO, Inc., spoke of the convergence of satellite, computer, telephone, and consumer-electronics technologies that would allow people to "control time and space" in their personal communications. The keynote address ended with a demonstration of the EO personal communicator.

EO ON THE GO

The AT&T EO 440 personal communicator is the first device of its kind to hit the market, offered at select AT&T Phone Centers and EO resellers since June. Based on a Hobbitt microprocessor from

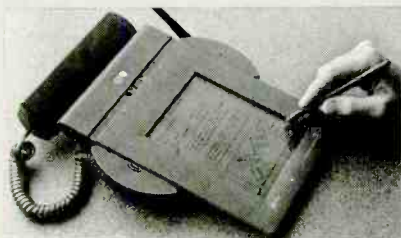

The AT&T EO 440 bridges the world of computing and communications.

AT&T Microelectronics and the Penpoint operating system from Go Corp., the EO 440 contains 4MB of RAM in its minimal configuration. Its processor runs at 20 MHz and delivers two to three times the performance of a 20-MHz Intel 386SX. The top-of-the-line EO 880, available later this year, runs at 30 MHz and is comparable in power to a 33-MHz Intel 486SX. Equipped with serial port and cable, a parallel port, a keyboard port, and VGA output (EO 880 only), and available with an optional 20- or 64-megabyte hard drive, the device can be linked to a PC, or it can serve as a portable computing center. An industry-standard Personal Computer Memory Card International Association (PCMCIA) type-2 slot allows future expansion by plugging in credit-card-sized, application-specific PCMCIA cards.

Nine applications reside along with the operating system in an 8-megabyte ROM. Those programs provide for faxing, electronic mail, calculation, note-taking, scheduling, an address book, and to-do list management. The EO contains a built-in, high-speed modem; an optional cellular modem is available for wireless networking, fax, and E-mail. The purchase price includes a free subscription to AT&T Mail from Easylink Services.

What all of that means to the user is the ability to stay in touch not only by phone, but through fax, E-mail, and computer networks, from virtually anywhere. An editor attending a press briefing might have the office fax magazine proof sheets. He could check the overall layout, zoom in on parts of the screen for closeups, mark any changes—on screen, printing with a pen-like stylus—and then fax the corrected proofs back to the office, all while waiting for the briefing to begin. He could make phone calls, access electronic messages, jot down hand-written notes, record spoken reminders via the built-in microphone—all without leaving the room. The notes he took during the briefing could be transcribed into type, and faxed back to the office, or he could connect the EO to a keyboard and type up the story on the spot.

With prices starting at \$2000 (for an EO 440 without a modem) and ranging to \$3300 (for the 880 with 8 MB RAM), and \$800 for the cellular phone module, EO is firmly aimed at business executives, although both AT&T and EO hope it will trickle down to the point where everyone carries around an EO personal communicator.

ZOOMING IN

Casio and Tandy, on the other hand, scaled their Zoomer Personal Digital Assistants (PDA) to consumer proportions, in terms of size, price, and functionality. While Casio's XL-7000 has a suggested

retail price of \$900, Tandy's Z-550 Zoomer PDA will carry a list price of under \$700 at its September introduction. Both Zoomers weigh less than a pound and measure 1×4.2×6.8 inches (compared with the EO 440, which measures 0.9×7.1×10.8 and weighs 2.3 pounds, and the EO 880, which measures 1.1×9×13 and weighs four pounds). The Zoomer also runs for an incredible 100 hours on three standard "AA" batteries. With 1 MB RAM and 4 MB ROM, it can't compete in computing power or cellular



Jointly developed by Tandy and Casio, the Zoomer Personal Digital Assistant brings pen-based technology to consumers.

potential with the EO. But the Zoomer also features a PCMCIA type-2 slot that can be used for various applications including memory expansion and the addition of fax/modem or pager capabilities.

Developed with the consumer and small businesses in mind, the Zoomer performs six basic functions: organization, calculation, communication, information, entertainment, and management. To keep social and business appointments organized, the Zoomer acts as a datebook, to-do list, address book, and notebook. Information can be input using "electronic ink" or a pop-up on-screen keyboard; hand-printed text is recognized and can be translated to typewritten text. The user isn't limited to letters and numbers, but can also store drawings. The PDA can "communicate" with a PC via an RS-232 port, PC Link software, or an optional modem; it communicates with other PDA's via infrared transfer. Built-in software allows modem-equipped Zoomers to access America Online for E-mail, stock quotes, news, and an on-line encyclopedia, and Motorola plans to develop a Zoomer-compatible version of their EM-BARC wireless data service, which will allow users to receive wireless electronic messages and other automated information services. Other information is provided by the device's built-in dictionary,

thesaurus, 26-language translator, and reference material. Three games are built in as well. And personal financial management is possible with Pocket Quicken, an on-the-go version of Intuit's Quicken software. The user can keep track of day-to-day expenses on the Zoomer, and transfer that data to a PC on which Quicken is installed.

APPLE PIE

Although they chose not to participate in the PCC show (or CES), Apple held an off-site press conference during the show to provide an update on the Newton personal digital assistant developed by the company's Personal Interactive Electronics (PIE) division. The Newton that will finally be available by the end of the summer has been expanded to include a screen-based telephone system, thanks to joint ventures with Bell South, US West, and Ameritech. Newton users will have access to fax, electronic messaging, and other information services. Bell South's Intelligent Messaging Services Group is testing a display telephone that will provide banking and communications services, and is eventually expected to allow Newton users to access account balances, check ATM transactions, and order checks. When Ameritech's messaging system is made available to Newton users early next year, an on-screen message will alert them when messages are received. Other capabilities that have been added to the Newton include an infrared-based beaming feature that provides communications between two PDA's, and a PC link to transfer information to and from a PC.

INTERACTIVE MULTIMEDIA

Interactive multimedia was the theme of the Summer CES keynote address, given by Tripp Hawkins, president and CEO of The 3DO Company, who predicted that it has the potential to become the fastest growth industry in the 1990's thanks to its potential to change the way consumers learn and are entertained. Hawkins emphasized the need for standardization in multimedia, nominating his company's interactive hardware and software technologies as the models on which those standards might be based.

3GET REAL!

3DO is not a hardware or software manufacturer; instead, it is in the business of licensing the technologies needed to create products that fit the 3DO standard for an interactive multiplayer and related software. The technology is said to offer speed and performance 50 times greater than conventional CD-ROM and video games. The system can process an average 50 million pixels per second and deliver more than 16 million colors. (It outperforms its

delivery medium, the television, which can process only 6 million pixels per second.) The system uses custom animation processors operating in parallel, and a 32-bit Reduced Instruction Set Computer (RISC) processor to execute normal computing code. Future applications are expected to include networking, home shopping and banking, video on demand, full-motion video, video editing and special effects, and MIDI capability.

At a Summer CES press conference, 3DO announced several major developments, including their intention to enter the coin-operated arcade market within the next year. This spring, 3DO went public, raising more than \$48 million at their initial public stock offering. Back in January, the budding company already had strategic alliances with the backing of a host of impressive companies, including Matsushita, Time Warner, AT&T, MCA, and Electronic Arts. Now, Sanyo is negotiating a hardware license, and motion-picture giants Universal and Warner Brothers have expressed serious interest in 3DO. AT&T has signed a hardware license agreement, and intends to manufacture a network version of the interactive multiplayer that would allow access to a wide variety of interactive entertainment and education services via the telephone network. More than 300 software companies are 3DO licensees, and 91 titles are currently in development.



Panasonic's REAL 3DO interactive multiplayer promises 50 times the speed and performance of today's CD-ROM and video games.

Software demonstrations were impressive, but not quite up to our high expectations (having heard the system's capabilities praised to the sky). But Hawkins repeatedly reminded the audience that the programs were still in the development stage, and the software companies had another six months of fine-tuning before release. We wonder, then, how ten titles will be ready to accompany the product introduction in October, just four months from the demo.

Matsushita-owned Panasonic exhibited the world's first interactive 3DO multiplayer, and confirmed that it is on schedule for October sales. Their FZ-1 REAL 3DO (REAL stands for *Realistic Entertainment*

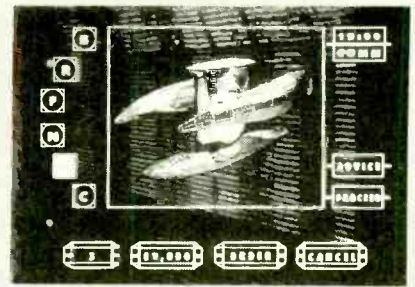

Electronic Arts' Worldbuilders 3DO program lets players "terraform" new-found planets to make them habitable for humans, while learning the principles of physics and astronomy.

Active Learning) will be actively marketed with an ad campaign based on the slogan "Get REAL!" The player, intended to be hooked up to a color television in the family room, offers full 3DO capabilities, and is compatible with audio and Photo CD's, as well as motion video CD's. For whole-family entertainment, up to eight control pads can be linked; a headphone jack is provided for unobtrusive single-player use.

(INTER)-ACTIVE IMAGINATION

While 3DO has been hustling to reach the market, CD-I has slowly, but steadily, penetrated the market. Sales might get a boost from the major developments in Compact Disc-Interactive technology announced by Philips at SCES. Most important is the introduction of a full-motion video (FMV) add-on cartridge for their "Imagination Machine." The book-sized cartridge will cost about \$250 when it becomes available this fall. Installation can be done by the consumer, who plugs it into a slot on the back of the CD-I player.

Full-motion video was achieved by Laser-Pacific Media Corporation in its digital-compression facility (a joint development effort with IBM Research). Laser-Pacific used the IBM POWER-Visualization supercomputer system to provide digital encoding-services based

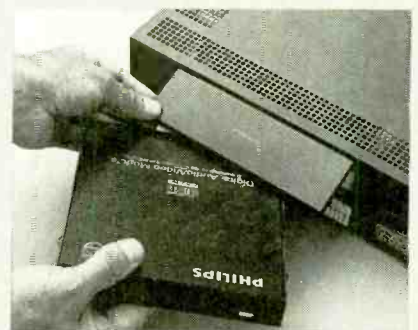

With the addition of a plug-in adaptor cartridge, Philips CD-I player is updated to provide full-motion video and extra memory storage.

on the international MPEG-1 standard. Five-inch FMV CD-I discs, when played on a CD-I player equipped with the add-on FMV adaptor, provide 72 minutes of full-motion video, of at least VHS quality, and CD-quality audio. The cartridge also provides 1.5 MB of memory for faster response time and more activity on the screen at any one time.



Robert Culp and Grace Zabriskle star in the interactive political thriller "Voyeur," the first interactive film for CD-I.

The first FMV cartridges were shipped to software developers back in April, and a host of soon-to-be released FMV-based programs were previewed at the conference. Paramount Pictures and Philips Interactive Media of America (PIMA) announced an agreement that will put 50 Paramount films on CD-I in the next two years. The first releases, due this fall, are *Top Gun*, *Apocalypse Now*, and *Beverly Hills Cop*. Several celebrities were on hand to introduce the CD-I titles in which they were involved, including Robert Culp, who stars in "Voyeur," an interactive mystery game said to offer the suspense of Hitchcock's *Rear Window*. Players spy on the unsavory activities—and try to solve a murder—that take place (in full-motion video, of course) at presidential hopeful Reed Hawke's family es-



Billy Ray Cyrus' "Live on Tour" is one of the full-motion music videos for CD-I.

tate. Kathy Smith, who has starred in and produced a popular line of exercise videos for the past decade, introduced the "Kathy Smith Personal Trainer," an interactive disc that can be customized to take into account the user's weight-loss and fitness goals, preferred type of exercise, level of difficulty, length of workout, musical accompaniment, and whether or not to include vocal instructions. The program lets users know how many calories fat grams they are burning off and provides nutritional tips. Full-motion video also is used in the "sports fantasy" program called "Caesar's World of Boxing," and a children's title called "Hanna-Barbera's Cartoon Carnival" that includes six games featuring the Flintstones, Yogi Bear, the Jetsons, and other favorite animated characters. Finally, a full-motion video concert series will initially feature music videos from Sting, Bryan Adams, Eric Clapton, Tina Turner, Billy Ray Cyrus, Diana Ross, U2, Bon Jovi, Paul McCartney, Andrew Lloyd Weber, and Shari Lewis.

Not all of Philips new software announcements concerned full-motion video. Musician Todd Rundgren, (or TR-I, his self-christened interactive persona) announced at the conference that he will release his latest album, *No World Order*, both as a standard audio CD and as a CD-I compatible disc. Using a technology that he developed and is trying to patent, Rundgren broke the music up into 4-bar segments, which can be manipulated and rearranged to create a virtually infinite number of song versions. Users can opt to passively listen to the songs just as they appear on Rundgren's non-interactive CD or to alternate versions created by several well-known music producers. Or they can take full advantage of the interactivity and their own creativity. Philips also announced that they would be offering CD-I versions of the popular Nintendo games "Link: The Faces of Evil" and "Zelda: The Wand of Gamelon; a *Star Wars*-like game from PIMA and LucasArts Entertainment Company called "Rebel Assault," and a line of adult titles that will include an interactive version of *The Joy of Sex*.

WATCHING TV

Not all of the interaction between consumers and their televisions will require interactive multimedia devices. A new satellite-based television service will provide pay-per-view events as well as up to 100 channels of programming. And another new service will help those folks who already have trouble keeping up with all of the channels they receive.

Thomson announced at the Summer Consumer Electronics Show that all preparations for DSS (Digital Satellite Service)



The RCA Digital Satellite Service system will use a stationary, 18-inch dish antenna to pick up as many as 150 TV channels from two high-powered direct-broadcast satellite services, DirecTV and USSB.

are proceeding on schedule, including the December launch of the nation's first high-powered direct broadcast satellite TV service, dubbed DirecTV. Two high-powered satellites, each equipped with 16 120-watt transponders, are being built by Hughes. The first will be launched in December, and the digital service will be in operation by April 1994, by which time Thomson's RCA-brand DirecTV decoder and 18-inch satellite dish will be commercially available. The second satellite will be launched next June. Because all of the programming is beamed down from those two satellites, the dish remains stationary once it is initially aligned. The small antennas make installation possible in places where standard 8- or 10-foot dishes can't be used, and the entire system is expected to cost about \$700.

DirecTV is capable carrying more than

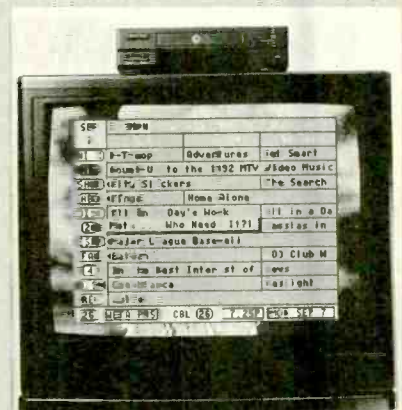

The grid-style on-screen programming guide from StarSight can be customized for viewer preferences and provides one-button VCR timer recording.

100 channels, and DirecTV (a subsidiary of GM Hughes Electronics) has been busy lining up programmers. Distribution agreements with The Discovery Channel, The Learning Channel, C-SPAN, C-SPAN-2, and E! Entertainment Television were announced at the show. That brings the number of programmers to 16, including The Disney Channel, CNN, The Sci-Fi Channel, USA Network, The Family Channel, and the Canadian Broadcasting Corporation. Various programming packages will be offered by subscription. In addition, pay-per-view films will be provided by Paramount Pictures, Sony Pictures (which includes Columbia/TriStar releases), and Turner Broadcasting. Sufficient channel capability will be dedicated to pay-per-view to provide a wide selection of programming with more convenience than a video store.

Many people have trouble deciding what to watch on television with the meager 30 or 40 broadcast and cable stations they now have, and others have still not mastered the art of programming their VCR's. An on-screen program-listing/VCR-programming service from StarSight Telecast Inc. provides both an interactive program guide and automatic VCR-timer setting. The StarSight programming information is delivered over the vertical blanking system of a local Public Broadcasting Service or over cable. The signal can be picked up by subscribers (the service is expected to cost about \$5 a month) who have StarSight-enabled televisions, VCR's, cable converters, or stand-alone decoders. The on-screen programming guide can be customized by the user to show favorite channels or types of show, such as sports, movie, comedy, or news. Users can point and click on a program that sounds interesting to get more details about it. If the user wanted to decide what to watch right now, he could scan the guide until he came to a program he wanted to see, and then press the TUNE button to go right to it. And if he wanted to tape a show that came on now or later, a press of the RECORD button makes sure that it will be taped. The system was demonstrated live at CES, and will be launched later this year, first to purchasers of select Zenith TV's that have the technology built in, and then to cable TV subscribers using cable converters made by Jerrold, Zenith, and Scientific Atlanta. Next in line: those who buy StarSight-equipped TV's or VCR's from Mitsubishi, who reached a preliminary agreement just before Summer CES.

COUCH POTATOES—RELAX!

Even those folks who are content to spend the rest of the century being passively entertained, and who prefer to remain totally *incommunicado* when away from home or the office, will be faced with

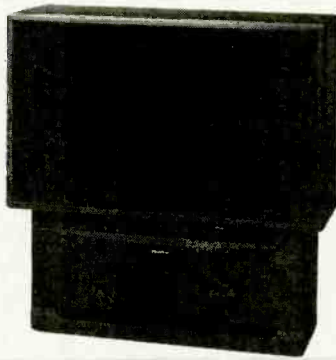

Quasar's 58-inch rear-projection set was one of many 16:9 TV's exhibited at CES.

some technology decisions when buying their next TV, audio receiver, portable listening device, and the like.

Next time you shop for a TV, you won't only have to decide what size screen to get, but also what shape. Widescreen (16:9 aspect-ratio) TV's might not really catch on until HDTV becomes a reality—or at least until more laserdiscs and videotapes are released in that format. (The old programming = consumer demand = lower prices routine.) But manufacturers aren't waiting around until then. Following Thomson's lead with their Pro Scan and RCA models, Quasar, Samsung, and Panasonic were among the exhibitors showing 16:9 sets. Quasar's entry is a 58-inch diagonal projection set that offers several viewing modes that allow the user to alter the picture to compensate for various aspect ratios. Equipped with two tuners, the set allows viewers to make the most of picture-in-picture and picture-outside-of-picture functions (a headphone jack is

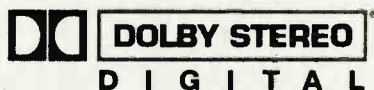

Dolby's digital optical soundtrack, used in such films as *Batman Returns*, *Aladdin*, *The Bodyguard*, and *Under Siege*, is currently being installed in theaters and should find its way into home theaters well before the turn of the century.

provided for the audio accompanying the inset picture). Also included is Quasar's Techno-Surround Sound, as well as Dolby Pro Logic center channel input for use with home-theater systems. The unit's slim (21.6-inch) depth will allow it to fit into smaller rooms, even if its high (\$6500) price tag won't fit smaller budgets.

COMING SOON TO A THEATER NEAR YOU?

Those of us who still frequent movie theaters might also be in for some changes, courtesy of Dolby Laboratories.

Dolby Stereo Digital, demonstrated at a local theater, promises "a giant step forward" in movie sound.

Along with the Dolby Stereo soundtrack that is contained as analog information on a magnetic track, Dolby Stereo Digital prints have a six-channel digital track that is located between the sprocket holes and is read by an optical sensor. The six channels are left, center, right, left-surround, right-surround, and subwoofer. The results, as demonstrated, were nothing short of impressive. We can hardly wait until the process finds its way into home applications. In the meantime, consumers will have to be content with the latest digital-audio products for the home—and for the road.

DIGITAL AUDIO: RECORDABLE AND PORTABLE

Since the demise of eight-track and reel-to-reel recorders, the audio cassette has been the medium of choice—virtually the only choice—for at-home music recordings. But we're in the digital age now, and if you're thinking of buying a new recording device, you might want to consider a digital compact cassette (DCC) deck or a MiniDisc player/recorder. No longer the big news makers at CES, both formats are moving steadily ahead, and both were shown at several exhibits. Insiders give MD a slight edge over DCC, but it's still too soon to know whether one format will win out in the end or if there's room for two recordable formats.



Philips' first portable DCC player is the Model DCC130.

For on-the-go listening, Philips debuted a portable DCC player, to be marketed this fall at a suggested price of \$549. The unit weighs only 1.1 pounds including battery and provides skip-free digital sound. The smallest portable MiniDisc player is Sharp's MD-S10, which weighs only 10.2 ounces and has been selling since the spring at a suggested price of \$549.



Sharp's MD-S10 has the distinction of being the world's smallest and lightest MiniDisc player.

PICTURE THIS!

Yet another portable-listening option was introduced at Summer CES—the portable Photo CD Player from Kodak. The unit is both a full-featured CD player, but also can be connected to any television for viewing Photo CD discs. The portable deck offers all the features of the top-of-the-line full-sized Photo CD player—allowing on-screen panning, rotating, zoom, and editing. It also adds a feature not found in



Kodak's portable Photo CD player provides continuous sound while the pictures change.

any previous Photo CD player—it can play continuous sound while pictures are being viewed, so that the sound is not interrupted as the picture changes. That makes sense for showing photos at Grandma's house as well as for portable business presentations. The PCD 970 will have a suggested retail price of \$449.

RADIO REVOLUTION

Those folks who prefer the status quo to

anything new and improved might be thinking about now: "Well at least there's still good ol' radio. That never changes."

Wrong! Whether you're shopping for a home or car receiver, there's a new option to consider: Radio Broadcast Data Service, or RBDS. The system permits encoder-equipped FM stations to send text data to RBDS receivers. So, for example, instead of seeing only 92.3, a listener might also see "K-ROCK" and call letters "WXRK" displayed when tuned to that frequency in New York. Stations would also be able to send their program format,



RBDS—Radio Broadcast Data Service—was demonstrated live on the show floor. Denon's TU-650RD home tuner was displayed at the RBDS booth, along with models from five other manufacturers.

allowing listeners to scan by formats such as "classic rock" or "jazz" instead of just by frequency.

Perhaps because the ability to scan by format rather than frequency will be particularly convenient on long car trips, the EIA's Consumer Electronics Group (EIA/CEG) set up an RBDS booth (named, somewhat misleadingly, "Video Radio") in the Car Audio & Security pavilion. Fifteen Chicago radio stations were on the air with RBDS during the show, and six manufacturers were represented in the booth: Axxess U.S.A., Delco, Denon, Goldstar, International Jensen, and Sony. RBDS automotive AM/FM/cassette units from Delco and Jensen are expected to be available early in 1994. Denon's TU-650RD home unit features an 8-character alphanumeric display on which the RBDS-broadcasting station's call letters or logo will appear. For non-RBDS stations, the user can input a identifying code. The TU-650RD will sell at a suggested retail price of \$375.



Onkyo previewed its new products, including this home RBDS tuner, in a suite at a nearby hotel.

Hoping to beat Denon to the market is Onkyo, who demonstrated its T-450RDS AM/FM tuner in an off-site hotel suite. The radio-text feature will allow the tuner to pick up additional information including artist, song and album title, and traffic reports, when broadcast by RBDS stations. The tuner, which also features 30 random station presets, direct-access tuning, automatic scan tuning, dial tuning, battery-free memory backup, and an FM-bandwidth switch, will carry a \$350 suggested retail price.

THAT'S NOT ALL, FOLKS!

It's impossible to sum up the entire Summer Consumer Electronics Show in one article—and we haven't even attempted to do so. There was plenty more to see at the show. We'll allow the high-end audio, computer, car-audio, and video-game magazines to cover those specialty areas. But for a round-up of some of this year's Innovation winners, read on. ■

And The Winners Are ...

Highlights from Innovations 93, an exhibition of 1993's Most Innovative Consumer Electronics Gear

One of the highlights of the annual Summer Consumer Electronics Show is the Innovations exhibit, where scores of new products, chosen by a panel of judges for excellence in design and engineering, are on display. The following is a small sampling of some Innovations 93 award winners, arranged alphabetically by manufacturer.

WANTED: GUY/GAL FRIDAY

Not all small businesses can afford a receptionist, and a mere answering machine can't do an adequate job. *Bogen Communications* calls its *Model FR 2000*

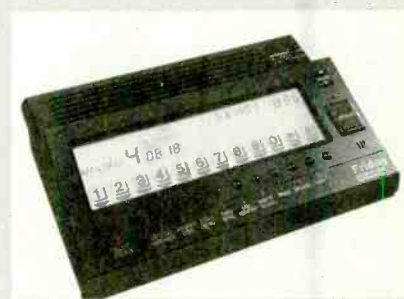

digital answering system *Friday, the Personal/Office Receptionist*. It provides call-forwarding, remote notification, and PC/fax switching functions. Eight voice mailboxes are provided, and urgent messages can be sent to a pager. Voice and visual prompts make it easy to set up and use. Friday can remind users of pending appointments, provides music-on-hold via an audio input, and never takes a coffee break, vacation day, or, we hope, a sick day.

TAKING IT (ALL) ON THE ROAD

If you can't bear the thought of missing your favorite sit-com or Howard Stern's morning tirade, you can carry around *Casio's CD-TV-100* portable AM/FM/CD/cassette-deck with a built-in 2.2-inch color LCD TV. The video boom box offers a bass-boost system and a stereo headphone jack. And should you get bored with TV, radio, tapes, and CD's, a video-game feature provides two video games.

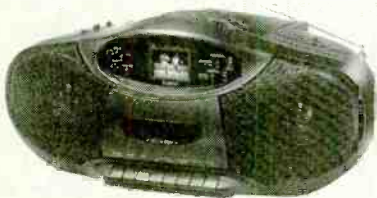

FEEL THE SOUND

Although many people are content merely *listening* to movie soundtracks, others want to *feel* them. That's what *Cerwin-Vega's* six-piece *Sensurround Compact Speaker System* is designed for. The system features a low-profile center-channel speaker; four satellites for the left, right, and surround channels; and a subwoofer. The magnetically shielded center-channel speaker obtains its low profile thanks to a 4 x 10-inch elliptical full-range speaker. The satellite speakers, which feature a five-inch woofer and one-inch dome tweeter, are also magnetically shielded. The system is available with a choice of two subwoofers, either a 10-inch or a 12-inch bass-reflex design. The dual voice-



coil design makes it easy to install the subwoofer in virtually any system.

ALL THAT JAZZ

Many titles contain audio and video just so they can use the term "Multimedia." That's not the case with *Jazz: A Multimedia History* from *Compton's NewMedia*. The CD-ROM disc contains an in-depth written history of jazz from 1923 to 1991, as well as photos, sound effects, and, of course, music. The disc also contains several short video segments of jazz legends including Charlie Parker, Dizzy Gillespie, Miles Davis, and Louis Armstrong. The multimedia features complement the text in an intelligent manner. For anyone seriously interested in jazz, we can't think of a better way to learn more about it.

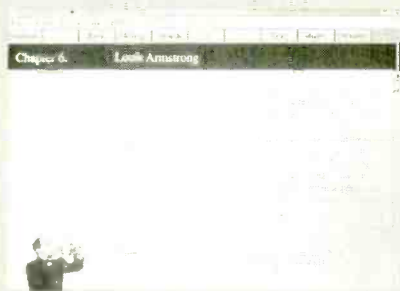

NEXT GENERATION ANTENNA

Cobra made a name for itself in the cordless phone market with its Intenna phones—the antenna is inside the handset, so there's no awkward telescoping antenna to break off or knock knick-knacks off shelves. The newest addition to the line is the *Intenna Model CP-910*, a digital 900-MHz cordless phone. The extended-range phone uses digital spread-spectrum technology for private, interference-free conversations. The relatively less crowded 900-MHz spectrum has less sources of interference than the standard 46/49-MHz



band, and spread-spectrum techniques make eavesdropping very difficult.

HOME-STYLE JUKEBOX

Take charge of your CD collection with *Fisher's Studio 24*. The 24-CD changer stores and plays discs by input names or categories. The vertical-oriented carousel makes it easy to keep track of which CD is which—and whose is whose. Discs can be categorized by type of music, owner, occasion, or disc name. Each family member can keep his or her own discs categorized eliminating the chance of Dad accidentally stumbling on Metallica when he was expecting vintage Beatles.

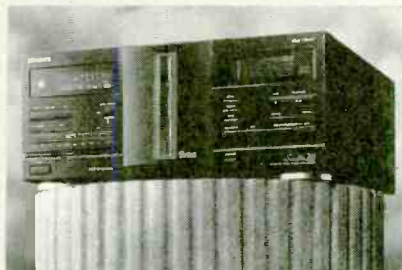

PORTABLE READER

Franklin's second-generation *Digital Book System (DBS-2)* has two significant improvements over its predecessor: It costs less (\$129), and it talks! The pocket-sized device "plays" tiny ROM cards that snap into the back of the unit. Each matchbook-sized card is a digital book containing up to 200 megabytes of information—the equivalent of 20 printed Bibles. Some of the digital books contain audio information, such as language translations or nature sounds. The DBS-2 also features a serial port for hookup to a PC.



HOME COMMUNICATIONS

The average size of houses might be decreasing, but the noise level sure seems to be on the rise. To make yourself heard over the din of stereos, TV's, Nintendo's, and the like, you can shout—or you can install *Lloyd's Clock-Radio/Intercom Sys-*



tem (Model CR-400). The inexpensive system sends voices over household AC wiring between the base clock-radio and the remote intercom station. Additional remote stations can be added throughout the house. Besides saving your vocal cords, the system can serve as a baby monitor.

KEEP IT SIMPLE

Remote controls are meant to make life easier, but today's complex models with dozens of tiny, closely-spaced buttons can make things difficult for anyone with reduced mobility, poor eyesight, or a low tolerance for complex electronics. *Mista Products* came to the rescue with the *Remote Idea*, which slips over the existing remote and provides large buttons to access the most important remote-control features, including power, volume, and channel controls. Young children, the elderly, and the technologically-impaired will find it a useful add-on.

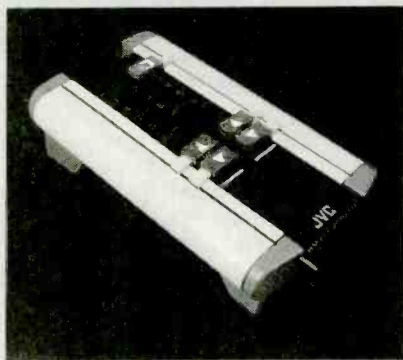

TUBE TALK

Proton Corporation, a highly regarded manufacturer of high-end video equipment, came up with a winner: the *MT-297* 27-inch, high-performance, PIP, stereo monitor/receiver. The monitor contains the performance-oriented advanced circuitry for which that Proton is famous, including ABCL (automatic brightness and contrast limiting) and DBLE (dynamic black-level extension). ABCL automatically adjusts the maximum level of the video signal to fit the linear range of picture-tube operation. DBLE compensates for shifts in black-level that can occur with various video media, especially VCR's.

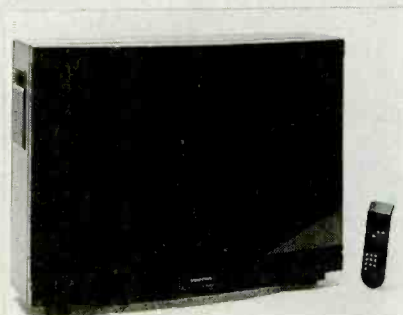

IT PAX A PUNCH

"PAX" is *Quasar's* (somewhat stilted) acronym for its line of *Phone/Answering/Fax* machines aimed at small businesses and home offices—two of which won Innovations awards. Each features an answering machine with digital outgoing message, toll-saver, and remote-caller functions, automatic switching between phone and fax, and a "help" command that prints out a brief set of instructions at the push of a button. Pictured here is the top-of-the-line *Model PAX410*, which adds a two-way speaker phone, 12 one-touch and 100 speed-dial numbers, an automatic paper cutter, and a two-line LCD that can display phone numbers and the corresponding names.



MINI MINIDISC

One of the highly touted attributes of MiniDisc is its portability. *Sanyo* is trying to make the format even more portable with its *MDG-P1* MiniDisc player. Thanks in part to two Sanyo-designed LSI (large-scale integration) integrated circuits, the player weighs just under 13 ounces and measures 3.4 x 1.4 x 5.2 inches. A two-line dot-matrix LCD readout can display track titles, the artist name, or other text included on the disc. Track number, elapsed time, and operating mode are also displayed. A remote control is contained in line with the stereo headphones, making it easier to control the player when you're on the go.



SHARP'S CUTTING EDGE CAMCORDER

Having spent several weeks using and reviewing the *Sharp Hi8 ViewCam VL-HL100U* (see *Gizmo*, September 1993), we definitely agree with the judges who presented it with an Innovations award. The ViewCam eliminates the traditional camcorder viewfinder, replacing it with a



4-inch color LCD screen. That takes the camcorder out of the videographer's face, and allows him to see and experience the big picture as he tapes it. Even shy subjects feel more comfortable with the ViewCam—which conveniently doubles as an 8mm VCR for playback of homemade or rented tapes.

PROFESSIONAL POST-PRODUCTION

The modestly priced *Video Pro-Magic* digital-art effects generator and audio mixer from *Sima* brings professional results to home-edited videos. Available at the touch of a button are three speeds of strobe effect, a paint function that allows "MTV-like" effects to be created in a variety of colors and forms, and mosaic effects using large and small patterns of both positive and negative images, picture-in-picture, and a multiscreen effect. The mixer lets you add music, narration, or both to an original soundtrack, using the included microphone.



DSP-EAKERS

Even the best speaker can sound awful in a poor listening environment. But not if *Snell Acoustics* has its way. The company's *DSP Loudspeaker/Room Correction System CQ10* addresses the interaction between the speaker and the listening room's acoustics. The system contains four independent digital signal processing IC's running at 50 MHz—the "most powerful digital signal processing hardware ever made available for consumer audio application," according to Snell. The CQ 10 features both analog and digital inputs and outputs.

Be a computer programmer!

Only NRI gives you hands-on training with the latest programming tools:

- A 486sx computer with 80 meg hard drive ■ Windows
- Visual Basic ■ Power C ■ QBasic ■ MS-DOS
- And much more!

NEW!
486sx/25 MHz
computer — the most
powerful computer
included in any
at-home training
program!

Only NRI at-home training gives you real-world programming skills in three in-demand languages: QBasic, C, and Visual Basic, today's hot new language designed for writing popular Windows applications. Best of all, you get hands-on training with a powerful new 486sx-based computer system, complete with 80 meg hard drive, Windows, and professional programming software you keep!

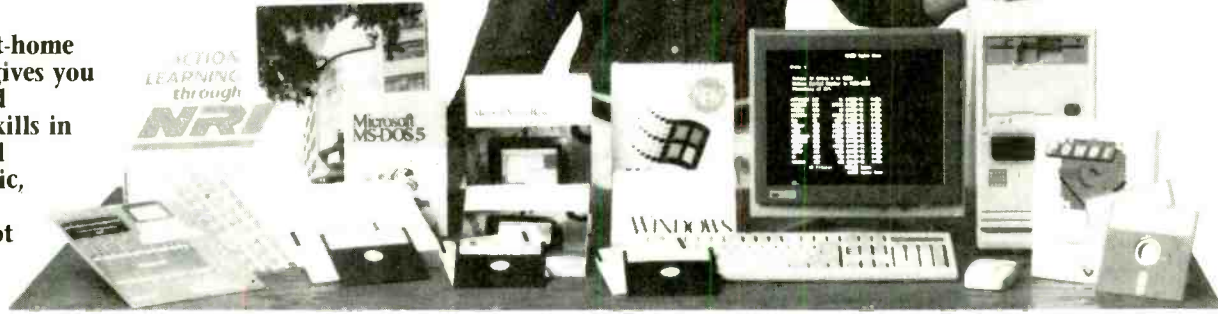

demand...including programs designed for use in a Windows environment!

Only NRI gives you first-hand programming experience with a state-of-the-art 486sx mini-tower computer system, complete with hard disk drive, a full megabyte of RAM, high-density floppy drive, mouse, monitor, and more — all yours to train with and keep!

Plus you explore the extraordinary capabilities of three in-demand programming languages. You learn to design, code, run, debug, and document programs in QBasic, C, and Visual Basic. Best of all, since Visual Basic is specifically designed for creating Windows applications, you learn to generate fully functioning Windows programs, complete with text boxes, command buttons, and other sophisticated graphical interface elements.

NRI's step-by-step lessons and hands-on programming projects help you first master the design concepts used every day by successful PC programmers. Then, with the support of your experienced NRI instructor, you quickly move on to learn programming in three of today's hottest languages.

By the time you complete your course, you have a clear understanding of programming methods, languages, and techniques... and you're ready to handle any programming task with confidence.

NRI, the leader in at-home computer training, shows you how to take advantage of today's newest programming opportunities

Get in on the ground floor of one of today's fastest-growing career fields: computer programming. The Bureau of Labor Statistics forecasts that job opportunities for programmers will increase much faster than average over the next 10 years, with as many as 400,000 new jobs opening up by 2005.

And the fastest-growing segment of programming jobs will be PC programming, fueled by the phenomenal popularity of Windows, the efficient power of C, and the ascent of exciting new languages like QBasic and Visual Basic.

Now, with NRI at-home training, you can get the new skills you need to build a top-paying career — even a full- or part-time business of your own — in this high-growth, high-opportunity field.

No previous experience necessary

Train with NRI, and immediately start getting the money-making job skills you need to be a computer programmer — no matter what your previous background.

Send today for your FREE catalog

See how NRI at-home training gives you the programming know-how, the computer, and the software you need to get started in this top-paying field. Send today for your FREE catalog!

If the coupon is missing, write to us at the NRI School of Computer Programming, McGraw-Hill Continuing Education Center, 4401 Connecticut Avenue, NW, Washington, DC 20008.

IBM PC/AT is a registered trademark of the IBM Corporation. Windows, QBasic, and Visual Basic are trademarks of Microsoft Corporation.

NEW! The only programming course that includes a powerful 486sx-based computer, 80 meg hard drive, Windows, Visual Basic, and more — all yours to keep!

Right from the start, NRI gets you actively involved in the challenge of real-world programming. Step by step, you learn to create the kinds of full-featured, powerful programs today's employers and clients

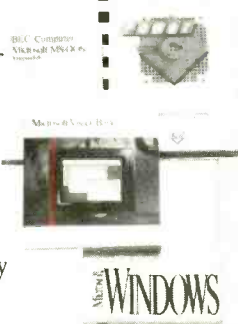

SEND COUPON TODAY FOR FREE NRI CATALOG!

NRI Schools

McGraw-Hill Continuing Education Center
4401 Connecticut Avenue, NW, Washington, DC 20008

Check one FREE catalog only

COMPUTER PROGRAMMING

PC Applications Specialist

Programming in C++ with Windows



For career courses
 approved under GI Bill,
check for details

Other Computer Career Courses

Microcomputer Servicing

Desktop Publishing

Bookkeeping and Accounting

Computer-Aided Drafting

Name (please print) _____ Age _____

Address _____

City/State/Zip _____

Accredited Member, National Home Study Council

5413-1093

NAMES AND ADDRESSES

APPLE COMPUTER INC.
20525 Mariani Avenue.
MS 482
Cupertino, CA 95014
CIRCLE 50 ON FREE INFORMATION CARD

AT&T
Consumer Products Division
5 Wood Hollow Road
Parsippany, NJ 07054
CIRCLE 51 ON FREE INFORMATION CARD

BOGAN COMMUNICATIONS, INC.
50 Spring Street
P. O. Box 575
Ramsey, NJ 07446
CIRCLE 52 ON FREE INFORMATION CARD

CASIO, INC.
570 Mt. Pleasant Avenue
P. O. Box 7000
Dover, NJ 07801
CIRCLE 53 ON FREE INFORMATION CARD

CERWIN-VEGA
55 East Easy Street
Simi Valley, CA 90010
CIRCLE 54 ON FREE INFORMATION CARD

COBRA ELECTRONICS
CORPORATION
6500 West Cortland Street
Chicago, IL 60635
CIRCLE 55 ON FREE INFORMATION CARD

COMPTON'S NEWMEDIA
2320 Camino Vida Roble
Carlsbad, CA 92009
CIRCLE 56 ON FREE INFORMATION CARD

DENON AMERICA, INC.
222 New Road
Parsippany, NJ 07054
CIRCLE 57 ON FREE INFORMATION CARD

DIRECTV, INC.
P. O. Box 92424
Los Angeles, CA 90009
CIRCLE 58 ON FREE INFORMATION CARD

DOLBY LABORATORIES
100 Potrero Avenue
San Francisco, CA 94103-4813
CIRCLE 59 ON FREE INFORMATION CARD

EASTMAN KODAK COMPANY
343 State Street
Rochester, NY 14650
CIRCLE 60 ON FREE INFORMATION CARD

EIA/CEG
2001 Pennsylvania Ave. NW
Washington, DC 20006-1813
CIRCLE 61 ON FREE INFORMATION CARD

ELECTRONIC ARTS
1450 Fashion Island Blvd.
San Mateo, CA 94404-2064
CIRCLE 62 ON FREE INFORMATION CARD

EO, INC.
800A East Middlefield Road
Mountain View, CA 94043
CIRCLE 63 ON FREE INFORMATION CARD

FISHER
21350 Lassen Street
Chatsworth, CA 91311-2329
CIRCLE 64 ON FREE INFORMATION CARD

FRANKLIN ELECTRONIC
PUBLISHERS, INC.
122 Burrs Road
Mt. Holly, NJ 08060
CIRCLE 65 ON FREE INFORMATION CARD

LLOYDS ELECTRONICS
Division of Cobra
6500 West Cortland St.
Chicago, IL 60635
CIRCLE 66 ON FREE INFORMATION CARD

MISTA PRODUCTS INC.
27 East Mall
Plainview, NY 11803
CIRCLE 67 ON FREE INFORMATION CARD

MITSUBISHI ELECTRONICS
AMERICA, INC.
5757 Plaza Drive
Cypress, CA 90630
CIRCLE 68 ON FREE INFORMATION CARD

ONKYO U.S.A. CORPORATION
200 Williams Drive
Ramsey, NJ 07446
CIRCLE 69 ON FREE INFORMATION CARD

PANASONIC COMPANY
One Panasonic Way
Secaucus, NJ 07094
CIRCLE 70 ON FREE INFORMATION CARD

PHILIPS CONSUMER ELECTRONICS
COMPANY
One Philips Drive
Knoxville, TN 37914
CIRCLE 71 ON FREE INFORMATION CARD

PROTON CORPORATION
16826 Edwards Road
Cerritos, CA 90701
CIRCLE 72 ON FREE INFORMATION CARD

QUASAR COMPANY
1707 N. Randall Road
Elgin, IL 60123-7847
CIRCLE 73 ON FREE INFORMATION CARD

SAMSUNG ELECTRONICS AMERICA,
INC.
105 Challenger Road
Ridgefield Park, NJ 07660
CIRCLE 74 ON FREE INFORMATION CARD

SANYO FISHER (USA) CORP.
21350 Lassen St.
P. O. Box 2329
Chatsworth, CA 91311-2329
CIRCLE 75 ON FREE INFORMATION CARD

SHARP ELECTRONICS
CORPORATION
Sharp Plaza
Mahwah, NJ 07430
CIRCLE 76 ON FREE INFORMATION CARD

SIMA PRODUCTS CORPORATION
8707 North Skokie Blvd.
Skokie, IL 60077
CIRCLE 77 ON FREE INFORMATION CARD

SNELL ACOUSTICS
143 Essex Street
Haverhill, MA 01832
CIRCLE 78 ON FREE INFORMATION CARD

SONANCE
961 Calle Negocia
San Clemente, CA 92673
CIRCLE 79 ON FREE INFORMATION CARD

STARSIGHT TELECAST, INC.
39650 Liberty Street
Third Floor
Fremont, CA 94538
CIRCLE 80 ON FREE INFORMATION CARD

TANDY CORPORATION
700 One Tandy Center
Fort Worth, TX 76102
CIRCLE 81 ON FREE INFORMATION CARD

THE 3DO COMPANY
1820 Gateway Drive
San Mateo, CA 94404
CIRCLE 82 ON FREE INFORMATION CARD

THOMSON CONSUMER
ELECTRONICS/HUGHES
COMMUNICATIONS
600 N. Sherman Drive
Indianapolis, IN 46201
CIRCLE 83 ON FREE INFORMATION CARD

TURBO TECHNOLOGIES, INC.
6701 Center Drive West
Suite 500
Los Angeles, CA 90045
CIRCLE 84 ON FREE INFORMATION CARD

VIDEONICS, INC.
1370 Dell Avenue
Campbell, CA 95008-6604
CIRCLE 85 ON FREE INFORMATION CARD

ZENITH ELECTRONICS
CORPORATION
1000 Milwaukee Avenue
Glenview, IL 60025
CIRCLE 86 ON FREE INFORMATION CARD

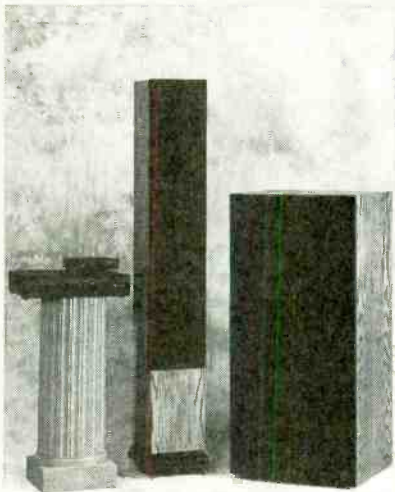

A MOVING SPEAKER

In-wall speakers can't be moved around once they're installed. But the *Sonance S3500* in-wall high-fidelity loudspeaker provides some welcome flexibility. The speaker incorporates a pivoting tweeter that allows the high frequencies to be directed toward the listening area, even if aesthetics dictate that the speaker be mounted in a less-than-optimum position. The pivoting tweeter might be especially useful for in-ceiling mounts. High- and low-frequency adjustments are also featured.

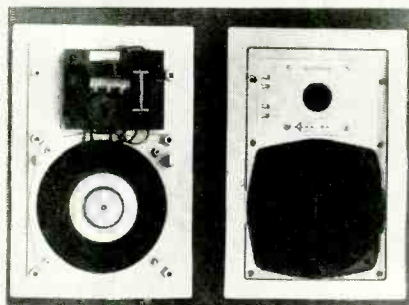

DOUBLE YOUR FUN

With this item, your kids will be in double the trouble if you're already on their case about spending too much time video-gaming. *Turbo Technologies' Duo* is an integrated CD-ROM and cartridge-based video-game system. It not only plays video games, including SuperCD's,

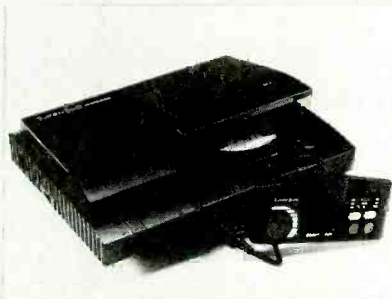

but also plays audio CD's and CD+G discs. A karaoke attachment is available, and next up is an interface device that will convert the Duo into an external CD-ROM drive for personal computers.

DIGITAL VIDEO-MIXER

Now you can take all of your boring camcorder footage and turn it into exciting, professional-looking entertainment. *Videonics' Digital Video Mixer* can create over 200 broadcast-quality special effects. Its dual-field timebase corrector (TBC)



makes it possible to mix two video images without glitches. One image can be dissolved into another, or a new image can wipe over an old one. Chroma keying makes it possible to add a new background to existing footage. Up to four sources can be switched by the mixer. ■

You Beeped?

BRAVO EXPRESS PAGER. From: Motorola, Americas Paging Products Division, 1500 N.W. 22nd Avenue, Boynton Beach, FL 33426-8292. Price: \$199.99.

Contrary to popular belief, pagers aren't just for doctors. In fact, more construction workers use pagers than doctors and other medical workers combined. Lawyers use pagers to receive new facts even while they are in court. Stockbrokers use pagers to keep up to date on stock prices and financial news. Home-office workers keep in touch with clients even if they leave home. Other businesses have found innovative uses for pagers. Car-repair shops provide pagers to customers who are having their cars repaired. And restaurants who don't want their waiting areas overflowing provide customers with pagers so that they can wander or shop nearby. More nefarious users—ones who have given pagers a bad rap with potential customers—include drug dealers and call girls.

In reality, roughly 14 million Americans use pagers. Drug dealers account for a scant 1%. Interestingly, about 20%–25% use pagers not for business, but for personal communications. In the busy 1990's,

teenagers, single parents, two-career spouses, and housewives have begun carrying beepers to help them keep in touch with their family and friends. In fact, it's the consumer market that's expected to create a surge of growth in the pager industry, with Motorola predicting that 50 mil-

lion of the little devices will be beeping away by the turn of the century, and promising to make pagers "as common as phones by the end of the decade."

The industry is doing all it can to make those predictions a reality. Compared to the 1970's, when pagers cost about \$300



CIRCLE 87 ON FREE INFORMATION CARD

and monthly service fees ran between \$30 and \$50 a month, pagers in the 90's are available for less than \$100—in a choice of designer colors, no less—and fees are as low as \$10. Some service companies have even tailored special rate structures for consumers, who are unlikely to receive anywhere near the number of pages per month as a doctor would. Such services charge a low, flat rate per number of pages (30, 60, or 100), even if it takes two years for the owner to receive that many pages.

In their aggressive pursuit of consumers, pager manufacturers have formed the Paging Services Council, to actively educate the public about the advantages of pagers. We'll help them out by explaining precisely what pagers are, how they work, what options are available, and how consumers can put them to use. Then we'll discuss our try-out of *Motorola's Bravo Express*.

A PAGER PRIMER

Pagers are not particularly high-tech gadgets. In general, a person buys or leases a pager and he signs up with a local paging service that covers an area with up to a 200 mile radius. There also are some national and even global services. Every pager has its own dedicated phone number (their rise in popularity contributed to the need for the addition of a "718" area code to supplement New York City's "212"), and every pager service is assigned its own radio frequency. When someone calls a pager number, after a short tone, the caller enters the phone number where he can be reached. The paging company routes that information to a radio transmitter to be relayed to the pager. The pager then beeps (hence the nickname "beeper") or vibrates to alert the user to a message.

There are four basic types of beepers: numeric, alphanumeric, tone-only, and tone and voice. They differ primarily in the way that messages are received.

The numeric pager, which has a small screen on which up to 20 numbers can be displayed, is by far the most popular type (77% of total sales). Among consumer users, numeric pagers account for a whopping 95%. When a page is received, the caller's phone number appears on the screen. The extra space on the screen can be used to input coded messages. For example, children or teenagers might see their home phone number displayed followed by "1-2-3", the family's code for "Come home immediately." Busy, but still romantic, couples have devised codes for "I love you" and various other sweet nothings. A man who had to attend a church function that unfortunately coincided with a big football game managed to stay tuned by having his son (at home in front of the tube) page him after each touchdown or field goal. Their pre-ar-

Basic Radio Paging System

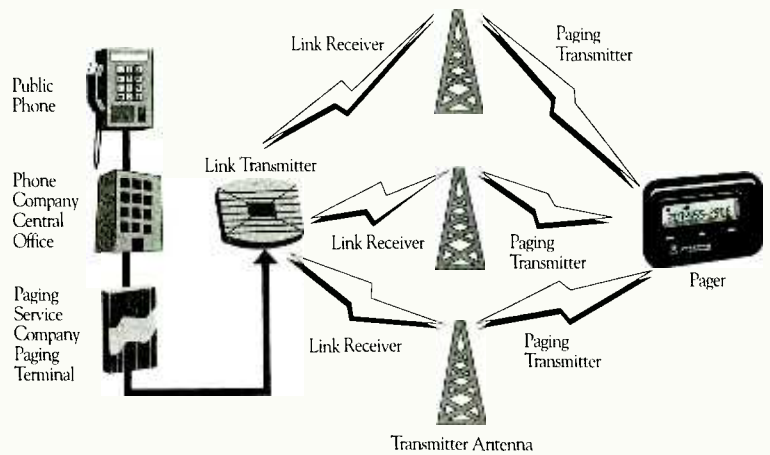

Source: Paging Services Council

When a caller dials the pager number, the call is received by a paging terminal or control center. The center then sends the message by wire or radio signal to a paging transmitter. From there, the message is broadcast over the radio waves on a frequency dedicated to the paging service. As long as the pager is in the coverage area, it will receive the message.

ranged code was the home team's score, a star, and then opponents score. With the pager, in its vibrating mode, attached to his shoe, the man could see the score without disturbing the meeting. Numeric pagers cost about \$100; monthly local service fees average \$11-\$17.

Second in popularity is the tone-only pager, the least sophisticated and least expensive (\$70-80) type. The unit simply beeps to indicate that a call has been received. The user then knows to call the pre-determined number—the home office, for example. Obviously, a tone-only pager is not useful if you want to be in contact with several people, although most of today's tone-only pagers can emit two different tones, to indicate one of two numbers to be called. Hospitals that provide beepers to expecting couples in the last month of pregnancy—so that the husband can always be reached for the big event—often use tone-only pagers for that purpose.

A tone-and-voice pager emits first a tone, and then an actual voice message. A person calls the pager number and leaves a recorded message. The pager plays back the message in the caller's own voice. The average price of tone-and-voice pagers ranges from \$225 to \$300, and monthly service costs average \$25-\$30—one factor that keeps their market share low.

Primarily used by business people, alphanumeric pagers cost between \$200 and \$250. Both numbers and letters can be displayed on a relatively large screen. Some alphanumeric pagers can receive messages up to 80 characters long, so the

user can get a complete message without having to return a call. The caller speaks to an operator at the paging service, who types the message into the system's network. (Some paging companies offer software that can be used to enter messages from a computer. Dedicated portable keyboards are also available.) The pager alerts the user that a message has been received, and the text appears on the screen. Fairly standard alphanumeric features include the ability to store up to 20 messages, and an on-screen time and date display. Alphanumeric service starts at about \$25 per month. If an operator is required to input text messages, the cost increases to about \$38 per month.

Most pagers are used locally, and the fees quoted in this article are for local service. There are some nationwide paging companies, however, and a six-year old service called Skypager will beep a pager user anywhere near a city in the United States, Mexico, Canada, Singapore, and Hong Kong. For consumer use, local service is generally sufficient, unless, of course, a person travels frequently or wants to keep in touch with out-of-town family members.

It's possible to subscribe to more than just the basic service. Some pager companies charge a monthly fee to send weather reports, sports updates, news headlines, and stock prices to pager users. Voice mail is another optional service. Callers leave recorded messages that pager users retrieve by calling the paging service. That service generally costs an extra \$5 or \$10 a month.

ABOARD THE BRAVO EXPRESS

The Bravo Express is a small, rugged numeric pager. It measures roughly 2×3 inches and is about a half-inch thick. The front panel of the pager features a 12-digit LCD and three buttons. Although not labeled, they function as a read button, a menu button, and a select button. The read button turns the pager on. A round annunciator in the top left corner of the display indicates that the pager is active. Whether the pager is on or off, a clock is normally displayed. Although the backlit LCD readout is capable of displaying letters, it can't print out messages from people who are trying to page you. It can, however, show messages from the pager itself. (PAGER OFF, for example.)

The Bravo Express is available in 12 colors, ranging from neon green to black. Our sample had a clear plastic case. Motorola also offers plastic covers that will help the self-conscious teenager color-coordinate the pager with their colors from Benetton, or Guess jeans, or neon-tued gym wear. The covers have a clip on back that allow the beeper to be worn on a belt, purse, or just about any piece of clothing.

When a page is received, the pager emits an alert for eight seconds. Rather than a simple beep, the pager emits what Motorola calls "musical alert tones." To us, it sounded something like a modern phone ringing. If you would prefer to be more discrete, you can turn off the alert tones and put the pager into is vibrator mode instead. When pages are received in that mode, the Bravo Express vibrates for about five seconds.

The Bravo Express has an automatic

timer function that can help maximize the life of the single "AAA" battery required to power it. The automatic timer allows you to set the times at which the pager will come on and turn off. You might want business associates to be able to reach you only between the hours of 8:00 AM and 6:00 PM. The timer would make sure that the unit was always on when you wanted to receive pages, and off at other times to conserve battery life (and give you some privacy during off hours). We found that feature to be valuable because we didn't have to remember to turn the pager on or off.

All of the pager functions are accessed through an easy-to-use menu system. Hit the menu button once, and the display reads "silent?" If you push the select button at that prompt, the pager enters its vibrating mode. The "pager off?" prompt lets you turn the pager off by pressing the select button. Selecting the third menu option—"pgr auto?"—puts the pager into its automatic timed-operation mode. "Set auto?" lets you set the hours for auto operation, and "set time?" lets you set the clock.

When you select an option, the menu prompts change accordingly. For example, if you selected the silent operating mode, the next time you scrolled through the menu, your choice would be "audio?" If you are in the automatic timed mode, the menu prompt "pgr manual?" appears.

Up to 160 characters can be stored in the pager's memory; each message can contain 20 characters. If messages are currently stored in memory, a "clear?" prompt also appears. Up to four stored

messages can be "locked" to prevent them from being erased or overwritten.

The Bravo Express performed flawlessly, as far as we could tell, during our tests. But it wasn't able to meet our communications needs—not due to any limitations in the pager itself, but in the pager service.

We are usually available at our office on any given day, and are homebodies during off hours. The only time that we can't be reached is when we are out of town. Usually, calling our voice-mail system at the office, and answering machines at home, for messages is sufficient—most calls don't require an immediate response. On a trip to Florida, we did have a need to be reached quickly—contractors were working on a remodeling project in our absence, and several decisions needed to be made long-distance.

Like all other pagers, the Bravo Express is factory preset to receive messages at a certain radio frequency. That's why it's important to determine which service you want to use *before* you buy a pager. Even those that are sold at retail outlets have been designed to work at the frequency used by one specific paging company in your area. In our case, Metromedia Paging was our provider, and our pager was designed to operate on a frequency of about 931.9 MHz in the New York metropolitan region. Unfortunately, Metromedia Paging does not provide service in Florida, so we couldn't have our pager activated in the Miami area.

For our needs, we'd prefer a nationwide alphanumeric pager, which usually sends signals over an SCA subcarrier on a network of FM stations. As you might expect, however, such pagers are more expensive, more than twice the price of the Bravo Express. The monthly fee for the paging service is also more expensive. To meet most personal pager needs, however, local coverage is sufficient.

Pagers have a lot to offer the average person. Precisely because they are low-tech, anyone can learn to use one in a matter of minutes. Pagers are efficient time-savers. But the most valuable thing pagers offer is peace of mind. These days, kids' schedules are just as hectic as their parents'—and working moms aren't always home to field phone calls or pick someone up early if soccer practice is canceled. By allowing people to stay immediately accessible to family and friends, pagers not only make it easy to keep track of family members that are running off in a dozen different directions, they also offer reassurance to working parents, latchkey kids, and babysitters.

If the pager industries can get that peace-of-mind message across to the general public, they're sure to make a splash with consumers. ■



The Bravo pager is available in a wide range of cover and case colors. The covers have a handy clip on the back.

A Hands-on Electronics REPORT

DYNAART DESIGNS TONER TRANSFER SYSTEM

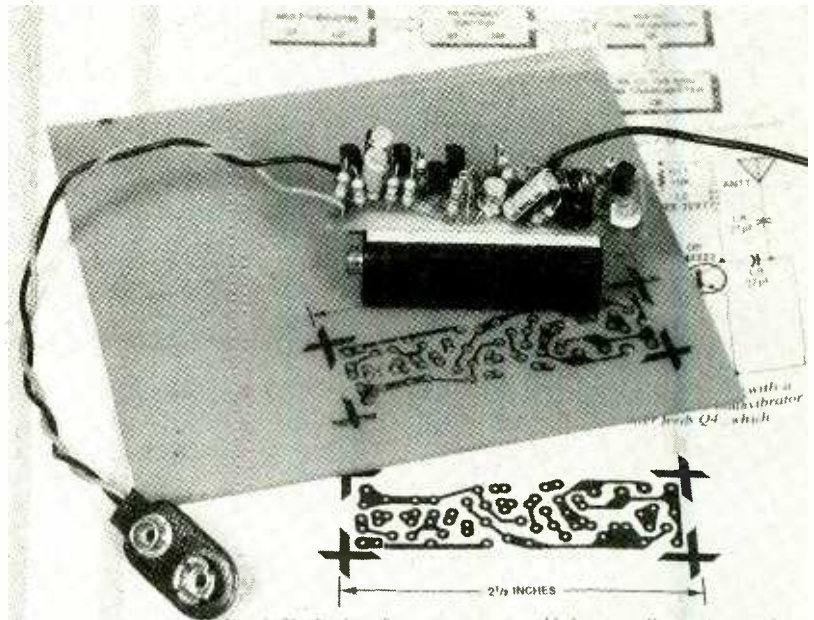

Fig. 5 The Tracking Transmitter was assembled on a small printed circuit board measuring only 2 1/2 inches long by 1 1/2 inches wide. Because of its size, the active components (all resistors and 11) must be mounted vertically.

CIRCLE 119 ON FREE INFORMATION CARD

Homebrew printed-circuit boards that once took hours to make now take just minutes!

You've probably heard all about techniques for transferring printed-circuit art to copper-clad boards so that you can etch a snappy, clean, and clear foil pattern. Well, if you've tried using one of those methods, as I have, you have likely ended up with fuzzy, sometimes-incomplete foils that make the entire attempt worthless!

It's no wonder then that when the new DynaArt-Designs Toner Transfer System came out it was met with general skepticism. I reacted the same way until I heard a ham on two meters make a favorable comment about it. So I gave the system a try on my next project.

The Inside Story. It is common knowledge in the graphics industry that common copier and laser-printer toner consists of about 50% pulverized plastic. As it turns out, the plastic makes an excellent etch resist for the fabrication of printed-circuit boards. So, some have unsuccessfully attempted to transfer a foil design from a laser printer or copier to paper, and from there, to a copper-plated

PC board. Such methods have failed, mostly because as the paper travels through the printer or copier, the toner deposited onto the paper is melted, or fused, locking the toner into the fibers of the paper. After that the paper is reluctant to release at least part of the toner to the copper.

DynaArt Designs' solution is a Toner Transfer System that contains a "transfer paper" that has a special coating to accept the toner—the toner is not deposited on, or fused to, the actual paper surface, but to the coating instead. Once a foil pattern is printed on one of these sheets, it is then placed toner-side down on a copper-clad board. The paper, and so the board underneath, are then heated again so that the toner on the paper fuses to the copper. When this board/toner/paper sandwich is then placed in a bowl of water, the special coating dissolves, releasing the paper and leaving the toner fused to the copper. What you end up with is a faithful reproduction of the foil pattern (the toner/etch-resist) bonded to the copper-clad board. The board is now ready for the etching bath.

It's that simple and note: No chemicals other than tap water are used to prepare the board for etching. In fact, even the soluble surface on the paper is non-toxic and washes away quickly.

Transferring to the Paper. If you have a home computer with an optical scanner and laser printer, you can scan-in a foil pattern from a magazine page, then print it out on the DynaArt Designs transfer paper. If not, you may know someone who has a system at home or office that can do it for you. Should the scanned foil pattern be less than perfect, you can retouch the image on the computer screen. Retouching can eliminate the most common problem: the loss of lead holes in the center of solder pads.

Alternatively, you could make photocopies. First, you run off copies of the magazine foil pattern, adjusting the density control till you get a very sharp reproduction with no gray areas. When that is achieved, load the copier with the transfer paper so the shiny side receives the image.

1-800-831-4242

Your Resource for Value. Only a Phone Call Away.

20
YEARS OF
EXCELLENCE
1973-1993

Metex Digital Multimeters

- Handheld high accuracy
- Measures AC/DC voltage, AC/DC current, resistance, diodes, audible continuity test, transistor hFE
- Manual ranging w/overload protection
- Comes with probes, batteries, case and manual
- One-year warranty



OP27158

OP27086 & OP27158 only:
• Also measures frequency and capacitance

Part No.	Description	Price
OP27078	3.5 digit multimeter	\$59.95
OP27086	3.5 digit multimeter w/frequency & capacitance	74.95
OP27115	3.5 digit multimeter	39.95
OP27140	4.5 digit multimeter, w/tach/dwell	59.95
OP27158	4.5 digit w/frequency & capacitance & data hold switch	99.95

Jameco Solderless Breadboards

Our long-lasting breadboards feature screen printed color coordinates and are suitable for many kinds of prototyping and circuit design. Larger models feature heavy-duty aluminum backing with voltage and grounding posts.



OP20757

Part No.	Terminal Strips	Bus Strips	Contact Points	Price
OP20343	0	2	200.....	\$3.49
OP20600	1	2	400.....	4.95
OP20669	1	0	630.....	5.95
OP20722	1	2	830.....	6.95
OP20757	2	1	1,360.....	12.95
OP20773	2	4	1,660.....	17.95
OP20790	3	5	2,390.....	24.95
OP20811	4	7	3,220.....	32.95

Regulated Power Supply Kits

Build the power supply you've been needing for years. Ideal for home or instructional use. Select from three different versions. Each kit is complete with printed circuit board, electronic components and user assembly instructions.



OP73613

Part No.	Product No.	Input Voltage (VAC)	Output Voltage (VDC)	Current (mA)	Dimensions (L x W x H inches)	Price
OP20360	JE200	120	+5	1000	3.5 x 5.0 x 2.0	\$14.95
OP20626	JE215	120	+5 to +15 -5 to -15	750 to 175 750 to 175	3.5 x 5.0 x 2.0	19.95
OP73613	JE225	120	+5 fixed +3 to +12 -3 to -12	1000 100 100	5.12 x 5.12 x 2.25	29.95

See our Catalog for more kits

EPROMS

Part No.	Product No.	Price
OP33611	TMS2716	\$5.95
OP39909	2708	4.95
OP40002	2716	4.49
OP40125	2732A-25	4.49
OP40230	2764A-20	4.75
OP39829	27C64-15	4.49
OP39933	27128-25	7.75
OP39968	27128A-20	4.95
OP39984	27128A-25	3.95
OP39677	27C128-15	5.75
OP40037	27256-15	5.49
OP40061	27256-25	4.75
OP39714	27C256-15	5.25
OP39722	27C256-20	4.95
OP40150	27512-20	6.95
OP39781	27C512-15	6.49
OP65699	27C020-15	10.95
OP43692	68766-35	4.95



OP26622 OP21936

Switches

Part No.	Product	Description	Price
OP21936	JMT123	SPDT, on-on (toggle)	\$1.15
OP38842	206-8	SPST, 16-pin (DIP)	1.09
OP26622	MS102	SPST, momentary (push-button)	.39

*Additional components available



National, Intel & TI Databooks

Part No.	Product No.	Description	Price
OP79071	400061	National Operational Amplifier Linear Devices Databook	\$14.95
OP79089	400060	National Linear Application Specific IC's Databook	12.95
OP41208	400015	National Data Acquisition Linear Devices Databook	11.95
OP79062	400062	National Power IC's Linear Devices Databook	11.95
OP88225	—	Texas Instrument LS/S/TTL Databook	24.95
OP39280	230843	Intel Memory Databook	24.95
OP39870	270645	Intel Embedded Controller Processors Databook	24.95

3/4 Watt Linear Taper-1.5 Turn Cermet Potentiometers

Part No.	Ohms	Price
OP41785	1K	\$0.99
OP41822	10K	.99
OP41849	100K	.99
OP41806	1MEG	.99



1/2 Watt Linear Taper- Single Turn Cermet Potentiometers

Part No.	Ohms	Price
OP42964	1K	\$0.89
OP43001	10K	.89
OP43027	100K	.89
OP42981	1MEG	.89



SMT product now available!
Call for price and availability

Other Jameco Resources

- Test/Measurement and Prototyping Equipment
- Full line of Integrated Circuits and Electronic Components
- Call for computer parts

Integrated Circuits*

Part No.	Product No.	Price
OP48979	7400	\$0.29
OP49015	7402	.39
OP49040	7404	.39
OP49091	7406	.39
OP49120	7407	.39
OP49146	7408	.39
OP49189	7410	.29
OP49728	7417	.35
OP50008	7420	.35
OP50235	7432	.39
OP50420	7447	.89
OP50551	7474	.39
OP50593	7476	.59
OP50665	7486	.39
OP50681	7489	2.95
OP50690	7490	.79
OP49322	74121	.49
OP49912	74192	.99
OP49939	74193	.99

*Name brand IC's in stock

Order toll-free 1-800-831-4242

Call or write for your FREE Summer Component Catalog:
1-800-637-8471



JAMECO™
ELECTRONIC COMPONENTS
COMPUTER PRODUCTS

For International Sales, Customer Service, Credit Department and all other inquiries: Call 415-592-8097 between 7AM-5PM P.S.T.

CA Residents please add applicable sales tax.

\$30.00 Minimum Order

Terms: Prices subject to change without notice. Items subject to availability and prior sale. Complete list of terms/warranties is available upon request.

© 1993 Jameco 10/93 All trademarks are registered trademarks of their respective companies.

1355 Shoreway Road
Belmont, CA 94002
FAX: 1-800-237-6948 (Domestic)
FAX: 415-592-2503 (International)



Mention V.I.P.# OP3

CIRCLE 156 ON FREE INFORMATION CARD

www.americanradiohistory.com

After printing, or copying the foil pattern should be inspected with a lens, or preferably with a 10× loupe (available at art-supply and photography stores), paying particular attention to any circuit paths that run in directly the same direction as the paper path through the printer or photocopier. Those lines are the most difficult to get completely black and without dropouts. A dropout will appear as thin white lines in the middle of thin traces.

By the way, slight dropouts do not necessarily mean that the pattern can't be used. When the pattern is fused to the copper surface (which we'll discuss shortly), the melting action will tend to fill-in (or smear-in) dropouts. So, even if the pattern is of poor quality at this point, the user should continue on and transfer the pattern to the copper. Then the pattern should be inspected again to see if the dropouts have healed.

Transferring to the Board. The copper-clad board should be thoroughly cleaned so that the copper surface is

nice and bright. A scouring pad or sponge and a mildly abrasive cleanser are recommended for this. One should also lightly file the edges of the board because copper burrs at the edges will prevent the paper from resting flat on the copper. Next you cut the foil pattern from the transfer sheet and place it over the copper-clad board.

Now you must use heat to fuse the toner onto the board. For that, you simply use your clothes iron. Adjust it to its highest "cotton" setting, which is about 300°F. If a steam iron is used, all its water must be drained and the iron left to heat up until all traces of steam disappear. Before using the iron, fill a bowl of water so you can dunk the copper-clad board immediately in it after the heat is removed from the board.

While the iron heats up, secure the transfer sheet to the PC board with a bit of tape to prevent the paper from moving. Next, place a supplied translucent sheet over the transfer paper to protect the paper and copper from chaffing, and to provide a smooth gliding surface for the iron.

To perform the actual transfer, the iron should then be moved in circles over the paper/board assembly while applying very little pressure; the iron's weight should suffice. The board should be heated for 1-½ to 11 minutes, depending on the size of the board (larger boards, of course, take longer).

Next, place the board in the water and leave it be for a few minutes. When the paper floats away, just remove the board and shake off the water droplets. Inspect the board with the loupe or magnifying glass to be sure you have a good resist foil pattern on the board. If you do, place the board in the etching bath and finish off as you would normally.

However, if the pattern is defective, clean the copper surface and transfer the foil again. Try to determine what went wrong. Usually the problem is too little heat, or poorly distributed heat

My Test. The truth of the matter is that the system is very easy to use. True, there are some variables, such as toner quality, transfer pressure, heat, etc., that affect the results, but they are discussed in the instructions that ac-

company the system. In fact, my very first board was perfect. So were a few others. I did goof on two boards because I was sloppy. (I suppose success came too easily.) My fingernail scratched the resist of one board as I transported it to the etching solution and another did not receive enough heat. I have made many printed-circuit boards since then, one being 150 × 175 millimeters, and each board was a gem.

There's a Bonus. You can also make decals with the toner-transfer paper. First off, you need to design the decal. For decal work, you can use a color copier, so let your creative imagination have at it. Then, print it on the transfer paper using an appropriate copier, or a laser printer. Trim the paper to about the size of the printed area leaving about a ½-inch border.

Apply three light coats of spray lacquer, letting each coat dry before proceeding with the next. When dry, retrim all four sides of the print to remove any lacquer buildup that will occur at the edges of the paper. Place the decal paper in a bowl of water and soak the print for about one minute. Carefully lift the paper out of the water and slide the lacquer decal from the paper to the surface where the decal will adhere.

Prices range from \$14.95 for a packet of five 8-½ × 11 transfer sheets and a protective sheet, to about \$27.95 for a larger packet of 10 transfer sheets and a protective sheet. I think the DynaArt Designs Toner Transfer System is a winner. If you think it might be also, write or call DynaArt Designs for details at 3535 Stillmeadow Lane, Lancaster, CA 93536; Tel. 805-943-4746 or circle No. 119 on the Free Information Card. ■

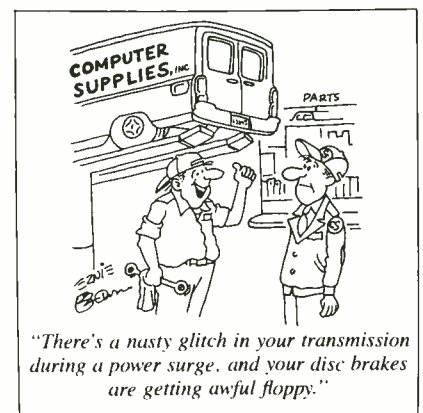

HOME FIRE SAFETY. ACT ON IT!



**FOR FREE HOME FIRE
SAFETY TIPS, WRITE:**

**United States
Fire Administration
P.O. Box 70274
Washington, DC 20024**



Just like these Fully Trained Electronics Professionals



"Thanks to CIE I have tripled my previous salary, and I am now in a challenging and rewarding new field where only the sky is the limit."

Daniel Wade Reynolds
Industrial Electrician
Ore-Ida Foods



"CIE was recommended to me by my boss. It was appealing since I could study at my own pace at home and during business travel."

Dan Parks
Marketing Manager/Consumer Products
Analog Devices, Inc.

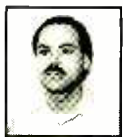

"I loved the flexibility CIE offered. It was the only way I could continue both school and my demanding job."

Britt A. Hanks
Director of Engineering
Petroleum Helicopters, Inc.



"I liked the way the school was set up with laboratory assignments to enforce conceptual learning. The thing which impressed me the most about CIE's curriculum is the way they show application for all the theory that is presented."

Daniel N. Parkman
Missile Electro-Mechanical Technician
U.S. Air Force



"Completing the course gave me the ability to efficiently troubleshoot modern microprocessor based audio and video systems and enjoy a sense of job security."

Tony Reynolds
Service Manager/Technician
Threshold Audio & Video

Graduate with an Associate Degree from CIE!

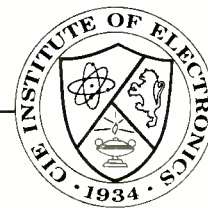

CIE is the best educational value you can receive if you want to learn about electronics, and earn a good income with that knowledge. CIE's reputation as the world leader in home study electronics is based solely on the success of our graduates. And we've earned our reputation with an unconditional commitment to provide our students with the very best electronics training.

Just ask any of the 150,000-plus graduates of the Cleveland Institute of Electronics who are working in high-paying positions with aerospace, computer, medical, automotive and communications firms throughout the world. They'll tell you success didn't come easy...but it did come...thanks to their CIE training. And today, a career in electronics offers more rewards than ever before.

CIE'S COMMITTED TO BEING THE BEST...IN ONE AREA...ELECTRONICS.

CIE isn't another be-everything-to-everyone school. CIE teaches only one subject and we believe we're the best at what we do. Also, CIE is accredited by the National Home Study Council. And with more than 1,000 graduates each year, we're the largest home study school specializing exclusively in electronics. CIE has been training career-minded students for nearly sixty years and we're the best at our subject...
ELECTRONICS... IT'S THE ONLY SUBJECT WE TEACH!

CIE PROVIDES A LEARNING METHOD SO GOOD IT'S PATENTED.

CIE's AUTO-PRO-GRAMMED® lessons are a proven learning method for building valuable electronics

career skills. Each lesson is designed to take you step-by-step and principle-by-principle. And while all of CIE's lessons are designed for independent study, CIE's instructors are personally available to assist you with just a toll free call. The result is practical training... the kind of experience you can put to work in today's marketplace.

LEARN BY DOING...WITH STATE-OF-THE-ART EQUIPMENT AND TRAINING.

CIE pioneered the first Electronics Laboratory

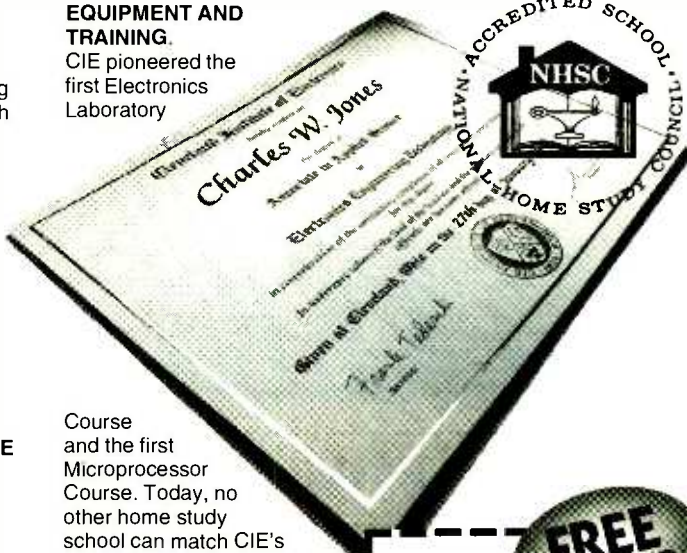

Course and the first Microprocessor Course. Today, no other home study school can match CIE's state-of-the-art equipment and training. And all your laboratory equipment, books and lessons are included in your tuition. It's all yours to use while you study and for on-the-job after you graduate.

PERSONALIZED TRAINING....TO MATCH YOUR BACKGROUND.

While some of our students have a working knowledge of electronics others are just starting out. That's why CIE has developed twelve career courses and an A.A.S. Degree program to choose from. So, even if you're not sure which electronics career is best for you, CIE can get you started with core lessons applicable to all areas in

electronics. And every CIE Course earns credit towards the completion of your Associate in Applied Science Degree. So you can work toward your degree in stages or as fast as you wish. In fact, CIE is the only school that actually rewards you for fast study, which can save you money.



YES! I want to get started. Send me my CIE course catalog including details about the Associate Degree Program. (For your convenience, CIE will have a representative contact you - there is no obligation.)

Please Print Clearly

AH45

Name _____

Address _____

City _____

State _____ Zip _____ Age _____

Phone No. _____

Check box for G.I. Bill Benefits.

Veteran

Active Duty

Cleveland Institute of Electronics, Inc.
1776 East 17th Street
Cleveland, OH 44114

A School of Thousands.
A Class of One. Since 1934.

Send for CIE's FREE Course Catalog and See How We Can Help Your Career Too!

PRODUCT TEST REPORTS

By Len Feldman

Carver CT3 Preamplifier/ Tuner

We have always felt that more manufacturers ought to offer combination tuner/pre-amps, rather than separate tuners and integrated pre-amp-amplifiers. Combining the switching, level-adjustment and tone-control functions with a high-quality AM/FM stereo tuner makes a lot of sense since it affords the user the flexibility of adding separate power



CIRCLE 120 ON FREE INFORMATION CARD

The Carver CT-3 integrated tuner/preamplifier.

power level required by the listening room and the efficiency of the associated loudspeakers. Carver is one of the few manufacturers that seems to understand the need for this type of component.

In fact, the CT-3 is really much more than just a pre-amplifier/tuner combination. This unit can serve as the control center for a high-quality music and video system. Carver has also incorporated their patented "Sonic Holography Generator," a circuit that increases the sound-stage depth as well as width (provided the seating position

and speaker placement are carefully arranged). In addition, the CT-3 has a number of operator-convenience features. There are six audio-input pairs and three composite-video inputs. A "Sleep" feature will turn off the CT-3 after a selectable time period of up to two hours. A CATV (FM) coaxial antenna input is provided; the standard AM and FM antenna inputs are also present. Up to 30 radio-station frequencies can be programmed for instant access. The unit is equipped with a full-featured remote control which, besides enabling operation of most functions from your listening position, can also operate a motorized volume control. A tape monitor loop not only enables connection of a cassette or other audio tape deck, but also can serve as the point at which such external signal processors as an equalizer or a Dolby surround-sound processor (for home-theater installations) can be connected.

CONTROL LAYOUT

A large, fluorescent display at the upper left of the front panel shows signal strength, tape-monitor status, a status display of the tuner section (including frequency, stereo/mono mode, etc.), wake-up and sleep-timer modes, selected video inputs, and power standby status. Below that display are buttons for selecting audio and vid-

eo inputs. To the right of the display are preset number buttons (as well as preset "Memory" and "Clear" buttons), "Once" and "Daily" timer buttons, a preset "Scan" button, and a "Wakeup" button. Below those are a "Mode" button (for selecting mono or stereo FM reception), a "Sleep" button, and tuning "Up" and "Down" buttons. Manual tuning, in increments of 50 kHz for FM and 10 kHz for AM, can be done by lightly tapping either the "up" or the "down" tuning button. Holding the appropriate button down for about two seconds and then releasing it initiates "scan" tuning (tuning proceeds from strong signal to strong signal). If a button is held down continuously, a continuous fast scan of the frequencies will result.

A master volume control is located at the extreme right of the front panel, while along the lower edge of the panel are a "Sonic Holography" on/off button and rotary "bass," "treble," and "balance" controls. The rear panel of the CT-3 is equipped with regular and coaxial FM-antenna inputs, AM-antenna terminals, six pairs of audio-input jacks, tape and VCR audio-output jacks, three sets of video-input jacks, VCR and TV-monitor output jacks, pre-amplifier- (main) output jacks, remote-in and -out terminals (for connection to other, compatible audio components), a phono-ground terminal, and two

Get 3 PROFESSIONAL BOOKS for only \$9⁹⁵

when you join the **ELECTRONICS ENGINEERS' BOOK CLUB**®

Values to \$142.50



012742H-XX \$26.95
Counts as 2



003961H \$40.00

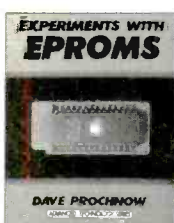

2962P \$18.95
Softcover

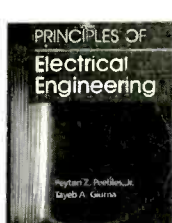

049252H-XX \$58.29
Counts as 2

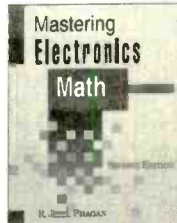

3589H \$27.95



008522H-XX \$49.00
Counts as 2

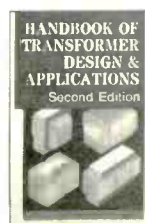

021291H-XX \$59.50
Counts as 2

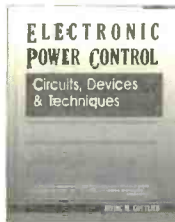

3837H \$27.95

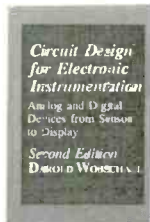

071231H-XX \$60.00
Counts as 2

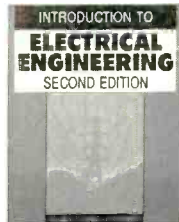

011322P-XX \$43.95
Counts as 2/Softcover



031716H \$50.00



3787H \$29.95

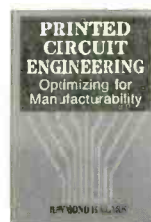

9245H-XX \$46.95
Counts as 2



3279P \$24.95
Softcover

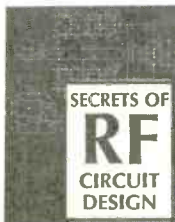

3710H \$32.95

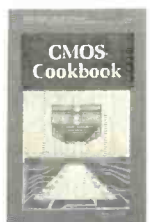

9244P \$18.95
Softcover



9255H-XXX \$105.50
Counts as 3

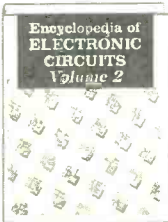

3138H-XX \$60.00
Counts as 2

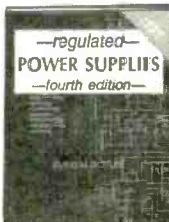

3991H \$39.95

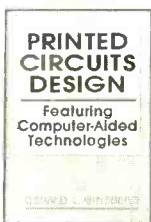

10016H \$43.00

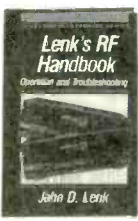

037504H \$39.50

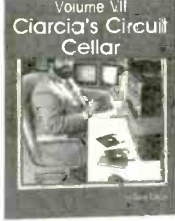

10010P \$22.95
Softcover

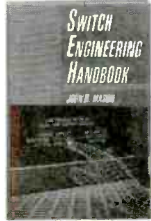

040769H-XX \$60.50
Counts as 2



050806H-XX \$58.00
Counts as 2



2672H \$49.50

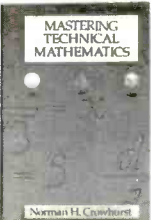

3438H \$39.95

As a member of the Electronics Engineers' Book Club . . .

. . . you'll enjoy receiving Club bulletins every 3-4 weeks containing exciting offers on the latest books in the field at savings of up to 50% off of regular publishers' prices. If you want the Main Selection do nothing and it will be shipped automatically. If you want another book, or no book at all, simply return the reply form to us by the date specified. You'll have at least 10 days to decide. And you'll be eligible for **FREE BOOKS** through the Bonus Book Program. Your only obligation is to purchase 3 more books during the next 2 years, after which you may cancel your membership at any time.

All books are hardcover unless otherwise noted. Publishers' prices shown. ©1993 EEBC. A shipping/handling charge & sales tax will be added to all orders.

If you select a book that counts as 2 choices, write the book number in one box and XX in the next. If you select a Counts as 3 choice, write the book number in one box and XXX in the next 2 boxes.

If coupon is missing, write to:
Electronics Engineers' Book Club, Blue Ridge Summit, PA 17294-0860

ELECTRONICS ENGINEERS' BOOK CLUB

Blue Ridge Summit, PA 17294-0860

YES! Please send me the book(s) listed below for just \$9.95, plus shipping/handling & tax. Enroll me as a member of the **Electronics Engineers' Book Club** according to the terms outlined in this ad. If not satisfied, I may return the book(s) within ten days and have my membership cancelled.

--	--	--

If you select a book that counts as 2 choices, write the book number in one box and XX in the next.
If you select a Counts as 3 choice, write the book number in one box and XXX in the next 2 boxes.

Name _____

Address _____

City/State _____

Zip _____ Phone _____

Valid for new members only, subject to acceptance by EEBC. Canada must remit in U.S. funds drawn on U.S. banks. Applicants outside the U.S. and Canada will receive special ordering instructions. A shipping/handling charge & sales tax will be added to all orders.

PIPF1093

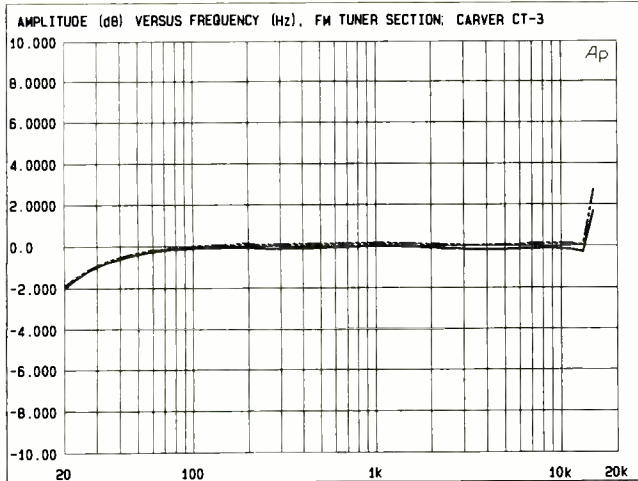

The frequency response of the FM tuner section, an unusual rise in response was noted at 15 kHz, amounting to no more than about 2 dB, but otherwise response was quite flat over most of the balance of the audio range, with an attenuation of 2 dB at 20 Hz.

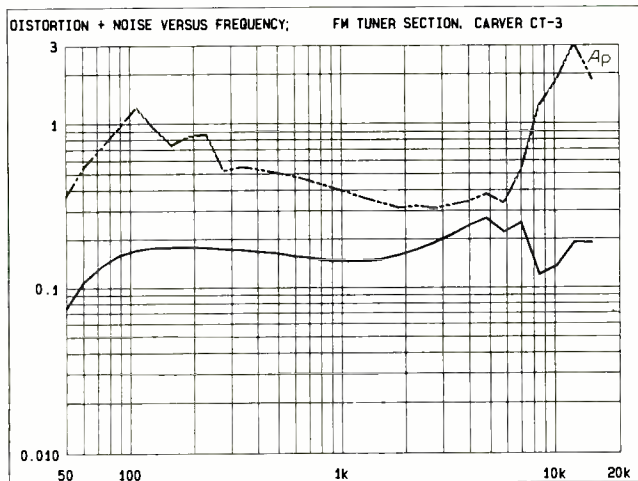

For the FM section of the tuner, at 1 kHz, monophonic THD-plus-noise measured 0.15%, while in stereo, THD plus noise was nearly 0.4%. The solid line is mono; the dashed line is stereo.

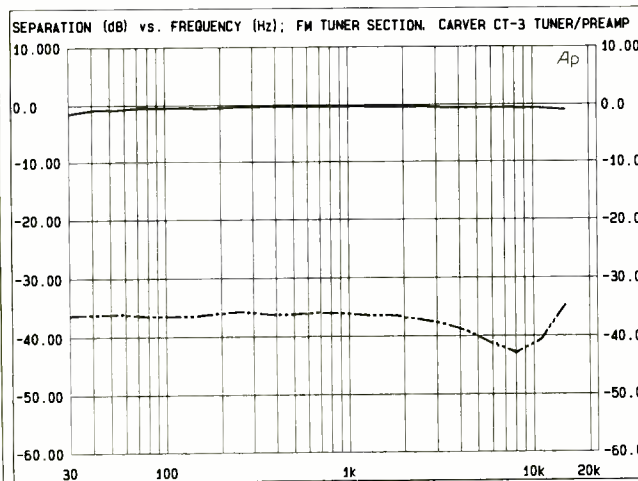

The stereo FM separation fell a bit short of the 40 dB claimed by Carver, with separation at 1 kHz measuring about 37 dB.

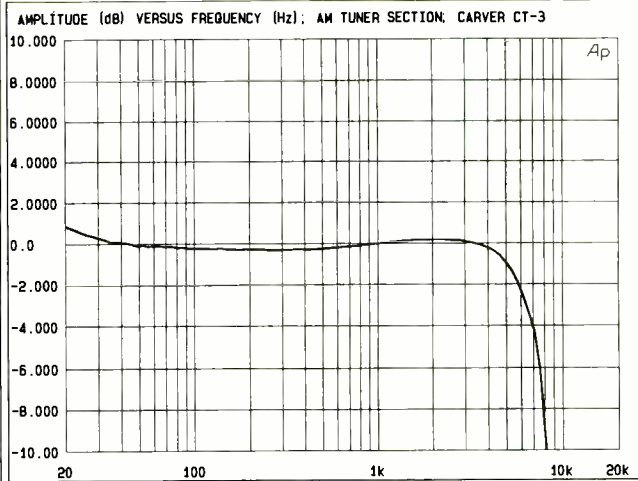

The frequency response for the AM section of the tuner was virtually flat down to 20 Hz, and, more important, the -6dB cutoff at the high end occurred at just above 7 kHz.

convenience AC outlets (one switched, one unswitched).

LAB TEST RESULTS

In testing the frequency response of the FM tuner section, an unusual rise in response was noted at 15 kHz, amounting to no more than about 2 dB, but otherwise response was quite flat over most of the balance of the audio range, with an attenuation of 2 dB at 20 Hz. To achieve 50-dB of quieting in mono required a signal input of 20 dBf, while for stereo, 17 dBf of signal strength was required for the same degree of noise quieting. With strong signals, the best signal-to-noise in mono was about 74 dB, while for stereo, the signal-to-noise ratio reached the specified value of 68 dB.

For the FM section of the tuner, at 1 kHz, monophonic THD-plus-noise measured 0.15%, while in stereo, THD plus noise was nearly 0.4%. Slight retuning of the generator resulted in somewhat better readings when we plotted THD-plus-noise versus signal level: This time, mono THD-plus-noise measured just under 0.15%, while stereo THD-plus-noise

was actually a bit lower, measuring only 0.13%.

The FM stereo separation fell a bit short of the 40 dB claimed by Carver, with separation at 1 kHz measuring about 37 dB. The good news, however, was that separation remained almost constant over the entire audio spectrum, actually increasing to 41 dB at 10 kHz and remaining at about 37 dB at 100 Hz.

One of the biggest and most welcome surprises came when we switched to the AM band and measured frequency response for this section of the tuner. Response was virtually flat down to 20 Hz, and, more important, the -6dB cutoff at the high end occurred at just above 7 kHz. When you consider the fact that the AM sections of most so-called "hi-fi" tuners rarely extend beyond 2.5 or 3.0 kHz, the significance of that frequency response becomes apparent. The sound quality of the AM-tuner section of this product came close to rivaling that of FM. If you habitually tune to some AM stations in your area, this tuner will show you just how good AM can sound when reproduced by a properly designed tuner.

TEST RESULTS—CARVER CT-3 PREAMPLIFIER/TUNER

Specification	Mfr's Claim	PE Measured
FM Tuner Section		
IHF usable sensitivity	13.5 dBf	13.0 dBf
50 dB quieting, mono/stereo	N/A	20/27 dBf
S/N ratio (mono/stereo)	-76/68 dB	74/68 dB
THD (mono/stereo)	0.2/0.5%	0/15/0.4%
Stereo separation @ 1 kHz	40 dB	37 dB
Alternate channel selectivity	60 dB	62 dB
Output level	940 mV	Confirmed
AM Tuner Section		
Sensitivity (dummy/loop)	15/500 × V	Confirmed
Adj. channel selectivity	25 dB	23 dB
Frequency response (to -6 dB)	N/A	20 to 7.5 kHz
Audio (Preamplifier) Section		
S/N Ratio		
Phono	75 dB	74 dB
High level inputs	82 dB	89.9 dB
Input Sensitivity		
Phono	3.5 mV*	1.0 mV
High level inputs	220 mV*	65 mV
Phono Overload	120 mV	130 mV
General Specifications		
Dimensions (W × H × D, inches)	19 × 5¼ × 15¼	Confirmed
Weight	10.6 lbs (4.8 kg)	Confirmed
Suggested Retail Price	\$449.95	

(*Carver used a different reference level in determining input sensitivity, so no direct comparison can be made)

Since this product also incorporates a full pre-amplifier/control section, we applied a test signal to one of the high-level inputs in order to run a frequency-response curve as well as to study the action of the bass and treble tone controls. As we might have expected, with tone controls set to their mid-positions, response was "ruler-flat" from 20 Hz to 20 kHz. The bass control provided 12 dB of boost or cut at 100 Hz, while the treble control had a range of approximately ± 10 dB at 10 kHz. The high-level line-input sensitivity (with the volume control set to maximum) was 65 millivolts for a standard output of 500 mV. The signal-to-noise ratio of the high-level line inputs, referred to a 500-mV input with the volume control set for unity gain, was nearly 90 dB; far better than we have typically measured for separate preamplifiers, integrated amplifiers, and integrated receivers.

Turning to the phono inputs, we measured an input sensitivity of 1.0 mV for a 500-mV output. With 5 millivolts applied to these inputs and the volume control adjusted to produce a standard output of 500 mV, the A-weighted signal-to-noise ratio for the phono section was a more than satisfactory 74 dB. Finally, we measured the accuracy of the RIAA equalization playback curve incorporated in the phono preamplifier section of the CT-3. The equalization was virtually perfect from 20 kHz down to around 70 Hz. At 20 Hz, deviation was -2.0 dB, but we suspect that this was deliberate on the part of Carver, since this attenuation characteristic has been recommended by the IEC (an international standards organization) in an attempt to reduce audible rumble from less-than-perfect phonograph turntables. All of the above measurements, as well as a few additional ones, are

summarized in the Test Results table that can be found elsewhere in this report

HANDS-ON TESTS

The CT-3 tuner/pre-amplifier was very easy to install and hook up to program sources and to our reference stereo power amplifier and speakers. We checked out the FM tuner first, and were able to log no fewer than 51 usable monophonic signals and, using the "auto stereo" mode, some 15 stereo stations. We used only the dipole antenna supplied with the tuner, and our location is some 18 miles from most of the FM transmitters in our area. We would have wished that the "Auto"-mode sensitivity had been adjusted to a somewhat lower threshold. As matters stood, only the strongest signals were received in stereo, using the "Auto" mode. No doubt Carver adjusted the stereo threshold in this manner so that only relatively noise-free stereo signals would come through, but the mode switch operates so that if a listener were unhappy with the noise level of a given stereo signal, turning off the "Auto" mode would automatically switch the system to mono, with reduced background noise.

Attaching the supplied AM loopstick to the antenna terminals and orienting it for best reception, we logged some 26 acceptable AM signals. Of course, the use of properly installed outdoor AM and FM antennas would no doubt have yielded more FM stereo signals and perhaps more noise-free AM signals, and we would recommend that anyone purchasing this product install outdoor antennas if at all possible.

As for the Sonic Hologra-

phy feature, it does, indeed, provide increased spatial depth and width when listening to stereo signals, but we must once again stress that in order to really derive the full benefit from this circuit innovation, listeners must be positioned at the so-called "sweet spot" (mid way between the speakers and some six to 10 feet away from them and from one to four feet away from the back wall of the listening room). Additionally, speakers must be properly positioned relative to each other and relative to the nearest wall. Users are advised to follow the recommendations detailed in the owner's manual.

All-in-all, at its suggested retail price of just under \$450.00, the Carver CT-3 offers excellent value for its price and provides the flexibility and features found only in separate tuners and preamplifiers costing considerably more.

For more information on the Carver CT-3 contact Carver (20121 48th Ave. West, P.O. Box 1237, Lynnwood, WA 98036) directly, or circle No. 120 on the Free Information Card. ■

When someone in your family gets cancer, everyone in your family needs help.

Nobody knows better than we do how much help and understanding is needed. That's why our service and rehabilitation programs emphasize the whole family, not just the cancer patient.

Among our regular services we provide information and guidance to patients and families, transport patients to and from treatment, supply home care items and assist patients in their return to every-day life.

Life is what concerns us. So you can see we are even more than the research organization we are so well known to be. No one faces cancer alone.

AMERICAN CANCER SOCIETY

There's Big Profits In Electronics If you have the Proper Training

Foley-Belsaw can give you that training. Training that will provide high income potential in the 90's and on into the twenty-first century. The right training can give you the potential for a bright, economically, rewarding and fascinating future. You can take control of your future by choosing one of these highly profitable career fields. Our experience proves when you're in a field you're interested in you'll earn more and advance farther than you ever will in a field where you lack interest.

If you're unhappy with your present job, not satisfied with your income, or if you feel you can't reach your full potential, now is the time to act. There is no obligation to get a free Career Kit from Foley-Belsaw. Just check the coupon - mail it to us - we'll send your Career Kit free.

VCR Repair



VCR Technician

VCR Technicians report earning \$80.00 and more per hour. That's because this career field lacks the qualified technicians to handle the demand. We use the Viejo Method by Foley-Belsaw to quickly teach you VCR Repair without all the unnecessary basic electronics. The Viejo Method has been proven best right in the VCR repair shop.

The vast majority of VCR repairs are mechanical or electrome-

chanical. You learn these simple repairs first so you start earning right away. These basic repairs become the foundation on which you build your career.

Personal Computer Repair



If you have used a computer or are interested in how computers work you've probably got what it takes to become a computer repair specialist. This field continues to grow as personal computers are being used in almost every office and many homes.

You can cash in on this big demand quickly when you learn personal computer repair by the Foley-

Belsaw method. This quick learning method teaches you the basics of computer repair so you start earning quickly as you continue to learn more complicated procedures. In a short time you'll be earning \$80, \$100 or more an hour.

Beside VCR and Computer Repair Foley-Belsaw can offer you specialized training in other high paying electronic fields. These courses all provide the knowledge you need to start a business of your own. A business where you're the boss. A business that provides both financial and personal security.

Foley-Belsaw can also provide you with nationally acclaimed training in several high paying mechanical career fields. Just check the coupon for your area of interest. We'll rush you a free career kit with all the exciting details.

FREE Kit

For a free information kit in one of these high paying career fields, contact:

Foley-Belsaw Institute
6301 Equitable Road
Kansas City, MO 64120



Since 1926

Foley-Belsaw Institute, 6301 Equitable Road
Kansas City, MO 64120

Check One Box Only, Please.

Electronic Courses

- VCR Repair, Dept. 62062
- Computer Repair, Dept. 64000
- Basic Digital Electronics, Dept. 69000
- Fax Machine Repair, Dept. 67000
- Printer Repair, Dept. 68000
- Camcorder Repair, Dept. 66000

Mechanical Courses

- Locksmithing, Dept. 12359
- Small Engine Repair, Dept. 52302
- Saw and Tool Maintenance, Dept. 21258
- Upholstery, Dept. 80891
- Woodworking, Dept. 43226

Name _____

Address _____

City _____

State _____ Zip _____

Have you ever wondered how microwave signals are used to detect movement within a defined area? Well, here's your chance to find out! The *Microwave Motion Detector* described in this article can be used to sense speed or any moving body—a person, animal, car, or bicycle!—using the *Doppler effect*.

Doppler theory states that when sound, light, or even radio waves are emitted or reflected by a moving object, the frequency of the waves will be different from those emitted or reflected when the object is stationary.

Circuit Description. The Microwave Motion Detector is nothing more than a combination transmitter/receiver circuit that's built around four transistors, and a quad op-amp. A schematic diagram of the Microwave Motion Detector is shown in Fig. 1. In that circuit, Q3 (a 2SC2570 high-frequency NPN silicon transistor) is configured as a free-running (astable) RF oscillator that is designed to operate at the low end of the microwave band (approximately 1.0 GHz).

The microwave signal developed by the oscillator follows two paths. In

ference, which can range from 10 to 40 Hz depending upon the speed of the moving object, is applied to the input of U1-c ($\frac{1}{4}$ of an LM324 quad op-amp) at pin 10. The output of U1-c is fed to sensitivity control R8, which allows you to adjust the Doppler-shift difference signal. The Doppler-shift signal is applied to U1-d (another $\frac{1}{4}$ of the LM324 quad op-amp), which, in this instance, is configured as a bandpass filter.

The output of the bandpass filter (U1-d) is fed to U1-a (another op-amp; this one configured as a buffer), and

Build This Microwave Motion Detector

BY FRED BLECHMAN

Essentially what happens is that as the object moves toward you, the frequency emitted by or reflected off of the object increases. The opposite is true as the object moves away from you; the frequency decreases.

A similar effect can be seen in everyday life: Have you ever noticed how a train whistle, racing car engine, or car horn appears to alter in frequency as the vehicle approaches, passes, and moves away? The perceived change in frequency is caused by the waves being either compressed or stretched as they leave the moving object. Compressing the waves increases the perceived frequency, while stretching the waves reduces it.

Doppler-effect based systems are used to clock speeding cars, missile velocity, and even to detect moving air. In fact, Doppler radar systems are used at some of the larger airports to detect dangerous cross winds, called *windshear*, which have been blamed for countless takeoff and landing accidents.



This security-system add-on for your home or car works on the same principles as police radar.

one path, the microwave signal is applied to D1, a 1SS99 Schottky barrier diode, which is designed for operation at low microwave frequencies. At the same time, the microwave signal is applied to ANT1 and is radiated outward in an omni-directional pattern, filling the surrounding area with microwave signals.

The radiated microwave signals, upon contacting an object within the covered area, are reflected back to the antenna. The frequency of the reflected signal depends on the object's direction of movement. (The motion detector doesn't care which direction is taken by the object; it is only interested in the frequency shift that results because of that movement.) The antenna, in turn, picks up the reflected signal, and feeds it to D1, where it is mixed with the originally radiated signal, to produce both a sum and difference signal at D1's cathode.

The sum frequency is bypassed to ground via capacitor C8, leaving only the difference frequency. The dif-

ference signal is applied to the input of U1-b, which is wired as a comparator. During the negative half cycle, the charge on C17 is bled to ground through R17 and U1-a. Components C17 and R17 determine the "on" time of U1-b. Larger values of either C17 or R17 result in a longer on time for U1-b.

Each time that the voltage at pin 5 of U1-b exceeds the reference voltage on pin 6, the output of U1-b at pin 7 swings positive. The pin-7 output is applied to the gate terminal of Q4 (a BS170 N-channel TMOS FET) and causes it to turn on and off. Each time that Q4 turns on, a ground path (though Q4) for LED1 is completed, causing it to turn on and off, as the input signal dictates. Transistor Q4 can

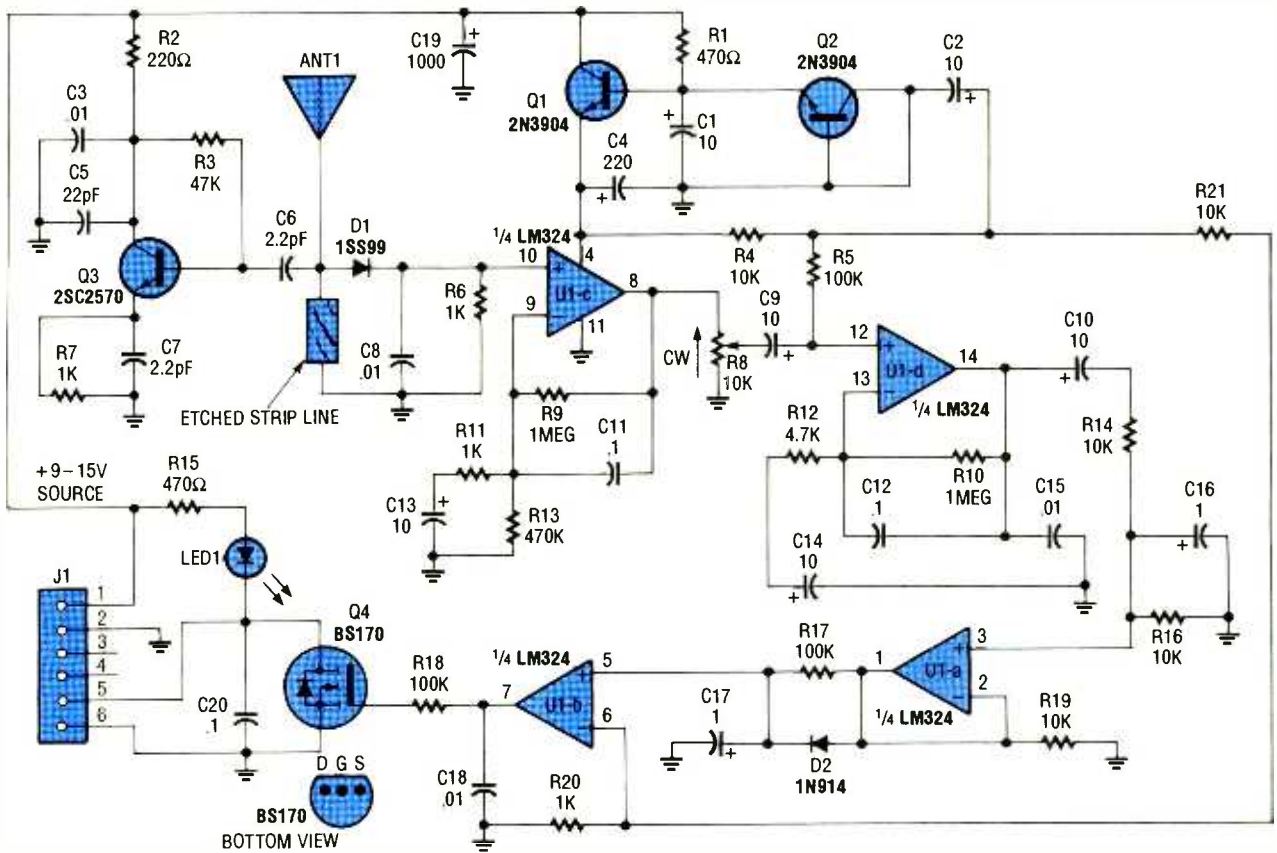

Fig. 1. The Microwave Motion Detector is essentially a combination transmitter/receiver circuit built around four transistors, and a quad op-amp.

PARTS LIST FOR THE MICROWAVE MOTION DETECTOR

SEMICONDUCTORS

- U1—LM324 quad op-amp, integrated circuit
 Q1, Q2—2N3904 general-purpose NPN silicon transistor
 Q3—2SC2570 high-frequency, NPN silicon transistor (or NEC NE02132E).
 Q4—BS170P-ND N-Channel, enhancement, TMOS FET (Digi-Key)
 D1—ISS99 Schottky barrier diode (NEC). See text.
 D2—1N914 or 1N4148 general-purpose, small-signal, silicon diode
 LED1—Green light-emitting diode

RESISTORS

- (All fixed resistors are 1/2-watt, 5% units.)
 R1, R15—470-ohm
 R2—220-ohm
 R3—47,000-ohm
 R4, R14, R16, R19, R21—10,000-ohm
 R5, R17, R18—100,000-ohm

- R6, R7, R11, R20—1,000-ohm
 R8—10,000-ohm PC-mount 1/2-watt potentiometer (see text)
 R9, R10—1-megohm
 R12—4,700-ohm
 R13—470,000-ohm

CAPACITORS

- C1, C2, C9, C10, C13, C14—10- μ F, 16-WVDC, electrolytic
 C3, C8, C15, C18—0.01- μ F, ceramic-disc
 C4—220- μ F, 16-WVDC, electrolytic
 C5—22-pF, ceramic-disc
 C6, C7—2.2-pF, ceramic-disc
 C11, C12, C20—0.1- μ F, ceramic-disc
 C16, C17—1.0- μ F, 16-WVDC, electrolytic
 C19—1000- μ F, 16-WVDC, electrolytic

ADDITIONAL PARTS AND MATERIALS

- J1—Molex WM 3303 6-pin female PC board connector (Digi-Key)
 Printed-circuit materials, enclosure,

9-15 volt DC power source, solder, hardware, etc.

Note: The following items are available from Ramsey Electronics, Inc. (793 Canning Parkway, Victor, NY 14564; Tel. 716-924-4560): A complete kit of parts for the Microwave Motion Detector (MD-3BP), including printed-circuit board (but not the case or control knobs)—\$19.95; an etched and drilled printed-circuit board only (MD-3PCBP)—\$10.00; a Special Parts Kit (MD-3SPKBP) containing all semiconductors, R8, and J1—\$12.50; a custom case and knob set (CMD-BP)—\$12.95; optional Siren Kit (SM-3BP) including printed-circuit board and manual—\$3.95; optional Universal Timer Kit (UT-5BP) including printed-circuit board and manual—\$5.95. Please add \$3 for orders under \$20, plus \$3.75 postage/handling. New York residents, please add appropriate sales tax.

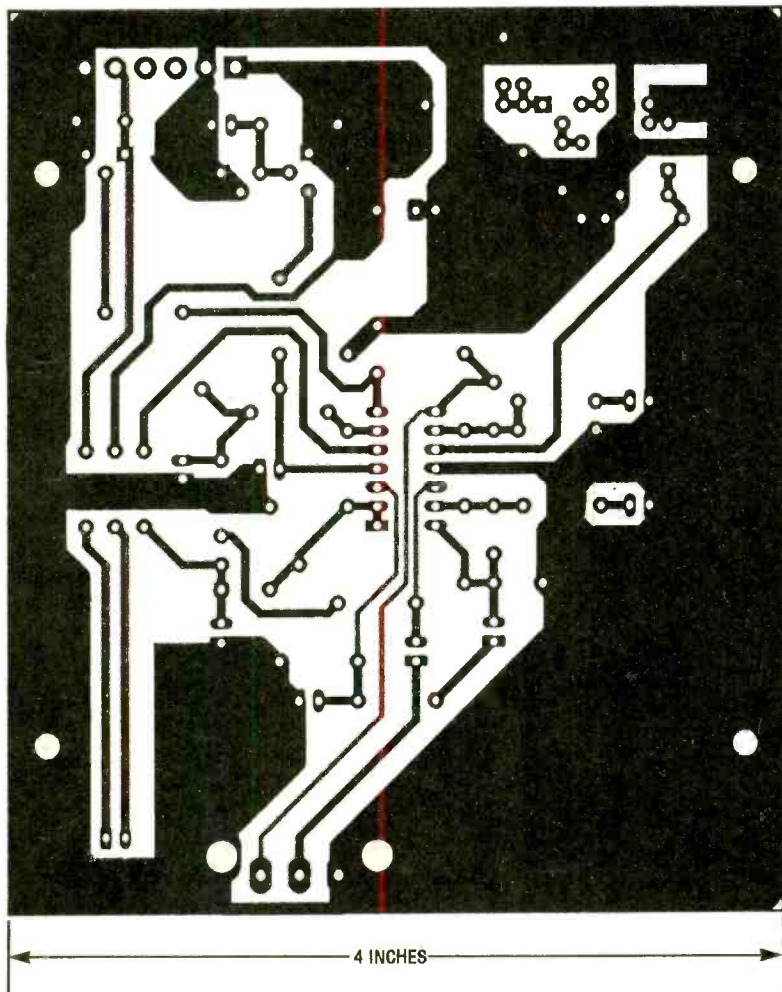

Fig. 2. The project was assembled on a printed-circuit measuring about $4 \times 4\frac{3}{4}$ inches. A template of that printed-circuit board layout is shown here full-size.

be safely operated at voltage levels as high as 50 volts DC and current levels of 250 mA. Capacitor C20 is included in the circuit to provide transient suppression for stability.

The output of the Microwave Motion Detector (via pins 5 and 6 of J1) can be used to drive any number of signaling devices, timers, counters, etc. More on that later.

Power for the circuit is supplied through J1 (a multi-conductor jack) from an external source of 9–15 volts. The external source voltage is regulated by Q1 and Q2. That transistor regulator circuit also provides the reference voltage used by comparator U1-b. In the regulator portion of the circuit, the reverse-biased base-emitter junction of Q2 behaves like a low-power Zener diode, with a breakdown voltage in the 6- to 8-volt range. Capacitor C19 is used to filter the external power source to assure a clean and smooth source of current.

Construction. The Microwave Motion Detector was assembled on a printed-circuit measuring about $4 \times 4\frac{3}{4}$ inches. Because of the critical nature of microwave-circuit wiring, where lead lengths and ground connections can effect circuit operation, don't try building this project without using the printed-circuit board layout. And don't be alarmed when looking at the printed-circuit board pads that connect the anode of D1 and the antenna to what looks like ground. That short "etched stripline," is carefully designed to function as a small inductor at the selected microwave frequency, forming part of the resonant tank circuit for the microwave oscillator (Q3)!

Figure 2 shows a full-size template of the Microwave Motion Detector's printed-circuit board layout. You can etch your own board from the template provided and gather your own parts, or you can order the board only or a kit (which includes an etched and

pre-drilled, printed circuit board and all the components, but no case) from the supplier listed in the Parts List.

Although most of the parts for this project are commonly available through conventional electronic-component suppliers, some of them may be difficult to find. A source for the more difficult-to-find parts is indicated in the Parts List. The difficult-to-find parts (such as Q3, D1, and R8) are available in a "Special Parts Kit" from the listed source. If you opt to gather your own parts, or you plan to use what you have on hand, keep in mind that the printed-circuit board layout was designed to accommodate the special mounting or specific dimensions of J1 and R8.

In any event, once you have the printed-circuit board and all of the parts, assemble the Microwave Motion Detector according to the parts-placement diagram shown Fig. 3. When assembling the Microwave Motion Detector, take special care that polarity-sensitive components (electrolytic capacitors, diodes, transistors, and the integrated circuit) are installed in the right direction.

Begin construction by installing the passive components (jumper wires, resistors, and capacitors) first; follow that by installing the active components (diodes, transistors, and the IC). Once the active components have been installed, check your work for the usual construction errors: cold solder joints, misplaced or misoriented components, solder bridges (a magnifying glass helps here), etc.

Once you've determined that the circuit has been correctly assembled, it's time to consider the enclosure that will house the Microwave Motion Detector. The circuit can be housed in any enclosure of your own choosing. However, if you prefer, an optional case and knob kit is available from the supplier listed in the Parts List. The sturdy black plastic instrument case is supplied with neatly lettered front and rear panels, knobs, rubber feet and mounting screws.

If you choose a case other than the one available from the listed supplier, it will be necessary to drill holes in the front panel of the enclosure to accommodate the shaft of R8 and LED1's lens. Once that's taken care of, it will be necessary to make a cutout in the rear panel for the output connector,

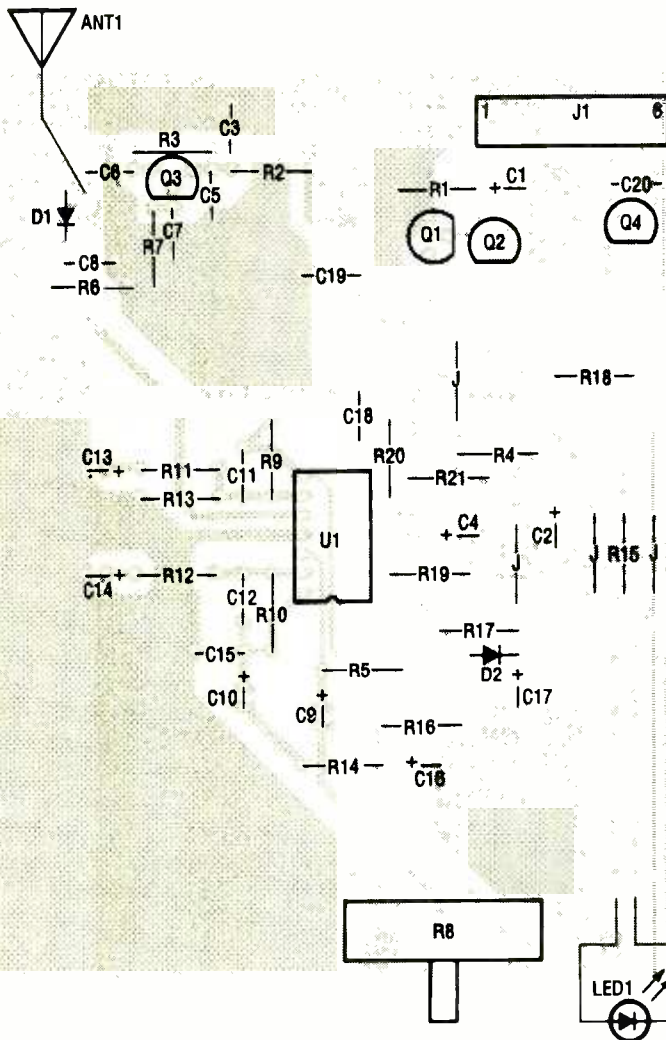

Fig. 3. Once you have the printed-circuit board and all of the parts, assemble the Microwave Motion Detector according to this parts-placement diagram. Note when assembling the circuit, take special care that the polarized components are properly oriented.

J1, and a small hole in the top of the enclosure for the antenna. Once properly prepared, the cabinet's front and rear panels can be labeled using dry-transfer lettering.

Testing and Tune Up. Testing the Microwave Motion Detector requires nothing more than a stable source of direct current of from 9 to 15 volts. There should be no tendency for the voltage to drop when under load. While the Detector uses only about 15 mA on standby, it draws about 30 mA when triggered. That difference is enough to affect the operation of the circuit when using a typical small 9-volt transistor radio battery—even an alkaline unit. The effect is that once triggered, the Detector output keeps retriggering itself due to the on-off

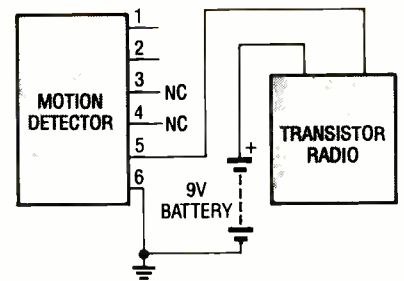

Fig. 4. The detector can easily be tested by using a transistor radio as a signaling device. Simply wire the two devices together as shown here, and turn on the radio. When the detector is triggered, power will be applied to the radio, turning it on.

voltage change. For the same reason, use short leads when feeding power to the circuit through J1. Connect +9–15 volts DC to pin 1 of J1, and connect pin 2 of J1 to the ground terminal of the DC supply.

Rotate R8 fully counter-clockwise—to the minimum-sensitivity position—and the LED extinguish. Slowly rotate R8 clockwise until the LED lights. Back off R8 until the LED just goes out. Now move your hand near the antenna; you should see the LED light up. Moving either toward or away from the Detector should trigger it. The LED should stay lit for only about one second. Adjust R8 for the desired sensitivity.

Figure 4 shows how the Motion Detector can be wired to use a transistor radio as a signaling device; other, more practical applications will be discussed later on, but this set-up is useful for testing. The positive terminal

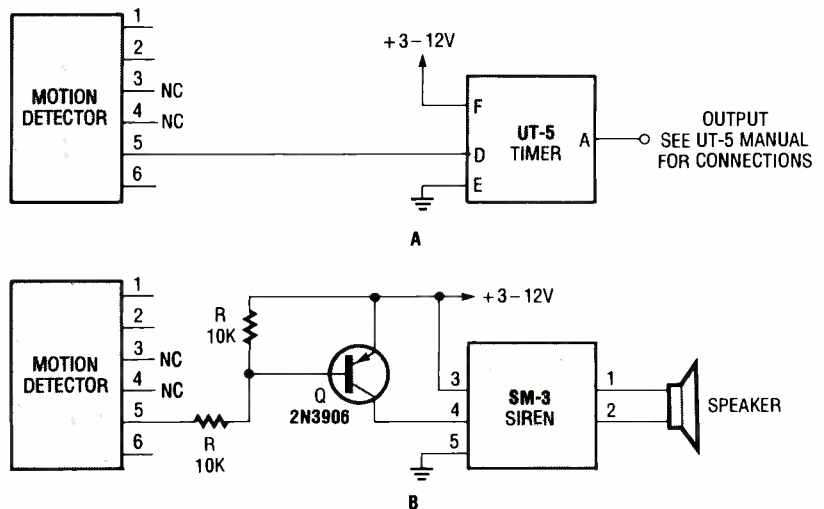

Fig. 5. The output of the detector can be used to trigger a timer (as shown in A), or to drive siren (as shown in B). The timer and siren circuits can be obtained in kit form from the supplier listed in the Parts List.

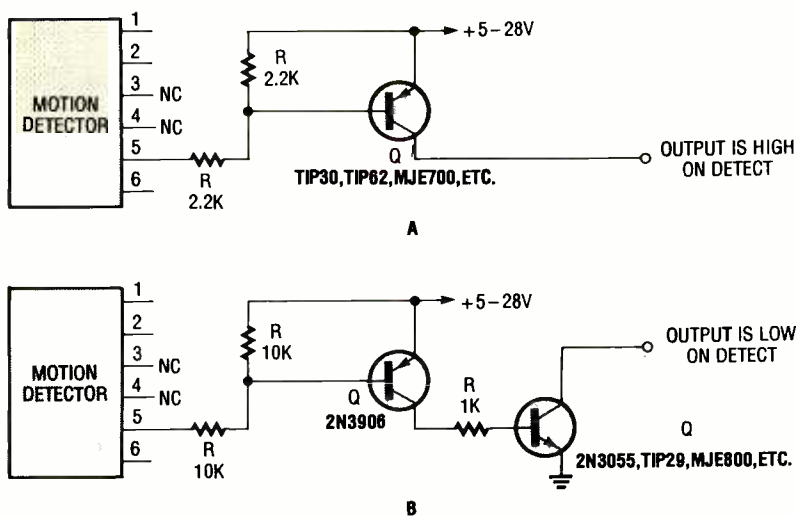

Fig. 6. The output of the motion detector can be used to trigger a transistor driver circuit, like those shown here. The one in A is designed to deliver a positive output voltage to the circuit that follows, while the one in B is designed to complete the ground-return path for that same circuit.

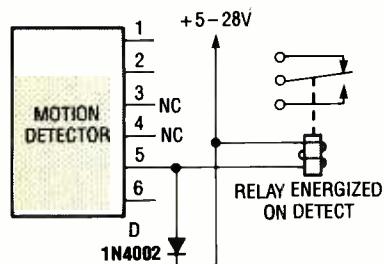

Fig. 7. The Microwave Motion Detector's output can also be used to trigger a relay.

of a separate power source (a 9-volt battery in this case) is connected to the positive supply input of a transistor radio, and the negative terminal of the radio going to pin 5 of J1. Pin 6 of J1 is connected to the negative side of the 9-volt battery.

With the radio switched on, it should play whenever the Motion Detector is triggered. Note that trying to use the Motion Detector power supply to also power your external load will probably result in unwanted retriggering. If you find that your load triggers the detector, try moving it further away. The detector is extremely sensitive to its surroundings.

The control (pin 5 of J1) switches to ground through Q4 when motion is detected. **Do not** apply an AC voltage to the circuit and **do not** attempt to "sink" more than 250 mA at pin 5.

Modifications. If you find that the detector seems to constantly retrigger

ger at the medium- or high-sensitivity settings, try adding a 0.1- μ F non-polarized capacitor across pins 5 and 6 of J1.

The antenna may be tweaked to maximize the detector's range by simply clipping or adding $\frac{1}{4}$ -inch lengths of wire to the antenna, while checking for a range improvement. Typically, the detector should have enough sensitivity to pick up an adult walking at a normal pace from 10 to 12 feet away in a clear room. Note that room characteristics can affect range.

You may wish to shape the pickup pattern of the Microwave Motion Detector. That's fairly easy to do. Try placing a 12- x 12-inch metal plate about 4 inches behind the Microwave Motion Detector's antenna. That sharpens the detection beam forward of the plate and reduces it behind the plate. You may wish to experiment with different sizes of plates placed at different distances from the antenna.

Interface Circuits. The Microwave Motion Detector's output transistor, Q4, provides only a short switched "on" time when motion is sensed. You have probably asked the question, how do I make it do something other than just make the LED blink?

For instance, you might want to activate an alarm for a period of time after the motion is detected. That's easily accomplished using a solid-state timer, such as the optional UT-5 Universal Timer-Oscillator (based on

the popular 555 oscillator/timer) offered in the Parts List. The UT-5 can be wired as either a timer or an oscillator. Figure 5A shows how the two circuit's are wired together.

When the UT-5 is wired as a timer, a variable resistor and several supplied capacitors allow you to set "on" times of from several seconds to several minutes with a single trigger pulse. The output of the UT-5 can be used to trigger a relay or alarm siren.

If you'd prefer to have the Microwave Motion Detector drive a siren directly, one is offered (the SM-3 Police Siren) in the Parts List. The connections for the siren and the Motion Detector are shown in Fig. 5B. The Siren sounds with an upward wail whenever the PNP transistor turns on, connecting pin 4 to the positive supply voltage.

In that circuit, a 10k pull-up resistor is tied to the base of the transistor, holding it at cutoff. Whenever the Detector is triggered, the base of the PNP transistor is pulled to ground, allowing the transistor to conduct. That places a positive voltage on pin 4, causing the siren to sound. When the Detector turns off, positive voltage is removed from pin 4 of the siren, turning it off. The total sounding time of the siren is roughly twice the detector's on time.

Figures 6A and 6B show typical transistor driver circuits triggered by the Motion Detector in a similar fashion. The circuit in Fig. 6A is designed to deliver a positive output voltage to the circuit that follows. The circuit in Fig. 6B, with the aid of a second transistor (which is used as an inverter), is designed to complete the ground-return path for the circuit that follows.

Figure 7 shows how the Microwave Motion Detector can be used to trigger a relay. If that scheme is used, just be sure to note the limits of 50 volts DC or 250 mA at pin 5 of J1. Of course, if a higher capacity is required, the small relay of the circuit in Fig. 7 can be used to trigger one that's capable of handling the heavier load.

Another application for the motion detector might be to connect a tape recorder with a recorded message (or perhaps the sound of a barking dog) to the circuit using the scheme outlined back in Fig. 4. Then with the recorder turned on and set to the playback mode, when the motion detector senses movement, the recorder will play the message. ■



A Flea-Market Survival Guide

We present some Swiss-army knife tips for the radio flea market and hamfest.

BY KARL T. THURBER, Jr., D.P.A.

Radio flea markets or hamfests are great traditions among radio amateurs, scanner buffs, shortwave listeners (SWLs), CB'ers, computerists, and other electronics enthusiasts. If you've never attended one, you're missing out on some fun.

Flea markets are popular activities, especially from the earliest days of spring through the start of the football season. Attendees rub elbows with fellow hobbyists, second-hand equipment sellers, manufacturers' representatives, and radio-equipment dealers. There are usually programs and activities of interest to everyone, including non-ham family members.

This article helps radio beginners survive radio flea markets, swap meets, and hamfests, with their many second-hand electronic temptations. We'll cover radio events and their activities; tips for buyers; negotiating a good deal; and cleaning up, restoring, and troubleshooting purchases.

We'll also discuss equipment acquisition for the beginner; books and magazines on old radio equipment; and information on scheduled radio events that beginners should know about.

What's a Hamfest? A hamfest, by definition, is a grand meeting of radio enthusiasts, but the term covers a lot of ground. There are affairs that are strictly horse-trading radio flea markets or swap meets. These are usually sponsored by local clubs for their own members and other local aficionados.

Some hamfests are small, attracting only a few hundred visitors. Others, like the regional or American Radio Relay League (ARRL) affiliated conventions, attract many thousand attendees. An example of a larger exposition is the Tropical Hamboree with more than 200 exhibit booths, parking for 15,000 vehicles, 300 campsites with RV hook-

ups, and more than 800 indoor tables.

The main activity is the swapping, selling, and buying of radio and electronic components and equipment. Typically held in a civic center, parking lot, or school auditorium or cafeteria, this type of event often includes an old-time radio auction, a bid table (where the bidding is written rather than verbal), and "tailgaters," people who sell from their car trunks in the parking lot (sometimes called the "bone yard").

However, while the core activity of most events is their flea market or swap area, many affairs are more than just sales events and swap meets. Frequently they include educational activities such as technical seminars and operating presentations. Discussions include such topics as beginner operating procedures; contesting; DX activities, including DX-pedition reports, travelogues, and field checking of DX. Century Club

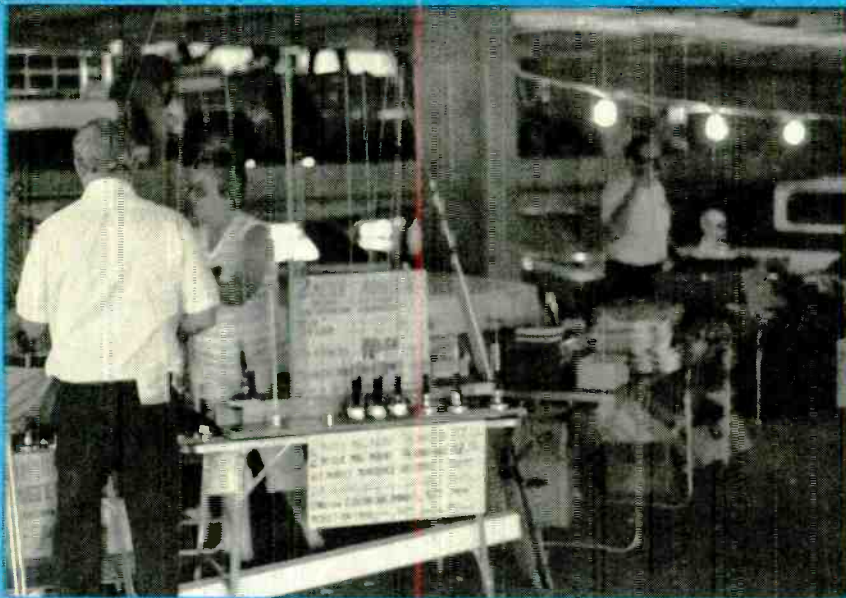

Need to replace your mobile antenna. Often the best way to do so is at a radio flea market, where the variety is great and prices are usually rock-bottom. The wise shopper avoids impulse buying and makes several rounds through the swap area, noting what's available and at what prices, then goes back with a list that gets all the parts and equipment together.

(DXCC) and other QSL cards for operating awards; vintage radio equipment; radioteletype (RTTY); antennas; slow-scan television (SSTV); VHF, UHF, and satellite techniques; message-handling; and digital applications.

Other popular activities include youth forums; disaster communications sessions; educational workshops for teachers, adult education instructors, and parents; and more. These sessions are a good way to broaden one's knowledge of radio.

The scope of some hamfests is broader still. Reflecting the upsurge in interest in computers, packet radio, and digital equipment in the hamshack and listening post, most flea markets and hamfests include computers and software alongside radio gear. Many really are combination ham and computer events, although some have become more "computer" than "radio."

Activities for All Second perhaps to swapping, radio contests are popular event activities. These include QSL card contests, Morse code proficiency matches, homebrew equipment competitions, "amateur of the year" presentations, and fox hunts (hidden transmitter searches). Some have humorous events like "left-foot code sending" contests. Some also award prizes to the oldest and youngest li-

censed amateurs present: the most-recently licensed ham, the person who traveled the greatest distance to attend, and the largest all-ham family in attendance. Prize drawings, raffles, and door prizes are standard features of most events.

Also, almost all radio flea markets and hamfests are frequented by dealers and manufacturers who wish to build up clientele and sell their wares. They're especially prominent at larger affairs where high-volume dealers and name-brand manufacturers display their newest gear. This type event is great if you're in the market for a new radio since you can compare specifications and get a "hands-on-feel" of competing equipment. Some manufacturers even set up complete on-site stations and radio listening posts, allowing you to operate their gear as you would your own equipment in your own home.

Don't be surprised if you become "hooked" by a particularly fine piece of equipment you inspect and try out. If you find yourself sold, it's often possible to buy the gear at a substantial discount directly from the manufacturer or from a discount dealer. You'll also save on shipping costs and sometimes even sales tax, depending on local laws. A few events even offer on-site packing and shipping of your purchases.

As mentioned earlier, many hamfests feature supervised on-site amateur radio examinations. Volunteer Examiners (VEs)—amateurs who volunteer their services as test-givers—are certified by the Federal Communications Commission (FCC) to administer the exams. The VECs administer tests for the five classes of amateur operator license: Novice, Technician, General, Advanced, and Extra. Although you can initially qualify for any of the five operator classes, most newcomers find the Novice and Technician licenses are the ideal hobby-by-entry points.

The FCC doesn't charge to issue licenses, but VECs may charge examinees nominal fees, usually around \$5. The good news is that you no longer must travel to a distant FCC office to take your exam. The bad news is that hamfest walk-ins are not always accepted; often you must pre-register for testing and send in a signed application form and other paperwork.

Information on becoming a radio amateur is available from any of the 18 VEC groups, your local amateur radio club or hamfest sponsor, or any FCC office. The two main VEC groups operating nationally are the ARRL/VEC and W5YI-VEC/The W5YI Group; both are listed in the boxed text entitled "Names and Numbers."

While many small affairs cater exclusively to amateurs, larger ones—especially all-weekend events—serve the entire family because hams and other enthusiasts are more likely to travel a great distance with their families if there's something for them, too. Thus, spouses' and children's events are popular, and many YLs (young ladies), XYLs (wives), and harmonics (children) attend. Some events even offer complimentary admission for students, spouses, and other non-hams.

Typical activities for non-hams include bingo, musical entertainment, tours of historic sites and attractions, shopping excursions, cartoon and magic shows, and special prize drawings. Some event sponsors also allow non-electronic items to be sold, such as arts and crafts items, ceramics, comic books, and the like; these goods also attract non-hams.

Now that we've discussed the peripheral hamfest activities, let's concentrate on the core of most events:

the buying and selling of equipment. To get started here are some tips for the beginner.

Perfect for Beginners. Don't let the cost of new radio equipment scare you off: your local radio flea market or hamfest may be just the place to find the equipment you need to start with. The beginner usually can find good used-gear bargains. At many swap meets you can buy what you need to equip your listening post or get on the air for as little as \$100 or \$200. Such gear can turn out to be quite decent, and is often the kind that hams used to dream of 20, 30, or 40 years ago.

While most receivers and transmitters today are solid state, and many hobbyists thumb their noses at the idea of tubes in a solid-state world, some vacuum-tube era equipment still can do a creditable job, especially for starters. For many, there's magic in the old sets whose tube filaments glow brightly and warmly in the dark. Here are some considerations for big-ticket items starting with receivers.

Older general-coverage receivers typically cover 540 kHz to 30 MHz on one dial, with a bandsread dial for fine tuning. Ham-bands-only radios normally cover only the "old" HF amateur bands from 1.8 to 30 MHz, and they may not cover the newer bands at 10, 18, and 24 MHz. Selectivity (the narrower the better), sensitivity (the higher the better), and stability (the more the better) are the main determinants of a set's quality. Well-known brands among older sets include Drake, Collins, Hallicrafters, National Radio, Hammarlund, RME, and TMC.

With regard to transmitters, many of the massive 1950's and 1960's AM and early SSB-era rigs still are seen today and often make good buys. The older CW-only rigs were relatively simple affairs, typically being crystal controlled and running power levels of 75 watts or less; they can make good starter novice rigs. Some of better-known transmitter names include Collins, Heathkit, E. F. Johnson, Harvey Wells, and World Radio Laboratories (WRL). However, if you buy a Heath, it was assembled from a kit so check it out carefully for the quality of the wiring techniques and for any sign that corrosive acid-core solder was used.

Last, if you're an absolute beginner,

ARRL/VEC

225 Main St.
Newington, CT 06111;
Tel. 800-927-7583

Amateur Electronic Supply

5710 W. Good Hope Road
Milwaukee, WI 53223;
Tel. 800-558-0411
(Branch stores in Wickliffe, OH; Orlando, FL; Clearwater, FL; and Las Vegas, NV.)

Antique Radio Club of America, Inc.

Attn: Ron Frisbie
312 South 10th St.
Akron, PA 17501

Ardco Electronics

PO Box 95
Berwyn, IL 60402

Associated Radio

8012 Conser, Box 4327
Overland Park, KS 66204;
Tel. 913-381-5900

Billboard Publications, Inc.

1515 Broadway
New York, NY 10036;
Tel. 212-764-7300

CBC International

Box 31500
Phoenix, AZ 85046

OAR Electronics, DBA National Radio Company

229 Marginal Street
Chelsea, MA 02150;
Tel. 617-884-8100

Dayton HamVenture

Box 964
Dayton, OH 45401-0964;
Tel. 513-454-1456

Electric Radio

PO Box 57
Hesperus CO 81326;
Tel. 303-247-4935

Grove Enterprises, Inc.

PO Box 98
Brasstown, NC 28902;
Tel. 704-837-9200

Ham Radio Bookstore

PO Box 209
Rindge, NH 03461-0209;
Tel. 800-457-7373

have a more experienced individual accompany you. The multitude of nameless equipment and strange-looking components may prove frustrating without expert guidance. If you can't arrange for someone to guide you, steer clear of complicated gear you know nothing about, and try to solicit a "second opinion" from others you encounter in the flea market.

Apply Caution. Obviously, flea-market buying is not just for newcomers:

Names and Numbers

Ham Radio Outlet

933 N. Euclid St.
Anaheim, CA 92801;
Tel. 800-854-6046.
(Contact them regarding their ten other locations.)

Ham Trader Yellow Sheets (HTYS)

PO Box 15142
Seattle, WA 98115;
or PO Box 2057
Glen Ellyn, IL 60138

The Ham Station

PO Box 6522
220 N. Fulton Ave.
Evansville, IN 47719-0522;
Tel. 800-729-4373

HI Manuals

Box 802
Council Bluffs, IA 51502.

LTA

PO Box 77
New Bedford, PA 16140;
Tel. 216-565-9950

North American Short Wave Association (NASWA)

William E. Oliver, Publisher
45 Wildflower Road
Levittown, PA 19057

RSM Communications

PO Box 218
Norwood MA 02062;
Tel. 508-660-1481

Universal Radio, Inc.

6830 Americana Pkwy
Reynoldsburg, OH 43068;
Tel. 800-431-3939

W5YI-VEC/The W5YI Group

PO Box 565101
Dallas, TX 75356-5101;
Tel. 800-669-9594

W7FG Repair Manuals and Repair Service

c/o Karolena and Gary Gompf
3300 Wayside Drive
Bartlesville, OK 74006;
Tel. 918-333-7893

Bill Welsh, W6DDB

45527 3rd Street East
Lancaster, CA 93535-1802

many experienced hobbyists attend. Though a radio amateur for 39 years, I've been to countless flea markets and hamfests in search of parts and equipment, and sometimes just as an observer. The trip always is enjoyable, and I usually come home with some great deals. In fact, I usually return with so much junk that I have to go to the next meet and sell some of it—thus like many other hobbyists becoming part of what pundits might call the "swap meet ecological cycle."



For the seller, the outdoor swap area—famously known in flea market lingo as the “bone yard”—is a chance to relax in the sun and display unneeded equipment before prospective purchasers. Older, tube-type gear abounds in the bone yard and on the auction block at most radio flea markets. However, be sure you know what you’re buying before you buy.

Whether you’re a beginner or an experienced market shopper, adopt the attitude *Caveat Emptor!* Flea markets can yield savings for the well-informed buyer, but there’s little protection from bad deals, and there’s no scarcity of junk at the typical meet. Bargains abound, but be skeptical, canny, and wary. Most flea market deals are on a no-refund basis, so ascertain that what you buy is in reasonably good shape or that it’s repairable. You have to rely on the integrity of the seller and your own judgment; there is no real warranty and lots of risk. It’s best to shop with specific equipment in mind and know the range of acceptable prices. With that in mind, let’s discuss some advice for making the most of your purchases.

Tips for Buyers. First of all, come prepared. Before you venture into the world of pickup trucks, vans, and folding card tables loaded with stuff, be sure of what you want to buy. It pays to come armed with a detailed shopping list and target prices. Impulse buying can be dangerous, so when you enter the flea market, stick to your list as closely as possible.

Also, arrive early: the best bargains often disappear in the first few hours of the first day. Everyone knows this, so the flea market tends to be crowded



Receivers, transmitters, transceivers, scanners, VHF gear, test equipment—it’s all there, and you’ll feel like the little boy in the penny-candy department when it comes to making up your mind. Are you ready to tackle the adjustment and troubleshooting to put that good-deal “boat anchor” in shipshape condition? Be sure you have all the facts before lugging home an “unknown.”

in the morning, but peters-out after lunch. However, you may be able to make very good deals at the end of the selling day since many vendors dearly hate the prospect of lugging their stuff back home again. Wear comfortable shoes and have available clothing to cope with summer sun, cold drafts, thunderstorms, drizzle, and winter snow.

Paying by check offers you some protections, but checks are rarely accepted. In the flea-market world, cash is king, so bring money—but don’t take more cash than you intend, or can afford, to spend. Carry just enough currency to handle your shopping list plus a little extra for unexpected finds.

Carry simple checkout tools. A small screwdriver set, pair of pliers, knife, and pocket multimeter (to make continuity and short-circuit checks) are helpful, as are batteries.

Small electronic parts and accessories usually are the best and safest buys at flea markets. A component that may sell for several dollars at a retail electronics store, for example, may be found at one-tenth the price in the flea market.

Try not to buy parts or equipment you don’t intend to use right away. Flea markets are great places to pick up inexpensive gear and components, but you can easily become an



Radio flea market sponsors rent tables to vendors just as in non-electronics flea markets. When a vendor doesn’t show up, their absence often is quite visible with a bare booth among the sea of busy display tables. Nevertheless, it looks like this vendor had a very good reason for not making the show. Wonder what their table would have looked like?

electronic pack rat with a much-too-large junkbox if you’re not careful.

Avoid buying equipment without an instruction manual, especially if it’s sold as-is, unless you know for certain how you can get one (see the sidebar for more on manuals).

If large sums are involved, ask the seller to demonstrate the item. Don’t buy a receiver, transmitter, transceiver, linear amplifier, computer, or other costly item unless you can see it operate. Check and test equipment before taking it home; the risk of missing out on a one-time good deal is far outweighed by the burden of a \$500

Resources

Whatever you buy, you'll certainly want to know what's available. You'll need to acquire some general electronics catalogs (like Radio Shack) and catalogs of radio equipment dealers and distributors such as Ham Radio Outlet, Universal Radio, and Amateur Electronic Supply. You'll also want the catalogs and spec sheets of current equipment manufacturers such as Drake, Yaesu, Kenwood, Icom, Ten-Tec, and others.

The used books and magazines seen at flea markets can be bargains. While much information is dated, it's the old books and magazines on radio and electronics that offer something special. Reading them can supplement your understanding of modern-day radio and electronics with a good historical perspective.

Nostalgia is "in," so there's a burgeoning market in books, booklets, magazines, and newsletters serving the market for older radio equipment. Let's look at some of what's offered, and where to get it (for the addresses and telephone numbers of the sources that follow, see the boxed text entitled "Names and Numbers").

At the solid-state end of the spectrum is Fred Osterman's booklet, *Buying a Used Shortwave Receiver*. Its 20 pages are for the SWL who's looking for a used solid-state (not vacuum tube) set. The author discusses the relative merits of purchasing radios privately, at hamfests, or from radio stores. He also offers a six-point receiver performance checklist for quick and accurate evaluation at a radio flea market or hamfest.

Of most use is the table of pricing information and an overall rating score for 50 popular communications receivers and 20 best-selling digital portables. The booklet is available for \$3.95 plus \$1 shipping from Universal Radio, Inc.

Shortwave Receivers Past and Present, a 1987 "blue book" classic of more than 200 communications receivers marketed over the past 20 years. It provides specifications and photos of most of the receivers it lists. Also included is a chart showing the new and approximate used cost of each set. It's \$6.95 plus \$1 shipping also from Universal Radio, Inc.

Another good book is *Communications Receivers, 2nd Edition*, by Ray Moore, ex-K1DBR. Moore has amassed a great deal of data on American-made, general-coverage communications receivers from 1932 to 1981. He covers RME, National, Hallicrafters, Hammarlund, Collins, and others, and shows photos of 375 receivers made by 58 companies. Including variations on

the 375 illustrated receivers, over 700 sets are covered. The 115-page book is \$17.95 plus \$2.50 postage and handling from RSM Communications.

The book *The Hallicrafters Story* describes the best-known name in communications radios, the Hallicrafters Company, which in the 1940's and 1950's was a synonym for "shortwave radio." Max C. de Henseler, HB9RS, covers the company's operations from 1933 to 1975, when it disappeared. Included are photos of most sets, a nostalgic sampling of magazine advertisements, and tube complements. The book is \$14.95 plus \$2 shipping (total \$16.95) from the Antique Radio Club of America, Inc. Orders from outside the U.S. are \$18.95 in U.S. funds, shipping by surface mail.

Offered by the publishers of the authoritative shortwave reference book, the *World Radio TV Handbook (WRTVH)*, the new *1993 WRTVH Equipment Buyers Guide* presents test results on most modern receivers and a handy price-vs.-performance evaluation. Also included is a used radio-equipment checklist and advice on shortwave antennas. The guide is published by Billboard Publications, Inc., and (priced at \$19.95) is available from radio booksellers including Ham Radio Bookstore (both addresses appear in the boxed copy entitled "Names and Numbers"). The HR Bookstore offers the guide separately, or together with the 1993 WRTVH for \$34.90 plus \$4 UPS shipping.

Magazines and newsletters are also helpful. For example, *73 Amateur Radio Today*, *CQ*, and *QST* (as well as *Ham Radio Horizons* and *Ham Radio*, both no longer published) constitute a treasure-trove of information about current and past equipment. The classified ads in those magazine can give you a good picture of the used market, and you can read the product reviews to find out about the performance of new and old equipment. Also, the *Antique Radio* column by Marc Ellis in *Popular Electronics* is a good source of tips and techniques for restoring vintage radios.

A good source of back-issue radio magazines, though a chancy and casual one, is the next flea market in your area. Back issues of amateur radio, communications, electronics, and computer magazines typically can be had for 10 cents to \$1 apiece, depending on condition, demand, and age.

You also can obtain back issues of the major amateur radio magazines (*QST*, *CQ*, *Ham Radio*, and *73 Amateur Radio Today*) from Bill Welsh, W6DDB. Back issues are \$2 each for pre-1960 issues, \$1.50 for pre-1976 small-size is-

sues, and \$2 for large-size 1976-and-up issues. Prices include domestic shipping, with a \$5 minimum order. Checks should be payable to W6DDB.

Electric Radio, Published by Barry R. Wiseman, N6CSW/O, is a magazine for those who appreciate older tube-type equipment. Each issue explores vintage radio gear and the people who once produced it. Issues also provide information on the modification, repair, and building of equipment. The pages are replete with excellent photos and there's a large classified section. Domestic subscriptions are \$24 by second-class mail and \$34 via first class. Subscriptions for Canada and overseas are more. Contact Electric Radio for more information.

For more than 32 years, the *Ham Trader Yellow Sheets* (HTYS) have helped radio amateurs, scanner enthusiasts, and SWL's buy, sell, and trade their radio and electronics gear. The newsletter ads also present guideposts to current market prices and values. HTYS is published twice monthly and mailed first class so ads circulate quickly. A 1-year subscription is \$16.50. A sample copy is free if you provide a No. 10 (business size) SASE with two stamps affixed. Several ham equipment buyers' guides also are available. Contact HTYS for more information.

It's difficult to repair and maintain electronic equipment (and, sometimes, even to use it) without instruction or service manuals and schematic diagrams. Unfortunately, many manufacturers of older equipment are defunct, or the manuals are out-of-print. However, several third-party resources can furnish originals or reproductions of the originals. Here are some sources:

- Manuals for most ham gear made from 1935-1970 are available from HI Manuals. A catalog (required to order manuals) is \$2. There is a research fee for information requests.

- Hallicrafters service manuals for amateur/SWL equipment are available from Ardco Electronics. Specify model numbers when writing.

- The W7FG Manuals and Repair Service provides manuals as well as repair and restoration work for most vintage radio gear. Contact Karolena and Gary Gompf

- Manuals for National Radio Company receivers are available from DAR Electronics, DBA National Radio Company.

- For CB rigs, *The Screwdriver Experts Guide*, a 380-page technical reference, includes circuit descriptions and a troubleshooting guide for most CB radios. It's \$29.95 plus \$3.50 shipping from CBC International. ■

white elephant residing in your workshop. Scout out a nearby AC power source if the gear isn't plugged in or if there's no power at the seller's booth or table.

If buying an expensive rig, try to buy it "on approval," arranging a return policy with the seller. Obtain a receipt and business card, if possible, showing the seller's name, address, and telephone number—and the agreement right to return it within 10 days or so if something proves seriously wrong with it. Further, buy on the first day of 2-day flea markets so you can test and return unsatisfactory items on the second day.

Closely inspect anything you're thinking of purchasing. Open it up to check for obvious damage, rust, burn marks, corrosion, missing parts, and butchered insides. Smell-check for mustiness and burn odors. Feel the equipment's controls, especially dial indicators, for smoothness of operation, and check the condition of the power cord. Give kits and homebrew gear a very close look for wiring and construction quality.

If it's a receiver you seek, bring a pair of headphones and a 15–20 ft. length of wire for a test antenna. Connect the antenna, plug in the phones, and listen to the receiver in operation. Even if indoors, you probably will hear at least some signals on the 40- and 20-meter amateur bands, and on the 10- or 15-MHz WWV time-standard frequencies.

If you're searching for a transmitter, bring along or borrow a dummy load—even one as simple as an electric light bulb of appropriate power rating. A straight key is handy for CW transmitter testing: The dummy load should illuminate when the key is depressed. Observe how the transmitter tunes up.

The bid table procedure that many event sponsors promote is also a good thing, as opposed to auctioning equipment. The emotional factor that usually enters the auction process is largely missing from the bid table. It's also a good method for disposing of your excess gear when you don't have enough stuff to justify renting a flea market space.

Negotiating a Good Deal. You should observe a few simple but important rules for making a mutually

A Radio Flea Market and Hamfest Sampler

Here is a sampling of the events—large and small—you'll find across the U.S. Check with your local radio-club members and the radio magazines' monthly hamfest calendars and special-events listings. All listings are annual affairs, and the dates shown are 1993 dates:

Alabama

Huntsville: Huntsville Hamfest and 1993 ARRL National Convention, August 14–15

Montgomery: Central Alabama Hamfest, November 13

California

Ventura: Southwestern Division Convention, September 17–19

Florida

Jacksonville: Florida State Convention, July 31–August 1

Miami: ARRL Hamfest of the Americas and Tropical Hamboree, February 6–7

Orlando: ARRL North Florida Convention/Oriando Hamcation and Computer Show, March 12–14

Tampa: ARRL Hamfest, November 20–21

Georgia

Atlanta: Atlanta HamFestival, July 17–18;

Monitoring Times Convention, October 15–17 (see note 1, below)

Illinois

Grayslake: ARRL Hamfest, September 25–26

Indiana

Ft. Wayne: Indiana State Convention, November 13–14

Indianapolis: Indiana Hamfest, March 14

Louisiana

West Monroe: ARRL Hamfest, November 13

New Hampshire

Manchester: New England Division Convention, July 24

New Mexico

Albuquerque: ARRL Hamfest, August 21–22

New York

Rochester: Atlantic Division/New York State Convention, May 21–23

Ohio

Dayton: Dayton Hamvention, April 23–25

Pennsylvania

Kulpsville: Annual Winter SWL Festival, February 18–21 (see note 2, below)

Tennessee

Knoxville: Amateur Radio and Computer Fair, June 5

Memphis: ARRL Delta Division Convention, October 9–10

Texas

Arlington: Texas State Convention, June 4–6

Houston: West Gulf Division Convention, November 5–7

Washington

Spokane: ARRL Hamfest, April 3–4

West Virginia

Jackson's Mill: Weston, West Virginia State Convention, July 3–4

Note 1: The annual Monitoring Times Convention focus is on shortwave listening and scanning. Sponsored by Monitoring Times magazine, information is available from Grove Enterprises, Inc., PO Box 98, Brasstown, NC 28902; (704)-837-9200.

Note 2: The Annual Winter SWL Festival is oriented toward shortwave listening, rather than amateur radio, as are most hamfests. The Festival is sponsored by the North American Short Wave Association (NASWA), William E. Oliver, Publisher, 45 Wildflower Rd., Levittown, PA 19057. ■

satisfactory swap-meet deal. For one, allow sufficient time to scout the area for comparative checks on price, quality, and availability. In fairness to sellers, it's hard to accurately price used gear and parts, and you, as a buyer, should expect to find a wide variety of prices and conditions for the same item. Ensure that you have a handle on what's available before you deal, to avoid later regrets.

Ask the seller if the equipment works properly, and if he or she has the instruction manual. If neither answer is affirmative, it's a yellow if not a red flag for the purchase. Such answers may

at least justify seeking a lower price.

Don't accept an asking price: sellers expect to bargain. But if you've located just what you want, and the price is in the ballpark, don't lose the deal by haggling over pennies. If the price is fair, buy; the goodie probably won't be there later.

Don't be in such a hurry that you can't devote the time to inspect the gear. Ask about any quirks in the equipment. Take the time the deal deserves.

Establish the identity of the seller, particularly if the deal is substantial, for two reasons: (1) the gear could

possibly be stolen; and (2) if it doesn't work as stated, you can at least contact the seller for help or try to get your money back. Be very wary of goods that are priced just too low to be for real.

Above all else, exercise good judgment and common sense in what you buy and how you buy it. You won't be sorry you did.

Cleaning Up and Restoring Used Gear. Whether you've bought a tube-type "boat anchor" or a nearly new, solid-state gizmo, it's best not to "smoke test" the unit until its cleaned up. This ensures that dust, grime, and dead bugs don't short-out components.

After giving the unit a thorough visual inspection, first clean up the exterior case, if necessary. A kitchen-type cleanser such as Clorox's Soft Scrub often does the trick. Metal cabinets may be brought up to respectability with a very light buffing with a jeweler's polishing cloth. Wooden cabinets can often be restored by using a scratch-coating furniture polish such as Boyle-Midway's Old English. You can remove small rust spots by sanding with fine sandpaper or by using rust-removing chemicals. Commercial penetrants can be effective in loosening rusted parts.

You can clean the chassis or enclosure using a vacuum cleaner and a small brush; a toothbrush is good for hard-to-reach places. You can usually remove grease, dirt, battery acid, and capacitor electrolyte with a solvent or cleaning fluid such as carbon tetrachloride, and remove resins and pitch with benzene or kerosene. Inspect for broken or charred components and connectors, loose or frayed wires, and cold solder joints. Nail-polish remover removes gummy residues from cords and cables.

You can clean variable-capacitor plates by using a pipe cleaner dampened with carbon tetrachloride or alcohol. The pipe-cleaner can also be used to clean areas that a larger brush can't reach.

Assume that most switch contacts and potentiometers are noisy. You can remove dirt and oxide by spraying electronic-contact cleaner into them, vigorously rotating the shafts several times to make sure that the cleaner has a chance to work in and

make good electrical contact before it evaporates. Repeat the process several times.

Remove and replace broken parts and loose or frayed wiring, resoldering possible cold solder joints. In old equipment, especially vintage tube-type receivers, consider replacing all of the paper bypass capacitors with new ceramic or mylar types to avoid problems with leaky, shorted, or open capacitors. This step can wait until you've finished initially checking the equipment.

Be safe. Replace stiff, cracked, or frayed line cords before plugging units into AC power since plastic and rubber cords tend to deteriorate after a few years.

For an especially neat unit—particularly if the gear has seen hard service—you might want to tear down the equipment, respraying the cabinet and relabeling the operating controls and jacks. However refrain from doing that if you want to sell the unit commercially or trade it in. A resprayed, relabeled unit rates low on the commercial resale market, unless you're a real restoration master. Finally, you can replace broken or missing mounting feet with adhesive-backed feet, while you can give older units a classy look by installing modern instrument knobs.

After delaying this moment as long as possible, it finally comes time to actually try out your purchase. With luck, and since you've already rejected gear that has been butchered or drastically modified, the unit should, hopefully, work as pitched by the seller. And if it doesn't?

Usually there's no practical recourse other than to fix the unit yourself, checking first for the obvious, such as blown or missing fuses, bad tubes, poor connections, shorts, open circuits, thermal problems, and the like. If difficulties persist, contact the seller, who may be able to shed light on the problem. If you still can't fix it, ask for help from a friend experienced in radio troubleshooting, and obtain a manual or schematic if one wasn't furnished. Repairing electronic gear is next to impossible without a circuit diagram (see the sidebar entitled "Resources" for more on manuals).

Event Generalities. There are several ways to find flea markets and

hamfests in your area. The best is to ask the members of a local radio club; if you're not a member, listen to the chitchat on amateur VHF FM repeaters. Radio stores often post notices of upcoming hamfests. And check the hamfest and event calendars in *CQ*, *73 Amateur Radio Today*, and *QST*. You can usually save a dollar or two on your ticket if you buy it in advance rather than at the door.

There are three rungs on the flea market and hamfest ladder. The first rung consists of local meets. They can be found just about everywhere that hams live. Often local meets are mostly informal swap-oriented affairs and have few organized activities such as forums and family fare, but most have low or nominal admission fees. Typically these events tend to be swap-meet, bone-yard, and "tail-gater"-type affairs.

The second rung is made up of small- and medium-size regional affairs. They tend to be a cross between less-formal local hamfests and formal expo's and conventions. Many regular hamfest activities are present, with swapping and horse-trading sometimes competing for attendees' attention with technical seminars and manufacturers' displays. There's usually a limited amount of organized activities for non-hams at such affairs.

At the top rung are the major amateur expo's and conventions. They are often sponsored by, or affiliated with, the American Radio Relay League (ARRL), the national association of radio amateurs. ARRL conventions are conducted on division and state levels, and a national convention is held each year in different cities on a rotating basis. (The 1993 annual ARRL convention is in Huntsville, AL, August 14–15; 1994 is set for Arlington, TX, June 10–12.)

At the third rung, many formal, organized activities abound and business meetings, membership sessions, and elections for officers may be held. These major affairs tend to run two or three days.

Major expo's and conventions feature something for everyone. Besides dealer displays and the ever-present flea market, there tend to be many technical and operating forums, spouses' and children's tours, a hospitality suite for spouses, breakfast and

(Continued on page 98)

Build a

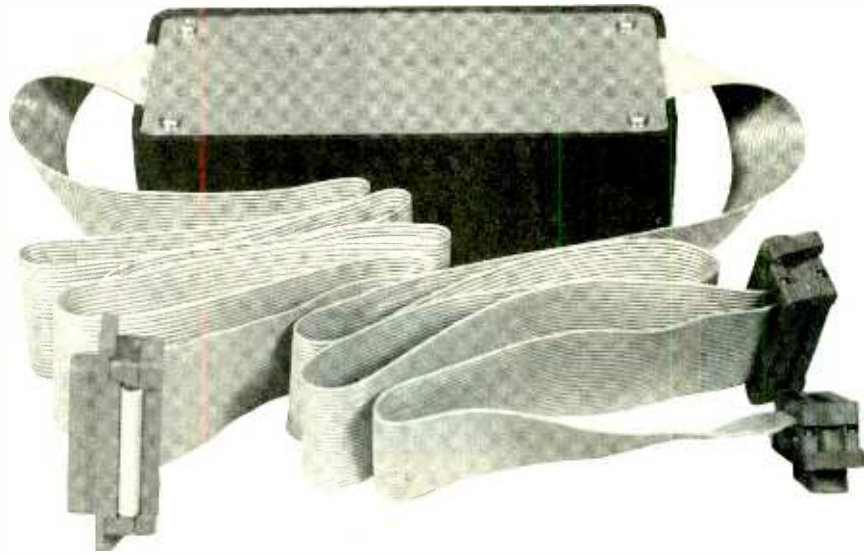

Computer-Controlled A/B Switch

Our simple computer-controlled A/B switch makes it easy to switch any pair of AC or DC signals, including RS-232 signals.

BY JOHN YACONO AND MARC SPIWAK

It would seem that there are two general types of computer owners: power users with up-to-the-minute hardware and those that get by with slightly older equipment. However, both types eventually end up with a stockpile of hardware; advanced users quickly amass hardware because they want to, while modest users accumulate wares because they have to upgrade just to remain moderately current.

Once you end up with enough surplus hardware, old and/or new, it seems pretty natural to want to connect at least some of it (terminals, modems, printers) together, if for no other reason than the versatility that such a mini-network can provide. That usually leads to the purchase of a couple of A/B switches to permit you to configure new set ups on the fly.

Unfortunately, simple A/B switches must be directly operated by the user. That is pretty inconvenient if you're working from a remote terminal. Besides, your computer should "know" what resources you need and auto-

matically provide them for you—shouldn't it? After all, let's say that you have two computers or terminals sharing a modem. It would be nice if the A/B switch between them automatically switched to the computer that's presently running communications software. An A/B switch like that could even be used in a similar way to allow two computers to share a serial printer.

The *Computer-Controlled A/B Switch* presented in this article is such a device. In fact, it's one of the most versatile communication devices that you'll find. It can direct just about any pair of AC and/or DC signals. With it, power users can use one to multiplex input to a data-acquisition board, and more common folks can redirect audio signals between their home-entertainment components. Further still, just about anything possible with a double-pole, double-throw switch rated for 350 volts at 120-mA AC or 200-mA DC can be done with our A/B Switch.

The device was originally designed

to allow a computer to disconnect one device on a three-wire RS-232 communications link and switch to another device on the line. (Specifically, the unit would interrupt a communication between two modems so the computer could communicate with one of them). However, after the prototype was working, we found that by re-wiring the "contacts and poles" of the switch, its operation could be modified for use in many other applications. In this article we'll show you how to build, configure, and (if necessary) write software to "A/B switch" almost any pair of signals.

Circuit Operation. The A/B Switch circuit is the electronic equivalent of the double-pole double-throw switch shown in Fig. 1. Refer back to that figure (in particular the labels on the poles and contacts) from time to time as we discuss the actual A/B Switch circuit.

The Switch's schematic diagram is shown in Fig. 2. Note that key points in the schematic bear the same labels

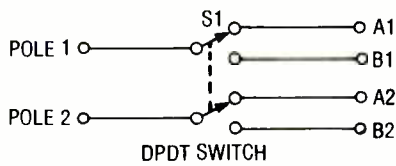

Fig. 1. The A/B switch is very similar to a standard double-pole, double-throw switch, like the one shown here.

as the poles and contacts in Fig. 1. The circuit's active components are nothing more than a pair of diodes that steer current through the inputs of four special optocouplers. The optocouplers are specially designed for telecom (standard slang for "telecommunications") applications and conform to the RS-232C standard.

As you can see, each diode is connected in series with (and in between) the inputs of two optocouplers. Also note that the two series-connected optocoupler-diode-optocoupler legs of the circuit are connected back-to-back (i.e., with opposite polarity) between the control input and ground. In that configuration, U1 and U2 will turn on whenever the control voltage is positive, and U3 and U4 will turn on when the control voltage is negative. When any one of the optocouplers is on, its output pins short to simulate switching action.

The circuit wired as shown in Fig. 2 is fine for AC signals, but it can be modified for enhanced DC performance. The necessary modifications are shown in Fig. 3. The revised circuit operates just like the AC circuit, but wiring the optocoupler outputs as shown permits them to handle more current and yields faster switching action. However, you must obey the polarity indicators to wire the device properly.

If desired, one pole of the circuit can be wired to handle AC with the other pole configured for enhanced DC operation. For example, U1 and U3 can be wired for AC, as shown back in Fig. 2, while U2 and U4 can be wired for DC as in Fig. 3, or vice versa.

One benefit of using optocouplers in an application like this is the isolation provided between the device generating the control signal and the signal lines. The incidental isolation will protect the controlling device from harmful voltages (perhaps due to a nearby lightning strike) on the signal line up to 3750 volts! Since the controlling device will likely be a computer or terminal, that sort of protection is very nice indeed.

Our Application. Take a look at the version of the A/B Switch circuit shown in Fig. 4. Note that pins 2 and 3 of J3 (the connector to modem 2) are connected to the poles of the switch. That way, the circuit can switch J3 (the poles) between J1 (which you can think of as position A) and J2 (or position B).

The switch receives its control signal from pin 20 of J1, which supports the data-terminal ready (DTR) line on the computer. (The reason that we used the DTR line will be explained a little later.) The DTR line causes one pair of optocouplers to turn on when

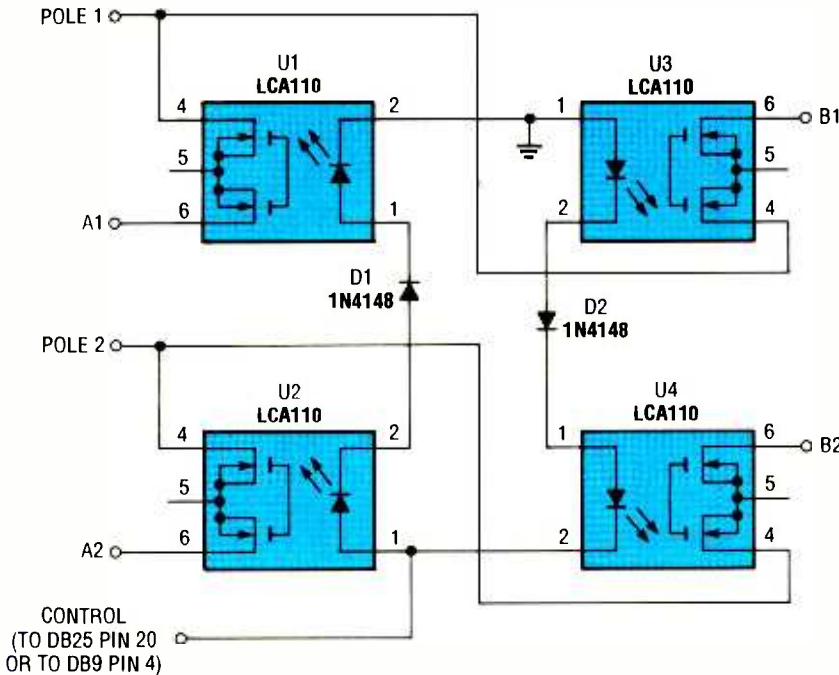

Fig. 2. The A/B switch is very simple, as you can see. Four special telecom switches (U1-U4) are wired together to form a double-pole, double-throw switch.

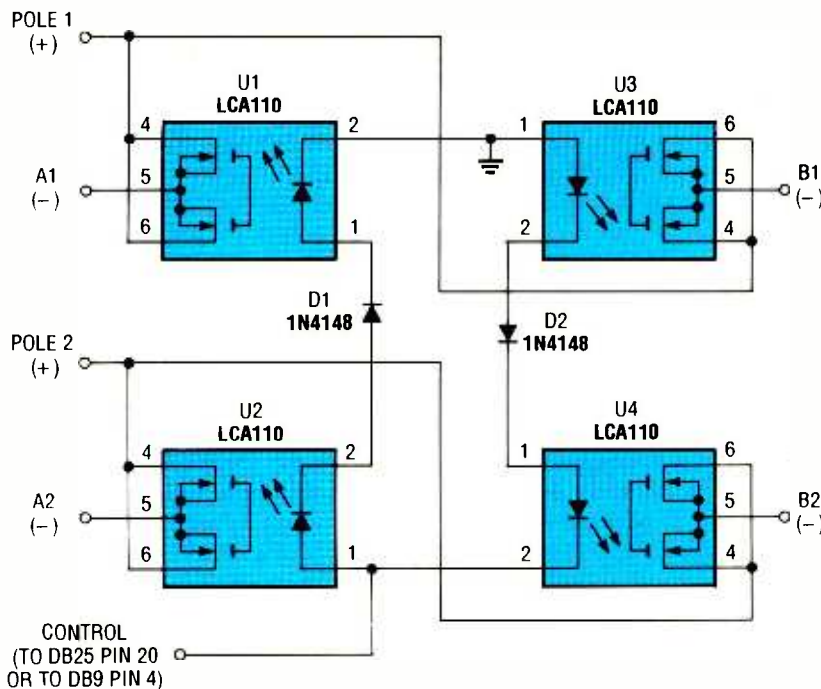

Fig. 3. The version of the A/B switch shown back in Fig. 2 is fine for AC signals, but it can be enhanced for DC operation by rewiring the optocoupler outputs as shown here.

ters (special-purpose memory locations in the CPU) by "pushing them onto the stack" (storing them in another special location). The third instruction places the hexadecimal number "3FC" into the DX register. That number is the address of the byte that controls the DTR line. In the next step, the value stored in the address in DX (to be literal, the value stored at address 3FC in hexadecimal) is placed in the lower half of the AX register (the lower half is denoted "AL").

We now seek to toggle the bit that controls the DTR line. That would be the least-significant bit of the number that was taken from address 3FC, which is now in AL. To toggle that bit,

PARTS LIST FOR THE COMPUTER-CONTROLLED A/B SWITCH

- U1-U4—LCA110 opto-MOS telecom switch
- D1, D2—1N4148 general-purpose small-signal silicon diode
- Printed-circuit board, DB9 and/or DB25 connectors as needed (see text), ribbon or other suitable cable, IC sockets, case and mounting hardware, solder, etc.

Note: The following items are available from John Yacono, PO Box 4042, Farmingdale, NY 11735: printed-circuit board only—\$5.00 + \$1.00 shipping and handling; U1-U4 only—\$15.00 + \$1.00 shipping and handling; Software only—\$5.00 + \$2.00 shipping and handling; Partial kit (includes printed-circuit board and all board-mounted components)—\$20.00 + \$3.00 shipping and handling; Complete kit (includes printed-circuit board, all board-mounted components, case, 4-conductor cable, DB-25 connectors with hoods, and software)—\$35.00 + \$3.00 shipping and handling; Fully assembled unit (supply filled-in copies of Table 1 with each order)—\$40.00 + \$3.00 shipping and handling. Send check or money order only. New York residents, please add appropriate sales tax. If you have any technical questions, contact the authors at the above address (include self-addressed stamped envelope, phone number, and brief description of your situation).

TABLE 1—CONFIGURATION CHART

Device	Required Connectors (DB9 or DB25)	Ground Pins (5 or 7)	Control Pin (One Entry Only)	Receive Pin Numbers	Transmit Pin Numbers
Pole					
A					
B					

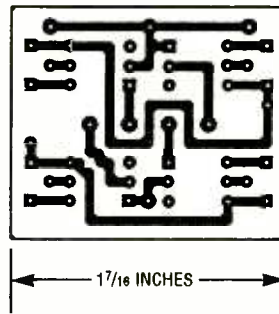

Fig. 5. You can use this foil pattern to build your own A/B switch, or order the board, kits, etc. from the listed supplier.

you simply take the exclusive xor of 1 and the value in AL, which is performed by the next instruction. Now that the value of AL has been appropriately altered, it replaces the old value in 3FC as soon as the OUT instruction is performed. The DX and AX registers are then restored to their ini-

tial values by "popping them off the stack" (retrieving them from the special location mentioned before) and the program terminates. The state of the DTR line will change each time this program is run, toggling the A/B Switch.

Determining Your Needs. Table 1 has been provided mainly to assist you in configuring your switch for RS-232 applications, although it does have limited use for other applications. In particular, the table will help you configure the connector wiring. Let's discuss how to fill-in the table.

Start by mentally designating the device being switched as the "pole" device, one of the other devices as unit "A," and the remaining one as unit "B." Now examine each peripheral in turn to determine the connector it requires (DB9 or DB25) and fill-in the first

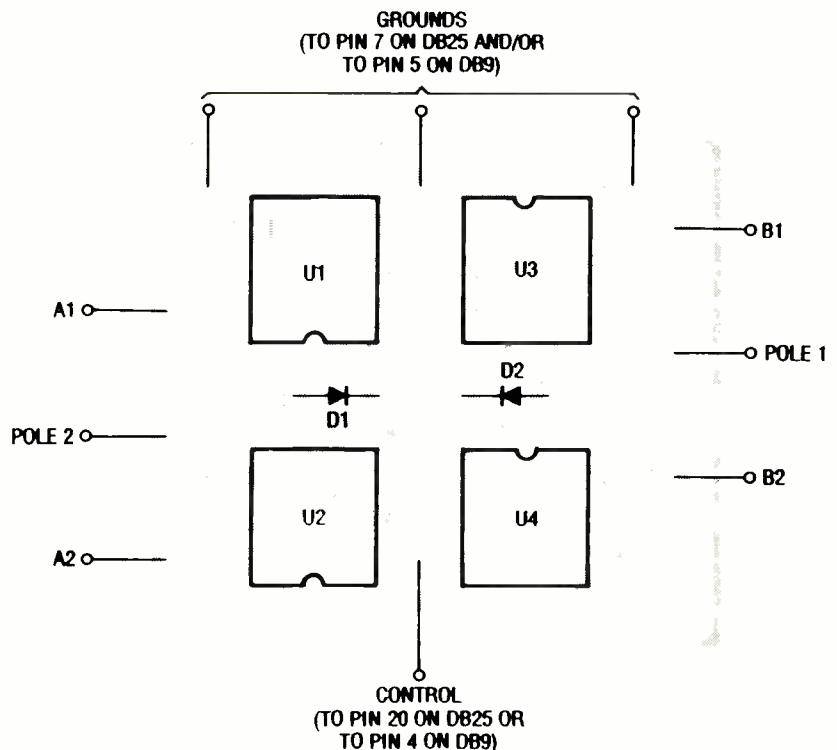

Fig. 6. Follow this parts placement diagram to stuff the board for AC use (such for true RS-232 applications or audio projects).

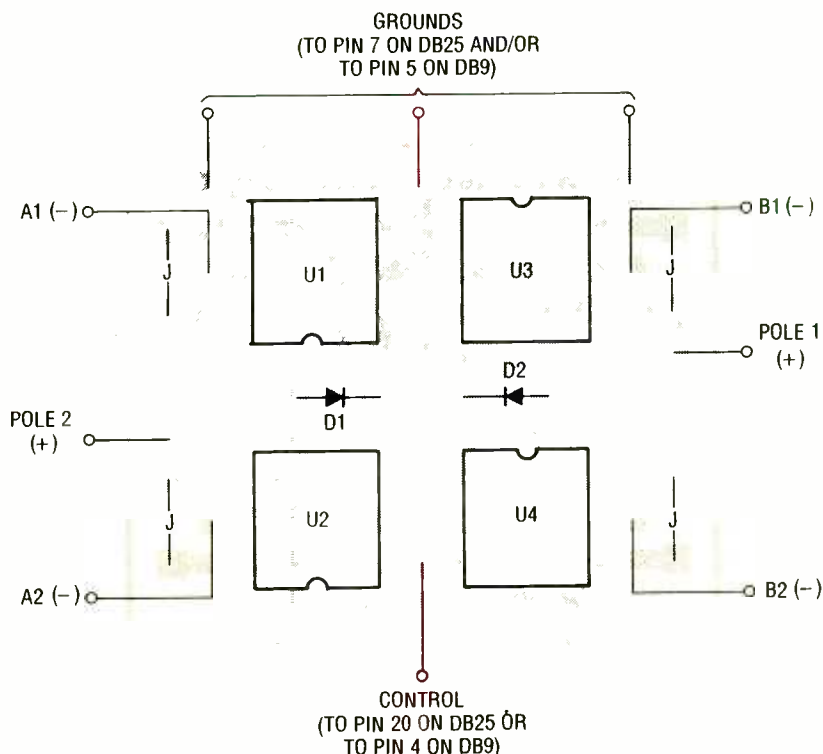
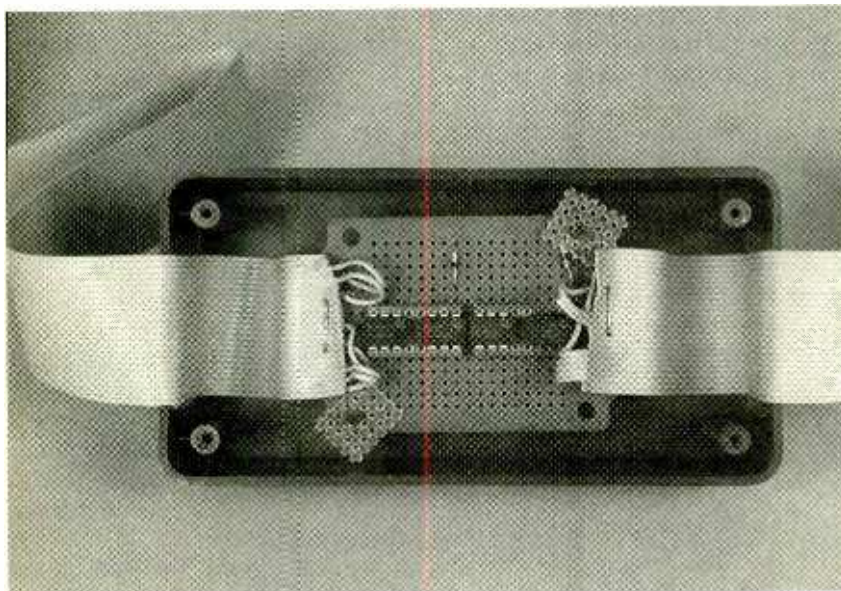

Fig. 7. To use the switch for DC operation, this method of stuffing the board will yield a device that is faster and capable of handling higher current.



Here's what the inside of the A/B switch looks like. Note the compactness of the design.

blank column of Table 1. The connectors you list there should be on your shopping list for the project.

In the ground-pin column, place a 5 in each row with a DB9 connector, and/or a 7 for each DB25 connector. That column now indicates the appropriate ground pin for each connector. Determine which device (the pole, A, or B) will have control of the

switch. In the row for that device under the control-pin column, place a 20 if the device uses a DB25 connector, or a 4 if the device uses a DB9 connector. That tells you which pin on which connector carries the control signal. Leave the other two spaces in that column blank or cross them out as the other connectors will not generate a control signal.

For the last two columns, you'll need to check the documentation for your peripherals. You must find out which pin (pin 2 or pin 3) is used for transmission and which is for reception on each device. Fill the last columns with those pin numbers accordingly. In general, computers use pin 2 for transmit and pin 3 for receive when they have a DB25 connector, and just the opposite when they have a DB9 connector. Most modems are entirely the opposite: they use pin 3 for transmit and pin 2 for receive over a DB25 connector, and vice versa for a DB9 connector.

Construction. Now that we understand how the A/B switch works, it's time to build one. A printed-circuit board should be used. Not only will using a printed-circuit board save you time and lessen the chance of wiring errors, it will also eliminate the possibility of signals interfering with one another. If you want to make your own printed-circuit board, you can use the foil pattern shown in Fig. 5. Otherwise, printed-circuit boards, kits, and fully assembled units are available from the source mentioned in the Parts List.

If, as we talked about before, you want to use the A/B switch for AC (like RS-232 and audio applications), follow the parts-placement diagram in Fig. 6, and wire your connectors using Fig. 1 as a guide. However, to use the switch for DC operation, the configuration shown in Fig. 7 will yield a device that is faster and capable of handling higher current. (Please observe the proper polarity of the outputs for DC use.) As mentioned earlier, you can even wire half the unit for AC and the other half for DC signals.

For strict RS-232 applications, you should follow the parts-placement diagram in Fig. 6 to stuff the board (that illustration omits the jumpers of Fig. 7). Connect the grounds and the control line guided by Table 1. Connect the transmit and receive lines from the pole device to poles 1 and 2, respectively. Connect the receive and transmit pins of the A device to A1 and A2, respectively (again guided by the table). Also use the table to help you connect the receive and transmit pins of the B device to B1 and B2, respectively, and the wiring is complete. The finished board can now be installed in any case you like. ■

Build a Sideswiper

The Sideswiper was the first of the go-fast code keys. You can't buy them anymore, but you can build one in an hour or so with parts from the hardware store!

BY LARRY LISLE, K9KZT

For those who have never seen one, the Sideswiper is a Morse-code sender that stands somewhere between the straight key and the bug or keyer in speed, and it's easy on the arm. In use, a paddle or handle is moved back and forth continually between two contacts. Unlike a bug, the paddle is not moved one way for dots and the other for dashes; the key is simply kept on whichever contact is next in sequence longer for the dashes than the dots.

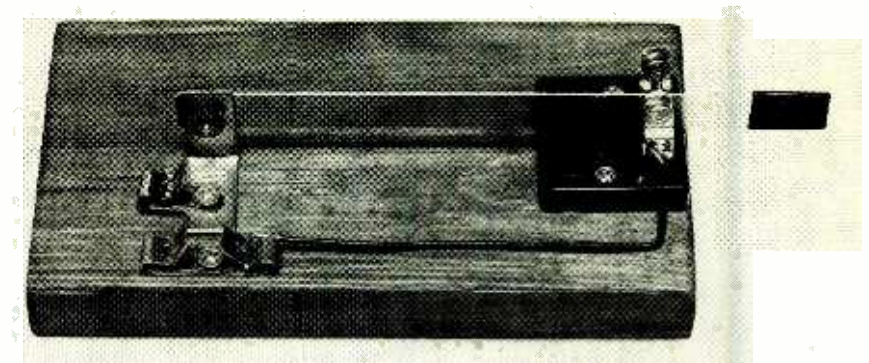

The Sideswiper is no longer made, but it is was the first of the high speed code keys. It's as easy to build as it is to use, and you can get all the parts at a hardware store!

Construction. The Sideswiper is a snap to build. I used the base of a plastic double-pole knife switch for the contacts. They're connected together underneath and the common (ground) wire is brought out to a fahnstock clip or directly to the transmitter.

The other connection goes to the brass corner bracket that holds the paddle. I used a piece of 0.032-inch brass strip for the paddle because it felt right at the hardware store, but you might want to make yours thicker or thinner. Try your own ideas!

Use. The contacts on the switch base can be adjusted by bending them in or out, but I'd suggest that they be left

as they are until you learn the proper technique. To get the hang of using your keyer, you should hold your thumb and forefinger about an inch apart and sort of slap the paddle from side to side. That helps you avoid the most common error in sending code with a Sideswiper—running the dots and dashes together.

Be sure to practice with an oscillator or buzzer before trying the key on the air. As you become more proficient, you can put the contacts closer together, which will allow you to speed

PARTS LIST FOR THE SIDESWIPIER

- Knife-switch base
- Brass strip
- Brass corner bracket
- Fahnstock clips
- Wood block
- Wire, solder, hardware, etc.

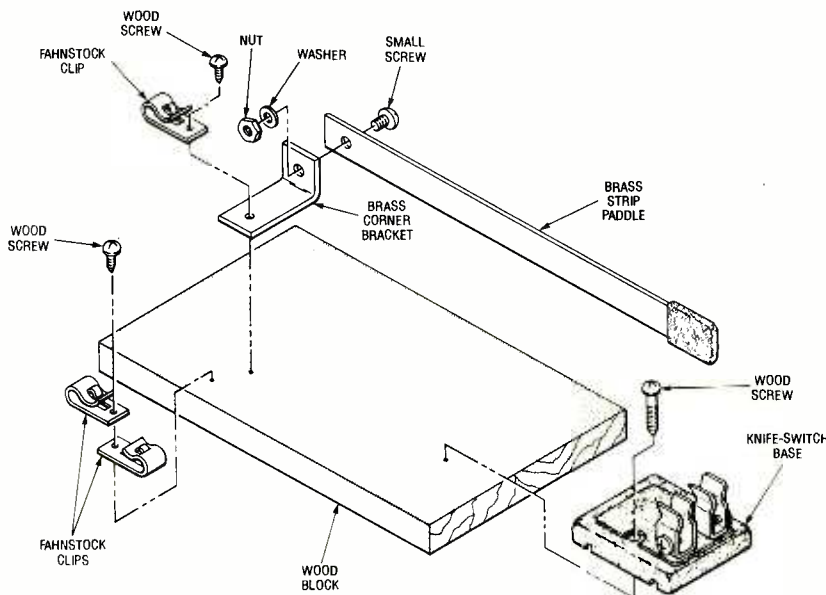
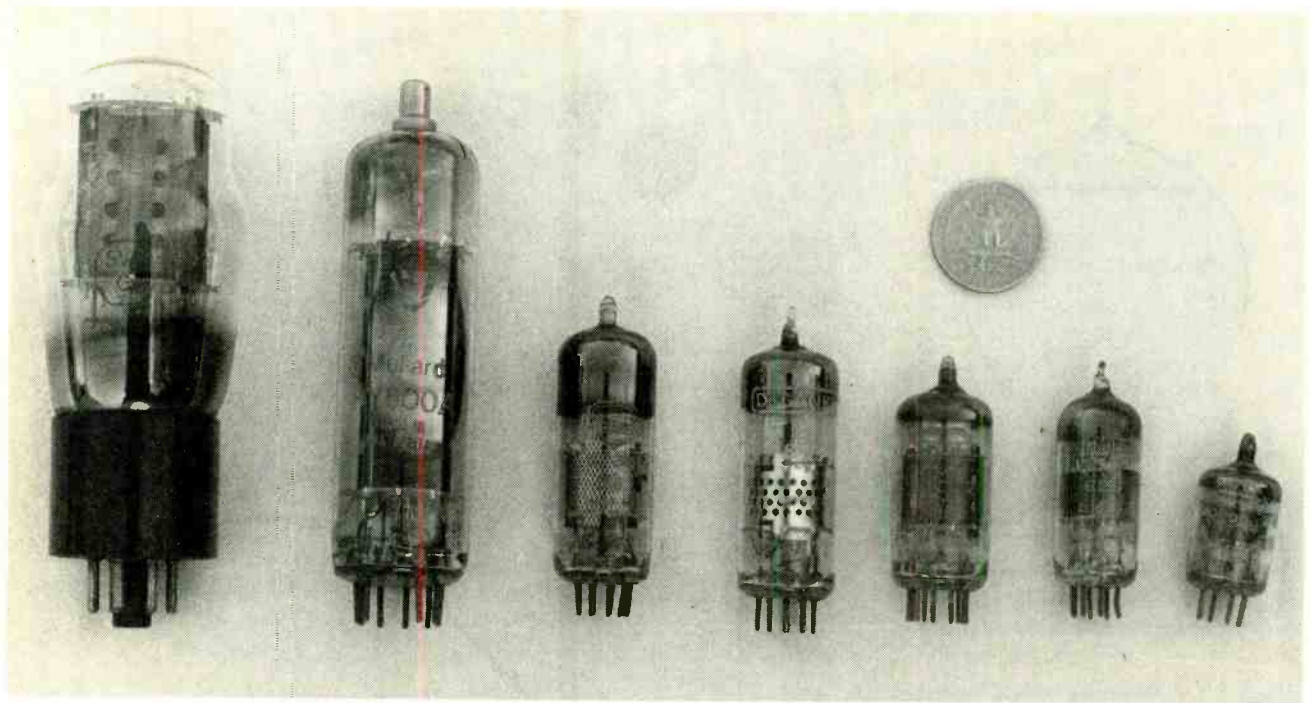

Fig. 1. As this breakaway diagram shows, the Sideswiper is composed of materials—the plastic base of a double-pole knife switch, fahnstock clips, brass corner bracket, a brass strip (the paddle), a block of wood, etc.—that are readily available from local sources.

up your keying. If the keyer tends to move while in use, it can be held in place on the table with some double-sided masking tape.

The Sideswiper is very easy on the arm. Let your forearm rest on the table and roll back and forth as you key. If your arm becomes unusually tired, you're doing something wrong. Try placing the key at different angles or elevate either the key or your wrist until you find the position where the back and forth motion is without tension and seems effortless.

That's all there is to it. The Sideswiper is fun to use and is a good conversation starter when you make a contact on the air. See you on 40 meters!



VACUUM-TUBE BASICS

Come with us as we take an in-depth look at the forerunner to the modern transistor.

BY PAUL COXWELL

Since the invention of the transistor some 45 years ago, vacuum tubes have gradually been replaced by their solid-state counterparts. Today, electronics research is mostly centered on discrete and integrated semiconductors; the tube is largely limited to specific fields, such as high-power transmitters and the cathode-ray tube in television receivers.

There is still, however, a considerable quantity of tube-type equipment in existence, and although it is becoming harder to obtain tubes, it is well worth maintaining such equipment. Many enthusiasts still take great pleasure in building tube amplifiers and receivers. It is to readers who have not previously used tubes and who are interested in learning about their operation that this article is addressed.

The Diode Rectifier. The earliest example of the tube can be traced back to Thomas Edison at the end of the last century. Edison was experimenting with the electric light bulb

and needed a way to support a fragile filament. He arranged a metal plate in the bulb and used insulated supports from the plate to hold the filament in place (see Fig. 1). Power applied to the ends of the filament caused it to heat up and glow, but Edison also discovered that by connecting a second power source between the plate and the filament a current would flow through the vacuum, even though there was no direct electrical connection. Edison's experiments were concerned with electric light, so he did not see any practical use of the discovery.

It took over 20 years, before British scientist Sir John Ambrose Fleming would use the technique to develop the first diode rectifier tube in 1904. He showed that current flowed through the vacuum only when the plate was made positive with respect to the filament. With the polarity reversed, no current would flow. Because of that one-way action, Fleming named his device a "valve," and that name is still used in England and some other countries to refer to any type of tube.

Look at Fig. 2 as we explain the action of a diode. Power is applied to the filament of the tube in Fig. 2A, causing it to generate heat. Filaments are generally run at low voltages, 6.3 volts and 12.6 volts being two very common values, although other voltages between 2 volts and 35 volts are not uncommon. The heat causes a chemical coating on the filament to emit electrons into the vacuum surrounding it. The coating may be based on tungsten, barium, or strontium oxides, and the effect is known as thermionic emission. Since electrons carry a negative electrical charge, they form a negative charge around the filament. The accumulated charge is called a space charge.

Basic electrical theory states that like charges repel and unlike charges attract. If a positive voltage is applied to the plate, the negatively charged electrons from the space charge are attracted toward it, causing a current to flow. As the voltage applied to the plate is increased, more electrons are attracted to it, so more current flows. The graph in Fig. 2B shows how plate

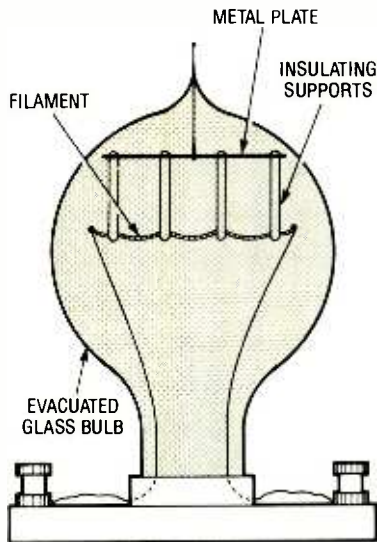

Fig. 1. This version of Edison's light bulb led to the diode vacuum tube.

current (I_p) increases as the applied plate voltage (V_p) is increased.

Every diode tube has a saturation point where a further increase in applied voltage does not cause a significant increase in current. In the example shown, as the plate voltage is increased above about 70 volts, the plate current levels off at just under 150mA. The voltage and current values at saturation depend on the type of tube in use. Saturation occurs when the positive plate voltage is sufficient to attract all the electrons that the filament can emit. If the filament cannot emit more electrons, then the flow of electrons to the plate (and hence the plate current) cannot be increased. The only way to increase the plate current above that shown would be to raise filament emission by increasing the filament current. If the plate supply's polarity is reversed, making the plate negative with respect to the filament, no plate current flows. That is because the negatively charged electrons in the space charge are repelled by the negative voltage of the plate.

The basic diode tube can be used as a simple half-wave rectifier, with the plate acting as the anode and the filament as the cathode (see Fig. 3). With alternating current applied to the circuit, the tube conducts on alternate half cycles. When the top end of the 250-volt winding of T1 is positive and the lower end is negative (as in Fig. 3A), the plate of the tube is positive with respect to its filament, so

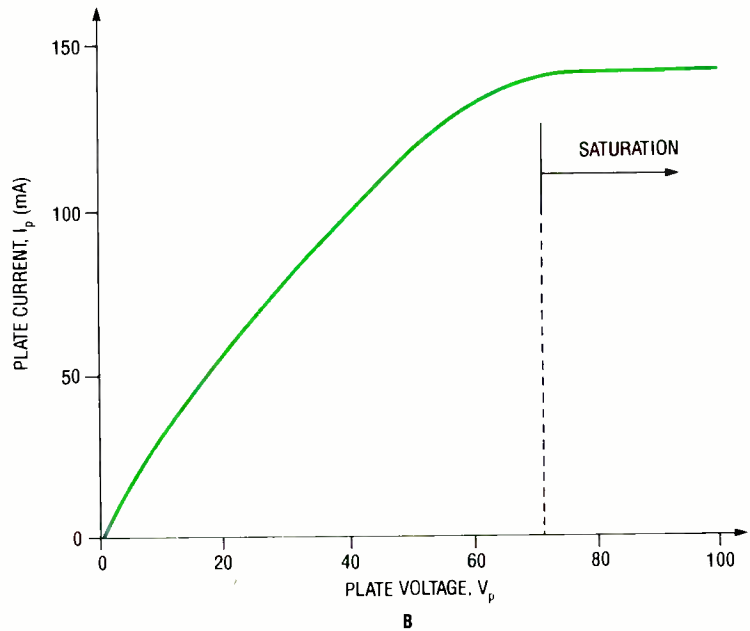
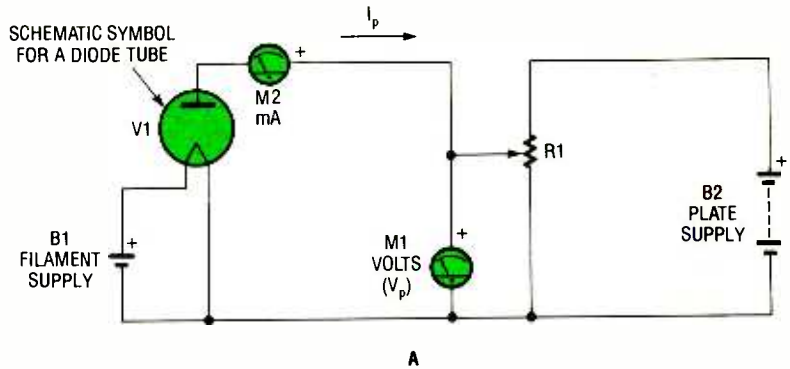

Fig. 2. When a vacuum diode is placed in a circuit like the one in A, it exhibits the quasi-exponential characteristic curve shown in B.

current flows through the load. On the following half cycle (shown in Fig. 3B), the polarity of the winding is reversed, making the plate negative with respect to the filament, which prevents any current flow. The current through the load, therefore, takes the form of half-cycle pulses. Note that the 5-volt transformer winding supplies power for the tube's filament. In a practical power supply, the rectifier output is usually followed by a storage capacitor and filter circuit to provide a fairly smooth DC voltage.

The Indirectly Heated Cathode. So far, it has been assumed that the filament of the tube acts as its cathode. That type of tube functioning in that fashion is said to have a directly heated cathode. Figure 4 shows the electrode construction of a typical diode,

along with another type that has an indirectly heated cathode. Note how the filament completely surrounds the plate in more modern tubes such as the one shown.

The indirectly heated diode has a separate electrode to form the cathode. Of course, the cathode has a coating to enhance thermionic emission. The filament now becomes a separate entity and is placed inside the cathode assembly, which is usually cylindrical or oval in shape. The sole purpose of the filament in this type of tube is to provide sufficient heat to the cathode to stimulate emission, so the filament is sometimes referred to as "the heater." The drawing also shows the schematic symbol for the indirectly heated diode. Note that the symbol "K" is used to identify the cathode of a tube.

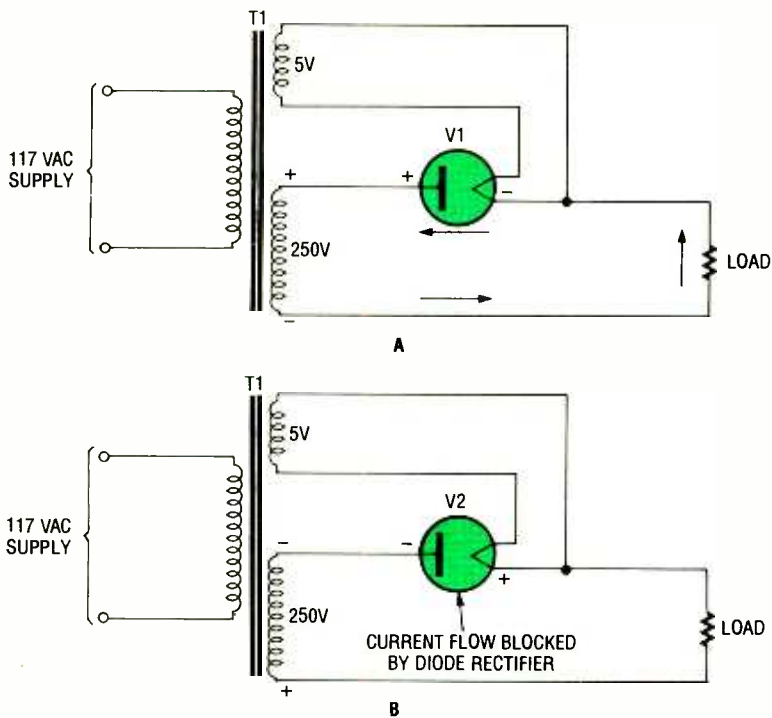

Fig. 3. The vacuum diode, like its semiconductor equivalent, allows current to flow in one direction (A), but not in the reverse direction.

The main reason for using indirectly heated tubes is that they provide isolation between different parts of a circuit. With directly heated tubes, connecting all the filaments to a common supply would also effectively join all the cathodes together, which is typically undesirable. Indirectly heated tubes allow all the filaments to be connected together while maintaining isolation between cathodes.

For that reason, most tubes are of the indirectly heated type. Directly heated tubes can provide greater emission from the combined filament and cathode, so they are used mostly in high-power circuits, such as large power-supply rectifiers and the output stages of broadcast transmitters. In these circuits, the filament of the tube is usually fed from its own separate winding on a transformer, thereby providing sufficient isolation from other circuits.

The Triode. The invention of the triode by Dr. Lee de Forest in 1907 provided a means for the amplification of electronic signals. That tube is very similar to the diode, but has an additional, third electrode, hence the name "triode." Figure 5 shows the basic construction of a modern, indirectly heated triode. Notice that the

plate, cathode, and heater all resemble their counterparts in the diode; the only addition is a length of fine wire, wound in a spiral between vertical supports, and placed between the cathode and plate. That extra electrode is called the control grid.

If the control grid is at the same voltage as the cathode, the device behaves just like a diode: The heated cathode emits electrons to form a space charge and a positive voltage on the plate will attract the electrons causing plate current to flow. As with the diode, no current can flow if the plate becomes negative with respect to the cathode, and the tube has a saturation point where a further increase in positive plate voltage cannot cause a corresponding increase in current.

However, plate current in the triode can also be affected by the control grid. When the grid is made negative with respect to the cathode, electrons in the space charge are repelled by the negative charge on the grid. That restricts the flow of electrons through the grid, and reduces plate current. The greater the negative voltage applied to the grid, the more the plate current is reduced. As the negative voltage (called the "grid bias") is further increased, there will come a

point where the grid repels all the electrons from the space charge so the plate current will drop to zero. That is referred to as the cut-off point.

Figure 6A shows a test circuit that can be used to determine the characteristics of a triode. The two potentiometers allow the grid and plate voltages to be set to any desired value, and a milliammeter can then be used to measure the resulting plate current. Observe the polarity of the plate- and grid-bias batteries carefully: The plate is positive with respect to the cathode, but the control grid is negative with respect to the cathode. Also notice that the three batteries have been given letters. These designations have become standard with tube circuits. The "A" supply provides power for the filaments, the "B+" supply is the main positive line to the plates of the tubes, and the "C-" battery provides a negative voltage for grid bias.

In Fig. 6B the results for a typical triode are shown. The plotted curves, called characteristic curves, show the relationship between plate current and plate voltage for specific values of grid bias. The first curve is plotted by setting the grid voltage to -2 volts and taking current readings for various plate voltages. The grid voltage is then changed to -4 volts and the plate voltage varied again for the second curve. The process is repeated for the remaining grid-bias values. As expected, plate current increases as plate voltage increases, but notice that for any given plate voltage the current is lower when the grid bias is greater. For example, assume that the plate voltage is set at 125 volts (shown in dots on the graph). With a grid bias of -2 volts, plate current is a little under 7mA, but if the grid bias is increased to -4 volts, the current drops to 4mA. With a bias voltage of -10 volts, plate current is zero because the tube is cut off. The only way to obtain a plate current with this level of grid bias is to increase the plate voltage.

Figure 6C shows another set of curves for the same tube. This graph shows how plate current varies with grid bias for specific values of plate voltage. Basically, this is the same information as in the previous graph, it is just presented in a slightly different way. Whichever set of curves you use, you will get the same results. With a

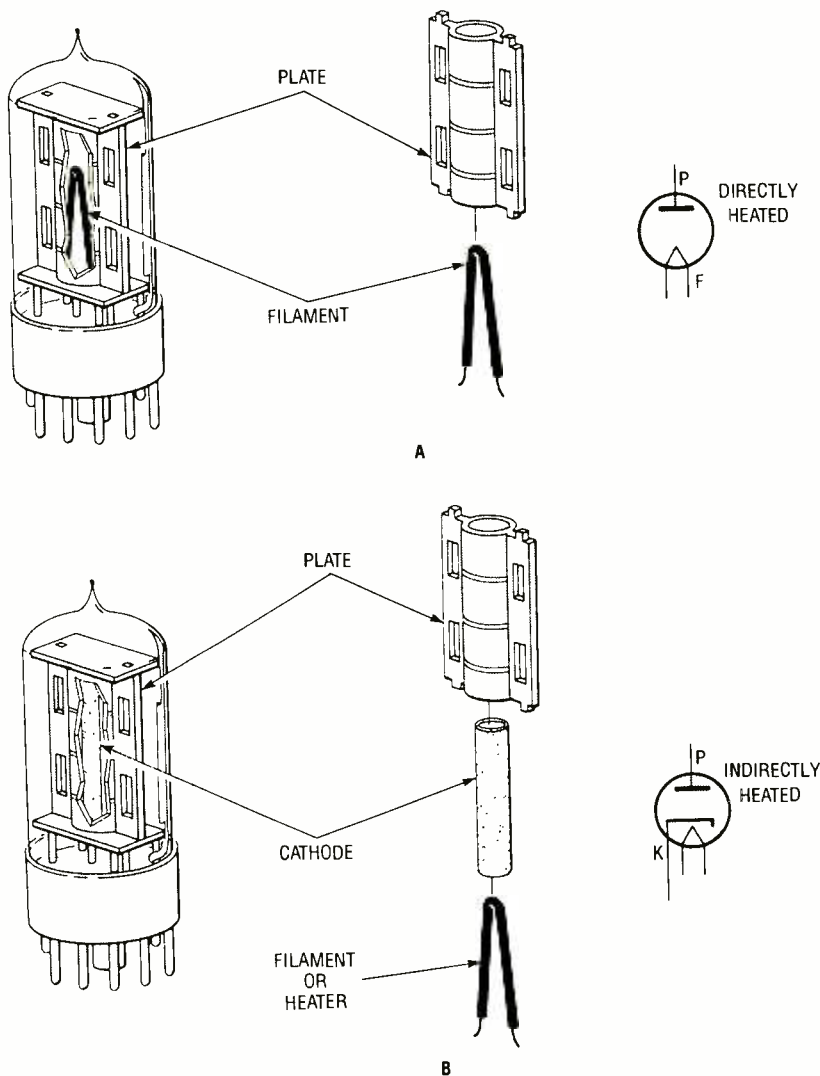

Fig. 4. The problem with directly heated tubes is that they couple with other tubes via the filament supply. That is overcome in an indirectly heated tube because the cathode is separate from the filament.

grid bias of -4 volts, for example, plate current is 2mA when the applied plate voltage is a little under 100 volts.

Triode Characteristics. So far, you have seen that the plate current is affected by both the plate voltage and the grid-bias voltage. Examine the I_p/V_g curves of Fig. 6C again. With an applied plate voltage of 125 volts and a grid bias of -4 volts, the plate current is 4mA for that particular triode. If the grid bias is decreased to -2 volts, the plate current will increase to 6.4mA . From the curves, it is possible to determine that with this new value of grid bias, the current can be reduced to 4mA again by reducing the plate voltage to approximate-

ly 85 volts. This shows that a 2 -volt change in grid bias produces the same amount of change in current as a 40 -volt change in plate voltage; the grid voltage, therefore, is much more effective at controlling current than is the plate voltage.

The comparison of plate-voltage change to grid-voltage change is very important, for it gives an indication of the amount of amplification that the tube can provide. The ratio of the plate-voltage change to the grid-voltage change required to maintain a constant plate current is called the amplification factor, and is represented by the Greek letter μ , where for constant I_p :

$$\mu = \text{Change in } V_p / \text{Change in } V_g$$

With a plate-voltage change of 40 volts and a grid-voltage change of 2 volts for a constant plate current, the amplification factor, or μ , of this tube is 20 . A triode amplifier cannot provide a voltage gain in excess of its amplification factor; indeed, the actual gain is always less than that figure for reasons that will be explained a little later.

A second characteristic of the triode is its plate resistance, represented by R_p . The tube behaves as though it had an internal resistance through which the plate current must pass. This resistance can be measured by setting the grid voltage to some specific value and measuring the amount of plate-current change that is produced by a given amount of plate-voltage change:

$$R_p = \text{Change in } V_p / \text{Change in } I_p$$

with V_g held constant. Assume that the grid voltage is held constant at -4 volts. With the plate voltage set at 125 volts, current is 4mA as has already been noted. If the plate voltage is now increased to 150 volts, the plate current will rise to approximately 5.5mA . A voltage change of 25 volts has produced a current change of 1.5mA , giving a plate resistance of approximately 16.7 kilohms. (Note that the plate-resistance formula is derived from Ohm's Law, so with the current specified in milliamps the resulting resistance figure will be in kilohms.)

The final characteristic of the triode that must be considered at this time is its mutual conductance, symbolized by g_m . (Note that "g" is the symbol for conductance, which is the reciprocal, or inverse of resistance.) Mutual conductance can be measured by setting the plate voltage to a specific value and measuring the amount of plate-current change for a given change in grid voltage. It was shown earlier that with plate voltage set at 125 volts and a grid bias of -4 volts, plate current is 4mA . It was also shown that reducing the grid bias to -2 volts while maintaining the plate voltage at the same level resulted in a plate current of 6.4mA . A change in grid bias of 2 volts resulted in a change of approximately 2.4mA in plate current. Mutual conductance is calculated as:

$$g_m = \text{Change in } I_p / \text{Change in } V_g$$

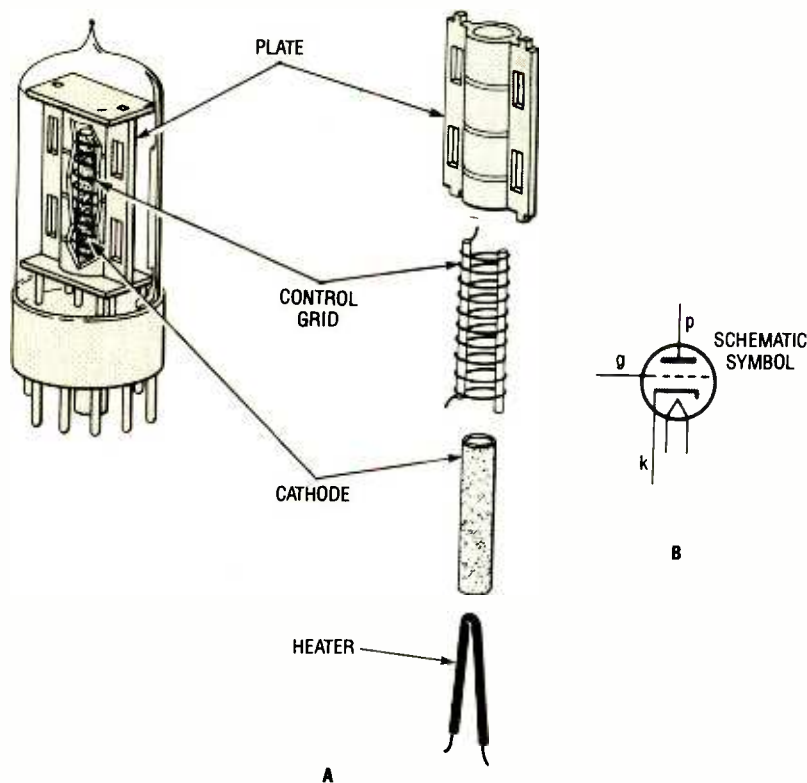

Fig. 5. The triode is useful for amplifying signals at its control grid, much the way a transistor amplifies signals at its base in common-collector mode.

with V_p held constant. The change in plate current is always specified in milliamps, and the result is given as milliamps-per-volt. (Note that that is current divided by voltage, which is the exact inverse of dividing voltage by current to give resistance, according to Ohm's Law.) A plate-current change of 2.4mA for a grid-voltage change of 2 volts gives a result of 1.2mA/V. That means that for each 1-volt change in applied grid voltage, the plate current will change by 1.2mA. If the negative grid bias is increased by 1 volt, the current will decrease by 1.2mA; if the negative grid bias is reduced by 1 volt, the plate current will increase by 1.2mA.

The amplification factor, plate resistance, and mutual conductance of a triode are related to each other:

$$\mu = g_m R_p$$

Any one quantity can be calculated if the other two are known. Notice the similarity between these characteristics and Ohm's Law, with μ in place of voltage, g_m for current, and R_p for resistance.

The Basic Triode Amplifier. A varying signal on the grid of the tube re-

sults in a corresponding variation in plate current. Since the purpose of the triode amplifier is to provide voltage amplification of a signal, the plate-current variations must be converted to voltage variations. This is accomplished with the aid of a load resistor in series with the supply to the plate (see Fig. 7A). Note that the circuit differs from those we've presented thus far in other ways, too, as we'll start describing more practical circuits now. First of all, the input to the grid is from a bias battery and an AC-signal source in series. Second, the variable plate supply has been replaced by a fixed 225-volt B+ line. The tube heater has also been omitted for clarity. In most schematics of any size the filaments of indirectly heated tubes are generally shown separately in the power supply section to simplify the diagram.

With no AC signal applied, the grid bias is determined by the C - battery (B1) and is fixed at -4 volts. As the AC signal swings to its 2-volt positive peak, it subtracts from the fixed bias to cause the grid to swing to -2 volts. When the signal reverses on its second half cycle, the 2-volt negative peak causes the grid to swing down

to -6 volts. The grid voltage, therefore, is a 4-volt peak-to-peak AC signal centered on -4 volts rather than zero.

The mutual conductance calculation showed that this tube gives a plate-current change of 1.2mA for each volt of grid-voltage change. Remember, however, that that is only true if the plate voltage is held constant; the presence of the load resistor causes the plate voltage to vary: As plate current increases so does the voltage dropped across R_L , which causes the plate voltage to drop. The behavior of the amplifier can be determined by plotting some points on the I_p/V_p characteristic curves (see Fig. 7B). When plate current is zero, there is no voltage drop across the load resistor, so the plate voltage rises to the B+ level of 225 volts. If the plate current is now increased to 2mA, Ohm's Law shows that R_L must drop 70 volts. This results in the plate voltage dropping 70 volts below B+ to 155 volts. By the time the plate current has increased to 5mA, R_L drops 175 volts, leaving the plate at just 50 volts above ground.

When those points are joined, a straight line called a "load line" is formed. Using the line, it is a simple matter to find the plate current and voltage for any given grid input, since the point must lie somewhere along the load line. The fixed -4-volt grid bias (shown dotted on the graph) gives a plate current of 3.2mA and a plate voltage of 110 volts. When the positive half cycle of the AC signal causes the grid to swing to -2 volts, the plate current rises to 4.1mA, while the plate voltage drops to 83 volts. When the negative half cycle takes the grid to -6 volts, the plate current decreases to 2.5mA and the plate voltage rises to 137 volts. Note that a phase reversal has occurred: When the input signal swings positive the output swings negative, and vice versa. The signal is also centered on 110 volts, so in most circuits a capacitor would be used at the output to couple the AC portion of the signal to the next stage by removing the 110-volt DC component.

The voltage gain of the circuit can now be determined by:

$$\text{Voltage gain} = \frac{\text{Output amplitude}}{\text{Input amplitude}}$$

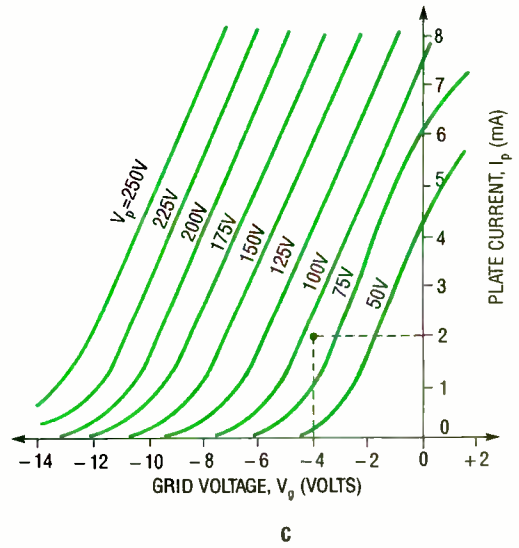
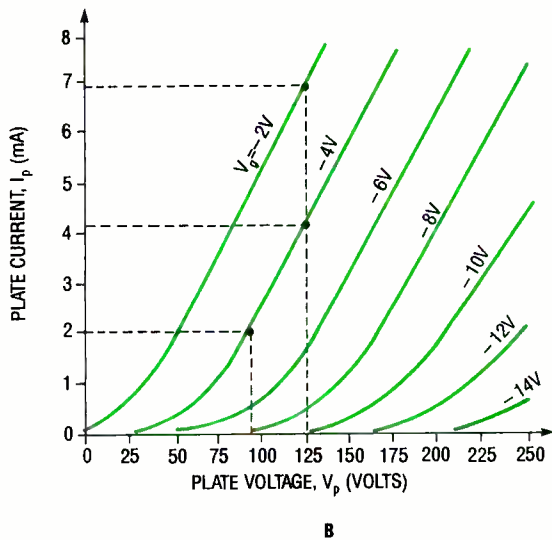
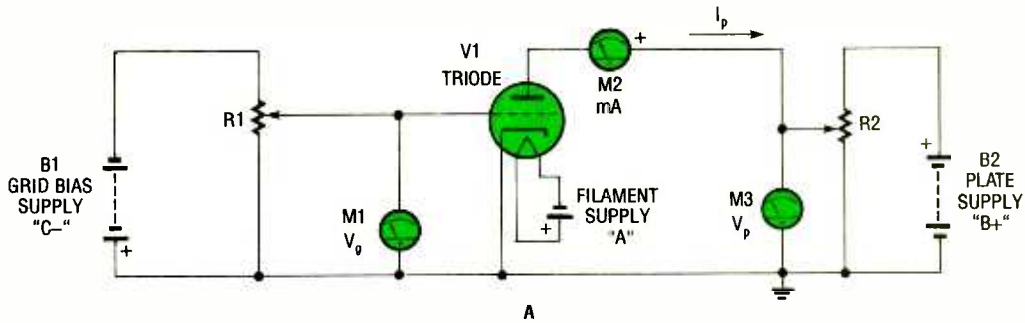

Fig. 6. The simple circuit in A can be used to characterize a triode by measuring its output voltage, and output current while adjusting its input voltage and load. the results are shown in B and C.

The input signal of 4 volts peak-to-peak results in an amplified output of 54 volts peak-to-peak, so the voltage gain in this case is 13.5. It was shown earlier that the amplification factor, or μ , of the triode is 20, yet the circuit provides a voltage gain of just 13.5. It is the internal plate resistance that is responsible for this difference.

Figure 8A shows the circuit redrawn in an unconventional manner. Arranged that way, it becomes obvious that the plate and cathode of the tube and the B+ supply are in series with the load resistor. The current flowing in the circuit varies with the 4 volts peak-to-peak signal input at the grid, so it is helpful to analyze the circuit by looking on the tube and B+ supply as being an AC generator, producing a peak-to-peak amplitude equal to the input signal multiplied by the amplification factor of the tube. This leads to the circuit shown in Fig. 8B. The points marked "P" and "K" represent the plate and cathode connections to the tube; R_p has been added to represent

the internal plate resistance of the tube, which was shown earlier to be around 16.7 kilohms.

The reason for the overall gain being less than the specified amplification factor can now be seen. The output from the tube "generator" is applied across R_p and R_L which effectively form a voltage divider. So, the actual gain of the circuit can be calculated as:

$$\text{Gain} = \mu R_L / (R_p + R_L)$$

That shows that the higher the value of the load resistance, the closer the voltage gain becomes to the amplification factor of the tube. It is important to realize that the plate resistance is determined by the construction of the tube and cannot be changed, whereas the load line and actual gain of the amplifier can be altered by adjusting the value of the load resistance. A useful exercise toward understanding what is happening would be to plot a second load line on the graph for a different value of R_L

and then determine the new characteristics of the amplifier.

Now that we've examined the vacuum diode and analyzed the operation and characteristics of the basic triode amplifier, it is time to look at some implications of the triode's characteristics and see how the device can be put to use in a practical circuit.

Grid Bias. One of the most important considerations in the design of a triode-amplifier stage is the choice of the grid-bias level. Examination of the graph back in Fig. 7B will show that each characteristic curve has both a straight (linear) section and a curved, non-linear section; the latter can be seen toward the bottom of each curve. With a grid bias of -4 volts, the input signal causes the grid voltage to swing between -2 volts and -6 volts. The load line intersects both of these curves on their linear portion and produces an output signal of 54 volts peak-to-peak, centered on the quies-

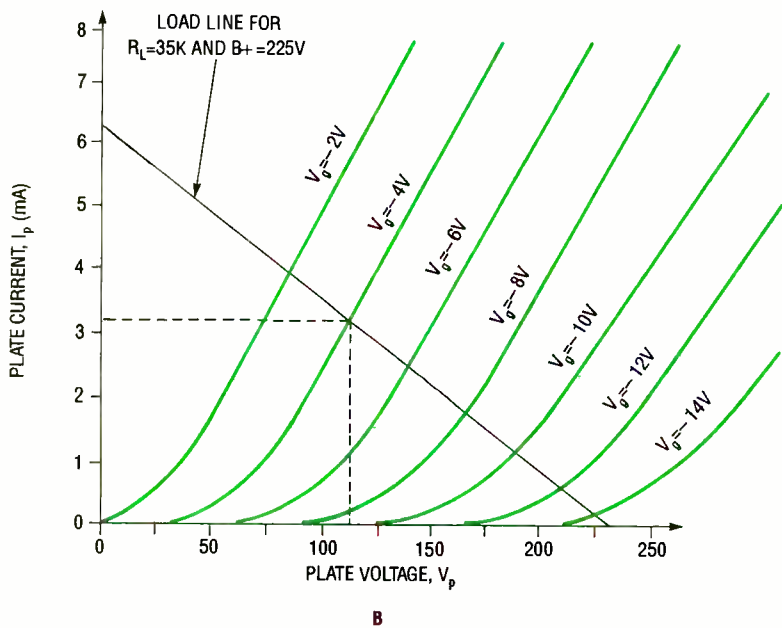
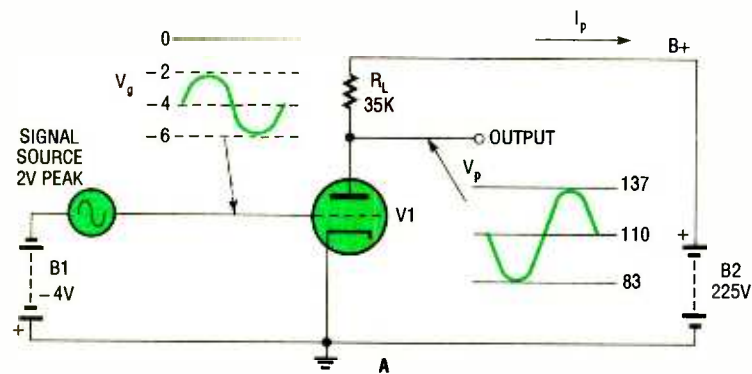

Fig. 7. A triode is an inverting amplifying device as indicated in A. The setup shown generates the family of curves in B. Note that the filament has been left out of the drawing in A for enhanced clarity as is customary in most vacuum-tube schematics.

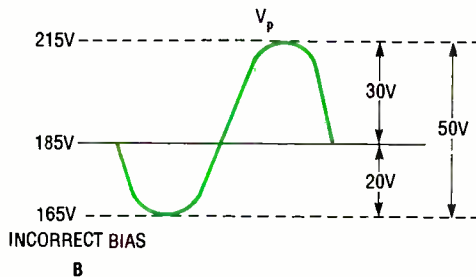
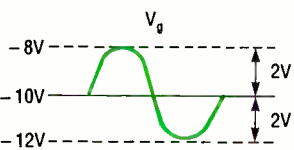
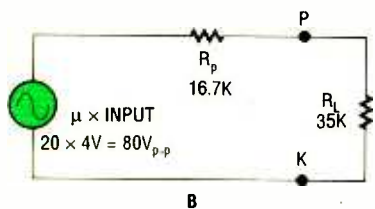
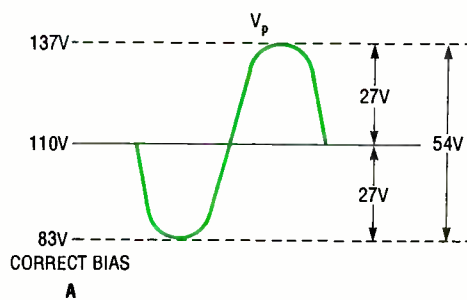
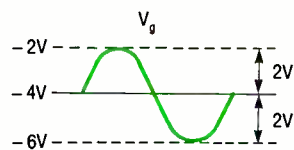
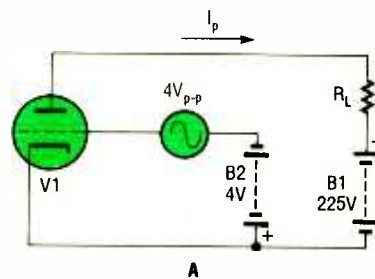

Fig. 8. Redrawing the triode amplifier so it appears as in A makes it easier to view as a signal generator with output impedance, as shown in B.

Fig. 9. With correct biasing, the quiescent output voltage should be right in the middle of the minimum and maximum output voltages (A). Incorrect biasing (B) leads to unsymmetrical waveforms and distortion.

cent (no-signal) plate voltage of 110 volts.

If the grid bias is increased to, say, -10 volts, the result will be quite different. The input signal will swing the grid voltage between -8 volts and -12 volts, both of which are intersected by the load line on their non-linear section. When the input signal is at zero, the -10 volts grid bias gives a plate current of 1.15mA and a plate voltage of 185 volts. When the grid swings to -8 volts, current rises and the plate voltage drops to 165 volts; when the grid swings to -12 volts, current drops and the plate voltage increases to 215 volts (see Fig. 9). The peak-to-peak amplitude of the output signal is now only 50 volts, so the gain of the stage has dropped from 13.5 to 12.5. Of far greater importance is the fact that the output is no longer an amplified, faithful reproduction of the original signal: The positive peak is 30 volts while the negative peak is just 20 volts. If this circuit formed part of the audio amplifier in a radio or phonograph, the reproduced sound would be distorted.

Incorrect bias or excessive signal input can also cause the control grid to be driven above ground voltage on the positive peaks of the input signal or to drop below the cut-off point on negative peaks (see Fig. 10). Normally, the grid is negative with respect to the cathode, so it repels electrons and no current flows in the grid circuit. The

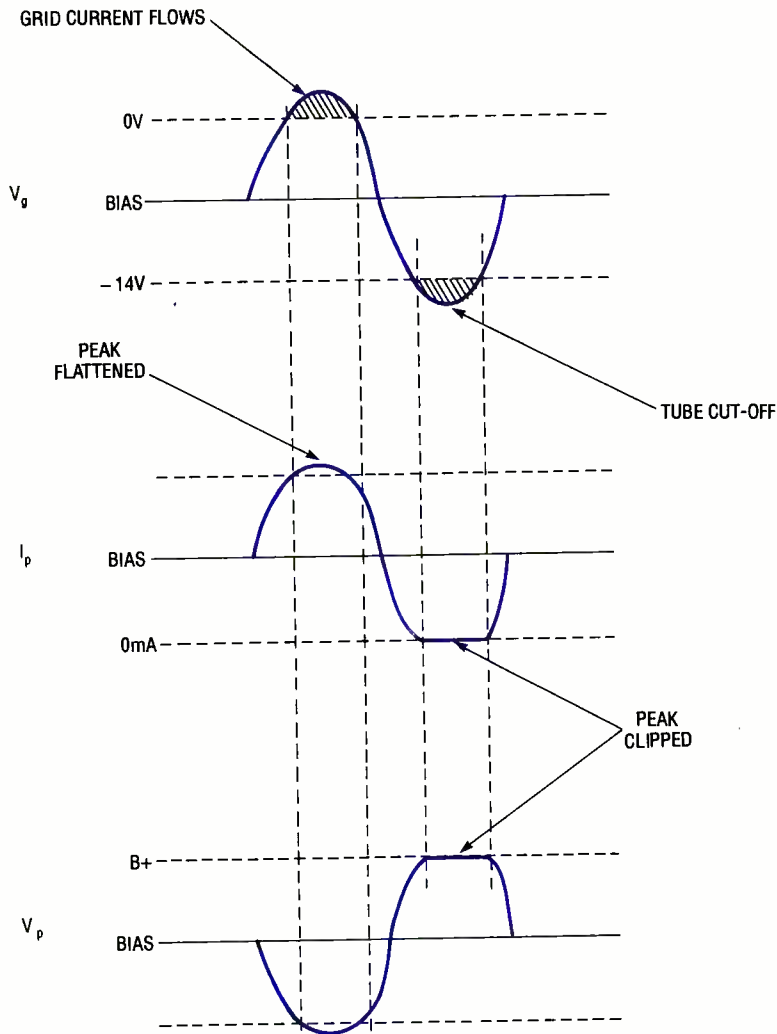

Fig. 10. An excessive input signal or excessive amplification can lead to clipping distortion in a variety of forms.

tube input, therefore, has a very high impedance. If the grid becomes positive with respect to the cathode, current can flow in the grid circuit since the negative electrons are attracted to the now positively charged grid. That grid current causes a reduction of plate current, resulting in the corresponding "peak" of the output waveform being flattened. The grid current can also load the previous stage excessively, since the input impedance to the tube is lowered.

On excessive negative signals, the tube can be driven to cut-off. In the circuit we have been considering, cut-off would occur when the grid is taken below -14 volts. Further increasing the negative voltage on the grid cannot reduce the plate current since it is already zero. With no plate current flowing, the plate voltage rises

to the full B+ level of 225 volts. Again, the result is a clipped peak on the output waveform. Clearly then, the amplitude of the input signal and the level of fixed grid bias must both be considered carefully if the amplifier is to provide a faithful reproduction of the original signal. Keeping the tube within its linear range is called "class-A" operation. A little later we will discuss some other amplifier classifications.

Cathode Bias. Since the power supplied to the tube plates must be positive with respect to ground and the grid-bias voltages must be negative, it would appear that a separate battery or power supply section must be used to provide the grid-bias supply. In some circuits, particularly the output stages of high-power transmit-

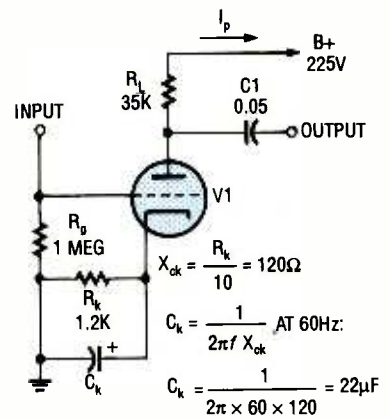

Fig. 11. As a rule of thumb, the impedance of the AC-bypass capacitor at the lowest frequency of interest be ten times smaller than the cathode resistor.

ters, this arrangement is used, but far more common is a method that completely dispenses with the need for a separate grid bias supply. This method applies the bias to the cathode instead of the control grid.

Figure 11 shows a typical amplifier stage that uses cathode bias. Resistor R_l is the load resistor and the capacitor at the plate couples the output signal to the next stage. The negative grid-bias supply has been removed and the input signal coupled straight to the control grid. Resistor R_g insures that the grid is kept at DC ground voltage when the input signal is capacitively coupled from a previous circuit. The value of 1 megohm is typical, since the input impedance of the tube is very high. In cases where the signal source provides a DC path to ground, such as a matching transformer, the resistor is not needed.

It was shown earlier that correct operation of this triode was obtained when the grid bias was set at -4 volts. That gave a quiescent plate current of 3.2mA (determined by the load line on the characteristic curves). In this new version of the circuit, however, the grid is at zero DC voltage. If the grid must be 4 volts below the cathode, but the grid is maintained at DC ground, the cathode must be pulled 4 volts positive with respect to ground. That is achieved by inserting a resistor, R_k , in the cathode connection. Determining the value of R_k is straightforward. The grid draws no current, so the current flowing in the cathode circuit must be equal to the plate current. The standing plate current is 3.2mA

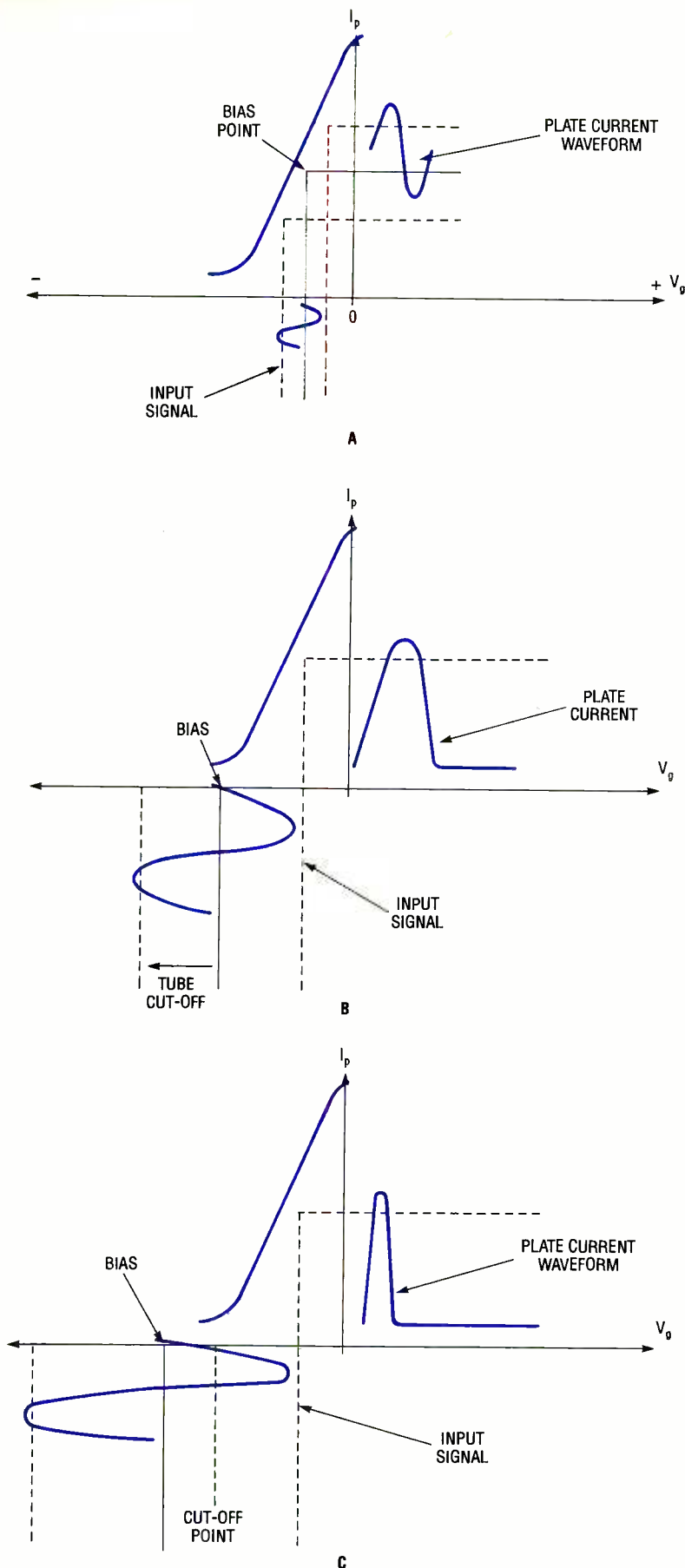

Fig. 12. These graphs show the relationship between the input and output signals for typical class-A (A), class-B (B), and class-C vacuum-tube amplifiers (C).

and the required voltage drop across R_k is 4 volts, so Ohm's Law can be applied:

$$R_k = \text{Bias voltage} / \text{Quiescent } I_p$$

This gives a figure of 1250 ohms. In practice the nearest standard value of 1200 ohms would be satisfactory.

Although the cathode resistor provides the correct DC bias for the tube to operate, it does introduce a problem: the gain of the amplifier is reduced. As the input signal swings toward its positive peak, the plate current will attempt to rise to the value indicated by the load-line graph. As the current increases, however, the voltage drop across R_k also increases. This makes the cathode more positive with respect to ground, which has the same effect as increasing the negative bias on the grid. That increased bias effectively cancels part of the positive input from the signal. Similarly, when the input signal swings negative the plate current starts to decrease. That causes the voltage drop across R_k to become smaller, reducing the voltage at the cathode. That has the same effect as decreasing the grid bias. The net effect is that the cathode-voltage variations subtract from the input signal and partially cancel it, so the gain of the circuit is lowered. This is known as negative feedback, or degeneration. Although negative feedback has its uses, such as reducing distortion in high-fidelity amplifiers, it is often not wanted.

Fortunately, the full gain of the circuit can be restored by the addition of a bypass capacitor, C_k , in parallel with the cathode resistor. This capacitor shunts out AC signal variations on the cathode but allows R_k to provide the correct amount of DC bias. The value of C_k is generally chosen so that its capacitive reactance is approximately one-tenth of the value of R_k at the lowest frequency in use. Figure 11 shows the calculation for an audio amplifier that must have a frequency response down to 60 Hz. In a practical circuit, the capacitor can be the nearest available value above the calculated figure.

Classes of Operation. The importance of using the correct amount of grid bias to prevent distortion was stressed earlier. In audio amplifiers the fidelity of the sound will suffer if the

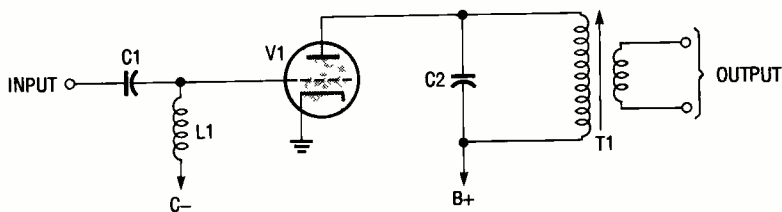

Fig. 13. This is a simple class-C RF amplifier. Note that the load resistor has been replaced by a tuned circuit that provides coupling to the next stage.

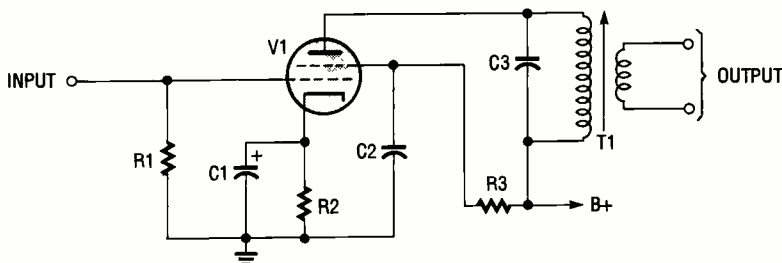

Fig. 14. In this typical RF amplifier stage Resistor R1 keeps the control grid at DC ground voltage, R2 provides the correct biasing for the tube, C1 acts as the cathode bypass, and the load is the tuned circuit.

tube is allowed to operate in its non-linear range. Similarly, the video amplifiers in radar and television sets must be free of distortion if a good display is to be produced. There are times, however, when a tube can be operated in a different manner.

Figure 12A shows an I_p/V_g curve. The grid signal has been drawn sideways since the horizontal axis of the graph represents grid voltage and lines can then be extended to plot the corresponding plate current. The signal never drives the tube out of its linear region and plate current flows all the time, giving a faithful reproduction of the signal at the output. As was mentioned before, that is called "class-A" amplification.

Figure 12B represents a quite different type of operation, called "class B." The fixed grid bias is made just high enough to cause the tube to cut-off, so with no signal applied plate current is zero. The positive half of an incoming signal brings the tube out of cut-off and plate current flows until the signal returns to zero. As the signal swings negative, the grid bias is increased, and since the tube is now being driven beyond the cut-off point, plate current remains at zero. Notice that plate current flows for only half the time—when the input signal is on its positive half cycle.

Figure 12C shows the situation when the fixed grid bias is further increased. The tube is now biased well below the cut-off point, so plate current can flow

only when the positive part of the input signal is sufficient to bring the grid voltage above cut-off. Plate current flows for only a small portion of the input signal, and it takes the form of large pulses.

It may appear that operating the tube in this manner is of little use, since the output waveform bears little resemblance to the input signal. The class-C amplifier, however, is used extensively in RF circuitry. Figure 13 shows a simple RF amplifier stage. The input signal is applied to the grid through a coupling capacitor and the C- supply is connected to the grid by way of an RF choke. That inductor prevents RF at the grid from finding its way back to the supply. The load resistor has been replaced by a tuned circuit that also provides coupling to the next stage.

It is beyond the scope of this article to carry a detailed examination of tuned circuits, but a brief summary is in order. In a perfect parallel-tuned LC-tank circuit, oscillations can continue indefinitely as energy is transferred back and forth between the capacitor and inductor. In practice, the tank circuit must have an external energy source to overcome the tank's energy-draining internal resistance to allow oscillation to continue.

The class-C amplifier performs this function admirably. When the input signal reaches its positive peak, a brief pulse of plate current flows, shocking the tank circuit into oscillation at its resonant frequency. The in-

put signal then drops to a level such that the tube is cut-off and plate current is zero, but the oscillations of the tuned circuit continue. When the next positive peak of input signal comes along, the pulse of plate current reinforces the oscillation in the tank circuit. In this way, the tube supplies just enough power to the tuned circuit to overcome the resistance. The oscillation in the tank circuit restores the signal to a perfect sinewave.

The advantage of the class-C amplifier over other types is that it is far more efficient because the plate current only flows for brief periods. The class-A amplifier is the least efficient, since plate current flows all the time, but it is the only type that can provide an output signal that is an amplified replica of the original signal.

You may occasionally see references to class-AB operation. As the name implies, the tube in such a circuit is biased at some point between class-A and class-B circuits, so that the input signal drives the tube into cut-off on its negative peak but plate current flows the rest of time. Such circuits are commonly found in the output stage of push-pull audio amplifiers.

The Tetrode and Pentode. The design of the triode places the three electrodes fairly close to each other. Any conductors placed in close proximity exhibit stray capacitance, and the triode has a small, but measurable capacitance between its electrodes, typically a few picofarads. At low frequencies that is of little consequence, but at radio frequencies the grid-to-plate capacitance can cause feedback, resulting in instability or oscillation. That problem led to the development of the tetrode.

The tetrode is very similar to the triode in overall construction, but it has a second grid, called the screen grid, wound between the control grid and the plate. That grid is connected to a positive voltage and acts as a screen between the plate and grid, thereby reducing the grid-to-plate capacitance and allowing the tube to be used at high frequencies.

Figure 14 shows how a tetrode can be wired in a typical RF-amplifier stage. Resistor R1 keeps the control grid at DC ground voltage, R2 provides the correct biasing for the tube, and C1 acts as the cathode bypass to

prevent the cathode resistor from reducing the gain of the stage. The plate load is the tuned circuit, which also couples the signal to the next stage. All of these components serve the same purpose as their counterparts in the triode amplifier. Resistor R3 has been added to provide a positive voltage on the screen grid. Since the screen is positive with respect to the cathode, it draws some current. This screen current is usually considerably less than the plate current. Capacitor C2 is added to shunt AC signals to ground to prevent input signals from causing variations in the screen current. It must have a value that is high enough to provide a low-impedance path to ground for AC at the frequency in use.

Note that when calculating the value of the cathode resistor (R_k) for a tetrode, the sum of the plate and screen currents must be used, since the cathode provides a common source of electrons for both:

$$R_k = \text{Bias voltage} / (\text{Quiescent } I_p + I_{sg})$$

The screen grid in the tetrode solves the problem of unwanted capacitance between the control grid and plate, but it introduces another problem. Electrons striking the plate of a tube after their journey from the cathode can cause other electrons already on the plate to be emitted. That effect is known as "secondary emission" and the electrons released in this way are called "secondary electrons."

In the triode, secondary emission is of no consequence, since secondary electrons are immediately drawn back toward the positively charged plate. In the tetrode, however, secondary electrons can be attracted to the positively charged screen grid, thereby adding to the screen current and reducing the plate current. Figure 15 shows how plate current varies with plate voltage in a typical tetrode when the screen voltage is fixed at 200 volts.

Starting from zero, current increases with rising plate voltage as you would expect. The dip in the line is the point where secondary emission starts to occur; since the plate voltage at this point is still well below the screen voltage, most of the secondary electrons are drawn to the screen grid, so plate current is reduced. Current starts to

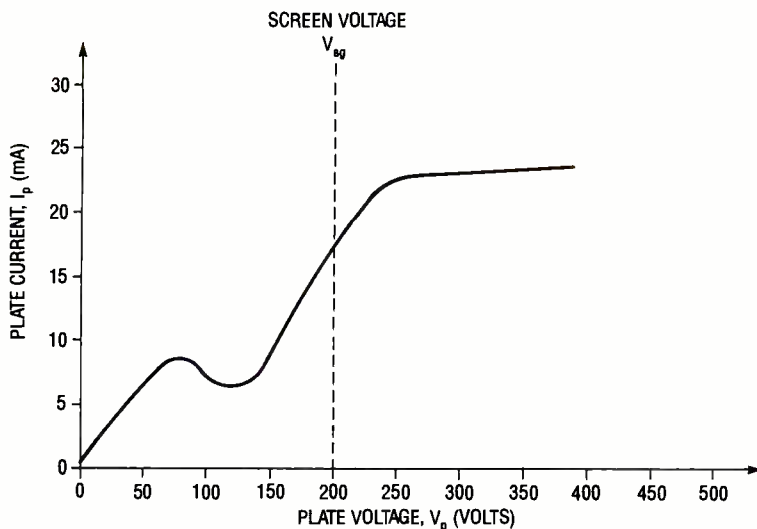

Fig. 15. Secondary emission produces a dip in the characteristic curve of a tetrode because of the presence of the screen grid. Obviously, that is therefore not a problem with a triode

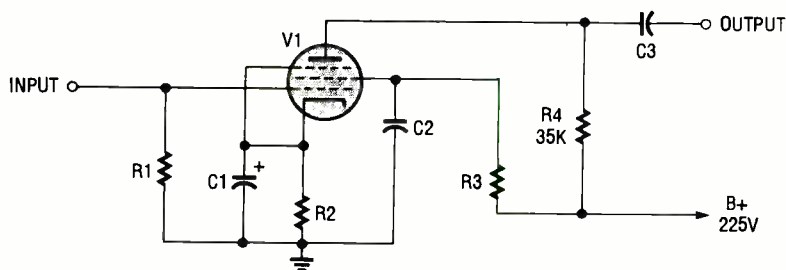

Fig. 16. In the pentode, a third grid, known as the suppressor, is fitted between the screen and plate. The suppressor prevents secondary electrons from the plate from reaching the screen.

rise again as the plate voltage approaches, and then exceeds, the screen voltage.

It is the plate current that is used to produce a voltage drop across the load and provide an output signal, so any reduction of the plate current by secondary emission can lead to distortion. The way to avoid that is to make the standing plate voltage considerably higher than the screen voltage. If the difference in voltage is not sufficient, the positive peak of the input signal can cause the plate voltage to drop to a value close to, or even below, the screen voltage. That will cause the peak of the output waveform to be flattened due to the secondary electrons flowing to the screen grid.

The need for a high B+ supply to provide sufficient plate voltage is the reason for the invention of the pentode. As its name implies, the tube has five basic electrodes. The cathode, plate, control grid, and screen grid of the tetrode are all present, but a third

grid, known as the suppressor grid, is fitted between the screen and plate. That grid is usually connected to either the cathode or ground (see Fig. 16). Secondary electrons emitted from the plate are now prevented from reaching the screen by the suppressor; since the suppressor is at the cathode voltage, the electrons are attracted back to the plate. The third grid, therefore, has suppressed the effects of secondary emission, hence its name.

If the pentode's only benefit was its ability to be used in high-frequency circuitry, it would not also be used extensively in audio applications. In fact, the pentode and tetrode also provide far greater amounts of amplification than the triode, which makes them ideal in high-gain, low-frequency applications, too.

Referring back to Fig. 15, notice that above a certain value the plate voltage has very little effect on the plate current. In both the tetrode and the

(Continued on page 94)

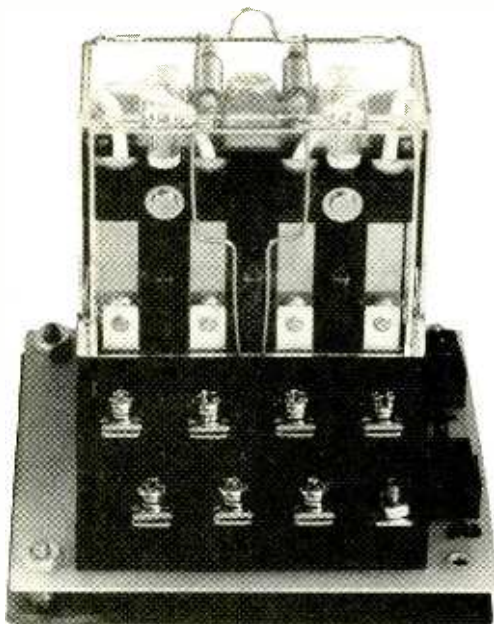

Baffle the thieves and carjackers with this easy-to-build security device.

BY WALTER W. SCHOPP

Build a Time-Delayed Kill Switch for your Car

Now that automobile burglar alarms have become so complex and sophisticated, many thieves (primarily the non-professionals) will not take the chance of setting them off anymore. And, however, just when you thought you had heard of everything, the crooks have come up with a new wrinkle, something new called *carjacking*—wherein the thief simply takes your car away from you while you're waiting at a stop light; that way the thief doesn't have to hot-wire the ignition, nor does he have to hassle with an alarm. What defense do you have in that situation?

Just suppose for a moment that you are a carjacker; you've just misappropriated (stolen) a car by making the driver get out—it was oh so easy. Now you're driving down the street for a couple of minutes and suddenly the car stops running. You try to restart the car, but the starter won't turn the engine over. Since you are not proficient in electronics, and your time is very limited, there is nothing to do but abandon the vehicle, and hopefully disappear.

Again put yourself in the shoes of the would be car thief. You have just slid a jimmy bar down the window and popped the door lock open. You jump into the seat and hot wire the ignition switch. Wow that was easy, so now you're ready for a joy ride. Think again! The engine will not run, or even turn over with the starter. No time for diagnosing the problem, nothing to do but split.

In both of those examples, the results are the same: the thief is foiled, and the car is largely undamaged. But that is only true if the automobile is equipped with the *Automobile Delayed Kill Switch* that is described in this article.

The Automobile Delayed Kill Switch is simple in concept. When you get out of your car, a secretly located pushbutton switch is pressed. Nothing apparently happens, but at the end of a predetermined time, a relay is pulled in and locked. When the relay is pulled in, contacts open, and the hot lead from the ignition to the coil and the hot wire from the key switch to the starter solenoid is opened or disconnected. If the engine is running, it stops immediately and the starter will not operate. If the car is parked, you might think the battery was completely dead. When you get into the car, another pushbutton switch is pressed and the relay drops out and everything goes back to normal.

The kill switch is not normally engaged while the owner is in the car or driving. It is fail safe because, if it fails to operate as intended, it falls into the normal-operation mode—with the relay open. The switch can be initiated after you park and the car will be immobilized 3 minutes after you leave it. If, heaven forbid, you are asked to get out of your car by a carjacker, by all means do it, but you secretly press the start button as you are exiting the car. Three minutes later, hopefully when the carjacker is just down the

road and out of sight, the car will become completely disabled.

How it Works. A schematic diagram of the Automobile Delayed Kill Switch is shown in Fig. 1. The kill switch is nothing more than a cascaded timer built around a common LM556CN dual oscillator/timer (U1). In that circuit, the first timer is initiated by pressing the START switch, S1. That applies a negative voltage to pin 6 of U1, which starts the timing sequence. The delay period of the first timer can be set at anywhere from 3 to 10 minutes; your setting is determined by how far away you want the car to be when it goes dead. (If you are still within sight, the thief might be provoked to violence. But you also do not want him to be able to travel too far before the car goes dead.) About 3 to 5 minutes should be about right.

The time that elapses before the automobile has an "electrical failure" is determined by R1 and C1. The components shown give a time of about 3 minutes and 20 seconds. The time is determined by:

$$T(\text{second}) = 1.1 \times RC$$

where R is resistance in ohms and C is capacitance in farads. The time can be altered using that formula.

When S1 is pushed, nothing perceptible happens, but the countdown time starts. At the end of the countdown, a positive signal on pin 5 abruptly goes negative and a negative pulse is transferred to pin 8

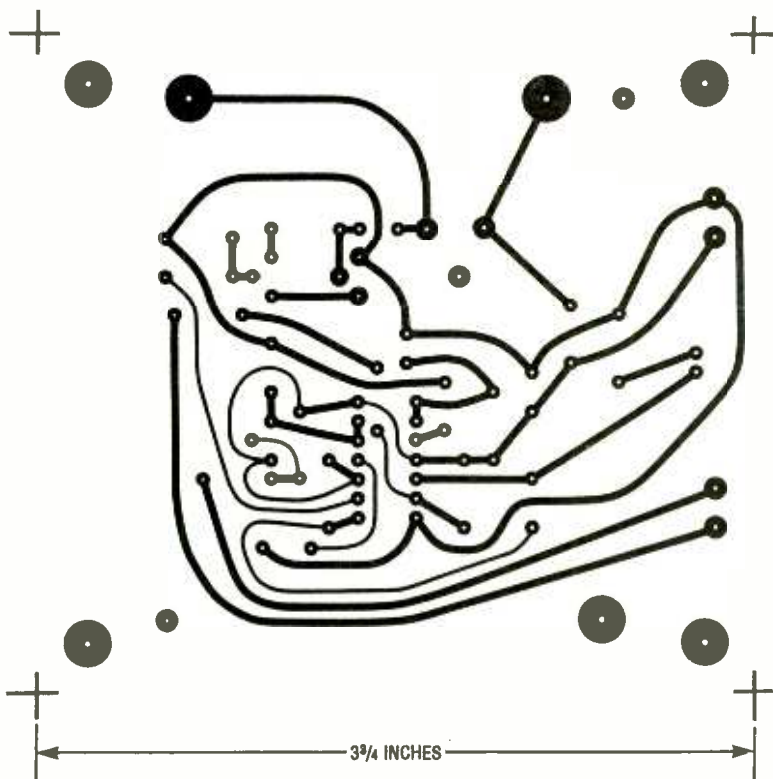

Fig. 3. The timer portion of the kill switch was assembled on a printed-circuit board (shown here), measuring about 3 3/4 by 3 7/16 inches full-scale.

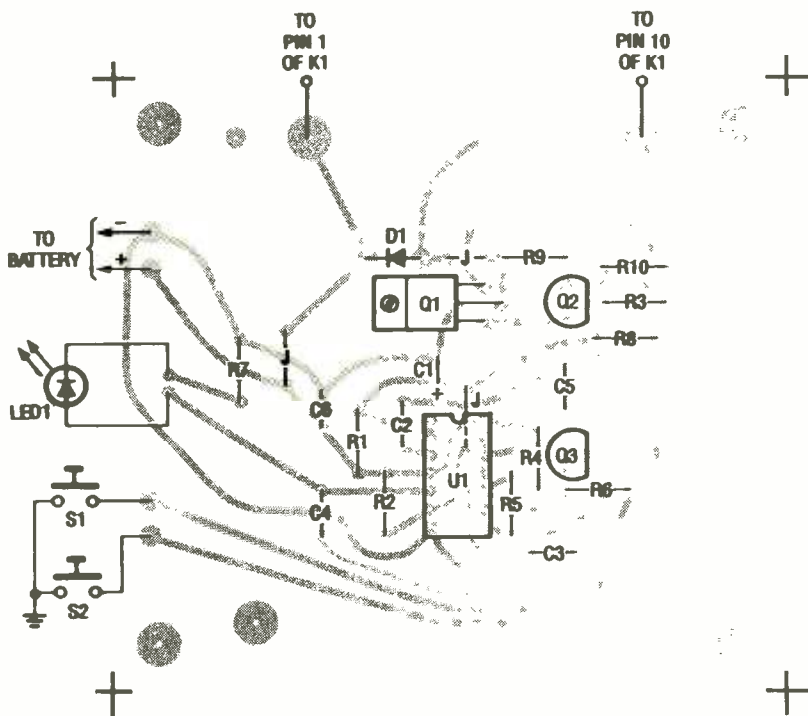

Fig. 4. When assembling the printed-circuit board, it is necessary to use low-profile parts so that the circuit board can be fitted inside the relay socket.

The high-current requirements of the relay-contact circuit dictate that the contacts not be soldered to the foil of the printed-circuit board. With

the design used, the two circuits that are interrupted are connected directly to the screw terminals on the relay base.

PARTS LIST FOR THE AUTOMOBILE DELAYED KILL SWITCH

SEMICONDUCTORS

- U1—LM555 dual oscillator/timer, integrated circuit
- Q1—TIP31 NPN silicon power transistor (Radio Shack #276-2017)
- Q2—2N3903 general-purpose, NPN silicon transistor
- Q3—2N3905 general-purpose, PNP silicon transistor
- D1—1N4001 1-amp, 50-PIV, silicon rectifier diode
- LED1—Light-emitting diode

RESISTORS

- (All fixed resistors are 1/4-watt, 5% units.)
- R1—1.8-megohm
- R2, R4, R5, R10—10,000-ohm
- R3, R6R9—1000-ohm

CAPACITORS

- C1—100- μ F, 16-WVDC, electrolytic
- C2—C5—0.0047- μ F, ceramic-disc
- C6—0.1- μ F, ceramic-disc

ADDITIONAL PARTS AND MATERIALS

- K1—Aromat #HG4-DC12V 4PDT, relay with 20-amp, 250-volt contacts
- S1, S2—Normally open, miniature pushbutton switch
- Printed-circuit board materials, HG4-SF Aromat relay socket, dual-tie point 1/4-inch terminal block (Radio Shack part 276-1388), three M4 \times 16 pitch 0.7 screws, wire, solder, hardware, etc.
- Note:** If you cannot locate the HG4-DC12V relay and/or the HG4-SF relay socket, contact Aromat Corp. (629 Central Ave., New Providence, NJ 07974) directly at 908-464-3550 for nearest local distributor.

Construction. The timer portion of the circuit was built on a printed-circuit board, measuring about 3 3/4 by 3 7/16 inches. A full-scale foil template of that circuit-board layout is shown in Fig. 3, with the corresponding parts placement diagram shown in Fig. 4. The low profile of the parts allowed the circuit board to be laid out in such a way as to fit inside the relay socket.

The bottom plastic plate was removed by prying it off of the socket, and the socket mounted directly over
(Continued on page 94)

Introducing a New Era In Technical Training.

World College, an affiliate of the Cleveland Institute of Electronics, was created to provide a four year, independent study, technical degree program to individuals seeking a higher education. The Bachelor of Electronics Engineering Technology Degree, offered by World College, prepares students for high-paying careers in electronics, telecommunications, electrical power, computer and control systems. World College's curriculum is taught in an effective, time-proven, independent study environment. With World College's flexible study schedule, students have the opportunity to work or spend time with their family without having to worry about rigid scheduling residential colleges offer.

A Quality Education with a Flexible Schedule.

In a world heavily dependent on electronic equipment, people who understand electronics will have no problem putting their knowledge to work... in high-paying careers. The staff and faculty of World College have invested over ten years developing, what we believe to be, the finest independent-study, baccalaureate degree program available. World College's mission is to instill in each student the knowledge, *education, and training* that employers are seeking for the many technical positions available today. It's a program created to provide the best education and training possible with a flexible schedule to match your busy lifestyle.



World College is currently seeking approval to confer the Bachelor Degree from the Virginia Council of Higher Education.

Earn A Bachelor of Electronic Engineering Technology Degree from



**WORLD
COLLEGE**
Bringing Technology Home!

Lake Shores Plaza
5193 Shore Drive, Suite 113
Virginia Beach, VA 23455-2500

Send For Your Free Course Catalog.

Take the first step towards a new start in life. Send for World College's Free Independent Course Catalog today and discover how easy and affordable it is to get started on your Bachelor Degree.

World College is affiliated with



Complete the Entire Degree Program Under One Roof. Yours!

Only World College offers an independent study, four year technical degree which can be completed through one school. All lab equipment*, parts, and software are included in your tuition and the program's 300-plus laboratory experiments can be completed in your own home.

You Pay Only For Time Actually Used.

World College not only provides a means to earn a Bachelor Degree while fulfilling current obligations, but there are no restrictions on how fast you can complete the program. At World College, you pay tuition only for the actual upper-level semesters it takes to graduate. The quicker you complete the program, the less you pay in tuition. It's an effective way to keep you motivated in order to complete the course and move on to a better paying position as quickly as possible.

Currently not available in Ohio.
* Student must have access to a personal computer system.

YES! Please send me World College's Free Course Catalog detailing the full curriculum.

Name: _____

Address: _____

Apt: _____

City: _____

State: _____ Zip: _____

Phone: (_____) _____

Age: _____

Return to: WAH01

World College
Lake Shores Plaza
5193 Shore Drive, Suite 113
Virginia Beach, VA 23455-2500

ANTIQUE RADIO

By Marc Ellis

Radio to Go— The Motorola Story

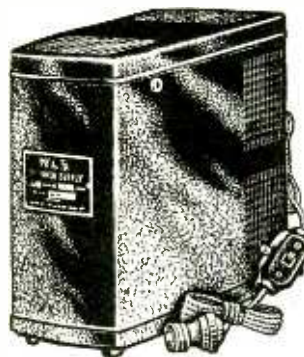

“B” Battery Eliminator

Dependable and Trouble-Free

This is absolutely the finest and most dependable “B” Battery Eliminator obtainable at anywhere near our low price. Quality built throughout to give you steady dependable service and trouble-free operation. Rugged and powerful; with the latest and best engineering principles and construction. Has an output of 45 milliamperes at 180 volts, which is sufficient power to operate almost any receiver, including those using power tubes. Primary voltage control affords a means of regulating the voltage at all taps. This not only prevents condenser breakdown within the eliminator but avoids any possibility of paralyzing the tubes in receiver. The detector control permits a range of voltages from 20 to 60 volts. Has three amplifier taps, 67½ volts, 90 volts and “power,” the power tap handling up to 180 volts. No “C” battery and “power” taps are provided, as better results are obtained with the use of a separate “C” battery. All binding posts and controls housed in a neat, compact, sturdy metal case, 11½ inches long, 4¾ inches wide and 9¾ inches high. Furnished complete with non-filament type rectifying tube. Operates from any 110-115-volt 50-60-cycle alternating house current. If wanted for 25 to 30-cycle house current, write for price. For replacement tubes for the above “B” eliminator see 57R4621 on our Tube page. **We pay postage. \$23.98**
67R520 1/4

Galvin Manufacturing Corporation's first product, as advertised in the 1928 Sears Roebuck catalog.

Motorola—it's an electronics industry giant with roots going back to the early days of broadcast radio. Yet the products of this distinguished company might not be quite as familiar to many collectors as those of other classic broadcast-set manufacturers. Manufacturers like Atwater Kent, Freed-Eisemann, Crosley, and Philco. The reasons for this are related to the reasons why

Motorola now ranks among the top 50 industrial companies in the United States, while the other trademarks have disappeared.

I don't want to pose as a business writer, but Motorola's success stems from the fact that its founders staked out a broad corporate playing field. They came to see themselves not primarily as manufacturers of consumer broadcast sets, but rather as manufacturers of portable and mobile

communications equipment. They also had the vision to foresee needs for products requiring their chosen area of expertise and the entrepreneurial spirit to develop these products into new lines of business, some of which had never existed before. But more on that later.

THE MOTOROLA MUSEUM

Motorola is unusual among large modern corporations in that it has a keen interest in preserving its own history. In 1991, the company opened a large museum facility that includes a 20,000-square-foot exhibit gallery chronicling the growth of the company and the industries it helped to shape. Behind the scenes are facilities for housing thousands of vintage company products, marketing aids, and other artifacts, as well as an equally large collection of photographs and graphics.

The museum is part of Motorola's Corporate Education complex, which is located in Schaumburg, Illinois, a suburb of Chicago. As it happens, I live about an hour's drive from the facility and had been curious about it for some time. Recently my curiosity got the better of me, and I put in a call to Sharon Darling, who is the museum director. We arranged for me to come out, visit, and do a story for the column, and that was a fascinating experience indeed.

Space limitations prevent me from giving you a detailed description of the museum. I really need lots

of room to tell you what I found out there! But suffice it to say that the gallery is divided into eleven discrete display areas; the first four (where I spent most of my time) deal with the history of the company and the industry, while the remaining seven deal with specific current topics, such as robotic manufacturing, radio communications, microelectronics, the “intelligent vehicle highway system,” cellular communications, electronics exploration through computer simulations, and corporate culture.

The quality of these exhibits is outstanding. They are carefully organized, aesthetically pleasing, and contain much unusual material. If you're in the neighborhood, drop in! The museum is usually open from 9 a.m. to 4:30 p.m. Monday through Friday, but it's best to call ahead and verify your date. Phone (708) 576-6559. You should allow 1½ to 2 hours to see the museum. Guided tours are available by appointment.

MOTOROLA'S SHAKY START

It's ironic that a company whose success was founded on shrewd business vision got off to a shaky start because of some very poor market timing. The Galvin Manufacturing Corporation, predecessor of Motorola, was founded in Chicago in 1928 by brothers Paul and Joseph Galvin. The two young entrepreneurs (who were in their early thirties and late twenties, respectively) start-

ed their company to go into the manufacture of "B"-battery eliminators, a business they had purchased from the bankrupt Stewart Storage Battery Company.

These eliminators plugged into the AC line and supplied the necessary high voltages for the three-dial, five- and six-tube, battery sets then in vogue. They were very useful accessories for such sets, since they freed the owners from the expense and annoyance of continually buying the necessary high-voltage, or "B" batteries. The sets still required storage batteries ("A" batteries) for lighting the tube filaments, however, unless a separate "A" eliminator (not offered by the Galvins) was also purchased.

And there was another catch. In 1928, the first AC radios had begun to appear on the market. These, of course, were totally battery-free. They were also more sensitive than the battery sets, had better speaker volume, and were far easier to operate. Just two months before the Galvin Manufacturing Corporation was founded, Atwater Kent released the Model 40, a plug-in, six-tubes-plus-rectifier set with a single-dial tuning control, selling for just \$77.00 (less tubes and speaker).

The Galvin "B" eliminator was advertised for \$23.98 in the 1928 Sears-Roebuck catalog. That sum would have made quite a good down payment on a radio such as the Model 40, and many people preferred to invest their money in that manner rather than in prolonging the life of an outmoded receiver.

ENTER THE AUTO RADIO

With "B"-eliminator sales plummeting, the Galvins



A corner of the Motorola Museum's Radio Reigns section illustrates the development of the auto radio.

needed a new product to keep their company afloat. They might well have jumped on the establishment bandwagon and begun to make AC-operated radios. However, this time they chose to enter a cutting-edge field that they believed had a lot of potential—auto radio. America's love affair with the auto and radio receiver were in full swing. Anyone who could combine the two technologies in a practical manner should've done a lot of business.

And do business they did! In 1930, the year the auto set was introduced, Galvin Manufacturing Corporation's net sales were well over a quarter of a million dollars. And that year the Galvins coined the name "Motorola" for their new auto radio products.

Though they certainly sold well, the early auto radios were clumsy contraptions that were difficult and expensive to install. The set's electronics were built into one bulky box. Another, much larger, cabinet housed the loudspeaker. These two items had to be mounted on the vehicle's firewall, shoehorned under

All photographs courtesy Motorola Museum of Electronics.

By 1933, auto sets like the Motorola "44" had been downsized considerably and no longer required separate batteries.



This moody 1930's street scene includes an outdoor ad dating from the introduction of Motorola's home-radio product line.

the dashboard into a space never meant to receive them.

Since there is no AC power on an automobile,

these radios needed "A" and "B" batteries like the pre-plug-in sets of the previous era. The batteries were carried in heavy-gauge steel cases mounted under the car, and holes had to be cut in the car's flooring to access the cases for battery changing.

It was also a bit difficult to arrange for radio-signal pickup. Typically, part of the vehicle's ceiling liner was temporarily torn down to gain access to the chicken-wire support system for the fabric roof panel. Electrical connections were then made to the wire so that it could do double duty as an antenna. Finally, mechanical drive cables had to be run from the electronics package to the set's tuning- and volume-control head mounted on the steering column.

Motorola museum personnel estimate that it took two men several days to complete such an auto-radio installation. Cost for the equipment and labor was about \$150.00. Think of what that meant at a time when the cost for an entire auto was in the \$600.00 range!

The Galvins pioneered the significant downsizing of auto-radio systems that would take place over the next few years. By 1933, the company was advertising radios such as the "44," in which the loudspeaker and electronics were contained in just one relatively compact cabinet. A vibrator power supply, also built into the cabinet, supplied all necessary operating voltages from the vehicle's storage battery. No additional batteries or battery boxes were required.

The cost of a "44," with installation, probably averaged about \$100.00—

(Continued on page 93)

COMPUTER BITS

By Jeff Holtzman

Amber Waves of Data

Last month we began a discussion of Microsoft's Visual Basic, a "visual" programming environment that gives ordinary people a way to create Windows programs. I had planned to continue that discussion, but other things cropped up in the meantime. We'll

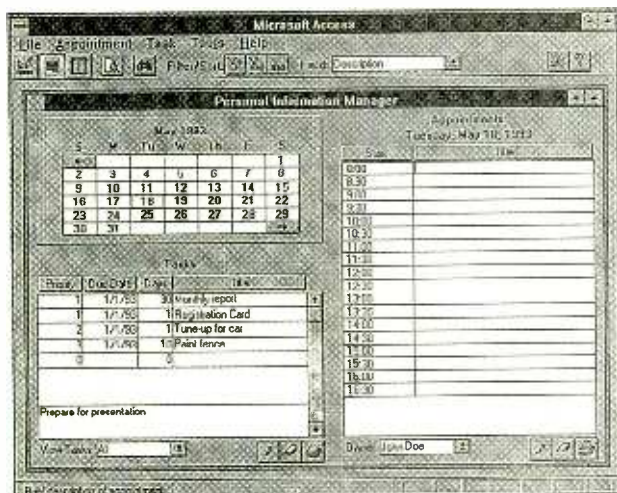

You can create snazzy database applications like this with Microsoft's Access, a multilingual, multi-user relational database. It's not as easy as the ads would have you believe, but it's light-years better than command-driven programs like dBASE.

get back to Visual Basic later on. For now, suffice it to say that VB is a ground-breaking product, and one that is a heck of a lot of fun to play with. If you're interested in Windows programming, you owe it to yourself to investigate that ground-breaking product.

For now, let's switch the discussion to database-management systems (DBMS). That term may scare you, but it shouldn't. Not because it's not technical. Only because you may not have background in the requisite concepts—concepts which, by the way, are no more difficult

than set theory, which I remember studying in 7th grade.

Database theory is typically taught in a second or third-year college-level course, and typically only to computer-science majors. In this day and age, that's ridiculous, for several reasons. The first is that many practicing engineers from other disciplines have incomplete, inaccurate notions about what constitutes a database, how to maintain data integrity, the most efficient ways of storing data, links among tables of data, and related topics. That type of ignorance is simply inexcusable for a technical professional.

The second reason is that people in nearly all professional disciplines, ranging from library science to medicine to psychology to marketing to history to plain old reading and writing, all need to have some basic understanding of database theory. Why? Because this is the information age. Everything is going electronic. It is impossible to do research in any field today without coming up against a database. And we all need to know something about how to manage the "amber waves of data" that threaten to engulf us.

There are two aspects to this. One involves searching databases created by various institutions; the other involves creating your own databases to store and analyze the information you collect.

In the old days, we learned how to search card catalogs and reference works like "The

Reader's Guide to Periodical Literature." We would take the results, get physical copies of the referenced books and periodicals and read them, take notes on index cards, categorize the cards, and then write up a report.

That type of manually intensive work is for the birds. Most people today own a computer and use it for the post-research part of the process (writing notes and reports). More significant is that many colleges and universities now have their "card catalogs" available on-line. Even my small-town library recently announced that it would be following suit in the near future. Some databases provide not only the bibliographic reference information (title, author, call number, etc.), but the complete text as well.

DESPERATELY SEEKING DATA

Today's information worker—which now includes just about every white-collar job—needs to know two things: How to search databases created by others and how to create databases for his or her own work. There are public libraries, school libraries, corporate libraries, commercial databases, governmental databases, and others.

The good news about this diversity is that there is a lot of information available. The bad news is that every database stores its information in a different format, and provides a different user interface for getting at it. Thus, you can't simply learn one and expect to

CIRCUIT CIRCUS

By Charles D. Rakes

Nothing But Amplifiers

This month, we're going to play around with a few audio-amplifier circuits, based on a couple of neat integrated-amplifier chips. Our first is based on an MC34119 chip in a general-purpose audio-amplifier circuit that is designed to drive stereo headphones or

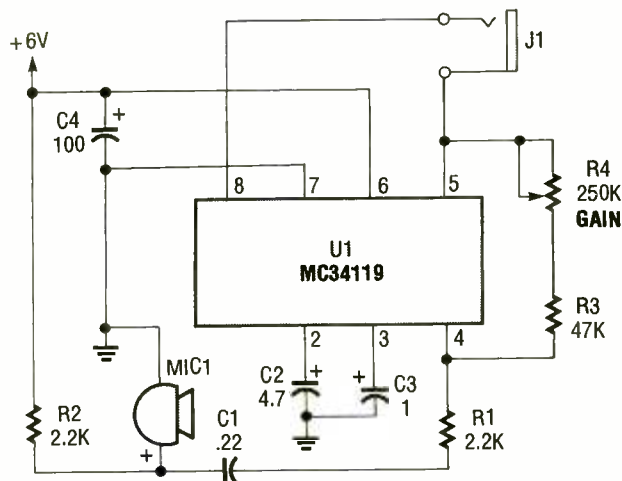

Fig. 1. The bird-feeder monitor is little more than an electret mike (MIC1) that feeds an amplifier, built around an MC34119, which in turn drives a 16-ohm speaker.

a speaker with an impedance of 8 ohms and up. But, before we discuss the specifics of our circuit, let's first deal with how this particular IC differs from the typical low-power integrated audio-amplifier chip.

The MC34119 contains two power op-amps that are driven out of phase to allow the output load (speaker/phones) to be connected directly to the output of the amplifier without the need of a large-value coupling capacitor. The chip can be operated from a power source of 2 to 16-volts, and has a typical quiescent current drain of less than 3 mA.

A chip-disable input (pin 1) allows the amplifier to be

placed in a low-power condition in which the stand-by current is less than 100 µA. The IC's output can exceed ¼-watt (with less than 1% total harmonic distortion) when driving a 32-ohm speaker or headphones. The amp's gain can exceed 46 dB and may be set to a desired value by selecting two external resistors. And best of all, very few external components are required.

BIRD-FEEDER MONITOR

Our first amplifier circuit, see Fig. 1, turned out to be the shop's bird phone. In that circuit, the electret mike (MIC1) was mounted in the neck of a large plastic funnel. The amplifier, built around an MC34119 (which is available from D.C. Electronics, P.O. Box 3203, Scottsdale, AZ 85271-3203; Tel. 800-467-7736 and elsewhere), was then placed outside of the funnel with the pick-up facing a nearby bird feeder. The

output of the amplifier is then connected to a 16-ohm speaker that was located in the shop.

The amplifier's voltage gain is determined by the values of the input resistor (R1) and the feed-back resistors (R3 and R4, respectively). The differential gain of the amplifier is given by: $R3 + R4/R1 \times 2$. With the component values shown in Fig. 1, the maximum voltage gain is about 270.

EAR PROTECTOR

Our next item, see Fig. 2, is an add-on ear protector circuit that connects to the amplifier in Fig. 1 or any similar MC34119 amplifier circuit. The ear protector is actually a peak audio-detector/shutdown circuit that disables the amplifier through its chip disable input whenever the audio signal exceeds a certain level.

The input to the circuit in Fig. 2 is tied to the output of U1 at pin 5 in Fig. 1 to

PARTS LIST FOR THE BIRD-FEEDER MONITOR

RESISTORS

(All fixed resistors are ¼-watt, 5% units.)

- R1, R2—2200-ohm
- R3—47,000-ohm
- R4—250,000-ohm potentiometer

CAPACITORS

- C1—0.22-µF, ceramic-disc
- C2—4.7-µF, 16-WVDC, electrolytic
- C3—1-µF, 35-WVDC, electrolytic
- C4—100-µF, 16-WVDC, electrolytic

ADDITIONAL PARTS AND MATERIALS

- U1—MC34119 low-power audio-amplifier, integrated circuit
- MIC1—Electret microphone element
- J1—Phone jack
- Perfboard materials, enclosure, Perfboard, IC socket, 6-volt power source, wire, solder, hardware, etc.

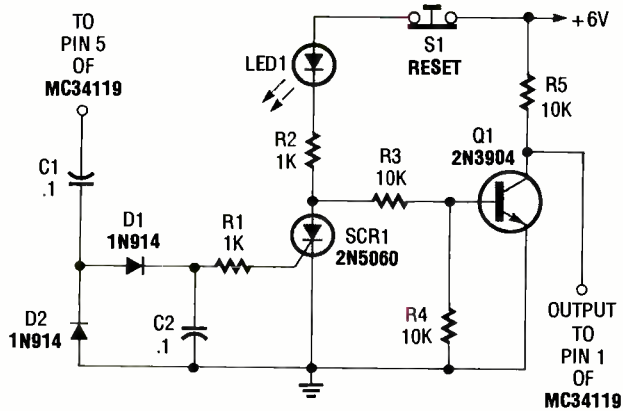

Fig. 2. The ear protector is actually a peak audio-detector/shutdown circuit that disables the amplifier through its chip-disable input when the output volume of an amplifier reaches the set level.

PARTS LIST FOR THE EAR PROTECTOR

SEMICONDUCTORS

- SCR1—2N5060 0.8-amp, 30-PIV, sensitive-gate silicon-controlled rectifier
- Q1—2N3904 NPN general-purpose NPN silicon transistor
- D1, D2—1N914 general-purpose small-signal silicon diode
- LED1—Light-emitting diode (any color)

RESISTORS

(All fixed resistors are 1/4-watt, 5% units.)

- R1, R2—1000-ohm
- R3—R5—10,000-ohm

ADDITIONAL PARTS AND MATERIALS

- C1, C2—0.1- μ F, ceramic-disc capacitor
- S1—Normally closed pushbutton switch
- Perfboard materials, enclosure, 6-volt power source, wire, solder, hardware, etc.

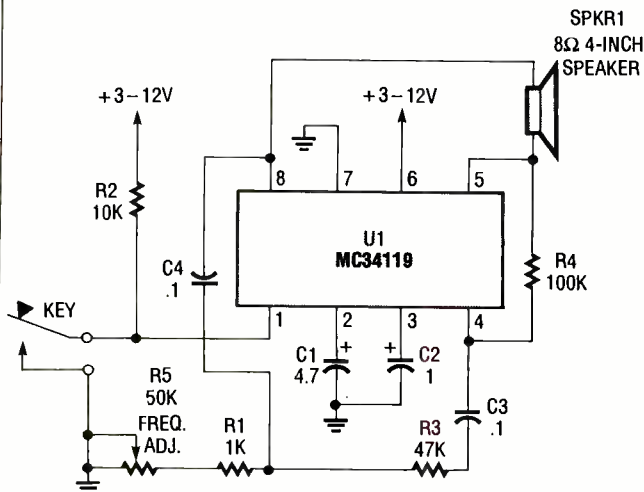

Fig. 3. The variable-frequency audio oscillator can be used as a low-level alarm sounder or a code-practice oscillator.

sample the audio that drives the headphones. The output of the Fig. 2. circuit connects to pin 1 (the disable input) of U1 in Fig. 1.

With normal audio, the signal level at pin 5 of U1 (Fig. 1) is too low to produce a sufficient DC output to turn on SCR1 (Fig. 2). With SCR1

CABLE TV DESCRAMBLERS

How You Can Save Money on Cable Rental Fees

Bullet Proof



- | | | |
|---|-------------------|---|
| BEST Super Tri-Bi Auto/Var. Gain Adjustment | \$119.95...\$85 | US Cable'll Beat Anyone's Price Advertis'd in this Magazine! |
| Jerrold Super Tri-Bi ... | \$109.95...\$79 | |
| Scientific Atlanta | \$109.....\$79 | |
| Pioneer | \$109.....\$79 | |
| Panasonic TZPC145.... | \$99.95...\$79 | |
| Stargate Converter..... | \$95.....\$69 | |
| Digital Video Stabilizer. | \$59.95...\$29 | |
| Wireless Video Sender. | \$59.95...\$49.95 | |

30 Day Money Back Guarantee

FREE 20 page Catalog

Visa, M/C, COD or send money order to:
U.S. Cable TV Inc. DEPT. KPE1093
 4100 N. Powerline Rd., Bldg. F-4
 Pompano Beach, FL 33073

1-800-772-6244

For Our Record

I, the undersigned, do hereby declare under penalty of perjury that all products purchased, now and in the future, will only be used on Cable TV systems with proper authorization from local officials or cable company officials in accordance with all applicable federal and state laws. FEDERAL AND VARIOUS STATE LAWS PROVIDE FOR SUBSTANTIAL CRIMINAL AND CIVIL PENALTIES FOR UNAUTHORIZED USE.

Date: _____
 Signed: _____

No Florida Sales!

CIRCLE 160 ON FREE INFORMATION CARD

Be an FCC LICENSED ELECTRONIC TECHNICIAN!



Earn up to \$2000/Week and more!

Learn at home in spare time. No previous experience needed!

No costly school. No commuting to class. The Original Home-Study course prepares you for the "FCC Commercial Radiotelephone License." This valuable license is your professional "ticket" to thousands of exciting jobs in Communications, Radio-TV, Microwave, Maritime, Radar, Avionics and more... even start your own business! You don't need a college degree to qualify, but you do need an FCC License.

No Need to Quit Your Job or Go To School
 This proven course is easy, fast and low cost! **GUARANTEED PASS**—You get your FCC License or money refunded. **Send for FREE facts now. MAIL COUPON TODAY!**

COMMAND PRODUCTIONS

FCC LICENSE TRAINING, Dept. 100
 P.O. Box 2824, San Francisco, CA 94126
 Please rush FREE details immediately!

NAME _____
 ADDRESS _____
 CITY _____ STATE _____ ZIP _____

PARTS LIST FOR THE VARIABLE-FREQUENCY AUDIO OSCILLATOR

RESISTORS

(All fixed resistors are 1/4-watt, 5% units.)

- R1—1000-ohm
- R2—10,000-ohm
- R3—47,000-ohm
- R4—100,000-ohm
- R5—50,000-ohm potentiometer

CAPACITORS

- C1—4.7- μ F, 16-WVDC, electrolytic
- C2—1- μ F, 35-WVDC, electrolytic
- C3, C4—0.1- μ F, ceramic-disc

ADDITIONAL PARTS AND MATERIALS

- U1—MC34119 audio amplifier, integrated circuit
- SPKR1—8-ohm, 4-inch speaker
- Perfboard materials, enclosure, IC socket, key, 3–12-volt power source, wire, solder, hardware, etc.

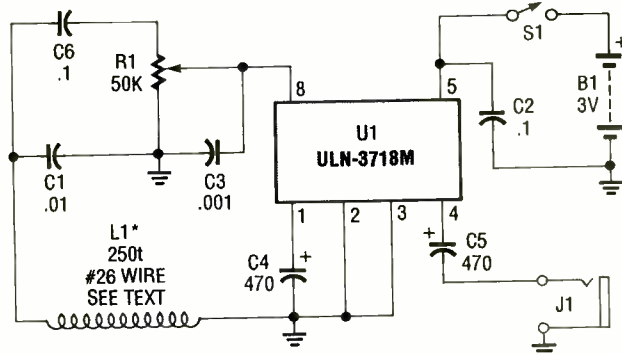

Fig. 4. The VLF whistler receiver is built around an ULN3718M, and uses a large loop (approximately 3-feet in diameter) as the pick-up.

PARTS LIST FOR THE VLF WHISTLER RECEIVER

CAPACITORS

- C1—0.01–0.03- μ F, ceramic-disc (see text)
- C2, C6—0.1- μ F, ceramic-disc
- C3—0.001- μ F, ceramic-disc
- C4, C5—470- μ F, 16-WVDC, electrolytic

ADDITIONAL PARTS AND MATERIALS

- U1—ULN3718 audio power-amplifier, integrated circuit
- R1—50,000-ohm potentiometer
- B1—Two AA cells
- L1—See text
- J1—Phone jack
- S1—SPST switch
- Perfboard materials, enclosure, IC socket, wire, solder, hardware, etc.

in the off condition, its anode voltage of is high. That high voltage biases Q1 on, placing its collector at near ground potential. As

long as pin 1 of the U1 is low, the amplifier operates normally. When the audio increases to a sufficient level, the DC output of the

voltage doubler circuit (comprised of D1, D2, C1, and C2) rises sharply, turning on the SCR, which, in turn, turns off Q1. With Q1 turned off, its collector goes high, turning off the amplifier. To re-activate the amplifier, current flow through SCR1 must be disrupted by pressing the reset switch (S1).

VARIABLE-FREQUENCY AUDIO OSCILLATOR

It's always fun to build a circuit that makes a racket and that's what you'll get from the circuit in Fig. 3. In Fig. 3, the MC34119 (U1) is configured as a variable-frequency audio oscillator. That circuit can be used as a low-level alarm sounder or a code-practice oscillator. The output of U1 at pin 8 is fed back to U1's input at pin 4 through an R/C network. That controlled positive feedback causes the amplifier to go into oscillation. Potentiometer R5 can be used to vary the oscillator's frequency from about 250 Hz to over 4 kHz. The chip disable input of U1 at pin 1 is kept high through R2.

As long as the disable input is high, the amp does nothing. The oscillator is activated by either closing the key or by electronically pulling pin 1 to ground.

VLF WHISTLER RECEIVER

Our last circuit places a low-voltage audio power amplifier in an unusual receiver circuit. If you have never listened to a VLF whistler receiver, it's unlikely that you have heard mother nature's symphony or the dawn chorus at sunrise. But if you haven't, build the circuit in Fig. 4 and you can experience those and other unusual sounds that occur in the RF spectrum below 20 kHz.

The whistler receiver consists of a large pick-up coil (L1) and an audio-amplifier circuit, built around a U1 (an ULN3718M, which is also available from D.C. Electronics and elsewhere). Since the frequencies of interest are within the human hearing range, no detector or converter circuit is necessary. The loop picks up the signal and U1 amplifies it sufficiently to drive a set of headphones via J1.

The loop consists of about 250 to 300 turns of #26 enameled copper wire wound on a 3-foot diameter wood or plastic form. The exact loop size and number of turns really isn't critical as long as the circuit can be tuned to somewhere below 20 kHz. Try different capacitor values of between 0.01 and 0.03 μ F for C1 for the best reception.

One problem you may have to overcome in using the VLF receiver is that the loop must be kept away from any 60-Hz power source. About all you can do to reduce the hum is to move as far away from any AC power source as possible and rotate the loop for minimum hum.

The greatest whistler activity occurs when Mother Nature is kicking up her heels during an electrical storm. Be careful and never take the receiver out doors during an electrical storm.

Looks like it's time to close for now. See you here next month. ■



THINK TANK

By John J. Yacono

More Derbys

Last month's column really got long. So this month I'll forgo our discussion on logic in order to continue presenting some of the Pinewood Derby contributions (which get pretty lengthy with no help from me). As you may remember, contributors to the Pinewood-Derby community effort will receive a book

series. You further mention that "The only differences between the two series is their temperature range for guaranteed operation: 74-series chips operate from -55 to 125°C , but 54-series devices are only useful from 0 to 70°C ."

While it is true that the guaranteed operating temperature for the two groups

series devices can be found in both ceramic and plastic packages, an option which reduces the cost of the chips for consumers. Finally, the 74-series operates on from 4.75 to 5.25 volts, whereas 54-series devices are designed to operate from supply voltages between 4.50 and 5.50 volts, a feature which reduces the

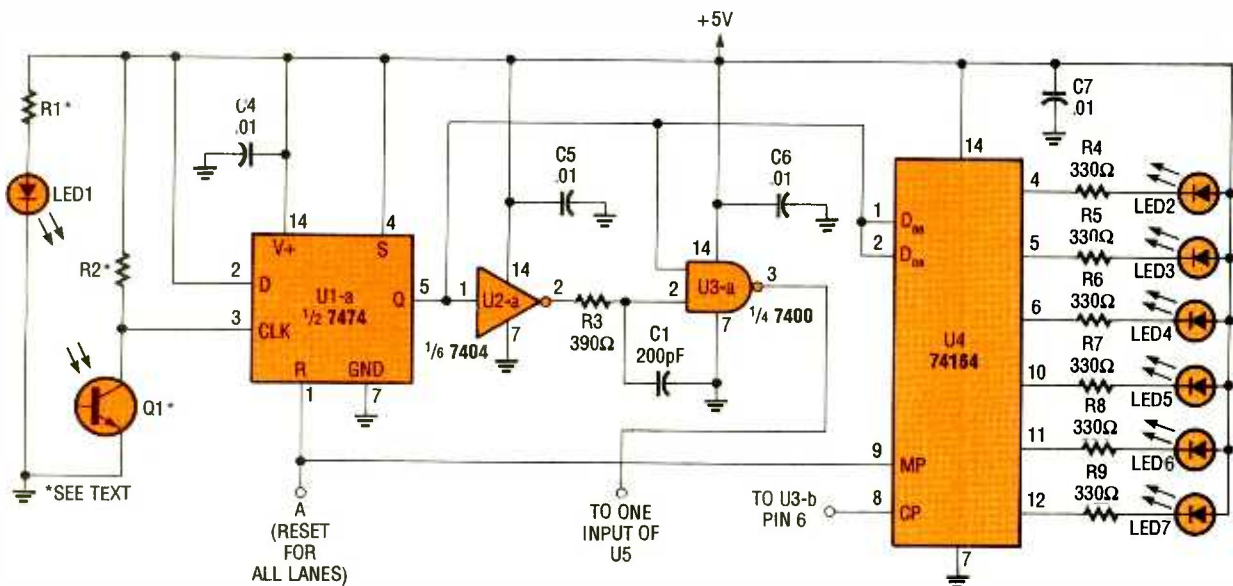

Fig. 1. The components for each lane of this pinewood derby circuit come together to form an optical detector, pulse edge-conditioner/pulse generator, and a display circuit.

and, as a special premium, a MCL1010 logic chip.

Before we get to the circuits, though, I would like to draw your attention to the following letter on logic. It further clarifies the distinctions between the 74' and 54' series chips and corrects a mistake that I made in a former column.

SERIES SWAP

In your July, 1993 column, you discuss TTL-class chips and mention that they are divided into 54XX and 74XX

are different, the specifications claimed in the article are reversed. The 54-series devices are military-grade components. All TTL datasheets indicate that 54XX versions operate from -55 to 125°C , whereas 74-series units, which are consumer-grade devices, are only designed to operate from 0 to 70°C .

Furthermore, the temperature specification for 54-series devices mean that they are found only in ceramic packages while 74-

probability that fluctuations in the supply voltage will cause a failure.

—David N. Yee, Boston MA

Thanks for the correction and extra information. Sorry if transposing the temperature ranges caused anybody any trouble.

6, 5, 4, . . .

I am writing this in response to reader Stephen Guye's need. My six-lane pinewood derby circuit design has six indicator

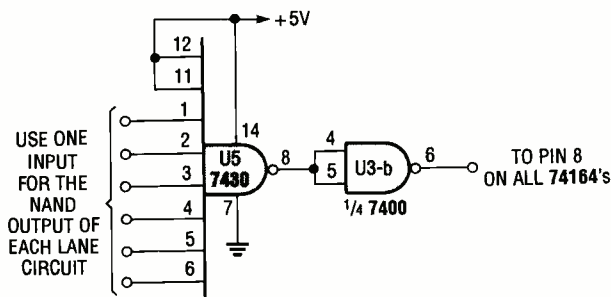

Fig. 2. The pulses from each lane circuit are passed to this section, which increments any enabled counters.

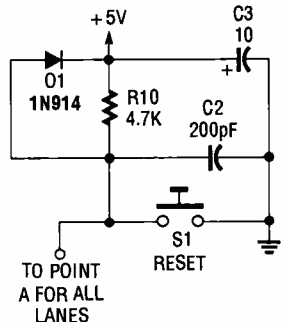

Fig. 3. This section performs three functions: power-on reset (via R10 and C2), power-down protection (using D1), and power-supply filtering (thanks to C3).

identical subcircuits, one additional gate, and a reset circuit. In the subcircuit for each lane (see Fig. 1), the IR LED and IR phototransistor should be arranged so that they "see" each other, until a car in that lane breaks the optical path. The D-type flip-flop's (U1-a) \bar{Q} output is initially reset to a logic low, as are all of the outputs of the 8-bit shift register (U4). As the car breaks the optical path, Q1 comes out of saturation and turns off. Its rising edge

rising-edge detector. Together they generate a narrow (around 100 ns), negative-going pulse when the \bar{Q} output goes high. The pulses from each lane trigger all shift registers to load and shift via the 8-input NAND (see Fig. 2) that is connected to the pulse generators of each of the subcircuits.

Every car that crosses the finish line causes the shift registers to shift. A logic "1" is loaded into a shift register when its car crosses the line. A logic "1" at a shift register output turns its indicator LED off. Therefore, the first car to pass the finish line will have the logic "1" shifted the furthest, and thus have the fewest LED's lit. When all six cars finish, the first-place car will have only one LED lit.

The circuit resets itself at power-up, as C2 (see Fig. 3) is charged through R10. Subsequent resets are ac-

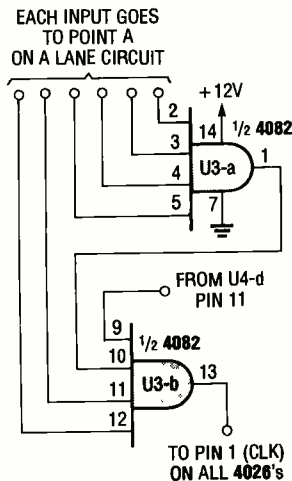

Fig. 5. Two gates are combined to form a larger AND gate, which is used to generate a clock pulse for each car as it crosses the finish line.

capacitor's discharge when power is turned off.

One possible problem is that if a very large resistor is required at the collectors of the phototransistors to achieve the necessary gain, the input bias current of the flip-flop may cause an unacceptable voltage drop to appear across the resistor. In that case, a simple emitter follower can be used to buffer the phototransistor output.

The final unmentioned components are the supply decoupling capacitors, one per IC and one electrolytic (C3 in Fig. 3). I didn't put part numbers on the IR LED's and phototransistors (or values for their dropping resistors, R1 and R2 in Fig. 1) since I don't have any reference materials on them. Perhaps we could take a clue from Roy Worrall's design in the same column and use the SEP8703-1 LED and SDP8403-301 phototransistor, and set the resistor values accordingly.

—Alan Wolke, Phillipsburg, NJ

Normally I wouldn't print a circuit that hadn't been tested, but your's is so

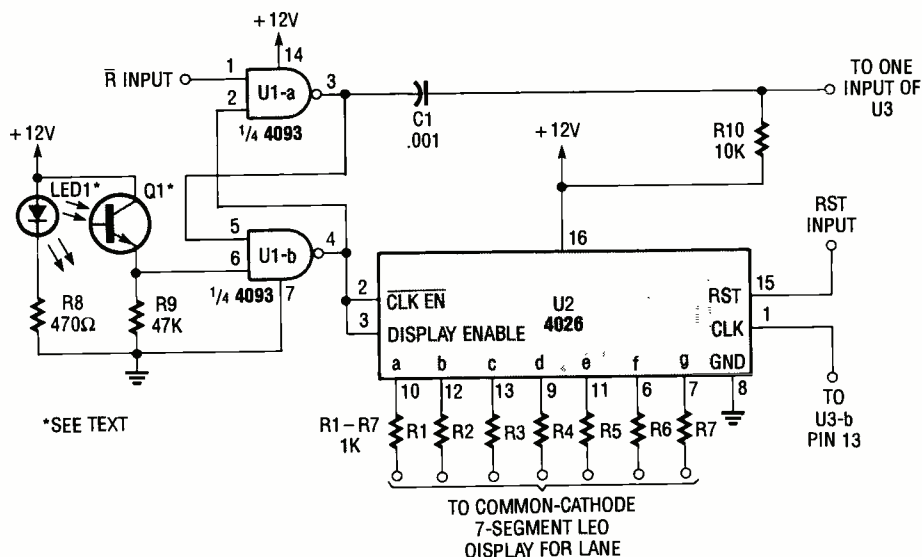

Fig. 4. Like most pinewood derby circuits, this section for a single lane detects the interruption of an IR beam to advance and disable a counter displaying the car's place.

LED's per lane. At the beginning of a race, all the LED's are lit. After all six cars cross the finish line, the number of LED's remaining lit in a lane indicates the finishing position of its car.

The circuit consists of six

lector voltage triggers the flip-flop, transferring a logic "1" to its \bar{Q} output. That "1" is presented to the serial input of the shift register. The inverter (U2-a), resistor (R3), capacitor (C1), and NAND gate (U3-a) implement a

complicated by depressing S1. The reset action places a low on the reset lines of the flip-flops, and on the master reset on the shift registers, setting all outputs to logic low. Diode D1 protects the circuit from the

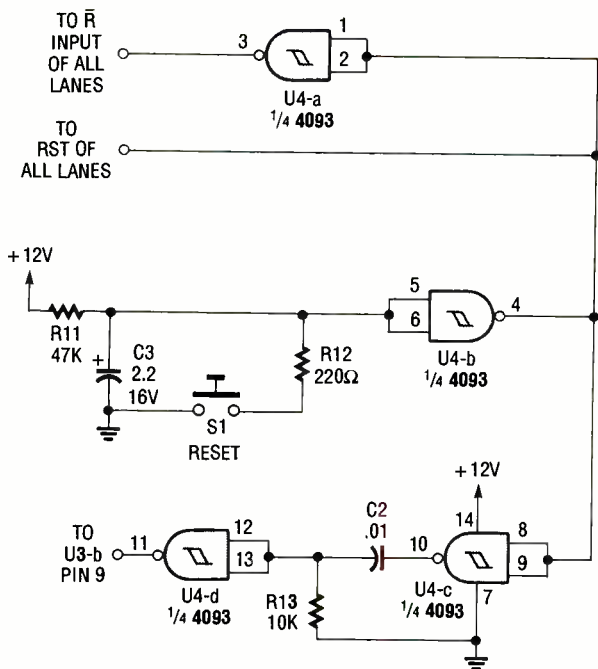

Fig. 6. This section turns signals from the reset pushbutton into logic pulses for the circuit back in Fig. 5.

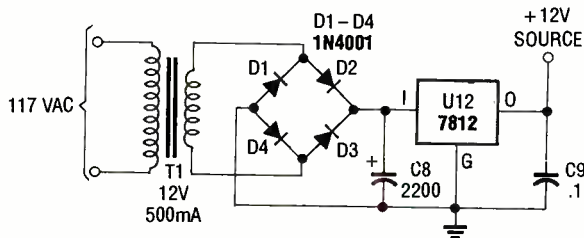

Fig. 7. This power supply goes with the pinewood derby made from the sections appearing in Figs. 4 through 6.

straightforward that I feel certain that it should work. By the way, I'm forwarding your address to Mr. Guye so he can write you if necessary.

CMOS DERBY JUDGE

Here's my idea for a six-lane Pinewood Derby judge. In my design, a single-digit display is mounted above each lane. As the cars cross the finish line, each display lights up with a number (1-6); a "1" for first place, a "2" for second place, etc.

To see how the circuit works, let's examine the circuitry for one lane (see Fig. 4). LED1 is an IR unit mounted on an assembly directly above the finish line; Q1 is an IR receiver

mounted in the track directly below. As car 1 crosses the line, it blocks the light from LED1, cutting off Q1 and making pin 6 of U1-b low. Since U1-a and U1-b comprise a low-triggered S/R latch, pin 3 of U1-a will latch low, while pin 4 of U1-b latches high. That high is fed to the clock-enable (pin 2) and display enable (pin 3) inputs of U2, a decade counter/display driver, making lane 1's display come on and show a "1" for first place. (The counters all start with a count of "one" rather than "zero." (I'll explain the reason for that in just a bit.) That high also disables U2's clock input, so lane 1's display will show a "1" until the circuit is manually reset. Note that at this

point, only the display for lane 1 is lit.

The low at pin 3 of U1-a is shortened to a 10- μ s pulse by C1 and R10, and fed into U3-a (see Fig. 5), which together with U3-b, forms a seven-input NAND gate. The inputs of that gate are all normally high, so the low-going pulse at pin 2 appears at the output (pin 13 of U3-b), which is connected to the clock inputs of the decade counter/display driver chip (like U2) for each lane. When pin 2 returns high, all the counters (except U2, whose clock input is inhibited) will advance to a "2" count. That pattern continues until all the cars have crossed the finish line.

When the race is over, pressing S1 (see Fig. 6) will reset the circuit. That makes pin 4 of U4-b high, forcing all the decade counters to

return to a "0" count. The low produced by U4-a resets all the S/R latches, which also blanks the displays. When S1 is released, C3 charges through R11, making pin 4 of U4-b high and pin 10 of U4-c high. That high is shortened to a brief pulse by C2 and R13 and inverted by U4-d, causing the output of U3-b to go momentarily low. The rising edge of that pulse clocks the decade counters to their number "1" count, so the first display to be lit during the next race will show a "1" rather than a "0."

—Steve Forbes, Fullerton, CA

Very nice! Steve also provided a power supply, which is shown in Fig. 7. Until next time, be sure to send your ideas to Think Tank, Popular Electronics, 500-B Bi-County Blvd., Farmingdale, NY 11735.

42,398

ELECTRONIC COMPONENTS

Whether you order 1 part or all 42,398...MOUSER stocks and...ships same day!!

CALL...
(800) 992-9943

for your
FREE
CATALOG

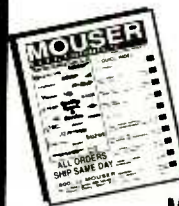

2401 Hwy 287 N.
Mansfield, TX 76063

MOUSER

ELECTRONICS

Sales & Stocking Locations Nationwide

CIRCLE 163 ON FREE INFORMATION CARD

DX LISTENING

By Don Jensen

Shortwave Contests and Quizzes

Shortwave contests and quizzes are nothing new. They've been around for years. Each year, a goodly number of the major international SW broadcasters promote their on-the-air competition, offering winning listeners attractive prizes.

Not surprisingly, those sta-

Beijing broadcaster and a Chinese cosmetic firm, drew over 100,000 entries from 80 countries. Listeners submitted answers to a series of questions about China. In addition to the trips, there were 350 first-place, 700 second-place and 1,050 third-place winners, who received prizes ranging from Chinese silk tablecloths to albums of papercut art.

Ontario DX Association member Roger Chambers, reporting in that club's "DX Ontario" bulletin, won one of the third-place prizes, a monogrammed shirt. The questions—for example "What are the four most important inventions of ancient China?"—took a bit of library time, Chambers said, but the contest was interesting and fun.

Chambers also noted that he won one of eight first prizes in *Swiss Radio International's* "nutty New Year's Quiz." The 16 multiple-choice questions were based on SRI programming during the previous year. His prize was a Swiss quartz wrist watch, while other winners got music CD's and books about Switzerland.

As this is written, Albania's *Radio Tirana* has a contest going that, on each weekend's "Variety" program, asks questions on "What do you know about Albania." Hopefully, some SWL's will know enough about this drab and depressed Balkan nation to win prizes. And if you miss this competition, there'll be another along soon, sponsored by some shortwave broadcaster or another around the world. Keep listening for these SW

contests and, if you win a trip to Beijing or Bucharest, drop me a postcard.

In fact, even if you don't win, why not write me here at *DX Listening*, **Popular Electronics**, 500-B Bi-County Blvd., Farmingdale, NY 11735. I'm always happy to hear from you!

MORE OLD-TIME FUN

Last month, you'll recall, several readers wrote in praise of keeping SWL'ing cheap and simple. Half the fun, one said, is tuning in some distant SW signal on a simple receiver that you built yourself. With such unsophisticated gear, common loggings like the *BBC*, *Radio Nederland* or *HCJB* suddenly become challenging DX again.

Easy-to-follow instructions for constructing a simple SW set, I suggested, might be found in some out-of-date, but still useful beginners' radio manuals, gathering dust in your public library.

Now, Alan Johnson, writing in the North American SW Association's "Journal," has a great alternative suggestion for building a bare-bones shortwave set, the MFJ-8100 regenerative SW receiver kit, marketed by MFJ Enterprises (P.O. Box 494, Mississippi State, MS 39762; Tel. 800-647-1800).

In his excellent "Equipment Review" column, Alan notes that the regenerative detector design was a technological breakthrough in the 1920's. Because of its simplicity and excellent sensitivity, the regenerative receiver was, for many SWL's and radio amateurs, their first shortwave set, long

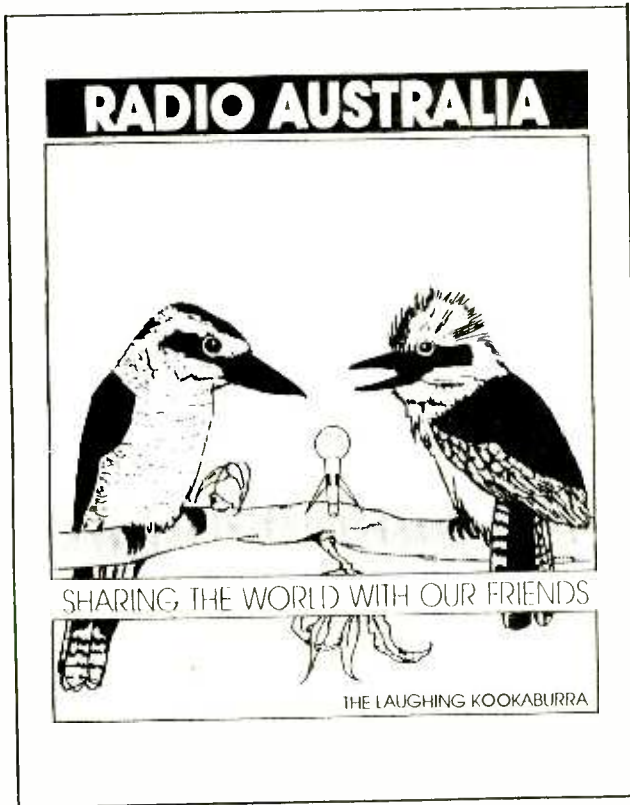

For many years, the haunting laugh of the kookaburra, a unique Australian bird, has begun each foreign-service transmission of Radio Australia.

tion contests are highly popular with SWL's, and why not? Answer a few questions right and you might be a winner, winging off on an all-expenses-paid trip to who knows where. Six lucky Asian winners, not long ago, won free trips to Beijing in a *China Radio International* shortwave contest. The contest, sponsored jointly by the

after state-of-the-art radio moved on to the super heterodyne design. The regenerative SW receiver was, and is, based on the principle of positive feedback, in which a feeble incoming radio signal is repeatedly fed back through the circuit's detector stage, each time increasing its amplification.

In the early days, the key component was a triode vacuum tube. In MFJ's updated version, three transistors and an integrated audio amplifier improve the 70-year-old basic design, while keeping the building simple enough. It covers five SW tuning ranges; roughly 3,500–4,400, 5,000–7,500, 9,500–12,100, 13,100–16,600, and 17,500–22,500 kHz, which includes most, though not all, of the major international shortwave bands.

Johnson reports that the construction of the MFJ-8100 regenerative receiver kit went easily and smoothly, taking him only about two hours, following the step-by-step assembly and operating instructions.

His reaction: "It is a load of fun to play with. There is no problem receiving all the major international broadcasters with 15 feet of wire indoors . . . I love this little radio."

Make no mistake, this is no match for some of the modern high-tech, shortwave communications receivers on the market today. So be prepared to fiddle the knobs a bit and there will be more than a

*Credits: Jim Clar, NY; Jerry Klinck, NY; Marie Lamb, NY; Greg Martin, MI; Marina Pappas, SD; Mike Wolfson, OH; Ontario DX Association, P.O. Box 161, Station A, Willowdale, Ontario, M2N 5S8, Canada; North American SW Association, 45 Wildflower Road, Levittown, PA 19057

little "guess-and-by-gosh" in tuning in specific frequencies. Still, it can be, as Alan says, a challenging SWL'ing "thrill box." The MFJ-8100 kit is priced at \$59.95, and wired and tested for \$79.95.

STORY WITH A POINT

Phil DuRall, Aliso Viejo, CA, writes with a first-person DX'ing story that I especially enjoyed. "I've been interested in SWL'ing since I was 10-years old," Phil says. "I've always liked the challenge of receiving stations from all around the world. It exposes you to a worldwide view. You realize that your immediate realm of existence is not the only thing going on in the world.

"One experience stands out in my memory. When I was 11, my teacher gave us a social-studies assignment. 'Present to the class,' she said, 'something interesting we had learned.' I had been listening to *Radio Peking*, as it was known then, and had heard a fascinating program. So I told the class what I'd learned about acupuncture. That was back around 1963, before many westerners, including my teacher, knew much about the Chinese culture, much less acupuncture. So she accused me of making it all up! I've often wondered if she ever remembered that incident when acupuncture became so widely known in the 1980's."

Next, James K. Murphy of Muncie, IN, has a question: "I've heard hams talking about using a Slinky—those coiled spring toys children play with—as a shortwave antenna. Have you any ideas about this?"

I know, Jim, that an old friend of mine, and top-notch DX'er, Ralph Perry once found himself living in a multi-storied apartment

building where he couldn't install any sort of usual shortwave antenna. His solution was to connect a lead from his receiver's antenna terminal to one end of a Slinky toy, which was mounted in a wooden box on his outside window ledge.

The weight of the Slinky caused it to uncoil downward, three or four floors, becoming a makeshift ended longwire antenna. By attaching a length of fishing line and a reel, he was able to haul in the Slinky until it recoiled itself in the mounting box, out-of-sight during non-listening daytime hours.

SWL'ing in an urban setting can present problems. I get letters from many listeners living in condominiums and apartments asking how they can put up effective shortwave antennas. Now there's a good

book on the subject, "Shortwave Listener's Guide for Apartment-Condo Dwellers," by Edward M. Noll, and published by MFJ Enterprises (\$9.95 plus \$3 shipping/handling).

DOWN THE DIAL

Here are a few listening targets.

AUSTRALIA—15,170.

Radio Australia offers an English-language newscast at 0900 UTC.

ICELAND—11,402 kHz.

The *Icelandic National Broadcasting Service* in Reykjavik is a nice DX log reported here with Icelandic-language programming. The schedule runs from 1853 to 1930 UTC signoff.

USA—9,355 kHz.

WEWN, the new Roman Catholic shortwave voice operating from Alabama, is heard here with religious programming in English at 2100 UTC. ■

Learn VCR repair at home!

MAKE GOOD MONEY IN YOUR OWN FULL- OR PART-TIME JOB



Professional-level home study course. You will master easy-to-learn, high-profit repairs *without* investing in high-tech instruments or a costly workshop. Want more independence and higher income? Send or call today!

Free career literature:
800-223-4542

Name _____ Age _____
Address _____ Phone (____) _____
City _____ State _____ Zip _____

The School of VCR Repair
6065 Roswell Road
Dept. VL341, Atlanta, Georgia 30328

CIRCLE 159 ON FREE INFORMATION CARD

HAM RADIO

By Joseph J. Carr, K4IPV

Wanna Be A CAD?

Nobody really wants to be a CAD, but in this case I'm referring to the Computer Aided Design (CAD) of printed-circuit boards. I use a 486-33DX Windows/MS-DOS 6.0 machine, but anyone who has a decent personal computer can obtain any of sev-

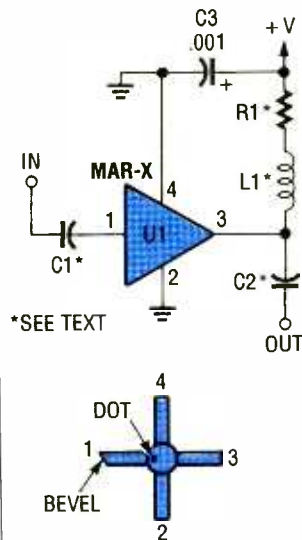

Fig. 1. Shown here is a schematic diagram for a 10 kHz to 1000 MHz RF amplifier, built around the MAR-1, that features 50-ohm input and output impedances. A top-viewed pinout diagram of the MAR-1 package is also shown.

eral software packages that allow you to design and layout printed-circuit boards. My personal favorite is a British offering: *EASY-PC*.

EASY-PC is available from Number One Systems, Ltd. (Harding Way, St. Ives, Huntingdon, Cambs., PE17 4WR, England), or c/o Ms. Sandy Thornblad (1795 Granger Avenue, Los Altos, CA 94024; Tel. 415-968-9306) in the USA, at a cost of 105 pounds sterling (the U.S. price varies with the exchange rate, but the U.S.

agent will set a fixed price).

If you order from the British address, you can use a standard U.S. credit card, such as Mastercard or Visa. The bank will convert the British currency to U.S. dollars and charge your account. Number One Systems, Ltd. also sells circuit analysis and Smith chart (RF) software.

BUILD AN RF PREAMPLIFIER

In an article, entitled "Receiver Preamplifiers That You Can Build" (which appeared in the June, 1993 issue of *Popular Electronics*), I covered the Mini-Circuits MAR-1 monolithic microwave integrated circuit (MMIC) device. The MAR-1 is capable of operating from near-DC to 1000 MHz, and without external circuitry offers 50-ohm input and output impedances (which is the standard impedance for RF circuits).

Figure 1 shows a schematic diagram of the conventional circuit for the MAR-1. A top-view pinout diagram of the package is also included in that figure. The MAR-1 is simplicity itself because there are only four connections: pin 1 is the input, pin 3 is the output, and pins 2 and 4 are ground. The DC power supply is connected through the output terminal. We won't repeat all of the MAR-1 information that can be found in that article, but I would like to correct a shortcoming.

In the original article, there was a sample perf-board circuit layout, but no foil pattern or parts-placement diagram. For those

who would like to build that circuit (which, by the way, is the circuit that's shown in Fig. 1), a printed-circuit layout is shown in Fig. 2, with the corresponding parts-placement diagram appearing in Fig. 3. The printed-circuit layout was done using *EASY-PC*.

Capacitors C1 and C2 should be chip type units if you want to operate above 100 MHz, although I've found that good quality, ceramic-disc capacitors work to at least 2 meters (144-148 MHz). The spacing of the input/output pads and the line to U1 (the MAR-1) is set for 1000-pF chip capacitors, although holes are provided at each capacitor location for, ceramic-disc units. With disc capacitors, the unit will operate from a few kilohertz to at least 2 meters, and with chip capacitors it will operate to 1000 MHz (the upper limit for the MAR-1).

The RF choke (L1) connected between the output of the MAR-1 and current-limiting resistor R1 can be a 100- μ H axial-lead RF unit for lower frequency operation, or a ferrite bead on a piece of #22 solid hook-up wire (or a cut-off resistor lead) for higher frequency operation.

The current-limiting resistor (R1) is 100 ohms for operation at a power-supply voltage of +5 volts DC. For higher-voltage operation (up to +9 volts DC), use a resistor calculated from:

$$R(\text{ohms}) = +V - 5/0.015$$

where +V is the device's operating voltage in volts and 0.015 is the current

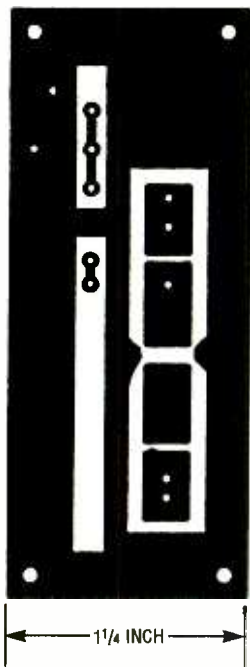

Fig. 2. A printed-circuit layout for the circuit in Fig. 1 is shown here full-size.

draw in amps—i.e., if the circuit is to be operated from a 9-volt battery, you would first subtract the required voltage level (+5V) from the actual power-supply voltage (+9V) and divide the result by the required current to find the value of the voltage-dropping resistor (in this case, R1).

For operation from DC power supplies greater than +9 volts, use a three-terminal regulator to reduce the voltage to +5 volts, and set R1 to 100 ohms. The 78L05 low-power voltage regulator (which comes in a TO-92 package) will supply 100 mA, and can easily satisfy the MAR-1's 15-mA requirement.

I'm not able to offer readers printed-circuit boards for this project, but I can offer the MAR-1; write to me at the address given a little later in this column. They are a little hard to come by in quantities of one or two because of the minimum order requirements of the manufacturer. So, for a lim-

ited time, I'll supply the MAR-1 for \$4.95 postpaid. If you want to buy 20 or more of the devices, contact the manufacturer, Mini-Circuits (P.O. Box 350166, Brooklyn, NY, 11235-0003; Tel. 718-934-4500), directly for information.

Receiver preamplifiers, whether based on the MAR-1 or not, are frequently used ahead of receivers to improve the noise figure, or to boost weak signals. If you want to make a preselector, then add a tuned RF LC-tank circuit in front of the MAR-1 amplifier. The tank circuit should use a tapped inductor to allow you to match the 50-ohm impedance of the MAR-1. The tank-circuit inductor should have a minimum reactance of 200 ohms at the operating frequency. For example, if you want a 15-meter preselector, use a 1.5- μ H inductor, (which has a 200-ohm reactance at 21 MHz) resonated to 15 meters by 39 pF.

Additional information on the MAR-1 and related MAR-x devices can be found in my book "Secrets of RF Circuit Design" (TAB/McGrawHill, Blue Ridge Summit, PA 17294; Tel. 800-233-1128).

ARRL SWEEPSTAKES ANYONE?

If operating is your thing, then you'll undoubtedly get into contesting at one time or another. I've done the various DX contests—like Field Day and the ARRL Sweepstakes—over the years. November is sweepstakes month, so if you want a real blast operating, then contact the American Radio Relay League (ARRL, 225 Main Street, Newington, CT, 06111) for the rules and details.

Some amateurs get bent out of shape because the various DX contests tend to

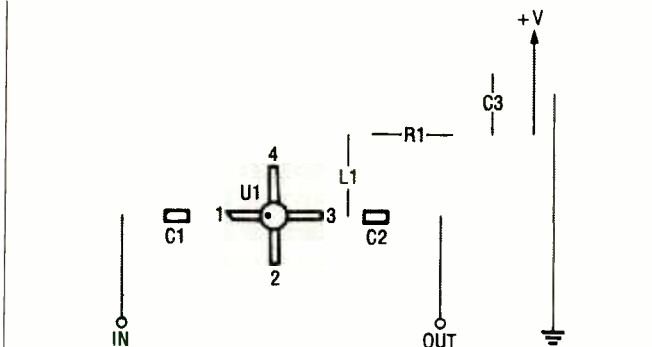

Fig. 3. Note that in this parts-placement diagram two capacitors, C1 and C2, are chip type units.

take up one or all HF bands for an entire weekend, or two, or four. I admit that it's a bother to non-contesters, but a lot of people enjoy the competition, so let's live and let live. The contesters only take up space a few times a year, and contests are a big part of the fun of ham radio.

RECEIVER/SWL ANTENNAS

If you're a ham operator who uses a separate receiver antenna, or a shortwave listener (SWL), you'll be interested in my new book "Joe Carr's Receiver Antenna Handbook." I am told that the coverage of small loop (the direction-finding kind) is particularly good. The book is available from HighText Publications (125 North Acacia Avenue, Suite 110, Solana Beach, CA 92075; or from IPG at 800-888-4741).

SCIENCE FAIR, ANYONE?

Several times a year, I have the privilege of judging high-school and middle-school science fairs, and a regional science fair in northern Virginia. Now that school is back in session, why not consider volunteering at your local school to help interest the kids in the various fields of science and electronics.

If you are an electronics professional or at least very

knowledgeable about electronics in general, or an advanced amateur, or any other field of science, then contact the local high school or middle school and volunteer as you feel proper. Electronics astuteness amongst our youngsters seems to be slipping and this is a good way to encourage and mentor some really bright kids . . . and perhaps win them over so that they become interested in the electronics hobby.

Also, if you are a science teacher in middle or high schools, then drop me a line (at P.O. Box 1099, Falls Church, VA 22041). Perhaps we can find some common interests. I would also like to hear from anyone who has any science-fair or experiment ideas that involve ham radio, shortwave listening, or other radio phenomena.

Mentoring youngsters is a lot of fun, and makes a difference for the future of our country. Of course (please forgive the crass commercial pitch), if you really want to encourage and mentor a kid, tear out the subscription card in this issue and buy them a complimentary subscription to **Popular Electronics**—just an idea, but that's what a mentor did for me thirty-five years ago and I've never forgotten it. Thanks again, Hugh.

SCANNER SCENE

By Marc Saxon

An FM Interceptor

In the June issue, we told you about the Optoelectronics R20 AM Interceptor, a non-tunable handheld receiver that detects and locks in on all close-proximity AM RF sources between 500 kHz and 2.5 GHz. The innovative



Optoelectronics' R10 FM Interceptor locks in on all close-proximity FM-signal sources, making it ideal for testing communications or locating hidden "bugs."

The R10 detects all close-proximity FM transmissions between 30 and 1000 MHz (to 2200 MHz with reduced sensitivity). You don't need to know the operating frequency of a nearby FM transmitter to monitor it on the R10. Just turn on the R10, and, in a second or so, it finds and locks onto any nearby FM signal source. It does not read out the frequency. There's a SKIP button on the top of the R10 if you want the unit to ditch the signal being received and look for another one. A DEVIATION button allows the user to select either 10-kHz or 100-kHz receive peak bandwidth. Two bargraphs read out relative signal strength and FM-signal deviation.

Reception is controlled by volume and squelch controls; the squelch is actually an RF-sensitivity adjustment. There is a built-in speaker as well as provision for headphones. Its rechargeable batteries provide four hours of operation per charge.

Although a tuned pre-amplifier can substantially increase the R10's operational range. The basic R10 typically will zero in on a 5-watt VHF handheld radio to 200-feet away, and almost 500 feet for a UHF radio. The sensitivity has been deliberately limited for close-in work. Otherwise, the R10 would pick up unwanted signals from distant two-way and broadcast stations, which would defeat its operational purpose.

Besides its use for radio technicians when servicing communications equipment, the R10 shines as a security device. For instance, it will quickly detect wireless telephone and room "bugs," and tracking transmitters ("bumper beepers") that have been hidden in vehicles. It's not surprising that security personnel are finding many uses for the R10. It allows a person to be quickly assured of being in an environment that is totally devoid of locally generated FM signals. And, if they aren't, it allows them to monitor the signals.

Another group who has put the R10 to use is the news media. A reporter can take an R10 to a fire, crime scene, accident scene, or investigation site and instantly begin monitoring on-site communications without knowing which specific frequencies are in use or programming a single channel into a scanner. It even picks up nearby cellular calls. Hooked to a moving mobile unit's cellular antenna, the range is increased, and the R10 receives cellular calls being made in nearby vehicles.

Scanner enthusiasts have come up with many of their own favorite applications for this unusual piece of receiving equipment. For more information on the R10, contact Optoelectronics, Inc., 5821 N.E. 14th Avenue, Fort Lauderdale, FL 33334. Their phone number is 305-771-2050.

company that designed that device now offers its companion, the R10 FM Interceptor. For monitoring fans, the R10 is even more tantalizing than the R20.

CITY BY THE BAY

The FCC has designated VHF marine channel 14 (156.70 MHz) for the U.S. Coast Guard Vessel Traffic Service (VTS) System in the San Francisco port area. VTS frequencies are used to coordinate the movements of large vessels in busy ports in order to prevent collisions. Different ports use specific VTS channels.

Vessels report information relating to position, course, speed, and conditions affecting their ability to navigate. The U.S.C.G. then plots their movements.

Other presently active VTS channels include New Orleans and Baton Rouge on 156.05 and 156.175 MHz; New Orleans and Houston on 156.25 MHz; and the Great Lakes and St. Lawrence Seaway on 156.55, 156.60, and 156.70 MHz.

Port operations in areas where VTS isn't used include 156.275, 156.325, 156.675, and 156.725 MHz. Intership communications in all areas (including VTS) can be found on 156.875 and 157.00 MHz.

IT ALL COMES OUT IN THE WASH

A report from Jarvis Albertson, Seattle, WA, lets us know that the police there have Car/Car (F-1) on 460.375 MHz; Information (F-2) on 460.425 MHz; East Precinct (F-6) on 460.175 MHz; and Tactical (F-7) on 460.25 MHz. The fire dispatcher uses 453.525 MHz, and the medics operate on 453.70 MHz.

Metro buses in Seattle can be monitored on 453.525 MHz. For good measure, Jarvis tossed in two local ship-to-shore operator frequencies for Seattle: 161.85 and 161.90 MHz.

Russell Lundquist of Des Moines, IA, wrote to tell us that the security force at

the Prairie Meadows race track operates on 461.3375 MHz. The Des Moines school patrol can be monitored on 461.025 MHz. He also mentions that scanner owners often get confused when they hear the police dispatcher mention Channel 12, because Des Moines has only six police channels. Russell discovered that Channel 12 is actually the Des Moines city government frequency and is also used for car/car communications at night and on weekends by the animal-control units. He tells us that "at times the channel is hilarious." Unfortunately, Russell forgot to tell us the frequency of this hilarious channel. However, we suspect that it might be 155.10 MHz.

OUR MAINE MAN

From his monitoring station on the coast of Maine, Wes Balsam passes along several state frequencies that he has collected. Fish and game wardens are on 155.655, 155.725, 155.73, and 155.97 MHz. Forestry stations are on 151.40, 159.255, and 159.285 MHz.

Wes verifies the Acadia National Park information that appears in the 8th Edition of the *Top Secret Registry of U.S. Government Frequencies* as being 164.175-MHz repeater output, with the input on 164.725 MHz. Wes tells us that he has become very interested in federal-agency monitoring of late, and also verifies that the U.S. Department of Labor in Bangor is on 162.225 MHz.

LET'S HEAR FROM YOU

Your letters, frequencies, and loggings are welcome. Our address is *Scanner Scene*, Popular Electronics, 500-B Bi-County Blvd., Farmingdale, NY 11735. ■

Earn Your B.S. Degree in ELECTRONICS or COMPUTERS



By Studying at Home

Grantham College of Engineering, now in our 43rd year, is highly experienced in "distance education"—teaching by correspondence—through printed materials, computer materials, fax, and phone.

No commuting to class. Study at your own pace, while continuing on your present job. Learn from easy-to-understand but complete and thorough lesson materials, with additional help from our instructors.

Our Computer B.S. Degree Program includes courses in BASIC, PASCAL and C languages — as well as Assembly Language, MS DOS, CADD, Robotics, and much more.

Our Electronics B.S. Degree Program includes courses in Solid-State Circuit Analysis and Design, Control Systems, Analog/Digital Communications, Microwave Engr, and much more.

An important part of being prepared to *move up* is holding the right college degree, and the absolutely necessary part is knowing your field. Grantham can help you both ways—to learn more and to earn your degree in the process.

Write or phone for our free catalog. Toll free, 1-800-955-2527, or see mailing address below.

Accredited by
the Accrediting Commission of the
National Home Study Council

GRANTHAM
College of Engineering
Grantham College Road
Slidell, LA 70460

ELECTRONICS LIBRARY

MIDI Survival Guide

by Vic Lennard

Subtitled "Scale the MIDI Mountain," this book clearly leads the way for those who want to put the technology to work but don't want to get hung up on its complexities. The book provides a wealth of practical advice on starting up, setting up, and ending up with a working MIDI system—without getting bogged down with theory and mathematics. Beginners who have yet

chines, and multitracks. The book helps readers understand MIDI implementation charts and how to get the most from General MIDI. In addition, it covers such practicalities as staying on budget and buying second-hand equipment.

The MIDI Survival Guide (order number PCP118) is available for \$7.75 plus \$2.50 shipping and handling from Electronics Technology Today Inc., P.O. Box 240, Massapequa Park, NY 11762-0240.

CIRCLE 97 ON FREE INFORMATION CARD

McGraw-Hill Circuit Encyclopedia & Troubleshooting Guide

Volume 1

by John D. Lenk

This comprehensive compilation of more than 700 commonly used integrated- and discrete-component circuits provides not only expert information about the circuits, but also includes a step-by-step troubleshooting guide for tackling any problems that might arise. Aimed at anyone involved with electronic circuits—engineers, technicians, hobbyists, and designers—the guide is designed so that the circuits can be put to work immediately as

is, or the circuit values can be easily changed to suit particular requirements.

A wide range of circuits are featured, including ultrasonic, DC, IF, AF, RF, and video circuits; regulators; op-amp circuits; oscillator and generator circuits; switching and electronic-control circuits; unijunction and programmable unijunction circuits; and OTA and Norton circuits. In addition, the book covers a number of special-purpose circuits, ranging from voltage/frequency converters through temperature sensors and controllers, to RS-232 ports. All of the circuits are grouped by function, and a specific troubleshooting approach is given for each type of circuit. The text explains precisely how each circuit works and how it fits into electronic equipment and systems. Proven component values for actual circuits are supplied, as well as sources and mailing addresses.

The McGraw-Hill Circuit Encyclopedia & Troubleshooting Guide; Volume 1 costs \$59.59 and is published by McGraw-Hill, Inc., 11 West 19th Street, New York, NY 10011; Tel: 800-2-MCGRAW.

CIRCLE 96 ON FREE INFORMATION CARD

Handbook for Sound Engineers: The New Audio Encyclopedia Second Edition

edited by Glen M. Ballou

Audio students and professionals should consider clearing a few inches of shelf space for this 1500-page, all-encompassing, sound-engineering resource. The completely updated book details all the essentials of sound, acoustic, and sound-system design, in-



Survival guide

scale the MIDI mountain with

VIC LENNARD



to buy their first piece of MIDI gear, as well as seasoned pro's who are wondering how to hook up their new drum machine or sequencer to their existing system, can benefit from the hands-on advice offered here. More than 40 cabling diagrams illustrate how to connect synths, sound modules, drum ma-



Select any 5 books for only \$4⁹⁵

(values up to \$173.70)

plus 1 book FREE upon prepayment when you join the Electronics Book Club®

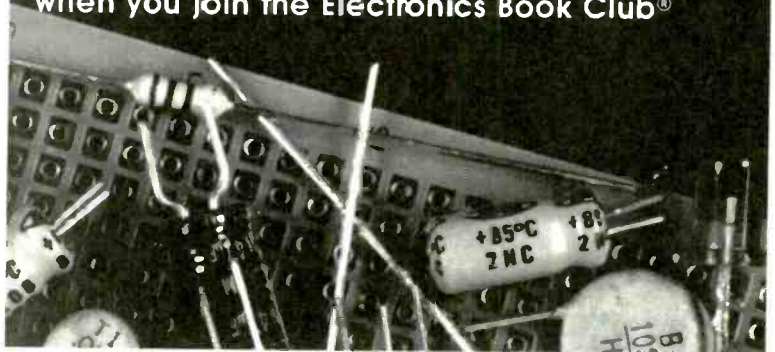

1367P \$26.95
Softcover



052394H-XX \$35.00
Counts as 2



2790P \$15.95
Softcover



4270H \$29.95



2613P \$18.95
Softcover

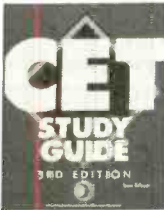

4076H \$27.95

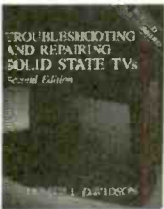

3700H-XX \$36.95
Counts as 2



4179H \$27.95



2800P \$17.95
Softcover



3765P \$18.95
Softcover

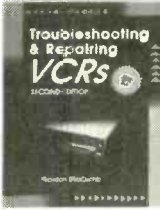

3777H-XX \$32.95
Counts as 2

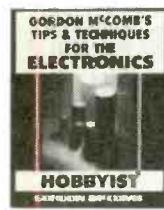

3485H \$27.95



3258P \$19.95
Softcover



3122P \$21.95
Softcover



4139H \$27.95



4269H \$29.95

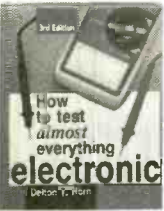

4227H \$24.95

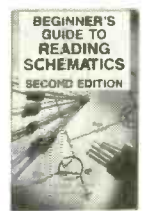

3632P \$10.95
Softcover

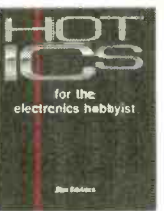

4122H-XX \$36.95
Counts as 2

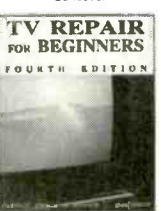

3627P \$19.95
Softcover

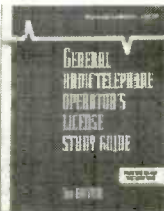

4075P \$17.95
Softcover



3886P \$13.95
Softcover



3711P \$19.95
Softcover



3270H-XX \$32.95
Counts as 2

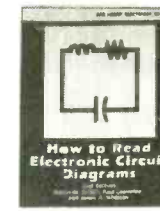

2EB0P \$15.95
Softcover



4111H \$27.95



3457P \$19.95
Softcover



3279P \$24.95
Softcover



EB04P \$17.95
Softcover



3795P \$19.95
Softcover



3739H-XX \$39.95
Counts as 2

As a member of the Electronics Book Club . . .

... you'll enjoy receiving Club bulletins every 3-4 weeks containing exciting offers on the latest books in the field at savings of up to 50% off of regular publishers' prices. If you want the Main Selection do nothing and it will be shipped automatically. If you want another book, or no book at all, simply return the reply form to us by the date specified. You'll have at least 10 days to decide. And you'll be eligible for FREE BOOKS through the Bonus Book Program. Your only obligation is to purchase 3 more books during the next 12 months, after which you may cancel your membership at any time. ©1993 EBC

A shipping and handling charge and sales tax will be added to all orders. All books are hardcover unless otherwise noted. (Publishers' prices shown) If you select a book that counts as 2 choices, write the book number in one box and XX in the next. PE1093

Your most complete and comprehensive source for the finest electronics books.

cluding proper installation techniques and performance ideals. New technology and traditional sound mechanics are synthesized into a single audio library meant to be kept close at hand during work or study.

The book covers the fundamentals of sound and acoustics, and provides in-depth coverage of the design, application, and installation of sound systems. It explains how loudspeakers and enclosures are designed, built, measured, and tested. Various methods of sound recording and playback are explored, including disk, magnetic, and digital. The book presents audio circuits including amplifiers, filters, power supplies, and consoles. The second edition also offers the latest details on computer-generated music production.

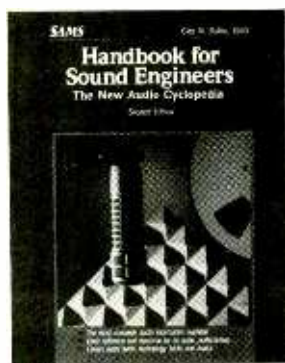

The Handbook for Sound Engineers: The New Audio Encyclopedia, Second Edition costs \$99.95 and is published by Howard W. Sams & Company, 11711 North College, Carmel, IN 46032; Tel: 800-428-5331; Fax: 800-448-3804.

CIRCLE 90 ON FREE INFORMATION CARD

TECHNICIAN NO-CODE CLASS:

Your Question and Answer Guide to the New FCC Amateur Radio License

by Gordon West, WB6NOA

It is now possible to obtain your Technician Class Ham Operator privileges without passing the Morse-code test. Under recent FCC rules, only two short examinations are required for

licensing. Technician Class privileges include full 6-meter, 2-meter, 222-MHz, 440-MHz, 1270-MHz, and higher bands; full power output to 1500 watts VHF/UHF; 6-meter, long-range, skywave communications around the world; unlimited repeater privileges, satellite communications, packet digipeters, and tropospheric ducting; and an amateur operator's distinctive call sign.

This book provides the exact questions from the Element 2 and Element 3A question pools, from which the examinations are drawn. Each of the multiple-

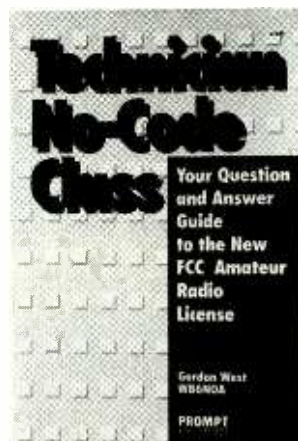

choice questions is followed by the correct answer, and a clearly written explanation of why that answer is correct.

Technician No-Code Class: Your Question and Answer Guide to the New FCC Amateur Radio License costs \$16.95 and is published by Prompt Publications, Howard W. Sams & Company, 2647 Waterfront Parkway East Drive, Indianapolis, IN 46214-2012; Tel: 317-298-5710; Fax: 317-298-5604.

CIRCLE 95 ON FREE INFORMATION CARD

COMPUTER MONEY: MAKING SERIOUS DOLLARS (\$80,000+) IN HIGH-TECH CONSULTING

by Alan N. Canton

With the end of the Cold War, drastic military cutbacks, and the fragile state of the economy, high-tech careers are no longer secure. But there is an alter-

native career available for computer programmers, engineers, analysts, graphic designers, technical writers, and other high-tech workers—consulting. This book goes beyond the typical “how to start your own business” advice. It addresses the entire spectrum of the technical consulting industry, ranging from precisely what it is (and is not) to the practical requirements of finding clients, signing contracts, and getting paid. Following the premise that technical people don't need agents, the book explains how to bypass “body shops” that place technical people in short-term assignments. Instead, it explains how, by learning marketing and sales skills, technical people can become highly-paid consultants. In an easy-going, anecdotal style, a vast array of tips and information on making it as an independent consultant are provided.

ComputerMoney: Making Serious Dollars (\$80,000+) in High-Tech Consulting is available for \$29.95 plus \$2 shipping from Adams-Blake Publishing, 8401 Sierra Street, Fair Oaks, CA 95628; Tel/Fax: 916-962-9296.

CIRCLE 91 ON FREE INFORMATION CARD

TEST & DESIGN INSTRUMENTATION CATALOG

from Global Specialties

The 32 pages of this full-color catalog are packed with frequency counters, pulse generators, power supplies, logic probes, and solderless breadboards that are made in America and priced to be economical while holding up to industrial use. New products include a programmable bench power supply, a sweep function generator, an intelligent universal counter/timer, and a portable design workstation. The catalog also features an “Easy-to-Use Instrument Selection Guide,” which shows a comparison of specifications and key information on all the instruments contained in the catalog. After selecting the desired model from the chart, the reader can

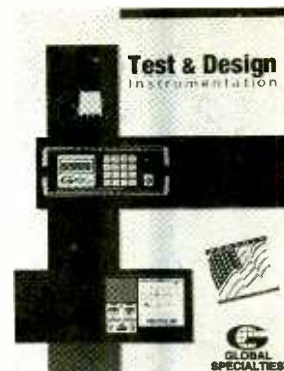

turn to the indicated page for complete information.

The 1993 Test & Design Instrumentation Catalog is free upon request from Global Specialties, 70 Fulton Terrace, New Haven, CT 06512; Tel: 800-572-1028.

CIRCLE 92 ON FREE INFORMATION CARD

1993 ELECTRONIC HOBBY AND AMATEUR RADIO KITS CATALOG

from Ramsey Electronics

This newly expanded, 20-page catalog offers a wide selection of kits and wired equipment for amateur radio, two-way radio, and scanner buffs. You'll also find kits for a radio direction finder, a digital voice recorder, an SCA music adapter, and



more. Each kit comes with a detailed and educational instruction manual.

The 1993 Electronic and Amateur Radio Kits Catalog is free upon request from Ramsey Electronics, Inc., 793 Canning Parkway, Victor, NY 14564; Tel: 716-924-4650; Fax: 716-924-4555.

CIRCLE 93 ON FREE INFORMATION CARD

NEW PRODUCTS

Personal Digital Assistant

Merging the simplicity of pen and paper with the logical power of a computer and the ability to connect to the outside world, *Tandy Corporation's Zoomer A-550* represents a new consumer-electronics product category—the personal digital assistant, or PDA. The coat-pocket-sized device was developed jointly by Tandy, Casio, and four software companies—GeoWorks, Intuit, Palm Computing, and America Online—to

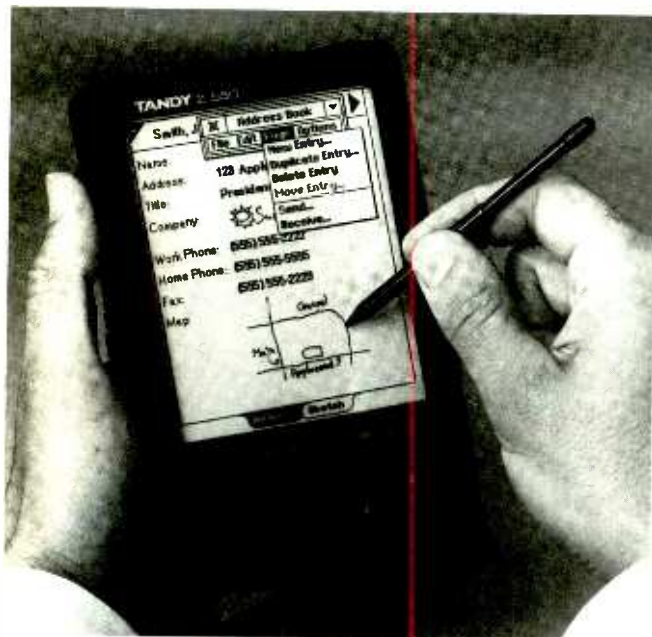

serve as an electronic note pad, financial planner, date book, address book, bank book, calculator, dictionary, thesaurus, world clock, and language translator. It also includes three game applications, a reference section for U.S. city and state information, a nutrition guide, U.S. and international dialing codes, and other information.

Zoomer is designed for ease of use, portability, long battery life, communications, and expandability. Information can be entered either using a "pen"—Zoomer recognizes and saves the user's printed handwriting either as is or as typed text—or via an on-screen keyboard. On-screen icons are touched to

move from one application to another. The unit measures $1 \times 3.1 \times 6.8$ inches and weighs less than one pound. Three standard "AA" batteries provide up to 100 hours of use. Built-in infrared transceivers allow wireless communications between two Zoomers; a serial port is also provided. An industry-standard PCMCIA (Personal Computer Memory Card International Association) card slot can be used for third-party applications, memory expansion, or add-on peripherals. With an optional modem, users can connect to the America Online information service, or send and receive E-mail.

The Zoomer Z-550 will be available in October for \$699 at Radio Shack stores nationwide. For more information, contact Tandy Corporation, 1800 One Tandy Center, Fort Worth, TX 76102. (For more information on the emerging PDA field, see this month's *Gizmo*.)

CIRCLE 101 ON FREE INFORMATION CARD

INVERTER POWER SOURCE PLANS

Inverter Scientific's Inverter Power Source Plans include all

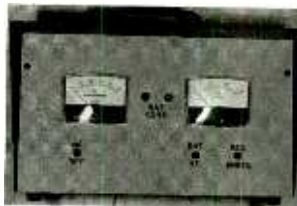

the information you need to build your own custom-designed 12VDC-to-120VAC inverter. It uses a frequency generator locked at 60 Hz, regardless of load. The plans cover units ranging from 200 to 1000 watts, allowing you to build the size you need. The inverter allows you to add the extras that you need, so that you can view input/output voltage, for in-

stance. It also has an adjustable red-light/green-light status indicator for battery condition. All technical and manufacturer information is included, along with a picture of the assembled inverter. Instructions, schematics, and theory of operation are all clear and easy to read.

The Inverter Power Source Plans cost \$29.95, including postage. For additional information, contact Inverter Scientific, P. O. Box 778, Suffern, NY 10901.

CIRCLE 102 ON FREE INFORMATION CARD

A/V SURROUND-SOUND PROCESSOR

NAD's first entry into the home-theater market is the *Model 910 A/V Surround Sound Processor*, which provides Dolby Pro Logic decoding as well as several additional modes to enhance both video soundtracks and conventional stereo-music listening. Distinguishing the Model 910 from other A/V receivers on



the market is its sensible simplicity. It is designed to be exceptionally easy to set up and use, yet it provides reference-quality decoding surround-sound and accepts and selects stereo-audio and video signals from three sources and stereo-audio from a hi-fi receiver or preamplifier. Line-level outputs are provided for the left-front, center, right-front, left-rear, and right-rear channels, as well as for a subwoofer. Besides the Pro Logic Mode, the Model 910 offers three additional surround modes—club, hall, and stadium. There is also a "super-stereo" mode that can add carefully calculated center-channel fill to stereo listening. A sibilance filter

Introducing Australia's Leading Electronics Magazine...

Silicon Chip, the most popular hobby electronics magazine south of the equator is written for you; if you are fascinated by building projects, increasing your understanding of theory, fixing consumer electronic products, and keeping up-to-date with world-wide trends within your electronics interests.

Silicon Chip, an Australian publication, is reprinted in the United States offering the best of selected articles suitable for North American readers.

Plan to become a reader of

SILICON CHIP®

Packaged in a specially prepared format guaranteed to excite the electronics hobbyist with new ideas, novel projects, extraordinary features and down-right good reading.

Inside **Silicon Chip** you will discover how the other side of our world—down under—approaches the same hobby interests as you do, with ramifications that will amaze you.

Detailed construction projects to appear in upcoming issues of Silicon Chip include:

- 4-Channel Guitar Mixer**
- Adjustable 0-45V, 8A Power Supply**
- Interphone Digital Telephone Exchange**
- 1.5V to 9V DC Converter**
- Multi-Sector Home Burglar Alarm**
- 1-Megabyte Printer Buffer**

Exciting and Imaginative Features like:

- Understanding Computer Memory**
- How to Interlink Musical Instruments**
- What's New in Oscilloscopes**

**Become
A Charter
Subscriber
Today**



SPECIAL OFFER

A sample copy may be ordered for only **\$2.50!**
In Canada: \$3.50!
Use coupon below and write across top "SAMPLE ISSUE." Fill out coupon except for subscription information and mail. Sorry—no credit cards. Send only check or money order in U.S. funds.

If you are fascinated by electronics, especially the hobby aspects related to construction projects, theory, applications in home and shop, and latest developments, if you are compelled to experiment and "fix-it," then **Silicon Chip** is your kind of magazine.

Silicon Chip is available exclusively by subscription. So take advantage of this great opportunity and start your Charter Subscription today.

SILICON CHIP, 500-B BI-County Boulevard, Farmingdale, New York 11735

PE1093

I'm convinced! Enroll me as a Charter Subscriber. Enter my subscription as designated below.

United States of America

- 12 issues for \$29.95
 24 issues for \$49.95

Canada

- 12 issues for \$40.61
 24 issues for \$70.57
(Includes postage & G.S.T.)

Payment enclosed

Please charge my

VISA

Mastercard

For your convenience, if paying by credit card: To avoid any interruption in service, your subscription will be renewed automatically at 12-issue intervals, at the then prevailing introductory rate, until you advise us to cancel it.

Signature _____

Expiration Date _____

Account No. _____

Offer valid in the U.S.A. and Canada only. No foreign Orders.

Name _____

Address _____

City _____

State _____

Zip _____

All orders payable in U.S.A. and Canada only. Allow 6-8 weeks for delivery. Additional postage: All other countries add \$11.00/12 issues

reduces hiss from poorly transferred laserdiscs or videotapes. The CDR feature automatically and subtly raises the volume of low-level passages without affecting louder ones. For listening purists, a bypass switch removes all processing from the signal path, returning the system to "straight-through" stereo mode.

The Model 910 A/V Surround Sound Processor has a suggested retail price of \$599. For additional information, contact NAD, 633 Granite Court, Pickering, Ontario, Canada L1W 3K1; Tel: 416-831-6333; Fax: 416-831-6936.

CIRCLE 103 ON FREE INFORMATION CARD

AMATEUR-RADIO VIDEO COURSE

For anyone who wants to obtain a Technician Class Amateur Radio license but is nervous about taking the FCC exam required to qualify, the *American Radio Relay League (ARRL)* offers the *ARRL Technician Class Video Course*. The five-hour videotape course provides all the information needed to pass the exam, even if you don't have an electronics background. The course includes five hours of videotape, a review book, and an optional practice exam on computer dis-



ette, which administers and scores sample tests using the exact questions that are in the FCC test pool. The videotapes, produced by King Schools of San Diego, feature exciting graphics, 3-D animations, and on-location video that gives a real-life feel for what can be done with Amateur Radio.

The ARRL Technician Class Video Course costs \$99 for the videotapes and book, or \$119 with the optional computerized exam review. For additional information, contact the American Radio Relay League, 225 Main Street, Newington, CT 06111; Tel: 800-32-NEWHAM.

CIRCLE 104 ON FREE INFORMATION CARD

BARGRAPH DIGITAL MULTIMETER

Protek's Model D-937 is a 3 1/4-digit, 4000-count, true-rms digital multimeter that incorporates computer-like switch entry for all functions and ranges, as well as an LED port with optically coupled serial output for data logging or recording. The DMM features an LCD readout with full annunciators and a 42-segment bargraph. Full autoranging capability is present for all functions except current. Other features include logic and data



hold, relative set, min/max with a 100-ms capture time, and data storage and recall. The Model D-937 also features a unique adaptor mode that can expand functions for any custom application, such as sensor or current measurements. The meter is supplied complete with holster, built-in tilt stand, safety probes, two "AA" batteries, and an instruction manual.

The Model D-937 digital multimeter costs \$139. For further information, contact HC Protek, P. O. Box 59, Norwood, NJ 07648; Tel: 201-767-7242; Fax: 201-767-7343.

CIRCLE 105 ON FREE INFORMATION CARD

FREE

Electronics & Computer Software Education Catalog

- *Fast-Track Individual Learning Programs
- *State-of-the-Art Classroom Courses
- *The Best Values in Electronics Education

New

Career-Level Courses
Personal Computer Servicing
TV and VCR Servicing

New

Computer-Aided Instruction

DC & AC Electronics
Semiconductors
Electronic Circuits

The stunning animations, hypertext glossary, and easy-to-understand text make learning electronics a breeze...and fun!

Learn the easy and affordable way from the Masters in Electronics Training - **Heathkit**. From Basic Electricity to Advanced Microprocessor Applications and more, Heathkit will provide you with an unparalleled learning experience at a fraction of the cost of other programs.

Heathkit

Educational Systems

For your FREE Catalog, call

Toll-Free 1-800-44-HEATH

please mention this code when calling 107-016

CIRCLE 155 ON FREE INFORMATION CARD



Thanks to the Weather Wizard II, now you can have a fully sophisticated weather monitoring system right in your own home. Weather Wizard II has all it takes to watch the weather like the pros. All for only \$250

FEATURES INCLUDE:

- Inside & Outside Temps
- Wind Speed & Direction
- Wind Chill
- Time & Date
- Alarms
- Highs & Lows
- Instant Metric Conversions
- Rainfall Option
- Optional PC Interface



WEATHER WIZARD II

THE PROFESSIONAL HOME WEATHER STATION

Only \$250 Add \$50 for self-emptying rain collector.
Order today: 1-800-678-3669 • PE634H

M - F 7 a.m. to 5:30 p.m. Pacific Time • FAX 1-510-670-0589
MC and VISA • Add \$5 for shipping. CA residents add sales tax.
One-year warranty • 30-day money-back guarantee

DAVIS INSTRUMENTS 3465 DIABLO AVE., HAYWARD, CA 94545

CIRCLE 162 ON FREE INFORMATION CARD

Electronic Paperbacks at Special Prices

BP325—A CONCISE USER'S GUIDE TO WINDOWS 3.1 . . . \$7.95. Come to grips with Windows 3.1 in the shortest and most effective way. Learn how to manipulate Windows screens and DOS by Windows graphics interface. Master its word processor, Paintbrush and data base along with Notepad, Macro Recorder, PIF Editor, and Calculator.

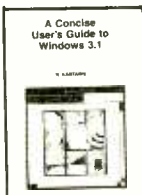

BP311—AN INTRODUCTION TO SCANNERS AND SCANNING . . . \$7.95. Radio scanners have opened a realm of exciting radio listening. Understand radio wave propagation, types of transmissions, antennas, band assignments—the straight dope on what to hear and where to hear it! Comes complete with index, glossary of important terminology.

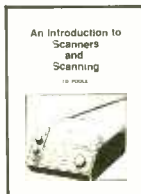

BP287—A REFERENCE GUIDE TO PRACTICAL ELECTRONICS TERMS . . . \$8.95. More than just a dictionary of practical electronics terms, the book goes a step further in getting down to fundamentals. A reference volume that can be read casually by a reader seeking knowledge.

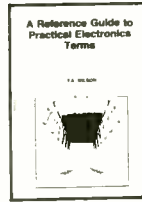

BP248—TEST EQUIPMENT CONSTRUCTION . . . \$5.95. Details construction of simple, inexpensive, but extremely useful test equipment. AF Gen, Test Bench Ampl, Audio Millivoltmeter, Transistor Tester and six more.



BP267—HOW TO USE OSCILLOSCOPES AND OTHER TEST EQUIPMENT . . . \$6.95. Mastering the oscilloscope is not really too difficult. This book explains all the standard controls and functions. Other equipment is also described.



BP265—MORE ADVANCED USES OF THE MULTIMETER . . . \$5.95. Use these techniques to test and analyze the performance of a variety of components. Also see how to build add-ons to extend multi-meter capabilities.



BP256—INTRO TO LOUDSPEAKERS AND ENCLOSURE DESIGN . . . \$5.95. We explore the variety of enclosure and speaker designs in use today, so the reader can understand the principles involved.

CMOS1—CMOS POCKET GUIDE 1 . . . \$18.95. Works like the TTL Guides but covers all commonly used CMOS standard devices. Six major sections. The first shows the device schematic. Next is a brief description of the component and is followed by full operating details. The fourth section lists major applications, while the 5th and 6th sections present essential data for that device and a list of the relevant manufacturers. The final two sections are a valuable cross-reference.



BP299—PRACTICAL ELECTRONIC FILTERS . . . \$6.95. Presents a dozen filter-based practical projects with applications in and around the home or in the constructor's workshop. Complete construction details are included.



BP249—MORE ADVANCED TEST EQUIPMENT CONSTRUCTION . . . \$6.95. Eleven more test equipment construction projects. They include a digital voltmeter, capacitance meter, current tracer, etc.



BP245—DIGITAL AUDIO PROJECTS . . . \$5.95. Practical circuits to build and experiment with. Includes A/D converter, input amplifier, digital delay line, compander, echo effect and more.



BP247—MORE ADVANCED MIDI PROJECTS . . . \$5.95. Circuits included are a MIDI indicator, THRU box, merge unit, code generator, pedal, programmer, channelizer, and analyzer.



BP257—INTRO TO AMATEUR RADIO . . . \$6.95. Amateur Radio is a unique and fascinating hobby. This book gives the newcomer a comprehensive and easy to understand guide to the subject.

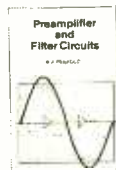

BP309—PREAMPLIFIER AND FILTER CIRCUITS . . . \$6.95. Provides circuits and background info for a range of preamplifiers, plus tone controls, filters, mixers and more. All are high-performance circuits that can be built at a reasonable cost.

BP303—UNDERSTANDING PC SOFTWARE . . . \$6.95. This book will help you understand the basics of various types of business software in common use. Types of software covered include word processors, spelling checkers, graphics programs, desktop publishing, databases, spreadsheets and utilities.



BP251—COMPUTER HOBBYISTS HANDBOOK . . . \$8.95. A wrapup of everything the computer hobbyist needs to know in one easy to use volume. Provides a range of useful reference material in a single source.



PCP115—ELECTRONIC PROJECTS FOR HOME SECURITY . . . \$10.00. 25 projects ranging from a single-door protection circuit that can be completed in an hour or two, to a sophisticated multi-channel security system. Each project is described in detail with circuit diagrams, explanations of how it works, instructions for building and testing, and how to adapt circuits to meet special requirements.



- BP190—ADVANCED ELECTRONIC SECURITY PROJECTS . . . \$5.95.** Includes a passive infra-red detector, a fiber-optic loop alarm, computer-based alarms and an unusual form of ultrasonic intruder detector.
- BP235—POWER SELECTOR GUIDE . . . \$10.00.** Complete guide to semiconductor power devices. More than 1000 power handling devices are included. They are tabulated in alpha-numeric sequence, by technical specs. Includes power diodes, Thyristors, Triacs, Power Transistors and FETs.
- BP234—TRANSISTOR SELECTOR GUIDE . . . \$10.00.** Companion volume to BP235. Book covers more than 1400 JEDEC, JIS, and brand-specific devices. Also contains listing by case type, and electronic parameters. Includes Darlingtons transistors, high-voltage devices, high-current devices, high power devices.
- BP117—PRACTICAL ELECTRONIC BUILDING BLOCKS—Book 1 . . . \$5.75.** Oscillators, Timers, Noise Generators, Rectifiers, Comparators, Triggers and more.
- BP195—INTRODUCTION TO SATELLITE TV . . . \$9.95.** A definitive introduction to the subject written for the professional engineer, electronics enthusiast, or others who want to know more before they buy. 8 x 10 in.
- BP179—ELECTRONIC CIRCUITS FOR THE COMPUTER CONTROL OF ROBOTS . . . \$7.50.** Data and circuits for interfacing the computer to the robot's motors and sensors.

- BP239—GETTING THE MOST FROM YOUR MULTIMETER . . . \$5.95.** Covers basics of analog and digital meters. Methods of component testing includes transistors, thyristors, resistors, capacitors and other active and passive devices.
- BP97—IC PROJECTS FOR BEGINNERS . . . \$5.50.** Power supplies, radio and audio circuits, oscillators, timers, switches, and more. If you can use a soldering iron you can build these devices.
- RADIO—100 RADIO HOOKUPS . . . \$3.00.** Reprint of 1924 booklet presents radio circuits of the era including regenerative, neutrodyne, reflex & more.
- BP42—SIMPLE LED CIRCUITS . . . \$5.50.** A large selection of simple applications for this simple electronic component.
- BP122—AUDIO AMPLIFIER CONSTRUCTION . . . \$5.75.** Construction details for preamps and power amplifiers up through a 100-watt DC-coupled FET amplifier.
- BP92—CRYSTAL SET CONSTRUCTION . . . \$5.50.** Everything you need to know about building crystal radio receivers.

BP255—INTERNATIONAL RADIO STATIONS GUIDE . . . \$7.95. Provides the casual listener, amateur radio DXer and the professional radio monitor with an essential reference work designed to guide him or her around the more than ever complex radio bands.

CHECK OFF THE BOOKS YOU WANT

ELECTRONIC TECHNOLOGY TODAY INC.
P.O. Box 240, Massapequa Park, NY 11762-0240

SHIPPING CHARGES IN USA AND CANADA

SORRY No orders accepted outside of USA & Canada

Number of books ordered

Name
Address
City State Zip

\$0.01 to \$5.00	\$1.50
\$5.01 to \$10.00	\$2.50
\$10.01 to \$20.00	\$3.50
\$20.01 to \$30.00	\$4.50
\$30.01 to \$40.00	\$5.50
\$40.01 to \$50.00	\$6.50
\$50.01 and above	\$8.00

Total price of merchandise . . . \$
Shipping (see chart at left) . . . \$
Subtotal \$
Sales Tax (NY State only) . . . \$
Total Enclosed \$

All payments must be in U.S. funds

PE1093

ANTIQUE RADIO

(Continued from page 69)

down about a third from the 1930 figure. In the ensuing years, Motorola would continue to improve and downsize the auto radio—producing the first all-transistor model in 1959. By that time, the sets had become so small, lightweight, and easy to install that a handy car owner could put one in by himself in a few hours.

OTHER PRE-WAR BUSINESSES

1936 saw Galvin Manufacturing Corporation's first entry into the new field of land-mobile communications. It was the *Police Cruiser*, which was a single-frequency AM auto receiver preset to receive transmissions from a specific dispatching station. In 1940, the first Motorola two-way AM police radio system was installed.

A year later, the company introduced the first commercial two-way FM radio systems. The greater range and quieter operation of these systems made them popular in police, taxi, and other applications.

In 1937, the company expanded into a new line of Motorola home radios. As you might imagine, it included a wide variety of portable sets as well as the traditional living-room models. Those receivers are the ones most likely to find their way into the collections of antique-radio enthusiasts. But because home radio was not the Galvin Corporation's core business, there just aren't as many of them in circulation as the models produced by some of the less-diversified competitors. By 1940, the corporation's net sales were almost 10 million dollars.

In that year, correctly pre-

dicting that the United States would soon be drawn into World War II, the company entered the arena of military communications. There was at that time no lightweight, tactical radio-communications equipment for field troops, and the Galvins decided to concentrate in that area. Working at their own expense, and without a military contract, they developed the *Handie Talkie*. When we entered the conflict, the highly effective little handheld set was ready to serve.

A little later, the company developed the *walkie talkie*, a heavier, more powerful radio using newer FM technology. Like the beloved Jeep, these two sets were to become symbolically associated with our wartime military actions.

We don't have space for exploration of the company's postwar activities, but it should be mentioned that one of the first new markets to be entered was home TV, with the company concentrating on low-cost models like the \$179.00 *Golden View* released in 1948. It's also important to note that in the prior year, recognizing the wide recognition of the *Motorola* trademark, Galvin Manufacturing Corporation officially changed its name to Motorola, Inc.

By 1990 Motorola had become an 11-billion-dollar corporation with over 100,000 employees and interests in semiconductor and integrated-circuit manufacture, paging devices, space technology, micro-processors, data communications, auto-engine control modules, cellular phones, and computer systems. All-in-all, quite a step from the Galvin Brothers' \$23.98 battery eliminator! ■

SUPER 12 HOUR RECORDER

CALL TOLL FREE



Modified Panasonic
Slimline. 6 hrs per side.
120 TDK tape furnished.
AC/DC Operation.
Quality Playback.
Digital Counter.
Durable Lightweight Plastic.

\$119.00*

PHONE RECORDING ADAPTER

Starts & Stops Recorder
Automatically When
Hand Set is Used.
Solid State!

FCC
APPROVED

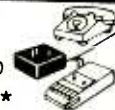

\$28.50*

VOX VOICE ACTIVATED CONTROL

Solidstate Adjustable
Sensitivity. Voices &
Sounds Activate Recorder.
Adjustable Sensitivity.
Provisions for Remote Mike.



\$28.50*

*Add for ship. & handling. Phone Adapter & Vox \$2.00 each. Recorders \$5.00 each. Colo. Res. add tax. Mail Order, VISA, M/C, COD's OK. Money Back Guar. Qty. Disc. available. Dealer inquiries invited. Free data on other products.

ALL MAIL TO: Box 20100, Boulder, CO 80308
AMC SALES INC., 193 Vaquero Dr.,
Boulder, CO 80303

Phones (303) 499-5405 • 1-800-926-2488
FAX (303) 494-4924 • Mon-Fri 8-5 MTN. TIME

CIRCLE 151 ON FREE INFORMATION CARD



Your Ticket To SUCCESS

Over 28,000 technicians have gained admittance worldwide as certified professionals. Let your ticket start opening doors for you.

ISCET offers Journeyman certification in Consumer Electronics, Industrial, Medical, Communications, Radar, Computer and Video. For more information, contact the International Society of Certified Electronics Technicians, 2708 West Berry Street, Fort Worth, TX 76109; (817) 921-9101.

Name _____
Address _____
City _____
State _____ Zip _____

Send material about ISCET and becoming certified.

Send one "Study Guide for the Associate Level CET Test." Enclosed is \$10 (inc. postage).

VACUUM-TUBE BASICS

(Continued from page 63)

pentode, the screen grid has a shielding effect on the cathode, preventing the positive voltage on the plate from having as much effect on cathode emission as it does in the triode.

It has already been shown that the plate resistance, R_p , of a tube is calculated by dividing the amount of plate-voltage change by the amount of plate-current change. If a large change in V_p is required to produce a small change in I_p , then the plate resistance of the pentode must be very high. The formula:

$$\mu = g_m \times R_p$$

shows that if the mutual conductance, g_m , remains the same, but R_p is made much greater, then the amplification factor of the tube (μ) must also be much higher. Recall also that the actual gain of a stage is calculated as:

$$\text{Gain} = \mu R_L / (R_p + R_L)$$

A typical pentode might have a plate resistance of 800 kilohms or so. That is much higher than any value of load resistor that would be used, so the gain formula can be approximated to:

$$\text{Gain} = \mu R_L / R_p$$

Since the amplification factor multiplied by the plate resistance is equal to the mutual conductance, substitution and re-arrangement of the formula results in:

$$\text{Gain} = g_m \times R_L$$

This short-cut formula for pentode-stage gain generally yields results that are close enough that they can be used for most applications.

Compare this new pentode amplifier with the triode amplifier shown back in Fig. 7. The triode had a μ of 20, a plate resistance of 16.7 kilohms, and a mutual conductance of 1.2mA/V. Assuming that the mutual conductance of the pentode is the same, the increased plate resistance of 800 kilohms gives an amplification factor of 960. If the values for R_L and B+ are also the same, the gain of the stage is a little over 40, as compared with 13.5 for the triode. The short-cut gain formula yields a result of 42, which would

be accurate enough in most practical applications.

Other Types of Tubes. Two or more of the basic tube configurations are often combined in one glass envelope. A double-triode, for example, has two triodes within the tube, each with its own separate connections, although the filaments are generally wired together internally since they will be fed from the same power source anyway. The triode-pentode is popular for forming a two-stage amplifier, with the triode acting as the first stage and the pentode providing the power necessary to drive a loud-speaker.

The beam tetrode is a close relative of the pentode. Instead of the suppressor grid, it has beam-forming plates placed between the screen and plate. They cause the electrons to pass through the beam plates in such a way that they create a negatively charged area. The negative charge then acts in the same way as the suppressor in a pentode, preventing secondary electrons from being attracted to the screen. The advantage of the beam tetrode is that it can provide greater amounts of power than the pentode, so it is often used in audio-output stages.

Extensions of the pentode are the hexode and heptode, which have four and five grids respectively. These tubes are often used as mixers where two signals must be applied to the tube simultaneously.

Cathode-ray tubes work on exactly the same thermionic emission principle as the vacuum tube, but arrange for the electrons to strike a coated fluorescent screen so that it will glow. Miniature cathode-ray tubes are no larger than a regular vacuum tube and were once used extensively as level indicators for tape recorders and as tuning indicators ("magic eyes") in receivers.

These are just a few of the many variations of the basic tube. There are specialized devices, such as the klystron, which is used in applications where frequencies of thousands of megacycles must be handled. Each of these special devices has its own particular characteristics, but they all have the fundamental principles that have been presented here as their basis. ■

KILL SWITCH

(Continued from page 66)

the printed-circuit-board components. The only parts that were exposed were the four connection terminals and LED1 (which indicates that the start timer is running).

Terminals 1 and 10 of the relay are the coil connections. In order to connect the coil of the relay to the board, the set screws for those terminals were removed and two M4 x 7 16mm-long metric screws were inserted from the bottom through the printed-circuit board; those screws also help to hold the socket onto the printed-circuit board. Since terminal 4 was not used, another metric screw was used in the same way to hold the relay in place on the board. The two supplied screws and nuts can also be used to further hold the relay by the two corner mounting holes.

The complete board can then be mounted on a sheet of plastic using standoffs to give the soldered side of the printed-circuit board clearance. The plastic sheet must be large enough to cover the exposed copper side of the printed-circuit board. Once completed, mount the unit in a convenient place in the engine compartment.

Once the relay is mounted, the positive and negative power leads of the relay are connected to the terminal block. The positive lead must go directly to the battery, so that it will not be switched off via the ignition switch. The negative lead should go to a good chassis ground. The two initiating wires, "start" and "reset" are connected to the other terminal block and run through the fire wall into the cab.

Locate the START switch, S1, where it can be pressed casually without drawing any attention to yourself while you are exiting the car. The RESET switch, S2, can be hidden from view. A good place for it might be inside the glove compartment or under the dash board on the passenger side out of direct sight. The second wire of the pushbutton switches should go to a good chassis ground.

Once the Delayed Kill Switch is built and installed, you should rest easier knowing that you and your vehicle are at least a little safer. ■

ELECTRONICS MARKET PLACE

FOR SALE

CABLE descrambler liquidation. Major makes and models available. Industry pricing! (Example: Hamlin Combo's, \$44 each... Minimum 10 orders). Call **WEST COAST ELECTRONICS**, 1 (800) 628-9656.

DESCRAMBLING secrets revealed. Free 24 hour hotline reveals secret satellite and cable descrambling information. (718) 390-7130.

RADIATION detector — test for hazardous electromagnetic radiation from power lines, appliances. \$25.00 with battery: **FABATE**, Box 143, Hillsdale, NJ 07642.

TUBES. (Thousands in stock). Send SASE for list. **FALA ELECTRONICS**, PO Box 1376-2, Milw., WI 53201.

CABLE test-chips as low as \$9.95, for testing cable boxes in **full service** mode. Jerrold: 400, 450, DL4, Starcom VI & VII; Pioneer, clears E2 thru E5; Pioneer cubes: BA-5000 thru BA-6700; Tocom 5503/5507; Scientific Atlanta: 8500 thru 8600; Zenith: all but PZ1; remotes \$10.00; money back guarantee **N.E. ENGINEERING**, 1 (800) 926-4030, fax (617) 770-2305.

CLASSIFIED AD ORDER FORM

To run your own classified ad, put one word on each of the lines below and send this form along with your check to:

Popular Electronics Classified Ads, 500-B Bi-County Boulevard, Farmingdale, N.Y. 11735

PLEASE INDICATE in which category of classified advertising you wish your ad to appear. For special headings, there is a surcharge of \$11.00.

{ } Plans/Kits () Business Opportunities () For Sale
{ } Education/Instruction () Wanted () Satellite Television

Special Category: \$11.00

PLEASE PRINT EACH WORD SEPARATELY, IN BLOCK LETTERS.

(No refunds or credits for typesetting errors can be made unless you clearly print or type your copy.) Rates indicated are for standard style classified ads only. See below for additional charges for special ads. **Minimum: 15 words.**

1	2	3	4	5
6	7	8	9	10
11	12	13	14	15 (\$23.25)
16 (\$24.80)	17 (\$26.35)	18 (\$27.90)	19 (\$29.45)	20 (\$31.00)
21 (\$32.55)	22 (\$34.10)	23 (\$35.65)	24 (\$37.20)	25 (\$38.75)
26 (\$40.30)	27 (\$41.85)	28 (\$43.40)	29 (\$44.95)	30 (\$46.50)
31 (\$48.05)	32 (\$49.60)	33 (\$51.15)	34 (\$52.70)	35 (\$54.25)

We accept MasterCard and Visa for payment of orders. If you wish to use your credit card to pay for your ad fill in the following additional information (Sorry, no telephone orders can be accepted.):

Card Number

Expiration Date

PRINT NAME

SIGNATURE

IF YOU USE A BOX NUMBER YOU MUST INCLUDE YOUR PERMANENT ADDRESS AND PHONE NUMBER FOR OUR FILES. ADS SUBMITTED WITHOUT THIS INFORMATION WILL NOT BE ACCEPTED.

CLASSIFIED COMMERCIAL RATE: (for firms or individuals offering commercial products or services) \$1.55 per word prepaid (no charge for ZIP code)...**MINIMUM 15 WORDS.** 5% discount for same ad in 6 issues within one year; 10% discount for 12 issues within one year if prepaid not applicable on credit card orders. **NON-COMMERCIAL RATE:** (for individuals who want to buy or sell a personal item) \$1.25 per word, prepaid...no minimum. **ONLY FIRST WORD AND NAME** set in bold caps at no extra charge. Additional bold face (not available as all caps) 30¢ per word additional. Entire ad in boldface, \$1.85 per word. **TINT SCREEN BEHIND ENTIRE AD:** \$1.90 per word. **TINT SCREEN BEHIND ENTIRE AD PLUS ALL BOLD FACE AD:** \$2.25 per word. **EXPANDED TYPE AD:** \$2.05 per word prepaid. Entire ad in boldface, \$2.45 per word. **TINT SCREEN BEHIND ENTIRE EXPANDED TYPE AD:** \$2.55 per word. **TINT SCREEN BEHIND ENTIRE EXPANDED TYPE AD PLUS ALL BOLD FACE AD:** \$2.95 per word. **DISPLAY ADS:** 1" x 2 1/2" — \$205.00; 2" x 2 1/2" — \$410.00; 3" x 2 1/2" — \$615.00. **General Information:** Frequency rates and prepayment discounts are available. **ALL COPY SUBJECT TO PUBLISHERS APPROVAL. ADVERTISEMENTS USING P.O. BOX ADDRESS WILL NOT BE ACCEPTED UNTIL ADVERTISER SUPPLIES PUBLISHER WITH PERMANENT ADDRESS AND PHONE NUMBER.** Copy to be in our hands on the 18th of the fourth month preceding the date of issue (i.e., Sept. issue copy must be received by May 18th). When normal closing date falls on Saturday, Sunday or Holiday, issue closes on preceding work day. Send for the classified brochure. Circle Number 49 on the Free Information Card.

**CABLE TV DESCRAMBLERS
★ CONVERTERS ★
and ACCESSORIES.**

**SAVE MONEY.
DON'T RENT!**

PANASONIC,
PIONEER, JERROLD, OAK,
SCIENTIFIC ATLANTA
AND MORE. LOWEST PRICES.
FREE CATALOG.
(800) 234-1006
CABLE READY COMPANY

CABLE descramblers, turn-on kits and bullet stoppers. No 800#, no bull equals your lowest price. We buy, sell and trade. Call (305) 425-0751. No Florida sales.

PROTOTYPE service for hobbyists & engineers. Single quantity ss PCB's. \$10.00 minimum. No setup fee. We also scan magazine artwork. Get out your back issues! **FIRST PROTO**, (407) 392-8677.

FREE CATALOG

**FAMOUS "FIRESTIK" BRAND CB ANTENNAS
AND ACCESSORIES. QUALITY PRODUCTS
FOR THE SERIOUS CB'er. SINCE 1962**
FIRESTIK ANTENNA COMPANY
2614 EAST ADAMS
PHOENIX, ARIZONA 85034

SECRET cable descramblers! Build your own descrambler for less than \$12.00 in seven easy steps. **Radio Shack parts list and free descrambling methods that cost nothing to try, included.** Send \$10.00 to: **INFORMATION FACTORY**, Dept. 5, PO Box 1790, Baytown, TX 77522.

HUGE 100 page communications catalog of shortwave, amateur and scanner equipment. Antennas, books, and accessories too. Send \$1.00 to: **UNIVERSAL RADIO**, 6830 Americana Pkwy., Dept. PE, Reynoldsburg, OH 43068.

300 Experimenters Circuits — Complete in 6 practical books using diodes, relays, FET's, LED's, IC 555's, and IC CA3130's for building blocks. Only \$33.00 plus \$5.50 for shipping. USA and Canada only. US funds. **ETT, INC.**, PO Box 240, Massapequa Park, NY 11762-0240.

CB RADIO OWNERS!

We specialize in a wide variety of technical information, parts and services for CB radios. 10-Meter and FM conversion kits, repair books, plans, high-performance accessories. Thousands of satisfied customers since 1976! Catalog \$2.

CBC INTERNATIONAL

P.O. BOX 31500PE, PHOENIX, AZ 85046

CABLE test chips. Jerrold, Tocom, S.A., Zenith. Puts cable boxes into full service mode! \$29.95 to \$59.95. 1 (800) 452-7090, (310) 867-0081.

DESCRAMBLERS for cable and satellite. Kits and assembled units. All types. Guaranteed. From \$19.95. Free catalog. (212) 330-8035.

PC Boards in minutes using a laser printer or photocopier. New "press-n-peel" technique irons onto standard copper clad board. **ALZATEX-PE**, 6400 SW 213th Ave., Aloha, OR 97007.

INFORMATIVE Video Camcorder Guide explains styles and formats. Easy to understand, written by professional. 1000's benefitting. Send \$10.00 **AFM**, 109 Southland, Rochester, NY 14623.

LASER & special effects products. Lasers from \$9.95. We specialize in laser and special effects products. Free catalog: **DESIGN IMAGES**, DeptP7, Box 292125, Lewisville, TX 75029. (214) 221-9711.

CREDIT card, ATM, read/write theory \$29.00, backup your credit cards, system for PC schematic \$39.00, info \$5.00. CPU ADVANCE, Box 1089, Waltham, MA 02154.

BUGGED? Telephone tapped? Find out fast! Free catalog of fantastic counter-surveillance equipment! 1 (800) 732-5000.

FASCINATING, useful, fun and educational! Lasers, voice changers, message recorders, software, detectors, talking clocks and more. We supply all the parts. You build using our detailed manuals. Send \$1.00 (refundable) for catalog: **LNS TECHNOLOGIES**, 20993 Foothill Blvd., Suite 307R, Hayward, CA 94541-1511.



Great kit for electronic buffs. **Silent Sam** Turn Signal reminder. Patent Approved! Best reminder yet. Will not bug you. Sounds briefly & repeats only if you forget to cancel. Quiet; braking resets it. Complete kit of all parts PCB, case & instructions only \$15 PPD. Wired units \$7 more. **Visa, MC.** (814) 231-8814. Call for free information sheet. **Silent Sam**, 1827 Basil Dr, Columbus, OH 43227.

ANNOUNCING OmniAlert! (pat. pend) Designed by F-18 tactical radar engineer. Revolutionary photosensitive alarm safeguards your home, office, car, & valuables. Professionally engineered board & plans, guaranteed foolproof! \$11.95. **DRALIN DESIGNS**, PO Box 04, Ellenburg Depot, NY 12935.

SYNTHESIZER kits digitally generate low-distortion signals. Model DDS-3: 2Hz steps to 12MHz, \$149.95. Model DDS-1: 1Hz steps to 524kHz, \$89.95. \$5.00 S/H. **SASE** for specifications. **NOVATECH INSTRUMENTS**, 1530 Eastlake East, Suite 303, Seattle, WA 98102.

STEREO amplifiers to 500WRMS/CH, pre-amps, etc. Build yourself. Call for custom plans. **ELECTRONICS HOSPITAL**, (407) 952-3838.

BUSINESS OPPORTUNITIES

MAKE \$75,000.00 to \$250,000.00 yearly. Learn IBM monitors repairs (solutions most brands). New home based business program. Software available. Information: **USA-Canada** \$3.00 cash (no checks), Dealers wanted worldwide (\$35.00) US funds. **RANDALL DISPLAY**, PO Box 2168-H, Van Nuys, CA 91404, USA.

HOME assembly work available! Guaranteed easy money! Free details! **SASE. HOMEWORK-P**, Box 520, Danville, NH 03819.

EASY work! Excellent pay! Assemble products at home. Call toll free 1 (800) 467-5566 ext. 5730.

NEED money? Guaranteed employment! Assemble simple products at home. Easy work! Excellent income! 1 (800) 377-6000, ex7930.

DISTRIBUTORS needed — High profits. Largest selection & lowest prices. Mini-satellite antennas for homes, RV, business, & many new markets. Starting at \$296.00. 1 (800) 886-5008.

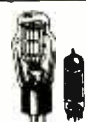

RECEIVING TUBES

OVER 3000 TYPES IN STOCK!

Also hard-to-find transformers, capacitors and parts for tube equipment.

Send \$2.00 for our 32 page catalog.

ANTIQUE ELECTRONIC SUPPLY
6221 S. Maple Ave. +Tempe, AZ 85283 • 602-820-5411

GUARANTEED earn \$100.00 per hour repairing VCR's. No electronic experience necessary. Most malfunctions simple mechanical or electro-mechanical. Start repairing the first day! Call 1 (800) 682-6877 or write **VCR MASTER SERVICE**, 2001 Denison, Denton, TX 76201.

Learn to fix computers!



Home study. Earn great money repairing troubleshooting, upgrading, and installing PCs. Free literature: 800-223-4842.

Name _____ Age _____
Address _____
City _____ State _____ Zip _____
The School of PC Repair, Dept. JL341
6065 Roswell Road, Atlanta, Georgia 30328

EDUCATION/INSTRUCTION

ELECTRONIC engineering. 8 volumes complete. \$109.95. No prior knowledge required. Free brochure. **BANNER TECHNICAL BOOKS**, 1203 Grant Avenue, Rockford, IL 61103.

VCR Repairs You Can Do. Save\$. Make\$. 403-page textbook. Simple solutions for difficult problems. \$Back-guarantee. Over 36,100 sold. 704 illustrations + tool. Mail \$24.95 to **WORTHINGTON PUBLISHING**, Box 16691N, Tampa, FL 33687-6691.

FCC license preparation course. Send **SASE** to **H. FRANCISCO**, 8332 Peggy Street, Tampa, FL 33615.

ELECTRICITY/Electronics training series used by U.S. military. 23 volumes, other courses available. Free info: **FEDERAL TECHNICAL PUBLISHERS**, Box 1061 E. Glen Lake, MN 55345.

ANTIQUE RADIO CLASSIFIED

Free Sample!

Antique Radio's
Largest Circulation Monthly.
Articles, Ads & Classifieds.

6-Month Trial: \$16.95. 1-Yr: \$29.95 (\$44.95-1st Class).
A.R.C., P.O. Box 802-L10, Carlisle, MA 01741

SPEAKER BUILDERS

BUILD your own speaker systems using our first class speaker cabinets. Solid MDF cabinets beautifully finished in textured black or with basecoat to paint own color. Call or write for product info and pricelist. **VIRGIN CABINETS**, R.R. #1, Desbarats, Ontario, Canada P0R 1E0 (705) 736-2826.

INVENTORS

INVENTORS: CONCEPT NETWORK offers professional, inexpensive patenting and marketing services. (New product ideas with prototype or schematics preferred; but they are not required.) Free information packet: Call 1 (800) 835-2246 extension 67.

SATELLITE TV

SUPER low satellite prices. Free U.S. and International catalog. **SATMAN**, (309) 692-4140 (Int'l), 1 (800) 472-8626 in U.S.

BUY BONDS

MASTERCARD AND VISA are now accepted for payment of your advertising. Simply complete the Classified Ad order form and we will bill you.

CABLE RENTAL FEES AP BY OWNING YOUR OWN

Converter & Descrambler!

FREE CATALOG! **ALL MAJOR BRANDS**

1-800-228-7404

NU-TEK ELECTRONICS

3250 Hatch Rd. Suite 1A Cedar Park, TX 78613

PLANS & KITS

SURVEILLANCE transmitter kits tune from 65 to 305 MHz. Mains powered duplex, telephone, room, combination telephone/room. Catalog with **Popular Communications**, **Popular Electronics** and **Radio-Electronics** book reviews of "Electronic Eavesdropping Equipment Design," \$2.00. **SHEFFIELD ELECTRONICS**, PO Box 377785-A, Chicago, IL 60637-7785.

60 Solderless Breadboard Projects in two easy-to-read pocket books. Complete with circuit descriptions, schematics, parts layouts, component listings, etc. Both books (BP107 & BP113) only \$11.90 plus \$3.50 for shipping. USA and Canada only. US funds. **ETT, INC.**, PO Box 240, Massapequa Park, NY 11762-0240.

MOTORIZED your hand scanner, no more distorted or crooked images. Plans and schematic, send \$20.00 to **UNIQUE MACH. SYSTEMS**, 945 Rosedale Ave., Baltimore, MD 21237.

GET CONTROL!

with
**CABLE TV DESCRAMBLERS
AND CONVERTERS**

Gain complete control of your TV and save money on monthly rental charges by owning your cable equipment!

TOP BRANDS AVAILABLE

Everquest • Panasonic • Jerrold • Zenith • Pioneer • Scientific Atlanta • Tocom • and many more!

SATISFACTION GUARANTEED!

Quantity Pricing Available

Orders can be placed 24 hours a day 7 days a week!

Same day shipment if order placed before 5 pm EST M-F



Call Toll-Free

1-800-775-0444



MC, Visa and COD.



★ U.S. CABLE SUPPLY ★

Special Note: Decoders and Descramblers must not be used without authorization by your local cable operator. Sorry, no Tennessee sales.

CIRCLE 164 ON FREE INFORMATION CARD

BEST BY MAIL

Rates: Write National, Box 5, Sarasota, FL 34230

PLANS

CONFUSE LIDARI PLANS, parts, sources to construct laser speed gun confuser. Info pack \$3.00, plans \$20. Send Check/MO to: M. Wallace & Assoc., POB 267-Paul, Morrison, CO 80465.

MONEYMAKING OPPORTUNITIES

EARN \$50-\$300 DAILY Using Your Camcorder. Free information: WCE, Box 9803E, Fountain Valley, CA 92728.

FULL TIME INCOME Mailing Flyers. SASE Brings Details: FLYERS, Box 1143-(PE), Clinton, MD 20735.

COLLECTIBLES

ORIGINAL MARTIAN MONUMENTS LITHOGRAPH. Limited Edition 800, \$69 to: COSMIC ORIGINALS, POB 6422-(PE), Whittier, CA 90609-6422.

"YOUR FREE CATALOG KNOCKED MY SOCKS OFF"

Our free Catalog of free and low-cost government booklets will very likely knock your socks off, too. But first you have to get it. Just send your name and address to:

**Consumer Information Center
Department KO
Pueblo, Colorado 81009**

For your Heart's sake get **PULSE STICK II**

Your very own sophisticated pocket health monitor, PULSE STICK II, checks your pulse rate quickly and accurately anywhere. Regular monitoring of your pulse rate during exercise will enable you to plan an exercise regimen suitable for your stage of fitness. Pulse stick II provides an early warning that you may be exceeding your own capabilities.

PULSE STICK II photoelectrically measures the changes

in the pulsed intensity of infrared radiation emitted by superficial blood vessels below the skin of the thumb. The time intervals between pulses are automatically measured and analogued by the micro-processor based circuitry and displayed in a liquid-crystal display (LCD).

Before attempting any exercise program, consult your doctor. Ask for guidance regarding the recommended safe pulse ranges for your exercise program. Follow your doctor's instructions carefully.

Only
\$39⁹⁵



Uses three AA dry cells
supplied with PULSE STICK II



Ideal for running, walking and
aerobic training programs!

PSII-2

YES! Please send me _____ PULSE STICK II at \$39.95 each. Price includes shipping and handling charges.

Print Name _____

Address _____

Total amount of order \$ _____

City _____ State _____ Zip _____

Check or Money Order enclosed. Make check payable to **CLAGGK Inc. PULSE STICK II Offer**

No telephone orders or C.O.D. Signature required on credit card orders. All prices include postage and handling. Payments in U.S.A. funds only. New York residents must include local applicable sales taxes. No foreign orders.

Charge my Visa MasterCard

Account No. _____

Exp. Date _____ / _____

Mail orders to CLAGGK Inc. Pulse Stick II Offer, P.O. Box 4099, Farmingdale, NY 11735.

Credit Card
Signature _____

FAX orders to 1-516-293-3115.

RADIO FLEA MARKET

(Continued from page 42)

luncheon meetings, formal banquets, FCC regulatory sessions, ARRL membership and directors' meetings and forums, and church services (often conducted by clergymen who are hams).

And then, there's Dayton. The Dayton HamVention is in a class all by itself. It is the very largest U.S. amateur radio convention and is a three-day affair held in late April (the 1993 dates were April 23-25). It draws 30,000 or more attendees each year to Dayton's Hara Arena and Conference Center. Its seemingly endless flea market space and its countless indoor forums and exhibits are inevitably jam-packed.

Dayton's also the place where companies and individuals annually unveil a dazzling array of new goodies for the amateur radio, shortwave, scanner, and computer markets. Whether you're looking for a receiver, transmitter, transceiver, satellite station, packet or digital gear, kits, UHF and microwave gear, computer hardware and software, or almost anything else—new or used—that's even vaguely electronic, Dayton's the place to find it. For more information on this Mecca of hamfests and radio flea markets, contact the Dayton HamVention (see the address in the "Names and Numbers" boxed copy).

Summary. This article should help anyone survive the radio flea market. We covered an introduction to flea markets, hamfests, and their activities; tips for buyers; negotiating a good deal; and cleaning up, restoring, and troubleshooting purchases. In the sidebars, we've also presented books, magazines, newsletters, and manuals for old radio equipment; information on events everyone should know about; and key goods suppliers.

If you've never been to such an affair, I hope that I've convinced you to try one. They're great fun; you'll meet interesting people, learn something useful, and possibly find that dream rig for a sweet price. Most importantly, attending radio flea markets and hamfests is an excellent way to get a single-dose maximum exposure to all aspects of radio. ■

ADVERTISING INDEX

POPULAR ELECTRONICS magazine does not assume any responsibility for errors that may appear in the index below.

Free Information No.	Page
151 AMC Sales	93
— Antique Electronic Supply	96
— Antique Radio Classified	96
— CBC International	96
— CIE	25
— CLAGGK Inc. Monitor	97
— CLAGGK Inc. Video Offer	CV3
— Cable Ready Company	95
— Command Productions	73
— Copyright Clearance Center, Inc.	71
16 Covox, Inc.	CV4
162 Davis Instruments	91
— Electronic Tech. Today	92
— Electronics Book Club	27, 87
— Firestik II	95
153 Fluke Manufacturing	CV2
154 Foley-Belsaw Company	30
— Grantham College	83
155 Heathkit	91
— ISCET	93
156 Jameco	21
— Motorola	4
163 Mouser	77
— NRI Schools	15
— Nu-Tek	96
— Pulse Stick II	97
— Silent Sam TSR Co.	96
— The School of PC Repair	96
159 The School of VCR Repair	79
164 U.S. Cable Supply, Inc.	97
— World College	67
160 Zentek Corp.	73

ADVERTISING SALES OFFICE

Gernsback Publications, Inc.
500-B Bi-County Blvd.
Farmingdale, NY 11735
1-(516) 293-3000

Larry Steckler
President

Christina Estrada
Assistant to the President

For Advertising ONLY
516-293-3000
Fax 1-516-293-3115

Larry Steckler
publisher

Arline Fishman
advertising director

Denise Mullen
advertising assistant

Kelly Twist
credit manager

**Subscription/
Customer Service/
Order Entry**
1-800-827-0383
7:30 AM - 8:30 PM EST

ADVERTISING SALES OFFICES EAST/SOUTHEAST

Stanley Levitan
Eastern Sales
1 Overlook Ave.
Great Neck, NY 11021
1-516-487-9357, 1-516-293-3000
Fax 1-516-487-8402

MIDWEST/Texas/Arkansas/ Oklahoma, Colorado, Arizona

Ralph Bergen
Midwest Sales
One Northfield Plaza, Suite 300
Northfield, IL 60093-1214
1-708-446-1444
Fax 1-708-559-0562

PACIFIC COAST/Mountain States

Mike Brooks
Pattis/3M
1800 North Highland Avenue
Suite 717
Hollywood, CA 90028
1-213-462-2700
Fax 1-213-463-0544

Countersurveillance

Never before has so much professional information on the art of detecting and eliminating electronic snooping devices—and how to defend against experienced information thieves—been placed in one VHS video. If you are a Fortune 500 CEO, an executive in any hi-tech industry, or a novice seeking entry into an honorable, rewarding field of work in countersurveillance, you must view this video presentation again and again.



CALL NOW!

1-516-293-3751

HAVE YOUR VISA or MC CARD AVAILABLE

Wake up! You may be the victim of stolen words—precious ideas that would have made you very wealthy! Yes, professionals, even rank amateurs, may be listening to your most private conversations.

Wake up! If you are not the victim, then you are surrounded by countless victims who need your help if you know how to discover telephone taps, locate bugs, or “sweep” a room clean.

There is a thriving professional service steeped in high-tech techniques that you can become a part of! But first, you must know and understand Countersurveillance Technology. Your very first insight into this highly rewarding field is made possible by a video VHS presentation that you cannot view on broadcast television, satellite, or cable. It presents an informative program prepared by professionals in the field who know their industry, its techniques, kinks and loopholes. Men who can tell you more in 45 minutes in a straightforward, exclusive talk than was ever attempted before.

Foiling Information Thieves

Discover the targets professional snoopers seek out! The prey are stock brokers, arbitrage firms, manufacturers, high-tech companies, any competitive industry, or even small businesses in the same community. The valuable information they filch may be marketing strategies, customer lists, product formulas, manufacturing techniques, even advertising plans. Information thieves eavesdrop on court decisions, bidding information, financial data. The list is unlimited in the mind of man—especially if he is a thief!

You know that the Russians secretly installed countless microphones in the concrete work of the American Embassy building in Moscow. They converted

what was to be an embassy and private residence into the most sophisticated recording studio the world had ever known. The building had to be torn down in order to remove all the bugs.

Stolen Information

The open taps from where the information pours out may be from FAX's, computer communications, telephone calls, and everyday business meetings and lunchtime encounters. Businessmen need counselling on how to eliminate this information drain. Basic telephone use coupled with the user's understanding that someone may be listening or recording vital data and information greatly reduces the opportunity for others to purloin meaningful information.

The professional discussions seen on the TV screen in your home reveals how to detect and disable wiretaps, midjet radio-frequency transmitters, and other bugs, plus when to use disinformation to confuse the unwanted listener, and the technique of voice scrambling telephone communications. In fact, do you know how to look for a bug, where to look for a bug, and what to do when you find it?

Bugs of a very small size are easy to build and they can be placed quickly in a matter of seconds, in any object or room. Today you may have used a telephone handset that was bugged. It probably contained three bugs. One was a phony bug to fool you into believing you found a bug and secured the telephone. The second bug placates the investigator when he finds the real thing! And the third bug is found only by the professional, who continued to search just in case there were more bugs.

The professional is not without his tools. Special equipment has been designed so that the professional can sweep a room so that he can detect voice-activated (VOX) and remote-activated bugs. Some of this equipment can be operated by novices, others require a trained countersurveillance professional.

The professionals viewed on your television screen reveal information on the latest technological advances like laser-beam snoopers that are installed hundreds of feet away from the room they snoop on. The professionals disclose that computers yield information too easily.

This advertisement was not written by a countersurveillance professional, but by a beginner whose only experience came from viewing the video tape in the privacy of his home. After you review the video carefully and understand its contents, you have taken the first important step in either acquiring professional help with your surveillance problems, or you may very well consider a career as a countersurveillance professional.

The Dollars You Save

To obtain the information contained in the video VHS cassette, you would attend a professional seminar costing \$350-750 and possibly pay hundreds of dollars more if you had to travel to a distant city to attend. Now, for only \$49.95 (plus \$4.00 P&H) you can view *Countersurveillance Techniques* at home and take refresher views often. To obtain your copy, complete the coupon or call.

CLAGGK INC. PE
P.O. Box 4099 • Farmingdale, NY 11735

Please rush my copy of the Countersurveillance Techniques Video VHS Cassette for a total cost of \$53.95 each (which includes \$4.00 postage and handling).

No. of Cassettes ordered _____
 Amount of payment \$ _____
 Sales tax (N.Y.S. only) _____
 Total enclosed _____
 Bill my VISA MasterCard
 Card No. _____
 Expire Date _____ / _____
 Signature _____
 Name _____
 Address _____
 City _____ State _____ ZIP _____

All payments in U.S.A. funds. Canadians add \$4.00 per VHS cassette. No foreign orders.

If you LISTEN to your computer with one of these...



now you can TALK to your computer with THIS!

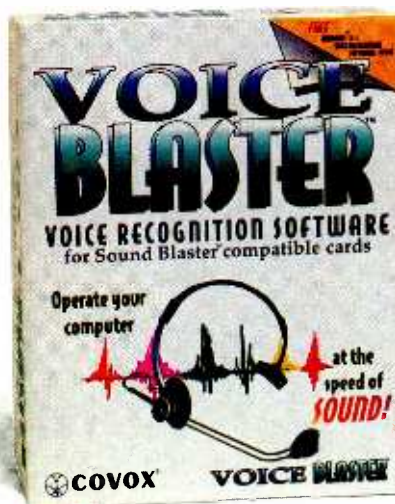

From the developers of the U.S. Air Force's "Bionic Ear" comes VOICE BLASTER, the world's first voice recognition software for popular sound cards.

The DOS and Windows 3.1 voice recognition programs included allow you to add voice commands to popular education, business and entertainment programs such as WordPerfect, F117A, Lotus 123, Secret Weapons of the Luftwaffe, DAC Easy, and hundreds more.

Easy to install and use, you will be up and running *at the speed of sound* in no time!

Also included are DOS and Windows 3.1 recording, editing and playback programs which represent leading edge PC sound technology.

Voice annotation software included brings your Windows 3.1 word processor to life by adding your own recorded messages to your documents.

The COVOX E/Q module and headset provided with VOICE BLASTER will improve your sound card's recording capability while giving you the best voice recognition possible. VOICE BLASTER *will change the way you use your computer!*

VOICE BLASTER is available at CompUSA, Electronics Boutique, Software Etc. and other fine computer retail outlets

Call COVOX, INC. (800)733-0420 Dealer inquiries call (818) 446-9932

Copyright 1993 COVOX, INC. All products and corporate names are trademarks and registered trademarks of their respective owners. All rights reserved. COVOX, INC. 675 Conger St. Eugene, OR 97402 (503) 342-1271

CIRCLE 16 ON FREE INFORMATION CARD