

BUILD AN RF REMOTE CONTROL

Popular Electronics[®]

AUGUST 1993

BUILD A SUPER-SIMPLE SHORTWAVE RADIO

Tune in to the excitement and drama of international radio broadcasts with this easy-to-build, HF shortwave receiver

BUILD A CARDBOARD-TUBE RADIO

Some common household materials put a novel twist on an always popular project

TEST GEAR FOR SWL'S

Keep your listening post in tip-top shape

FIGHTING INTERFERENCE

Learn how to track down and eliminate the causes of troublesome RF interference

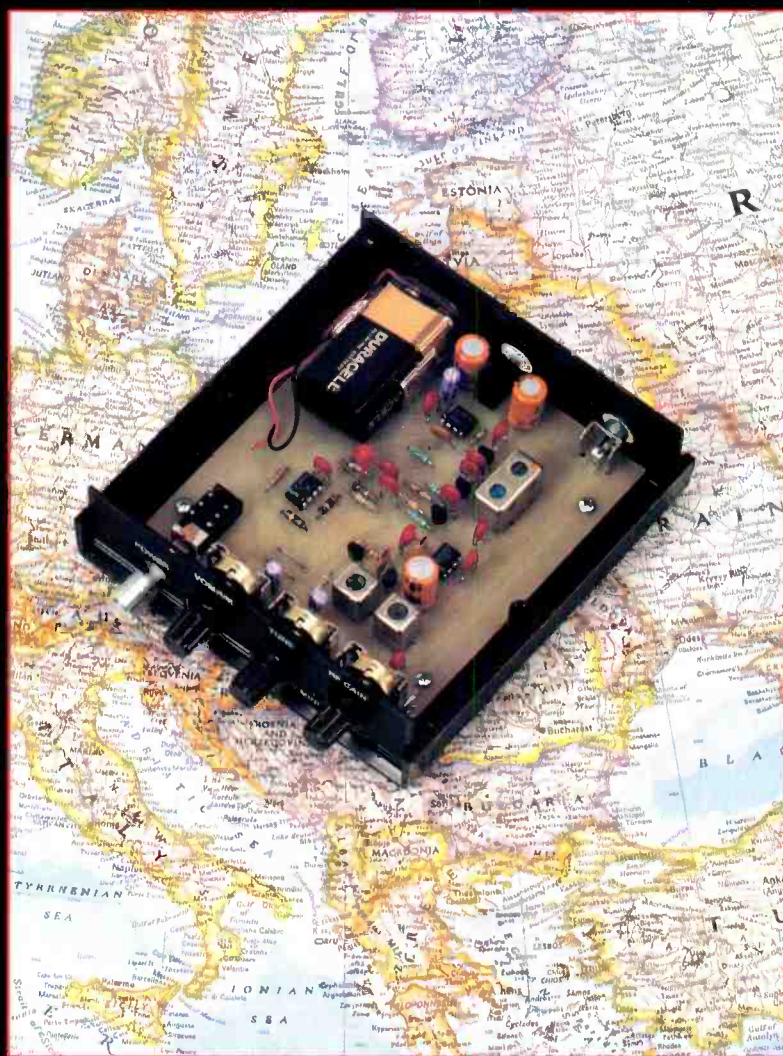

A
GERNSBACK
PUBLICATION

#BXBDCCH CAR-ST SORT ** CR24
#62506DHM957GAC06# FEB94 P80

ROBERT DAHM RESP
093

997 GRAND AVE
AURORA IL 60506-2513



3 NEW FactCards
IN THIS ISSUE

\$3.50 U.S.
\$3.95 CANADA

1·800·831·4242

Your Resource for Value. Only a Phone Call Away.

20
YEARS OF
EXCELLENCE
1973-1993



40 Watt Switching Power Supply

+5V @ 1.5A -5V @ .32A
+5V @ .4A -12V @ .075A
+12V @ .5A +22V @ 1A

- Input: 115VAC @ 60Hz
- 2-pin Molex input connector and 4 output connectors
- Size: 5.375"L x 3.5"W x 1.25"H
- Weight: .5 lb.

Part No.	Product No.	Price
8P77972	PS512	\$14.95

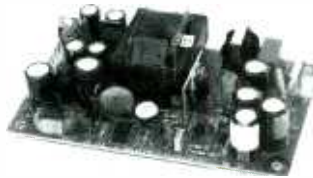

23 Watt Switching Power Supply

+5V @ 1.8A
+15V @ .450A
-15V @ .450A

- Input: 120VAC @ 50/60Hz
- Molex style input and output connectors
- Size: 5"L x 3"W x 1.375"H
- Weight: .5 lb.

Part No.	Product No.	Price
8P76611	PS9099	\$12.95

Metex Digital Multimeters

- Handheld high accuracy
 - Measures AC/DC voltage, AC/DC current, resistance, diodes, audible continuity test, transistor hFE
 - Manual ranging w/overload protection
 - Comes with probes, batteries, case and manual
 - One-year warranty
- 27086 & 27158 only:**
- Also measures frequency and capacitance



Part No.	Description	Price
8P27078	3.5 digit multimeter	\$59.95
8P27086	3.5 digit multimeter w/frequency & capacitance	74.95
8P27115	3.5 digit multimeter	39.95
8P27140	4.5 digit multimeter w/tach/dwell	59.95
8P27158	4.5 digit w/frequency & capacitance & data hold switch	99.95

Jameco Solderless Breadboards

Our long-lasting breadboards feature screen printed color coordinates and are suitable for many kinds of prototyping and circuit design. Larger models feature heavy-duty aluminum backing with voltage and grounding posts.



Part No.	Terminal Strips	Bus Strips	Contact Points	Price 1-9
8P20343	0	2	200	\$3.49
8P20600	1	2	400	4.95
8P20669	1	0	630	5.95
8P20722	1	2	830	6.95
8P20757	2	1	1,360	12.95
8P20773	2	4	1,660	17.95
8P20790	3	5	2,390	24.95
8P20811	4	7	3,220	32.95

See our Catalog for more power supplies

Name brand IC's in stock!

Linear ICs

Part No.	Product No.	Price 1-9
8P33241	TL082CP	\$5.99
8P23579	LM317T	.65
8P23683	LM324N	.35
8P23771	LM336Z	1.09
8P23851	LM339N	.45
8P27422	NE555V	.35
8P24328	LM556N	.49
8P24467	LM723CN	.49
8P24539	LM741CN	.29
8P23131	LM1458N	.39
8P23157	LM1488N	.45
8P23181	LM1489N	.45
8P34278	ULN2003A	.69
8P24230	LM3914N	2.49
8P27385	NE5532	1.19
8P51262	7805T	.45
8P51334	7812T	.45

Name brand IC's in stock!

TTL ICs

Part No.	Product No.	Price 1-9
8P46252	74LS00	\$25
8P46287	74LS02	.25
8P46316	74LS04	.25
8P46375	74LS08	.29
8P46640	74LS14	.39
8P47458	74LS30	.25
8P47466	74LS32	.25
8P48004	74LS74	.29
8P48039	74LS76	.49
8P48098	74LS86	.25
8P46447	74LS112	.25
8P46480	74LS123	.39
8P46607	74LS138	.39
8P46957	74LS175	.35
8P47036	74LS193	.59
8P47183	74LS244	.69
8P47212	74LS245	.69
8P47600	74LS373	.69
8P47634	74LS374	.69

Diodes and Transistors

Part No.	Product No.	Description	Price
8P38236	1N4148	Switching diode	\$0.07
8P36038	1N4733	Zener diode	.25
8P35991	1N4004	Silicon rectifier	.10
8P38236	2N2222A	Gen. pur. transistor	.25
8P38279	2N2907A	Gen. pur. transistor	.25
8P38359	2N3904	Gen. pur. transistor	.12

Ceramic Capacitors (50v) ± 20% Ceramic

Part No.	Capacitance	Price
8P15333	10pf	\$0.10
8P15341	100pf	.10
8P15190	.001µF	.10
8P15229	.01µF	.10
8P15253	.047µF	.10
8P15270	.1µF	.15

Soldertail Low Profile Tin Plated IC Sockets

Part No.	Pins	Price
8P51570	8 pin	\$0.10
8P37161	14 pin	.11
8P37372	16 pin	.12
8P39335	24 pin	.19
8P40301	28 pin	.22
8P41110	40 pin	.28

Lead Length: .125"
Body Height: .156"

*Additional components available

Carbon Film 1/4 Watt 5% Resistor Assortments

Part No.	Description	Price
8P10719	5 each 70 values (every other value from R10 thru R5 6 meg) 1/4 Watt C.F. Resistor Values (350 pcs)	\$9.95
8P10663	100 each (27 values) 1/4 Watt C.F. Resistors R10 thru R10M (2,700 pcs)	39.95

Part No.	Product No.	Description	Price
8P34796	XC556R	Red .200 dia	\$0.12
8P34761	XC556G	Green .200 dia	.16
8P34825	XC556Y	Yellow .200 dia	.16
8P34622	XC209R	Red .125 dia	.14
8P34606	XC209G	Green .125 dia	.18
8P34657	XC209Y	Yellow .125 dia	.18

Other Jameco Resources

- Test/Measurement and Prototyping Equipment
- Computer Upgrade and Accessory Products
- Full line of Integrated Circuits and Electronic Components
- Call for hobby kits

Order toll-free 1·800·831·4242

Call or write for your FREE Spring Component Catalog: 1·800·637·8471



JAMECOTM
ELECTRONIC COMPONENTS
COMPUTER PRODUCTS

1355 Shoreway Road
Belmont, CA 94002
FAX: 1·800·237·6948 (Domestic)
FAX: 415·592·2503 (International)

For International Sales, Customer Service, Credit Department and all other inquiries: Call 415·592·8097 between 7AM-5PM P.S.T.

CA Residents please add applicable sales tax.

\$30.00 Minimum Order

Terms: Prices subject to change without notice. Items subject to availability and prior sale. Complete list of terms/warranties is available upon request.

© 1993 Jameco 8/93 All trademarks are registered trademarks of their respective companies.

Popular Electronics®

THE MAGAZINE FOR THE ELECTRONICS ACTIVIST!

DIY ACTION ARTICLES

DIY SIMPLE SHORTWAVE RECEIVER	Fred Blechman	31
<i>Listeners of world travel without the expense through the magic of shortwave radio</i>		
DIY GRID TUBE RADIO	David D. Lee	41
<i>Build a grid tube radio receiver from common household items</i>		
DIY INEL RF REMOTE CONTROL	Brian McKean	53
<i>Build a simple RF remote-control transmitter that can be used in a variety of applications</i>		

DIY GEAR ARTICLES

DIY GEAR FOR SWL'S	Karl T. Thurber	36
<i>A look at some testing aids that can help keep your listening post in shape</i>		
DIY FIGHTING INTERFERENCE	Gary Eggleston	44
<i>Find out what you can do about unwanted signals</i>		
DIY AN INTRODUCTION TO ANALOG-TO-DIGITAL CONVERTERS	James E. Tarchinski	57
<i>Learn about the components that convert real-world signals to a language that logic circuits can understand</i>		
DIY PROGRAMMING SERIAL PORTS	John J. Yacono	63
<i>Learn how to program the serial ports on your computer so you can build RS-232 based projects</i>		

PRODUCT REVIEWS

DIY GIZMO		5
<i>Including: AudioSource AM/FM Receiver/CD Changers; Yamaha MIDI Tone Generator; Zeos Pocket PC; and more!</i>		
DIY HANDS-ON REPORT		24
<i>Graymark 5-Inch Color-TV Kit</i>		
DIY PRODUCT TEST REPORT	Len Feldman	27
<i>Onkyo Audio/Video Surround-Sound Receiver</i>		

COLUMNS

DIY ANTIQUE RADIO	Marc Ellis	66
<i>More from the mailbag</i>		
DIY COMPUTER BITS	Jeff Holtzman	68
<i>Language and the computer, II</i>		
DIY CIRCUIT CIRCUS	Charles D. Rakes	70
<i>Easy-to-build receiver circuits</i>		
DIY THINK TANK	John Yacono	73
<i>TTL logic, and hints</i>		
DIY DX LISTENING	Don Jensen	76
<i>Radio Moscow?</i>		
DIY HAM RADIO	Joseph J. Carr	78
<i>More on our ham-band VFO</i>		
DIY SCANNER SCENE	Marc Saxon	80
<i>Monitoring cordless telephones</i>		

DEPARTMENTS

DIY EDITORIAL	Carl Laron	2
DIY LETTERS		3
DIY FACTCARDS		49
DIY POPULAR ELECTRONICS MARKET CENTER		50A
DIY FREE INFORMATION CARD		51
DIY ELECTRONICS LIBRARY		82
DIY NEW PRODUCTS		84
DIY ELECTRONICS MARKET PLACE		93
DIY ADVERTISER'S INDEX		96

Popular Electronics (ISSN 1042-170X) Published monthly by Gernsback Publications, Inc., 500-B Bi-County Boulevard, Farmingdale, NY 11735. Second-Class postage paid at Farmingdale, NY and at additional mailing offices. One-year, twelve issues, subscription rate U.S. and possessions \$21.95, Canada \$28.94 (includes G.S.T., Canadian Goods and Services Tax Registration No. R125186280), all other countries \$29.45. Subscription orders payable in U.S. funds only. International Postal Money Order, or check drawn on a U.S. bank. U.S. single copy price \$3.50. © 1993 by Gernsback Publications, Inc. All rights reserved. Hands-on Electronics and Gizmo trademarks are registered in U.S. and Canada by Gernsback Publications, Inc. Popular Electronics trademark is registered in U.S. and Canada by Electronics Technology Today, Inc. and is licensed to Gernsback Publications, Inc. Printed in U.S.A.

Postmaster: Please send address changes to Popular Electronics, Subscription Dept., P.O. Box 338, Mount Morris, IL 61054-9932.

A stamped self-addressed envelope must accompany all submitted manuscripts and/or artwork or photographs if their return is desired should they be rejected. We disclaim any responsibility for the loss or damage of manuscripts and/or artwork or photographs while in our possession or otherwise.

As a service to readers, Popular Electronics publishes available plans or information relating to newsworthy products, techniques, and scientific and technological developments. Because of possible variances in the quality and condition of materials and workmanship used by readers, Popular Electronics disclaims any responsibility for the safe and proper functioning of reader-built projects based upon or from plans or information published in this magazine.

Larry Steckler

*EHF, CET
Editor-In-Chief and Publisher*

EDITORIAL DEPARTMENT

Carl Laron

Editor

Robert A. Young

Associate Editor

John J. Yacono

Associate Editor

Byron G. Wels, K2AVB

Associate Editor

Teri Scaduto

Assistant Editor

Kathy Terenzi

Editorial Assistant

Marc Spiwak

Editorial Associate

Fred Blechman

Joseph J. Carr, K4IPV

Marc Ellis

Len Feldman

Jeffrey K. Holtzman

Don Jensen

Charles D. Rakes

Marc Saxon

Contributing Editors

PRODUCTION DEPARTMENT

Ruby M. Yee

Production Director

Karen S. Brown

Production Manager

Marcella Amoroso

Production Assistant

Janice Box

Editorial Production

ART DEPARTMENT

Andre Duzant

Art Director

Injae Lee

Illustrator

Russell C. Truelson

Illustrator

Jacqueline P. Cheeseboro

Circulation Director

Michele Torrillo

P-E Bookstore

BUSINESS AND EDITORIAL OFFICES

Gernsback Publications, Inc.
500-B Bi-County Blvd.
Farmingdale, NY 11735
1-516-293-3000
Fax: 1-516-293-3115
President: **Larry Steckler**

**Subscription
Customer Service/Order Entry**

1-800-827-0383
7:30 AM - 8:30 PM EST

Advertising Sales offices listed on page 96

Cover photography by Diversified Photo Services



Composition by
Mates Graphics



Since some of the equipment and circuitry described in POPULAR ELECTRONICS may relate to or be covered by U.S. patents, POPULAR ELECTRONICS disclaims any liability for the infringement of such patents by the making, using, or selling of any such equipment or circuitry, and suggests that anyone interested in such projects consult a patent attorney.

SCAN BAN

In case you missed the news in last month's Scanner Scene (**Popular Electronics**, July, 1993), an era has ended for scanner enthusiasts. As of the end of last April, the FCC will refuse to type-accept new scanners that have cellular-telephone reception capability, or that can have their cellular frequencies easily restored. Six months later, at the end of October 1993, it will become illegal to manufacture or import such scanners.

These rule changes are the FCC's response to the Telephone Disclosure and Dispute Resolution Act, which was passed at the end of 1992. They extend the provisions of the 1986 Electronic Communications Privacy Act. Despite that act, cellular scanning has until now survived in the gray areas of the law.

It is unfortunate that the cellular industry's pressure on, and influence over, our government has succeeded in disrupting a largely harmless pastime. It is also unfortunate that these interests have forgotten a basic fact of human nature: Something banned becomes more attractive. Interestingly, to the best of our knowledge, it is the first time the U.S. government has banned the manufacture or sale of any piece of receiving gear.

What now? The remaining stock of cellular-capable receivers and scanners are sure to be snapped up in short order (they may already be in short supply as you read this). Further, as with any other type of "prohibition," a black market for these types of scanners is sure to develop, and develop to the point where anyone with enough interest, and the wherewithal to do a little "research," will have little trouble in obtaining one. Finally, while the law also covers the manufacture and sale of frequency converters, you are sure to see articles on homebrew converters that hobbyists can legally build.

Carl Laron
Editor

FOR UPDATE

ION F

ight in preparing
d an Ion Detec-
Electronics, May
information for
omitted. A com-
arts, priced at
n be obtained
Unlimited, P.C.
rst, NH 03031;
1705 (orders),
/30 (technical infor-
etc.). Contact them
y for any further informa-
We apologize for any
convenience that this has
caused.—Editor.

LETTERS

when the time for repairs comes around.

Kit building is not my forte. I have built far more equipment with no more to go on than a construction article in a magazine, a schematic with brief notes on coil data, and, in a few cases, nothing but my own design. I often used homemade components because, when I began building receivers in 1936, money was one thing I didn't have. A 10-year-old had no easy time finding gainful employment in 1936, believe me!

A kind man gave me a huge stack of *Shortwave Craft* and other magazines and a huge book of schematics and service data covering most commercial sets from 1924 to 1936. When I was 14, I was repairing radios for the neighbors and repairing and selling receivers salvaged

from the town dump. In the fall of 1941, I went to work on the bench in a radio-repair shop. The owner diagnosed; I repaired.

My suggestion for E.J. is that if he does not find kits enough of a challenge, he should get some of the books on early radios and try his hand at replicating some of the classic receivers of yesteryear. (Lindsay Publishing sells reprints of such books.) A very challenging project would be to construct a crystal set that will receive ICW signals without the use of a BFO.

I'm not being snide. It is a very educational and rewarding pursuit that pushes one's imagination and ingenuity to their limits. After 56 years, it still fascinates me.

B.R.P.
Lake Havasu City, AZ

HAVES & NEEDS

Popular Electronics has often provided the contacts that I have needed to find obscure parts and information. To return the favor, I am offering to other readers a photocopy of a relatively hard-to-find manual—the Instruction Manual (including full schematics) for the Allied (Radio Shack, Tandy Corporation) AX-190 solid-state, 11-band communications receiver (Cat. No. 20-5155). Those who would like a copy can send me four 29-cent stamps to cover postage costs. I've seen letters requesting this information in the past. I myself had contacted most of the manual-supply companies, to no avail. I got lucky at a recent ham fair.

RANDY WHEELER
5910 Blvd. Lp. SE
Olympia, WA 98501-8408

PINOUT PROBLEM

Readers who are using the Radio Shack SCR (Cat. No. 276-1067) for the construction article "Build a Water-Level Alert" (**Popular Electronics**, April 1993) should be aware that the pin-out description contained on the reverse side of some of the component packaging material is incorrect. As viewed from the side with the dot, the correct SCR pinout is Left—Cathode, Center—Gate, Right—Anode.

M.W.R.
Plano, TX

A LIFELONG HOBBY

I am moved to comment on the letter from E.J. (**Popular Electronics**, May 1993) regarding Heathkits. His criticism of their intensive documentation is unreasonable. Everyone has to start somewhere, and Heath made it possible for neophytes to possess sound, working equipment that many could not have afforded otherwise, providing a good deal of education in the process. Some were not and did not want to be technicians—they just wanted affordable equipment that they could use and enjoy.

I never built a Heathkit myself, but I have built a good many from other sources, with documentation ranging from excellent to execrable. Give me excellent any day! I do own several pieces of Heath test equipment and am glad to have documentation that I can rely on



PORTABLE 110 VOLT AC POWER PLUG FOR CAR

NEVER LEAVE HOME WITHOUT IT!!

Generate 110 volt AC power right from your car, boat, RV, or any other 12 volt DC source. Just plug the adapter into your car cigarette lighter and you can operate almost any AC powered device—even a small TV or video games! It's a GREAT camping companion too. Delivers a constant 140 watts of power.

You will also enjoy using this product to operate:

<ul style="list-style-type: none"> *Portable Personal Computers *Mobile Phones *Power Tools *Emergency Lighting 	<ul style="list-style-type: none"> *Personal Stereos *Recharge Camcorder, Laptop, Cellular batteries *Dust Buster *.....and many other uses
---	---

CLIP AND MAIL WITH CHECK OR MONEY ORDER

POWER PLUG

<input type="checkbox"/>	MODEL# DAC-100 (140 WATTS).....	\$59.95
	or TWO for \$98.90	
<input type="checkbox"/>	MODEL# DAC-201 (240 WATTS).....	\$79.95
	or TWO for \$131.90	

please add \$4.00 S/H for each unit
Texas residents add 8.25% sales tax



Send Check or Money Order TODAY!!

MAIL: MALLARD MARKETING/GECW
TO: 3913 BELL ST., SUITE C, AMARILLO, TEXAS 79109

**15-Day
Free Home Trial**

BUY 2 OF THE SAME ITEM
AND GET THE SECOND AT
35% OFF!

Electronic Paperbacks at Special Price

BP325—A CONCISE USER'S GUIDE TO WINDOWS 3.1 . . . \$7.95. Come to grips with Windows 3.1 in the shortest and most effective way. Learn how to manipulate Windows screens and DOS by Windows graphics interface. Master its word processor, Paintbrush and data base along with Notepad, Macro Recorder, PIF Editor, and Calculator.

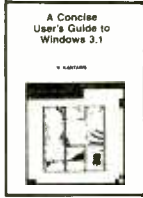

BP311—AN INTRODUCTION TO SCANNERS AND SCANNING . . . \$7.95. Radio scanners have opened a realm of exciting radio listening. Understand radio wave propagation, types of transmissions, antennas, band assignments—the straight dope on what to hear and where to hear it! Comes complete with index, glossary of important terminology.



BP287—A REFERENCE GUIDE TO PRACTICAL ELECTRONICS TERMS . . . \$8.95. More than just a dictionary of practical electronics terms, the book goes a step further in getting down to fundamentals. A reference volume that can be read casually by a reader seeking knowledge.



BP248—TEST EQUIPMENT CONSTRUCTION . . . \$5.95. Details construction of simple, inexpensive, but extremely useful test equipment. AF Gen, Test Bench Ampl, Audio Millivoltmeter, Transistor Tester and six more.



BP267—HOW TO USE OSCILLOSCOPES AND OTHER TEST EQUIPMENT . . . \$6.95. Mastering the oscilloscope is not really too difficult. This book explains all the standard controls and functions. Other equipment is also described.



BP265—MORE ADVANCED USES OF THE MULTIMETER . . . \$5.95. Use these techniques to test and analyze the performance of a variety of components. Also see how to build add-ons to extend multi-meter capabilities.



BP256—INTRO 1 LOUDSPEAKER & ENCLOSURE DESIGN . . . \$5.95. We explore the variety of enclosure and speaker designs in use today so the reader can understand the principles involved.

CMOS—CMOS POCKET GUIDE 1 . . . \$18.95. Works like the TTL Guides but covers all commonly used CMOS standard devices. Six major sections. The first shows the device schematic. Next is a brief description of the component and is followed by full operating details. The fourth section lists major applications, while the 5th and 6th sections present essential data for that device and a list of the relevant manufacturers. The final two sections are a valuable cross-reference.



BP299—PRACTICAL ELECTRONIC FILTERS . . . \$6.95. Presents a dozen filter-based practical projects with applications in and around the home or in the constructor's workshop. Complete construction details are included.



BP249—MORE ADVANCED TEST EQUIPMENT CONSTRUCTION . . . \$6.95. Eleven more test equipment construction projects. They include a digital voltmeter, capacitance meter, current tracer, etc.



BP245—DIGITAL AUDIO PROJECTS . . . \$5.95. Practical circuits to build and experiment with. Includes A/D converter, input amplifier, digital delay line, compander, echo effect and more.



BP247—MORE ADVANCED MIDI PROJECTS . . . \$5.95. Circuits included are a MIDI indicator, THRU box, merge unit, code generator, pedal, programmer, channelizer, and analyzer.



BP257—INTRO TO AMATEUR RADIO . . . \$6.95. Amateur Radio is a unique and fascinating hobby. This book gives the newcomer a comprehensive and easy to understand guide to the subject.

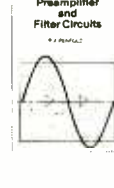

BP309—PREAMPLIFIER AND FILTER CIRCUITS . . . \$6.95. Provides circuits and background info for a range of preamplifiers, plus tone controls, filters, mixers and more. All are high-performance circuits that can be built at a reasonable cost.

BP303—UNDERSTANDING PC SOFTWARE . . . \$6.95. This book will help you understand the basics of various types of business software in common use. Types of software covered include word processors, spelling checkers, graphics programs, desktop publishing, databases, spreadsheets and utilities.



BP251—COMPUTER HOBBYISTS HANDBOOK . . . \$8.95. A wrapup of everything the computer hobbyist needs to know in one easy to use volume. Provides a range of useful reference material in a single source.



PCP115—ELECTRONIC PROJECTS FOR HOME SECURITY . . . \$10.00. 25 projects ranging from a single-door protection circuit that can be completed in an hour or two, to a sophisticated multi-channel security system. Each project is described in detail with circuit diagrams, explanations of how it works, instructions for building and testing, and how to adapt circuits to meet special requirements.



BP190—ADVANCED ELECTRONIC SECURITY PROJECTS . . . \$5.95. Includes a passive infra-red detector, a fiber-optic loop alarm, computer-based alarms and an unusual form of ultrasonic intruder detector.

BP235—POWER SELECTOR GUIDE . . . \$10.00 Complete guide to semiconductor power devices. More than 1000 power handling devices are included. They are tabulated in alpha-numeric sequence, by technical specs Includes power diodes, Thyristors, Triacs, Power Transistors and FET's.

BP234—TRANSISTOR SELECTOR GUIDE . . . \$10.00. Companion volume to BP235. Book covers more than 1400 JEDEC, JIS, and brand-specific devices. Also contains listing by case type, and electronic parameters. Includes Darlingtons transistors, high-voltage devices, high-current devices, high power devices.

BP117—PRACTICAL ELECTRONIC BUILDING BLOCKS—Book 1 . . . \$5.75. Oscillators, Timers, Noise Generators, Rectifiers, Comparators, Triggers and more.

BP195—INTRODUCTION TO SATELLITE TV . . . \$9.95. A definitive introduction to the subject written for the professional engineer, electronics enthusiast, or others who want to know more before they buy. 8 x 10 in.

BP179—ELECTRONIC CIRCUITS FOR THE COMPUTER CONTROL OF ROBOTS . . . \$7.50. Data and circuits for interfacing the computer to the robot's motors and sensors.

BP239—GETTING THE MOST FROM YOUR MULTIMETER . . . \$5.95. Covers basics of analog and digital meters. Methods of component testing includes transistors, thyristors, resistors, capacitors and other active and passive devices.

BP97—IC PROJECTS FOR BEGINNERS . . . \$5.50. Power supplies, radio and audio circuits, oscillators, timers, switches, and more. If you can use a soldering iron you can build these devices.

RADIO—100 RADIO HOOKUPS . . . \$3.00. Reprint of 1924 booklet presents radio circuits of the era including regenerative, neutrodyne, reflex & more.

BP42—SIMPLE LED CIRCUITS . . . \$5.50. A large selection of simple applications for this simple electronic component.

BP122—AUDIO AMPLIFIER CONSTRUCTION . . . \$5.75. Construction details for preamps and power amplifiers up through a 100-watt DC-coupled FET amplifier.

BP92—CRYSTAL SET CONSTRUCTION . . . \$5.50. Everything you need to know about building crystal radio receivers.

BP255—INTERNATIONAL RADIO STATIONS GUIDE . . . \$7.95. Provides the casual listener, amateur radio DXer and the professional radio monitor with an essential reference work designed to guide him or her around the more than ever complex radio bands

CHECK OFF THE BOOKS YOU WANT

ELECTRONIC TECHNOLOGY TODAY INC.
P.O. Box 240, Massapequa Park, NY 11762-0240

Name _____
Address _____
City _____ State _____ Zip _____

SHIPPING CHARGES IN USA AND CANADA

\$0.01 to \$5.00	\$1.50
\$5.01 to \$10.00	\$2.50
\$10.01 to 20.00	\$3.50
\$20.01 to 30.00	\$4.50
\$30.01 to 40.00	\$5.50
\$40.01 to 50.00	\$6.50
\$50.01 and above	\$8.00

SORRY No orders accepted outside of USA & Canada

Total price of merchandise	\$ _____
Shipping (see chart at left)	\$ _____
Subtotal	\$ _____
Sales Tax (NY State only)	\$ _____
Total Enclosed	\$ _____

Number of books ordered

All payments must be in U.S. funds

PE893

GIZMO

AUGUST 1993

VOLUME 6,
NUMBER 8

A CHRONICLE OF CONSUMER ELECTRONICS

One for All

CD CEIVER/ONE AM/FM RECEIVER WITH 6-DISC CD CHANGER. Manufactured by AudioSource, Inc., 1327 North Carolan Avenue, Burlingame, CA 94010. Price: \$599.

We've heard rumors that, in some parts of the country, it's still possible to walk into a record store and purchase an LP, and that, ten years after the introduction of the compact disc, there are some folks who continue to resist the transition to digital sound. But in our neck of the woods—and up and down both coasts and in every major city—the CD player has pushed the turntable out of the picture, and virtually all “record” stores now carry only discs and tapes.

For those who, in their pursuit of digital sound quality and convenience, have forsaken the audio cassette tape as well as the LP, AudioSource has come up with the CD Ceiver/One. Shipped with a pair of magnetically shielded loudspeakers, the CD Ceiver/One is a complete, high-quality stereo system—including a 30-watt-per-channel amplifier, a digitally-tuned AM/FM receiver, a 6-disc CD changer, and a pre-amp—in one standard-sized component.

Although it can stand on its own as a good quality audio “system” (for example, the specifications include a frequency response of 20 Hz–20 kHz, ± 0.5 dB), the CD Ceiver is targeted primarily at folks who are looking for an audio extension for their video systems, or who want a simple secondary audio system. After all, what could be simpler than finding the space in your entertainment center for one 17(W) \times 4 $\frac{3}{4}$ (H) \times 14(D)-inch component that is almost ready to go as soon as you take it out of the box? Setup requires only that you connect the speakers, attach the antennas, and plug in the power cord.

You can add on a video source such as a laserdisc player or a VCR. In addition, you can hook up a cassette deck and add a surround sound-processor to enhance your A/V system. The CD Ceiver also supports



CIFCLE 50 ON FREE INFORMATION CARD

a second pair of speakers.

We first tried using the CD Ceiver in its most basic configuration, as a CD player and AM/FM tuner. Generally speaking, the controls for those two “components” are separate and discrete, with the CD section at the left side of the unit, and the tuner section on the right (although there is some overlapping). Even the LCD readout has two separate sections, displaying tuner data on the right and CD information on the left.

As you might expect on a unit that incorporates two different components, the front panel is chock full of control buttons and knobs. A large rotary volume control is located at the upper-right side of the front panel. A red LED mounted in the knob's pointer lets you see the volume setting from across the room, and flashes

when in the mute mode. Below the volume control are knobs used to adjust the bass, midrange, treble, and balance. Tuner controls are located directly below the display, and source selection buttons—CD, TUNER, TAPE and VIDEO—are found below those. Ranging along the front edge of the top of the unit, directly above the CD magazine well, are a row of CD control buttons. (In tuner mode, those buttons double as numerical keys used to directly select preset stations.) At the far left side of the front panel are the power on/off and magazine-eject controls, as well as speaker A/B buttons and a headphone jack.

Using the buttons at the top of the CD Ceiver, it's possible to select normal- or random-play modes, repeat a track or a disc, skip forward or backward a track or a disc at time, and change the readout to

TURN PAGE FOR CONTENTS

This month in GIZMO®

AudioSource CD Ceiver One AM/FM Receiver with 6-Disc CD Changer	pg. 5
Yamaha TG100 MIDI Tone Generator	pg. 6
SSI Cinema 3200 Surround Sound Package	pg. 7
Zeos Pocket PC	pg. 8
DesignWare myHouse 3D Home Project Software	pg. 14
Design Acoustics PS-SW Passive Subwoofer	pg. 20
Electronics Wish List	pg. 22

Gizmo is published by Gernsback Publications, Inc., 500-B Bi-County Blvd., Farmingdale, NY 11735. Senior Writers: Chris F. O'Brian and Teri Scaduto. ©Copyright 1993 by Gernsback Publications, Inc. Gizmo is a registered trademark. All rights reserved.

display the elapsed time of the current track or the time remaining on the track or the disc. The **PLAY MODE** button selects normal, program, or magazine-program mode. In the program mode, up to 32 "steps" can be programmed for the currently loaded magazine. A step can be a single track or an entire disc. The program is retained until you eject the magazine. Magazine program, on the other hand, retains the programs for as many as ten different magazines (you can literally use ten separate magazines, or simply change the discs in one). Disc One (the bottom one in the magazine) must be different in each, because the CD Ceiver "reads" that disc to identify the magazine and recall the proper program. Again, a maximum of 32 steps per magazine can be programmed.

The only difficult thing about programming is deciding—and jotting down—which 32 steps to include. After that, you select either program or magazine-program mode and then use the **SKIP** buttons to advance to the desired discs or tracks. The disc/track number appears in the display, with "P-01" flashing next to it. A

press of the **STORE** key (called the **PROGRAM** key in the manual), sets that step into memory. The process is repeated until all the desired tracks are programmed. The **REMAIN** button is used to review your selections: each time you press it, the display will advance to the next programmed step. If you make a mistake, or change your mind, a press of the **STOP/CLEAR** button deletes that step. Pressing **STOP/CLEAR** twice erases the entire program. Playback functions within each program mode include standard play, random play, repeat current track, and repeat program; the **SKIP DISC** button is inactive in program mode.

Programming in radio stations is just as easy. After tuning the CD Ceiver to the station, a press of the **MEMORY** button causes the word memory to appear in the display, and the frequency is replaced by "P1," indicating that the unit is ready to store that station into the first bank of presets. (There are two banks of eight stations each.) The top row of buttons, used for controlling the CD player, double as numeric keys when using the tuner section. A single press of one of the keys labeled 1/9 through 8/16 assigns the first number (1–8) to your station. Pressing the button twice assigns the second number (9–16), placing the station into the second preset block.

To recall a preset station, you can press the appropriate numeric key on the front panel or on the remote control. The **P-SCAN** buttons, also present on both the main unit and the remote, scans through each of the presets, playing five seconds of each. A second touch of the **P-SCAN** key stops the scanning process. It's also possible to scan through all available stations using the **AUTO TUNE** button, or manually tune up or down, using the appropriate arrow keys. Those two functions can be accessed only from the main unit, not from the remote control.

For the most part, however, the remote duplicates the front-panel controls. The remote can be used to directly select a specific track, disc, or preset station using the numeric keys; to select the source, play mode, and radio band; to skip forward or backward by tracks; to move quickly forward or backward through a track; and to program the CD player. We were surprised that the manual made no mention of the remote control, beyond saying that one was included. Actually, because the remote keys duplicate well-documented front-panel buttons, no explanation was required.

Besides not being able to use the remote to tune through the bands—yes, we sometimes like to take a break from our usual radio fare to hear what's available elsewhere—we had a few complaints about the CD Ceiver. Getting picky, we

(Continued on page 21)

Multi-MIDI-a

TG100 MIDI TONE GENERATOR. From Yamaha Corporation of America, P.O. Box 6600, Buena Park, CA 90622-6600. Price: \$449.

Like it or not, sound is becoming an increasingly important part of computing, and not just for games. As the quality of sound available in PC applications has gotten better, we've come to realize how many applications can be improved with high-quality sound—the kind of sound that the *Yamaha TG100 General MIDI Tone Generator* delivers.

Why sound? Adding sound to business presentations helps to drive home important points. In training programs, sound can increase the student's memory retention. In games, of course, quality sound can make an otherwise dull contest quite exciting.

Multimedia for the PC was officially born in early 1991 when a group of 12 hardware and software companies formed the Multimedia PC Marketing council and established the MPC standard. But multimedia has a longer history than that—both on the PC and on other computers such as the Macintosh, Atari ST, and Commodore Amiga.

In the world of IBM PC-compatible computers (a world in which we're firmly entrenched), having multimedia capability generally means that you have a CD-ROM drive, a sound card, and Windows 3.1.

Yamaha's TG100, however, requires none of that. It's a MIDI (Musical Instrument Digital Interface) device that connects directly—without a sound card—through the serial port on a PC or Macintosh, or through a MIDI jack on an Amiga or a PC with a MIDI port. (Many sound cards contain a MIDI port.) It has 192 instrument voices and 10 drum kits in memory, and offers 28-note polyphony; that is, 28 notes can sound at any one time, and they can be from as many as 16 different instruments.

Why would you want to add sound to your application or to your PC presentation with MIDI instead of a sound card? The advantages are numerous: better sound (at least in comparison to 8-bit cards), easier portability, multiple-computer manufacturer compatibility, greater flexibility, and General MIDI compatibility.

The first advantage—one that becomes immediately apparent—is that the TG100 just sounds better than less-expensive sound cards. While many sound cards use synthesizer chips to imitate sounds, the TG100 uses actual audio samples of sounds to produce its output. Because the



CIRCLE 51 ON FREE INFORMATION CARD

notes that are stored in the TG100 are actual sampled sounds, a guitar sounds like a guitar and a drum like a drum, instead of like a synthesized guitar and a computerized drum. To operate a sound card in this manner would require you to sample each sound you wanted.

The TG100 also has the advantage of being more portable than a sound card, which is important if you take your presentations on the road. The unit looks something like a car stereo, and is about the same size. Once your software is set up, the hardware setup is easy—just plug the connector into the serial port. Even if you don't have any slots left in your computer—or if your laptop doesn't have any slots at all—you can get the TG100 up and running.

The tone generator isn't just transportable between PC-compatible computers, of course. Macintosh computers, Amiga computers, and virtually any other computer can be used to control the TG100.

Perhaps the most important feature of the TG100 is its compliance with the General MIDI standard, which defines the way that instrument sounds are accessed. Before we can appreciate the importance of General MIDI, we have to understand some MIDI basics.

MIDI is a standard that was developed in the early 1980's by manufacturers of electronic musical instruments. The standard defines how data is transferred between instruments, and what the data represents. Data that is sent from a controller (which can be a MIDI keyboard or other instrument, or a sequencer, which can be thought of as the piano roll of a player piano) contains information on the note (a "note number" message), when the note is turned on (a "note on" message), with what force it is played (a "note-velocity" message), and when it is turned off (a "note off" message).

General MIDI, developed in 1991, is an extension of the MIDI standard. The main advantage of General MIDI is that it allows non-musicians to use MIDI without getting into the technicalities of producing

music. Without General MIDI, you might find yourself playing back "clip music" or canned MIDI music files, and having them sound nothing like what you expected. A piano file might sound like an alto saxophone, for example. Someone experienced in MIDI would know that the data could be "re-mapped" to correspond to the correct instruments. Someone who was inexperienced might just throw up his hands and come to the conclusion that MIDI is just too complicated for average people.

With the General MIDI standard, however, things aren't complicated. You can use clip music and be confident that it will sound right when it is played back. That's because with General MIDI, the addresses for instruments are standardized. In slot number 12, you'll always find a vibraphone. In slot number 43, a cello. The drum kit is in slot number 10, and the keys that control the individual drums will be consistent, too. Middle C will be a high bongo sound, for example. The C two octaves lower will play a bass drum.

We gave the TG100 a trial run in a couple of different ways. First, we used WordPerfect's Presentations 2.0, a DOS-based presentation package that allows slide shows to be created with audio accompaniment. It provides graphing, charting, clip-art, and other capabilities, and conforms to the General MIDI specification. (Interestingly, when WordPerfect Corporation took its show on the road to Comdex and PC Expo, the TG100 was the sound source of choice for demonstrating the capabilities of Presentations 2.0.) We also controlled the TG100 through Microsoft Windows' Media Player. (Windows drivers are not supplied with the TG100. They can be downloaded, free of charge, from Yamaha's BBS, however.)

The results were impressive. So impressive, in fact, that the TG100 seemed a little out of place as a PC peripheral. It would be more at home, perhaps, in a musician's equipment rack. But perhaps not—the TG100 is so easy to use that it fits right in anywhere! ■

A Pro Logic-al Choice

CINEMA 3200 DOLBY PRO LOGIC HOME THEATER FOR STEREO SYSTEMS. Manufactured by SSI Products, Inc., 11836 Clark Street, Arcadia, CA 91006. Price: \$449.00.

We might think of surround sound as a recent innovation, but the concept has actually been around for more than half a century. Surround speakers were first used during opening-night showings of Disney's 1940 animated classic, *Fantasia*. Of course, the real introduction of surround sound as we know it today was the dramatic debut of Dolby Stereo in *Star Wars*. During the 1970's and 80's, Dolby Surround became as big a hit with theater owners as *Star War* sequels did with audiences.

Today, the most commonly used systems in home theaters are direct descendants of Dolby Stereo. That system, created in the 1970's by Dolby Laboratories, took four original signals and mixed them to create a two-channel stereo recording. During playback, the two channels are decoded to sound like four—center, right, left, and surround.

From the beginning of home surround-sound, every Dolby Surround system has included Dolby B noise-reduction circuitry to minimize hiss, and a delay circuit that inserts a lag time of a fraction of a second in the surround signal to separate the front-channel signals from the surround information. Yet poor imaging remained a problem until the development of Dolby Pro Logic. The Pro Logic "steering" circuitry places the sounds more precisely in relation to the action on the screen; in particular, the logic circuit steers the dialog to an additional, dedicated center-channel speaker. Pro Logic systems also detect the loudest channel at any given moment, and temporarily raise the volume in that channel while lowering the volume in the other three. Thus, the system precisely "tracks" the action on screen so that, for instance, if a horse gallops from left to right across the screen, the sound of thundering hoofs will appear to move from left to right as well.

As much as movie-goers loved the surround-sound effects, theater owners applauded Dolby Stereo's universal compatibility. A film that has surround effects in its stereo soundtrack can still be played in theaters equipped with mono sound systems (although the surround effects are, of course, lost in reproduction). And when that film is transferred to videotape or laserdisc, or shown on television, the surround-encoded soundtrack can be played



CIRCLE 52 ON FREE INFORMATION CARD

back on anything from a mono TV to a surround-equipped home-theater system.

Because of that compatibility, virtually all new movies released on videotape or laserdisc contain surround-sound data, as do an increasing number of broadcast-television shows—and even some compact discs. Why let all that data go to waste? The most dramatic improvement in your home-entertainment system can be achieved by extracting those signals with the simple addition of a surround-sound system.

Most people, however, don't think of surround sound as something simple. The idea of buying and adding all those speakers and a decoder, making all the necessary connections, and properly calibrating the system can seem daunting. In reality, today's surround-sound systems might contain some complex circuitry, but owning and using one doesn't have to be very complicated or expensive.

In fact, if you already own a perfectly good receiver and a decent set of speakers—and if you fit the profile of the typical home-theater enthusiast, you most likely do—it makes sense to supplement those existing components rather than replace them with a complete surround system. All that's needed is the addition of a decoder, a center-channel speaker, and a pair of surround (rear) speakers. That's precisely what's included in the *SSI Cinema 3200 Dolby Pro Logic Package*: the System 3200 decoder with two built-in 25-watt amplifiers to drive the surround and magnetically shielded center-channel speaker and a pair of satellite surround speakers. The package also includes a remote control, and even speaker wires that "have been matched carefully to the sys-

tem to prevent noise and provide years of trouble free service." (It's also possible to purchase the decoder/amplifier and speakers separately.)

In Cinema 3200's most basic configuration, the video source (VCR or laserdisc player) is hooked up to the System 3200's input jacks. The system's right and left outputs are fed to the auxiliary inputs on your existing receiver, which, in turn, feeds your existing speakers. (Those serve as the front-channel speakers.) The SSI surround and center channel-speakers are connected to their own clearly labeled terminals.

Cinema 3200 also provides two other ways to extract surround-sound effects. It's possible to use an external amplifier to drive the center and surround speakers—presumably if you want more power than the built-in 25-watt amplifiers can kick out, although that is sufficient for all but the largest home theaters. If you're lucky enough to have a huge viewing space, your best bet would be the third option: Combine both hook-ups for a total of four surround speakers.

Our viewing space is smaller than average, so we used the system in its basic configuration, with one exception—we added a subwoofer to get the low frequencies needed to make the whole room rumble when the Enterprise is hit by enemy fire, or the time-machine car careens through the years in *Back to the Future*. A separate amplifier or a self-powered subwoofer is required if the subwoofer output is used. The System 3200 has a built-in low-pass filter, and rolls off high frequencies above 100 Hz at a rate of 12-dB per octave.

The clearly written and highly infor-

mative manual (a bonus sometimes encountered when you buy consumer-electronics gear that's made in the United States, as this system is) includes hook-up diagrams for various configurations and speaker-placement diagrams for small, average, and large rooms. It also thoroughly explains how to properly calibrate the system. Calibration, which balances the audio inputs so that sounds are positioned correctly and imaging is optimized, is essential if the system is to provide peak performance.

As on all Pro Logic decoders, Cinema 3200 simplifies calibration by providing an audible test tone to verify that all speakers are connected, functioning properly, and set to the same level. Easy-to-follow directions walk you through the rest of the process. For example, while listening to a scene that contains mostly on-screen dialogue, the front-panel CENTER-CHANNEL control is set to "min" and the adjacent NULL knob is adjusted so that the dialogue volume can barely be heard from the front and surround speakers. When the CENTER CHANNEL control is returned to its normal position, dialogue should be heard only through the center-channel speaker. Next, while listening to an action scene with almost constant surround effects, the CENTER CHANNEL control is adjusted until the dialogue can be heard distinctly over those effects. The BALANCE control is used to fine tune the balance between the front and rear speakers.

If you purchase the decoder separately and don't add a center-channel speaker—a set-up that will work, but isn't recommended—a center-channel Phantom mode will feed center-channel information to both right and left speakers for adequate, but not optimal, results.

Cinema 3200 also provides a delay that is variable from 15 to 30 ms. When listening to stereo sources, the delay eliminates echo and assures that sound emanating from the front and rear speakers reach the listeners' ears at the same time. You can adjust the front-panel DELAY control to customize the system to rooms of various sizes. In average-sized rooms, the system will sound right regardless of the position of the delay control, but in particularly large or small rooms, it is possible to hear a difference between the various delay settings. When listening to mono sources, the Cinema 3200 can be set to Mono Enhance mode. In that mode, the delay creates synthesized surround for the rear-channel speakers and provides a slight amount of echo to add ambience and create the illusion of stereo sound.

Besides the Dolby Pro Logic and Mono Enhance modes, Cinema 3200 offers a Music Surround mode. When listening to stereo recordings, that mode is claimed to

(Continued on page 21)

Be a computer programmer!

Only NRI gives you hands-on training with the latest programming tools:

- A 486sx computer with 80 meg hard drive ■ Windows
- Visual Basic ■ Power C ■ QBasic ■ MS-DOS
- And much more!

Only NRI at-home training gives you real-world programming skills in three in-demand languages: QBasic, C, and Visual Basic, today's hot new language designed for writing popular Windows applications. Best of all, you get hands-on training with a powerful new 486sx-based computer system, complete with 80 meg hard drive, Windows, and professional programming software you keep!

NRI, the leader in at-home computer training, shows you how to take advantage of today's newest programming opportunities

Get in on the ground floor of one of today's fastest-growing career fields: computer programming. The Bureau of Labor Statistics forecasts that job opportunities for programmers will increase much faster than average over the next 10 years, with as many as 400,000 new jobs opening up by 2005.

And the fastest-growing segment of programming jobs will be PC programming, fueled by the phenomenal popularity of Windows, the efficient power of C, and the ascent of exciting new languages like QBasic and Visual Basic.

Now, with NRI at-home training, you can get the new skills you need to build a top-paying career — even a full- or part-time business of your own — in this high-growth, high-opportunity field.

NEW! The only programming course that includes a powerful 486sx-based computer, 80 meg hard drive, Windows, Visual Basic, and more — all yours to keep!

Right from the start, NRI gets you actively involved in the challenge of real-world programming. Step by step, you learn to create the kinds of full-featured, powerful programs today's employers and clients

NEW!
486sx/25 MHz
computer — the most
powerful computer
included in any
at-home training
program!



demand...including programs designed for use in a Windows environment!

Only NRI gives you first-hand programming experience with a state-of-the-art 486sx mini-tower computer system, complete with hard disk drive, a full megabyte of RAM, high-density floppy drive, mouse, monitor, and more — all yours to train with and keep!

Plus you explore the extraordinary capabilities of three in-demand programming languages. You learn to design, code, run, debug, and document programs in QBasic, C, and Visual Basic. Best of all, since Visual Basic is specifically designed for creating Windows applications, you learn to generate fully functioning Windows programs, complete with text boxes, command buttons, and other sophisticated graphical interface elements.

No previous experience necessary

Train with NRI, and immediately start getting the money-making job skills you need to be a computer programmer — no matter what your previous background.

NRI's step-by-step lessons and hands-on programming projects help you first master the design concepts used every day by successful PC programmers. Then, with the support of your experienced NRI instructor, you quickly move on to learn programming in three of today's hottest languages.

By the time you complete your course, you have a clear understanding of programming methods, languages, and techniques... and you're ready to handle any programming task with confidence.

Send today for your FREE catalog

See how NRI at-home training gives you the programming know-how, the computer, and the software you need to get started in this top-paying field. Send today for your FREE catalog!

If the coupon is missing, write to us at the NRI School of Computer Programming, McGraw-Hill Continuing Education Center, 4401 Connecticut Avenue, NW, Washington, DC 20008.

IBM PC/AT is a registered trademark of the IBM Corporation. Windows, QBasic, and Visual Basic are trademarks of Microsoft Corporation.

SEND COUPON TODAY FOR FREE NRI CATALOG!

NRI Schools

McGraw-Hill Continuing Education Center
4401 Connecticut Avenue, NW, Washington, DC 20008

Check one FREE catalog only

- COMPUTER PROGRAMMING
- PC Applications Specialist
- Programming in C++ with Windows

Other Computer Career Courses

- Microcomputer Servicing
- Desktop Publishing
- Bookkeeping and Accounting
- Computer-Aided Drafting

For career courses approved under GI Bill, check for details

Name _____ (please print) Age _____

Address _____

City/State/Zip _____ Accredited Member, National Home Study Council 5413-0893



Power in your Pocket

ZEOS POCKET PC. From ZEOS International, Ltd., 530 Fifth Avenue NW, St. Paul, MN 55112. Price: \$595.

On business or pleasure trips, we like to travel lightly, preferably with everything packed neatly into one bag that isn't too heavy to carry onto the plane. That's why, if we want video memories of a vacation, we bring along a small, lightweight 8mm camcorder and leave behind the hefty VHS unit. That's also why, if we must work away from home, we try to bring the smallest, lightest computer we can find.

Computers have shrunk so much over the years that it's now possible to fit a 486-based computer with a color VGA screen comfortably in your briefcase. While we're quite impressed with that engineering accomplishment, notebook computers are simply too big and heavy for our tastes.

When we're on the road, we tend to leave our notebook computer home with our VHS camcorder, unless bringing it is absolutely essential.

We recently found a computer that we can carry with us all the time: the *Zeos Pocket PC*. The Pocket PC is amazingly small, although it's not really pocket-sized—unless you are wearing a winter overcoat with big pockets. When closed, it measures about $9\frac{1}{2} \times 4\frac{1}{2} \times 1$ inches, and it weighs just 1.2 pounds.

If you're looking for a small take-anywhere computer, the *Zeos Pocket PC* is worth more than a casual glance. But if power is what you're after, look elsewhere—the Pocket PC is no 486-based machine! Rather, it's built around the NEC V30—equivalent to the low-power CMOS version of the 8088. The processor runs at 7.15 MHz, but can be set to run at 4.77 MHz to conserve power.

Why would anyone want to go out and buy a new machine that offers all the performance of a ten-year-old clunker of a PC? When color VGA screens are avail-

able on notebook computers, why would anyone be willing to put up with monochrome CGA graphics on a non-backlit LCD? For the same basic reason that so many people are willing to sacrifice the stability of a full-sized, full-featured camcorder for the portability of a compact unit.

Although it's sometimes easy to forget, not everyone needs the power of a 80486. Not everyone needs to run Microsoft Windows. Some people need only a convenient way to make notes when they're on the road, or perhaps to write correspondence while on the plane back from a trade show or business meeting. Or just a way to organize things—lists of business contacts, daily schedules, and the like. That's why digital "organizers" are so popular. But they lack an important "something" that the Pocket PC offers: PC compatibility.

The Pocket PC is 100% PC compatible and features a subset of MS-DOS 5.0 in ROM (permanent, read-only memory). Also in ROM is Microsoft Works 2.0, an integrated word processor, spreadsheet, database, and communications program; and a personal organizer that features a planner, a to-do list, a phone book, and a calculator.

Data that is generated by those applications, as well as additional applications you might like to run, are stored in 1 megabyte of RAM (random-access, read/write memory). If additional memory is required, it can be installed by inserting one or two memory cards. The Pocket PC supports any card that is compatible with the PCMCIA (Personal Computer Memory Card International Association) 1.0 specification—from 128 kilobytes to 8 megabytes.

A serial port and a parallel port are also provided. Special cables are required, however, to convert the miniature connectors on the rear panel of the Pocket PC to standard 9-pin and 25-pin serial and parallel D-type connectors.

Perhaps the best feature of the Pocket PC is its frugal use of power. Unlike traditional notebook PC's, you don't have to worry about running out of power before your flight is finished—battery life is about ten hours! Even better, instead of heavy nickel-cadmium, lead-acid, or nickel-metal-hydride batteries, the Pocket PC runs on a pair of standard "AA" alkaline batteries! So if you do see an in-flight low-battery warning, you can simply take the batteries out of your personal stereo, pop them in the Pocket PC, and you're ready to go!

Even if you use the Pocket PC until its batteries are in a state of exhaustion, you won't lose your data because a 3-volt lithium battery protects the memory contents. (RAM cards have their own internal



CIRCLE 53 ON FREE INFORMATION CARD

backup batteries.) The lithium battery has a life of about a year.

Because it is so small, the Pocket PC takes a little getting used to. The keyboard, although not the smallest on the market, is the smallest that we've ever felt comfortable using. But it took us a while to be comfortable enough to touch-type on it. Like most portable computers, auxiliary keys (PAGE UP, PAGE DOWN, etc.) and the numeric keypad aren't separate entities. Instead, their functions are part of multi-function keys, and extra keys must be held down to activate them.

The power switch is located just above the backspace key—where it is subject to being hit accidentally, which we did with frustrating frequency at first. Fortunately, it's only a minor bother when that happens. Turning the machine back on does not reboot it. Instead, an auto-resume feature takes you right back to where you left off.

The version of MS-DOS installed on the Pocket PC is far from complete, containing only nine commands. You're probably familiar with seven of them: FORMAT, DOSKEY, XCOPY, LABEL, PRINT, KEYB and ATTRIB. You might not be familiar with INTERSVR and INTERLNK, two programs used to move files between the Pocket PC and another computer and not a part of regular DOS.

INTERLNK.EXE is a device driver that can be loaded from the DOS command line. INTERSVR.EXE is a communications program. In theory, the programs are easy to use—the desktop computer doesn't have

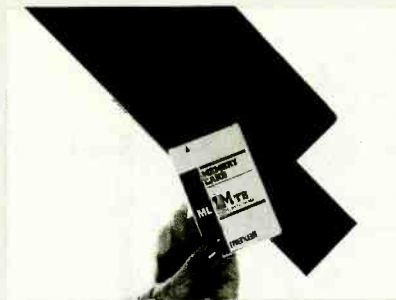

Two slots on the back of the Pocket PC accept memory cards or other PCMCIA peripherals.

to have Intersvr loaded to get started. Rather, the program loads itself from the Pocket PC into the desktop's memory over the serial or parallel connection. In practice, we weren't able to get it to work, and found ourselves using third-party communications software to move files. Interestingly, although the user's manual supplied with the Pocket PC was, in general, very good, the description of Intersvr was poor.

We had no similar complaints with the rest of the software supplied in ROM. We usually used the main menu of the system, which lets you choose between eight programs with the push of a single key. Most of our work was done in Microsoft Works. The program contains the four most commonly used computer applications: a word processor, a spreadsheet, a database, and communications. They all work reasonably well together. It's easy to insert a chart that you created with the spreadsheet

program into a document that you created with the word processor. And the chart will reflect the latest changes made to the spreadsheet when it is printed. It's also easy to print mailing labels—whose data are stored in the database program—from the word processor.

Another option at the main menu is the planner, which is a calendar and appointment scheduler. It can be set for daily, weekly, or monthly planning, and includes an alarm for appointment reminders. A to-do program, another main-menu option, is a simple tool for project management; the card file is a simple address book. Utility lets you set up the Pocket PC (power-saving features, password, ports, etc.), shell to DOS, or enter Intersvr communications. File management is an easy way to keep track of and manipulate files.

The Information main-menu selection provides access to a variety of data that could be useful to a traveler. Domestic and international telephone area codes are available, as are time zones for cities around the world. A conversion table for weights and measures is provided, as is a currency-exchange table.

The Zeos Pocket PC is the smallest PC we've ever used that we consider practical. It's not a computer that a power user would appreciate, but for many applications, it's powerful enough. It's small and light enough not to be a nuisance, even if you have to carry it around all day. And that makes it a lot more powerful than the PC that's left behind because it's too much of a bother to carry along. ■

Desktop Housing

myHOUSE 3D HOME PROJECT SOFTWARE. From DesignWare Inc., 17 Main Street, Watertown, MA 02172. Price: \$84.95.

If you own a house, you probably spend a good portion of your "leisure" time and "discretionary" income fixing it up. Even ignoring the routine chores such as yard work, there's always *something* that can be done to make your house feel more comfortable or functional. Perhaps you've considered adding a deck, replacing drafty old windows, upgrading the kitchen or bath, building shelves—or even converting the attic to living space.

It's easy to plot out room dimensions on a piece of graph paper, but three-dimensional renderings require training. Without such visual aids, it's not easy to imagine how a room will look, or how it will feel to live in that space.

We've spent more time than we care to admit sketching out schemes to enlarge our home and office space on graph paper. Should we raise the roof on the Cape Cod-style building to make a full second story, or dormer out the back? Convert the garage to office space? Bump out an addition behind the kitchen? And what can be done about that poorly planned, dark and dreary 1970's kitchen?

For years now, it's been possible to take your sketched-out kitchen plan to a home center equipped with computers capable of specifying cabinets and appliances, tallying up the prices, and printing out both two-dimensional floor plans and three-dimensional views of the room. You can see how the sink would look if it was moved out of a dark corner and placed under a window instead, and determine if there is sufficient counter space between the stove and the sink.

Now it's possible to apply that same sort of program to all types of home-improvement projects, without the pressure to buy any cabinets or fixtures—in fact, without leaving your home. *DesignWare's my-House version 1.2*, intended for at-home

use, allows the do-it-yourselfer to transfer that graph-paper sketch to the computer screen, and then convert it into a three-dimensional rendering.

The sophistication and features of my-House far surpass any similarly priced home-design programs we've tried out. The major difference, of course, is its 3D capability. Using what DesignWare calls "virtual-reality technology," the program not only allows you to create a 3D view, but also to "walk through" the rooms you've designed, to get a feel for how the elements you've specified look together, and how the traffic patterns work. True solid modeling—a feature generally found only in expensive 3D-capable programs—allows you to select opaque or transparent objects, so that you can have, for instance, a large window with a scenic view. The opacity level can be controlled, allowing you to opt for clear, tinted, or semi-transparent glass.

That sort of flexibility extends to most design elements. Walls can be drawn at various widths, and can be set at different angles, or they can even curve. Extensive "libraries" of design elements provide a

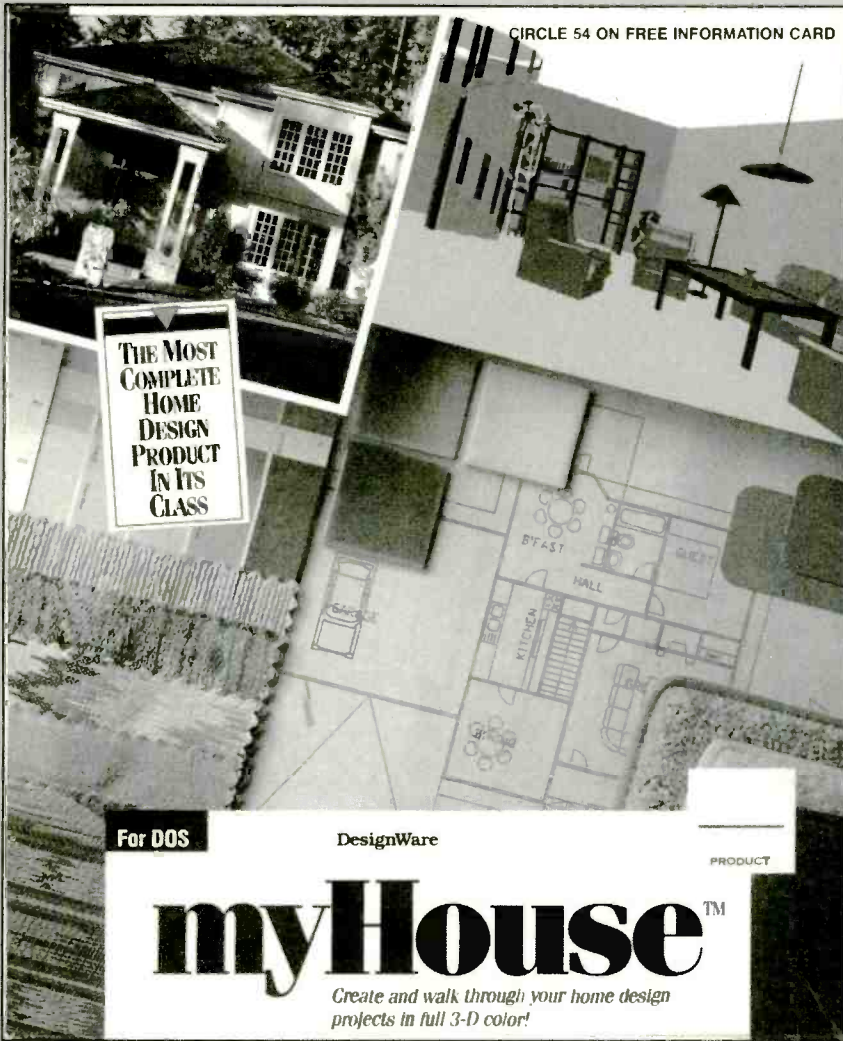

CIRCLE 54 ON FREE INFORMATION CARD

THE MOST COMPLETE HOME DESIGN PRODUCT IN ITS CLASS

For DOS

DesignWare

PRODUCT

myHouse™

Create and walk through your home design projects in full 3-D color!

myriad of choices of doors, windows, roofs, furniture, kitchen cabinets and appliances, bathroom fixtures, and landscaping materials. Once you've selected a window, door, sofa, or other element from almost 350 available, you can rotate them for placement in your plan. And you needn't settle for their default specifications. You can change the height, width, length, or depth to suit your needs.

The software also has provisions for adding different levels to a building, and for topping off the entire plan with a roof—features missing from most similar programs. Stairs can be drawn as straight flights, L-shaped, or U-shaped, or you can opt for a spiral staircase; any of those can be created at your choice of heights, widths, and angles. Dormers, skylights, and chimneys can be added to the roof.

Don't stop with the house itself—you can add trees and shrubs, and even put in a swimming pool. When you've finished designing and furnishing your dream house, you can park your car in the garage and yourself in front of the fireplace, using the program's car and people symbols.

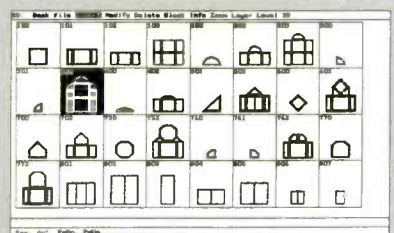

The myHouse window library provides users with a wide selection of window symbols to select for their designs.

When you're ready to take a look at your finished plan—or at any stage during the design process—you can view the exterior from any side, or look at a three dimensional rendering of each of the rooms. You can zoom in for a closer look at design details. Perspective, axonometric, isometric, and front projections can be generated. You can paint the house and furnishings in up to 256 colors (depending on your system), adjusting the color intensity and brush size. Shadows and night-time views can be created using contrast controls.

Your work can be output in PCX and

DXF formats for use in such programs as PC Paintbrush and AutoCAD, or printed out on dot-matrix, LaserJet, or DeskJet printers. Various scaling options are offered (ranging from 1/40 inch = 1 foot to 3 inches = 1 foot). Even for large plans, a plotter isn't necessary. The plan can be divided into sections to be printed separately and then pieced together. The resulting two-dimensional drawings are ready to be handed to a contractor or to have converted to professional blueprints, while three-dimensional drawings show your family and friends just what you have in mind.

We couldn't wait to take all the ideas we've been tossing around for improving the house and the office, and put them to the 3D test with myHouse. In fact, we didn't wait long. Installation, an automated process, went smoothly. Then we jumped right in after only a cursory glance at the 8-page "Quick Start" manual—and jumped right back out again!

It became immediately apparent that there's a price to pay for all that sophistication: myHouse is not an easy program to use, particularly for anyone with more experience in building bookshelves than in using computer-aided design programs. The 94-page user's manual starts off by saying that "myHouse neither assumes you have mastered computer techniques, nor that you are an experienced architect." Nevertheless, designing a house—or "just" a kitchen or bath—is a complex project. The lingo used by architects and builders—and throughout the manual—includes terms and concepts that are unfamiliar to many laymen. No explanations are provided in the text; nor is there a glossary of terms. And, surprising for a visually-based program, there are virtually no drawings in the manual that might clarify what a "roof node," a "plinth," or a "cote" is. (We turned to our well-thumbed Random House pocket dictionary to learn that a node is "a swollen area in the body" or "a part of a stem that normally bears a leaf" and a cote is "a shelter for sheep, pigs, pigeons, etc."—clearly not the proper architectural definitions! We did learn, however, that a plinth is a slab under a column.) It takes time, patience, and a good deal of reading between the lines of the manual to master the intricacies myHouse.

The basic screen configuration of this menu-driven program consists of four fields. The menu bar at the top of the screen is used to access drop-down menus under the headings File, Insert, Modify, Delete, Block, Info, Zoom, Layer, Level, and 3D. The Editor Window, in which the house being drawn or viewed appears, takes up almost the entire screen. Directly below it, the Coordinate Line displays positional data including the x and y coordi-

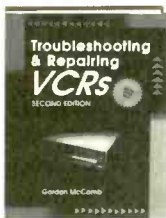

3777H-XX \$32.95
Counts as 2

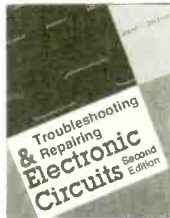

3258P \$19.95
Softcover

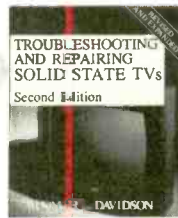

370CH-XX \$36.95
Counts as 2

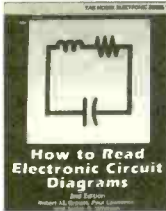

2880P \$14.95
Softcover



3485H \$27.95



3543P \$17.95
Softcover



3457H \$29.95

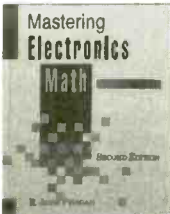

3589H \$27.95

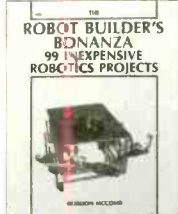

2880P \$17.95
Softcover



3975H \$29.95

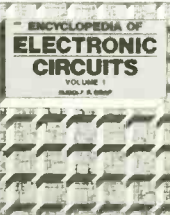

1938H-XXX \$60.00
Counts as 3



2613P \$18.95
Softcover

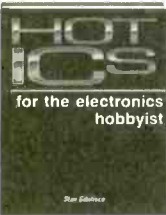

4122H-XX \$36.95
Counts as 2



3475P \$18.95
Softcover



4111H \$27.95

As a member of the Electronics Book Club . . .
 . . . you'll enjoy receiving Club bulletins every 3-4 weeks containing exciting offers on the latest books in the field at savings of up to 50% off of regular publishers' prices. If you want the Main Selection do nothing and it will be shipped automatically. If you want another book, or no book at all, simply return the reply form to us by the date specified. You'll have at least 10 days to decide. And you'll be eligible for **FREE** Books through the Bonus Book Program. Your only obligation is to purchase 3 more books during the next 12 months, after which you may cancel your membership at any time. (Publishers' prices shown)

If you select a book that counts as 2 choices, write the book number in one box and XX in the next. If you select a Counts as 3 choice, write the book number in one box and XXX in the next 2 boxes. A shipping/handling charge and sales tax will be added to all orders. All books are hardcover unless otherwise noted. ©1993 EBC

Your most complete and comprehensive source for the finest electronics books.

Select any 5 books

for only \$4⁹⁵

(values up to \$145.75)

when you join the Electronics Book Club®



3627H \$29.95

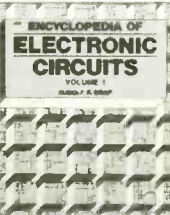

3632P \$10.95
Softcover



3795P \$19.95
Softcover

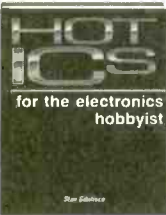

3677H-XX \$34.95
Counts as 2



1367P \$25.95
Softcover



3765H \$29.95



3739H-XX \$39.95
Counts as 2

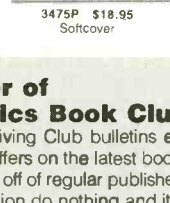

3107P \$18.95
Softcover

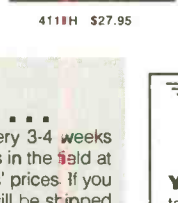

370CH-XX \$36.95
Counts as 2

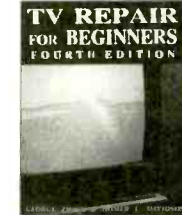

3777H-XX \$32.95
Counts as 2

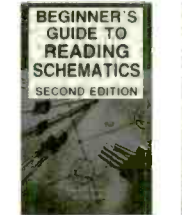

2880P \$14.95
Softcover



3543P \$17.95
Softcover

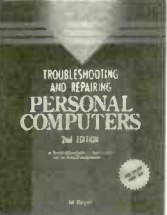

2880P \$17.95
Softcover



3739H-XX \$39.95
Counts as 2

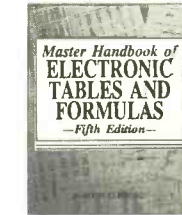

3107P \$18.95
Softcover

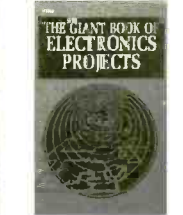

3795P \$19.95
Softcover



3765H \$29.95

If coupon is missing, write to: Electronics Book Club, Blue Ridge Summit, PA 17294-0810

Electronics Book Club®

Blue Ridge Summit, PA 17294-0810

YES! Please send me the books listed below, billing me for just \$4.95 plus shipping/handling & tax. Enroll me as a member of the **Electronics Book Club** according to the terms outlined in this ad. If not satisfied, I may return the books within 10 days without obligation and have my membership cancelled.

--	--	--	--

If you select a book that counts as 2 choices, write the book number in one box and XX in the next. If you select a Counts as 3 choice, write the book number in one box and XXX in the next 2 boxes.

Name _____

Address _____

City/State _____

Zip _____ Phone _____

Valid for new members only, subject to acceptance by EBC. Canada must remit in U.S. funds drawn on U.S. banks. Applicants outside the U.S. and Canada will receive special ordering instructions. All books are hardcover unless otherwise noted. Publishers' prices shown. A shipping/handling charge & sales tax will be added to all orders. PE893

August 1993, Popular Electronics

nates of the cursor. At the bottom of the screen, the Dialogue Line displays messages and prompts.

The cursor usually appears as a small circle with cross hairs over it. The myHouse software uses the Cartesian coordinate system to plot a drawing, and the cross hairs indicate the x and y axes. For certain functions, the cursor changes shape. It becomes a flexible box when defining a region to be copied, moved, or zoomed; a representative symbol when positioning a piece of furniture or other element; and a brush when retouching a painted picture.

The cursor can be moved using the arrow keys on your keyboard, or with a mouse. With the keypad, drawing is a ponderous task. Each press of an arrow key moves the cursor in increments representing one inch (it's also possible to use metric measurements). Holding down the shift key and pressing an arrow key increases each step to four feet. You can also directly key in the x and y coordinates. It's *much* easier to use the program with a mouse. We also tried using a pen-based computer "pad" called Inforite (which will be reviewed in an upcoming issue of *Gizmo*), with excellent results.

But we're getting ahead of ourselves. The first step is to pull down the File menu and select either New, to start a new drawing, or Load, to call up an existing design. To give the user an idea of the program's scope, myHouse includes several designs, most of which are quite complex (and inspirational—we jumped ahead of ourselves again to explore the 3D versions of those designs, before we even started our own).

As soon as we did begin our own design, we found ourselves wishing for a better manual, or a really basic on-screen demo or tutorial. The main portion of the manual explains how to use each command, in the order in which those commands appear in the pull-down menus. That order, unfortunately, bears little resemblance to the order in which you'll use them.

Most drawing is done using the Insert menu commands—Wall, Pillar, Window, Door, Slab, Stairs, Rail, Roof, Symbol, Line, Grid Line, Text, Area, Dimension—which are described in that order. However, you'll probably first want to put down a slab on which to raise your home's walls, and you can't put in stairs until you put on the second story—which isn't explained until the tenth menu!

What was needed was not a more detailed manual, but a supplemental tutorial that walked the user through a few sample designs—perhaps a simple one-story cabin could be drawn, and its kitchen and bath equipped with cabinets, fixtures, and appliances. From that point, the manual

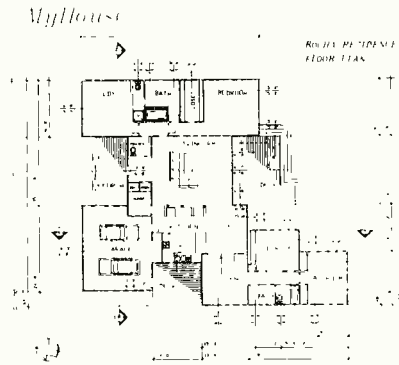

Floor plans can include such details as room dimensions, furniture and fixture placement, and labels.

could explain how to add a second story to the house, and maybe a family-room addition with a vaulted ceiling, fireplace, and skylights. Pointers on such basic design principles as how much space to allow for stairs should be included, and we consider a glossary to be essential. (Not many folks outside the architectural/interior design fields know what an axonometric view is—our pocket dictionary didn't even list the word.) Ideally, such a how-to demo manual would be heavily illustrated and cross-referenced to the details of using myHouse commands that appear in the reg-

Lacking such a tutorial, we proceeded much more slowly than we would have liked, and found ourselves using the Modify and Delete menu commands at least as often as any Insert menu commands.

Still, Insert commands are the backbone of the design process. We won't get into much detail here, but, basically, once you've set down your slab (you can determine its depth, length, and width) and raised the outside walls (generally one-foot thick, although you can change that parameter as well), you can begin partitioning off rooms with (generally 6-inch-wide) interior walls.

We particularly enjoyed using the design-element libraries to select doors and windows, furniture, appliances, cabinets, shelves—even audio/video equipment and house plants—to make the design seem like home. For a contractor's plan, you can leave out the furniture and insert dimensions instead. It's also possible label each room and to determine the area in square feet.

Anytime you make a mistake, you can change or delete the problem. It's easy to move a door or window (placing it using an edge or center mark), or to lengthen or shorten a wall.

Sometimes you don't realize you've made a mistake until you view a plan in 3D. For instance, we were a bit dismayed to learn that choosing upper cabinets in the kitchen didn't necessarily mean that they'd be placed 4½ feet off the floor

(which is fairly standard). Instead, they showed up superimposed over the bottom cupboards. Similarly, we somehow ended up with a deck floating 10 feet in the air! We figured out on our own how to rectify both problems, but couldn't find explanations in the manual.

Three-dimensional viewing is possible in both 3D and Walk-Through modes. 3D gives outside views of the structure, from any angle, while Walk-Through allows you to select various points of view inside the house. Contrary to its name, Walk-Through doesn't provide the illusion of strolling through the rooms. Instead, you can move the on-screen camera icon anywhere on the floor plan, widen or narrow the aperture, and raise or lower the point of view, to get different perspectives.

The software generates a 3D view fairly quickly, but that view shows every line of the structure. To see how it actually would look without x-ray vision, you must use the hide function, which deletes any lines that would be hidden from view. Depending on your computer, that can be quite time-consuming.

We used a 40-MHz 386 with no math coprocessor to design a cozy mountain-side cabin. It looked rather drab when we first viewed it in 3D, so we went back and added porches, a deck, and railings, and then created a heavily wooded landscape. Generating a 3D image of the landscaped plan took only twice as long as the original. We knew that hiding all the lines in the forest behind the cabin, however, would take quite some time, so we set it up and then went out to eat. After dinner (a couple of hours later), the process was only 2% done! It finally was finished about an hour after *breakfast* the following day.

Although we knew that a more powerful machine could do the job much faster, we didn't have the time or patience to use the cabin design in a race between the 386 and a 486 with a math coprocessor. But we did try it with other designs. As an example, the 386 took 2 minutes, 36 seconds to hide the lines in one basic design, while a 486 took just 26 seconds to complete the hidden-line drawing.

It was fun to create a cabin in the woods, but we really wanted to use the program to determine how various renovations on an actual house would look. Unfortunately, that house is a 1½-story Cape Cod, and in the time we had to use the program, we couldn't figure out how to draw a half-story, or how to change the roof angles to bump out a full-back dormer. We do know that myHouse can do both, and we fully intend to teach ourselves how once this issue is put to bed.

That about sums up our myHouse experience—it can handle difficult tasks, but first *you* must surmount the difficult task of learning how to put it to work. ■

Just like these Fully Trained Electronics Professionals



"Thanks to CIE I have tripled my previous salary, and I am now in a challenging and rewarding new field where only the sky is the limit."

Daniel Wade Reynolds
Industrial Electrician
Ore-Ida Foods



"CIE was recommended to me by my boss. It was appealing since I could study at my own pace at home and during business travel."

Dan Parks
Marketing Manager/Consumer Products
Analog Devices, Inc.



"I loved the flexibility CIE offered. It was the only way I could continue both school and my demanding job."

Britt A. Hanks
Director of Engineering
Petroleum Helicopters, Inc.



"I liked the way the school was set up with laboratory assignments to enforce conceptual learning. The thing which impressed me the most about CIE's curriculum is the way they show application for all the theory that is presented."

Daniel N. Parkman
Missile Electro-Mechanical Technician
U.S. Air Force



"Completing the course gave me the ability to efficiently troubleshoot modern microprocessor based audio and video systems and enjoy a sense of job security."

Tony Reynolds
Service Manager/Technician
Threshold Audio & Video

Graduate with an Associate Degree from CIE!

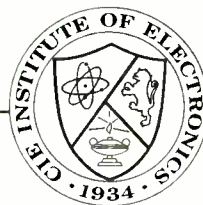

CIE is the best educational value you can receive if you want to learn about electronics, and earn a good income with that knowledge. CIE's reputation as the world leader in home study electronics is based solely on the success of our graduates. And we've earned our reputation with an unconditional commitment to provide our students with the very best electronics training.

Just ask any of the 150,000-plus graduates of the Cleveland Institute of Electronics who are working in high-paying positions with aerospace, computer, medical, automotive and communications firms throughout the world. They'll tell you success didn't come easy...but it did come...thanks to their CIE training. And today, a career in electronics offers more rewards than ever before.

CIE'S COMMITTED TO BEING THE BEST...IN ONE AREA...ELECTRONICS.

CIE isn't another be-everything-to-everyone school. CIE teaches only one subject and we believe we're the best at what we do. Also, CIE is accredited by the National Home Study Council. And with more than 1,000 graduates each year, we're the largest home study school specializing exclusively in electronics. CIE has been training career-minded students for nearly sixty years and we're the best at our subject...
ELECTRONICS... IT'S THE ONLY SUBJECT WE TEACH!

CIE PROVIDES A LEARNING METHOD SO GOOD IT'S PATENTED. CIE's AUTO-PROGRAMMED® lessons are a proven learning method for building valuable electronics

career skills. Each lesson is designed to take you step-by-step and principle-by-principle. And while all of CIE's lessons are designed for independent study, CIE's instructors are personally available to assist you with just a toll free call. The result is practical training... the kind of experience you can put to work in today's marketplace.

LEARN BY DOING...WITH STATE-OF-THE-ART EQUIPMENT AND TRAINING.

CIE pioneered the first Electronics Laboratory



Course and the first Microprocessor Course. Today, no other home study school can match CIE's state-of-the-art equipment and training. And all your laboratory equipment, books and lessons are included in your tuition. It's all yours to use while you study and for on-the-job after you graduate.

PERSONALIZED TRAINING...TO MATCH YOUR BACKGROUND.

While some of our students have a working knowledge of electronics others are just starting out. That's why CIE has developed twelve career courses and an A.A.S. Degree program to choose from. So, even if you're not sure which electronics career is best for you, CIE can get you started with core lessons applicable to all areas in

electronics. And every CIE Course earns credit towards the completion of your Associate in Applied Science Degree. So you can work toward your degree in stages or as fast as you wish. In fact, CIE is the only school that actually rewards you for fast study, which can save you money.



YES! I want to get started. Send me my CIE course catalog including details about the Associate Degree Program. (For your convenience, CIE will have a representative contact you - there is no obligation.)

Please Print Clearly **AH43**

Name _____

Address _____

City _____

State _____ Zip _____ Age _____

Phone No. _____

Check box for G.I. Bill Benefits.

Veteran

Active Duty

Cleveland Institute of Electronics, Inc.
1776 East 17th Street
Cleveland, OH 44114

A School of Thousands.
A Class of One. Since 1934.

Send for CIE's FREE Course Catalog and See How We Can Help Your Career Too!

Heard but Not Seen

PS-SW PASSIVE SUBWOOFER. From Design Acoustics, 1225 Commerce Drive, Stow, OH 44244. Price: \$339.95.

Even people who don't listen to music seriously can appreciate good audio reproduction when it enhances their movie-theater or home-theater experiences. Despite that, many home-theater owners are short-changing themselves on their systems' sound. Perhaps that's because they aren't aware of an easy way to boost the performance of their home theaters: a passive subwoofer like the *Design Acoustics PS-SW*. A subwoofer can bring out the low rumble of the Enterprise in *Star Trek: The Next Generation*, which gives the show its unique sound. It can make the room shake as a thundering herd of buffalo stampedes in *Dances with Wolves*. And, of course, it can add life to music, too—everything from MTV to "Great Performances."

The PS-SW is a passive—as opposed to active—subwoofer. The 10-inch driver has dual voice coils, which helps to make the hookup simple: the output of the amplifier is fed to the subwoofer, which, in turn, feeds the left and right speakers. The PS-SW incorporates low-pass and high-pass filters, so that the audio is divided into two separate bands above and below 130 Hz. The frequencies below 130 Hz are sent to the subwoofer, while the midrange and high frequencies above 130 Hz are fed to the left- and right-channel speakers.

Because of the crossovers, the PS-SW is not truly in parallel with the front speakers. Therefore, the hookup is safe even for low-powered receivers or amplifiers that might otherwise be overdriven when feeding a low impedance. According to Design Acoustics, if the amplifier or audio/video receiver can drive a three-way speaker, it can safely drive the PS-SW. The PS-SW can actually increase the power-handling capacity of your current speaker system because only those frequencies above 130 Hz are fed to them. The low frequencies, which require the greatest power to reproduce, are handled by the subwoofer. However, Design Acoustics recommends that amplifiers from 15-200 watts be used, or an amplifier appropriate for the main speakers, whichever is lower.

The hookup arrangement for the PS-SW is the same as that for three-piece subwoofer/satellite speaker systems. And, in fact, the PS-SW would make a good choice for such an audio-system setup. If you like your sound system to be heard but not seen, you can hide the subwoofer in an inconspicuous spot and use in-wall speakers as the satellites. Because humans

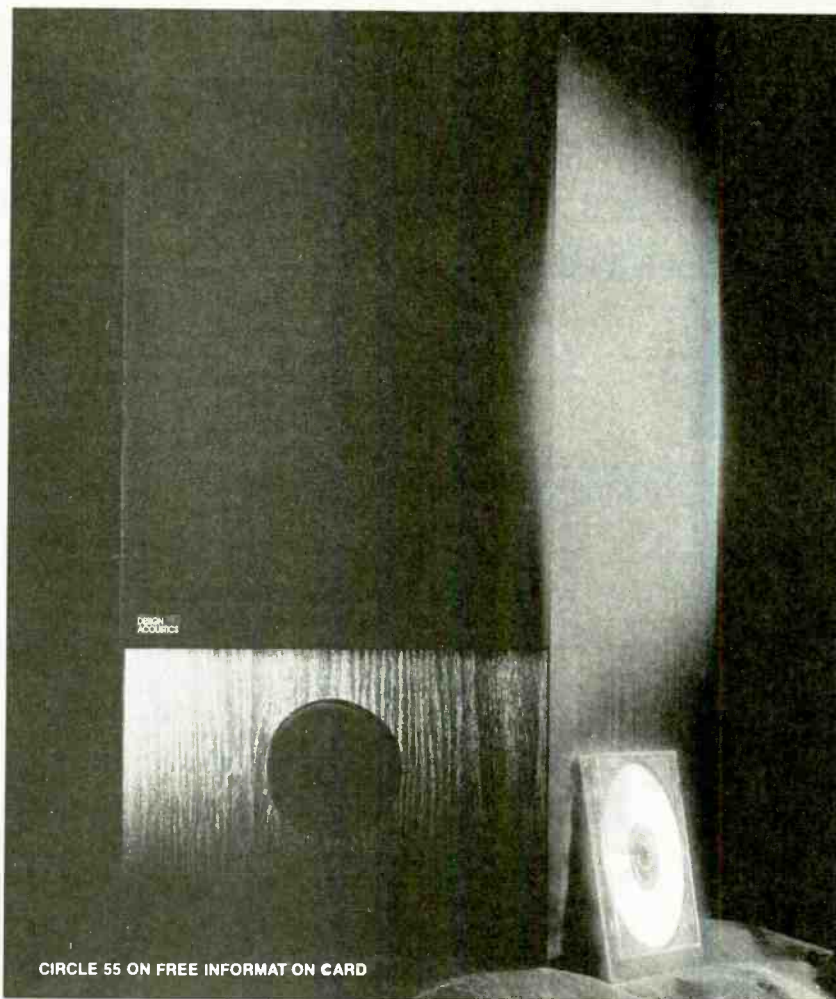

The hookup panel for the PS-SW gives a good indication of how easy it is to incorporate the subwoofer into an existing home-theater system.

aren't sensitive to the directionality of the low frequencies produced by subwoofers, a subwoofer can be located almost any-

where in a room without affecting the stereo imaging. (The bass in most recordings is monaural anyway—one reason why driving the woofer with dual voice coils is a sensible approach.)

But that's not to say that its position is unimportant. Although often unappreciated, the position of a subwoofer can affect its performance dramatically. To be more accurate, we should say that the subwoofer performance stays the same. What you *hear* is different. That's because the wavelength of low-frequency sound can be comparable to the dimensions of your listening or viewing room. Thus, standing waves can be set up and peaks and nulls will be distributed around the room. The worst case will be the fundamental (lowest) frequency on a given axis of a room. Nulls will exist at the wall surfaces, and at a point midway between them. If you sit there, you'll hear something far different from what you'll hear if you sit near a peak. Determining the effect isn't easy—standing waves are set up on each of the room's axes, but it's an important point to remember.

The PS-SW is a bass-reflex design, in which pressure waves off the back of the woofer cone vibrate an air mass in a tuned

port. The vented enclosure is designed so that the air in the port is in phase with the cone motion. That adds to the speaker's output, and extends the low-frequency response that would otherwise be available from a speaker box of a given size. Although one potential drawback of a bass-reflex speaker is that a poor design can lead to "boominess," the PS-SW did not suffer from that problem.

Apartment dwellers should appreciate the PS-SW (though perhaps their neighbors would feel differently!). Not only is the unit compact (16¼ × 22 × 11 inches) but it is also magnetically shielded. That feature, not normally found in subwoofers, permits the PS-SW to be placed close to a video monitor if necessary.

The subwoofer's driver is a 10-inch long-throw woofer; its cone material is impregnated with carbon fiber, which is said to improve the woofer's movement without reducing the subwoofer's efficiency. The twin voice coils are mounted concentrically on an aluminum form to maximize heat dissipation. The sensitivity of the woofer is rated at a high 90 dB (1 watt/1 meter). Its nominal impedance is 8 ohms.

The PS-SW is a sensible way to upgrade an existing surround-sound system. The full, rich bass that it delivers can truly add excitement and viewing enjoyment. It can open up a whole new dimension to your home theater in much the same way that surround sound did. ■

CD CEIVER

(Continued from page 6)

didn't like the standby LED that lights when the unit is off, and is dark when power is on. Because the unit blanks completely when powered up—and stays dark for about a second before the display lights—until we got used to it, we kept hitting the power switch to turn the unit off when it was off already. More inconvenient was the fact that you can't listen to the radio while programming the CD player—in fact, you can't even eject the magazine without switching to CD mode, silencing the tuner. For an "integrated" component, that's unacceptable.

Despite those inconveniences, the CD Ceiver quickly became a frequently used component in our entertainment center. When not listening to the radio or CD's, we used the CD Ceiver to drive the front-channel speakers for an audio/video set-up that included the SSI surround-sound package and Design Acoustics subwoofer, both reviewed elsewhere in this month's *Gizmo*. In conventional stereo listening, as well as home-theater applications, the sound quality was much better than we expected from such a compact unit. We only wish that AudioSource's integration of a CD player and an AM/FM receiver was handled as cleverly as the name CD Ceiver implies. ■

CINEMA 3200

(Continued from page 8)

reproduce the depth that is lost in conventional, two-channel stereo playback. Despite our usual dislike of such processing, we found ourselves growing fond of Music Surround.

Cinema 3200 was easy to use—there were no unwelcome surprises in its operation. One feature we felt was missing from the decoder/amplifier, however, is visual feedback. Adjusting the volume during quiet scenes is pretty much a hit-or-miss operation—you can't even be sure that the unit is receiving signals from the infrared remote.

Once the system was calibrated, the results were as impressive as we've come to expect from the addition of Dolby Pro Logic to a home-theater environment. Whether watching a quiet scene with subtle background sounds—a phone ringing or door slamming—or an action-packed movie filled with rear-channel information, surround sound brings the movie to life.

SSI set out to design a surround-sound add-on for existing stereo equipment, and Cinema 3200 is the well-thought-out result. It is a well-matched, easy-to-use addition that turns ordinary, every-day viewing into an exciting, multi-sensory experience. ■

For more information on any product in this section, circle the appropriate number on the Free Information Card.

ELECTRONICS WISH LIST

Whole-House Security

The do-it-yourself, eight-zone *Plug 'n Power Wireless Security Console* can be installed in minutes and provides 24-hour protection for a home or office. Available as *Cat. No. 61-2609* from *Radio Shack* (700 One Tandy Way, Fort Worth, TX 76102), the device plugs into any AC outlet and telephone wall jack. Up to eight window and door sensors (sold separately) can be monitored. When a sensor is tripped, an 85-dB siren will sound, and any lights that have been connected to optional lamp modules will flash. The console features an automatic dialer that can dial as many as four numbers. A user-recorded message notifies friends, family, or neighbors when the system is activated by either a sensor or by the panic alarm buttons located on the console and on the included remote control. The person called can listen for disturbances over the console's built-in microphone. The Security Console is compatible with all Plug 'n Power components, and can be expanded to accommodate up to 16 groups of door/window sensors, lamp modules, motion detectors, and other optional accessories. Price: \$99.95.

CIRCLE 56 ON FREE INFORMATION CARD

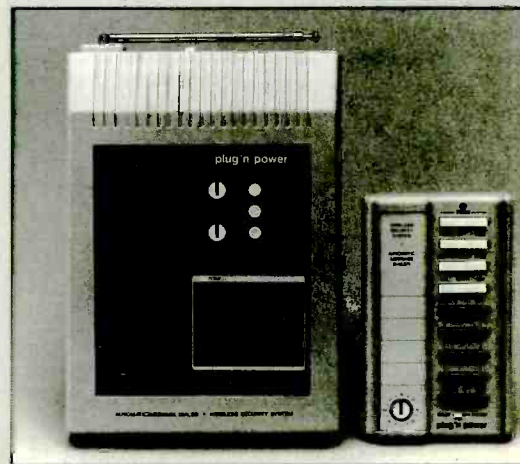

Wireless Security System

ELECTRONICS WISH LIST

For more information on any product in this section, circle the appropriate number on the Free Information Card.



Memtek Clock Radio

Sweet Dreams

Slip off to sleep to the sounds of your favorite songs on the *CR 3800 Clock Radio* from *Memtek Products* (P.O. Box 901021, Fort Worth, TX 76101). The unit features an AM/FM radio, a CD player, and three-inch speakers. You can wake up to the sound of a CD, the radio, or a standard alarm. If you'd rather not wake up right away, the clock radio also has snooze and sleep buttons. Price: \$169.99.

CIRCLE 57 ON FREE INFORMATION CARD



Sharp Travel Organizer

Tuneful Calorie-Counter

If you prefer to jog or walk to the sound of music—and you want to know precisely what fat-burning benefits you might be reaping from your daily workout, check out *Sanyo's* (21350 Lassen Street, Chatsworth, CA 91311-2329) *SPT-1500 Sportable* personal AM/FM cassette player with built-in pedometer and calorie counter. The calorie counter displays the calories you're burning away on the unit's LCD readout, while the pedometer records the impact of your feet to calculate the distance traveled. You can set a beep to sound as you reach various distances, and a stop-watch function lets you temporarily freeze the readout for lap time. The Sportable's audio section offers BASSXpander-enhanced sound and an extended AM band for access to the recently approved spectrum between 1600 and 1710 kHz. Price: \$69.99.

CIRCLE 58 ON FREE INFORMATION CARD

Travel Organizer

Aimed at traveling executives, sales people, tourists, and frequent flyers, the *EL-6330 Travel Organizer* from *Sharp Electronics Corporation* (Sharp Plaza, Mahwah, NJ 07430-2135) fits in a shirt pocket and weighs just four ounces. The world-clock key tells the time in any of 24 zones, while a home clock with an alarm keeps users abreast of activities back home. The currency-conversion function and a 10-digit calculator allow travelers to easily conduct foreign-money transactions. The organizer has a three-line display. Its telephone directory stores about 600 entries consisting of up to 12 characters for names and 24 digits for numbers. A 10-digit "Remark" section allows notes to be attached to each telephone entry. A schedule function allows traveling business people to track appointments, while an alarm alerts them to time-sensitive events. The unit's memo function provides a convenient place to keep notes, and a password function keeps private information confidential. Price: \$59.99.

CIRCLE 59 ON FREE INFORMATION CARD



Eveready Battery Chargers

Five-Hour Battery Charger

Are you getting tired of replacing the batteries in all those toys and gadgets—such as portable compact-disc players, radios, tape players, TV's, and stereos—that your family got for Christmas? If so, *Eveready Battery Company's* (Checkerboard Square, St. Louis, MO 63164) *5-Hour Charger* should be of interest. The device lets you charge as many as eight AA, AAA, C, or D rechargeable batteries—it even charges batteries of different sizes at the same time—so that they are ready to use in just five hours. Four 9-volt batteries can be charged in 10 hours. Price: \$18.

CIRCLE 60 ON FREE INFORMATION CARD

For more information on any product in this section, circle the appropriate number on the Free Information Card.

ELECTRONICS WISH LIST

Free-Ranging Phone

The *Extended Range Cordless Telephone 9530* has four times the range of today's conventional cordless phones, according to AT&T (Consumer Products Division, 5 Wood Hollow Road, 3L11, Parsippany, NJ 07054; Tel: 800-222-3111). The all-digital phone operates in the 900-MHz frequency range at up to one watt of power using spread-spectrum, frequency-hopping technology over 172 channels, providing interference-free conversations at up to one mile from the base. The 900-MHz band is free from common interference sources that plague 46/49-MHz cordless phones, including baby monitors, garage-door openers, and radio intercoms. Conversations are digitally encoded onto a radio signal that passes between the base and handset on randomly selected channels, making eavesdropping virtually impossible for all but the most determined spies. Price: \$449.99.

CIRCLE 61 ON FREE INFORMATION CARD

Home-Shaking Theater

You'll be able to feel the action as well as hear it, with the *Home THX Audio Speaker System* from Miller & Kreisel Sound Corporation (M&K, 10391 Jefferson Blvd., Culver City, CA 90232). The six-speaker set has been certified for use in the Lucasfilm THX home-theater system, and has been designed to deliver audiophile-quality music reproduction as well as realistic movie soundtracks. The speaker system has three principle components: the *S-5000THX* front-channel satellite speakers, the *SS-500THX* surround speakers, and the *MX-500THX* push-pull dual-driver powered subwoofer. The six-speaker setup includes three front-channel satellites, two surround speakers, and one subwoofer. Each are offered in a finished light oak or painted black oak genuine hardwood veneer. Apartment-dwellers need not apply! Price: \$6495.

CIRCLE 62 ON FREE INFORMATION CARD

Quick Retrieval CD Storage

Opening a CD jewel box presents a problem to some people, according to *Dynasound Organizer, Inc.* (Suite 124, Rush Lake Business Park, 1801 Old Highway, New Brighton, MN 55112). The *CD Magic Quick Retrieval System (Model 45624)* is a unique CD-storage rack that automatically opens each jewel box upon selection. The spring-loaded unit provides easy, one-handed access to compact discs and their program booklets, and consumers only have to handle the jewel box once, when they load the CD Magic organizer. The organizer holds up to 24 discs in their cases. Price: \$39.95.

CIRCLE 63 ON FREE INFORMATION CARD

Big Sound, Small Package

Although it's designed to serve as a secondary audio system, the *CD-C6300* mini-system from *Sharp Electronics Corporation* (Sharp Plaza, Mahwah, NJ 07430-2135) provides the power and performance you'd expect from a full-size system. It features a 50-watt-per-channel amplifier, a three-way speaker system, a six-disc magazine-style CD changer, a double-cassette deck with Dolby B noise reduction, a ten-band graphic equalizer, a digital-synthesized tuner with 30 station presets, and an audio/video remote control. The unit's X-Bass System and the speakers' Active Servo Technology are said to enhance the bass sound by "allowing the amplifier to instantaneously respond to the motion of the speaker by allowing air to flow through open ports." Well, maybe. We're more inclined to think it has something to do with the loudspeaker diaphragm—made up of fibers from the Chishima bamboo plant, harvested in Northern Japan. The CD-C6300 is just 8 $\frac{1}{8}$ inches wide. Price: \$799.95.

CIRCLE 64 ON FREE INFORMATION CARD



AT&T Cordless Telephone



THX Speaker System



Sharp Audio System



GRAYMARK 5-INCH COLOR-TV KIT



CIRCLE 119 ON FREE INFORMATION CARD

Kit building is back, with the Graymark 5-inch color-TV kit.

It often seems kit building is on its way out, and the only kit builders left today are true die-hards who would rather build anything than buy it in a store. That is unfortunate, since there are a lot of advantages to building. For instance, the act of building a kit can be quite enjoyable in itself and there's a certain amount of pride associated with something that an owner can claim he built. In addition, the knowledge gained from building a kit can come in handy should the unit ever need servicing. As a matter of fact, some of us here at **Popular Electronics** truly like building kits.

So, we die-hard kit builders still exist, although the declining number of vendors and other hardships sometimes make it feel like we've been left high and dry—that is, until now. Introducing the Graymark Model 544 5-inch color TV, available *only* as a kit.

Features. Even though this TV is built from a kit, don't think for a minute that it's at all short on features. To begin with, it is a *color* set. Its 5-inch tube provides a very watchable picture—not like those pocket TV's that you really can't watch anything on. As expected on a color TV, there are controls for brightness, contrast, color, and tint. An automatic color control is located on the top of the unit. The TV

includes RCA jacks for audio and video inputs. An earphone jack is included for private listening, and a picture-tube degaussing switch is provided on the back of the set.

The set is capable of receiving VHF (channels 2–13) and UHF (channels 14–83)—depending on the signal strength in your area—via a female F connector on the back of the set. The connector can be attached to a roof antenna, cable-television source, or a built-in telescopic antenna. To use the built-in antenna, you must plug a male F connector (which hangs off the back of the set) into the female F connector.

The TV can be powered from several different sources. Included with the set is an AC adapter for use when you're near any AC outlet. The AC adapter doubles as charger if you install five Gates Energy HC-2D-G Power Stick Plus' (not included with the set), which are the equivalent of ten rechargeable D cells. (Each Power Stick is the length of two D cells.) The difference between a Power Stick and an ordinary Ni-Cd cell is that a Power Stick contains a charging ring that's separate from the positive terminal. The charging ring makes contact with a separate charging post within the TV's battery compartment. That way, the Power Stick can be recharged

without removing them from the set, and it's impossible to inadvertently charge non-rechargeable D cells. So, with the Power Sticks installed, you can use the TV on the go and recharge the batteries whenever possible without removing them. An LED on the front of the TV lets you know when the batteries are charging. You could use ten regular Ni-Cd D cells to power the set instead, but they must be recharged outside the TV in a separate charger (not included).

One last accessory that's included with the set is an automotive DC power cord that plugs into your car's cigarette-lighter socket. That way, passengers—or the driver if you're parked—can watch TV on the road. If you have a camcorder, you can use it as a VCR so your kids can watch movies on road trips.

The Kit. Unpacking the shipping carton reveals the TV cabinet all snapped together with the picture tube in place. That is, after all, a very secure way to ship it. Cracking open the cabinet is somewhat disheartening, because the cabinet literally makes a cracking noise when it opens. Fortunately that cracking noise is mentioned in the manual, and it is not at all harmful to the cabinet. Once opened up, you can tell

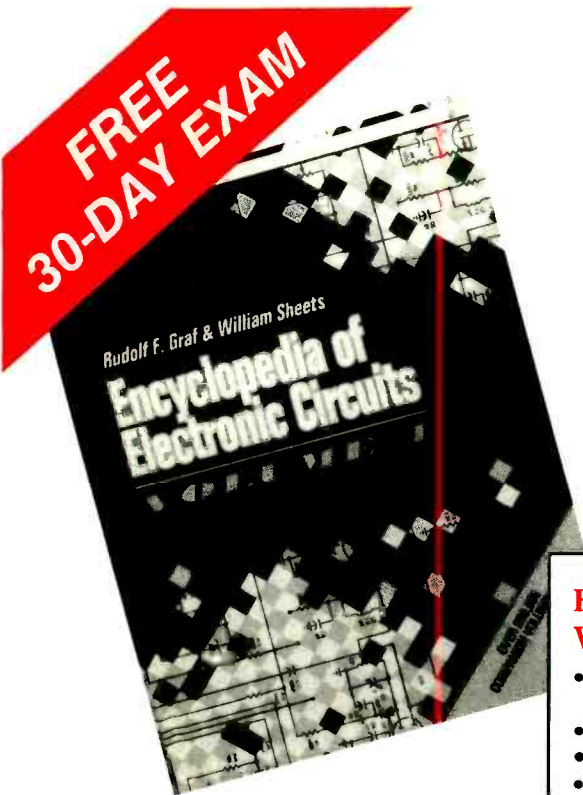

Save over \$20.00 on this GIANT circuit project and idea encyclopedia!

“... a collection of more than a thousand all-new circuits ... includes schematics for the latest electronic circuits from industry leaders ...”

—*Popular Electronics*, on the previous volume



THE ESSENTIAL REFERENCE FOR EVERYONE IN ELECTRONICS!

Enhance your PC performance... improve the quality and sound of audio equipment... protect your home and car with first-rate security set-ups... perform circuit tests and measurements... and more. This 729-page collection is bursting with circuits you can use for all your reference and project needs.

This comprehensive compilation of circuit specifications, data, and uses puts hundreds of project ideas right at your fingertips!

And, if you are adding to your Encyclopedia collection, Volume 4 features a complete index of every circuit in all four volumes!

3 EASY WAYS TO ORDER:

1.  CALL 1-800-822-8158 (24 hours a day)
2.  FAX 1-717-794-2080
3.  Mail Coupon to: TAB/McGraw-Hill, Inc.
Blue Ridge Summit, PA 17294-0840

Satisfaction Guaranteed—Order these references FREE for 30 days. Within 30 days, pay the stated amount plus postage, handling, and applicable sales tax, or return them and owe nothing.

ENCYCLOPEDIA OF ELECTRONIC CIRCUITS, VOLUME 4 by Rudolf F. Graf and William Sheets

- 1,000 illustrations, 729 pages, written and compiled by two industry experts!
- #3752H • ~~\$60.00~~ ... **Special Price \$39.95**
- Fully updated to cover over 1,000 of the latest circuits
- Covers over 100 circuit categories from antennas to window circuits
- Valuable circuit schematics, diagrams, and references

Turn to it when you need:

antenna circuits	audio circuits
measuring and test circuits	power-control circuits
automotive circuits	fiberoptic circuits
computer circuits	laser circuits
receiving circuits	RF circuits
filter circuits	sound effects circuits
video circuits	and hundreds more!

SAVE \$90 IF YOU ORDER ALL 4 VOLUMES NOW!

There's never been any circuit references like these before. Get thousands of circuits and projects ideas in the Encyclopedias of Electronic Circuits. Volume 3 covers everything from antenna to voltage circuits. Volume 2 presents you with a wide range of circuits from fiber optics to thermal reactors. And Volume 1 features circuits from alarms to zero cross-detecting.

Order all 4 volumes (#586148-8) for only \$149.95.00—regularly \$240.00

Please cut along dotted line

FREE 30-DAY EXAMINATION

Mail to: TAB/McGraw-Hill, Inc., Blue Ridge Summit, PA 17294-0840

Please send me:

Book#	Title	Qty.	Price
586148-8	Encyclopedias of Electronic Circuits, Vol. 1-4		\$149.95
3752H	Encyclopedia of Electronic Circuits, Vol. 4		\$39.95

Name _____

Address _____

City/State/Zip _____

Signature **X** _____

Offer invalid without signature. Order subject to credit approval. If you are ordering outside the U.S., please prepay in U.S. dollars drawn on U.S. banks and include an additional \$5.00 postage and handling. All orders over \$150.00 must be prepaid.

CODE = PE893

Earn Your B.S. Degree in ELECTRONICS or COMPUTERS



By Studying at Home

Grantham College of Engineering, now in our 43rd year, is highly experienced in "distance education"—teaching by correspondence—through printed materials, computer materials, fax, and phone.

No commuting to class. Study at your own pace, while continuing on your present job. Learn from easy-to-understand but complete and thorough lesson materials, with additional help from our instructors.

Our Computer B.S. Degree Program includes courses in BASIC, PASCAL and C languages — as well as Assembly Language, MS DOS, CADD, Robotics, and much more.

Our Electronics B.S. Degree Program includes courses in Solid-State Circuit Analysis and Design, Control Systems, Analog/Digital Communications, Microwave Engr, and much more.

An important part of being prepared to *move up* is holding the right college degree, and the absolutely necessary part is knowing your field. Grantham can help you both ways—to learn more and to earn your degree in the process.

Write or phone for our free catalog. Toll free, 1-800-955-2527, or see mailing address below.

Accredited by
the Accrediting Commission of the
National Home Study Council

GRANTHAM
College of Engineering
Grantham College Road
Slidell, LA 70460

SUPER 12 HOUR RECORDER CALL TOLL FREE

Modified Panasonic
Slimline. 6 hrs per side.
120 TDK tape furnished.
AC/DC Operation.
Quality Playback.
Digital Counter.
Durable Lightweight Plastic.



\$119.00*

PHONE RECORDING ADAPTER

Starts & Stops Recorder
Automatically When
Hand Set is Used.
Solid State!

FCC
APPROVED

\$28.50*



VOX VOICE ACTIVATED CONTROL

Solidstate Adjustable
Sensitivity. Voices &
Sounds Activate Recorder.
Adjustable Sensitivity.
Provisions for Remote Mike.

\$28.50*



*Add for ship. & handling. Phone Adapter & Vox \$2.00 each, Recorders \$5.00 each, Colo. Res. add tax. Mail Order, VISA, M/C, COD's OK. Money Back Guar. Qty Disc. available. Dealer inquiries invited. Free data on other products.

ALL MAIL TO: Box 20100, Boulder, CO 80308
AMC SALES INC., 193 Vaquero Dr.,
Boulder, CO 80303
Phones (303) 499-5405 • 1-800-926-2488
FAX (303) 494-4924 • Mon-Fri 8-5 MTN. TIME

CIRCLE 7 ON FREE INFORMATION CARD



And now for a look at today's weather.

You just won't find a more professional, complete picture of the weather than the one you'll get with Weather Wizard II. Weather Wizard II has all it takes to watch the weather like the pros. All for only \$250.00

FEATURES INCLUDE:

- Inside & Outside Temps
- Wind Speed & Direction
- Wind Chill
- Time & Date
- Alarms
- Highs & Lows
- Instant Metric Conversions
- Rainfall Option
- Optional PC Interface



WEATHER WIZARD II

THE PROFESSIONAL
HOME WEATHER STATION

Only \$250. Add \$75 for self-emptying rain collector.
Order today: 1-800-678-3669 • PE 632T
M: 7 a.m. to 5:30 p.m. Pacific Time • FAX 1-510-670-0589
M/C and VISA • Add \$8 for shipping. CA residents add sales tax.
One-year warranty • 30-day money-back guarantee

DAVIS INSTRUMENTS 3465 DIABLO AVE., HAYWARD, CA 94545

CIRCLE 6 ON FREE INFORMATION CARD

that the TV is manufactured by Samsung, however the kit supplier, Graymark, provides full technical support for the set.

Because the TV has to be built before it can be used, it's important that the assembly instructions are clearly written and that the parts packaging is neat and orderly. We have no complaints in either area, as we found no mistakes or typographical errors in the assembly/owner's manual, and the parts were carefully packaged in individual bags according to the order of assembly. Also included in the manual are circuit descriptions, block diagrams, schematics, and alignment instructions. Alignment of the TV circuitry is not at all necessary, although instructions are provided nonetheless for future servicing.

While aligning the set might have required some extensive test equipment and servicing knowledge, building it and getting it to work as a pre-aligned unit certainly doesn't. All you really require is a common volt/ohmmeter to do some simple safety checks before turning on the TV.

As you may have guessed, all of the TV's circuit boards come pre-assembled as well as pre-aligned. Otherwise, the majority of us kit builders would never be able to get the set to work properly. Because those boards come pre-assembled, building the TV does not take as long to build as some other kits we've seen. That's either good or bad, depending on how much time you like to spend working on one project. We actually found that once we got our kit started, we couldn't wait to see it finished so we could watch TV on it! Our set took about eight hours to complete.

Time to Watch TV. Our television worked perfectly, which felt very rewarding. After all, the best part about building a good kit is seeing it work the very first time around. The TV is the perfect size for portability in all sorts of locations, and a built-in tilt stand on the bottom of the set lets you adjust it for different viewing angles.

The Graymark Model 544 color TV kit costs \$291.95. For more information on the kit, contact Quantum Electronics (4 Brisbane Way, Irvine, CA 92715; Tel. 800-858-WATT) or circle number 119 on the Free Information Card in this issue.

PRODUCT TEST REPORTS

by Len Feldman

Onkyo Model TX-SV909PRO Audio Video Receiver

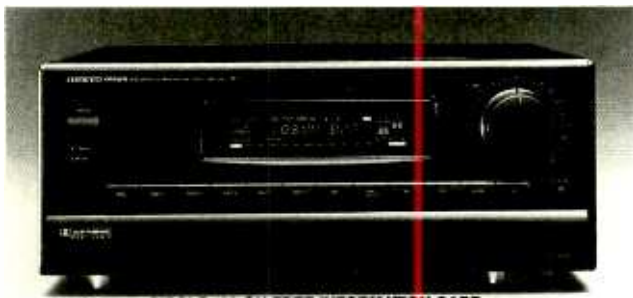

CIRCLE 120 ON FREE INFORMATION CARD

The Onkyo TX-SV909PRO audio/video receiver.

Too many audio/video enthusiasts are convinced that installing a home theater "surround sound" system in their home has to cost an astronomical amount of money. Nothing could be further from the truth! If you own a big-screen TV set (even a 27-inch model will do) and a good video program source (a stereo VCR or a laser video-disc player), all you need to create your

own "home theater" is a receiver such as the Onkyo TX-SV909PRO and four or more decent loudspeakers. This Onkyo receiver offers a digital Dolby Pro Logic surround-sound decoder, seven discrete channels of amplification, room-to-room sound-reproduction capability, on-screen programming, and a wealth of other features.

In addition to its Dolby Pro Logic surround system, this receiver offers an eight-mode digital sound-field processor that enables users to create an almost infinite range of audio environments. In addition to the usual surround-sound modes such as "Theater 1

or 2," "Hall 1 or 2," "Live Concert," and "Studio," this receiver features full decoding of Ambisonic-encoded source material. Several recordings have been made using the Ambisonic encoding method, which many listeners feel offers a superior type of 3-dimensional sound experience. As far as we have been able to determine, this is the first and only receiver to incorporate a full Ambisonic decoder.

The receiver boasts six video inputs, all of which are S-Video compatible, five audio inputs, an optical digital input, three video outputs (all S-video compatible), and five audio outputs. When connected to a video monitor, users can adjust nearly all tuner and amplifier parameters by using easy-to-follow on-screen menus in combination with the TX-SV909PRO's multifunction remote control. Other features include 40 random tuner presets, six categories of classified memory presets, a classified scan function, and 10-key direct-station tuning. The receiver is also fully compatible with Onkyo's RI (Remote Interactive) system, enabling it to communicate with other Onkyo components using the included remote control. Considering the versatility of this unit, its suggested price of around \$1800 seems completely reasonable.

CONTROLS

To keep an uncluttered look on the front panel,

many of the less-often used controls and pushbuttons are hidden behind a hinged panel that opens smoothly at the touch of a button. With this panel closed, the only controls visible are the power button, the major display area, the master volume control, and a row of twelve input-selector buttons (six video selectors, tape-1 and tape-2 monitors, AM, FM, Phono, and CD).

With the hinged panel lowered, the additional controls disclosed include speaker-selection, direct-access tuning, multi-source (which allows one program to be heard in the main location and another in a remote room), scan, surround-mode, FM-muting, tuning "up" and "down," parameter-selection, and parameter-control buttons. The parameter buttons are used to adjust such parameters as bass and treble, channel balance, center-channel bass, and center-channel treble. A panel-dimmer button, a head-phone jack, and the "Video 6" input jack cluster are also found behind the hinged panel section. Virtually all of the controls found on the front panel are duplicated on the wireless remote control.

We counted no less than 28 standard input and output jacks on the rear panel, not to mention nine video input and output jacks (plus an equal number of S-video connectors); eight pairs of color-coded speaker binding posts for front, front-

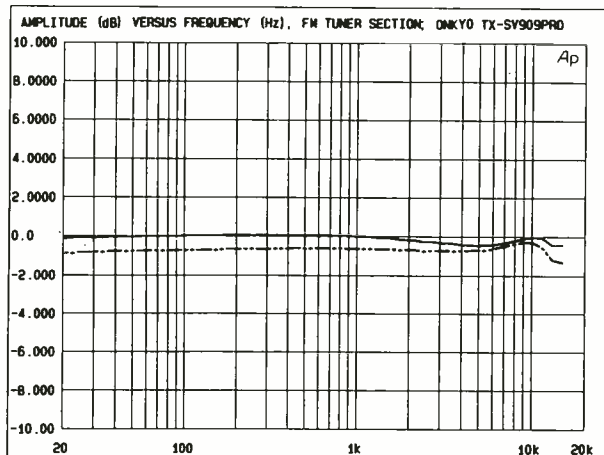

The FM frequency response was superb, varying by no more than 0.25 dB over the range from 30 Hz to 15 kHz.

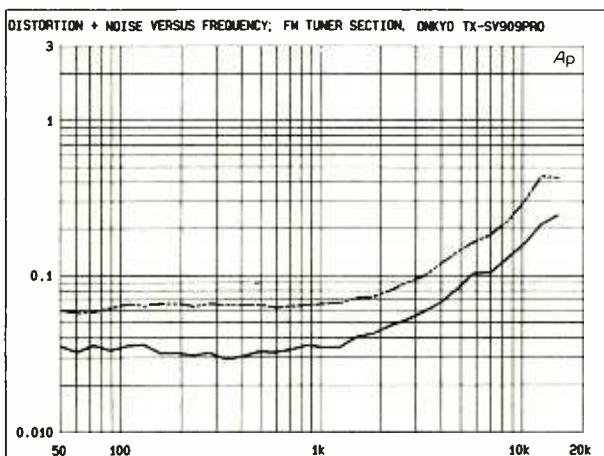

At mid- and low-frequencies, THD measured only a bit over 0.03% for mono FM and 0.065% for stereo. At 6 kHz (the highest frequency at which THD is measured for an FM set), mono distortion rose to only 0.1%, while stereo THD increased to an acceptable level of 0.16%.

enhance, center, rear-channel, and remote speakers; AM and FM antenna terminals; a digital optical input; the special RI input and output terminals; and three switched AC convenience outlets. In addition to the previously described input and output jacks, there is also a cluster of output jacks that, in effect, deliver the front channel, enhance channel, center channel, rear channel, and sub-woofer signals at line levels should you wish to augment the system with more powerful amplifiers than are available in the receiver itself. However,

with more than 110 watts per channel available from the front and center channels, and with 30 watts per channel available from the front-enhance and rear surround channels, for most listening situations it is most unlikely that you would need to use any of these outputs to connect additional amplifiers.

TEST RESULTS

As is our usual practice with integrated receivers, we measured the performance of the tuner section first. FM frequency response was superb, varying by no more than 0.25 dB over the

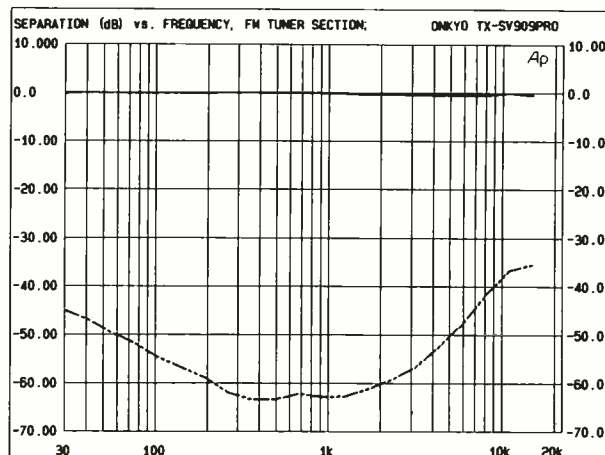

At mid-frequencies, separation actually exceeded 60 dB! Even for a 10 kHz signal, where most FM-stereo circuits exhibit much poorer separation, the stereo separation for this tuner section remained close to 40 dB.

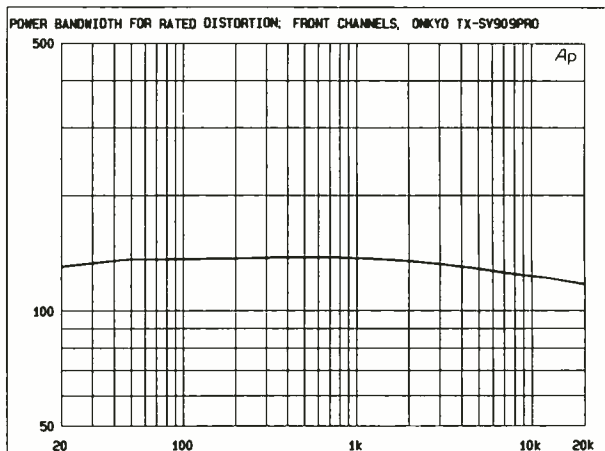

At mid-frequencies, the front-channels amplifiers pumped out more than 136 watts-per-channel, with both channels driven, before the rated distortion of 0.04% was reached.

range from 30 Hz to 15 kHz. While Onkyo claims FM signal-to-noise ratios of 76 dB for mono and 70 dB for stereo, in fact, our sample delivered S/N ratios of nearly 80 dB in mono and 75 dB for stereo FM.

The distortion was about as low as we have ever measured for an FM tuner, let alone the FM section of an all-in-one receiver. At mid- and low-frequencies, THD measured only a bit over 0.03% for mono FM and 0.065% for stereo. At 6 kHz (the highest frequency at which THD is measured for an FM set), mono distortion rose to only 0.1%, while

stereo THD increased to an acceptable level of 0.16%. Achieving 50-dB quieting in mono required an input signal level of only 16.0 dBf (as against 17.2 dBf claimed by Onkyo). Usable sensitivity in mono measured 11.2 dBf, exactly as claimed. Because stereo can only be received when muting is activated, no meaningful usable sensitivity figure for stereo FM could be obtained. For all practical purposes, stereo becomes available at an input signal level of around 17 dBf, the signal level at which muting circuitry is defeated.

Perhaps the most remark-

able thing about this FM tuner section was its stereo-separation capability. At mid-frequencies, separation actually exceeded 60 dB! Even for a 10 kHz signal, where most FM stereo circuits exhibit much poorer separation, the stereo separation for this tuner section remained close to 40 dB.

If there was one disappointing aspect to the performance of the tuner section, it was its AM circuitry. Like so many other manufacturers, Onkyo treated the AM section of this receiver in a minimal manner, despite efforts of broadcasters and others to encourage manufacturers to improve the performance of AM radios. Having measured the response as extending only from 90 Hz to around 2.9 kHz (for an attenuation of 6 dB), we decided that additional measurements of the AM section would be pointless.

Next, we measured the action of the bass and treble controls, which are adjustable in 2-dB increments for up to 12 dB of boost or attenuation at 100 Hz and 10 kHz, respectively. The signal-to-noise ratio for the high-level inputs, referred to a 1-watt output, measured over 78 dB. Referred to the full-rated output, that would correspond to 98.6 dB—close enough to the 100 dB claimed by Onkyo. The signal-to-noise ratio via the phono inputs, referred to a 1 watt output and an input of 5 millivolts, was an incredibly high 85.2 dB, or more than 5 dB higher than claimed by Onkyo! As for phono equalization, it was close to perfect, never deviating from the approved RIAA playback curve by more than 0.3 dB.

Turning our attention to the amplifier sections, we

TEST RESULTS—ONKYO TX-SV909PRO AUDIO/VIDEO RECEIVER		
Specification	Mfr's Claim	PE Measured
	FM Tuner Section	
Mono usable sensitivity	11.2 dBf	Confirmed
50 dB quieting sensitivity		
Mono/stereo	17.2/37.2 dBf	16.0/38.0 dBf
S/N ratio, mono/stereo	76/70 dB	79/75 dB
Distortion, mono/stereo	0.1/0.2%	0.03/0.065%
Frequency response, 30Hz–15kHz	±1.0 dB	+0, -0.25 dB
Muting level	17.2 dBf	Confirmed
	Amplifier Section	
Rated power output,		
8-ohm loads		
Front, center channels	110 watts	136 watts
Surround channels	30 watts	38 watts
Rated distortion		
Front channels	0.04%	0.01%
Center, surround channels	0.08%	0.03%
IM distortion	0.04%	0.015%
Damping factor	70	78
Input sensitivity (for rated output)		
Phono	2.5 mV	Confirmed
High-level inputs	150 mV	Confirmed
Phono overload	120 mV	125 mV
Frequency response,	+0, -3 dB	+0, -1.0 dB
20 Hz–30 k Hz		
RIAA deviation	±0.8 dB	+0, -0.3 dB
S/N ratio phono/high-level	80/100 dB	85.2/98.6 dB
Tone-control range		
Bass, @ 100 Hz	±10 dB	+9, -9.5 dB
Treble, @ 10 kHz	±10 dB	+7.5, -9.0 dB
	General Specifications	
Power supply	AC 120 V, 60 Hz	Confirmed
Dimensions (W × H × D, inches)	17 ¹⁵ / ₁₆ × 7 ⁷ / ₁₆ × 16 ¹ / ₁₆	Confirmed
Weight (lbs./kg.)	48.5/22	Confirmed
Suggested price:	\$1799.95	

first measured distortion versus frequency for the front channels, regulating the input to maintain a constant rated output of 110 watts-per-channel. While Onkyo's rated distortion figure is an already low 0.04% for any frequency from 20 Hz to 20 kHz, we were astounded to find that our sample exhibited a maximum distortion-plus-noise figure of only 0.01% at worst, while at mid-frequencies, distortion was even lower, at about 0.005%. Our curiosity was aroused and we wanted to see just how much power could be produced by the front-channel amplifiers before the rated distortion of 0.04% was reached. At mid-frequencies, these amplifier channels pumped out more than 136 watts-per-channel, with both chan-

nels driven! Center-channel and surround-channel power outputs were also conservatively rated by Onkyo, each delivering a good 20% to 30% more than specified by the manufacturer.

Finally, we measured intermodulation distortion as a function of power output for the front channels. Once again, at the rated power output of 110 watts-per-channel, SMPTE-IM distortion was far lower than the 0.04% specified by Onkyo, measuring only about 0.015%.

HANDS-ON TESTS

Setting up the Onkyo TX-SV909PRO for a full home-theater installation will take you quite a while, but if you follow the diagrams and instructions provided in the well-written 45-page in-

struction manual that comes with the receiver you should have no trouble. If you can afford the extra pair of speakers intended for the "enhance channels," by all means include them in your installation. They are normally mounted somewhat behind and above the usual front-left and front-right main-channel speakers and they will add a sense of sonic space that you just can't achieve with four or five speakers.

Once the setup was complete, we found that operating the receiver from the comfort of our listening and viewing position was preferable to trying to adjust all the parameters via the front-panel controls. Experiencing a motion picture, reproduced by means of a laser video disc
(Continued on page 88)

Enter A World Of Excitement with a Subscription to

Popular Electronics®

Get the latest electronic technology and information monthly!

Now you can subscribe to the magazine that plugs you into the exciting world of electronics. With every issue of Popular Electronics you'll find a wide variety of electronics projects you can build and enjoy.

Popular Electronics brings you informative new product and literature listings, feature articles on test equipment and tools—all designed to keep you tuned in to the latest developments in electronics. So if you love to build fascinating electronics, just fill out the subscription form below to subscribe to Popular Electronics... It's a power-house of fun for the electronics enthusiast.

EXCITING MONTHLY FEATURES LIKE:

- CONSTRUCTION**—Building projects from crystal sets to electronic roulette
- FEATURES**—Educational training on digital electronics, Ohm's Law, Antennas, Communications, Antique Radio, Simplified Theory
- HANDS-ON-REPORTS**—User test comments on new and unusual consumer products
- SPECIAL COLUMNS**—Think Tank, Circuit Circus, Computer Bits, DX Listening, Antique Radio, Amateur, Scanner Scene

PLUS: ALL OUR GREAT DEPARTMENTS!

You'll get 12 exciting and informative issues of Popular Electronics for only \$18.95. That's a savings of \$23.05 off the regular single copy price. Subscribe to Popular Electronics today! Just fill out the subscription order form below.

JUNE 1993
Popular Electronics

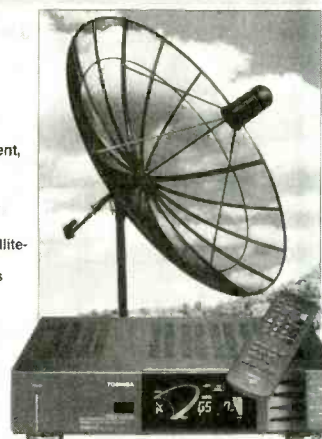

A component-by-component primer on setting up a system, selecting the equipment, and doing your own installation

A look at today's satellite-TV technology, and a preview of tomorrow's systems

Easy-to-build project keeps your favorite beverage at the perfect temperature almost indefinitely

Save
55%
 Off The Regular
 NEWSSTAND
 Rate

- Also: • Product Reviews
 • Scanner Scene • Computer Bits
 • Antique Radio • Think Tank
 • Ham Radio • DX Listening
 • And A Whole Lot More!

FOR FASTER SERVICE CALL TODAY

1-800-827-0383

(7:30AM-8:30PM)
 EASTERN STANDARD TIME

Popular Electronics® SUBSCRIPTION ORDER FORM

APEH3

P.O. Box 338, Mt. Morris IL. 61054

YES! I want to subscribe to Popular Electronics for 1 Full year (12 Issues) for only \$18.95. That's a savings of \$23.05 off the newsstand price.

(Basic Subscription Rate—1 yr/\$21.95)

Payment Enclosed Bill me later

Please charge my: Visa Mastercard

Acct. #

Signature _____

Exp. Date _____

PLEASE PRINT BELOW:

NAME _____

ADDRESS _____

CITY _____

STATE _____

ZIP _____

Allow 6 to 8 weeks for delivery of first issue. U.S. Funds only.
 In Canada add \$6.68 Postage (Includes G.S.T. All Other Foreign add \$7.30 Postage.)

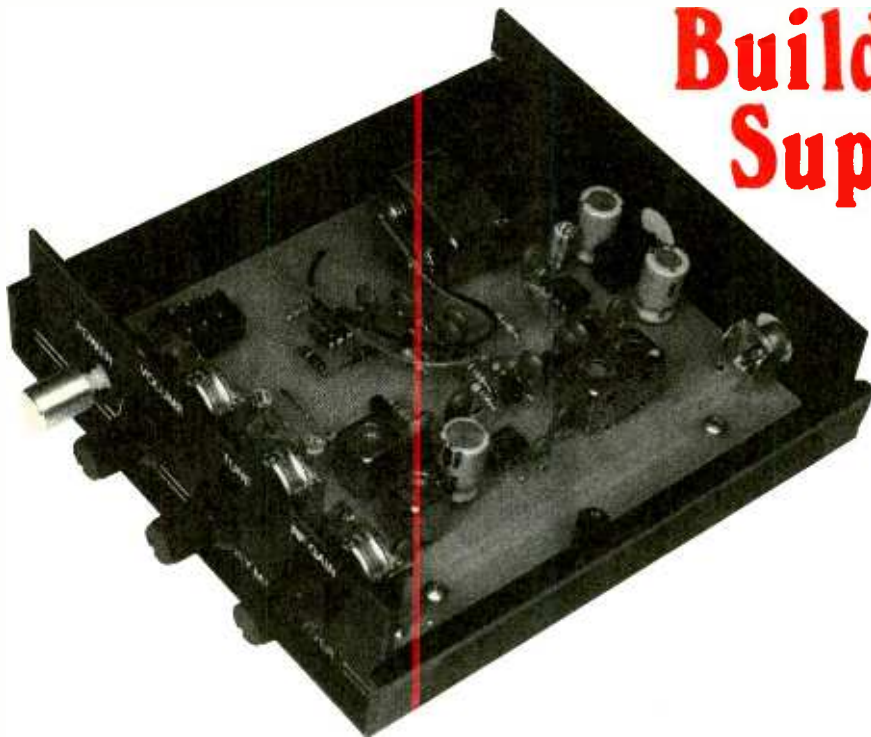

Build a Super-Simple Shortwave Receiver

BY FRED BLECHMAN

*Enjoy the wonders of world
travel without the expense
through the magic of
shortwave radio!*

Have you ever wanted to hear shortwave news broadcasts or music, but thought you needed an expensive receiver and a long antenna? Do you speak a foreign language, and would like to hear foreign-language broadcasts? You can do all that and more with the shortwave radio receiver described in this article. It will allow people of all ages to enjoy hours of fascinating international broadcasts using a simple indoor wire antenna.

The receiver, which is powered from a standard 9-volt battery, has just three front-panel controls—RF GAIN, TUNING, and VOLUME. The multi-stage audio amplifier provides room-filling volume with a speaker, or an earphone can be used for private listening. The Super-Simple Shortwave Radio is a single-conversion superheterodyne receiver designed specifically for listening to amplitude-modulated (AM) broadcast stations in the range of 4- to 10-MHz (75- to 30-meters). The radio can tune any 2.5-MHz portion of the 4- to 10-MHz shortwave radio band that you select, and can easily be retuned to any other 2.5-MHz portion when you prefer.

The "superhet" design brings in your favorite foreign broadcasting services loud and clear, with pleasing audio quality, and a minimum of overload, frequency drift or heterodyne whistles.

Because of the AM-broadcast oriented design, other types of shortwave signals commonly used by hams and commercial services, such as Morse code (CW), single sideband (SSB), frequency-modulated (FM) voice communications, and teletype signals will sound garbled or just like so much noise. On the other hand, similarly inexpensive receivers designed for CW, SSB, or FM, offer only marginal performance in receiving AM-broadcast stations.

Circuit Description. The schematic diagram for the 4-10-MHz Radio is shown in Fig. 1. Integrated circuit U1 (an NE602 double-balanced mixer) is a combination oscillator and frequency mixer. Signals from the antenna input (at J1) are fed through DC-blocking capacitor C1 to the RF-GAIN control, R1, which controls the strength of the incoming signals to prevent overloading. A broadband of signals is then peaked by a shielded tunable transformer, L1, and fed to the inputs of U1 at pins 1 and 2. Integrated circuit U1's local-oscillator frequency is determined by the values of capacitors C3 and C4, the setting of inductor L2 (of which only the secondary coil is used), and the voltage applied to varactor D1 via R2 (the TUNING CONTROL), C5, C6, and R4. The particular varactor used permits a tuning range of over 2.5-

MHz as R2 is rotated between its stops.

The local-oscillator frequency, which varies with the settings of R2 and L2, is mixed internally within U1, resulting in an output with various frequency components: the band of signal frequencies peaked by L1, the local oscillator frequency, and the sum and differences between the L1 frequencies and the local oscillator frequency. The mixer output at pin 4 of U1 is applied to a tunable 260-kHz-band-pass intermediate-frequency (IF) transformer, L3, through DC-blocking capacitor C7. The reverse-biased base-emitter junction of transistor Q4 behaves like a Zener diode, with a breakdown voltage in the 6- to 8-volt range, providing a stable voltage to L3.

The purpose of L3 is to reject all frequencies outside of a relatively narrow band of frequencies near the IF of 260-kHz. Therefore, signals roughly 260-kHz above and below the local-oscillator frequency are passed, while others are effectively blocked. The IF frequencies are now amplified by Q2 and Q3. The AM audio signal is detected by D2 and its associated components, which bypass the RF signals, leaving only the audio signals. The signals are preamplified by U2—a (half of an LM358 dual op-amp). The audio is then boosted to speaker level by the LM386 low-voltage, audio-

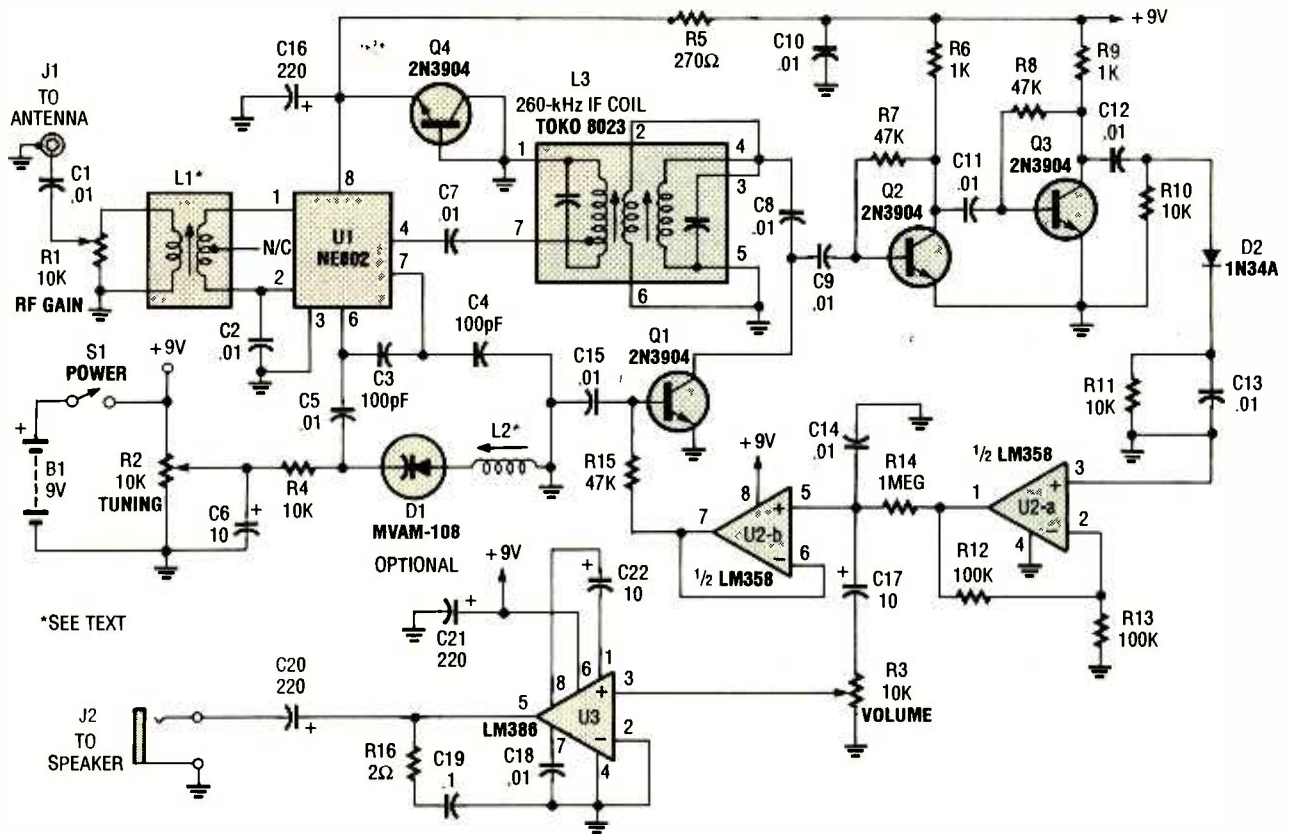

Fig. 1. The Super-Simple Shortwave Radio is comprised of three IC's, three inductors, two diodes, and a variety of support components.

power amplifier, U3, with the input signal level controlled by potentiometer R3 (the VOLUME control).

The other half of the LM358 (U2-b), together with transistor Q1 and capacitor C15, provides AGC (automatic gain control) feedback to keep strong signals from overloading U3. That helps to provide a relatively even volume as the output of U3 is coupled through blocking capacitor C20 to the speaker/earphone jack, J2. AGC is especially important with shortwave signals, which tend to greatly waver in strength.

The very low 260-kHz IF provides exceptional gain and selectivity characteristics; the IF also offers a sort of bonus that would not normally be welcome in a receiver intended for communications and listening for very weak signals—you can hear signals in two places on your dial!

In tuning the radio, it is useful to understand that you will hear any signal at the local-oscillator frequency, plus 260-kHz, and also at that frequency minus 260-kHz. That's not a problem for general listening to shortwave broadcasts, as long as you realize that

you will find every broadcast twice as you pass through the over-2.5-MHz range of the TUNING control.

The circuitry required to minimize that "image" reception would defeat the goal of economy and simplicity intended for this radio. More elaborate receivers deal with that phenomenon by using a higher intermediate frequency, dual IF conversion, several IF stages, and very exact tuning at the antenna-input circuit. However, you will find this radio gives perkier reception with simple antennas than many more costly portable receivers.

Construction. The Super-Simple Shortwave Radio is assembled on a printed-circuit board measuring about 4 × 4½ inches. Figure 2 shows a full-size template of that printed-circuit board's layout. Because of the critical nature of radio-circuit wiring, where lead lengths and ground connections can affect circuit operation, don't try building this project without using the printed-circuit board layout.

A kit of parts (which includes an etched and pre-drilled, printed-cir-

cuit board, but no case) is offered in the Parts List. Figure 3 shows a parts-placement diagram. If you opt to gather your own parts, or you plan to use what you have on hand, keep in mind that the printed-circuit board layout was designed to specifically accommodate the physical mounting dimensions of many parts.

Although many of the parts for this project are commonly available through conventional electronic-components suppliers, a source for some of the more difficult to find parts is given in the Parts List for those who prefer to do their own shopping. These parts, together with a number of other unique parts that might be difficult or impossible to obtain in single quantities from U.S.A. sources (such as D1, L1, L2, L3, and others) are available in a "Special Parts Kit" from the listed source.

Inductors L1 and L2 need to be modified to operate properly in the circuit. Looking at the underside of those units, locate a single small tubular part, probably white with a brown band, in each. Those are capacitors that must be destroyed. Using

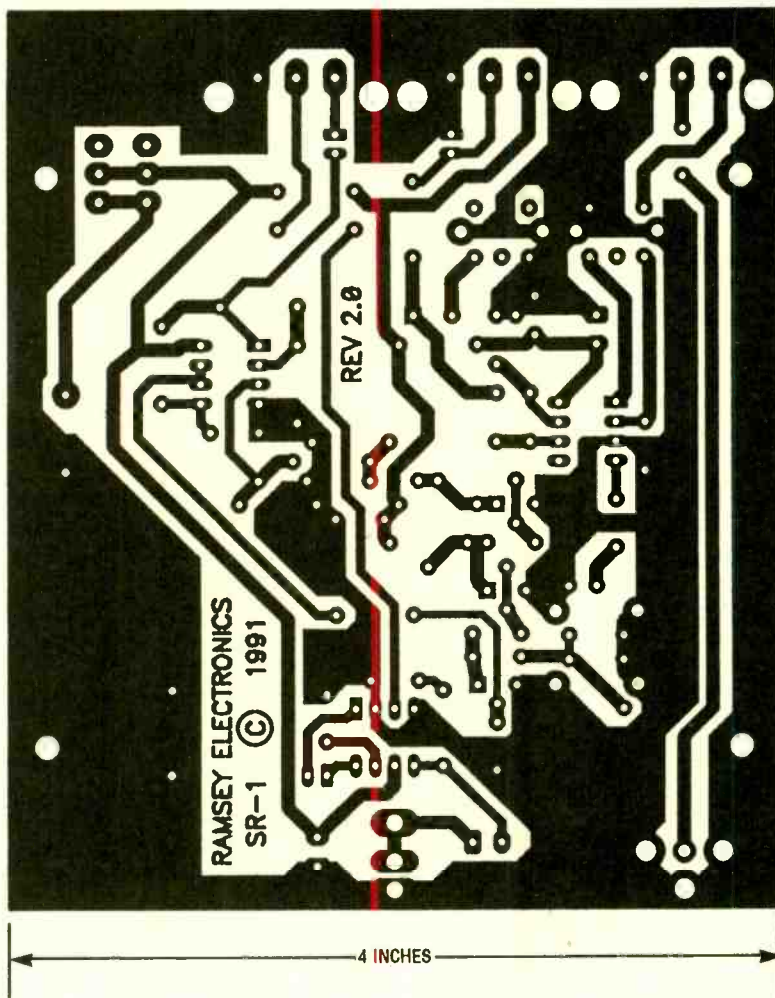

Fig. 2. The radio was assembled on a printed circuit board measuring about $4 \times 4\frac{3}{4}$ inches; a full size template of the printed-circuit layout is shown here.

a small screwdriver, simply crush them! They are brittle and will disintegrate easily. Leave transformer L3 alone.

When assembling the Super-Simple Shortwave Radio, take special care that polarity-sensitive components (electrolytic capacitors, diodes, transistors, and the integrated circuits) are installed in the right direction. Although the parts-placement diagram notes the positive electrolytic-capacitor lead, bear in mind that on the actual part, it is usually the negative lead that is marked. Be careful about getting the proper resistor values in the right places as well.

If you buy the kit, a manual is included that provides step-by-step assembly instructions. If you don't have that manual, begin by installing the passive components (jumper wires, resistors, and capacitors). Follow that by installing the active components (diode, transistors, IC's).

Testing and Adjusting Your Radio.

Before turning on your receiver, double check your work for the correct orientation of the three integrated circuits, the four transistors, the two diodes, and all of the electrolytic capacitors. Once you are convinced that everything is okay, plug a short antenna (more on that later) into J1, and an 8-ohm speaker or earphone into J2. Make sure the POWER SWITCH (S1) is in the out (off) position. Connect a fresh 9-volt alkaline battery to the snap terminals. Set all three controls to their middle positions. Turn on the receiver by pressing in S1.

After adjusting the volume to a pleasant level, you should hear some stations by turning the TUNE control, R2, no matter how the four adjustable inductors happen to be set. Turn the RF GAIN control to make sure it is working and then set it at the lowest level needed for good reception.

While listening to any kind of station, whether broadcast, teletype, or whatever, use a small screwdriver to adjust both slugs in L3, for the best-sounding reception. The black slug will be almost to the top of its range. The blue slug will give peak reception about two turns clockwise down from its highest position.

The TUNING control covers any 2.5-MHz segment selected by adjusting L2. Inductor L1 is simply adjusted for the strongest reception of any signal in the tuning range. Sometimes a band of shortwave frequencies is referred to by the average wavelength in meters, such as "the 40-meter band." The wavelength in meters equals 300 divided by the frequency in MHz. Similarly, the frequency in MHz equals 300 divided by the wavelength in meters.

Both L1 and L2 must be adjusted with a non-metallic alignment tool such as is used in radio-TV servicing. If you do not have one, a suitable tool can be made by patiently sanding a screwdriver-like blade on the end of a wooden match stick, kabob skewer, or small plastic crochet needle. Again, be aware that a metal screwdriver blade will drastically increase the coil inductance and make adjustment quite difficult.

If you do not have any kind of testing or frequency-reference equipment, the easiest way to start enjoying your radio is, with the TUNING control set at mid-point, to slowly tune L2 with your alignment tool as though it were a tuning dial. Stop when you come into the middle of a group or cluster of foreign broadcast stations.

Try tuning around those stations with the TUNING control. If you like what you hear, readjust both L2 and L3 for the best reception. Eventually, you will get a clue as to what general frequency band you are hearing; many stations periodically announce their frequencies, particularly at sign-on and sign-off.

If you like precision, use a frequency counter or calibrated receiver to find the radio's strong oscillator signal, remembering that there is a 260-kHz IF difference between the local-oscillator frequency and the broadcast signal you are hearing.

The results of tests on this design (see Table 1) will give you a general guideline on what to expect if you

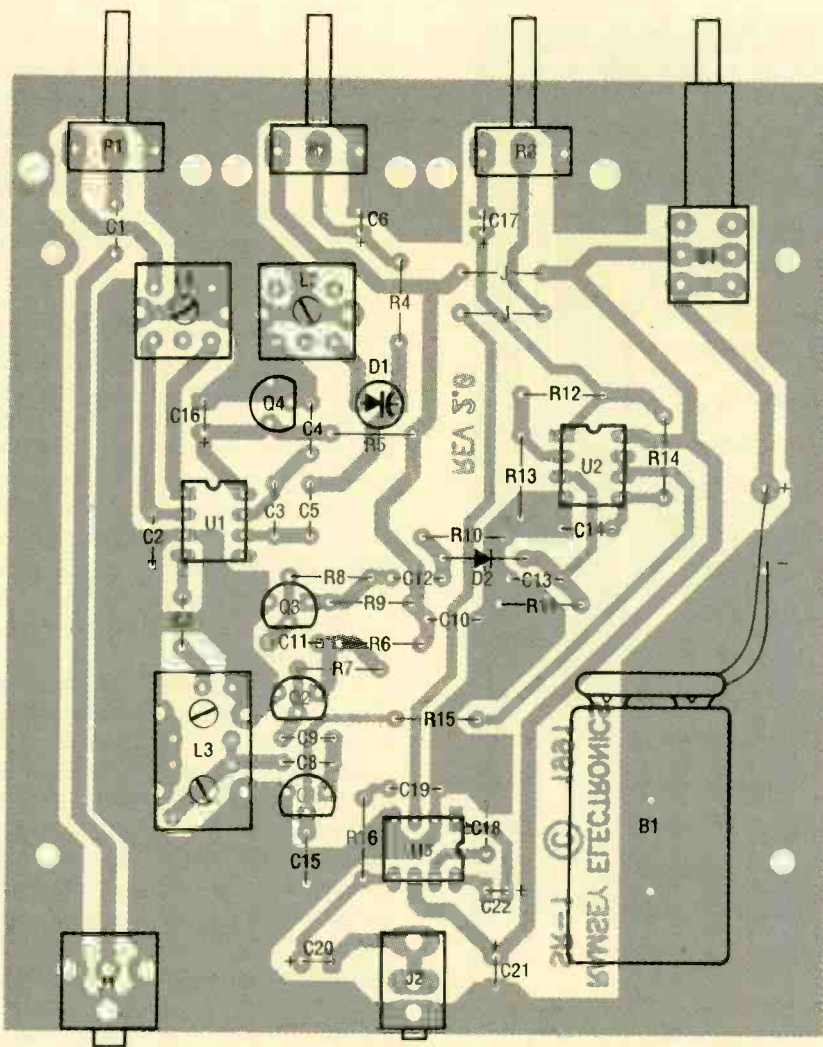

Fig. 3. Assemble the circuit guided by this parts-placement diagram. Note that L1 and L2 must be modified before installation on the circuit board. When assembling the circuit take care that the polarity-sensitive components (electrolytic capacitors, diodes, transistors, and the integrated circuit) are properly oriented on the board.

wish to preset L2. Each turn of L2 is one full turn clockwise. Realize the margin of error from receiver to receiver in such measurements is due to the manufacturing tolerances of the capacitors and coils involved. A setting of somewhere between 4 and 5 turns from the top might permit tuning of all three of the major shortwave bands under 10-MHz, depending on the

characteristics of your particular varactor diode. A 2.5-MHz swing is all that can be reasonably expected.

Troubleshooting Tips. Of course, make sure all components are properly oriented, that all solder joints look good (shiny, not dull), and that there are no solder "bridges" across traces. If self-oscillation or "motorboating"

TABLE 1—4-10-MHz RADIO TEST RESULTS

L2 Setting	Oscillator Range	Tuning Range
Flush at top	3.94-6.77 MHz	3.68-7.03 MHz
1 turn	4.01-6.87 MHz	3.75-7.13 MHz
2 turns	4.27-7.31 MHz	4.01-7.57 MHz
3 turns	4.77-8.20 MHz	4.51-8.46 MHz
4 turns	5.50-9.30 MHz	5.24-9.56 MHz
5 turns	6.31-9.83 MHz	6.05-10.09 MHz
6 turns	7.10-10.20 MHz	6.84-10.46 MHz
Maximum	7.27-10.25 MHz	7.01-10.51 MHz

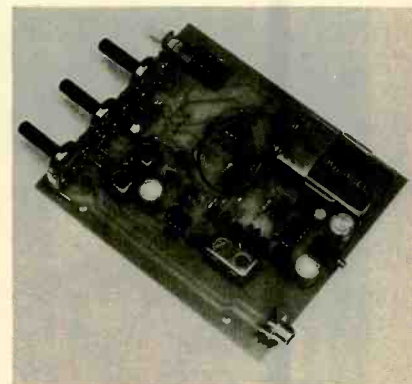

All the parts (including the battery) are mounted on the printed-circuit board.

occurs, be certain that C6 is a 4.7- to 10- μ F electrolytic capacitor, and that R12 is 100,000-ohms. A minor tendency toward oscillation may be noted when the TUNING control is in an extreme position of its rotation; however, that need not be a problem if L2 is adjusted so that desired stations fall in the main rotation range.

A strong shortwave broadcast may be heard throughout the tuning range if your antenna is too good, or if the RF GAIN control is turned up too high. The high sensitivity of the NE602 front end is designed for simple antennas, with most reception quite satisfactory when the RF GAIN control is set near its midpoint.

AM signals can be heard throughout the tuning range if you are close to a strong local AM station. Some stations change their power output at different times of the day. It is very important that all component leads be as short as possible, since just a bit of wire can help D2 and the several stages of audio amplification give you a free, unwanted, classic untunable crystal radio!

A grounded metal case for the radio is one possible solution. Another fix is to solder a .001- μ F capacitor in parallel with R10, so that it bypasses the anode of D2 to ground. In theory, that would bypass all signals to ground, but that solution has proven effective in only two of the radios built by the designer.

You may encounter unstable, chirpy signals at higher speaker levels. That's a sign that the current requirements of the IF and audio stages are causing variations in the voltage feeding the NE602 oscillator and the varactor tuning diode. The receiver draws about 200 mA at peak volume,

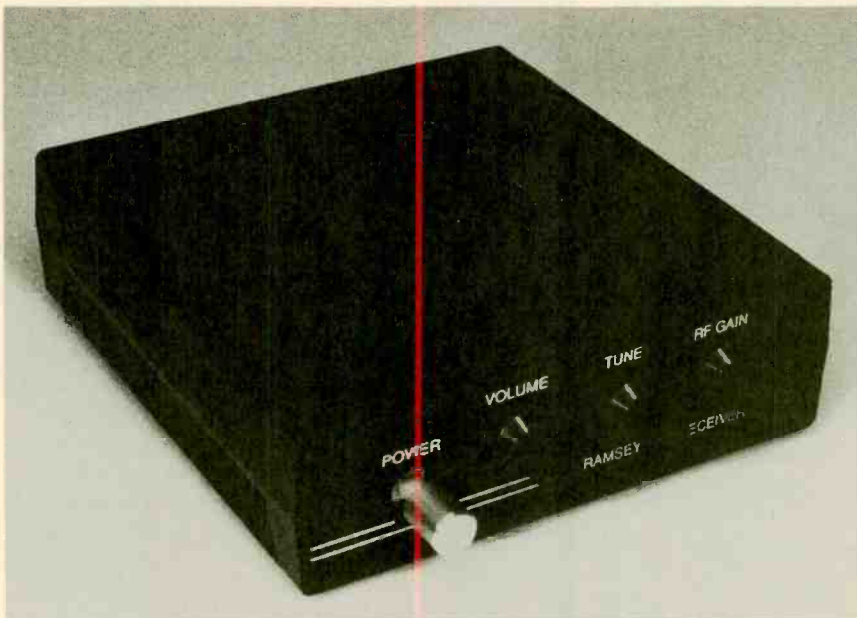

The optional 5- x 5.25- x 1.5-inch custom cabinet includes knobs, hardware, silk-screened front and back panels, and even rubber mounting feet.



An external antenna plugs into J1 and an 8-ohm speaker or earphones plug into J2.

PARTS LIST FOR THE SUPER-SIMPLE SHORTWAVE RADIO

SEMICONDUCTORS

- U1—NE602 double-balanced mixer, integrated circuit
- U2—LM358 dual op-amp, integrated circuit
- U3—LM386 low-voltage, audio-power amplifier, integrated circuit
- Q1—Q4—2N3904 general-purpose NPN silicon transistor
- D1—MVAM108 varactor diode, 30–500-pF (Motorola)
- D2—1N34A, 1N270, or similar germanium signal diode (Radio Shack #276-1123)

RESISTORS

- (All fixed resistors are 1/4-watt, 10% carbon units)
- R1–R3—10,000-ohm PC-mount, 2-watt potentiometer
 - R4, R10, R11—10,000-ohm
 - R5—270-ohm
 - R6, R9—1000-ohm
 - R7, R8, R15—47,000-ohm
 - R12, R13—100,000-ohm
 - R14—1-megohm
 - R16—2-ohm

CAPACITORS

- C1, C2, C5, C7–C15, C18—0.01- μ F ceramic-disc
- C3, C4—100-pF ceramic-disc
- C6, C17, C22—4.7- to 10- μ F, 16-WVDC, electrolytic
- C16, C20, C21—100- to 220- μ F, 16-WVDC, electrolytic

C19—0.1- μ F, ceramic-disc

ADDITIONAL PARTS AND MATERIALS

- L1, L2—Shielded IF transformer (see text)
- L3—Dual-section 260-kHz IF transformer (Toko 8023)
- B1—9-volt transistor-radio battery
- J1—RCA jack, PC mount
- J2—Subminiature phone jack, PC mount
- S1—SPST switch, PC mount
- Printed-circuit materials, enclosure, 9-volt battery connector, wire, solder, hardware, etc.

Note: The following items are available from Ramsey Electronics, Inc. (793 Canning Parkway, Victor, NY 14564; Tel. 716-924-4560): A complete kit of parts (SR-1BP), including printed-circuit board (but not the case or control knobs), \$29.95; an etched and drilled printed-circuit board only (SR-1PCBP), \$10.00; a Special Parts Kit (SR-1SPKBP) containing all semiconductors, all inductors, R1, R2, R3, J1, J2, and S1 (but no PC board), \$14.95; custom case and knob set (CSR-BP), \$12.95. Please add \$3 for orders under \$20, and \$3.95 postage/handling. New York State residents, please add appropriate sales tax.

which means that a good, fresh alkaline battery is essential. If that poses a serious problem for pleasant listening and your battery budget, consider an external battery supply such as six D cells connected in series, or a regulated low-ripple power supply. For casual listening at moderate speaker volume, or earphone listening, the single 9-volt alkaline battery will give very satisfactory service.

Shortwave Antenna Ideas. The type of antenna that you use for your 4–10-MHz Radio depends on the degree of interest you have in shortwave listening, on whether you are limited to an indoor or balcony antenna, and whether you think you may soon want to obtain a ham license. If the latter is true, you may want to consult ham literature and build the dipole or vertical antenna, which you can also use for your ham station.

A 40-meter (7.5-MHz) antenna is quite nice for the tuning range of this radio. However, the best simple long-wire or whip antenna is one whose physical length is close to one-half the wavelength of your target frequency. See the earlier discussion on wavelength for the calculation of a full wavelength, then divide this length by two.

The rest of these notes on antennas are for the benefit of those who simply wish to enjoy some shortwave-broadcast listening. The radio is very sensitive, so its antenna requirements are minimal for casual evening listening, when international broadcast signals are quite strong. If an all-band indoor antenna is desired, simply make it as long as possible and as high up from concrete floors as you can. Ten to 20 feet of insulated hookup wire can be

(Continued on page 89)

Today most shortwave listeners (SWL's) and scanner hobbyists don't do much experimenting with their equipment or their antennas. Fine, but how do they know whether or not their antennas and their radios are working in harmony?

Fortunately, you can check the performance of your radio and your antenna system by making simple measurements of radio frequency (RF), standing-wave ratio, and other parameters. While you don't need an expensive suite of RF test equipment to make such simple checks, you can benefit greatly from some basic and relatively inexpensive RF accessories.

What are some of the things you can do with modest, passive RF test equipment? You can, for example, find your antenna's standing-wave ratio (SWR), resistance, and resonant frequency. You can monitor SWR changes as you tweak your antenna by lengthening or shortening it, or by adjusting an antenna tuner (if one is used). You can use a frequency counter as a check of your radio's calibration as well as that of your RF test instruments. You can also use the instruments we'll discuss to help wind coils; measure inductance, capacitance, and the resonant frequency of tuned circuits; and more.

This article surveys RF test gear for SWL's and scanner hobbyists—gear that doesn't require a radio transmitter or other source of high-level RF energy to make checks and take readings. After briefly discussing antenna and matching considerations, we'll cover the SWR analyzer, antenna bridge, antenna-resistance analyzer, dip meter, antenna-noise bridge (ANB), RF-communications interceptor, frequency counter, external RF readout, spectrum-display unit (SDU), and other devices. First, though, let's go over a little background.

Antennas and Matching. While resonance and impedance matching is more important for transmitting than receiving, achieving antenna resonance and a good match between a receiver and its antenna helps deliver the greatest received signal strength and gives one confidence that "all is well" with the entire system. A resonant antenna designed for a given frequency that's one-half wavelength long (*i.e.*, a dipole) typically has an

Test Gear for



SWL's

These handy test aids can help keep your listening post in tip-top shape.

BY KARL T. THURBER, Jr., W8FX

impedance of 30 to 75 ohms. Because of that, most shortwave receivers and scanners have a nominal antenna-input impedance of about 50 ohms. That figure usually makes for a good match and provides optimal transfer of received signal between the antenna and the radio when using 50–75 ohm coaxial cable as lead-in.

On the other hand, untuned, non-

resonant "random-wire" antennas have impedances that vary band-to-band over a wide range—usually by several hundred ohms or more. When you connect this type of antenna to your receiver, there's usually a mismatch that prevents maximum signal transfer. As a result some of the signal developed by the antenna may be lost.

To overcome that potential loss, some receivers (especially older, tube-type sets) have a separate, high-impedance antenna input. Note, however, that most solid-state radios don't have this alternate connection. In such cases, to obtain a better antenna-to-receiver match and more efficient signal transfer, you need to use an antenna tuner, sometimes called an antenna coupler or "transmatch." Couplers for receiver use are widely available from radio-equipment manufacturers, distributors, and dealers, many of which we'll mention later on in this article.

Although it might not make a big difference with strong signals and/or a highly sensitive receiver, most antennas and antenna couplers must be tuned to achieve optimum performance. There are various ways to do this. Minimizing SWR, either on the lead-in itself or on the coax link between the antenna coupler and receiver—a technique that SWL's and scanner monitors have borrowed directly from their ham friends—is one of the most common ways of doing so.

Checking SWR. Unfortunately, the most-used and popular hamshack accessory—the SWR bridge and directional wattmeter—is one that isn't of much help to non-hams. It is an insertion-type instrument that lets you determine the quality of the match between your radio, transmission line, and antenna. It effectively measures and displays actual forward and reflected power, or the ratio of forward voltage to reflected voltage in the antenna system.

These parameters depend on the impedances of the equipment, transmission line, and antenna. A perfectly matched system has an SWR of 1-to-1, often written as "1:1." When you connect your transmitter or receiver to one end of a 50-ohm transmission line terminated in a 50-ohm load at the

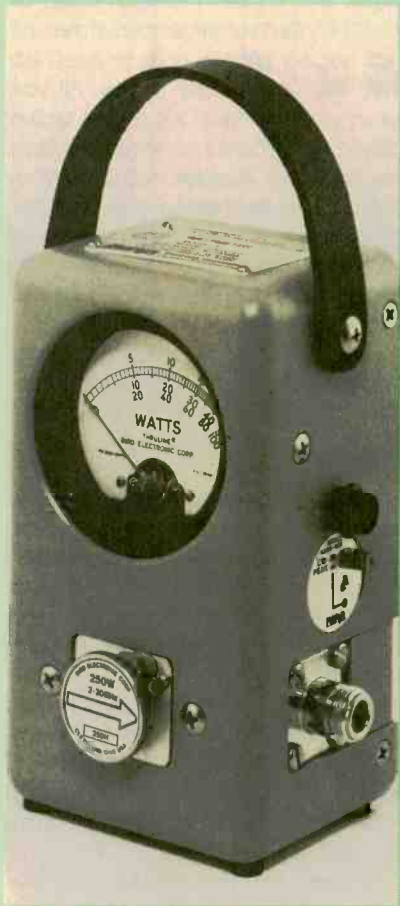

The Bird Thrline Model 43P RF Directional Wattmeter is a top-quality test instrument that lets you accurately determine how good the match between your radio, transmission line, and antenna is.

other end, you should have a perfect match—an SWR of 1:1. Most amateurs use SWR-bridge/directional-wattmeter combos, like the ones available from Bird, to tune their antenna systems, leaving the devices in place at all times as a constant, bottom-line check on the entire system.

However you shouldn't place total reliance on SWR readings. Why? Only adjusting the antenna itself, and not an antenna coupler or the transmission-line length, changes SWR at the antenna, where it really counts. So, if you have the SWR bridge connected between the radio and the antenna coupler, all you're really doing is making sure the radio "sees" the proper load impedance. This does nothing for the actual SWR.

Another fly in the ointment is that to effectively measure SWR, you need an external RF source (usually a transmitter) to power the instrument. But unlike

hams, most SWL's and scanner monitors don't have access to a source of high-level RF energy such as a transmitter.

A third "fly" is that SWR is of most importance in transmitting, especially when using potentially lossy coaxial cable. For receiving, SWR is not of prime importance though it can be a convenient benchmark for proper antenna installation and operation. In any case, now there's an SWR instrument that's convenient for SWL's and scanner hobbyists as well as radio amateurs. It's known as the SWR analyzer.

The SWR Analyzer. As discussed above, tuning an antenna using a conventional SWR bridge requires a high-level RF source to take readings and usually requires two-people. To tune the antenna and match it to a coax feedline requires one person at the antenna to make adjustments and another in the radio shack to sweep the band with a radio transmitter and observe SWR changes. The procedure is clearly illegal, for non-hams and it generates unnecessary, annoying interference to others. A better procedure has long been needed.

Only recently have the three needed RF devices (SWR bridge, low-power RF signal generator, and frequency counter) been combined into a single instrument. MFJ Enterprises has done this in several inexpensive devices. The MFJ-249 HF/VHF SWR Analyzer is at the top of the MFJ

line, which includes five SWR analyzers with varying features and frequency coverage. The \$199.95 MFJ-249 is a universal (all-band) analyzer that covers 1.8 to 170 MHz, including most commercial two-way, police, fire, FM and shortwave broadcast, military, marine, and amateur bands. It uses six AA cells or an optional AC power supply.

The SWR Analyzer's circuitry automatically calculates SWR and displays it on a built-in meter. To measure SWR, you simply connect the antenna feedline to the analyzer's antenna input, set the device for the desired frequency, and directly read the SWR—it couldn't be easier. Or, you can find the antenna's approximate resonant frequency by sweeping across the unit's tuning range and noting the frequency at which the lowest SWR occurs. You can also use the instrument to quickly adjust an antenna coupler.

The built-in frequency counter is used to read the frequency of the internal oscillator. But you also can let the analyzer double as a frequency counter by attaching a short piece of wire to the counter's input connector, to precisely measure the frequency of an external RF source. Several similar analyzers, such as the MFJ-207 HF SWR Analyzer and the MFJ-208 VHF SWR Analyzer, don't include a built-in frequency counter but can be used with an external counter for accurate measurement.

The Antenna Bridge. Several other

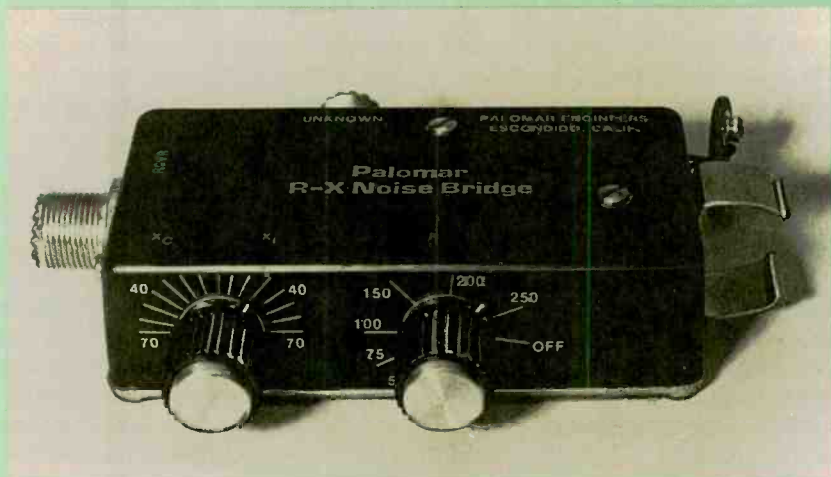

The classic Palomar Engineers RX-100 Noise Bridge tells you if your antenna is resonant or not and, if not resonant, whether it's too long or too short. It works with various receiving and transmitting antennas such as dipoles, inverted Vees, quads, Yagis, multiband trap dipoles, and verticals.

instruments can help you adjust your antenna quickly and easily. A very inexpensive device for just this purpose is the MFJ-204B Antenna Bridge, which is a combination "dip meter" and "null detector." It helps optimize antenna performance by measuring an antenna's feedpoint impedance and resistance, determining its resonant frequency, and adjusting an antenna coupler. With it, you can measure antenna resistance up to 500 ohms over the range of 1.8 to 30 MHz.

The self-contained unit consists of a built-in resistance bridge, a null meter, and a tunable oscillator, so that no other equipment (such as a transmitter) is needed to make antenna checks. The unit can also double as a signal generator, which is useful in receiver repair and alignment. Like the MFJ SWR analyzers without built-in frequency counters, the MFJ-204B has a frequency-counter output jack for precise frequency measurement. Its price is \$79.95.

Antenna Resistance Meter.

Another highly useful instrument with a more specialized range of applications is the MFJ-205 Antenna Resistance Meter, sometimes called the Antenna Resistance Analyzer. It's designed to let you measure the feedpoint resistance of your antenna.

Unlike antenna bridges, where you must adjust the bridge for a null, all you need do with the MFJ-205 is to read the resistance directly from the unit's built-in, calibrated meter. The unit also helps you determine your antenna's resonant frequency and establish whether the antenna is too long or too short. The device covers 160–10 meters and has a frequency-counter jack. The MFJ-205 also can be used as a signal generator. Its price is \$89.95.

Grid-Dip Meters. The classic, tube-type grid-dip meter (GDM), sometimes called the grid-dip oscillator, or GDO, was a classic vacuum tube device used to determine RF circuit or antenna resonance and other parameters. In fact, the GDM was one of the most versatile RF test instruments ever designed.

The GDM could be used in either an active (oscillating) mode or in a passive mode. The GDM also served as a



The Optoelectronics R10 FM Communications Interceptor lets you search for signals from any FM transmitter over 30 MHz to 2 GHz. Tuning is automatic; the R10 locks on instantly to the nearest transmitter.

wideband signal generator since it usually covered the RF spectrum from LF through UHF. It had a built-in RF oscillator and a meter to indicate absorption of energy from the unit's resonant tank circuit by the circuit under test (i.e., an antenna system, a loading coil, or a coil-and-capacitor combination). The frequency at which the maximum power transfer occurred was the circuit-under-test's resonant frequency.

The GDM was simple to use—you simply held it next to the circuit being tested and turned its dial. When the meter reading dipped, you had found the resonant frequency. Unfortunately, the calibration of most GDM's was only approximate at best, not good enough for precision work or frequency setting. But, like other RF test instruments with a built-in source of RF, GDM's could be used with a calibrated communications receiver or a frequency counter to increase measurement accuracy.

The MFJ-203 Bandswitched HF Dip

Meter is a modern reincarnation of the GDM. It's a sensitive, solid-state unit that has no plug-in coils to keep up with. The unit is easy to use. All you need do is to tune for a dip; unlike classic units, there's no sensitivity control to adjust. Besides adjusting your antenna to resonance, you can determine the resonant frequency of tuned circuits, measure capacitance and inductance, determine coil "Q" (quality factor), and much more. The device can also be used as a signal generator to align receivers and supply RF for antenna measurements. It's \$99.95.

Using an Antenna Noise Bridge.

An antenna noise bridge (or ANB) is useful in adjusting an antenna system to resonance using it and a receiver alone. The big difference between the ANB and predecessor instruments is that it includes a built-in noise source. Thus, you don't have to drive it with an external signal from a transmitter, grid-dip meter, or other RF instrument. This solo characteristic makes it a natural for SWL's and scanner enthusiasts.

Modern ANB's contain two key elements: a broadband noise generator and an RF impedance bridge. The known leg of the bridge has a calibrated variable resistor and a calibrated variable capacitor, which are controlled by front-panel knobs. You connect the antenna to the "unknown leg" of the bridge and use a well-calibrated receiver to determine frequency. When adjusting your antenna for a specific impedance and resonant frequency, you set your radio to the desired frequency and the ANB for the desired impedance. You make antenna adjustments that result in a pronounced noise null, as indicated by the receiver's signal-strength or "S" meter. Thus, you can measure both an antenna's resonant frequency and its impedance. The ANB also lets you determine capacitive and inductance reactance, the resonant frequency of tuned circuits, and resistive impedance, as well as make other useful measurements in the radio shack.

An ANB variant of interest to SWL's is the Palomar Engineers PT-340 Tuner-Tuner. It's especially designed to adjust an antenna tuner and is named based on the fact that it literally lets you tune your tuner without the need

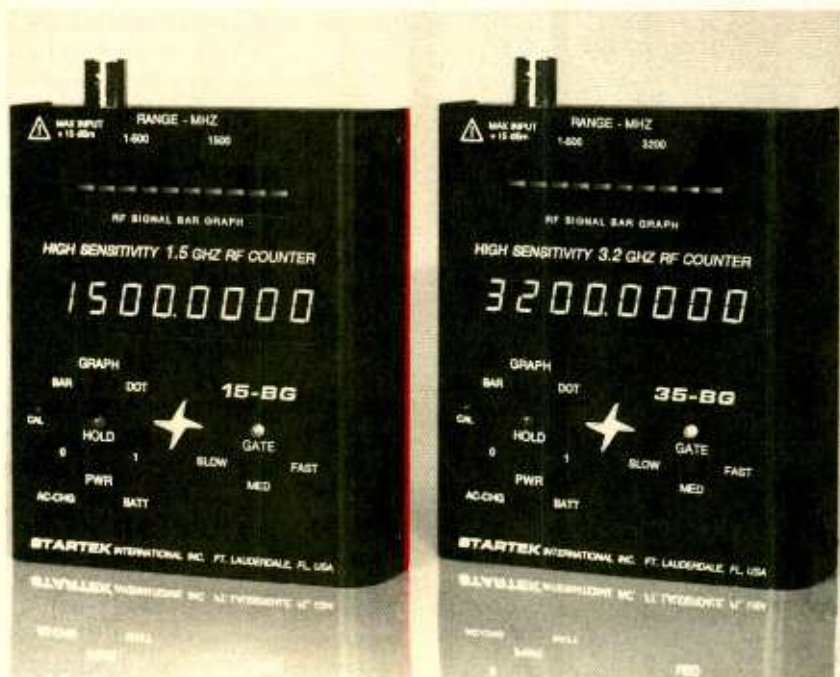

The Startek BG-series counters sport a bright 2-inch LED bar-graph that functions as a signal-strength indicator. This feature makes the BG counters useful for testing, adjusting, repairing, and locating RF devices.

for a transmitter. In operation, you connect the device between your radio and the antenna tuner. You tune the receiver to the desired frequency and turn on the Tuner-Tuner; you'll hear a loud noise. You adjust the tuner until the noise drops out or nulls completely; then you turn off the device and you're ready to go. The PT-340 is \$99.95 and covers 1.7 to 30 MHz; a front-panel switch lets you bypass the unit.

RF Communications Interceptor.

An RF Communications Interceptor is a wideband device that intercepts, detects, and captures nearby radio transmissions in a way that eliminates searching, scanning, or tuning for them—you don't have to tune the spectrum to find signals.

The pocket-size R10 FM Communications Interceptor from Optoelectronics was originally designed for two-way communications test use. But the R10 also has applications in signal-modulation monitoring, countersurveillance, security, cellular-telephone testing, and general communications monitoring. You can even think of the device as a high-tech reincarnation of the old-time crystal set.

The R10 lets you find signals from any FM transmitter over 30 MHz to 2 GHz, including cellular-telephone fre-

quencies, with no gaps. Tuning is automatic, and the device instantly locks onto the nearest transmitter—even if its frequency changes. A dual, ten-segment LED bar-graph provides deviation and relative signal level indications, while a "skip" pushbutton frees the unit to lock onto a different signal. It's priced at \$359. A similar unit, the R20 AM Interceptor, at \$119, has an LED bar-graph calibrated in 3-dB steps that lets the instrument double as a field-strength meter (FSM).

Optoelectronics also offers the TC200 Tone Counter, a companion for the R10 FM Communications Interceptor, that measures sub-audible signaling tones off the air. The \$179 unit can be used with scanners and communications receivers to monitor transmitted sub-audible tones and map out frequency assignments in installed communications systems.

Frequency Counters and their Accessories.

The frequency counter is a precise measuring instrument with a digital readout and is in wide use today because it's better, cheaper, and easier to use than ever before. Indeed, recent price reductions have moved the device out of the laboratory and into the radio shack and home workshop. Today, you can buy a no-frills, handheld, 2-GHz frequency

counter for as little as \$100 or so.

Many counters feature high readout accuracy and excellent sensitivity, even at UHF. They can be used for such purposes as checking the frequencies of walkie-talkies of all types, cordless telephones, CB and amateur transmitters, baby monitors, wireless intercoms, and even hidden "bugs." Because they are untuned, broadband instruments they respond to all signals strong enough to register. For this reason, in populated areas it's best to use a counter with a short antenna, close to the source of the signal you want to measure—although using a preselector with the counter can offer additional sensitivity and selectivity.

The frequency counter can also be used to extend the accuracy of other RF test equipment. If you want to fine-tune the frequency at which antenna resonance or minimum antenna SWR occurs when using an SWR analyzer, dip meter, antenna bridge, or other roughly calibrated instrument, you need a precise external frequency indicator. This can be a calibrated receiver, though a digital frequency counter usually is a better choice.

Optoelectronics offers several frequency counters suitable for hobbyist, amateur, and communications-professional use. The handheld frequency counters in their Handi-Counter series are more sensitive than conventional units. Thus, they are used in cellular frequency-finding applications and for picking up RF sources at relatively great distances. With the new counters, a useful response to frequencies that are only 10 to 15 dB greater than the background RF level is possible.

A popular and inexpensive pocket-size counter for general hobbyist use is the Model 2300 Handi-Counter. The tiny unit covers 1 MHz to 2.4 GHz with an 8-digit LED display. Priced at \$99, it boasts high sensitivity and includes a frequency "hold" switch, rechargeable NiCd batteries, and a battery charger and adapter. Other counters in the Handi-Counter series offer expanded capabilities and are priced at \$199 and up.

Optoelectronics also has pioneered preselectors for frequency counters and RF-communications interceptors. They are useful in picking up low-level signals that may be "washed out" using high-sensitivity

counters in crowded RF environments. The APS104 Active Preselector is a high-gain, tunable band-pass filter system useful over 10 to 1000 MHz. It can multiply by a factor of ten or more the possible frequency detection distance from a radio transmitter, with an effective sensitivity increase of 40 dB or more. Often you can use the unit as much as a quarter-mile from a two-way radio or 120 feet from a cordless telephone. Unfortunately for most of us, the APS104 is, at \$995, an expensive accessory. A sister unit, the APS204R1, is designed for use with a communications receiver and can be tuned to reject a strong interfering signal close to the desired frequency.

Startek International also offers several counter lines. The Pocket Counter subcompact, high-sensitivity frequency counters are available in four different basic models to cover up to 3500 MHz; prices range from \$129 to \$250. The firm also offers a new series of high-sensitivity bar-graph display, handheld counters. As part of the BG series, the counters sport a bright 2-inch, ten-segment LED bar-graph used as an instantaneous signal-strength indicator. That feature makes the units useful for testing, adjusting, repairing, and locating RF devices. The Model 13-BG covers 1 to 1500 MHz and the Model 35-BG covers 1 to 3500 MHz; prices are \$199 and \$265, respectively.

At the top of the Startek line is the Model ATH 15, an ATH, or "Auto Trigger and Hold," bar-graph display, handheld counter at \$235. Its advanced features virtually eliminate random counting and false readings over the counter's range of 1 to 1500 MHz.

All of the Startek counters may be used with the MFJ SWR Analyzers and other roughly calibrated RF test instruments lacking built-in counters for precision frequency readout. Various accessories are available, including a connecting cable for the MFJ-207 and MFJ-208 SWR Analyzers, and other RF devices.

External RF Readouts. Modern radios have many "bells and whistles," some of which aren't all that useful. But newer sets do have an important improvement in common: a direct digital readout that lets you know the radio's frequency to a kHz or less. Older sets had analog dials, making it

Names and Numbers

Bird Electronic Corporation
30303 Aurora Road,
Cleveland, OH 44139-2794;
Tel. 216-248-1200

Electronic Equipment Bank (EEB)
323 Mill St., N.E.,
Vienna, VA 22180;
Tel. 800-368-3270.

Grove Enterprises
PO Box 98, 140 Dog Branch Rd.,
Brasstown, NC 28902-0098;
Tel. 800-438-8155.

MFJ Enterprises, Inc.
PO Box 494,
Mississippi State, MS 39762;
Tel. 800-647-1800

Optoelectronics
5821 N.E. 14th Avenue,
Ft. Lauderdale, FL 33334;
Tel. 800-327-5912

Palomar Engineers
PO Box 462222,
Escondido, CA 92046;
Tel. 619-747-3343

Standard Amateur Radio Products, Inc.
PO Box 48480,
Niles, IL 60648;
Tel. 312-763-0081

Startek International, Inc.
398 N.E. 38th St.,
Ft. Lauderdale, FL 33334;
Tel. 800-638-8050

Universal Radio, Inc.
6830 Americana Pkwy.,
Reynoldsburg, OH 43068;
Tel. 1-800-431-3939.

a crapshoot to find a specific frequency on shortwave. The situation has improved greatly, so that now there's hardly any reason to purchase a new shortwave radio that doesn't have a digital display of some sort.

The good news is, you can use an external digital frequency display to update many of the classic radios (receivers and transceivers) of the 1960's and 1970's. These are sets that often work well and sound good, but whose lack of accurate calibration and precise dial readout frustrate serious frequency finding.

The Palomar Engineers PD-700 Digital Frequency Display is representative of the readouts that you can add to older radios to provide an accurate, easy-to-read frequency display. The PD-700 looks at the local and carrier oscillators of the receiver (or receiving portion of the transceiver) to find the exact frequency

and displays it on a six-digit LED giving a readout to the nearest 100 Hz. The \$199.95 unit works with a variety of radios, including all Swan tube-type receivers and the Drake R4C, plus many Atlas, Drake, Heath, and Ten-Tec transceivers. The sister PD-800 model covers Collins, Heath, Kenwood, and Yaesu sets. Recently Palomar Engineers introduced the PD-600 display for older tube-type receivers. The displays include connecting cables.

Spectrum-Display Unit. Due to the short-term nature of many transmissions, locating a new frequency with your receiver alone can be chancy. The spectrum-display unit, sometimes called a spectrum analyzer, lets you look at the radio spectrum above and below the frequency to which your radio is tuned. The SDU opens a high-visibility window on the RF spectrum that lets you see stations as "spikes" on the screen as soon as they pop up, even for just a few seconds. That capability allows you to tune to that area of the band to investigate the signals. The SDU also lets you read the relative signal strengths of all stations transmitting within the SDU's bandwidth. There's no need to wait for the slow, hit-or-miss search offered by a conventional scanner.

Some practical uses for the SDU include aligning receivers and transmitters, locating jamming signals, studying signal propagation, and identifying sources of radio interference. Security and countersurveillance professionals also use SDU's to find eavesdropping transmitters, or "bugs," which, in many cases, an SDU can spot as soon as they start transmitting. Most SDU's let you identify and measure the modulation type, amplitude, and bandwidth, as well as frequency.

The Electronic Equipment Bank (or EEB) distributes the high-tech Novex SC3100 LCD Spectral Display, a \$995 SDU that offers full 6-MHz wide sweep coverage (± 3 MHz from where the receiver is tuned). The unit plugs into many popular shortwave receivers and scanners having a direct IF output. Novex also offers a computer-interface option that lets you enhance, store, transfer, and analyze received signals with your PC.

There's also the SDU-100 Spectrum Display Unit, a \$499.95 appliance
(Continued on page 96)

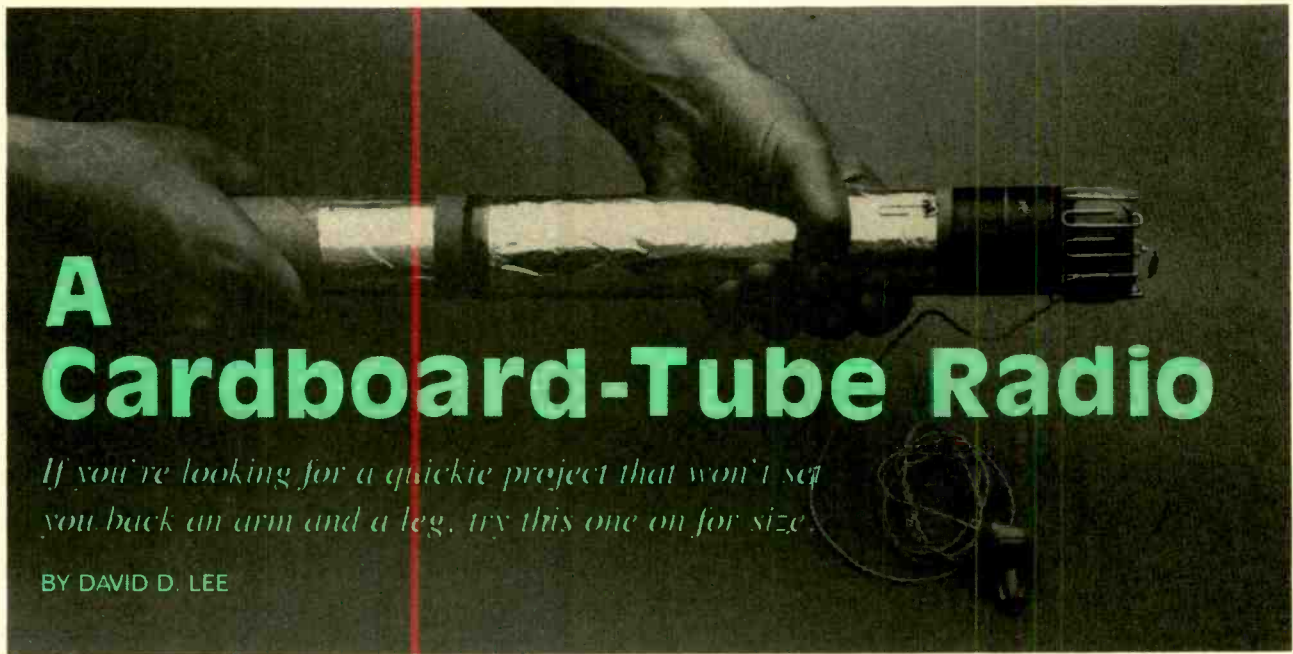

A Cardboard-Tube Radio

If you're looking for a quickie project that won't set you back an arm and a leg, try this one on for size.

BY DAVID D. LEE

Crystal radios, powered only by the energy of the airwaves, are a favorite first project for aspiring young scientists. The version of that project that is presented in this article is comprised of household items—such as tin foil, paper clips, and cardboard tubes—and continues to keep alive the scientific spirit of the typical home experimenter. For many like me, this type of project has led to enriching careers and exciting experiences in science and engineering. Hopefully, this project will do the same for you, too.

Besides the fun of building something out of homemade parts, it gets the beginner past the hardships of finding and buying a variable capacitor. For radio projects, the typical 365-pF broadcast variable capacitor has become a challenge to locate. That's because the popularity of digitally controlled radio tuners and electronically variable capacitors (varactors) has made the standard air-gapped 365-pF capacitor as unpopular as the ancient receiving vacuum tube. (Note: cheap mylar dielectric versions are sometimes still available, though they are disappearing quickly, too.)

AM Broadcast Signals. Let's first understand what our AM radio will receive. When a singer belts out a tune, he/she produces a complex mixture of sound waves, consisting of many frequencies from low bass (around 30

Hz) to high, shrill sounds (around 15–20,000 Hz). Sound waves cannot travel very far because they naturally do not carry well (how far can a shout be heard?), so they must be converted into another form capable of traveling vast distances.

The audio produced by the singer is picked up by a microphone that converts the sound energy into an audio-frequency electrical signal. That converted audio signal is then electronically mixed with a radio-frequency (carrier) signal, producing a carrier signal with the audio signal taking a piggyback ride—just like a person riding on a jet plane in order to move faster and go farther. The process of mixing is called AM (amplitude modulation). The amplitude-modulated signal is then radiated into the air via a radio transmitter connected to an antenna (see Fig. 1).

The RF signal travels through the atmosphere (passing through trees, buildings, and non-metallic objects), and sometimes skips off of the invisible ionosphere (located 30 to 260 miles above the Earth's surface), returning to Earth hundreds and even thousands of miles away from the transmitting site.

The RF signal is picked up by an antenna and is delivered to a radio receiver, where the signal is demodulated (converted), returning it to an audio-frequency electrical signal. That audio-frequency electrical signal, is applied to a transducer (speak-

er or earphones), which then converts the electrical energy back into sound waves.

About the Circuit. To make use of the radiated RF energy, an antenna—which acts as an electric net—captures and feeds the waves to a radio receiver. Upon entering the radio, the RF energy arrives at inductor L1 (see Fig. 2). Energy built up in L1 energizes L2 and L3 through a transformer effect, which moves the RF energy from the antenna to L2, L3, and C1. That combination, called a tuned circuit, selectively passes only one signal frequency (called the resonant frequency) to the earphone, while blocking all the other frequencies. The neat thing about tuned circuits is that they are variable. By varying the tuned circuit, it is possible to choose the signal (station) you want to hear.

Tuning is accomplished via a variable capacitor, C1. Capacitor C1 is a homemade variable capacitor fabricated by inserting an aluminum-foil covered tube within another larger tube, which is also covered with aluminum foil. The two foil layers, or plates, never electrically touch because they are always separated by the width of the cardboard tube wall (called the dielectric). Capacitance, which is related to the amount of overlapping surface area between two plates, increases as the smaller tube is pushed further into the larger tube. The tuner (resonant) frequency

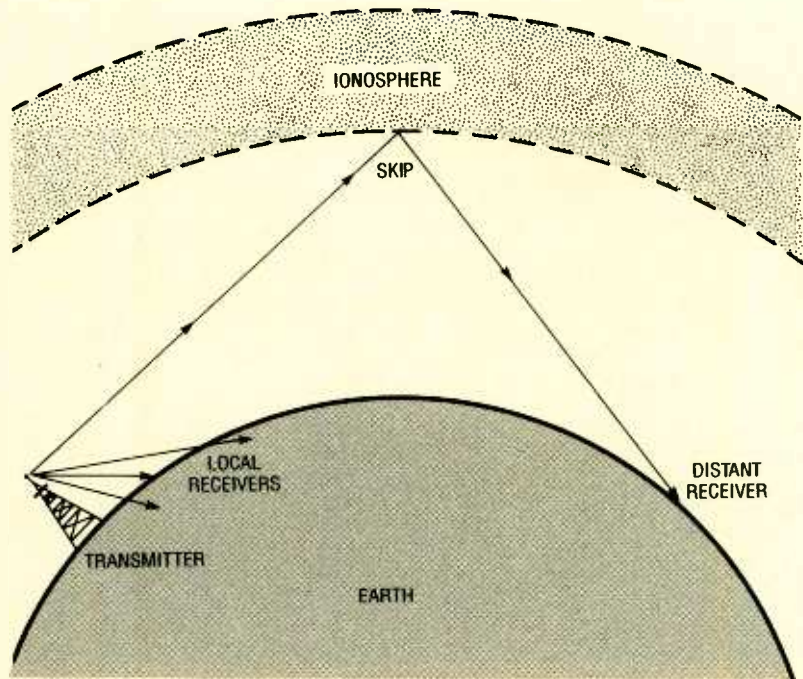

Fig. 1. Radio frequency (RF) signals can sometimes skip or bounce off the ionosphere (which is located 30 to 260 miles above the Earth's surface), and land thousands of miles away from the transmission site.

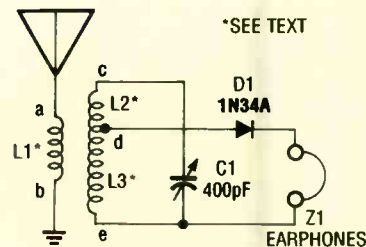

Fig. 2. The Cardboard Tube Radio is comprised of three homemade coils, a diode, a capacitor, some foil, and of course, the tubes.

crystal earphone transforms the electrical signals into sound waves, which then becomes music to your ears.

Construction. The capacitor was fabricated from two identical cardboard tubes like those used in kitchen paper towels. Any cardboard tube will work fine (even bathroom tissue tubes can be glued together), but make sure that each finished tube is at least 11 inches in length (as shown in Fig. 3).

For the inner tube, a slit is cut all

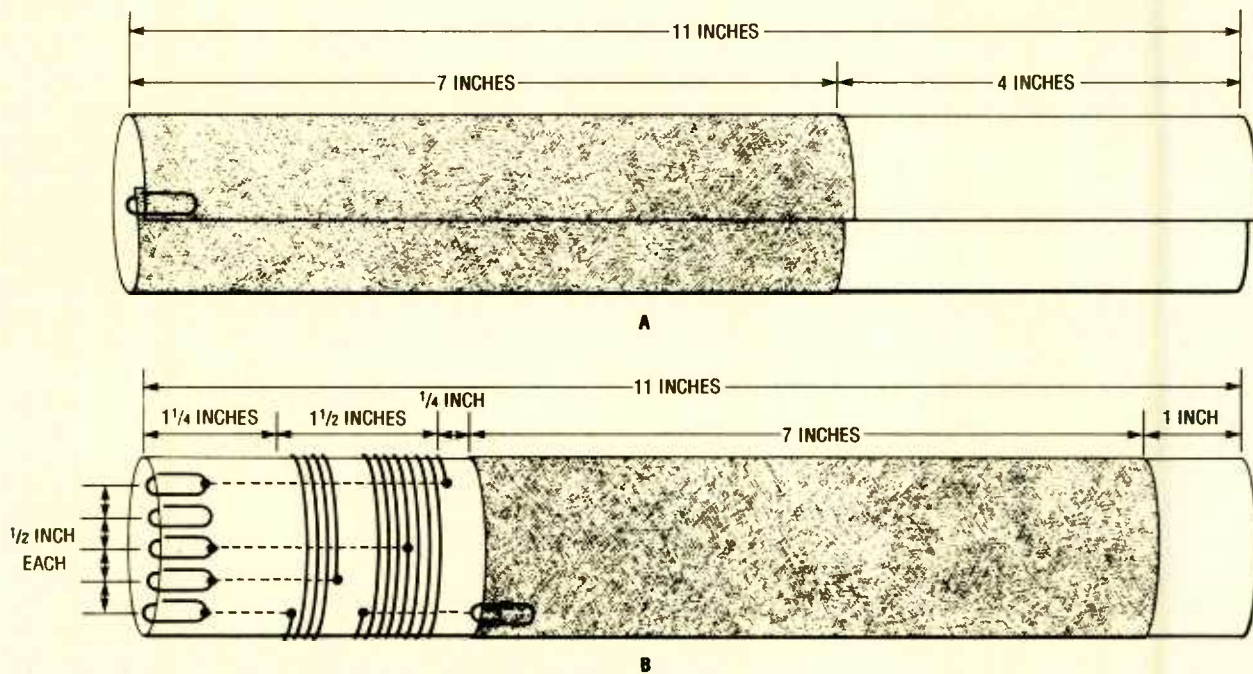

Fig. 3. The capacitor was fabricated from two identical 11-inch cardboard tubes. One tube (which will serve as the inner one) is slit along its length, and about seven inches of it is covered with foil (as shown in A). The second tube is then also covered with foil over about seven inches of its length; the non-foiled end of the tube then serves as a form for winding the three coils (as shown in B).

decreases with the amount of capacitance, so you will notice the effect of tuning down (right to left on an imaginary radio dial) as the tubes mesh together.

The tuned-frequency energy then flows through diode D1 (a common

1N34A general-purpose germanium unit). The diode's job is to extract audio signals from the RF (carrier) signal. The diode picks out these signals through a process called rectification, or demodulation, and converts the RF into electrical audio signals. Finally, the

along the tube's length. The slit lets you compress the inner tube's size so that it can slide snugly inside the outer tube. After the slit is cut, wrap aluminum foil over 7 inches of the tube's length, starting at the top edge. Use Scotch tape to secure the foil in place. Leave

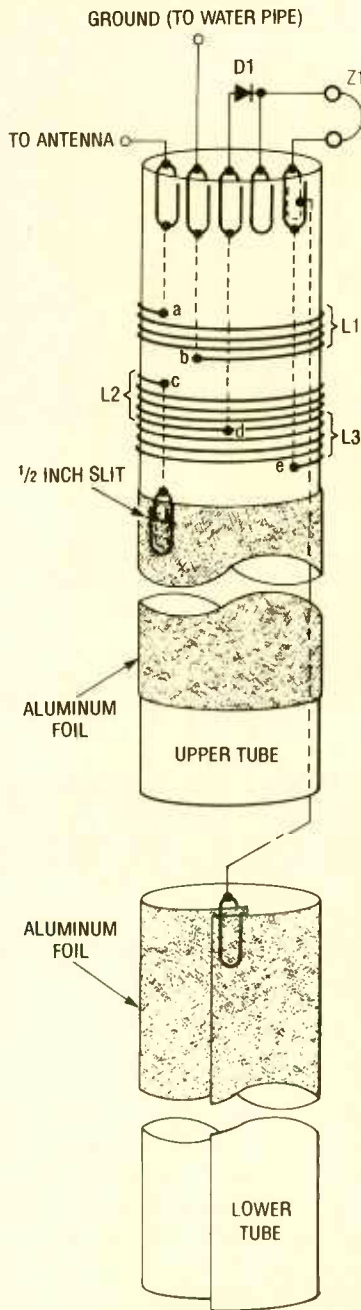

Fig. 4. After the coils have been wound on the foil-covered tube (see text for details of coil fabrication), and the paper clips, diode, etc., as shown here, to complete your radio. Note: The inner foil-covered tube is referred to in the diagram as the lower tube, because that's the position it occupies relative to the outer tube (which is designated as the upper tube).

at least 3 inches at the tube bottom uncovered. That's where you'll need to hold and tune the inner tube without electrically interfering with the properties of the foil capacitor.

Another 7 inches of aluminum foil is then wrapped around the bottom



Here are all of the items need to assemble your own Cardboard Tube Radio.

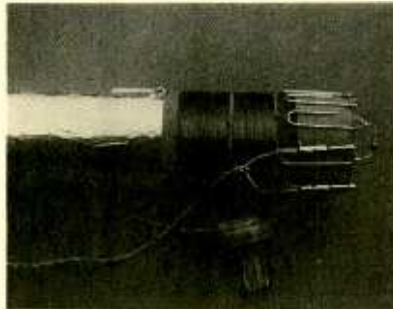

The outer tube serves as both one plate of the variable capacitor and the coil form.

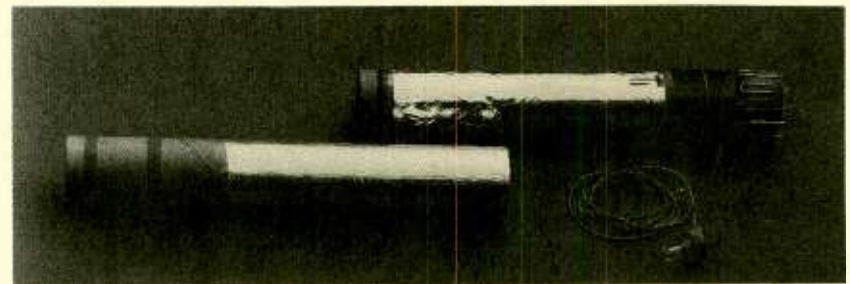

The two halves of the Cardboard Tube Radio are shown here just prior to final assembly, which involves nothing more that inserting the smaller tube inside the coil capacitor assembly (the larger one).

outside wall of the outer tube, and again scotch tape is used to keep the foil secured on the tube. Afterward, coil L1, which consists of 25 turns of 24-gauge enameled wire (also called magnet wire), is wound at the top end of the outer tube as shown in Fig. 4. Don't forget to leave a little extra wire at both ends of the coil to serve as leads.

After that, wind another 25 turns on the tube directly below L1 for coil L2, leaving a little extra wire at both ends for the leads. Finally, wind 60 turns of wire directly below L2 for L3 (don't forget the extra wire length for the leads). Using sandpaper or a sharp knife, scrape the enamel insulation from the ends of the coil leads to prepare them for connection to paper clips.

PARTS LIST FOR THE CARDBOARD TUBE RADIO

- C1—400-pF variable capacitor (see text)
- D1—1N34A general-purpose germanium diode
- L1-L3—See text
- Z1—Crystal earphone (see text)
- Small metallic paper clips (5), aluminum foil, 24-gauge magnet wire, Scotch tape, etc.

Note: The crystal earphone, Z1, is available from Mouser Electronics (2401 HWY, 287 N. Mansfield, TX 76063-4827; Tel. 800-346-6873) as part number 25CR060 for \$1.56 + shipping and handling.

Then punch small holes into the cardboard tube to serve as wiring guides. Use a sharp needle or nail, but avoid pressing too hard and collapsing the tube's wall.

Small paper clips are used as connection posts. It is best to solder each wire connection to its respective paper clip; but if you don't have solder-

ing iron, do not despair; the connections can be made by simply wrapping the lead wires snugly around the paper clips. For good electrical contact to the foil, make sure that the paper clip has plenty of tension against the foil. Aluminum foil does not normally solder, so do not try to solder the wires or clips to the foil.

The connection to the upper tube's foil is a little tricky. Cut a slit through the foil and tube, about 1/2-inch wide, and slip the paper clip into the slit so that a good connection is made with the foil. It is recommended that the wires be attached or soldered onto the clip before slipping the clip into the slit.

Connect diode D1 between the clip connected to point D (see Fig. 4) (Continued on page 87)

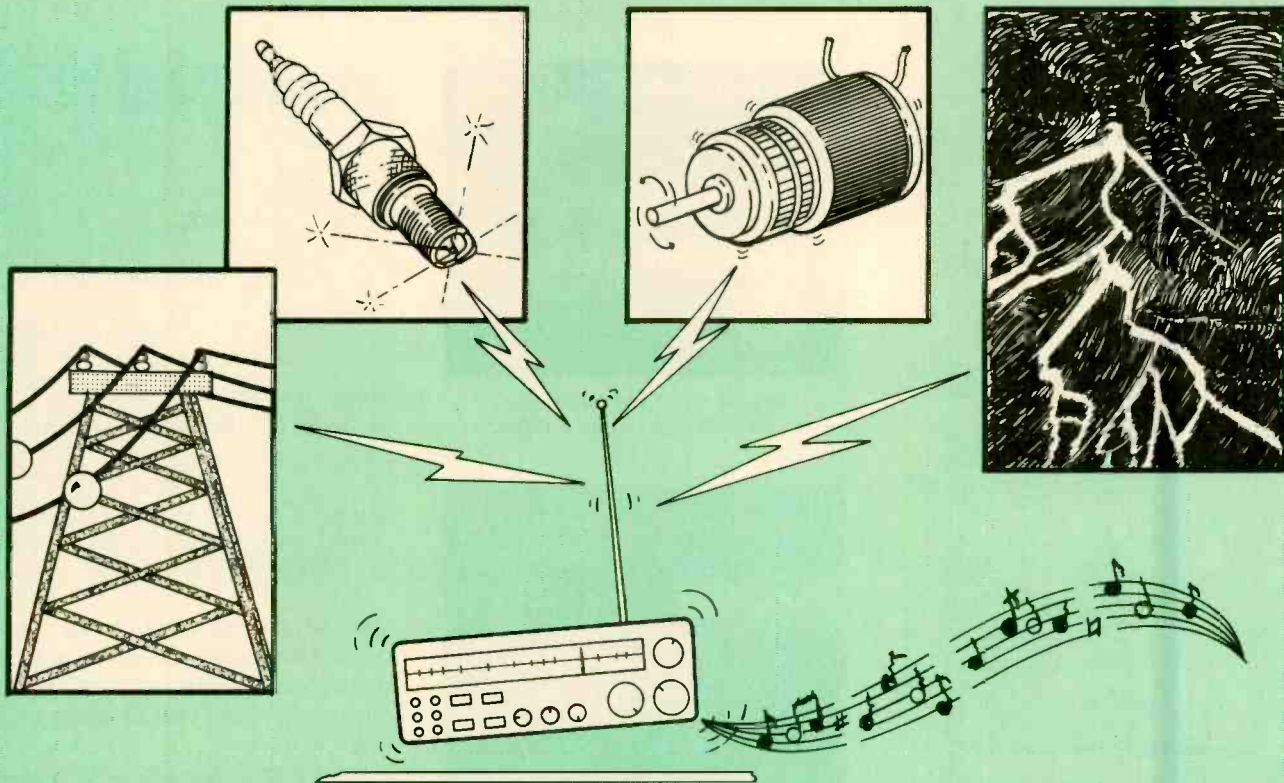

FIGHTING INTERFERENCE

Learn about the various types of electrical interference, the harm it can do, and the measures you can take to stop it cold.

BY GARY EGGLESTON

Electrical interference takes many forms. It can be the squiggly lines on your television screen, the strange voice on top of the music from your stereo, or a ghost-like noise on an FM signal. However, these are only harmless examples; Interference can be dangerous. Consider an RFI-induced malfunction of a pacemaker in a cardiac patient, or the failure of a car's electronic braking system during a crucial moment.

Obviously then, electrical interference is something every electronics hobbyist should be aware of to help make safe, interference-free projects and for general troubleshooting purposes. The solution to all interference problems lies in finding the source and then applying the appropriate remedy, which isn't always easy. Let's take a look at how the sources of interference have multiplied over the years before we discuss the cures for each one.

The History of Interference.

Electrical interference was born the day the first radio transmissions were made by Marconi. Marconi had great difficulty reducing interference between two broadly tuned spark transmitters. The trouble was that the coherer of that day was much too hospitable a device. It accepted any signal that came its way.

Such interference became known as Radio-Frequency Interference or RFI. Another name for RFI is electromagnetic interference or EMI. Those terms now cover any type of electrical signal capable of being propagated into, and interfering with, the proper operation of any electrical or electronic equipment (not just transmitters and receivers). Over the years interference has acquired more specific names. In the early days of radio, the term "broadcast interference" or BCI was coined. When television boomed around the fifties,

television interference or TVI was born.

Early broadcast interference was manageable because it affected only a few listeners. The TVI problem was much greater because of the explosion in TV viewing once inexpensive black-and-white sets became available. Now the kinds of RFI have multiplied and devices that are susceptible to RFI abound.

Anything that radiates radio waves (especially an inadvertent source) is a potential source of radio interference. Furthermore, all radio receivers and all transmitters are potential sources and victims of RFI for a number of reasons: the receiver or transmitter may be poorly designed, improperly built, incorrectly installed, or badly tuned. Any or all of these factors can create unwanted interference in a nearby radio, television, or stereo set. Navigational, public-service, and government services can also be affected.

Electromagnetic interference first

became a truly big problem in the early days of the telegraph and telephone. By 1885, the routing of telegraph and telephone lines together on common poles created interference and coupling between the two systems. By 1890 interference on telephone circuits was introduced by the then-new DC electric railways or trolleys that came into general use.

By 1900 it was necessary to separate telephone, telegraph, and power lines because of interference. About that same time, the first investigations of inductive power-line interference and construction practices were underway.

Finally, the Radio Act of 1912 officially recognized the problem of radio interference for the first time, but offered no solution other than to suggest that radio transmitters should emit "pure waves."

After World War I, telephone and telegraph systems became more complicated and telephone dialing pulses were introduced. Those advances furthered the interference between communications lines. To resolve interference, the International Telephone Consulting Committee was created under the sponsorship of the League of Nations.

Radio communication also developed rapidly in the twenties. It quickly progressed into a number of rather sophisticated systems without much thought being given to problems of interference. Because of the interference problems caused by fre-

quency congestion and poor regulation of signals and harmonics, the Federal Government established the Federal Communications Commission or FCC in 1934 to regulate the use of radio and wire communications.

Spark-Discharge Interference.

Electromagnetic interference can be transmitted by radiation, induction, or conduction. By radiation we mean the electromagnetic propagation of noise through space. Conduction is transmission through an electrical circuit. The most common path for both radiated and conducted interference are the power and control leads of equipment. Figure 1 illustrates both mechanisms. The interference can be radiated directly from the interference source to the receiver by inductive or capacitive coupling, or it may be coupled through the power source or its filtering network.

Of course, radiation is the key mechanism of interference between two devices that don't share power lines. One of the nastiest forms of radiative interference is generated by spark discharges. When the voltage between two points separated by an air gap is high enough to ionize the air in the gap, a spark discharge bridges the gap. As the air ionizes, it radiates various electromagnetic signals that will interfere with just about any nearby radio or television receiver.

A lightning stroke is a natural source of sparks and thus of spark-discharge interference. A good example of a

useful man-made spark discharge is the spark produced by a spark plug during fuel ignition in a standard combustion engine.

The characteristic sound associated with a spark-discharge interference (not to be confused with the sound of a spark itself) may be described as a buzzing, rasping, or popping noise (similar to bacon frying in a skillet). Spark-discharge interference seen on the TV screen appears as a band of horizontal white dashes moving slowly up the screen. The width and intensity of the dashes depend on the severity of the interference.

Something called "commutation noise" can be loosely considered a form of spark discharge. Commutation noise is generated when contacts of a switch, motor brush, relay, or whatever complete a current-carrying circuit and generate a tiny spark. Since the noise generated during contact commutation indirectly results from a spark, the solutions for discharge and commutation noise are essentially the same. For that reason and for the sake of simplicity, we'll discuss commutation noise as though it were just a form of spark-discharge noise.

Eliminating Spark-Discharge Interference.

Many times spark-discharge interference can be suppressed by the use of a noise filter. A noise filter suppresses the energy in the spark and prevents it from being radiated or conducted down the power line.

The simplest suppression device is a small capacitor placed at the terminals of the spark discharge. To see how this can be used to reduce noise from a motor look at Fig. 2. A capacitor may be placed across the motor terminals or two capacitors may be used to bypass both brushes to the metal frame of the device. Special ceramic-disc capacitors are available for this job and are recommended. "Plain Jane" 600-volt disc capacitors are not recommended as they are not tested for use with a continuous AC signal such as electrical noise.

Automobile-Based Interference.

Gasoline engines are full of spark-noise sources. Spark plugs, points, distributor contacts, alternator slip rings,

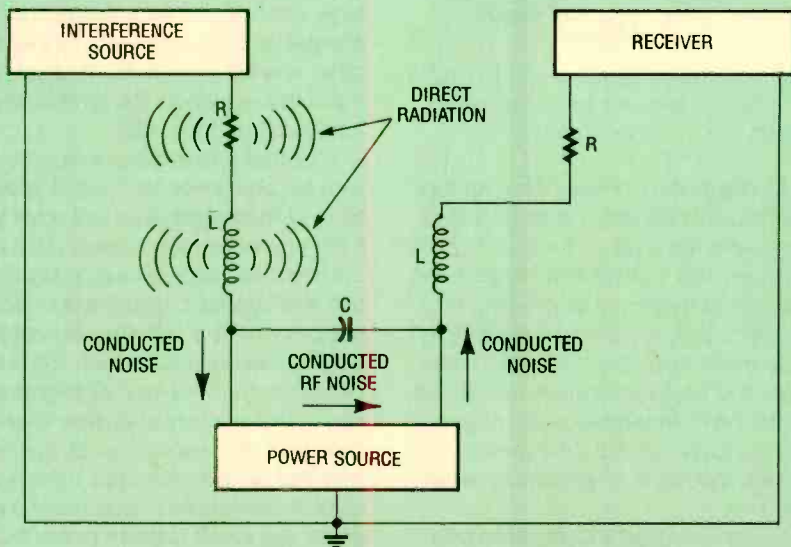

Fig. 1. There are numerous transmission mechanisms for RFI. Shown here are some of its conduction paths and radiation paths.

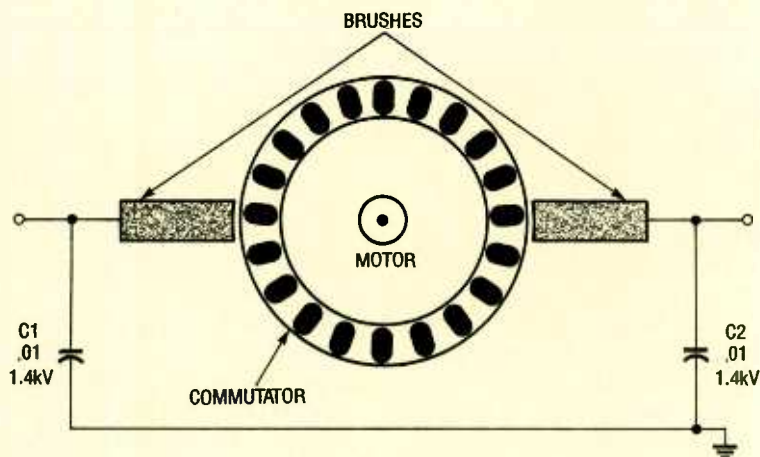

Fig. 2. The brush noise of a small electric motor can be eliminated by bypassing each brushes noise to the metal frame of the motor.

generator brushes, and voltage-regulator contacts all have gaps that electricity must jump in the normal operation of the engine. These parts form three separate circuits. First, there is the high-voltage secondary circuit consisting of spark plugs, distributor contacts, and the ignition coil's secondary winding. The high-voltage secondary circuit is the source of the worst radiated interference. Next, there is the low-voltage primary ignition circuit, which consists of the distributor points, condenser, and ignition-coil primary winding. The primary circuit generates both conducted and radiated interference. Last, there is the alternator/generator and voltage-regulator circuit. It can also produce both conducted and radiated interference.

The distributor cam, which is geared to the engine, opens and closes the distributor points in step with the crankshaft's revolutions. When the points are closed, current flows from the battery through the ignition switch, to the distributor points and primary winding of the ignition coil. Since the current through the primary is DC there is no current flow induced in the secondary at this time.

When the distributor points are opened, the primary current is interrupted, so the magnetic field around the windings of the coil collapses, inducing a high voltage (over 10,000 volts) across the secondary winding. That high voltage is applied across one of the spark-plug gaps via a set of contacts in the distributor cap. Consequently, there are two high voltage arcs, or sparks, generated each time

the points open: one at the spark plug and the other in the distributor cap. The primary ignition circuit also produces noise, specifically commutation noise, because there is a spark whenever the points start to open.

A car's alternator is another source of interference. An alternator is an AC generator driven by the engine. Its alternating current is rectified by diodes that are part of the alternator. The rectified direct current is then fed to a regulator and other systems in the car.

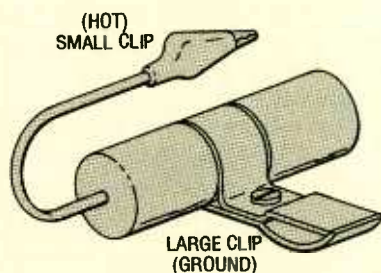

Fig. 3. A bypass capacitor can be used as a noise suppressor or, if equipped as shown here, a noise-locating tool.

An alternator contains slip rings that electrically connect the rectifying diodes with the coils in the rotating armature. This contact arrangement results in a minimum of sparking and, consequently, a minimum of noise interference from the alternator. However, the spark amplitude increases when the commutator or slip rings are worn or dirty. Naturally, the greater the sparks, the more interference generated.

So, as we've just shown, even properly adjusted and carefully tuned engines create some radio interference.

However, if the spark plugs, points, or distributor contacts are defective, there will be more sparking. If the sparks are bad enough they can generate more noise. The same is true if the spark plug gap has widened or the voltage-regulator points are not making good contact.

Note that these conditions can exist without affecting the operation of the engine enough to be apparent to the average driver. They should be checked and repaired before installation of a noise-suppression system. However, a perfectly maintained engine can still produce serious amounts of electrical noise.

Vehicle-Noise Hunting. Although it cannot be totally eliminated, engine noise can be suppressed in two ways: by discovering and suppressing it at the source, or by suppressing it along the signal path just before the recipient of the interference. A combination of both methods may even be necessary.

Of course, checking-out the vehicle is the first step. With the car in motion, operate the equipment experiencing interference. Listen to the interference carefully; each type of interference you hear on a mobile receiver will give you a clue as to its identity by its characteristic sound.

Ignition noise is identified by a popping sound that increases in tempo with higher engine revolutions. It stops instantly when the ignition key is turned off even at a fast idle.

Generator or alternator noise is a high pitched musical whine that increases in frequency with higher engine speed. However, it does not instantly stop when the ignition key is turned off at a fast idle.

If the radio noise is more elusive, you may be able to locate it with a special tracing technique that will save you time and effort. You'll need a clip-on coaxial capacitor (shown in Fig. 3). To use the bypass capacitor, it must be clipped to the engine or vehicle frame. Then you just touch the small clip lead to all live electrical connections in the battery and alternator circuits with the exception of the field terminal on the alternator. If the noise level in the troubled equipment drops when you touch a given point, it indicates a noise suppression device such as a bypass capacitor should be

permanently connected at that point in the circuit.

You can also hunt for interference sources using a "sniffer coil," (like that shown in Fig. 4). To use the sniffer coil, attach the plug to the receiver in place of the regular antenna. The clip is then attached to the vehicle's frame or engine. Start the engine and turn on the radio. Probe around the engine and wiring with the coil. Bounce or shake the vehicle during probing. Maximum interference will be heard when the probe is near the noise source.

Another method for finding noise requires that you place a dummy load on the receiver antenna terminals in place of the regular antenna feedline. Start the vehicle, turn on the radio, and listen. You won't hear signals, of course, but you may hear noise. If you do, the noise is entering the radio via the power and control cables.

Vehicle Noise Suppression.

Conventional bypass capacitors (like the one shown back in Fig. 3) are not very effective at high frequencies. So to eliminate power-line-conducted noise in HF or VHF equipment, you should use coaxial capacitors (see Fig. 5) instead. They work by passing noise current to ground, while leaving the DC on a radio's power lead unaffected.

To place the capacitor in a circuit, the body flange of the capacitor is bolted to the engine frame or body of the vehicle. Make sure good electrical contact is made at this point. The lead to be filtered is broken and the free ends are connected to the two capacitor end terminals. The coaxial capacitor is rated for the number of amperes it can carry between the two terminals. Make sure the one you use is rugged enough for your needs.

To reduce the radio noise generated by the ignition system, it is necessary to install noise filter capacitors on the ignition coil and to restrict radiation from the wiring. This reduces the transfer of noise to the radio equipment by both conduction and radiation.

Begin by removing the coil and scrape the paint from the brackets and mount at the mating surfaces. Bolt the coil back in place using lock washers under the nuts to achieve a

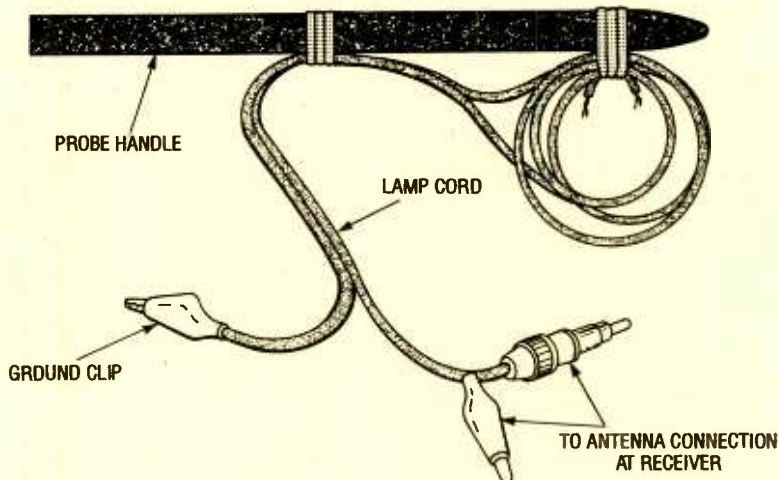

Fig. 4. An RFI sniffer can be made from a stick, zip cord, two alligator clips, and a male motorola connector to trace noise to its source.

secure ground connection. Next, install a 0.005- μ F, 1.6-kV ceramic-disc capacitor at the coil distributor terminal and solder the free lead to the mounting bracket. Lastly, install a 0.1- μ F coaxial capacitor near the battery terminal of the coil. This is connected in line from the ignition switch. Once the coil modification has been made, the level of radio noise should

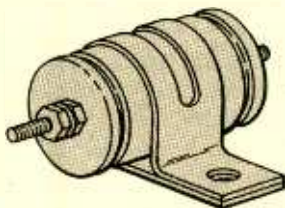

Fig. 5. Since bypass capacitors are useless at shortwave or VHF frequencies, a coaxial capacitor is used for noise suppression at those frequencies.

be checked with a dummy antenna connected to the radio equipment. If noise can still be heard, a coaxial capacitor must be installed on the "hot" power lead to the radio and bolted to the radio case. That should rid the radio of conducted interference.

The high-voltage wiring can radiate ignition noise directly to the antenna of communications equipment. Noise suppressor resistors are commonly used to reduce the level of noise radiated by the spark-plug wiring. Various types of resistors are available. Some are separate components for use at the distributor or spark plug terminals. Sometimes a sup-

pressor is molded into the distributor rotor.

The most popular form of suppressor resistor is resistance ignition cable, which contains a resistive conductor rather than ordinary wire. Those cables are available from most automotive-supply outlets.

A more effective and expensive device for noise suppression is the resistor spark plug. This is a special plug with a built-in resistor. The effectiveness of the plug is due to the proximity of the suppression resistor to the spark gap, which prevents the radio noise from escaping from the plug.

To prevent alternator whine from affecting the communications equipment, clean the slip rings and make sure the brushes are making good contact. Then install a 0.5- μ F coaxial capacitor at the output terminal of the alternator. Ground the capacitor to the alternator frame. Two capacitors are required for the dual terminals of a heavy-duty alternator.

Corona Discharge on Powerlines.

Power-line RFI can be traced to several sources. The first is interference attributed to the components of the distribution system. Second, interference attributed to consumer equipment connected to the power line. Third, interference remotely generated and coupled into the line by normal electromagnetic propagation. Let's talk about problems in the distribution system.

Once electric power is generated, its voltage is stepped-up as high as 500 to 1,000 kV for better long-dis-

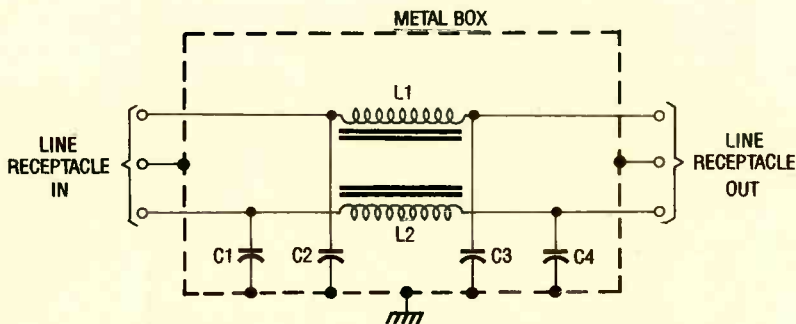

Fig. 6. This is an example of what is contained in a typical line filter. The components impede the transmission of noise and guide it to ground instead.

tance transmission. It is stepped back down for local distribution, and finally stepped down to a still lower voltage for use by the consumer.

Electronic-noise can be introduced to the line in any of the circuits between the power facility and the home. RFI from power lines is principally caused either by spark or "corona" discharge. Corona discharge is due to ionization of the air in the vicinity of a high-voltage conductor. Ionization is an energy transformation process, producing visible light and broadband RF energy as well as ozone. Ozone is a corrosive product that brings about the ultimate destruction of insulators and nearby metallic surfaces.

Radio noise from corona discharge varies substantially with frequency and atmospheric conditions. The intensity is usually greatest in damp weather. Bursts of noise occur at distinct frequencies, with the general noise amplitude gradually decreasing with increasing frequency.

Corona discharge can be reduced by proper attention to power-line construction and elimination of dirt and contaminants on line insulators. Obviously, you should not attempt this yourself. This is a job that must be left to the local power utility.

Power-Line Sparking. Another common source of noise is sparking at some point along the powerline. A blue spark will occur at sea-level atmospheric pressure when there is an air gap of less than .05 cm between metal components or hardware on a power pole. The metal surfaces need not be connected to the lines since induced voltage from the lines can charge the nearby metals to a sparking potential of about 300 volts. The spark releases broadband RF energy

and, for a 60-Hz power line, has a repetition rate of 120 Hz. From its origin, the noise might then be distributed over a wide distance by the power lines.

Most sparking RFI generated in an overhead power system originates on wood poles, which support powerlines that carry distribution voltages from 2.4 to 55 kV and long-distance transmission voltages from 60 to 115 kV. Typically, the higher the line voltage, the less the noise.

A power-line spark cannot take place unless there is a high resistance between the power source and the spark gap. The resistance can be rust or corrosion on the pole hardware, the electrical resistance of the wood of the pole, the leakage path across an insulator, or a combination of these elements.

When the potential difference across the gap is great enough and the series resistance is high, a relaxation-oscillator circuit is formed in which displacement current alternately flows and ceases to flow across the gap. A molecule of gas in the gap will be ionized when the gap potential is sufficient to give enough kinetic energy to a free electron. Once free an electron can knock other electrons from their orbits as it accelerates toward the positive side of the spark gap. If the number of free electrons gets high enough the gap becomes sufficiently ionized to cause a rapid decrease in gap resistance from thousands of ohms to about 200 ohms. As that occurs, a flood of electrons flows across the gap.

Interestingly, photons of light are released when the electrons are knocked from their orbits and recombine with other ions. The photons released for by oxygen's electrons is in the blue part of the spectrum, which accounts

for the bluish color of high-voltage sparks.

Spark interference can cause radio-receiver audio undulation, and/or produce a frying, buzzing, scratching, or popping noise. On a TV screen it visually shows up as "shot lines" or "snow" in horizontal bands moving vertically up the screen. The width of the interference bands depends upon the proximity and intensity of the noise source.

If a capacitor won't suppress all the RFI in an AC power circuit, it is usually advisable to use a line filter instead. Figure 6 illustrates a typical line filter. It is composed of bypass capacitors that provide low-impedance paths to ground for the noise signal and inductors that present a high-impedance path along the lines to impede noise conduction. Such filters are enclosed in a grounded metal box.

What is Being Done About RFI.

The fact that most pieces of electronic equipment effect one another has been known for decades. Numerous programs to study "electromagnetic compatibility" have been undertaken by the military and by private industry. Much has been done to eliminate or reduce the effects of RFI in expensive military and aeronautical equipment. Unfortunately, little of that thinking has filtered down into the less-expensive, highly competitive consumer market.

Manufacturers of home-entertainment equipment believe that only a small percentage of the total units sold will ever be used under RFI-rich conditions. So they are reluctant to incorporate interference-rejection circuits that drive up unit prices but might never serve a useful purpose. Similarly, the manufacturers of transmitting and industrial power equipment only include enough RFI-filtering and -suppression circuitry in their equipment to satisfy the minimum requirements of the Federal Communications Commission.

The Solution: Consumer Protection.

Given the present unsuitable situation, what can be done? A consumer should inquire, before they make a purchase of an electronic device, whether the product has been certified for operation in the pres-

(Continued on page 92)

A ONE-CHANNEL RF REMOTE CONTROL

BY BRIAN MCKEAN

Build a simple yet versatile RF remote-control transmitter that can be used in variety of applications.

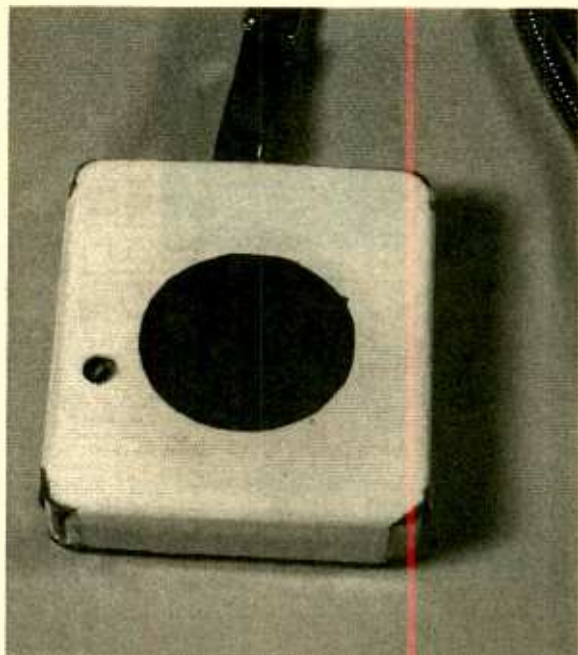

This article describes a simple, single-channel, RF remote-control transmitter for use with a conventional stereo receiver. The circuit, which transmits a 19-kHz tone, has an unobstructed range of about 30 to 40 meters using a 15 cm wire for an antenna. Without an external antenna, the circuit is capable of transmitting over a distance of 2 to 4 meters.

Applications for the transmitter include its use as a remote annunciator (doorbell switch), remote power control, intrusion alarm, stereo decoder/tester, etc. It also has value as a practical VHF demonstrator project. Several possible receiver circuits are also presented that can be adapted to a particular need.

Circuit Detail. The transmitter is built around the ECG/NTE1014 hybrid RF amplifier/oscillator, a functional block/pinout diagram of which is shown in Fig. 1. As shown, that chip contains two transistors and assorted biasing elements that can be configured in a variety of ways.

In our circuit (see Fig. 2), one of U2's internal transistors is used to form a conventional grounded-base Colpitts oscillator (as indicated by the circuit's tapped-capacitor feedback).

The resonance frequency of the LC tank circuit is modulated by varactor diode D1. The varactor diode's capacitance changes from 25 to 30 pF for reverse bias voltages of 1.5 to 0.1 volt, respectively. The varactor diode

has two functions in the circuit: it provides fine-frequency control of the carrier by means of a DC bias adjustment, and it is the element that implements the frequency modulation function.

A 7555 CMOS timer/oscillator (U1)—which is configured as an astable oscillator with a duty cycle of 35%—is used to generate a 19-kHz "pilot" tone (modulating signal). The modulating signal is applied to the anode of D1 after being scaled by a resistor network (consisting of R5 and R6) and summed with a DC offset voltage provided via potentiometer R3. That signal is filtered to reduce harmonics of the fundamental. The peak modulation amplitude applied to the varactor is selected to provide a frequency deviation of approximately 20 kHz, which is somewhat greater than the 10% modulation of commercial broadcast pilot tones.

Diodes D2 and D3 provide a voltage reference for the varactor. Without the reference, the varactor voltage would shift with changes in the supply voltage, thereby shifting the frequency. Those two diodes allow a 1.3-volt maximum bias across the varactor. Although that may appear somewhat restrictive, it allows the circuit to function without significant frequency drift down to 2.0 volts on the supply.

A loosely coupled, untuned secondary winding (L2) that is wound on L1 couples the oscillator to the output

buffer (formed by U2's second transistor). The buffer is biased in Class-A mode, and the collector of the buffer is a tuned LC circuit with a tapped capacitor impedance transformer.

Antenna tuning is accomplished via L4. That inductance is chosen for a 15-cm, linear, thin-wire antenna that has a capacitive reactance of 500 ohms and a real resistance of less than 10 ohms. The RF output power is slightly less than 1 mW with a 3 volt supply. No discrete component filtering is used after the RF amplifier stage, although the ground plane will provide HF attenuation. The second carrier harmonic has measured typically 60-dB down.

The circuit draws about 6 mA from two button-cell batteries. (RM-675 cells will provide 30 hours of continuous use, while zinc-air cells will provide twice that.) The circuit will function down to 2.0 volts with a 3- to 6-dB decrease in output power.

Assembly. The author's prototype of the Remote Control Transmitter was surface-mounted on a double-sided 1/16-inch thick printed-circuit board, measuring about 1 1/4 by 1 7/16 inches in area. (The cladding thickness of the printed-circuit slug is not critical.) At that size, the transmitter can easily fit into any one of a number of plastic fuse containers.

A template of the components side of the author's foil pattern is shown in Fig. 3A; the other side of the board

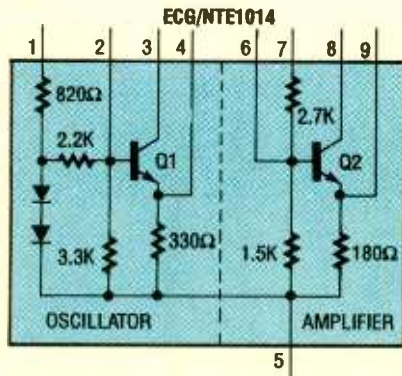

Fig. 1. The transmitter circuit is built around an ECG/NTE1014 hybrid RF amplifier/oscillator, which contains two transistors and assorted biasing elements that can be configured in a variety of ways; a functional block/pinout diagram of that unit is shown here.

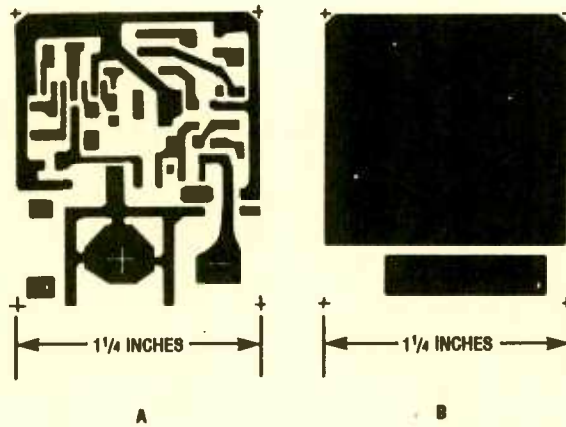

Fig. 3. The author's prototype of the Remote Control Transmitter was surface-mounted on a double-sided printed-circuit board, measuring about 1 1/4 by 1 7/16 inches in area. A template of the component side of the author's foil pattern is shown in A; the other side of the board (essentially a ground plane) is shown in B.

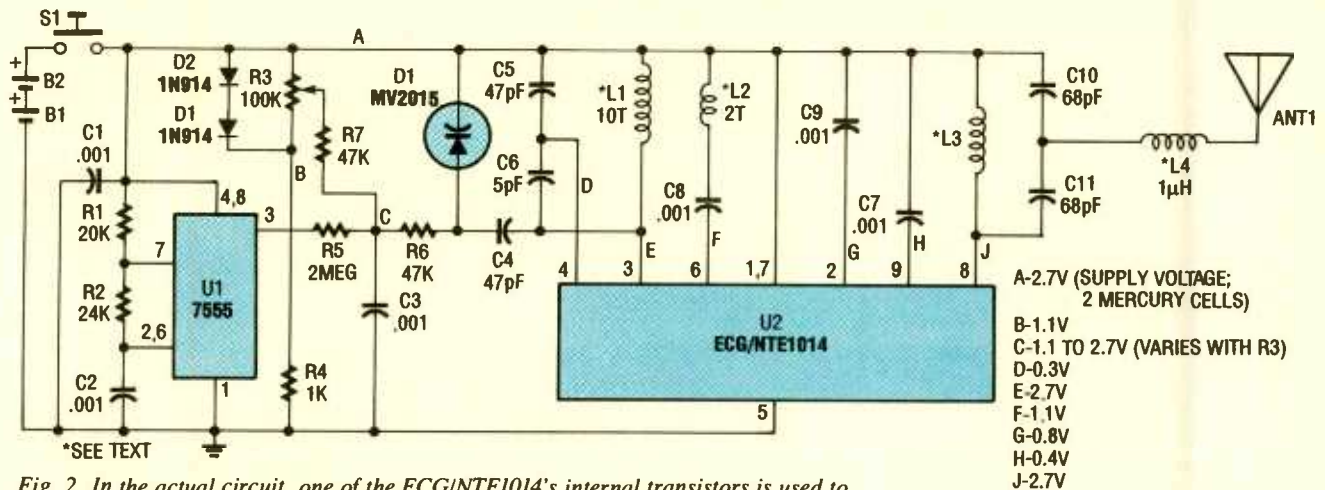

Fig. 2. In the actual circuit, one of the ECG/NTE1014's internal transistors is used to form a Colpitts oscillator, whose LC tank resonance frequency is modulated by varactor diode D1.

(essentially a ground plane) is shown in Fig. 3B. Once the board has been etched, drill four holes in the board at the points labeled FT (for feedthrough) in Fig. 4, using a #76 (0.020-inch, 0.5mm diameter) drill bit. Note that those four holes represent the only board drilling that's required.

When assembling the board, a 7- to 15-watt soldering pencil is recommended. Use fine-gauge solder or reflow soldering methods to minimize the amount of solder deposited at a joint. Most of the capacitors and all the resistors are specified as surface mount, however the resistors can be replaced with 1/8- or 1/10-watt leaded units. When installing surface-mount (SMT) components, it is common practice to use the minimum amount of solder to perform the job. The solder at a good SMT joint should not rise

above the level of the component and should form a smooth, curved (concave) surface between the component's side and the top of the printed-circuit board. The idea is to ensure that the solder yields rather than the component in the event of board stress.

Begin assembly by inserting 30-gauge wire through the holes shown in Fig. 4 and soldering the ends to the pads on either side of the board. Then, referring to Fig. 5, install capacitors C1 through C11. Capacitor C6 is specified as a leaded part for convenience, however, an SMT-style unit can be used, if available.

Next install resistors R1 through R7. Potentiometer R3 may be positioned with a counter-clockwise (CCW) shaft rotation, moving the slider in the direction indicated in Fig. 5. That orien-

tation allows clockwise (CW) rotation of the turn screw to increase the frequency. Potentiometer R3 may be any suitable single or multi-turn unit. Fine frequency control is easily accomplished with a single turn unit.

Mount S1 on the four pads provided. Only two pads serve as electrical connections, so the switch can actually be one of a number of physical styles. Cut the leads of the switch so that the upper surface of the button is flush with the upper edge of the case sides; that allows the switch to be depressed when the case lid is squeezed.

The next step is to bend and trim the leads of U2, and then position and solder U2 as shown in the parts-placement diagram (Fig. 5). The upper surface of U2 should not project beyond the upper surface of the case sides.

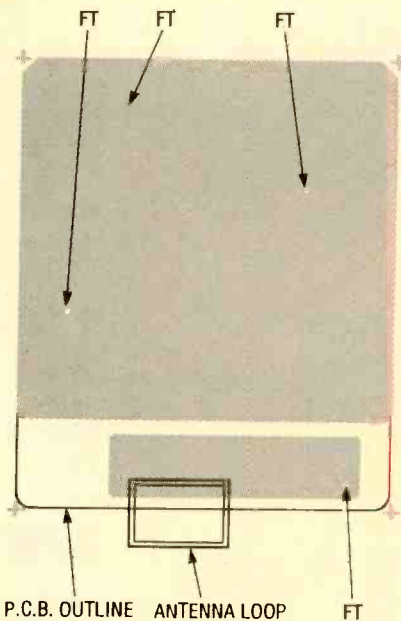

Fig. 4. Once the board has been etched, drill four holes in the board at the points indicated in this diagram, using a #76 drill bit. Note that those four holes are the only board drilling that's required. Once drilled insert #30-gauge wire through the holes and solder the ends of the wires to the pads on both sides of the board.

After U2 is installed, clip the leads of U1 to 0.5 mm from the bottom of its body and mount it as shown. Pin 5 of U1 need not be soldered to the board.

Once that's done, install L1, L2, L3 and L4. (See the boxed text titled "Inductor Winding" for coil winding details.) Coils L1/L2 and L3 are formed so that their leads straddle the capacitors underneath. If a ceramic-disc unit is used for C6, it may have to be moved from directly under the L1/L2 assembly. Components should not rise more than 0.5 cm above the upper surface of the circuit board. That allows the circuit to be installed in a conventional fuse pack.

Wells for the button cells were formed from 3 strips of 1/32-inch single-sided, copper-clad, circuit-board material; two of which are cut to about 1 x 0.3 cm, and the third to about 2.5 x 0.3 cm. Orient the shorter strips above the metal pads provided on the board between points S and S, and P and P. The metal cladding must face toward L4. Tack solder the strips to the board. Mount the longer 2.5-cm strip between points L and L with the copper-clad surface facing towards the circuitry. Before soldering the 2.5-cm strip, cut a shallow groove

in the strip at the location that crosses the negative circuit trace.

Bend and form the leads of D1, D2, and D3 to fit the parts layout. Those diodes are all physically positioned adjacent to strip LL, so they are mounted last. Route an insulated jumper wire from the junction of C10 and C11 to L4. Use the path illustrated in Fig. 5.

The antenna used in the prototype is actually a flexible metal-link chain that was outfitted with a jeweler's clasp. A closed-loop soldered to the antenna pad on the reverse side of the board serves as the contact point (refer back to Fig. 4). That loop extends beyond the case wall through a slot and allows the antenna to be removed as the user desires. The loop itself does not act as a loop antenna—it is simply an attaching point. A secure, soldered connection is preferred due to the low antenna imped-

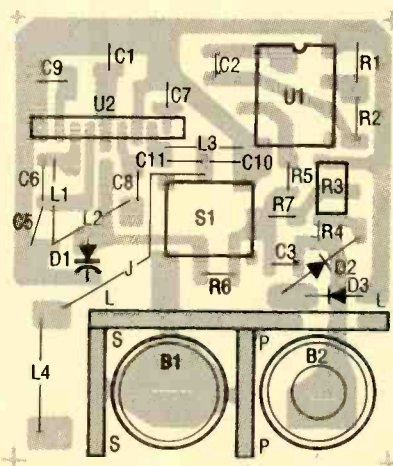

Fig. 5. Referring to this parts-placement diagram, install capacitors C1 through C11, followed by resistors R1 through R7, switch S1, and so on until assembly is complete.

ance, however, the clasp arrangement proved practical and functional.

Chip Capacitors. If you cannot find, or a minimum quantity prevents you from buying chip capacitors, an excellent source for surface-mount chip capacitors are general-purpose, ceramic, multi-layer leaded parts of the CK05BX or CDR31BP series (or similar). Those capacitors are small (1 x 3 x 3 mm), rectangular, black or tan epoxy coated units that are found in high density computer/instrumentation

INDUCTOR WINDING

All of the coils were close-wound on the body of 1/4-watt carbon-composition resistors; the resistors should have values of 10k or more. Do not use metal film or carbon film with flared end-cap terminations. Carbon-composition resistors make convenient forms for hand-wound coils; the Q of the coil is not degraded so long as resistor values greater than 10k or so are used.

Coil L1 (which serves as a transformer primary) consists of 9 turns of 26 AWG enamel-coated wire wound on a 10k or more resistor body. Start by wrapping a turn on one resistor lead, and then winding 9 turns on the resistor body. After the 9 turns have been placed on the resistor body, secure the turns in place, and connect the free end of the coil to the other resistor lead.

Coil L2 (serving as a secondary) consists of two turns of #26 wire wound adjacent to the windings of L1. See Fig. A. Beginning on the end of the resistor opposite to where L1 began, place one turn on the lead of the resistor, and then wind two turns on the resistor body. Do not connect the free end to the opposite lead. Install that homebrewed unit on the circuit board as shown in Fig. 5 elsewhere in this article. The common end of the L1/L2 assembly connects where L1 and L2 meet in the parts-placement diagram; that lead serves as the V+ common lead for L1/L2. The other end of L2 is then cut to 1 cm in length, and soldered as shown (connecting it to C8).

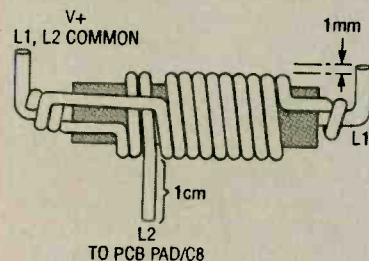

Fig. A. All of the coils used in this project were fabricated by close-winding the specified wire on the bodies of three 1/4-watt carbon-composition resistors.

Coil L3 consists of 7 close-wound turns of 26-AWG wire on another resistor body. Secure and solder the ends of this coil to the resistor leads. Then solder the component in place. Next wind coil L4, which is comprised of 35 turns of 36-AWG wire wound on a third resistor body. The resistor leads must be bent perpendicular to the body axis and as close to the soldered connections as possible. Cut the leads 1 mm from the bottom of the windings. Note: 26-AWG enamelled wire is approximately 0.4 mm diameter and will wind about 23 turns per cm; 36-AWG enamelled wire is approximately 0.15 mm diameter and will wind about 65 turns per cm.

PARTS LIST FOR THE REMOTE-CONTROL TRANSMITTER

SEMICONDUCTORS

- U1—7555 CMOS oscillator/timer, integrated circuit
 U2—ECG/NTE1014 hybrid RF-oscillator/amplifier, integrated circuit
 D1—MV2015, ECG612, or equivalent 23-pF, -1.5-volt varactor tuning diode
 D2, D3—1N914, 1N4148, or similar general-purpose silicon diode

RESISTORS

- (All fixed resistors are 1/10 or 1/8-watt, 5%, chip or leaded film units, unless otherwise noted.)
 R1—20,000-ohm
 R2—24,000-ohm
 R3—100,000-ohm, sub-miniature, Bourns single-turn trimmer potentiometer (part 3329) or Bourns 12-turn (part 3266) or equivalent
 R4—1000-ohm
 R5—2-megohm
 R6, R7—47,000-ohm

CAPACITORS

- C1—C3, C7—C9—0.001- μ F, multi-layer ceramic-chip
 C4, C5—47-pF chip capacitor
 C6—5-pF, NPO, ceramic-disc, or similar
 C10, C11—68-pF ceramic-chip

ADDITIONAL PARTS AND MATERIALS

- L1—L4—See text
 B1, B2—RM675, mercury, or zinc-air button cells
 S1—Subminiature tactile pushbutton switch (Mouser part # P8006S or JAE 62T, or similar)
 ANT1—See text
 Printed-circuit materials (single-sided copper clad, 1/16-inch double-side copper clad), enclosure (fuse box, see text), #26 and #36 enamelled wire, #30 wire-wrap wire, 1/32-inch #22 stiff, solder, hardware, etc.

boards. Those parts are available with various dielectrics (NPO, X7R, etc.), and typically having a 100-volt rating.

They are easily disassembled. Just soften the epoxy by applying a hot soldering pencil to the leads. When the internal solder joint melts, the leads can be pulled away from the part, which will also remove the epoxy over the ends of the unit. That opera-

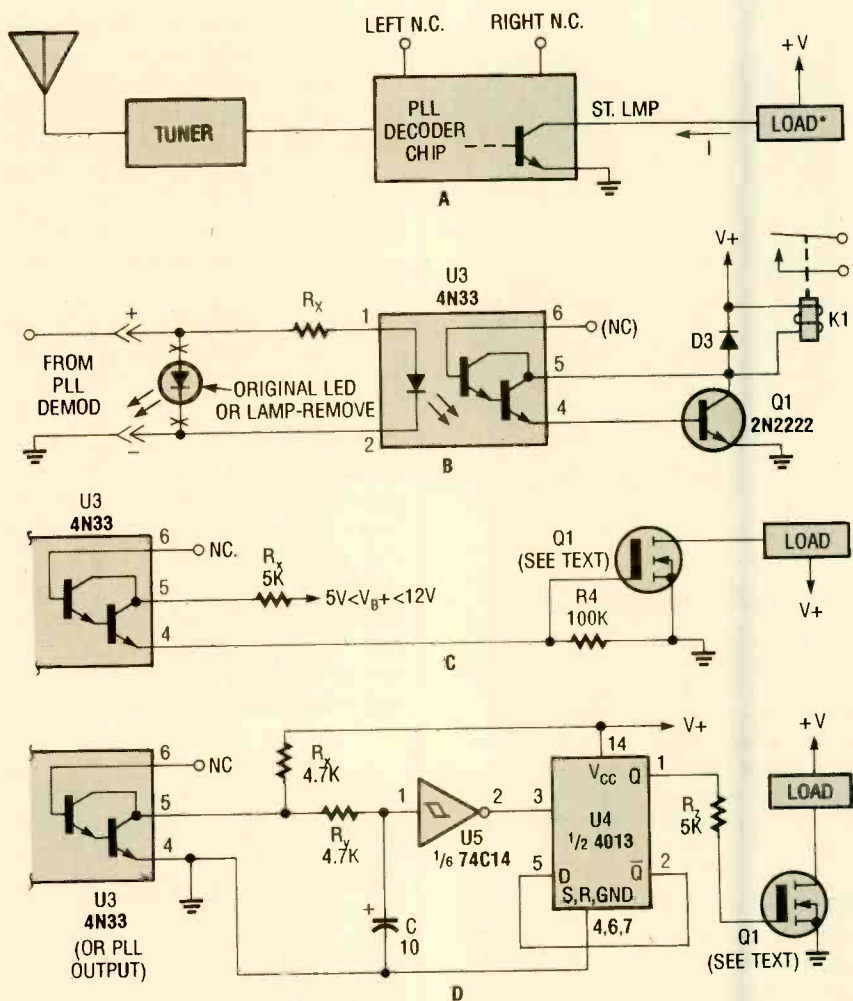

Fig. 6. Shown here are several possible interface circuits that can be used with the Remote Control Transmitter. The one in A illustrates a typical FM stereo MUX decoder with a load connected directly to the open-collector output of a TA7343 PLL; B illustrates an optoisolator-coupled output driving a 12-volt relay coil via a general-purpose transistor; C shows the gate of an N-channel power MOSFET connected to the output of a 4N33; and the final circuit, D, is a toggle flip-flop that allows push-on/push-off control.

tion exposes the chip, providing pry points for further dismantling. The epoxy can also be pulverized by gently crushing the part with pliers, however it is usually easiest to heat the part and chip away the epoxy with a knife.

The success of the chipping procedure depends on the particular type of epoxy used. Some coatings soften but do not melt, others melt readily. The molten state is not particularly easy to work with, but it can be managed. None of the epoxies bond to the chip at high temperature, so the chip can be removed intact. The chip should be discarded if there is any evidence of chipping on the surface of the ceramic. Overheating (especially the leads) may destroy the end-cap metalization by leaching

the metal into the solder. Pulling the lead away from the part before the solder softens will also destroy the end metalization. The typical part numbers for the capacitor values used in this project are: 47 pF, CKO5BX 470; 68 pF, CKO5BX 680; and 0.001- μ F, CKO5BX 102.

The chip bodies are not marked, and size is not an indicator of part value, so keep track of the part values after disassembling the component. If you manage to find a scraped board containing chip capacitors, be aware that conventional two-sided surface mount techniques call for such components to be glued to the board before soldering so that the removal process requires additional heat to

(Continued on page 91)

An Introduction to

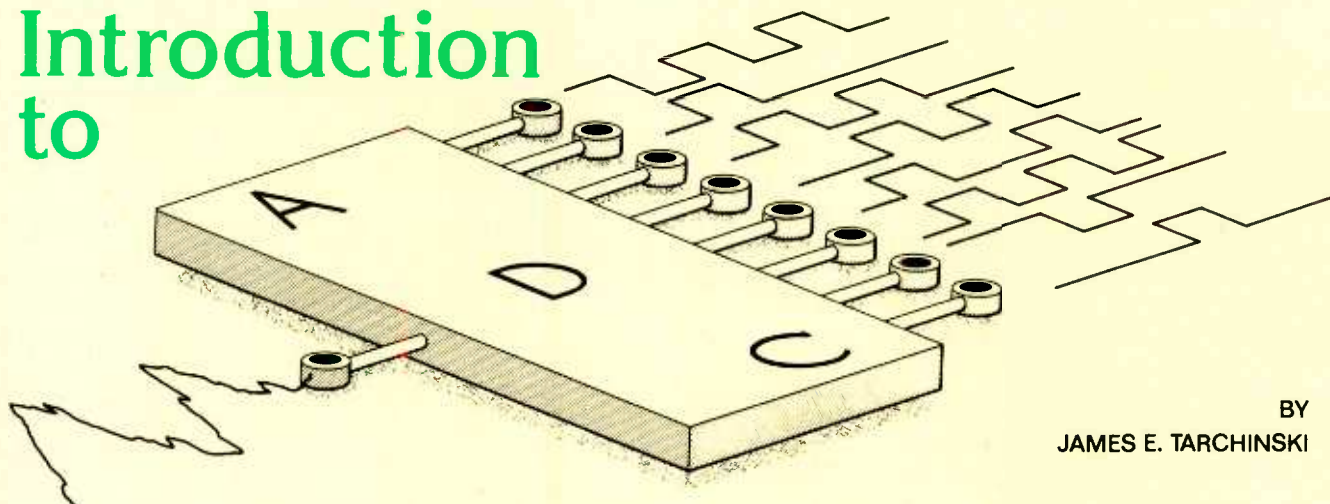

BY
JAMES E. TARCHINSKI

Analog-to-Digital Converters

We look at the components that convert analog signals from the real world into digital signals for use in logic circuits.

Although most people today don't realize it, there are two fundamental types of electronic computers: analog and digital. Back when both varieties were still in their infancy, gatherings of computer scientists and engineers often sounded like a certain modern-day beer commercial. On one side of the room a group would chant "analog computers," while the phrase "digital computers" would come from the other side of the room. From the first side, "the real-world is analog!" From the second side, "digital computers are more flexible!" and so on.

Supporters of digital computers have emerged victorious after the test of time. In fact, they've won by such a large margin that analog computers are now not very well known, being confined to only a small set of specialized applications. However, while digital computers have won the race because of their extreme flexibility, the supporters of analog computers certainly had a good point when they noted that the real-world almost exclusively contains analog signals.

To allow digital computers to deal with nature's analog signals, a special class of integrated circuits called "analog-to-digital converters" (some-

times abbreviated as ADC or A/D converters) are used. Such IC's can read an analog signal and transform it into a series of digital bits. These bits, forming a digital word of a certain length, can then be read and processed by a digital computer. An A/D converter is a digital computer's "window" to the analog world around it.

This article presents a brief overview of analog-to-digital converter technology. It begins with a sample application that is used to introduce the parameters and limitations associated with ADC's. Next, several of the most common types of converters are compared. Finally, the ADC0800 integrated circuit is discussed in detail to provide the reader with a case study of one of the most popular converters currently on the market.

After reading this article, you should be able to ask intelligent questions about, and make educated evaluations of, products containing analog-to-digital converters such as: test and measurement equipment (such as digital multimeters), computer input and pointing devices, digital control systems, data-acquisition systems, digital audio-recording equipment, (CD players, etc.), systems-monitoring instruments, and voice-synthesis and

recognition devices. If you really care to put this new knowledge into practice, you should even be able to design an ADC into your next project.

Example Application. Our example ADC application comes from the automotive industry—a seat control system with two position memories. As shown in Fig. 1, a digital computer (called a "digital system controller") is used to control the entire system.

The system's user interface consists of five pushbutton switches. Two switches allow the driver to manually move the seat either forward or backward. Once the seat is positioned correctly, the driver then presses the set button followed by the button corresponding to his driver number (which amounts to the position number), either 1 or 2. The next time the driver gets behind the wheel, all he needs to do to recall his memorized seat position is press the switch corresponding to his driver number.

Besides needing to know where the driver would like to move the seat, the digital controller also needs to know where the seat is currently located. Acquiring that information is the job of the analog-to-digital converter in the system.

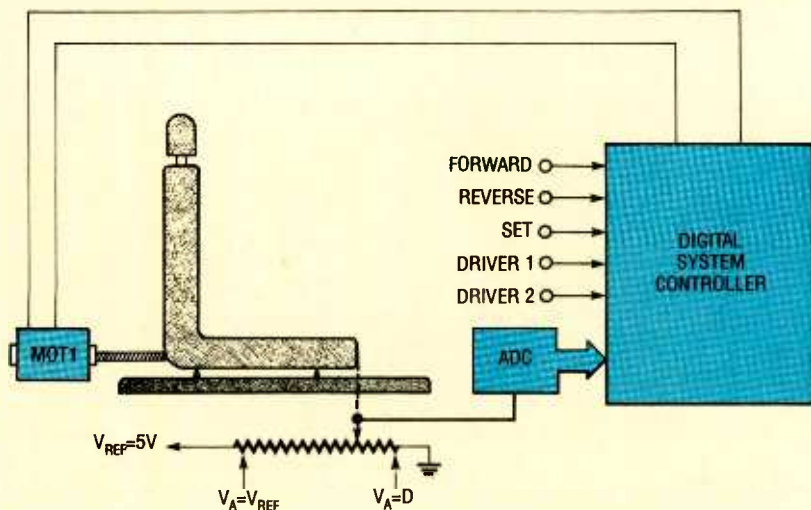

Fig. 1. This is an example of an analog-to-digital converter being used in an automotive control application. As the seat moves, it varies the potentiometer setting.

Figure 1 illustrates how the driver's seat is connected to a linear-movement potentiometer. One end of the potentiometer is tied to +5 volts, while the other side is wired to ground. Therefore, when the seat is at the full-forward position, the potentiometer's wiper terminal will have an analog potential of zero volts, and that voltage will increase linearly as the driver moves the seat rearward.

An analog-to-digital converter is used to read the continuously variable potentiometer voltage (V_A). By reading the digital output of the ADC, the system controller (computer) can determine the location of the driver's seat at any time.

Once the digital controller knows where the driver wants to move his seat, and where the seat is currently located, all it needs to do is calculate the direction in which it needs to move the seat. The controller can then actuate the two lines running to the motor to command it to move the seat in the appropriate direction.

By continually monitoring the position of the seat via the analog-to-digital converter, the controller can deactivate the motor when the seat has reached the desired position, or when it is close to reaching the mechanical limit of its travel. Using this example as a basis, we can now discuss a number of key terms used with this technology.

A/D Converter Terminology. The primary figure of merit for any A/D converter is its "resolution." Nowadays,

the most common resolution is eight bits, meaning that the analog voltage input to a ADC is transformed into digital data (called "codes") consisting of eight binary bits. Because 2^8 is 256, an 8-bit ADC can output 256 valid codes.

Assume that the ADC used in our auto example has eight bits of resolution. When the seat is at the full-forward position, the input to the ADC will be zero volts, while the output lines will read B00000000 (note that the "B" indicates a binary number). When the seat is half way through its full travel, the ADC input will be 2.5 volts and the output will be B01111111 (127 in decimal). Fully rearward, the input is 5 volts and the output would be B11111111 (255 decimal).

To obtain the output code for any particular input voltage to an ADC, the following equation is used:

$$V_D = \text{INT}(V_A \cdot 2^N / V_{\text{REF}})$$

Where V_D is the digital representation (in decimal notation) of V_A , which is the analog input voltage to the ADC, N is the number of bits of resolution provided by the ADC, V_{REF} is the ADC reference voltage (which equals the maximum value of V_A), and INT is the integer function—it returns only the integer portion of the expression in parenthesis.

Next, assume that the full travel distance for the seat is eight inches. We can convert the resolution of the ADC from the number of binary bits to the equivalent physical distance by dividing the number of valid codes into the physical distance, therefore:

$$8 \text{ inches} / 256 \text{ codes} = 0.125\text{-inches}$$

From this we see that the digital system can only determine the location of the seat to a maximum resolution of an eighth-of-an-inch. If better resolution than this is required, an ADC with more than eight bits of output should be utilized. (Although mathematical purists will cringe at the suggestion, you can loosely think of resolution as being proportional to the overall accuracy of the system.)

Table 1 might help give you a better perception of the numbers associated with the resolution of an ADC. The table assumes that a 4-bit ADC is used in the above seat-control application (not eight bits as we have been discussing). You should keep in mind that a 4-bit ADC would not be practical in this application, as the resulting resolution would only be half of an inch (8 inches/16 codes). The table is presented for illustration purposes only.

The first column of Table 1, labeled "D," is a measure of seat-travel distance (in inches). The second column, V_A , gives the corresponding analog voltage that would be sent by the potentiometer to the ADC. The last two columns give the resulting digital output of the ADC—one in binary notation, and the other in standard decimal numbers.

Today, 8-bit A/D's are by far the most commonly used converters, but it is not the only resolution available on the market. There are also 10-, 12-, and 16-bit integrated circuits, and even some devices with still higher resolutions. Everything else being equal, however, it generally costs more to purchase analog-to-digital converters with better (i.e., higher) resolutions. It is, therefore, a good idea to first check the price of an ADC before you design it into a project.

For our sample application, a 10-bit ADC would be able to resolve the distance, D , into 0.0078125 inch increments, while a 12-bit ADC could theoretically resolve D down to 0.001953125 of an inch.

Just to drive the resolution issue home, you might consider a simple comparator to be a 1-bit analog-to-digital converter (see Fig. 2). While the input voltage is below the set-point voltage of the circuit, V_x , the comparator's single output line will be low (false). When the input voltage rises to

TABLE 1—ANALOG VOLTAGE AND DIGITAL OUTPUT

D	V _A	Binary V _D	Decimal V _D
0.0 – 0.5	0.0000 – 0.3125	0000	0
0.5 – 1.0	0.3125 – 0.6250	0001	1
1.0 – 1.5	0.6250 – 0.9375	0010	2
1.5 – 2.0	0.9375 – 1.2500	0011	3
2.0 – 2.5	1.2500 – 1.5625	0100	4
2.5 – 3.0	1.5625 – 1.8750	0101	5
3.0 – 3.5	1.8750 – 2.1875	0110	6
3.5 – 4.0	2.1875 – 2.5000	0111	7
4.0 – 4.5	2.5000 – 2.8125	1000	8
4.5 – 5.0	2.8125 – 3.1250	1001	9
5.0 – 5.5	3.1250 – 3.4375	1010	10
5.5 – 6.0	3.4375 – 3.7500	1011	11
6.0 – 6.5	3.7500 – 4.0625	1100	12
6.5 – 7.0	4.0625 – 4.3750	1101	13
7.0 – 7.5	4.3750 – 4.6875	1110	14
7.5 – 8.0	4.6875 – 5.0000	1111	15

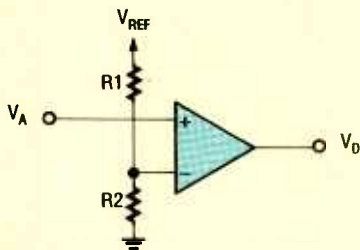

Fig. 2. A simple comparator can be considered a one-bit ADC— V_A is the input analog voltage and V_D is the one-bit digital output. Both resistors should be of equal value for this ADC to be linear.

the set-point voltage or higher, the comparator will change states and the single output bit will go high (true). So the set-point voltage is the voltage resolution of this simple ADC as it is the smallest change in the input that causes the output to change.

Quantization Error. Closely tied to the resolution of an ADC is its “quantization error.” Figure 3 shows a plot of the analog input voltage and the digital output of the 4-bit ADC illustrated in Table 2. Since the digital output can only have certain discrete values, there is an inherent error of the device that is called the “quantization error.” By definition, this error is the difference between the analog-voltage equivalent of the digital output and the actual analog-voltage input.

The error induced by the quantization error varies based on the design of the A/D converter. To balance the effects of this error, most designs use what is called a “half-bit offset” of the analog input voltage. This reduces the offset of the quantization error from a

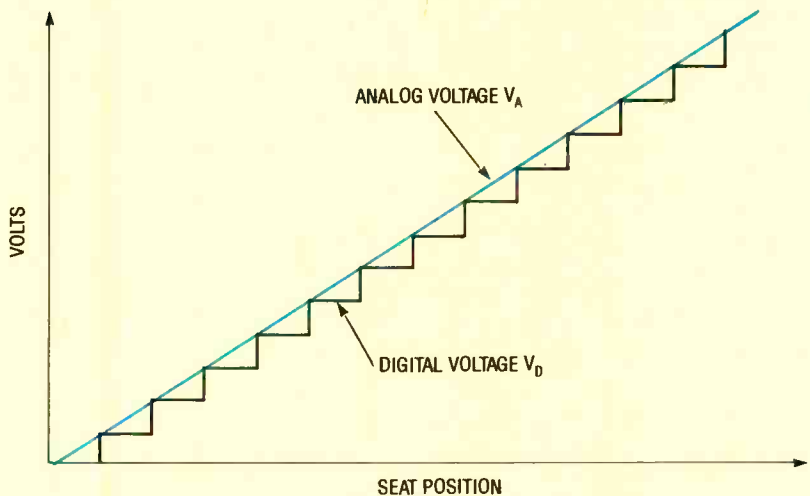

Fig. 3. This plot shows the quantization error induced because the digital output of an analog-to-digital converter can only take on certain discrete values.

maximum of one full bit (as seen in Table 1), to a more acceptable plus-or-minus one-half of the least significant bit ($\pm \frac{1}{2}$ LSB).

Conversion Time. Another key parameter for an ADC is “conversion time.” Due to the time delays and processing steps internal to the converter, there is a delay between the time a ADC chip is told to perform a conversion, and when the result is available to be read on the binary-output lines. This delay is known as the conversion time.

The main reason conversion time is important is that this determines the maximum sampling rate, and hence the ultimate bandwidth, of the system. In some applications the intent is to store enough information to completely reconstruct the original analog signal. That requires that some-

thing known as the “sampling theorem” be met.

What the sampling theorem basically tells us is that if the frequency of the signal we wish to reconstruct is f_i hertz, then the sampling rate, f_s , of the ADC must be at least twice as great as f_i . For example, if you want to record and then reconstruct a 1000-Hz audible tone, your analog-to-digital converter must be able to sample the original sound 2000 or more times a second. Different styles of converters have different conversion times. Therefore, a discussion of these times will be given later when we discuss the different types of converters.

Nonlinearity. Nonlinearity (also called linearity error) is the last parameter of ADC’s that merits a detailed discussion. This error can be induced by a number of factors, but is most commonly associated with component variation within the ADC integrated circuit.

Every 1-bit transition of an A/D converter is designed to occur at regularly spaced intervals of the input voltage. For example, in the car-seat application, a new code was assumed to be generated by the ADC every time the seat were to move 0.125 of an inch. Because of the converter’s nonlinearity, the actual transition point will sometimes take place at an increment of a little less than 0.125 inches, and sometimes at an increment of a little more than 0.125 inches. That is called the device’s nonlinearity, and is generally specified by

the device's manufacturer as a fraction of the device's least significant bit (LSB).

Figure 4 shows an input/output plot of an analog-to-digital converter with a severe linearization error. Note that distances between bit transitions are not equally spaced as they should be.

Types of ADC's. There are a wide range of analog-to-digital converters on the market today. The hobbyist or design engineer must choose between these alternatives by balancing a number of important variables, not the least of which are resolution, conversion time, and the ADC's cost.

This section will take an in-depth look at several of the most commonly used converter types. The four styles of converters we will look at are pre-

sented in order of decreasing cost, which is, of course, generally the same as being presented in order of decreasing overall performance. We'll begin with the very fast "flash converter," continue with the "cascaded" flash converter, then to the "successive-approximation device," and then we'll discuss one form of an "integration-type device." To finish this section, two other flavors of ADC's will be briefly mentioned.

Flash Converter. The flash converter is the logical extension of the one-bit ADC presented in Fig. 2. It uses a number of voltage comparators to generate the digital output.

Figure 5 shows a small portion of a schematic diagram of a flash analog-to-digital converter, which is some-

times call a parallel-comparator converter. This device uses a resistor network to act as a multi-stage voltage divider. The output from this ladder network is then fed into the voltage reference inputs of a series of voltage comparators. The remaining inputs (the non-inverting one) on all the comparators are then tied directly to the analog input voltage, V_A . The outputs from the comparators are then fed into a block of logic (the digital control logic) that takes note of only the highest-weighted comparator active. The logic is used to set the outputs to form the appropriate digital code.

As previously stated, the parallel-comparator converter is one of the most expensive types generally used. The reason for this high cost is the large number of comparators needed. The cost difference is significant because comparators require a large amount of surface area in integrated circuits, and area is directly proportional to the price of the final chip.

To construct an N-bit converter, $2^N - 1$ comparators are required. Therefore, a four-bit A/D converter needs only 15 comparators, while an eight-bit device would need a total of 255 comparators. About 16 times more comparators are necessary just to double the resolution.

One final note will be made about flash ADC's, relating the resistor voltage divider circuit with the quantization error detailed above. In most ladder designs, the top and bottom "rungs" of the network use resistors with only half the resistance of the other rungs. By doing this, the device's quantization error becomes symmetric. Instead of being a maximum of +1 LSB, for example, it will be centered on the band and become a maximum of $\pm 1/2$ of the LSB.

Cascaded Flash ADC. To reduce the high cost of the flash ADC, the cascaded flash (or sub-ranging) parallel-comparator converter was developed. This device combines (or cascades) the digital outputs from two or more separate flash A/D converters, to create a single series of output lines with a digital code representation of the input analog voltage. The key to this device is its use of a digital-to-analog converter.

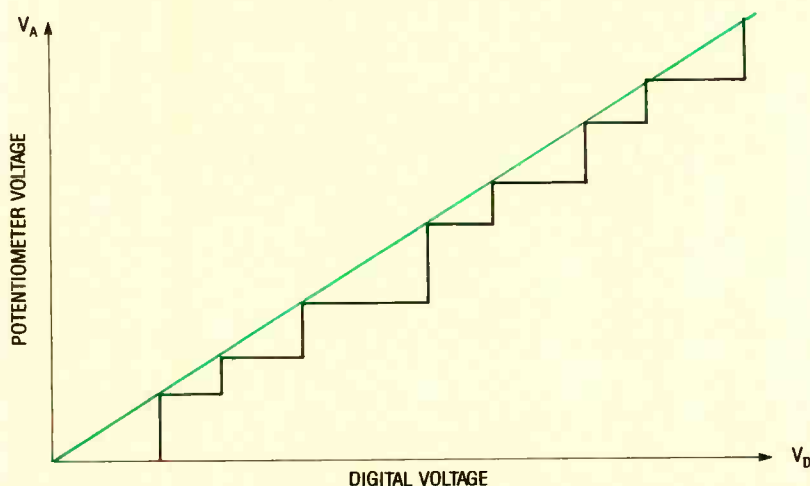

Fig. 4. This is a portion of an input/output plot of an ADC with a linearization error that's extremely pronounced. Note the inconsistent step height.

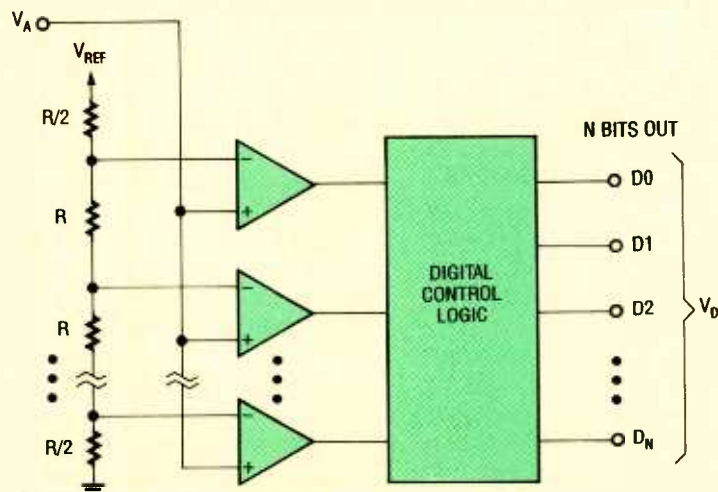

Fig. 5. This is a block diagram of a section of a flash (parallel converter) type of A/D converter. Only the most significant active comparator affects the control-logic output at any given time.

The digital-to-analog (D/A or DAC) converter is the exact opposite of an A/D converter: a DAC converts a series of N binary input lines into the equivalent analog voltage, V_A . Figure 6 shows one of the conceptually simplest methods of accomplishing this, through the use of weighted current sources and a current-to-voltage converter. Each current source produces twice the current of the previous one (1, 2, 4, 8, etc.). Also, the current for each source is turned on or off under the control of a digital input line. The total current, I_A , is then the sum of all the current sources that are turned on. An op-amp and resistor combination are then used as a current-to-voltage converter, generating the analog output voltage, V_A .

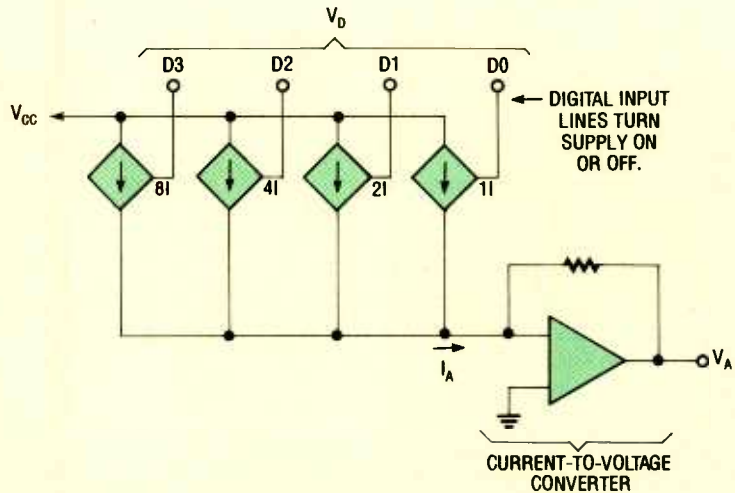

Fig. 6. One implementation of a digital-to-analog converter sums current, which is then converted to produce the output voltage.

The block diagram of Fig. 7 illustrates how a D/A converter is used inside a cascaded flash comparator A/D converter. The input analog voltage, V_A , is fed into an N_1 -bit flash ADC. The N_1 binary output lines of this ADC are then simultaneously sent to a digital-to-analog converter and to the upper N_1 bits of the device's output register. The output of the D/A converter is then input to the inverting terminal of a single operational amplifier, so it can essentially be subtracted from the original analog voltage, V_A , on the op-amp's non-inverting terminal. A second flash ADC in the system then generates another N_2 binary output lines from the resulting voltage. In the last stage of this circuit, these N_2 bits are appended to the N_1 bits from the first ADC to create a digital output code of:

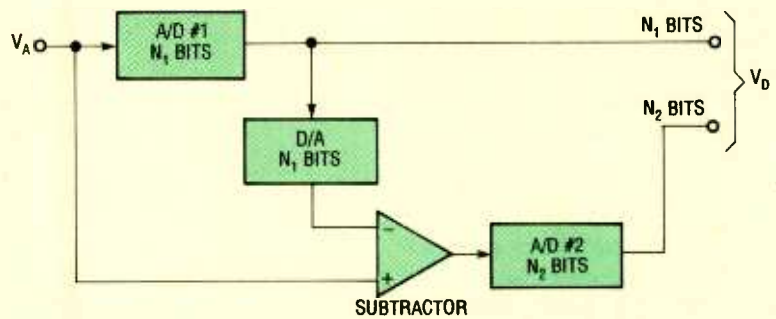

Fig. 7. As this block diagram of a cascaded flash type of converter shows, only a certain number (N_1) of bits are derived from flash conversion.

$$N = N_1 + N_2 \text{ bits}$$

To see how this greatly reduces the number of comparators required over a full parallel-comparator A/D converter, consider the number of comparators needed on each device to generate eight bits of binary resolution (i.e. $N=8$). A subranging flash ADC, assuming it utilized two four-bit flash converters inside, would require:

$$1 + 2(2^{N/2} - 1)$$

comparators. Thus for eight bits of resolution, a total of 31 comparators would be required. A full flash converter would require a total of 255 comparators—over eight times as many as the subranging flash ADC.

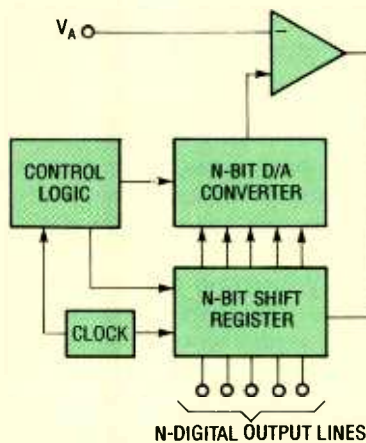

Fig. 8. As you can see from this block diagram of a four-bit successive-approximation analog-to-digital converter, a comparable digital-to-analog converter is needed for conversion.

Even with the need to add a complete D/A converter, subranging flash converters still tend to be much less expensive than the full parallel-comparator converter, although they are

not nearly as fast.

In the above example and discussion, only two flash ADC's were cascaded together. For applications that require extremely high resolutions, additional stages could easily be added in the same manner. While this technique would tend to decrease the cost of the resulting high-resolution converter, it would also tend to decrease its accuracy. This is because the error from several D/A converters would be present in the digital output code, as well as the errors associated with each of the flash A/D stages.

Successive-Approximation Converter.

A further reduction in the number of comparators required for the conversion process is achieved in a successive-approximation analog-to-digital converter. This device only requires a single voltage comparator to perform the conversion, regardless of the number of bits of resolution required at the output lines. With this reduction in comparators, a corre-

sponding price decrease can generally be achieved.

As you might infer from the name, the successive-approximation converter makes a series of educated guesses at the digital value of the input voltage. Just like a child playing a game of high/low, the converter makes subsequent guesses at the value based on the "too high" or "too low" feedback from previous guesses. The four-bit successive-approximation ADC shown in Fig. 8 will help illustrate the make-up and operation of this style of circuit.

As shown, the analog voltage to be converted is fed directly to the inverting terminal of the unit's voltage comparator. The non-inverting terminal of this comparator gets its signal from the output of a digital-to-analog converter, which gets its digital signal directly from the device's output register.

When the conversion process is initially started, the output register (a shift register) contains a value corresponding to half the reference voltage (V_{REF} in the diagram). If $V_A > V_{REF}/2$, then the comparator will output a logic 1, otherwise it will output a logic 0. That value is then shifted into the digital output register, and another voltage comparison is made—this time between the analog input voltage (V_A) and the voltage equivalent of the modified output register. After four such comparisons are made (one for each bit of resolution), the output register contains the digital representation of the input analog voltage, V_A .

Besides the basic components of a successive-approximation ADC just discussed, several other support elements are also required. As shown in Fig. 8, a clock signal must be generated to control the timing of all the events inside the converter. Among the component sections not shown is a counter needed to keep track of the number of iterations that have been made for calculating the digital voltage. It is also used to terminate the conversion process after the correct number of comparison steps, and to generate a "conversion complete" signal to be sent to the rest of the system. Finally, an R/S flip-flop (also not shown in the figure) is used to start and terminate the entire conversion process.

In some ways, the successive-ap-

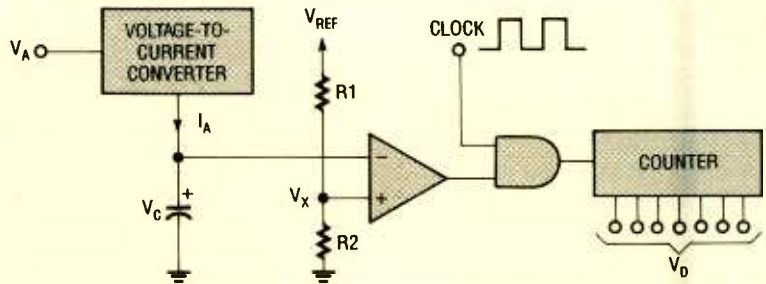

Fig. 9. This is a simplified implementation of one type of integrating analog-to-digital converter. It really measures the charging time of a linearly-charged capacitor.

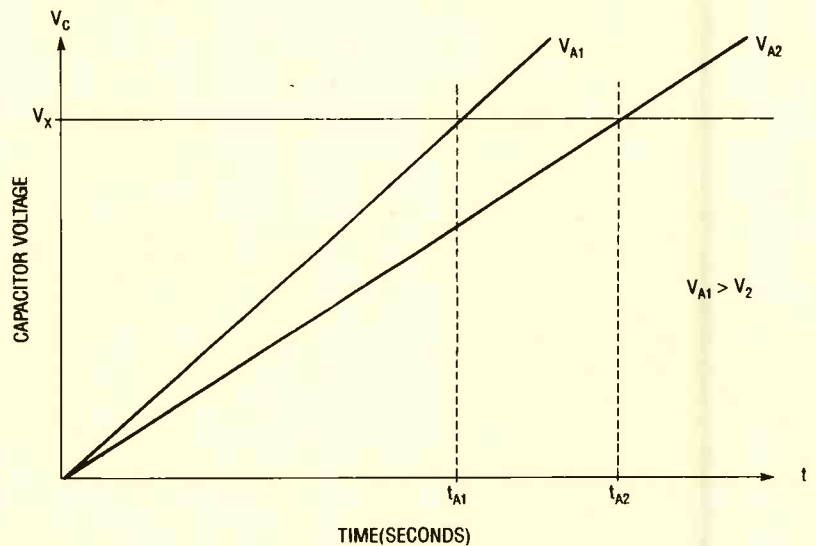

Fig. 10. These are the charging characteristics of the capacitor in the circuit of Fig. 9. Note that the curves are linear, not exponential.

proximation converter is the exact opposite of the parallel-comparator (flash) converter; while the number of comparators required for a parallel comparator ADC increases exponentially as the number of bits of resolution increases, only one comparator is ever required for a successive-approximation ADC. On the other hand, as the conversion speed of a successive-approximation ADC increases proportional to the number of bits of resolution required, the speed of a flash ADC is very nearly constant regardless of the resolution of the device.

While the conversion speed of a successive-approximation ADC is generally slower than that of a flash ADC, a successive-approximation device can still perform conversions at a fairly fast rate.

Integration (Counter-Comparator) ADC. The last type of converter we will look at in detail is called an integration ADC. Actually, there are many

different types of integration converters, but in the interests of space and simplicity, the only one we'll be considering in this article is the counter-comparator A/D converter. A simplified implementation of this unit is shown in Fig. 9.

As shown, the analog input voltage, V_A , is sent to a voltage-to-current converter. This voltage-to-current converter then generates a current, I_A , that is directly proportional to V_A . The output current is then used to charge a fixed-value capacitor, whose voltage will increase a fixed number of volts for every fixed length of time that I_A is applied.

The capacitor's ever-increasing voltage, V_C , is then applied to the input of a single operational amplifier, which then compares this voltage to a reference voltage, V_x , created by the $R1/R2$ voltage divider. The output of the comparator is then ANDed with a standard clock signal, which is then used to decrement a binary counter.

(Continued on page 92)

Programming Serial Ports

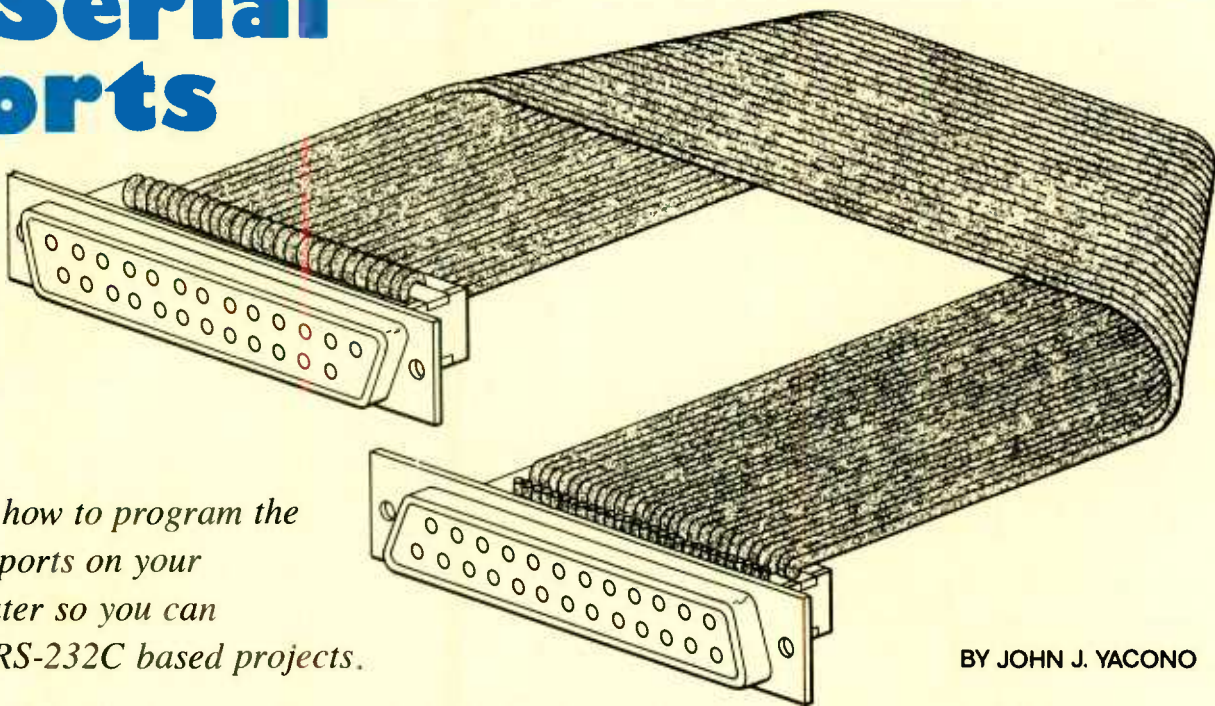

Learn how to program the serial ports on your computer so you can build RS-232C based projects.

BY JOHN J. YACONO

Computers sure have become popular. Since at least one RS-232C serial interface can be found on almost any IBM-compatible computer, that standard is also popular. Oddly, the popularity of PC's and their serial interfaces notwithstanding, there's a scarcity of information about programming your computer to use a serial port.

Being the sort that likes to connect all kinds of stuff to my computer, I found that lack of data a little frustrating. If you have experienced the same frustration, or would just like some general tips on port programming, this article was written with you in mind. Here I'll present some information on the RS-232C lines most commonly supported by PC's, port-input/output/control programming, and the actual bits in the computer that control the serial port.

I'll assume you have at least a little knowledge of programming (like what a statement is, what memory is, what a port is, etc.), and a basic understanding of communication parameters (the number of data bits, odd/even parity, stick parity, and stop bits). As a starting point, let's discuss how the RS-232C standard is implemented on most PC's.

Serial Signals. The RS-232C specification is the Electronics Industry Association standard for low-speed serial communication. It defines voltage levels, loading, signal types, timing relationships, and a lot of other communication parameters.

On a PC/XT, the male DB-25 connector is the standard RS-232C termination (see Fig. 1A). Many AT-386- and 486-class computers are now using a DB-9 connector on at least one of their serial-communications ports (see Fig. 1B). Table 1 shows the signals supported by the pins on both types of connector and their standard abbreviations.

Obviously the 9-pin connectors only carry a subset of the RS-232C standard signals. Frankly, that subset is more than enough for all but the most intense (way-beyond-hobbyist-level) applications. In fact, even though your computer may use a DB-25 connector, chances are that at most only nine pins are connected to anything. That being true, it makes sense to restrict our attention to only the signals that are supported by a PC's serial expansion board, as listed back in Table 1.

All signal voltages are read with respect to the signal-ground line. A volt-

age from 3 to 25 volts represents a 0 (called a "space" in RS-232C "lingo"); and -3 to -25 volts is a binary 1 (called a "mark"). Note that this is negative logic—the high-logic value corresponds to the more negative voltage.

The transmit-data line allows data to be sent from the computer. The complement to that line is the receive-data line. That pin is used to bring serial data from the world into the computer.

The remainder of the signals are used for handshaking. One of those signal lines is said to be on, active, asserted, and true when its voltage is above 3 volts—the logic-zero state of the line.

The request-to-send line carries a signal that indicates that the computer wishes to send data. When the computer has data to send, it will turn that line on and wait for an on condition on the clear-to-send line. When that occurs, the computer sends the data, and when finished it will reset the request-to-send line.

The logic present on the data-set-ready line informs the computer whether the communications link is alive and well. The complement of this line is the data-terminal-ready line. It

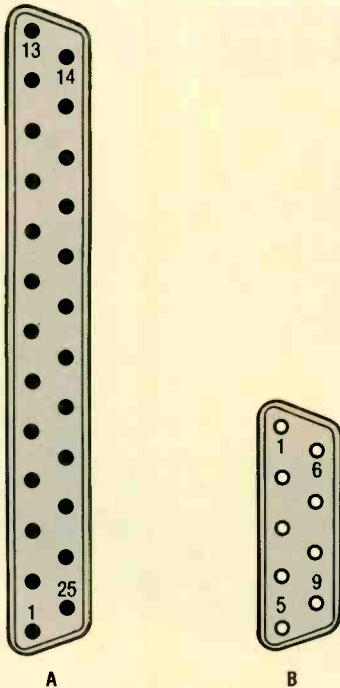

Fig. 1. If you look at the back of your computer, you should find at least one male connector that looks like the one in A or one female connector like that in B.

provides a signal that informs whatever the computer is connected to (a modem or another computer) that the originating computer is up and running.

The data-carrier-detect line is used by a modem to tell the computer that it has an incoming carrier—a signal modulated with information.

When a modem detects a phone-line ring signal it turns the "ring indicator" (RI) line on. That gives the computer a chance to "wake up" and get ready when it's in an auto-answer application. Now that you know the functions of the serial signals implemented by a PC, let's discuss what a

TABLE 1—SIGNALS AND PINS

Signal Name	Abbreviation	Pin on DB-25	Pin on DB-9
Transmit	TXD	2	3
Receive	RXD	3	2
Request To Send	RTS	4	7
Clear To Send	CTS	5	8
Data-Set Ready	DSR	6	6
Signal Ground	SG	7	5
Carrier Detect	CD	8	1
Data-Terminal Ready	DTR	20	4
Ring Indicator	RI	22	9

TABLE 2—ADDRESSES, BITS, AND PINS

Port Addresses in Hexadecimal				Bit in Byte (N)	Input, Output, or Control	Signal or Function
COM1:	COM2:	COM3:	COM4:			
3F8	2F8	3E8	2E8	0	I/O	Databit 0
				1	I/O	Databit 1
				2	I/O	Databit 2
				3	I/O	Databit 3
				4	I/O	Databit 4
				5	I/O	Databit 5
				6	I/O	Databit 6
				7	I/O	Databit 7
3F9	2F9	3E9	2E9	0-7	NA	—
3FA	2FA	3EA	2EA	0-7	NA	—
3FB	2FB	3EB	2EB	0, 1	Control	Number of data bits (00 = 5, 01 = 6, 10 = 7, 11 = 8)
				2	Control	Number of stop bits (0 = 1, 1 = 2)
				3	Control	Parity enable
				4	Control	Odd/Even parity (0 = Odd, 1 = Even)
				5	Control	Stick parity
				6, 7	NA	—
3FC	2FC	3EC	2EC	0	Output	DTR
				1	Output	RTS
				2-7	NA	—
3FD	2FD	3ED	2ED	0-7	NA	—
3FE	2FE	3EE	2EE	0-3	NA	—
				4	Input	CTS
				5	Input	DSR
				6	Input	RI
				7	NA	—

program must do to work with those signals.

Using Addresses. All of the handshaking performed by a serial port is not hardware-automated; for any handshaking to take place the handshaking lines must be directly controlled by a program of some sort. It must be the program's duty to orchestrate the handshaking lines, establish the proper communications parameters (stop bits, parity, etc.), and transfer data.

As you probably know, all programs use a computer's memory to temporarily store data. To organize a computer's memory, it is broken up into small pieces called bytes, and each byte is given its own address to help identify it. It's sort of like marking distinct numbers (addresses) on a bunch of boxes (bytes) so you can refer to the stuff inside each box (data) by using the number of the box it's in (the address). If you want to store (or "write") a byte of data, you can tell the computer to place it in a certain box (address). If you want to look at (read)

some already stored data, you can ask the computer to retrieve it from the appropriate box (address).

Data addresses—unlike residential addresses, which identify a house by number, street, city, and state—are simply numbers. However, most of the time, programmers don't write programs that refer to actual addresses to store and retrieve data. Instead, they use variable names—various combinations of letters and numbers, which are more descriptive and thus more intuitive for we humans to use—like "TOTAL" or "CUSTOMER." After a program has been written, the variable names are translated into appropriate addresses so the program can store and retrieve data in a manner that suits the computer.

However, there are certain times when even we humans need to use the numerical value of an address instead of some made-up variable name. Typically, numerical addresses are written in a number system called "hexadecimal," which is neither binary or decimal. The hexadecimal system contains 16 digits (0-9 and A-F)

rather than two (as in binary) or ten (as in decimal). For the rest of this article, when we refer to any address, we will use the hexadecimal number system. In BASIC, to indicate a number is written in hexadecimal, you append the prefix "&H" to the number. For example, the hexadecimal number "B" (which is 11 in decimal form), would be written "&HB."

So far we've discussed how to write to and read from memory using addresses. Fortunately, reading incoming data from, and writing out-going data to ports is done in the same way; in a program, you refer to a port by specifying the address of that port. In BASIC, to send data to a port you would use a statement of the form:

```
OUT address, data
```

where *address* is the address of the port, and *data* is the data you wish to send (note the customary line number has been dropped for clarity). For example, to send the decimal number 4 to a port with the hexadecimal address D2, a program must contain the statement:

```
OUT &HD2, 4
```

Note that since 4 is a decimal number, it has no prefix.

Similarly, you can use the following statement to get data from a port:

```
IN address, variable name
```

where *address* is the address of the port, and *variable name* is the name of the variable (which the computer will translate into a memory address) you want the data to be stored under. For example, to grab data from a port with the hexadecimal address E7, and store it in the variable "PORTDAT," a program must contain the statement:

```
PORTDAT=INP(&HE7)
```

The statement sets the value contained in the variable PORTDAT equal to the data contained in the port with the hexadecimal address E7.

In BASIC, the OUT and INP statements are precisely what a program needs to communicate and control the serial ports of a computer. You should be able to find analogous programming statements in your own favorite computer language. Since we've covered how to write programs to talk to ports, let's discuss how to handle serial ports in particular.

Serial-Port Addressing. Each serial port, normally referred to as COM1:, COM2:, COM3:, and COM4: in DOS documentation, is supported by seven addresses as shown in Table 2 (although it should be mentioned that COM3: and COM4: are not supported by older computer BIOS's nor DOS prior to version 3.3). For example, bytes 3F8 through 3FE are associated with COM1:. Each address contains one byte of information and each bit in each byte performs a certain job. Some bits reflect the logic state of the input lines, others can be used to control the state of output lines or protocol, some are used for both input and output, and the remainder are not applicable to our discussion.

The first byte for each port (3F8, 2F8, 3E8, or 2E8) is interesting since it is used for both transmitting and receiving data. Obviously, a one-byte memory location cannot contain both an input and an output byte simultaneously, so a first-byte address actually gives you access to two bytes: one used for input and one used for output. To provide you with access to the right memory location, the port automatically detects whether you are reading or writing to the byte address. If you use an INP statement, for example:

```
DATAIN=INP(&H2F8)
```

the port assumes you want a byte of incoming data. For the example shown, a byte received via COM2: will be placed in a variable called DATAIN. If you used an OUT statement, the port assumes you wish to place data in the byte location used for transmission. For example, if the computer receives this instruction:

```
OUT &H2F8, "A"
```

it assumes you wish to transmit the character "A" through COM2:, so it places that character in the "out-going" byte location for that port. In this way one address is used for two separate functions.

The fourth byte for each port can be used to set the communications protocol (number of data bits, number of stop bits, and the use of parity, the parity type, and its polarity) to be implemented by a port. To alter a parameter, you need only send a byte with the appropriate bits set to the fourth byte address.

To determine the value to send to the protocol byte, first find the numerical value of each bit you wish to set high by raising 2 to the number of the bit. For example, if you wish to set bit 3 high (to enable parity), you find the numerical value of that bit by raising 2 to the third power. Thus the numerical value of the third bit, which is 2^3 , is 8. Once you have figured out the numerical value of all the bits you wish to set, you add them, which gives you the value of the byte you need to send.

For example, let's say you wish to set a port for 7 data bits, 2 stop bits, with parity enabled, and using odd stick parity. That means bits 0, 2, 3, and 5 should be set high. The computation could look something like this:

$$\begin{aligned} 2^0 + 2^2 + 2^3 + 2^5 \\ = 1 + 4 + 8 + 32 \\ = 45 \end{aligned}$$

If you wanted to have COM2: operate with this protocol, you could use this statement to set it up:

```
OUT &H2FB, 45
```

The last byte for each port (3FE, 2FE, 3EE, or 2EE) is used to indicate the status of the input lines used for handshaking. To take an example, let's say you wanted to find the status of the handshaking inputs for COM1: from a basic program. The program would have to contain a statement to get input from the last byte associated with COM1: (address 3FE), like this:

```
SERDAT=INP(&H3FE)
```

After a program executes this statement, the value of the variable SERDAT will equal the byte stored in address 3FE. That byte can be analyzed to determine which bits are high and which are low. A low or 0 bit indicates its associated signal input is active, asserted, and true, while a high or 1 bit indicates its signal input is idle, unasserted, and false.

To analyze a byte and determine if a particular bit is high, you just take the logical AND of the byte and two raised to the number of the bit you are testing (0-7). For example, this statement checks to see if bit N is high in a variable called SDAT:

```
TRUFAL=SDAT AND 2^N
```

(In case you don't know, the caret indicates
(Continued on page 87)

ANTIQUE RADIO

By Marc Ellis

More From the Mailbag

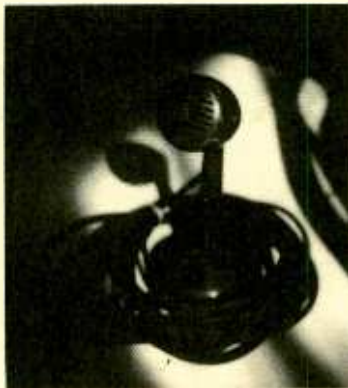

Write to reader Frank Donohoe if you're interested in acquiring this interesting Philco speaker/mike (left) or this old-model RCA desk microphone. (See text.)

Last time we discussed some very interesting letters that I had received over the past several months, but were waiting in the wings for the Hallicrafters *Sky Buddy* restoration project to be completed. We didn't quite cover all of them, though, completely neglecting those all-important "help wanted" messages. So let's

keep emptying the mailbag and see if we can get to the bottom before turning to new topics!

HELP WANTED

C. Youngblood (P.O. Box 477, Bacliff, TX 77518) has been building up a collection of vintage test equipment and is now using it on his first radio restoration (a Philco #37-630 Tombstone). He needs information on the Philco; sources of manuals for DeVry, Knight, B/K, and Simpson equipment; and a good tube manual. Ray Linker (60 Guadeloupe Dr., Toms River, NJ 08757) needs info on an early Columbia receiver. No model number

given, but from Ray's sketch, it looks like some type of portable. Its finished wood cabinet is fitted with a carrying handle, and there's some type of meter on the front panel (possibly a filament voltmeter).

Gene Ray (2388 Highway 36E, Milner, GA 30257) seeks a source of loopstick antennas similar to the ones pictured in the old ad he enclosed (see photo). Thanks for the copy of the theremin construction article enclosed with your letter, Gene!

Robert Gray (941 Eldorado Lane, Louisville, CO 80027) has an empty cabinet for a magneto telephone wall set. He thinks it might be a Kellogg of 1913 vintage. Can anyone come up with a source of parts (they don't have to be original) to rebuild the unit?

Reginald Tremblay (45 Bauer Crescent, Unionville, Ontario, Canada L3R 4H3) recently purchased a Splitdorf set (no model number given) at an antique store and would like some background on it. Is there a Splitdorf expert who'd like to contact him?

Michael Coffey, Jr. (105 Delmar Circle, Oak Ridge, TN) has a "huge floor-model" Magnavox of late 1930's or early '40's vintage. It's labeled "Model 52-F" but Mike can't find any mention of the radio in his reference books or catalogs. He needs schematics and service info.

Nick Oshana (101 Treble Rd., Bristol, CT 06010) has a Philco Model 18 that has lost all of its panel lettering.

He needs a photograph or a photocopy of an original ad that might provide some guidance in restoration.

Richard J. Marshall (1985 Blossom Hill Rd., Easton, PA 18042) is looking for an original theremin to restore. He's also attempting to duplicate a Moog solid-state theremin of the early 1960's, and needs certain Miller forms to wind the coils.

Roger Day (3659 McPhail Drive, Kennesaw, GA 30144) purchased a Hallicrafters S118 when he worked for that company in the early 1960's. Now it's ready for rebuilding, but he lacks a schematic and manual.

It seems we owe an apology to reader Alton A. Dubois, Jr. (67 Peggyann Rd., Queensbury, NY 12804) for messing up not only his first and last names, but also his request, in the February, 1993 "mailbag" column. He requires an audio-output transformer for a Philco Model 41-295. The transformer works with a pair of push-pull 42's and has a center-tapped primary. It also has a special feedback tap on its 8-ohm secondary. Alton has tried to substitute transformers not having the tapped secondary, using resistor and choke networks to provide the feedback. But the resulting audio just doesn't sound right.

Finally, how about some help for the columnist? I've been looking for one of the classic Philco large cathedrals (model 70 or 90) to restore on these pages. I do have a Philco 70 chassis on hand, thanks to the good offices of reader Don

Contact reader Gene Ray (see text) if you know of a source for ferri-loopsticks such as this one.

Lehman (Columbus, Ohio), but it needs a cabinet. Anyone know of a Philco 70 cabinet in restorable condition, a "junkie" 70 that can be purchased for the cabinet, or a complete restorable 70 or 90 available at a reasonable price? Write me at the address given at the end of the column.

GOODIES AVAILABLE!

I have a few letters from readers with things to sell or give away. Some of the letters are more than a few months old, and it will be a few more months before this column is published. So don't be disappointed if an item is no longer available. However, about all you have to lose is a stamp!

Frank Donohoe (26021 W. 119th St., Plainfield, IL 60544) has an intriguing little Philco "sound transducer" like the one we featured as a mystery item a few years ago. Units of this type were used as speaker/mikes in Philco intercoms and as mikes for that company's home disk-

recording sets. Frank also has an older RCA table microphone. Both units are pictured on these pages. If you like one or both of them, write and make an offer!

Thomas C. Rawley (352 Kribs St., Cambridge, Ontario, Canada N3C 3L6) has acquired a large collection of schematics and parts lists for 1940's and 1950's equipment. He's interested in making contact with individuals or businesses who might like to purchase this lot of publications as a package deal.

And, speaking of literature, Harold Huehoff (2128 South Riverside Drive, #90, Iowa City, Iowa 52246) is looking for ideas about disposing of a large collection of Howard Sams "Photofacts" folders. These were acquired from a neighbor who retired from his home-based service business a few years ago. Harold is in the process of cataloging the sets (or maybe he's finished by now) and, at least at the time of writing, wasn't sure if he should try to sell whole folders or service notes for individual receivers.

Some of you shortwave-receiver enthusiasts out there might be interested in an RME 45 offered by Karl Alexander (1000 Sharon Lane, Westminster, MD 21157). He's willing to let it go for the cost of packing and shipping only, but warns that the set seems to have extensive non-factory modifications and does not work. It comes with some Sams Photofacts data, and would be a great source of parts for the restoration of a similar radio.

S-40 SUCCESS STORY

Thanks to reader Harry Schmidt (6 Hartsville Ave., Scarborough, Ontario, Canada) for sharing the story of



I've been looking for a good opportunity to slip in another photo from the collection of reader Terry Schwartz (see February, 1993 column). This Wards Airline may have a set of mismatched knobs, but its interesting dial sports rear-projected call letters. Note the tuning eye at upper right.

his meticulous Hallicrafters S-40 restoration. Some years ago, he decided to replace the S-40 he'd owned and loved as a boy. However, the only example he could find was a "rust bucket" that had been left on the porch of someone's summer cottage for a couple of years.

Undaunted, Harry separated all the parts from the chassis—drilling out the riveted components. That allowed him to remove most of the wiring as a unit. Thanks to a friendly electroplater who was a supplier for his company, the chassis was acid-cleaned and zinc-plated to look like new.

In the meantime, the cabinet was being sand-blasted by a local tombstone maker so it could receive a new black anodized finish. And Harry had talked a woman in his company's drafting department into creating artwork to duplicate the original front-panel lettering.

As he reassembled the set, Harry replaced the PM speaker, the line cord, some tubes and resistors, and all of the capacitors (molded polystyrene units were substituted for the original paper types). A realignment followed, which

was as difficult as the one I carried out on the Hallicrafters Sky Buddy recently restored in this column.

The Hallicrafters now works beautifully, although its dial tracking is not entirely satisfactory—possibly due to aging of the coils. Perhaps another reader could help Harry find a better set of coils. Or maybe he could use the "boiling in beeswax" technique successfully used by reader Gerald Hassell (see last month's column) on the RF and oscillator coils of his Sky Buddy. The alignment suggestions described below might also help.

Thanks for the neat story, Harry. Maybe there's some hope for my own recently-acquired rust-bucket S-40, now waiting in the attic to be transformed into the radio that I knew and loved as a boy. Send us a picture of your restoration sometime!

ALIGNMENT LORE

I'd like to thank reader Billy Pogue (4039 Blue Canyon Rd., Lake Havasu City, AZ 86403) for the many comments and suggestions sent in over the past few months. He obviously speaks from a lot of experience, and his ideas will—I am sure—influence many
(Continued on page 81)

Vendor Information

Transparent Language (\$119/DOS, \$139/Macintosh)
 Transparent Language, Inc.
 9 Ash Street
 P.O. Box 575
 Hollis, NH 03049
 800-752-1767
 603-465-2230

French Assistant (\$99.95)
 Microtac Software
 4655 Cass Street, Suite 214
 San Diego, CA 92109
 800-366-4170
 619-272-5700

CONCLUSIONS

Americans can no longer afford our traditional head-in-the-sand attitude toward non-English languages. However, traditional methods of teaching foreign languages are at least partly responsible for our collective ignorance. The good news is that emerging computer technologies offer tremendous potential for responsive, multimedia-based training that can reach out and grab us and make learning fun.

Neither French Assistant nor Transparent Language by itself lives up to the long-term potential of multimedia-based education. However, both provide significant strides in the right direction. Transparent Language is more suitable for language recognition (i.e., reading); French Assistant, for language synthesis (i.e., writing). Neither seriously impacts hearing or speaking. But one day soon, I hope they will. Until then, these complementary tools can help you learn Spanish, French, Italian, German, and other languages.

Knowing other languages can improve your employment potential, and can also provide you a great deal of pleasure. Help destroy the myth of the ignorant American. Give these programs a try. *Adios. Ciao. Auf Wiedersehen.*

For your Heart's sake get **PULSE STICK II**

Your very own sophisticated pocket health monitor, PULSE STICK II, checks your pulse rate quickly and accurately anywhere. Regular monitoring of your pulse rate during exercise will enable you to plan an exercise regimen suitable for your stage of fitness. Pulse stick II provides an early warning that you may be exceeding your own capabilities.

PULSE STICK II photoelectrically measures the changes

in the pulsed intensity of infrared radiation emitted by superficial blood vessels below the skin of the thumb. The time intervals between pulses are automatically measured and analogued by the micro-processor based circuitry and displayed in a liquid-crystal display (LCD).

Before attempting any exercise program, consult your doctor. Ask for guidance regarding the recommended safe pulse ranges for your exercise program. Follow your doctor's instructions carefully.

Only
\$39⁹⁵

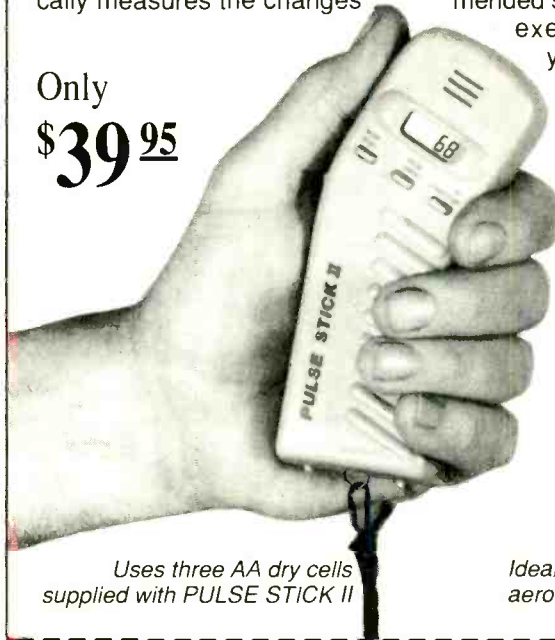

Uses three AA dry cells supplied with PULSE STICK II



Ideal for running, walking and aerobic training programs!

PSII-2

YES! Please send me _____ PULSE STICK II at \$39.95 each. Price includes shipping and handling charges.

Total amount of order \$ _____

Check or Money Order enclosed. Make check payable to **CLAGGK Inc. PULSE STICK II Offer**

Charge my Visa MasterCard

Account No. _____

Exp. Date ____ / ____

Credit Card Signature _____

Print Name _____

Address _____

City _____ State ____ Zip _____

No telephone orders or C.O.D. Signature required on credit card orders. All prices include postage and handling. Payments in U.S.A. funds only. New York residents must include local applicable sales taxes. No foreign orders.

Mail orders to CLAGGK Inc. Pulse Stick II Offer, P.O. Box 4099, Farmingdale, NY 11735.

FAX orders to 1-516-293-3115.

CIRCUIT CIRCUS

By Charles D. Rakes

Easy-to-Build Receiver Circuits

Not too many years ago, assembling your own AM radio was one of the most popular projects around. It seemed like everyone who was into project building had a favorite radio circuit that would perform magnificently at pulling in distant stations. Most of the better performing receiver circuits were fairly simple (consisting of as few active components as possible) and usually revolved around a regenerative design.

Even with today's high-performance, inexpensive mini-radios, it can still be

ered output stage that's designed to directly drive a set of low-impedance headphones.

The ZN416E—which is available from DC Electronics (2334 N. Scottsdale Rd., Scottsdale, AZ 85257; Tel. 800-467-7736) for \$3.95—offers the best performance of the two IC's. A block pinout diagram of the ZN416E is shown in Fig. 1. The ZN416E, whose buffered output stage boasts an 18-dB voltage gain, has a maximum output voltage of 340 mV peak-to-peak into a 64-ohm load before clipping when operated from a 1.5-volt power source. It can be powered from any source of between 1.1 to 1.6 volts, and has a current drain of around 5 mA. Its frequency range runs from a low of 150 kHz to 3.0 MHz, and features an input resistance of 4 megohms. The chip offers a power gain of 72 dB with a 20 dB AGC range.

The buffer's low audio-cutoff frequency is set by

an external capacitor connected between pins 2 and 3. Plessey suggests that you use 0.47 μF for a 50-Hz cutoff frequency. The upper cutoff frequency is set by tying a capacitor between pin 7 and ground. A 0.01- μF unit sets the chip's upper cutoff frequency to 10 kHz. The output load (low-impedance headphones, etc.) connects between pin 5 and ground (pin 4).

A basic receiver circuit built around the ZN416E is shown in Fig. 2. In spite of the circuit's simplicity (requiring fewer than a dozen parts and no external resistors), it's a real performer.

AMPLIFIED-OUTPUT RECEIVER

The second receiver circuit, see Fig. 3, uses a 9-inch loop for the tuned circuit and a ULN3718M low-voltage, audio-power amplifier (U2) to boost the circuit's output volume to a sufficient level to drive a 4-inch 8-ohm speaker. The circuit is powered by two

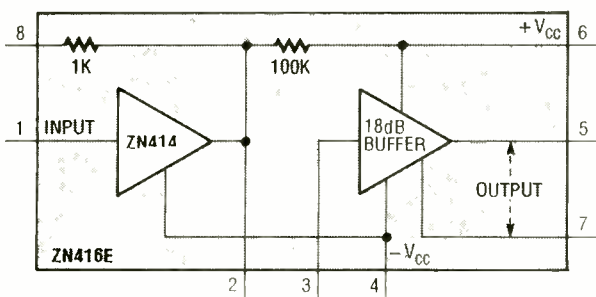

Fig. 1. Of the two new TRF chips, the ZN416E—a block pinout diagram of which is shown here—offers the best performance. As shown, the ZN416E combines the circuitry of the ZN414 (the forerunner of this unit) with a buffer/amplifier output stage.

lots of fun to build and show off a homebrew receiver. If the prospect sounds interesting to you, read on.

GEC Plessey Semiconductors, the people that gave radio builders a shot in the arm by introducing the ZN414 tuned, radio-frequency (TRF) integrated AM radio receiver, has introduced two new devices—ZN415E and ZN416E. Both IC's, which are housed in 8-pin DIP packages, contain ZN414 circuitry plus a buff-

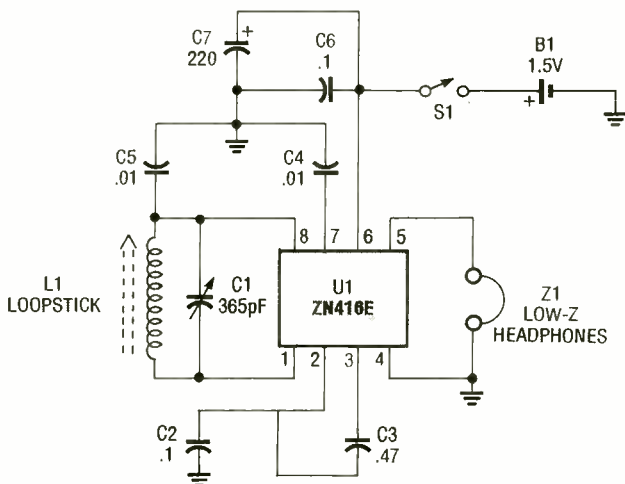

Fig. 2. The basic receiver circuit requires fewer than a dozen parts, none of which are resistors.

PARTS LIST FOR THE BASIC RECEIVER CIRCUIT

CAPACITORS

- C1—365-pF variable tuning capacitor (see text)
 C2, C6—0.1- μ F, ceramic-disc
 C3—0.47- μ F, ceramic-disc
 C4, C5—0.01- μ F, ceramic-disc
 C7—220- μ F, 16-WVDC, electrolytic

ADDITIONAL PARTS AND MATERIALS

- U1—ZN416E tuned radio-frequency, AM receiver, integrated circuit (DC Electronics)
 B1—1.5-volt battery
 L1—Loopstick antenna coil
 L2—Loopstick antenna coil
 S1—SPST switch
 Z1—Low-impedance headphones
 Perfboard materials, enclosure, IC socket, battery holder, wire, solder, hardware, etc.

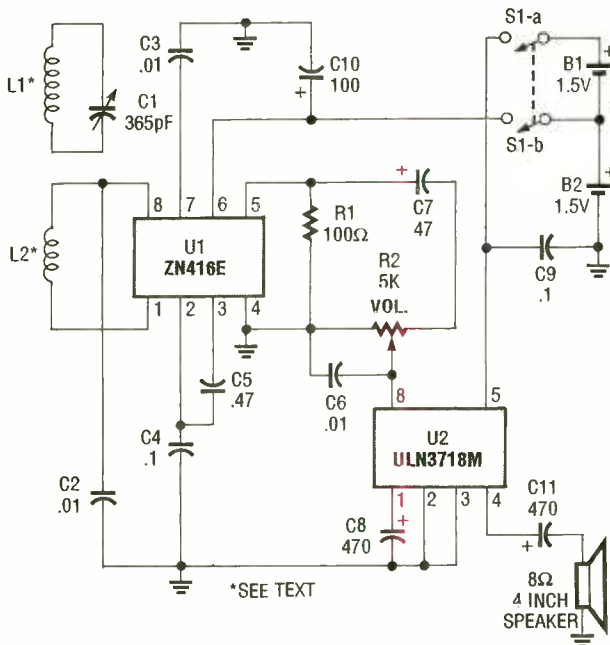

Fig. 3. The basic receiver circuit, with only a slight modification and the addition of a ULN3718M low-voltage, audio-power amplifier, can drive a 4-inch 8-ohm speaker.

1.5-volt cells connected in series.

Both L1 (the loop) and L2 are homebrew inductors that were neatly wound in a single layer on a 9-inch diameter by 1-inch wide wood or plastic form, and separated by about 1/8th inch. Inductor L1 consists of 12 turns of #26 copper magnet wire, while L2 is comprised of 4 turns of the same size wire. The tuning capacitor (C1) can be pur-

chased new or a salvaged one from an old tube-type receiver. If you can make it to a few of the local ham-fests, you might be able to pick up a tuning capacitor for a buck.

The ULN3718M (available from DC Electronics for \$1.45) adds up to 40 dB of voltage gain to the receiver, with an output of 80 mW feeding an 8-ohm load when operated from a 3-volt power source. Its output

42,398

ELECTRONIC COMPONENTS

Whether you order 1 part or all 42,398...MOUSER stocks and...ships same day!!

CALL...
(800) 992-9943

for your
FREE
CATALOG

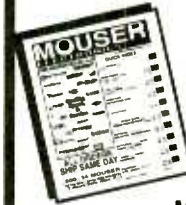

2401 Hwy 287 N.
Mansfield, TX 76063

MOUSER

ELECTRONICS

Sales & Stocking Locations Nationwide

CIRCLE 10 ON FREE INFORMATION CARD

Be an FCC LICENSED ELECTRONIC TECHNICIAN!

Earn up to \$2000/Week and more!

Learn at home in spare time. No previous experience needed!

No costly school. No commuting to class. The Original Home-Study course prepares you for the "FCC Commercial Radiotelephone License." This valuable license is your professional "ticket" to thousands of exciting jobs in Communications, Radio-TV, Microwave, Maritime, Radar, Avionics and more... even start your own business! You don't need a college degree to qualify, but you do need an FCC License.

No Need to Quit Your Job or Go To School
 This proven course is easy, fast and low cost! **GUARANTEED PASS**—You get your FCC License or money refunded. **Send for FREE facts now. MAIL COUPON TODAY!**

COMMAND PRODUCTIONS

FCC LICENSE TRAINING, Dept. 100
 P.O. Box 2824, San Francisco, CA 94126
 Please rush FREE details immediately!

NAME _____
 ADDRESS _____
 CITY _____ STATE _____ ZIP _____

PARTS LIST FOR THE AMPLIFIED OUTPUT RECEIVER

SEMICONDUCTORS

U1—ZN416E tuned, radio-frequency AM receiver, integrated circuit
 U2—ULN3718M low-voltage power amplifier, integrated circuit

RESISTORS

(All fixed resistors are 1/4-watt, 5% units.)

R1—100-ohm
 R2—5000-ohm potentiometer

CAPACITORS

C1—365-pF tuning capacitor (see text)
 C2, C3, C6—0.01- μ F, ceramic-disc
 C4, C9—0.1- μ F, ceramic-disc
 C5—0.47- μ F, ceramic-disc
 C7—47- μ F, 16-WVDC, electrolytic
 C8, C11—470- μ F, 16-WVDC, electrolytic
 C10—100- μ F, 16-WVDC, electrolytic

ADDITIONAL PARTS AND MATERIALS

B1, B2—1.5-volt battery
 S1, S2—STDT switch
 L1, L2—See text
 SPKR1—8-ohm, 4-inch speaker
 Perfboard materials, enclosure, #26 magnet wire, coil form (see text), IC sockets, battery holder, wire, solder, hardware, etc.

can extend beyond 400 mW when operating from a 6-volt source. The chip's absolute maximum recommended supply voltage is 9. At 3 volts, the quiescent current is less than 10 mA. The amplifier's input resistance (at pin 8) is about 250k.

The receiver's front end can be altered enabling it to tune any frequency between 150 kHz and 3 MHz. All you need do is connect an LC tuning circuit to U1.

VLF TUNER

The VLF tuning circuit shown in Fig. 4 can be added to the receiver circuit to allow it to cover the frequencies below the AM broadcast band. With it connected to the Fig. 3 receiver circuit, you can listen to public-service radio broadcasts in the 500-kHz range. Such stations (located around public parks and lakes) are usually very low powered.

Below 500 kHz, there are numerous tones, beacons,

and odd signals. For example, you might hear an experimenter sending out signals in the 160 to 190 kHz range, most of which will be CW. To receive CW on our

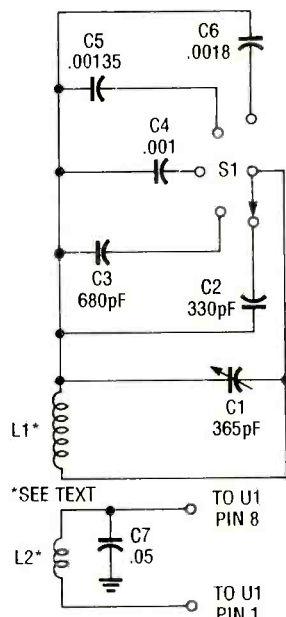

Fig. 4. This VLF tuning network can be added to the receiver circuit, enabling it to cover the frequencies below the AM broadcast band.

receiver, you must use a BFO (beat-frequency oscillator). To receive those signals without the trouble of building a BFO, try tuning your receiver until you hear a clicking sound or an interrupted hiss. That's what you'll hear when receiving CW on an AM receiver. Now turn on an RF generator and lay the output lead close to the receiver's loop and tune the generator to

wound turns, while L2 consists of 6 to 8 turns spaced the distance of one turn and wound next to L1.

Capacitor C1 is a 365-pF broadcast tuning capacitor like the one used in our previous circuit. If you have a multi-stage AM tuning capacitor with at least two or more ganged sections, connect all of the capacitor sections in parallel and use it in place of C1 to

PARTS LIST FOR THE VLF TUNER

CAPACITORS

C1—365-pF broadcast variable (see text)
 C2—330-pF, ceramic-disc
 C3—680-pF, ceramic-disc
 C4—0.001- μ F, ceramic-disc
 C5—0.00135- μ F, ceramic-disc
 C6—0.0018- μ F, ceramic-disc
 C7—0.05- μ F, ceramic-disc

ADDITIONAL PARTS AND MATERIALS

L1, L2—See text
 S1—SP5T rotary switch
 Perfboard materials, coil form, wire, solder, hardware, etc.

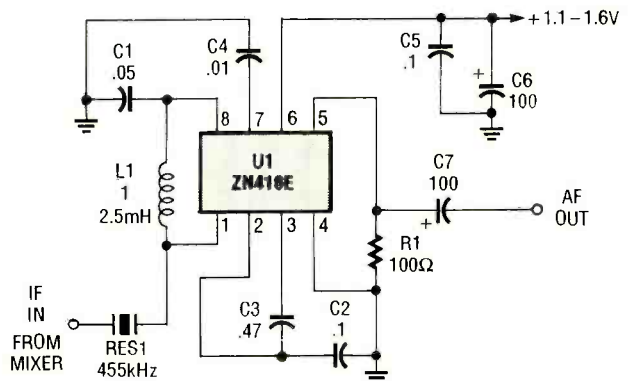

Fig. 5. The ZN416E can be configured as a simple 455-kHz IF amplifier. In this case, the circuit's center frequency and bandwidth are set by RES1 (a Murata CSB455E ceramic resonator).

the same frequency or until you hear the clicks turn into a nice interrupted audio tone.

The inductors (L1 and L2) are fabricated by winding #26 copper magnet wire on a 9-inch diameter by 2 1/2-inch form like the one used in the amplifier receiver of Fig. 3. Inductor L1 is comprised of 30 neatly

increase the tuning range. Capacitors C2 through C6 allow the tuning range to descend to a lower frequency range with each advance of rotary-switch S1.

To achieve the best results with the circuit, it will be necessary to experiment with the number of turns used for L2. Fewer turns narrow the tuning range. (Continued on page 88)

THINK TANK

By John J. Yacono

TTL and Hints

This month, we'll be continuing both our discussion on logic IC's (dabbling with the different TTL families this time) and continue presenting some helpful-hints letters. Of course, all of this month's contributors will be awarded with a book.

Oh, before I forget, the 6-lane pinewood-derby circuits requested by Stephen Guye (see the May 1993 issue) have started coming in. By the time you read this, I will have already begun preparing the ones I have for publication; however, if you wish to slip a good one in under the wire, I will present it in a later column so that nobody gets left out. Besides, these kinds of projects are good for community spirit, and I'm all for that. Remember, if your derby circuit meets Step-

hen's criteria and appears here, you'll receive a MCL1010 chip (which I wrote about in my first column—April 1991) in addition to a book from our library. Well, time's a wasting, so let's get right to it.

THE BIPOLAR FAMILY TREE

There are several varieties of bipolar logic chips. Specifically, they are: saturated-logic (more often referred to as standard TTL), low-power bipolar, high-power bipolar, Schottky, advanced Schottky, low-power Schottky, FAST (or Fairchild Advanced-Schottky TTL), and advanced low-power Schottky. You can determine which family an IC belongs to by looking for an abbreviation embedded in its part number. For example, we know a 74LS000 is a

low-power Schottky chip because of the entrenched "LS." Standard TTL has no abbreviation (for example, 74000), low-power bipolar is indicated by an "L," high-power bipolar by an "H," Schottky with an "S," advanced Schottky by "AS," advanced low-power Schottky by a "ALS," and the FAST abbreviation is just "F." By the way, these abbreviations are used for both the 54-series and the 74-series chips (for the distinction between the two series, see last month's column).

The key difference between the families is how much they compromise low power consumption for the sake of speed. Of course, there are other operational differences between the families that arise as a result of playing the low power vs. speed game (such as in their current handling and fan-out capability), and they must be taken into account. However, those other differences are seldom *deciding* factors for a hobbyist trying to select a family to suit a logic circuit.

To see how the families stack up in the power and speed categories, take a look at Fig. 1. That figure shows typical values of power-consumption and propagation-delay per gate for each family in graphical form. Typical values are shown in the figure because actual values vary from manufacturer—the hint implied here is check the data sheets for critical applications.

Since a circuit designer will always seek to minimize both propagation delay

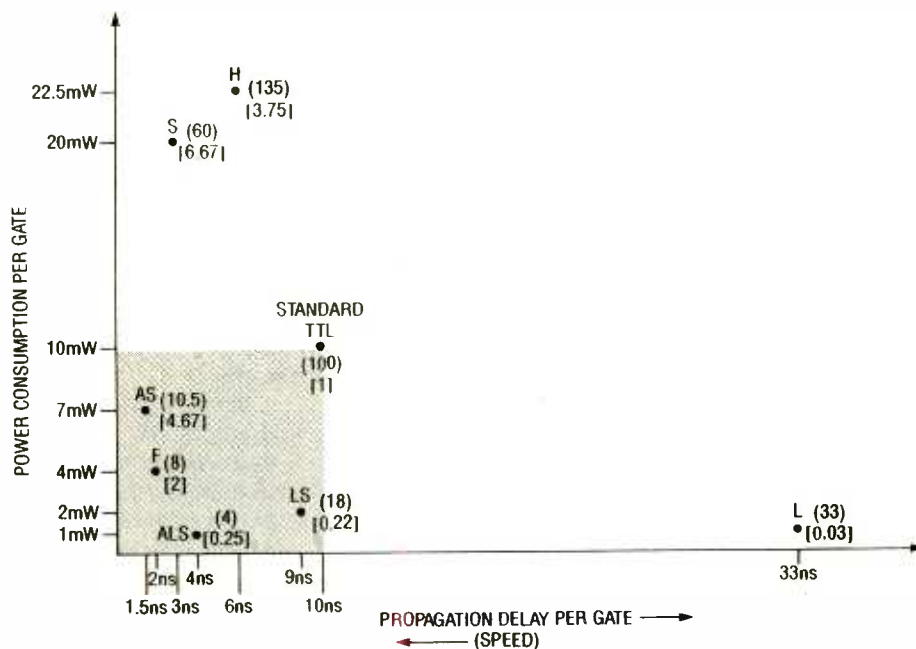

Fig. 1. This simple graph should give you a feel for the trade-offs made for each family. The power/delay product and my power-to-delay ratio for each family appear in parenthesis and brackets, respectively.

and power consumption, the most attractive families for most applications appear near the origin of the graph (the origin being the spot where infinite speed with no power requirement can be found—yeah, right). In fact, the families in the shaded area below and to the right of the standard TTL family (i.e., faster and less power-hungry than standard TTL) are all you might ever need. Note how those families hug the two axes (you can almost “feel” an IC engineer attempting to push the families toward the origin, only to have them snap up against the axes as a compromise) making selection rather easy.

To further ease chip selection, a chip parameter called the “power/delay product” was invented. It is nothing more than the power dissipation of a gate in milliwatts (mW) times its propagation delay. The product for each family is shown in parenthesis next to the family’s abbreviation back in Fig. 1. Typically, the lower a gate’s power/delay product (the closer its family is to the origin), the better. That is a generalization, however, which falls far short of the truth for the families outside the shaded region. That’s because the power/delay product doesn’t tell you how much of a trade-off was made in the architecture. One other thing that I don’t like about the product is that it doesn’t indicate which parameter (speed or low-power consumption) is being slighted.

Leaping onto a soap box (encouraged by 20/20 hindsight), I think it would be better if we also used a power-to-delay ratio. Large ratios would indicate low-power consumption was sacrificed, while small ones would indicate the delay

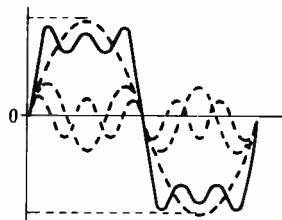

Fig. 2. A squarewave can be viewed as the sum of an infinite number of sinewaves of certain amplitudes and frequencies. Here we show three sinewaves (dashed) that have been added to form a wave (solid) that looks like a cross between a sinewave and a squarewave.

was substantial. It would also give a relative indication of how great a trade-off has been made. I’ve calculated the ratios for the various families and placed them in brackets in Fig. 1. By pure luck, the ratio for TTL is 1, so any family with a ratio greater than 1 will hug the power-consumption axis, any family with a ratio less than 1 will fall close to the propagation-delay axis.

Next month we’ll continue our bipolar-family comparison by exploring other IC characteristics. For now, its onto the mail!

ALMOST-FREE BATTERIES

Don’t throw away those spent Polaroid film cartridges so fast. Carefully cut open the plastic casing and you’ll find a thin (1/8-

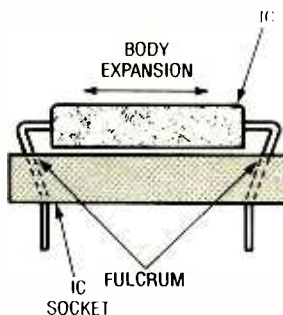

Fig. 3. In the course of operation, chips expand. As they do so, their pins act as levers, which tend to pry the chips from their sockets.

inch) 2½ × 3-inch battery. The terminal voltage is about 5 volts. It’s great for experimenting or for low-power DC projects.

—Elron A. Yellin, Villanova, PA

Another neat photography/electronics trick is to use fully exposed (black) Kodachrome negatives as infrared-light filters. When placed in front of the focusing lens of an IR phototransistor, it will block out visible light so that only the appropriate wavelengths reach the phototransistor. The next letter is IR related, too.

IR OR RF?

Just the other day, I found another use for an AM radio. I was playing around with my clock-radio and found that the remote control for my TV made the radio produce clicking sounds. I raced around the house looking for infrared remotes. When I had gathered them together, I tried them one-by-one. They all produced clicks, and they all had a different sound. The range was only a few inches, so I held them up to the case of the radio.

That works quite well on just about any frequency on the AM dial. I thought that knowledge would be useful for testing remote controls. I think the signal is being received by the antenna coil in the radio, but I don’t understand how infrared remotes can send out RF signals.

—Jesse Druehl, Dana Point, CA

Squarewaves, like those produced in digital devices (such as remotes) can be considered to consist of an infinite number of harmonically related sinewaves (see Fig. 2). The amplitudes and phases of the waves are such that when they are summed together,

some portions of the waves cancel each other out, while others are reinforced, the end result of which is a squarewave. If some of those harmonic components leak out of the remote in the form of radiation, which can affect nearby electronic equipment.

HF HINTS

I have a couple of tips that may be of value to those building VHF or UHF devices and winding their own coils. I have discovered that many early-day TV tuners have coils wound with silver-containing or silver-plated wire that can be salvaged and used to fabricate coils, giving such coils substantially higher Q values than copper-wire coils. (Not many people today remember that high-performance shortwave coils for frequencies above 18 MHz were manufactured by Hammarlund and others back in the 20’s and 30’s, using silver wire.)

Another way to improve the Q of VHF or UHF inductances is to wind them using fine-gauge capillary tubing. Having both an inside and outside surface reduces the RF skin effect, lowering the effective RF resistance and raising the Q of the coil. It may, in fact, even prove worthwhile to use capillary tubing to wire RF circuits instead of solid wire in low-power transmitters, etc.

—Billy R. Pogue, Lake Hauasu City, AZ

Your advice certainly makes sense. I think your use of capillary tubing is very, very inventive and insightful. When working with RF circuits, reducing every loss is important.

CHIP CREAK

As any IC works it pro-

duces a small amount of heat that warms its package. When it heats up, it attempts to expand in its socket (see Fig. 3), but the socket resists because it is not expanding. So in its attempt to expand, the IC moves in the only direction it can, up away from the PC-board and IC socket. That action is called walking. Walking occurs when the chip heats up as well as when it cools down.

As walking occurs over time, one of the legs of the IC may no longer make contact with its receptacle in the IC socket. That leads to intermittent problems. Usually you will find that that sort of problem doesn't show itself when the device is first turned on, but rather towards the end of the day when the internal temperature of the IC has basically "maxed-out" and the chip is fully expanded.

There is however an extremely simple solution to that problem. Simply push on the chip and reset the IC within its socket. As you reset them, listen for a creaking sound and you will know how I came up with the phrase "chip creak." Resetting the IC's should obviously be done before going through any type of troubleshooting technique as a matter of course. If it is not done before troubleshooting, then the readings you take might be off enough to cause you to trash the board thinking it has a bad trace or pad.

—Jeffery Flaker, Haledon, NJ

That's a problem I don't think I have come across yet, although there was that one old intermittent board that I couldn't fix . . . come to think of it, maybe I have come across the problem! Well, at least next time I'll know a quick fix worth trying.

By the way, if anyone out there finds this technique helps repair a board, I have a further tip of my own: after reseating the troublesome IC, try spraying it with a conformal coating to hold it in place. That way you won't need to re-do the repair down the road.

SOLDERING TIP

Most of us never take advantage of the sponges for our soldering stations. But you can buy two-sided sponges at your local supermarket with a smooth side and a rough side (Scotch-Brite, for example) for scouring. Keep the sponge moist, and use the smooth side for normal operations. When solder build-up or oxidation occurs, use the rough side. By keeping your soldering iron clean and tinned, you'll find that heat flows more readily, making the job easier and neater.

Screw-on soldering-tip manufacturers recommend that you install tips finger-tight and loosen them, once cooled until the next use. That keeps the tip from seizing up in the iron and damaging the threads. If you're like me, that rarely (if ever) gets done. Apply a bit of Never-Seize to the threads before assembly. That makes removing the tip a cinch after repeated heating and cooling operations. Never Seize is available at most auto-supply stores.

—Mike Giamportone, Yale, MI

Thanks, Mike! You've given us a complete soldering course in a couple of paragraphs.

That's a wrap for this month. Remember, send your better works and thoughts to Think Tank, Popular Electronics, 500-B Bi-County Blvd., Farmingdale, NY 11735. ■

FREE

Electronics & Computer Software
Education Catalog

- *Fast-Track Individual Learning Programs
- *State-of-the-Art Classroom Courses
- *The Best Values in Electronics Education

New

Career-Level Courses
Personal Computer Servicing
TV and VCR Servicing

New

Computer-Aided Instruction

DC & AC Electronics
Semiconductors
Electronic Circuits

The stunning animations, hypertext glossary, and easy-to-understand text make learning electronics a breeze...and fun!

Learn the easy and affordable way from the Masters in Electronics Training - Heathkit®. From Basic Electricity to Advanced Microprocessor Applications and more, Heathkit will provide you with an unparalleled learning experience at a fraction of the cost of other programs.

Heathkit®

Educational Systems

For your FREE Catalog, call

Toll-Free 1-800-44-HEATH

please mention this code when calling 107 014

CIRCLE 9 ON FREE INFORMATION CARD

LEARN VCR

Cleaning/Maintenance/Repair
Earn up to \$1000 a Week, Working
Part Time from Your Own Home!



Secrets Revealed! . . .

NO Special
Tools or
Equipment
Needed . . .
Train at Home
in Your Spare
Time!

If you are able to work with common small hand tools. If you possess average mechanical ability, and have a VCR on which to practice and learn... then we can teach YOU VCR Maintenance and Repair!

FACT: Up to 90% of all VCR malfunctions are due to simple Mechanical or Electro-Mechanical breakdowns!

FACT: Over 86 million VCRs in use nationwide! Average VCR needs service or repair every 12 to 18 months!

For FREE Information Package!

Send coupon to: Foley-Belsaw Institute of VCR Repair, Dept. 62040, 6301 Equitable Rd., Kansas City, MO 64120

FOLEY BELSAW Since 1926 Dept. 62040

Check for FREE Lifetime Career Kit on VCR Repair.

Name _____

Address _____

City _____

State _____ Zip _____

CIRCLE 8 ON FREE INFORMATION CARD

DX LISTENING

By Don Jensen

Radio Moscow?

The 1989 edition of "Passport to World Band Radio" reported that the former Soviet Union, once the biggest international shortwave broadcaster, using scores and scores of powerful transmitters, aired a total of 28,892 hours a week on shortwave during the year! That's head and

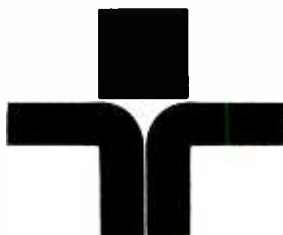

TV2-CULTURA

**RADIO-CULTURA
SÃO PAULO**

This is the logo of Radio Cultura in Sao Paulo, Brazil, which uses 9,615 and 17,815 kHz for shortwave as well as TV channel 2.

shoulders above the No. 2 broadcaster, the *Voice of America* with 17,853 hours of airtime. And the *British Broadcasting Corp.* (BBC), long recognized as one of the major players in world-band radio, ranked a poor fourth (behind China no less) with just under 5,000 hours of broadcasting weekly.

But the situation has changed since the break up of the U.S.S.R. These days, most of the Russian SW transmitters are being rented out to other broadcasters, including (as I noted a few months ago) some brand new Russian and Commonwealth programmers who are trying to get commercial radio off the ground. On other ex-*Radio Moscow* transmitters,

air time is being leased to a number of western religious broadcasters and, yes, even to former "opponents" in the international radio wars, the BBC and VOA.

Although its hours and frequencies have been cut back, *Radio Moscow's* English-language World Service is still around, noted with some interesting listening. If it's been a while since you have tuned in one of their broadcasts, you might like to get reacquainted. Here are some programming suggestions from Anatoly S. Klepov, writing in the World DX Club's monthly publication, "Contact:"

Radio Moscow's "World Service News" is offered on the hour; News in brief every hour on the half hour. Commentary is presented in its "News and Views" program, while interviews and in-depth analysis of major issues and events are heard on "Update." And "Top Priority," a weekly program, features a panel discussion on key events.

"Newmarket" is an especially interesting program these days, indeed, with brand new markets opening up in the former USSR. Newmarket is described as a visiting card for the world business community. *Radio Moscow's* World Service tells listeners where and how to invest their money, sell their products, or how to start a business in the Russian Federation.

"Culture and the Arts" is a program that introduces listeners to the more than 100 ethnic cultures that make-up the Russian Federation. Both classical and contem-

porary Russian literature is highlighted in *Radio Moscow World Services' "Audio Book Club."*

Music? What's your choice? Classical? Folk? Popular? There's likely to be something to suit your taste. "Music and Musicians" features some of the world's best known performers and composers. "Folk Box" offers a wide range of Russian folk music. There's the "Jazz Show," which is self explanatory; "Yours For the Asking," a half hour request program, and "Your Top Tune," where prizes await SWL's who respond to questions about popular songs.

Somewhere out there, perhaps, is a shortwave Rip Van Winkle—an SWL who drifted away from the listening hobby 20-years ago during the time when, as a young parent, he or she simply had no free time. Returning to SWL'ing two decades later, that person is sure to find tremendous differences! New SW stations, new programs, new personalities! But there is one program, one voice, that would still be familiar after all of those year: "Moscow Mailbag" with Joe Adamov.

Adamov has been around for, well, as long as I can remember, with his question and answer program. He has been responding to mail from North American listeners since the chilliest days of the Cold War era. He gained a good bit of listener popularity then because of his American accent and idioms, and because of his seeming candor and everyday style. A master

propagandist, many said, and they were right.

But SWLs liked Joe and, in fact, invited him to speak some years back at a gathering of shortwave listeners in Minneapolis. And he would have, too, except for the fact that at the last minute, U.S. authorities had second thoughts and denied Adamov entry into the country.

Although no longer the controversial air personality he once was, Joe Adamov is always interesting. You can look for Radio Moscow's World Service in English between about 2000 and 0600 UTC. Because this column is written several months prior to publication, and because Radio Moscow changes frequencies rather frequently, it is a bit chancy to suggest specific channels to tune, but some you might try are 12,010, 9,685, 9,470, 7,180, 7,115, and 5,925 kHz at various times during the hours noted.

LETTERS TO ENTERTAIN YOU

Before I get to the letters, I'd like to invite the rest of you to drop me a line if you have a question or comment about shortwave listening, or if you want to tell the rest of us about what you've been tuning lately, about your favorite programs or, if you're so inclined, your pet peeves about SWL'ing.

And, while I'm at it, I invite you to send along a photo of yourself and your SW listening gear. I'd like to

*Credits: Juhanna Bickus, VA; W. Karcheski, MA; E. Newbury, NE; Dave Weinrich, ND; North American SW Association, 45 Wildflower Road, Levittown, PA 19057; Ontario DX Association, P.O. Box 161, Station A, Willowdale, ONT. M2N 5S8, Canada; World DX Club, c/o Richard D'Angelo, 2216 Burke Drive, Wyomissing, PA 19610.

include more photos of you readers in this column, just so that we can see what you and your listening posts look like. Send your letters to Don Jensen, *DX Listening*, **Popular Electronics**, 500-B Bi-County Blvd., Farmingdale, NY 11736.

Digging into the pile of mail on hand, I came up with a letter postmarked Lima, OH. "I'm a big fan of the British Broadcasting Corp.," writes Ted March. "In fact, I guess you could say it is my favorite SW station by far. Is there some way you know of to get a BBC T-shirt? That would be a quite an attention grabber, don't you think?"

As a matter of fact, Ted, I do. The BBC Shop offers all sorts of BBC World Service memorabilia, including clothing, CD's and tapes, books and much more. In fact, I enjoy my coffee in a doggone good looking BBC china mug that I picked up when I stopped by the retail shop at Bush House in London a few years back.

Fortunately, you don't have to cross the Atlantic to get a souvenir. The BBC Shop has a mail-order catalog; send an International Reply Coupon (a return-postage alternative to mint British stamps, available at your post office) and a self-addressed airmail envelope to The BBC Shop, P.O. Box 1QX, Newcastle-upon-Tyne, NE99 1QX, England for a copy.

James Olson, Bismarck, ND, has a question about Jamming, the transmission of radio "noise" deliberately intended to block reception of SW programming. "A few years ago," Jim writes, "I remember reading in the newspaper that the Cold War practice of jamming shortwave programs was dead. Is that still true?"

In fact, Jim, it was never really true. It is correct that

most radio jamming ended as East-West tensions faded; but, to a limited extent, some countries continue to jam what they consider to be offensive foreign shortwave transmissions. Today, for instance, in North Korea, the Pyongyang government still attempts to jam some signals, most notably, the Korean-language programs emanating from South Korea. Reportedly the effort is not especially successful.

Still, Jim, there is far less jamming—which, unfortunately, affected totally innocent victims as well as the targeted stations by blocking segments of many SW bands—than in the past.

Bradley Weins of Popano Beach, FL, writes to say that he enjoys listening to international aeronautical traffic on shortwave. "One good frequency to try for planes and ground control is 8,855 kHz," Bradley says. "I note quite a lot of upper-sideband traffic on Latin American flights on this channel."

Thanks for the tip, Brad. Let me add a few words on monitoring aeronautical traffic on shortwave. These, of course, are not programs, but actual air-to-ground—and vice versa—communications. Aeronautical communications in North America are located in VHF frequency bands, far above the shortwave range. However, overseas flights do use SW for communications. Additionally, SW aeronautical transmissions use a single-sideband mode, not the normal AM (amplitude modulation) used by regular SW broadcasters. Many of the better SW receivers these days can tune upper- or lower-sideband signals.

Another interesting frequency to try is 11,288 kHz, USB. David Ross, in his

Monitoring Services column in the Ontario DX Association's "DX Ontario" bulletin, notes that this channel is used for Stateside flight tests by such companies as Rockwell/Collins, Boeing, Grumman, Lockheed, and McDonald Douglas.

DOWN THE DIAL

Here are some shortwave broadcasters that others are tuning.

ARGENTINA—11,710 kHz. *RAE*, Argentina's foreign shortwave service, transmitting from Buenos Aires, can be heard with English-language transmissions at about 0130 UTC, with tango music, features, and identification.

GERMANY—7,265 kHz. *Sudwestfunk* is one of several domestic shortwave stations whose programming is intended for German-speaking listeners at home and elsewhere in Europe. It has been logged in New England at around 2200 UTC.

MOROCCO—17,815 kHz. *Radiodiffusion TV Marocaine* has an English-language transmission, including popular music, commentary, and identification, at 1700 UTC.

PARAGUAY—9,735 kHz. *Radio Nacional del Paraguay* in Asuncion offers a chance for SWers to hear one of the rarer South American countries on shortwave, with its programming, naturally, all in Spanish. With some luck, you may be able to hear this one at around 2200 UTC.

VENEZUELA—4,980. *Ecos del Torbes* is a Venezuelan outlet that has been noted here during the evening hours, at around, say, 0130 to 0330 UTC. Besides some great salsa, you'll note identifications, commercials, and newscasts, all in Spanish, of course. ■

HAM RADIO

By Joseph J. Carr, K4IPV

More On Our 5-5.5 MHz Ham-Band VFO

Last month, we discussed some of the basics of designing a variable-frequency oscillator (VFO) for the ham-bands. We also presented a sample design for a 5- to 5.5-MHz VFO. This month, we'll continue that discussion with a look at some of the construction details and the methods for temperature compensating the VFO.

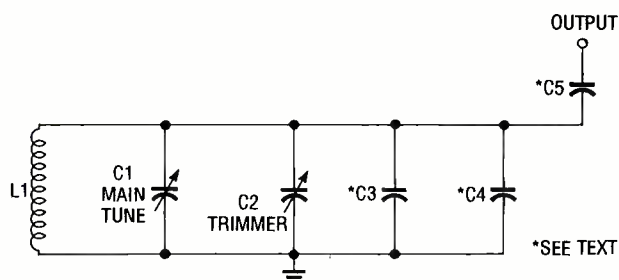

Fig. 1. All capacitors that effect operating frequency (those marked with an asterisk) should be either NPO ceramic-disc, silvered-mica, or polyethylene types for minimum drift.

Previously, it was stated that all capacitors that have an effect on the operating frequency (those marked with an asterisk in Fig. 1) should be either NPO ceramic-disc, silvered-mica, or polyethylene units to help keep frequency drift to a minimum. However, silvered-mica capacitors are somewhat suspect because of their wide variation in temperature coefficient (measured in parts-per-million per-degree centigrade or PPM/°C); some are very good, while others, well, leave a lot to be desired. Another source of drift in that circuit is the inductor (L1).

Because most oscillators drift lower in frequency from turn-on due to temperature change, it is common practice to place a temper-

ature-compensating capacitor—one with a negative temperature coefficient; e.g., N750 or EIA P3K—in parallel with the main tuning capacitor. In Fig. 1, either C3 or C4 could serve as the temperature-compensation capacitor.

The procedure for finding the value of the compensation capacitor is relatively straight forward. First, you must devise a test set up wherein the VFO will not be affected by stray air currents. (I place the VFO inside a styrofoam picnic cooler—the sort intended for a six-pack is suitable, as long as the circuit is not too large.)

TEST PROCEDURE

For the test procedure to be outlined, you'll need a digital frequency counter. Before beginning the test, the counter must be turned on and allowed to warm up until it stabilizes (about 1½ hours). The test procedure is as follows:

1. Turn on the oscillator, adjust it to the high end, and 10 seconds later, measure its oscillating frequency. Call that frequency f_0 .

2. Wait 1½ hours—keep the oscillator and the frequency counter on during this time—and measure the frequency again. Call the second frequency measurement f_1 .

3. Now, turn the oscillator off (but leave counter on), and let the oscillator cool to room temperature (about 1 hour).

4. Replace C4 with a capacitor of the same value, but with a temperature coefficient of N750 (a

negative temperature coefficient of 750 PPM/°C); Refer to that capacitance as $C_{4\text{trial}}$. Turn on the oscillator, and readjust it to the original f_0 . Wait 1½ hours and measure the frequency: This frequency, we'll call f_2 .

5. Replace $C_{4\text{trial}}$ with an N750 capacitor with a capacitance of:

$$C_{4\text{new}} = C_{4\text{trial}}(f_1/f_1 - f_2)$$

if f_2 is less than f_1 , or one with a capacitance of:

$$C_{4\text{new}} = C_{4\text{trial}}(f_1/f_1 + f_2)$$

if f_2 is greater than f_1 . Install the new capacitor in the circuit, and readjust the trimmer capacitor or the inductance of the coil.

AN ALTERNATE WAY

Another means of temperature compensating a VFO is shown in Fig. 2. That circuit is similar to one used in the old Hallicrafters HT-32 AM/CW/SSB HF transmitter a number of years ago. In that circuit, a portion of the total capacitance is made up from two small ceramic-disc units, C4 and C6. Capacitor C4 is an NPO (zero temperature coefficient) and capacitor C5 is an N1500 (negative 1500 PPM) unit. Capacitor C6 is a differential variable capacitor. Such units are comprised of two variable capacitors controlled by a single tuning shaft, that are arranged so that one unit's capacitance increases (with shaft rotation), as the other unit's capacitance decreases a like amount.

In such a capacitor, the sum of the two halves of C6 remains constant with shaft rotation. By adjusting C6, it is possible to crank in a

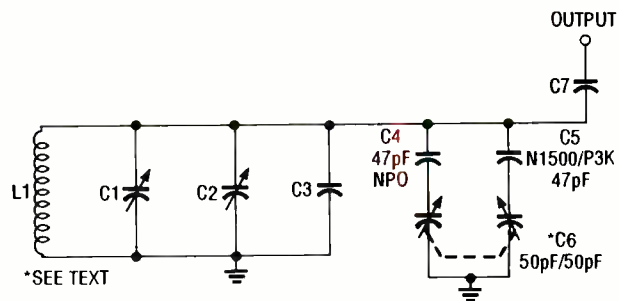

Fig. 2. An alternative way of temperature compensating a VFO using a differential capacitor (C6) is shown here.

variable temperature coefficient from NPO to N1500; thus, as long as C4 equals C5, the total capacitance of C4-C6 remains constant as C6 is varied.

The trick is to set C6 to midrange so that equal amounts of C6's two sections are in the circuit. The adjustment procedure is as follows:

1. Turn the counter on and let it warm up for 1½ hours. Turn on the oscillator, adjust it to the high end, and after 10 seconds note the frequency (f_0).
2. Wait 1½ hours and measure the frequency again (f_1). If f_1 is lower than f_0 , then turn C6 in a direction to crank in a little more N1500 characteristic.
3. Turn the oscillator off, and let it cool down for 1 hour.
4. Turn the oscillator on, and readjust C1 to f_0 . Wait 1½ hours, and measure the operating frequency (f_2). If the operating frequency is less than 500 Hz, then do nothing (unless you want to home in on the best stability, about 100 Hz).
5. If f_2 is considerably different from f_1 , then adjust C6 to crank in more or less N1500 characteristic as needed to cancel the drift.
6. Repeat the procedure until no further improvement is possible (sorry about how much time it takes).

For best stability, the coil for the VFO should be an

air-core unit. B&W Miniductor or Air-Dux coil stock can be used (although rumor has it that B&W will cease offering some lines in the near future). Outfits like Ocean State Electronics (P.O. Box 1458, 6 Industrial Drive, Westerly, RI, 02891; Tel. 800-866-6626 or 401-596-3080) are dealers for B&W products. They also stock toroid coil forms, slug-tuned coil forms, and ready-made slug-tuned inductors.

ASSEMBLY AND USE

Operating the VFO from a low-voltage power source helps keep internal heating down. Most people recommend using a VFO voltage of between 4.5 and 7.5 volts. It's good practice is to use a 78L05, 7805, 7806, or 7807 regulator to provide a stable power source for the VFO; that source should power no other circuit.

Finally, use good, solid construction practices to make the VFO mechanically stable. Mount the coil and capacitors so that vibration cannot affect them very much. Also, keep the entire VFO assembly away from heat sources such as power-supply circuits, lamps, LEDs, and audio amplifiers. Although the VFO power source should be regulated, keep the regulator outside of the VFO cabinet.

In addition, it is standard

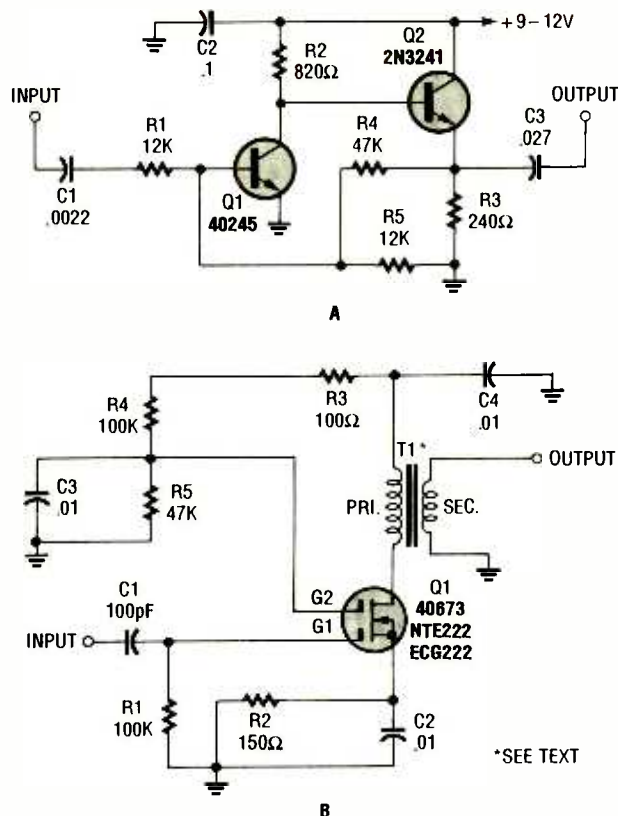

Fig. 3. Here are two buffer amplifiers that have been successfully used with VFO's: one (shown in A) is based on a pair of bipolar NPN transistors, and the other (shown in B) is built around a dual-gate MOSFET.

practice to place a buffer/amplifier between the output of the VFO and the circuit that it drives. That amplifier not only builds up the signal level, but also serves to isolate the VFO from frequency pulling ("chirp" to CW freaks) due to changing load requirements.

Figure 3 shows two buffer/amplifiers that have been successfully used with VFO's. Figure 3A shows a buffer/amplifier circuit based on a pair of direct-coupled bipolar NPN transistors, that uses amplitude-stabilizing feedback (from the emitter of the second transistor to the base of the first transistor). Think of it as a fairly straightforward two-stage amplifier in which the input stage operates in the common-emitter mode and the output is configured as an emitter follower (a.k.a. common collector).

Figure 3B shows a buffer/amplifier of straightforward design, built around a 40673 dual-gate MOSFET. The input signal is fed through C1 to gate 1 (G1) of Q1. Capacitor C1 can be of the value shown, or be equal in value to the capacitor used in the output in the VFO. Values as low as 10 pF have been used successfully where the VFO needs to be lightly loaded.

Note that the output of the circuit is transformer coupled to the following stage. For operation in the 5- to 15-MHz region, the simplest thing to do is to use a 10.7-MHz IF transformer (of the type intended for transistor radios) for T1. If that type of transformer is used, it will be necessary to remove the fixed capacitor that tunes it to 10.7 MHz. I've used Mouser Electronics (2401 Highway 287 N., Man-

(Continued on page 81)

SCANNER SCENE

By Marc Saxon

Scanning The Cordless Band



Cordless phones have a lot more range than you might imagine.

We want to remind you that the cordless-telephone band is very active in all areas. The new 900-MHz cordless phones are still relatively costly, but regular cordless phones are cheap and extremely popular. They are quickly being snapped up by the public for use in homes and of-

fices. While federal law theoretically makes it illegal to monitor cellular calls, there are no federal laws that ban the monitoring of cordless telephones.

Cordless telephones operate within the 46.61–46.97-MHz band. The two-way communications range between the handset and its associated pedestal is usually specified by the manufacturer as being at least 1000 feet, and sometimes as much as 1500 feet. When you think

that a 10-story building is only 100-feet tall, you realize that cordless phones operate over a far greater distance than is required to cover most houses, yards, or office complexes. Furthermore, the operational range is measured when using the small antenna on the cordless phones, while indoors, and at ground level.

But hook a scanner to an antenna cut for the VHF 30–50-MHz “low band,” or an omnidirectional six-meter vertical antenna, mounted outdoors on a roof, and search/scan that band at different hours of the day and evening. Then you’ll find out the distances that those signals actually travel. It’s much further than 1500 feet, and often more than a mile.

You might recognize some of the voices you monitor on that band. The conversations can get very interesting. You will undoubtedly learn many new things about your neighborhood. Don’t be too surprised if you even hear your own name come up in a conversation—it could happen.

DATA IN THE AIR

Several devices are in use that allow computers to access modems or networks via UHF instead of land lines. We’ve had a number of inquiries about the devices and the frequencies used.

We quickly turned up two such devices. One is the *FM*

96 Data Radio, made by IWL Communications of Friendswood, Texas (telephone 713-482-0289). The unit is a UDS half-duplex wireless modem that transmits or receives synchronous or asynchronous serial data at 9600 bps in the 450–4470-MHz band.

The other device we came across is *GINA*, which stands for Global Integrated Network Access. It is a mobile transceiver that has a range of three miles, operating with 1 watt on up to 12 channels (spread spectrum) in the 902–928-MHz band. It handles either 9600 or 128K baud (user-selectable), half-duplex. It comes from GRE America, Inc., (Belmont, California; tel. 415-591-1400).

READERS WRITE

From Paul Kennerly, of Frankfort, Kentucky, we learned that the Kentucky National Guard uses 142.35 and 143.00 MHz, while the U.S. Army Corps of Engineers can be monitored on 149.715, 150.735, and 163.4375 MHz. Kentucky State Police special details use 154.92 MHz.

According to S. G. Montrose of Ticonderoga, New York, the local police are on 154.044 and 153.31 MHz, with area fire operations on 46.16, 446.22, 46.28, and 154.145 MHz. The remote frequency of local radio station WIPS is 161.64 MHz.

A letter we received from Bill Kelly of Portage, Wiscon-

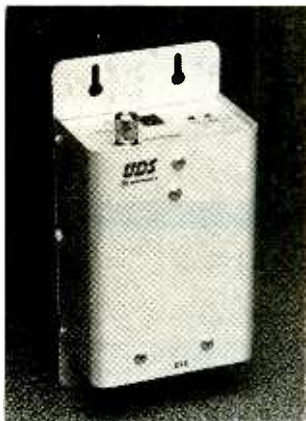

The FM 96 Data Radio operates in the 450-470 MHz band.



GINA uses spread spectrum in the 902-928-MHz band.

sin, let us know about the State Prison frequencies of 46.54 and 158.895 MHz. He tells us that fire mutual aid throughout the state takes place on 154.295 MHz.

IMPORTANT FREQUENCIES

As we fast approach the height of the severe weather season, this is a good time to point out that a scanner is more than something useful to pursue as part of your hobby. Some 90% of the nation is blanketed with signals in the 162-MHz band that consist of weather warnings, broadcasts, and forecasts from the National Oceanic and Atmospheric Administration (NOAA).

Dave Smaron, of Addison, Illinois, wrote to say that NOAA has a free listing of all its VHF weather stations and their respective channels. Ask your nearest National

Weather Service office for a copy, or write to request one from the National Weather Service, Attn: E/OM11, National Oceanic and Atmospheric Administration, Silver Springs, MD 20910.

Most people think that NOAA uses only its two very well-known frequencies: 162.55 and 162.40 MHz. In fact, there are no less than five additional NOAA weather-broadcast frequencies in use: 162.4255, 162.45, 162.475, 162.50, and 162.525 MHz. Just because you normally receive your local weather information on one frequency doesn't mean that you can't receive distant stations on one or more of those other channels.

At my own station, I use those stations to check out antennas and receivers. I know that some distant stations will come in only when I am using a superior antenna or scanner.

NOAA estimates that each station has a reliable range of 40 miles, but most cover far more than that if you are monitoring on a base station with a good outdoor antenna. In addition, there are occasional freak reception conditions when signals have come in from very long distances.

Still, the main purpose of the NOAA stations is to issue weather bulletins. Weather conditions being what they are this time of the year, it is worth keeping in mind that your scanner is a valuable safety device that lets you access important information that is vital to the security of your family and property.

We welcome your letters, comments, frequency reports, and questions. Write to us at *Scanner Scene*, **Popular Electronics**, 500-B Bi-County Blvd., Farmingdale, NY 11735. ■

ANTIQUE RADIO

(Continued from page 67)

columns to come.

Billy has been closely following the Sky Buddy restoration project, usually anticipating all of my diagnostics and coming up with the correct solution before I did (although, because of the spread between the dates these articles are submitted and published, I haven't had the benefit of his thinking in time to apply it to the problem at hand).

One suggestion I wish I'd had time to try before buttoning up the Sky Buddy for the last time involves alignment procedure. The set manufacturer generally specifies two calibration points to use for RF alignment on a particular band: one at the upper end and one at the lower. The Hallicrafters alignment instructions call for adjusting at the high point first, then the low one.

Billy suggests beginning with the oscillator adjustment at the low point, then checking calibration in the middle of the dial. If necessary, the low-point adjustment is now tweaked for a good compromise between dial accuracy at the low point and middle. Next, make the high-point oscillator adjustment. Then go back and peak the mixer adjustments at the same three points. That should result in much better accuracy, and I'm certainly going to try the procedure on the next set I align.

By the way, Billy could use a schematic and service literature for the Hallicrafters SX28.

THIS 'N THAT

Thanks to *Professor Dan Fielder* of Georgia Tech for sending me some interesting follow-up mail he

received from a Canadian reader after Dan's Radiola III reminiscences appeared in the November, 1992 column. Maybe we can cover some of the material from that letter in a future column. Thanks also for sending me a copy of the theremin article that appeared in the Spring 1993 issue of *Invention and Technology* magazine. Thanks, also, to *Dan Lehman* (Columbus, Ohio) for sending the same article.

Reader *M. Bivens* (Oshkosh, WI) recommends the following source for old service literature: Allen J. Loeb, 414 Chestnut Lane, East Meadow, NY 11554. Write for current prices.

That's it for now. As always, I look forward to hearing from you. Send your comments and questions c/o *Antique Radio*, **Popular Electronics**, 500-B Bi-County Blvd., Farmingdale, NY 11735. ■

HAM RADIO

(Continued from page 79)

sfield, TX, 76063-4827; Tel. 800-346-6873) part no. 421F123 for that purpose because its capacitor is external to the transformer housing, and is recessed in a little hollow of the housing base. A sharp instrument can be used to remove (crush) it.

Alternatively, you might use a toroid transformer. An Amidon (2216 East Gladwick Street, Dominguez Hills, CA 90220; Tel. 310-763-5770) T-50-2 (red) core, wound with 18 turns of #26 wire for the primary and 4 turns for the secondary is about right for most applications.

Well, now that we've beat ham-band VFO circuits to death, why not go and try one out? Building is a lot of fun! ■

ELECTRONICS LIBRARY

Shortwave Radio Listening for Beginners

by Anita Louise McCormick

Aimed at anyone who wants to find out what's happening on the shortwave-radio bands, this book allows the newcomer to start listening right away without wading through a lot of unnecessary technical information. Instead, the book offers the practical guidance that beginners need to listen in on radio broadcasts from across the country and around the world. Opening with a brief history of radio, the book goes on to describe how shortwave radio works, what kinds of equipment are available and where to find it, and where and when stations can be heard. If you find yourself hooked, and want to do

of some of the stations that can be heard on the shortwave bands. A list of resources, including shortwave radio magazines, listeners' clubs, and mail-order catalogs, is sure to come in handy.

Shortwave Radio Listening for Beginners costs \$10.95 and is published by TAB Books, Division of McGraw-Hill Inc., Blue Ridge Summit, PA 17294-0850; Tel. 800-822-8138.

CIRCLE 98 ON FREE INFORMATION CARD

CIRCUIT SOURCE BOOKS 1 AND 2

by R. A. Penfold

By providing various standard "building block" circuits, these two books help readers create and experiment with their own electronic designs. Wherever applicable, advice on how to alter the circuit parameters is provided. The circuits in Book 1 primarily cover analog-signal processing and include audio amplifiers (op-amp and bipolar transistors); audio power amplifiers; DC amplifiers; high-pass, low-pass, band-pass, and notch filters; tone controls, voltage-controlled amplifiers and filters; gates and electronic switching; bar graphs; triggers and voltage comparators; phase shifters, current mirrors, and hold circuits; and mixers. Book 2 covers signal generation, power supplies, and digital electronics. Included are 555, sinewave, CMOS, voltage-controlled, and RF oscillators; 555, CMOS, and TTL monostables; counters and display drivers; function generators; precision long-duration timers; power supply and regulator circuits; negative voltage generators and voltage boosters; and D/A and A/D converters. More than 150 tested circuits, aimed at professionals, students, and hobbyists in-

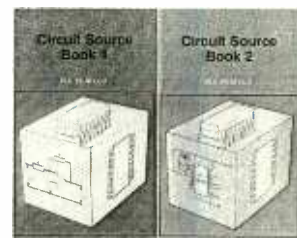

involved in circuit design and application, are offered in each book.

Circuit Source Book 1 and Circuit Source Book 2 each cost \$6.50 plus \$2.50 shipping and handling and are available from Electronics Technology Today Inc., P.O. Box 240, Massapequa Park, NY 11762-0240.

CIRCLE 97 ON FREE INFORMATION CARD

TEST MEASUREMENT INSTRUMENTS CATALOG

from Bel Merit Corporation

New for summer 1993, this 12-page catalog features detailed specifications and descriptions of portable and benchtop test and measurement instruments designed for the engineer, student, technician, or hobbyist



who tests, repairs, or assembles electronic equipment. Highlighted new products in-

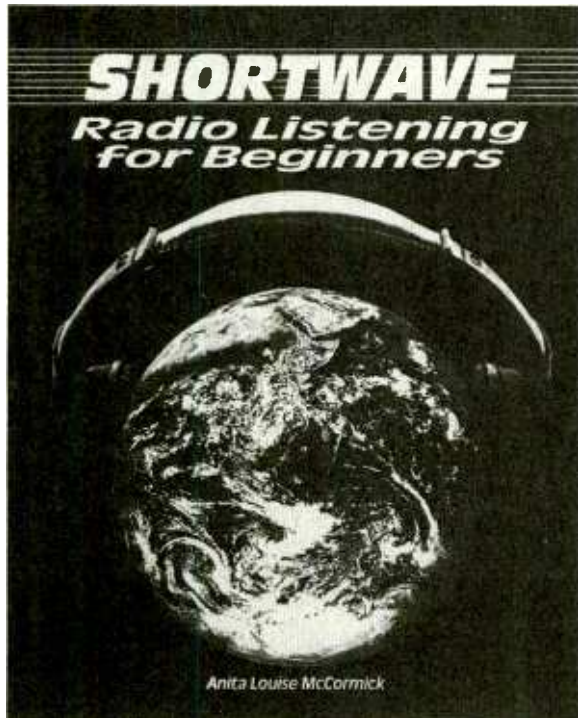

more than just listen, the book also provides advice on how to apply for a ham-radio operator's license. Definitions for many of the most common shortwave radio abbreviations and terms are included, as well as profiles

clude multi-function digital multimeters with holsters, clamp-on current meters, frequency counters, sweep/function generators, DC power supplies, audio- and RF-signal generators, voltage testers, continuity checkers, and circuit analyzers.

The Test Measurement Instruments Catalog is free upon request from Bel Merit Corporation, 17 Hammond, #403, Irvine, CA 92718-1635; Tel: 714-586-3700; Fax: 714-586-3399.

CIRCLE 90 ON FREE INFORMATION CARD

GUIDE TO THE NATIONAL ELECTRICAL CODE 1993 EDITION

by Thomas L. Harman and Charles E. Allen

This detailed guide to the National Electrical Code and the principles of electrical design that are based on the code is aimed at aspiring and practicing Master Electricians, as well as electrical-technology students. With an emphasis on the types

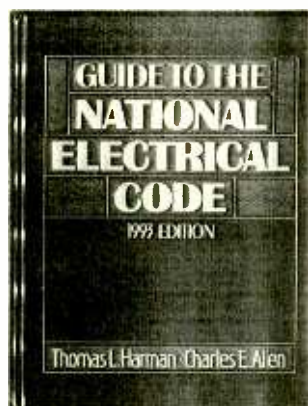

of questions and problems that appear on Master Electrician's Examinations, each subject area is discussed in detail, accompanied by example problems and solutions.

The book is divided into four sections. Parts I and II, directly based on the National Electrical Code, cover the design of electrical wiring systems, and the construction and installation of electrical systems, respectively. Included are the rules and design calculations required to determine the ratings of elec-

trical services, feeders, and branch circuits for typical electrical installations. Part III covers basic electrical theory and practice that, for the most part, falls outside the scope of the code, although it is required knowledge for working electricians. It includes basic DC circuits and reviews the properties of conductors, basic AC circuits, and equipment in AC circuits. Part IV contains two sample examinations representative of those given by various city and state exam boards for a Master Electrician's license. Quizzes, end-of-chapter exams, tables, problems, examples, and appendices supplement the text.

The Guide to the National Electrical Code: 1993 Edition costs \$44.00 and is published by Prentice Hall, Englewood Cliffs, NJ 07632; Tel: 201-592-2000.

CIRCLE 99 ON FREE INFORMATION CARD

THE AUTOCAD PRODUCTIVITY BOOK: The Non-Programmer's Guide to Customizing AutoCAD: Fourth Edition

by James L. Brittain, George O. Head, and A. Ted Schaefer

Right out of the box, AutoCAD is a powerful computer-aided design and drafting program that allows users at all levels to create professional drawings. But by customizing AutoCAD, you can truly get the most out of the program. This book shows you how to take control of AutoCAD and customize it to meet your particular needs. The fourth edition, which has been completely revised with the non-programmer in mind, provides a

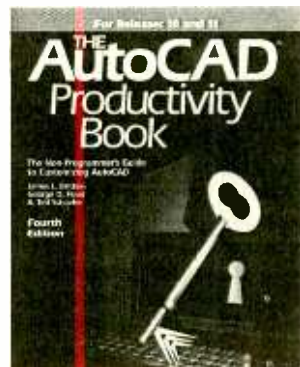

solutions-oriented approach to helping you dramatically enhance the speed and performance of your AutoCAD system. Twelve step-by-step tutorial chapters and three appendices help you customize menus, create hatch patterns, make your own icons, and organize your AutoLISP library. The book's "AutoCAD Productivity Library" contains 30 never-before-published AutoLISP routines that provide valuable techniques for tailoring AutoCAD Releases 10 and 11 to suit your specific requirements.

The AutoCAD Productivity Book costs \$24.95 and is published by Ventana Press, P.O. Box 2468, Chapel Hill, NC 27515; Tel: 919-942-0220; Fax: 919-942-1140.

CIRCLE 91 ON FREE INFORMATION CARD

1993 COMPONENTS EDITION CATALOG

from JDR Microdevices

This 51-page, full-color catalog, JDR's first Components Edition, contains a wide variety of the latest electronic devices. Besides a large selection of IC's, components, prototyping devices, and development tools, it features many new products and hard-to-find reference



books. Also included are hand tools, test equipment, wire, cables, and more. There is no minimum order.

The 1993 Components Edition Catalog is free upon request from JDR Microdevices, 2233 Samaritan Drive, San Jose, CA 95124; Tel: 408-559-1200.

CIRCLE 92 ON FREE INFORMATION CARD

UNDERSTANDING SOLID STATE ELECTRONICS: Fifth Edition

by Don L. Cannon

If you or someone you know wants to understand electronics, but can't spend years studying it, this book can help provide a solid foundation in electronic theory, concepts, and practical applications. Electronics concepts are explained without complicated mathematics—in fact, only a little fourth-grade level arithmetic is used. Technical concepts are explained with non-technical people in mind, so every new idea and term is explained along the way. Each chapter

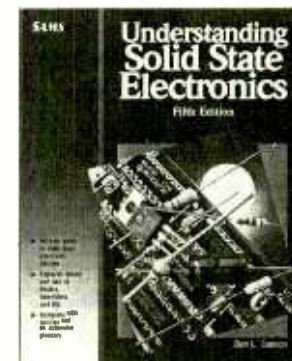

ends with a self-quiz; answers appear at the end of the book.

The easy-to-understand presentation does not detract from the scope or depth of the information presented. The book explores the latest in semiconductor theory and technology, with an emphasis on how semiconductors "fit" within circuits. It explains how circuits and logic gates "make decisions" and how to properly include solid-state devices into a circuit design. Digital and linear IC's are covered. Design specification and operating principles on the most important components—including transistors, diodes, IC's—are clearly spelled out.

Understanding Solid State Electronics: Fifth Edition costs \$24.95 and is published by Sams, Division of Macmillan Computer Publishing, 11711 North College, Carmel, IN 46032; Tel: 800-428-5331 or 317-573-2500; Fax: 800-448-3804 or 317-573-2655.

CIRCLE 95 ON FREE INFORMATION CARD

NEW PRODUCTS

Phone Line Manager

Now it's possible to monitor and screen out unwanted phone calls even if you live in an area where Caller ID is not available, and to control incoming calls from non-Caller ID areas. The *Model 3000 Phone Line Manager* from *ATDI* stops unwanted calls, such as those from computerized telemarketers, while allowing wanted calls to go through. In non-Caller ID areas,



for a call to go through, the caller must input either his phone number or a pre-arranged PIN (personal identification number). In Caller ID areas, the Model 3000 acts like a typical Caller ID device or phone, displaying the caller's name and number before the phone is answered, but adds some features not found on most Caller ID units. The Phone Line Manager offers distinctive ringing and 4½ minutes of voice messages. Call blocking can be customized or overridden using the unit's various modes. It can be set in a normal screening mode, or a call-blocking code can be used to stop specific numbers. The unit's "Do Not Disturb" mode allows only those callers on your "A List" or "B List" to ring through. It's easy to

change a person's status (from A to B List), and to change the numbers to be blocked or unblocked. A modular call-accounting printing option lets you print out records of phone calls, ID numbers, or call-blocking selections. A hands-free automatic dialer holds 100 names and numbers. The unit is compatible with all telephone company feature-phone options and works in both ANI (Automatic Number Identification) and non-ANI states.

The Model 3000 has a suggested retail price of \$299. For more information, contact Advanced Technologies Development Inc., 185 Brandy Hill Road, Vernon, CT 06066; Tel. 203-872-3813; Fax: 203-875-8226.

CIRCLE 101 ON FREE INFORMATION CARD

DESKTOP CAMERA

Complete desktop multimedia production is possible with *VideoLabs' FlexCam* integrated color camera and microphone designed for desktop video and communications. The unit consists of a ½-inch, high-resolution (510 × 492), color CCD camera and two stereo microphones. The FlexCam outputs color NTSC video and industry-standard, line-level audio. It is compatible with all popular video-digitizing boards offered for the Apple Macintosh, PC's (including Microsoft Video for Windows), and other computers. It also can be used for video and audio input to VCR's, videoconferencing systems, and any other product that accepts NTSC video. (A PAL version is also available.) The camera and microphones are mounted on a thin, 18-inch flexible stand that can be easily adjusted for precise positioning. The microphones are mounted at 60-degree angles for stereo imaging. The base of the FlexCam contains all its electronics, and a single cable carries both



audio and video to a convenient "behind the computer" location.

The FlexCam has a suggested retail price of \$595. For further information, contact VideoLabs, Inc., 5270 West 84th Street, Minneapolis, MN 55436; Tel. 612-897-1995.

CIRCLE 102 ON FREE INFORMATION CARD

NON-CONTACT TEMPERATURE PROBE

Ideal for situations where it is difficult to measure temperature, such as when the subject is electrically live, moving, hard to reach, or can be contaminated



by touch, the *Fluke's 80T-IR Infrared Temperature Probe* allows users to make non-contact measurements using a digital multimeter. The probe's rugged, ergonomic design makes it suitable for harsh environments and allows easy one-handed use. Its 0°F to 500°F range and 3% accuracy allow it to be used in a wide range of applications, including predictive and preventative maintenance. Emissivity is pre-set at 0.95, which is adequate for most industrial ap-

Introducing Australia's Leading Electronics Magazine...

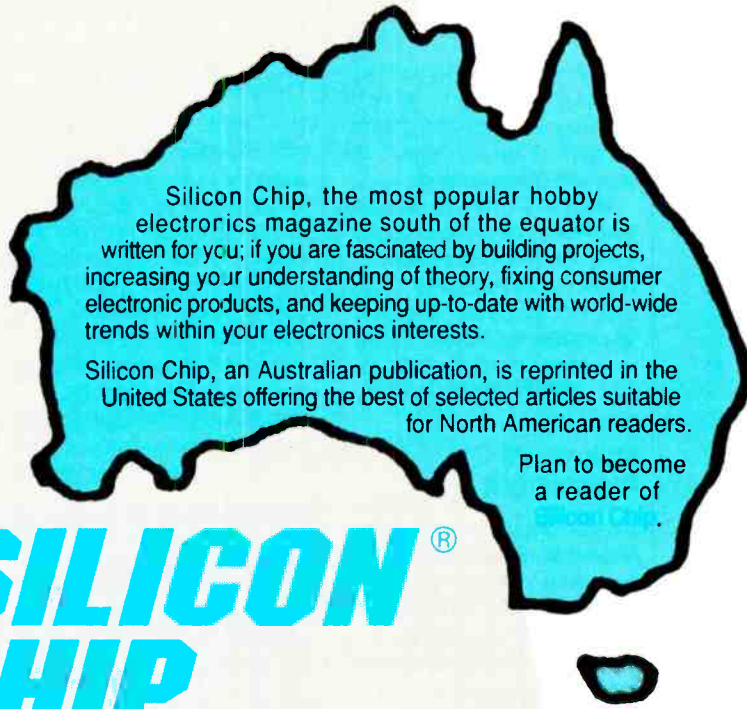

SILICON CHIP®

Packaged in a specially prepared format guaranteed to excite the electronics hobbyist with new ideas, novel projects, extraordinary features and down-right good reading.

Inside **Silicon Chip** you will discover how the other side of our world—down under—approaches the same hobby interests as you do, with ramifications that will amaze you.

Detailed construction projects to appear in upcoming issues of Silicon Chip include:

- 4-Channel Guitar Mixer**
- Adjustable 0-45V, 8A Power Supply**
- Interphone Digital Telephone Exchange**
- 1.5V to 9V DC Converter**
- Multi-Sector Home Burglar Alarm**
- 1-Megabyte Printer Buffer**

Exciting and Imaginative Features like:

- Understanding Computer Memory**
- How to Interlink Musical Instruments**
- What's New in Oscilloscopes**



SPECIAL OFFER

A sample copy may be ordered for only **\$2.50!**
In Canada: \$3.50!
Use coupon below and write across top "SAMPLE ISSUE." Fill out coupon except for subscription information and mail. Sorry—no credit cards. Send only check or money order in U.S. funds.

If you are fascinated by electronics, especially the hobby aspects related to construction projects, theory, applications in home and shop, and latest developments, if you are compelled to experiment and "fix-it," then **Silicon Chip** is your kind of magazine.

Silicon Chip is available exclusively by subscription. So take advantage of this great opportunity and start your Charter Subscription today.

SILICON CHIP, 500-B Bi-County Boulevard, Farmingdale, New York 11735

PE893

I'm convinced! Enroll me as a Charter Subscriber. Enter my subscription as designated below.

United States of America

- 12 issues for \$29.95
- 24 issues for \$49.95

Canada

- 12 issues for \$40.61
- 24 issues for \$70.57
(Includes postage & G.S.T.)

- Payment enclosed
- Please charge my
- VISA
- Mastercard

For your convenience, if paying by credit card: To avoid any interruption in service, your subscription will be renewed automatically at 12-issue intervals, at the then prevailing introductory rate, until you advise us to cancel it.

Signature _____

Account No. _____ Expiration Date _____

Offer valid in the U.S.A. and Canada only. No foreign Orders.

Name _____

Address _____

City _____ State _____ Zip _____

All orders payable in U.S.A. funds only. Allow 6-8 weeks for delivery.

lications. The 80T-IR can be used with any digital multimeter, and the measured temperature appears on the multimeter's display within one second.

The 80T-IR Infrared Temperature Probe has a list price of \$199. For more information, contact John Fluke Mfg. Co., Inc., P.O. Box 9090, Everett, WA 98206; Tel. 800-87-FLUKE.

CIRCLE 103 ON FREE INFORMATION CARD

VGA-TO-TV CONVERTER

You can display your computer presentations on TV, or record them on a VCR, using *Advanced Digital Systems' VGA to TV Elite*. The combination software/hardware package allows a desktop computer to display text and graphics on any standard color TV or monitor without using an expensive RGB converter or large VGA monitors and LCD panels. The portable unit is easy to use



for presentations or meetings, when the output from a PC can be used by video projectors, TV sets, or VCR's for large-screen viewing—or for playing computer games on a big-screen TV. The VGA to TV Elite offers flicker-free circuitry, and "High Color" support. It supports VGA modes up to 640 × 480 in 16.7 million colors. It also supports the desktop VGA monitor and TV output simultaneously. All necessary cables and software drivers are included.

The VGA to TV Elite has a suggested retail price of \$399. For more information, contact Advanced Digital Systems, 20204 State Road, Cerritos, CA 90701; Tel. 800-888-5244 or 310-865-1432; Fax: 310-809-6144.

CIRCLE 104 ON FREE INFORMATION CARD

VOLUME STABILIZER

The *VVS301 Volume Stabilizer* from *Brookline Technologies* is designed to solve two problems that commonly plague stereo and home-theater listeners: the inability to hear softer music and dialogue over typical background noise (such as air conditioner drone or kids playing), and the dramatic changes in volume levels when, for instance, loud action scenes are followed by quiet dialogue. The Volume Stabilizer automatically



increases the volume of the audio source during soft passages and reduces the volume during louder segments. Instead of frequently adjusting the volume level or just living with the problems, using the device allows you to hear all the audio at normal volume levels, even over normal background noise. Sound dynamics are maintained, so that the music and dialogue still sound alive, not flat or dull. The VS301 is easy to install and use. About the size of a portable CD player, the unit fits into almost any audio/video system. A single adjustment knob allows you to control the level of volume stabilization.

The VS301 has a suggested retail price of \$129.95. For additional information, contact Brookline Technologies, 2035 Carriage Hill Road, Allison Park, PA 15101; Tel. 412-366-9290.

CIRCLE 105 ON FREE INFORMATION CARD

STANDBY POWER SYSTEM

The latest addition to *Best Power Technology's Patriot* line of standby Power Systems (SPS) is the *SPS 300 VA*, designed for supporting small, single-user PC's (it can support the IBM PS/2 Model 30 with VGA monitor for 22 minutes). Like the rest of the line, the SPS

300 VA has a microprocessor-controlled detection system that assures transfer to battery power in 4 milliseconds or less under all conditions. Its output is carefully regulated to avoid stressing the computer's power supply, which can happen with the unregulated squarewave output of other standbys. The Patriot SPS 300 VA constantly protects equipment from spike damage, and has a UL 1449 surge-suppression rating. The unit switches to the inverter to protect loads from prolonged over-voltages that can damage computer power supplies, and stops electrical noise that scrambles data and locks up computers. The SPS 300 VA can be configured with an optional interface port that lets it trigger a safe, orderly shutdown on many popular computer systems. Optional CheckUPS software and shutdown kits are available for DOS, OS/2, AS/400, RS/6000 AIX, Novell



NetWare, LAN Manager, UNIX/XENIX, Lantastic, Banyan VINES, Prime, and more. Two audible alarms and a triple-mode status indicator light warn users of overloads or low battery.

The Patriot SPS 300 has a list price of \$199. For more information, contact Best Power Technology, Inc., P.O. Box 280, Necedah, WI 54646; Tel: 608-565-7200 or 800-356-5794.

CIRCLE 106 ON FREE INFORMATION CARD

DESKTOP VGA-TO-NTSC CONVERTER

Because it offers all video formats—including AV video, S-Video, and an RF-modulated

output—the *Model 702 Desktop Videoverter* from *Telebyte Technology* can be used with any type of TV, VCR, or projection device. The Videoverter is compatible with all notebook and desktop PC's that operate in a VGA display format. The device provides the link to convert the image on any VGA screen to NTSC for use on any standard TV or VCR. The Model 702's choice of outputs allows interfacing to any video device from a low-end TV equipped with



only an RF input to a VCR with AV inputs (composite video) to a top-of-the-line TV or VCR that uses S-Video. All three outputs can be used simultaneously. The Videoverter is a self-contained package that provides a pass-through link for VGA signals from the PC to the VGA monitor. Thus the computer monitor and the TV will both operate at the same time. For notebook PC's, the external monitor output is connected to the Model 702.

The Desktop Videoverter comes with a user-installed TSR software driver program and demo routines on floppy disk. When the display is required on the TV, a hot key combination is activated on the computer's keyboard. That activates the Videoverter to convert the image for display on the TV, and the SYNC LED lights. Additional hot keys allow image movement, overscan under-scan, flicker reduction, and TSR unloading. The device supports 11 VGA modes and is also available for operation with the European PAL standard.

The Model 702 Desktop Videoverter costs \$345. For more information, contact Telebyte Technology, Inc., 270 East Pulaski Road, Greenlawn, NY 11740; Tel: 800-835-3298 or 516-423-3232; Fax: 516-385-8184.

CIRCLE 107 ON FREE INFORMATION CARD

CARDBOARD TUBE RADIO

(Continued from page 43)

and the clip with no wire connection. Be sure that the anode on the diode faces toward the point-D clip. From the cathode clip, bring out a wire lead, which will be used to connect the earphone. The earphone, Z1, is unfortunately the most difficult part to get. I recommend ordering it through Mouser Electronics (and be sure to get their catalog for future electronic projects). Continue making the connections, as illustrated in Fig. 4. When finished, your tube/coil assembly should resemble the Fig. 4 illustration.

Antenna and Ground. The secret to a good AM crystal radio is a good antenna and a good ground. The antenna can be a length of wire about 80 to 100 feet in length, strung high outside in your yard. The antenna should be mounted at least 20 feet above the ground for best results. If you're lucky and live in a metropolitan area with AM-broadcast stations nearby, 10 feet of wire lying on the rug may even be adequate to receive the local stations. For ground, any metal water pipe entering your house will do.

Operation. Attach the antenna, ground, and earphones to the appropriate paper-clip posts. Grasp the foil-lined portion of the outer tube with one hand, and with the other hand, grasp the bare bottom end of the inner tube. Slowly slide the inner tube into the outer tube to tune in stations. You'll find that the radio's sensitivity is excellent.

Late at night, when reception is best, you can easily receive out of state signals. Pay special attention at the start of each hour when all stations usually give their call sign and location. You'll be surprised at the distant stations you can receive.

If you have problems with the radio, make sure that the paper clips are making adequate contact with each wire and especially the aluminum foil. Also check that you have completely scraped off the enamel insulation from the wire ends. Note that common "Walkman" type headphones will not work; high-impedance crystal earphones must be used. ■

SERIAL PORTS

(Continued from page 65)

cates that what follows it—in this case N—is an exponent.) If TRUFAL is high, then bit N in SDAT was high, if TRUFAL is low, then bit N in SDAT was low.

The fifth byte that supports each serial port can be used to set the logic state of the two handshaking outputs. If one of those bits is set high, its corresponding signal will become negative (unasserted and false), if either bit is brought low, its corresponding line will become positive (asserted and true).

As an example, to set bit N (and its associated output) in the fifth byte of COM3: high, you could use a statement like this:

```
OUT &H3EC, 2^N
```

There is one drawback to that statement however: all bits except N will be set low. If before you executed this statement some bits were set high and you wanted to keep them that way, this statement would screw things up. On some PC-compatible computers it is possible to rectify the situation by reading the value of the byte before adjusting it and making sure you preserve the desired bits when you modify the byte. For example, you could use:

```
SETBITS = INP(&H3EC)
```

to find the data already stored in hexadecimal address 3EC, then use:

```
ALLBITS = SETBITS OR 2^N
```

to combine the current bits with a bit (N) you wish set and then send the updated data to the port using:

```
OUT &H3EC, ALLBITS
```

If your computer doesn't allow you to read the output bytes (the first and third bytes) then you must write your program so it keeps track of the bits that have been set in the course of operation and preserves them as appropriate. In other words, your program must update the value of whatever variable you use in place of SETBITS used in the equation for ALLBITS.

I hope that the information that's been presented will help get you started writing your own port-control programs. ■

CABLE TV DESCRAMBLERS How You Can Save Money on Cable Rental Fees Bullet Proof



1 Unit 5+
BEST Super Tri-Bi Auto/
Var. Gain Adjustment \$119.95...\$85
Jerrold Super Tri-Bi... \$109.95...\$79
Scientific Atlanta..... \$109.....\$79
Pioneer.....\$109.....\$79
Panasonic TZPC145.... \$99.95...\$79
Stargate Converter..... \$95.....\$69
Digital Video Stabilizer. \$59.95...\$29
Wireless Video Sender. \$59.95...\$49.95

US Cable'll Beat
Anyone's Price
Advertised in
this Magazine!

30 Day Money Back Guarantee
FREE 20 page Catalog

Visa, M/C, COD or send money order to:
U.S. Cable TV Inc. Dept. KPE893
4100 N. Powerline Rd., Bldg. F-4
Pompano Beach, FL 33073

1-800-772-6244

For Our Record

I, the undersigned, do hereby declare under penalty of perjury that all products purchased, now and in the future, will only be used on Cable TV systems with proper authorization from local officials or cable company officials in accordance with all applicable federal and state laws. FEDERAL AND VARIOUS STATE LAWS PROVIDE FOR SUBSTANTIAL CRIMINAL AND CIVIL PENALTIES FOR UNAUTHORIZED USE.

Date: _____
Signed: _____

No Florida Sales!

CIRCLE 12 ON FREE INFORMATION CARD

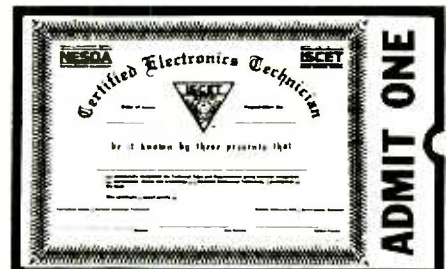

Your Ticket To SUCCESS

Over 28,000 technicians have gained admittance worldwide as certified professionals. Let your ticket start opening doors for you.

ISCEI offers Journeyman certification in Consumer Electronics, Industrial, Medical, Communications, Radar, Computer and Video. For more information, contact the International Society of Certified Electronics Technicians, 2708 West Berry Street, Fort Worth, TX 76109; (817) 921-9101.

Name _____
Address _____
City _____
State _____ Zip _____

Send material about ISCEI and becoming certified.

Send one "Study Guide for the Associate Level CET Test." Enclosed is \$10 (inc. postage).

August 1993, Popular Electronics

87

CIRCUIT CIRCUS

(Continued from page 72)

rows the receiver's bandwidth, with some loss in sensitivity. Increasing the number of turns will, quite naturally, increase the bandwidth and that sensitivity.

IF AMPLIFIER

In Fig. 5, the ZN416E is configured as a simple 455-kHz IF amplifier. The IF's center frequency and bandwidth is set by RES1 (a Murata CSB455E ceramic resonator). That part can be a little hard to find, so if you can not locate a resonator send me a self-addressed

PARTS LIST FOR THE IF AMPLIFIER

CAPACITORS

- C1—0.05- μ F, ceramic-disc
- C2, C5—0.1- μ F, ceramic-disc
- C3—0.47- μ F, ceramic-disc
- C4—0.01- μ F, ceramic-disc
- C6, C7—100- μ F, 16-WVDC, electrolytic

ADDITIONAL PARTS AND MATERIALS

- U1—ZN416E tuned, radio-frequency AM receiver, integrated circuit
- R1—100-ohm $\frac{1}{4}$ -watt, 5% resistor
- RES1—CSB455E Murata ceramic resonator (see text)
- L1—2.5-mH RF choke
- Perfboard materials, enclosure, AC molded power plug with line cord, battery(s), battery holder and connector, wire, solder, hardware, etc.

PARTS LIST FOR THE VOLTAGE CONTROL

RESISTORS

(All fixed resistors are $\frac{1}{4}$ -watt, 5% units.)

- R1—1500-ohm
- R2—1000-ohm potentiometer
- R3—2500-ohm potentiometer

ADDITIONAL PARTS AND MATERIALS

- C1—0.1- μ F, ceramic-disc capacitor
- Q1—2N2222 general-purpose NPN silicon transistor
- Perfboard materials, 6-volt DC power source, knobs, wire, solder, hardware, etc.

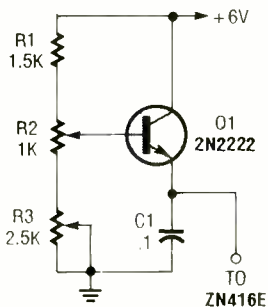

Fig. 6. Designed as a regulator for a 6-volt source, this circuit makes supplying the receiver with a precise power source an easy task.

stamped envelope in care of **Popular Electronics**, and I'll send you one free.

Although (as stated earlier), the ZN416E is designed to operate from supply voltages ranging between 1.1 and 1.6 volts, the actual voltage can be fine tuned to peak the chip's performance. In strong signal areas, a lower supply voltage helps to correct the AGC action. If the supply voltage is too high, the AGC range will be limited, caus-

ing a strong station to occupy a much wider bandwidth. That condition is undesirable, since it can cause weaker stations, that are close by in frequency, to be masked.

VOLTAGE CONTROL

The circuit in Fig. 6, which is designed as a regulator for a 6-volt source, makes voltage adjustments for the previous circuit an easy task. In that circuit, the base bias of Q1 (a 2N2222 NPN transistor configured as an emitter follower) can be adjusted via R2 (a 1k potentiometer). Potentiometer R3 is used to set the maximum output level of the circuit to a level that is no greater than 1.6 volts.

Setting up the circuit is easy. Connect the circuit to a 6-volt DC source, and connect a DC voltmeter between Q1's emitter and ground. Adjust potentiometer R2 fully clockwise for a maximum voltage reading, then adjust potentiometer R3 for 1.6-volts at the output of the circuit.

If you really enjoy experimenting and get a kick out of building things that work great, then why not try one of these receiver circuits. I don't think you'll be disappointed.

Well, it looks like our time is up for now. As always, we'll be looking for you here next month for some more fun circuitry.



"All it says is: Some Assembly Required."

ONKYO RECEIVER

(Continued from page 29)

with Dolby surround-sound augmented by the electronics of a receiver such as this Onkyo "do-it-all" unit is something that comes as close to the actual motion-picture-theater experience as anything we have tested or evaluated to date.

But don't overlook the fact that even as a straight stereo receiver, this unit offers unsurpassed performance. Onkyo has always been noted for their superb FM tuner designs, and they have obviously incorporated much of what they've learned into this outstanding receiver.

For more information on the TX-SV909PRO, contact Onkyo (200 Williams Dr., Ramsey, NJ 07446) directly, or circle No. 120 on the Free Information Card.

Radio CRAFT

The Magazine for Fun-Loving Experimenters

Everything about radio that appeals to the hobbyist, experimenter, the technically inclined. There's practical information on all areas of radio—SWL, DX-listening, scanners, amateur radio, AM, AM stereo, FM, antique radios, and antennas. Plus construction projects on receivers, tuners, converters, and transmitters. And tips on police communications and radio technology.

**It's Project
Building!**

It's Theory!

**It's On Sale
June 15, 1993**

SHORTWAVE RADIO

(Continued from page 35)

neatly strung behind furniture and curtains for an adequate indoor antenna. The same length of wire, or more, outdoors or up in the attic, will be an even better receiving antenna.

Even with a short whip antenna, you'll get surprising results. The longer the whip, the better, unless you're subject to overloading from a strong local station. The ideal antenna setup for this frequency range is an outdoor wire 25 to 50 feet in length, with the ground side of the antenna jack connected to a copper cold-water pipe.

For your convenience, a short length of audio cable with a pre-wired RCA plug to mate with J1 is adequate for making antenna and ground connections. RF coaxial cable is not essential for this application.

When installing any outdoor antenna, be very careful not to let your antenna wire come in contact with electric power lines. Any antenna wire

for shortwave listening may run horizontally, vertically, both ways, or at an angle. In fact, if you have a roof-mounted TV antenna, its feedline will make a great antenna for your radio. Even some existing metal objects, such as metal downspouts, gutters, windows, door screens, or attic insulation foil, can serve as antennas!

If you are completely restricted to indoor antennas, you can get an extra boost from the AA-7 Active Antenna described in the March 1993 issue of **Popular Electronics**. If you need more construction details on antennas, check any introductory ham radio book, or the Radio Shack book *Antennas* (Catalog No. 62-1083, \$3.95).

Packaging. Your finished receiver can be housed in a variety of enclosures of your own design and choosing. Use of the optional inexpensive and attractive case and knob kit available from the supplier listed in Parts List will give your unit that professionally finished look. The sturdy

black case is supplied with neatly lettered front and rear panels, knobs, rubber feet, and mounting screws. You will need to drill four access holes in the top of the cabinet if you wish to retune the four slugs of L1, L2, and L3 while the radio is in the cabinet.

Alternately, if your first goal is economy and rugged portability, you will find that the circuit board can be mounted nicely in a standard VHS videotape storage box, which also has sufficient room for a speaker, or ear-phone storage, and even a roll of antenna wire. The controls are easily mounted at one end of such a box. It will be necessary to cut away the box's molded posts that secure the tape cassette inside the box.

To accomplish RF shielding, Radio Shack sells an economical metal enclosure (catalog No. 270-253A, \$6.99) that is well suited as the receiver's enclosure. That 3 × 5.25 × 5.88-inch metal utility cabinet can accommodate the radio and a speaker, with room for various refinements that you might like to add. ■

**ONLY
\$9.95
EACH**

TTL-CMOS **BONANZA**

The Biggest Budget Buy an Experimenter, Circuit Designer, or Engineer would want!



5 compact pocket guides provide a comprehensive listing of all commonly used TTL and CMOS integrated circuits. All current families including: Standard, Low Power, Schottky, Low Power Schottky, Advanced Schottky, Advanced Low Power Schottky, High Speed and Fast Schottky, and all the commonly used CMOS devices.

They're easy to use! Each page describes one component only and is divided into eight parts, which offer the following: 1—The device's schematic diagram. 2—Logic description. 3—Data on the chip's operational characteristics such as signal levels, etc. 4—Major applications. 5—Summary of essential data. 6—Table of TTL families in which the component is available. 7—Device common name. 8—Type reference number highlighted at the bottom of page for rapid and easy reference.

ORDER THE COMPLETE SET TODAY!

ELECTRONICS TECHNOLOGY TODAY INC.
P.O. Box 240, Massapequa Park, NY 11762-0240

Paying by Check Please charge my Visa MasterCard
Card No. _____ Expiration Date _____
Signature _____
Name _____
Address _____
City _____ State _____ Zip _____

US and Canada orders only. Sorry, no Foreign orders.

Each Book is \$9.95

- TTL Pocket Guide 7400-74200,**
Volume 1
 - TTL Pocket Guide 74201-74640,**
Volume 2
 - TTL Pocket Guide 74641-7430640,**
Volume 3
 - CMOS Pocket Guide Standard Components,** Volume 1
 - CMOS Pocket Guide Special Components,** Volume 2
- Check Off the Books You Want

Shipping Charges

Under \$10.00	\$2.50
\$10.00 to \$20.00	\$3.50
\$20.01 to \$30.00	\$4.50
\$30.01 to \$40.00	\$5.50
\$40.01 to \$50.01	\$6.50
Over \$50.00	\$8.00
<input type="checkbox"/> Number of books ordered	
Total prices of books	\$ _____
Shipping (See Chart)	\$ _____
Subtotal	\$ _____
Sales Tax (NY Only)	\$ _____
Total Amount	\$ _____

ALL PAYMENTS MUST BE IN U.S. FUNDS

GET THE LATEST ADVANCES IN ELECTRONICS

WITH A SUBSCRIPTION TO

Electronics

Radio Combined with
Electronics[®]

NOW

[®]

Electronics Now gives you exciting articles like:

- Buyer's Guide to Digital Oscilloscopes
- Build A Scanner Converter
- Single-Chip Voice Recorder
- Build A MIDI Interface for your PC
- Troubleshoot Microprocessor Circuits
- Build A High-Power Amplifier for your Car
- Add Music On Hold to your Phone
- All About Binaural Recording
- VGA-to-NTSC Converter

ENJOY THE WORLD OF ELECTRONICS EACH MONTH!

Subscribe to the best electronics magazine—the one that brings you the latest high-tech construction projects, feature articles on new technology, practical troubleshooting techniques, circuit design fundamentals, and much more.

Electronics Now looks to the future and shows you what new video, audio and computer products are on the horizon. What's more you'll find helpful, monthly departments such as Video News, Equipment Reports, Hardware Hacker, Audio Update, Drawing Board, Computer Connections, New Products, and more. All designed to give you instruction, tips, and fun.



FOR FASTER SERVICE CALL TODAY

1-800-999-7139

DON'T DELAY SUBSCRIBE TODAY!

Just fill out the order card in this magazine and mail it in today.

REMOTE CONTROL

(Continued from page 56)

soften the glue. The part will have to be gently pried (with the tip of a fine blade) after the solder melts.

Case. The circuit can be installed in a plastic or metal case, however the presence of the nearby metal will alter the tuned frequency of the LC circuits. Such metal will act as a loosely coupled, shorted turn, resulting in a decrease in the inductor's value. That effect occurs regardless of the permeability of the metal.

If either plastic or metal case material is used, a common contact must be provided on the inner surface of the case lid immediately above the two power cells. A strip of gold plated 0.5 × 1-cm foil glued to the inner surface of the case will be adequate. That contact is compressed when the button is depressed, thus, aiding continuity. An antenna loop projects beyond the printed-circuit board and out of the case. A slot must be cut in the case to admit the loop. If external frequency control is desired, a hole must also be drilled for the turnscrew of the trimmer potentiometer.

Antenna. A metal pocket-purse wrist strap (12 cm in length) and a 15-cm length of decorative gold chain were tested in the prototype. It may be possible to operate without an external antenna, depending on the range requirements, nearby structures, and receiver sensitivity. Optimum range can be obtained with the antenna hanging free and facing away from the users' body.

Testing. Set R3 to mid-range for all initial adjustments. Activate the transmitter with a nearby FM receiver set to a clear frequency near 100 MHz. If L1 and L2 are wound as described and capacitors are nominal, the circuit should resonate at 100 ±10 MHz. Adjust the receiver frequency until the carrier is found (it will sound like a quiet spot in the FM band—no static). To simplify the tuning procedure, and more readily identify the signal, the modulating frequency of the transmitter can be temporarily decreased to the audible range by placing a 0.01-μF capacitor across C1. Modula-

tion sidebands are well suppressed, so the signal will not be heard until the receiver is adjusted to the carrier's center frequency.

If the carrier is not found, recheck all wiring, verify the physical dimensions of the inductors, and check the circuit's DC voltages. The windings of L1 can be altered (spread-apart to increase frequency, or turns added to decrease frequency) as a final option in de-bugging.

Once you have located the carrier, determine if you want to adjust it up or down to a clear frequency. The trimmer potentiometer (R3) can be adjusted to produce frequency shifts of up to 10 MHz. For larger frequency shifts, the windings of L1 will need to be adjusted. With the carrier established, verify that the "stereo" lamp comes on when the transmitter is on. Repeat the test at the working range of the transmitter. If the stereo lamp fails to light, trim the 19-kHz modulation frequency by temporarily removing R1 and replacing it with a 50–100k potentiometer. Adjust the potentiometer for an output frequency (at pin 3 of U2) equal to 19.0 kHz, or until the stereo lamp illuminates. Remove and measure the resistance across the potentiometer and replace R1 with the nearest fixed value.

The Receiver. The FM stereo receiver used with the transmitter should have an incandescent- or LED-stereo indicator. The receiver audio and AM circuitry can be removed. In many modular receivers, the FM/multiplex is a physically separate printed-circuit card that can be used essentially without modification. Figure 6A illustrates a typical FM stereo MUX decoder with a load connected directly to the open-collector output of a TA7343 PLL. Further receiver modifications should not be necessary.

For applications requiring load isolation, Fig. 6B illustrates an optoisolator-coupled output. The 4N33 optoisolator/coupler has a current gain of 500% and can drive 20- to 30-mA loads directly. That figure illustrates the optoisolator/coupler output driving a 100-mA, 12-volt relay coil via a 2N2222 general-purpose silicon transistor. Although the optoisolator/coupler is ideally suited for isolated loads, the load and receiver power supplies can be connected together, pro-

vided, of course, that they are compatible.

Figure 6C shows the gate of an N-channel power MOSFET connected to the output of a 4N33. MOSFETs typically require 12 volts to fully bias the channel on. The circuits of Figs. 6A or 6B should be used where lower voltage operation is desired.

The circuits of Figs. 6A through 6C are momentary contact. The circuit illustrated in Fig. 6D is a toggle flip-flop circuit that will allow push-on/push-off control. The RC time constant provides interference filtering, and the inverter provides positive switching action—i.e., the flip-flop output switches when the transmitter button is depressed.

Although the system lacks the security offered by digital encoding, it does allow for an inexpensive alternative to assembling a remote control. The part requirements depend on which interface circuit is used with the receiver. (Refer to Fig. 6 for the required receiver parts.) The parts layout and assembly for the interface is not critical, and no printed-circuit artwork is provided for the receiver. ■

Learn VCR repair at home!

MAKE GOOD MONEY IN YOUR OWN FULL- OR PART-TIME JOB



Professional-level home study course. You will master easy-to-learn, high-profit repairs *without* investing in high-tech instruments or a costly workshop. Want more independence and higher income? Send or call today!

Free career literature:
800-223-4542

Name _____ Age _____

Address _____ Phone () _____

City _____ State _____ Zip _____

The School of VCR Repair
6065 Roswell Road
Dept. VJ341, Atlanta, Georgia 30328

CIRCLE 11 ON FREE INFORMATION CARD

A/D CONVERTERS

(Continued from page 62)

The longer it takes for the capacitor's voltage to reach the reference voltage, V_x , the lower the binary counter is able to decrement.

As shown in Fig. 10, the time (t_{A1}) it takes the capacitor's voltage to reach V_x is inversely proportional to the applied analog voltage, V_{A1} . That is:

$$V_{A1} = V_x / t_{A1}$$

This inverse proportionality is the reason a count-down timer is used instead of a normal count-up timer. With this implementation, the lower the input voltage, V_A , is, the lower I_A becomes, the slower the capacitor charges, and the lower the counter is able to decrement. Hence, the binary output from the counter is a fairly good representation of the original analog voltage.

Several other items must be added to the circuit of Fig. 9 to make the system operate in a practical manner. Most importantly, a "start-conversion" signal must be used to discharge the circuit's capacitor (generally through a FET) and to reset the binary counter to its initial state.

There are several advantages to this style of analog-to-digital converter. The main two are: it's extremely inexpensive to implement due to its minimal reliance on comparators and the fact that it does not require any D/A converters; and a wide range of resolutions can be obtained by appropriately sizing the components in the system, especially the voltage-to-current converter and the count-down register.

Miscellaneous Types. Besides the four ADC's that were detailed so far in this article, there are numerous other types of analog-to-digital converters available, each with their own unique set of advantages and disadvantages. For the sake of completeness, I'll briefly present the two other commonly used types now.

First, there's the dual-slope counter/ramp converter. This variety of ADC is very similar to the counter/comparator system that was just discussed, except that it generates two integration slopes in an attempt to eliminate the dependence of the overall de-

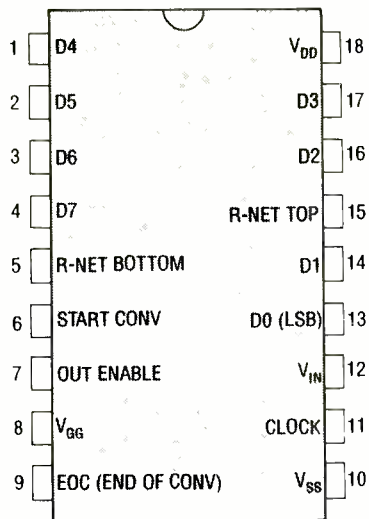

Fig. 11. This is the pinout of National Semiconductor's ADC0800, 8-bit successive-approximation ADC.

vice accuracy on the accuracy of the circuit used to generate a single integration ramp.

Second, there are voltage-to-frequency converters. In this style of device, the input analog voltage is used to drive a circuit that outputs a pulse train with a frequency proportional to the input voltage. The resulting frequency can then be measured and scaled to create a binary output that is directly proportional to the original analog voltage.

The ADC0800. In this final section, we'll take a brief look at one of the most popular analog-to-digital converters currently available: the ADC0800 A/D converter produced by National Semiconductor. It is an 8-bit monolithic device that uses P-channel, ion-implanted metal-oxide semiconductor (MOS) technology. The chip is packaged in a plastic, 18-pin dual in-line package; the package pin-out is shown in Fig. 11.

In operation, the ADC0800 uses a variation of the successive-approximation technique that was previously discussed to convert an analog input voltage into an 8-bit digital representation. The circuit has a minimum conversion time of only 50 microseconds, and a linearity of +1 LSB. Also, the device's binary output lines are directly compatible with TTL devices and logic levels.

Interfacing the ADC0800 A/D converter with a modern microprocessor system, such as the one shown in the

block diagram of Fig. 1, is a fairly easy task. Once the microprocessor controller decides it would like to initiate a conversion, all it must do is send an active-high signal to the start conversion input (pin 6) of the ADC0800. When it receives this signal, the ADC drops its end of conversion line (from pin 9) into the inactive-low state, indicating that the conversion is not yet completed. When the conversion process is complete, after a conversion time of not less than 50 microseconds, the ADC0800 raises its end of conversion line (assuming pin 7 is in the correct state), indicating that valid data exists on the eight output lines. This end of conversion output is generally used to generate an interrupt to the microprocessor, indicating the presence of the valid data at the outputs.

We hope that by now you've gained an understanding of how various types of analog-to-digital converter's work. We also hope that the information presented in this article will, in the near future, help you to include one in a project of your own. ■

INTERFERENCE

(Continued from page 48)

ence of a radio transmitter. Manufacturers must be made to recognize that RFI protection of their home-entertainment equipment has become imperative. Further, when interference is experienced, the consumer should be encouraged to contact the manufacturer of his equipment and to request that the manufacturer furnish the components or services required to eliminate RFI.

Many responsible manufacturers have a policy of supplying filters to eliminate television interference when such cases are brought to their attention. For audio devices, some manufacturers will supply modified schematic diagrams showing the recommended placement of bypass capacitors and other components to reduce RFI susceptibility. A list of manufacturers that provide assistance and information on interference problems may be obtained from the American Radio Relay League, 225 Main Street, Newington, CT 06111. ■

ELECTRONICS MARKET PLACE

FOR SALE

SECRET cable descramblers! Build your own descrambler for less than \$12.00 in seven easy steps. Radio Shack parts list and free descrambling methods, that cost nothing to try, included. Send \$10.00 to: **INFORMATION FACTORY**, Dept. 5, PO Box 1790, Baytown, TX 77522.

CABLE descrambler liquidation. Major makes and models available. Industry pricing! (Example: Hamlin Combo's, \$44 each... Minimum 10 orders). Call **WEST COAST ELECTRONICS**, 1 (800) 628-9656.

TUBES. (Thousands in stock). Send SASE for list. **FALA ELECTRONICS**, PO Box 1376-2, Milw., WI 53201.

HUGE 100 page communications catalog of shortwave, amateur and scanner equipment. Antennas, books, and accessories too. Send \$1.00 to: **UNIVERSAL RADIO**, 6830 Americana Pkwy., Dept. PE, Reynoldsburg, OH 43068.

300 EXPERIMENTERS CIRCUITS — Complete in 6 practical books using diodes, relays, FET's, LED's, IC 555's, and IC CA3130's for building blocks. Only \$33.00 plus \$5.50 for shipping. USA and Canada only. US funds. **ETT, INC.**, PO Box 240, Massapequa Park, NY 11762-0240.

CLASSIFIED AD ORDER FORM

To run your own classified ad, put one word on each of the lines below and send this form along with your check to:

Popular Electronics Classified Ads, 500-B Bi-County Boulevard, Farmingdale, N.Y. 11735

PLEASE INDICATE in which category of classified advertising you wish your ad to appear. For special headings, there is a surcharge of \$11.00.

() Plans/Kits () Business Opportunities () For Sale
() Education/Instruction () Wanted () Satellite Television
()

Special Category: \$11.00

PLEASE PRINT EACH WORD SEPARATELY, IN BLOCK LETTERS.

(No refunds or credits for typesetting errors can be made unless you clearly print or type your copy.) Rates indicated are for standard style classified ads only. See below for additional charges for special ads. **Minimum: 15 words.**

1	2	3	4	5
6	7	8	9	10
11	12	13	14	15 (\$23.25)
16 (\$24.80)	17 (\$26.35)	18 (\$27.90)	19 (\$29.45)	20 (\$31.00)
21 (\$32.55)	22 (\$34.10)	23 (\$35.65)	24 (\$37.20)	25 (\$38.75)
26 (\$40.30)	27 (\$41.85)	28 (\$43.40)	29 (\$44.95)	30 (\$46.50)
31 (\$48.05)	32 (\$49.60)	33 (\$51.15)	34 (\$52.70)	35 (\$54.25)

We accept MasterCard and Visa for payment of orders. If you wish to use your credit card to pay for your ad fill in the following additional information (Sorry, no telephone orders can be accepted):

Card Number _____ Expiration Date _____

PRINT NAME _____

SIGNATURE _____

IF YOU USE A BOX NUMBER YOU MUST INCLUDE YOUR PERMANENT ADDRESS AND PHONE NUMBER FOR OUR FILES. ADS SUBMITTED WITHOUT THIS INFORMATION WILL NOT BE ACCEPTED.

CLASSIFIED COMMERCIAL RATE: (for firms or individuals offering commercial products or services) \$1.55 per word prepaid (no charge for ZIP code). **MINIMUM 15 WORDS.** 5% discount for same ad in 6 issues within one year; 10% discount for 12 issues within one year if prepaid not applicable on credit card orders. **NON-COMMERCIAL RATE:** (for individuals who want to buy or sell a personal item) \$1.25 per word, prepaid....no minimum. **ONLY FIRST WORD AND NAME** set in bold caps at no extra charge. Additional bold face (not available as all caps) **30¢ per word additional.** Entire ad in boldface, \$1.85 per word. **TINT SCREEN BEHIND ENTIRE AD:** \$1.90 per word. **TINT SCREEN BEHIND ENTIRE AD PLUS ALL BOLD FACE AD:** \$2.25 per word. **EXPANDED TYPE AD:** \$2.05 per word prepaid. Entire ad in boldface, \$2.45 per word. **TINT SCREEN BEHIND ENTIRE EXPANDED TYPE AD:** \$2.55 per word. **TINT SCREEN BEHIND ENTIRE EXPANDED TYPE AD PLUS ALL BOLD FACE AD:** \$2.95 per word. **DISPLAY ADS:** 1" x 2 1/2" — \$205.00; 2" x 2 1/2" — \$410.00; 3" x 2 1/2" — \$615.00. **General Information:** Frequency rates and prepayment discounts are available. **ALL COPY SUBJECT TO PUBLISHERS' APPROVAL. ADVERTISEMENTS USING P.O. BOX ADDRESS WILL NOT BE ACCEPTED UNTIL ADVERTISER SUPPLIES PUBLISHER WITH PERMANENT ADDRESS AND PHONE NUMBER.** Copy to be in our hands on the 18th of the fourth month preceding the date of issue (i.e., Sept. Issue copy must be received by May 18th). When normal closing date falls on Saturday, Sunday or Holiday, issue closes on preceding work day. Send for the classified brochure. Circle Number 49 on the Free Information Card.

CABLE TV DESCRAMBLERS
★ **CONVERTERS** ★
and ACCESSORIES.

**SAVE MONEY.
DON'T RENT!**

PANASONIC,
PIONEER, JERROLD, OAK,
SCIENTIFIC ATLANTA
AND MORE. LOWEST PRICES.
FREE CATALOG.
(800) 234-1006
CABLE READY COMPANY

OSCILLOSCOPE 50 MHz, dual channel, solid state calibrated, manual, \$250.00. 1 (800) 835-8335 X-123.

CABLE TV descramblers. All major brands. Have make/model used in your area when calling. 1 (800) 327-3407. For a free catalog write: **K.D. VIDEO**, PO Box 29538, Minneapolis, MN 55429.

CB RADIO OWNERS!

We specialize in a wide variety of technical information, parts and services for CB radios. 10-Meter and FM conversion kits, repair books, plans, high-performance accessories. Thousands of satisfied customers since 1976! Catalog \$2.

CBC INTERNATIONAL

P.O. BOX 31500PE, PHOENIX, AZ 85046

PC board service. Single quantity ss. No setup fee. We also scan magazine artwork. Get out your back issues. **FIRST PROTO**, (407) 392-8677.

CABLE test chips. Jerrold, Tocom, S.A., Zenith. Puts cable boxes into full service model \$29.95 to \$59.95. 1 (800) 452-7090, (310) 867-0081.

FREE CATALOG

FAMOUS "FIRESTIK" BRAND CB ANTENNAS AND ACCESSORIES. QUALITY PRODUCTS FOR THE SERIOUS CB'er. SINCE 1962
FIRESTIK ANTENNA COMPANY
2614 EAST ADAMS
PHOENIX, ARIZONA 85034

TEST-Aids for testing units in full service mode. Jerrold, \$40.00; Pioneer, clears error codes E2 thru E5, \$60.00; Pioneer cubes, will not alter internal serial number, \$125.00; Tocom mapping, \$40.00; Tocom 5503/5507, \$25.00; S.A. 8500, \$25.00; 8550 \$30.00; 8580, \$40.00; 8570/90, \$50.00; 8600, \$50.00; Zenith ZTac, \$25.00; **N.E. ENGINEERING**, (617) 770-3830.

CABLE descramblers and turn-ons we buy, sell and trade. We'll beat any legitimate price. Call (305) 425-0751.

CALL 1 (800) 423-VCRS for all your audio/video needs and (713) 486-3939 for the largest selection of video laser discs. **COLONEL VIDEO & AUDIO** — Discount prices!



RECEIVING TUBES OVER 3000 TYPES IN STOCK!

Also hard-to-find transformers, capacitors and parts for tube equipment.

Send \$2.00 for our 32 page catalog.

ANTIQUE ELECTRONIC SUPPLY
6221 S. Maple Ave. • Tempe, AZ 85283 • 602-820-5411

PLANS & KITS

FASCINATING Electronic Devices! Voice Disguiser! Vocal Truth Indicator! Lasers! Transmitters! Detectors! Free energy! High Voltage! More! Kits/Assembled! Catalog \$4.00 (refundable) **QUANTUM RESEARCH**, 17919-77th Ave., Edmonton, Alberta, Canada T5T 2S1.

DESCRAMBLER kits. Complete cable kit \$44.95. Complete satellite kit \$49.95. Add \$5.00 shipping. Free brochure. No New York sales. **SUMMIT PE**, Box 489, Bronx, NY 10465.

SURVEILLANCE transmitter kits tune from 65 to 305 MHz. Mains powered duplex, telephone, room, combination telephone/room. Catalog with **Popular Communications**, **Popular Electronics** and **Radio-Electronics** book reviews of "Electronic Eavesdropping Equipment Design," \$2.00. **SHEFFIELD ELECTRONICS**, PO Box 377785-A, Chicago, IL 60637-7785.



Great kit for electronic buffs. Silent Sam Turn Signal reminder. Patent Approved! Best reminder yet. Will not bug you. Sounds briefly & repeats only if you forget to cancel. Quiet; braking resets it. Complete kit of all parts PCB, case & instructions only \$15 PPD. Wired units \$7 more. Visa, MC. (814) 231-8814. Call for free information sheet. Silent Sam, 1827 Basil Dr, Columbus, OH 43227.

60 SOLDERLESS Breadboard Projects in two easy-to-read pocket books. Complete with circuit descriptions, schematics, parts layouts, component listings, etc. Both books (BP107 & BP113) only \$11.90 plus \$3.50 for shipping. USA and Canada only. US funds. **ETT, INC.**, PO Box 240, Massapequa Park, NY 11762-0240.

UNINTERRUPTABLE power supply for your PC or Mac. Complete plans \$9.95. Backup power, when you need it. **CUSTOM POWER SOLUTIONS**, Box 1242, Hampton, NH 03842.

BUGGED? Telephone tapped? Find out fast! Free catalog of fantastic counter-surveillance equipment! 1 (800) 732-5000.

BUILD 0-50 volt regulated dual tracking power supply. Complete schematics and instructions. \$5.95. **SMS ENGINEERING**, 5932 West Bell Road, Suite D106, Glendale, AZ 85308.

CREDIT card program yourself, theory \$49.00, design for PC \$49.00, kits etc. Resellers wanted worldwide, info \$10.00. **CPU ADVANCE**, Box 1089, Waltham, MA 02154.

TRAFFIC signal controller design \$49.00, barcode theory \$25.00, credit card theory \$49.00, 87C51 controller kit program yourself from PC \$39.00. Resellers wanted worldwide, info \$10.00. **CPU ADVANCE**, Box 1089, Waltham, MA 02154.

ANTIQUE RADIO CLASSIFIED

Free Sample!

Antique Radio's

Largest Circulation Monthly
Articles, Ads & Classifieds.

6-Month Trial: \$16.95. 1-Yr: \$29.95 (\$44.95-1st Class).
A.R.C., P.O. Box 802-L10, Carlisle, MA 01741



INTERFACE! Electronic circuits through the 8-bit edge-card slots of your IBM/AT/XT computer. Plans, documentation, schematics, artwork, diskette, included. \$6.00. **LEIFKER**, PO Box 632, Lemont, IL 60439.

SURVEILLANCE equipment transmitters, cameras, recorders, nite vision, bug detection. Kits, plans \$4.00 for catalog — **SPY LABS**, PO Box 231, Thornwood, NY 10594.

IBM interfacing. A very practical manual of the how and why of interfacing to the IBM (or clone) computer. Complete details on board design, programming of parallel interface, timer chips, A/D, D/A, and much more! Complete detailed examples include programmable waveform generator, precision (1 Hz) audio sine generator, etc. Lots of detailed schematics and programming examples in Basic and Pascal. Price includes floppy with all software and 171 page manual. \$39.95. Send to **AFS**, 91 Point Judith Road, Suite 211-PE, Narragansett, RI 02882-3445.

ROBOT control 8 servos or 4 steppers through IBM parallel port. Disk with programs and plans \$10.00. **ROBOTIC INTENTIONS**, 415 E. Huisache, San Antonio, TX 78212.

EXCITING new plans and kits. Learn latest technologies! Info \$2.00 refundable. **MICROBYTE**, 6 Newbrook Road, Newark, DE 19711.

How To Get A High-Paying Job In ELECTRONICS

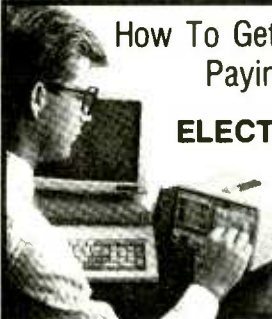

Become more competitive in the job market with **EDUCATION**

Specialized Associate degree and diploma programs in electronics technology, computer repair, communications, and industrial electronics by

DISTANCE EDUCATION

Call or write for college catalog and booklet "How to Get a High-Paying Job in Electronics."

1-800-765-7247

PEOPLES COLLEGE OF INDEPENDENT STUDIES

233 Academy Drive • P.O. Box 421768
Kissimmee FL 34742-1768

Member, D.L. Peoples Group • Accredited Member, NHSC

BUSINESS OPPORTUNITIES

MAKE \$75,000.00 to \$250,000.00 yearly or more fixing IBM color monitors. No investment, start doing it from your home (a telephone required). Information, USA, Canada \$2.00 cash for brochure, other countries \$10.00 US funds. RANDALL DISPLAY, Box 2168-H, Van Nuys, CA 91404, USA.

HOME assembly work available! Guaranteed easy money! Free details! **SASE. HOMEWORK-P**, Box 520, Danville, NH 03819.

DISTRIBUTORS needed — High profits. Largest selection & lowest prices of mini-satellite antennas for homes, RV's & business use. Starting at \$296.00. 1 (800) 886-5008.

FEDERAL loans for small businesses now available. 1 (800) 777-6342 for free details.

EASY work! Excellent pay! Assemble products at home. Call toll free 1 (800) 467-5566 ext. 5730.

NEED money? Guaranteed employment! Assemble simple products at home. Easy work! Excellent income! 1 (800) 377-6000, ex7930.

CONTRACT manufacturing international or domestic. We can assemble and test your electronic, electro-mechanical or mechanical assemblies. Highly skilled technicians, cutting edge test equipment, QA to regulatory compliance. Kitted or purchased to your specs., machining and surface finishing for made to order parts. Stocking and shipping for JIT delivery, state of the art support software. FDA listed medical device manufacturer. Please call **MIKE PETRI**, at (404) 642-9869 ext. 3115 for more information.

GUARANTEED earn \$100.00 per hour repairing VCR's. No electronic experience necessary. Most malfunctions simple mechanical or electro-mechanical. Start repairing the first day! Call 1 (800) 682-6877 or write **VCR MASTER SERVICE**, 2001 Denison, Denton, TX 76201.

VISA/MC Guaranteed. Solve your credit problems. 1 (800) 777-6342 for free details.

SPEAKER BUILDERS

BUILD your own speaker systems using our first class speaker cabinets. Solid MDF cabinets beautifully finished in textured black or with base-coat to paint own color. Call or write for product info and pricelist. **VIRGIN CABINETS, R.R. #1**, Desbarats, Ontario, Canada P0R 1E0 (705) 736-2826.

Imagine Little
Red Riding
Hood without
a forest.



PLEASE be very careful with matches. Because without the forests, life is unimaginable.

Only You Can Prevent Forest Fires.



USA Forest Service and your State Forester

AP THE HIGH COST OF RENTAL FEES BY OWNING YOUR OWN

Descrambler and Converter!

CHAMELEON Interchangeable Descrambler

SST Interchangeable Combination

SCIENTIFIC ATLANTA TOCOM
 PIONEER ZENITH
 JERROLD EVERQUEST
 OAK PANASONIC
 HAMLIN EAGLE

NU-TEK ELECTRONICS
 3250 Hatch Rd., Suite 1A
 Cedar Park, TX 78613

FREE CATALOG! ORDER TOLL-FREE 1-800-228-7404

EDUCATION/INSTRUCTION

VCR Repairs You Can Do. Save \$. Make \$. 403-page textbook used by national correspondence schools. \$ Back-guarantee. Over 35,000 sold. 704 illustrations + tool. Mail \$24.95 to **WORTHINGTON PUBLISHING**, Box 16691M, Tampa, FL 33687-6691.

ELECTRONIC engineering. 8 volumes complete. \$109.95. No prior knowledge required. Free brochure. **BANNER TECHNICAL BOOKS**, 1203 Grant Avenue, Rockford, IL 61103.

LEARN newest symbols and diagrams. 353 page hardback guide. \$11.95 Satisfaction guaranteed. **LACY**, 356 Claridge, Satellite Beach, FL 32937.

DO-It-Yourself TV diagnosis/repair booklet. Details — send **LSASE: TV DOCTOR**, 5223-E Hackberry, Sacramento, CA 95841.

LEARN COMPUTERS!

Home study: become an expert with the personal computer for home or business use. Free literature: 800-223-4542.

Name _____ Age _____
 Address _____
 City _____ State _____ Zip _____

School of Computer Training, Dept. KJ341
 6065 Roswell Rd., Atlanta, Georgia 30328

MASTERCARD AND VISA are now accepted for payment of your advertising. Simply complete the form on the first page of this section and we will bill. \$15.00 minimum.

BUY BONDS

SATELLITE TV

FREE Catalog — Lowest prices world wide. **SKYVISION**, 1048 Frontier, Fergus Falls, MN 56537. 1 (800) 334-6455. (See full page ad the Market Center).

SUPER low satellite prices. Free U.S. and International catalog. **SATMAN**, (309) 692-4140 (Int'l.), 1 (800) 472-8626 in U.S.

"YOUR FREE CATALOG KNOCKED MY SOCKS OFF"

We get that sort of comment all the time. People are impressed that our free Consumer Information Catalog lists so many free and low-cost government booklets. There are more than 200 in all, containing a wealth of valuable information.

They tell you how to make money, how to save money and how to invest it wisely. They tell you about federal benefits, housing and learning activities for children. They fill you in on nutrition, jobs, health and much, much more.

Our free Catalog will very likely impress you, too. But first you have to get it. Just send your name and address to:

**Consumer Information Center
 Department KO
 Pueblo, Colorado 81009**



A public service of this publication and the Consumer Information Center of the U. S. General Services Administration

COMING NEXT MONTH

in the September 1993 Issue of **Popular Electronics**

The Editors offer a potpourri of informative articles on computer viruses, complete plans on a telephone scrambler, test gear that novices can build in an hour and test gear information for the ham.

**On Sale
 JULY 20, 1993**

Watch for it!

Pick up Popular Electronics at your favorite Newsstand, Bookstore or Supermarket

When someone in your family gets cancer, everyone in your family needs help.

Nobody knows better than we do how much help and understanding is needed. That's why our service and rehabilitation programs emphasize the whole family, not just the cancer patient. Among our regular services we provide information and guidance to patients and families, transport patients to and from treatment, supply home care items and assist patients in their return to everyday life. Life is what concerns us. So you can see we are even more than the research organization we are so well known to be. No one faces cancer alone.

AMERICAN CANCER SOCIETY

TEST GEAR

(Continued from page 40)

(\$599.95 with matching 9-inch video monitor) offered by Grove Enterprises. It lets you display as little as 100 kHz and as much as 10 MHz of spectrum simultaneously.

If, on the other hand, you're seeking a complete, wideband scanning receiver with a spectral-display capability, consider the Standard CCR708A VHF/UHF Communications Surveillance Receiver. It features coverage from 50 to 940.995 MHz in AM, narrow-FM, and wide-FM modes. The built-in LCD spectral display (which Standard calls a "band-scope") lets you study selected sections of the RF spectrum up to 1 MHz wide for analysis or surveillance. The receiver, with a \$750 list price, has 100 memories divided into ten banks. While Standard imports the receiver, Universal Radio, Inc., is a major dealer for the unit.

Note: The SDU's mentioned in the preceding are all new devices, so check with the manufacturer or distributor for availability and price.

Summary. In this article, we surveyed RF test equipment for SWL's and scanner buffs—gear that doesn't require a transmitter or other source of high-level RF energy to make checks and take readings. We discussed basic antenna and matching considerations and featured the SWR analyzer, antenna bridge, antenna-resistance meter, dip meter, antenna noise bridge, RF communications interceptor, frequency counter, external RF readout, spectrum-display unit, and other devices.

The bottom line is you don't have to be a radio ham to check out your antenna system and radio gear. Look further into the no-RF RF test instruments we suggested. ■



"I'm glad you can pick-up France and Italy—now, learn how to speak French and Italian."

ADVERTISING INDEX

POPULAR ELECTRONICS magazine does not assume any responsibility for errors that may appear in the index below.

Free Information No.	Page
7	AMC Sales 26
—	Antique Electronic Supply 94
—	Antique Radio Classified 94
—	CBC International 94
—	CIE 19
—	CLAGGK Inc. Video Offer CV4
—	Cable Ready Company 93
—	Command Productions 71
—	Content Promo 88
6	Davis Instruments 26
—	Doc Tech International 3
—	EIA CV3
—	Electronics Book Club 15, 25
—	Electronic Tech. Today 4, 95
—	Firestik II 93
8	Foley-Belsaw Company 75
—	Grantham College 26
9	Heathkit 75
—	ISCET 87
5	Jameco CV2
—	Mouser 71
—	NRI Schools 11
—	Nu-Tek 95
—	People's College 94
—	Popular Electronics 30
—	Pulse Stick II 69
—	Silent Sam TSR Co. 94
—	Silicon Chip Magazine 85
11	The School of VCR Repair ... 91, 95
12	Zentek Corp. 87

ADVERTISING SALES OFFICE

Gernsback Publications, Inc.
500-B Bi-County Blvd.
Farmingdale, NY 11735
1-(516) 293-3000

Larry Steckler
President

Christina Estrada
Assistant to the President

For Advertising ONLY
516-293-3000
Fax 1-516-293-3115

Larry Steckler
publisher

Arline Fishman
advertising director

Denise Mullen
advertising assistant

Kelly Twist
credit manager

Subscription/
Customer Service/
Order Entry
1-800-827-0383
7:30 AM - 8:30 PM EST

ADVERTISING SALES OFFICES EAST/SOUTHEAST

Stanley Levitan
Eastern Sales
1 Overlook Ave.
Great Neck, NY 11021
1-516-487-9357, 1-516-293-3000
Fax 1-516-487-8402

MIDWEST/Texas/Arkansas/
Oklahoma, Colorado, Arizona

Ralph Bergen
Midwest Sales
One Northfield Plaza, Suite 300
Northfield, IL 60093-1214
1-708-446-1444
Fax 1-708-559-0562

PACIFIC COAST/Mountain States

Mike Brooks
Pattis/3M
1800 North Highland Avenue
Suite 717
Hollywood, CA 90028
1-213-462-2700
Fax 1-213-463-0544

What Do These Prestigious Companies Have In Common?

Aerovox®
DC Film and RFI Suppression Capacitors,
AC Oil Capacitors, EMI Filters

AMP
Electrical/Electronic Connectors,
IC Sockets PCB Switches

AVX CORPORATION
A WHI EIA GROUP COMPANY
MLC, Tantalum and Thin Film
Capacitors, Resistors,
Networks, Trimmers,
Oscillators, Resonators, Filters
and Piezo Devices

BERG
ELECTRONICS
High Density and Industry Standard
Connectors/Subsystems

BURNDY
an FCI Company
Electronic Connectors

CAROL
CABLE COMPANY, INC.
Electronic and Electrical Wire and Cable
and Power Supply Cords

COLE FLEX
Tubing, Conduits, Hose, Sleeveings, Splices,
Insulation and Cable Harness Products

Communications Instruments, Inc.
Relays and Solenoid Relays

COOPER
Belden
Multi Conductor, Paired, Coaxial, Flat,
Fiber Optic, Instrumentation/Process
Control, LAN, Special Application Cables,
Power Supply Cords & Molded Cable
Assemblies

COOPER
Bussmann
Fuses, Fuseholders, Fuse Blocks,
and Fuse Accessories

CORNELL DUBILIER
Capacitors - Aluminum
Electrolytics, Mica, AC Oil, Film,
MICA Paper and Relays

A COMPANY OF
DALE
Dale Electronics, Inc.
Resistors, Networks, Oscillators, Displays,
Inductors & Thermistors

D1 DANTONA INDUSTRIES, INC.
BATTERIES: Computer, Cordless
Phone, Scanner & R/C
ANTENNAS: Cordless Phone (metal &
rubber), Scanner Bumpers,
Grommets and Stick-On Feet

DEARBORN
WIRE AND CABLE I.P.

EATON
Eaton Corporation, Commercial
& Military Controls Operation
Switches, Relays, Displays and Keyboards

A
GERNSBACK
PUBLICATION
Popular Electronics
Electronics Now Magazine

KOA SPEER ELECTRONICS, INC.
Resistors, SMT Tantalum Capacitors Inductors,
Resistor Networks, SMT Thermistors

MALLORY
North American Capacitor Company
Tantalums, Aluminums, Sonalerts®
Ceramics, Films and AC's

M-tron
Quartz Crystal Clock Oscillators
and Special Hybrid Products

muPlata ERIE
MURATA ERIE NORTH AMERICA
Monolithics, Discs, Variable Capacitors,
Oscillators, Potentiometers, RFI/EMI Filters,
Microwave, Surface Mount Capacitors

NTE
NTE ELECTRONICS, INC.
A WORLDWIDE REPUTATION FOR QUALITY SERVICE AND VALUE
Semiconductors, Resistors,
Capacitors, Relays

Philips ECG
A North American Philips Company
Semiconductors, Test Equipment,
Relays, A/V Parts and
Chemicals

Quam
Loudspeakers and Commercial Sound
Products

ROHM
Rohm Electronics Division
Resistors, Ceramic Capacitors,
Transistors/Diodes,
Opto Components and IC's

SELECTA
Electrical Electronic Products
Switches, Relays, Terminals,
Indicator/Pilot Lights, LED Indicators,
Test Clips, Test Leads, Cable Ties and
Heat Shrinkable Tubing

A COMPANY OF
SPRAGUE
Tantalum Capacitors, Wet & Foil
Capacitors, Resistor Networks,
Resistor Capacitor Networks, Filters

Switchcraft
A Raytheon Company
Switches, Connectors, Jacks, Plugs,
Jackfields & Audio Accessories

TECH SPRAY
Non-CFC Cleaners/Degreasers,
UV Cured Compounds, Swabs, Wipes,
Brushes, Wick, Cleanroom Supplies, and
Static Control Products.

They sell through distributors. They belong to the E.I.A. They belong on your vendor list.

Leadership in electronics is not just a matter of designing products better and manufacturing them better, but also of marketing them better. And the sponsors of this message understand that better service to customers *requires* effectively involving distributors as part of their marketing teams.

Distributor involvement means lower prices, quicker deliveries, better service over-all. The Buyer wins. . . the Seller wins.

Distributors help achieve marketing leadership. So does the manufacturer's involvement in the Components Group of the Electronic Industries Association. EIA fosters better industry relations, coherent industry standards, and the sharing of ideas, which helps one another *and* serves customers better.

In choosing your component supplier, look for the marks of leadership —

- availability through distribution
- membership in the E.I.A.



Electronic Industries
Association/Components Group
2001 Pennsylvania Avenue, N.W. 11th Floor
Washington, D.C. 20006
Phone: (202) 457-4930 Fax: (202) 457-4985

*Committed to the competitiveness of the
American electronics producer*

Countersurveillance

Never before has so much professional information on the art of detecting and eliminating electronic snooping devices—and how to defend against experienced information thieves—been placed in one VHS video. If you are a Fortune 500 CEO, an executive in any hi-tech industry, or a novice seeking entry into an honorable, rewarding field of work in countersurveillance, you must view this video presentation again and again.

Wake up! You may be the victim of stolen words—precious ideas that would have made you very wealthy! Yes, professionals, even rank amateurs, may be listening to your most private conversations.

Wake up! If you are not the victim, then you are surrounded by countless victims who need your help if you know how to discover telephone taps, locate bugs, or “sweep” a room clean.

There is a thriving professional service steeped in high-tech techniques that you can become a part of! But first, you must know and understand Countersurveillance Technology. Your very first insight into this highly rewarding field is made possible by a video VHS presentation that you cannot view on broadcast television, satellite, or cable. It presents an informative program prepared by professionals in the field who know their industry, its techniques, kinks and loopholes. Men who can tell you more in 45 minutes in a straightforward, exclusive talk than was ever attempted before.

Foiling Information Thieves

Discover the targets professional snoopers seek out! The prey are stock brokers, arbitrage firms, manufacturers, high-tech companies, any competitive industry, or even small businesses in the same community. The valuable information they filch may be marketing strategies, customer lists, product formulas, manufacturing techniques, even advertising plans. Information thieves eavesdrop on court decisions, bidding information, financial data. The list is unlimited in the mind of man—especially if he is a thief!

You know that the Russians secretly installed countless microphones in the concrete work of the American Embassy building in Moscow. They converted



CALL NOW!

1-516-293-3751

**HAVE YOUR
VISA or MC CARD
AVAILABLE**

what was to be an embassy and private residence into the most sophisticated recording studio the world had ever known. The building had to be torn down in order to remove all the bugs.

Stolen Information

The open taps from where the information pours out may be from FAX's, computer communications, telephone calls, and everyday business meetings and lunchtime encounters. Businessmen need counselling on how to eliminate this information drain. Basic telephone use coupled with the user's understanding that someone may be listening or recording vital data and information greatly reduces the opportunity for others to purloin meaningful information.

The professional discussions seen on the TV screen in your home reveals how to detect and disable wiretaps, midget radio-frequency transmitters, and other bugs, plus when to use disinformation to confuse the unwanted listener, and the technique of voice scrambling telephone communications. In fact, do you know how to look for a bug, where to look for a bug, and what to do when you find it?

Bugs of a very small size are easy to build and they can be placed quickly in a matter of seconds, in any object or room. Today you may have used a telephone handset that was bugged. It probably contained three bugs. One was a phony bug to fool you into believing you found a bug and secured the telephone. The second bug placates the investigator when he finds the real thing! And the third bug is found only by the professional, who continued to search just in case there were more bugs.

The professional is not without his tools. Special equipment has been designed so that the professional can sweep a room so that he can detect voice-activated (VOX) and remote-activated bugs. Some of this equipment can be operated by novices, others require a trained countersurveillance professional.

The professionals viewed on your television screen reveal information on the latest technological advances like laser-beam snoopers that are installed hundreds of feet away from the room they snoop on. The professionals disclose that computers yield information too easily.

This advertisement was not written by a countersurveillance professional, but by a beginner whose only experience came from viewing the video tape in the privacy of his home. After you review the video carefully and understand its contents, you have taken the first important step in either acquiring professional help with your surveillance problems, or you may very well consider a career as a countersurveillance professional.

The Dollars You Save

To obtain the information contained in the video VHS cassette, you would attend a professional seminar costing \$350-750 and possibly pay hundreds of dollars more if you had to travel to a distant city to attend. Now, for only \$49.95 (plus \$4.00 P&H) you can view *Countersurveillance Techniques* at home and take refresher views often. To obtain your copy, complete the coupon or call.

PE

CLAGGK INC.
P.O. Box 4099 • Farmingdale, NY 11735

Please rush my copy of the Countersurveillance Techniques Video VHS Cassette for a total cost of \$53.95 each (which includes \$4.00 postage and handling)

No. of Cassettes ordered _____
 Amount of payment \$ _____
 Sales tax (N.Y.S. only) _____
 Total enclosed _____
 Bill my VISA MasterCard
 Card No. _____
 Expire Date _____ / _____

Signature _____
 Name _____
 Address _____
 City _____ State _____ ZIP _____

All payments in U.S.A. funds. Canadians add \$4.00 per VHS cassette. No foreign orders.