

**BUILD A SLIDE-PRESENTATION MANAGER**

# Popular Electronics<sup>®</sup>

JULY 1993

## **BUILD A POST-CODE READER**

Let your personal computer diagnose itself with this easy-to-build troubleshooting aid that reads and displays PC power-on self-test codes

## **BUILD A COMPUTER-CONTROLLED KILL SWITCH**

Have your computer turn itself off after completing a task, or control anything that plugs into an AC socket



## **COMPUTER SOFTWARE FOR HAMS AND SWL'S**

Bring your radio hobby into the 1990's with a personal computer and these varied and versatile software products

## **A NO-NONSENSE GUIDE FOR PC BUYERS**

Choose the right equipment, at the right price, for today and tomorrow



3 NEW FactCards  
IN THIS ISSUE



A  
**GERNSBACK**  
PUBLICATION

\$3.50 U.S.  
\$3.95 CANADA

#BXBDCCCH\*\*\* 5-DIGIT 60506  
#60506DH1997GA008# FEB94 P49

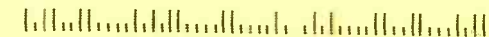

ROBERT DAHM

RESP  
092

997 GRAND AVE  
AURORA IL

60506-2513

# 1·800·831·4242

Your Resource for Value. Only a Phone Call Away.

**20**  
YEARS OF  
EXCELLENCE  
1973-1993

## Metex Digital Multimeters



- Handheld high accuracy
- Measures AC/DC voltage, AC/DC current, resistance, diodes, audible continuity test, transistor hFE
- Manual ranging w/overload protection
- Comes with probes, batteries, case and manual
- One-year warranty

27086 & 27158 only:

- Also measures frequency and capacitance

Part No.	Description	Price
7P27078	3.5 digit multimeter .....	\$59.95
7P27086	3.5 digit multimeter w/frequency & capacitance .....	74.95
7P27115	3.5 digit multimeter .....	39.95
7P27140	4.5 digit multimeter, w/tach/dwell .....	59.95
7P27158	4.5 digit w/frequency & capacitance & data hold switch .....	99.95

## Jameco Solderless Breadboards



Our long-lasting breadboards feature screen printed color coordinates and are suitable for many kinds of prototyping and circuit design. Larger models feature heavy-duty aluminum backing with voltage and grounding posts.

Part No.	Terminal Strips	Bus Strips	Contact Points	Price 1 9
7P20343	0	2	200.....	\$3.49
7P20600	1	2	400.....	4.95
7P20669	1	0	630.....	5.95
7P20722	1	2	830.....	6.95
7P20757	2	1	1,360.....	12.95
7P20773	2	4	1,660.....	17.95
7P20790	3	5	2,390.....	24.95
7P20811	4	7	3,220.....	32.95

## Function Generator Kit

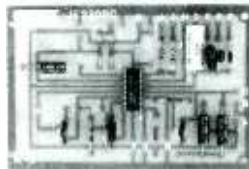

Great for prototyping electronic circuits, whether analog or digital! Produces sinusoidal, triangular (saw-tooth), and square wave-forms at frequencies continuously variable from 1 kHz to 100 kHz.

(Requires 12 VDC supply or  $\pm 6$  VDC split supply; recommended power supply #20626)

Part No.	Product No.	Price
7P20685	JE2206 .....	\$19.95

## Fiber Optics Kit



Discover the intriguing principles of fiber optics data communications. The kit includes separate transmitter and receiver circuit boards, fiber optics cable and all connectors for interfacing cables with the circuit boards. Either a square-wave or TTL signal from 200 Hz to 5 kHz can be input.

Part No.	Product No.	Price
7P21135	JE310 .....	\$19.95

See our Catalog for more kits

## Crystals



Part No.	Product No.	Frequency	Price
7P14533	CY3.57	3.579545MHz	\$1.19
7P14592	CY4	4.0000MHz	1.19
7P14681	CY6	6.000MHz	1.19
7P14402	CY12	12.000MHz	1.19
7P14517	CY20	20.000MHz	1.19

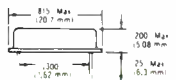

## Clock Oscillators

Part No.	Product No.	Frequency	Price
7P27861	OSC1	1.0000MHz	\$3.95
7P27991	OSC8	8.0000MHz	3.95
7P27941	OSC32	32.0000MHz	3.95
7P77489	OSC80	80.0000MHz	4.95

## Integrated Circuits\*

Part No.	Product No.	Price
7P48979	7400	\$5.29
7P49015	7402	3.39
7P49040	7404	3.39
7P49091	7406	4.45
7P49120	7407	4.45
7P49146	7408	4.45
7P49189	7410	2.29
7P49728	7417	3.35
7P50008	7420	2.29
7P50235	7432	4.45
7P50420	7447	.89
7P50551	7474	2.25
7P50593	7476	5.59
7P50665	7486	3.39
7P50681	7489	2.95
7P50690	7490	2.79
7P49322	74121	4.49
7P49912	74192	9.99
7P49939	74193	9.99

\*Name brand IC's in stock

## Radial Lead Electrolytic Capacitors

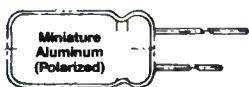

Part No.	Cap.	Volt.	Price
7P29831	1 $\mu$ F	50V .....	\$1.12
7P29891	10 $\mu$ F	50V .....	.13
7P31114	47 $\mu$ F	50V .....	.15
7P29962	100 $\mu$ F	50V .....	.19
7P30015	1000 $\mu$ F	16V .....	.35

## Dipped Tantalum Capacitors



Part No.	Cap.	Volt.	Price
7P33486	.1 $\mu$ F	35V .....	\$1.19
7P33662	1 $\mu$ F	35V .....	.25
7P33734	2.2 $\mu$ F	35V .....	.25
7P33806	4.7 $\mu$ F	35V .....	.45

## Machine Tooled Low Profile Tin Plated IC Sockets



Part No.	Pins	Price
7P51625	8 pin .....	\$5.55
7P37196	14 pin .....	.59
7P37401	16 pin .....	.69
7P39351	24 pin .....	.99
7P40328	28 pin .....	1.09
7P41136	40 pin .....	1.25

\*Additional components available

## Carbon Film 1/4 Watt 5% Resistor Assortments

Part No.	Description	Price
7P10719	5 each 70 values (every other value from R10 ohm R5.6 meg) 1/4 Watt C.F. Resistor Values (350 pcs.)	\$9.95
7P10663	100 each (27 values) 1/4 Watt C.F. Resistors R10 thru R10M (2,700 pcs.)	39.95

## 1/2 Watt Linear Taper- Single Turn Cermet Potentiometers

Part No.	Ohms	Price
7P42964	1K .....	\$8.99
7P43001	10K .....	.89
7P43027	100K .....	.89
7P42981	1MEG .....	.89

## Other Jameco Resources

- Test/Measurement and Prototyping Equipment
- Computer Upgrade and Accessory Products
- Full line of Integrated Circuits and Electronic Components
- Call for kit pricing

Order toll-free 1-800-831-4242



Call or write for your FREE Spring Component Catalog: 1-800-637-8471

**JAMECO**  
ELECTRONIC COMPONENTS  
COMPUTER PRODUCTS

1355 Shoreway Road  
Belmont, CA 94002  
FAX: 1-800-237-6948 (Domestic)  
FAX: 415-592-2503 (International)

For International Sales, Customer Service, Credit Department and all other inquiries: Call 415-592-8097 between 7AM-5PM P.S.T.

CA Residents please add applicable sales tax.

### \$30.00 Minimum Order

Terms: Prices subject to change without notice. Items subject to availability and prior sale. Complete list of terms/warranties is available upon request.

© 1993 Jameco 7193 All trademarks are registered trademarks of their respective companies.



Mention V.I.P.# 7P3

CIRCLE 8 ON FREE INFORMATION CARD

www.americanradiohistory.com



# Popular Electronics®

THE MAGAZINE FOR THE ELECTRONICS ACTIVIST!

## CONSTRUCTION ARTICLES

<b>BUILD A POST-CODE READER</b> .....	Mark Hanslip	31
<i>Diagnose your own PC hardware problems with a circuit that lets you see the error codes passing on the PC's bus</i>		
<b>BUILD A COMPUTER-CONTROLLED KILL SWITCH</b> .....	John Yacono and Marc Spiwak	41
<i>With this circuit attached, your computer will automatically turn itself off after completing its task</i>		
<b>BUILD THIS SLIDE-PRESENTATION MANAGER</b> .....	J.A. Nunley	61
<i>Create professional-quality slide presentations and let this interface circuit control the show</i>		

## FEATURE ARTICLES

<b>A NO-NONSENSE GUIDE FOR PC BUYERS</b> .....	Karl T. Thurber, Jr.	33
<i>Learn to navigate the PC buying maze as we describe how and what you should look for in an IBM-Compatible PC</i>		
<b>THE SKY CHORUS</b> .....	Gary Eggleston	46
<i>The upper atmosphere is alive with sounds generated by particles and waves from the sun and deep space</i>		
<b>COMPUTER SOFTWARE FOR HAMS AND SWL'S</b> .....	Karl T. Thurber, Jr.	53
<i>A review of computer software for the contemporary ham shack or listening post</i>		

## PRODUCT REVIEWS

<b>GIZMO</b> .....		5
<i>Including: Universal Electronics' Satellite Audio Receiver; Showtime Satellite Networks' Programming Package; Tandy Video Information System; and more!</i>		
<b>HANDS-ON REPORT</b> .....		24
<i>Hearth Business Communications IC Master Software</i>		
<b>PRODUCT TEST REPORT</b> .....	Len Feldman	28
<i>Panasonic CTP-27XF20 TV Monitor/Receiver</i>		

## COLUMNS

<b>ANTIQUÉ RADIO</b> .....	Marc Ellis	70
<i>Mailbag time once more</i>		
<b>COMPUTER BITS</b> .....	Jeff Holtzman	72
<i>Language and the computer</i>		
<b>CIRCUIT CIRCUS</b> .....	Charles D. Rakes	73
<i>An introduction to Hall-effect switches</i>		
<b>THINK TANK</b> .....	John Yacono	76
<i>Chips and tips</i>		
<b>HAM RADIO</b> .....	Joseph J. Carr	79
<i>Building a ham-band VFO</i>		
<b>DX LISTENING</b> .....	Don Jensen	81
<i>QSL'ing lives</i>		
<b>SCANNER SCENE</b> .....	Marc Saxon	83
<i>Paging all scanners</i>		

## DEPARTMENTS

<b>EDITORIAL</b> .....	Carl Laron	2
<b>LETTERS</b> .....		3
<b>FACTCARDS</b> .....		49
<b>POPULAR ELECTRONICS MARKET CENTER</b> .....		51A
<b>FREE INFORMATION CARD</b> .....		52
<b>ELECTRONICS LIBRARY</b> .....		85
<b>NEW PRODUCTS</b> .....		87
<b>ELECTRONICS MARKET PLACE</b> .....		93
<b>ADVERTISER'S INDEX</b> .....		96

Popular Electronics (ISSN 1042-170X) Published monthly by Gernsback Publications, Inc., 500-B Bi-County Boulevard, Farmingdale, NY 11735. Second-Class postage paid at Farmingdale, NY and at additional mailing offices. One-year, twelve issues, subscription rate U.S. and possessions \$21.95. Canada \$28.84 (includes G.S.T. Canadian Goods and Services Tax; Registration No. R125166280), all other countries \$29.45. Subscription orders payable in U.S. funds only. International Postal Money Order, or check drawn on a U.S. bank. U.S. single copy price \$3.50. © 1993 by Gernsback Publications, Inc. All rights reserved. Hands-on Electronics and Gizmo trademarks are registered in U.S. and Canada by Gernsback Publications, Inc. Popular Electronics trademark is registered in U.S. and Canada by Electronics Technology Today, Inc. and is licensed to Gernsback Publications, Inc. Printed in U.S.A.

Postmaster: Please send address changes to Popular Electronics, Subscription Dept., P.O. Box 338, Mount Morris, IL 61054-9932.

A stamped self-addressed envelope must accompany all submitted manuscripts and/or artwork or photographs if their return is desired should they be rejected. We disclaim any responsibility for the loss or damage of manuscripts and/or artwork or photographs while in our possession or otherwise.

As a service to readers, Popular Electronics publishes available plans or information relating to newsworthy products, techniques, and scientific and technological developments. Because of possible variances in the quality and condition of materials and workmanship used by readers, Popular Electronics disclaims any responsibility for the safe and proper functioning of reader-built projects based upon or from plans or information published in this magazine.

**Larry Steckler**

*EHF, CET*

*Editor-In-Chief and Publisher*

## EDITORIAL DEPARTMENT

**Carl Laron**

*Editor*

**Robert A. Young**

*Associate Editor*

**John J. Yacono**

*Associate Editor*

**Byron G. Wels, K2AVB**

*Associate Editor*

**Teri Scaduto**

*Assistant Editor*

**Kathy Terenzi**

*Editorial Assistant*

**Marc Spiwak**

*Editorial Associate*

**Joseph J. Carr, K4IPV**

**Marc Ellis**

**Len Feldman**

**Jeffrey K. Holtzman**

**Don Jensen**

**Chris F. O'Brian**

**Charles D. Rakes**

**Marc Saxon**

*Contributing Editors*

## PRODUCTION DEPARTMENT

**Ruby M. Yee**

*Production Director*

**Karen S. Brown**

*Production Manager*

**Marcella Amoroso**

*Production Assistant*

**Lisa Rachowitz**

*Editorial Production*

## ART DEPARTMENT

**Andre Duzant**

*Art Director*

**Injae Lee**

*Illustrator*

**Russell C. Truelson**

*Illustrator*

**Jacqueline P. Cheeseboro**

*Circulation Director*

**Michele Torrillo**

*P-E Bookstore*

## BUSINESS AND EDITORIAL OFFICES

Gernsback Publications, Inc

500-B Bi-County Blvd.

Farmingdale, NY 11735

1-516-293-3000

Fax: 1-516-293-3115

President: **Larry Steckler**

**Subscription**

**Customer Service/Order Entry**

1-800-827-0383

7:30 AM - 8:30 PM EST

Advertising Sales offices listed on page 98

**ABC  
AUDITED**

Composition by  
Mates Graphics



Since some of the equipment and circuitry described in POPULAR ELECTRONICS may relate to or be covered by U.S. patents, POPULAR ELECTRONICS disclaims any liability for the infringement of such patents by the making, using, or selling of any such equipment or circuitry, and suggests that anyone interested in such projects consult a patent attorney.

## FOCUS ON COMPUTERS

This month, **Popular Electronics** turns its attention to computers. Love'em or loath'em, computers now dominate many aspects of our lives, including our favorite hobby.

We are approaching the topic of computers from several different angles. For instance, "A No-Nonsense Guide for PC Buyers" provides valuable hints for computer neophytes looking to purchase their first system, as well as those with older machines who want to upgrade.

For project builders, there are two computer-related construction projects: "Build a Computer-Controlled Kill Switch" describes an easy-to-build accessory that eliminates the tedium of waiting for long printouts or other computer jobs to end. "Build a POST-Code Reader" describes a valuable troubleshooting aid that can save a computer owner both time and money.

There's even an article on how hams and SWL's can use computers to get more out of their hobby. "In Computer Software for Hams and SWL's" we describe computer products that handle logging chores, antenna calculations, circuit design, station control, and much more.

But just because we've dedicated this issue to the world of computers doesn't mean we've gone completely computer crazy. You'll also find articles on non-computer topics, as well as our regular lineup of columns, reviews, and more.

And future issues will give equal treatment to other segments of our electronics hobby. Be on the lookout for issues dedicated to radio, test gear, and even a project-builder's special issue before the end of the year. It's all part of our pledge to bring you the very best, balanced coverage of the entire electronics hobby.

**Carl Laron**  
Editor

## UNFORTUNATE OMISSION

Due to an oversight—perhaps we were using less than 20/20 vision—we inadvertently omitted the address of 50/50 Micro Electronics Inc., whose 50/50 Dual Desktop kit was covered in Gizmo (Popular Electronics, May 1993). The company can be reached at 550 Lakeside Drive, Building 8, Sunnyvale, CA 94086. Their phone number is 408-730-5050. We apologize for any inconvenience caused.—Editor.

## DEFENDING THE FUEL MISER

I disagree with some of the information presented by K.E.S. ("Fuel Miser Efficiency," Letters, Popular Electronics, May 1993), particularly the premise that in a properly designed and balanced warm-air heating system (hot air is incorrect nomenclature), the outlet air temperature should be held to 140° at all times. A system set up like that would surely cause an extreme waste of fuel, with a possible plenum temperature of 160° or more. Such a red-hot plenum certainly cannot be efficient. It's precisely that condition that the Fuel Miser was designed to prevent!

A properly operating warm-air system should have the blower running 100% of the time to maintain comfort. That is called continuous air circulation. To attain that condition, the plenum temperature control thermostat switch should be set to about 90°–100° so that any amount of heat trapped in the heat exchanger during burner-off time will ensure blower operation. The 90° air emanating from the wall registers on a continuous basis will provide sufficient heat during much of the heating season.

The Fuel Miser will work with the warm-air furnace thermostat to keep the plenum from overheating, yet allows the blower to operate continuously for maximum comfort level. If the blower shuts off much of the time, its speed is too high and it should be set lower.

With hot-water systems, the thermostat does control the cir-

culating motor, as K.E.S. says. In that case, when the Fuel Miser opens the thermostat circuit, there is a temporary interruption of the flow of hot water, which in turn results in minimizing the operation of the burner. In the meantime, the hot water already present in the baseboard system continues to deliver heat into the rooms while the precious heat stored in the boiler is conserved. The potential for the Fuel Miser to reduce heating bills in a hot-water system is more dramatic than in a warm-air system because an uncontrolled hot-water system can easily overshoot on milder days.

Since most heating systems in use today are many years old, they do not benefit from such features as outside air

sensors or microprocessor control. Even so, they can still derive some benefit from the Fuel Miser. Even a 10% decrease in fuel use can amount to a significant savings.

ANTHONY J. CARISTI

## HAVES & NEEDS

I am searching for the operator's manual for a tube-type oscilloscope. It is a Telequipment S51E, 117-volt/60-Hz made by Tektronix Canada Ltd. I'm hoping a fellow Popular Electronics reader might have a manual. I would gladly pay for any photostat and postage costs. Thanks.

DAVID BJORKMAN  
Box 308  
Elk Point, Alberta  
T0A 1A0, Canada

I'm an avid reader of Popular Electronics, and I hope you, or another reader, can help me. I am trying to locate a manufacturer or distributor who could supply a schematic for a stereo or four-channel reverb unit, but it must be battery- or 12V-operated as I want it for my car.

I know I had one back in the late 1960's, but I don't recall seeing one since then. I did find an equalizer for my car that had an echo effect, but I have a four-channel stereo and it wouldn't work no matter how I hooked it up. I even tried to use it only on the rear speakers. When I turned up the echo/delay I couldn't get any volume, and vice versa. Thanks for any help.  
MICHAEL J. BRICKO  
S52 W23235 Partridge Lane  
Waukesha, WA 53186

# LETTERS

## "Tapeless" Answering Machine Uses Digital Technology!!

THIS HANDSOME & ELEGANT ELECTRONIC  
MARVEL is also a model of SIMPLICITY in  
"One-Touch operation"

You'll also enjoy advanced features like:

- Streamline design
- Variable outgoing message time up to 16 seconds
- Instant digital switching from message to message
- Incoming Call Screening
- 7 memory 16 seconds messages and built-in microphone, which also lets you use the machine as a Digital Memo Recorder.
- Easy to operate. Runs on AC/Adapter (included) or 4 "AAA" batteries (not included) for Memo Recording

CLIP AND MAIL WITH CHECK OR MONEY ORDER

MODEL# DA-716.....\$29.95  
 .....or TWO for \$53.90  
 please add \$4.00 S/H for each unit  
 Texas residents add 8.25% sales tax

Send Check or Money Order TODAY!!

MAIL G.B. CONSUMERS WHOLESAL  
TO: P.O. BOX 351001 - PALM COAST, FLORIDA 32135



NO-MOVING PARTS

NO-BROKEN TAPES

NO-GARBLLED MESSAGES

BUY 2 ITEMS AND GET  
THE SECOND AT  
**20% OFF!**

**15-Day Free Home Trial**



# Countersurveillance

**Never before has so much professional information on the art of detecting and eliminating electronic snooping devices—and how to defend against experienced information thieves—been placed in one VHS video. If you are a Fortune 500 CEO, an executive in any hi-tech industry, or a novice seeking entry into an honorable, rewarding field of work in countersurveillance, you must view this video presentation again and again.**

*Wake up!* You may be the victim of stolen words—precious ideas that would have made you very wealthy! Yes, professionals, even rank amateurs, may be listening to your most private conversations.

*Wake up!* If you are not the victim, then you are surrounded by countless victims who need your help if you know how to discover telephone taps, locate bugs, or “sweep” a room clean.

There is a thriving professional service steeped in high-tech techniques that you can become a part of! But first, you must know and understand Countersurveillance Technology. Your very first insight into this highly rewarding field is made possible by a video VHS presentation that you cannot view on broadcast television, satellite, or cable. It presents an informative program prepared by professionals in the field who know their industry, its techniques, kinks and loopholes. Men who can tell you more in 45 minutes in a straightforward, exclusive talk than was ever attempted before.

## Foiling Information Thieves

Discover the targets professional snoopers seek out! The prey are stock brokers, arbitrage firms, manufacturers, high-tech companies, any competitive industry, or even small businesses in the same community. The valuable information they filch may be marketing strategies, customer lists, product formulas, manufacturing techniques, even advertising plans. Information thieves eavesdrop on court decisions, bidding information, financial data. The list is unlimited in the mind of man—especially if he is a thief!

You know that the Russians secretly installed countless microphones in the concrete work of the American Embassy building in Moscow. They converted



**CALL NOW!**

**1-516-293-3751**

**HAVE YOUR VISA or MC CARD AVAILABLE**

what was to be an embassy and private residence into the most sophisticated recording studio the world had ever known. The building had to be torn down in order to remove all the bugs.

## Stolen Information

The open taps from where the information pours out may be from FAX's, computer communications, telephone calls, and everyday business meetings and lunchtime encounters. Businessmen need counselling on how to eliminate this information drain. Basic telephone use coupled with the user's understanding that someone may be listening or recording vital data and information greatly reduces the opportunity for others to purloin meaningful information.

The professional discussions seen on the TV screen in your home reveals how to detect and disable wiretaps, midget radio-frequency transmitters, and other bugs, plus when to use disinformation to confuse the unwanted listener, and the technique of voice scrambling telephone communications. In fact, do you know how to look for a bug, where to look for a bug, and what to do when you find it?

Bugs of a very small size are easy to build and they can be placed quickly in a matter of seconds, in any object or room. Today you may have used a telephone handset that was bugged. It probably contained three bugs. One was a phony bug to fool you into believing you found a bug and secured the telephone. The second bug placates the investigator when he finds the real thing! And the third bug is found only by the professional, who continued to search just in case there were more bugs.

The professional is not without his tools. Special equipment has been designed so that the professional can sweep a room so that he can detect voice-activated (VOX) and remote-activated bugs. Some of this equipment can be operated by novices, others require a trained countersurveillance professional.

The professionals viewed on your television screen reveal information on the latest technological advances like laser-beam snoopers that are installed hundreds of feet away from the room they snoop on. The professionals disclose that computers yield information too easily.

This advertisement was not written by a countersurveillance professional, but by a beginner whose only experience came from viewing the video tape in the privacy of his home. After you review the video carefully and understand its contents, you have taken the first important step in either acquiring professional help with your surveillance problems, or you may very well consider a career as a countersurveillance professional.

## The Dollars You Save

To obtain the information contained in the video VHS cassette, you would attend a professional seminar costing \$350-750 and possibly pay hundreds of dollars more if you had to travel to a distant city to attend. Now, for only \$49.95 (plus \$4.00 P&H) you can view *Countersurveillance Techniques* at home and take refresher views often. To obtain your coupon, complete the coupon or call.

PE

**CLAGGK INC.**  
**P.O. Box 4099 • Farmingdale, NY 11735**

Please rush my copy of the Countersurveillance Techniques Video VHS Cassette for a total cost of \$54.95 each (which includes \$4.00 postage and handling)

No. of Cassettes ordered \_\_\_\_\_  
 Amount of payment \$ \_\_\_\_\_  
 Sales tax (N.Y.S. only) \_\_\_\_\_  
 Total enclosed \_\_\_\_\_  
 Bill me  VISA  MasterCard  
 Card No. \_\_\_\_\_  
 Expire Date \_\_\_\_ / \_\_\_\_

Signature \_\_\_\_\_  
 Name \_\_\_\_\_  
 Address \_\_\_\_\_  
 City \_\_\_\_\_ State \_\_\_\_\_ ZIP \_\_\_\_\_

All payments in U.S.A. funds. Canadians add \$4.00 per VHS cassette. No foreign orders.

# GIZMO

A CHRONICLE OF CONSUMER ELECTRONICS

JULY 1993

VOLUME 6,  
NUMBER 7

## VIS-ions of the Future

**MEMOREX MD 2500 VIDEO INFORMATION SYSTEM.** Manufactured by Tandy Corporation, 700 One Tandy Center, Fort Worth, TX 76102. Price: \$699.

We are firm believers in the potential of multimedia. Multimedia programs combine the ease of TV viewing with the excitement of playing a game and the benefit of learning new information or visiting far-off places. Adding several new dimensions to home entertainment, multimedia devices could represent the logical progression from passive TV watching and mind-numbing video-game playing to rewarding interactive experiences. The potential market exists, with money in hand. Technology-oriented, high-earning, baby-boomer families represent an estimated six-million U.S. households. Of those, two million have been categorized as "early adopters"—folks who rush out to buy the latest technologies. Certainly, then, anyone who comes up with an interactive multimedia device will have a sure hit in the marketplace—perhaps even the next VCR.

To date, that hasn't proven to be true, despite the efforts of several major players. Commodore's Amiga-based CDTV has found a niche, but has missed the mainstream mass market. CD-ROM computer add-ons, and Multimedia Personal Computers (MPC) have been gaining in popularity with PC users, but they're still tucked away in home offices or kid's rooms; they haven't made it to the entertainment center in the family room. Philips completely bypassed the "evil specter" of the computer, positioning its Imagination Machine CD-I player as strictly a consumer item, to be hooked up to a TV and stereo and used in the family room. CD-I has had some success, but hasn't been an overnight sensation.

The most recent entry into the elusive multimedia marketplace is the *Memorex MD 2500 Video Information System* of



CIRCLE 50 ON FREE INFORMATION CARD

*VIS*, from Tandy's Radio Shack. From the outside, *VIS* closely resembles CD-I in terms of both hardware—a VCR-like TV add-on with wireless remote-control—and software—an assortment of children's, reference, game, and learning discs. Both also play audio CD's. The two systems operate in much the same manner, as well.

Despite the many similarities, *VIS* and CD-I are not compatible with each other. Steering clear of the computer, Philips came up with their own platform built around Motorola's 68000-series microprocessor. Tandy—a company that has been selling home computers to families for years—went a different route. Realizing the potential of a device that was compatible with existing hardware and software, Tandy teamed up with PC-software giant Microsoft to come up with a system that looked and acted like an A/V component, but had the power of a PC hidden under its hood.

The result is *VIS*, which is based on Intel's 80X86-series and runs an operating system that is a subset of Microsoft Windows. While it is initially being positioned solely as a player, according to Tandy, *VIS* will be able to take advantage of other methods of delivering digital information to the home as they evolve. Beyond adding on a modem for telecommunications, Tan-

dy will only hint at the future applications of *VIS*. After all, Tandy and Microsoft worked hard to disguise all that PC compatibility, so as not to scare off computer-shy consumers—in Tandy's words, to create "a simple, productive, even fun information-delivery device."

There's certainly nothing "scary" about the *VIS* front panel. To the left is the CD tray, which slides open with a push of the OPEN/CLOSE button immediately to its right. The only other exposed control is the POWER button, about six inches further to the right. In the bottom right corner of the front panel, a door flips up to reveal the Save-It card slot (one card is included with the MD 2500), jacks for a microphone and headphones, and a headphone-volume control. PC power makes it possible to store information such as game scores and CD-track selections in memory, but Tandy calls the technology "Save-It" cartridges instead of memory cards.

The rear panel also belies any relation to a computer. On it are found the same sort of A/V inputs you'd expect to see on a VCR, including one for S-Video. To take full advantage of CD sound, the *VIS* player should be connected to your stereo as well as to your TV. There are none of the serial or parallel ports you'd expect on a PC.

TURN PAGE FOR CONTENTS



# This month in GIZMO

Tandy Memorex MD 2500 VIS Video Information System . . . . .	pg. 5
VIS Software Sampler . . . . .	pg. 8
Universal Electronics SCPC 100 Satellite Audio Receiver . . . . .	pg. 12
Showtime Satellite Networks' Ultraview Programming Package . . . . .	pg. 14
Samsung Model CXA1926B 19-Inch TV/VCR Combination . . . . .	pg. 17
Bib America Storage Tower . . . . .	pg. 18
Sony DAT Recorder . . . . .	pg. 18
McGraw-Hill Biology Encyclopedia . . . . .	pg. 22
Radio Shack Voiced-Dialing Telephone . . . . .	pg. 22
Rock Solid Subwoofer . . . . .	pg. 22
Zenith Satellite Receiver . . . . .	pg. 22
Camcorder Bag . . . . .	pg. 23
Home-Entertainment Furniture . . . . .	pg. 23
JVC Widescreen TV . . . . .	pg. 23
Protective Camcorder Housing . . . . .	pg. 23

Gizmo is published by Gernsback Publications, Inc., 500-B Bi-County Blvd., Farmingdale, NY 11735. Senior Writers: Chris F. O'Brian and Teri Scaduto. ©Copyright 1993 by Gernsback Publications, Inc. Gizmo is a registered trademark. All rights reserved.

VIS is operated not via a keyboard or even a mouse, but with a wireless remote that looks more like a Nintendo game controller than a typical audio or video remote control. It features a round, four-way direction controller to move the pointer around the screen; a three-way player-selection switch that indicates the number of players (additional wireless or wired controllers are available optionally); four selection buttons, labeled A, B, 1, and 2; and buttons labeled 3 and 4. The controller is intended to be held with both hands, horizontally in front of the player.

Because people tend to point the remote toward the on-screen action, Tandy recommends that the VIS player be placed as

close as possible to the TV so that the infrared beam reaches the sensor on the front panel. We followed that advice, but still found the controls unresponsive. One major drawback to hiding the computer is that the controller is awkward and slow, particularly when used to "key-in" words and phrases by pointing and clicking at an on-screen (non-QWERTY) keyboard.

Not even the VIS manual hints at the inner workings of VIS. In fact, the manual doesn't even mention multimedia! Its 15 pages are devoted to descriptions of hook-ups to your existing video and audio equipment, a diagram and brief description of the game controller, a troubleshooting chart, specifications (which do not include any data on the computer portion of the player), and instructions on using VIS to play audio CD's.

VIS does have some neat features for playing audio CD's. When the disc is inserted, a control panel appears on the TV screen. Using the hand controller, you can manipulate the on-screen display to select standard CD functions such as play, pause, stop, fast-forward, reverse, and intro scan. You can delete some tracks from the play list and choose shuffle play or continuous play. You also can use the hand controller to select letters and numbers from an on-screen keyboard to enter the name of the disc. All of the custom settings from several CD's can be saved to a Save-It cartridge for future use. Unfortunately, the hand controller offers no way to control the CD player without having the TV on—there are no buttons on the remote or the front panel with which to directly control the CD player. (Once you've stored your preferred settings for your favorite discs onto a Save-It cartridge—and connected the VIS to your stereo, of course—there's no need for the on-screen controls.)

Save-It cartridges must be inserted when the power is off. It's a good idea to simply leave one in at all times, so that you don't find yourself wanting to store something and being unable to insert the cartridge because the unit is on. When a Save-It cartridge is full, and you try to save data, a screen appears to let you know and offer you the chance to delete some of the stored data to make room for new information. You can erase the entire cartridge, or remove individual items.

When using VIS for multimedia applications, each program comes with written instructions (in place of an audio CD's liner notes) that provide specific details on the roles played by each controller button for that specific piece of software. Many programs also contain an on-screen demo. We wouldn't go as far as to call it intuitive, but after using a few programs, we could usually figure out which buttons to press without consulting the instructions.

Each program also uses the same basic

screen arrangement. The main action screen takes-up almost the entire TV screen. To the right of it, and often along the bottom as well, is a row of "buttons." Moving the pointer to the on-screen button and clicking the action button performs various actions.

## COMPTON'S MULTIMEDIA ENCYCLOPEDIA FOR VIS

The VIS version of *Compton's Multimedia Encyclopedia*, which is included with the system, provides an excellent example of the powers of interactive multimedia, as well as illustrating how VIS works. The single disc contains the entire text of the 24-volume set of encyclopedias, as well as video clips, narrated "slide shows," photographs, sound effects, and a dictionary. It's easy—if not fast—to move from an article to its related pictures, or to look up an unfamiliar word in the dictionary, and then return to the previous screen.

Thirty seconds after the disc is inserted, the Compton's logo and illustration appears on the main screen. The main screen is flanked on the right by a vertical row of six button icons that provide various means of accessing information. Collectively called the "path bar," from top to bottom, they are labeled Contents, Idea Search, Topic Tree, Picture Tour, Tools, and Back. Across the bottom of the screen runs the "status bar," which tells you what will happen—albeit somewhat cryptically at times—if you select the button on which the pointer is located. For instance, when the cursor is on the Topic Tree icon, the status bar reads "Explore the encyclopedia with the tree of knowledge," and for Idea Search it says simply "Research an idea." The Back icon returns you to the previous screen, while pressing the Tools icon lets you go directly to the dictionary, the credits for the encyclopedia, or the help screen, which is just an illustration of the hand controller, with the function of each button labeled.

As with every VIS program that we sampled, the four blue keys arranged in a circle on the left-hand side of the controller are used to move the pointer up, down, left, and right. The circle of four keys on the right hand side features two yellow (A and B) and two red (1 and 2) keys. Acting like the ENTER key on a computer, A is used to select "action." Compton's calls B the path-bar key; it's used to quickly return to the path bar from anywhere on the screen. Buttons 1 and 2 are used for page up and page down, respectively. The two rectangular buttons in the center of the controller are used to directly access the dictionary and—in case you can't keep all this straight—the help screen.

Basically, the top four button icons provide different "paths" to your research,





each intended to pique the user's interest. A press of the Contents button calls up alphabetic lists of every article, picture, sound, slide show, and video in the encyclopedia. Slide shows are just that—a brief sequence of slides about a given subject, complete with narration. The videos are actually collages of “film clips” that have been digitally processed; they don't move at full motion, and they use only a fraction of the screen. While that's not ideal, the video segments do work. If you see or hear something about which you'd like to know more, you can opt to read the related article.

Idea Search had us a bit confused until we looked it up in the written manual. You can use Idea Search to type in a word or phrase that describes a topic, or simply ask a question. For instance, we typed in (somewhat laboriously, using the controller to point and click on the on-screen keyboard) the question “Can cats see colors?” The encyclopedia called up a list of articles that contained the words cat and/or color—Cats, Color, Lion, Jewelry and Gems, Tiger, etc. The one that answered our question (“... it probably cannot distinguish color”) was the first on the list: Cats. The article is extremely detailed, including information about different breeds, typical size and weight, feeding, breeding, diseases, life span, physical characteristics, and the role cats have played in history and in the arts, hunting, scientific classification, and descriptions of famous cats of fact and fiction. Unfortunately, unbeknownst to us, our request brought us to the *middle* of the article. We scrolled through to the end without having our question answered, because the sec-

tion on cat anatomy was near the beginning of the article. There is no equivalent to a PC's CTRL-HOME keys to bring you to the beginning of an article, and scrolling through pages can be quite time consuming. So, while we did find the answer to our question in the first article cited, it still took quite a while.

Selecting Topic Tree brings up a list of general topics—The Arts, Government, Living Things, etc. Selecting Communication from the tree created a “branch” consisting of Language, Public Relations, Telecommunications, Biographies, and—in capital letters—COMMUNICATION and LIBRARY. Selecting one of the capitalized words brings you directly to the article of that title. We clicked on Telecommunication instead, and got another branch: a list of articles (all capitalized) ranging from COMPUTER to TELEVISION.

The Picture Tour displays a sampling of the photos available in the encyclopedia, in sequence. If one interests you, you can read its caption or go directly to the related article for more details.

We have to admit that Compton's hidden agenda in the search methods—piquing user interest—worked on us. Using the Multimedia Encyclopedia can be highly addictive—and we mean that in a positive way. If we had kids, we'd rather they spent an evening hooked on an encyclopedia than on the latest version of Super Mario Brothers. The articles are well-written, providing in-depth information without getting overly technical. Icons in the left-hand margin that indicate related articles, pictures, or sounds (a cat purring, for instance) make it easy to keep hopping

around, browsing through various articles and audio/video offerings. (Don't worry if in your wanderings you forget what it was that you were researching in the first place. You can keep pressing the Back icon to reverse your path through every screen you've perused at that sitting.)

A particularly dramatic example of the multimedia encyclopedia's power is the 1½-minute-long video sequence titled Moon Exploration. Beginning with a clip of President Kennedy's rousing speech about the space program, the video goes on to show the lift off of Apollo 11, the landing of the moon vehicle (“The Eagle has landed”), and Neal Armstrong climbing down to the moon's surface, saying “That's one small step for man, one giant leap for mankind.” That moment is one that few baby boomers, or their parents and grandparents, will ever forget—but their kids weren't around to witness it. Compton's Multimedia Encyclopedia brings the moon landing to life for another generation.

Our only complaint about the encyclopedia (other than the inability to go directly to the beginning of an article that you're reading), is that there are no icons in the article margins to indicate the presence of a related video or slide show. Related sound effects are indicated by a headphones icon; pictures by a camera; and other articles by pages of a book.

## CLOSING COMMENTS

Although we used Compton's encyclopedia to illustrate how VIS works, each program operates somewhat differently. (See the following story for some brief descriptions of other VIS software titles.) Dozens of titles are available for learning, entertainment, and general information. The vast majority are aimed at children—starting as early as two years old—and have an emphasis on having fun while learning. In general, we enjoyed the children's games, books, and reference works. We'd consider buying VIS if we had kids—although we doubt we'd put it in our main TV-watching room.

As non-parents, however, we'd have a hard time justifying the cost of VIS. The adult titles, generally speaking, tended to suffer from slowness—the response time to commands often seemed interminable. We found ourselves losing patience in no time. In fact, our main complaint—not only with VIS, but with each multimedia format we've tried—is the sluggish response time.

Besides that, we'd like to see at least one addition to the hand controller—a power switch. It would be nice to be able to switch to the TV without getting up once you've finished researching your term paper... but maybe that's why Tandy left it off! ■



# VIS Software Sampler +

The following is a very small, but representative, sampling of the types of programs available for VIS. Prices range from \$29.95 to \$79.95.

**KIDS CAN READ! THE PAPER BAG PRINCESS.** From Discus Knowledge Research Inc., P.O. Box 66, Buffalo, NY 14223-0066.

What could be more right for a '90's-style information system than a '90's-style fairy tale? *Kids Can Read! The Paper Bag Princess* puts a new spin on a familiar story. Beautiful Princess Elizabeth and handsome Prince Ronald are engaged to be married and live happily ever after in their castle when a dragon attacks and carries off—the prince! With her castle, her clothes, and all her belongings destroyed, the princess garbs herself in the only thing she can find—a paper bag—and sets out to rescue the prince. Using brains instead of brawn, Elizabeth outwits the dragon, and... well, don't expect us to reveal the surprise ending!

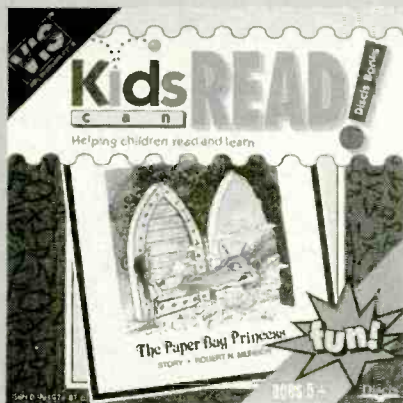

This VIS book, like others we've seen, allows the user to point-and-click on words or pictures to hear sound effects or the correct pronunciation. This disc, however, allows parents to customize the effect of clicking once, double-clicking, and clicking-and-holding, choosing from such options as Spanish pronunciation, syllables, and explanation. It's also possible to vary the speed at which the story is read and to insert pauses of up to four seconds between each phrase, making it easier for small children to read along with the narrator.

CIRCLE 52 ON FREE INFORMATION CARD

**BETTER HOMES AND GARDENS HEALTHY COOKING CD COOKBOOK.** From Multicom Publishing Inc., 1100 Olive Way, Suite 1250, Seattle, WA 98101.

In these days of fast changing health fads, it's difficult to keep coming up with recipes that don't violate any "health laws." *The Better Homes and Gardens™ Healthy Cooking CD Cookbook* from Multicom Publishing provides hundreds of healthy recipes. You can opt to see only those that fit your particular dietary needs—low calorie, low fat, low cholesterol, or low sodium. A photograph accompanies each recipe, as does its nutritional breakdown. You can call up a shopping list, and if you're unsure of how to do anything from boiling water to cleaning a shrimp, you can watch a short video



demonstration of the technique. A "Calorie Tally" provides nutritional information about 450 different foods, and a "Slide Show" option lets you look at the pictures without seeing the recipes. There's music, too. In the default setting, the musical accompaniment matches the recipe—Italian music for meatballs, Eastern for curries. You can also opt to hear the same sort of music (choosing from a list of about a dozen types) all the time, or none at all if you wish.

We didn't much care for the music, but at least it gave us something to listen to while we waited, and waited, for the recipes to come up. The *Healthy Cooking CD Cookbook* was one of the worst offenders in the slowness department. Not only did it take a long time to respond to commands, but it provided no means of scrolling page-by-page through the recipe index—going line-by-line, it could take forever to reach a recipe for zucchini! We also ran into a technical glitch—when returning to the recipe menu from the video clips, we frequently came up with partial screen "black outs." The main screen was visible, as was the pointer, but the control icons were blacked out. We were able to move the pointer to the area on the screen where we remembered seeing the icons, and get back to the main menu. Despite those problems, we did find a few tasty low-fat recipes that we look forward to trying out.

CIRCLE 53 ON FREE INFORMATION CARD

**HENRY AND MUDGE: THE FIRST BOOK.** From Macmillan New Media, Division of Macmillan, Inc., 124 Mt. Auburn Street, Cambridge, MA 02138.

Aimed at kids aged 3-7, there's nothing sophisticated about the storyline of this electronic book: Boy meets dog, boy loses dog, boy finds dog again. They live happily ever after. What is sophisticated is the technology that allows kids to choose to have the story narrated, or read each page themselves. If they have trouble with a word, they can have it pronounced. They can also click on elements in the pictures

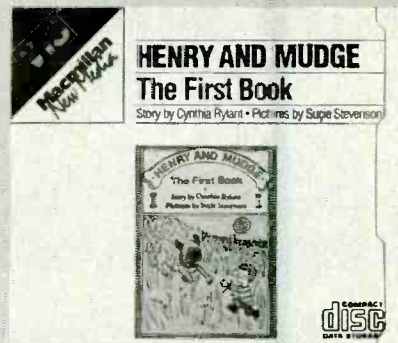

to have them identified with a written label read by the narrator. The story, by Cynthia Rylant, and pictures by Sucie Stevenson, are charming, as are the accompanying music and sounds.

CIRCLE 54 ON FREE INFORMATION CARD

**SHERLOCK HOLMES CONSULTING DETECTIVE: VOLUME I.** From ICOM Simulations, Inc., 648 South Wheeling Road, Wheeling, IL 60090.

This interactive video-mystery disc contains three complex cases that you can try to solve with the help of Sherlock Holmes and Dr. Watson. We played *The Mummy's Curse*; the other two are *The Case of the Mystified Murderess* and *The Case of the Tin Soldier*. In each, you are presented with a wealth of leads—some pan out, some are worthless. You can watch video clips of Holmes interviewing witnesses and suspects, read the reports in





## Just like these Fully Trained Electronics Professionals



"Thanks to CIE I have tripled my previous salary, and I am now in a challenging and rewarding new field where only the sky is the limit."

Daniel Wade Reynolds  
Industrial Electrician  
Ore-Ida Foods



"CIE was recommended to me by my boss. It was appealing since I could study at my own pace at home and during business travel."

Dan Parks  
Marketing Manager/Consumer Products  
Analog Devices, Inc.



"I loved the flexibility CIE offered. It was the only way I could continue both school and my demanding job."

Britt A. Hanks  
Director of Engineering  
Petroleum Helicopters, Inc.



"I liked the way the school was set up with laboratory assignments to enforce conceptual learning. The thing which impressed me the most about CIE's curriculum is the way they show application for all the theory that is presented."

Daniel N. Parkman  
Missile Electro-Mechanical Technician  
U.S. Air Force



"Completing the course gave me the ability to efficiently troubleshoot modern microprocessor based audio and video systems and enjoy a sense of job security."

Tony Reynolds  
Service Manager/Technician  
Threshold Audio & Video

# Graduate with an Associate Degree from CIE!

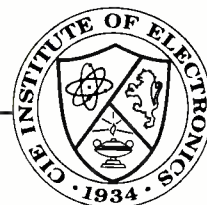

CIE is the best educational value you can receive if you want to learn about electronics, and earn a good income with that knowledge. CIE's reputation as the world leader in home study electronics is based solely on the success of our graduates. And we've earned our reputation with an unconditional commitment to provide our students with the very best electronics training.

Just ask any of the 150,000-plus graduates of the Cleveland Institute of Electronics who are working in high-paying positions with aerospace, computer, medical, automotive and communications firms throughout the world. They'll tell you success didn't come easy...but it did come...thanks to their CIE training. And today, a career in electronics offers more rewards than ever before.

### CIE'S COMMITTED TO BEING THE BEST...IN ONE AREA...ELECTRONICS.

CIE isn't another be-everything-to-everyone school. CIE teaches only one subject and we believe we're the best at what we do. Also, CIE is accredited by the National Home Study Council. And with more than 1,000 graduates each year, we're the largest home study school specializing exclusively in electronics. CIE has been training career-minded students for nearly sixty years and we're the best at our subject...  
**ELECTRONICS... IT'S THE ONLY SUBJECT WE TEACH!**

### CIE PROVIDES A LEARNING METHOD SO GOOD IT'S PATENTED.

CIE's AUTO-PRO-GRAMMED® lessons are a proven learning method for building valuable electronics

career skills. Each lesson is designed to take you step-by-step and principle-by-principle. And while all of CIE's lessons are designed for independent study, CIE's instructors are personally available to assist you with just a toll free call. The result is practical training... the kind of experience you can put to work in today's marketplace.

### LEARN BY DOING...WITH STATE-OF-THE-ART EQUIPMENT AND TRAINING.

CIE pioneered the first Electronics Laboratory

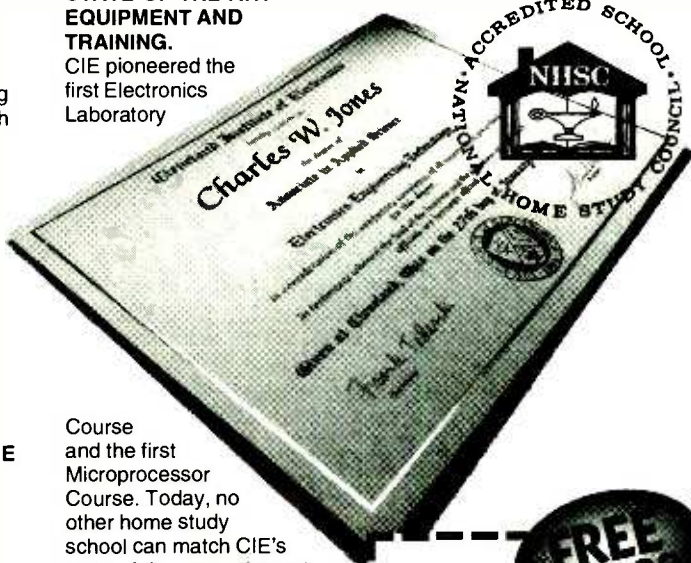

Course and the first Microprocessor Course. Today, no other home study school can match CIE's state-of-the-art equipment and training. And all your laboratory equipment, books and lessons are included in your tuition. It's all yours to use while you study and for on-the-job after you graduate.

### PERSONALIZED TRAINING.... TO MATCH YOUR BACKGROUND.

While some of our students have a working knowledge of electronics others are just starting out. That's why CIE has developed twelve career courses and an A.A.S. Degree program to choose from. So, even if you're not sure which electronics career is best for you, CIE can get you started with core lessons applicable to all areas in

electronics. And every CIE Course earns credit towards the completion of your Associate in Applied Science Degree. So you can work toward your degree in stages or as fast as you wish. In fact, CIE is the only school that actually rewards you for fast study, which can save you money.

## YES!

I want to get started. Send me my CIE course catalog including details about the Associate Degree Program. (For your convenience, CIE will have a representative contact you - there is no obligation.)

Please Print Clearly

AH42

Name \_\_\_\_\_

Address \_\_\_\_\_

City \_\_\_\_\_

State \_\_\_\_\_ Zip \_\_\_\_\_ Age \_\_\_\_\_

Phone No. \_\_\_\_\_

Check box for G.I. Bill Benefits.

Veteran  
 Active Duty

Cleveland Institute of Electronics, Inc.  
1776 East 17th Street  
Cleveland, OH 44114

A School of Thousands.  
A Class of One. Since 1934.

Send for CIE's FREE Course Catalog and See How We Can Help Your Career Too!



*The London Times*, do research in the library, and meet with Scotland Yard. We needed a pen and paper to keep track of all the goings-on—three murders are committed in *The Mummy's Curse*, not all by the same perpetrator. We'll admit we haven't quite solved it yet. In fact, we only came up with one of the three suspects, and even then, we got his motive wrong! The game is for players aged 12 and up, but it does require patience, logic, and clear, deductive reasoning. (Perhaps that's why we're still trying to catch the murderers!)  
**CIRCLE 55 ON FREE INFORMATION CARD**

**RICK RIBBIT ADVENTURES IN EARLY LEARNING.** From Tadpole Productions, 11361 Sunset Hills Road, Reston, VA 22090.

Preschoolers can get in on the VIS action with this delightful program starring a frog named Rick Ribbit. Learning adventures take place in his house, in the swamp, and at Frog Face Cliff. In Rick Ribbit's kitchen, players can serve Rick a bowl of alphabet soup, number soup, shape soup, or—yum!—colorful fly soup, which teach letters, numbers, shapes, and colors. In the bedroom, players can help Rick Ribbit

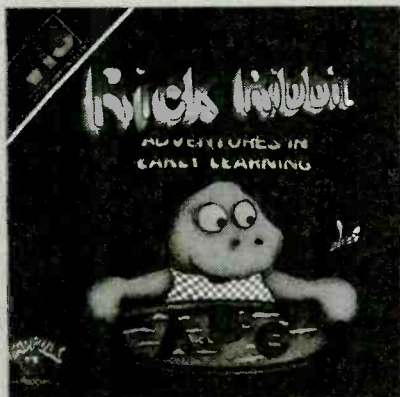

get dressed in a fanciful assortment of mix-and-(occasionally) match clothing and accessories. Down in the swamp, players must help Rick jump from rock to rock, across a stream. Each rock has letters on it; the idea is to spell a word. Parents might have to help very young children with the controller, but, according to the manual, those older than three years old should be able to master it on their own.

**CIRCLE 56 ON FREE INFORMATION CARD**

**OUR HOUSE FEATURING THE FAMILY CIRCUS.** From Con-Text Systems, Inc., The Technology Center, 333 Byberry Road, Hatboro, PA 19040.

When sociologists talk about what's wrong with the way kids are raised today, one problem they cite is the lack of inter-generational contact—kids don't really get to know their grandparents, and even

their parents aren't around as much now that both are out working. Those kids are deprived of the wealth of wisdom that comes with age, and of the historical perspective gained from hearing family stories.

*Our House Featuring the Family Circus* tries to fill that gap electronically. The program takes a close-up look at a home and everything in it from the points of view of kids today, kids in the 1950's, (representing parents), 1920's (grandparents), 1860's (Abe Lincoln's day), and 1780's (George Washington's day). Icons beneath the main screen show pictures of Washington, Lincoln, and the familiar family from the syndicated *Our House* comic strip: Grandmom and Granddad, Mom and Dad, and Billy and Dolly.

The main screen opens with a cut-away view of a home, through which you can glimpse the attic, parent's room, children's room, living room, dining room, bathroom, kitchen, and basement. Moving the pointer around the screen and clicking on any one room zooms in on that room. As you move the pointer around the room, each object that has a story attached to it is highlighted in turn. As you click on an object, Billy and Dolly explain what it is and how it is used today. Then you can select the other people icons to hear what it was like in their day, while the main screen shows a picture of how things used to look (frequently using Norman Rockwell illustrations and old advertisements).

At the right side of the main screen is another row of icons: a magnifying glass, a crystal ball, a picture of Ben Franklin, an arrow, and the house. The magnifying glass is the animation button—for a few systems in the home, including the refrigerator, sink, and toilet, there are animated sequences that show how they work. The crystal-ball button predicts future trends, while Franklin explains who invented various devices. The arrow key returns you to the previous main screen, and the house key brings up the cut-away view of the whole house.

It might not take the place of Grandma and Grandpa, but we certainly like the idea of showing today's sophisticated, and often jaded, kids how people used to dress, eat, cook, clean, learn, and interact with other family members. We'd imagine that, particularly when viewed with parents or grandparents, *Our House* could lead to some interesting family discussions.

About the only complaint we have with this program is that it might make some parents seem like dinosaurs in the eyes of their kids. Even with the trend toward postponing having babies, we wonder how many of today's parents of young children grew up in the early 1950's, before super-markets, color TV, or portable radios. ■

**CIRCLE 57 ON FREE INFORMATION CARD**

## A Feast for your Ears

**SCPC-100 SATELLITE AUDIO RECEIVER.** Manufactured by Universal Electronics, Inc., 4555 Groves Road, Suite 13, Columbus, OH 43232; \$399.

You don't have to own a satellite-TV system to be aware that there is an incredible variety of programming available via satellite. Home TVRO owners know firsthand that there's more programming than they're able to watch. They've also experienced the fun of tracking down and watching "wild feeds"—program feeds not meant for public consumption that provide candid, sometimes embarrassingly so, glimpses of news- and sportscasters who think that no one's watching them.

Most people who don't have satellite systems—and even some who do—are unaware of the wide variety of audio services on satellite subcarriers. More than one hundred subcarriers broadcast such programming as FM radio station WFMT, a public radio station in Chicago, and WQXR, a commercial classical station in New York. Non-commercial stations include the Voice of America, the BBC World Service, and satellite-delivered in-store background music.

But even those dedicated satellite owners who hunt out the wild feeds and listen to satellite radio might not know that there is another whole world of signals that travel via satellite. Many of the channels that appear blank on the TV screen are actually chock full of such services as telephone communications and data distribution—and a dizzying array of audio channels broadcast in what is known as the SCPC format.

The main reason that most people don't know about SCPC audio is that a special receiver is required to hear them—a receiver such as *Universal Electronics' SCPC-100*.

SCPC stands for Single Carrier Per Channel. Unlike the satellite audio channels that are "piggybacked" as subcarriers of the video signal (making use of the "left-over" bandwidth), each SCPC audio signal has its own carrier. Because audio signals have bandwidths far narrower than video signals, a single satellite transponder (which has a bandwidth of 36 MHz), can support 80 or more SCPC audio signals!

The SCPC-100 is designed to work with satellite systems that have block downconverters, which convert the received satellite signals from the satellite frequencies (the C and Ku microwave bands) to a band of frequencies (950-1450 MHz) that can be shipped from the dish to the satellite



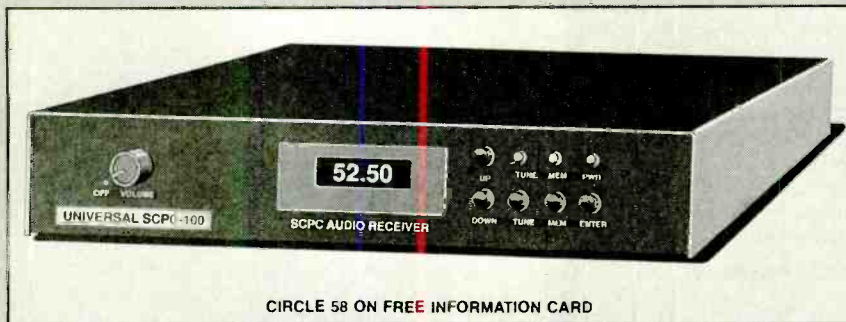

CIRCLE 58 ON FREE INFORMATION CARD

receiver over ordinary coaxial cable. In a typical system, the cable from the dish is connected to the input of the SCPC-100; an output connector on the SCPC-100 is fed to the satellite receiver. The DC voltage from the satellite receiver that provides power to the electronics at the dish—namely the LNB or low-noise block down-converter—is passed through the SCPC-100.

The SCPC-100 also must be hooked to a small speaker, which is not included. With just a 1.5-watt output, a small speaker is all the SCPC 100 is capable of driving. We opted to connect the output to an audio amplifier instead, and got much better sound from the unit.

The SCPC-100 is very easy to hook up; it's a little more difficult to use. The receiver has six front-panel controls: a power/volume switch and tuning buttons labeled TUNE, MEM, ENTER, UP, and DOWN. A four-digit LED readout is centered on the receiver's front panel.

Interestingly, the digital tuning display is not a frequency readout. It's merely a relative indicator. There's a good reason for that: The frequencies that the SCPC-100 receives are not those that are transmitted from the satellite, but those that are output by the satellite system's downconverter. In a perfect world, given the same inputs, all downconverters would output the same frequencies. In the real world, they don't. At the microwave frequencies involved, a difference of one percent translates into a difference of more than 100 MHz!

Because of the relative "frequency" readout, making a log of available programming is essential. Log sheets that are suitable for that purpose are included in the manual. The receiver also provides 50 memory locations where you can store your favorite stations.

Finding the services that are available on SCPC reminded us a lot of shortwave DX'ing, the hobby of trying to find distant stations from around the world. Program guides containing SCPC listings are not readily available. *Satellite Orbit*, a monthly guide to satellite TV, occasionally lists a smattering of the SCPC services. An accurate guide is difficult to publish because there are just too many

services, and they tend to come and go on an irregular basis.

One guide that does list SCPC services regularly is the *Satellite Channel Chart* from Westsat Communications (P.O. Box 434, Pleasanton, CA 94566). The price (\$65 per year) puts it out of the range of casual listeners.

Finding the audio services isn't all that easy even if you know where they are. Suppose, for example, that you know that Minnesota Public Radio transmits on transponder three of the Galaxy 6 satellite. You would assume, of course, that you have to aim your dish at Galaxy 6 and tune to transponder three. Well, that's not strictly true, because the SCPC-100 is in the signal path in front of the satellite receiver. Therefore, it receives the complete output of the LNB. The channel to which the satellite receiver is tuned isn't necessarily relevant. However, tuning the receiver to the proper transponder will ensure that your antenna is set for the proper polarity. Finding the services requires some searching. But once a record is made of the blocks where audio is available, things get a little easier.

Tuning the receiver takes a little getting used to. The UP and DOWN buttons function at variable speeds depending on how long they are held down. A single push of

one of the tuning buttons, for example, will change the frequency by 8 kHz. Hold the button down, and the receiver will tune at about 4 steps per second. Hold it down for a few seconds longer, and the tuning speeds up. Holding it for yet a few more seconds speeds it up even more. At the fastest speed, it is just possible to hear stations as the tuner passes them. But it still takes two minutes and 15 seconds to get from 0000 to 9999—unless you jump ahead by 1000 steps by holding down the TUNE button and pressing either UP or DOWN.

The amount of programming available via SCPC services is astounding. Sports fans will appreciate the ability to pick up what seemed to be almost every professional game being played, as well as quite a bit of minor-league action. On Galaxy 6, for example, you'll find the Houston Rockets Radio Network, the Minnesota North Stars Radio Network, and the Minnesota Timberwolves Radio Network. Galaxy 2 is home to the Cincinnati Reds Radio Network and the flagship stations of the St. Louis Cardinals, the Chicago Cubs, the Milwaukee Brewers, the L.A. Dodgers, the Detroit Tigers, the New Orleans Saints, the Seattle Sonics, the Pittsburgh Pirates, and more! There's also a lot of talk radio, especially telephone call-in shows. Your local broadcast of Larry King's radio show is likely received by your local affiliates via SCPC. Howard Stern's radio show, which originates at radio-station WXRK in New York, is also broadcast in Philadelphia and Los Angeles thanks to SCPC.

Other services carried on SCPC include network news. When you hear news at the top of the hour, it's probably coming to your local station via satellite. We've heard feeds from CNN Radio, CBS, NPR, Mutual, UPI, and others.

The biggest problem with receiving SCPC services using a home satellite-TV system is that most LNB's are not temperature-stable. Even an LNB that is excellent for wide-bandwidth video might drift too much for narrowband audio. We didn't have problems with drift while we were listening, thanks in part to the SCPC-100's automatic frequency control. However, we'd often return to the SCPC receiver only to find that the stations we were looking for were no longer where we expected them to be.

The problem was caused by the temperature swings the outdoor portion of our satellite system was experiencing. Night-time temperatures would drop into the teens, while daytime temperatures would rise to the high 40's. Add some sunshine, a black dish, and a black LNB cover, and the temperature swing could be even higher. Because the thought of reprogramming 50 memory positions is not appealing, the

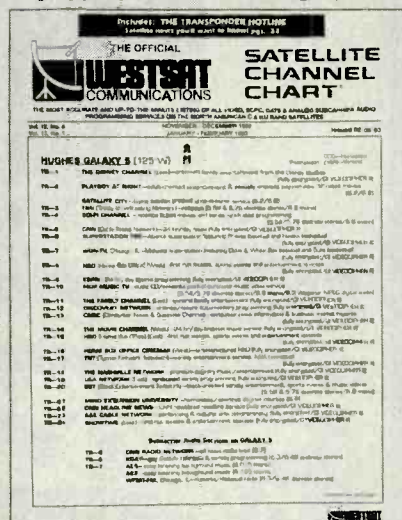

The Satellite Channel Guide from Westsat Communications lists SCPC services.



**TABLE 1**  
**A SHORT SAMPLE OF SERVICES AVAILABLE ON**  
**SCPC SATELLITE AUDIO**

**GALAXY 2 (74° W)**

*Radio Stations:*

KIRO-AM Seattle, WA—news-radio format, Seattle Mariners and Seahawks  
 KSFO-AM San Francisco, CA—oldies music, Oakland A's  
 KOA-AM Denver, CO—talk radio, Denver Broncos and Nuggets  
 WXRK-FM New York, NY—classic rock and Howard Stern  
 WGN-AM Chicago, IL—news, talk radio, Chicago Cubs  
 WTMJ-AM Milwaukee, WI—news, talk radio, Milwaukee Brewers  
 KWKW-AM Los Angeles, CA—Hispanic adult-oriented rock music, L.A. Dodgers (Spanish)  
 WMAQ-AM Chicago, IL—news and talk radio  
 KUSC-FM Los Angeles, CA—classical, APR  
 WBT-AM Charlotte, NC—news, talk radio, Hornets

*Other Services:*

ESPN Radio Network  
 Wisconsin Badgers Network  
 Colorado Basketball Network  
 Sacramento Kings Basketball  
 Portland Trailblazers Network  
 North Carolina Basketball  
 USA Radio Network  
 Tampa Bay Lightning Hockey  
 Montreal Canadiens Hockey  
 Vancouver Canucks Hockey  
 L.A. Kings Hockey

**SPACENET 3 (87° W)**

VCY America  
 Good News Radio Network  
 Satellite Music Network/Starstation

Satellite Music Network/Country Coast-to-Coast

Satellite Music Network/Stardust  
 Satellite Music Network/Z Rock  
 Satellite Music Network/Pure Gold  
 Satellite Music Network/The Heat  
 Satellite Music Network/Classic Rock

**GALAXY 6 (99° W)**

*Radio Stations:*

WFMT-FM Chicago, IL—NPR affiliate  
 WFAE-FM Charlotte, NC—NPR affiliate  
 KCBI-AM Dallas TX—religious  
 WNTL-AM Indian Head, MD—multilingual and international  
 KPRC-AM Houston, TX—news, talk radio, Houston Astros  
 WWL-AM New Orleans, LA—news, talk radio  
 WCCO-AM Minneapolis-St. Paul, MN—news, talk radio, Minnesota Twins  
 WHO-AM Des Moines, IA—news, talk radio  
 WBAP-AM Ft. Worth, TX—news, talk radio, Texas Rangers

*Other Services:*

Family Radio Network  
 Voice of Free China  
 Louisiana Radio Network  
 Oklahoma News  
 Ambassador Radio Network  
 BBS World Service  
 Mutual Radio Network  
 National Public Radio  
 NPR Classical  
 American Public Radio  
 U.S. Naval Observatory Clock  
 Kansas Audio Reader  
 Unistar Radio  
 Utah Jazz Basketball  
 International Broadcasting Network

SCPC-100 provides a method to offset the memory frequencies to compensate for drift. By putting the receiver in the recalibration mode (which is done by holding down the MEM and TUNE buttons), you can tune the unit up or down in frequency until you find your reference signal. All memory settings will then be adjusted. Unfortunately, the programmed offset is lost when power is turned off. Universal recommends leaving the power on at all times for stability. (The receiver consumes about 5 watts.) Of course, a power failure will also erase the offset memory. All other memory settings remain in place, however.

One thing missing from the SCPC-100 is stereo reception. Stereo SCPC programming is sent in a discrete format—the right and left channels are sent as separate carriers, and there are no real channel-spacing standards. To receive stereo, you essentially need two receivers. The SCPC-100 also lacks expansion circuitry, which a commercial SCPC receiver (generally costing many thousands of dollars) requires because SCPC signals are usually compressed. To us, the fidelity of the receiver, when connected to a good amplifier and speakers, was slightly worse than FM broadcasts.

Even so, we greatly enjoyed using the SCPC-100. We loved having the ability to listen to KIRO-AM in Seattle, Washington, with reception equivalent to local stations. We enjoyed catching feeds from National Public Radio of programs that are not offered by our local NPR affiliates. We marveled at the sheer overload of sports programming on the satellites. With the SCPC-100, who needs video? ■

**The Sky's the Limit!**

SHOWTIME, THE MOVIE CHANNEL, FLIX, AND ULTRAVIEW SATELLITE PROGRAMMING PACKAGE. From Showtime Satellite Networks, 800-422-9021. Price at press time: \$29.55 per month or \$320.88 (\$26.74/month) per year. (Call for current pricing and new specials.)

In last month's *Gizmo* and a related article in *Popular Electronics*, we told you all about satellite TV—how it works, what each component does, how a system is installed. The only problem was, between the time we spent up on the roof of the garage setting up the dish and the time we spent writing about it, we didn't have time to watch much of anything.

At the risk of missing our deadline this

**SHOWTIME SATELLITE NETWORKS™**  
 The Power to Please®

SHOWTIME SHOWTIME 2 ESPN USA NETWORK Bravo PRIME TIME 24  
 THE MOVIE CHANNEL NEW CMT BOSTON WGN CHICAGO VHI LIFETIME  
 TNN LOS ANGELES ALL NEWS CHANNEL COMEDY CENTRAL THE WEATHER CHANNEL TBS NICKELODEON  
 FLIX Family MTV WOR PRIME NETWORK A&E DISCOVERY

CIRCLE 59 ON FREE INFORMATION CARD



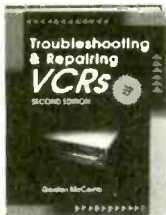

3777H-XX \$32.95  
Counts as 2



3248P \$19.95  
Softcover

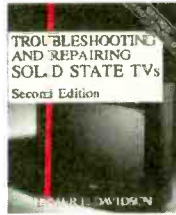

3700H-XX \$36.95  
Counts as 2

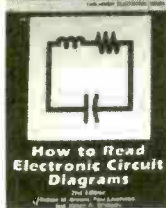

2880P \$14.95  
Softcover

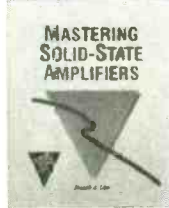

3976H \$29.95

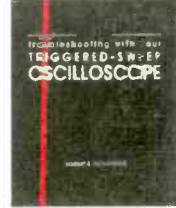

3669H \$27.95



3923H \$32.95

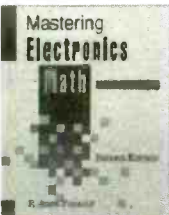

3589H \$27.95



3279H-XX \$36.95  
Counts as 2



3975H \$29.95

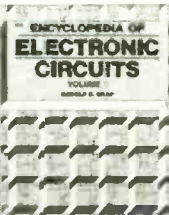

1938H-XXX \$60.00  
Counts as 3



2613P \$18.95  
Softcover

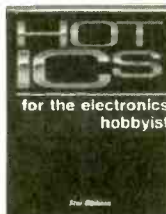

4122H-XX \$36.95  
Counts as 2



3475P \$18.95  
Softcover



4111H \$27.95



3627H \$29.95

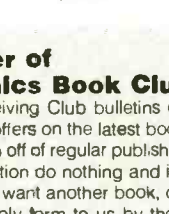

3632P \$10.95  
Softcover

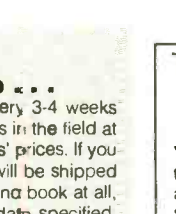

2790P \$16.95  
Softcover

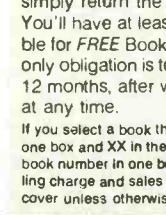

4255P \$14.95  
Softcover

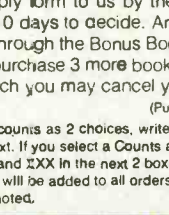

3739H-XX \$39.95  
Counts as 2

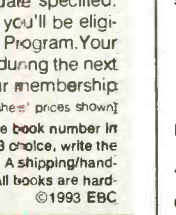

3765H \$29.95



3765H \$29.95

Select any 5 books  
for only \$4.95 (values up to \$152.75)  
when you join the Electronics Book Club®

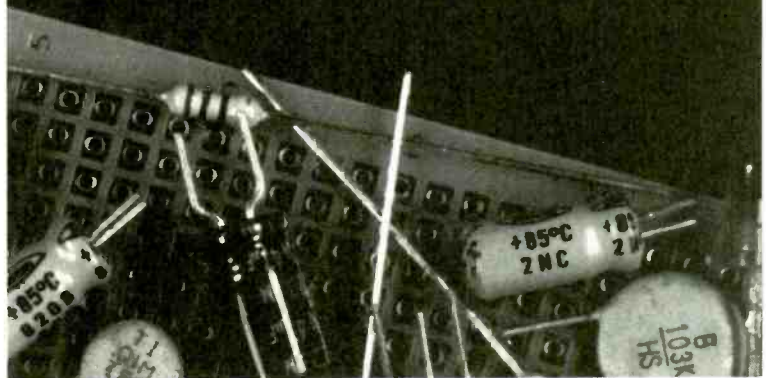

3627H \$29.95

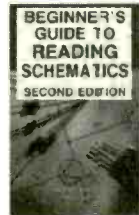

3632P \$10.95  
Softcover

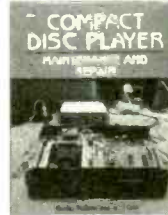

2790P \$16.95  
Softcover

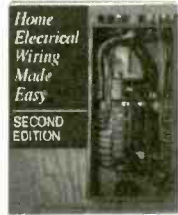

4255P \$14.95  
Softcover



3739H-XX \$39.95  
Counts as 2



1367F \$29.95  
Softcover



3765H \$29.95

If coupon is missing, write to: Electronics Book Club, Blue Ridge Summit, PA 17294-0810

As a member of the Electronics Book Club...

... you'll enjoy receiving Club bulletins every 3-4 weeks containing exciting offers on the latest books in the field at savings of up to 50% off of regular publishers' prices. If you want the Main Selection do nothing and it will be shipped automatically. If you want another book, or no book at all, simply return the reply form to us by the date specified. You'll have at least 10 days to decide. And you'll be eligible for FREE Books through the Bonus Book Program. Your only obligation is to purchase 3 more books during the next 12 months, after which you may cancel your membership at any time. (Publishers' prices shown)

If you select a book that counts as 2 choices, write the book number in one box and XX in the next. If you select a Counts as 3 choice, write the book number in one box and XXX in the next 2 boxes. A shipping/handling charge and sales tax will be added to all orders. All books are hardcover unless otherwise noted. ©1993 EBC

Your most complete and comprehensive source for the finest electronics books.

Electronics Book Club®

Blue Ridge Summit, PA 17294-0810

YES! Please send me the books listed below, billing me for just \$4.95 plus shipping/handling & tax. Enroll me as a member of the Electronics Book Club according to the terms outlined in this ad. If not satisfied, I may return the books within 10 days without obligation and have my membership cancelled.

Five empty boxes for book selection.

If you select a book that counts as 2 choices, write the book number in one box and XX in the next. If you select a Counts as 3 choice, write the book number in one box and XXX in the next 2 boxes.

Name \_\_\_\_\_

Address \_\_\_\_\_

City/State \_\_\_\_\_

Zip \_\_\_\_\_ Phone \_\_\_\_\_

Valid for new members only, subject to acceptance by EBC. Canada must remit in U.S. funds drawn on U.S. banks. Applicants outside the U.S. and Canada will receive special ordering instructions. All books are hardcover unless otherwise noted. Publishers' prices shown. A shipping/handling charge & sales tax will be added to all orders. PE793



month, we signed up for one of the popular programming packages being offered to owners of satellite systems. *Showtime Satellite Networks'* combination of three movie channels—Showtime, The Movie Channel, and Flix—with their *Ultraview* package of 25 basic services. "Basic" is an industry term—we consider receiving such stations as Bravo, ESPN, American Movie Classics, Nickelodeon, Discover, A&E, Comedy Central, MTV, VH-1, and The Weather Channel more a luxury than a basic service. In addition, Ultraview provides Lifetime; The Family Channel; The Nashville Network; USA Network; All News Channel; CMT: Country Music Television; PrimeTime 24 (network affiliates NBC—WXIA, Atlanta; CBS—WRAL, Raleigh; ABC—WABC, New York); and Superstations TBS (Atlanta), WSBK (Boston), WGN (Chicago), WWOR (New York), and KTLA (Los Angeles).

Showtime features more than 70 different movies each month, with the emphasis on new ones. The Movie Channel shows more than 130 films, both classics and new releases, each month. Flix is a new channel that plays "movies from the '60's, '70's, and '80's—movies you grew up with"—sort of a 'baby-boomer' nostalgia network that tries not to duplicate movies on other services. High-brow films and cultural events can be seen on Bravo and A&E: old movies on American Movie Classics; music videos on MTV, VH-1, and Country Music Television; news on The All News Channel (we'd have preferred CNN); sports on ESPN and Prime Network; kids' programming on Nickelodeon; science and nature shows on The Discovery Channel; tips on health and relationships, as well as reruns of such yuppie favorites as *Thirtysomething* on Lifetime; and assorted programming on SuperStations.

And that's not all. Remember, with satellite TV, you have access to multiplexed and multiple feeds. For package subscribers, that means that you can see Showtime, The Movie Channel, MTV, and Nickelodeon on more than one channel—the East and West feeds.

We never considered ourselves to be big television watchers. In the days before satellite, there were two or three sitcoms that we enjoyed, as well as a couple of dramatic series, assorted sporting events, occasional specials on public television, and *Jeopardy*. We rarely watched movies on TV, because of all the commercials. We didn't subscribe to cable, partly on principle and partly because we just didn't think it was worth it. Now we know it wasn't worth it. To get equivalent programming from our local cable operator would cost at least twice as much as this package.

Our viewing habits sure have changed!

## Stormy Weather

On Friday morning, March 12, the weathermen began predicting doom and gloom for the weekend ahead. Perhaps we'd have heeded their warnings if the day hadn't dawned bright and sunny, with a hint of the coming spring in the air. As it was, we didn't give it much thought until mid-afternoon, when we heard a familiar tone on the radio, followed by the unfamiliar words: "This is *not* a test."

They were calling it the Storm of the Century, a maelstrom that would affect the entire eastern seaboard. Already, it was causing tornadoes in Florida, and dropping unprecedented amounts of snow in places like Mobile, Alabama. According to the experts, it wasn't going to let up before hitting New York. We were warned to brace for severe coastal flooding and beach erosion, up to a foot of snow, and hurricane-force winds.

By the time we got home from work that day, we were a little worried. Not about flooding—we're far enough inland. Not about the snow—we didn't have to travel anywhere, and could always shovel out by Monday. Not about possible blackouts—losing power would give us an excuse to do nothing but relax all weekend! Not about friends or relatives—everyone was safely at home, with plenty of supplies and no intentions of leaving.

What made us nervous was our brand-new satellite dish. After all, we'd mounted it ourselves, up on the roof of the garage where it made a great "sail" to catch the wind. (See last month's *Gizmo* for all the details.) We had no idea if the hardware—mounted by amateurs, could withstand hurricane-force winds without blowing away—maybe taking part of the garage roof along with it! But by the time we got home, it was already dark. We needed another set of hands to safely get the dish down, and none of the neighbors was around to help out. So we took a "wait-and-see" attitude, figuring that if the weather still looked bad in the morning, we'd take it down then.

Unfortunately, by the time we woke up, the ground—and the roof of the garage—had a 4-inch covering of snow, and the winds were really howling. Even with help, we couldn't safely do the job.

Luckily, our area wasn't hit too hard. We're not saying it wasn't bad—they had three feet of snow upstate, windows were blown out in several tall buildings in Manhattan, mass transit was disrupted, some waterfront homes were even destroyed. But in our area, the snow turned to sleet and then rain,



keeping the accumulation to about six inches. Winds were blowing at a steady 40 mps or so, with occasional stronger gusts.

Those gusts had us worried. We could actually see the dish bouncing around in the wind. We turned it to the position in which it had the least wind resistance, and kept our fingers crossed. (We actually got up at 4 AM to make sure it was still there!)

Despite wind gusts reported to be around 90 mph, the dish came through with flying colors. The Rohn sawhorse mount, with the added roof supports, held firm. The Orbitron dish didn't move a bit off track—we didn't have to re-aim it, or even fine-tune the tracking. There was no damage to the LNB, and the Thomson Saginaw actuator held firm.

It's a tribute to all the manufacturers—and our installation—that the entire system weathered the storm perfectly. ■

Now it's virtually impossible, at any time of the day or night, not to find something that we really want to watch. In fact, it's rare that we don't have to choose between several good programs, or compromise between a movie and a hockey game. For instance, at 8:00 on a recent Saturday

night, we could have tuned in to any of the following films: *City Slickers*, *Backdraft*, *Alice*, *McBain*, *Year of the Gun*, *Silkwood*, *Call Northside 777*, or *A Summer Place*. Or we could have watched the NCAA tournament or a college hockey (Continued on page 18)



# No More Tangles

**MODEL CXA1926B 19-INCH COMBINATION MONITOR-VCR.** Manufactured by Samsung Electronics America, Inc., 105 Challenger Road, Ridgefield Park, NJ 07660. Price: \$599.95.

Scan through the pages of consumer-electronics and video magazines, and you'll see page after page devoted to home theater—the biggest, the brightest, total sound, loaded with features. Most of us, if we had the space and the money, would love to have a full home-theater set up in our homes. Many of us already do have a media room filled with sophisticated audio/video gear. But, let's face it, there are times when home theater is over-kill.

If you're shopping for a TV and VCR for casual viewing before you fall asleep at night, or for your kid's room or the kitchen, you don't really need a big screen, four-head, stereo, surround-sound system. Ditto if you're a realtor who shows videotapes of homes to prospective buyers, or an employer who shows each new trainee a video about business procedures. Perhaps you know someone who would like to tape the daytime soaps to watch at night if only he or she could figure out how to properly connect the TV and VCR and get the timer to work. There are plenty of folks out there who have trouble with anything more difficult than plugging in an appliance, and the last thing they need is a complex home-theater system.

For those situations, and those non-technical types, a combination TV/VCR (or "TVCR") should be considered—keeping in mind that what you gain in simplicity, you lose in sophistication. You're not likely to find stereo sound in a TVCR. You rarely see a TVCR with a screen size larger than 19 inches. Two heads are the TVCR norm (most of today's high-quality stand-alone VCR's have four heads). And because combination units share one tuner, you can't watch one show while taping another. For all those reasons, we would never recommend a TVCR as the main set for family viewing (unless severe technophobia was a family trait.) But there are a few good reasons why TVCR's represent one of the fastest growing segments of the video market: They take up less room than two separate components, and they require no hook up—just connect an antenna and plug it in. And you don't have to sacrifice all the advanced features when you opt for a TVCR: Remote controls, electronic tuning, and on-screen programming are common combo-unit features.

When we tried out the 19-inch

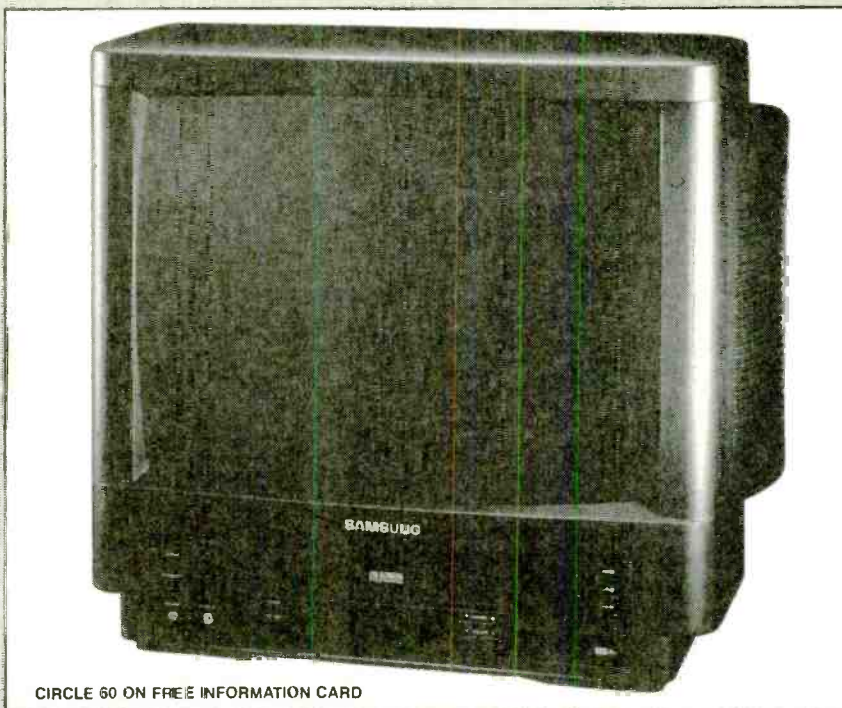

CIRCLE 60 ON FREE INFORMATION CARD

*CXA1926B* TV/VCR combo from Samsung, the first thing we noticed was the scarcity of jacks on the back of the set. There are a total of five, but only one—the antenna input—is necessary. If we had wanted to connect another source to the TVCR, we could have used the audio and video inputs and outputs on the back of the set. Targeting its market—those who would prefer not to mess with a bunch of wires in the back—Samsung also placed a pair of audio and video inputs on the front panel, making it easy to temporarily connect a camcorder.

Once the antenna is connected, you're ready to watch TV and/or use the VCR portion of the set. From the front, the top portion of the CXA1926B looks like a 19-inch stereo TV, with speakers attached to each side of the set. One of those projections is just for show—to give the set a more modern look, we presume. Sound comes out of the left side only, which caused some volume-level disputes when viewers sat on opposite sides of the unit. The videocassette compartment is centered under the screen. To the left of the compartment are the power and eject buttons; function keys (rew, play, and ff) are located to the right. Below the compartment are indicators that light when the VCR is set for timer recording and during recording, along with channel and volume up and down buttons. Advanced features are accessed with the remote control.

The VCR portion of the unit has just about every basic feature we've come to expect, from on-screen programming to index search. The 1-year/8-event timer programming was easy to use, and should present no problem for even the most non-

technical types. On-screen prompts lead you through the process. The machine offers you the choice of daily (Monday through Friday), weekly, or one-time programming. The only thing we found to be unusual was that you couldn't change the tape speed from inside the timer-recording menu. A separate TAPE SPEED button is provided on the remote.

Other on-screen menus are used to set the clock, various timers, and other parameters. For instance, picture settings (brightness, contrast, color, tint, etc.) are changed on screen. Another menu option automatically programs the set to receive only channels that are active in your area. On-screen prompts guide you through each process.

We used the CXA1926B for about a week without a hitch, and then we decided to take a look at the user's manual. After that, we had mixed results! The manual is obviously aimed at non-techies. It explains clearly and at great length how to insert a video cassette into the well and how to use the most basic (play, fast-forward, etc.) functions. The descriptions of more advanced functions became somewhat convoluted, and would probably confuse the very folks it aims to enlighten.

Certain functions were overlooked in the manual. For instance, we thought that the demonstration mode, touted in the press kit as "providing brief on-screen descriptions of all functions," might clear up any confusion caused by reading the printed instructions. Selecting the demonstration option from the on-screen menu had no effect other than to recall the previous menu. The manual's explanation said simply "The demonstration mode is



used just as its name implies. It is used as an aid to show you how most of the Menu work." End of story. End of our try for an on-screen demo.

Similarly, we found no explanation for the remote button labeled P-STD, beyond "press to select memory (picture settings), standard 1 or standard 2." After playing around a bit with the picture settings, it appears that "standard 1" and "standard 2" are two factory-preset picture settings (the main difference between the two seems to be in picture brightness and contrast). When we selected "memory," the set used the picture settings that we had previously adjusted using the on-screen menu. Actually, the settings of standard 1 provided a terrific picture in our setting.

We did learn a few tricks from the manual however. A button labeled VISS turned out to mean "VHS Index Search System." It allows you to insert markers into the tapes that you record, and then to directly access the specific program segments that you've marked. Even without using VISS, the VCR's linear counter makes it easy to fast forward or reverse to a specific spot on the tape according to the time of the program recorded. In addition, it's possible to

place the TVCR into memory-counter mode and reset the counter to 0:00:00 at the scene to which you'd like to return. During fast forward and rewind (in memory mode), the VCR automatically stops when the counter hits zero.

The CXA1926B has exceptionally fast rewind and fast-forward functions. Rewind time for a T-120 tape is less than three minutes. Even when in the play mode, the VCR rewinds and fast forwards at a higher speed than most decks. The high speed was convenient in general (we even found ourselves using the CXA1926B to rewind tapes played or recorded on other VCR's to save time), but not when trying to skip past commercials. We never managed to stop in time to catch the beginning of the programming again, and that's a trick we quickly got down pat on every other VCR we've used.

Following our own recommendation, we didn't attempt to use the TVCR in a home-theater-type set up. Actually, we set it up in the kitchen, and used it to catch the news while cooking dinner, and to record *Murphy Brown* to watch later on. And we can honestly say that we didn't miss hearing the theme song in stereo. ■

## SATELLITE PROGRAMMING

(Continued from page 16)

game. Musical options abounded, ranging from opera on Bravo to "Backstage at the Opry" on Country Music Television. Learning options included "Clarissa Explains It" on Nickelodeon and The Discovery Channel's "The Living Planet." We had planned to go out to eat, but after checking the TV schedule, ordering in a pizza seemed a much better idea.

There are a number of drawbacks to all that programming—besides missed deadlines, staying home a lot, and fighting over what to watch. Seriously, we've already noticed that we're spending less time reading books and listening to the radio than we did before satellite TV. Not quite as serious is the flap over "flipping." It used to take a few seconds to flip through all the stations on the dial—you could do it several times during one commercial break, driving other viewers crazy. Now, however, it's possible to spend the entire night flipping from channel to channel, satellite to satellite, without ever really watching anything! ■

# ELECTRONICS WISH LIST

For more information on any product in this section, circle the appropriate number on the Free Information Card.



Sony Portable DAT

### Dis, Dat, or D'Other?

As if the portable-digital-audio arena wasn't crowded (and confusing) enough with the recent introductions of Mini Disc and DCC units, *Sony Corporation of America* (One Sony Drive, Park Ridge, NJ 07656) has come out with two new Digital Audio Tape (DAT) Walkman personal stereos: the *TCD-D7* DAT recorder/player (pictured) and the *WMD-DT*/play-only model. DAT is the only commercially available consumer product that offers full 16-bit recording capability, providing CD-quality sound reproduction. Both units are lightweight and run on "AA" batteries or, with adapters, on AC or DC power. Digital volume-limiter systems help maintain listener comfort through the entire range of dynamic reproduction. The *TCD-D7* features manual or automatic recording-level control modes, and can place a time and date stamp on each piece of audio it records and then display that information on its LCD readout. The play-back-only unit features "digital mega bass," which allows users to increase the bass without distorting the sound. Prices: *TCD-D7*, \$629.95; *WMD-DT*, \$499.95.

CIRCLE 61 ON FREE INFORMATION CARD

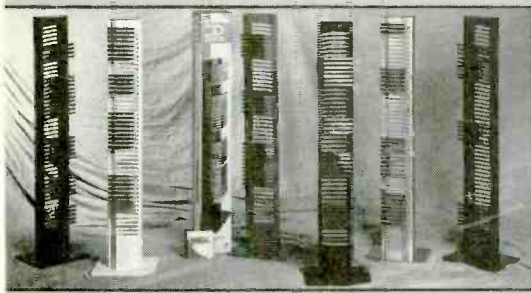

Storage Towers

### Tower Power

Clear off a few shelves by stacking your CD's vertically in the *Model C-100 CD Storage Tower* from *Bib America* (10497 Centennial Road, Littleton, CO 80127). Made of strong aluminum and finished in a scratch-resistant, powder-coated paint, the tower is available in matte black, white, silver/gray, blue, red, and chrome. Each unit holds 50 compact discs, and two can be fitted back-to-back to store 100 discs. The base is removable for wall mounting. Price: \$99.95.

CIRCLE 62 ON FREE INFORMATION CARD



**Take Charge of Your Own Future. . .**

# Train with NRI for a high-paying career servicing computers!



## BUILD YOUR OWN COMPUTER

Ask anyone in the field. They'll say the best way to learn to service *today's* computers is to actually *build* a state-of-the-art computer from the keyboard up. And with NRI, you train with and keep the powerful 486sx, 1 meg RAM, 32-bit CPU computer system — the most powerful computer available in *any* home study course.

You start by performing hands-on electronics experiments with your NRI Discovery Lab and digital multimeter. You then learn to build and test the powerful 486sx/25 MHz computer and install the 1.2 meg, 5-1/4" floppy disk drive, learning disk drive operation and adjustment. Later, you dramatically improve your computer's data storage capacity by installing a powerful 80 meg IDE hard drive. You even learn to diagnose and service virtually any computer problem with the extraordinary R.A.C.E.R. plug-in diagnostic card and QuickTech diagnostic software included in your course.

What's more, working with today's most popular integrated software package, Microsoft Works, you learn to use its word processing, spreadsheet, database, and communications utilities for your own personal and professional applications.

## TRAIN AT YOUR OWN PACE

With NRI, you go from lesson to lesson at your own pace. No classroom pressures, no night school, no need to quit your present job until you're ready to make your move. As you're guided step-by-step through the assembly of a powerful 486sx-based computer system —



the centerpiece of your coursework — you get the hands-on experience you need to work with, troubleshoot, and service any IBM PC/AT-compatible computer, plus the confidence to tackle any service job that you take on.

## LEARN FROM YOUR OWN PERSONAL INSTRUCTOR

Prepare for today's computer service opportunities in the privacy and convenience of your own home — with the support of your personal instructor and NRI's team of technical professionals behind you every step of the way. NRI's experts are on hand to guide you from the simplest to the most complex lessons, and they're available to assist you with technical support long after you've graduated.

## START YOUR OWN BUSINESS

The Department of Labor forecasts over 220,000 jobs for computer service technicians by the year 2005 — a 38%

increase over today's level. With the right training and skills, you can cash in on this wide-open opportunity and become a high-paid computer service technician — even start a computer service business of your own. You'll be well prepared for any job that comes your way — continuously drawing on the real-world experience of your NRI training.

## GET YOUR OWN COPY OF NRI'S FREE CATALOG!

Take the first step toward your future! Send today for NRI's free full-color catalog which describes every aspect of NRI's innovative training in microcomputer servicing and other growing high-tech fields. If the coupon is missing, write to NRI Schools, McGraw-Hill Continuing Education Center, 4401 Connecticut Avenue, NW, Washington, DC 20008.

IBM is a registered trademark of International Business Machines Corp. R.A.C.E.R. and QuickTech are registered trademarks of Ultra-X, Inc.

**SEND COUPON TODAY FOR FREE NRI CATALOG!**

**NRI Schools**

McGraw-Hill Continuing Education Center  
4401 Connecticut Avenue, NW, Washington, DC 20008



For career courses approved under GI Bill,  check for details

Check one FREE catalog only

- Microcomputer Servicing
- TV/Video/Audio Servicing
- Industrial Electronics & Robotics
- Basic Electronics
- Computer-Aided Drafting
- PC Applications Specialist
- Computer Programming
- Desktop Publishing & Design
- Programming in C++ with Windows

Name \_\_\_\_\_ (please print) \_\_\_\_\_ Age \_\_\_\_\_

Address \_\_\_\_\_

City \_\_\_\_\_ State \_\_\_\_\_ Zip \_\_\_\_\_

Accredited Member, National Home Study Council

18-0793

July 1993, Popular Electronics

21



# ELECTRONICS WISH LIST

For more information on any product in this section, circle the appropriate number on the Free Information Card.



Voice-Dialing Telephone

## Talking to the Phone

You can tell your phone who you want to talk to, and it will obediently dial that person's number—if you have the *DUoFONE-600 Voice Dialing Telephone* from *Radio Shack* (700 One Tandy Center, Fort Worth, TX 76102). Voice-recognition technology allows you to teach the phone to respond to spoken commands. The phone learns to recognize and make “voiceprints” of spoken names, and to learn the phone number for each voiceprint. It can be trained, in any language, to recognize twenty names, which are stored in voice-dial memory. In addition, 50 speed-dial numbers can be stored in a separate memory. More than one person can use the phone, but it must be taught to recognize each voice. Other features include mute; hold; last-number redial; telephone-line status indicator; an adjustable display that shows the time, date, and time elapsed during a call; and a flash button for custom calling services. Price: \$139.95.

CIRCLE 63 ON FREE INFORMATION CARD



Satellite-TV Receiver

## Tuning in to Satellites

It's easier than ever to watch satellite TV with the *ZS8000LE* integrated receiver/decoder (IRD). According to *Zenith Electronics Corporation* (1000 Milwaukee Avenue, Glenview, IL 60025), “extended threshold sensitivity circuitry” produces better pictures even in weak-signal areas, and Ku-band automatic frequency control really pulls in Ku-band signals. The color-coded UHF “Space Command” remote control provides simplified operation of the IRD and its on-screen menus, and its Quick Sat feature makes it easy to program in new satellites. Because satellite broadcasters often move their programs from one channel to another, an easy-to-use Move Channel feature has been added. The IRD also features 100 favorite video programming memory, 100 favorite radio programming memory, automatic peaking, discrete stereo sound, and a programmable VCR-style timer/clock. Price: \$1199.

CIRCLE 64 ON FREE INFORMATION CARD



Multimedia Mammalian Biology

## Multimedia Biology

Nature meets technology in the *Multimedia Encyclopedia of Mammalian Biology* from *McGraw-Hill* (11 West 19th Street, New York, NY 10011-4285). The CD-ROM version of the five-volume *Grzimek's Encyclopedia of Mammals* uses text, graphics, sound, and full-motion video to present articles and essays about the life and behavior of mammals, written by more than 200 leading international naturalists, zoologists, biologists, and ecologists. It includes more than 3500 illustrations, photos, and charts; nearly 500 maps, and video and sound from the archives of the BBC natural-history film library. A typical entry offers an article or essay, graphics, and in many cases, an chance to see the mammal in motion and hear its sounds. The Windows-based program is easy to use, with a “browser” window that allows new users to start up immediately. Powerful search and retrieval features make it easy to locate data, images, sound, and video elements. Price: \$995 (\$1250 for a network version for up to 16 users).

CIRCLE 65 ON FREE INFORMATION CARD

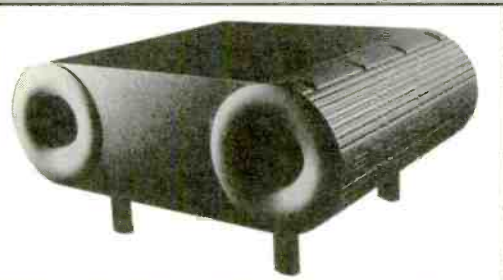

Rock Solid Subwoofer

## Rock-Solid Sound

*Rock Solid Sounds* (P.O. Box 653, Buffalo, NY 14240) is marketing the *Twin Bass Subwoofer* as a companion piece to their successful Rock Solid Monitor speakers. The subwoofer, the foundation for a three-piece loudspeaker system, redefines the speakers' already impressive performance and expands the speaker's versatility in home-theater applications. Dual 6¼-inch bass drivers, mounted in a vented enclosure with an internal volume of 40 liters, were used to achieve the desired deep bass response and high sensitivity. The subwoofer's crossover network frees the satellites from reproducing the low frequencies, so significantly higher output levels can be achieved. The subwoofer features 150-watt power-handling capability and sophisticated overload-protection circuitry. Price: \$350.

CIRCLE 66 ON FREE INFORMATION CARD



For more information on any product in this section, circle the appropriate number on the Free Information Card.

# ELECTRONICS WISH LIST

## Mission Accomplished

If your decorating scheme follows the trendy Mission or Sante Fe style, but the only entertainment centers you've seen have been sleekly modern laminates or cheap-looking, nondescript "wood" boxes, don't despair. *CWD International* (180 East North Street, Bradley, IL 60915) offers the *Rialto* line of home-entertainment furniture, handcrafted in birch with a variety of finishes. The 84½(H) × 46(W) × 24¼(D)-inch center-column unit, pictured, neatly holds a TV (up to 35 inches) and a VCR tucked behind fold-away wooden doors. Glass-fronted upper doors display collectibles, while bottom drawers and storage space can hold tapes and discs. You can flank the center unit with matching 76½(H) × 25½(W) × 20¼(D)-inch columns to hold your stereo equipment.

Price: Center Column, \$1995; Side Column: \$1495.

CIRCLE 67 ON FREE INFORMATION CARD

## Widescreen Wonder

With an increasing number of 16:9 movies available on laserdisc, and the long-awaited advent of HDTV just around the corner, demand for 16:9 aspect ratio TV's is on the rise. To meet that demand, *JVC Company of America* (41 Slater Drive, Elmwood Park, NJ 07407) has introduced the *NV-55BX4* widescreen rear-projection television. It features a horizontal resolution specification of 800 lines, four screen display modes for various types of software, a Dolby Pro Logic sound system, nine DSP modes, and both picture-in-picture (PIP) and picture-outside-picture (POP). The display modes include Regular, for viewing a 4:3 picture in the center of the screen with dark bars filling in the edges; Panorama, which stretches the left and right edges of a 4:3 picture to fill the 16:9 screen; Cinema, which zooms 4:3 letterboxed movies to fill the entire width of the screen; and Full, which expands "squeeze-mode" video from sources such as JVC's compact S-VHS camcorder. Ready for future hardware and software systems, the set has four A/V inputs, three with S-Video inputs, a front-panel AV/S-Video input, two RF inputs, and an RF loop out. Price: \$4495.

CIRCLE 68 ON FREE INFORMATION CARD

## Wet & Wild Camcorder Cover

One of the most popular uses for camcorders is taking vacation videos, but many of the most popular vacation spots are unfriendly to camcorders. Sandy beaches, sailboats, and cruise ships are home to grit, salt water, and high humidity—all of which can damage camcorders. *Ewa-Marine Camcorder Housings*, marketing in the States by *Pioneer Research, Inc.* (216 Haddon Avenue Westmont, NJ 08108), are made using a high-tech process that bonds two 2-ply PVC sheets together. The result is a flexible, lightweight housing that is airtight and waterproof—sort of a spacesuit for your camcorder. The housings are available in sizes to fit most popular camcorders, including the new ultra-compact models, and don't inhibit access to control buttons and settings. Optical-glass ports mounted in the front of the housing provide distortion-free viewing. Price: N/A.

CIRCLE 69 ON FREE INFORMATION CARD

## Double-Duty Camcorder Bag

The well-prepared videographer, who carries a host of accessories when on the go, can lighten his load considerably if all that gear is packed in the *PF-908 Twin-Pack Cam Bag* from *Geneva* (9909 South Shore Drive, Plymouth, MN 55441). The bag comes with a detachable, zip-off pouch. The user can bring along batteries, charger, lights, and more in the heavy-duty nylon bag. When it comes time to head for the actual shoot, the bottom pouch can be detached and left behind. The fully-padded bag features a zippered pocket and a quick-release shoulder strap. Price: \$49.95.

CIRCLE 70 ON FREE INFORMATION CARD

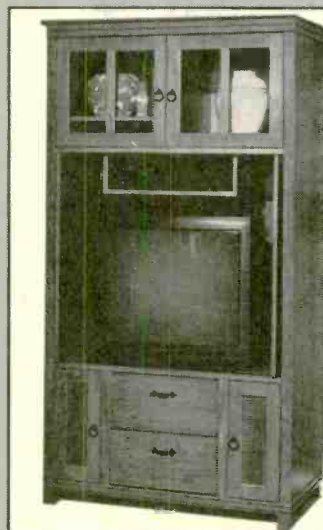

Home Entertainment Furniture



Widescreen TV



Camcorder Bag



## HEARST BUSINESS COMMUNICATIONS IC MASTER SOFTWARE

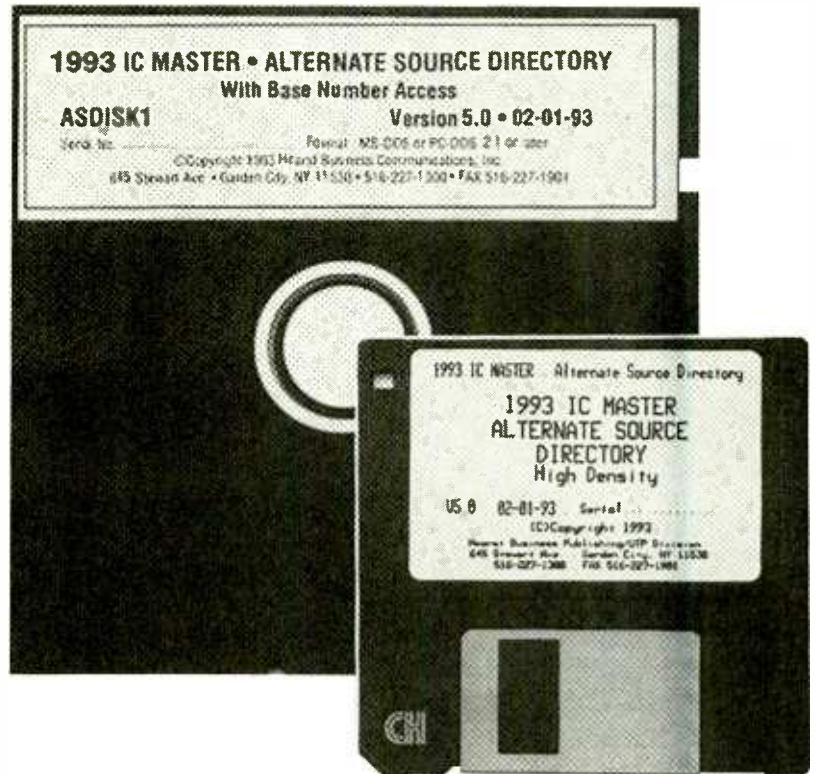

CIRCLE 119 ON FREE INFORMATION CARD

*This computer-based version of the IC Master Alternate-Source Directory can help you make parts substitutions and identify unknown semiconductors quickly.*

Nothing is more frustrating to an electronics hobbyist than discovering a project cannot be completed (or begun) because it requires one "magic" part that can't be purchased locally. When in such a situation there's always a suspicion lurking in the deep recesses of one's mind that maybe, just maybe, there's a suitable replacement component available at the local electronics emporium or even in the home junk pile—if only you had a way to cross-reference the elusive device.

Of course, this poses no problem for the electronics professional armed with expensive cross-reference manuals; especially if he has the multi-volume IC Master on hand. In its books are all sorts of technical information, as well as equivalent parts for an incredible number of integrated circuits. Unfortunately, the paper-bound and CD-ROM based IC Masters are rather expensive. Besides, you really only need the Alternate Source Directory volume from the set to cross-reference parts.

Now there is a relatively inexpensive (\$179.50) and automated alternative for those with IBM-compatible computers: a software-based version of the IC Master Alternate Source Directory. Besides its low cost, some of its advantages over the bound edition are ease of use due to the fact you won't be thumbing through multiple volumes of the IC Master and the ability to perform searches using both generic and manufacturer-specific part numbers.

The software is designed to run on IBM-compatible machines running PC-DOS or MS-DOS with at least 8 megabytes of unused hard-disk space. It is available on four double-sided double-density 5¼-inch floppy disks, or one high-density 5¼-inch or 3½-inch floppy. To begin describing the software, let's discuss its installation.

**Installation and Startup.** There are two sets of installation instructions: one set is for people upgrading a prior version of the software, the other set is

for those installing the software for the first time. Both sets cover how to install the software from either the low-density or high-density diskettes.

However, the procedure for upgrading the software from a previous version contains some important extra steps. The additional directions cause the installation software to load a batch file and a special program onto the disk. You are then instructed to run an included program that erases some of the older files. Then you must run the special program, which removes comments you may have added to the old database (more on adding user comments later), stores them in a file, and prints them out. This step is necessary to preserve your old comments as the comments from prior versions cannot be automatically imported into the new version of the software. Of course, if you are upgrading the software, but choose not to preserve any of your old comments, you can simply follow the pertinent steps in the procedure for first-time installation.



IC MASTER MANUFACTURER LIST

Mfg Mfg Name  
 TEF AEG Corporation-Telefunken  
 AT&T AT&T Microelectronics, 52AL330240  
 ATM ATMEL Corporation  
 ACT Actel Corporation  
 ADP Adaptec  
 ADV Advanced Analog  
 ALD Advanced Linear Devices  
 AMD Advanced Micro Devices, Inc.  
 SPR Allegro Micro Systems, Inc.  
 ALT Altera Corporation  
 AD Analog Devices  
 AM Analog Microsystems  
 ANC Analogic Corporation  
 APX Apex Microtechnology Corporation  
 ASP Aspen Semiconductor Corp.  
 AVS Avaseam Corporation  
 BIT Bipolar Integrated Technology  
 BRK Brooktree Corporation  
 BUR Burr-Brown Corporation

UpArrow DnArrow PgUp PgDn Home End Esc Enter F1-Help F5-Mfg Info

If you're unsure of a manufacturer's code, the program can provide you with a list of all codes and manufacturers, a small portion of which is shown here.

IC MASTER MFG - DEVICE LIST

Mfg: Device:  
 VTI 20C18  
 VTI 20C68  
 VTI 20C69  
 VTI 20C79  
 VTI 20C98  
 VTI 5468  
 VTI 7C122  
 VTI VL16160  
 VTI VL16C450  
 VTI VL16C451  
 VTI VL16C452  
 VTI VL1772  
 VTI VL2793  
 VTI VL2797  
 VTI VL4500  
 VTI VL4502  
 VTI VL6765  
 VTI VL82103  
 VTI VL82C100

UpArrow DnArrow PgUp PgDn Home End Esc Enter F1-Help F5-Mfg Info

The program can list all of a manufacturer's devices (including discontinued stock) if you're curious as to their wares.

ALTERNATE SOURCES

NTL 74LS21 \*

MFG	DEVICE	DISC	COMMENT
GSS	GD74LS21		
HIT	HD74LS21		
MTR	SN74LS21		
NTL	DM74LS21		
ROE	74LS21		
ROE	74LS21		
SGN	74LS21		
SGS	74LS21		
SGS	T74LS21		
TI	SN74LS21		

UpArrow DnArrow PgUp PgDn Esc <ENTER> F5-Mfg Info  
 F6-Mfg List F2-Add F3-Edit/Comment/Disc F4-Delete

Here the software has cross referenced a discontinued low-power Schottky version of the 7421 from National Semiconductor (as indicated at the top of the screen) with ten other parts.

Most of the original-installation instructions are of the usual variety—make a directory, change over to that directory, and run an installation batch file(s) on the floppy (floppies). With the software now on your hard drive, you must run a program that

generates an index file for the software. This last step takes about 10 minutes on a 286 or 386 computer.

To start the program, you simply enter "ASD" (for Alternate Source Directory) and press the enter key at the DOS prompt. The usual copyright-notice

# Earn Your B.S. Degree in ELECTRONICS or COMPUTERS



## By Studying at Home

Grantham College of Engineering, now in our 43rd year, is highly experienced in "distance education"—teaching by correspondence—through printed materials, computer materials, fax, and phone.

No commuting to class. Study at your own pace, while continuing on your present job. Learn from easy-to-understand but complete and thorough lesson materials, with additional help from our instructors.

Our Computer B.S. Degree Program includes courses in BASIC, PASCAL and C languages — as well as Assembly Language, MS DOS, CADD, Robotics, and much more.

Our Electronics B.S. Degree Program includes courses in Solid-State Circuit Analysis and Design, Control Systems, Analog/Digital Communications, Microwave Engr, and much more.

An important part of being prepared to *move up* is holding the right college degree, and the absolutely necessary part is knowing your field. Grantham can help you both ways—to learn more and to earn your degree in the process.

Write or phone for our free catalog. Toll free, 1-800-955-2527, or see mailing address below.

Accredited by  
the Accrediting Commission of the  
National Home Study Council

**GRANTHAM**  
**College of Engineering**  
Grantham College Road  
Slidell, LA 70460



screen then pops up, but is replaced by the main menu if you hit the enter key.

The main menu contains four numbered options: alternate source by manufacturer and device number, search by base number (the device number), recreate indexes, and quit. It has a highlight bar that can be moved up and down (via the up and down arrow keys) to point to an option on the menu. Once the highlight bar is over an option, pressing the enter key activates that option. Alternatively, you could press the number that appears to the left of the desired option. As is true of all the screens in the program, pressing escape allows you to exit that screen.

### Search by Manufacturer and Number.

If you select the first option (search for an alternate source by manufacturer and device number), you are prompted to enter a "manufacturer code"—a two or three letter abbreviation for the name of the company (e.g., AD for Analog Devices)—in capital letters. You can only use one lower case letter, the letter "u," which is really intended to stand

for the greek letter mu ( $\mu$ ).

If you're unsure as to the code of a manufacturer, you can simply hit enter and a list of all the supported manufacturers will appear along with their codes. You can scroll through the list one manufacturer at a time using the up and down arrow keys, or a screenful at a time using the page-up and page-down keys. To jump to the very beginning or end of the list, you can press the home or end keys, respectively.

Pressing enter while the highlight bar is over a particular manufacturer selects that manufacturer's code, causing the program to prompt you for a device number. If you now press enter instead of entering a device number, the program displays a list of all the devices supported from that manufacturer. You can then select the device of interest using the highlight bar and the enter, up-arrow, down-arrow, home, end, page-up, and/or page-down keys just as you would for the manufacturer code.

Once a device is selected, the alternate sources for that device are listed by manufacturer and part number. There is also a place for comments about each device. To go back to the list of manufacturers, you just press the F6 key. While viewing a list of devices, if you see an asterisk to the right of a device number, it indicates the part has been discontinued.

At this point, you can press the F3 key to add information for the selected part. For example, you could enter an asterisk of your own to indicate the part has been discontinued, or you can enter a comment for future reference. To terminate your entry, you must press enter and the space bar. You can also use the F3 key to change old comments or remove asterisks if you wish.

Alternatively, you could add a device to the software by pressing the F2 key. However, you must use one of the existing manufacturer's codes when entering the new part—new manufacturer codes cannot be added to the software.

Pressing the F4 key will delete a device. The software asks you to confirm the deletion and then removes the device from the master list. The only way to get the device back is by using the F2 key to enter the device again, so it's a good idea to just mark parts as

discontinued rather than delete them.

Pointing to a part and pressing the F5 key will bring up the full name, address, and telephone number of its manufacturer. Pressing the space bar gets you out of this mode.

**Other Options and Operation.** If you choose the alternate source by base number option from the main menu, you are prompted for the device's base number—the part number without the manufacturer's prefix (e.g., 7400 as opposed to DM7400). When the software lists the manufacturers supporting the chip, selecting one with the highlight bar and pressing enter will bring up that manufacturer's name, address, and telephone number.

The third main-menu option, recreate indexes, does some file-based housekeeping. It keys any comments and additions you've made to the master index for faster access times. That need only be done after you've modified information for a few chips, but it is never really mandatory.

Of course, choosing the quit option from the main menu allows you to leave the program. Alternatively, you can press <Alt-C> to interrupt the program's operation at any point. When you use that double keystroke, the program prompts you for confirmation before terminating.

To get printouts of any screen you must use the print-screen key. Unfortunately, there is no other facility for obtaining printouts.

Overall the program turned-out to be amazingly fast, even on an old 16-MHz 386SX. There was never an observable pause between making a request and having it fulfilled. Whatever compression and retrieval algorithm Hearst is using must be really fine-tuned for the application. As far as ease of use is concerned, while the program's function-key assignments are not intuitive, that is inconsequential to using the program as the appropriate key functions are always posted at the bottom of the screen.

If the Alternate Source Directory sounds interesting to you, you can contact Hearst Business Communications, Inc. (645 Stewart Ave., Garden City, NY 11530) directly, or circle No. 119 on the Free Information Card for more information. ■



**Be an FCC LICENSED ELECTRONIC TECHNICIAN!**

**Earn up to \$2000/Week and more!**

Learn at home in spare time. No previous experience needed!

No costly school. No commuting to class. The Original Home-Study course prepares you for the "FCC Commercial Radiotelephone License." This valuable license is your professional "ticket" to thousands of exciting jobs in Communications, Radio-TV, Microwave, Maritime, Radar, Avionics and more... even start your own business! You don't need a college degree to qualify, but you do need an FCC License.

**No Need to Quit Your Job or Go To School**  
This proven course is easy, fast and low cost! **GUARANTEED PASS**—You get your FCC License or money refunded. **Send for FREE facts now. MAIL COUPON TODAY!**

**COMMAND PRODUCTIONS**  
FCC LICENSE TRAINING, Dept. 100  
P.O. Box 2824, San Francisco, CA 94126  
Please rush FREE details immediately!

NAME \_\_\_\_\_  
ADDRESS \_\_\_\_\_  
CITY \_\_\_\_\_ STATE \_\_\_\_\_ ZIP \_\_\_\_\_



# Turn to TAB/McGraw-Hill for the electronic skills you need!



**HOME VCR REPAIR ILLUSTRATED**  
Save time and money by servicing and repairing your own VCR—even learn how to repair for profit. More than 450 photographs guide you through every step of the repair—from getting inside the VCR to examining the remote control. 400 pp., 459 illus. #3711H, \$20.95

**PRACTICAL RF POWER DESIGN TECHNIQUES**  
Turn here for an exciting look at the theory of RF circuitry and how you can use it. Plus, get the solutions you need to easily design and troubleshoot RF generating circuits, transformers, and coils. 320 pp., 220 illus. #4228H, \$32.95

**SHORTWAVE RADIO LISTENING FOR BEGINNERS**  
"... can help open the door to the many strange and wonderful things available only on the shortwave band." —Allan Weiner, Radio New York International  
Listen in on today's most unusual radio broadcasts from across the country and around the world. This book helps you get your equipment and get up and running fast on the band. 192 pp., 105 illus. #4231H, \$18.95

**ELECTRONICS ENGINEER'S HANDBOOK—3rd Ed.** More than 200 formulas, illustrations, and fact-filled pages make this the most useful electronics resource you can own. Features expanded coverage of: principles, data, standards, computers, functions, applications; digital electronics, telecommunications, and more. 2,496 pp., 1,600 illus. #9255H, \$106.50..... Only \$79.95

**MICROCONTROLLERS: Architecture, Implementation, & Programming**  
Unleash the power and complexity of the latest controller designs. You get complete coverage of all aspects of microcontrollers—from general principles, to specific implementations, to detailed use at the software level. 496 pp., 125 illus. #028977-0, \$44.95

**HOME WIRING FROM START TO FINISH—2nd Ed.** Save money-do your own wiring. You'll be able to • repair switches • replace fuses and circuit breakers • mount light fixtures and ceiling fans • install overhead and underground services to out-buildings • and install remote systems 320 pp., 350 illus. #4254H, \$28.95

**TELEPHONE REPAIR ILLUSTRATED**  
Get the troubleshooting tables, service guidelines, and illustrated techniques you need to make safe and speedy telephone and answering machine repairs. Covers rotary, electronic, cordless, and cellular telephones, plus two-tape, voice-synthesizing, and digital answering machines. 240 pp., 169 illus. #4179H, \$27.95

**TROUBLESHOOTING AND REPAIRING PERSONAL COMPUTERS—2nd Ed.**  
Use this all-in-one volume for practical techniques and background theory to service Macintosh®, Commodore™, 80286, 80386 and 80486 PCs. Includes updated information on servicing chips, laptops, displays, disk drives, and power supplies. 696 pp., 460 illus. #3677H, \$34.95

**BUILD YOUR OWN UNIVERSAL COMPUTER INTERFACE**  
Use your computer to control your home security system...run laboratory experiments...collect data...and more. Step-by-step instructions help you build electronics interfacing circuits that enable almost any computer to control external devices. 285 pp., 224 illus. #3122H, \$27.95

## EVERYTHING YOU NEED TO BE A CET!

**CET STUDY GUIDE—3rd Ed.**  
"this book will be a great help in your preparation."  
—Electronic Servicing & Technology, on the second edition  
Find everything you need to know to pass the tests, including basic theory and workbench techniques. Pinpoint your strengths and weaknesses as you learn how to properly service radios, TVs, VCRs, stereos, computers, and more. 280 pp., 188 illus. #4076H, \$27.95

**THE CET EXAM BOOK—3rd Ed.**  
This new edition covers every CET certification including Journeyman, and can be used with the study guide. You get sample quizzes on each topic, and full explanations of principles involved. By examining your practice test scores, you can effectively gauge your progress and concentrate on the subjects you need to study most. 304 pp., 265 illus. #4199H, \$27.95

**SAVE 15%—Order both guides (#586274-3) for only \$47.50—regularly \$55.90**

## The Encyclopedia of Electronic Circuits, Volumes 1 through 4

There's never been any circuit references like these before. The Encyclopedias of Electronic Circuits give you the answers you need on any circuit imaginable.

For your projects, designs, or applications, you'll use over 4,000 circuitry components in • computers • telecommunications • modern circuit design • lasers • fiber optics • voltage references • thermal reactors • sensors • antennas and alarms • and more.

Order all 4 Volumes (#586148-8) for only \$149.95 (regularly \$240.00)



## FREE 30-DAY EXAM

### 3 EASY WAYS TO ORDER:

1. CALL ☎ **1-800-822-8158** (24 hours a day)
2. FAX 📠 **1-717-794-2080**
3. Mail Coupon to:  **McGraw-Hill, Inc.**  
Blue Ridge Summit, PA 17294-0840

**Satisfaction Guaranteed—**  
Within 30 days, pay the amount stated plus postage, handling, and state and local sales tax, or return the books and owe nothing.

Please cut along dotted line • • • • •  
Please send me the book(s) below for a FREE 30-day exam:

Book #	Title	Qty.	Total Price

Name \_\_\_\_\_  
Address \_\_\_\_\_  
City/State/Zip \_\_\_\_\_  
Signature **X** \_\_\_\_\_

• Invalid without signature. Order subject to credit approval. Orders outside the U.S. must be prepaid in U.S. dollars drawn on U.S. banks and include \$5.00 for shipping and handling. Orders over \$150.00 require prepayment.

PE73



# PRODUCT TEST REPORTS

By Len Feldman

## Panasonic CTP-27XF20 TV Monitor/Receiver

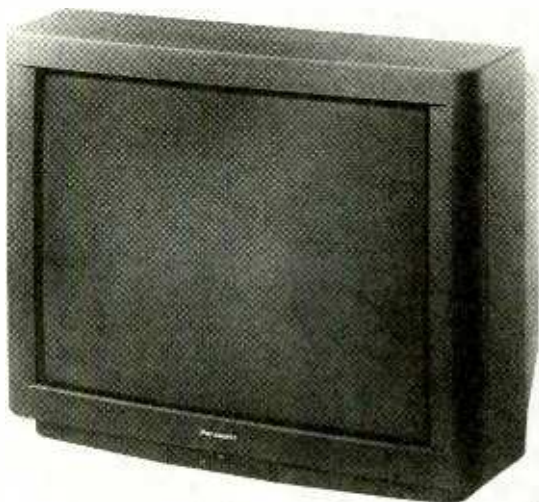

CIRCLE 120 ON FREE INFORMATION CARD

*The Panasonic CTP-27XF20 TV monitor/receiver.*

As direct-view picture tubes get bigger and bigger, it becomes increasingly important that TV sets provide better and better resolution or detail. In that respect, the 27-inch (measured diagonally) CTP-27XF20 from Panasonic (One Panasonic Way, Secaucus, NJ 07094) is a star performer with its 600-line horizontal-resolution capability. But resolution, color quality, and good interlace are just a part of the story for this excellent

receiver. It is loaded with special features. It can tune to a total of 181 channels. Connect a second video source to one of the set's external video and audio inputs and you can view a picture-in-picture inset. Either main- or inset-picture sound can be selected,

and the inset picture can be positioned anywhere on the main picture by using the "frame-locator" buttons found on the remote control.

The supplied remote control can be programmed to recognize and control other video components such as VCR's and cable-TV converter boxes, including those made by other manufacturers. In addition, this remote offers such features as Rapid Tune (instant switching between the last two channels or video modes selected); a Skip feature that lets you set the desired time (up to six minutes) after which, when changing channels or video mode, the set returns to the original channel viewed; and the familiar Sleep Timer for automatic set turn-off after 30, 60, or 90 minutes. A Favorite-Picture feature allows you to select three individual settings for the various video sources (including the set's tuner). A Favorite-Channel button found on the remote control can be used to scan up to 15 of your favorite channels. A Surround feature enhances the audio-output response when listening to stereo broadcasts.

Additional advanced features include a program timer; a channel-lockout feature that allows you to lock out up to four channels; and a station-identification feature that allows the user to enter the call letters or another ID of up to 30 stations, using 4

characters for each. A search function, activated with a search button on the remote, sequentially scans channels in program or favorite-channel memory; the scanned channels are displayed within an inset box. When a desired channel is observed, pressing the search button again causes the inset search frame to become the main full-screen picture. Of course, the usual array of picture and sound adjustment are also available, using on-screen menus.

### CONTROLS

The unit's controls are all located behind a drop-down door located below the picture-tube area. Included here are a TV-speakers on/off switch; a headphone jack; video and audio jacks (including an S-video jack); a power on/off switch; channel up/down buttons; and volume up/down buttons. Also located there are menu, video, TV/video, norm (for resetting audio or video adjustments to factory-preset levels), ant (to select between the two available antenna inputs), display (to initiate a demonstration of many of the on-screen menus and picture-in-picture features), and recall adv (to display time of day, channel number, video and audio modes and to select desired features) buttons.

The rear panel of this TV set is equipped with two sets of audio and video inputs (one of which also



includes an S-video connector), audio and video "program-output" jacks, and left-and-right stereo audio outputs for connection to an external stereo amplifier. Also found on the rear panel are two antenna input connectors as well as a "split out" coaxial connector that's useful in some cable converter-box hook-ups.

The remote control, in addition to including most of the controls and functions found on the TV set itself, also contains buttons for activating the advanced features described earlier and buttons for operating a VCR, video-disc player, or cable box. Number buttons are also found on the remote control so that any channel can be accessed directly without having to scan or use the channel up/down buttons.

## TEST RESULTS

As always, the performance of this product was carefully measured by the Advanced Product Evaluation Labs, under the direction of Frank Barr. A summary of the measured results can be found in the table elsewhere in this article. Picture settings during the tests were as follows: auto-color was off, video noise-reduction was turned off, and the white-temperature selector was set to its standard position. The program-output audio jacks were used for all of the audio measurements made for this report.

The maximum usable luminance was about average for a set having this picture size. Horizontal resolution was excellent, with a reading of 600 lines. That's far more than you would need to display all the detail contained in S-VHS or ED-Beta videotapes,

## TEST RESULTS—PANASONIC CTP-27XF20 TV MONITOR/RECEIVER

### Specification

Maximum usable luminance  
Horizontal resolution  
Interface  
Black-level retention  
Overscan  
Color quality  
Transient Response  
Reception

### PE Measured

82.5 foot-lamberts  
600 lines  
50/50 (perfect)  
100%  
0%  
Excellent  
Very good  
Very good

### Audio Section

0 dB reference level  
Signal/noise ratio  
Total harmonic distortion @ -10 dB

2.7 volts, 0.64% THD  
61.7 dB  
0.17%

### TV Stereo Section

Signal-to-noise ratio  
Total harmonic distortion @ -20 dB  
Stereo separation, 1 kHz  
At 100% modulation  
At -20 dB modulation

48.3 dB  
0.56%

Mono signal-to-noise ratio  
Mono harmonic distortion @ -20 dB

20.5 dB  
14.8 dB  
45.9 dB  
0.35%

### Additional Data

Picture size  
Power consumption  
Dimensions (W x H x D, inches)  
Suggested price:

27" diagonal  
170 watts  
27½ x 22 x 19¾  
\$1199.95

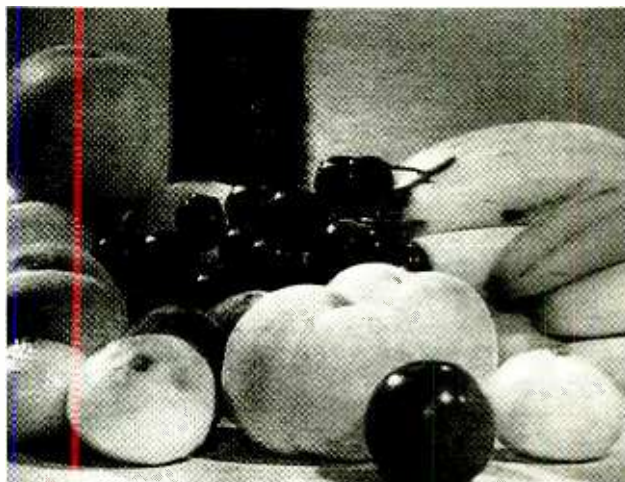

*Tuner reception was very good, with simulated "fringe-area" signals yielding acceptably noise-free picture quality.*

or even in today's best laser video-discs.

The black-level retention, which, when equal to 100% as in the case of this receiver, contributes to the overall crispness of the displayed picture. APEL and we considered the picture quality of this set to be excellent; that subjective impression was confirmed

by displaying a color-bar test pattern.

Tuner reception was very good, with simulated "fringe-area" signals (100-microvolt intensity) yielding acceptably noise-free picture quality. There was virtually no horizontal or vertical picture overscan. That not only suggests that the set has a well-regulated

power-supply, but also that no part of a received picture will be "chopped off" along its edges when power supply voltages are up to, or exceed standard values.

As for audio performance, the A-weighted signal-to-noise ratio measured a more-than-adequate 61.7 dB, and the harmonic distortion at 1 kHz and a level of -10 dB below reference level was an inaudible 0.17%. While signal-to-noise ratio during stereo reception was only 48.3 dB, the stereo separation provided by the unit was adequate, with readings of 20.5 dB at 1 kHz for a 100% modulated signal.

## HANDS-ON TESTS

In evaluating the actual performance of this set, we were particularly impressed with its many advanced features. The picture-in-picture feature worked flawlessly, as did all of the other features described earlier in this report. Most important, though, was the excellent resolution and picture detail that we observed even when we sat closer to the set's screen than would normally be the case in a typical home viewing room.

The 40-page "Operating Instructions" booklet might have been organized a bit better, but if you thumb through the pages patiently, you will find each feature described as well as step-by-step instructions on how to use them. Both APEL and we agree that this 27-inch set would make an excellent display component in a typical "home theater" room.

For more information on the Panasonic CTP-27XF20 monitor/receiver, contact the manufacturer directly, or circle No. 120 on the Free Information Card. ■

# GET THE LATEST ADVANCES IN ELECTRONICS

WITH A SUBSCRIPTION TO

# Electronics

Radio Combined with  
**Electronics**<sup>®</sup>

# NOW

<sup>®</sup>

Electronics Now gives you exciting articles like:

- Buyer's Guide to Digital Oscilloscopes
- Build A Scanner Converter
- Single-Chip Voice Recorder
- Build A MIDI Interface for your PC
- Troubleshoot Microprocessor Circuits
- Build A High-Power Amplifier for your Car
- Add Music On Hold to your Phone
- All About Binaural Recording
- VGA-to-NTSC Converter

ENJOY THE WORLD OF ELECTRONICS EACH MONTH!

Subscribe to the best electronics magazine—the one that brings you the latest high-tech construction projects, feature articles on new technology, practical troubleshooting techniques, circuit design fundamentals, and much more.

Electronics Now looks to the future and shows you what new video, audio and computer products are on the horizon. What's more you'll find helpful, monthly departments such as Video News, Equipment Reports, Hardware Hacker, Audio Update, Drawing Board, Computer Connections, New Products, and more. All designed to give you instruction, tips, and fun.



FOR FASTER SERVICE CALL TODAY

**1-800-999-7139**

# DON'T DELAY SUBSCRIBE TODAY!

Just fill out the order card in this magazine and mail it in today.

7PG35





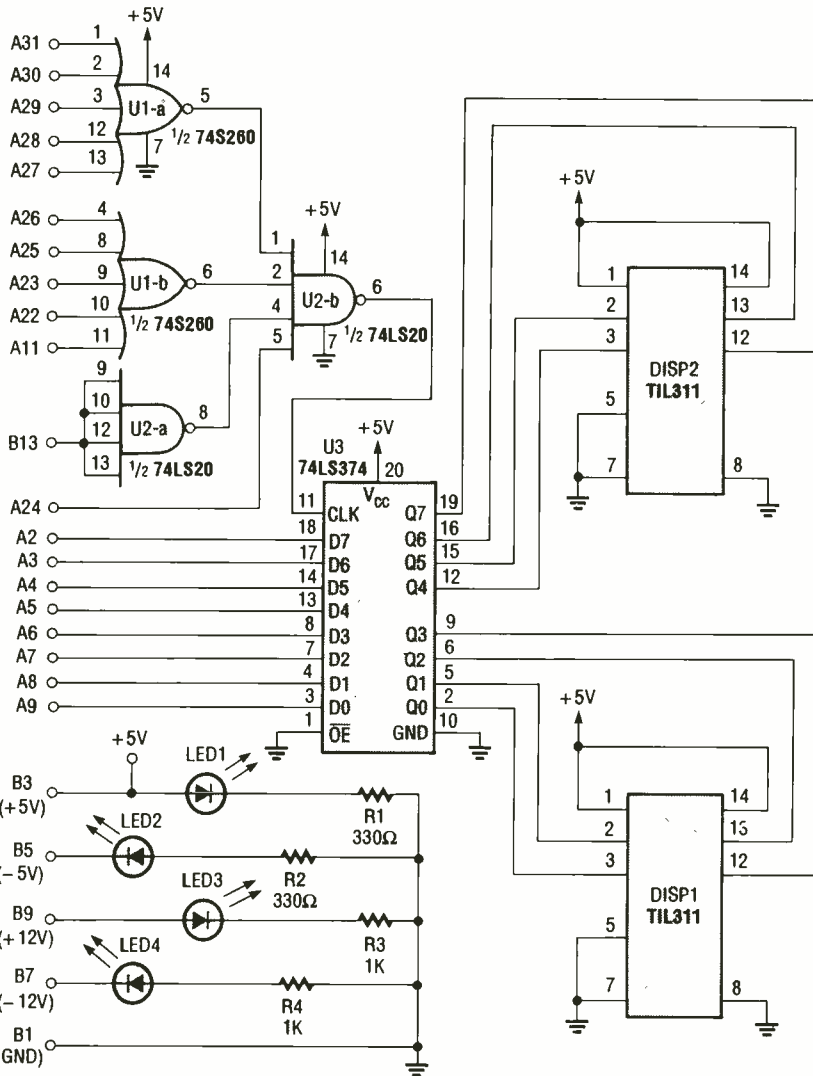

Fig. 1. The main portion of the diagnostic tester includes port-address decoding and a data latch. Data is latched when the decoder detects a hex 80 on the address lines.

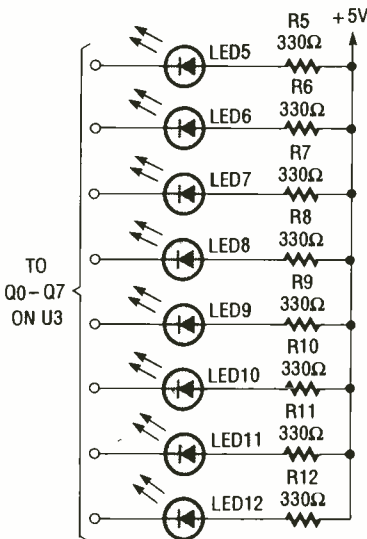

Fig. 2. The POST codes can be displayed by 8 LED's. This is a good low-price alternative to using the TIL311's.

## PARTS LIST FOR THE POST CODE READER

### SEMICONDUCTORS

- U1—74S260 dual, 5-input NOR-gate, integrated circuit
- U2—74LS20 dual 4-input NAND-gate, integrated circuit
- U3—74LS374, octal latch, integrated circuit
- DISP1, DISP2—TIL311 hex display with built-in driver (optional, see text)
- LED1-LED4—Green light-emitting diode
- LED5-LED12—Red light-emitting diode (optional, see text)

### RESISTORS

- (All resistors are 1/4-watt, 5% units)
- R1, R2—330-ohm
- R3, R4—1000-ohm
- R5-R12—330-ohm (optional, see text)
- PC board (Radio Shack 276-192 or equivalent), two 14-pin wire-wrap IC sockets (optional, see text), two 14-pin solder-tail IC sockets, 20-pin IC socket, wire, solder, etc.

inch spacing. Any protoboard will work, but PC-style protoboards with gold contacts are a minimum of \$12 each and this board is only \$5. I used a nibbling tool to reduce the number of contacts to 62 (31 per side). When you have done that, (and prior to installing parts) be sure to test-fit the board in one of your computer's open slots.

The component side of the board should be the A side. When facing that

## LISTING 1

```

10 rem display testing routine by Mark Hanslip 9-28-90
20 rem this will cycle the display from 0 to 255 and repeat
100 for a=0 to 255
110 out 128,a
120 for b=1 to 2000:next b
130 next a
140 go to 100

```

lines. This part of the circuit is optional, however if any one of the power lines ceases to function, the problems that result would be hard to diagnose without those indicators.

**Construction.** The construction of this project is very simple. As a base for the project, I used a modified piece of protoboard that originally had an edge connector with 72 pins at .100-

side with the card edge pointing downward, pin A1 will be on the right and pin A31 to the left. When you face the B or solder side, pin B1 is to the left and pin B31 to the right.

Keeping that in mind, the IC sockets for the three chips should be mounted close to the edge connector, so that the wires from the connector to the chips can be kept as

(Continued on page 90)





# A No-Nonsense Guide for PC Buyers

BY KARL T. THURBER, Jr.

*Learn how to successfully navigate the PC buying maze.*

It was easy to make a choice when purchasing a personal computer (or PC) in 1975. There was only one to choose from: the \$350 MITS Altair that **Popular Electronics** featured on its January cover. It had few options; the memory was 256 bytes, there was no permanent storage, it came sans keyboard, oh, and you had to assemble it yourself—it was offered only as a kit.

Computers have changed dramatically since then. PC choices have exploded and prices have plummeted so that high technology is within most people's budget. Besides which, even unsophisticated users can benefit from a fully-equipped PC; today, almost everyone really is a power user. High cost is no longer an excuse for buying a minimally equipped system. Why? The costs of under-buying in the long run far exceed the costs of over-buying: if you don't need high-end PC power now, you likely will soon,

as programs get larger and graphical software demands hefty processing power. So you must be careful to choose a PC that won't be obsolete 12 months downstream.

Factors like that have made the task of selecting a PC and its peripherals a confusing experience that would try the patience of Job. In this article we will present practical PC buying hints and tips for the performance-aware but budget-conscious shopper.

We'll cover the basics of savvy computer buying, showing you features to look for and avoid, help separate needs from wants, stimulate questions, help narrow choices, and keep you from spending more than you should. We'll also point to some new, high-tech methods of obtaining accurate, up-to-date product information. Bottom line: we'll give you everything you need to know to become a knowledgeable and dollar-stretching PC buyer.

**Starting Out.** Before you buy, rule number one is, don't confuse wants with needs; make sure you must have a PC to meet your personal, business, or professional needs. Ask yourself penetrating questions about what you really want to do with a PC right now, and what you might want to do a few months' hence.

Having said that, rule number two is, don't place the hardware horse before the software cart. A computer is little more than a collection of electronic parts that needs software to tell it what to do and how to manipulate information. So decide what kinds of software you expect to run and gear the hardware to fit the software—not the other way around.

With a firm grip on your needs, you need to hunt around for a vendor. Just where to purchase—from a traditional computer dealer, superstore, discount warehouse, chain electronics store, department store, or



*Desktop-style cases are what most users opt for. However, you may find it advantageous to go with a vertical tower case like this one, especially if your desktop space is limited. Sometimes a tower case is standard equipment; in other cases, you pay a small premium for a vertical configuration.*

mail-order (direct sales) house—is a tough question. All have locked horns in competition for your computing dollar, and each offers distinct advantages. If you need handholding and TLC, a local dealer is best, and you can try before you buy—although you'll often find that retail salesmen are not always that helpful.

Look for a well-established dealer, mail-order house, or other vendor. The vendor you select should be known for good workmanship and high-quality components. Seek a strong, proven company that's likely to be around when you may need support or repairs. You'll find life with a PC easier if you stick with proven product lines from established firms. So, look carefully at who you're buying from—but don't assume the PC's nameplate

must bear the name IBM, Compaq, or another premium-price vendor.

If you buy from a firm that specializes in custom-assembling inexpensive clones to produce a no-name "Pacific PC" with components from all over the Pacific rim—Taiwan, Singapore, Hong Kong, Japan, and Korea—you may run into trouble getting parts and service later if the vendor goes under. This caution particularly applies to the motherboard, which may be hard to replace (or get technical support for) if it's a no-name model.

IBM compatibles today tend to look alike, have similar performance, and are priced similarly. As a result, the quality of a company and its service capability is paramount. The firm you select should have a reputation for

outstanding performance and pride itself on good customer service and knowledgeable, easily accessed technical support. Some firms go to great lengths to help solve customers' hardware and software problems by going online. For example, CompuAdd Express has an innovative service called Remote Rescue: it uses a remote communications program that lets a factory specialist use a modem to view and control your PC to diagnose and solve problems and even configure it.

I can offer a few helpful tips with regard to this:

- Ask the vendor if the PC's he sells have all of the "alphabet-soup" approvals—UL, FCC, and the like. If they don't bear these approvals, beware of what's under the hood.

- Look for computer-magazine surveys that report on customer service, repair support, and satisfaction as well as hardware specs and prices. Also, test the company's technical-support number before you buy to see if the support is up to par.

- Pay close attention to how the sales representative treats you; even with mail order, there's a salesman involved. The better salesmen will ask you how you intend to use the PC to determine what you need. He or she will neither get you to commit to a system that exceeds your needs nor recommend that you buy a machine that's too puny for your intended use. Above all, don't buy on price alone. Doing so is the best way to get ripped off, or at a minimum, to be treated to poor service and support.

**Warranty Expectations.** You should expect at least a one-year parts-and-labor limited warranty. If you buy through the mail, make sure you're offered a no-questions-asked return guarantee so you can back out if the PC doesn't meet your expectations; most good mail-order houses offer these no-risk guarantees. You usually can anticipate a year's free on-site service (at least for desktops) and lifetime toll-free technical support that preferably extends to evenings and weekends.

Also, buying your PC with a credit card (not with cash, check, money order, or C.O.D.) offers you protection against fraud. And, if you use a gold Mastercard or Visa, or a green or gold



American Express card, you can increase (sometimes doubling) the warranty period on merchandise just by using the card for the purchase. Free extended warranties represent a valuable plus with systems costing \$2,000–\$3,000 or more if your PC suffers an expensive failure just outside the factory warranty period.

**Bundle to Save a Bundle.** Buy your PC as a single hardware package, especially if you're not handy with hardware. While you can fit together your own PC, buying a complete system helps ensure that the vendor will be responsible for the whole system and that compatibility is his problem, not yours. A good vendor will ensure that everything works together as it should. But if you buy the options piecemeal later on, you're on your own for any compatibility problems that may arise.

If you piece together your system and something goes wrong, you will have to figure out what's wrong, identify the supplier of the offending hardware, and work with that vendor. You may save a few dollars by mixing and matching, but you risk not achieving good system integration and overall high performance.

Bundled hardware-and-software deals, in which extras are included in the system price, can be very cost effective, so keep a sharp eye out for them. However, you should not buy a particular computer just because it comes packaged with bundled software, especially since you often don't get full support with such freebies. But if you're torn between competing systems, the bundle may break the tie. Many good hardware/software combos are available from computer superstores and direct channel suppliers; I've found that Gateway 2000 is particularly good at bundling.

By the way, don't buy directly from a magazine or newspaper ad. Ask the vendor for a catalog or detailed specification sheets on each system you might consider so you can tailor your system by adding and subtracting options from basic configurations. Spec sheets usually show all available options, more than can be shown in ads, and sometimes the spec sheets show items that you don't need and can delete from the advertised system to reduce your cost.

What about starter software? Your PC should come with at least the operating system (such as MS-DOS 5.0 or higher) and a user-friendly graphical operating system (GUI) such as Windows, preloaded and ready to run. Many vendors also offer a choice of free or low-cost application software packages.

Also, any bundled software should be installed, configured, and tested to minimize the chance of faulty installation. But ask if the preloaded software includes all the manuals and original distribution disks. The vendor's arrangements with the manufacturer may cut you out of the pretty retail box; that's okay. But it's not okay to receive the software without the manuals and original disks, for obvious reasons—software theft.

**Inside Desktops: the CPU.** The three main areas with which you should be concerned when shopping for any PC are the central processing unit (CPU), memory, and hard disk. Other important aspects are video, keyboards, add-ons, and other peripherals. We'll first look at what you should seek when buying a desktop

computer, which, by the way, probably will set you back \$1,200 to \$4,000, depending on features. Much of what we say applies to portables; we'll point out special considerations that apply to them later.

At the PC's core is its brain called a microprocessor, or central processing unit (CPU). It controls the motherboard and the rest of the system. The 80286, 80386, and 80486 processors are more powerful than their predecessors, and the 80586 soon will eclipse them all once it hits the streets. The first processors used in IBM PC's and compatibles were the s-l-o-w 8086 and 8088 CPU's. Then came the AT class PC with its faster 80286 processor; it introduced protected-mode operation and a 16-bit data path.

The 80386 (used in 386 machines) increased the data-processing path to 32 bits to add speed. The 80486 CPU (used in 486's) is, at the time this was written, the top-of-the-line processor: it's lightning fast with an internal 8K processor cache and a built-in math coprocessor to handle today's most sophisticated applications.

Since the resource-hogging Microsoft Windows environment is where the action is today, you'll find PC vendors vying to combine the hottest CPU, memory, storage, and video to support its demanding graphics software. Your choice for that kind of power today is between a 386 and 486. Be ready for tomorrow with at least a 386 and preferably a 486 system. Until recently the 386 was the basic business workhorse, but now the 486 is the new corporate standard that's also becoming the home and home office standard as well.

Within the 386 and 486 classes, there are actually two basic types, both of which use the same instruction set. There's the regular 386 or 486 processor, also known as the "DX" and a trimmed down version, the "SX." A 386SX performs 32-bit data handling 16 bits at a time, which takes twice as long as a 386DX. A 486SX lacks the internal coprocessor of a 486DX.

To give you a feel for pricing, a 386SX system with a 16- or 33-MHz operating (clock) speed, super VGA (SVGA) video, an 80MB hard drive, and 2 MB or more of memory can be had for under \$1200. (Yes, you can get a 16-MHz 286 system for much less if you look carefully on store shelves, but

### A Starter Bookshelf For PC Buyers.

*The Computer Buyers Handbook*, 2nd ed., R. Wayne Parker, Fast Forward Publishing Inc., 1992, 284 pages, \$17.95.

*Dvorak's Inside Track to DOS and PC Performance*, John C. Dvorak and Nick Anis, Osborne McGraw-Hill, 1992, 879 pages and one 3.5-inch utility diskette, \$39.95.

*Jamsa's 1001 DOS & PC Tips*, Kris Jamsa, Osborne McGraw-Hill, 1992, 896 pages and one 3.5-inch utility diskette, \$39.95.

*Jim Seymour's On The Road: The Portable Computing Bible*, Jim Seymour, Brady Publishing, 1992, 283 pages, \$26.95.

*Que's 1993 Computer Buyer's Guide*, Bud Smith, Que, 1992, 432 pages, \$16.95.

*Upgrading & Repairing PC's*, 2nd ed., Scott Mueller, 1992, \$34.95, 1293 pages.

*The Winn L. Rosch PC Upgrade Bible*, Winn L. Rosch, Brady Publishing, 1991, 621 pages, \$26.95.

*Your First Computer*, Alan Simpson, Sybex, 1992, 396 pages, \$19.95.

that's not a wise choice for a new machine today. A 286 just no longer qualifies, especially when running Windows.)

In the 486 class, there's also "speed doubler" or DX2 technology. The DX2 designation means that the chip internally runs at double the rated clock speed, but communicates with the rest of the system at the normal clock speed. This capability is valuable since it increases computing speed without the expense of high-speed hardware with the exception of the CPU. Also, other things being equal, a zero-wait state processor is optimal: the fewer the "wait states" in the CPU spec, the better. So look for a zero-wait-state machine.

With CPU prices tumbling, many experts advise against buying any 486 desktop with an SX chip. However, you can upgrade many 25-MHz and 33-MHz 486SX system to faster DX-style performance by installing Intel's OverDrive processor. It effectively doubles the on-chip internal processing speed (but not the speed at which it communicates to the rest of the system), and it adds coprocessor functionality. Making this upgrade gives you better performance overall—without trading out hardware—though it doesn't quite double processor performance.

**Random Access Memory.** How much dynamic or volatile memory (usually called RAM) should you have? Two MB of 70-ns (nanosecond) or faster RAM is a bare minimum even for an unadorned, for-the-kids PC. Really, though, 4 MB of RAM is better, and you'll be happier with 8 MB or more if you run Windows or desktop publishing software. Ensure that the PC is expandable to at least 16 MB, preferably to 32 MB. Ample room for RAM expansion to run ever-larger Windows applications will help keep your system viable for a few years.

What about cache memory? An external high-speed RAM cache of 64K, 128K, or 256K can be a good investment. Don't confuse this type of cache with three other types of caches, such as the internal (on-chip) 8K cache in the 486 processor, hard-disk controller caches, and software-created disk caches. Cache memory can make things zip along several times as fast as regular memory. How-



*The palmtop ("pocketable") PC is a real PC that runs DOS and has good expandability. Palmtop punch is all the portable PC power needed to send and receive E-mail, modem a memo home, write reports, create spreadsheets, figure expenses, or manage an appointment calendar. This 1.3-lb. ZEOS Pocket PC boasts at least 10 hours on two AA alkaline batteries using power management features that let the computer "doze" or suspend operations to increase battery life.*

ever, while paying for a 64K or larger hardware cache is admirable, a caution applies: a 64K cache is good, but the law of diminishing returns applies so that a large (and expensive) 256K cache isn't really four times as good as a 64K cache. But both are much faster than the PC's regular RAM.

**Disk Choices.** My advice: double whatever hard-disk storage you think you might need, then add a few MB extra capacity for good measure! You never can have a too-big hard drive: more is better. (Remember, each major Windows application can easily gobble up 5–15MB of hard disk space.) Hard drives today should store at least 80MB as an absolute minimum, but be aware 200MB hard disks

are rapidly becoming standard equipment.

For good performance, hard-disk speed is second only to capacity. The lower the access time, the better, but also the more expensive. A figure of less than 28 ms is essential; 15 ms or lower is best. Don't let your PC be hobbled by a slow drive.

Most 386 and 486 PC's come equipped with relatively inexpensive but good-performing IDE (integrated drive electronics) drive controllers. Most IDE drives include integral buffers or caches, mostly 64K, with some hard-disk caches as large as 128K or more. Onboard caches allow the drive to quickly process data for quicker reads and writes. Consider a SCSI (small computer system inter-



face) drive instead of an IDE unit if you'll use a very large hard disk or if you plan to expand your system with multiple peripherals like CD-ROM's and tape backup drives. While you may not be installing the hard drive yourself, ask the PC vendor which drives he uses. It's best to stick with drives from well-known firms such as Fujitsu, Maxtor, Micropolis, Seagate, and Conner Peripherals.

You should be aware that you can double the hard-disk capacity of a desktop or portable at minimal cost with good on-the-fly disk-compression programs like Stacker (from Stac Electronics) or SuperStor (from AddStor). However, make things easy for yourself: install disk-doubling software when you first set up your system.

With regard to floppies, insist on both 5.25- and 3.5-inch high-density floppy drives for maximum flexibility—no low-density 360K or 720K drives, please. Having both is handy in installing new software, where you can be caught short if you have the wrong size drive. You might even opt for one of the newer 2.88 MB 3.5-inch floppies.

### **Expansion Slots and Data Buses.**

To increase the performance and functionality of your PC, you'll likely add peripheral devices—scanners, CD-ROM drives, modems, and the like. Most require an interface card that plugs into a slot on the PC's motherboard, so you'll want a PC with lots of expansion room. PC's may come with as many as eight slots (the more the better), while others—especially small-footprint, slimline desktops—may have as few as three slots. But what's really important is how many vacant slots are available, considering that the factory configuration may already preempt several slots for disk controllers, serial and parallel ports, and video adapters.

So much for the *number* of expansion slots. Things get confusing when we consider what type of expansion bus the PC uses. Most PC's today have Industry Standard Architecture (ISA) buses—the old AT-style bus—or a high-end Extended Industry Standard Architecture (EISA) bus. The latter is ISA-compatible but offers higher performance by "bus mastering," which frees the processor from performing bus-management tasks.

A recent development is the local bus, sometimes called the direct-expansion bus. This fast, full 32-bit bus increases performance by giving some peripherals direct access to the processor, using the full 32-bit path, rather than going through the ISA or EISA bus. The local bus is reported to be about four times faster than the EISA bus and 20 times faster than the ISA, but it's compatible with both. A local-bus PC used to cost more than others, but it's now fairly inexpensive for PC manufacturers to implement since local buses can use existing chipsets, so they've come down in price. So far the local bus is used mostly with fast video cards and some disk controllers, but its use will expand to other peripherals.

The main point behind the local bus concept was to eliminate video bottlenecks particularly to enhance Windows performance, so consider a local-bus PC instead of one with ISA or possibly even EISA architecture if you want snappy Windows performance. Preferably, your PC should use a local bus that meets the Video Electronics Standards Association (VESA) compatibility requirements. The VESA standard VL-Bus will help ensure that your peripherals will be compatible with your PC's motherboard.

**Video-Display Adapters.** Old-style color-graphics adapters (CGA) and enhanced graphics adapters (EGA) are out. Go with at least a video graphics array (VGA), which, with its maximum 640 (horizontal) × 480 (vertical) picture element (pixel, or dot) resolution, is the minimum acceptable today. Going to a Super VGA (SVGA) card with at least 800 × 600 resolution, you'll find a much clearer image. Even better are beyond-SVGA video display adapters supporting 1024 × 768 or 1280 × 1024 resolution to accommodate newer graphics software packages. Also, the more the video RAM the better—don't settle for less than 512K.

Paralleling the move to the local bus is fast video coprocessor or "accelerator" technology. Video-coprocessor equipped graphics cards usually have at least 1MB of video RAM to pep up performance and increase the number of colors you can display at one time. These benefits are important for Windows, which

can be painfully slow with older cards. Accelerator boards operate many times faster than standard VGA or SVGA cards, and are especially fast when teamed with local-bus architectures. For truly top performance, look for these video features on a 50- or 66-MHz 486.

**Monitors.** The monitor is a critical part of your system: you'll be staring at it whenever you use your PC. The more pixels the better; if the dot pitch (the distance, in millimeters, between the red, green, and blue dots or pixels) is too large, images look blocky. With color monitors, the lower the dot pitch value, the clearer and sharper the screen image. A 14-inch color monitor with 0.28mm or less dot pitch that supports 1024 × 768 or 1280 × 1024 resolution is desirable for good readability, sharpness, minimum eyestrain, and overall picture quality.

Oversize (15 to 20 inch) monitors are excellent but expensive choices. A large, square, flat, non-glare screen is a plus for desktop publishing. So is a non-interlaced monitor, which helps minimize flicker. The refresh rate should be at least 72 Hz; 90 Hz is better. If you can view the monitor before buying, check the clarity of the smallest type; this is a good rough check of resolution. Avoid monochrome monitors in today's color PC world.

**Keyboards and Rodents.** Don't overlook the keyboard, which must be comfortable to use. If possible, try out the keyboard before buying. The old 84-key models are out. An AT-style or enhanced, programmable keyboard with 101 or (preferably) more keys is desirable in a desktop. Two sets of function keys and a calculator are handy. You'll need a mouse, but a 2- or 3-button rodent is usually bundled along with Windows and some application software sold with most PC's.

By the way, a dedicated mouse port or a bus mouse can keep one of your valuable serial ports free, although the associated bus card occupies an expansion port. If you think you'll need more than one serial port for other purposes, look for a dedicated mouse port or specify a bus mouse if you have a choice.

**Add-Ons and Nice-to-Haves.** Various optional add-ons should be

available factory installed. These include CD-ROM drives, scanners, FAX/modems, tape backups, and other devices. To easily accommodate them and peripherals you add later, you should avoid compact, small footprint models with limited expandability. The PC's power supply should be big enough to handle all the cards you can stuff in: 220 watts minimum—300 watts is best.

If you're into serious business computing, you'll probably want a FAX/modem. It should have a 9,600-bits-per-second (bps) FAX send and receive speed, or at least 2400-bps data-modem capability, with built-in data compression and error correction. However, you'll find that 14,400-bps modems now are quite affordable. You'll probably also want a tape-backup system, especially if your hard drive is large as that would make performing floppy backups tedious and time-consuming.

Few users need a full multimedia PC (MPC), in which sound, graphics, animation, and video are melded in software applications that support the Tandy/Microsoft MPC specification. But if you do, it's wise to order a multimedia model that's fully equipped up-front to ensure that the hardware and software elements of the MPC system coexist well: CD-ROM drive, sound card, game port, amplified stereo speakers, and software. Even if you don't need full multimedia, you may benefit from having a no-frills CD-ROM drive onboard your PC.

While shopping, don't forget the small stuff, which just might include these items:

- Surge protector (AC and FAX/modem)
- Computer console or desk
- Computer cover
- Monitor glare filter
- Floppy diskettes
- Tape backup data cartridges
- Copy holder
- Wrist and/or foot rest
- Mouse pad
- Joystick or trackball
- Page scanner
- Printer and printer stand
- Computer toolkit

### Portables: Navigating the Maze.

What if you're looking for a portable PC: palmtop, sub-notebook, notebook, or laptop? Much of what we've

said about desktops—their CPU, memory, hard disk, and other aspects—applies to portables. We won't be repetitious; instead, we'll stress the differences.

Feature-for-feature, a comparably equipped portable PC will cost you more than a desktop. About \$3000 is a ballpark figure for a good monochrome portable; plan to sink at least \$5,000 or more into a top active-matrix color model. Keep in mind that the best all-round portable design isn't just a matter of chip and hard drive speed, but is the whole set of performance and convenience features that makes for a well-integrated PC.

mance shortcomings. This is no place to be shortsighted: if you skimp on a portable that doubles as a desktop, you'll almost certainly eventually have to buy a more powerful desktop, negating your two-birds-with-one-stone economy objective.

Even the travel-only portable should avoid serious compromises. Its power should roughly approach that of the desktop since—to keep your sanity—you'll probably want to run the very same applications on both—not stripped-down or DOS versions on one and Windows versions on the other.

No longer are portables suitcase-



*Gateway 2000, a major direct-channel seller, was founded in 1985 by Ted Waitt, a computer maverick who strayed from the four-generation family cattle business—his first shop was in the cattle company's offices on a farm near Sioux City. Today's sprawling North Sioux City, South Dakota "spread" employs 1,400 and conforms to Gateway's low-overhead approach to production and pricing. The firm uses "cell" teams that consist of 19 employees, each of whom is crosstrained on all manufacturing tasks and inspect each other's work.*

Versatility vs. portability is the fundamental measure of portable performance. You can accept somewhat less power and convenience on the hardware side, unless you're going to use it as a substitute for a desktop rather than as an adjunct—a difficult task when you consider desktop flexibility, modularity, and expandability. If your only computer is to be a portable, you'll definitely want desktop power, meaning a fast 386 or a 486. However, you can use desktop peripherals (such as a standard VGA color monitor and a full-size keyboard) to round out minor perfor-

sized behemoths; the big laptop is getting much smaller. The trend is to slimmer, thinner, faster, smaller, and cheaper machines that pack more PC power into ever-tinier packages.

The mid-size notebook is where the action is, although the next generation will be the smaller subnotebook. But the state-of-the-art is paused there now. Anything smaller—like the palmtop or pocketable ("real" PC's that run DOS, like the Hewlett-Packard 95LX palmtop and the ZEOS Pocket PC), and the smaller gizmos and organizers (Casio B.O.S.S., Sharp Wizard, and the like)—are really "wannabe"



computers that we won't cover here.

You'll want small size and light weight: 7–8 pounds or less for a notebook—including battery but not including the AC adapter—though color models tend to be heavier. For a subnotebook, go for four pounds or less; 11 pounds is the maximum for a laptop. And you probably don't really want to trudge around with anything larger than 9 x 11 x 3 inches.

### **A Portable's CPU, Memory, and Hard Disk.**

Portable CPU performance varies all over the lot: the fastest portables are as much as five times as fast as the slowest. In fact, in this arena there's still room for 286's—like the subnotebook-size Gateway NoteBook—as note pads if you can be satisfied with undemanding DOS-only applications; don't consider Windows on any 286.

If you're an average user, you'll probably want at least a 386 processor with 2 MB of RAM and an 80-MB hard drive. If you're a power user, you'll look askance at anything less than 8 MB of RAM and a 120–200-MB hard drive in a 486-based portable. Be mindful that portable RAM upgrades are expensive and may require proprietary memory expansion cards.

When shopping the portable ads, you'll see references to the 386SL processor. It's a power-saving 386SX-style chip that's specifically designed for portable computers by integrating more motherboard components onto the chip and including more power-management features. The 386SLC is similar; it boosts speed by adding a performance-enhancing 8K cache to the 386SL chip.

Just when you thought you had CPU's straight, you'll probably notice 486 ads showing the 486SLC processor: it's a 32-bit processor that uses a 16-bit bus. The 486SLC uses the 486SX instruction set, but it doesn't have a coprocessor. However, it—like the 386SLC—does sport an 8KB cache.

### **The All-Important Screen Display.**

Having a big, bright, crisp, backlit VGA-driven LCD screen at least 9¼ inches diagonally is highly desirable for monochrome work; reflective screens can be difficult to read in low light conditions. A 10-inch sidelet screen is even easier to read under a

## **Ways to Obtain Buying Information**

Having good, up-to-date product information helps you to make informed buying decisions. If you're in the market for a PC, desktop, or portable, or are interested in upgrading a PC you already own, you'll likely want to check into various CompuServe and ZiffNet-online forums. If you're a professional buyer, also consider the Computer Library's Computer Select service. Let's look at these hi-tech buying aids.

Most of us are familiar with CompuServe, the large Columbus, Ohio online utility. Many vendors offer technical support for their PC's there. On most forums, you can find specific purchasing and technical information. You can also find messages from forum members discussing their systems—good and bad—so you're wise to check out the forum-message traffic before buying. At least 15 computer vendors, including Compaq, Dell, Gateway 2000, and Zeos, participate in these forums.

You'll also find advice on buying and upgrading computers and hardware in the IBM Hardware Forum (type "GO IBMHW" at any CompuServe "I" prompt) and in the IBM New Users Forum (GO IBMNEW). You also can access the various ZiffNet services (GO ZIFFNET) through CompuServe (more on this follows).

Of course, you must be a member to access these online features. Several membership-plan options are available, and membership includes a subscription to the monthly CompuServe Magazine.

ZiffNet is a specialized online information service, hosted on CompuServe. It's for active PC buyers and users, offering a broad range of information and technical advice. Created by Ziff Communications, publisher of *PC Magazine*, ZiffNet brings together thousands of downloadable shareware and public-domain software programs, discussion forums, computing news, product reviews, technical support, industry analyses, and buying advice. A special ZiffNet area serves Macintosh computer buyers and users.

Several features help you buy smarter. One is Ziff Buyers' Market (GO ZNT:MARKET). It lets you search for and find the product and pricing information you need on more than 10,000 PC products that are available via the direct channel. It also gives expert comparisons of technical specifications, pricing, service policies, and ordering information. Also available are indexed product reviews from Ziff-Davis publications (GO ZNT:REVIEWS).

Other resources on ZiffNet that may

aid your search include the extra-cost Computer Database Plus (GO ZNT:COMPDB); it contains computer-related articles from more than 130 magazines. There's also the Computer Shopper (GO ZNT:COMPSHOPPER) and PC Sources (GO ZNT:SOURCES) Forums; and the PC Magazine Editor's Choice and Product Awards Index (GO ZNT:EDCHOICE). Membership is separate from CompuServe though you optionally can access ZiffNet through CompuServe; the ZiffNet monthly membership fee is \$2.50. Information is available through CompuServe or in PC Magazine.

The Computer Library's Computer Select is a premium CD-ROM service that gives you immediate access to tens of thousands of product reviews and analyses; it's actually an entire year's worth of magazine articles you can retrieve, updated monthly on CD-ROM, from 170 leading computer publications. Included are specs on some 72,000 products, addresses and telephone numbers of 13,000 computer companies, a glossary of over 11,000 computer and telecommunications terms, and more. With the service, you can identify, evaluate, and select products that fit your needs, operating environment, and budget; compare competing products' performance; and obtain expert opinions on each product.

The service is expensive—\$995 for a 1-year subscription. What you get is a CD-ROM disc each month; each month's disc contains the previous 12 months' information. A free demo on floppy disk and an information packet are available.

If you would like comparable benefits, but can't afford them, there's a solution: DAK Industries has made arrangements with the Computer Library to distribute a budget version, Computer Select limited Edition. For \$99.90 plus \$6 S/H, you get a single disk (instead of a continuing subscription) that contains more than 81,000 computer articles and the full Computer Select glossary.

Some publishers have dial-up FAX product information services, based on the "demand publishing" concept. Often, readers can call a FAX line and have free editorial and advertisers' product information sent to them immediately without the delays of reader service cards. Many PC vendors (such as Dell) also have installed demand publishing systems. These services typically have toll-free FAX numbers you can access to obtain FAX'ed product information and technical-support documents. ■

## Names and Numbers

### **AddStor, Inc.**

3905 Bohannon Dr.  
Menlo Park, CA 94025  
Tel. 800-732-3133

### **AST Research, Inc.**

16215 Alton Pkwy.  
Irvine, CA 92718  
Tel. 800-876-4278

### **Austin Computer Systems**

10300 Metric Blvd.  
Austin, TX 78758  
Tel. 800-752-1577

### **Casio, Inc.**

570 Mount Pleasant Ave.  
Dover, NJ 07801  
Tel. (201)-361-5400

### **CompuAdd Express**

12301 Technology Blvd.  
Austin, TX 78727  
Tel. 800-925-3000

### **Computer Library**

One Park Avenue, Fifth Floor  
New York, NY 10016  
Tel. 800-827-7889

### **CompuServe**

PO Box 20212  
Columbus, OH 43220-0212  
Tel. 800-848-8199 or 8990

### **Conner Peripherals, Inc.**

3881 Zanker Rd.  
San Jose, CA 95134  
Tel. (408)-433-3340

### **DAK Industries, Inc.**

8200 Remmet Ave.  
Canoga Park, CA 91304  
Tel. 800-325-0800

### **Dell Computer Corp.**

9505 Arboretum Blvd.  
Austin, TX 78759-7299  
Tel. 800-289-3355

### **Fujitsu Computer Products of America**

2904 Orchard Pkwy.  
San Jose, CA 95134  
Tel. 800-826-6112

### **Gateway 2000**

610 Gateway Drive, PO Box 2000  
North Sioux City, SD 57049-2000  
Tel. 800-523-2000

### **GRiD Systems**

47211 Lakeview Blvd.  
Fremont, CA 94537-5003  
Tel. (510)-656-1661

### **Hewlett-Packard Co.**

PO Box 58059  
Santa Clara, CA 95051  
Tel. 800-752-0900

### **Maxtor Corp.**

211 River Oaks Pkwy.  
San Jose, CA 95134  
Tel. 800-262-9867

### **Micropolis Corp.**

21211 Nordhoff St.  
Chatsworth, CA 91311  
Tel. 800-358-7243

### **Microsoft Corp.**

One Microsoft Way  
Redmond, WA 98052  
Tel. 800-426-9400

### **Seagate Technology, Inc.**

920 Disc Drive  
Scotts Valley, CA 95066  
Tel. (408)-438-6550

### **Sharp Electronics Corp.**

PO Box 650  
Sharp Plaza  
Mahwah, NJ 07430  
Tel. 800-237-4277

### **Stac Electronics**

5993 Avenida Encinas  
Carlsbad, CA 92008  
Tel. (619)-431-7474

### **Swan Technologies**

3075 Research Drive  
State College, PA 16801  
Tel. 800-468-9044

### **Zeos International Ltd.**

530 5th Ave. N.W.  
St. Paul, MN 55112  
Tel. 800-423-5891

### **Zenith Data Systems**

215 East Lake Cook Rd.,  
Buffalo Grove, IL 60089  
Tel. 800-553-0331

### **ZiffNet (Ziff Communications).**

Contact via CompuServe at Tel.  
800-848-8199 or 8990.

they depend greatly on the processor's power needs, the type of battery, how you use the machine, and which power management features are enabled. Shoot for claimed battery times of 4 hours or more, recognizing that most manufacturers' assertions are overstated; you'll be doing very well to get 3 hours. Buy a spare battery to double your PC's useful consciousness and cover yourself on long trips.

Batteries should be quick-changing and quick-charging, snapping in and out with no fuss. Nickel hydride cells are the preferred power source over more common nickel-cadmium and alkaline batteries. Newer notebooks favor 3.3-volt batteries over 5-volt types, to almost double possible battery life.

### **Keyboards and Pointing Devices.**

Just because it's a portable doesn't mean you have to type in miniature. You'll want a comfortable, full-size keyboard with at least 79 keys, preferably 84 or 85, plus 12 full-size function keys and a full set of inverted-T directional keys as on your desktop; no "chiclet." There also should be an external keyboard connector to let you use a desktop keyboard or numeric keypad.

A built-in trackball helps you work comfortably in cramped quarters, though few machines have them. Despite their heavy promotion, pen-based (sometimes called tablet or slate) portables really aren't affordable for most of us just yet.

**Extra Goodies.** For maximum on-the-road versatility and flexibility, the portable should include a built-in mouse port, file-transfer software, parallel and serial ports, easily upgraded memory, a small power transformer, and a carrying case. With file-transfer capability, the portable actually doesn't have to have a built-in floppy disk drive—but if you have one, front-loading rather than side-loading drives are better since access isn't obscured if you use a clip-on trackball.

The portable should have easy-to-access connectors. It also should have PCMCIA (Personal Computer Memory Card International Association), ISA/EISA, or other standard I/O

*(Continued on page 92)*

wide range of lighting conditions. A passive-matrix LCD display with 640 x 480 or 800 x 600 pixel resolution is adequate for most applications.

Do you really need color? If you do, bring your checkbook: mainstream models range from just under \$4,000 to over \$15,000. The state-of-the-art (and much more expensive and power-hungry) thin-film transistor (TFT) active-matrix display is far superior to passive-matrix machines for color

quality, contrast, and brightness. But these machines command premiums of \$2000 or more over comparably equipped monochrome portables. Regardless of display, you'll want "simultaneous video" provided through an external VGA connector that lets you route your display to an external color-video monitor.

**Battery Baloney.** Battery-time claims vary all over the spectrum, and





# Build a Computer-Controlled Kill Switch

BY JOHN YACONO and  
MARC SPIWAK

*You need not hang around your computer waiting for a long job to finish.*

**F**or those of you who are fortunate enough to have your computer do work for you unattended, it really can be irritating when you have to return to it, just to turn it off. And it goes against the laws of logic to leave the computer on until you return, which could very well be the next day. We have a gadget that will eliminate that predicament: our computer-controlled *Kill Switch*. Not only can the device be used to turn off the computer that's controlling it, but it can also be used to turn off, by computer control, anything else that plugs into an outlet.

The Switch can automatically turn off a computer and a peripheral after handling a FAX or modem communication, printing a document, or allowing a lengthy program to complete (so you can begin your home-ward commute, or whatever, that much sooner). It can enable you to control AC devices via your computer, and when used with a timer program, it can turn something off according to a schedule. Although it connects to the computer's parallel port, it is designed to pass signals through to a printer and will not interfere with normal printer operation.

**The Parallel Interface.** Simply put, the Kill Switch does its job by comparing the data (8-bit characters) com-

ing from your computer's parallel-printer port to a value (an 8-bit character) set by the user. When there is a match between the preset value and data from the computer, the unit shuts down both the computer and itself. To help explain how the comparison is performed, let's talk about how data appears at a parallel printer port in the first place.

Oddly enough, most parallel ports on the back of IBM-compatible computers sport a DB-25 connector. That's odd because the DB-25 connector is the standard connector used for serial interfaces. The connector is usually female (having holes instead of pins) to distinguish it from any serial connectors (which are normally female only on cabling) that may also be on the computer.

The designations of each pin on the DB-25 connector are shown in Fig. 1. The signals that occupy those pins can be broken down into four basic groups: grounds, data outputs, handshaking inputs, and handshaking outputs. In Fig. 1, grounds are denoted by circles, handshaking inputs are indicated by arrows pointing to the connector, and outputs (both for data and handshaking) have arrows pointing away from the connector. (Note that some of the signal lines have a fairly standard abbreviation shown in parenthesis.)

The grounds perform two jobs: One, they link the signal grounds of the two devices being connected so they can share a common ground to use as a signal reference. Two, since the connection between the two devices is often made via ribbon cable, the grounds (often called ground returns when discussed in this context) act as shields for the more important lines. For example, the wire connected to pin 19 on a ribbon cable would shield pin 6 from pin 7, and vice versa. That prevents D4 signals (whose function we'll get to in a bit) from capacitively affecting the D5 line, and vice versa. In quality cables not made with ribbon cable, each ground return is twisted around a signal line to form a twisted pair that provides a little shielding.

As their name implies, the data outputs transfer information from the computer to a parallel peripheral. That is done eight bits (one byte) at a time using pins 2-9. Bit D0 is considered the least-significant bit (or LSB) and D7 is the most-significant bit (or MSB). (Note that some computer manuals use designations D1-D8 instead of D0-D7.)

The bits, as well as all the other signals, are represented by standard TTL voltage levels; a signal between 2.4 and 5 volts is a high, or a binary 1, anything between 0 and 0.8 volts is a low, or binary 0. Anything between 0.8 and 2.4 volts is considered invalid data. Table 1 shows all standard IBM-compatible characters and their associated logic values.

Since a computer is much faster than any peripheral that it communicates with, it could easily transmit more data than a peripheral could handle. So peripherals use special signals to tell the computer to momentarily stop sending data when they have enough to work with. That gives the peripheral a chance to catch up and the computer can perform some other task in the meantime. Once sufficiently caught-up, the peripheral tells the computer to transmit more data and the process continues.

That computerized game of "red light, green light" is accomplished by sending signals along wires dedicated to that purpose. The process of using signals to control the flow of data is called "handshaking," so the

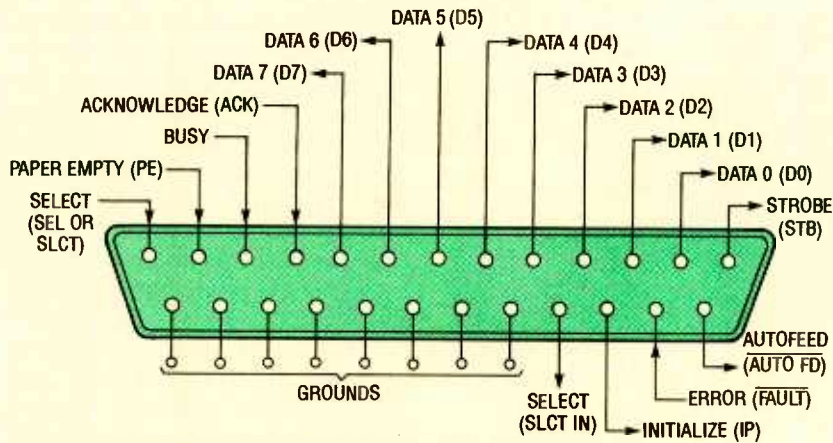

Fig. 1. The parallel port on most IBM-compatible (and some non-compatible computers) looks like this. The arrows pointing away from the DB-25 connector are outputs, the ones pointing to the connector are inputs, and the remaining pin outs (shown with circles) are grounds.

signals used for that purpose are called "handshaking signals."

The strobe, busy, and acknowledge signals are the most important handshaking signals. To help explain how they are related and control data flow, take a look at Fig. 2. There the eight data lines are shown lumped together at the top as a single band. Don't let that throw you, the value of the individual bits is not important. What is important is the time at which data undergoes a transition (represented by the crossed lines) and the time that it remains constant (the bands).

The data that is being output on lines D0-D7 starts to form at time  $t_1$ , and it settles down and is ready for use by time  $t_2$ . A moment later (at  $t_3$ ), the computer sends a momentary low-going pulse (called the strobe signal) to the peripheral to indicate that the data is ready and waiting on the data lines. After  $t_3$ , the peripheral may respond in one of two ways: it can pull the busy line high until it's ready for more data, or it can wait until it has used the new data and then send a low-going acknowledge pulse to the computer when it wants more. Either response keeps the computer from proceeding until the peripheral says it's ready. After the busy line goes low or an acknowledge pulse is received, the computer will set up the data lines for the next byte, and the procedure repeats.

Along similar lines, sometimes parallel peripherals (especially printers) use dedicated wires to indicate their status. Since the status of a peripheral

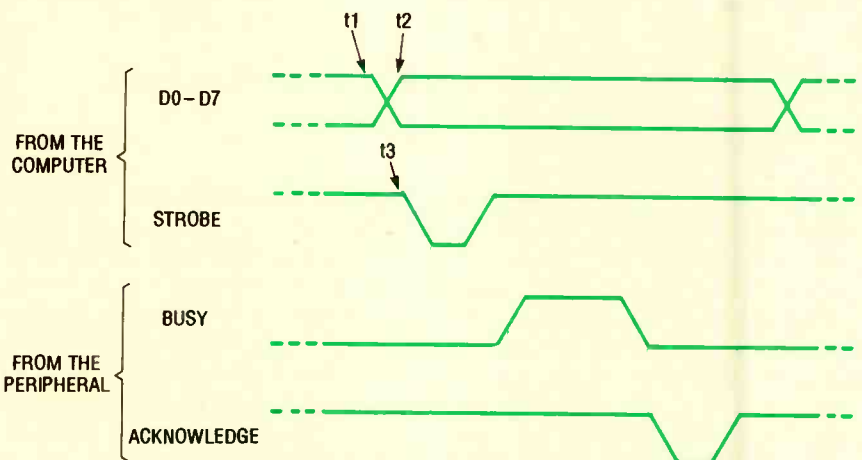

Fig. 2. Once a computer sets up the data on the parallel data lines, it signals the peripheral with a low-going strobe pulse. The peripheral responds by sending the busy line high until it's ready for more, and/or it waits until it's finished with the data and sends a low-going acknowledge pulse.

can affect the flow of data, this can also be considered a form of handshaking. For example, if a printer, plotter, or oscillograph needs to tell the computer that it's out of paper, it can do so by holding the "paper empty" line (look back at Fig. 1) high until its supply is replenished. That keeps the computer from sending data to the peripheral when the device is incapable of doing anything with it.

A peripheral can tell the computer that it's powered-up and on-line by holding the "select" line at pin 13 high. (Note that there are two select lines, so don't confuse them.) This signal is necessary because some peripherals can be powered up, but taken off line by sending them a special "deselect" character. A peripheral can even cry for help by holding the error line low.

The remaining lines (select, auto-feed, and initialize) are beyond the scope of this article. But now that you know how data appears at the parallel port, let's talk about how a device might hunt for the desired data and ignore all else.

**Character Detection.** The theory behind detecting the proper data or character at the parallel port is pretty simple. Let's say, for instance, that we wanted to detect the ASCII character represented by the binary number 11111111 (character 255) at the printer port. An easy way to do that would be to connect pins 2-9 on the parallel port to an eight-input AND gate. The output of the AND gate will then go

high only if all eight inputs are high. Now, if we were to use an eight-input NAND gate instead, the only difference would be that the gate output would go low when all inputs are high. Since we want the gate's output to activate another device when triggered, a NAND gate is actually preferred over an AND gate, because TTL IC's are very poor at supplying current to other devices, but they are pretty good at sinking it.

That arrangement is fine if you are only interested in detecting ASCII character 255, but what about characters with binary zeros in them? The obvious answer is to invert each bit that should be zero before sending it to the NAND gate. However, using inverters is a bad idea because you'll have to rewire the circuit whenever



TABLE 1—CHARACTERS AND BIT VALUES

Bit Values:				D7	0	0	0	0	0	0	0	0	1	1	1	1	1	1	1	1	
				D6	0	0	0	0	1	1	1	1	0	0	0	1	1	1	1	1	
				D5	0	0	1	1	0	0	1	1	0	0	1	1	0	1	1	1	
				D4	0	1	0	1	0	1	0	1	0	1	0	1	0	1	0	1	1
D3	D2	D1	D0																		
0	0	0	0	(1)	▶	(2)	0	@	P	`	p	Ç	É	á	␣	␣	␣	␣	␣		
0	0	0	1	⊕	◀	!	1	A	Q	a	q	ü	æ	í	␣	␣	␣	␣	␣		
0	0	1	0	⊗	†	"	2	B	R	b	r	é	Æ	ó	␣	␣	␣	␣	␣		
0	0	1	1	♥	!!	#	3	C	S	c	s	â	ô	ú		†	␣	␣	␣		
0	1	0	0	♦	¶	\$	4	D	T	d	t	ä	ö	ñ	†	-	␣	␣	␣		
0	1	0	1	♣	§	%	5	E	U	e	u	à	ò	ñ	†	†	␣	␣	␣		
0	1	1	0	♠	-	&	6	F	V	f	v	â	û	â	†	†	␣	␣	␣		
0	1	1	1	•	‡	'	7	G	W	g	w	ç	ù	ó	†	†	†	␣	␣		
1	0	0	0	☐	↑	(	8	H	X	h	x	ê	ÿ	¿	†	␣	␣	␣	␣		
1	0	0	1	◦	↓	)	9	I	Y	i	y	ë	ö	␣	†	†	␣	␣	␣		
1	0	1	0	☐	→	*	:	J	Z	j	z	è	ü	␣		␣	␣	␣	␣		
1	0	1	1	♂	-	+	;	K	[	k	{	ï	ç	½	†	†	␣	␣	␣		
1	1	0	0	♀	␣	,	<	L	\	l		ï	£	¼	␣	†	␣	␣	␣		
1	1	0	1	♫	↔	-	=	M	]	m	}	ì	¥	;	␣	=	␣	␣	␣		
1	1	1	0	♯	▲	.	>	N	^	n	~	À	␣	«	␣	†	␣	␣	␣		
1	1	1	1	✱	▼	/	?	O	_	o	ó	À	ƒ	»	␣	␣	␣	␣	(3)		

Notes:

- (1) The null character, which is not printable.
- (2) The space character, which cannot be represented.
- (3) Undefined character.

you want detect a different character. Not only that, you could wind up with phase-delay problems.

A chip's phase delay is the time difference between a change at the input and the corresponding change at the output. It's like when you're playing catch with someone; there is a time difference between when you catch the ball and when you throw it. That's not to be confused with rise time; the output of the chip takes time to reach the peak voltage after it has "made up its mind." Just like when you throw a ball up in the air; it takes a certain amount of time for the ball to

reach its peak altitude after it has left your hand.

So, if an inverter is used along one of the data lines, it will slow that line down so all the bits will not arrive at the NAND gate at the same time. If the phase delay is long enough in comparison to the transmission speed, the device will fail to function properly.

What we need, then, is a gate that can be used as an inverter or a buffer. That way, signals that need inverting will pass through the same number of gates as signals that are simply buffered. Further, if the gate can be "programmed" to be an inverter or a

buffer with a simple switch, then there will be no need to rewire the circuit to detect a different character. Simply set the switches to invert the lines you expect to be low, and buffer the rest.

The perfect gate for our purpose is the XOR gate. If you hold one of an XOR gate's inputs high, the compliment (inverse) of the other input appears at the output. If you hold one input low, the signal at the other input will be buffered through unchanged.

There are a few chips that actually contain a combination of XOR gates and a NAND gate configured to compare bits just as we've described. We

used one such chip in the Kill Switch. Denoted the 74521, that chip's internal arrangement and pinout is shown in Fig. 3. Note that the chip contains XOR gates and a NAND gate wired as described with an additional input (at pin 1) that acts as a chip-enable pin. If two eight-bit numbers, A (composed of bits A0–A7) and B (made up of bits B0–B7) are applied to the indicated inputs, and if A equals B and the G input is held low, the output (pin 19) of the chip will go low. Now let's discuss how the chip is implemented.

**The Circuit.** The schematic diagram for the Kill Switch is shown in Fig. 4. One obvious feature of the circuit is the straight-through cable formed by PL2 and SO2. That cable allows data from the computer (attached to PL2) to flow freely to any printer cable connected to SO2. That permits the printer to operate normally without any hindrance from the Switch. If you will not be using a printer along with the unit, you can dispense with SO2, but you might have to further modify the cable to eliminate handshaking problems (more on that later).

Note that the strobe and data lines are tapped off and sent to the 74521. The strobe line is used to enable the chip (when the strobe goes low to

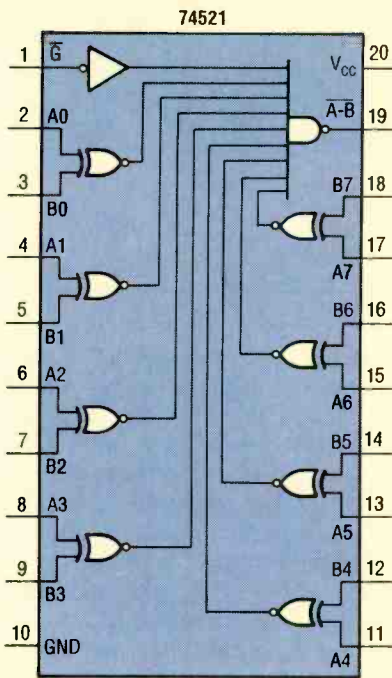

Fig. 3. The 74521 is technically known as an 8-bit identity comparator. Its output will go low provided each of its A inputs matches its corresponding B inputs and the enable input (G) is low.

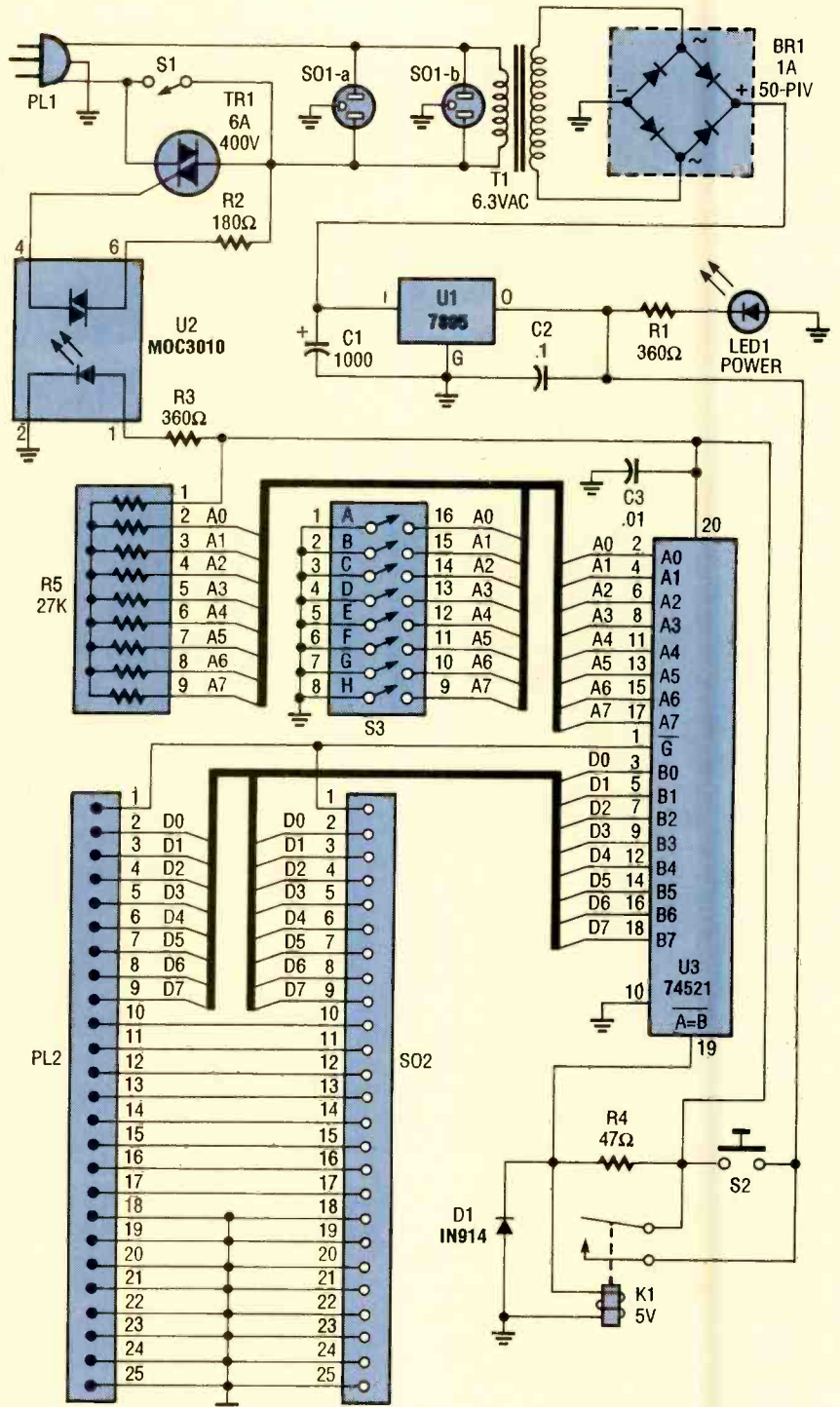

Fig. 4. At long last, here is the schematic diagram for the Kill Switch. Note how the 74521 is connected directly to the data lines.

indicate the presence of data, the chip is enabled), while the data lines feed the B inputs of the chip. The B inputs are compared with the A inputs, which are set by the ganged switches S3-a through S3-h as follows: If a switch is closed, it grounds its corresponding input, and if a switch is open, the input in question is pulled high by one of the pull-up resistors (R5-a through R5-h). In effect, each time

data is present on lines D0 through D7 and the strobe is brought low, the 74521 compares the data against the switch settings. To see what affect the result of the comparison has, let's examine the rest of the circuit.

Imagine that PL1 is plugged into a wall socket and S1 is closed. That allows power to flow to sockets SO1-a and SO1-b (two halves of a duplex AC socket used to power a computer



and an optional peripheral), and to the 5-volt power supply composed of T1, BR1, C1, U1, and C2. Diode LED1 acts as a power indicator for the 5-volt supply.

Note that the normally open contacts of K1 prevent current from flowing to the rest of the circuit at this point. That can be resolved by depressing S2, which momentarily applies power to the remainder of the circuit including the relay coil. The relay then closes so S2 can be released without a loss of power. With the power applied, current flows through the LED in the optocoupler activating the Triac output and the Triac.

Let's say that we turn off (open) S1, which will not affect the circuit because it is shorted by the Triac; now the system is armed. If any data from the parallel port matches the switch settings while the strobe line is low, the output of the 74521 will go low depriving the relay coil of power. The relay will immediately let go, depriving the main circuit (including the optocoupler's LED) of power. The optocoupler will then shut down so the Triac goes off. The sockets are then powerless so the computer and peripheral shut down, and after the filter capacitor (C1) discharges, the power LED goes out. That's how the unit does its job.

#### LISTING 1

```

MOV          DX,03BC
MOV          AL,FF
OUT          DX,AL
ADD          DX,+02
MOV          AL,01
OUT          DX,AL
JMP

A

MOV          DX,0378
MOV          AL,FF
OUT          DX,AL
ADD          DX,+02
MOV          AL,01
OUT          DX,AL
JMP

B

MOV          DX,0278
MOV          AL,FF
OUT          DX,AL
ADD          DX,+02
MOV          AL,01
OUT          DX,AL
JMP

C

```

**Triggering.** Since you can send data through the parallel port in a variety of ways, the Kill Switch can be tripped in just as many ways. For example, you could send the switch data from a program, DOS, keyboard, batch procedure, or word processor.

To trip the unit from a BASIC program, use a statement like:

```
LPRINT A$
```

where A\$ is a string variable containing the data to trip the Switch. From any other language, any output statement that can send data to the parallel port will work.

Take a look at Listing 1 for some assembly language programming examples. Each program addresses one of the three printer ports available on a PC or compatible. Other than that they are identical, so we'll only explain how the first one works. By the way, if you don't understand how parallel ports are addressed, check out the article "Programming Parallel Printer Ports," in the February, 1993 issue of **Popular Electronics**.

The first line simply places the address of the first printer port (3BC in hexadecimal) in the DX register. The next instruction places the value 255 (FF in hexadecimal) in the AL register. That value will be used in this example to trip the unit, so all the switches in the device must be open for that value to work. (If necessary, alter that value to accommodate the switch setting you wish to use.) With the registers properly set, the third line uses the data in the registers to output value 255 to port 3BC. All that makes the data lines (D0 to D7) go high.

The next line adds two to the address to give the address that controls the strobe line (3BE). A one must be placed in that address to make the strobe line go low, so a one is next placed in the AL register. The next output instruction sends the number one to the address for the strobe line. Once the strobe line goes low, the Kill Switch should pull the plug.

There is a chance that the unit will not turn off immediately. That is because the AC waveform through the Triac must go to zero before the Triac will shut off. If the data at the port triggers the 74521 while the AC wave is not at zero, the Triac may not shut off. For that reason, the last line of the program causes it to try again and

## PARTS LIST FOR THE KILL SWITCH

### SEMICONDUCTORS

U1—7805, 5-volt regulator, integrated circuit  
 U2—MOC3010 optocoupler, integrated circuit  
 U3—74521 8-bit identity-comparator, integrated circuit  
 TRI—6-amp 400-volt Triac  
 DI—1N4001 1-amp, 50-PIV, rectifier diode  
 BR1—1-amp, 50-PIV, fullwave bridge rectifier  
 LED1—Miniature red light-emitting diode

### RESISTORS

(All fixed resistors are ¼-watt, 5% units.)

R1, R3—360-ohm  
 R2—180-ohm  
 R4—47-ohm  
 R5—27,000-ohm, 8-resistor SIP pack

### CAPACITORS

C1—1000-µF electrolytic capacitor  
 C2—0.1-µF monolithic capacitor  
 C3—0.01-µF monolithic capacitor

### ADDITIONAL PARTS AND MATERIALS

K1—Miniature 5-volt, SPST relay  
 PL1—AC plug and linecord  
 PL2—DB-25 male connector  
 S1—SPST switch  
 S2—SPST, normally open, momentary-contact switch  
 S3—8-station DIP switch  
 SO1—Duplex AC socket  
 SO2—DB-25 female connector  
 T1—6.3-volt, 300-mA power transformer  
 Perfboard materials, cabinet, 25-conductor ribbon cable, wire-wrap sockets, solder posts, wire-wrap wire, bus wire, solder, etc.

**Note:** Copies of the software in Listing 1 are available already assembled on floppy disk for \$5 (postage paid) from John Yacono, P.O. Box 4042, Farmingdale, NY 11735. Specify floppy size (5¼ or 3½ inches) when ordering. All payments in U.S. funds only; NY residents must add appropriate sales tax.

again until the computer shuts down. That generally takes only a couple of high-speed passes at most.

If you wish to use any of these programs but do not own an assembler, (Continued on page 88)



# THE SKY CHORUS

*Our upper atmosphere is alive with "sounds" generated by particles and waves from the sun and deep space.*

BY GARY EGGLESTON

**D**uring World War I, the German physicist Henrich Barkhausen discovered a way to tap Allied telephone conversations on the battlefield from behind his own lines. To do it, he inserted two prods into the Earth several hundred yards apart and connected them to a sensitive amplifier. That enabled him to pick up and amplify minute electric currents leaking into the ground from the Allied telephone wires in order to reproduce the communications.

Occasionally, he also heard something else that amazed him. He heard strange whistling sounds that completely swamped the conversations he was trying to listen to. Barkhausen's first reaction was that something was wrong with his equipment. After finding nothing wrong with his apparatus,

he decided that the whistles were coming from the atmosphere. He was correct, but it would be many years before anyone understood what the odd sounds were or would care to pay any attention to them.

However, the sounds Barkhausen heard were not in the ordinary radio-broadcasting bands. Instead, they were long-wavelength signals that were so low in frequency, they fell into the audio band. A "whistler" (as the signals came to be called) begins at the upper range of the human ear and decays in pitch, rapidly at first and then more slowly at the lower frequencies. The sound can sweep down through several octaves in a second or two. Since the signals are in the audio range, it is only necessary to string up a long-wire antenna and

connect it to the amplifier of a phonograph or radio to pick up one.

**The Mechanics.** People studying whistlers through the 1920's and 1930's noticed that a whistler often followed a loud click. Apparently there was some connection between the whistle and click. The source of the clicks was also in doubt at the time, but it was a lead. It was known that radio waves of different frequencies travel at different speeds through the atmosphere. Higher frequencies traveled faster than the lower ones. If a click traveled far enough, its frequencies would spread out in time. So a receiver would detect the high frequencies first, followed by the lower ones—just as a whistler behaved. Experiments later proved this theory.



The next theoretical point of interest was the path taken by a whistler. First it was necessary to determine the distance traveled by one. Since distance equals velocity multiplied by time, one would assume that's easy to do. However, while the time between the click and whistler (thus the travel time for the lowest frequency note) was known, the velocity of the wave could vary. A wave's velocity depends in part on the atmosphere's average electron density and the strength of the Earth's magnetic field along the path. By using an average value for the magnetic field strength and assuming the highest electron density, it was possible to estimate the minimum distance. The result was an astonishing figure of 15,000 miles; far beyond what was then thought to be the limit of the Earth's atmosphere, which was assumed to end at the ionosphere.

Thus, Barkhausen's discovery made it possible for us to study the regions beyond the ionosphere from the ground. These regions have been named the "magnetosphere." They begin where the ionosphere thins out so much that it no longer reflects radio waves back to us.

T.L. Eckersley correctly suggested in 1935 that whistlers originated from the energy in lightning discharges. The electromagnetic radiation given off by lightning bolts are commonly called "atmospherics" or "spherics." They travel in the space between the earth and the ionosphere or they penetrate the ionosphere and travel around the magnetosphere. When they traverse the magnetosphere the radiation produces a whistler, as you'll see.

It remained for the English physicist L.R.O. Storey to fill in the rest of the picture in the 1950's. He discovered that lightning within 600 miles of his receivers invariably produced whistlers. From that distance out to about 1,200 miles the whistlers became weaker. Beyond that distance very few were received at all.

This situation was puzzling because when a lightning flash occurs its electromagnetic waves spread out in all directions. Yet, here were waves that traveled at least 15,000 miles and only returned to a limited area—a circle no more than 1200 miles in radius. What type of mechanism in the atmosphere was producing this focusing?

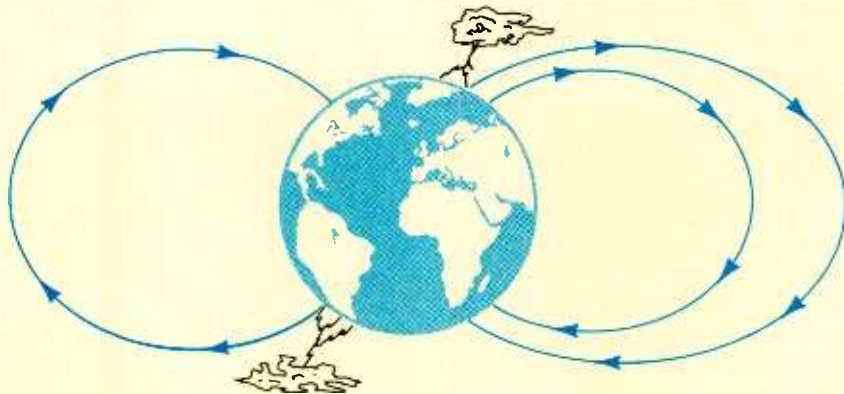

*Fig. 1. The energy from a lightning bolt follows the geomagnetic lines, bouncing from hemisphere to hemisphere, as it is drawn out into a whistler.*

As it turns out, most of the electromagnetic waves that strike the ionosphere are reflected back to Earth and are confined to a conical space between the earth and the ionosphere. As a result, some of the energy from the lightning stroke is concentrated in a relatively narrow vertical beam. This generates a new kind of wave, named after its discoverer, the Swedish physicist Hannes Alfvén, which travels into the magnetosphere. As it rises, the beam does not continue in the vertical direction. Instead it follows the lines of the Earth's magnetic field.

Figure 1 illustrates this concept. The wave's intimate association with a magnetic line of force explains why whistlers travel along the Earth's magnetic-field lines.

If indeed the wave does follow a line of the Earth's magnetic field, we can figure its path with ease and see if it adds up to at least 15,000 miles. From the earth's surface in England, for example, a line of force swings southward, crossing the magnetic equator at a height of 7,000 miles. It comes down again at its "mirror point" in the southern hemisphere. Such a path is a little more than 15,000 miles long.

When the wave comes back down to the ionosphere above the mirror point, some of the energy is reflected back into the magnetosphere. Meanwhile, some of the energy penetrates down to the ground where it can be picked up on a radio receiver. Since it originated in the opposite hemisphere, such a whistler is not preceded by a click. The click, traveling in the lower atmosphere, is absorbed before it reaches the receiver. This is

called a "short whistler" for reasons that will become obvious shortly.

The energy reflected at the mirror point is reflected back through the magnetosphere again, following the same magnetic field line until it reaches the area of the original lightning discharge, give or take 1200 miles. There, some of its energy reaches the ground in the form of what is called a "long whistler." It gets its name from the fact that it has traveled twice the distance of a short whistler and is therefore twice as long in duration.

An additional kind of whistler has recently been discovered: the "nose" whistler. It is phase retarded in both the high and low frequencies. That tells us that time delays occur at the high as well as the low end of the frequency range.

**What We've Learned.** Whistlers have told us and continue to tell us much about the electric and magnetic fields above us. They especially reveal the distribution of electrons in the upper regions. Sounding rockets, balloons, and satellites have also done their part in this area, but are expensive and are not always located where they are needed at a given time. Besides, Earth satellites that directly measure electron densities have generally confirmed what has been learned from whistlers anyway.

Since lightning is always flashing somewhere on the globe and whistler equipment can remain on duty 24 hours a day, much can be learned in this way. Also, since whistlers and other atmospherics generate signals in the audio-frequency range, they can be recorded on magnetic tape and ex-

amined on a sound spectrograph, which spreads out and displays the component frequencies as a function of time.

Using transit time and the duration of whistlers, it has been estimated that there are about 1000 electrons per cubic centimeter at a height of 3500 miles, and about 100 electrons per cubic centimeter at four times that height. These densities vary greatly, especially during magnetic storms, and over relatively small differences in altitude.

Detectable numbers of electrons have been found at great distances from the Earth. It has been observed that there are measurable numbers of electrons all the way out to the Moon. Thus, in a loose sense, the Moon can be considered to be within the Earth's "atmosphere."

Similarly, both the Earth and the Moon may be considered to be within the Sun's corona of electrons. It may be that the clouds of electrons occasionally shot to Earth by the Sun may affect our weather. If so, a better understanding of the ebb and flow of electrons from the Sun, such as those that produce whistlers, may lead to improved weather forecasting.

**Other Sounds.** Electrical "sounds" other than whistlers have also been

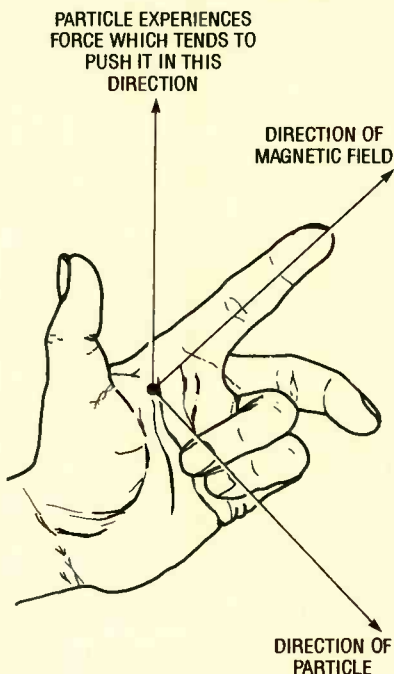

Fig. 2. The left-hand rule is a mnemonic device for remembering how an electron would be affected when traveling through a magnetic field.

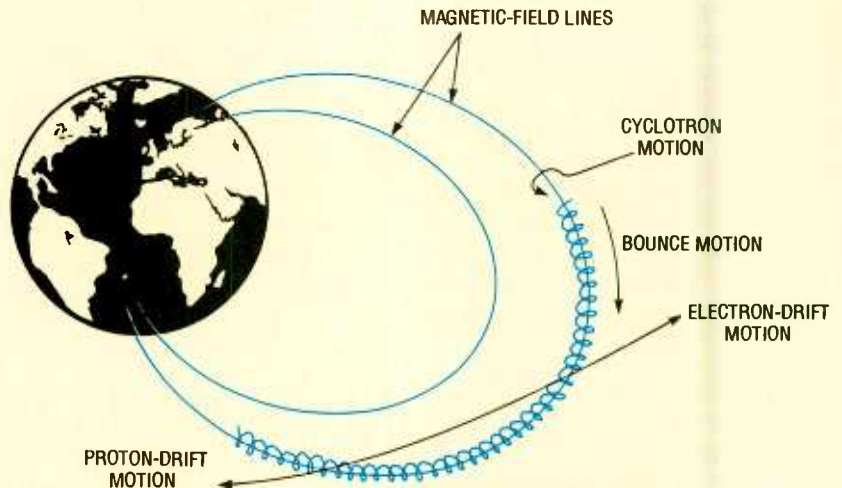

Fig. 3. A charged particle will travel in a bent spiral path along the Earth's magnetic field lines, bouncing back and forth between mirror points.

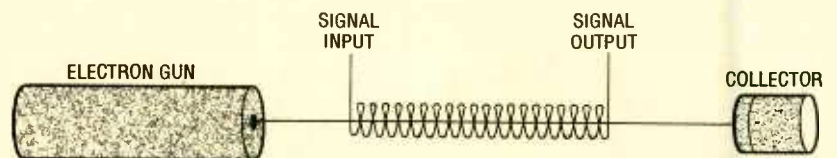

Fig. 4. The ionosphere may act like the traveling-tube amplifier shown here, in that it reduces a wave's velocity by making it travel a longer distance over a helical path.

found in the atmosphere. These take two main forms, both of which are in the VLF range below 30,000 hertz. One is a "hiss" that may continue for a long time, although confined to a narrow range of frequencies. The other is a separate, short noise in which the frequencies are dispersed or spread out in much the same way as in a whistler. Often the tone first falls and then rises, in which case, a "hook" is formed on the spectrograph.

All the suggested explanations incorporate the fact that ionized particles from the Sun are trapped in the magnetic field of the Earth. When a charged, moving particle crosses a uniform magnetic field, the particle experiences a force that tends to deflect it in a direction perpendicular to both its direction of travel and that of the magnetic field. This can be illustrated by the "left-hand rule" (See Fig. 2). If the index finger depicts the field and the middle finger represents the direction of particle movement, then a negatively charged particle will tend to be deflected in the direction of the thumb.

Therefore, an electron that enters the Earth's magnetic field from space will generally be deflected toward

the east. If the particle enters at an angle, which is usually the case, it begins to spiral around a magnetic-field line until it reaches the north or south magnetic pole, as illustrated in Fig. 3. At this point, the particle might smash into the Earth, or it will be "squeezed" into close proximity with other electrons at one of the Earth's poles, which is where the field lines come together. The electron may then be slowed to a stop, and sent back along the same route where it might continue to corkscrew back and forth between the magnetic-mirror points of the Earth.

In this dizzying dance, the electron is constantly changing direction. However, when an electron changes direction or speed, it emits electromagnetic radiation called "cyclotron" radiation. The frequency of the radiation depends upon the strength of the local magnetic field and the particle involved. However, it is below 1000 cycles-per-second for a proton and is on the order of tens or hundreds of kilocycles-per-second for the lighter and faster-moving electron.

Consequently, cyclotron radiation might explain some of various LF noises. To explain the hooks men-

(Continued from page 92)



# Computer Software



## for Hams and SWL's

*A hands-on survey of super software for the contemporary ham shack or listening post.*

BY KARL T. THURBER, Jr., W8FX

**F**ew activities go together as well as personal computing and amateur radio: if you know something about one, you probably already know something about the other. Microcomputers can perform many valuable tasks in the ham shack or listening post. For example, you can use your PC for powerful, fast-paced radio contest logging and duplicate-contact checking; Morse code (CW), radioteletype (RTTY), and packet communications; radio theory and code instruction; antenna modeling; directional beam-antenna aiming; radio-propagation prediction; awards and accomplishment tracking; confirmation card (QSL) addressing and mail-out; and many other tasks. And that's just the beginning. Best of all, you don't have to be a computer whiz to take advantage of this technology.

Amateur radio is more exciting than ever before, due mostly to digital-based operating modes. Today, a modern ham shack is typically equipped with at least one computer and takes advantage of state-of-the-art radio-communications techniques. The 1990's are clearly the years in which digitized, computerized amateur-radio communications will take off. In this article, I'll review major uses for computers in the ham shack or listening post and survey some commercial and shareware software.

By the way, much of what we'll discuss is also applicable to shortwave listeners (SWL's), scanner monitors, and others interested in radio transmission and reception—not just to licensed radio amateurs. Also, emphasis is placed on the IBM PC, rather than other PC's such as the Macintosh or Commodore, though we'll make sug-

gestions on where you can obtain non-IBM software. Last, ham-shack software still is largely in the "cottage industry" stage, so product quality varies widely. Still, most amateur-software authors are conscientious programmers: their programs result from developing software for their own use and being encouraged by friends to offer their programs publicly. Let's turn to some typical ham shack-software applications.

**Contact Logging, Contesting, and Awards Tracking.** Logging programs are the most common ham-shack software, so we'll give them a good deal of attention. Most radio amateurs keep detailed records of their contacts, even though the Federal Communications Commission (FCC) long ago eliminated the requirement for most station logging.

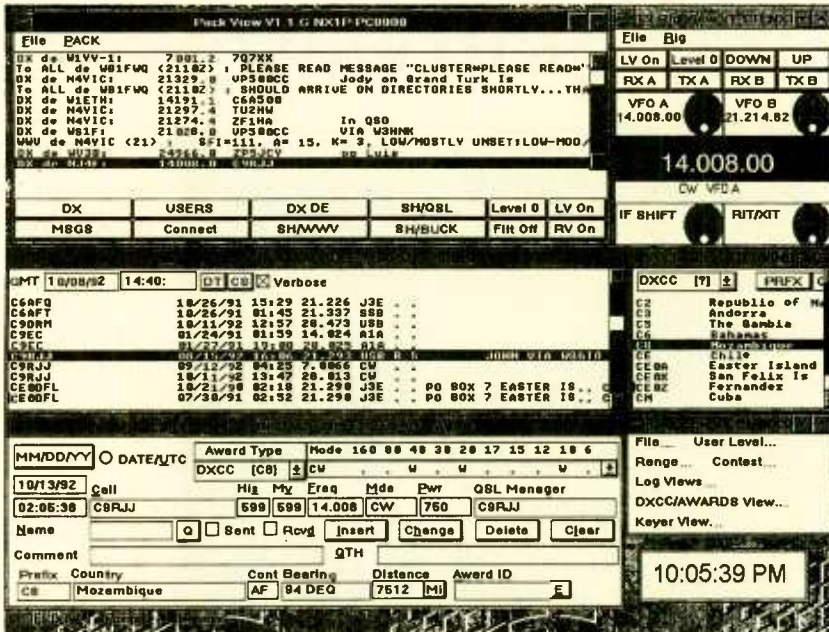

The latest loggers, like Log View for Windows, are GUI-based. Log View is reportedly the first Windows amateur radio application. It integrates real-time logging, awards tracking, contesting, keyboard keying, and QSL-management capabilities.

Contact (QSO) logging is still important as a record of contacts made and for contest operating and awards tracking, and computers lend themselves well to recordkeeping and log-data retrieval. Most logging programs are for real-time (on-the-air) use, with data stored to disk, and massaged and printed out later.

A specialized logging program is the contest logger. It permits use of a special log format to properly record the all-important "contest exchange" contact information needed for the QSO to count for contest credit, and to extract and print out QSO data in a mail-ready format easily scored by the contest sponsors—without re-copying information. Most contest loggers also reduce the drudgery of checking for duplicate QSO's ("dupes") that don't count for credit.

Many amateurs are certificate and awards collectors ("paper chasers"), so some loggers are set up for awards tracking. Awards offered by the American Radio Relay League (ARRL), *CQ magazine*, and others have widely varying criteria. Many contest programs have features that allow a summary printout of QSO's by such diverse criteria. For example, it's possible to print out a by-band or by-mode summary of your country, state, province, county, continent, and world radio zone, accomplishments and a tabulation of whether the necessary con-

firmation (QSL) cards have been received.

A popular software package for the awards-oriented operator is the N6RJ Electronic Second Op. This menu-driven program is more than just a logger as it presents a wealth of DX (distant station) information you can access. It's also a high-speed database that tracks ARRL DXCC (DX Century Club) and *CQ magazine* WAZ (Worked-All-Zones) awards accomplishments. Important features include rapid location of bearing/distance information; DXCC/WAZ/country/continent data; DXCC and WAZ summaries; sunrise/sunset calculations; a complete International Telecommunications Union (ITU) callsign allocation listing; and conversion of callsign prefixes to DXCC countries. It's \$59.95 from Ham Radio Outlet, 933 N. Euclid St., Anaheim, CA 92801; Tel. 800-444-0047 (east) or 800-854-6046 (west).

The K4HAV Contest Logging Program (1010) is a special-purpose recordkeeping program for 10-meter band contests. Many amateurs chase certificates and awards sponsored by the 10-10 International organization that focuses exclusively on 10-meter operations. Each member operator is individually registered and given a number that's exchanged on-the-air in contests and to accumulate various operating awards.

Two 1010 program features are

unique. The first is the ability to convert stations worked in the first contest to a database available for subsequent 10-10 contests. As you work more contests, your personal database can grow to include up to 13,000 callsigns. The second feature lets you access a master list of all issued 10-10 numbers on the air, to let you know a station's 10-10 number as soon as you hear their call and log it!

The 1010 program is \$25 from Hardy Data Systems, PO Box 7304, Tifton, GA 31793-7304. Also available is the 1010CH County Hunter program (\$25) for tracking the 10-10 Worked All Counties Award and the 1010Zip Zip/County Index Program, an add-in package (also \$25). The latter gives the active 10-10 operator detailed city, county, state, and Zip-code information on contacts made.

**Radio Propagation Prediction.** No one can second-guess ol' Sol. But predicting whether radio conditions are likely to be good enough to "work" various areas of the world is important to the DX'er. Using a computer, you can produce timely predictions of HF skywave conditions between any two points on the globe.

Most propagation programs trace their lineage to an ionospheric model developed by the government. Using a few easily obtainable parameters, these programs predict the maximum usable frequency (MUF) and/or received signal strength. Some programs do more, including estimating the lowest usable frequency (LUF) over a path; calculating the distance to the target area; and providing beam-antenna headings. Many let you "scan the world" to see which areas are likely to be active, propagation-wise, at a given time. And some let you look for periods of daylight and darkness and track sunrise and sunset times on both ends of the path, when favorable day-night terminator ("grayline") conditions are likely to prevail. Several commercial propagation programs, such as MINIPROP PLUS by Sheldon Shalton, W6EL, offer exceptionally comprehensive propagation predictions.

**Directional Beam Antenna Aiming.** Whether as part of another software package or as a standalone algorithm, it's easy to point your rotary



beam antenna in the right direction using a global-heading calculation program. Such programs have you enter the coordinates of the station with which you want to communicate, along with your own coordinates, to calculate the correct beam heading, short path and long path (over the pole) distance, and other information such as time-zone differences.

Most include a database of country and/or callsign-prefix information, eliminating the need to enter actual coordinates; the programs usually are customized for your location (QTH). The same geographical database can be used in both propagation and beam-heading programs, so the two frequently are combined in a single package. Beam-heading information is also offered in many contact-logging, contesting, and awards-tracking packages.

A very simple heading-calculation program is BEAMHEAD. It lets you enter almost any callsign prefix; in return it gives you accurate beam-pointing directions and distances for long and short paths. The program is shareware, so you can freely copy it, but the author asks that if you use the program, you make a freewill monetary contribution. If you can't find BEAMHEAD on a computer bulletin board system (BBS), contact Jim Hammer, KO9T, at E. C. Software, 622 N. Illinois St., Monticello, IN 47960.

### Indexing and Database Management.

Practically any task that requires data collecting, sorting, searching, and tracking lends itself to database management, either using a general purpose database or a dedicated program. Practical in-shack database management activities include tracking QSL cards sent and received; indexing magazine articles; inventorying ham-shack equipment for insurance; generating parts lists for construction projects; preparing membership and mailing lists for a radio club; and, for SWLs, maintaining station schedules and logs.

Commercially available databases for amateurs fall into two major categories: technical-magazine article indexes and station callsign databases. Both applications dramatically extend the power of your PC. Let's look at representative commercial applications in these two areas.

A few years ago, Didah Publishing began offering a microfiche listing of almost every article to appear in the communications-electronics press. The index now contains about 60,000 references or abstracts in 92 subject areas. They now offer a bibliography (called *From Beverages Through OSCAR—A Bibliography 1909-1990*) on diskette—great since most folks don't relish working with microfiche. The main and subsidiary databases include QST (1945-1990), CQ (1945-1990), 73 (1960-1990), Ham Radio (1968-1990), the British Radio Communication (1979-1990), and many other journals. The index fills a real void in radio reference/retrieval.

Each journal article is classified and cross referenced in one or more of 11 major categories subdivided into 92 areas. Most entries contain the publication or source name; a description; the year, month, and page number of publication; the author(s) by name or radio callsign; and additional information. The full Bibliography on diskette is \$85. Various single-magazine and specialized subject indexes also are available from Didah Publishing (PO Box 7368, Nashua, NH 03060-7368; Tel. 603-878-3628).

With computers, Zip codes and telephone area codes are available for instant look-up, and fast hard-disk and CD-ROM technologies let you find not only Zip and area codes, but

also most street addresses and telephone numbers in the country. This capability is changing how we look up and use amateur callsigns and addresses. Previously, the only way to find an amateur's address was to consult a telephone-book size directory, and you had to know the callsign—the amateur's name didn't help at all. The personal computer has changed all that for the better.

The HamCall database has nearly 600,000 FCC-licensed U.S. amateur stations, plus over 250,000 international listings. With HamCall, you can retrieve data by callsign, name, address, city, state, Zipcode, or license class; copy output to disk, another database, or a printer; generate labels and ASCII text files; and compile specialized databases, such as club directories and membership lists. Interfacing software is available for callsign databases like HamCall and others, allowing the databases to be used with logging programs, packet-radio based mailboxes, and radio BBS'es to provide real-time (on-the-air) callsign-database access.

The HamCall CD-ROM comes with a bonus: some 6,000 public-domain (PD) and shareware programs and files, mostly pertaining to amateur radio; the complete FCC Part 97 amateur rules; and Kenwood, ICOM, and Yaesu radio-service bulletins. HamCall is \$50 from Buckmaster Publishing

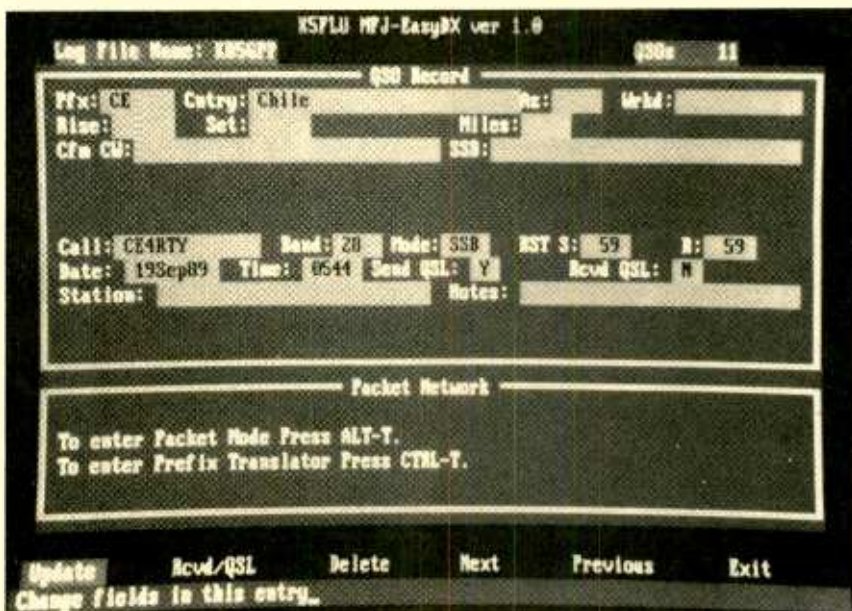

The MFJ-1281 Easy-DX logging program organizes your station's DXCC activity. You can enter any callsign and see if you need the country on the particular band and/or operating mode; the program tells you if you have worked the station before. It also provides lists of contacts by country, bands, modes, QSL status, and more.

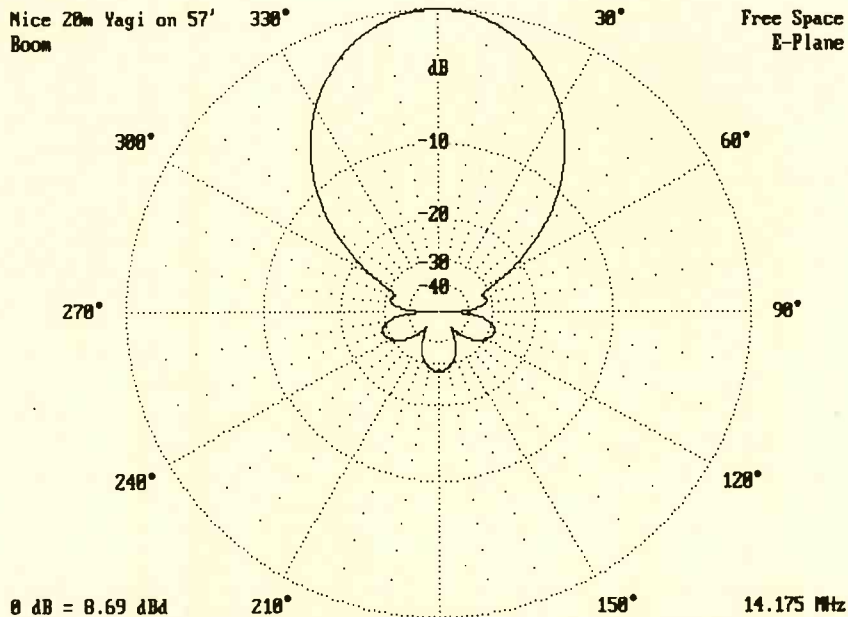

Shown here is a representative polar antenna pattern printout from the YO software package. YO can model stacked Yagis, dual-driven and tapered elements, matching networks, and account for skin effect, and ground effects from HF to microwave.

(Route 3, PO Box 56, Mineral, VA 23117; Tel. 800-282-5628). Updates are issued in October and April.

**Antenna Design, Construction, and Modeling.** Amateur antennas used to be designed by the seat of the pants or using stubby pencil and calculator. Either way, final performance characteristics were hard to predict. Now it's possible to do your figuring on your PC. With antenna-modeling programs, it's fairly simple to calculate the correct dimensions and wire sizes for all sorts of antennas, including dipoles, quads, Yagis, and verticals. Some programs even include construction data for log periodics, phased verticals, and stacking harnesses, and many include determination of ERP (effective radiated power) and predicted gain. Such programs offer the intrepid experimenter and casual user alike some nice "what if" possibilities as well as confidence in the overall results. One popular modeler is ELNEC.

ELNEC, based on the classic MININEC program, is a capable but easy-to-use program for modeling and analyzing practically any antenna. Its menu-driven structure, spreadsheet-like entry format, graphic and tabular antenna displays, and shortcut features make it very user-friendly. The program plots azimuth and elevation patterns; tells you gain, feedpoint im-

pedance, SWR, and current distribution; and reports beamwidth, angles of the 3-dB pattern points, front-to-back (F/B) ratio, and several types of sidelobe data. Recent enhancements include graphical antenna representation, in which you can view or print a three-view thumbnail representation of the antenna; the ability to store on disk all the antenna calculations and plots; the power to save and recall traces (far-field patterns); and the capability to superimpose multiple traces on the current pattern for comparison. Versions are available for coprocessor and non-coprocessor equipped PC's. Either is \$49 from Roy Lewallen, W7EL (PO Box 6658, Beaverton, OR 97007; Tel. 503-646-2885). A new "MaxP" option, which extends ELNEC's capability to highly complex antennas with up to 260 pulses, is available for \$25, and requires a coprocessor.

**Electronic Circuit Design and Calculation.** Technically inclined amateurs make use of a wide range of radio and electronic formulas using computers. Available programs simplify calculations involving Ohm's Law; power supply design; resonant frequency; transmission lines; resistors and capacitors; filters, stubs and traps; series and parallel inductors; and the like.

More complex programs handle

electronic-circuit design problems that are not limited to radio applications. One is the shareware program PC-ECAP. It's an AC circuit-analysis package that features on-screen plotting of the frequency- and phase-response analysis of either magnitude vs. frequency or phase vs. frequency. It can analyze any circuit with up to 40 nodes and an unlimited number of components. The program analyzes circuits consisting of resistors, capacitors, inductors, transistors, operational amplifiers, and transconductance amplifiers.

PC-ECAP is menu driven. It contains several sample analysis circuits and online help so you don't have to remember the correct format for the circuit elements. The program also has a full-screen text editor and file selector. Registration is \$69 (disk only) or \$79 (disk and printed manual) from Circuit Systems (418 Church Rd., Sicklerville, NJ 08081-1727).

**Satellite Tracking.** Communication through amateur-radio satellites and bouncing signals off of the Moon are two of the current "hot" areas in amateur radio. Since 1961, when the first Orbiting Satellite Carrying Amateur Radio (OSCAR) was launched, amateurs have communicated over thousands of miles using very-high frequencies (VHF) and ultra-high frequencies (UHF), wavelengths traditionally for short, line-of-sight distances.

A new era dawned in 1983, when the first Phase III satellite, OSCAR 10, was launched. Its highly elliptical orbit allowed amateurs in the northern hemisphere to use it on a 10 to 12 hour basis, over intercontinental distances. Later, packet-radio capable, low earth-orbit microsats added new dimensions to satellite communications. To effectively use a satellite, it's necessary to precisely locate the satellite and determine the times when it's within range. Many operators slave their antenna rotators to their tracking program for automatic antenna aiming.

The nonprofit Amateur Satellite Corporation (AMSAT) offers inexpensive programs that allow simple and rapid antenna positioning. The AMSAT programs provide accurate schedule and tracking information on satellites in circular and elliptical orbits using



"Keplerian" orbital information from AMSAT or NASA. Among other things, the programs determine the times when a satellite will be above the horizon and timed coordinates for zeroing-in a directional antenna on the satellite.

For the IBM PC, the ORBITS II, ORBITS III, QUIKTRAK, and INSTANTTRACK programs are popular. AMSAT also offers both IBM PC and Mac software to access the BBS capabilities of the microsats and telemetry-decoding programs that allow observation of telemetry frames from the satellites. AMSAT also offers programs for the Commodore 64 and 128, Amiga, Mac, and Radio Shack CoCo computers. For a software list, contact AMSAT (850 Sligo Ave., Silver Spring, MD 20910; Tel. 301-589-6062).

**Station and Radio Control.** Many amateurs employ "smart" computer control of various radio (receiver or transceiver) functions. Many modern radios have interfacing ports (usually RS-232 based) that allow external computer control of most functions using software and/or hardware "rig-control" systems. Many firms have developed user-programmable software to control the scanning pattern and other frequency functions of ICOM, Kenwood, Yaesu, JRC, AOR, and other radios.

A typical CAT (computer-aided transceiver) program is CAT980. This shareware software by Art Harding, K5YEF, interfaces with the popular Yaesu 980 transceiver to provide computer control and on-screen display of radio functions. The software adds four memories to each VFO. It also offers 300 memory channels with downloadable frequency files, variable tuning speed, scanning capabilities, and on-screen status display of radio parameters. Documentation includes an interface schematic. Registration is \$20 from CAT980, PO Box 1719, Plano, TX 75074.

**Morse-Code Practice and Instruction.** Various approaches are taken by Morse-code (or CW) practice software, but most promote a sense of letter and sound association. Such programs typically include progressively more difficult learning of individual characters, automatic generation of random code groups,

screen displays of quizzes and tests, and user-definable messages and practice groups that offer immediate performance feedback.

For the beginner, computer-generated code practice probably is superior to even on-the-air practice sessions, since the latter are subject to interference and static. However, some sophisticated Morse-practice programs can optionally re-inject these real-world inhibiting factors into training sessions for increased realism.

MorseMan Plus lets you select your own method of instruction, choosing between random characters, words, or callsigns, for variations in practice style. Features include random characters and rates from 5 to 99 WPM; a realistic radio callsign generator; a keyboard sending mode; an ability to create ASCII text files; step-by-step character instruction; interactive word and character modes; and an easy "windowing" environment.

Attractive features include the random callsign generator, which allows the program to generate realistic callsigns. The QSO/FCC test feature provides help for those going for FCC exams. When you select this option, the program randomly builds one side of a test-style QSO, with abbreviations, Morse prosigns, radio callsigns, and Q-signals. The QSO monitor feature lets you listen to simulated QSO's at speeds you can copy; the program generates both sides of the con-

versation, but lets you choose the speed and audio frequency range. The program is \$34.95 from Renaissance Development (PO Box 640, Killen, AL 35645; Tel. 800-525-7235).

**CW and RTTY Communications.** Manual Morse code, or CW, is the oldest form of digital communication, but it's benefited greatly from the hamshack-computer revolution. While CW communications leave a lot to be desired from a technical-efficiency standpoint, it has the advantage that no coding or decoding equipment is needed. Many operators now use keyboards rather than straight keys or mechanical "bugs," and video monitors rather than their ears, to exchange messages. The features of computer CW programs resemble those provided by their radioteletype (RTTY) counterparts, and interfaces are simpler.

Amateur RTTY operation has been popular for about 50 years. Fortunately, noisy mechanical teleprinter units have been swapped for computers. PC's are popular for modern RTTY setups, the only extras required being an interface (terminal) unit between the computer and the radio, and the associated software. Most RTTY packages include options to use Baudot or ASCII code at different data rates, split-screen receive and transmit, user-definable messages, disk message storage, and type-ahead

**MFJ Theory Tutor**  
Copyright 1988 by QSO Software

**MFJ Enterprises**  
P.O. Box 494  
Mississippi State, MS  
(601) 323-5868 39762

Press any key to continue -->  
Press H for Help!

*The MFJ Theory Tutor claims to practically guarantee you will pass the theory portion of any FCC amateur license exam. You get the FCC question pool and can study the entire pool, concentrate on selected areas, or take sample tests. Scoring analysis, an online calculator, and explanations of hard questions are provided.*





*AEA-FAX is a standalone demodulator and display combo that doesn't require a hardware TNC to capture weather facsimile (WEFAX) images from Earth-orbiting satellites or photos from wire services. The AEA-FAX hardware is simply a small RS-232 port connector housing containing the demodulator circuitry.*

buffers that let you continue typing while listening to the other station. RTTY "electronic mailbox," radio BBS, and automated relay options that let you keep in touch with other amateurs automatically even when the radio equipment is unattended are becoming increasingly popular.

Combining RTTY and CW in a single package is a natural, and several manufacturers offer both communications modes. There's no lack of vendors offering RTTY and CW software and interfaces, and receive-only RTTY/CW packages make for very sophisticated SWL'ing.

**AMTOR, Packet Radio, and PACTOR.** A relatively new development is AMateur Teleprinting Over Radio (AMTOR). This is a RTTY-like mode with a "handshaking" or error checking feature that minimizes glitches caused by interference (QRM), fading (QSB), and static (QRN). Thus, it's much more reliable than Baudot or ASCII RTTY. AMTOR's error-free transmission even offers reliable, over-the-air exchange of computer programs.

Packet radio is an exciting mode of highly reliable communications, the most advanced mode amateurs regularly use. It's a high-speed, digital, frequency-space efficient mode that lets you send, receive, store, and forward messages to and from other amateurs. While similar to RTTY and AMTOR, packet is different in that communications data is sent at a much higher speed, and in a "con-

nected" or telephone-like, virtually interference-free, error-checking, and networked manner.

Each packet station must have special equipment, such as a terminal-node controller (TNC), operating to standard protocols, plus appropriate terminal software. Despite the initial expense of setting up a station, packet radio already has caused a "silent revolution" in amateur radio, and thus it holds great promise as the premier communications mode of the future. Many vendors offer packet-radio software and hardware interfaces.

PACTOR is an even newer, experimental mode pioneered by German amateurs to fill a void in digital communications. Sort of a "souped-up" AMTOR that combines some of the best features of AMTOR and HF packet radio, it's a merger of the technologies of the two systems. Its packet-like error-checking makes it good for long-distance HF work, where AMTOR and packet both have notable performance and capability deficiencies. To date, the only commercial PACTOR controllers are made by Pac-Comm (4413 N. Hesperides St., Tampa, FL 33614-7618; Tel. 813-874-2980).

PacketCluster is a specialized packet application that not only supports contest and DX enthusiasts (where operators trade timely tips and announcements about DX-station operations), but it also provides a great utility for the packet community as a whole. The software lets multiple Pack-

etCluster computers (nodes) connect to each other and form a network or cluster of nodes. All connected users can communicate with each other, regardless of the node to which they are connected. Multiple PacketCluster nodes can link to form one large network.

PacketCluster software (\$219.95) requires a Kantronics or DRSI TNC (terminal node controller) and an IBM PC or compatible; PacketCluster Limited (\$75) has reduced functionality. Contact Pavillion Software (PO Box 803, Hudson, MA 01749; Tel. 508-779-6527).

**Automated QSL Software.** The final proof of an amateur QSO is the QSL card, evidence of a contact usually required for many operating awards and contests. In the pre-computer days, QSL'ing chores were often prohibitively time-consuming after major contests. Fortunately, QSL automation is right up the PC's alley.

Some log and contest programs automatically generate QSL card labels using logbook data. On keystroke command, a day's QSL chores can be taken care of, with the cards made ready for mailing directly or through a QSL mail-forwarding bureau. This automatic QSL feature is a boon to high-volume contest operations in which thousands of QSO's might be made in only a few days. Today, on so-called "DXpeditions" to remote locations, operators often do real-time log-data entry using a small portable computer, transferring the log data to a desktop PC later for log printout and QSL-label production. Several custom QSL applications have been developed to refine the process. Let's look at two examples.

PSQSL, by Gary C. Sutcliffe, W9XT, helps overcome one of the problems involved in using computerized logging programs. Many amateurs use such programs to generate QSL labels. While these programs can save hours of work, tedious sorting can remain after printing labels if you use the ARRL Outgoing QSL Service, which requires that the cards you send through them be sorted by country.

PSQSL takes the QSL label files from any of several popular logging programs and combines them into a single, sorted (by DXCC country) label file ready for printing. Cards for countries not handled by the ARRL service



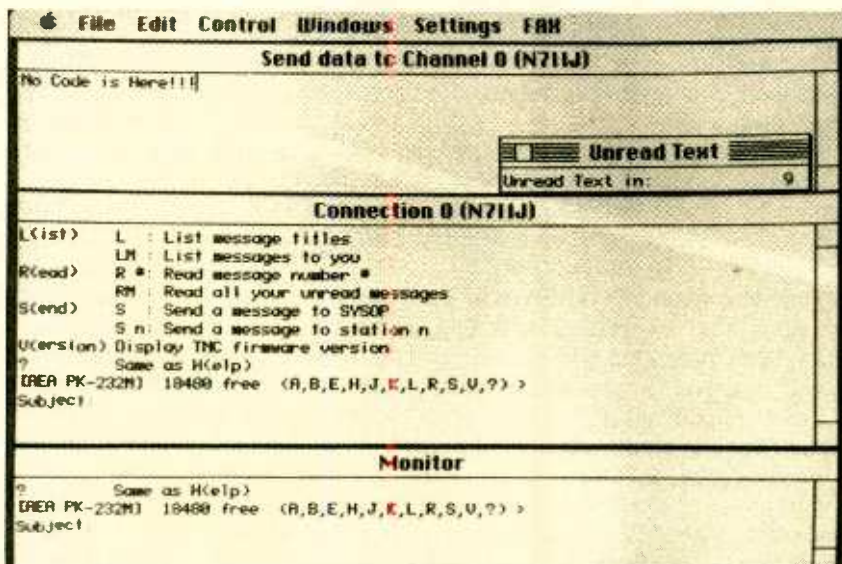

AEA's MacRATT is an Apple-friendly terminal program for use with their popular PK-232MBX Multi-Mode Data Controller. Used together they let you communicate over the full range (HF and VHF packet, AMTOR, WEFAX, ASCII, Baudot RTTY, and manual Morse code) of digital modes.

are separated from those it handles

You can also create labels by manually entering QSO information from the keyboard. You can obtain an unregistered copy from BBS'es or from the author for \$5; registration is \$10 (without a disk), or \$20 for the latest version with manual. Contact Unified Microsystems (PO Box 133, Slinger, WI 53086; Tel. 414-644-9036.)

QQSL, the Quick QSL Label program, is a comprehensive standalone QSL-database tracker to do just one thing: print QSL labels fast and easily. The program boasts a user-friendly interface, fast keyboard entry, import capability, ability to create responses to SWL QSL cards, a variety of input entry forms, alphabetical sorting, and a batch-printing mode. Recent versions also include QQSLCD, a shareware program by Tom Palko, WB5ASD. With this module, a CD-ROM disc drive, and the Buckmaster HamCall CD callsign database, you can produce matching address labels along with your own return labels. The package is shareware; registration is \$19.95 from Bill Mullin, AA4M/6 (3042 Larkin Place, San Diego, CA 92123-3026; Tel. 619-292-7227).

**Multifunctional and Integrated Hamshack Software.** Amateur radio software has become more sophisticated, but what's been lacking is a way to logically "put it all together" for maximum efficiency and con-



*A good way to learn more about digital developments is to obtain good reference books like Jonathan L. Mayo's new "The Radio Amateur's Digital Communications Handbook." Mayo provides a one-stop source for most everything you need to know about digital history, capabilities, and applications.*

venience. The traditional software classifications blur as applications become more multifunctional and integrated. We'll look at two hybrids that hold great promise for the future of the soft shack: LOGic II and HamWindows.

LOGic II is an integrated package that's more than a computer logbook: its comprehensive database-management abilities place it in a program class by itself. Developed by Dennis Hevener, WN4AZY, LOGic II al-

lows logging in real-time and non-real-time modes. It has a customizable screen, flexible data retrieval, automatic tracking of practically any major award, QSL management, user-defined data fields, sophisticated print options, and up to 20 pages of free-form notes per QSO.

LOGic II interfaces to most computer-compatible transceivers to control the radio and logging of mode, frequency, and band. It features automatic contest duping and scoring; antenna-rotor control via an RS-232 interface; a menu-driven report writer; a complete "QSL manager" with a regularly updated database subscription plan; a day/night grayline propagation chart; and mail merge to generate letters using data from your logbook. LOGic II also includes a table of amateur-callsign prefixes (over 3800 entries) that contain such parameters as ITU and CQ magazine zone and DXCC country names. The \$79 program has a communications terminal for packet radio TNC access, and the program interfaces with several popular callsign databases, including SAM. A simplified \$39 version, LOGic II Jr., promotes easy introduction to computerized logging; it offers most features of LOGic II but lacks the radio-interfacing options. Contact Personal Database Applications (2616 Meadow Ridge Dr., Duluth, GA 30136-6037; Tel. 404-242-0887). A demo is \$5.

Perhaps the most ambitious Windows-based amateur-radio application is HamWindows, developed by California Software and marketed by Kenwood U.S.A. for most Kenwood radios. The program works in the graphical user interface (GUI) environment offered by Microsoft Windows. This allows it to take advantage of many Windows features, especially Dynamic Data Exchange (DDE) to allow efficient and consistent exchange of data among program modules and with other Windows programs.

At \$139.95, HamWindows is at heart a logger and awards tracker, but its nine main windowing modules make it considerably more than that—they integrate several key functions to let you see the world your radio hears by "point-and-clicking" your mouse. In addition to logging and awards tracking, the program offers callsign and other information look-up (country,

zone, beam heading and distance, etc.); a grayline propagation map and 31 regional maps; a SWL window that includes more than 9000 station frequencies with operating schedules; a detailed amateur-radio oriented almanac for each country; a terminal-node controller (TNC) window for packet DX spotting; a control window for Kenwood radios; several useful amateur-radio utility routines; a setup window for system configuration; and comprehensive online help.

The program's callbook module accesses various callsign databases, such as SAM and HamCall. Other features include import of country list data from other logging programs, onscreen display of beam heading and distance, the ability to store extensive notes for each contact, and a very comprehensive user's manual. Several add-on options are available, including the online CIA World Fact Book Almanac, online Windows versions of Kenwood's users manuals, and a 1½-hour HamWindows video-training tape. Upcoming enhancements include new graphics to support Super VGA (SVGA) video in the 800 × 600 resolution mode.

Information is available from any Kenwood dealer or from California Software, Inc. (2121 E. Pacific Coast Hwy. #220, Corona del Mar, CA 92625-3235; Tel. 800-245-2741).

Note: Windows and HamWindows together make some very heavy demands on your PC hardware, so make sure your computer is adequately configured. An XT or 286 PC just won't do—and even a 386SX is only marginal!

**BBS Shareware.** Retail-marketing costs add greatly to the price of regular commercial software. So some of the biggest bargains in software are marketed via the shareware concept. A large percentage of amateur-radio software is distributed this way. Shareware is try-before-buying software, copyrighted but usually freely distributed as though in the public domain.

The shareware concept lets you use software on a trial basis. If you like the software and use it, you're expected to register it with the author and remit a fee. Many authors provide registered users with newer or enhanced versions, printed documentation,

technical support, and upgrades. This type of software is distinguished from PD software, where the author allows anyone to use the software freely, but rarely supports it.

How can you mine this software goldmine? Some of the best sources are computer bulletin-board systems (BBS'es). Thousands of open-access BBS'es let you download software, including shareware. Many BBS'es are amateur-radio oriented—one list I've seen shows at least 125 ham boards in the U.S. and Canada. Also, many BBS'es specialize in PC's other than the IBM, so don't overlook them.

Another potential source of amateur-radio software is CompuServe and other online utilities. Just bear in mind that you need modem equipment and may have to pay online-connect and toll charges, and you don't know the quality of the software you're getting until you go through the whole download process.

The HamNet Special Interest Group (SIG) is a forum open to all CompuServe users, not only licensed radio amateurs. HamNet is dedicated to amateur radio and related hobbies including shortwave listening, scanning, and satellite TV. It's a vast resource of computer software, amateur-radio newsletters, information on technical developments, FCC regulatory information, and more. Since most software on HamNet is PD or shareware, the only up-front costs are the moderate CompuServe online charges. HamNet membership itself is free.

Messaging and teleconferencing are available on HamNet. There's an online swap shop, and several radio vendors offer online technical support for their products. The HamNet SysOp is Scott Loftesness, W3VS (CompuServe ID 76703,407). Of course, you must be a CompuServe member to access these online treasures. For more information on membership, contact CompuServe (PO Box 20212, Columbus, OH 43220-0212; Tel. 800-848-8199 or 800-848-8990). Once aboard CompuServe, just type "GO HAMNET" at any "!" prompt.

#### **Shareware Disk Distributors.**

Another way of obtaining shareware is through disk distributors. Many shareware authors not only upload their programs to BBS'es and online

utilities but also send copies to distributors to include in their program libraries. Many users prefer obtaining programs in this way since they feel they are exposed to minimal risk from computer viruses. Let's look at four such distributors.

HAM-SOFT Public Domain Software offers a 60-page catalog of amateur-radio PD and shareware software that includes several hundred program disks for the IBM PC. Each program is profiled in a thumbnail sketch. Besides the IBM PC disks, there also are several pages of C-64 and Mac programs. Disk pricing is modest, and all software is certified virus free. Catalogs are \$1 from HAM-SOFT (PO Box 443, Galena, TX 77547-0443).

Though its catalog isn't as extensive as HAM-SOFT's, K-Quest offers dozens of carefully selected shareware and PD amateur-radio programs. Only the most recent program versions are featured, and each program is tested for proper operation. The K-Quest catalog helpfully displays typical screens of many of the programs offered. A free catalog is available from K-Quest (PO Box 92877, Southlake, TX 76092; Tel. 817-421-0560).

The developer of the popular MorseMan Plus program also operates the Renaissance Software Library. This library offers a very good selection of top-rated shareware and public domain software for the IBM PC and compatibles. Included in the Renaissance library are about 60 amateur-radio program disks. Contact Renaissance Development (PO Box 640, Killen, AL 35645; Tel. 800-525-7235).

One way to build your collection of amateur-radio software very fast is by obtaining a CD-ROM shareware disc of programs—assuming, of course, you have a CD-ROM drive. Amsoft has deposited about 275MB of amateur-radio, SWL, and scanner-oriented shareware and PD programs on its "World of Ham Radio Shareware" CD-ROM disc, Vol II.

Assembled by Pete DeVolpi, KC3TL, the disc's contents are almost overwhelming. It contains over 8,000 files, including many hundreds of executable programs, organized in logical subdirectories that group similar program types. Many of the CD-ROM programs can be run directly from the disc; others are in compressed (Zip)

*(Continued on page 96)*



# Build This SLIDE- PRESENTATION MANAGER



*Synchronize your slide presentations with a disciplined and brief narrative and let your stereo tape recorder and this interface circuit control the show.*

BY J.A. NUNLEY

**T**oday's personal computers make it relatively easy to produce superb presentation graphics. But seeing the graphics materialize on a VGA screen and presenting the graphics to the audience for which they are intended involves a jump. Probably the most common method of presenting the graphics is to make a hard copy of the graphics on the computer printer, and then make that into a large format transparency (using either a heat or a xerographic process) for an overhead projector.

Although that method is easy and fast, it loses the outstanding colors of the computer-generated graphics. In addition, overhead projectors are limited to small audiences and even then are somewhat distracting in terms of stray light, the lens head sticking up in the middle of the room, and the inevitable keystone distortion that results from the short focal length of the typical overhead projector lens.

Another possibility is to display the graphics on a large-screen television,

or even a huge projection television. While that preserves the color of the graphics, if not the original resolution, it requires expensive electronics to convert the image files from the disk to standard NTSC signals that can be displayed on a television set. Furthermore, if the presentation is at a location other than where the graphics originated, there may be considerable difficulty in transporting the bulky equipment that's required to the presentation site.

More and more, those responsible for presentations are turning to an old standby—the 35-mm color slide—which first came into widespread use in the 1930's. The 35-mm slide offers substantial advantages over other presentation methods; it preserves all of the color, even subtle variations, of which most PC applications are now capable. In addition, the 35-mm color slide can deliver all the resolution up to and past super-VGA, and can produce a striking, self-illuminated image big enough for really large audiences.

Furthermore, there are two highly effective methods of producing 35-mm transparencies directly from the graphics files on computer floppy disks. One method is to use an electronic Film Recorder. Although one would have to have a high rate of slide production to justify the cost of a Film Recorder, they do offer privacy, speed, and on-premises control of the process. One model, made by Polaroid Corp., can even produce instant color transparencies without having to send the 35-mm film to a processor. The other method is to submit the floppy disk files to a Film Service Bureau, which will make the graphics into finished 35-mm slides at a nominal cost per slide.

Having then obtained, by some method, a host of presentation graphics on 35-mm slides, the presenter is faced with the problem of making the best use of all that sophistication to avoid boring his audience with the usual disorganized jumble of slides, accompanied by a live, rambling, often repetitious narrative. In-

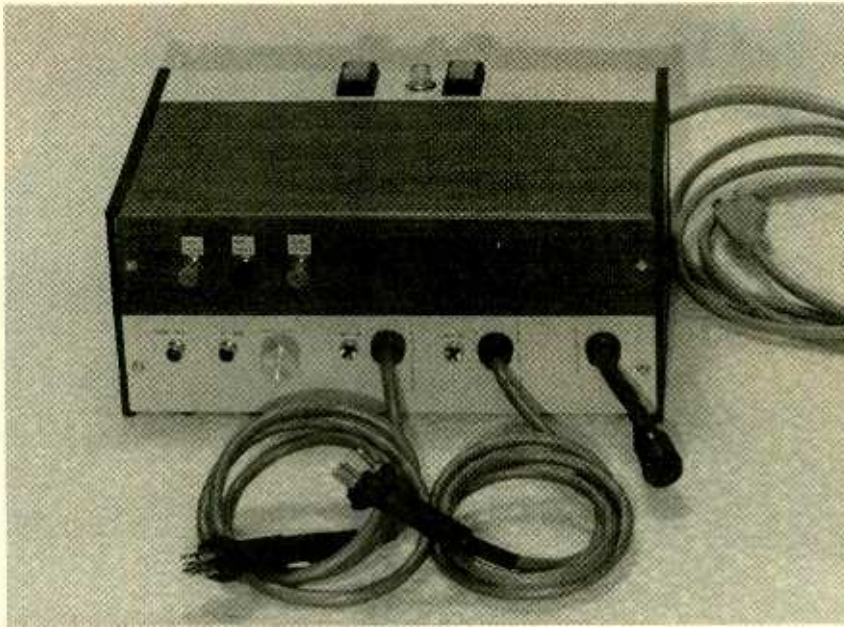

Fig. 1. On the top of the Slide-Presentation Manager toward the rear are two power switches; one for the overall power (which applies power to the Slide-Presentation Manager and controls power to a convenience outlet on the back of the unit), and one for power to the two projector lamps.

stead, each presentation should be thought out and carefully organized in some logical manner that will give it continuity and meaning.

A written narrative that's disciplined, brief, and pertinent should be prepared. To eliminate the temptation of the presenter to pause, ramble, or digress, the presentation should be mechanized by recording the narrative (with background music if desired) on a tape that also contains signals directing the slide changes at the correct times. And to make the slide presentation really attractive and professional, two projectors should be used so that there is no jarring one- or two-second blackout for each slide change. Instead, the images should fade smoothly, the on-screen slide dimming to black, with the next slide going to full brightness at the same time.

The *Slide-Presentation Manager* described in this article provides an efficient means of preparing and presenting a slide presentation. It does so by allowing you to interface one track of a stereo tape recorder with two projectors for control of the projectors, while synchronizing slide changes with the narrative recorded on the other track.

**Functional Description.** Figure 1 shows an overall frontal view of the

Slide-Presentation Manager. On the top of the unit toward the rear are two power switches, one for the overall power and one for power to the two projector lamps. The overall power switch applies power to the Slide-Presentation Manager, and also controls power to convenience outlets on the back of the unit for connecting the power cords of the two projectors.

The projector lamp's switch is needed for two reasons: first, you will want to set up and aim the projectors so that their frames coincide before your audience arrives. That involves setting the slide trays at the proper starting points, checking focus, etc., leaving the Slide-Presentation Manager on and ready, but the projector lamps turned off so that there is no image on the screen. Then, to start the presentation, you need only turn on the projector lamps and start the tape player.

The second reason for the lamp switch is that it is wise to turn off the projector lamps, but leave their fans running for a few minutes to cool the lamps before moving the projectors. Moving projectors while the lamp filaments are still hot can lead to the early "death" of those lamps.

On the front panel at the upper left side are three momentary contact pushbutton switches, labeled FAST CYCLE, MED CYCLE, and SLOW CYCLE, which are

used when recording a slide presentation. Pressing one of them causes the projectors to complete a cycle at the selected rate, and routes an AC signal to the TO TAPE jack on the front panel for recording on the control track of the tape recorder.

The projector cycle begins with the departing slide being dimmed to black. When that projector reaches full black, a command is issued, causing it to change to the next slide in preparation for the next cycle, while at the same time, the arriving slide is brought up from black to full brightness, resulting in a fade or dissolve effect that's very pleasing. Three fade or dissolve rates are provided for aesthetic effect: the fast rate results in a complete fade in 1.42 seconds, medium in 2.84 seconds, and slow in 5.69 seconds.

The medium cycle should be relied on most of the time, and the fast cycle can be used to move a series of slides through at a brisk clip. While the slow cycle can at times provide very dramatic effects, excessive use can be irritating to your audience.

The FROM TAPE jack on the front panel is connected to the control-track output of the tape recorder during a slide presentation. The three frequencies will have been recorded at various places on the control track during preparation of the slide presentation. When that signal is received at the FROM TAPE jack, it causes the projector to cycle at the fast, medium, or slow speed as described in the preceding paragraph. Because many tape decks do not have an output-level control, an INPUT LEVEL control is included on the front panel.

The Slide-Presentation Manager can be triggered with an input of from 100 to 200 mV. Setting the control too low results in some cycles being missed; setting it too high may result in false cycles due to noise, especially if the cable between the tape recorder and the unit is long. But the setting is not really critical and a proper setting can easily be arrived at by brief trial and error.

Note: The Slide Presentation Manager was designed specifically for use with two Kodak *Carousel* projectors, and the following descriptions are with reference to that fact. Although it is possible to adapt the Slide-Presentation Manager to other models of



projectors, the author will not cover such adaptations in this article, and that task is left to the reader.

To the right of the INPUT LEVEL control are two cables that connect to the rear jacks of the two projectors. Those cables carry the low-level signals for slide-change and remote focusing of the projector lenses, and the 117-volt AC signals to the projector lamps for the fade-down and fade-up of lamp brightnesses.

Adjacent to the two projector cables are a pair of LED's that show which projector is active; e.g., which projector's lamp will be at full brightness when the projector lamp switch is turned on. It should be noted that during operation, the projector's own lamp switch must be set to *fan only*, and not to either of the two *lamp on* positions, which would defeat the fade function. Power to the projector lamps must be controlled entirely by the Slide-Presentation Manager, not by the projector's lamp switches.

Finally, at the right of the front panel is the connector for a single remote control; use the remote from one of the projectors for this. Here's how the remote will work in conjunction with the Slide Presentation Manager: the control operates only with the active projector (the one indicated by the ACTIVE LED). The remote-focus function works normally (if you have projectors with automatic focus, you may want to omit the part of the circuit dealing with that function).

The forward and reverse buttons on the remote control function somewhat differently; The forward button simply adds a fast cycle to the program routine. That's useful in the unlikely event that a cycle command from the tape has been missed due to some malfunction or if the input level has been set too low; it allows you to put the program back in sync. The reverse function simply would not make sense in a tape-controlled, synchronized presentation; therefore, the reverse button is used to delete a cycle. To do so, the reverse button must be held down during the time when a cycle signal is arriving at the FROM TAPE jack. Holding down the reverse button merely shorts out the FROM TAPE jack input. It is also useful if somewhere in the presentation a false cycle occurs as a result of noise on the FROM-TAPE line, or a power surge, or some such unlikely

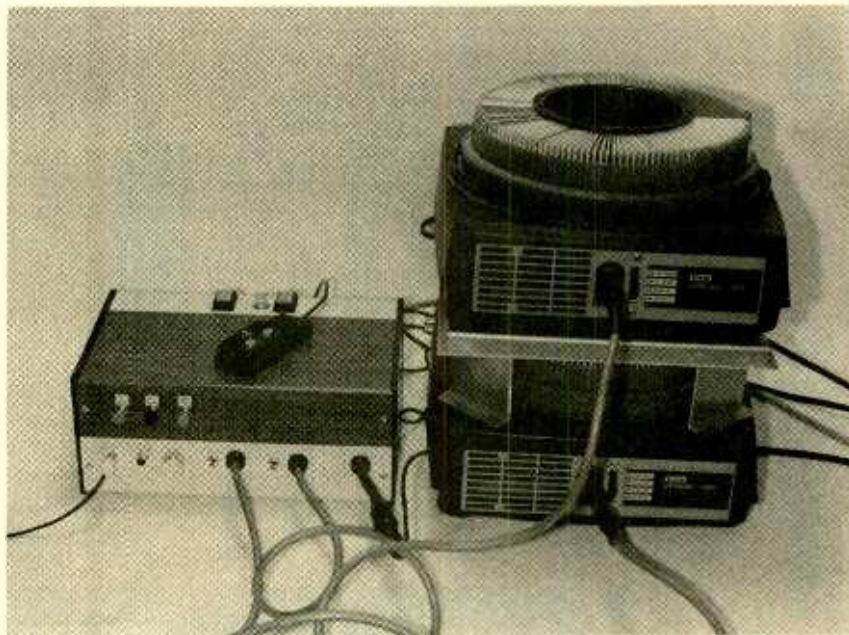

Fig. 2. Here is the Slide-Presentation Manager placed alongside the two projectors and connected as it would be during a slide presentation. The two projectors are stacked on top of one another in order to place the lenses of the two projectors as close together as possible to achieve the maximum registration (superimposition) of the frames of the projected images.

event. Deleting a cycle allows the presentation to come back into synchronization with the tape. It is a good idea to keep the remote control in your hand during a slide presentation in order to touch up the focus from slide-to-slide if necessary, and to add or bypass a cycle if required to restore synchronization of the slides with the narrative.

Figure 2 shows the Slide-Presentation Manager placed alongside two projectors and connected as it would be during a slide presentation. The two projectors are stacked one on top of the other to place the lenses of the two projectors as close together as possible in order to achieve the maximum registration (superimposition) of the frames of the projected images. If the projectors were placed side-by-side, the distance between the lenses would be greater and lateral keystoneing of the frames would create an obvious mis-registration. Racks for stacking Kodak *Carousel* projectors vertically are available at larger photography or audio-visual retailers. The rack shown in Fig. 2 was easily fabricated using 16-gauge sheet aluminum and pop rivets.

**Circuit Description.** The schematic diagram of the Slide Presentation Manager's main logic circuitry is

shown in Fig. 3. During preparation of the slide presentation, audio signals from the Slide-Presentation Manager will have been recorded on one track of a stereo tape recorder. During the presentation itself, the output of that track is routed to J1 and applied to level-control R3.

From the slider of R3 through C1, the signal is applied to the pin 3 inputs of U1-U3 (three LM567 tone decoders). Those IC's consist of a highly stable oscillator, whose frequency is determined by the resistance between pin 5 and pin 6, and the capacitance between pin 6 and ground, and a phase-locked loop, which detects when the input-signal frequency equals the internal-oscillator frequency.

When that happens, an internal transistor with its open collector connected to pin 8 turns on, forcing that pin low. The oscillator in U1 is adjusted for 360 Hz, U2 for 180 Hz, and U3 for 90 Hz. The outputs of U1, U2, and U3 (at pin 5 of each IC) are routed to U7. From there, during preparation of the slide presentation, the selected signal is routed J2 for recording on the control track.

The capacitors connected from pins 1 and 2 of U1-U3 to ground (C3 and C4, C6 and C7, C9, and C10) determine the bandwidth of the tone

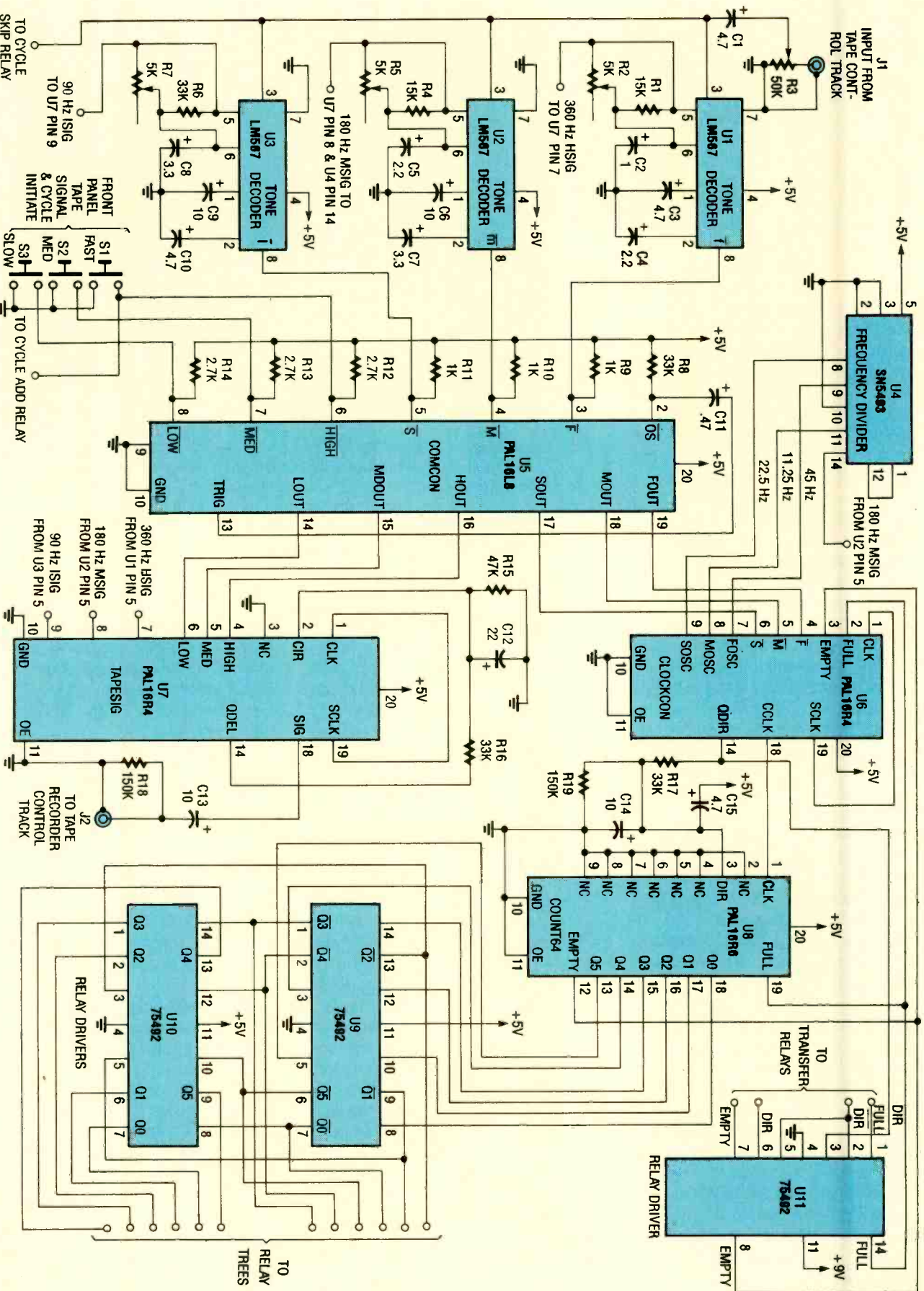

Fig. 3. The main logic circuit of the Slide Presentation Manager is comprised of 11 ICs, four of which (U5-U8) are programmable logic devices.



decoders, which in this application is about 7% or 8% above and below the fundamental frequency, allowing for some error in the tape speed. That results in slightly off-center frequencies. The 180-Hz output of U2 is also routed to the first stage of a 4-stage binary counter (U4) where the signal is divided down to the frequencies that will be used, after some processing, as the clock pulses for U8.

The central part of the circuit consists of four 20-pin programmable-logic devices (PLD's) of three different types. Those units (U5–U8) have been programmed as special-purpose IC's to do specific jobs within the Slide-Presentation Manager. They greatly simplify the construction of the unit. (A full disclosure of the programming sheets and other data pertaining to those IC's is available from the author if you have the inclination and access to the required equipment to program the PLD's yourself; more on that later.) Suffice it to say, those four IC's take the place of approximately 20 conventional 54/74 series devices that would be required to implement the same functions.

Integrated circuit U5 (Command Control, or COMCON) receives six signals; three from the tone decoders (U1–U3) and three from the front-panel pushbutton switches (S1–S3). Pressing one of the three pushbuttons switches initiates a slide cycle and causes U5 to send a signal to U7, which then outputs a measured pulse that is routed to J2 for recording. Pull-up resistors are required at pins 3–8 of U5 because the tone decoder outputs are open-collector transistors, and to provide the appropriate high-to-low transition from S1–S3.

Integrated circuit U5 provides three functions. When a signal is received on one of its inputs, it locks out the other inputs until the corresponding required output has been generated, preventing ambiguity and improving noise immunity. It also provides the logic to send only the slide cycle signal if the input is received from a tone decoder (signifying that a slide presentation is in progress rather than being prepared), or both a slide cycle and a tone output if the input comes from one of the pushbuttons switches (which would only be used if a slide presentation were being prepared).

Lastly, U5 one-shots all of the inputs

to the outputs. Thus, regardless of the duration of the inputs, the output will be a one-shot pulse of about 15 milliseconds. That one-shot action is provided by delaying the trigger signal at pin 13 of U5. Pin 13 of U5 goes low when any signal is input, provided pin 2 is high. Pin 13, after the delay injected by C11 and R8, pulls pin 2 of U5 low, terminating all input signals and sending pin 13 high again.

Next, consider the action of U7 (the TAPESIG-PLD). That IC has the single purpose of metering approximately 0.75 seconds of AC signal to J2 in response to a high, medium, or low pulse from U5 (pins 14–16). The high output (U5 pin 16) sends the 360-Hz signal (which corresponds to a fast cycle command) to the Slide-Presentation Manager; the medium output (pin 15) routes a 180-Hz signal for the medium cycle; and the low output (pin 14) feeds a 90-Hz signal for the slow cycle.

Unlike U5, which contains no flip-flops, U7 contains four flip-flops in addition to four unregistered outputs. The high, medium, and low inputs each sets its own "hold" flip-flop and any of the three will also set pin 14 of U7 (the QDEL flip-flop) and generate a self clock (SCLK) pulse at pin 19 of U7. We are assured of that short pulse by the one-shot action of U5. The internal propagation delay assures that the clock will arrive at each flip-flop after the D input is in place. The QDEL output of U7 (through a delay established by R16, C12, and R15) is applied to pin 2 (CLR) of U7, which clears all four flip-flops, terminating the AC output at pin 18, SIG, of U7. Thus, the appropriate AC output (one of the three frequencies) is delivered to J2, starting when the one-shot pulse is received from U5, and ending about 0.75 seconds later, when the delayed QDEL signal is received at U7 pin 2. The 0.75-second duration of the AC signal is right for reliable recording on the control track, and for reliable triggering of U1–U3 during playback.

Refer back to U4 (the four-bit binary counter), which receives a 180-Hz input from the U2 oscillator. That 180-Hz signal is divided down to 90, 45, 22.5, and 11.25 Hz. The 90-Hz signal from the counter is not used, but the other three frequencies will ultimately be gated through to become clock pulses for U8. That's accomplished by

means of U6 (which is programmed as the Clock Control, or CLOCKCON). Like U7, U6 has four flip-flops and four unregistered outputs. When one of the EM, or S signals (all are active low) is received, it sets one of the D flip-flops as a hold flip-flop. (Like U7, U6 generates its own clock pulses—which is output at SCLK, pin 19, and applied to pin 1, CLR—for the flip-flops when any of the three inputs are received).

The output of those three hold flip-flops are actually available on pins 15, 16, and 17, which are not shown in the schematic. The reason is that the direct outputs are not used, but are fed back internally to gates that will control the CCLK (counter clock) output at pin 18 of U6. Meanwhile, the FOSC, MOSC, and SOSC signals are continuously being received at pins 7, 8, and 9 of U6. When the F signal sets its hold flip-flop, the FOSC signal is gated out at pin 18, and to the pin 1 input of U8. Similarly, the M signal gates out MOSC, and the S signal gates out SOSC.

The hold flip-flops are reset, and thus the clock signal at CCLK is terminated, when either the full or empty signal is received at pin 2 or pin 3 from pin 19 or pin 12 of U8, respectively. Integrated circuit U6 also outputs a direction signal at pin 14 and is routed to pin 3 of U8, where it determines if the counter will count up from 0 through 63, or down from 63 through 0. The direction flip-flop is set or reset by the FULL and EMPTY signals that are operated on and gated in U6. The FULL and EMPTY signals are also routed to relay driver U11 to bring about relay closures that cause the inactive projector (the one that has just gone fully dark) to change to the next slide.

The duration of the full and empty signals is actually determined by the pin 3 output of U11, which, when it arrives at pin 3 of U6, terminates the FULL or EMPTY signal, whichever is active. To be sure the FULL or EMPTY signal is of sufficiently long duration to reliably trigger a slide change (a mechanical process), the signal at U6 pin 14 (the direction signal) is delayed by a network composed of C14, C15, R17, and R18. The reason that this network is a bit more complicated than the usual RC delay circuit is that the direction signal must be delayed on each transition, whether from high to low or from low to high. The direction signal is also routed to relay driver U11, which

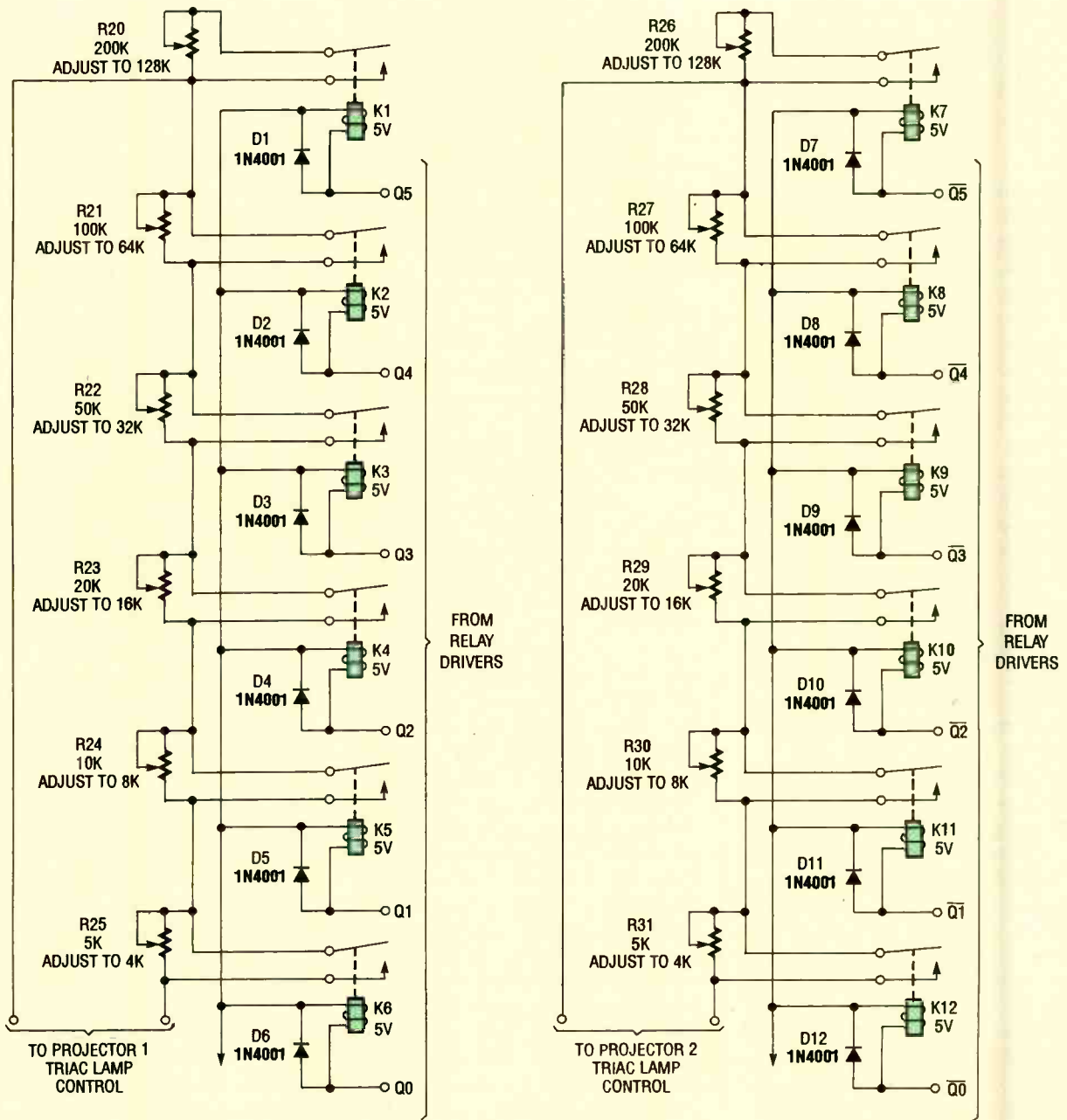

Fig. 4. The relay trees, a relatively simple circuit, is actually a form of digital-to-analog converter (DAC) that is used to convert a six-bit binary input to resistance values.

activates relays that transfer the projector's remote-control functions (focus, forward, and reverse) to the active projector; i.e., the one that has just gone to full brightness.

Finally, we come to U8 ("COUNT64"), a six-bit binary counter capable of 64 steps (0 through 63). Like all binary counters, it must have a flip-flop for each bit, Q0 through Q5, pins 13 through 18. In addition, it has two unregistered outputs at pins 12 and 19. As with the other PLD's having flip-flops,

pin 11 is grounded to enable the outputs. The IC has only two inputs; clock at pin 1 (which is received from U6 as described above) and direction at pin 3 (again as described above). The other inputs are grounded to provide stability and low power usage.

When clock pulses are delivered to pin 1 of U8, it begins to count at the rate of the clock pulse supplied, and in the direction dictated by the direction input. A low direction signal is recognized as a command to count up,

and a high signal is recognized as a command to count down. When the count is at binary 63—i.e., pins 13–18 (Q0 through Q5) are all high, and the direction signal is low—the full signal is generated and sent back to U6, terminating the clock input and stopping the counter.

Similarly, when the clock pulses arrive and the direction signal is high, U8 counts down until pins 13–18 (Q0 through Q5) are all low. At that point, an empty signal is sent to U6, causing



the clock pulses to cease and U8 to stop. Thus, U8 merely counts from 0 through 63 (in binary) then stops, then counts from 63 through 0 and stops.

Integrated circuit U8 receives clock pulses at either 45 Hz, 22.5 Hz, or 11.25 Hz. To make 64 counts at a rate of 45 Hz, the counter will take  $64/45 = 1.42$  seconds;  $64/22.5 = 2.84$  seconds; and  $64/11.25 = 5.69$  seconds. Those are the times of the fast, medium, and slow slide dissolves provided by the Slide-Presentation Manager. The Q0 through Q5 outputs (U8 pins 13–18) are routed to relay drivers U9 and U10, which, in turn, activate a set of relay trees.

**Relay Trees.** Figure 4 is a schematic diagram of the relay trees. That relatively simple circuit is actually a form of digital-to-analog converter (DAC), which converts the six-bit binary input to resistance values. Relays, rather than some other type of DAC are used to provide the necessary isolation between the logic circuitry and a pair of Triac-based 117-volt AC control circuits. The Triac circuits, to be discussed shortly, are lamp dimmers that are not unlike the wall-mounted dimmers in your home. However, in this case, the lamp dimmers are used to control the projector lamps.

The relay trees take the place of the variable resistor found in conventional lamp dimmers. The particular Triac circuits in the Slide-Presentation Manager require a resistance that varies from 0 to approximately 250k in order to go from full-off to full-on. The six relays in each of the two trees correspond to Q0 through Q5 and the inverse of Q0 through Q5. When activated, each of the SPST relays merely shorts across a segment of resistance, the six resistors of the tree all being in series. For a relay tree of that type, having a total number of counting steps (S), a maximum required resistance of  $R_{max}$ , the value of the resistor at Qn is:

$$ResQ_n = 2^n(R_{max})/S$$

For convenience, we'll allow  $R_{max}$  to be 256k, which is well within the tolerance of the circuit. Then:

$$R_{max} = 256000$$

$$S = 64$$

$$R_{max}/S = 256000/64 = 4000$$

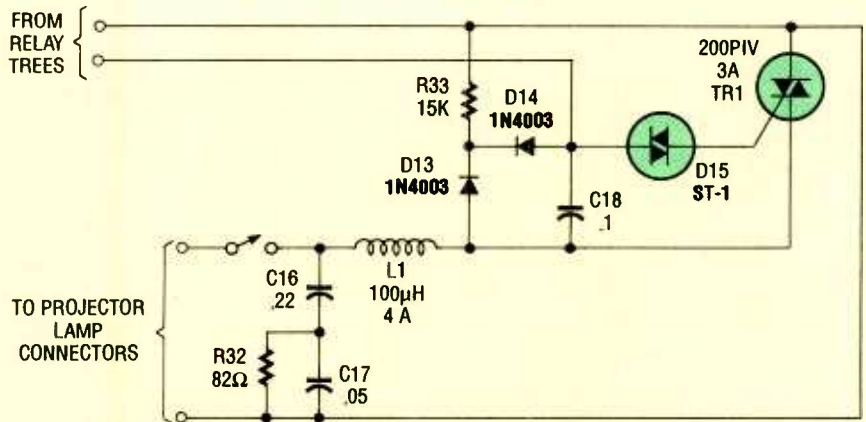

Fig. 5. The Triac lamp dimmer circuits are controlled by the relay trees and they, in turn, control the projector lamps.

The individual resistors are then 1 × 4000 ohms, 2 × 4000 ohms, 4 × 4000 ohms, and so on. The result is a variable resistor that changes in 4000-ohm increments, or 1.56% of the total, with each binary count, which provides a smooth transition of the Triac circuits and the resulting change in the brightness of the projector lamps. Since the resistor values must be close in order for the slide fades to be smooth, and because the multiples of 4000-ohm resistors do not correspond with standard resistor values, potentiometers are used and adjusted to the required values (as indicated in Fig. 4) using an accurate ohmmeter.

**Triac Lamp Dimmers.** Figure 5 shows the schematic diagram for the Triac lamp-dimmer circuit; two such circuit are required (one for each projector). The dimmer circuits are controlled by the relay trees, which, in turn, control the projector lamps. The dimmer circuit (which was taken from General Electric Triac-application literature) differs from the common run of lamp dimmers in that it has extra components to prevent hysteresis effects.

Hysteresis in this application would be disastrous from an aesthetic point of view, since the rate of change in brightness in the up direction would not be the same as in the down direction. In addition, in the up direction, there is a characteristic delay of turn-on until about one-third of the resistance is in the circuit, resulting in a sudden turn-on at partial brightness. The circuit also contains circuitry to prevent RF interference that, in my opinion, no thyristor circuit should be allowed to be without.

**Transfer Relays.** The operation of the Kodak Carousel projectors is electromechanically controlled by switches mounted on the body of the projector or on the remote control. The basic power for that control comes from a 25-volt AC transformer secondary that is actually a winding on the core of the fan motors.

For practical purposes, the fan motor can be considered a transformer as well as a motor. One side of the 25-volt AC winding is connected to the metal body of the projector; thus, the windings on the two projectors must be isolated from each other or, depending on the orientation of the two AC power input plugs, the two windings could be out of phase and effectively in series, placing a potential 50 volts AC between the body of one projector and the body of the other. That's enough voltage to render a very unpleasant shock or, if the two projector bodies should come in direct contact, enough to cause damage to the projectors.

Figure 6 shows the schematic diagram of a section of the Slide Presentation Manager that I call the transfer relays. Those relays provide the required transformer-winding isolation, transfer the remote control functions to the active (full bright) projector, and send a slide-change command to the projector that has just gone full dark.

Relay K14—which is activated by the DIR signal from U6 through relay driver U11—transfers the focus function from one projector to the other. The focus has two directions, of course, so that the lens can be racked in either direction to achieve focus.

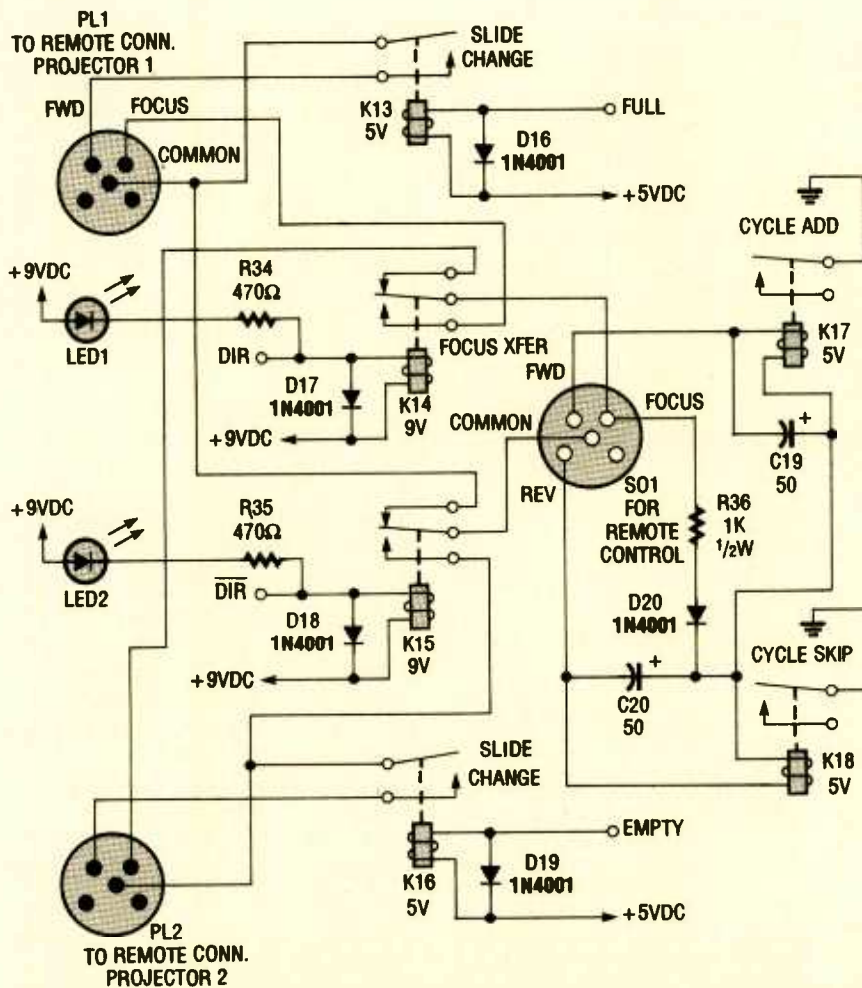

Fig. 6. The transfer relays provide the required transformer-winding isolation, transfer the remote control functions to the active (full bright) projector, and send a slide-change command to the projector that has just gone full dark.

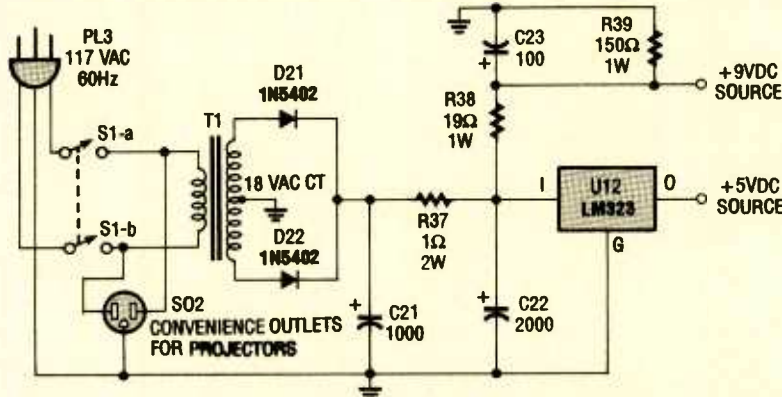

Fig. 7. The power supply for the Slide-Presentation Manager is conventional in every respect. It consists of a fullwave rectifier, RC filter circuit, and a 3-terminal LM323 voltage regulator.

That's accomplished with a single line by means of diodes in the remote control, which apply either a positive or negative DC voltage to the FOCUS line. The focus motor in the projector is a small permanent-magnet unit that runs forward or reverse depending on

the polarity of the voltage applied across it.

Relay K15 selects the common return of the transformer winding of the active projector. It is driven by the inverse DIR signal from U11, a scheme which has no significance except to

provide the most efficient use of the relay driver. Relays K13 and K16 provide the contact closure that causes a slide to be pushed up from the projection gate, the carousel to be advanced one notch, and the new slide to be dropped into the projection gate. Those relays are driven by the FULL and EMPTY signals from U8 through relay driver U11. As stated before, the slide change happens to the projector that has just gone dark, keeping the audience completely unaware of the slide change.

Relays K17 and K18 provide the cycle-add or cycle-skip functions by either triggering a fast cycle or shorting out the FROM TAPE input during a signal arrival, as discussed previously. The circuitry that activates those relays is a little odd because the pushbuttons activating the add cycle or skip cycle are actually in the remote control, labeled FOR and REV, respectively.

One side of those switches is connected to the common of the projector's 25-volt AC windings and so the relays must be driven by that source. We get into the other side of the winding through the focus line, which means that current to activate K17 or K18 actually passes through the winding of the focus motor. However, the relays require only 30 mA and are fed through R36, which is not sufficient to cause the focus motor to turn. The 25 volts AC, being dropped by R36, is half-wave rectified by D20 and applied to one side of both relays, each of which has its own 50- $\mu$ F filter capacitor.

Pressing either the FOR or REV button on the remote completes the circuit to the common of the active projector and closes the appropriate relay to provide either an added cycle or a skipped cycle. Sharp-eyed readers will notice that if the focus control is activated in either direction, neither K17 nor K18 can be activated—an unlikely event since it would require two thumbs to operate the remote control in that manner.

**Power Supply.** Figure 7 shows the schematic diagram of the power supply for the Slide-Presentation Manager. The power supply, conventional in every respect, consists of a fullwave rectifier, RC filter circuit, and a 3-terminal LM323 voltage regulator. Nine volts DC for some of the transfer relays



## PARTS LIST FOR THE SLIDE PRESENTATION MANAGER

### SEMICONDUCTORS

U1-U3—LM567 tone decoder, integrated circuit  
 U4—SN5493 4-bit binary counter, integrated circuit  
 U5—PAL16L8 programmable-logic device, integrated circuit, see text  
 U6, U7—PAL16R4 programmable-logic device, integrated circuit, see text  
 U8—PAL16R6 programmable-logic device, integrated circuit, see text  
 U9-U11—SN75492 MOS-to-LED hex digit-driver, integrated circuit, see text  
 U12—LM323 5-volt, 3-amp, positive-voltage regulator, integrated circuit  
 TR1—200-PIV, 3A Triac  
 D1-D12, D16-D20—1N4001 1-amp, 50-PIV, silicon-rectifier diode  
 D13, D14—1N4003 1-amp, 200-PIV, silicon-rectifier diode  
 D15—ST-1 diac  
 D21, D22—1N5402, 3-amp, 200-PIV, silicon-rectifier diode  
 LED1, LED2—Light-emitting diode

### RESISTORS

(All fixed resistors are 1/4-watt, 5% units, unless otherwise noted.)  
 R1, R4—15,000-ohm  
 R2, R5, R7, R25, R31—5000-ohm potentiometer  
 R3—50,000-ohm linear potentiometer  
 R6, R8, R16, R17—33,000-ohm  
 R9-R11—1000-ohm  
 R12-R14—2700-ohm

R15—47,000-ohm  
 R18, R19—150,000-ohm  
 R20, R26—200,000-ohm potentiometer  
 R21, R27—100,000-ohm potentiometer  
 R22, R28—50,000-ohm potentiometer  
 R23, R29—20,000-ohm potentiometer  
 R24, R30—10,000-ohm potentiometer  
 R32—82-ohm, 1/2-watt  
 R33—15,000-ohm, 1/2-watt  
 R34, R35—470-ohm  
 R36—1000-ohm, 1/2-watt  
 R37—1-ohm, 2-watt  
 R38—19-ohm, 1-watt  
 R39—150-ohm, 1-watt

### CAPACITORS

C1, C3, C10, C15—4.7- $\mu$ F, 10-WVDC, tantalum  
 C2—1- $\mu$ F, 10-WVDC, tantalum  
 C4, C5—2.2- $\mu$ F, 10-WVDC, tantalum  
 C6, C9, C13, C14—10- $\mu$ F, 10-WVDC, tantalum  
 C7, C8—3.3- $\mu$ F, 10-WVDC, tantalum  
 C11—0.47- $\mu$ F, 10-WVDC, tantalum  
 C12—22- $\mu$ F, 10-WVDC, tantalum  
 C16—0.22- $\mu$ F, ceramic-disc  
 C17—0.05- $\mu$ F, ceramic-disc  
 C18—0.1- $\mu$ F, ceramic-disc  
 C19, C20—50- $\mu$ F, 10-WVDC, electrolytic

C21—1000- $\mu$ F, 16-WVDC, electrolytic  
 C22—2000- $\mu$ F, 16-WVDC, electrolytic  
 C23—100- $\mu$ F, 16-WVDC, electrolytic

### ADDITIONAL PARTS AND MATERIALS

K1-K12—SPST 5-volt, 30-mA reed relay  
 K14-K15—SPDT 9-volt, 20-mA relay  
 K13, K16-K18—SPST 5-volt, 30-mA relay  
 L1—100- $\mu$ H, 4-amp, coil  
 T1—18-volt center-tapped step-down transformer  
 J1, J2—Stereo phono jack  
 PL1, PL2—5-conductor plug (see text)  
 PL3—117-volt molded AC power plug with line cord  
 SO1—5-conductor socket (see text)  
 SO2—117-volt AC power socket  
 S1—DPST toggle switch  
 Perfbord materials, enclosure, wire, solder, hardware, etc.

**Note:** A set of four PLD's (U5-U8) pre-programmed as COMCON, CLOCKCON, TAPESIG, and COUNT64 are available from the author for \$25.00, postage paid. Send check or money order to: J. A. Nunley, 1515-108 No. Milpitas Blvd., Milpitas, CA 95035. All checks will be held for 10 days to clear. California residents, please add appropriate sales tax.

is furnished unregulated by the voltage divider consisting of R38 and R39 and filtered by C23. The power switch is shown as switching both sides of the 117 volt AC input.

The significance of that is to disconnect both sides of the convenience outlets for the projectors as a safety measure. When the projectors are connected to the AC line, AC appears at the two-pin projector-lamp connectors. Those connectors, at least the ones on my projectors, are not the latest thing in fool-proof safety.

It would be possible, when making connections to these pin-type jacks, to touch a live conductor. It is imperative that connections to and disconnections from the lamp connectors be made with all power removed. The best way to assure that is to connect the projectors to the convenience

outlets on the Slide-Presentation Manager, then when connecting or disconnecting the lamp connectors, first make sure the AC power switch is off.

**PLD's.** For readers who are interested in learning more about the PLD's or perhaps wish to program their own, a brief tutorial on PLD's and how they are programmed, copies of the actual software coding used to create the PLD's in the four different configurations, and copies of the standard JEDEC fuse maps that are used to burn-in the PLD's, is available from J. A. Nunley, 1515-108 No. Milpitas Blvd., Milpitas, CA 95035 for \$8.00 check or money order (includes postage and handling).

Be forewarned, however, that programming the PLD's requires access to an IBM personal computer (or

compatible) and a compatible PLD programmer in which the blank chips are installed for the actual burn-in.

**Construction.** The main logic and relay sections of the Slide Presentation Manager were assembled on a 6- by 8-inch perforated board. The IC sockets were secured to the board, each by a single 2-56 screw and nut. The other components are held in place by their leads, which pass through the perforations and are bent so as to hold them in place. After the circuits were wired and tested, to be reasonably sure none of the components would have to be replaced, they were further secured to the board with a small dab of hot-melt glue.

Connections to the power supply, the Triac circuits, and the many leads

(Continued on page 89)

# ANTIQUUE RADIO

By Marc Ellis

## Mailbag Time Once More!

**N**ow that the Hallicrafters Sky Buddy restoration project is wrapped up, we can turn our attention once more to the mailbag. Quite a few interesting letters have been waiting in the wings for the past few months. So, without further ado, let's wade right in!

### DEDICATED SKY BUDDY OWNER

We'll start off with a note I received from *Gerald Hassell* (Shirley, NY). Gerald was an original Sky Buddy owner, having purchased his new back in the 1930's. He used the radio for sev-

er years, and says its fine reception kept him listening into the wee hours on many an evening. But eventually,

it fell into disuse and was stored for a long time in a damp location. When Gerry began to use the Sky Buddy again, he found that its performance was lackluster and that the RF and oscillator circuits wouldn't respond to his attempts at realignment. (Sounds very much like the problems I was having during my own Sky Buddy restoration project.) He figured that the alignment problems were being caused by moisture that had become absorbed into the wax-coated RF and oscillator coils.

Gerry's next move was something you'd really have to love a radio to do. Carefully desoldering the multiple connections to both coils, he removed the units and immersed them for about an hour in a bath of hot (but not boiling) beeswax. While he was at it, he also replaced all of the original wax-coated paper capacitors.

The beeswax treatment seems to have been quite effective in driving out the moisture because, after re-assembling the set, Gerry was able to realign it properly. When he was through, he reports, the Sky Buddy was performing like new.

### CAPACITOR CONTROVERSY

Speaking of those wax-coated paper capacitors, a while back I printed a (mild) rebuttal to some comments about them received from reader *Greg Lindsey* (1823 East Beaver St., Jacksonville, FL 32202). Greg had indicated (and his philosophy is

shared by many restorers) that he wouldn't want to begin troubleshooting an old radio until he'd replaced all such capacitors with new ones.

Greg also said that he preferred not to bother with the restorer's technique of "re-forming" electrolytic capacitors in long-unused sets (by building up the line voltage slowly when first starting up). While conceding that the method yields short-term results, he felt that such capacitors couldn't be trusted in the long term. Replacing the old units immediately would be safer, preventing them from burning out unexpectedly and taking hard-to-replace components with them.

While not really disputing Greg's point about the unreliability of the old capacitors, I went on record as saying that my approach is more conservative. I like to retain as many old components as possible for the sake of authenticity. I also enjoy troubleshooting individual problems in a logical manner, a challenge that would be sidestepped through wholesale replacement of old parts with new.

Recently I got another, more detailed, letter from Greg, who wanted to respond to my remarks. Greg says that his original reason for writing was not so much to advocate a particular approach, but rather to call attention to these capacitor issues for the benefit of newcomers to the hobby.

His own point of view, he admits, tends to be that of

**MOBILE  
RCVRS  
\$5.95**  
•  
**XMTRS  
\$9.95**

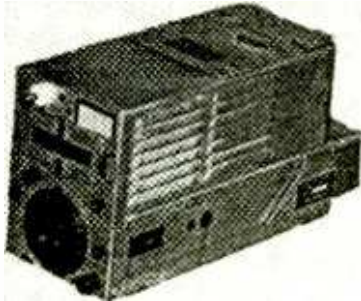

**RCVRS** Great for stand-by on 40-80 meters; phone or CW; ample band-spread; complete with 6 tubes

BC-454-B 3- 6 MC \$5.95

BC-455-B 6- 9.1 MC each

**XMTRS** Furnished with 4 tubes, including 1629 magic eye, 1626, and 2-1625's; also calibrating crystal.

BC-696-A 3-4 MC 9.95  
Shipping Wt. — rcvr or xmtr — 15 lbs. ea.

*Detail from 1947 ad for surplus ARC-5 receivers and transmitters of the type sought by Richard Arland. I'll bet there'd still be quite a good market at these prices!*



the repairman. Greg has a part-time business restoring vintage tube-type equipment, including radios, hi-fi's, TV's, and test gear. (In fact, you might like to contact him at the address given above if you could use some professional help in this area). If someone pays him good money to restore a set, and then expects to use that radio or TV on a regular basis, Greg is not going to be conservative about replacing questionable capacitors.

But besides being a professional restorer, Greg also has a personal radio collection, and he certainly understands the "purists'" point of view. If you want to keep a set as original as possible, are not going to play it that often, and have the know-how and time to pin-point troubles as they come up, that's fine.

Since video circuitry is much less forgiving than radio circuitry, Greg definitely favors "en masse" replacement of paper and electrolytic capacitors during restoration of vintage TV's. Otherwise, you may well be faced with difficult-to-correct cases of rolling, "tearing," jitters, and the other unpleasant maladies to which the TV picture is prone. Thanks a lot for the thoughtful follow-up letter, Greg!

I'd also like to acknowledge the note I received from *Harry Alenik* (Hawthorne, CA) who, responding to Greg's original letter, indicated that he was in agreement. Harry writes that he usually replaces all of the capacitors before powering up a newly-acquired set for the first time.

## WORLD WAR II ECHOES

During the just-completed Sky Buddy restoration project, and also during the Echophone EC1

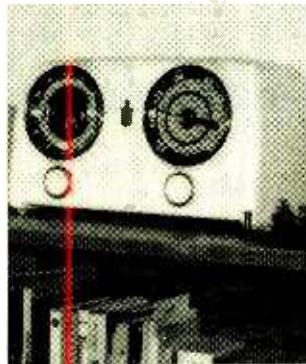

Reader *D.W. Naylor* used auto body repair materials to fill holes and cracks in the cabinet of this neatly restored Crosley clock radio.

restoration completed some years ago, I found instances where a shortwave band had been disabled by clipping band-switch wires. I had heard that, during World War II, the government had issued a directive to radio-service shops requiring them to disable certain shortwave bands on sets brought in for repair. During both restoration projects, I asked readers who had more information about this directive to write in.

Nobody contacted me during the Echophone project, but I recently received some information from *M.E. Ritcha* (Pomona, CA), who had worked in a radio repair shop after serving in the Navy during the war. He knew of one government directive requiring disablement of shortwave bands on civilian radios, but it applied only to sets belonging to those people of Japanese extraction who were interned in West Coast camps during the conflict. Ritcha recalls that he and the re-

pair-shop owner restored many of the sets to normal operation after the war at no charge.

I also heard from *Bob Baketz* (Elgin, IL), who reports that he found the 1.7–5.5-MHz band disabled on a Howard Model 368 radio that he restored a few years ago. And since the two sets that I found disabled in this manner were also collected at Midwest locations, I have to assume that there were other government directives besides the one affecting sets at the West Coast camps. Anyone else with info to share?

While we're on a World War II kick, *Richard Arland* (P.O. Box 1691, Wilkes-Barre, PA 18703) writes that his current project is to put together a 1950's-era ham station using the World War II surplus ARC-5 aircraft gear that was so inexpensive and commonly available during the first decade or so after the war's end. Write to Richard if you have any ARC-5 transmitters or receivers you'd like to sell. He's also looking for a copy of the paperback book *Surplus Conversion Handbook* published by *CQ Magazine* during the 1960's and 1970's.

## TIPS AND TECHNIQUES

When *D.W. Naylor* (Ossawatimie, KS) went to work on an old Crosley plastic-case clock radio, he looked through back issues of this column to find some advice on repairing the cracked and broken cabinet. Failing to find any help

from that normally reliable source, he worked out his own method—which he'd like to share with our readers.

The basic materials used were a Fiberglas auto-body repair kit (NAPA #765-1281) and some polyester auto-body filler (NAPA #6372). The Fiberglas was used to back up a large (¼ × 2-inch) hole; the filler was used to fill the hole and the cracks. The repaired surfaces were smoothed by milling with a router bit mounted in a drill press, then sanding with medium and fine sandpaper. Finally he applied three coats of white Krylon to the entire cabinet.

Thanks for the photo of the fine-looking result, Mr. Naylor. Future readers who may want to browse this column for hints on plastic-cabinet repair will also thank you!

Another good tip was received from reader *C.R. Zinck* (Halifax, N.S. Canada). And this one really speaks to me, personally.

After losing an expensive set of antique 1.1-volt tubes to a voltage surge caused by a shorted rectifier in his DC power supply, Mr. Zinck built up the little protective circuit of Fig. 1. It's commonly known as a "crowbar," and is intended to be connected between the power supply and the filament circuit.

Operation is simplicity itself. The diode string is connected "backward" across the power supply and so normally doesn't conduct. However, if the supply voltage should accidentally rise due to operator error or a failed part, the diodes in the string would become "swamped" and begin conducting before the voltage reached a dangerous level. That would  
(Continued on page 91)

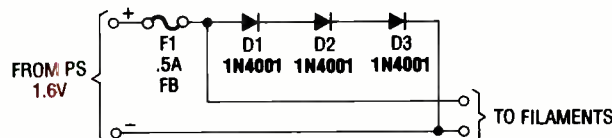

Fig. 1. *C.R. Zinck's* simple "crowbar" circuit will blow its fuse should the supply voltage become too high, thus protecting delicate 1.1-volt tubes (see text).

# COMPUTER BITS

By Jeff Holtzman

## Language And The Computer

**W**e Americans are really bad about learning foreign languages. And in a world of rapidly increasing global economic interdependence, that is not good. The reasons why are clear. Historically, the U.S. was populated by immigrants whose main desire was to assimilate into the mainstream of society. Even today, some second- and third-generation Americans often feel embarrassed when their parents or grandparents speak in their native language

On the other hand, all

several counts. First, it puts us at a severe economic disadvantage. For example, the automobile and computer industries (to name just a few) heavily depend on foreign suppliers for components and sub-assemblies. Going the other way, the U.S. desperately needs to improve its balance of trade by increasing exports. But how can we convince another country to allow our goods to be sold there if we can't even speak the language?

Second, the world's scientific research is neither conducted nor published exclusively in English. How can we be aware of, avoid duplicating, and simply take advantage of this research if we cannot read other languages? Third, our comprehension of past scientific achievement is limited by the translations that we read. Would we not be able to learn more and more accurately if we were able to read Andra-Marie Ampere, Jean B. J. Fourier, Carl Friedrich Gauss, Heinrich Hertz, and Alessandro Volta (to name just a few of interest to **Popular Electronics** readers) in the original French, German, and Italian languages?

Fourth, there is a tremendous mass of cultural artifacts comprising art, literature, music, and film that could bring great joy and pleasure if we could only experience them in their native forms.

Assuming that you buy the idea that learning a foreign language can be culturally and economically advantageous, what next? This is, after all, a column

about computer technology. What, if anything, can the computer do to aid the process of learning foreign languages?

### LANGUAGE LEARNING TOOLS

Quite a lot, as it turns out, with more on the way. Recently I've had the pleasure of using two computer-based, language-learning tools: French Assistant by Microtac Software, and Transparent Language, by the company of the same name. In addition to French, Microtac has developed "assistants" for Spanish, Italian, and German. Transparent Language has modules for Spanish, German, French, Italian, and Latin; in addition, Russian should be available by the time you read this. Transparent Language is available for PC's and Mac's; the Assistant series is available for PC's only. This time and next, I'll examine the strengths and weaknesses of these programs, and indicate future directions for these types of learning aids.

To begin, understand that Transparent Language and the Microtac Assistants cover different ground. Transparent Language aims to teach by having you read annotated foreign-language text. There are no grammar lessons, no declensions or conjugations to memorize, just real stories by real authors, along with a sophisticated but extremely easy-to-use help system that translates the meanings of words, phrases, and clauses; and

(Continued on page 84)



*Transparent Language helps you to acquire a language by having you read real stories by real authors in the original language, complete with extensive vocabulary and grammar help. This program is an excellent supplement to a traditional classroom approach.*

major cities, and many minor ones, have isolated enclaves of people who speak Spanish, Korean, Chinese, Japanese, Italian, Serbian, and other languages better than—and often to the exclusion of—English. Nonetheless, mainstream society still frowns on the use of other tongues in business, educational, and social settings.

The lack of language skills hinders our ability to communicate with our peers in other countries, and that is unfortunate on



# CIRCUIT CIRCUS

By Charles D. Rakes

## An Introduction to Hall-Effect Switches

During this month's visit, we're going to introduce you to a device that's based on a century old discovery—made in 1879 by E.H. Hall—which with today's modern integrated-circuit technology has been transformed into a rather versatile semiconductor. E.H. Hall's findings indicated that a small voltage was developed across a current carrying conductor when placed in a strong magnetic field. The current resulted from negative charges within the conductor being deflected by the magnetic field, thereby producing a small potential difference

tsdale, AZ 85271-3203; Tel. 800-467-7736 or 800-423-007) for \$.98.—are comprised of a Hall-voltage generator, a signal amplifier, a Schmitt trigger, and a transistor-output circuit all contained within a three-terminal, integrated-circuit chip.

Figure 1 is a block pinout diagram of Sprague Electric's UGN-3113U Hall-effect switch, which is used in all of the circuits presented this month. The UGN-3113U is a magnetically operated, solid-state Hall-effect switch whose output transistor is normally off until a magnetic field exceeds the device's specified operating point. Once that point is reached, the output transistor—which will sink 15 mA of current—switches on. The output transistor remains on until the activating field drops below the specified release point, which is lower than the operating point.

Figure 2 illustrates the Hall-effect switch's sensitive area (on the face side), which is activated by bring-

ing the south pole of a permanent magnet within a specified distance of the device.

### A SIMPLE SWITCH

When connected, as shown in Fig. 3, with no magnetic field present, the output transistor is off (open circuited), so no ground path through the output transistor is provided, thus, LED1 remains dark. If, however, the south pole of a permanent magnet is brought in proximity to the sensor area (within about 0.18 inches of its face), as shown Fig. 4, the Hall-effect

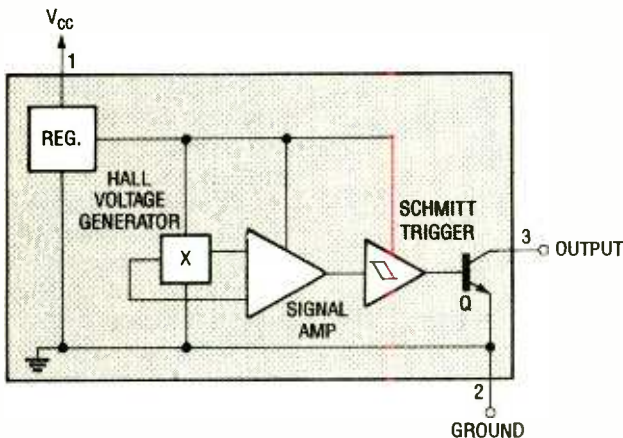

Fig. 1. The UGN-3113U is a magnetically operated, solid-state Hall-effect switch comprised of a Hall-voltage generator, a signal amplifier, a Schmitt trigger, and a transistor-output circuit, as shown by this block pinout diagram.

across the conductor. That phenomena came to be known as the Hall voltage.

Sprague Electric produces a line of Hall-effect switches that are user friendly, low cost, and can be an ideal replacement for the "stuttering" mechanical reed relay. The Sprague Hall-effect switches—which are available from D.C. Electronics (P.O. 3203, Scot-

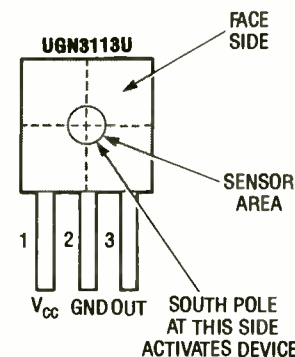

Fig. 2. In operation, the UGN-3113U Hall-effect switch is activated by bringing the south pole of a permanent magnet within a specified distance of the device's sensitive area (located on the face side).

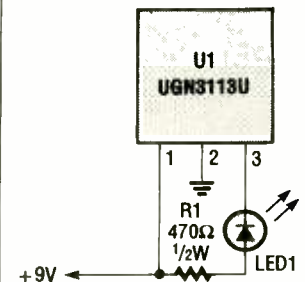

Fig. 3. When U1 is connected as shown and no magnetic field present, the output transistor is off (open circuited), so no ground path through the output transistor is provided, thus, LED1 remains dark.

IC's output transistor turns on, completing the ground path for LED1, causing it to light.

The IC's built-in hysteresis causes the output transistor to remain on until the magnet is moved about 0.25 inches away before turning off. That feature keeps the IC from being triggered by magnetic fields from other electrical devices. But any magnetic field strong enough and in close-enough proximity to the IC

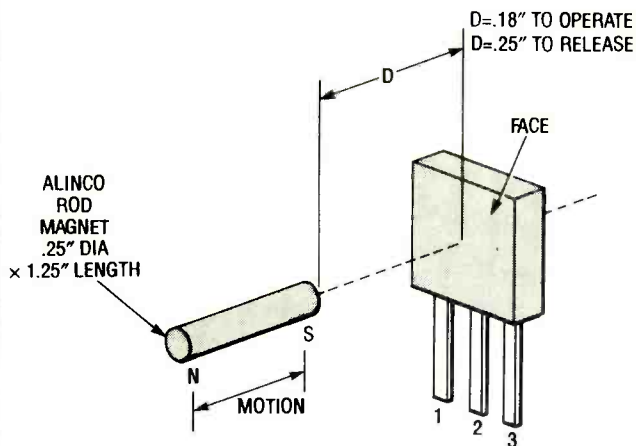

Fig. 4. If the south pole of a permanent magnet is brought in proximity to the sensor area (within about .18 inches of its face), as shown here, the Hall-effect switch's output transistor turns on, completing the ground path for LED1, causing it to light.

### PARTS LIST FOR THE SIMPLE SWITCH

- U1—UGN3113U Hall-effect digital switch, integrated circuit
- LED1—Light-emitting diode (any color)
- R1—470-ohm 1/2-watt, 5% resistor
- Perfboard materials, enclosure, 9–12-volt power source, wire, solder, hardware, etc.

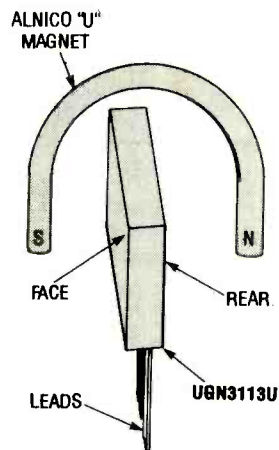

Fig. 5. By placing a strong horseshoe magnet over the IC, with the south pole at the face and the north pole at the rear, a very strong concentrated field flows through the IC, causing it to switch on at a much greater distance.

will cause it to activate. The actual flux density needed to operate the IC at a distance of about 0.18 inches is about 450 to 500

gauss. Stronger magnetic fields will activate the switch at greater distances and, of course, less powerful magnetic fields will lessen the trigger distance.

By placing a strong horseshoe magnet over the IC, as shown in Fig. 5, with the south pole at the face and the north pole at the rear, a very strong concentrated field flows through the IC, causing it to switch on at a much greater distance.

### LATCHING CIRCUIT

A simple latching circuit is shown in Fig. 6. In that illustration, a magnet is placed with the north pole facing the rear of the IC in a fixed position just far enough from the IC so as not to activate it, but close enough to hold it on when activated from the face side. When the south pole of another magnet is

moved toward the face of the IC, the output transistor switches on and remains on even after the second (movable) magnet is moved out of position. The circuit may be reset by operating S1 or by reversing the pole of the movable magnet.

The Hall-effect IC is primarily designed to operate as a bounce-less, magnetic on/off switch. That circuit feature overcomes the chatter problems that often occur when using a magnetically operated reed switch. Applications for the Hall-effect switch include its use in a timing sensor for a gas-engine ignition system; as a mechanical-motion or position-limit switch; as a keyboard switch, current

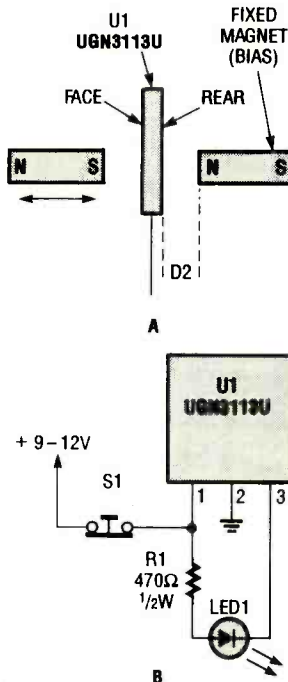

Fig. 6. In this simple latching circuit, a magnet is placed in a fixed position with the north pole facing the rear of the IC. When another magnet (with the south pole face the front of the IC) is moved toward IC, the output transistor switches on and remains on even after the second magnet is moved out of position.

sensor; as a position sensor; in security systems, etc.

### HALL-EFFECT OSCILLATOR

The circuit in Fig. 7 places the Hall-effect IC in an application far from its intended use. Normally for the IC to detect a magnetic field, the spacing between the magnet and the IC must be close. The same magnet when used with our magnetic-regeneration circuit can be detected up to 1 foot away—an increase in distance of over 100 times—and the magnet's pole position will be indicated.

In the circuit of Fig. 7A, a 20- to 30-ohm relay coil (L1) is placed with one end (pole) flush against the rear of the IC (as illustrated in Fig. 7B). The gate of Q1 (an IRF511 hexFET) is connected to the output of the Hall-effect IC. A piezo speaker (SPKR1) is also connected to the IC's output. Coil L1 is connected between the hexFET's drain and positive-supply source.

At the instant that power is applied to the circuit, the IC detects no magnetic field, so its the output at pin 3 is high. That high is applied to the gate of Q1, turning it on, which, in turn, provides a path to ground for the relay coil (L1). The current through L1 produces a strong magnetic (north-pole) field at the rear of U1, turning it on, which pulls U1's output to ground. That removes the high input signal from the gate of Q1, causing it to turn off, which prevents current flow through L1.

With no current flow through L1, the magnetic field associated with L1 collapses. That, in turn, causes U1's output at pin 3 to go high, and the cycle starts over again, producing an oscillating effect. The piezo



## PARTS LIST FOR THE LATCHING CIRCUIT

U1—UGN3113U Hall-effect digital switch, integrated circuit  
 LED1—Light-emitting diode (any color)  
 R1—470-ohm 1/2-watt, 5% resistor  
 S1—Normally closed pushbutton switch  
 Perfboard materials, enclosure, 9–12-volt power source, wire, solder, hardware, etc.

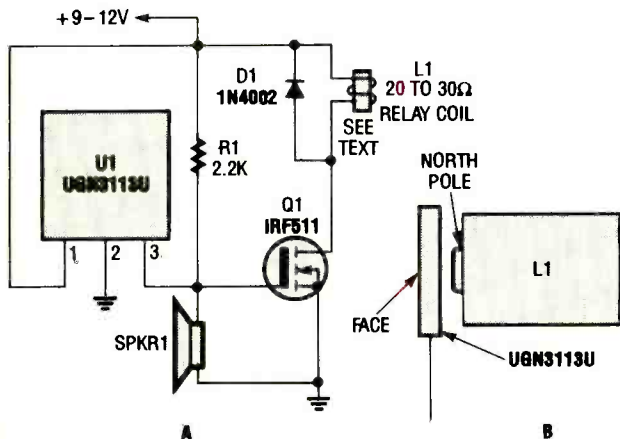

Fig. 7. While not intended for this application, Hall-effect switch can be used as the basis for a rather unusual oscillator, as shown here.

speaker, SPKR1, clicks for each cycle of oscillation. If no oscillation occurs, reverse the leads going to L1. Backing L1 away from the IC should cause the clicks coming from the piezo speaker to be heard less frequently; back L1 off until the clicks occur at a rate of about 1 per second (1 Hz). Then move the magnet toward the face of the IC and note the change in the oscillator's frequency. A magnet with its south pole facing the front of the IC will increase the output frequency as it approaches the IC; the north pole facing the front should decrease the frequency.

The circuit's actual operating voltage depends on the magnetic field generated by L1. A low resistance coil should produce a sufficient field with a lower voltage, power supply, while a higher resistance coil will need a higher supply voltage to trigger the

circuit. The Hall-effect switch can be powered from a supply ranging from 4.5 to 24 volts.

## RC OSCILLATOR

Another version of the regeneration (oscillator) circuit is shown in Fig. 8. Everything in that circuit remains pretty much the same as in the previous

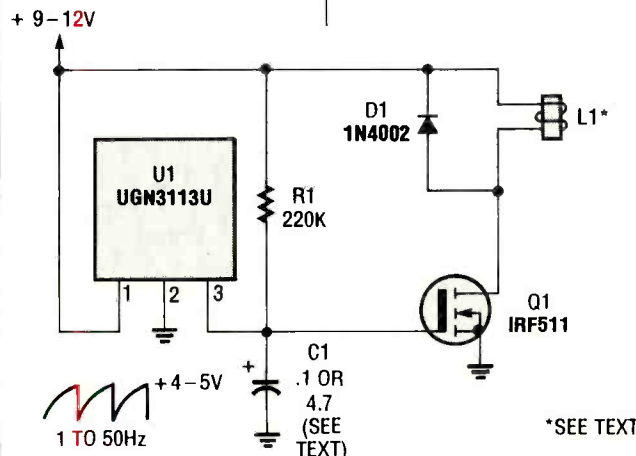

Fig. 8. The oscillator of the previous circuit can be reconfigured, as shown here, so as to allow the circuit's oscillating frequency to be controlled via an RC network, comprised of R1 and C1.

## PARTS LIST FOR THE HALL-EFFECT OSCILLATOR

### SEMICONDUCTORS

U1—UGN3113U Hall-effect digital switch, integrated circuit  
 Q1—IRF511 hexFET  
 D1—1N4002 1-amp, 100-PIV, rectifier diode

### ADDITIONAL PARTS AND MATERIALS

R1—2200-ohm, 1/4-watt, 5% resistor  
 L1—20-to-30-ohm relay coil (see text)  
 SPKR1—Piezo speaker, (Radio Shack #40-1383)  
 Perfboard materials, enclosure, 9–12-volt power source, wire, solder, hardware, etc.

## PARTS LIST FOR THE RC OSCILLATOR

### SEMICONDUCTORS

U1—UGN3113U Hall-effect digital switch, integrated circuit  
 Q1—IRF511 hexFET  
 D1—1N4002 1-amp, 100-PIV rectifier diode

### ADDITIONAL PARTS AND MATERIALS

R1—220,000-ohm, 1/2-watt, 5% resistor  
 C1—0.1–4.7- $\mu$ F, 35-WVDC, ceramic-disc or electrolytic capacitor (see text)  
 L1—20-to-30-ohm relay coil (see text)  
 Perfboard materials, 9–12-volt power source, wire, solder, hardware, etc.

circuit except that the IC's pull-up resistor (R1) has been increased from 2.2k to 220k and a timing capacitor (C1) has replaced the speaker.

When power is first applied to the circuit, U1 detects no magnetic field,

thus its output transistor remains at cut-off, and the full voltage of the power source appears at pin 3 (the output) of U1. Because, upon application of power, C1 initially acts as a short, Q1's gate is initially grounded through C1, so it remains at cutoff. The RC time constant of R1 and C1 (which can range between 0.1 and 4.7  $\mu$ F) will determine the time it takes the voltage across C1 to rise to a level that will turn on Q1. The current drain during the charging time is very low, making the circuit suitable for battery operation. The oscillator's output is sawtooth that varies from near 0 to about 5 volts. Adjust L1's position as in the previous circuit to vary the operating frequency of the oscillator.

That's all for now; see you here next time. ■

# THINK TANK

By John J. Yacono

## Chips And Tips

As promised last month, we'll take a look at the characteristics of various IC architectures. We will focus on the bipolar-logic family this month. Following that, I'll present the results of our "Computer coverage: more/less/fine?" poll.

This month's letters, which will follow the poll results, all deal with technical tips. By

tion for high operating speed. That has lead to a diversity of chip architectures, each having its own strengths and weaknesses. It is left to the circuit designer to decide which type is suitable to each application.

Rather than discuss the physical attributes that make the architectures dis-

can be further divided into emitter-coupled logic (ECL), resistor/transistor logic (RTL), diode/transistor logic (DTL), and transistor/transistor logic (TTL). The RTL and DTL formats are seldom used today, so I won't cover them. And while ECL products are still in vogue, they are only needed in the fastest circuits (with gate delays on the order of 100 or so picoseconds) and they dissipate significant amounts of power. Let's just say that they're not cut-out to be used as hobbyist parts.

However, TTL parts are overwhelmingly popular not only in industry but among hobbyists as well. They come in a variety of architectures each with its own inherent design trade-offs. That diversity is mostly responsible for TTL's widespread use; you can usually find a chip with a suitable speed/power-dissipation trade off for most applications from within this family.

In fact, the only time you must stray from the TTL series is when power dissipation is critically important (such as in portable devices composed of many logical devices). For such applications CMOS must be used. To summarize, the key advantage to using TTL over CMOS is speed; the key drawback is higher power dissipation (in the form of high current levels and heat).

Two series of chips form the TTL family: those prefixed with the number 74 and those beginning with 54. The only differences between the two series is their temperature range for guaranteed operation: 74-

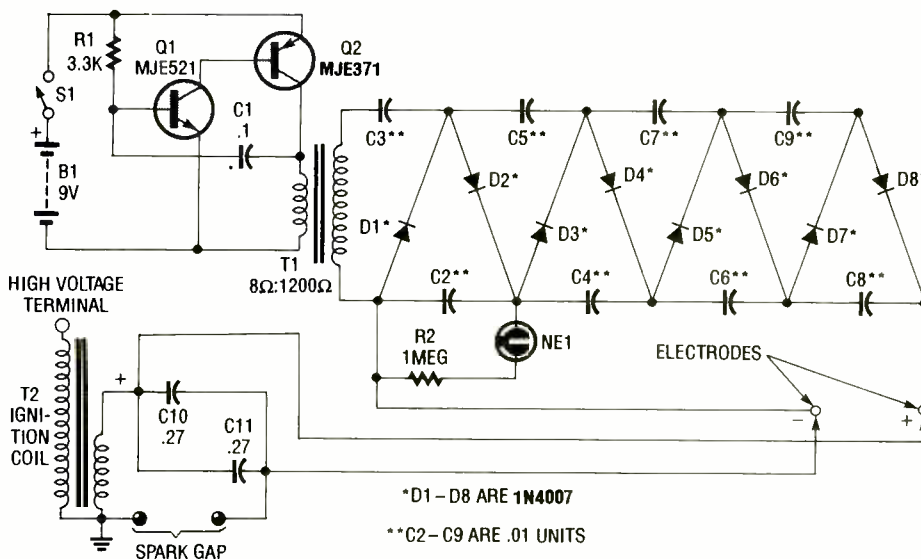

Fig. 1. This high-voltage circuit (based on a project that appeared in this magazine a couple of years ago) looks pretty lethal and probably is. Use it with great caution.

the way, from the looks of the mail I've received, we're in for some interesting topical columns for some months to come. For now, just sit back, relax, and follow along as I present an overview of the bipolar family of chips.

### UNDER THE HOOD

Life is a matter of give and take. In engineering, that becomes evident when one has to make a design compromise. For example, when selecting chips, a designer might sacrifice low-power opera-

tion (which would get really complicated, not to mention boring, really fast), I will present the names of the different chip styles and, in future columns, compare their operating characteristics. After all, it's things like current consumption, power dissipation, and load handling that determine which chip you'll use in a design; you need not know what's inside the device.

As mentioned some columns ago, logic IC's can be divided into two main categories: bipolar and CMOS. The bipolar-logic group



series chips operate from –55 to 125°C, but 54-series devices are only useful from 0 to 70°C. Obviously for hobbyist applications, which seldom fall outside either temperature range, it hardly matters if you select a part from one family or the other.

Next month we will break the 54- and 74-series chips into smaller groups still. However for now, let me present the results of our informal poll.

### POLL RESULTS

Well, the poll mail has trickled down to the point where I feel comfortable tabulating the results (I doubt I'll get many more cards or letters about it). The smallest percentage of people (18.18% to be exact) wanted more computer coverage. The next-highest percentage of readers (27.27%) wanted less. The greatest percentage, and a slight majority over both of the other categories combined, of you (54.54%) liked things the way they are!

Whew, what a relief, especially when one considers that the typical

**WARNING!!!** This article deals with and involves subject matter and the use of materials and substances that may be hazardous to health and life. Do not attempt to implement or use the information contained herein, unless you are experienced and skilled with respect to such subject matter, materials, and substances. Neither the publisher nor the author make any representations as for the completeness or the accuracy of the information contained herein, and disclaim any liability for damages or injuries, whether caused by or arising from the lack of completeness, inaccuracies of the information, misinterpretations of the directions, misapplication of the information or otherwise.

*Think Tank* reader would probably have a default preference for discrete electronics, as opposed to computers. Perhaps that accounts for the fact that the "less" group is larger than the "more" group. Regardless, it's nice to know that we're pulling off this tricky balancing act fairly well.

All the demographics aside, let's turn our attention to this month's letters. There's one stray letter left over from last month's topic (high voltage), so let's get to that before moving on to the technical-tip letters.

### IT'S JUST SHOCKING!

I have been reading your column of *Think Tank* for some time now and I have always wanted to contribute something of my own. However, I am not an electronics engineer or a technical anything so I knew that this would never be, or so I thought.

One day I was browsing through a magazine rack (about four years ago) looking for something to read. I like science articles, so I picked up a few magazines and one of them was *Hands-On Electronics*, April 1988. I thought it was okay, so I bought the May issue and I thought that was okay, too. It wasn't until the end of July 1988 that (for reasons unknown to me) I had this uncontrollable feeling I should buy another one of your magazines. I bought every electronics magazine since including *Radio Electronics*, *Experimenters Handbook*, *Hobbyist Handbook*, *Modern Electronics*, and *Elementary Electronics*.

Today, I have a complete library from mathematics to Ku-Band satellite TV in every field of electronics. I've assembled as complete a laboratory as needed for my experiments. I have a

complete IBM PC XT computer system full of programs necessary for design work (including some programs written in basic that I designed myself).

The field that interests me most is high-voltage, high-frequency electronics. I built a Tesla coil (**Popular Electronics** September 1990) that I use in some of my experiments. The output is too high for some experiments, so I picked up a violet-ray generator (**Popular Electronics** February 1990). It worked fine, that is until I tried to couple it to an unmatched circuit which, through my own fault, overloaded the secondary coil, causing it to short circuit, rendering the violet ray generator useless. I did manage to correct the problem somewhat, but the power output was never

quite the same. So I needed to design something else.

I gathered up some parts from my junkbox and dug up a circuit that I assembled about 14 months back. It was a high-voltage output, 9-volt battery-supplied stun gun (*Electronics Experimenters Handbook*, 1990, "High Voltage Projects," page 45). I can tell you from experience that it works. And it works well, so be careful! I placed two automobile condensers parallel to each other across the output of the voltage multiplier (see Fig. 1). I connected the end with the wire to the distributor terminal of an automobile coil and the other end in series with a spark gap to the battery terminal. The battery terminal is then grounded.

## LEARN VCR

Cleaning/Maintenance/Repair  
Earn up to \$1000 a Week, Working Part Time from Your Own Home!



Secrets Revealed! . . .  
**NO Special Tools or Equipment Needed . . .**  
Train at Home in Your Spare Time!

IF you are able to work with common small hand tools. IF you possess average mechanical ability, and have a VCR on which to practice and learn... then we can teach YOU VCR Maintenance and Repair!  
**FACT:** Up to 90% of all VCR malfunctions are due to simple Mechanical or Electro-Mechanical breakdowns!  
**FACT:** Over 86 million VCRs in use nationwide! Average VCR needs service or repair every 12 to 18 months!

### For FREE Information Package!

Send coupon to: Foley-Belsaw Institute of VCR Repair, Dept. 62026, 6301 Equitable Rd., Kansas City, MO 64120

**FOLEY-BELSAW** Since 1926 Dept. 62026

Check for FREE Lifetime Career Kit on VCR Repair.

Name \_\_\_\_\_

Address \_\_\_\_\_

City \_\_\_\_\_

State \_\_\_\_\_ Zip \_\_\_\_\_

CIRCLE 5 ON FREE INFORMATION CARD

When S1 is closed, C1 charges through R1 to the point that Q1 turns on. So Q2 turns on, connecting the power supply across the primary of audio transformer T1 and dissipating the charge on C1. The current pulse induces a high voltage across T1's secondary. Once the charge on C1 has dropped sufficiently, Q1 turns off. C1 charges again, so Q1 turns on and the cycle continues.

The rapid DC pulses are stepped-up by T1 to a voltage of about 300 volts. The voltage is rectified by the voltage-multiplier section that consists of C2 through C9, and D1 through D8. The final output is approximately 2000 volts. The neon lamp, NE1, is used to indicate that the unit is charging.

I substituted SK3080's for D1 through D8, plus an SK3190 and an SK3191 for Q1 and Q2, respectively. Also, the unit was designed to momentarily charge and retain that charge until something completed the path across the unit's output terminals. However, I allowed the unit to continually charge and discharge.

The voltage-multiplier's output is placed across the paralleled auto condensers, C10 and C11. An auto condenser is approximately 0.27  $\mu\text{F}$  and the two paralleled adds to about 0.54  $\mu\text{F}$ . The charge builds up in C10 and C11 until the voltage is strong enough to cause electrons to jump the spark gap to complete the path to the primary of the automobile ignition coil, T2. The sudden discharge into T2's primary induces a greater voltage in its secondary. The rate of discharge from T2's high-voltage terminal is controlled by the spacing of the spark gap.

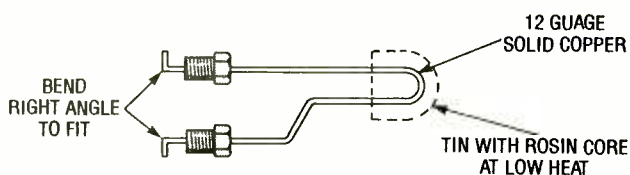

Fig. 2. If your soldering gun could use a new tip, try this heavy-gauge wire trick. Just be sure to tin the tip the very instant the tip heats enough.

The unit works well for approximately 45 to 90 seconds depending on how the spark gap is adjusted and produces a spark of 1.5 to 2 inches with a snap as loud as the sound I make when I snap my fingers.

Well there you have it, John. I said that I wasn't an engineer but maybe a little technical. Still, I feel I've come a long way from that newsstand, and I wonder just how far I'll go. The fire still burns inside me to work with electronics and I still don't know why. But one thing that I do know is that the more I know, the more I realize I need to know. Sorry for writing a novel; an electronics editor I am not, but I'm working on it. Thank you for a great magazine.

—Paul L. Piche, Cohoes, NY

Wow! I really like your "go-for-it" attitude. I would be pleased to have you as a colleague and I'm glad you've decided to join our circle of friends.

By the way, I like your modification, too; it sounds and looks like it packs quite a wallop. I'm afraid to ask what you use this thing for!

### A TIP TIP

My contribution is not a circuit, but . . . well here it is: Need a new tip for your Weller soldering gun? Then try using some No. 12 copper wire configured as shown in Fig. 2.

—George T. Fogelman, El Paso, TX

I can only assume the threaded hardware shown

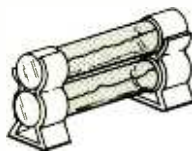

Fig. 3. If you ever need a fuse twice as capable as what you have on hand try this piggy back trick.

can be taken from the gun. It's an interesting suggestion, and I must admit, one I wouldn't have thought of. Your book is on the way.

### SAY IT WITH SOLDER

If you need to carry solder with you, but hate to carry that large, heavy spool of solder, don't despair. Make a solder pen!

Find a dried-up ink or felt-tip pen, remove the insides, throw them away, but keep the tip. I used a transparent pen so I could see how much solder I had left. Get a thin piece of wire and roll a coil of solder around it. Don't make the coil too long or thick, or it won't fit inside the pen. After you have a nice coil of solder, cut the solder, and gently insert it into the pen. Put the tip back on, leaving some solder sticking out of it. Now you'll have some solder with you wherever you go!

—Derek Fox, Sapulpa, OK  
Okay, not bad. Sometimes I use an old small plastic medicine bottle (the kind with the snap-on lid) for the same purpose. It makes it easy to carry solder around in my pocket for outdoor work, or jobs in tight places.

### IT AINT EASY

My name is Trevor Maicoo and I live in the Republic of Trinidad and Tobago, West Indies. I am a student of electronics and I have built a few projects, which I enjoyed immensely. The reason I am writing you is that I would very much like to get one of your books. Stores here do not sell any sort of electronics book, so the number of useful projects available to me is very limited. I know that your policy is when a letter/project is published, the writer gets a book. However, with my limited knowledge, plus the high cost of parts down here, (a 555 timer is \$15.00), I cannot devise or invent any sort of worthwhile project for you. The most I can do is give a few tips that I know about in the hope that they may be useful.

Here goes: For those who do not have a small drill but have to use very fine bits to do PC-board work, wrap the shank of each bit with a few turns of masking tape. They will then fit a larger drill.

Also, homemade washers and spacers can be easily made from clear ballpoint-pen barrels or the ink tube. These can be carefully sawed to the needed size.

Third, if you do not have a 2-amp fuse on hand, solder two 1-amp fuses together in parallel, as shown in Fig. 3. It stands to reason that the current will split in two and half the total will flow through each fuse.

Those are my suggestions. I do hope, sir, that you would consider my request for a book favorably. You would be doing me a great favor and I would be truly grateful.

—Trevor Maicoo, Trinidad, West Indies  
I was very affected by  
(Continued on page 91)



# HAM RADIO

By Joseph J. Carr, K4IPV

## Building A Ham-Band VFO

This month we are going to discuss designing a variable frequency oscillator (VFO). The VFO is used to control the frequency of transmitters, as the local oscillator (LO) that tunes a radio receiver, or as a signal generator to perform tests and measurements on radio equipment. The purpose of this month's column is to give you information on VFO's, while reviewing some of the basics of circuit design in general.

The fundamental block diagram of a VFO is the standard feedback oscillator shown Fig. 1. That type of circuit has a forward-gain element with an open-loop (without feedback) gain of  $-A_{vol}$ , and a feedback network with a

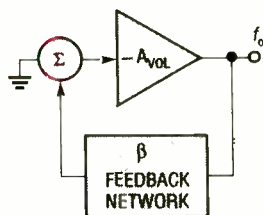

Fig. 1. This block diagram of a VFO shows that it is a standard feedback oscillator. In a VFO, the feedback network is frequency selective.

transfer characteristic of  $\beta$ . In a VFO, the feedback network is frequency selective. There are two criteria for oscillation: the closed-loop overall gain of the circuit is unity (1) or more; and the feedback signal is in-phase ( $360^\circ$ ) with the input signal. The gain block provides  $180^\circ$  of the required feedback phase shift, so the feedback network must

provide an additional  $180^\circ$  of phase shift at the desired operating frequency only. An inductor/capacitor (LC) resonant-tank circuit meets that requirement.

There are several different forms of the LC-tuned VFO circuit (e.g., Hartley, Armstrong, Colpitts, and Clapp), but we are going to examine the Colpitts oscillator. By implication, that means that we are also examining the Clapp oscillator because the Clapp and Colpitts are the same except for the actual resonant-tank circuit. In the Colpitts oscillator, parallel-resonant tuning is used, while the Clapp-type circuit uses series-resonant tuning.

Figure 2 shows the basic circuit for the Colpitts oscillator. That circuit is based on the junction field-effect transistor (JFET), although, with proper biasing, a PNP or NPN bipolar transistor could also be used. The device to use for Q1 is the MPF102 or MPF106 JFET. Those can be replaced by either NTE312 or ECG312 devices (which are widely available service-shop replacement devices).

The drain terminal of Q1 is kept at RF ground by decoupling capacitor C8. For most HF work, the value of C8 can be  $0.01 \mu\text{F}$ , although at frequencies lower than 3.5 MHz one might prefer to use a  $0.1\text{-}\mu\text{F}$  unit. Similarly, above 30 MHz, use a  $0.001\text{-}\mu\text{F}$  unit. Resistor R2 serves to self-bias the JFET; source-to-drain current flowing in the JFET creates a voltage drop that makes the source terminal of Q1 more positive than the gate terminal,

which in effect is the same as applying a small negative bias directly to the gate. The bias resistor (R2) is bypassed by capacitor C7. The value of C7 is selected to have a capacitive reactance that is less than one-tenth the resistance of R2, or less than 22 ohms, at the lowest frequency of oscillation. For frequencies down to 1.8 MHz, the capacitor must be at least  $0.004 \mu\text{F}$  (or larger where possible).

The source terminal of the JFET is kept above RF ground by the action of RF choke L2. The general rule for that part is that it should have a minimum reactance of 4,700 ohms (4.7k) at the lowest frequency of oscillation. For the ham bands (1.8 MHz and up) a minimum value of  $415 \mu\text{H}$  will suffice, but again most builders prefer to use a 1-mH or 2.5-mH device rather than the bare minimum.

There are three elements to the gate circuit: DC components, feedback-network components, and frequency-setting components. The DC components consist of resistor R1 and diode D1. The resistor prevents gate circuit currents from building up on the coupling capacitor (C3), which could eventually form a blocking bias that shuts off the JFET. The diode is used to regulate the amplitude of the oscillator output. It rectifies strong signals and produces a small negative bias that reduces the gain of the JFET. In that way, the amplitude remains relatively constant over a wider range of operating frequencies (some amplitude variation is normal).

The feedback network consists of capacitor voltage divider; C1 and C2. Those capacitors should have a reactance of about 45 ohms at the lowest oscillation frequency. The value of C1 and C2 in picofarads is found from  $106/283 f_{\text{MHz}}$ . Thus, for an 8-MHz oscillator, use about 440 pF; for 5–5.5 MHz VFO's, use 700 pF (actually, use 680-pF, standard value), and for 3.5-4 MHz VFO's, use 1000 pF.

There are two theories for selecting the value of C3. One theory says make it a value that has a capacitive reactance of about 260 ohms at the lowest operating frequency. For a 5–5.5-MHz VFO, a 122-pF value (use 120 pF) is indicated. The other philosophy, is to use the smallest value of capacitor that will still oscillate reliably, which means a value in the 1- to 20-pF range. The actual value is found experimentally, but I usually start at 5 pF and work upwards. In general, I've found that 5-pF capacitors work well in the 3.5- to 10-MHz range, where most of my VFO's operate.

The tuning components are inductor L1 and capacitors C4 through C6. The inductive reactance of L1 should be on the order of 140 to 250 ohms (depending on how the coil was wound) and the combined capacitive reactance of C4 through C6 should be about the same. For a 5-MHz oscillator, the approximate value for L1 is:  $X_L/2\pi f = 4.46 \mu\text{H}$ ; where  $X_L$  is in ohms and  $f$  is in megahertz.

The capacitor values must be selected very carefully. First of all, the total capacitance of C4 + C5 + C6 should resonate with L1 at the desired operating frequencies. Capacitor C4 is the main tuning capacitor, and is typically a shaft-

driven air variable that has minimum and maximum values. Capacitor C5 is a low-value trimmer (also having minimum and maximum values) and is typically screw-driver (or tuning wand) driven. A typical scheme is to make the value of C5, at its mid-range point, no more than 10–20 percent of the maximum value of C4, although more is certainly permissible. Capacitor C6 is optional, and its inclusion in the circuit depends on the design. It is used to pad the total capacitance needed for resonance. It can also be used for setting such things as temperature compensation, but more of that later. In addition, C6 need not be a single capacitor; several parallel-connected units (C6-a, C6-b, C6-c, etc.) can be used if an odd value is required.

Plus, keep in mind that a few picofarads must be allocated to stray capacitance. The exact amount depends on the method of construction used, but about 7 pF seems like a good starting point for most ham HF calculations.

The total value of capacitance needed is a function of what resonates with L1 at

the minimum and maximum operating frequencies. Keep in mind that the ratio of maximum to minimum frequencies is the square root of the ratio of maximum to minimum capacitance:

$$f_{\text{max}}/f_{\text{min}} = \sqrt{C_{\text{max}}/C_{\text{min}}}$$

For example, for use in the AM band, an 18- to 365-pF main tuning capacitor (C4) would generally be used. Add to that the value of stray capacitance, the trimmer capacitor (C5), and capacitor C6; those should total about 25 pF. The capacitance ratio is therefore  $(365 + 25)/(18 + 25)$ , or 9.07:1; the square root of 9.07 is 3.012—which is just about right for the AM BCB ratio of 1620 kHz/540 kHz. It is in the relationship above that you must "tap dance" a little in order to get the band you want, with little overlap. That is, you must adjust the values of the capacitance, and possibly the inductance, in order to get the correct range.

That is done by trial and error, on paper. For a standard ham SSB-rig VFO, the operating frequency is 5 to 5.5 MHz, so the frequency ratio is 5.5/5, or 1.1. Thus, the capacitance ratio in the

tuning circuit is 1.21:1, or 1.22:1 if you want a little overlap.

Let's do a little math. By the rule above, our 5–5.5 MHz VFO should have an inductance value of about 4.46  $\mu\text{H}$ . By  $C_{\text{pF}} = 106/39.5 f^2 L_{\mu\text{H}}$ , the value of C4 + C5 + C6 at 5.5 MHz is 187 pF. Thus, because a 1.22:1 ratio is desired, a maximum capacitance (when C4 is fully closed) should be  $187 \text{ pF} \times 1.22 = 228 \text{ pF}$ , or a change of 41 pF. A standard 50-pF variable capacitor, with a minimum value of 7 to 9 pF should work well for the main tuning capacitor. With about 7 pF of stray capacitance, we still need to account for 171 pF. That can be made up with a 80-pF (40 pF at mid-scale) trimmer (C5), and any combination of fixed capacitors (C6) that total 130 pF. Thus, a 30 pF and a 100 pF in parallel will do the job. Note that some sloppiness will result because standard-value capacitors are used, and that's why the trimmer has a wider range than absolutely necessary.

The output capacitor C<sub>o</sub> is selected for a reactance of about 750 ohms at the lowest operating frequency. For a 5-5.5-MHz VFO, a 42-

(Continued on page 93)

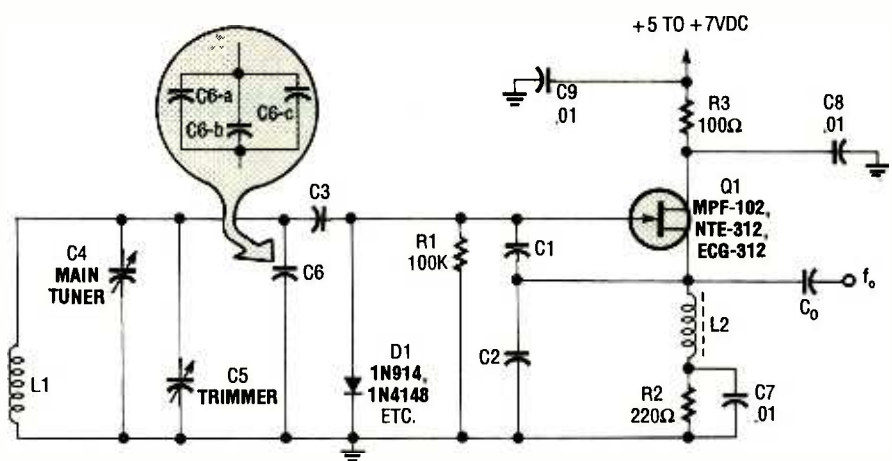

Fig. 2. This basic Colpitts oscillator circuit is based on the junction field-effect transistor (Q1) whose drain is kept at RF ground by decoupling capacitor C8.



# DX LISTENING

By Don Jensen

## QSL'ing Lives

Some shortwave listeners believe QSL'ing is outdated, a relic of the past. Sorry, guys, but I respectfully disagree. I think that collecting tangible confirmations of shortwave receptions is not only fun, but a worthwhile part of our hobby.

After all these years—and I began DX listening back in 1947—it's still a thrill to open

ing about QSL'ing. "What's the correct procedure for doing this?" he asked. Buzz's letter got me thinking that perhaps this month we should take a look at collecting verifications from shortwave stations. First, though, a little history.

In the earliest days of radio, everything was experimental. The handful of stations that were in operation were, understandably, curious about how far their signal was traveling and who, out there, was listening in. And radio enthusiasts, many of whom had built their own simple receivers, were anxious to discover how well they worked by hearing as many distant stations as they could.

Stations encouraged listeners to write in. "Tell us where you are and how you like our programs." In response to the letters received, the broadcasters sent each listener a postcard or letter, both as a souvenir and as tangible proof that the SWL had logged their radio signal. Those replies, through the years, have been known as verifications, confirmations or, simply, QSL's. In a fleeting medium like radio broadcasting, a QSL is a permanent memento of a listening experience.

Each time that I page through my albums of QSL's, the recollections flood back, from one of my first (a 45-year-old card from HCJB in Ecuador) to one of the most recent, a "verie" (abbreviation for verification) for a special broadcast last year from a remote island in the south Atlantic, *Radio St. Helena*.

Now, with some exceptions, today's high-powered shortwave stations really don't need listener letters to tell them how well their broadcasts are being received. Technology has advanced greatly since radio's earliest days. But stations do like to hear from you, even if only to learn how you liked their programming. And while cost restraints have cut back some broadcasters' responses to audience mail, most still will send you a QSL card or letter if you write and ask.

Now let's get back to Buzz's question.

### QSL'ING

Let us say, for example, that one evening you're listening to *Radio Cairo* in Egypt with an English language program. Hey, you think, I'd like to have a QSL card from this one! Okay! The first step is to make a good detailed log for your reception report. Note the program name, summarize what you've heard during a half hour or so of listening. Jot down any details that will establish that, in fact, you were listening. Your letter report to the station should list such a program summary, plus the station's frequency (in kilohertz, kHz), the date and time of your reception.

Perhaps an example is in order. But first a quick re-

\*Credits: Karl Racenis, MI; W. Karcheski, MA; William Davanport, TN; Juhanna Bickus, VA; Mike Wolfson, OH; Rufus Jordan, PA; Jerry Berg, MA; Michael Bilec, PA; North American SW Association, 45 Wildflower Road, Levittown, PA 19057.



This QSL card was received by the author from Austrian Radio.

the mailbox and find a colorful card or a letter with exotic stamps from some far-off SW station that I previously logged.

Recently I got a note from reader Bill (Buzz) Krone of Mechanicsburg, PA, ask-

fresher on time and date. SWL's and stations use Coordinated Universal Time (UTC) as a worldwide time standard. It is equivalent to Eastern Daylight Time plus 4 hours (or CDT + 5, MDT + 6, PDT + 7). Time references are based on the 24-hour system, where the A.M. hours are 0000 to 1200 and the P.M. are 1300 to 2300. So 0200 is 2 in the morning.

Now for our example; let's say that we're listening to Radio Cairo on 9,475 kHz at 0200 UTC on July 2, 1993.

The date ought to be an obvious item, and it is, except, remember that the date should match the UTC time reference. For instance, although you may be listening to Cairo in New York at 9 P.M. on the evening of July 1, that's the equivalent of 0200 UTC (EDT + 5 hours) the following morning, or July 2. Your report letter should contain information on how well the station was received. Did you receive a strong signal or a weak one?; was there interference from other stations?; how about static or noise?; was there fading?; how about signal clarity?

Also, stations appreciate knowing if you liked their program, or if you didn't. They also appreciate your suggestions, questions about the station or its schedule and other frequencies? Finally, a polite request for the broadcaster's QSL card or verification is in order.

You may wish to include return postage. Usually, with the major international broadcasters, it's not a necessity. But these are the '90's and shortwave-station budgets are tightening. With some smaller or less affluent stations, return postage could be the difference between getting or not getting a reply.

That's unfortunate, and

the added cost of collecting QSL's is one reason why some SWL's have opted out. Still, if you seek QSL's selectively, it need not be a major hobby expense. If you do send reply postage, it could be in the form of an International Reply Coupon (available at your post office) or, perhaps, a dollar bill which can be exchanged to pay for stamps at the other end. Don't send unused U.S. (or Canadian) postage stamps. Obviously they cannot be used on mail sent from a foreign country.

Where do you send your reports? Often, the station's mailing address will be announced during the program. If not, there are several source books available. I like the address list in *Passport To World Band Radio* (International Broadcasting Services, Ltd., Box 300, Penn's Park, PA 18943). That annual also has tons of other information on station frequencies, schedules, reviews of shortwave receivers, and much more.

The annual *World Radio TV Handbook* (Billboard Books, 1515 Broadway, New York, NY 10036) is another station-address source. Try your local bookseller for either.

The basics outlined here will get you QSL's. But if you'd like more how-to-do-it examples, you might try *Secrets Of Successful QSL'ing* (Tiare Publications, Box 493, Lake Geneva, WI 53147).

### IT'S IN THE MAIL

"I enjoy listening to shortwave DX and reading your monthly column," writes Aldo Raquita, Brooklyn, NY. "But I'd also like to listen to AM and FM broadcasting stations from Europe and South America. What do I need to do this?"

First, Aldo, forget about

FM! The chances of logging transoceanic VHF (very high frequency) FM signals are slim to none! Under the right conditions, and in the right location, however, AM medium-wave (540-1600 kHz) signals from Latin America and Europe can make it to North America.

While North American AM stations are separated by 10 kHz (650, 660, 670 kHz, etc.), the European AM band locates stations 9-kHz apart on the dial (648, 657, 666 kHz, etc.), meaning some of the more powerful transatlantic signals can "slip through" between the American stations. That sort of reception is very tough, but possible, on the east coast of the U.S. and Canada, but heavy interference probably will make it even more difficult in the New York City area.

U.S. listeners have a somewhat better chance of hearing a few medium-wave AM stations from northern South America, particularly Columbia. But most foreign MW (medium wave) DX'ing is a specialized activity that takes some skill and know-how.

Aldo, to you and anyone else interested in learning more about MW DX'ing, I'd recommend one or both of the following clubs, which specialize in that aspect of the listening hobby: International Radio Club of America (11300 Magnolia, No. 43, Riverside, CA 92505) and National Radio Club (Box 118, Poquonock, CT 06064).

### DOWN THE DIAL

Here are some interesting shortwave targets that you may want to try.

**ANGOLA**—7,100 kHz.

*Radio Nacional de Angola* broadcasts in Portuguese from this southern African trouble-spot. It has been noted at 2100 UTC with an

echo identification and tuning signal.

**CHAD**—4,904.5 kHz. Another African SW'er is *Radio Nationale Tchadienne*, which has been logged with French-language identification and news at around 0430 UTC. Still noted in French after 0500 UTC.

**HUNGARY**—9,835 kHz. *Radio Budapest* has English news, sports, and feature programming at 2200 UTC on this longtime Hungarian SW frequency.

**MADAGASCAR**—15,150 kHz. *Radio Nederland*, operating from its relay station on this large Indian Ocean island off Africa, is heard in English at 1430 UTC.

**SINGAPORE**—6,195 kHz. The *British Broadcasting Corp.* is another major broadcaster with shortwave relay transmitters around the world. This one is located at Singapore and is heard with BBC English-language programs at 1335 UTC.

**SOLOMON ISLANDS**—9,545 kHz. A nice bit of Pacific DX is the *Solomon Islands Broadcasting Service* at Honiara. Look for this one at around 0930 UTC, operating in parallel with 5,020 kHz. Island music is a tipoff with this one.

**VENEZUELA**—4,940 kHz. *Radio Continental* broadcasts in Spanish with lively Venezuelan music and frequent ads. Tune for this one at around 0915 or 0930 UTC.

**VIETNAM**—12,020 kHz. Hanoi's *Voice of Vietnam* can be heard in English, beginning with an organ tuning signal, identification, program notes, and a newscast, at 1230 UTC.

**NEW ZEALAND**—9,700 kHz. What's the weather like Down Under? Maybe you should listen to the weather forecast from *Radio New Zealand*. Tune in at around 1000 UTC. ■



# SCANNER SCENE

By Marc Saxon

## Paging All Scanners!

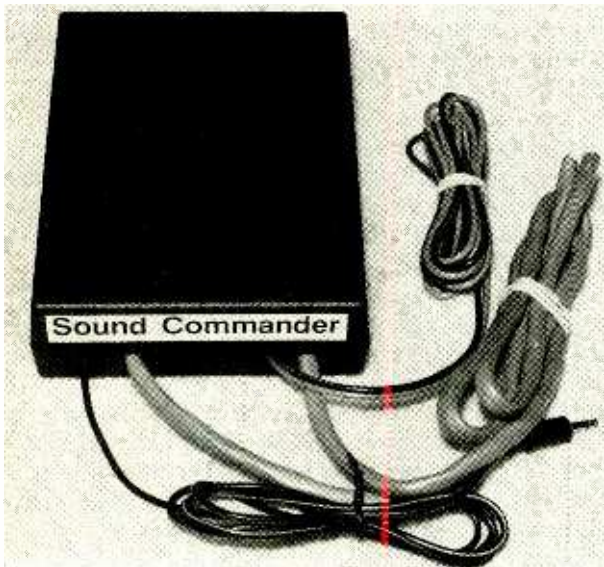

*You can listen to your car stereo without missing and scanner signals using the Sound Commander, which automatically routes incoming scanning traffic to your car's speakers.*

**M**any of us have scanners in our vehicles, but quickly realize that it isn't convenient to try listening to the car radio while the scanner is in use. When a call comes through on the scanner, it means groping around to lower the volume of the vehicle radio,

hoping you can do it in time to copy the scanner traffic. Then you have to reverse the process. Or you must keep the car radio at a very low volume so that it can barely be heard.

Here's another approach. The *Sound Commander* is a device that allows you to listen to your car radio without missing calls on your scanner. It's all hands-off, because the *Sound Commander* automatically switches your car speaker to your scanner whenever a

call comes in. You get all the scanner traffic, and you can still enjoy the car's AM/FM radio.

The connection to the car-radio speaker leads is simple, and the unit can be used with car radios that use up to four speakers (maximum 25 watts per channel). Sensitive VOX operation should work fine with any scanner. The *Sound Commander* costs \$80, plus \$5 shipping/handling. It comes from Electron Processing, Inc., P.O. Box 68, Cedar, MI 49621. Their phone number is 616-228-7020.

### TURN THE PAGE

As you go across the scanner bands, you might come across signals that sound like bursts of blips or strange gurgles. Chances are those signals are non-voice, one-way radio paging ("beeper") signals. Beepers have become a huge, widespread business that is growing rapidly. Service is available everywhere, and frequencies used range between 35 and 932 MHz.

Beepers were originally carried primarily by doctors, service technicians, and sales personnel. Today, however, the proliferation of low-cost service and equipment has popularized beepers with taxi dispatchers, families, drug dealers, and many other members of the public. Their uses cover messages relating to business, recreation, romance, and those

that sound somewhat tacky or downright illegal.

Non-voice beepers may only display a phone number to be called back. Those are the most common ones in use. More sophisticated beepers read out actual messages consisting of perhaps several lines of about 20 characters and spaces each. Each message is addressed to a specific beeper, which is activated by certain coded tones.

The casual scanner can make no sense out of any of those signals. It should be noted, however, that in many (but not all) areas there are several one-way paging channels used where voice paging messages are sent out. Sometimes the voice signals are shared with non-voice paging messages, although in some instances they have frequencies to themselves. Voice radio-paging signals can be copied on any scanner, and they often can be quite interesting. That is particularly true of those that are angry, intimate, or related to apparently illegal doings. Some messages are totally gross.

Each message is limited to about 30 seconds before it automatically times-out. At times, that cuts off a message right in the middle of someone's long-winded tirade. Messages are sent out twice, at least in my local area.

The major bands to search for beeper voice



As pagers like this one from Motorola become increasingly popular, there's a good chance that you can pick up pager voice messages on your scanner.

channels include 35.20–35.66 MHz, 43.20–43.66 MHz, 152.03–152.84 MHz, 454.025–454.65 MHz, and 931.0125–931.0875 MHz. There are many other radio-paging frequencies, but these bands are your best bets for coming upon voice-paging signals in the event that any exist within monitoring range of your location. Most of what you will hear will be non-voice garbage, but try over and over again just in case there were no voice transmissions when you listened the last time.

In my own area, the only voice beeper frequency is so active that it goes day and night. Often the carrier is on the air steadily for long stretches of time, feeding out long strings of messages. It never ceases to be lively and interesting, and there are some wild messages that come through.

### CHANGES AFOOT

Toward the end of 1992, the Telephone Disclosure and Dispute Resolution Act was passed in Washington. That law makes it illegal to manufacture or import scanners that can receive cellular frequencies, or that can "readily" be altered to do so.

It's up to the FCC to enforce that law. To do so, the FCC now proposes to

change Parts 2 and 15 of its rules so that those regulations will reflect the frequency limitations for scanners. If the changes are made, it would mean that, in the future, when manufacturers and importers submit new scanners to the FCC for approval, that approval would be granted only if the scanners did not cover the cellular bands, or could not "readily" be adapted to receive them. The law would also cover frequency converters.

Equipment that falls outside those rules presently in the hands of dealers will be snapped up very quickly by scanner enthusiasts in the event that those proposed changes go through.

### BIRDIE RECAP

Last month we ran satellite frequencies that operate within a scanner's coverage range and many readers have asked for more information. You might want to try TIROS-N on 136.77 and 137.77 MHz (telemetry), 137.50 and 137.62 MHz (data), GEOS satellites on 136.38 MHz, NOAA-9 on 137.62 MHz, NOAA-10 on 137.50 MHz, and NOAA-12 on 137.30 MHz.

### POLICE PATROL

P.N. Riccio, of Mansfield, MA, hopes that we can furnish the frequency of the Mansfield police. He tells us that they were on 39.54 MHz at one time. But he has been out of scanning for a while, and when he got back into the hobby, the agency had fled the frequency! Check out 856.4875, 857.4875, and 858.4875 MHz, and you'll find your agency.

We appreciate your input. Write to *Scanner Scene*, **Popular Electronics**, 500-B Bi-County Blvd., Farmingdale, NY 11735.

## COMPUTER BITS

(Continued from page 72)

that provides background on and interpretation of each story. Some stories also include traditional grammatical explanations. To help you learn correct pronunciation, Transparent Language also includes audio cassettes containing stories read by native speakers.

Each Transparent Language title is developed by a noted scholar in the language of interest, along with an editor who helps the "author" in the Transparent Language presentation format. Because different titles are developed by different scholars, stories vary as to the amount of grammar and background information presented. That is a weakness that the company is taking steps to correct.

Transparent Language works like this: A split screen displays the text of the story (in the original language) in the upper half, and several windows of help information (in English) in the lower half. There are separate help windows for the current word, current phrase, current clause (or sentence), as well as two information windows for displaying whatever the author considered important. Typically you'll see grammatical explanations, discussions of idiomatic phrases, and explanations of what's happening in the story.

The story reader is quite intuitive. Use cursor keys or a mouse to highlight a word, and corresponding explanation(s) appear automatically in the proper window(s). As your knowledge increases, the help windows can be turned on and off individually.

## VENDOR INFORMATION

Transparent Language (\$119/DOS, \$139/Macintosh)  
Transparent Language, Inc.  
9 Ash Street, P.O. Box 575  
Hollis, NH 03049  
800-752-1767  
603-465-2230

French Assistant (\$99.95)  
Microtac Software  
4655 Cass Street, Suite 214  
San Diego, CA 92109  
800-366-4170  
619-272-5700

An easy-to-use computer application does not necessarily make a good foreign-language teacher. Can Transparent Language teach effectively? Yes. You will not become fully fluent using Transparent Language alone; but it can help you acquire many rudiments without a lot of grammatical memorization.

What's bad about Transparent Language? The biggest weakness is the range and quantity of available titles. For example, the catalog that was current as of this writing includes only nine French and seven German titles. To rectify that problem, the company is adding titles as rapidly as possible.

Second, the lack of computer-based audio is a real deficiency. However, the company is working on a CD-based version with multimedia capabilities that it hopes to release in 1993.

Third, the text-mode DOS implementation leaves something to be desired. This program absolutely cries out for a Windows implementation with scrollable, sizable, placeable windows. Despite those criticisms, however, Transparent Language offers real benefits for anyone studying a supported non-English language.

Next time we'll talk about French Assistant.



# ELECTRONICS LIBRARY

## Making Sense of Sound: The Basics of Audio Theory and Technology

by Alvis J. Evans

Whether you are in the market for a new stereo, considering a career in the recording industry, or just curious about the nature of sound, this book holds the answers to your audio questions. It defines basic terms such as pitch, fidelity, and distortion, and explains how sound is electronically produced. It interprets the specifications for your receiver, CD player, and other audio components, and explains how they work together to produce quality sound.

With its easy-to-read text and plentiful illustrations, the book is easy enough for beginners to understand, yet it provides

enough detail to be of interest to professionals. Beginning with an explanation of how sound propagates and descriptions of its main characteristics—pitch, loudness, phase, frequency spectrum, timber, fidelity, distortion, and noise—the book goes on to cover amplification principles and the difference between various amplifier types. Subsequent chapters are devoted to sound transducers, AM/FM tuners and receivers, and video and TV stereo. A complete glossary and an index are included.

*Making Sense of Sound: The Basics of Audio Theory and Technology costs \$10.95 and is published by Prompt Publications, Howard W. Sams & Company, 2647 Waterfront Parkway East Drive, Indianapolis, IN 46214-2012; Tel: 317-298-5710; Fax: 317-298-5604.*

**CIRCLE 89 ON FREE INFORMATION CARD**

### ECG SEMICONDUCTORS MASTER REPLACEMENT GUIDE SUPPLEMENT 1

from Philips ECG

Reflecting the latest expansion to Philips replacement semiconductor line, this catalog features 60 new modules and IC's used in VCR, TV, audio, PC, and industrial applications. Functions include voltage regulators, motor drivers, signal processors, decoders, small-signal subsystems, deflection circuits, and electronic attenuators. Also represented in the expanded line are discrete transistors, rectifiers, and diodes. The Master Replacement Guide cross references more than 8000 additional industry part numbers to the ECG types. The complete cross-reference section from the Master Guide, merged with that of Supplement 1, is also available in an up-



dated version on floppy disk for IBM PC's and compatibles.

*The ECG Semiconductors Master Replacement Guide Supplement 1 is available from Philips ECG, 1025 Westminster Drive, Williamsport, PA 17701; Tel: 800-526-9354.*

**CIRCLE 90 ON FREE INFORMATION CARD**

### FIREWATCH!

by Cynthia Wall, KA71TT

Although it's likely to be found on the "Young Adult Fiction" shelves in your library or bookstore, hams of all ages will find a good read in this novel. Set in Oregon's Cascade Mountains, the story revolves around fire lookout Kim Stafford, KA7SJP, who is responsible for the safety of the woods and all its inhabitants. Kim and her friend and fellow ham Marc Lawrence, KA71TR, find themselves battling more than forest fires when they stumble upon a huge marijuana operation based in the Cascades. With the help of a sometimes dangerous pit bull and their ham radios, the two friends ably meet all challenges.

*Firewatch! costs \$5.95 and is published by The American Radio Relay League, 225 Main Street, Newington, CT 06111.*

**CIRCLE 91 ON FREE INFORMATION CARD**

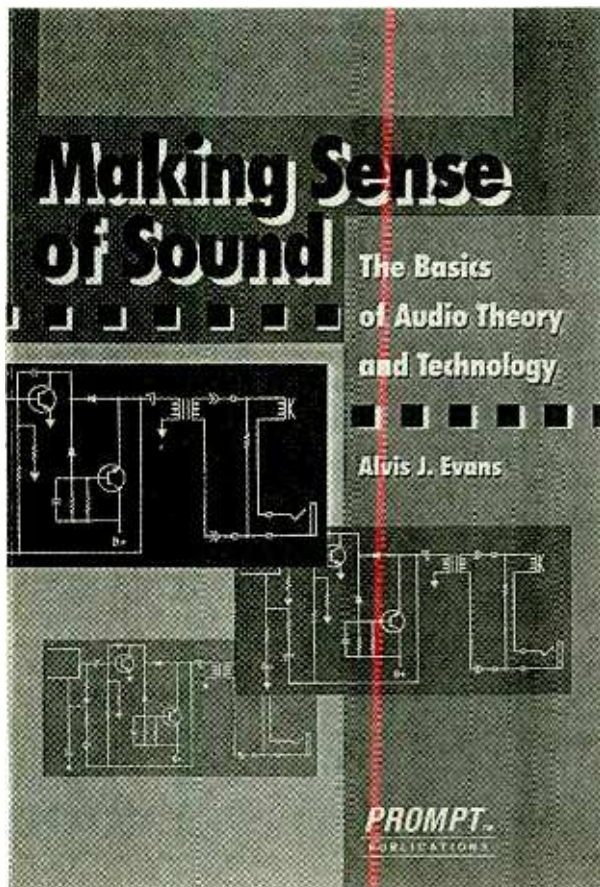



# Introducing Australia's Leading Electronics Magazine...

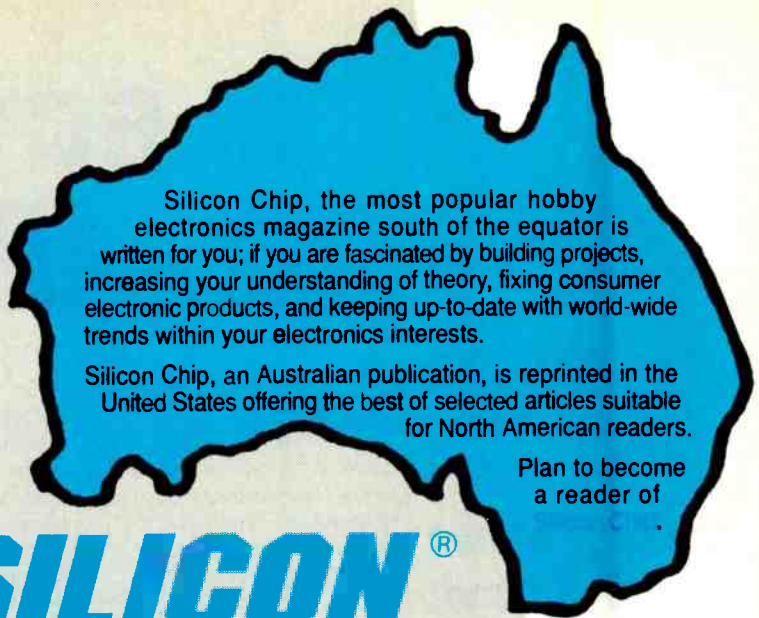

Silicon Chip, the most popular hobby electronics magazine south of the equator is written for you; if you are fascinated by building projects, increasing your understanding of theory, fixing consumer electronic products, and keeping up-to-date with world-wide trends within your electronics interests.

Silicon Chip, an Australian publication, is reprinted in the United States offering the best of selected articles suitable for North American readers.

Plan to become a reader of

## SILICON CHIP®

Packaged in a specially prepared format guaranteed to excite the electronics hobbyist with new ideas, novel projects, extraordinary features and down-right good reading.

Inside **Silicon Chip** you will discover how the other side of our world—down under—approaches the same hobby interests as you do, with ramifications that will amaze you.

Detailed construction projects to appear in upcoming issues of Silicon Chip include:

- 4-Channel Guitar Mixer**
- Adjustable 0-45V, 8A Power Supply**
- Interphone Digital Telephone Exchange**
- 1.5V to 9V DC Converter**
- Multi-Sector Home Burglar Alarm**
- 1-Megabyte Printer Buffer**

*Exciting and Imaginative Features like:*

- Understanding Computer Memory**
- How to Interlink Musical Instruments**
- What's New in Oscilloscopes**



**SPECIAL OFFER**  
A sample copy may be ordered for only **\$2.50!**  
In Canada: \$3.50!  
Use coupon below and write across top "SAMPLE ISSUE." Fill out coupon except for subscription information and mail. Sorry—no credit cards. Send only check or money order in U.S. funds.

If you are fascinated by electronics, especially the hobby aspects related to construction projects, theory, applications in home and shop, and latest developments, if you are compelled to experiment and "fix-it," then **Silicon Chip** is your kind of magazine.

**Silicon Chip** is available exclusively by subscription. So take advantage of this great opportunity and start your Charter Subscription today.

**SILICON CHIP**, 500-B Bi-County Boulevard, Farmingdale, New York 11735 PE793

I'm convinced! Enroll me as a Charter Subscriber. Enter my subscription as designated below.

<b>United States of America</b>		<b>Canada</b>	
<input type="checkbox"/> 12 issues for \$29.95	<input type="checkbox"/> 24 issues for \$49.95	<input type="checkbox"/> 12 issues for \$40.61	<input type="checkbox"/> 24 issues for \$70.57
		(Includes postage & G.S.T.)	
<input type="checkbox"/> Payment enclosed	<input type="checkbox"/> Please charge my	<input type="checkbox"/> VISA	<input type="checkbox"/> Mastercard

For your convenience, if paying by credit card: To avoid any interruption in service, your subscription will be renewed automatically at 12-issue intervals, at the then prevailing introductory rate, until you advise us to cancel it.

Signature \_\_\_\_\_

Account No. \_\_\_\_\_ Expiration Date \_\_\_\_\_

Offer valid in the U.S.A. and Canada only. No foreign Orders.

Name \_\_\_\_\_

Address \_\_\_\_\_

City \_\_\_\_\_ State \_\_\_\_\_ Zip \_\_\_\_\_

All orders payable in U.S.A. funds only. Allow 6-8 weeks for delivery.



# NEW PRODUCTS

## A/V Receiver

Designed to be the centerpiece of a home-theater system, the *Model RX-V660* digital sound-field processing (DSP) audio/video receiver with five-channel amplifier from *Yamaha Electronics* provides four DSP modes—concert video, mono movie, rock concert, and concert hall—as well as digitally processed Dolby Pro Logic surround sound. The user can opt to add digital sound-field processing to its Dolby Pro Logic, yielding a dramatic five-channel presentation that adds another dimension to the surround effect to create a realistic simulation of the movie theater experience. The *RX-V660* provides 65 watts per channel to the front pair of stereo speakers and 25 watts per channel for the center and

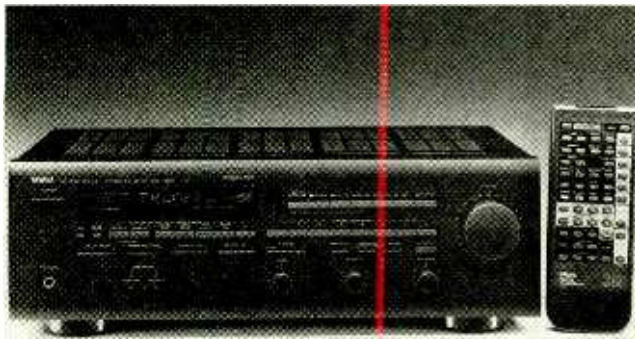

rear pair. Seven audio and three video inputs are provided. Level controls for front- and center-channel outputs, three center-channel mode positions, and variable digital delay make it easy to accommodate individual listening tastes and room conditions. A digital test-tone generator makes setting up and adjusting the unit's surround-sound function easy.

The *Model RX-V660* audio/video receiver has a suggested retail price of \$699. For further information, contact *Yamaha Electronics Corporation, USA*, 6722 Orangethorpe Avenue, Buena Park, CA 90620.

**CIRCLE 101 ON FREE INFORMATION CARD**

## DUAL ANALOG-OUTPUT POWER SUPPLY

Intended for vocational and other educational applications, as well as for use in servicing and circuit design, the versatile *WP-702B* dual analog-output power supply from *The Vector Group* is capable of series, parallel, and floating-ground operation. It has a unique over-voltage short-circuit protection circuit, and a convenient

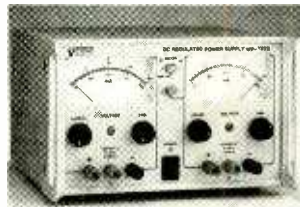

115–120/230–240 VAC 50/60-Hz switch is located on the rear of the unit. The *WP-702* dual 0–20-VDC at 0–200-mA analog supply has two large, easy-to-read meters that display DC voltage or current at the flip of a switch.

The *WP-702B* has a suggested list price of \$365. For additional information, contact *The Vector Group Inc.*, 189 Horsham Road, Horsham, PA 19044; Tel: 215-672-6702; Fax: 215-672-3411.

**CIRCLE 102 ON FREE INFORMATION CARD**

## MINI ACA LEAKAGE TESTER

For measuring low AC currents in ranges of 200 mA, 20 amps, and 200 amps, *Extech's Model 380654 Mini ACA Leakage Tester* provides ½% accuracy at 2.5 samples per second. The instrument features low-battery and overload indicators, auto polarity, and zero adjust. Its bright ½-inch LCD readout features a data-hold function. The pocket-sized leakage tester comes with test leads, a 9-volt battery, and a carrying case.

The *Mini ACA Leakage Tester*



costs \$139. For additional information, contact *Extech Instruments*, 335 Bear Hill Road, Waltham, MA 02154; Tel: 617-8907740; Fax: 617-890-7864.

**CIRCLE 103 ON FREE INFORMATION CARD**

## TINY HF TRANSCEIVER

According to *Kenwood*, their *TS-50S* is the world's smallest HF transceiver, measuring 7.16 × 2.4 × 9.32 inches and weighing in at 6.4 pounds. The full-featured unit offers 100-channel memory, 10 watts of



output power (adjustable to 50W, 10W), dual VFO's, wide receiver dynamic range, all-mode squelch, and automatic gain control (slow/fast). The *TS-50S* is an all-mode (SSB/CW/AM/FM) transceiver that is capable of being controlled by a computer. It features convenient menu programming, a large display with dimmer control, a noise blanker, a programmable function keypad, and a multi-function microphone.

The *TS-50S* compact HF transceiver has a suggested list price of \$1199.95. For further information, contact *Kenwood Amateur Radio Division*, 2201 East Dominguez, P.O. Box 22745, Long Beach, CA 90801-5745; Tel: 310-639-9000; Fax: 310-604-4487.

**CIRCLE 104 ON FREE INFORMATION CARD**

## COMPUTER KILL SWITCH

(Continued from page 45)

you can use the DEBUG.COM program supplied with DOS to directly assemble the programs. See your DOS manual for instructions on using the DEBUG.COM program. Alternatively, you can order a copy of the programs compiled on diskette from the supplier mentioned in the Parts List.

The programs can simply be run from DOS, which sounds a bit inadequate, but let's examine what you can do with these simple programs and DOS. Let's say your word processor is printing a long document in your office and you'd prefer beating rush-hour traffic rather than waiting for the printout to finish. While your word processor is busy with the print job (and ignoring the keyboard), just type in the command to exit to DOS and enter the name of whichever program you will use from Listing 1 followed by a carriage return. Arm the Switch by pressing S2, turn off S1, get your coat, and run for the parking lot. When the word processor is through printing it will process the keystrokes that allow it to exit to DOS, DOS will process the keyboard input to run the program, and the computer (and the printer if it's plugged into the unit) will shut down for the night.

You can use that technique when dealing with almost any prolonged software process—faxes, modem communications, CAD computations, etc. We use it to shut our system down at night after some CAD software routes a large PC board using multiple routing strategies. Large double-sided boards can take a long time, and since we ask the computer to try it twelve different ways (typically starting late at night), the process sometimes ends in the wee hours of the morning. We like our work, but not enough to sit in front of a computer all bleary eyed just to shut it off after four or five hours.

There are yet other ways to get DOS to control the Kill Switch. For example, you could use DOS's print command to transmit a file containing the trigger character. You could also use DOS to run a batch file containing an appropriate command or two to send the data to the port. You could even use DOS to give you keyboard control

over the interface. To do that type:

```
COPY CON: PRN:
```

at the DOS prompt. That command will cause anything that you type at the keyboard to pass to the printer port. You can now type in the trigger character and send it to the printer by pressing the control and Z keys simultaneously followed by enter.

You can use a word processor, too. You can place the trigger character in a file and print the file from the word processor. That is a particularly good technique if you want the computer to shut down after printing out a file; just place the trigger character at the end of the file.

**Construction.** The authors' prototype was built into a relatively small case considering everything that's packed into it. All of the small components are mounted on a piece of perfboard and point-to-point wired together.

To make the straight-through connection between the computer and printer, we attached PL2 (the male DB-25) to the free end of a 3-foot ribbon cable, and attached SO2 (the female DB-25), mounted on one end of the case, about 6 inches short of the other end of the cable. The extra 6 inches of ribbon cable makes the connections from the computer/printer combination to the rest of the circuitry. The LED and switches S1 and S2 are mounted on the top of the case.

The linecord from PL1 enters the case at the other end, and the ground and neutral leads connect directly to the AC sockets (SO1-a and SO1-b). The hot lead from PL1 connects directly to S1 and TR1, which are mounted on the perfboard. The output of TR1 is then connected directly to the hot side of SO1-a and SO1-b. The openings for the AC receptacles were cut in the case using a nibbling tool. After drilling a small hole, the nibbling tool allows you to carefully cut an opening in almost any project case. No electronics hobbyist should be without one. Radio Shack sells a pretty good nibbling tool for about ten dollars.

As mentioned earlier, you can use the device without a printer. That should cause no trouble for those of you who will control the switch using

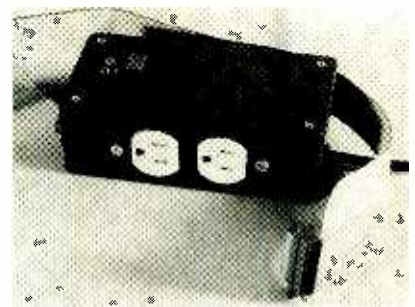

Here's the authors' completed prototype for their computer-controlled Kill-Switch.

the software in Listing 1. However, if you will be using software that relies on DOS and/or the computer's BIOS, you could run into trouble unless you modify the Kill Switch. Unlike our program, DOS and the BIOS might look at the various handshaking lines to make sure the "printer" is okay. Of course, since there is no printer, DOS and the BIOS will assume something is wrong and never send data to the port.

One way around that is to trick the computer into thinking that there is a ready and waiting printer available by tying the handshaking inputs to appropriate logic levels. Specifically, tie pin 12 (paper empty) and pin 11 (busy) low, tie pin 13 (select) and pin 15 (error) high, and connected pin 10 (acknowledge) to the strobe line. Note: the strobe line should still also be connected to the 74521.

Now you might be wondering why you should tie the acknowledge line to the strobe line. That permits the computer to "shake its own hand." When the computer sends the strobe pulse, it considers the falling edge the start of transmission (that's indicated by the arrow on that edge). By the time the strobe line is low, the computer has already begun waiting for the acknowledge pulse. Interestingly enough, the computer only concerns itself with the rising edge of the acknowledge pulse; it pays no attention to the pulse's logic level or its falling edge. Since the computer starts waiting for the rising edge of the acknowledge pulse right after the falling edge of the strobe pulse, we can use the rising edge of the strobe pulse in place of the rising edge of the acknowledge pulse. That's what the strange connection accomplishes.

Once you have a working Kill Switch, you'll wonder how you ever got along without one. ■



## SLIDE PRESENTATION

(Continued from page 69)

going to the projectors and remote control, are made with screw-type terminals, along the edge of the board. On the back side of the board, the circuit was interconnected with a combination of wire-wrap and solder connections.

The boards were housed in a general-purpose enclosure with aluminum top, bottom, front, and back, and plastic sides. The main logic board is mounted on stand-offs to the bottom of the case. The power supply was built directly on the bottom of the case at the right of the main logic board. The components were mounted on standard terminal strips fastened to the bottom of the case. The voltage regulator was mounted on a piece of 1/8-inch aluminum pop-riveted to the bottom of the case, providing adequate heat sinking. The power transformer is mounted to the rear of the case on the right side.

The two Triac lamp-dimmer circuits were built on the rear of the case to the left of the power transformer. The components are mounted on standard terminal strips, which are fastened to the back of the case. The Triacs themselves were chosen to have isolated tabs so that the tabs can be mounted directly to the aluminum back of the case with screws, avoiding the inconvenience of insulating hardware while still providing sufficient heat sinking by means of the case only. The fast, medium, and slow switches are mounted to the front of the removable top panel and are connected to the main logic board by a 4-pin connector, enabling the top cover to be removed without inconvenience.

There is little that is critical in any of the circuitry. Tantalum capacitors were used in most of the applications because of their compactness. If you have the space, you may want to use less expensive but bulkier standard electrolytics. The twelve relays used in the two relay trees must be reed-type units with fast pull-in and fast-release characteristics. Relays with more massive armatures, which pull in and release more slowly, will create a flickering effect during the slide fades.

The other relays are not critical as

long as they are within the voltage and current capabilities of the relay drivers. The relays driven by the relay drivers are all shunted with suppression diodes, which are necessary to prevent inductive pulses from causing spurious responses.

The Kodak *Carousel* projectors have two connectors on the back (or on the side in newer models), a five-pin connector for the remote control, and a 2-pin connector in series with the lamp filament. In searching for a connector that would match the spacing of the 5-pin connector, I stumbled across Radio Shack catalog numbers 270-041 (male) and 274-1215 (female), which fit the *Carousel* connector exactly, but are sold by Radio Shack as automotive sound system connectors.

The 2-pin connector, on the other hand, turned out to be more of a problem. Nowhere I did find a regularly available 2-pin connector that would match the spacing of the one on the *Carousel*. As luck would have it, I discovered a half-a-dozen 2-pin connectors in my junkbox that with a hard push would fit that connector.

The 2-pin connector was epoxied to the bottom of the 5-pin connector, and that combination was covered with shrink tubing to make a unified 7-pin assembly that connects to the back of the *Carousel* projector. If you are unable to find a 2-pin connector that will fit, one solution might be to open the projector and solder 18-gauge zip cord to the two pins of the 2-pin connector, and then bring out the zip cord and connect it to a female connector of a commonly available type. (Bear in mind that if your projectors are new, any modifications would void your warranty.) Be wary, however: the 2-pin lamp connector and anything subsequently connected to it is live with 117-volts AC whenever the *Carousel* projector is connected to the power line.

**Setting the Tone Decoders.** The last task to complete is to set the frequency of the tone-decoder oscillators. If the same Slide-Presentation Manager used to record the slide presentation is used to present the slide presentation, you can be sure the program will work no matter how the oscillators are set. The reason being that the same tone-decoder oscillators

that are used to generate the record signal to the tape recorder are also used to gate the fade signal from the tape recorder.

However, since the middle tone-decoder oscillator (U2, operating at 180 Hz) is also used as the base for the clock pulses that drive U8, if the frequency of that oscillator is far from 180 Hz, the dissolve times stated elsewhere in this article will be off. A lot of experimentation went into deciding on the right dissolve times, and a great departure from those times will result in less satisfactory results from an aesthetic point of view.

Set the tone-decoder oscillators as follows: If you have a frequency counter, connect its input to pin 5 of U1 and adjust R2 for exactly 360 Hz. Then connect the counter to pin 5 of U2 and adjust R5 for 180 Hz, and finally connect the counter to pin 5 of U3 and adjust R7 for 90 Hz. If you don't have a frequency counter, but have an oscilloscope, connect the vertical input to pin 5 of U1 and an isolated source of AC-line 60 Hz to the horizontal input, and adjust R2 for a stable Lissajous figure containing 6 loops, U2 and R5 for 3 loops, and U1 and R7 for 1½ loops.

If you have neither a frequency counter nor an oscilloscope, but have an audio oscillator or function generator, apply the output of the generator to J1 (the FROM-TAPE jack), and adjust the level for approximately 0.5 volt. Set the generator to 360 Hz (the accuracy of this setting will determine the accuracy of the tone decoder), connect a DC voltmeter (set to the 5-volt DC range) to pin 8 of U1, then adjust R2 until the voltage at R8 goes low. Similarly, do the same for U2 and U3, setting the audio oscillator for 180 Hz and 90 Hz and adjusting R5 and R7, respectively.

Finally, if you have none of the above equipment, set R2, R5, and R7 at mid-rotation and let the chips fall where they may. Then, never change the settings and always use the same Slide-Presentation Manager to present the slide show that was used to make the slide presentation. If you use the last method, before you make a slide presentation, try the various dissolve rates—fast, medium, and slow—with slides in the trays. If the dissolve rates don't please you, adjust R5 until you are happy with them. ■

## POST-CODE READER

(Continued from page 32)

short as possible. All the wiring should be done now except the connections going to the display.

The display presents us with a few choices. When I first built this device, I used the TIL311's plugged into regular IC sockets. I found that because I had cut the board to minimize its height above the mother board, the display now faced the back of the next board. This made it very difficult to read. To remedy this, I replaced the sockets with wire-wrap sockets with leads I had bent at a right angle (see the photo at the start of this story). The display would now face up and could be read by looking down on the computer's bus. Another option, along the same lines, is to have the display face the back of the computer. That way it could be seen through the hole normally covered by the backplate for the expansion slot. Of course, that requires being able to see the rear of the PC for use.

If you choose to go with the discrete-LED display (back in Fig. 2), you can use this same advice to aim it. Not only is the cost of this approach much

computer locks up at any time the display will indicate the code of the last test attempted by your PC.

The meaning of the codes is something determined by the manufacturer of your BIOS. Table 1 presents the meaning of a few codes for one version of a Phoenix BIOS as an example. It would be a good idea to get the proper POST codes for your particular BIOS and motherboard from its manufacturer as soon as possible so they're on hand in the event of a breakdown.

If you are using the discrete-LED display, you must convert the binary number represented by the display into two hex digits. It is important to note that the display is reversed from normal, so when an LED is unlit it represents a "1", and when it is lit, it represents a "0". For example, if LED1 through LED8 are, in order, lit, unlit, unlit, lit, lit, unlit, unlit, and lit, then they indicate a binary value of 01100110, or the hex value of "66."

There is one situation that will block the use of the this tester. Every motherboard is designed somewhat differently, and certain motherboards are designed in such a way that ports 0 through 1FF are not allowed on the expansion bus. For most applications, that is fine because those ports are used for system functions (such as the keyboard, the direct-memory-access controller, etc.). However, this scheme would prevent the code reader from working. Luckily, that should not pose too much of a problem since only a small percentage of motherboards have this limitation.

**Testing.** No project is complete until it's tested and working. Even though this is a simple project, errors can creep in. It is important that the display works accurately, otherwise you won't be able to trust it to tell you the real diagnostic code. Listing 1 contains a simple BASIC program that will test out this project. It sends values from 0 to 255 to port 80. By watching the display count from 0 to FF, you can verify that the device is working.

This board is a simple tool that can be very helpful if your system goes down. It won't be able to tell you exactly what's wrong, but it will point you in the right direction and certainly save you some time, and perhaps even a few bucks. ■

TABLE 1—SOME CODES FOR A PHOENIX BIOS

Post Code	Corresponding Test
00	Okay
09	First 54k ram test
0D	Parity error in first 64K
21	DMA-register error
22	Interrupt-register error
27	Keyboard-controller error
28	CMOS-power error
29	CMOS-configuration validation
2B	Screen initialization
31	Monochrome test
32	Color test 40 column
33	Color test 80 column
3B	Time of day clock test
3C	Serial port test
3D	Parallel port test
3E	Math coprocessor

less than using the TIL311 displays, the LED's are easier to see from the side as well. However, you should make sure that they are a different color than the power-monitoring LED's (which we'll get to shortly) to avoid confusion. Remember to orient the LED's correctly as they are polarized—the flat edge of each LED must face the more-negative voltage. If an LED is reversed, the LED won't light.

The four LED's and resistors for power monitoring should now be added to the board. Using the correct-value resistor for each of these LED's is important: be sure to use the 1k resistors for the +12 and -12 voltages, and the 330-ohm resistors for the +5 and -5 voltages.

**Use.** In normal usage the display can be left plugged into the computer's bus. It takes little power, but does occupy a slot. If you are tight for slots, it is easy enough to plug it in only when needed.

With the board in place, the four power LED's should be lit. Each monitors a different voltage that is important to your computers operation. If your computer dies, and any of the power LED's are out, the power supply would be the best place to start your diagnosis.

When you first turn on or reset your computer, the code display will indicate each test as it is run. If the com-

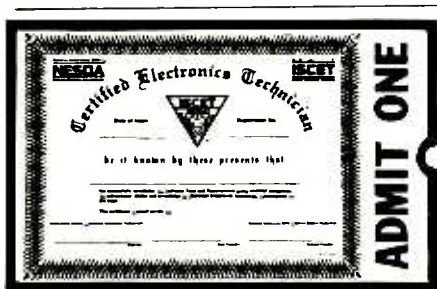

## Your Ticket To SUCCESS

Over 28,000 technicians have gained admittance worldwide as certified professionals. Let your ticket start opening doors for you.

ISCET offers Journeyman certification in Consumer Electronics, Industrial, Medical, Communications, Radar, Computer and Video. For more information, contact the International Society of Certified Electronics Technicians, 2708 West Berry Street, Fort Worth, TX 76109; (817) 921-9101.

Name \_\_\_\_\_  
 Address \_\_\_\_\_  
 City \_\_\_\_\_  
 State \_\_\_\_\_ Zip \_\_\_\_\_

Send material about ISCET and becoming certified.

Send one "Study Guide for the Associate Level CET Test." Enclosed is \$10 (inc. postage).



## ANTIQUE RADIO

(Continued from page 71)

effectively throw a short across the power supply, blowing the fuse and cutting off the filament circuit from the power-supply output.

The 1N4001 diodes used in the circuit will normally begin conducting at around two volts when connected as shown. But there are variations among diodes. Purchase several and try them in different combinations, selecting a set of three that will conduct when the voltage climbs to slightly under two volts.

As described, the circuit will protect 1.1-volt tubes such as the types '11 and '12. Incidentally, Mr. Zinck warns that low-current fuses such as the one used in his circuit have a high resistance. Your power supply might have to deliver about 1.6 volts to the circuit to get 1.1 volts out.

## YOURS FOR THE ASKING

Reader Don Lehman (378 Fairway Drive, Columbus, OH 43214-1848) has been interested in radio since he first began listening with a crystal set back in the mid-1920's. But since he's not into radio restoration right now, he's willing to pass along a couple of items to those who would provide them with a good home.

One of the items is a Philco Model A-361 receiver with speaker, but without its console cabinet. Don believes that this model receiver was originally built as an auto radio for use in Ford cars. But Philco, stuck with the sets when the onset of World War II halted civilian auto production, converted them to AC operation. The Philco is

available for the cost of packing and shipping only.

Don also has a copy of John Rider's *Servicing Superheterodynes*, published in 1934, that he'll be glad to send postpaid to the first person requesting it. Finally Don mentioned a Heathkit Model IM-21 VTVM available for the cost of packing and shipping. However, I'd guess that the latter has already found a home, since it was also offered in **Popular Electronics'** general letters column last April. Incidentally, if you want a response from Don on the status of your request, you should include an S.A.S.E.

That's all the room I have this month. I'll try to get to the remaining letters next time! In the meantime, write me *c/o Antique Radio, Popular Electronics*, 500-B Bi-County Blvd., Farmingdale, NY 11735. ■

## THINK TANK

(Continued from page 78)

*your letter. Even though I live in a suburb of America, I am fortunate enough to be surround by parts suppliers and very large bookstores. You really opened my eyes to how lucky I am.*

*You'll be happy to hear that since three of your ideas made this column, I'll be sending you three books. I hope they help, and thank you for enlightening me.*

Surely those of you that can get ahold of parts and such have something to contribute to this column. If so, please send your circuit ideas and hints to *Think Tank, Popular Electronics*, 500-B Bi-County Blvd., Farmingdale, NY 11735. If your work appears here, you will be rewarded with one of our books. ■

## SUPER 12 HOUR RECORDER CALL TOLL FREE

Modified Panasonic Slimline. 6 hrs per side. 120 TDK tape furnished. AC/DC Operation. Quality Playback. Digital Counter. Durable Lightweight Plastic.



**\$119.00\***

### PHONE RECORDING ADAPTER

Starts & Stops Recorder Automatically When Hand Set is Used. Solid State!

FCC APPROVED

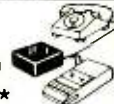

**\$28.50\***

### VOX VOICE ACTIVATED CONTROL

Solidstate Adjustable Sensitivity. Voices & Sounds Activate Recorder. Adjustable Sensitivity. Provisions for Remote Mike.



**\$28.50\***

\*Add for ship. & handling. Phone Adapter & Vox \$2.00 each. Recorders \$5.00 each. Colo. Res. add tax. Mail Order, VISA, M/C, COD's OK. Money Back Guar. Qty Disc. available. Dealer inquiries invited. Free data on other products.

ALL MAIL TO: Box 20100, Boulder, CO 80308  
AMC SALES INC., 193 Vaquero Dr.,  
Boulder, CO 80303

Phones (303) 499-5405 • 1-800-926-2488  
FAX (303) 494-4924 • Mon-Fri 8-5 MTN. TIME

CIRCLE 6 ON FREE INFORMATION CARD

## FREE

Electronics & Computer Software Education Catalog

- \*Fast-Track Individual Learning Programs
- \*State-of-the-Art Classroom Courses
- \*The **Best Values** in Electronics Education

### New

**Career-Level Courses**  
**Personal Computer Servicing**  
**TV and VCR Servicing**

### New

**Computer-Aided Instruction**

**DC & AC Electronics**  
**Semiconductors**  
**Electronic Circuits**

*The stunning animations, hypertext glossary, and easy-to-understand text make learning electronics a breeze...and fun!*

Learn the easy and affordable way from the Masters in Electronics Training - **Heathkit**. From Basic Electricity to Advanced Microprocessor Applications and more, Heathkit will provide you with an unparalleled learning experience at a fraction of the cost of other programs.

**Heathkit**<sup>®</sup>  
Educational Systems

For your FREE Catalog, call

**Toll-Free 1-800-44-HEATH**

please mention this code when calling 107-013

CIRCLE 7 ON FREE INFORMATION CARD

---

## PC GUIDE

*(Continued from page 40)*

---

expansion and accessory-port slots for memory, modems, and other peripherals. If your portable will double as a desktop PC, check to see if a special expansion unit (a "docking station") is available to simplify connecting the unit to power and peripherals.

To call home, you'll almost certainly need a modem and a variety of connecting cables. The portable should include or accept an internal 2400-bps data (9600-bps FAX) or higher speed modem, although external modems are favored by many travelers. A large carrying case is helpful to protect the portable and to carry the assorted paraphernalia you'll need. Other than a modem, you may find that you won't need other peripherals like printers.

**Portable Warranties.** Road warriors, be forewarned: because they get lots of abuse, portables tend to break and get lost or misplaced. Warranties on

portables are similar to those offered on desktops. However, on-site service often isn't included, since—unlike desktops—portables are relatively easy to ship to the factory. Check out the fine print on your warranty.

There are a few special procedures that manufacturers have developed to handle problems that occur on the road. For example, Dell, AST Research, GRiD Systems, and some others offer a loaner while your portable is being repaired. Local CompuAdd stores let you exchange your broken CompuAdd portable for a new one. They'll also help you transfer your data, if possible. However, the fine print states that this benefit is primarily for store-bought CompuAdd computers, not for mail-order CompuAdd Express PCs.

**Further Reading.** Wherever you buy your machine, be sure to comparison shop, not only for best price but to fully explore the maze of available options. How you do this is up to you, but let's explore your options.

One way to "get smart" on the current PC marketplace is to keep up

with a variety of computer magazines and buyers guides. Start by carefully perusing those magazines that cater to savvy direct buyers, such as Computer Shopper, InfoWorld Direct, PC Sources, and PC Magazine. Both the ads and the editorial pages of these publications—often with feature comparison matrices, best-price analyses and indices, and the like—should be of considerable value.

Note: some merchandisers have "low price guarantees" stating they will equal or beat prices advertised elsewhere. Often, you can secure a low mail-order price yet buy locally simply by presenting an advertisement.

The PC state of the art changes so fast that it's hard for books to keep pace. But a small library of computer "how to" reference books in the areas of PC selection, upgrading, and performance can help frame your buying guidelines. I've found several titles high on comprehensiveness and readability; see the boxed text entitled "A Starter Bookshelf for Prospective PC Buyers" for some recommended reading. ■

---

## THE SKY CHORUS

*(Continued from page 48)*

---

tioned earlier, an additional mechanism is required. This may have to do with an effect noticed in 1842 by the Austrian physicist Christian Johann Doppler. The frequency of a source of sound will rise if the source is approaching the listener and will fall if it is receding. The Doppler effect also applies to light, radio waves, and other wave-based phenomena. Since the particles alternately slow down as they approach the poles and speed up as they approach the magnetic equator, the Doppler effect could explain the existence of hooks, provided the electrons travel in bunches. It is not known whether this is the case. However, if they did not travel in bunches, the slowing down and speeding up effects would cancel.

Other possibilities are that the noises start out very weak and are amplified in the atmosphere and involve another somewhat complex phenomenon: the interaction be-

tween particles and waves in the ionosphere. If a stream of electrified particles moves along with, and at nearly the same speed as, an electromagnetic wave, the wave can be amplified at the expense of the energy of the particles. This may sound impossible at first since radio waves travel in general at the speed of light. It is true that particles cannot reach the speed of light, but electromagnetic waves can be slowed down to the speed of fast-moving particles.

In fact, that is the principle of the traveling-wave-tube amplifier, as illustrated in Fig. 4. In that type of amplifier, the wave is slowed down by making it travel through a helical or spiral-shaped duct or wave guide.

In the magnetosphere, the wave from a small electrical noise might be slowed naturally by interaction with electrons and the Earth's magnetic field. It is estimated that that would reduce the speed of the wave to about one-tenth of its speed in a vacuum, or to about the speed of the particles coming from the Sun. There are components in the magne-

tosphere that make a natural traveling-wave-tube, which could take the ever-present but exceedingly weak noises and amplify them.

The last possibility is that these VLF noises are actually the result of lightning discharges, but that they have been changed by some as yet unexplained phenomenon.

It could be that all these possibilities are correct. Each could act alone or in combinations at various times. It is worth noting that all involve the interaction of ionized particles from the Sun with the magnetic field of the Earth. That is supported by the close association found between solar disturbances and noise storms.

New phenomena has been detected beyond the altitude where normal whistler propagation cuts off. A powerful fluctuating noise has been detected with frequencies that extend from 200 to 100,000 hertz. The noise has been observed between five earth radii (about 20,000 miles out) and 25 earth radii out. Emissions have included hiss, chorus, risers, and constant tones. ■



# "YOUR FREE CATALOG KNOCKED MY SOCKS OFF"

We get that sort of comment all the time. People are impressed that our free Consumer Information Catalog lists so many free and low-cost government booklets. There are more than 200 in all, containing a wealth of valuable information.

They tell you how to make money, how to save money and how to invest it wisely. They tell you about federal benefits, housing and learning activities for children. They fill you in on nutrition, jobs, health and much, much more.

Our free Catalog will very likely impress you, too. But first you have to get it. Just send your name and address to:

**Consumer Information Center  
Department KO  
Pueblo, Colorado 81009**

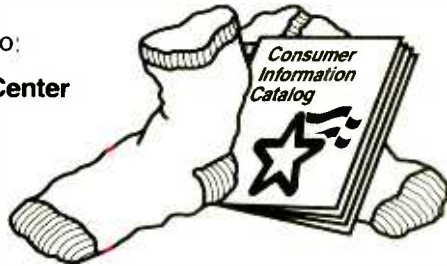

A public service of this publication and the Consumer Information Center of the U. S. General Services Administration

## HAM RADIO

(Continued from page 80)

pF value is needed (use 39-pF or 47-pF standard-value units).

In the final "cut-n-try" on the bench, adjust the exact values of the trimmer capacitor (C5) and the inductance of L1 to find the exact match needed. For the first trial, though, use the following component values: C1 and C2, 680 pF; C3, 5 pF or 120 pF (depending on philosophy); C4, a 50-pF variable; C5, 60- or 80-pF trimmer (set to about 40 pF); C6-a, 100 pF; C6-b, 27 pF (use 30 or 33 pF as available); C<sub>o</sub>, 39 or 47 pF; and L1, 4.46 μH.

All the capacitors that can affect the operating frequency (C1-C6 and C<sub>o</sub>) should be NPO ceramic-disc, silvered mica, or polyethylene types for best temperature-drift perfor-

mance. Be wary of silvered-mica units, however, because they can individually be quite poor in the temperature-coefficient department. I'd stick with NPO ceramic or polyethylene units unless you can hand select the silvered-mica units. Next month we will look at stabilizing the oscillator.

## ANOTHER PARTS SOURCE

Literally hours after mailing the June column, I received a new catalog in the mail. It is from Ocean State Electronics (P.O. Box 1458, 6 Industrial Drive, Westerly, RI, 02891; Tel. 800-866-6626 and 401-596-3080).

They stock a lot of different items that are otherwise hard to obtain. I bought some high-quality variable capacitors of the sort needed for the VFO's in this month's column. ■

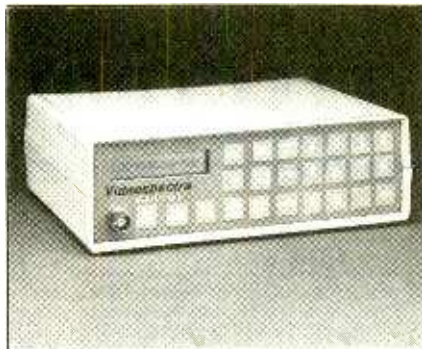

Model 1010 Digital Sweep/Function Gen.  
**\$289**

Finally, digital frequency and waveform synthesis at a price everyone can afford. Sine, Square, Triangle, Ramp, Pulse AM and FM modulation - All under full digital control with 9 programmable memory setups. 0 to 8 MHz at 50 parts per million frequency accuracy. Alphanumeric display. 30 Day money back guarantee. One year parts and labor.

Model 4010 Digital Function Generator  
**\$189**

Model 2010 1 GHz Frequency Counter  
**\$249**

Model 3010 2.4 GHz RF Freq. Gen.  
**\$389**

All prices subject to change without notice.

Videospectra  
P. O. Box 755  
Agoura, CA 91301

**(800) 835-8335**



CIRCLE 10 ON FREE INFORMATION CARD

## CABLE TV DESCRAMBLERS

How You Can Save Money on Cable Rental Fees

**Bullet Proof**

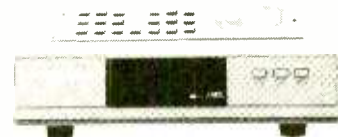

1 Unit 5+

**BEST Super Tri-Bi Auto/**  
Var. Gain Adjustment \$119.95...\$85  
Jerrold Super Tri-Bi ... \$109.95...\$79  
Scientific Atlanta ..... \$109.....\$79  
Pioneer ..... \$109.....\$79  
Panasonic TZPC145.... \$99.95....\$79  
Stargate Converter..... \$95.....\$69  
Digital Video Stabilizer..\$59.95...\$29  
Wireless Video Sender..\$59.95...\$49.95

**US Cable'll Beat  
Anyone's Price  
Advertised in  
this Magazine!**

**30 Day Money Back Guarantee  
FREE 20 page Catalog**

Visa, M/C, COD or send money order to:  
**U.S. Cable TV Inc.** Dept. KPE793  
4100 N. Powerline Rd., Bldg. F-4  
Pompano Beach, FL 33073

**1-800-772-6244**

### For Our Record

I, the undersigned, do hereby declare under penalty of perjury that all products purchased, now and in the future, will only be used on Cable TV systems with proper authorization from local officials or cable company officials in accordance with all applicable federal and state laws. **FEDERAL AND VARIOUS STATE LAWS PROVIDE FOR SUBSTANTIAL CRIMINAL AND CIVIL PENALTIES FOR UNAUTHORIZED USE.**

Date: \_\_\_\_\_

Signed: \_\_\_\_\_

**No Florida Sales!**

CIRCLE 9 ON FREE INFORMATION CARD

# ELECTRONICS MARKET PLACE

## FOR SALE

**CABLE test chips.** Jerrold, Tocom, S.A., Zenith. Puts cable boxes into full service model \$29.95 to \$59.95. 1 (800) 452-7090, (310) 867-0081.

**LASER & special effects products.** Lasers from \$9.95. We specialize in laser and special effects products for commercial, and hobbyist applications. Free catalog: **DESIGN IMAGES**, Dept P7, Box 292125, Lewisville, TX 75029. (214) 221-9711.

**SECRET cable descramblers!** Build your own descrambler for less than \$12.00 in seven easy steps. Radio Shack parts list and free descrambling methods, that cost nothing to try, included. Send \$10.00 to: **HARRY WHITE**, PO Box 1790, Baytown, TX 77522.

## Cable TV DESCRAMBLERS

**30-day  
Money Back  
Guarantee**



**ORDER  
NOW!**

➤ The Most Complete Line of Descramblers  
➤ Friendly, professional service  
➤ FREE Catalog





## 1-800-228-7404

Go to the Source  
**NU-TEK ELECTRONICS**  
3250 Hatch RD  
Cedar Park TEXAS 78613

**300 EXPERIMENTERS CIRCUITS** — Complete in 6 practical books using diodes, relays, FET's, LED's, IC 555's, and IC CA3130's for building blocks. Only \$33.00 plus \$5.50 for shipping. USA and Canada only. US funds. **ETT, INC.**, PO Box 240, Massapequa Park, NY 11762-0240.

**CABLE descrambler liquidation.** Major makes and models available. Industry pricing! (Example: Hamlin Combo's, \$44 each... Minimum 10 orders). Call **WEST COAST ELECTRONICS**, 1 (800) 628-9656.

## FREE CATALOG

**FAMOUS "FIRESTIK" BRAND CB ANTENNAS AND ACCESSORIES. QUALITY PRODUCTS FOR THE SERIOUS CB'er. SINCE 1962**

**FIRESTIK ANTENNA COMPANY**  
2614 EAST ADAMS  
PHOENIX, ARIZONA 85034

**SURROUND Sound** weatherized indoor/outdoor speakers. Retail \$249.95, factory direct price \$69.95 + \$8.00 S&H. Send check or money order to: **MTM ENTERPRISES INC.**, 561 Keystone Ave. #356, Reno, NV 89503. For brochure only, send \$1.00.

**LEARN** what strategies cable TV companies use to find bootleggers. Send \$12.50 to **R.M.S.**, Box 220685, Anchorage, AK 99522-0685.

**TUBES.** (Thousands in stock). Send SASE for list. **FALA ELECTRONICS**, PO Box 1376-2, Milw., WI 53201.

**PRINTED circuit boards** — etched, drilled, tin plated. Single sided \$1.25/sq. inch. Free shipping. **CHELCO ELECTRONICS**, 61 Water Street, Mayville, NY 14757. 1 (800) 388-8521.

## CB RADIO OWNERS!

We specialize in a wide variety of technical information, parts and services for CB radios. 10-Meter and FM conversion kits, repair books, plans, high-performance accessories. Thousands of satisfied customers since 1976! Catalog \$2

**CBC INTERNATIONAL**  
P.O. BOX 31500PE, PHOENIX, AZ 85046

**CELLULAR Hackers Bible Theory** — hacks — modifications — programming — \$53.95. Cellular Cloning Video — \$39.95. Cellular Programmers Bible — \$84.45. Catalog — \$3.00. **TELECODE**, PO Box 6426 PE, Yuma, AZ 85366-6426.

**OSCILLOSCOPE** 50 MHz, dual channel, solid state calibrated, manual, \$250.00. 1 (800) 835-8335 X-123.

**CABLE TV descramblers.** All major brands. Have make/model used in your area when calling. 1 (800) 327-3407. For a free catalog write: **K.D. VIDEO**, PO Box 29538, Minneapolis, MN 55429.

**COMPUTER** software IBM and Commodore, as low as \$1.80 per disk. Hundreds of titles available. Call for catalog **DAYTON SHAREWARE**, (513) 294-5828.

**PC board service.** Single quantity ss. No setup fee. We also scan magazine artwork. Get out your back issues. **FIRST PROTO**, (407) 392-8677.

**HUGE** 100 page communications catalog of shortwave, amateur and scanner equipment. Antennas, books, and accessories too. Send \$1.00 to: **UNIVERSAL RADIO**, 6830 Americana Pkwy., Dept. PE, Reynoldsburg, OH 43068.

## EDUCATION/INSTRUCTION

**LEARN Assembly Language** for IBM PC and compatibles. Disk \$5.00. Book \$18.00. **ZIPFAST**, Box 12238, Lexington, KY 40581-2238.

FULL- OR PART-TIME JOB/BUSINESS:

## Learn VCR repair!

Professional-level home study program. Master easy-to-learn, high-profit repairs without investing in costly high-tech instruments. Send or call today.

**Free career kit:**  
**800-223-4542**



Name \_\_\_\_\_ Age \_\_\_\_\_  
Address \_\_\_\_\_ Phone (\_\_\_\_) \_\_\_\_\_  
City \_\_\_\_\_ State \_\_\_\_\_ Zip \_\_\_\_\_

**The School of VCR Repair, Dept. VH341**  
6065 Roswell Road, Atlanta, GA 30328

**VCR Repairs You Can Do.** Save \$. Make \$. 403-page textbook used by national correspondence schools. \$ Back-guarantee. 35,000 sold, 2 returned. 704 illustrations + tool. Mail \$24.95 to **WORTHINGTON PUBLISHING**, Box 16691M, Tampa, FL 33687-6691.

**ELECTRONIC engineering.** 8 volumes complete. \$109.95. No prior knowledge required. Free brochure. **BANNER TECHNICAL BOOKS**, 1203 Grant Avenue, Rockford, IL 61103.

**ESP, bioelectricity, microwave hearing.** Introduction, comprehensive booklist...\$1.00. **RESEARCH ASSOCIATES**, PO Box 3583C, Boynton Beach, FL 33424-3583.

**ACTIVE Filter Handbook:** Easily design/build filters for most applications. Send \$10.95. **EE-Z-SOFT**, 9001 Swigert, Loveland, OH 45140.

**BEEP beep** Repair IBM compatible PC's with the "Post Code Master" plug in card. Shows result of Power On Self Test performed by all major BIOS's. Manual reveals their meaning and also explains those cryptic beep codes. \$59.00 **MSD**, 4100 Moorpark Ave. #104, San Jose, CA 95117. (408) 296-4000 Fax: (408) 296-5877.

## BEST BY MAIL

Rates: Write National, Box 5, Sarasota, FL 34230

### OF INTEREST TO ALL

**TWELVE-HOUR AUTOMATIC** Cassette TELEPHONE RECORDER. Records All Phones For Weeks. **FREE BROCHURE:** PEP, Box 173, Woodstock, GA 30188-0173. (404)516-1388.

### MONEYMAKING OPPORTUNITIES

**EARN \$50-\$300 DAILY** Using Your Camcorder. Free Information: **WCE**, Box 9803E, Fountain Valley, CA 92728.

**NEED EXTRA MONEY?** Let us show you how. Send \$2.00/p/h. Enterprises, 220 Sunrise Hwy. #171, Rockville Center, NY 11571.

### PLANS

**CONFUSE LIDAR! PLANS**, parts, sources to construct laser speed gun confuser. Info pack \$3.00, plans \$20. Send Check/MO to: **M. Wallace & Assoc.**, POB 267-Paul, Morrison, CO 80465.

## SATELLITE TV

**FREE** — Catalog — Do-it-Yourself. Save 40%-60%. Lowest prices world wide. Systems, upgrades, parts. All major brands factory fresh and warranted. **SKYVISION**, 1048 Frontier, Ferguson Falls, MN 56537. 1 (800) 334-6455.

**SUPER** low satellite prices. Free U.S. and International catalog. **SATMAN**, (309) 692-4140 (Int'l), 1 (800) 472-8626 in U.S.

**VC-2 RS** modules \$375.00 (old boards call for prices). 25k LNB \$85.00. Tracker V \$539.00. Uniden 4400 \$379.00. Uniden 4500 \$599.00 without modules. We advertise the best prices, call for phone quotes on other equipment. P.S. We repair all satellite related equipment. **SATELLITE T.V.**, 120 W. Centennial, Muncie IN 47303. (317) 288-0074.

## INVENTORS

**INVENTORS:** Concept Network offers professional, inexpensive patenting and marketing services. (New product ideas with prototype or schematics preferred; but they are not required.) **FREE** information packet: Call 1 (800) 835-2246 extension 67.

# BUY BONDS



**TELEPHONE LISTENING DEVICE**

Record telephone conversations in your office or home. Connects between any cassette or tape recorder and your telephone line. Starts automatically when phone is answered. Records both sides of conversation. Stops recorder when phone is hung up.

**\$19.95 EACH** (Dlx. Dlx. Avail.)

**Super Powerful FM TRANSMITTER**

Many times more powerful than other transmitters. Transmits up to 1/2 mile to any FM radio. (Easy to Assemble Kit - up to 9V battery not inc.) For catalog of Transmitters, Voice Scramblers and other specialty items, enclose \$2.00 to USI Corp.

Call 1-800-777-1000 or send \$19.95 + \$1.00 shipping to: USI Corp., PO Box PE-2062, Melbourne, FL 32902, 800-7-1000.

**REMOVE LEAD VOCALS**

From Records & CD's

Build this kit which removes lead vocals from standard stereo records, CD's, tapes or FM broadcasts. Sing along with the background music. Use with any home component stereo. Additional kit adds reverb to your voice, then mixes it with music. Pre-assembled boards also available. Write for free info: **Weeder Technologies, P.O. Box 421, Batavia, Ohio 45103.**

**FM Transmitter Amplifier.** Produces powerful 15-25 watt signal. Broadcast farther! Plans \$16.00. **PROGRESSIVE CONCEPTS**, 1313 Grand #291, Walnut, CA 91789.

**MINI FM transmitter** only 1" X 1" transmits to any FM radio, great science fair project! Complete kit only \$14.95 plus \$1.50 S&H. **D.V. ELECTRONICS**, PO Box 729, Middleburg, FL 32068.

**UNINTERRUPTABLE** power supply for your PC or Mac. Complete plans \$9.95. Backup power, when you need it. **CUSTOM POWER SOLUTIONS**, Box 1242, Hampton, NH 03842.

**SCHEMATIC** design program. Free brochure. Write **SCHEME-ADDICT**, Dept. 1, 8622 W. 44th Place, Wheatridge, CO 80033.

**YOUR IBM compatible computer** switches most any device with this simple inexpensive project! Schematic and parts list \$12.00. Application guide and program disk included. **SOFTWARE STIMULUS**, 1152 Reading Drive, Acworth, GA 30102.

 Great kit for electronic buffs. **SILENT SAM** Turn Signal reminder. Patent Approved! Best reminder yet. Will not bug you. Sounds briefly & repeats only if you forget to cancel. Quiet, braking resets it. Complete kit of all parts PCB, case & instructions only \$15 PPD. Wired units \$7 more. Visa, MC (614) 231-8814. Call for free information sheet. **Silent Sam**, 1627 Basil Dr., Columbus, Oh 43227

**BUGGED? Telephone tapped?** Find out fast! Free catalog of fantastic counter-surveillance equipment! **1 (800) 732-5000.**

**RADAR** jammer complete with schematics, parts list, board lay-out with art work, instructions. \$12.95 - \$3.00 S&H. **MATRIX MARKETING**, PO Box 33127P2, Kansas City, MO 64114.

**BUILD** 0-50 volt regulated dual tracking power supply. Complete schematics and instructions. \$5.95. **SMS ENGINEERING**, 5932 West Bell Road, Suite D106, Glendale, AZ 85308.

**METAL detector**, many applications: find lost coins, jewelry. Use as stud finder, car sensor... Schematics, construction instructions, diagrams, part sources. \$10.00. Catalog free with order. Catalog only. \$2.00. **DJ**, 27 Mansfield Place, D-D-O, Quebec, H9G 2B3.

**MASTERCARD AND VISA** are now accepted for payment of your advertising. Simply complete the form on the first page of this section and we will bill. \$15.00 minimum.

**COMPUTERS**

**FREE** catalog on disk of the newest IBM shareware programs. **EZ-WARE**, PO Box 5057-A, Central Point, OR 97502.

**LEARN COMPUTERS!**

Home study: become an expert with the personal computer for home or business use. Free literature: **800-223-4542.**

Name \_\_\_\_\_ Age \_\_\_\_\_  
Address \_\_\_\_\_  
City \_\_\_\_\_ State \_\_\_\_\_ Zip \_\_\_\_\_  
**School of Computer Training, Dept. KH341**  
6065 Roswell Rd., Atlanta, Georgia 30328

**CABLE TV DESCRAMBLERS**  
★ **CONVERTERS** ★  
and ACCESSORIES.

**SAVE MONEY. DON'T RENT!**

PANASONIC, PIONEER, JERROLD, OAK, SCIENTIFIC ATLANTA AND MORE. LOWEST PRICES. FREE CATALOG.

**(800) 234-1006**  
**CABLE READY COMPANY**

**ANTIQUE RADIO CLASSIFIED**

Free Sample!  
Antique Radio's

Largest Circulation Monthly. Articles, Ads & Classifieds.

6-Month Trial: \$16.95. 1-Yr: \$29.95 (\$44.95-1st Class). A.R.C., P.O. Box 802-L10, Carlisle, MA 01741

**HOME FIRE SAFETY. ACT ON IT!**



**FOR FREE HOME FIRE SAFETY TIPS, WRITE:**

United States  
Fire Administration  
P.O. Box 70274  
Washington, DC 20024

**BUSINESS OPPORTUNITIES**

**YOUR own radio station!** Licensed/unlicensed. AM, FM, TV, cable. Information \$1.00. **BROADCASTING**, Box 13C-H7, Paradise, CA 95967.

**MAKE \$75,000.00 to \$250,000.00 yearly** or more fixing IBM color monitors. No investment, start doing it from your home (a telephone required). Information, USA, Canada \$2.00 cash for brochure, other countries \$10.00 US funds. **RANDALL DISPLAY**, Box 2168-H, Van Nuys, CA 91404, USA. Fax (818) 990-7803.

**HOME assembly work** available! Guaranteed easy money! Free details! **SASE**. **HOMEWORK-P**, Box 520, Danville, NH 03819.

**FEDERAL loans** for small businesses now available. **1 (800) 777-6342** for free details.

**EASY work!** Excellent pay! Assemble products at home. Call toll free **1 (800) 467-5566** ext. 5730.

**NEED money?** Guaranteed employment! Assemble simple products at home. Easy work! Excellent income! **1 (800) 377-6000**, ex7930.

**DISTRIBUTORS needed** — High profits. Largest selection & lowest prices of mini-satellite antennas for homes, RV's & business use. Starting at \$296.00. **1 (800) 886-5008.**

**GUARANTEED earn \$100.00 per hour** repairing VCR's. No electronic experience necessary. Most malfunctions simple mechanical or electro-mechanical. Start repairing the first day! Call **1 (800) 682-6877** or write **VCR MASTER SERVICE**, 2001 Denison, Denton, TX 76201.

**VISA MC Guaranteed.** Solve your credit problems. Call **1 (800) 777-6342** for free details.

**PLANS & KITS**

**HOBBY broadcasting ham CB surveillance** transmitters, amplifiers, cable TV, science, bugs, other great projects! Catalog \$1.00. **PANAXIS**, Box 130-H7, Paradise, CA 95967.

**FASCINATING Electronic Devices!** Voice Disguiser! Vocal Truth Indicator! Lasers! Transmitters! Detectors! Free energy! High Voltage! More! Kits Assembled! Catalog \$4.00 (refundable). **QUANTUM RESEARCH**, 17919-77th Ave., Edmonton, Alberta, Canada T5T 2S1.

**DESCRAMBLER kits.** Complete cable kit \$44.95. Complete satellite kit \$49.95. Add \$5.00 shipping. Free brochure. No New York sales. **SUMMIT PE**, Box 489, Bronx, NY 10465.

**SURVEILLANCE transmitter kits** tune from 65 to 305 MHz. Mains powered duplex, telephone, room, combination telephone room. Catalog with **Popular Communications**, **Popular Electronics** and **Radio-Electronics** book reviews of "Electronic Eavesdropping Equipment Design," \$2.00. **SHEFFIELD ELECTRONICS**, PO Box 377785-A, Chicago, IL 60637-7785.

**60 SOLDERLESS Breadboard Projects** in two easy-to-read pocket books. Complete with circuit descriptions, schematics, parts layouts, component listings, etc. Both books (BP107 & BP113) only \$11.90 plus \$3.50 for shipping. USA and Canada only. US funds. **ETT, INC.**, PO Box 240, Massapequa Park, NY 11762-0240.

## ADVERTISING INDEX

POPULAR ELECTRONICS magazine does not assume any responsibility for errors that may appear in the index below.

Free Information No.		Page
6	AMC Sales .....	89
—	Antique Radio Classified .....	95
—	CBC International .....	94
—	CIE .....	11
—	Cable Ready Company .....	95
—	Claggk Video Offer .....	4
—	Command Productions .....	26
—	Doc Tech International .....	3
—	Electronics Book Club .....	15, 27
—	Electronic Tech. Today .....	CV3
—	Firestik II .....	94
5	Foley-Belsaw Company .....	77
—	Grantham College .....	25
7	Heathkit .....	89
—	ISCET .....	90
8	Jameco .....	CV2
—	NRI Schools .....	21
—	Nu-Tek .....	94
—	Silent Sam TSR Co. ....	95
—	Silicon Chip .....	86
—	The School of VCR Repair ..	94, 95
—	USI Corp. ....	95
10	Video Spectra .....	93
—	WTDT .....	CV4
—	Weeder Technologies .....	95
9	Zentek Corp. ....	93

## ADVERTISING SALES OFFICE

Gernsback Publications, Inc.  
500-B Bi-County Blvd.  
Farmingdale, NY 11735  
1-(516) 293-3000

**Larry Steckler**  
President

**Christina Estrada**  
Assistant to the President

**For Advertising ONLY**  
516-293-3000  
Fax 1-516-293-3115

**Larry Steckler**  
publisher

**Arline Fishman**  
advertising director

**Denise Mullen**  
advertising assistant

**Kelly Twist**  
credit manager

**Subscription/  
Customer Service/  
Order Entry**  
1-800-827-0383  
7:30 AM - 8:30 PM EST

## ADVERTISING SALES OFFICES EAST/SOUTHEAST

**Stanley Levitan**  
Eastern Sales  
1 Overlook Ave.  
Great Neck, NY 11021  
1-516-487-9357, 1-516-293-3000  
Fax 1-516-487-8402

## MIDWEST/Texas/Arkansas/ Oklahoma, Colorado, Arizona

**Ralph Bergen**  
Midwest Sales  
One Northfield Plaza, Suite 300  
Northfield, IL 60093-1214  
1-708-446-1444  
Fax 1-708-559-0562

## PACIFIC COAST/Mountain States

**Mike Brooks**  
Pattis/3M  
1800 North Highland Avenue  
Suite 717  
Hollywood, CA 90028  
1-213-462-2700  
Fax 1-213-463-0544

## PE Market Center

**Mike Brooks**  
Pattis/3M  
1800 North Highland Avenue  
Suite 717  
Hollywood, CA 90028  
1-213-462-2700  
Fax 1-213-463-0544

## HAM SOFTWARE

(Continued from page 60)

format, which must be uncompressed to your own disks. There is a good mixture of old and new programs and a large collection of PD clip art, mostly in the PCX-file format, that includes lots of artwork with amateur-radio themes. The disc is \$79.95 from Amsoft (PO Box 666, New Cumberland, PA 17070; Tel. 717-938-8249).

**The Future is Digital.** Amateur-radio software has come a long way since it first appeared on "home computers" in the late 1970's. No one knows where amateur-radio software development will end—really, it's a never-ending, evolutionary process. All that's certain is change, and that change is sure to have a digital complexion. The ham shack of the future will feature PC-controlled radios, digital-signal processing (DSP), high-speed modems, digital-satellite and spread-spectrum gear, packet networking, multimode TNC's, and digital-imaging systems such as FAX (facsimile), FSTV (fast-scan television), and SSTV (slow-scan television).

One excellent publication I recommend for learning more about digital communications is *Digital Digest*. Published by Tom Arvo, WA8DXD, it serves the growing interest in digital techniques by providing useful and timely information on all aspects of digital communications, computers, software, and related technologies. Packet, RTTY, AMTOR, PACTOR, CW, FAX, SSTV, PC's, computer interfaces, and other modes are covered. Published six times a year, subscriptions are \$16 from Digital Digest (1908 Howell Branch Road, Winter Park, FL 32792; Tel. 407-671-0185).

**Summing Up.** Using the two hobbies, computers and amateur radio, together makes good sense and can make each more interesting and enjoyable. And, with the lowered cost of high-performance PC's and other hardware priced at very attractive levels, it's now practical and even thrifty to dedicate (hard wire) one computer for ham shack activities and use a second fully-equipped computer for general purpose or household-computing chores. ■



# Electronic Paperbacks at Special Prices

**BP325—A CONCISE USER'S GUIDE TO WINDOWS 3.1 . . . . \$7.95.** Come to grips with Windows 3.1 in the shortest and most effective way. Learn how to manipulate Windows screens and DOS by Windows graphics interface. Master its word processor, Paintbrush and data base along with Notepad, Macro Recorder, PIF Editor, and Calculator.

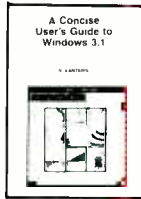

**BP311—AN INTRODUCTION TO SCANNERS AND SCANNING . . . . \$7.95.** Radio scanners have opened a realm of exciting radio listening. Understand radio wave propagation, types of transmissions, antennas, band assignments—the straight dope on what to hear and where to hear it! Comes complete with index, glossary of important terminology.

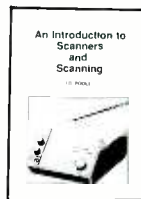

**BP287—A REFERENCE GUIDE TO PRACTICAL ELECTRONICS TERMS . . . . \$8.95.** More than just a dictionary of practical electronics terms, the book goes a step further in getting down to fundamentals. A reference volume that can be read casually by a reader seeking knowledge.

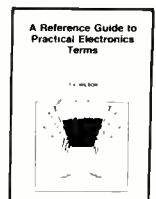

**BP248—TEST EQUIPMENT CONSTRUCTION . . . . \$5.95.** Details construction of simple, inexpensive, but extremely useful test equipment. AF Gen, Test Bench Ampl, Audio Millivoltmeter, Transistor Tester and six more.



**BP267—HOW TO USE OSCILLOSCOPES AND OTHER TEST EQUIPMENT . . . . \$6.95.** Mastering the oscilloscope is not really too difficult. This book explains all the standard controls and functions. Other equipment is also described.



**BP265—MORE ADVANCED USES OF THE MULTIMETER . . . . \$5.95.** Use these techniques to test and analyze the performance of a variety of components. Also see how to build add-ons to extend multi-meter capabilities.



**BP256—INTRO TO LOUDSPEAKERS AND ENCLOSURE DESIGN . . . . \$5.95.** We explore the variety of enclosure and speaker designs in use today so the reader can understand the principles involved.



**CMOS1—CMOS POCKET GUIDE 1 . . . . \$18.95.** Works like the TTL Guides but covers all commonly used CMOS standard devices. Six major sections. The first shows the device schematic. Next is a brief description of the component and is followed by full operating details. The fourth section lists major applications, while the 5th and 6th sections present essential data for that device and a list of the relevant manufacturers. The final two sections are a valuable cross-reference.



**BP299—PRACTICAL ELECTRONIC FILTERS . . . . \$6.95.** Presents a dozen filter-based practical projects with applications in and around the home or in the constructor's workshop. Complete construction details are included.



**BP249—MORE ADVANCED TEST EQUIPMENT CONSTRUCTION . . . . \$6.95.** Eleven more test equipment construction projects. They include a digital voltmeter, capacitance meter, current tracer, etc.



**BP245—DIGITAL AUDIO PROJECTS . . . . \$5.95.** Practical circuits to build and experiment with. Includes A/D converter, input amplifier, digital delay line, compander, echo effect and more.



**BP247—MORE ADVANCED MIDI PROJECTS . . . . \$5.95.** Circuits included are a MIDI indicator, THRU box, merge unit, code generator, pedal, programmer, channelizer, and analyzer.



**BP257—INTRO TO AMATEUR RADIO . . . . \$6.95.** Amateur Radio is a unique and fascinating hobby. This book gives the newcomer a comprehensive and easy to understand guide to the subject.

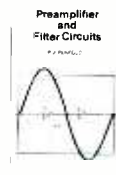

**BP309—PREAMPLIFIER AND FILTER CIRCUITS . . . . \$6.95.** Provides circuits and background info for a range of preamplifiers, plus tone controls, filters, mixers and more. All are high-performance circuits that can be built at a reasonable cost.

**BP303—UNDERSTANDING PC SOFTWARE . . . . \$6.95.** This book will help you understand the basics of various types of business software in common use. Types of software covered include word processors, spelling checkers, graphics programs, desktop publishing, databases, spreadsheets and utilities.



**BP251—COMPUTER HOBBYISTS HANDBOOK . . . . \$8.95.** A wrapup of everything the computer hobbyist needs to know in one easy to use volume. Provides a range of useful reference material in a single source.



**PCP15—ELECTRONIC PROJECTS FOR HOME SECURITY . . . . \$10.00.** 25 projects ranging from a single-door protection circuit that can be completed in an hour or two, to a sophisticated multi-channel security system. Each project is described in detail with circuit diagrams, explanations of how it works, instructions for building and testing, and how to adapt circuits to meet special requirements.



**BP190—ADVANCED ELECTRONIC SECURITY PROJECTS . . . . \$5.95.** Includes a passive infra-red detector, a fiber-optic loop alarm, computer-based alarms and an unusual form of ultrasonic intruder detector.

**BP235—POWER SELECTOR GUIDE . . . . \$10.00.** Complete guide to semiconductor power devices. More than 1000 power handling devices are included. They are tabulated in alpha-numeric sequence, by technical specs. Includes power diodes, Thyristors, Triacs, Power Transistors and FETs.

**BP234—TRANSISTOR SELECTOR GUIDE . . . . \$10.00.** Companion volume to BP235. Book covers more than 1400 JEDEC, JIS, and brand-specific devices. Also contains listing by case type, and electronic parameters. Includes Darlingtons transistors, high-voltage devices, high-current devices, high power devices.

**BP117—PRACTICAL ELECTRONIC BUILDING BLOCKS—Book 1 . . . . \$5.75.** Oscillators, Timers, Noise Generators, Rectifiers, Comparators, Triggers and more.

**BP195—INTRODUCTION TO SATELLITE TV . . . . \$9.95.** A definitive introduction to the subject written for the professional engineer, electronics enthusiast, or others who want to know more before they buy. 8 x 10 in.

**BP179—ELECTRONIC CIRCUITS FOR THE COMPUTER CONTROL OF ROBOTS . . . . \$7.50.** Data and circuits for interfacing the computer to the robot's motors and sensors.

**BP239—GETTING THE MOST FROM YOUR MULTIMETER . . . . \$5.95.** Covers basics of analog and digital meters. Methods of component testing includes transistors, thyristors, resistors, capacitors and other active and passive devices.

**BP97—IC PROJECTS FOR BEGINNERS . . . . \$5.50.** Power supplies, radio and audio circuits, oscillators, timers, switches, and more. If you can use a soldering iron you can build these devices.

**RADIO—100 RADIO HOOKUPS . . . . \$3.00.** Reprint of 1924 booklet presents radio circuits of the era including regenerative, neutrodyne, reflex and more.

**BP42—SIMPLE LED CIRCUITS . . . . \$5.50.** A large selection of simple applications for this simple electronic component.

**BP122—AUDIO AMPLIFIER CONSTRUCTION . . . . \$5.75.** Construction details for preamps and power amplifiers up through a 100-watt DC-coupled FET amplifier.

**BP92—CRYSTAL SET CONSTRUCTION . . . . \$5.50.** Everything you need to know about building crystal radio receivers.

**BP255—INTERNATIONAL RADIO STATIONS GUIDE . . . . \$7.95.** Provides the casual listener, amateur radio DXer and the professional radio monitor with an essential reference work designed to guide him or her around the more than ever complex radio bands.

## CHECK OFF THE BOOKS YOU WANT

**ELECTRONIC TECHNOLOGY TODAY INC.**  
P.O. Box 240, Massapequa Park, NY 11762-0240

Name \_\_\_\_\_  
Address \_\_\_\_\_  
City \_\_\_\_\_ State \_\_\_\_\_ Zip \_\_\_\_\_

**SHIPPING CHARGES IN USA AND CANADA**

\$0.01 to \$5.00 . . . . \$1.50  
\$5.01 to \$10.00 . . . . \$2.50  
\$10.01 to 20.00 . . . . \$3.50  
\$20.01 to 30.00 . . . . \$4.50  
\$30.01 to 40.00 . . . . \$5.50  
\$40.01 to 50.00 . . . . \$6.50  
\$50.01 and above . . . . \$8.00

**SORRY No orders accepted outside of USA & Canada**

Total price of merchandise . . . . \$ \_\_\_\_\_  
Shipping (see chart at left) . . . . \$ \_\_\_\_\_  
Subtotal . . . . \$ \_\_\_\_\_  
Sales Tax (NY State only) . . . . \$ \_\_\_\_\_  
Total Enclosed . . . . \$ \_\_\_\_\_

Number of books ordered

**All payments must be in U.S. funds**

PE793



# Vivid Memories

Looking to improve your videos? Bring your memories to life with **SIGHTS & SOUNDS**. Every week we offer helpful tips and instruction on how to make the most of your home video equipment. We also feature reports on the latest market place trends, product reviews and informative interviews with the industries leaders.



## Unomat DC 100 RS Auto

Join us Saturday, June 5th, for special tips on creative uses of video lighting. And, one of the only ways to capture true colors is to employ the all-new, high-tech, halogen lamp system from Eurotech Electronics -

### Unomat's Video Lights

Video Lights provides the exact amount of super-bright illumination you need to make that very special event memorable and lasting.

800/255-2277

Intelligent choices...

# SIGHTS & SOUNDS

Saturdays at 4:30 E.S.T. on CNBC.