

FUN WITH TESLA COILS

Popular Electronics

OCTOBER '92

THE ULTIMATE HOME THEATER AND OTHER WONDERS

The latest gear direct from the floor of the Consumer Electronics Show!

Keep tabs on your kids with our easy-to-build **BABY MONITOR**

Build a digital **SOLID STATE MESSAGE RECORDER**

Hear speech and music from a flame when you experiment with **PLASMA ACOUSTICS**



A **GERNSBACK** PUBLICATION



\$3.50 U.S.
\$3.95 CANADA

3 NEW
FactCards
IN THIS ISSUE

#BXBDCCH CAR-RT SORT ** CR24
#60506DHM997GAC06# FEB93 00
ROBERT DAHM RESP
997 GRAND AVE 083 *
AURORA, IL 60506

Electronics Paperback Books

GREAT PAPERBACKS AT SPECIAL PRICES

BP248—TEST EQUIPMENT CONSTRUCTION \$5.95. Details construction of simple, inexpensive, but extremely useful test equipment. AF Gen, Test Bench Ampl, Audio Millivoltmeter, Transistor Tester and six more.

Test Equipment Construction



How to Use Oscilloscopes and Other Test Equipment

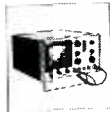

BP267—HOW TO USE OSCILLOSCOPES AND OTHER TEST EQUIPMENT \$6.95. Mastering the oscilloscope is not really too difficult. This book explains all the standard controls and functions. Other equipment is also described.

BP265—MORE ADVANCED USES OF THE MULTIMETER \$5.95. Use these techniques to test and analyze the performance of a variety of components. Also see how to build add-ons to extend multimeter capabilities.



An Introduction to Loudspeakers and Enclosure Design

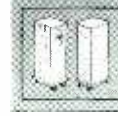

BP256—INTRO TO LOUDSPEAKERS AND ENCLOSURE DESIGN \$5.95. We explore the variety of enclosure and speaker designs in use today so the reader can understand the principles involved.

CMOS1—CMOS POCKET GUIDE 1 \$18.95. Works like the TTL Guides but covers all commonly used CMOS standard devices. Six major sections. The first shows the device schematic. Next is a brief description of the component and is followed by full operating details. The fourth section lists major applications, while the 5th and 6th sections present essential data for that device and a list of the relevant manufacturers. The final two sections are a valuable cross-reference.



BP299—PRACTICAL ELECTRONIC FILTERS \$6.95. Presents a dozen filter-based practical projects with applications in and around the home or in the constructor's workshop. Complete construction details are included.



BP249—MORE ADVANCED TEST EQUIPMENT CONSTRUCTION \$6.95. Eleven more test equipment construction projects. They include a digital voltmeter, capacitance meter, current tracer and more.



Digital Audio Projects



BP245—DIGITAL AUDIO PROJECTS \$5.95. Practical circuits to build and experiment with. Includes A/D converter, input amplifier, digital delay line, compander, echo effect and more.

BP247—MORE ADVANCED MIDI PROJECTS \$5.95. Circuits included are a MIDI indicator, THRU box, merge unit, code generator, pedal, programmer, channelizer, and analyzer.



BP257—INTRO TO AMATEUR RADIO \$6.95. Amateur is a unique and fascinating hobby. This book gives the newcomer a comprehensive and easy to understand guide to the subject.

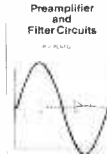

BP309—PREAMPLIFIER AND FILTER CIRCUITS \$6.95. Provides circuits and background info for a range of pre-amplifiers, plus tone controls, filters, mixers and more. All are high-performance circuits that can be built at a reasonable cost.

BP303—UNDERSTANDING PC SOFTWARE \$6.95. This book will help you understand the basics of various types of business software in common use. Types of software covered include word processors, spelling checkers, graphics programs, desktop publishing, databases, spreadsheets and utilities.



BP251—COMPUTER HOBBYISTS HANDBOOK \$8.95. A wrapup of everything the computer hobbyist needs to know in one easy to use volume. Provides a range of useful reference material in a single source.



PCP115—ELECTRONIC PROJECTS FOR HOME SECURITY \$10.00. 25 projects ranging from a single-door protection circuit that can be completed in an hour or two, to a sophisticated multi-channel security system. Each project is described in detail with circuit diagrams, explanations of how it works, instructions for building and testing, and how to adapt circuits to meet special requirements.

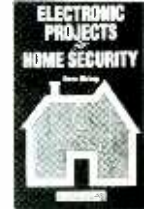

BP195—INTRODUCTION TO SATELLITE TV \$9.95. A definitive introduction to the subject written for the professional engineer, electronics enthusiast, or others who want to know more before they buy. 8 x 10 in.

BP190—ADVANCED ELECTRONIC SECURITY PROJECTS \$5.95. Includes a passive infra-red detector, a fiber-optic loop alarm, computer-based alarms and an unusual form of ultrasonic intruder detector.

BP235—POWER SELECTOR GUIDE \$10.00. Complete guide to semiconductor power devices. More than 1000 power handling devices are included. They are tabulated in alpha-numeric sequence, by technical specs. Includes power diodes, Thyristors, Triacs, Power Transistors and FET's.

BP234—TRANSISTOR SELECTOR GUIDE \$10.00. Companion volume to BP235. Book covers more than 1400 JEDEC, JIS, and brand-specific devices. Also contains listing by case type, and electronic parameters. Includes Darlingtons transistors, high-voltage devices, high-current devices, high power devices.

BP99—MINI-MATRIX BOARD PROJECTS \$5.50. Here are 20 useful circuits that can be built on a mini-matrix board that is just 24 holes by ten copper-foil strips.

BP117—PRACTICAL ELECTRONIC BUILDING BLOCKS—Book 1 \$5.75. Oscillators, Timers, Noise Generators, Rectifiers, Comparators, Triggers and more.

BP184—INTRO TO 68000 ASSEMBLY LANGUAGE \$6.95. The 68000 is a great new breed of microprocessor. Programming in assembly language increases the running speed of your programs. Here's what you need to know.

BP179—ELECTRONIC CIRCUITS FOR THE COMPUTER CONTROL OF ROBOTS \$7.50. Data and circuits for interfacing the computer to the robot's motors and sensors.

BP239—GETTING THE MOST FROM YOUR MULTIMETER \$5.95. Covers basics of analog and digital meters. Methods of component testing includes transistors, thyristors, resistors, capacitors and other active and passive devices.

BP97—IC PROJECTS FOR BEGINNERS \$5.50. Power supplies, radio and audio circuits, oscillators, timers, switches, and more. If you can use a soldering iron you can build these devices.

BP37—50 PROJECTS USING RELAYS, SCR'S & TRIACS \$5.50. Build priority indicators, light modulators, warning devices, light dimmers and more.

RADIO—100 RADIO HOOKUPS \$3.00. Reprint of 1924 booklet presents radio circuits of the era including regenerative, neutrodyne, reflex & more.

BP42—SIMPLE LED CIRCUITS \$5.50. A large selection of simple applications for this simple electronic component.

BP122—AUDIO AMPLIFIER CONSTRUCTION \$5.75. Construction details for preamps and power amplifiers up through a 100-watt DC-coupled FED amplifier.

BP92—CRYSTAL SET CONSTRUCTION \$5.50. Everything you need to know about building crystal radio receivers.

BP255—INTERNATIONAL RADIO STATIONS GUIDE \$7.95. Provides the casual listener, amateur radio DXer and the professional radio monitor with an essential reference work designed to guide him or her around than ever more complex radio bands.

CHECK OFF THE BOOKS YOU WANT

ELECTRONIC TECHNOLOGY TODAY INC.
P.O. Box 240, Massapequa Park, NY 11762-0240

SHIPPING CHARGES IN USA AND CANADA

SORRY No orders accepted outside of USA & Canada

Number of books ordered

Name _____
Address _____
City _____ State _____ Zip _____

\$0.01 to \$5.00 \$1.50
\$5.01 to \$10.00 \$2.50
\$10.01 to 20.00 \$3.50
\$20.01 to 30.00 \$4.50
\$30.01 to 40.00 \$5.50
\$40.01 to 50.00 \$6.50
\$50.01 and above ... \$8.00

Total price of merchandise \$ _____
Shipping (see chart) \$ _____
Subtotal \$ _____
Sales Tax (NYS only) \$ _____
Total Enclosed \$ _____

All payments must be in U.S. funds

PE1092

Popular Electronics®

THE MAGAZINE FOR THE ELECTRONICS ACTIVIST!

CONSTRUCTION ARTICLES

BUILD A BABY MONITOR	Anthony J. Caristi	31
<i>Keep a constant "watch" on your progeny from anywhere in your home with this carrier-current transmitter/receiver system</i>		
BUILD A PERSONAL MESSAGE RECORDER	David Williams	39
<i>Here is a simple and efficient way to leave a message for a family member, co-worker, or even yourself when using paper and pencil is inconvenient</i>		
THE ELECTROMAGNETIC RING LAUNCHER	Vincent Vollono	42
<i>Explore the principles of electromagnetic propulsion with this simple ring launcher</i>		
BUILD A SONIC KALEIDOSCOPE	Daniel P. Ray	58
<i>Build a fascinating variation on the ever popular color organ; it's a sight to behold</i>		
BUILD THE UNIVERSAL RS-232 CONNECTOR	James E. Tarchinski	63
<i>This inexpensive one-evening project can save you hours of labor spent connecting RS-232 devices</i>		

FEATURE ARTICLES

EXPERIMENT WITH PLASMA ACOUSTICS	John Iovine	37
<i>Did you know that you can make a speaker out of flame?</i>		
ELECTRIC WAVES AND THE HERTZ OSCILLATOR	Stanley A. Czarnik	45
<i>This classic experiment by Heinrich Hertz proved Maxwell's theory of electromagnetic waves</i>		
ALL ABOUT OPTOISOLATORS AND OPTOCOUPERS	Joseph J. Carr	53
<i>Learning to use this versatile family of chips can save you or your next project from disaster</i>		

PRODUCT REVIEWS

GIZMO		5
<i>Summer Consumer Electronics Show Report, Audio Source Pro-Logic Surround-Sound System, and more</i>		
HANDS-ON REPORT		22
<i>Beckman DM10XL Multimeter</i>		
PRODUCT TEST REPORT	Len Feldman	27
<i>Sony MDP-605 CD/CDV/LP Player</i>		

COLUMNS

ANTIQUÉ RADIO	Marc Ellis	65
<i>Cleaning up the Sky Buddy</i>		
COMPUTER BITS	Jeff Holtzman	67
<i>Integrated software tools</i>		
CIRCUIT CIRCUS	Charles D. Rakes	69
<i>Fun with Tesla coils</i>		
THINK TANK	John J. Yacono	72
<i>More 558 and alarm circuits</i>		
DX LISTENING	Don Jensen	75
<i>Exploring the lower shortwave bands</i>		
HAM RADIO	Joseph J. Carr	78
<i>Some more spectrum analyzer stuff</i>		
SCANNER SCENE	Marc Saxon	80
<i>Scanning the friendly skies</i>		

DEPARTMENTS

EDITORIAL	Carl Laron	2
LETTERS		3
FACTCARDS		49
POPULAR ELECTRONICS MARKET CENTER		50A
FREE INFORMATION CARD		51
ELECTRONICS LIBRARY		82
NEW PRODUCTS		85
ELECTRONICS MARKET PLACE		95
ADVERTISER'S INDEX		98

Popular Electronics (ISSN 1042-170X) Published monthly by Gernsback Publications, Inc., 500-B B-County Boulevard, Farmingdale, NY 11735. Second-Class postage paid at Farmingdale, NY and at additional mailing offices. One-year, twelve issues, subscription rate U.S. and possessions \$21.95, Canada \$28.94 (includes G.S.T. Canadian Goods and Services Tax Registration No. R125166280), all other countries \$29.45. Subscription orders payable in U.S. funds only. International Postal Money Order, or check drawn on a U.S. bank. U.S. single copy price \$2.95. © 1992 by Gernsback Publications, Inc. All rights reserved. Hands-on Electronics and Gizmo trademarks are registered in U.S. and Canada by Gernsback Publications, Inc. Popular Electronics trademark is registered in U.S. and Canada by Electronics Technology Today, Inc. and is licensed to Gernsback Publications, Inc. Printed in U.S.A.

Postmaster: Please send address changes to Popular Electronics, Subscription Dept., P.O. Box 338, Mount Morris, IL 61054-9932.

A stamped self-addressed envelope must accompany all submitted manuscripts and/or artwork or photographs if their return is desired should they be rejected. We disclaim any responsibility for the loss or damage of manuscripts and/or artwork or photographs while in our possession or otherwise.

As a service to readers, Popular Electronics publishes available plans or information relating to newsworthy products, techniques, and scientific and technological developments. Because of possible variances in the quality and condition of materials and workmanship used by readers, Popular Electronics disclaims any responsibility for the safe and proper functioning of reader-built projects based upon or from plans or information published in this magazine.

Larry Steckler
EHF, CET
Editor-In-Chief and Publisher

EDITORIAL DEPARTMENT

Carl Laron
Editor

Robert A. Young
Associate Editor

John J. Yacono
Associate Editor

Byron G. Wels, K2AVB
Associate Editor

Teri Scaduto
Assistant Editor

Kathy Terenzi
Editorial Assistant

Marc Spiwak
Editorial Associate

Joseph J. Carr, K4IPV
Marc Ellis
Len Feldman
Jeffrey K. Holtzman
Don Jensen
Chris F. O'Brian
Charles D. Rakes
Marc Saxon
Contributing Editors

PRODUCTION DEPARTMENT

Ruby M. Yee
Production Director

Karen S. Brown
Production Manager

Marcella Amoroso
Production Assistant

Lisa Rachowitz
Editorial Production

ART DEPARTMENT

Andre Duzant
Art Director

Injae Lee
Illustrator

Russell C. Truelson
Illustrator

Jacqueline P. Cheeseboro
Circulation Director

Michele Torillo
P-E Bookstore

BUSINESS AND EDITORIAL OFFICES

Gernsback Publications, Inc.
500-B Bi-County Blvd.
Farmingdale, NY 11735
1-516-293-3000
Fax: 1-516-293-3115
President: **Larry Steckler**

Customer Service/Order Entry
1-800-435-0715
7:30 AM - 8:30 PM EST

Advertising Sales offices listed on page 98

Cover photography by Phillip H. Ennis
Photography

Composition by
Mates Graphics



Since some of the equipment and circuitry described in POPULAR ELECTRONICS may relate to or be covered by U.S. patents, POPULAR ELECTRONICS disclaims any liability for the infringement of such patents by the making, using, or selling of any such equipment or circuitry, and suggests that anyone interested in such projects consult a patent attorney.

OLD GEAR, NEW LIVES

If you're in the market for new video, audio, computer, business, or other electronics gear, don't miss this month's installment of **Gizmo**. Among the highlights are cordless telephones that use advanced techniques to keep conversations completely private, radar detectors that also detect the new laser speed guns, computers that let you input data with a pen, high-performance home-theater systems, advanced digital-recording systems, and much more. It's enough to make any electronics enthusiast's mouth water.

But here's a question for you: After you've picked out your new piece of high-tech gear, made your purchase, and taken it home, what are you going to do with your old equipment? I'd like to make a suggestion.

Why not donate it to the National Cristina Foundation. The NCF is a not-for-profit foundation that places donated computers, software, peripherals, TV's, audio gear, and office equipment in training organizations and institutions to teach valuable skills to the disabled, disadvantaged, and others in need.

And the benefits that your old equipment can provide does not end there. All organizations that work with NCF promise to share any unique applications information or innovative training methods with NCF, who in turn passes it on to training institutions both in this country and around the world. Therefore, a single piece of donated gear has the ability to train hundreds of people to lead more productive lives.

If that wasn't enough, there's also a benefit to you. All gear donated is tax deductible, with additional tax benefits available to corporations that donate inventory items (property that is sold in the normal course of business).

So why not give your old gear a new life, and at the same time help others lead a more fulfilling life. It's a great idea, and one that can give you a great feeling. If you'd like to donate equipment, contact the National Cristina Foundation at 42 Hillcrest Dr., Penham Manor, NY 10803, or call 800-274-7846.

Carl Laron
Editor

CORDLESS-PHONE LOCK

I'm writing in regard to a small problem with the Cordless-Telephone Lock project (**Popular Electronics**, July 1992). As I understand the operation of the device as described in the last paragraph of page 46, it will produce an error tone immediately when an incorrect digit is entered. Though that would seem to be a convenience, it is also a faulty security policy. That feature makes it possible to guess the security code in no more than 50 guesses (at most ten guesses per digit, times five digits). Since the time to make a guess is fairly short, on the order of a few seconds, someone who knew anything about the device could break into it fairly easily.

The author, and some readers, might argue that most people attempting unauthorized use of the phone would give up after the first few failures and would not attempt further guesses of the unlocking code. That is certainly true, but it only takes one determined phone phreak, prankish neighbor, or precocious child to crack the code and run up your phone bill.

True security, whether of phones or computers or other devices, does not depend on maintaining secrecy about the nature of the protection mechanism so that it resists break-in attempts. In the present case, the solution is quite simple and doesn't change the cost of the unit.

The solution is to modify the control program so that when a digit mismatch is detected, the fact of the mismatch is remembered, but notice of success or failure is not given to the user until all five digits have been entered. That simple change raises the number of guesses required to crack the code by several orders of magnitude. (Of course, if the user picks a particularly easy-to-guess code, then all bets are off!)

A further improvement also could be implemented at no additional cost. The control program could be further modified so that a minimum of time, say 15 seconds, must elapse after an incorrect code is entered

before a new code may be entered. That considerably limits the rate of guessing.

The cordless-phone lock is a great project. Thanks to the author, Mr. Sokolowski, for his efforts.

P.D.S

Billerica, MA

GRAPH GAFFE

I just received my May copy of **Popular Electronics**, and in checking my *Product Test Report* I noted that in my review of the Sansui A/V Amplifier, the first graph on page 28 does not correspond to the caption. In selecting graphs to use with the story, someone picked up the wrong graph for the caption they intended to use. The graph shown depicts the frequency response of the center channel, not the front channels as stated.

Len Feldman

HAM ANTENNAS

I was very interested in Joseph Carr's article about antennas, "Wire Beams: Gain on the Cheap" (**Popular Electronics**, May 1992). Antennas are a particular interest of mine. By applying a little bit of theory, they can go a long way toward making your signal heard. Wire is very cheap.

I have several thoughts that might be useful to other hams: First of all, the feed impedance of a dipole is approximately 75 ohms *in free space*. Near the ground, however, the impedance varies about that figure. Also, the feed impedance drops by adding reflectors and directors. Fortunately, the feedline is relatively short in terms of wavelength and the correct impedance can be compensated at the transmitter. Therefore, very little power is lost in the feedline. Of more concern is that the Earth acts as a reflector, and, because the radiator is close to the Earth in terms of wavelength, a lot of

LETTERS

power is radiated *upward*, where it does little good. In addition, objects near the antenna, like buildings and trees, are a short distance away in terms of wavelength and can absorb power and affect the radiation pattern. The most useful radiation is from the center of the antenna. But a normal dipole *droops* at the center. That is why an inverted vee, with the center at the highest point, works well.

H.K., VE3HKD

Mississauga, Ontario, Canada

HAVES & NEEDS

I am looking for the schematic of an old Westinghouse radio, model 622. Any help would be greatly appreciated.

Christian Jacques

1326 Beaudet

Theftford Mines

Quebec, G6G-6R7, Canada

I recently was given an open-reel recorder from my high school. The machine is very old; my guess is that it probably was manufactured in the 1960's or 70's. The recorder was manufactured by Ampex and its model number is 768 (serial number H-32470). I'd be grateful for any help.

Dan Baldassari

1025 Sir Francis Drake Blvd.

San Anselmo, CA 94960

I have a renewed interest in electronics after inheriting a Philco Predicto UG4654. Now I am desperately seeking a flyback transformer—a Philco #32-88531-2 or Thord. 196. I realize that this is like looking for prehistoric bones, but somebody, somewhere, must have a supply of them.

Thanks for your help. I hope to see **Popular Electronics** on the stands for years to come.

D.E. DeLaho

27659 Miami Ave.

Hayward, CA 94594

I'm a **Popular Electronics** subscriber who needs help with a computer printer. I have an

Okidata Model 182 printer that is in need of a print-head part. I cannot find anyone who carries just the small plastic part that goes over the dot-matrix pins. The one on my printer is worn, which causes the print to be compressed. Even Okidata says that they don't sell the part.

Every place I've tried has quoted a price of about \$100, which I cannot afford. All I really need is a little plastic piece that should cost in the area of \$5. Can any fellow readers help me locate that part?

Edward D. Walbroehl

7022-D Brandemere Lane

Winston Salem, NC 27106

I recently bought a TEC-1802 board at a surplus store, and I am trying to find the operator's manual and schematic for it. The TEC-1802 was made by Tektron Equipment Corp. I would appreciate hearing from anyone who can help.

A. Boisvert

1748 Meadowview Ave.

Pickering, Ontario

Canada L1V 3G8

I'm writing this letter in the hope that one of your readers might be able to help me in my search for the following books: *Design of VMOS Circuits* by Howard M. Berlin and *Analog Instrumentation Fundamentals* by Vincent F. Leonard (ISBN: 0-672-21835-6). Both books are out of print and are so are no longer available from their publisher, Howard W. Sams.

Perhaps one of your readers has either or both of these books and has no further use for them. Or perhaps someone would be willing to photocopy them. In either case, I would be more than happy to pay for the books or the photocopies and the mailing charges to Pakistan. I would even prepay the costs if necessary. Any assistance would be greatly appreciated.

Azhar H. Shah

164-B-3 PECHS

Off Sir Syed Road

Karachi 75400

Pakistan

The Amazing Maze.

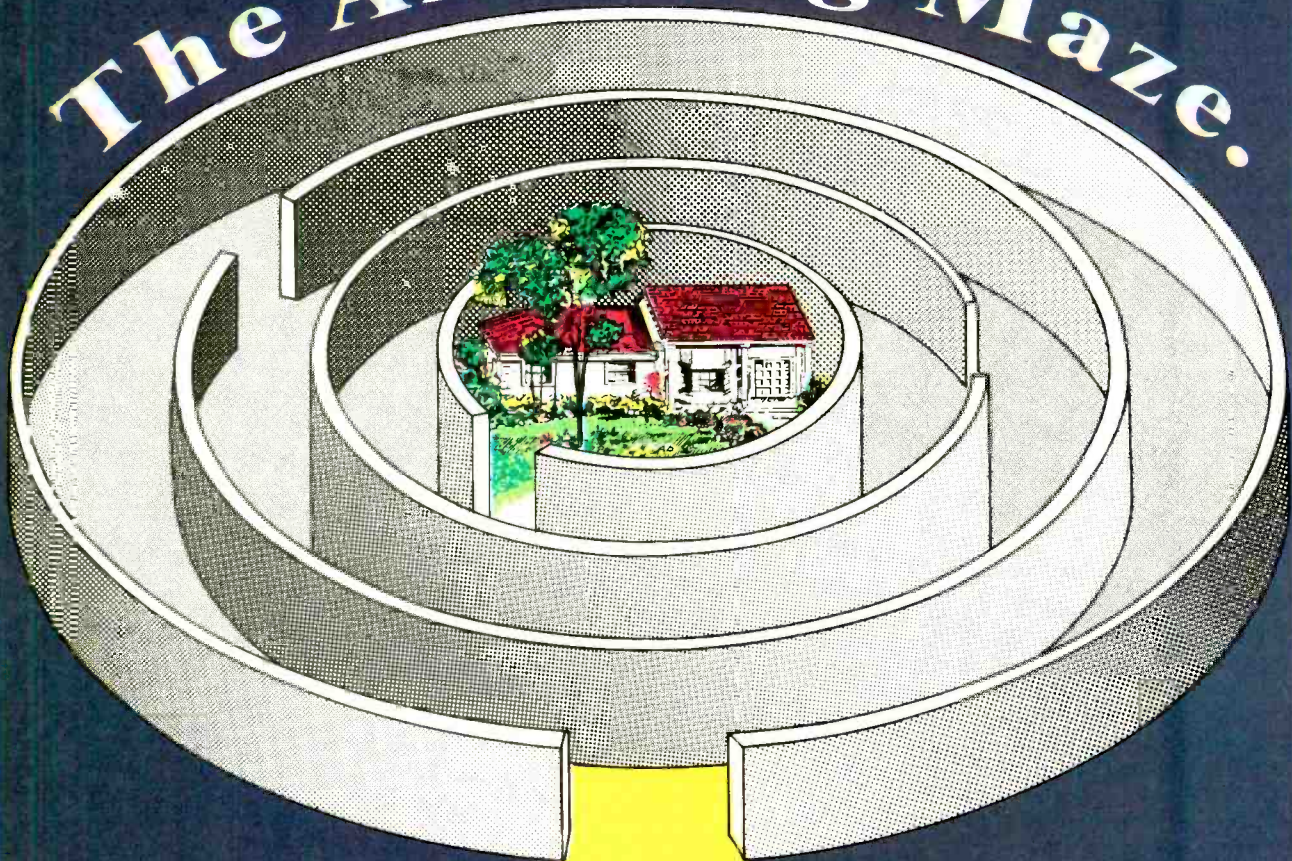

**YOUR HOME . . .
the television series,
will help guide you through it.**

For most families . . . our homes are the biggest purchase we'll ever make. From time to time we've all thought about making changes to our homes. By watching the YOUR HOME television series, you can catch all of the latest ideas and trends designed to get you through the maze of products that will enhance the beauty, functionality, and quality of the time that you spend at home. Whether you're building a dream kitchen or attempting to create the home theater experience, from the simple to the exotic, YOUR HOME has a wealth of great ideas. It's like going to the world's biggest home and garden store each and every week.

Tune into upcoming shows to check out the best and brightest in home products and services:

DUPONT FLOORING

The family of Stainmaster certified carpets, your assurance of value and quality.

CHAPARRAL COMMUNICATIONS

Monterey Integrated satellite receiver descramblers.

MANVILLE

Fiberglass Insulations and Building products for home remodeling.

SONY CORP.

DST—Digital Signal Transfer for the ultimate in Home Audio/Video control.

ZENITH

Leading the way in affordable Theater Projection TV.

JELD-WEN

Wenco—Maintenance free Aluminum Clad Windows and Patio Doors.

THOMASVILLE FURNITURE

Specifically designed furniture for home theater installations.

LAWN BOY

Mulching Lawn Mowers designed to reduce yard waste.

Check your local cable listing for the time and channel number in your area.

A presentation of

WJMK • 2424 N. Federal Highway • Boca Raton, FL 33431 • (407) 367-0703

GIZMO

OCTOBER 1992

VOLUME 5,
NUMBER 10

A CHRONICLE OF CONSUMER ELECTRONICS

The Consumer's Consumer Electronics Show

The past quarter century has witnessed the birth of dozens of electronic products for consumers. Some of those have actually changed the way we live—the video game (1972), the VCR (1975), the Walkman (1980), and the compact disc (1983), are all prime examples. The shift of products that were once for office use only—the personal computer and the fax machine, for instance—to the home has changed the way we work, and the advent of cellular phones and personal pagers has changed the way we communicate. Other consumer electronic items may have had less of a socio-economic impact, but have simply made our lives a little more pleasant—cordless phones, large-screen TV's, camcorders, and personal copiers, for example. What each of those items has in common is that they have been exhibited and, in many cases, introduced for the first time, at the Consumer Electronics Show.

In 1967, the year that saw solid-state color televisions marketed for the first time, the Consumer Electronics Show made its debut in New York City. In the two-and-a-half decades since, as befits a convention that celebrates a growing industry, CES became a twice-yearly affair. Each winter in Las Vegas and each summer in Chicago, a huge convention center is filled with innovative electronic products and the manufacturers, dealers, and buyers whose livelihood depends on consumer acceptance of those products. Also attending in droves have been members of the consumer-electronics press, hoping to witness headline-worthy innovations. There's almost always something new to report on, be it MD (Mini Disc), DCC (Digital Compact Cassette), or HDTV (high-definition television).

So what was the hot, never-seen-before item at the 1992 Summer Consumer Elec-

tronics Show? This year, it was RLC—Real Live Consumers. The one factor that's been missing from the Consumer Electronics Show for all these years has been the people who actually buy the products that are displayed there. The Electronic Industries Association (EIA) changed that this year, with their decision to set aside the first two-and-a-half days of the show for the trade, and to allow the public in starting at noon on Saturday and all day Sunday.

That controversial decision did not meet with whole-hearted approval from manufacturers, some of whom opted not to attend the show at all. Others moved their exhibits off the convention center floor, sequestering themselves in just-in-on-only hotel suites. Some limited their attendance to the trade-only days. (We heard one person mention his intention to wrap things up and clear out before the doors to McCormick Place were opened to "the great unwashed.")

While his attitude was extreme—not to mention autocratic—there were some legitimate reasons for misgivings on the part of manufacturers. Foremost was the fact that CES has always been a trade show, and as such it is, by definition, an arena in which serious business is conducted. We spoke to several exhibitors who were loathe to relinquish a day and a half of valuable Business Time to deal instead with consumers. CES also has always been the showcase for new technologies and future products. Many manufacturers expressed concern about the effect on consumers of displaying products that would not reach the retail stores for another year or two. Would consumers put off buying a new TV, or CD player, or stereo this year and choose to wait for the new-and-improved versions shown at CES? From a purely practical standpoint, there were the added hassles, and expense, and sheer exhaustion created by keeping the booths open until 9:00 PM on Saturday and for extra

TURN PAGE FOR CONTENTS

This month in GIZMO

Summer Consumer Electronic Show Report	pg. 5
Innovations '92 Design and Engineering Award Winners .	pg. 15
Sony CCD-FX510 Video 8 Handycam	pg. 17
Rolodex EO-100 Personal Planner	pg. 20
Audio Source 4001 Dolby Pro Logic Home Theater System.	pg. 18

Gizmo is published by Gernsback Publications, Inc., 500-B Bi-County Blvd., Farmingdale, NY 11735. Senior Writers: Chris F. O'Brian and Teri Scaduto. ©Copyright 1992 by Gernsback Publications, Inc. Gizmo is a registered trademark. All rights reserved.

hours on Sunday. Finally, with so much expensive equipment on the floor in open exhibits, there was concern about theft.

Beefed-up security forces dealt effectively with any potential theft problems, and some manufacturers chose to remove future products from their displays on the consumer days. But from a strictly business point of view, we'd have to say that SCES 1992 was not as successful as past shows have been. That was evident simply by glancing at this year's *Summer CES Official Directory*, which was significantly thinner than last year's. An off-the-record remark made by a prominent EIA member indicated that attendance by fewer exhibitors cost the show more than \$2 million dollars in unsold booth space. Trade attendance was down only slightly from last year—about 52,000, compared to 1991's 55,629—but aisles that had been widened to accommodate the crush of consumers made the convention center seem even emptier on trade-only days.

The decision to admit the public certainly wasn't the sole cause of diminished trade attendance at the Chicago show. For several years, the summer show has taken

a back seat to the bigger, more highly attended, Winter Consumer Electronics Show. Some exhibitors feel that two shows have become redundant and can't justify the expense of attending both, and others find that their marketing schedules simply don't coincide with a show held in June. Attendance has been on a slow but steady decline, and there have been whispers about the possibility of cutting back to one annual show, which almost certainly would be held in Las Vegas. Opening the doors to Chicago-area consumers was, perhaps, an attempted cure for flagging interest in the summer show.

Quite a few manufacturers applauded the decision and relished the opportunity to interact with their customers on a face-to-face basis. Cobra Electronics/Dynascan, for instance, took advantage of being based in Chicago. They called in virtually their entire sales and support staff, outfitted them all in distinctive white baseball-style jackets, and armed them with questionnaires designed to gauge consumer reaction to new and upcoming products. Jesse Rotman, Cobra's vice president of marketing and communications, summed up the attitude of those companies that welcomed consumers: "The people who made the effort to get here today are our best customers."

The difference in attitude, and the level of enthusiasm, toward consumer attendance seemed to hinge primarily on two factors: how closely a company wanted to interact with its customers and how much it had riding on consumer acceptance of, and demand for, an about-to-be-released product. According to Ed Juge, director of market planning of Tandy, "The consumers' presence at this show is the only reason Tandy is here!" (That's a hard statement to refute; Tandy hasn't been on the floor of CES in our memory.) A manufacturer that maintains close ties with its customers by marketing its products through its own Radio Shack, Computer Center, and soon-to-be opened Incredible Universe stores, Tandy was happy to devote personnel and time to demonstrations of their DCC machine, which will be released this fall. Kodak, whose Photo CD also is scheduled for fall introduction, seized the opportunity to demonstrate its product, as did Philips with CD-I. Although a lot has been written about those products, most consumers hadn't yet seen them up close.

The show provided an excellent opportunity for manufacturers with the right attitude to make great strides in consumer recognition and good will, and to get valuable feedback from their customers. But that wasn't the only plus to public admission. Consumer attendance drew considerable media attention to the Consumer Electronics Show, both in the Chicago area

and nationwide. And, of course, the sale of almost 10,000 tickets created quite a bit of revenue for the EIA. (One dollar from each ticket sold was donated to the Electronic Industries Foundation, which operates training and employment programs for Americans with disabilities.)

THE WORLD'S FAIR OF CONSUMER ELECTRONICS

So, what did those 98,780 consumers get to see for their \$10 admission fees? As might be expected from a show dubbed "The World's Fair of Consumer Electronics," there were quite a few spectacles to grab a thrill-seeker's attention. Three marching bands and a ribbon-cutting ceremony marked the opening of the doors to the public. Once inside, consumers could compete for prizes by singing at Cafe Karaoke; watch a laser-light show; pet the famous RCA dog, Nipper, and his new pal, Chipper; pick up freebies like Casio T-shirts and Toshiba shopping bags; check out the Batmobile; shop for souvenirs at



Three local high-school marching bands were on hand outside the McCormick Place Convention Center to greet the first consumers to attend the Summer Consumer Electronics Show.

the CES store; get an autograph from extreme skier Glenn Plake at the Aiwa booth; and fight the crowds vying to try out the newest video games.

Serious consumers could get their fill, too. After all, the goal of the show was to introduce new technologies to consumers, and to help them understand how those technologies could fit into their lives. To that end, a full program of workshops was offered, covering such topics as "Producing Home Videos," "Building a High-End Audio System," "Creating a Home Office," and "Planning for a Technical Career." In addition, product areas and pavilions were set up to highlight various new technologies and product areas, including multimedia and CD-ROM, mobile office, home office, the future of education, high-end audio, engineering/design award-winning products (see "Innovations," elsewhere in this issue), and assistive devices for the disabled.

Perhaps the most impressive exhibit area was the Home-Theater Promenade. Divided into several individual viewing/listening rooms, several possible audio/video setups were demonstrated, ranging in retail price from a couple of thousand dollars to tens of thousands of dollars. The on-screen programming was synchronized at each display so that those present could promenade from one to the next without missing anything. Along with showing movie clips and the like, the program explained what home theater is all about and what equipment is necessary. Because the system price was clearly marked outside each display, consumers could see real systems that might actually fit their budgets, and could experience the differences that stem from investing in more expensive home-theater gear. The Promenade was an excellent opportunity for any consumer contemplating a home-theater purchase; that kind of comparison display is just not available in retail settings (and wasn't available at the CES before this show).

Just outside that exhibit was displayed the ultimate home theater—the "Dream Palace." The electronics alone would make a spectacular showing in any darkened room. The system included a Vidikron VPF 40 projector (designed by Pininfarina, the Italian automotive design firm famous for styling the Ferrari), a THX-licensed, multi-channel amplifier by Audio Design Associates, speakers from Miller and Kriesel, and a Faroujda LD-100 line doubler (which produces an HDTV-like picture from NTSC sources, and makes a large-screen presentation resemble a movie screening). A clip from the movie *Far and Away*, which included a horse stampede, was played. Although we didn't get trampled, the room actually shook.

And what a "room!" The screening took place in a ready-to-install *Dream Palace* modular theater from Theater Design Associates that looked and felt exactly like a movie house (except that the floor wasn't sticky). Available in 14 sizes ranging from 12 x 14 feet to 18 x 23 feet, each theater comes complete with fabric-covered columns, an electronically-controlled velvet curtain, theater seats and risers, lights, wall sconces, and a curtain controller. Three distinct styles are available—the "Classic," "Art Deco," and "Traditional." Prices range from about \$15,350 to \$57,900, excluding the audio/visual equipment. The complete set-up shown at CES would have a retail cost of about \$100,000 installed. And that's without the optional accessories—box office, marquee, and popcorn stand.

Equally impressive, and even more inaccessible—for the next couple of years, at least—were the HDTV displays. Sharp showed how an LCD projector could pro-



Your basement or family room could look just like this with a modular theater from Theater Design Associates.

duce high-definition images. Toshiba showed a direct-view TV. It's one thing to read about HDTV in magazines, but to see it in real life is absolutely incredible. Such a demonstration is the ideal way to whet consumers' appetites for HDTV—once they see it, they'll want it. We've always questioned whether consumers would be willing to spend premium dollars for high definition. After seeing Sharp's large-screen projection system, we think that high-definition will succeed after all.

Several manufacturers discovered that SCES also was the perfect arena in which to create consumer demand for their soon-to-be-released products simply by allowing people to see, hear, and in some cases touch the items, while sales staff explained exactly what made them so special. DCC is a case in point. Tandy had their Optimus brand DCC machine on display in a glass case, with headphones available for listening. (No suggested retail price was given.) Marantz was showing two models (DD-82, \$1099 and DD-92, \$1199), and Philips had their model DCC900 (\$799) on the floor. Kodak drew crowds with displays of their Photo CD

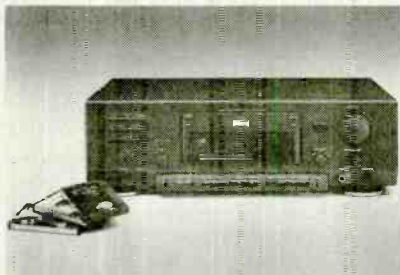

Philips, the inventor of the Digital Compact Cassette format, was one of many manufacturers exhibiting DCC decks that will be available in retail stores in time for Christmas.

players (models PCD 270, \$249 and PCD 870, \$549 and five-disc Photo CD Changer PCD 5870, \$649), demonstrating the convenience of viewing in the living room, on the family TV, family snapshots that have been processed onto compact discs—and then using the same machine to listen to audio CD's.

Thomson was previewing their HDTV-ready, widescreen (16:9 aspect ratio) TV's—another video format that must be seen to be understood (or desired)—that will be available late this year under the RCA and ProScan brands. AT&T demonstrated their *Smart Phone 2100*, which, when used in conjunction with subscription services provided by banks and other companies, will allow users to pay bills and perform bank transactions using its touch-sensitive screen. Consumers also got a close-up look at AT&T's Video Phone, which was introduced in January at the Winter Consumer Electronics Show. For budding video editors—or those on a budget—Videonics introduced *Thumbs Up*, a \$250 handheld editor that makes easy work of editing home videos.

The hands-on approach worked just as well for currently available gear. Philips took full advantage of the crowded show to



Kodak's Photo CD could be the end of all those shoeboxes full of photos that you keep meaning to organize into albums. Instead, your snapshots can be processed onto a compact disc to be "played back" on the family TV.

point out the fine points of their CD-I machines, and to preview the latest software releases. A bank of CD-I players were available for consumers to try out on their own, playing games or sampling educational programs. A few manufacturers had rows of camcorders set up on stands, and encouraged consumers to try them out and learn about their features and functions. Hitachi was highlighting their *Surfin-Snow* (\$1499) water-resistant camcorder for sports enthusiasts. Sharp's newest LCD projector (model XV-S250U, \$6500), which can be used as either a front or rear projector, presented an impressively clear image of up to 12-foot (measured diagonally).

At the Car Audio and Security Expo,



Thomson Executive V.P. of Marketing & Sales, Joseph P. Clayton, shows off the versatility of the company's HDTV-ready, 16:9 aspect-ratio widescreen TV, which can display a primary program and three additional channels—or preview up to 12 channels—simultaneously.

attendees could check out the vehicles of International Autosound Challenge Association (IASCA) finalists, and hear explanations from IASCA judges of what made the equipment and installation designs winners. Consumers also had the opportunity to select their own "Show Favorite" vehicle. Other interesting automotive electronic items on display at CES included Denon's model DCH-700 5-disc CD changer that's sized to fit in some DIN-sized openings or in the glove box, and Cobra's model LD-200 laser detector (\$129.95), which can be used alone or attached to any radar detector to create a complete detection system.

The big news in the video-game arena was Sega's *Sega-CD* (\$299), a CD-ROM attachment that turns the Sega Genesis into a multimedia entertainment system. *Sega-CD* adds CD-quality sound to games, plays CD's and CD+G's, provides full-motion video, and comes with enhanced versions of *Sonic 2* and *Batman Returns* games and other CD software.

CD's aren't just for games any more. Philips unveiled a new capability for its CD-I players—full motion video, or FMV—at SCES. FMV-ability opens the door to a new format for viewing feature

films—movies on CD's. Attendees at a Philips press conference were treated to several demonstrations of the new technology, including clips from a James Bond movie. There are a couple of drawbacks, however. The video quality is only about the equivalent of VHS tapes, and CD-I provides a maximum of 72 minutes of video (30 frames per second).

Philips isn't pushing the movie possibilities of the format, preferring to plug how FMV can be used in CD-I titles. Consumers on the floor got to see a new disc that included video from a Pavoratti performance, and two new CD-I games that incorporate full-motion video.

Those who already own CD-I players



Editing home videos has never been easier than it is with Videonics' Thumbs Up, an inexpensive video editor that anyone—even those who are all thumbs—can use effectively.

will be able to upgrade to FMV with the addition of a plug-in cartridge, available by the end of this year. Newer model CD-I players will have built-in FMV capability. Dr. Bernard Luskin, president of Philips Interactive Media of America (PIMA), envisions "new twists on sports, music videos, children's titles, games—even, potentially, full-length features with multiple middles and endings." Interactive movies are currently under development, and that James Bond movie will be available on CD-I in time for Christmas. Other CD-I news includes a portable player, to be introduced this fall, and a five-disc changer slated for early 1993.

WHAT ELSE IS NEW?

While many of the items described above were new to the consumers attending the show, the trade and press have seen it all before. That's not to say that the public was the only thing new at—or around—the 1992 Summer Consumer Electronics Show. That "or around" is an important distinction, since there were actually two separate shows in terms of substance as well as time. Not only did some exhibitors remove future items before the public could get a glimpse at them on Saturday and Sunday, but several others—including some non-exhibitors—purposely kept their exhibits in private hotel



Capture all the action on the beach or on the slopes, with Hitachi's Surf-n-Snow water-resistant camcorder.

suites, or staged events elsewhere around the Chicago area.

NEWTON MAKES NEWS

Apple managed to drag a large contingent of the press away from SCES for half a day—quite a feat for a show considered to be shorter than normal due to the consumer days—for the announcement of their first completely new product since the Macintosh. Named *Newton*, the device is a pocket-sized, pen-based computer. Those of you who might be thinking, "At last, a new technology that doesn't require us to memorize initials,"—forget it. New-



Newton, Apple's first PDA (personal digital assistant), is a hand-held, pen-based device that could revolutionize the way we organize our thoughts, our schedules, our notes, and our phone directories.

ton is the first in a new class of products dubbed Personal Digital Assistants, or PDA's, devices that "use digital technology to bridge the gap between personal computers and consumer electronics."

If you've signed for a UPS delivery not on the dotted line but on a handheld com-



You can do your banking and pay your bills without leaving the house, using the touch-sensitive screen of AT&T's Smart Phone 2100.

Training includes AT-compatible computer system with hard drive and AutoSketch® CAD software!

Be today's complete drafter.

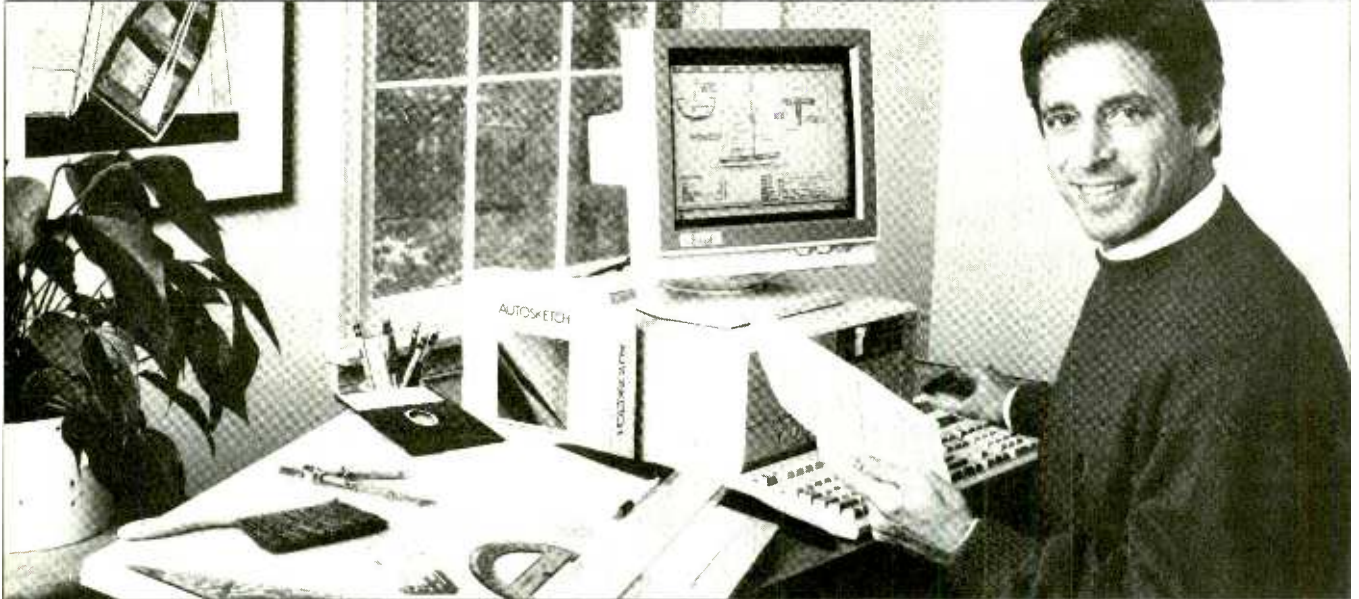

Now with NRI, you can get in on the ground floor of CAD, the new revolution in drafting!

Transforming rough sketches and calculations into accurate working drawings, drafters have always been the key link in the chain of creative people who envision, design, and build the world's products. And today, thanks to the computer revolution, a career in drafting offers more job security — and opportunity — than ever before.

It's true! People with computer-aided drafting (CAD) skills are achieving breakthrough success on design teams in all areas of business and industry. In fact, employment experts predict that manufacturers will hire some 300,000 of these computer-savvy drafters over the next decade!

Now, with NRI at-home training, you can get the hands-on skills and equipment you need for a fast start as today's *complete* drafter, equally comfortable with both manual and computer-aided drafting techniques.

Only NRI gives you an AT-compatible computer and CAD software you train with and keep

Working with a full array of drafting tools, you first master the techniques required to create detailed drawings by hand. Then, with a firm foundation in traditional methods, you move on to do the same kinds of drawings with greater speed and accuracy — using the high-powered PC and software also included with your course.

Only NRI gives you this priceless, practical experience ... with a complete computer system that's yours to train with and keep! You learn to create precision drawings using a fully IBM PC/AT-compatible system that includes a full meg of RAM, hard disk drive, high-density floppy drive, mouse, and 14" monitor. But that's just the beginning.

AutoSketch CAD software turns your computer into a high-tech drafting tool

Using your AutoSketch CAD software, you learn to draft objects with a variety of computer-generated drawing tools — from lines, arcs, and circles to fillets, ellipses, and pattern fill areas. And, once you've discovered how to draw an object, you learn how to quickly stretch it, scale it, copy it, rotate it at any angle, or change its dimensions.

You find out how fast and easy it is to manipulate your work with a single keystroke — moving or adding features such as wheels, doorways, and circuitry on your mechanical, architectural, and electrical drawings.

NRI Discovery Learning Method means no experience necessary

NRI's unique training method helps you learn by doing as you build a complete understanding of today's revolutionary drafting techniques.

Bite-size lessons expand your knowledge one step at a time while hands-on Discovery Learning projects give you practical drafting experience. You learn at home, at your own pace, guided by your personal NRI instructor from the basics of drafting to more advanced computer techniques.

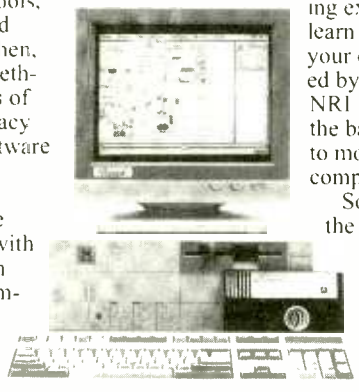

Soon you have the skills and confidence you need to draft detailed renderings of sprockets, homes,

circuit boards — indeed, virtually anything you'll be called on to produce on the job — at the drafting table or your computer terminal.

Send today for your FREE NRI catalog

Whether you want to change careers, advance on the job, or make good money in a business of your own, you can count on NRI hands-on training to give you the fast start you need to succeed. Send today for your free catalog describing NRI's new course in Computer-Aided Drafting.

If the coupon is missing, write to NRI Schools, McGraw-Hill Continuing Education Center, 4401 Connecticut Avenue, NW, Washington, DC 20008.

AutoSketch is a registered trademark of Autodesk, Inc., makers of AutoCAD®, IBM, PC, and AT are registered trademarks of IBM Corp.

Send Today For FREE Catalog!

NRI Schools

McGraw-Hill Continuing Education Center
4401 Connecticut Avenue, NW
Washington, DC 20008

- Check one FREE catalog only
- COMPUTER-AIDED DRAFTING**
- Computer Programming
- Microcomputer Servicing
- Desktop Publishing and Design
- Home Inspection
- Programming in C++ with Windows

NAME (please print) AGE

ADDRESS

CITY

STATE ZIP 18-102

Accredited Member, National Home Study Council

puter device, you have some idea of what Newton is all about. The first Newton products will be electronic notepads designed to help the user capture, organize, and communicate ideas and information in both words and drawings. Newton uses recognition architecture to read the user's handwriting and transform it into text as they write, and to "clean up" sketches by straightening out lines or rounding out circles as they are drawn. The simultaneous use of several recognition systems is said to allow a user to write naturally, without being limited to writing in boxes or on lines. In demonstrations at the product in-

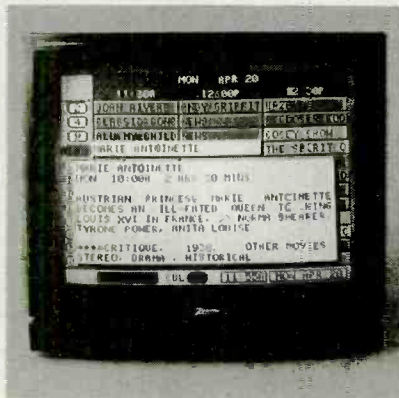

You won't ever have to hunt for the TV Guide if you have a Zenith TV equipped with the InSight on-screen program listing service.

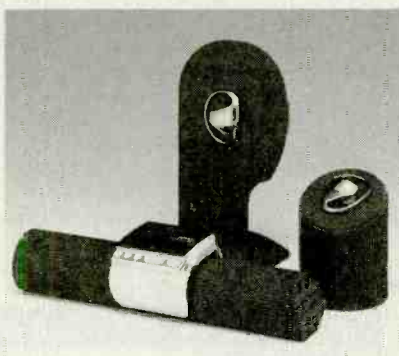

One of Aiwa's prototype Mini Disc (MD) players is this attractive wrist-band style.

roduction, Newton could interpret quite awful handwriting samples, although users must print instead of using script.

Newton is intended to act as a single repository for phone numbers, schedules, notes, directions, and all those other bits and pieces of information that we tend to scribble on scraps of paper shortly before we misplace them. According to Apple, "as the device is used, it will learn more about the user and actually propose solutions to help them work more efficiently." If the user typed in "lunch Jane Thursday," for instance, Newton would know

that lunchtime means noon and would recognize the name Jane as Jane Green from the address book, and would automatically open up the calendar to Thursday and schedule lunch from noon to 1:00 with Jane Green.

Each Newton can communicate with other Newton products (which don't exist yet, either), and will have built-in wired and wireless communications capabilities that will allow users to fax a letter, check electronic mail messages, or connect to a satellite news service. A powerful RISC (Reduced Instruction Set Computing) processor, the ARM 610, gives Newton power that is claimed to be equivalent to that of leading desktop computers, and a power-consumption level less than that of a small flashlight. Intelligent cards can be used to add specific functions. Newton will be built by Sharp in Japan, and is expected to be priced at under \$1000.

HEERE'S HDTV!

Zenith (a non-exhibitor) staged a live demonstration of a prototype of the Digital Spectrum Compatible HDTV system that it developed in conjunction with AT&T. The signal was broadcast from a transmitter in Milwaukee, WI, 75 miles away from Zenith's Glenview, IL headquarters where it was received. The HDTV image was remarkably clear, particularly when viewed in contrast with standard NTSC images, and no interference was experienced by local, low-power stations. Nor was the HDTV signal troubled by interference from nearby NTSC signals, thanks to the Zenith/AT&T "interference rejection filter."

Before transmission, the test material images—which included computer graphics, video segments produced in the 1125/60 interlaced HDTV format, and segments produced in the 525-line interlaced NTSC format that were up-converted (using a Faroudja line doubler) to progressively scanned Zenith/AT&T format—were processed through the Zenith/AT&T compression system. The signal was decompressed and displayed on high-definition monitors at Zenith's offices. The successful transmission went a long way toward convincing skeptics that HDTV might gain widespread acceptance and that the Zenith/AT&T system has a fighting chance of becoming the standard.

We had an opportunity to repeatedly watch a tape of the broadcast where we could watch it more critically. Considering the distance the low-power HDTV signal travelled, the results were impressive. It seems, however, that we will have to get used to a new set of digital artifacts, just as we've gotten used to such NTSC artifacts as dot crawl.

Zenith also has its hands in another joint venture aimed at keeping television on the

cutting edge. Together with InSight, Inc., Zenith demonstrated the *InSight Telecast* on-screen program guide, which provide program titles, start times, and descriptions. The system allows users to obtain detailed information about the programs in which they are interested, and to scan through schedules of specific types of programs—sporting events, for instance. In addition, it can be used for simple VCR programming, by pushing only one button on the remote control.

Insight obtains its data from a TV-listing provider and sends them via satellite to one station in each market (usually a PBS affiliate). The individual user receives the information over the vertical blanking interval of the PBS station. The process is all automatic. Insight will probably market a



Aiwa's prototype home MD system is a futuristic product with distinctive digital displays on both the main unit and the remote control.



Skip-resistant MD's and car audio could be an ideal combination. Alpine, who displayed this prototype automotive MD player, is certainly hoping the idea catches on big.

stand-alone decoder. Zenith expects to be the exclusive manufacturer of television sets that incorporate InSight's program guide for one year after production begins late this year.

MD MADNESS

It's been a dozen years since Sony introduced their Walkman personal stereo, and they must figure the time is ripe for another ground-breaking product intro. Up at the Four Seasons Hotel (Sony did not exhibit at the CES), Sony displayed their prototype portable Mini Disc (MD) player, which is being aimed at the "active-lifestyle" (read: teenagers and baby-boomers who wish they still were) market. The 2½-inch Mini Discs sound almost, but not quite as good as CD's, but have the advantages of being recordable, significantly

47st. Photo[®]

The latest in electronics is only a phone call away! **1-800-221-7774**

In N.Y. or if busy call: 1-718-722-4750. Please mention code ES892.



NEW!
AIWA CSD-EX1
PORTABLE LCD
RADIO CASSETTE CD PLAYER

- High power output
- Power saving switch plus auto stop
- 20-selection random programmable memory CD
- AM wide/FM stereo tuner

(AIW-427)
Sugg. Retail \$179.95 **Our Price \$139.95**



NEW!
AIWA NSX-330
30W/ch HI-FI MINI COMPONENT
SYSTEM WITH SURROUND SOUND

- Super T-bass

Includes:

- 3-preset graphic equalizer
- 5-band spectrum analyzer
- Wireless Remote
- FM/AM tuner with 32-station random preset
- Dual auto reverse cass. w/ Dolby B NR
- Optical digital output terminal
- 3-way speaker (AIW-424)

Our Price \$399.95
Sugg. Retail \$560.00



NEW!
AIWA XP-7
PORTABLE CD PLAYER
WITH IN CAR USE

- 1-bit dual D/A converter
- 8-times oversampling digital filter
- Optical digital output terminal
- 24-random programmable memory
- Heat-resistant for in car use
- Random Play with 3-way repeat

Includes: Rechargeable battery BP-50, stereo headphones with remote control, AC adaptor recharger, and connection cord. (AIW-420)

Our Price \$249.95
Sugg. Retail \$280.00



BONUS!
Free case with purchase of E-63 \$59 Value!

CANON E-63
8mm CAMCORDER WITH
8:1 POWER ZOOM

- High speed shutter
- 180° FlexiGrip
- 2-lux low light
- Sports finder
- Wireless Remote (CAN-6300)

Super Value!



NEW!
PANASONIC RQ-S35V
AM/FM STEREO CASSETTE
PLAYER WITH AUTO REVERSE

- Ultra compact size
- Digital synthesizer tuner with 7AM/7FM presets
- S-XBS & Dolby NR
- LCD tape/radio display
- Dual clock/alarm functions
- One button wired remote

Includes: Rechargeable battery and charger. (PAN-275*)

Our Price \$169.95
Sugg. Retail \$209.95



NEW!
SONY WM-WX50
WALKMAN®
STEREO CASSETTE
PLAYER

WIRELESS HEADSET!

- Broadcasts up to 9 ft.
- Auto reverse Mega Bass 2x sound system with variable control
- Dolby NR (SON-3483)

Our Price \$179.95
Sugg. Retail \$249.95



SHARP IQ-8400
ELECTRONIC ORGANIZER

- 256 KB memory
- Typewriter style keyboard
- Hi-contrast 40 char. by 8 line screen
- Month/week & day calendar
- 3 phone directories
- Business Card function (SHA-8400)

Our Price \$319.95
Sugg. Retail \$499.95



SONY XVT-600
ADD PRO STYLE SUPERIMPOSED
TITLES TO YOUR VIDEOS!

- 15 color picture computer superimposes picture title or background to video
- Draw lines, add color—endless possibilities!

(SON-4091) **SALE!**
\$109.95
Sugg. Retail \$600

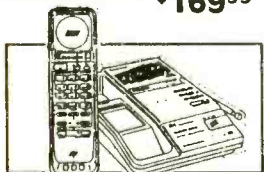

PANASONIC KX-T4300
CORDLESSPHONE WITH
ANSWERING MACHINE

- 10 channel access • Rubber antenna
- Tone/pulse • 2-way paging
- 10-number speed dial • Message alert
- LED readout
- 11-function tone remote
- Auto logic operation. (PAN-4300)

Our Price \$159.95
Sugg. Retail \$199.95

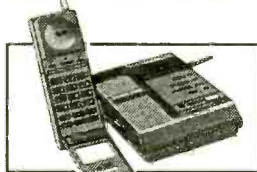

PANASONIC KX-T9000
900MHz POCKET-SIZED FOLDING
CORDLESSPHONE

- Operates on 902/928Mhz
- Sound Charger technology
- 30ch auto scan • Auto Intercom
- 2 interchangeable batteries
- 2-way paging & auto intercom
- 10, 20 digit no. auto dial
- Handset Auto switch to 'talk' mode (PAN-9000)

Our Price \$399.95
Sugg. Retail \$499.95

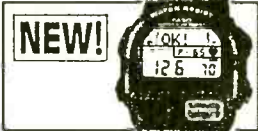

NEW!
CASIO BP-100
BLOOD PRESSURE
MONITOR WATCH

- Water resistant to 50 meter
- 12/24-hour formats
- 3 multi-function alarms
- Altimeter, Depth meter & Barometer
- Countdown alarm
- 1/100 stopwatch (CAS-826)

Our Price \$129.95
Sugg. Retail \$169.95



PANASONIC CTP-2066S
20" STEREO MONITOR-RECEIVER
WITH S-VHS INPUT (Over 500
lines horizontal resolution)

- Audio/Video Input jacks
- Unified TV/VCR remote
- Clock, sleep-timer & on-timer (PAN-2796)

SALE!
\$357.95
Sugg. Retail \$499.95

- Cameras
- Darkroom Supplies
- Video Equipment
- Televisions
- Hi-Fi Stereo Equipment
- Portable/Personal Audio
- Telephones
- Cellular Phones
- Computer Equipment
- Business Machines
- Calculators/Organizers
- Electronic Games
- Watches/Sunglasses
- Small Home Appliances
- Jewelry

Mail Order Dept.:
455 Smith Street, Brooklyn, N.Y. 11221

G1092

Visit our superstores at:

67 West 47th Street **115 West 45th Street**
Bet. 5th & 6th, NYC CA. LIC. #800189-691860 Bet. 6th & B'way, NYC CA. LIC. #800191-811628

1-212-921-1287

Sun. 10:00-5:00, Mon.-Thurs. 9:30-6:00, Fri. 9:30-2:00, Closed Saturday

A New York Landmark for over 26 years!

Toll-free line is open
SUN. 10-5, DAILY 8-7, FRI. 8-2
Local lines are open
SUN. 10-5, DAILY 9:30-6, FRI. 9:30-2

OVERNIGHT DELIVERY
to any point in the
continental USA
AVAILABLE
at additional cost

NAMES AND ADDRESSES

AIWA AMERICA
800 Corporate Drive
Mahwah, NJ 07430
CIRCLE 50 ON FREE INFORMATION CARD

ALPINE ELECTRONICS OF AMERICA
19145 Gramercy Place
Torrance, CA 90501
CIRCLE 51 ON FREE INFORMATION CARD

APPLE COMPUTER, INC.
20525 Mariani Ave.
MS 482
Cupertino, CA 95014
CIRCLE 52 ON FREE INFORMATION CARD

AT&T
Consumer Products Division
5 Wood Hollow Rd. 3L11
Parsippany, NJ 07054
CIRCLE 53 ON FREE INFORMATION CARD

AUDIO DESIGN ASSOCIATES
602-610 Mamaroneck Ave.
White Plains, NY 10605.
CIRCLE 54 ON FREE INFORMATION CARD

CERWIN-VEGA
55 East Easy Street
Simi Valley, CA 90010
CIRCLE 55 ON FREE INFORMATION CARD

CINCINNATI MICROWAVE
Escort Division
5200 Fields-Ertel Rd.
Cincinnati, OH 45249
CIRCLE 56 ON FREE INFORMATION CARD

COBRA ELECTRONICS/DYNASCAN
6500 West Cortland Street
Chicago, IL 60635
CIRCLE 57 ON FREE INFORMATION CARD

EASTMAN KODAK CO.
343 State St.
Rochester, NY 14650
CIRCLE 58 ON FREE INFORMATION CARD

FAROUDJA LABORATORIES
675 Palomar Ave.
Sunnyvale, CA 94086
CIRCLE 59 ON FREE INFORMATION CARD

HITACHI HOME ELECTRONICS
(AMERICA)
3890 Steve Reynolds Blvd.
Norcross, GA 30093
CIRCLE 60 ON FREE INFORMATION CARD

INSIGHT TELECAST, INC.
39650 Liberty Street
Third Floor
Fremont, CA 94538
CIRCLE 61 ON FREE INFORMATION CARD

MARANTZ USA
1150 Feehanville Drive
Mount Prospect, IL 60056
CIRCLE 62 ON FREE INFORMATION CARD

MILLER & KRIESEL SOUND CORP.
10391 Jefferson Blvd.
Culver City, CA 90232
CIRCLE 63 ON FREE INFORMATION CARD

MITSUBISHI ELECTRONICS
AMERICA, INC.
5757 Plaza Drive
Cypress, CA 90630
CIRCLE 64 ON FREE INFORMATION CARD

PHILIPS CONSUMER ELECTRONICS
CO.
One Philips Drive
Knoxville, TN 37914
CIRCLE 65 ON FREE INFORMATION CARD

QUASAR CO.
1797 North Randall Rd., 1-E-3
Elgin, IL 60123-7874
CIRCLE 66 ON FREE INFORMATION CARD

SANYO FISHER (USA) CORP.
21350 Lassen St.
Chatsworth, CA 91311
CIRCLE 67 ON FREE INFORMATION CARD

SEGA OF AMERICA, INC.
130 Shoreline Drive
Redwood City, CA 94065
CIRCLE 68 ON FREE INFORMATION CARD

SHARP ELECTRONICS CORP.
Sharp Plaza
Mahwah, NJ 07430
CIRCLE 69 ON FREE INFORMATION CARD

SONANCE
961 Calle Negocio
San Clemente, CA 92672
CIRCLE 70 ON FREE INFORMATION CARD

SONY CORPORATION OF AMERICA
Sony Drive
Park Ridge, NJ 07656
CIRCLE 71 ON FREE INFORMATION CARD

SQUARE D CO./ELAN
1601 Mercer Road
Lexington, KY 40511
CIRCLE 72 ON FREE INFORMATION CARD

TANDY CORP.
700 One Tandy Center
Fort Worth, TX 76102
CIRCLE 73 ON FREE INFORMATION CARD

THEATER DESIGN ASSOCIATES
894 Union Street
Brooklyn, NY 11215
CIRCLE 74 ON FREE INFORMATION CARD

THOMSON CONSUMER
ELECTRONICS
600 N. Sherman Dr.
Indianapolis, IN 46201
CIRCLE 75 ON FREE INFORMATION CARD

TOSHIBA AMERICA
9740 Irvine Blvd.
Irvine, CA 92718
CIRCLE 76 ON FREE INFORMATION CARD

VIDEONICS
1370 Dell Avenue
Campbell, CA 95008
CIRCLE 77 ON FREE INFORMATION CARD

VIDIKRON OF AMERICA, INC.
150 Bay Street
Jersey City, NJ 07302
CIRCLE 78 ON FREE INFORMATION CARD

YAMAHA ELECTRONICS CORP. USA
6660 Orangethorpe Avenue
Buena Park, CA 90620
CIRCLE 79 ON FREE INFORMATION CARD

ZENITH ELECTRONICS
CORPORATION
1000 Milwaukee Avenue
Glenview, IL 60025
CIRCLE 80 ON FREE INFORMATION CARD

smaller, and playable on a shock-resistant player said to virtually eliminate the mis-tracking that plagues portable CD players. » The players are being marketed more as a step up from portable audio-tape players than as a replacement for home CD play-

ers. (We think that despite Sony's view, MD could usurp a significant part of CD's market share.) MD represents a giant step forward from analog audio tape not only in terms of sound quality. MD's offer durability, packaged in protective cases sim-

ilar to those of 3½-inch computer diskettes. They are as convenient to use as CD's, providing quick random access and programmable playback. They are smaller, providing 74 minutes of music on an almost flat, 2½-inch disc. And they can be

recorded over and over again without incurring physical deterioration or loss of sound quality.

Sony has plenty of support for the format, from hardware manufacturers (Aiwa, Alpine, Clarion, Denon, Sanyo Fisher, and TDK), the recording industry (Capitol, EMI, SBK, Chrysalis, Liberty, Virgin, DMP, GRP, and Rykodisc), and blank-media manufacturers (Hitachi Maxell, Philips, TDK, and others). Aiwa showed futuristic prototypes of a portable, wristband model as well as a home MD player, while Alpine had a prototype car MD player on display. More than 300 pre-recorded titles are expected to be available at introduction. Sony is, however, having some problems with music publishers. Although several have jumped on the MD bandwagon (including EMI and Sony's



Philips, whose original Compact Disc Interactive System is pictured here, announced the imminent availability of a plug-in board that will upgrade the machine to full-motion video capability.

own publishing group), such "big guns" as Time Warner and Bertelsmann Music Group have begged off support and are supporting DCC.

Coinciding with the Consumer Electronics Show, Sony staged the first public demonstration of MD recording. A live piano performance at a local Chicago radio station was recorded on MD and then played back over the air, with what some said was "impressive accuracy." We didn't hear it, but we wouldn't think of using an FM broadcast as the testbed of a product that claims to be almost as good as CD.

Okay, so MD isn't trying to compete with CD. Nor is it likely to completely replace tape-based personal stereos any time in the near future. It is, however, poised to battle digital compact cassettes for consumer acceptance. It's unlikely that the market will bear two completely new audio formats, even if each of those has

significant technological advantages and significant industry support. Sony's portable MD player/recorder is expected to retail for between \$500 and \$600. Prices will be higher than originally expected for home DCC decks (with suggested retail prices now ranging from \$700 to \$1200), purportedly due to dealer pressure for more pricing flexibility.

PHONING AROUND

Cincinnati Microwave showed a prototype of their new Escort brand 900-MHz digital spread-spectrum cordless telephone. The product, which will also be sold by Dynascan under the Cobra brand, claims to have a range of one-half mile. We were impressed by the phone's performance in the halls of the Swissotel Chicago—a very tough environment for cordless phones. (The model we tried was still in the prototype stage, mounted on several PC boards in a box larger than any phone we'd like to own. By the time you read this, phone-sized units will be ready to hit the market—providing they obtain FCC approval.) The phone's range is only one of its attractive features. It should also prove to be secure from all but the most sophisticated of eavesdroppers.

UPSTAIRS DOWNSTAIRS

Sharp (and many other exhibitors) took its trade-only exhibits not uptown, but upstairs. The second level of Sharp's large booth was devoted to new items that they preferred to keep out of the public view until they are closer to hitting the store shelves. A standout among those selectively-shown items was the *CD-Q10* micro-component stereo system, which measures just 5¾ inches in width but delivers big sound. The system includes a CD player, an auto-reverse cassette deck, a digital tuner with 20-station memory, and speakers made with a bamboo fiber that maximizes sound and clarity in a compact design. The micro-component system will be available in October at a suggested retail price of \$899.

Tucked away in a back room upstairs was Sharp's new SE line of high-end audio/video products. The first products in the line, which will make their retail debut in late summer 1992, all fall into the video category. Included are the *VL-HX10U* Hi-8 camcorder that features a twin lens system with two camera sections and video-mixing capabilities; several televisions; and an eight-head (*VC-H96U*) and a six-head VCR (*VC-A66U*).

THAT'S A WRAP

For more information on products seen at the 1992 Summer Consumer Electronics show, read on. "Innovations '92" provides highlights of the recipients of this year's Design and Engineering Awards. ■

Innovations '92

Since 1976, the Innovations exhibit at the Summer CES has highlighted those consumer-electronics products that were selected to receive Design and Engineering Awards. According to Gary Shapiro, group vice president of the EIA's Consumer Electronics Group, "Innovations is a mirror of the consumer electronics industry, and delivers a state-of-the-art snapshot of the industry's hottest product categories."

While retaining that tradition, there were some changes made to this year's Innovations exhibit. First, of course, was the fact that consumers were admitted for the first time. Also for the first time, selected products were turned on, affording attendees a "live" look at them. In keeping with today's more sophisticated hardware, there was a new emphasis on product design. In addition to the traditional consumer-electronics contingent, judges were drawn from the industrial-design field, design schools, and the industrial-engineering trade. Finally, Innovations '92 was also larger and located on the main show floor instead of a small, out-of-the-way room.

Let's take a look at some of the video and audio products that achieved recognition for their engineering and design innovations.

VIDEO VICTORS

Many of the award-winning video products seemed to emphasize practicality. Mitsubishi, for example, makes the large-screen, rear-projection TV more practical in smaller rooms with their Slim Depth design sets. The *VS-70VF2* (\$6399) is the world's only 70-inch projection TV and



Sony Video Walkman with 8mm VCR

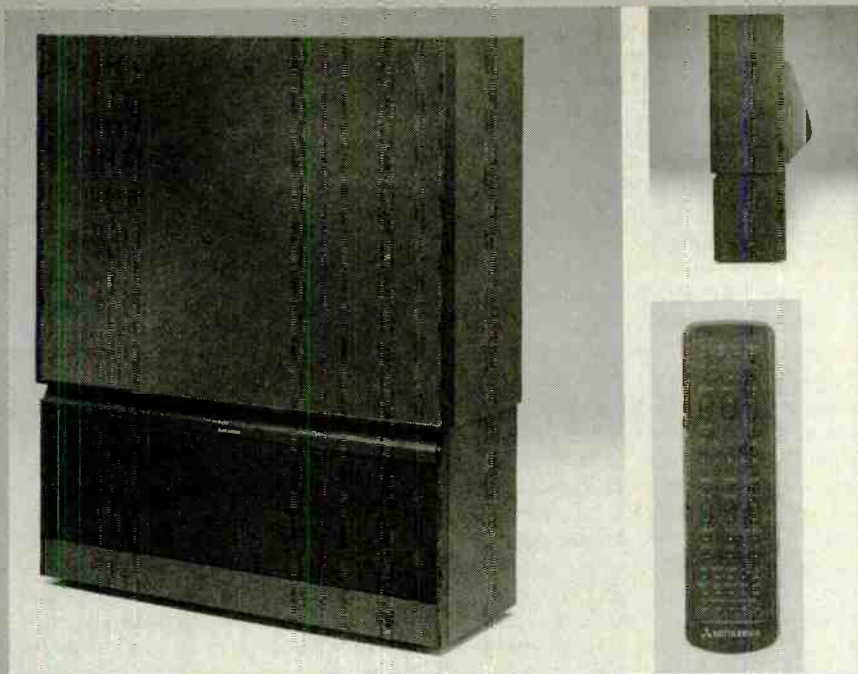

Mitsubishi VS-70VH2 70-inch TV with Slim-Profile Chassis

Mitsubishi's first 70-inch Slim Depth Model. (Its depth is a relatively slim 28¾ inches.) The TV features a "selective absorption, dark-tint screen" that absorbs room light for better contrast.

Placing convenience first, Philips' new line of televisions solves another common viewing problem—the case of the runaway remote control. The sets feature the Remote Locator. Pressing a button on the TV causes the missing remote to beep for 30 seconds or until any button on the remote is pushed. Since an RF signal is sent by the TV, the system works whether the remote is in another room or right under your nose. Three 27-inch, one 31-inch, and two

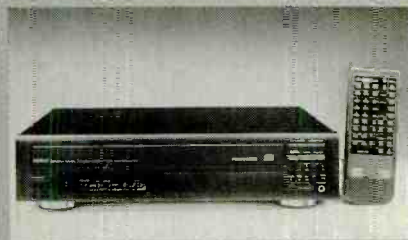

Yamaha CDC-835 CD Changer with Play-Xchange

35-inch sets with the Remote Locator will be available in late summer.

Quasar strives to eliminate component clutter with its VV1220W combination VCR/20-inch color TV (\$629.95). Available in black or white, it features on-screen menu for remote video adjustments. The VCR has a one-month, four-program calendar and on-screen programming.

Programming has never been easier than with the RCA VR536 VHS HiFi VCR. Unlike previous models that contained VCR Plus+ technology, this unit also can control your cable box. Now even if you live with a cable system that scrambles all channels, timer recording is simple. The VG4219 also features an automatic head cleaner, front-mounted input jacks, and oversized control buttons with brighter readouts.

Those videographers who simply can't deal with plugging their 8mm camcorders into their TV to see what images they've captured will appreciate Sony's *Video Walkman GV-500* (\$1400) with a built-in 8mm VCR that can be used for recording or playback. Not just for home videos, users can watch any of the more than 1800 prerecorded movies now available on 8mm tape on the set's four-inch color LCD screen. The VCR also offers editing function, an on-screen menu, and a six-event/one-month programmable timer. The GV-500 features AFM stereo, and Mega Bass sound.

Although it won its Design and Engineering award in the video category, Square D Company's *Elan Series HD* is actually a whole-house system that takes control of the TV, VCR, phone, stereo, doorbell, and other electronics that the user already owns, and links them together for unmatched convenience and multi-room accessibility. Elan HD components are designed with preprogrammed, plug-in cards that control specific functions, allowing installers to easily customize systems to meet individual needs.

AWARD-WINNING AUDIO

A couple of winners in the audio category are designed to work closely with video products. Marantz' SR-92 Dolby Pro-Logic A/V Receiver (\$1099), designed to meet the demands of the serious consumer, offers total audio and video integration in one easy-to-use component. It provides five separate amplifier channels that are used to drive the front, center, and surround speakers. A multi-room mode permits another audio program to be played in a separate room with independent remote control of source and volume. The receiver also includes a bass EQ control and a line-level output for powered subwoofers.

Cerwin-Vega calls its seven-piece home-theater speaker system *Sensurround* (\$1660). The system, which was honored along with Universal Studios with an Academy Award for the Sensurround technology, includes a center-channel, two subwoofers, and four satellite speakers. All speakers are magnetically shielded.

Strictly for your listening pleasure.

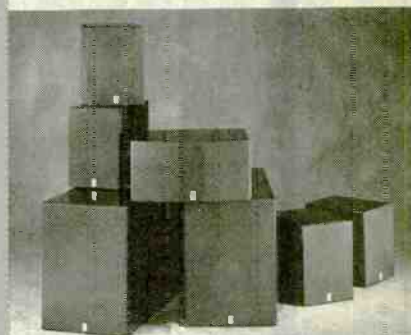

Cerwin-Vega Sensurround Home-Theater Speaker System

Yamaha's model CDC-835 five-disc CD changer (\$549) eliminates the vibration problems inherent in carousel changers by keeping the disc that's being played in a stationary position isolated from the carousel drawer. That design, dubbed "Play-Xchange," allows the other four discs to be changed while the fifth is playing. The drawer also extends farther than other carousel players that we've seen, for easier access to the discs.

Sony remains on the forefront of portability with their *model D-515 Discman* (\$499.95), the first portable CD player to feature "Electronic Shock Protection" to minimize loss of sound when subjected to shock and vibration. A four-megabit memory chip stores up to three seconds of real-time digital music, providing a buffer for uninterrupted playback. The D-515 Discman also features digital signal processing.

The boom box of the 90's bears little resemblance to its predecessors. Sanyo Fisher's *MCD-Z85* portable AM/FM/CD/double cassette system (\$449.99) features a smooth, rounded, modern design and such features as artificial-intelligence

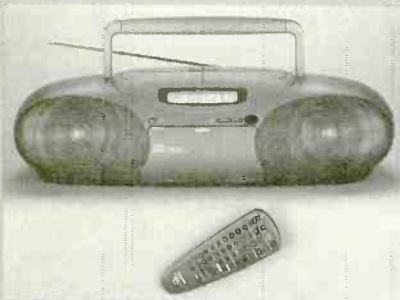

Sanyo MCDZ85 Remote-Controlled AM/FM/CD/Dual-Cassette System

technology and high-speed dubbing that make CD-to-tape recording almost fully automatic. The remote-controlled, 20-watt system has controls hidden behind a motorized front panel.

Speakers are also changing their shapes. Sonance has introduced the *S3R* (\$425/pair), a round speaker designed for in-wall and in-ceiling installations where a wide and uniform dispersion pattern is desired. The high-fidelity two-way speaker uses a dual voice-coil woofer; an acoustically transparent woofer basket protects the woofer. A pivoting dome tweeter with neodymium magnet mounted on a unique perforated platform provides a flat frequency response.

Philips' unique *DSS930 Digital Speaker System* (\$1200 each) achieves optimum sound reproduction by integrating a powerful digital signal-processing circuit and an amplifier in the speaker box. Philips claims that by keeping the signal digital for as long as possible—instead of relying on analog crossover networks to route frequencies—near-perfect sound is achieved. An optional digital system controller, *Model DSC950* (\$519.95) features seven analog or digital inputs and acts as a source selector with multi-room capability.

Keep your eyes on these pages in upcoming months for reports on many of these award-winning items! ■

Paying Attention to Details

SONY CCD-FX510 8mm CAMCORDER.
From: Sony Corporation of America,
Sony Drive, Park Ridge, NJ 07656. Price:
\$1200.

We don't envy camcorder manufacturers. It's tough to sell big-ticket items in a sluggish economy. Each year that the camcorder market matures, it becomes tougher still, as the growth rate naturally flattens out.

How do you make your camcorder stand out in a market that is saturated by many similar products? The people at Sony seem to be doing it by paying attention to details. Their newest FX-series Handycam camcorder, the *CCD-FX510*, is an example of how all those little features can add up to something special.

The CCD-FX510 has an in-line design, where the cassette is located behind the lens. Still, the unit is compact (roughly 4¾ × 4¾ × 10½ inches) and reasonably lightweight (about 2½ pounds including the battery and cassette). We prefer the sleek, thin design over shorter, fatter units, and found the camcorder to be very well balanced in our hands. It was comfortable for most of us, and usable even for those with small hands.

That is only one example that shows that Sony put a lot of thought into the design. We liked, for example, the focus ring that surrounds the internal-focus 10× zoom lens. We've never been fans of toggle-switch focusing, or the similar "toggle ring." We were far more comfortable with Sony's focusing ring, which let us manually focus in the same way we would with a 35-mm still camera.

We also liked the way that the shoulder strap is attached to the *bottom* of the cam-

era. The camcorder hangs upside-down so that it is easy and natural to get your hand into the hand grip. We found that the diopter, or eyepiece lens, which could be adjusted over an extra wide range, was a great convenience—even with the camcorder held at arm's length, it's possible to see the image in the viewfinder. That's particularly useful when taking low-angle shots or when shooting fast-moving sports, where you want to be able to keep your eyes on all the action instead of trying to view it through the camcorder's lens. A two-speed power zoom makes it easy to get in on the action in a hurry, but also lets you leisurely change the lens' focal length.

A defeatable beep function lets you know when the camcorder is switched into the record or pause modes. And an LCD panel on the side of the unit lets you quickly check the operating status. The viewfinder contains a host of annunciators that tell you everything from how much tape is left to how your zoom is set.

The camcorder also comes with an infrared remote control that is intended to be used not only during playback, but also for recording. You can get in your own scenes and control start, stop, and zooming.

Playing back a tape is also quite convenient, thanks to the various options that Sony included. The camcorder provides line-level video and audio outputs via standard RCA-type phono jacks. (The jacks are normally concealed by a dust cover, and can also be switch-selected to act as inputs). If your TV does not provide audio/video inputs, you'll want to use the supplied RF modulator. Another option is to use the "connecting adapter," which can be left permanently connected to your TV, a great convenience with 8mm camcorders since you can't play back tapes on your VHS VCR. A connecting plate that attaches to the back of the camcorder (where the battery normally attaches) both supplies power to the camcorder and accepts



CIRCLE 81 ON FREE INFORMATION CARD

audio and video from the camcorder. The connecting adapter provides audio and video outputs, but the RF modulator can also be used with it. The battery charger must be used to supply power to the adapter, but it can be left permanently attached to the adapter and still be used to charge the camcorder's battery.

The CCD-FX510 offers a full-auto mode, in which the camcorder makes all adjustments. It also offers three special Program AE, or auto-exposure, modes. The Portrait mode reduces the depth of field so that background objects will be out of focus and won't distract from your main subject. The Sports mode is designed for shooting high-speed action: the shutter speed is automatically selected to be as fast as possible for given lighting conditions. A high-speed shutter mode sets the shutter speed to 1/4000 second. This mode is meant primarily for slow playback, where you want each recorded frame to be sharp, not blurred. The camcorder does offer a 1/2 speed playback mode, but it is accessible only through the remote.

We tested the high-speed shutter mode by capturing the running leaps of a hyperactive kitten. We've always thought of cats as graceful creatures. Our slow-motion playback showed us just how graceful they can be. We felt as if we were watching something out of PBS's *Nature* series. We also discovered just how a cat can jump onto a high perch that seems too small without falling off.

An Auto Lock switch lets you return to (or maintain) full auto mode. When you turn off the lock, the camcorder returns to the mode that you were in previously—sports mode with auto focus, for example. A back-light compensation feature, which is used when shooting a subject against a bright background, is also available.

The other features that the Handycam offers are relatively straightforward. There is a digital memory that lets you store a title. To do that, you aim the camera at a prepared title card or other high-contrast image, press the "memory" button, and you should see the image in the viewfinder superimposed over the scene. We've never cared for such digital image memories because of the pre-planning they require to be used successfully. We'd prefer to see a built-in character generator, which this Sony unit does not offer. It is possible, however, to display the current date or time (unfortunately, both can't be displayed at the same time), or the age of your subject (assuming that you previously stored the subject's age—which is easy if you have only one child).

A fader control lets you create smooth scene transitions by fading into and out of each recorded segment. We didn't like where the control was mounted (on the

(Continued on page 21)

Sound Decisions

SS THREE/II PRO-LOGIC SURROUND SOUND PROCESSOR. From: AudioSource, 1327 N. Carolan Avenue, Burlingame, CA 94010. Price: \$579.95.

The very thought of home theater seems to frighten some people. Setting up a sound system—arguably the most important component of a home-theater setup—can be a daunting task for the uninitiated. All those terms: Dolby Surround, Pro Logic, Hall, Matrix. All those questions: How many speakers do I need? Why can't I use my current stereo system? All those decisions!

Setting up a surround-sound system is, fortunately, easier than it might seem once you understand a few basic points.

Home-theater surround sound is a spin-off of away-from-home theaters, which started the trend in the late 1970's. George Lucas's *Star Wars* is usually credited with bringing Dolby Stereo (the theater surround system) to the attention of the public. As more and more films were released in Dolby Stereo, the idea of re-creating the theater experience in the home took on steam.

Before surround-sound processors became readily available, many people tried to improve our TV sound in other ways. One popular approach was to use a stereo amplifier and a stereo VCR to improve the usually poor sound of most TV sets. The result is better sound, but it usually suffers from an unrealistic sound field, one with a "hole" in the middle. Since most of the sound relates to on-screen action, that hole

can sometimes be disconcerting. That's where surround sound comes in.

There are two kinds of Dolby Surround processors now available. The first is a straight Dolby Surround processor, which extracts the surround channel from the stereo tracks of a movie, and also offers a center-channel output by combining some of the audio from the two front channels. Some processors also offer a subwoofer output. Many people are quite satisfied with the results. There's something better, however.

The second type is the Dolby Pro Logic processor, which adds *steering logic* circuitry, which determines where the dominant sound is coming from, and generates control signals in the processor that increase the gain in the appropriate combination of channels (left, right, center, and surround) to produce a more realistic and directional sound. If you're looking to get better sound from your rental tapes, then you'll likely be satisfied with a Dolby Surround processor. But if you're looking to recreate sound that is better than what you'll hear in all but the best movie theaters—the sound that the director intended you to hear—then a Pro-Logic processor is what you want. And it comes with the added benefit of providing better sound for everyone in the room, since the "sweet spot" is considerably wider than standard surround sound.

Once you decide which kind of surround processor you want, you still have a lot of decisions to make, namely what kind of amplifier and speakers you're going to use. AudioSource helps the confused with their SS 3001 surround sound package system. The all-in-one package

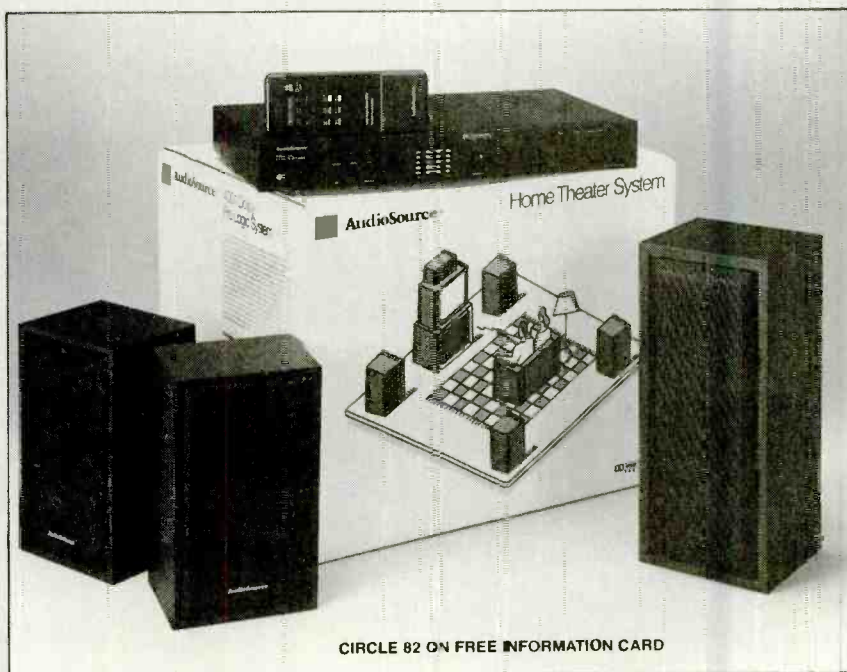

Take Any **3** PROFESSIONAL BOOKS for only \$**9.95**

when you join the **ELECTRONICS ENGINEERS' BOOK CLUB**

Values to \$155.40



9255-XXX \$105.00
Counts as 3

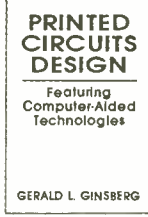

10016 \$39.95



003957-XX \$49.95
Counts as 2



9244P \$18.95
Softcover



9290 \$36.00
Counts as 2



071231 \$57.95



020975-XXX \$104.50
Counts as 3



3147-XX \$38.95
Count, es 2

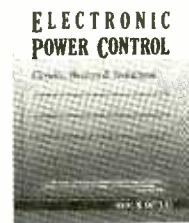

3837 \$27.95



050414 \$41.95

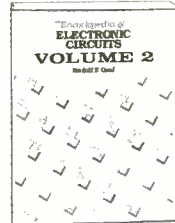

3138-XX \$60.00
Counts as 2

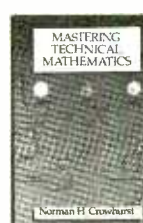

3438 \$39.95



013933-XX \$89.50
Counts as 2

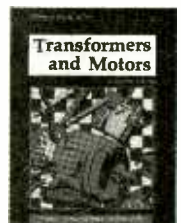

9458 \$29.95



3102-XX \$49.95
Count, as 2

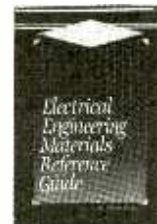

004196 \$47.95



3710 \$32.95

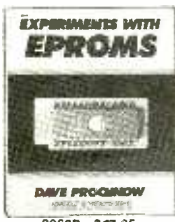

2962P \$17.95
Softcover



3151 \$42.95



3321P \$16.95
Softcover

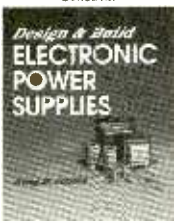

3540 \$26.95



057537-XX \$42.95
Counts as 2



3365P \$24.95
Softcover



3991 \$39.95

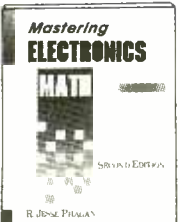

3589 \$27.95



2672 \$49.50

As a member of the Electronics Engineers' Book Club . . .

. . . you'll enjoy receiving Club bulletins every 3-4 weeks containing exciting offers on the latest books in the field at savings of up to 50% off of regular publishers' prices. If you want the Main Selection do nothing and it will be shipped automatically. If you want another book, or no book at all, simply return the reply form to us by the date specified. You'll have at least 10 days to decide. Your only obligation is to purchase 3 more books during the next 2 years, after which you may cancel your membership at any time.

All books are hardcover unless otherwise noted. Publishers' prices shown. ©1992 EBC

If coupon is missing, write to:
Electronics Engineers' Book Club, Blue Ridge Summit, PA 17294-0860

ELECTRONICS ENGINEERS' BOOK CLUB

Blue Ridge Summit, PA 17294-0860

YES! Please send me the books listed below for just \$9.95, plus shipping/handling & tax. Enroll me as a member of the **Electronics Engineers' Book Club** according to the terms outlined in this ad. If not satisfied, I may return the books within ten days and have my membership cancelled. A shipping/handling charge & tax will be added to all orders.

--	--	--

If you select a book that counts as 2 choices, write the book number in one box and XX in the next.
If you select a Counts as 3 choice, write the book number in one box and XXX in the next 2 boxes.

Name _____

Address _____

City/State _____

Zip _____ Phone _____

Valid for new members only, subject to acceptance by EEBC. Canada *must* remit in U.S. funds. Applicants outside the U.S. and Canada will receive special ordering instructions. PPIF1092

includes processor, speakers, RCA cables and 100 feet of speaker wire. If you love your current stereo system and have balked at the idea of buying an A/V receiver, then a separate processor/amplifier like the SS Three/II is the ideal solution.

The SS Three/II processor is an attractive unit; its black metal cabinet measures $16\frac{1}{2} \times 2\frac{1}{4} \times 1\frac{1}{2}$ inches and features a cleanly styled front panel. It can operate either delivering 30 watts to the center channel and 30 watts to the surround, or the center channel can be disabled so the surround channels receive 60 watts. Since the SS 3001 package includes both center and rear speakers, it's unlikely that you would want to disable the center channel. However, some people might choose to use the TV set's speakers as a center channel. A Phantom mode is also provided by the processor. In that mode, the processor "fakes" a center channel by diverting the center-channel information to both left and right speakers.

The center channel is powered by a 30-watt amplifier. The VS One center-channel speaker is magnetically shielded so that it can be placed directly next to or, preferably, on top of or below your TV. The speaker features two 4-inch woofers and a 1-inch dome tweeter. The tweeter is mounted in the center of the speaker, with the woofers on either side, so that the speaker can be positioned either horizontally or vertically. The compact design measures about $13 \times 5\frac{1}{2} \times 5\frac{1}{2}$ inches. The 8-ohm speakers have a 50-watt power capacity and a specified sensitivity of 93 dB. AudioSource specifies the frequency response of the VS One speaker at 70 Hz to 20 kHz. But because they don't characterize the amplitude response over that frequency range, those numbers are meaningless. The speaker is a bass-reflex type.

The rear-channel loudspeakers are AudioSource LS Ten/A acoustic suspension speakers, which feature a 4-inch woofer and 2.5-inch tweeter. The speakers have a 4-ohm impedance and a specified frequency response of 100 Hz to 20 kHz. (Again, no description of the amplitude variation within that frequency range is given by AudioSource.) They measure $9\frac{1}{4} \times 5\frac{1}{2} \times 4\frac{1}{2}$ inches.

The system offers several other modes of operation besides Phantom. First, of course, is Dolby Surround, supporting left, center, right, and surround channels. The time delay between the front and surround speakers can be set at either 20 or 30 milliseconds. If your surround-channel speakers are located close to your listening position, you can use the delay to simulate the effect of placing them farther behind you.

The SS Three/II processor was originally marketed as a stand-alone unit, and

some of its modes are aimed at people who don't own the speakers that come with the complete SS 3001 package. For instance, a Dolby 3 mode operates without rear (surround) speakers: Pro-Logic "steering" still occurs with the three front speakers.

A "Hall" mode is provided for non-Dolby material. It works to simulate the spaciousness of a concert hall by providing subtle reverberation and by digitally delaying the sound that is fed to the rear speakers. A Matrix mode synthesizes a stereo sound from a mono source.

A test mode makes it possible to properly set the volume level of the main, center, and surround channels without any program source.

Unfortunately, it's difficult to adjust the volume levels on the SS Three/II because of the way the volume controls work. When you first press any of the three controls (rear, center, and master), four level indicators on the front panel (surround, left, center, and right) show the volume setting for the respective channels—the button must be held for about 3 or 4 seconds before the volume actually changes. The pink-noise test signal stays in each channel for only about two seconds.

One other thing that we didn't like about the level indicators is that they can't be turned off. They are required when you adjust the input level (using a front-panel knob). But once that's set, the flashing LED indicators only serve as a distraction.

Most of the SS Three/II's functions can be controlled by the supplied infrared remote. That's especially important when you're adjusting the volume levels from your viewing position while in the test mode.

The rear panel of the processor provides left- and right-channel line inputs, plus stereo tape inputs. Line outputs are provided for the front, center, and surround channels. A mono line-level subwoofer output is provided as a convenience. A rear-panel slide switch selects one of two crossover frequencies, 150 Hz or 80 Hz, and a potentiometer adjusts the subwoofer output level. Tape outputs are also provided.

The SS 3001 system is quite easy to set up, which is fortunate, because the manuals that accompany it are reasonably poor. We think that the SS 3001 should have had its own manual in addition to the manuals that were included with the individual components. It's especially unfortunate because the SS 3001 has the potential to take some of the mystery and hardship out of setting up a home theater. We also think that the system should have included a mute function. However, even with those shortcomings, the system should satisfy anyone who wants to add high-quality surround sound to an existing audio/video system. ■

Much Ado About Note-ing

PERSONAL PLANNER MODEL EO-100.
Manufactured by Rolodex Corporation,
245 Secaucus Road, Secaucus, NJ
07094-2196; Price: \$129.

Somewhere along the line, life got complicated. And not just *our* lives, either. It seems that everyone we know lives in a dual-career household, at the minimum. In fact, three careers is much more common—the husband and wife each have full time jobs, and at least one person freelances or moonlights as well. Add to that picture a couple of kids per household, frequent business travel, and a busy social life, and you end up spending your daily 15 minutes of "free time" trying to juggle the next day's schedules.

There are all sorts of electronic organizers being marketed with the promise (either spoken or implicit) that one of them could actually replace the bulging appointment book—you know, the one with the broken binding and loose pages that's become a catch-all for business cards, shopping lists, memos, coupons, receipts, and the like, and that is held together with rubber bands—on which each of us relies. But no matter how sophisticated the devices get—scads of memory, the ability to upload data to a computer, direct dialing of telephones, add-on data cards, etc.—the basic fact remains that the computer has *not* replaced the plain old pencil and paper in daily living. When you're stopped at a red light on the way home from work, it's simply easier to jot down a shopping list on a scrap of paper than to input it into some electronic device using one of those tiny QWERTY keypads. The same goes when someone gives you directions to their office, or you need to take some brief notes at a meeting. For many things, the best solution is old-fashioned writing.

Apple recognized that fact, and came up with Newton, a hand-held pen-based device that we discussed earlier in this issue, in our Consumer Electronics Show Report. Newton, however, is still in the prototype stage. And when it does become available, it's expected to cost a steep \$1000.

Another company also noticed the problem, and came up with a solution that's not as high priced, or as high-tech. In fact, the *Rolodex Personal Planner* might best be described as a combination of mid- and low-tech. It consists of a basic electronic phone-directory/notebook/calendar/calculator unit, along with an assortment of convenient *paper* forms, all packaged in a checkbook-sized leather portfolio.



CIRCLE 83 ON FREE INFORMATION CARD

Rolodex makes no "use-this-gadget-and-you-can-get-rid-of-all-those-little-scrap-of-paper" claims. Just the opposite, in fact. Called a "bridge between paper and electronic planners," the idea behind the Personal Planner is that you can use the electronic unit to store all the addresses and phone numbers of all your business contacts and friends, and be able to keep all of the vital hand-written information that accumulates over time in the same holder. For instance, it allows you to make notes of your appointments electronically, or to jot them down on the included Week-At-A-View calendar. The Personal Planner also comes with daily task checklist pages, a general-purpose envelope, phone-message sheets, grid paper for drawing or note-taking, a plastic sheet with pockets for business cards and Post-It notes, and dividers with labeled tabs. Each of those forms fits into the portfolio's six-ring looseleaf binder. Users are encouraged to collect business cards and receipts, jot down notes, sketch out drawings—and keep everything conveniently accessible within the covers of the binder.

The electronic portion of the Personal Planner packs no surprises. Its 48K of memory holds about 400 names, numbers, and addresses, which can be input using a QWERTY-style keypad that's on the left side of the device. As you'd expect from a unit that measures $6 \times 3\frac{1}{2}$ inches, the keypad is uncomfortably small. Above the alphabetic keypad is a two-line by 16-character (plus a prompt line) "Super-twist" LCD readout. For lines that are longer than 16 characters, it's possible to scroll to see the rest. No scrolling is necessary to view names or phone numbers, since the former is limited to 16 characters and the latter to 13—which creates some

trouble if you want your entry to read "John and Jane Johnson," for instance.

On the right-hand side of the Personal Planner is a numerical keypad that serves as a standard calculator. Just above it are the controls for setting and calling up the perpetual calendar, and for instituting the calculator function. Icons (a clock, a calendar, and a calculator) make it easy to select the right function. On the other side of the unit are icons of a standard Rolodex card file and a pad and pencil, which indicate the contact-file and the notes-file modes, respectively.

Inputting information is straightforward, but not what we'd call intuitive. Fortunately, the manual is quite clear, and once you get the hang of it, the Personal Planner's phone directory, notebook, and calculator couldn't be easier to use.

You can recall contact files by scrolling through the entire file alphabetically, or search directly by keying in the initials of the person or company or the first few letters of a name. To recall a note, you can do a direct search by date, or can scroll through "numeric-alpha" style (0-9, A-Z).

There's nothing particularly remarkable about the electronic Personal Planner (Rolodex left out the bells and whistles in favor of functions that everyone would be likely to use).

What is remarkable is the combination of the paper and the electronics, and the fact that you can personalize the package to fit your needs.

We have only two misgivings about the Personal Planner. First, we wonder why the portfolio doesn't include a pen holder. Second, we wonder how long it will take ours to start bursting at the seams, requiring the old rubber-band fix. ■

SONY CAMCORDER

(Continued from page 18)

bottom of the camcorder, near the focus ring) but we were able to get used to it. We couldn't get used to the button's lack of tactile feedback, however.

A fairly standard edit/search feature lets you do some rudimentary in-camera editing. Also provided is a Control L or LANC (local application control bus) connector. Although most users will never need to use that connector, it's a nice feature that permits the camcorder to be controlled by editing equipment that conforms to Sony's LANC specification.

The camcorder records audio in the 8mm AFM (analog FM) system, which provides the best audio that 8mm is capable of. The camcorder does not support the digital PCM (pulse code modulation) capabilities of the 8mm format. The camcorder permits stereo recording. Although stereo is often regarded as an unnecessary camcorder feature, we think that it's beneficial. Stereo sound can increase the realism of your recordings, and can make dialogue much clearer if several people are talking at the same time.

The low-light sensitivity rating of the CCD-FX510 is 1 lux. (Remember, however, that every camcorder manufacturer determines its sensitivity differently.) That capability means that you will be able to shoot in quite dark situations and still get a usable picture. We say "usable" because the picture won't be perfect; it will suffer from poor, noisy color. Yet for shooting occasional low-light scenes—some video footage at an evening barbecue, or the ever-popular birthday cake in a dark room, for example—the CCD-FX510 will do a creditable job. For optimum results, Sony recommends shooting with greater illumination, about 100 lux.

The CCD-FX510 was a joy to use because of its sensible controls (except for the fader), convenient auto-exposure modes, and easy-to-use manual focus ring. (Shoppers looking for an even simpler camcorder might want to give its little brother, the CCD-FX410—which leaves off the digital superimposer and the hi-fi stereo sound capability and is rated at 2 lux—a try.)

Other things we like about the 510 is that its autofocusing is quick and accurate, and the "quick record" function greatly reduces the time between pushing the record button and when recording actually starts. Sony has done an excellent job of putting together a straightforward camcorder that showcases the 8mm format, without getting caught in the trap of offering little-used high-tech features and raising the price to accommodate those features. ■

A Hands-on Electronics REPORT

BECKMAN DM10XL MULTIMETER

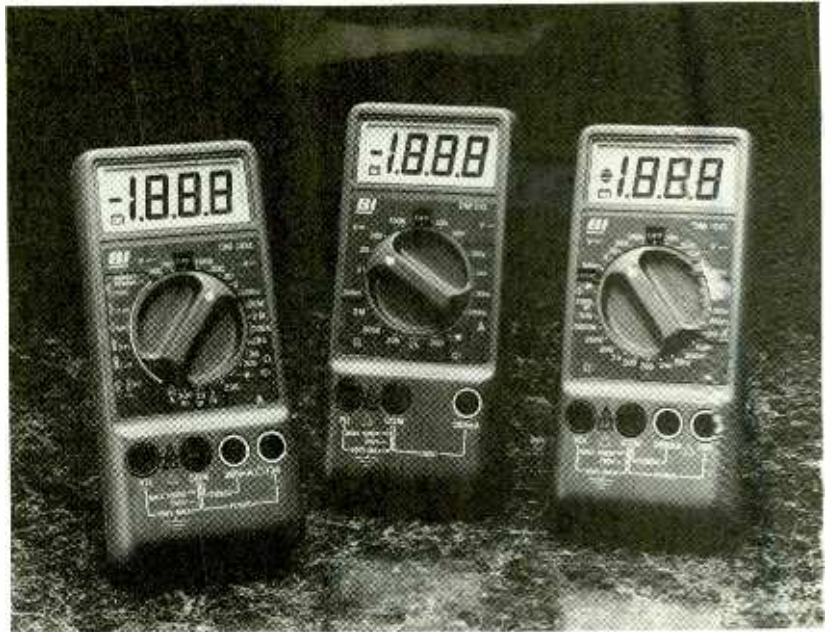

CIRCLE 119 ON FREE INFORMATION CARD

Here's an inexpensive multimeter with a few added frills.

Finding a multimeter to fit your budget in today's market should be a relatively easy task. In fact, the biggest problem is not finding one that you can afford—the main problem is actually sifting through the perhaps hundreds of different models available to you at affordable prices. In fact, you'll find that most inexpensive multimeters have very similar lists of features, and nearly any of them should satisfy your needs, especially if your needs are typical of a hobbyist.

So what is it that you should look for in a digital multimeter, or DMM, if you're not looking for anything in particular? To start off with, assuming that standard multimeter capabilities are sufficient, you should definitely look for something well-made. In a budget-priced multimeter, that translates into rugged construction, smooth-operating switches, a decent pair of test leads, and so on. The best way to find those features is to start off by looking at brand names that are known for their quality and reliability.

Surprisingly though, even among low-priced well-known brand names, you'll find many different models to choose from, and they're all pretty good instruments. (For a roundup of

multimeter prices and specs, see the *Multimeter Buyer's Guide* in **Popular Electronics**, October 1991.) So now we're almost back where we started from, not knowing exactly what to look for in a brand-name DMM.

In order for a DMM to stand out in a crowd of other similar DMM's, manufacturers have had to cram added features into their low-end products without increasing prices. Diode testers or audible continuity beepers used to be such features, although they're pretty much standard nowadays. So let's take a look at a low-cost DMM from a major manufacturer that has a couple of pretty handy but original features:

The Beckman DM10XL. Beckman Industrial Corporation (3883 Ruffin Road, San Diego, CA 92123-1898) has earned their reputation for making high-quality test instruments, so their name should sound familiar. They have recently introduced an enhanced line of low-cost, full-function DMM's, and they are the lowest priced DMM's in the Beckman lineup. They are models DM5XL (\$34.95), DM10XL (\$44.95), and DM15XL (\$59.95). This review will focus on the mid-priced DM10XL.

Before we tell you about the unusual features found on the DM10XL, we may as well go over the features you would expect to find. To begin with, the meter has an easy-to-read 3½-digit LCD, with large, 0.7-inch numerals. The included set of shrouded test probes have tips that are mostly insulated to prevent accidental shorting in cramped spaces. The insulation (heat-shrink tubing) can be removed if you so desire. The meter comes with a 9-volt battery installed, as well as a spare fuse stored inside the battery compartment.

The DM10XL can measure up to 1000-volts DC in four ranges of 2, 20, 200, and 1000 volts. An optional high-voltage probe is available for measuring over 1000 volts. The meter can also measure up to 750-volts AC in two ranges of 200 and 750 volts. An overload in any range is indicated by a "1." or a "-1." on the liquid-crystal display.

The DM10XL can also measure current, but unfortunately only DC. Fortunately that's the type of current you will almost always have to measure. There are five current ranges of 200 microamps, 2 milliamps, 20 milliamps, 200 milliamps, and 10 amps. An optional current clamp is available for

(Continued on page 26)

Graduate as a Fully Trained Electronics Professional!

If you want to learn about electronics, and earn a good income with that knowledge, then CIE is the best educational value you can receive.

CIE's reputation as the world leader in home study electronics is based solely on the success of our graduates. And we've earned our reputation with an unconditional commitment to provide our students with the very best electronics training.

Just ask any of the 150,000-plus graduates of the Cleveland Institute of Electronics who are working in high-paying positions with aerospace, computer, medical, automotive and communications firms throughout the world.

They'll tell you success didn't come easy...but it did come...thanks to their CIE training. And today, a career in electronics offers more rewards than ever before.

CIE'S COMMITTED TO BEING THE BEST...IN ONE AREA...ELECTRONICS.

CIE isn't another be-everything-to-everyone school. CIE teaches only one subject and we believe we're the best at what we do. Also, CIE is accredited by the National Home Study Council. And with more than 1,000 graduates each year, we're the

largest home study school specializing exclusively in electronics. CIE has been training career-minded students like yourself for nearly sixty years and we're the best at our subject....ELECTRONICS...BECAUSE IT'S THE ONLY SUBJECT WE TEACH!

CIE PROVIDES A LEARNING METHOD SO GOOD IT'S PATENTED.

CIE's AUTO-PROGRAMMED® lessons are a proven learning method for building valuable electronics career skills. Each lesson is designed to take you step-by-step and principle-by-principal. And while all of CIE lessons are designed for independent study, CIE's instructors are personally available to assist you with just a toll free call. The result is practical training... the kind of experience you can put to work in today's marketplace.

LEARN BY DOING..WITH STATE-OF-THE-ART EQUIPMENT AND TRAINING.

CIE pioneered the first Electronics Laboratory Course and the first Microprocessor Course. Today, no other home study school can match CIE's state-of-the-art equipment and

training. And all your laboratory equipment, books and lessons are included in your tuition. It's all yours to use while you study and for on-the-job after you graduate.

PERSONALIZED TRAINING....TO MATCH YOUR BACKGROUND.

While some of our students have a working knowledge of electronics others are just starting out. That's why CIE has developed twelve career courses and an A.A.S. Degree program to choose from. So, even if you're not sure which electronics career is best for you, CIE can get you started with core lessons applicable to all areas in electronics. And every CIE Course earns credit towards the completion of your Associate in Applied Science Degree. So you can work toward your degree in stages or as fast as you wish. In fact, CIE is the only school that actually rewards you for fast study, which can save you money.

SEND FOR YOUR CIE COURSE CATALOG AND WE'LL SEND YOU A FREE 24-PAGE CIE ELECTRONIC SYMBOLS HANDBOOK.



electronics

FREE!

SEND FOR YOUR CIE HOME STUDY COURSE CATALOG AND RECEIVE A FREE 24 PAGE CIE ELECTRONIC SYMBOLS HANDBOOK!

Includes hundreds of the most frequently used electronic symbols. Published exclusively by CIE for our students and alumni. Yours free when you request a CIE Course Catalog.

YES! I want to get started. Send me my CIE course catalog including details about the Associate Degree Program. (For your convenience, CIE will have a representative contact you - there is no obligation.)

AH33

Please print clearly

Name _____

Address _____

City _____ State _____

Zip _____ Age _____

Phone No. (____) _____

Check box for G.I. Bill Benefits

Veteran Active Duty



1776 East 17th Street
Cleveland, Ohio 44114

A School of Thousands.
A Class of One. Since 1934.

BECKMAN MULTIMETER

(Continued from page 22)

those times when you have to measure more than 10 A.

Measuring resistance is another task that can be done with the DM10XL. There are six resistance ranges of 200 ohms, 2 kilohms, 20 kilohms, 200 kilohms, 2000 kilohms, and 20 megohms. The meter also includes a diode test. During a diode test, with the test probes forward-biased, the meter will display the forward voltage drop of the diode; with the test leads reverse-biased, the meter will show a "1" (overrange), indicating nearly infinite resistance and a good diode. The diode-test position is also used as a continuity test; when a resistance of less than 75 ohms is present, a beeper will sound.

That about rounds up the features you would expect to find on a common multimeter. Now let's talk about the features you wouldn't expect.

Just by looking at the DM10XL you might notice the group of rectangular

LED's that form a bar graph toward the left side of the meter. That's what Beckman calls their "Safety Tester." That feature is used to measure voltages with the meter powered from the voltage being measured. The LED's are labelled 6V, 12V, 24V, 50V, 110V, and 220V, from bottom to top. At the "6V" position, there are actually two LED's; a red one labelled "+" and a yellow one labelled "-." When the test probes are placed across a DC voltage greater than +6 volts, the red 6V LED will light. When a voltage of greater than +12 volts DC is detected, both the 6V LED and the 12V LED will light, and so on. A DC voltage greater than -6 volts will cause only the yellow "-6V" LED to light. A DC voltage greater than -12 volts will cause the -6V LED (yellow) and the 12V LED to light, and so on. An AC voltage causes both the + and - 6V LED's to light, along with the rest of the bar up to the corresponding voltage. The Safety Tester feature allows you to use the meter even if the battery is dead. That can be very handy, especially if your meter will spend extended periods of

time sitting in a drawer.

Another feature found on the DM10XL, but on few other meters, is the "Input Lead Warning" when measuring current. That feature sounds a beeper when you have the test leads in the wrong "current" position. For example, if the test leads are in the COM and 10A sockets, but the function switch is set to anything but 10A or the Safety Tester positions the beeper will sound. Likewise, if the probes are in the COM and 200 mA sockets but the meter is set to anything other than the 200-mA, 20-mA, 2-mA, 200- μ A ranges or the Safety-Test function, the beeper will sound. This feature is good for protecting the meter itself from careless users.

Its features all totaled, the unit is a nice general-hobbyist meter. Perhaps with Beckman's DM10XL on the market, your search for an inexpensive DMM may be over. If you would like further information on that meter or any of Beckman's other products contact the company at the address given earlier, or circle No. 119 on the Free Information Card in this issue. ■

FREE Heathkit

Educational Systems

Electronics & Computer Software Education Catalog

- *Fast-Track Individual Learning Programs
- *State-of-the-Art Classroom Courses
- *The Best Values in Electronics Education Today

New

Computer Aided Instruction

DC Electronics AC Electronics Semiconductors Electronic Circuits

The stunning animations, hypertext glossary, and easy-to-understand text make learning the concepts of electronics a breeze...and fun!

Learn Electronics the easy and affordable way from the Masters in Electronics Training - Heathkit Educational Systems. From Basic Electricity and Electronics to Advanced Microprocessor Applications and much more, Heathkit will provide you will an unparalleled learning experience at a fraction of the cost of other programs.

For your FREE Catalog, call

Toll-Free 1-800-44-HEATH

please mention this code when calling 107-001

CIRCLE 13 ON FREE INFORMATION CARD

BIG PROFITS IN VIDEO REPAIR!

WORK FROM HOME-EARN \$85 HR!

With the tens of millions of VCRs and Camcorders in use, there currently is a **serious shortage** of trained techs to perform cleaning and repair jobs on these popular devices... Learn how you can start your own **highly profitable,**

Home-Based video servicing business...

And since up to 95% of all VCR and Camcorder malfunctions are due to a simple **mechanical or electro-mechanical** failure, you need not spend months or even years of complicated study before starting **paid, professional service work!**

Let Viejo's Training Program show you how!



1-800-537-0589

or mail coupon today!

VIEJO PUBLICATIONS, INC.

4470-107 Sunset Blvd., Suite 600
Dept. VK Los Angeles, CA 90027

Yes! Rush me your **FREE OPPORTUNITY KIT** today!
(Check appropriate box)

- VCR Repair
- Camcorder Repair
- Advanced VCR Repair
- Fax Machine Repair

Name _____

Address _____

City/State _____ Zip _____

Dept. PE

CIRCLE 9 ON FREE INFORMATION CARD

Forrest Mims Knows ICs!

Over 750,000 readers of earlier editions of

The Forrest Mims Engineer's Notebook

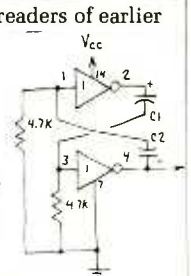

agree—nobody knows practical IC applications like Forrest Mims! This newly-revised edition contains hundreds of proven, tested circuits—hand-drawn by Forrest—using today's most popular linear, TTL, and CMOS ICs. Forrest gives you full data for each device and circuit—pin numbers, logic tables, supply voltages, and signal waveforms—so you can quickly duplicate each circuit. There's also practical information on construction methods, troubleshooting, and interfacing different IC families. If you work with ICs you gotta get this book!

Only \$14.95 at bookstores or electronic parts dealers. Or order direct from HighText! Add \$3 shipping (\$4 to Canada, \$5 elsewhere). CA please add sales tax. U.S. funds only please

HighText

7128 Miramar Road
Suite 151
San Diego, CA 92121

PRODUCT TEST REPORTS

By Len Feldman

Sony MDP-605 CD/CDV/LD Player

Sony was a relative late-comer to the video-disc-player arena, but their MDP-605 more than makes up for that late entry. As is true of most modern optical-disc players, this one handles all six types of optical discs currently available for home-entertainment use: 3-inch and 5-inch CD's, 5-inch CD-V discs, one-sided and two-sided 8-inch laser videodiscs, and standard 12-inch laser videodiscs.

For either CD's, CD-V's, or LD's (laser videodiscs), this player can play back

time. The player can be programmed to play back chapters or tracks within a designated time (useful, for example, when recording a compilation of musical tracks onto a cassette tape).

Another feature that home-taping enthusiasts will appreciate is the "auto-pause/auto-space" button found on the remote control. Using the auto-pause feature causes the player to pause after a selection is played. Resumption of play is then accomplished by pressing the play button. Using the auto-space feature causes a blank interval of 3 seconds to be inserted between each selection that is played back.

One feature that we found particularly appealing was the shuttle ring, which makes it easy to search for a desired scene by forward or reverse speed-scanning on a disc as it is playing. This shuttle ring, as well as all of the other controls found on the main unit itself, is also available on the supplied, wireless remote control.

The MDP-605 offers one of the most complete on-screen message displays we have ever encountered for an optical-disc player. Information concerning all aspects of the operating condition of the unit, as well as chapter and track numbers can be superimposed on the TV set or monitor screen. When no image is displayed (as, for example, during search mode), on-

screen information is displayed against a blue background.

In the case of videodiscs, automatic playback of both sides is possible without having to turn the disc over. For CAV (constant angular-velocity) videodiscs, 11 speed settings for normal and reverse playback, frame by frame playback, and freeze-frame viewing are all possible. Fast scanning without picture distortion is possible even on CLV (constant linear-velocity) discs. The player is also equipped with a picture-enhance control that adjusts picture quality in 5 steps from "sharp" to "soft."

CONTROLS

The front panel of the MDP-605 incorporates a power on/off switch and the picture-enhance control at the extreme left. Programming and number buttons are positioned to the right, above the disc tray. Also found here are buttons for selecting either side A or side B of a videodisc. Within these buttons are indicator lights to show which side of a disc is currently playing. Further to the right are open and close buttons, a pause and stop button, the shuttle ring, and a play button.

At the center of the disc tray there is a display window that, depending upon the type of disc currently playing, will show chapter number, total number of tracks or chapters, playing time (in hours, minutes, and

CIRCLE 120 ON FREE INFORMATION CARD

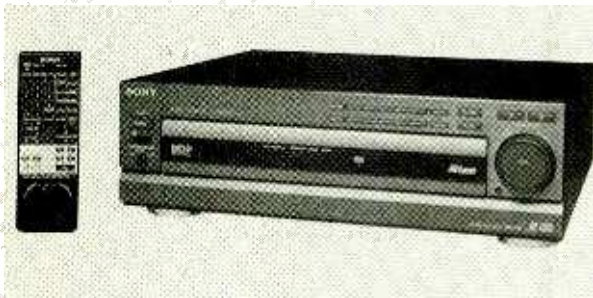

The Sony MDP-605 CD/CD-V/LD player can play all of the optical-disc formats currently used in the home-entertainment market.

chapters or tracks in any desired, programmed order. Shuffle play, or the ability to play all selections on a disc in random order is also possible. A feature called "auto disc protection" prevents damage to the disc if play is suddenly interrupted. A "calendar display" shows the number of tracks (up to 20) on a disc and the total playing

Earn Your B.S. Degree in ELECTRONICS or COMPUTERS



By Studying at Home

Grantham College of Engineering, now in our 42nd year, is highly experienced in "distance education"—teaching by correspondence—through printed materials, computer materials, fax, and phone.

No commuting to class. Study at your own pace, while continuing on your present job. Learn from easy-to-understand but complete and thorough lesson materials, with additional help from our instructors.

Our Computer B.S. Degree Program includes courses in BASIC, PASCAL and C languages — as well as Assembly Language, MS DOS, CADD, Robotics, and much more.

Our Electronics B.S. Degree Program includes courses in Solid-State Circuit Analysis and Design, Control Systems, Analog/Digital Communications, Microwave Engr, and much more.

An important part of being prepared to *move up* is holding the right college degree, and the absolutely necessary part is knowing your field. Grantham can help you both ways—to learn more and to earn your degree in the process.

Write or phone for our free catalog. Toll free, 1-800-955-2527, or see mailing address below.

●
Accredited by
the Accrediting Commission of the
National Home Study Council
●

GRANTHAM
College of Engineering
Grantham College Road
Slidell, LA 70460

seconds), or frame number. Other information is shown on the connected monitor or TV set via the unit's on-screen display system.

The supplied remote control, in addition to duplicating the controls found on the front panel, incorporates buttons for many of the extra features described earlier. Those include program repeat, shuffle play, search, audio monitoring, and more. The shuttle ring used for fast-forward or reverse scanning is also duplicated on the remote so that a user has complete control of the

player from the comfort of his or her viewing location.

TEST RESULTS

For all tests, APEL (the Advanced Product Evaluation Laboratories) placed the picture-enhance control at its "direct" or center position. Video frequency response was down only 2.92 dB at 4.2 MHz. That means that this player will display all the picture detail that can be put on a laser videodisc. Even sharper pictures (extended video-frequency response) can be obtained by moving the picture-enhance control to-

TEST RESULTS—SONY MDP-605 OPTICAL-DISC PLAYER

Specification	Mfr's Claim	PE Measured
Video frequency response	N/A	-2.92 dB @ 4.2 MHz
Video signal-to-noise ratio chroma (AM/PM)	N/A	42.8/34.4 dB
luminance (re: 100 IRE level)	N/A	42.7 dB
Max. staircase linearity deviation	N/A	4%
Analog Audio Section		
Signal-to-noise ratio (re: 100% modulation)		
CX on	N/A	83.8 dB
CX off	N/A	63.5 dB
Total harmonic distortion (at 1 kHz, 75% modulation)		
CX on	N/A	0.23%
CX off	N/A	0.24%
Output voltage (at 0-dB reference level)		
CX on	N/A	1.21 volts
CX off	N/A	0.43 volts
Harmonic distortion (at 0-dB reference level)		
CX on	N/A	0.27%
CX off	N/A	0.20%
Digital Audio Section		
Signal-to-noise ratio (re: 100% modulation)		
Deemphasis in	110 dB	106.2 dB
Deemphasis out	110 dB	106.1 dB
Total harmonic distortion (1 kHz)	0.003%	0.004%
Output voltage (at 0 dB ref. level)	N/A	2.40 volts
Channel separation (at 1 kHz, 0-dB reference)		
Left	N/A	116.2 dB
Right	N/A	116.5 dB
Frequency response	4 Hz to 20 kHz, +/- 0.2 dB	Confirmed
Additional Data		
Power requirements	52 watts	43 watts
Random access time	N/A	1.5 seconds
Scan time	N/A	6.5 seconds
Dimensions (H x W x D, inches)	5½ x 16¼ x 17½	
Weight	28.8 lbs.	28¾ lbs.
Suggested list price:	\$900.00	

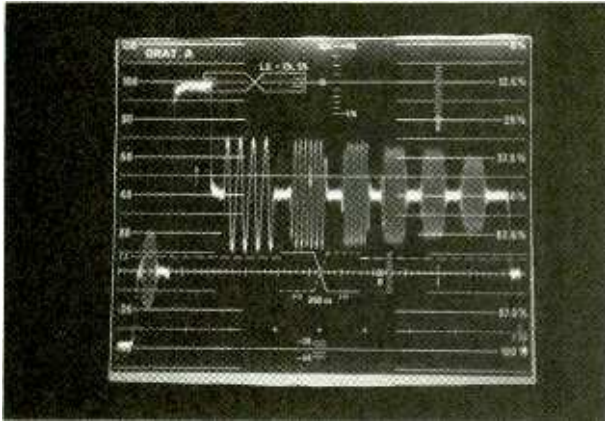

The video frequency response of the Sony MDP-605 was such that it is capable of displaying all of the picture information that can be put on a laser videodisc.

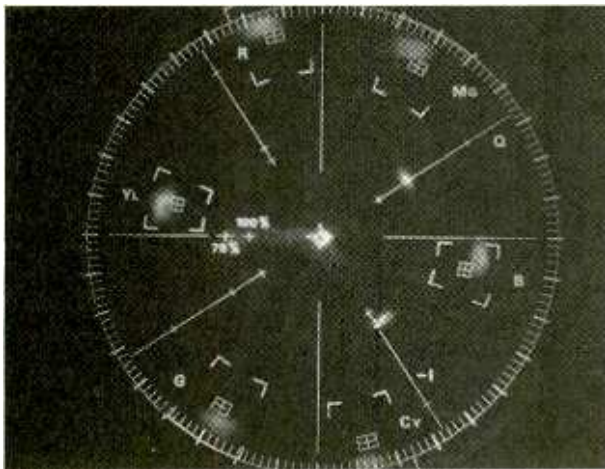

As indicated by this vectorscope photo, the unit's color accuracy and color saturation were close to perfect.

wards the "sharp" setting, although doing so increases background noise slightly.

Color accuracy and color saturation were close to perfect, as evidenced by APEL's vectorscope measurements. The video signal-to-noise ratio was a bit below average for this type of equipment, measuring 42.8 dB for chroma AM noise and 42.7 dB for the luminance signal-to-noise ratio. Using the S-video output connector improved the luminance signal-to-noise ratio by an extra 1.5 dB, so if you own a TV set or monitor equipped with an S-connector, that would be the preferred connection to use. The stairstep linearity, a measurement of the play-

er's ability to reproduce shades of gray from white to black, was very good with no single-step deviation from perfection exceeding 4%.

The reproduction of the analog sound tracks from a videodisc yielded very low distortion (around 0.25%), even at full modulation levels, and regardless of whether or not CX noise reduction was used. The signal-to-noise ratio for the analog audio section with CX turned on was almost as good as we have measured for some digital audio systems—83.8 dB. Even without CX, S/N for the analog audio section was a much better than average 63.5 dB.

As was to be expected,

the digital audio section outperformed the analog audio circuitry by far, yielding signal-to-noise ratios of better than 106 dB for both videodisc digital sound tracks and CD sound tracks. Channel separation exceeded 116 dB for both types of digital audio playback.

The distortion readings were of the order of 0.004% at mid-frequencies and remained extremely low (0.025%) even at the higher treble frequencies, where distortion increases markedly on many optical-disc players. The frequency response of the digital audio section remained flat, within a small fraction of a decibel, from 20 Hz to 20 kHz.

The player was able to randomly access a selected track within 6.5 seconds. Scanning time

measured 1.5 seconds.

We noted that the player is fairly heavy, weighing close to 29 pounds. That weight may well account for the unit's ability to withstand outside vibration and shock without mistracking or skipping.

As is usually true of Sony owner's manuals, the 39-page booklet accompanying this product is a model of clarity, with all of the operating features carefully outlined in step-by-step instructions accompanied by easy-to-understand, graphic illustrations. We particularly liked the glossary that appears near the end of the manual.

For more information on the Sony MDP-605 CD/CD-V/LD player, contact Sony (Sony Drive, Park Ridge, NJ 07656) directly, or circle no. 120 on the Free Information Card.

It's time to own your own Cable Equipment!

• Eliminate monthly equipment rental fees!

BUY FROM THE INDUSTRY LEADER...
M.D. ELECTRONICS!

YOUR CHOICE OF THE MOST COMPLETE LINE OF CONVERTERS & DESCRAMBLERS

Everquest • Panasonic • Jerrold
• Zenith • Pioneer • Scientific

Atlanta
• Oak
• Eagle
• Hamlin
• Tocom

Stargate 2001

Five Reasons To Buy

- Over 25 Brands & Models in stock!
- Toll Free Technical Support Line!
- 30 day guarantee!
- Friendly & Knowledgeable Sales People!
- FREE Catalog!

M.D. ELECTRONICS!
875 SOUTH 72ND STREET • OMAHA, NE 68114
FAX: (402) 392-0991

1 800 624 • 1150 EXT. 616

It is not the intent of M.D. Electronics to defraud any television operator and we will not assist any company or individual in doing the same.

CIRCLE 6 ON FREE INFORMATION CARD

START PACKING... You're going on a FREE trip!



Where will it be? Hawaii? Las Vegas? Mexico? The Bahamas? It's up to you. We're going to send you a free coupon for up to six days and five nights of free lodging at the destination of your choice. Now did we get your attention?

Here's how it works: We sell books, and instead of advertising our program on TV (at great expense) we decided to pass the savings along to you.

When you decide to participate in our program, we'll send you a booklet of 40 coupons and a catalog listing our current book offerings. Purchase one book and include one of the coupons for your second book. In all, you'll get 40 books for your \$19.95 investment.

When we receive your fifth coupon, there's a bonus for you in the form of a free membership in the Grocery Savers of America. This will entitle you to save up to \$50 or more on your monthly grocery bill. And on receipt of your 15th coupon, you automatically get a free membership in The Great American Traveler, entitling you to receive a 50% savings on hotels, motels and car rentals. On receipt of your 20th coupon, Bingo! You get that big free lodging for six days and five nights at your choice of Hawaii, Mexico, Las Vegas or the Bahamas.

You're going to be very impressed with the book selections as well. These are not all paperbacks, but the same, high-quality volumes you see in bookstores at many times your own purchase price. Frankly, there just isn't enough room on this page

to outline all of the details, but don't pass this up! Send us your name, address and \$19.95 so we can send you all of the information, including your catalog and 40-coupon book today. MasterCharge and Visa are accepted.

THE GREAT TWO FOR ONE

Readers Club of America

GIVE AWAY

UP TO \$1,000 RETAIL VALUE

If you find the same book or publication for less within 10 days, Readers Club will refund double the difference!

FREQUENT USER PROGRAM

RECEIVE FREE GIFTS

MEMBERSHIP NO. 1007850

The coupon entitles you to one book/publication in the Readers Club Catalog when purchasing another book/publication from this catalog of equal or greater value. No cash back on sale.	
MEMBERSHIP NO.	000000
Author:	Stephen King
Title:	The Eyes of the Dragon
Item No.:	1-0187 Price: 19.95
Author:	
Title:	THE COMPLETE DESKTOP PUBLISHING
Item No.:	2-0073-P Price: 21.95
Author:	JACKIE COLLINS
Title:	HOLLYWOOD HARBINGER
Item No.:	7-0183 Price: 19.95
Name:	JOHN SMITH
Address:	123 MAIN ST.
City:	ANYTOWN
State:	NJ Zip: 01001
El. Ser.:	Acc. 6% Sales Tax
Ship. Method:	(\$4.50 per Order)
Insured Delivery:	(\$2.00 per Coupon)
Rate:	10% of Consumer Funds
TOTAL ENCLOSED:	26.40

CLAGGK Inc.
P.O. Box 4099
Farmingdale, New York 11735

Gentlemen: I've enclosed \$19.95 in full payment. Please send my "The Great Two for One Give Away" booklet of 40 coupons and catalog.

Check Enclosed Visa MasterCard

Name _____

Address _____

City _____ State _____ ZIP _____

Credit Card No. _____ Exp. Date _____

Signature _____

(Clip coupon and mail today! Do not send cash through the mail.)

Build a

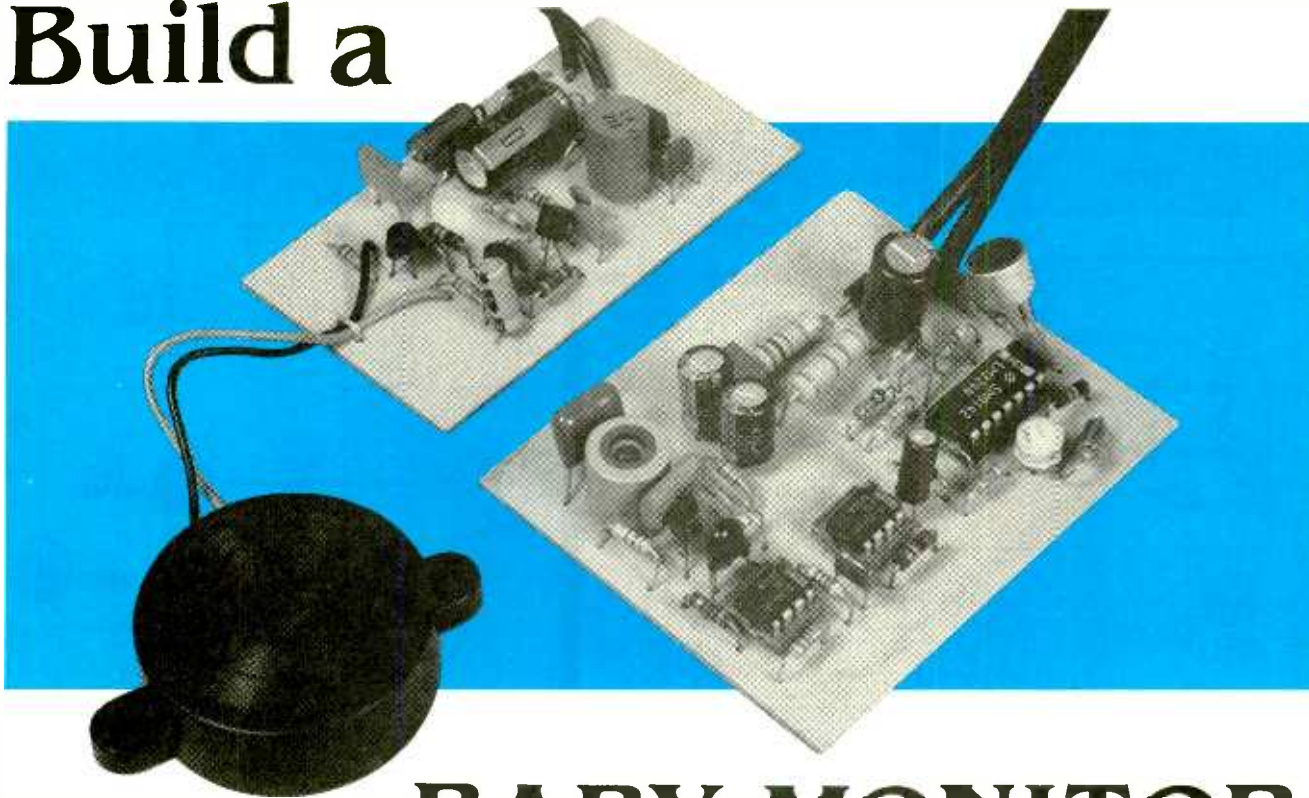

BY ANTHONY J. CARISTI

BABY MONITOR

Anyone who has been blessed with a new infant knows how important it is to keep a constant watch on your progeny. That's especially true when the baby is fast asleep in his or her crib; a time when one must be particularly vigilant. The circuit described in this article—dubbed the *Baby Alert*—is a simple electronic project that allows you to monitor the baby's room without having to be within earshot.

The project consists of a carrier-current transmitter and a receiver. The transmitter, which plugs into any AC outlet in the baby's room, generates an electronic signal when the baby cries. That signal is sent through the AC line and is picked up by the receiver, which can be plugged into any outlet within the home. Transmitter portion of the project is sensitive enough to detect sound that cannot easily be heard through a closed bedroom door, so even faint cries can be detected. It is also useful at night when you're asleep and may not easily hear the baby cry. If desired, multiple receivers can be placed at various locations throughout your home and be simultaneously active.

Keep a constant "watch" on your progeny from anywhere in your home with this carrier-current system

The Baby Alert can also be a valuable aid to the hearing impaired. Or it might be used to monitor an area for sound, perhaps as part of a security system—any sound made by an intruder would activate an alarm. It might also be used to extend the range of the doorbell (sort of a doorbell relay station).

Transmitter Operation. Figure 1 shows a schematic diagram of the transmitter portion of the project. Operating power for the circuit is derived directly from the AC line. DC power to operate the circuit is generated in two stages, one for an RF power-amplifier stage, and the second for the remainder of the circuit.

The AC line voltage is applied to D1, which half-wave rectifies the AC input. The resulting DC voltage (approximately 30 volts under load) is fed across an RC filter (comprised of R1 and C1) and used to operate amplifier, Q1. The second stage of the

power supply (composed of LED1, R2, D2, D3, C2, and C3, which forms a regulated +13.6-volt, center-tapped supply) feeds the remainder of the circuit. LED1 is connected in series with R2 and is used as a visual power-on indicator for the transmitter.

An electret microphone element (MIC1) is used as the pick-up. The output of the microphone is AC coupled through C5 to U1-a (a non-inverting op-amp with a gain of about 100). The output of U1-a at pin 1 is AC coupled through C4 to the non-inverting input of U1-b (which provides an additional gain of 48) at pin 5. The output of U1-b at pin 7 is then fed through D4 and R10, and across R11 and C6 to the inverting input of U1-c, which is configured as a voltage comparator. The non-inverting input of U1-c is biased to a positive voltage that is set by sensitivity-control R19. This represents a threshold voltage at which the output of U1-c switches from high to low.

During standby, the output of U1-c

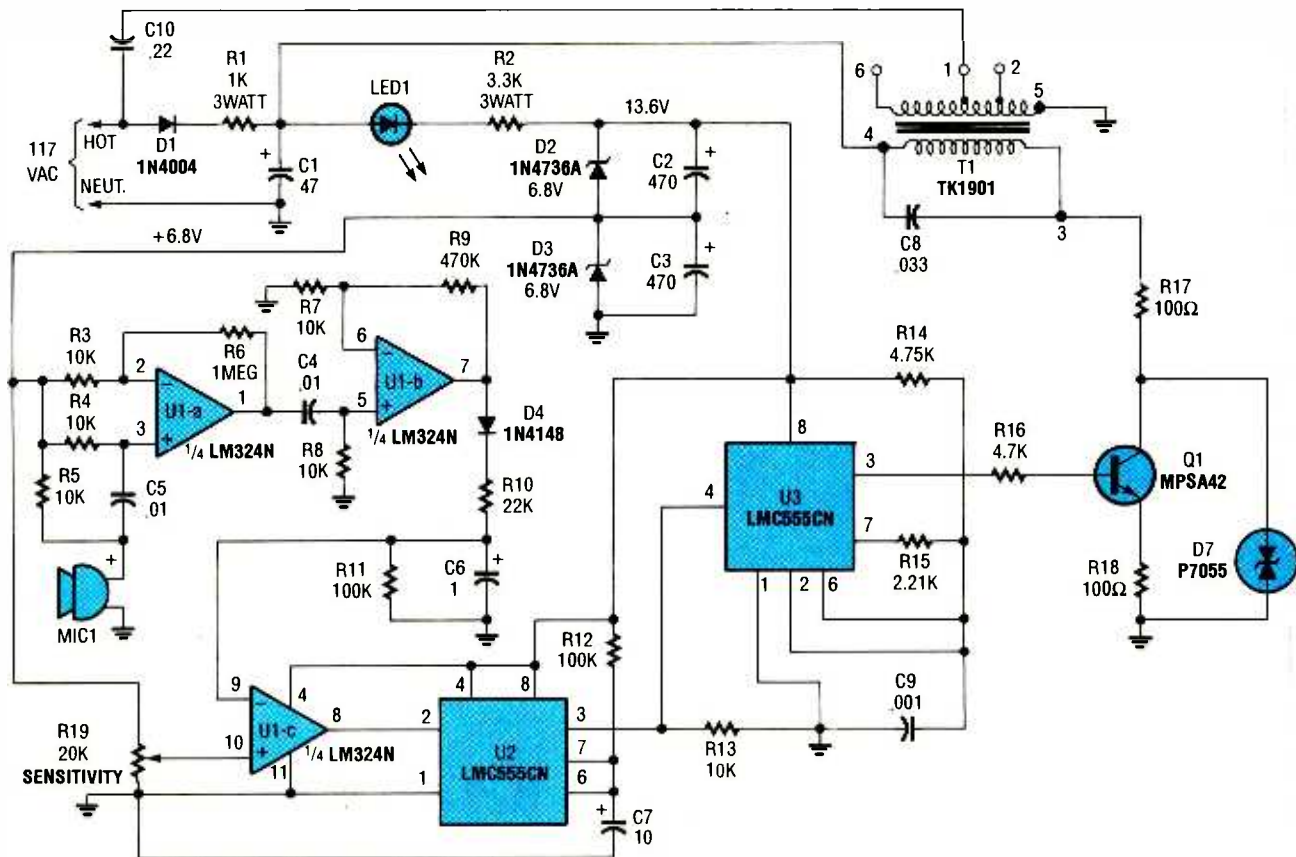

Fig. 1. The Baby Alert transmitter is built around an LM324 quad op-amp (U1), two LMC555CN CMOS oscillator/timers (U2 and U3), and a few support components.

at pin 8 is held at about 12 volts when the voltage developed across C6 is less than the bias-voltage setting at pin 10. When a sound of sufficient intensity and duration is detected, the voltage at pin 9 of U1-c exceeds the threshold level (set by R19), causing U1-c's output at pin 8 to go low. That low is applied to pin 2 of U2 (a 555 oscillator/timer that's configured as a monostable multivibrator). That causes the output of U2 to go high for about one second, as determined by the time constant of R12 and C7. The output of U2 at pin 3 is applied to pin 4 of U3 (a second 555 oscillator/timer that is configured for astable operation, with a frequency of about 125 kHz). That causes U3 to oscillate, producing a near squarewave output that is used to drive Q1 into conduction. The output of Q1 is applied across a parallel-tuned circuit composed of T1's primary and C8. The tuned circuit, in turn, reshapes the 125-kHz signal to appear across both the primary and the secondary of T1.

The signal appearing at T1's sec-

ondary (about 1 or 2 volts peak-to-peak) is impressed across the AC power line, and is then distributed throughout the building without affecting other electrical appliances connected to the line. Transient suppressor D7 is included in the circuit to help protect Q1 from voltage spikes that might appear across the power line and be coupled to the circuit through T1.

Receiver Operation. Refer to Fig. 2, the schematic diagram of the Baby Alert receiver. Power for the receiver, as with the transmitter, is derived from a traditional half-wave rectifier (D5). The resulting DC voltage is regulated to 27 volts by D6 and R20, and then filtered by C11 to provide a relatively clean, DC power source for the circuit. A light-emitting diode, LED2, connected in series with R20 provides a visual indication that the circuit is powered and ready to receive a signal.

The 125-kHz signal is plucked from the AC line and coupled through R21 and C12 to a parallel-tuned LC circuit,

consisting of C13 and L1. That LC circuit passes 125-kHz signals while attenuating all others. The 125-kHz signal is fed through C14 to the base of Q2 (which is configured as a high-gain linear amplifier), which boosts the relatively low amplitude of the 125-kHz signal. The RF output of Q2 is AC coupled to the base of Q3 through C15. Transistor Q3 acts as both an amplifier and detector. Since there is no bias voltage applied to the base of Q3, it remains cut off until driven by the amplified 125-kHz signal. When Q3 is forward biased, its collector voltage rises.

Capacitor C16, connected across Q3's collector resistor, filters the 125-kHz signal so that it is essentially DC. When the voltage at the collector of Q3 rises, Q4 is driven into conduction. That causes current to flow into piezo buzzer BZ1, producing a distinctive audio tone that alerts anyone within earshot that the baby needs attention.

Construction. The author's prototype was assembled on a pair of printed-circuit boards. Full-size tem-

plates of the two circuit-board layouts are shown in Figs. 3 (the transmitter) and 4 (the receiver). You may etch your own boards using the templates or obtain a set from the source given in the Parts List. Once you have a set of boards, assemble the transmitter and receiver boards guided by Fig. 5 and 6 (respectively).

It is recommended that sockets be used for all IC's; it is well worth the additional cost should the circuit ever require troubleshooting. Be very careful to orient all polarized components—such as transistors, diodes, integrated circuits, and electrolytic capacitors—as shown in the parts-placement diagram. A single mis-oriented component will render the circuit inoperative and may cause damage to itself, or to other components.

Resistors R1 and R2 in the transmitter and R20 in the receiver normally operate at temperatures that are very warm to the touch. Be sure that those components are allowed sufficient clearance from all other components, the sides and top of the enclosure, and the board itself. Capacitors C8 and C9 in the transmitter and C13 in the receiver are tuning components (which are part of frequency-selective networks). Because of that, use only the component types specified in the Parts List. Ordinary ceramic capacitors are not temperature stable and should not be used in place of the specified parts. The same consideration holds true for R14 and R15 in the transmitter. Use only metal-film resistors where directed; carbon types are not stable with temperature and should not be used in those locations.

Transistor Q1 and some of the capacitors used in both the transmitter and the receiver have higher voltage ratings than ordinarily found in solid-state circuits. Be sure to use parts that have the specified voltage rating. Note that U2 and U3 (in the transmitter) are the CMOS version of the common 555 oscillator/timer. Use only the specified parts; the ordinary 555 may not operate properly at the specified transmitter frequency (125 kHz).

Before mounting T1 to the transmitter board, use an ohmmeter to identify the primary, which is connected to terminals 3 and 4 and electrically isolated from the secondary. Secondary terminals 1 and 5 are used in this cir-

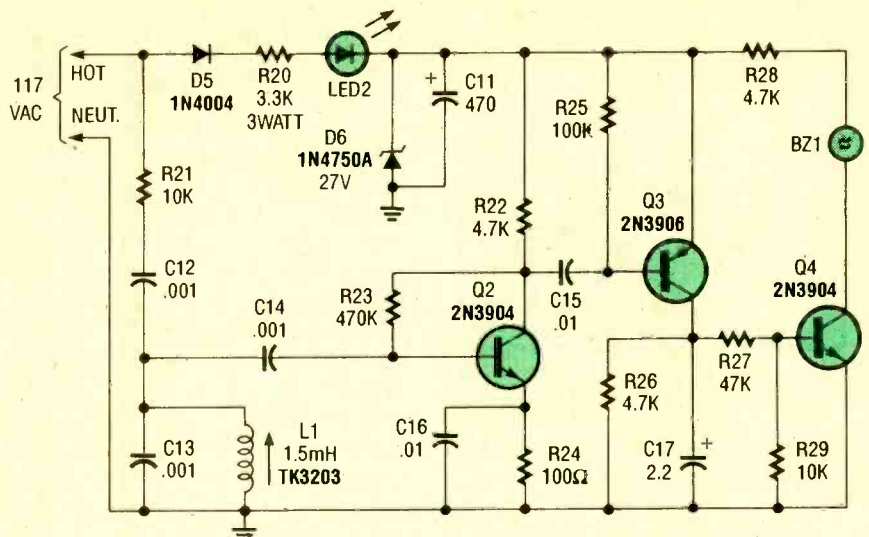

Fig. 2. The Baby Alert receiver is comprised of three transistors—Q2, which is configured as a high-gain linear amplifier; Q3, which serves as both an amplifier and detector; and Q4, which is essentially used as a switch—and a few additional components.

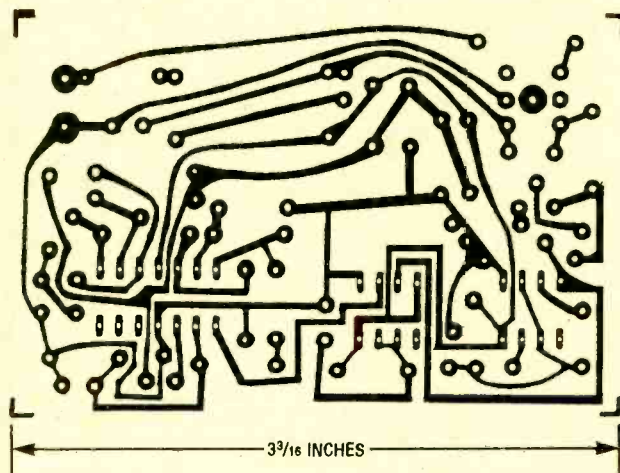

Fig. 3. Here is a full-size template of the transmitter's printed-circuit board.

cuit; 2 and 6 are not. When you have completely assembled the boards, examine them very carefully for cold solder joints; they appear as dull blobs of solder. Correct any joint that is suspect. Also check for opens and inadvertent short circuits between adjacent traces. Most problems can be attributed to faults such as those; it is far easier to correct them at this stage rather than later.

Both the transmitter and the receiver are powered directly from the AC line without transformer isolation. AC power receptacles have two power leads, one "hot" and the other "cold" (sometimes called neutral) that are generally color-coded black and white, respectively. The cold lead is essentially at ground potential, while

the hot lead is 117 volts above ground.

It is recommended that only polarized power cords, either 2- or 3-conductor types, be used for both circuits. The larger spade of a polarized plug is neutral and smaller one is hot; the same hold true for three-conductor plugs, with the third terminal being Earth ground. In any event, connect the hot and neutral leads of the power cord to the points indicated in the parts-placement diagrams (Figs. 5 and 6). Secure the cord so that the exposed ends cannot move and accidentally touch your body or anything else.

Enclosure. Once the leads of the power cords have been connected to the transmitter and receiver, it is

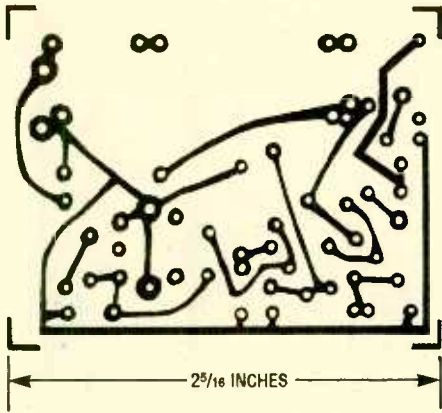

Fig. 4. This is a full-size template of the receiver's printed-circuit board.

time to consider the enclosures that will house the two circuit boards. **WARNING:** It is mandatory that the microphone element be mounted completely inside the transmitter's enclosure so that there is absolutely no possibility of anyone (including the infant) coming in contact with it. The metal shell of the element is connected to one side of the power line, and could represent a shock hazard.

Since both transmitter and receiver are directly connected to the AC power line with no isolation, it is recommended that 100% plastic cabinets be used to house both assemblies, thereby eliminating a

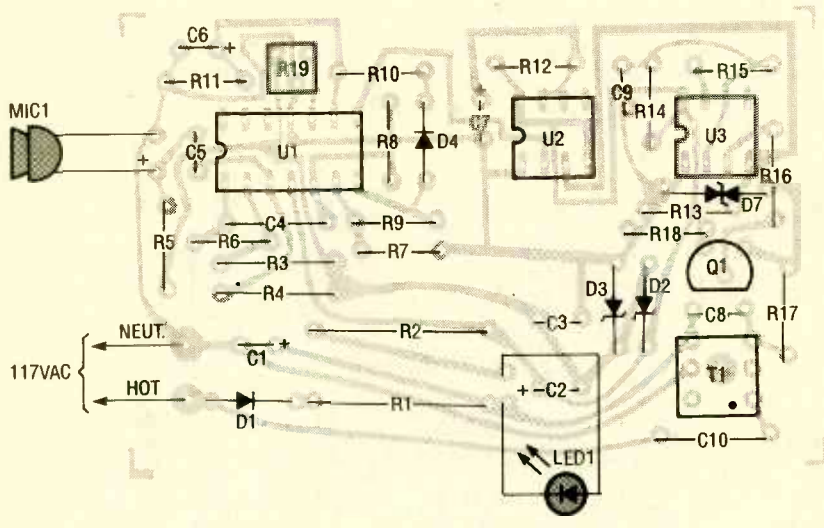

Fig. 5. Assemble the transmitter's printed-circuit board using this parts-placement diagram as a guide. When assembling the transmitter, it is recommended that sockets be used for the IC's.

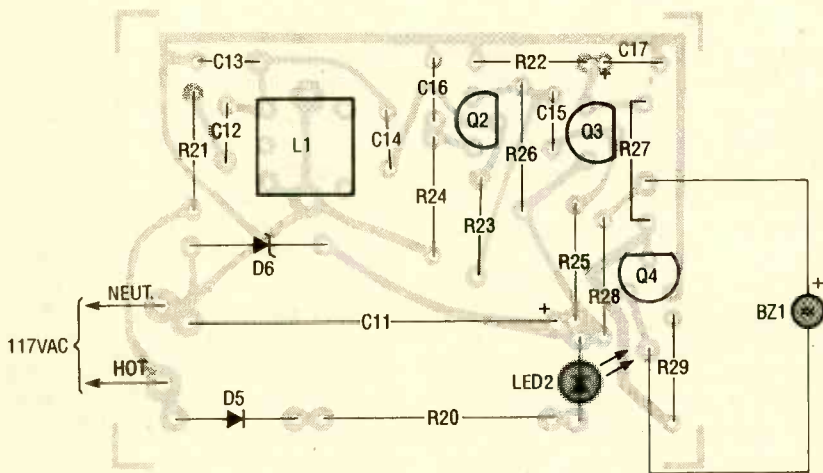

Fig. 6. Use this parts-placement diagram as a guide to assembling the receiver's printed-circuit board. It is important that only polarized power cords, either 2- or 3-conductor types, be used to connect either circuit board to the AC line. The larger spade of a polarized plug is neutral and smaller one is hot; in a three conductor plug, the third terminal is Earth ground.

PARTS LIST FOR THE BABY ALERT TRANSMITTER

SEMICONDUCTORS

- U1—LM324N quad op-amp, integrated circuit
- U2, U3—LMC555CN CMOS oscillator/timer, integrated circuit
- Q1—MPSA42 or equivalent high-voltage NPN silicon transistor
- D1—1N4004 1-amp, 400-PIV silicon rectifier diode
- D2, D3—1N4736A 6.8-volt, 1-watt, Zener diode
- D4—1N4148 general-purpose silicon diode
- D7—P7055 transient suppressor (Digi-Key)
- LED1—Light-emitting diode, 2-volt, 20-mA

RESISTORS

- (All fixed resistors are 1/4-watt, 5% carbon units, unless otherwise noted.)
- R1—1000-ohm, 3-watt, metal-oxide
 - R2—3300-ohm, 3-watt, metal-oxide
 - R3, R5, R7, R8, R13—10,000-ohm
 - R6—1-megohm
 - R9—470,000-ohm
 - R10—22,000-ohm
 - R11, R12—100,000-ohm
 - R14—4750-ohm 1/4-watt, 1% metal-film
 - R15—2210-ohm, 1/4-watt, 1% metal-film
 - R16—4700-ohm
 - R17, R18—100-ohm
 - R19—20,000-ohm, PC-mount potentiometer

CAPACITORS

- C1—47- μ F, 100-WVDC, electrolytic
- C2, C3—470- μ F, 10-WVDC, electrolytic
- C4, C5—0.01- μ F, 50-WVDC, ceramic-disc
- C6—1- μ F, 10-WVDC, electrolytic
- C7—10- μ F, 16-WVDC, electrolytic
- C8—0.033- μ F, 50-WVDC, metallized-film
- C9—0.001- μ F, 50-WVDC, metallized-film
- C10—0.22- μ F, 250-WVDC, metallized-film

ADDITIONAL PARTS AND MATERIALS

- MIC1—Electret microphone element (Radio Shack 270-090)
- T1—125-kHz matching transformer (Toko Coil, Digi-Key catalog #TK1901 or equivalent)
- Printed-circuit materials, enclosure, IC sockets, polarized AC power plug with line cord, wire, solder, hardware, etc.

PARTS LIST FOR THE BABY ALERT RECEIVER

SEMICONDUCTORS

- Q2, Q4—2N3904 general-purpose NPN silicon transistor
 Q3—2N3906 general-purpose PNP silicon transistor
 D5—1N4004 1-amp, 400-PIV, silicon rectifier diode
 D6—1N4750A 27-volt, 1-watt Zener diode
 LED2—Light-emitting diode, 2-volt, 20-mA

RESISTORS

(All fixed resistors are 1/4-watt, 5% carbon units, unless otherwise noted.)

- R20—3300-ohm, 3-watt, metal-oxide
 R21, R29—10,000-ohm
 R22, R26, R28—4700-ohm
 R23—470,000-ohm
 R24—100-ohm
 R25—100,000-ohm

R27—47,000-ohm

CAPACITORS

- C11—470- μ F, 35-WVDC, electrolytic
 C12—0.001- μ F, 200-WVDC, ceramic-disc
 C13—0.001- μ F, 50-WVDC, polyester-film
 C14—0.001- μ F, 50-WVDC, ceramic-disc
 C15, C16—0.01- μ F, 50-WVDC, ceramic-disc
 C17—2.2- μ F, 10-WVDC, electrolytic

ADDITIONAL PARTS AND MATERIALS

- L1—1.5-mH inductor (Toko Coil, Digi-Key catalog #TK3203 or equivalent)
 BZ1—Piezo buzzer (Radio Shack

273-065 or similar)

Printed-circuit materials, enclosure, polarized AC power plug with line cord, wire, solder, hardware, etc.

Note: The following parts are available from A. Caristi, 69 White Pond Road, Waldwick, N.J. 07463: Transmitter: printed-circuit board, \$9.95; LM324 quad op-amp (U1), \$2.50 each; LMC555CN oscillator/timer (U2 and U3), \$2.50 each; TK1901 125-kHz matching transformer (T1), \$8.75 each; MPSA42 high voltage transistor (Q1), \$2.25 each; set of 2 metal-film resistors, \$1.25 Receiver: printed-circuit board, \$9.95 each; TK3203 1.5-mH inductor (L1), \$7.75 each. Please add \$3.00 per order for postage and handling. New Jersey residents please add appropriate sales tax.

possible shock hazard. Low-priced plastic enclosures are readily available from electronics parts suppliers such as Radio Shack. Using a 100% plastic enclosure eliminates the need to ground the chassis, so a 3-conductor power cord is not necessary. If you use a 3-conductor cord and house the circuits in plastic enclosures, tape the ground conductors of the cords so that they cannot short to anything else.

On the other hand, if you choose to house either unit in a metallic or partially metallic enclosure (something that is not recommended), it will be necessary to use a 3-conductor line cord and tie the metal chassis, or the metal portion of the enclosure, to Earth ground.

Prepare the transmitter enclosure by drilling a series of very small holes

in the enclosure to allow sound to reach the element. It will also be necessary to drill holes in both enclosures for the LED indicators. Also you have to drill holes in the receiver enclosure to allow sound from the piezo buzzer to escape; keep in mind that no metal part or wire of the piezo element may be left exposed. No power switch is required for either unit, since current draw is extremely low. However, you always have the option of installing switches if desired.

Transmitter Checkout. Electrical checkout will require the use of a DVM or VOM; an oscilloscope may be necessary for troubleshooting if the circuit is non-functional due to improper assembly or one or more defective components. The transmitter must be checked first. Once its operation is

verified, it can be used to check the receiver's operation. For the initial test remove the IC's from their sockets before powering the circuit. **Caution:** As with any electronic project that is connected directly to the power line, using an isolation transformer is the best way to test the circuit, and one *must* be part of the test setup when checking the project with an oscilloscope.

A simple, low-cost way to obtain line isolation is to use two step-down transformers, with equal ratings, connected back-to-back (the two secondaries connected to each other) as shown in Fig. 7. If line isolation is not used, use only a voltmeter for testing; connect the meter to the circuit before plugging the transmitter line cord into the AC receptacle. Do not touch any part of the circuit or meter with your body when power is on. Voltage measurements are made with the negative or common lead of the voltmeter connected to circuit ground (the negative side of C1), unless otherwise specified.

With all IC's removed from the transmitter board, apply power to the circuit. The LED should light. Measure the voltage across C1. The voltage across C1 should be about 80 volts DC. Measure the voltage across C2, and across C3; about 6.8 volts DC across each capacitor is the reading you

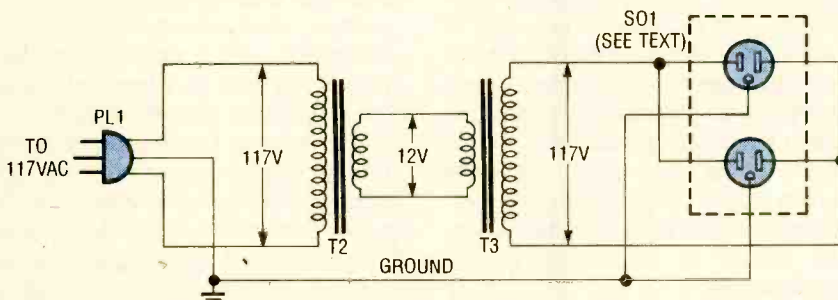

Fig. 7. Using an isolation transformer is the best way to test the circuit, and one must be part of the test setup when checking the project with an oscilloscope. You can use this simple, low-cost setup to obtain line isolation.

should get. Measure the voltage at pin 10 of the U1 socket. Adjust R19 for a reading of about 1 volt DC.

If you do not get the correct readings across the capacitors or at pin 10 of U1, disconnect the line cord and troubleshoot the circuit until the fault is found and corrected. Check the orientation of D1–D3, C1–C3, and LED1. Use an ohmmeter to verify that each blade of the line cord plug is connected to the proper part of the circuit as illustrated in the schematic diagram and the parts-placement diagram. Measure the resistance across C1–C3 to be sure that there is no short circuit on either the high-voltage bus or regulated-voltage bus.

When power-supply operation has been verified, and R19 has been set to 1 volt, disconnect power from the transmitter and insert the IC's into their respective sockets, being careful to observe proper orientation. Be sure that none of the IC pins are inadvertently bent under the body of the chip. Connect the voltmeter across C1. Apply power to the circuit and note the meter reading; again it should be about 80 volts.

Speak loudly into the microphone and observe that the reading decreases to about 40 volts as long as the microphone picks up sound, then returns to 80 volts when the room is silent. Note that LED brightness decreases significantly when the circuit is activated, as Q1 diverts current from the rest of the circuit. Failure to obtain the above results indicates that U1–U3 or Q1 is not operating. Isolate the fault by first measuring the voltage at pin 7 of U1, while speaking into the microphone. A normal indication is a voltage exceeding 1 volt that responds to the intensity of the sound.

If that measurement is normal, measure the voltage at pin 8 of U1. A normal indication is about 12 volts when the circuit is dormant, and about zero when speaking into the microphone.

The operation of U2 can be verified by measuring the voltage at its output terminal, pin 3. A normal indication is zero volts when the circuit is dormant and about 12 volts when activated during the 1-second pulse time of the one-shot multivibrator. An oscilloscope (with line isolation) may be used to verify that U3 is operational by examining its output waveform at pin

3. A normal indication is a near squarewave of about 13 volts peak-to-peak when the circuit is activated by sound. If U3 is normal, check pin 1 of T1 for a 125-kHz sinewave of about 1 or 2 volts peak-to-peak. Both top and bottom slugs of T1 may be adjusted for maximum amplitude.

When the transmitter is operating properly, the upper and lower slugs of T1 may be adjusted for maximum amplitude of the 125-kHz sinewave appearing at pin 1 of T1. Use the proper plastic tuning tool to avoid damage to the slugs. An oscilloscope is best for that adjustment. A normal indication is a 2-volt peak-to-peak sinewave.

When you are satisfied that the circuit performs properly, R19 may be adjusted for more or less sensitivity as desired. Use the LED as an indicator of circuit operation as sound reaches the microphone. The circuit is most sensitive when the voltage at pin 10 of U1 is near zero. It is best to use only as much sensitivity as necessary to avoid false alarms.

Receiver Checkout. Be sure to observe all safety precautions as described previously.

Connect a DC voltmeter across C10, and apply power to the receiver. The LED should light. Note the meter reading; a normal indication is about 26 to 28 volts DC. If you do not get the proper reading, disconnect the power and troubleshoot the circuit. Start by checking D5, D6, LED2, and C11 for correct orientation. Using an ohmmeter or continuity checker, verify that each blade of the line cord is connected to the proper points.

When the power supply is operational, plug the receiver's power cord directly into a duplex AC receptacle. Plug the transmitter's power cord directly into the other side of the same receptacle. Speak into the microphone. The receiver should emit a high-pitched sound, indicating that it has detected the 125-kHz signal generated by the transmitter. If possible, use a line isolation setup (like that in Fig. 7) for the receiver and adjust L1's tuning slug to obtain the highest amplitude 125-kHz voltage at the collector of Q3 as indicated by an oscilloscope.

Note the audio level that is required to operate the receiver. If more or less sensitivity is desired, adjust R19 in the

transmitter accordingly. Remember, use only as much sensitivity as necessary to avoid false alarms. If the receiver does not operate as described, check Q2, Q3, Q4, and their associated components. Check BZ1 to be sure that it's connected to the circuit with the correct polarity. The best way to troubleshoot the receiver is to power both receiver and transmitter through the same line-isolation transformer and use an oscilloscope to trace the 125-kHz signal from C13/L1 through Q3's collector.

With both transmitter and receiver plugged into the same duplex receptacle, the signal at the junction of C13 and L1 should be about a 1-volt peak-to-peak, 125-kHz sinewave riding on a relatively small 60-Hz waveform. At Q2's collector the signal should be amplified to about 6 volts peak-to-peak as Q2 saturates.

The tuning slug of L1 should be adjusted to obtain the maximum amplitude signal voltage at Q2's collector. That adjustment is best performed if the transmitter is relocated to a remote location to attenuate the RF signal through the AC-line wiring. When so attenuated, the RF input to the receiver at the junction of C13 and L1 may be only about 0.1 volt peak-to-peak.

With an RF amplitude of several volts peak-to-peak at Q2's collector, the output of Q3 at its collector should rise to 15 volts or more as Q3 responds to the drive signal from Q2. Finally, Q4 should be driven into conduction, causing the piezo buzzer to operate.

Final Checkout. To check the range of the Baby Alert, connect the transmitter to an AC-power receptacle at its permanent location. Have an assistant stand by the transmitter to speak into the microphone at your direction. Take the receiver to any remote location where there is an AC receptacle. Apply power to the receiver and have your assistant speak. The receiver should emit a tone.

That test can be performed at any remote location where an AC receptacle can be found to verify that the signal strength is sufficient to activate the receiver. If desired, several receivers can be assembled and placed inside and even outside your home so that you'll never be totally out of touch with your offspring. ■

About 20 years ago I read an interesting article on three researchers at the United Technology Center in California (W. Babcock, K.L. Baker, and A.G. Cataneo) who discovered an interesting phenomena: "plasma acoustics." The researchers were able to use a high-temperature plasma as a speaker, and in this article we will show you how you can, too. It will describe how you can use a flame from a propane or butane torch seeded with potassium nitrate to duplicate their experiment, albeit at a lower temperature.

Basic Operation. In Fig. 1 we show the experimental apparatus set-up to reproduce audio. Any sounds can be reproduced, but I'd advise trying music since it contains high-frequency components, which can be reproduced by the flame better than low-frequencies. The audio source must be able to supply 10 or more

watts of power to produce sufficient volume. If necessary, feed the audio signal through a power amplifier as shown.

From the amplifier, the audio is fed to a step-up transformer. The output of the step-up transformer is fed to two electrodes positioned in the flame.

The flame is seeded with a solution of potassium nitrate in water that's fed to the flame via a wick in the solution. The potassium nitrate is used to induce low-temperature ionization. Ionization of the potassium in the flame creates free electrons and positive potassium ions.

When we supply a high-voltage electrical signal to the flame, the positive ions move toward the negative electrode, while the free electrons move toward the positive electrode. Since the audio signal is AC, the polarity and voltage of the electrodes keeps changing. That causes the motion of the ions and electrons to change in step with the audio, caus-

ing the flame to vibrate in step as well. Flames, like liquids, exhibit surface tension. That means a gaseous membrane forms between the torch flame and the ambient air because their densities and temperatures are different. So the membrane acts as a speaker diaphragm compressing and rarefying the surrounding air to produce sound waves as the flame vibrates.

Experimenting With Plasma Acoustics. Figure 2 shows a clearer view of a simple speaker set-up that you can use in your experiments. The seeder I used was fashioned from an old coin tube holder, but any small container will work. An alcohol-lamp wick was used to continuously supply the potassium nitrate into the flame, as described. The step-up transformer is a high-voltage auto transformer available from a supplier mentioned in the Materials list.

Beyond that, there aren't any crit-

Experiment with Plasma Acoustics

BY JOHN IOVINE

*Did you know
you can
make a
speaker out
of a
flame?*

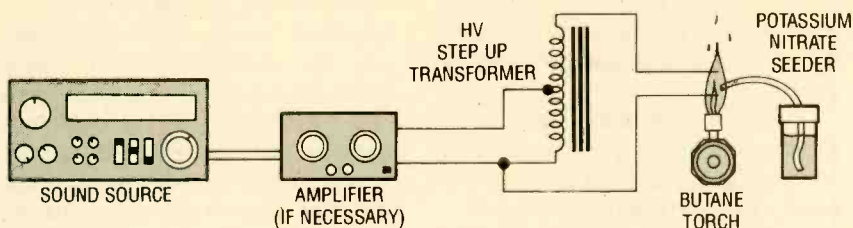

Fig. 1. A flame can be used as an audio transducer if it contains charged particles. The trick is to move the charged particles in step with the audio signal by using high-voltage.

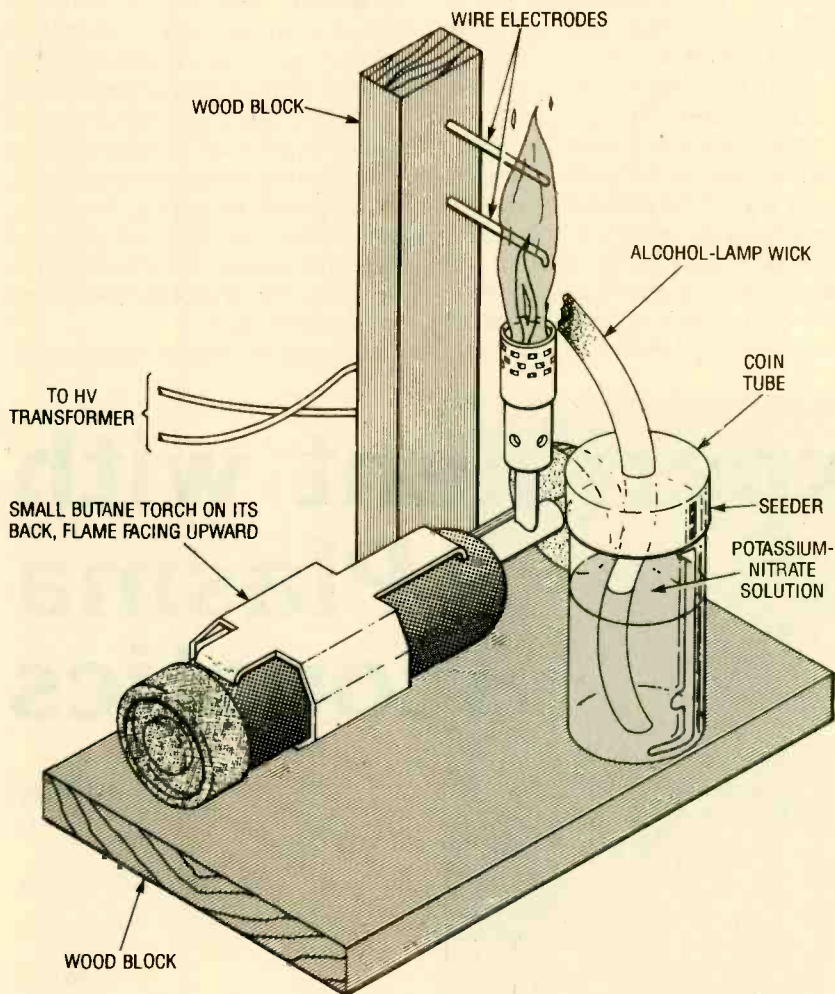

Fig. 2. As exotic as the experiment may sound, the main apparatus (the flame speaker) is very easy to build, and the parts and materials are all readily available.

ical details to attend to. Even the potassium-nitrate solution strength isn't important, so just dump a spoonful in a small quantity of water and it will work fine. If the electrodes start arcing when running the plasma speaker, try turning down the volume of the amplifier. If that doesn't work, turn off all the equipment and move the electrodes further apart. The amplifier must be turned off to do that because

the electrodes are connected to the high-voltage transformer and quite capable of giving you strong shock.

The experiment can be improved on if you use a larger and hotter flame. That will increase the quality of the sound. However, if possible, use nichrome or tungsten wire for the electrodes. Those wires will last longer in the high temperature flame. You could also try supplying a 500-volt DC

MATERIALS LIST FOR THE PLASMA ACOUSTICS EXPERIMENT

Butane or propane torch
Wood blocks
Water
Potassium nitrate
Coin tube or small vial
Alcohol-lamp wick
Wire
12 to 10,000-volt, auto transformer
10-watt audio source

The following are available from Images Company (P.O. Box 140742, Staten Island, NY 10314; Tel. 1-718-698-8305): a high-voltage auto transformer (part No. IMT1) for \$17.95; a ½ ounce of potassium nitrate for \$2.00; and an alcohol-lamp wick for \$1.00. Please add \$3.00 shipping and handling. New York residents must add appropriate tax.

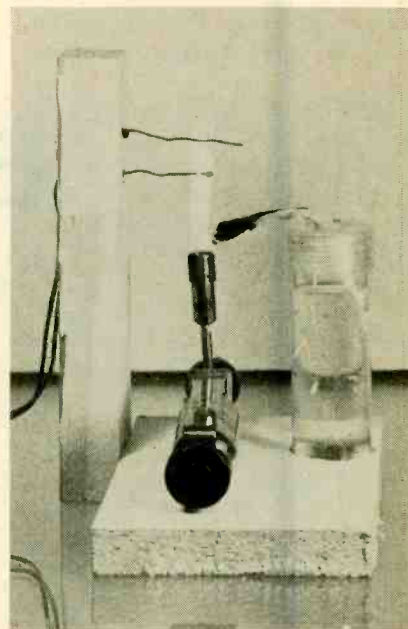

Here's the experimental setup in action. Using a hotter flame can improve sound quality.

bias to the electrodes to improve the sound quality.

You could try a number of different experiments with the set-up, too. For example, a solar cell connected to an audio amplifier will reproduce the sound signal fed into the flame. You just have to focus the light from the flame onto the photocell with a lens.

Another possibility is to direct a laser beam between the electrodes in the flame. That may be a low cost way to modulate a laser with information. ■

If you are like many people, you probably own a telephone-answering machine so that you never miss an important phone message. But what about those important messages at home or work that don't come from the telephone? How often do you search for pencil and paper just to leave a family member or co-worker a short note? Or how frequently, when driving your automobile, do you think of something important that you need to be reminded of later? Wouldn't it be great if you could just press a button to record your thoughts and instantly recall them whenever you desire?

You can do that and more with the *Personal Message Recorder*, described in this article. It works like a conventional tape recorder except that it is completely solid state. It features instant playback because there is nothing to re-wind. In addition, it will hold messages for more than 10 years without any power!

How It Works. The project is based on the new analog storage technology. Current techniques for recording analog signals involve several steps. In general, the signal is first compressed (or encoded) and then converted to digital values by an analog-to-digital converter. The converted values are stored in a large digital RAM area. That memory area requires a battery to prevent data loss when power is removed.

When the signal is to be played back, the digital data is clocked out of the RAM to a digital-to-analog converter. Finally, the restored signal passes through an expander (or decoder) circuit and an output amplifier, which feeds the signal to a speaker. That traditional approach is very complicated. And even with sophisticated compression schemes, huge amounts of memory are required to

Build a



PERSONAL MESSAGE RECORDER

This state-of-the-art, solid-state recorder uses no tape and can store messages for up to 10 years.

BY DAVID WILLIAMS

store relatively small amounts of speech. Typically, a 32,000-bit RAM holds less than 2 seconds of speech.

The Personal Message Recorder is built around an ISD1016 CMOS voice messaging system, which does away with the cumbersome and expensive analog-to-digital and digital-to-analog conversion circuits. The ISD1016 made by Information Storage Devices, Inc., of Austin, TX uses CMOS EEPROM technology to directly sample, store, and playback analog signals. And since EEPROM storage is non-volatile, the ISD1016 holds its data indefinitely without power.

A functional block diagram of the ISD1016 is shown in Fig. 1. The ISD1016 contains all of the functions necessary for a complete message-storage system. The pre-amplifier stage accepts

audio signals directly from an external microphone and routes the signal to the ANA OUT (analog out) terminal. An automatic-gain control (AGC) dynamically adjusts the preamplifier gain to extend the input signal range. Together the preamp and AGC circuits provide a maximum gain of 24 dB. The internal clock samples the signal and, under the control of the address-decoding logic, writes the sampling to the analog-storage array. Eight external input lines allow the ISD1016's message space to be addressed in 160 equal segments, each with a 100-millisecond duration. When all address lines are held low, the storage array can hold a single, continuous, 16-second message.

The ISD1016 also includes control signals for cascading multiple chips in order to achieve longer recording and playback times. Additionally, the ISD1016 has an internal output amplifier that can drive an external speaker with up to 50 mW of power.

Figure 2 shows the complete schematic of the Personal Message Recorder. The circuit is very straight-

forward, since the ISD1016 takes care of most functions. However, there is a special addition to the POWER DOWN input (pin 24) of U1. As mentioned earlier, the ISD1016 is designed to allow cascading multiple chips for longer recording times. That's a useful feature, but it causes a slight problem in our application. If the internal memory becomes full during recording, an overflow condition is generated in order to trigger the next device. Once an overflow occurs, pin 24 must be taken high and then low again before a new playback or record operation can be started.

A separate reset switch could be used to clear any overflows, but that would make the operation awkward. Instead, transistor Q1 along with components C3, R5, and R6 form a one-

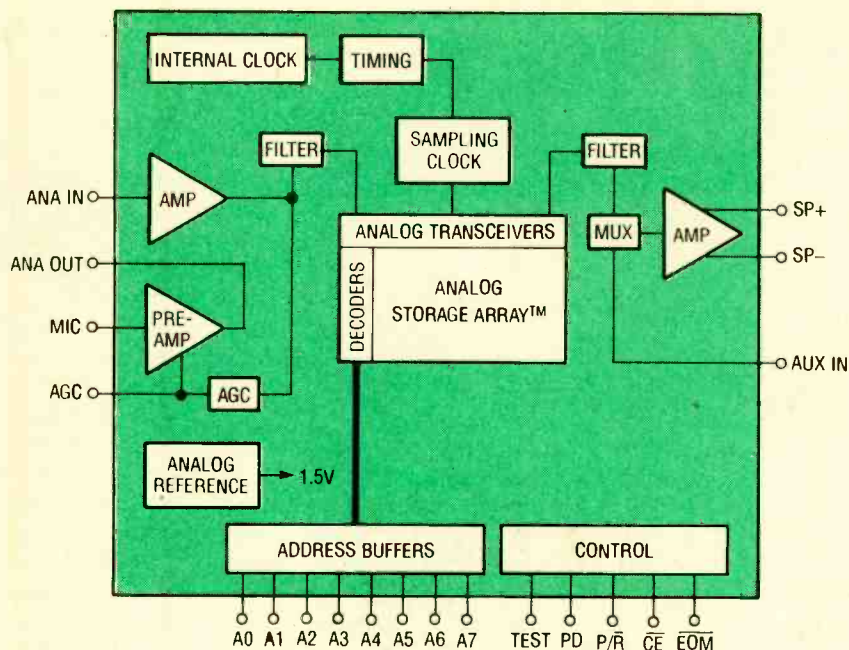

Fig. 1. This block diagram shows the internal structure of the ISD1016 voice-messaging system integrated circuit.

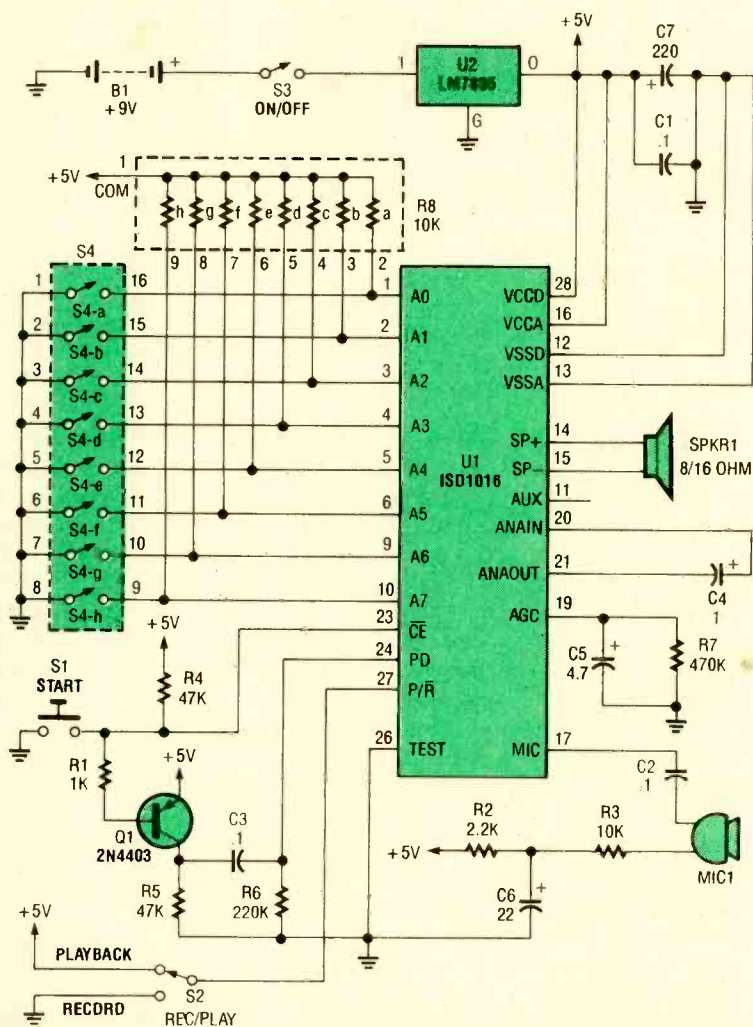

Fig. 2. The Personal Message Recorder is comprised almost entirely of the ISD1016, with a few additional components rounding out the system.

shot pulse generator that automatically clears any overflow condition each time the START switch (S1) is pressed. Switch S2 selects either the playback or the record mode. Switch S4—an 8-position (a-h) DIP switch—is included in the circuit to allow the circuit's record/playback time to be varied from 0 to 16 seconds, the maximum time being available when all 8 switch positions are close (or set to the on position). Resistor network R8 (a-h) is included in the circuit to provide a pull-up function for the address lines, thereby controlling U1's record/playback time.

Construction. Building the recorder is reasonably easy since the circuit contains few parts. However, since the ISD1016 has both analog and high-frequency digital signals within the same package, several precautions must be taken to assure good voice quality. First the analog components should be located close to U1, and all components-lead lengths must be kept as short as possible.

Also note that the ISD1016 has separate digital and analog power and ground pins. It is important to keep all four paths separate when wiring the circuit, and to tie the isolated power and grounds together at only at the +V and ground sides of C1/C7 parallel combination, respectively. Lastly, the microphone ground must be tied to analog ground (V_{SSA}) and never to digital ground (V_{SSD}).

The template of the circuit layout, shown half size in Fig. 3, incorporates all of those guidelines and will fit nicely into a Unibox plastic enclosure. Begin construction by referring to the parts-placement diagram shown in Fig. 4. Install the jumpers using 22-gauge bus wire. Next mount all of the resistors and install a 28-pin socket for U1. Then solder transistor Q1 and the SIP resistor network R8 (a-h), carefully observing the proper orientation of each. Install all of the capacitors and check the orientation of the polarized electrolytics.

The voltage regulator (U2) is mounted vertically with the metal tab facing away from U1. No heat sink is required in this application. Install the 8-position DIP switch (S4). The microphone (MIC1), switches (S1-S3), and the speaker (SPKR1) are mounted separately from the circuit board and are

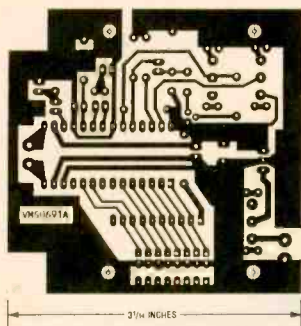

Fig. 3. Here is a half-size template of the author's printed-circuit artwork, which incorporates all of the guidelines restrictions outlined in the body of the article.

wired according to Fig 4. Use 26–28 gauge hookup wire for the three switches and the speaker. Connect the microphone to the board using shielded wire only. Try to keep all lengths of wire between the board and the off-board-mounted components as short as possible, while allowing enough for the parts to mount to the cover of the enclosure without being pulled too taut. The wires of the 9-volt battery connector must be threaded through the battery com-

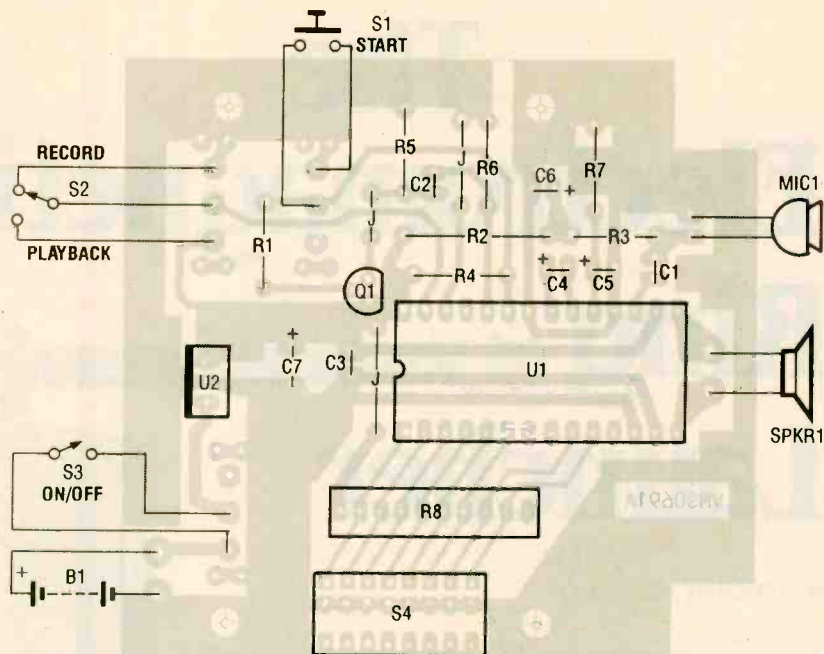

Fig. 4. Assemble the Personal Message Recorder using this parts-placement diagram as a guide. Start with the jumpers, followed by the resistors and a 28-pin socket for U1; then on to transistor Q1, the SIP resistor network R8, and the capacitors.

partment in the plastic case before soldering them to the circuit board. After attaching the battery connector. Mount the board in its case,

and install U1 in its socket, making sure that the IC is properly oriented.

The Unibox case already has mounting provisions for the speaker, but you will need to drill holes for the microphone and switches S1–S3.

PARTS LIST FOR THE PERSONAL MESSAGE RECORDER

SEMICONDUCTORS

- U1—ISD1016 single-chip voice messaging system, integrated circuit (Information Storage Devices, Inc.)
- U2—LM7805 5-volt, 1-amp, voltage regulator, integrated circuit
- Q1—2N4403 general-purpose PNP silicon transistor

RESISTORS

- (All fixed resistors are 1/4-watt, 5% units.)
- R1—1000-ohm
 - R2—2200-ohm
 - R3—10,000-ohm
 - R4, R5—47,000-ohm
 - R6—220,000-ohm
 - R7—470,000-ohm
 - R8—10,000-ohm × 9 SIP resistor network

CAPACITORS

- C1–C3—0.1-μF, ceramic-disc
- C4—1-μF, 16-WVDC, electrolytic
- C5—4.7-μF, 16-WVDC, electrolytic
- C6—22-μF, 16-WVDC, electrolytic
- C7—220-μF, 16-WVDC, electrolytic

SWITCHES

- S1—SPST momentary contact,

- pushbutton switch
- S2—SPDT toggle switch
- S3—SPST toggle switch
- S4—8-position DIP switch

ADDITIONAL PARTS AND MATERIALS

- MIC1—Electret microphone element
- SPKR1—8- or 16-ohm speaker
- B1—9-volt transistor-radio battery
- Printed-circuit materials, Unibox #188 plastic enclosure, 9-volt battery connector, shielded wire (see text), hookup wire, solder, hardware, etc.

Note: The following items are available from LNS Technologies, 20993 Foothill Blvd., Suite 307, Hayward, CA 94541-1511; Tel. 510-886-9296; A complete kit of parts, including all components, a PC board, and plastic case, along with complete assembly instructions (order part #VMS-KIT) for \$69.00; ISD1016 analog storage system (U1) for \$32.00. Add \$3.00 for shipping and handling to all orders. California residents please add appropriate sales tax.

Operation. Install a 9-volt battery and set all of the DIP switches to their on positions. That sets the starting address to zero and gives you up to 16 seconds of recording time. Flip S3 to ON and switch S2 to RECORD. Hold down switch S1, while speaking into the microphone, and when finished release S1.

It is not necessary to shout or to get close to the microphone while recording a message. The AGC circuit adjusts the gain of the preamp to produce sufficient signal strength for the rest of the circuit. Once a message is recorded, it is stored indefinitely, until changed by the user, even when the power is turned off. Subsequent pressing of the START switch (S1) while speaking into the microphone will automatically record over the previous recorded message.

To playback a message, flip S2 to the PLAYBACK position and momentarily press S1 (START). It is not necessary to hold S1 down during playback. In fact, pressing START during playback immediately re-starts the message from the beginning.

The Electromagnetic Ring Launcher

BY VINCENT VOLLONO

Explore the principles of electromagnetic propulsion with this simple ring launcher

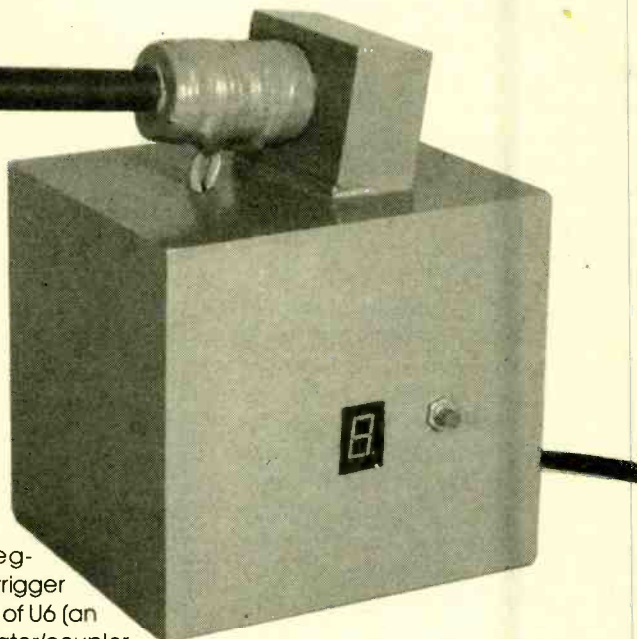

Many methods, such as gun-powder, spring action, water power, etc., have been used to propel various objects. But has anyone given any thought to propelling objects by electromagnetic repulsion? The principle of electromagnetic propulsion is a simple one based on the fact that like-charged bodies tend to repel each other; e.g., if a negatively (or positively) charged body is brought near another negatively (or positively) charged body, they tend to push against each other.

That principle (electromagnetic repulsion) is at the heart of the *Electromagnetic Ring Launcher* described in this article.

Circuit Description. Figure 1 is a schematic diagram of the Electromagnetic Ring Launcher. The launcher circuit is comprised of four sub-circuits: a clock circuit, a count-down/display circuit, a trigger circuit, and a reset circuit.

The clock circuit is built around U5 (a 555 oscillator/timer configured for astable operation) and a few support components. The counter circuit is built around U3 (a 74190 synchronous up/down counter with BCD outputs that is configured for count-down operation), U4 (an ECG8368 seven-segment latch/decoder/driver), and

DISP1 (a common-cathode seven-segment display). The trigger circuit is comprised of U6 (an MOC3010 optoisolator/coupler with a Triac-driver output), an SK3665 Triac and a few support components. The reset circuit is composed of U1 (a 7400 quad 2-input NAND gate), U2 (a second 555 oscillator/timer configured for monostable operation), and a few support components.

When power is first applied to the circuit, the output of a flip-flop (comprised of U1-a and U1-b) at U1-b pin 6 is low. That low is applied to pin 11 of U3, disabling it so that the clock pulses from U5 are ignored, and DISP1 dis-

plays a count of 9. When S1 is pressed, the output of the flip-flop goes high. That high enables U3, causing it to begin its descending count, outputting the count (in BCD form) to the seven-segment latch/decoder/driver, U4. The latch/decoder/driver decodes the BCD data and activates the appropriate segments of DISP1 to display the descending count.

When the count on U3 reaches zero, pin 12 of U3 goes high. From U3, the high output divides along two paths. In one path, that signal is fed through R5 (a 470-ohm resistor) to pin 1 of U6 (the optoisolator/coupler). That causes U6's internal LED to turn on, activating its internal Triac driver. The Triac driver, in turn, triggers TR1 (an SK3665 200-PIV, 4-amp Triac), sending a burst of current through L1. The current going through L1 induces an opposing current in the aluminum ring, causing the ring to be propelled into the air.

At the same time, in the other path, the pin 12 output of U3 is fed to the base of Q1 through R4 (another 470-ohm resistor), causing it to conduct. With Q1 conducting, pin 2 of U2 is pulled low, triggering the monostable

WARNING!! This article deals with and involves subject matter and the use of materials and substances that may be hazardous to health and life. Do not attempt to implement or use the information contained herein unless you are experienced and skilled with respect to such subject matter, materials and substances. Neither the publisher nor the author make any representations as for the completeness or the accuracy of the information contained herein and disclaim any liability for damages or injuries, whether caused by or arising from the lack of completeness, inaccuracies of the information, misinterpretations of the directions, misapplication of the information or otherwise.

timer. The output of the monostable at pin 3 goes high for about 1½ seconds. That high is fed to pin 1 of U1-a, causing the flip-flop output at pin 6 to go low, once again disabling the counter, and resetting the display to 9. Potentiometer R8 is used control the clock frequency which, in turn, controls the counter rate.

The circuit is powered from a regulated 5-volt power supply consisting of T1, BR1, U7, and C4. Transformer T1 (a 12-volt 2-amp unit) reduces the 117-volt AC line voltage to 12-volts AC. The output of the transformer is then applied to BR1 (the fullwave-bridge rectifier), which provides a pulsating DC output. The output of the bridge rectifier is then filtered by capacitor C1, and fed to U7, which provides a regulated 5-volt DC output.

Construction. The author's prototype of the Electromagnetic Ring Launcher was assembled on a single section of perfboard using point-to-point wiring. When assembling the project, it is recommended that sockets be provided for all of the IC's, and that Triac TR1 be mounted to a heat sink. It is further recommended that a socket be provided for the display; socketing the display allows you to wire the socket to the display without risking thermal damage to the unit itself. Note that the display is not mounted to the circuit board along with the other components, but is instead mounted to the side of the enclosure (where it can be seen) along with S1 (the trigger or start switch).

Begin assembly by mounting the sockets for the IC's to the board; but

do not install the IC's in their sockets until the project is completely assembled and checked for correctness. The sockets, in addition to preventing thermal destruction to the IC's, also allow easy parts substitution should that become necessary. Once the sockets are installed, wire the circuit together using Fig. 1 as a guide. Be careful when installing the polarized components (diodes, Triac, fullwave-bridge rectifier, etc.). Installing one or more of those components incorrectly can, and probably will, result in an inoperative circuit and destroyed components. In the worst-case scenario, incorrect wiring of the circuit could also place you at greater shock hazard; remember, coil L1 is fed directly from the AC line. In short, a little care now can save a lot of aggravation.

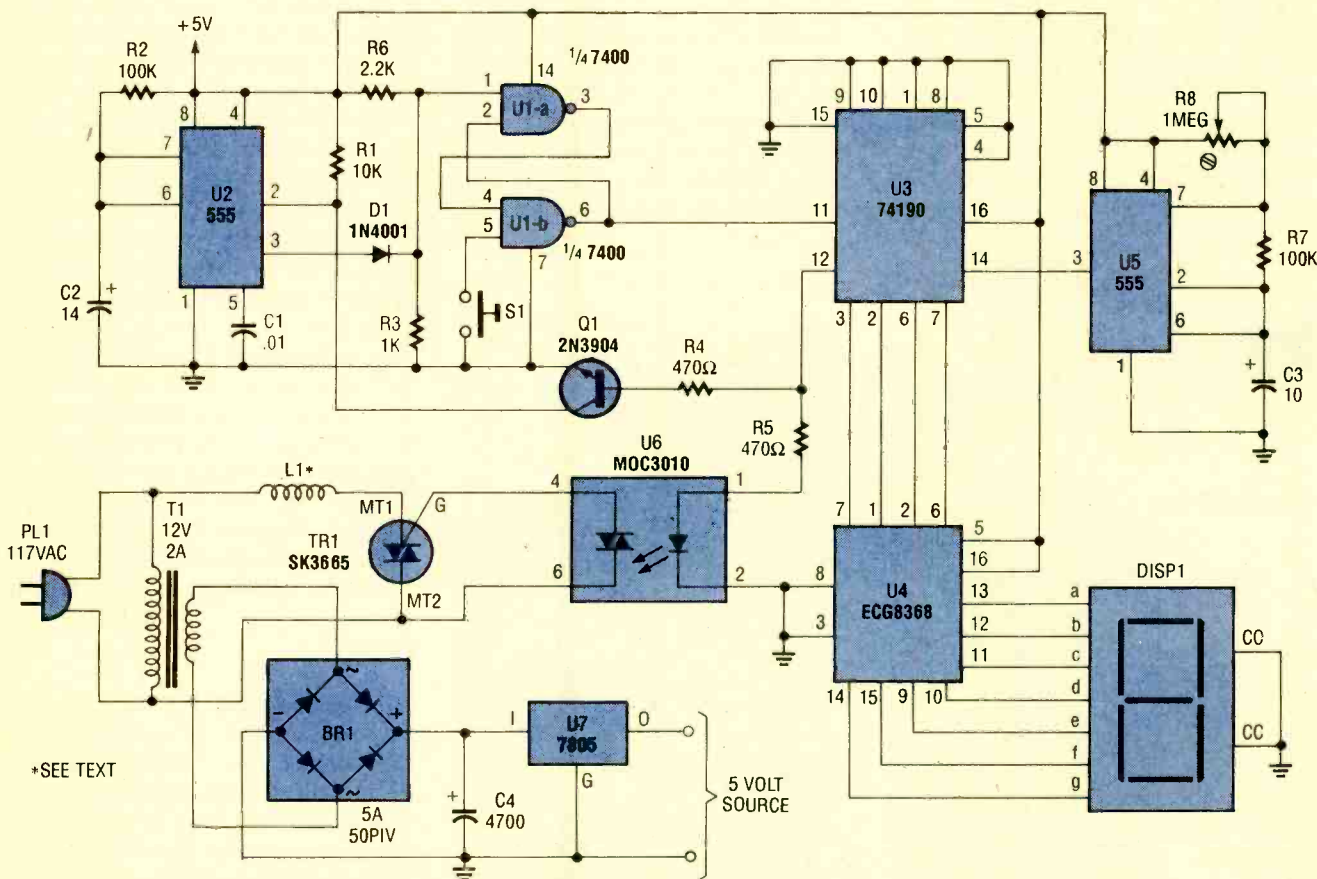

Fig. 1. The Electromagnetic Ring Launcher is comprised of four sub-circuits: a clock circuit (built around U5, a 555 oscillator/timer configured for astable operation), a count-down/display circuit (built around U3, a 74190 synchronous up/down counter with BCD outputs that is configured for count-down operation; U4, an ECG8368 BCD-to-seven-segment latch/decoder/display driver; and DISP1, a common-cathode seven-segment display), a trigger circuit (comprised of U6, an MOC3010 optoisolator/coupler with Triac-driver output; TR1, an SK3665 200-PIV, 4-amp Triac; and a few support components), and a reset circuit (composed of U1, a 7400 quad 2-input NAND gate; U2, a second 555 oscillator/timer configured for monostable operation; and a few support components).

PARTS LIST FOR THE ELECTROMAGNETIC RING LAUNCHER

SEMICONDUCTORS

- U1—7400 quad 2-input NAND gate, integrated circuit
 U2, U5—555 oscillator/timer, integrated circuit
 U3—74190 synchronous up/down counter with BCD outputs, integrated circuit
 U4—ECG8368 BCD-to-7-segment latch/decoder/display driver, integrated circuit
 U6—MOC3010 optoisolator/coupler with Triac driver output, integrated circuit
 U7—7805 5-volt, 1-amp voltage regulator, integrated circuit
 Q1—2N3904 general-purpose NPN silicon transistor
 TRI—SK3665 200-PIV, 4-amp Triac

- DI—1N4001 50-PIV, 1-amp rectifier diode
 BR1—50-PIV, 5-amp, fullwave bridge rectifier
 DISPI—Common-cathode, 7-segment LED display (see text)

RESISTORS

- (All fixed resistors are 1/4-watt, 5% units.)
 R1—10,000-ohm
 R2, R7—100,000-ohm
 R3—1000-ohm
 R4, R5—470-ohms
 R6—2200-ohm
 R8—1-megohm, trimmer potentiometer

CAPACITORS

- C1—0.01- μ F, ceramic-disc

- C2—14- μ F, 10-WVDC, electrolytic
 C3—10- μ F, 10-WVDC, electrolytic
 C4—4700- μ F, 35-WVDC, electrolytic

ADDITIONAL PARTS AND MATERIALS

- T1—12-volt, 2-amp power transformer
 PL1—117-volt molded AC power plug with line cord
 Perfboard materials, enclosure (see text), aluminum ring (see text), #28 magnet wire, 3-inch length of 1/2-inch diameter paper tubing, 1-foot length of 1/2-inch diameter steel rod, heat-shrink tubing, heavy-gauge electrical wire, hook-up wire, electrical tape, solder, hardware, etc.

tion later.

Coil L1 is a hand-wound unit that was made by winding 1/4-pound of #28 magnet wire on a 1/2-inch diameter paper tube about 3 inches long, fitted onto a 1/2-inch diameter 1-foot length of steel rod that was first covered with black heat-shrink tubing.

After winding the coil, heavy gauge insulated wire was connected to the coil ends, and electrical tape was wrapped around the coil body to hold the windings in place.

The Electromagnetic Ring Launcher was housed in a home-made wooden enclosure (which with its pro-

truding metal rod resembles a battleship gun turret, see Fig. 2), however, any non-metallic enclosure of suitable size will do. The enclosure used for the author's prototype was made from 1/2-inch plywood.

In any event, regardless of the type of enclosure used, a cutout must be made in the side of the enclosure for DISP1. Once the cutout was made, the display was epoxied into place. You'll also have to drill a hole in the enclosure for switch S1. When your project is completed, it should look something like the illustration in Fig. 2.

The ring was cut from a length of 3/4-inch diameter aluminum tubing to 1/2-inch in length. The ring must be made of a non-magnetic metal such as aluminum. If a magnetic metal is used, it will be attracted to the core, nullifying the principle on which the project is based.

Troubleshooting. While the circuit is so easy to build that it should work just fine the first time, construction errors may find their way into the circuit. Before applying power to the circuit, thoroughly inspect the circuit board for construction errors—cold solder joints, misconnected components, shorts, etc.—that may prevent the circuit from operating. **Caution: AC line voltage is used in transformerless fashion in the trigger section of the circuit to supply the necessary burst of AC current to L1, therefore, caution must be exercised. Do not**

(Continued on page 93)

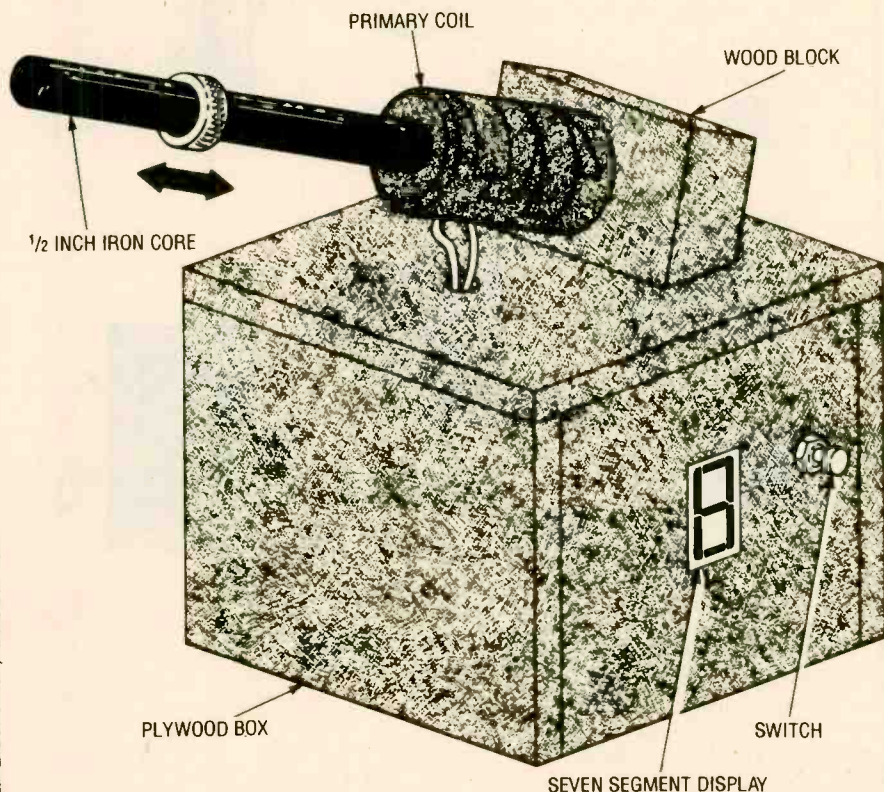
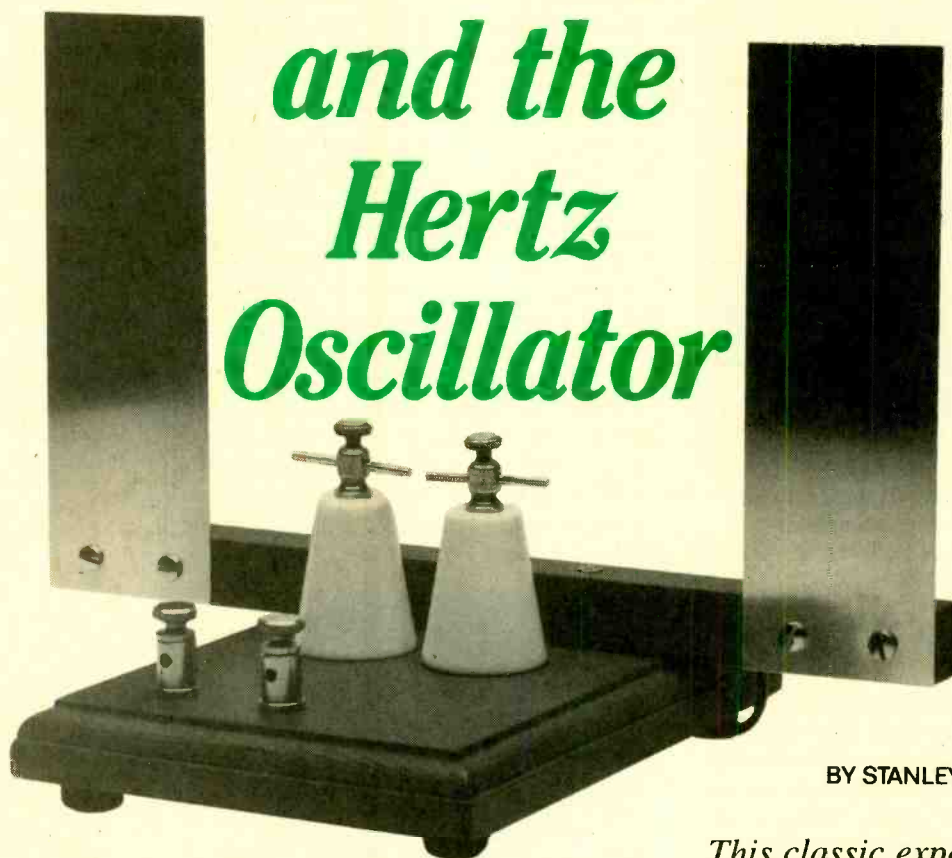

Fig. 2. When your project is completed, it should bare some remote resemblance to this illustration, with its gun-turret like core support from which to launch the ring. The ring—which must be made of a non-magnetic metal—was cut from a length of 3/4-inch diameter aluminum tubing to 1/2-inch in length.

Electric Waves and the Hertz Oscillator



BY STANLEY A. CZARNIK

This classic experiment by Heinrich Hertz proved Maxwell's theory of electromagnetic waves.

By the middle of the 19th century, certain regularities in the behavior of electricity were becoming obvious to experimenters everywhere. Following the work of Coulomb, Oersted, Ampere, Faraday, and others, it was clear that an electric current created a magnetic field, that a magnetic field in motion near a conductor created a current, and that a current in one circuit could induce a current in another circuit. It was also known that electric charges attracted and repelled each other according to a law similar to the one associated with gravitation (the inverse square law).

But questions remained. For example: How did the electric and magnetic forces move through space? One popular explanation involved the analogy between electricity and gravitation. Theorists imagined a charge (or mass) located at one point exerting an instantaneous influence on another charge (or mass) at some

other point. No manifest connection had to exist between the two points. This old and somewhat mystical idea was known as "action at a distance."

Another theory was suggested by Michael Faraday. He postulated about "lines of force," the kind made visible by sprinkling iron filings on a sheet of paper placed over a magnet. The idea of lines of force stimulated the interest of another Englishman, James Clerk Maxwell, one of the greatest mathematical physicists ever. Ultimately, that interest was to become a theoretical representation of the electromagnetic wave.

The evolution of Maxwell's thinking on the matter passed through a number of preliminary phases and is (as it always was) quite complicated. The following should be considered only a very short summary of the points relevant to the rest of our story.

It had been known for a time that localized electrical activity occurred in insulators, like the air in a Leyden jar

capacitor. Maxwell was the first to suggest that a current moving through such an insulator was a current of a special kind. He called it a displacement current. The reasoning ran like this: If an electric force applied to a dielectric (like air) was varied continuously, the result would be a wave of electric displacement. The periodic displacement wave would be accompanied by a periodic magnetic force. When the two were taken together, the result was an electromagnetic wave.

Next, the question of velocity came up. By the middle of the 19th century, the speed of light was known both from astronomical observations and from direct terrestrial experimentation. In 1849, Hypolyte Louis Fizeau calculated it by using a rapidly rotating toothed wheel and a mirror to reflect the light back to the wheel. Since the light was blocked by one of the teeth on its return journey, the speed of light could be calculated from the size and



James Clerk Maxwell (1831-1879) was the first to formulate a consistent mathematical representation of electromagnetic waves.

spin of the wheel and the distance of the mirror.

Now, following the work of Wilhelm Weber and Friedrich Kohlrausch on the speed of an electric disturbance along a wire, Maxwell was able to calculate the velocity of displacement currents in a dielectric. The numbers corresponded closely with those obtained for the speed of light.

The scientist pressed ahead to what was, for him, the obvious conclusion: the fundamental identity of electrical disturbances and light. As he phrased it: "light consists in the transverse undulations of the same medium which is the cause of electrical and magnetic phenomena." The idea was developed further and acquired a formidable mathematical representation in the important paper "A Dynamical Theory of the Electromagnetic Field" published in 1864.

Heinrich Hertz. Maxwell's electromagnetic theory was expressed as an arrangement of equations. But just what sort of physical system might correspond to the mathematical constructions was not clear. He failed to provide a circuit capable of generating the electromagnetic waves. Maxwell's model was difficult to visualize and the lack of experimental verification created a certain skepticism among many of Europe's leading physicists.

The experimental illustration of the electromagnetic theory did not come until 1888, nine years after Maxwell's early death at the age of 48. The necessary electrical apparatus was put together by a young German scientist, Heinrich Hertz.

Heinrich Rudolf Hertz was born in Hamburg, Germany, on February 22, 1857. His family was both cultured and prosperous; he had three younger sisters and one younger brother. Hertz's practical skills became evident at an early age. By the time he was twelve, he had wood-working tools and a workbench. Later, he obtained a lathe and used it to build various physical instruments. His paternal grandfather studied natural philosophy and had a small private laboratory. While still in his boyhood, Hertz was able to acquire some of his ancestor's scientific equipment.



Heinrich Rudolf Hertz (1857-1894) provided a reproducible experimental illustration of Maxwell's theories. The work was carried out in a lecture hall at the Technische Hochschule at Karlsruhe, Germany, in 1888.

Hertz studied at the University of Munich and then at the University of Berlin, where he came under the influence of the great German physicist, Hermann von Helmholtz. After completing his education, Hertz took a teaching position at the University of Kiel in 1883. It was at Kiel that Hertz found the time to make his first deep study of Maxwellian electrodynamics.

Like many of his contemporaries,

Hertz found Maxwell's ideas and equations hard to understand. Indeed, at one point, the unusual mathematical difficulties nearly forced him to give up all hope of forming any consistent conception of Maxwell's models. But he persisted. In the spring of 1884, he wrote in his diary: "Hard at Maxwellian electromagnetics. Nothing but electromagnetics. Hit upon the solution to electromagnetics this morning."

Further Reading

The Identity of Light and Electricity, Heinrich Hertz, *Popular Science Monthly*, Volume 38 (December 1890): pages 179-188.

"Some Possibilities of Electricity," William Crookes, *Fortnightly Review*, Volume 52 (1892): pages 173-181.

Electric Waves, Heinrich Hertz, Macmillan, 1893

Pioneers of Electrical Communication, Rollo Appleyard, Macmillan, 1930.

"Action at a Distance in Classical Physics," Mary Hesse, *Isis*, Volume 46 (1955): pages 337-353

"James Clerk Maxwell," J.R. Newman, *Scientific American*, Volume 192 (June 1955): pages 58-71.

"Heinrich Hertz," Philip and Emily Morrison, *Scientific American*, Volume 197 (December 1957): pages 98-106. ■

The school at Kiel had no physics laboratory. So, when Hertz was offered a professorship at the *Technische Hochschule* at Karlsruhe, with its well-equipped Physical Institute, he accepted. Hertz found some high-voltage induction coils in the equipment collection. The transformers were just what he needed to build a real, working, experimental illustration of Maxwell's theories.

Given the complicated mathematical symbolism which inspired it, the extreme simplicity of Hertz's oscillator system is remarkable. This is what he did. He connected a strong battery of Bunsen cells to the primary windings of an induction coil equipped with a mercury interrupter. The secondary of the coil was attached to two large spheres or plates of zinc mediated by a spark gap. The two large conductors amounted to a radiating dipole antenna. In a sense, the two conductive ends of the Hertz's dipole

were actually the inner and outer foils of a disassembled Leyden jar. There was no ground connection. For a detector or resonator, Hertz used a simple loop of wire the ends of which were separated by a very small spark gap.

The Experiment. Hertz set up his novel oscillator at one end of the Karlsruhe lecture hall; the resonator was placed at the opposite end. The room lights were extinguished and the scientist permitted his eyes to become accustomed to the dark. When the transmitter was switched on, a series of tiny electrical flashes became visible at the spark gap of the resonator.

Here were the electromagnetic waves he wanted. But, how fast were they moving? Hertz had no oscilloscopes or electronic test equipment of any kind, so direct measurements were impossible. Instead, he worked with the wavelengths. He set up a sheet of zinc against a wall to reflect the signals. Then, by studying the patterns of interference between the waves going out and the one coming back, he was able to calculate the wavelength and finally the speed of propagation. Hertz found no evidence for the mysterious and instantaneous action at a distance. The velocity of the waves was not infinite; it was finite; it was the speed of light.

The young physicist had verified a very difficult theory with a very simple demonstration, and the illustrative power of the experiment cannot be over-estimated. Hertz phrased it like this: "There are many friends of nature interested in the problem of light who are capable of comprehending simple experiments, but to whom Maxwell's theory is still unintelligible."

The Project. With an induction coil, low-voltage DC power supply, and a few scraps of wood and metal, you can build a functional replica of the Hertz oscillator and transmit electromagnetic signals to an ordinary AM radio. Like Hertz's original construction, the unit makes use of no electronic components whatsoever. The system goes together quickly; for those of you who have not yet worked with high-voltage apparatus, the beautifully simple Hertz oscillator is an excellent place to begin.

The cylinder-shaped high-voltage transformer shown in the photograph has been featured in this magazine before (June 1989 and March 1990); the earlier article also appears in the 1990 edition of the Electronics Hobbyist Handbook. It's an automobile ignition coil plus interrupter and runs on about 12 volts.

The particular unit shown, to the best of my knowledge, is no longer available on the regular commercial

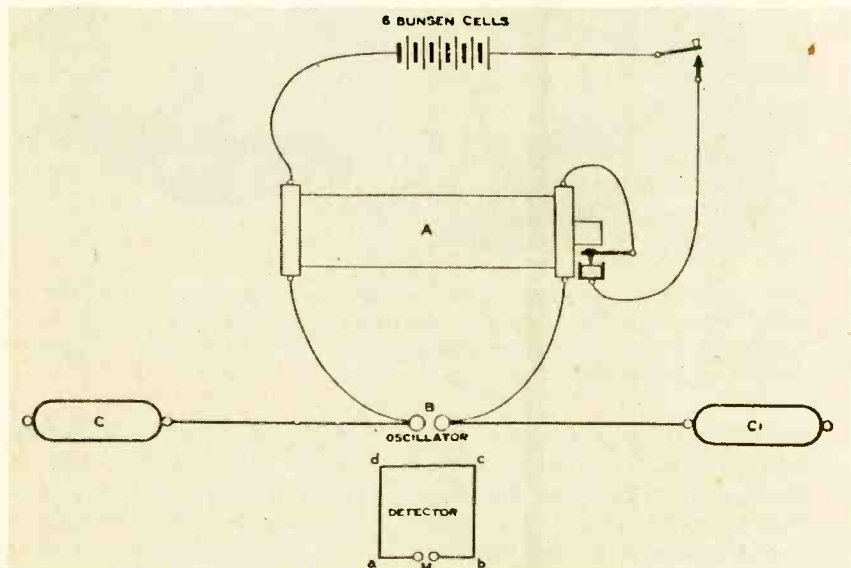

Given the complicated mathematical symbolism that inspired it, the extreme simplicity of Hertz's electromagnetic oscillator is remarkable. The high-voltage output of an induction coil (A) is connected to a radiating dipole antenna (C and C'), the two parts of which are separated by a spark gap (B). For a resonator, Hertz used a loop of wire (a, b, c, and d), the ends of which form a very small spark gap (M).

PARTS LIST FOR THE HERTZ-OSCILLATOR EXPERIMENT

AM radio
 Binding posts (4)
 DC power supply, low-voltage
 Induction coil (see text)
 Porcelain insulators, or equivalent (2)
 Narrow metal rods (2)
 Rubber feet (4)
 Brass or aluminum sheet metal, 2 × 6 inches (2 pieces)
 Telegraph key, or equivalent
 Wooden block, 5 × 7 inches
 Wooden stick, 10 × 3/4 inches
 Wood screws, machine screws, threaded rod, solder, soldering lugs, hook-up wire, etc.

Induction coils, enclosed in a hardwood box and equipped with an adjustable vibrator mechanism, are available from Fisher Scientific, Educational-Materials Division, 4901 W. LeMoyne Street, Chicago, Illinois 60651 (Telephone: 1-800-621-4769, or, within 312 area code, 378-7770. The catalog number is S-43525 and the price is \$112.00. Add \$5.00 for shipping and handling. IL residents must add appropriate sales tax.

market. However, almost any high-voltage induction coil equipped with low-voltage DC input terminals and a make-and-break vibrator mechanism will work just fine. Coils of this type are currently available from Fisher Scientific, a laboratory supply company, in Chicago; see the Parts and Materials List for more information. The coil from Fisher is a bit more powerful than the typical auto ignition unit.

Construction. Obtain a block of wood about 5-inches wide, 7-inches long, and 3/4-inch thick. Somewhere near one of narrower ends of the block, drill two holes for the input terminals. Remember that this device runs on high voltage; do not place the input terminals too close together. The space between the binding posts should be somewhat larger than the maximum size of the spark available from the induction coil.

The appearance of the oscillator is improved by doing all of the wiring on the underside of the baseboard so now might be a good time to attach four small rubber feet to the bottom of the block to provide space beneath

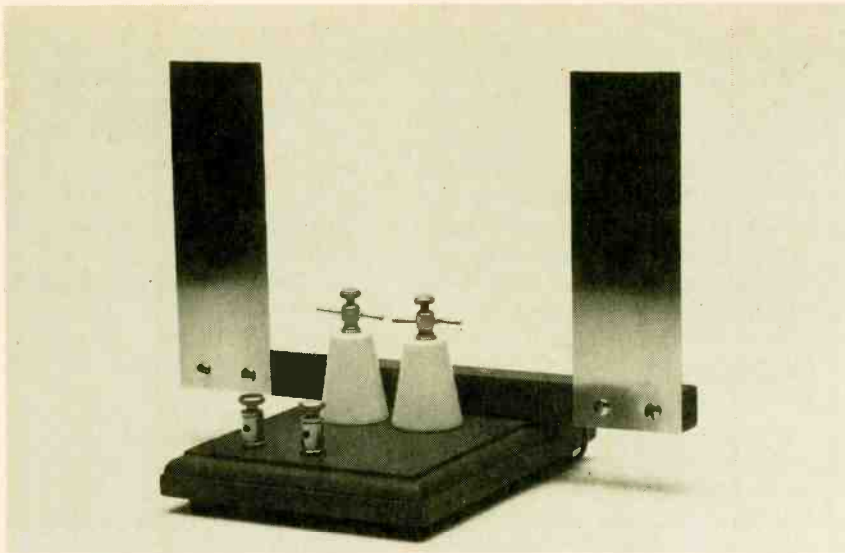

The oscillator described in this article is similar to the original built by Hertz over 100 years ago. A dipole antenna made of two metal sheets is connected in parallel to a spark gap and a pair of high-voltage input terminals. The unit measures 7 inches high, 10 inches wide, and about 7 inches long. The wooden base and crossbar have been stained.

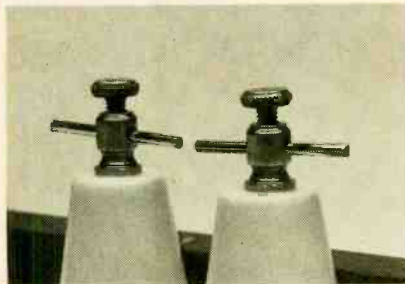

The size of the oscillator spark gap depends in part on the power of your induction coil. A small coil will call for a 1/8- to 3/8-inch air break. A larger coil may require more space. The spark gap terminal posts should be at least 1/2-inch apart.

the wood for the necessary connections.

Next, somewhere near the center of the block, drill two holes for the oscillator spark gap. Those holes should be at least 1 1/2-inch apart. A very powerful induction coil may require a still larger separation.

The size of the spark gap must be to some extent adjustable. The easiest way to do that is with two short metal rods held in place by a couple of small binding posts. The spark gap in the photographs is mounted on a pair of old-fashioned porcelain insulators. I just happened to find a few, covered with dust, sitting on a shelf in my workshop; perhaps you can locate something similar. The arrangement is fastened to the baseboard with two

threaded rods cut to the proper length and furnished with soldering lugs.

Now you'll need two rectangular

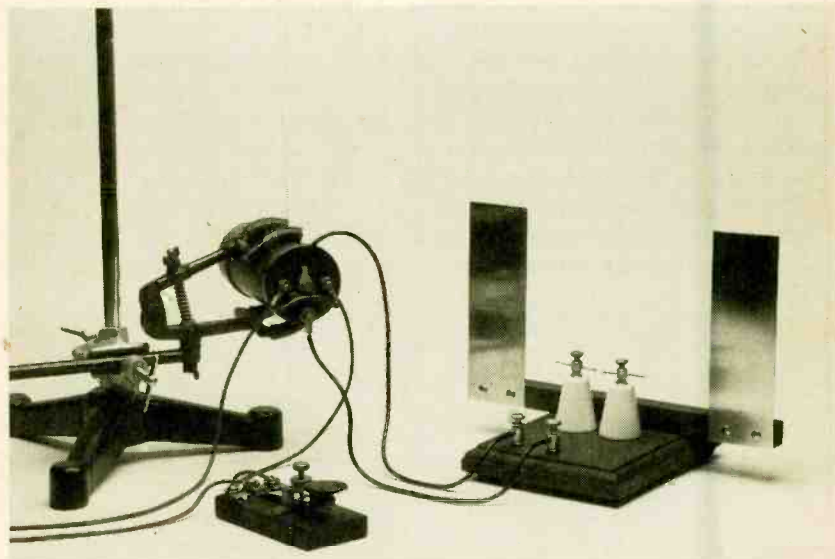

Here's one way of setting up your electromagnetic wave generator system. The low-voltage input to the induction coil is controlled with a momentary switch, in this case, a telegraph key. The high-voltage output goes directly to the oscillator. The circuit requires no ground connection.

sections of brass or aluminum sheet metal for the dipole antenna. Small pieces of sheet metal are often available at certain large hobby shops. Each piece should be about 2-inches wide and 6-inches long. Drill two small holes near one narrow end of each piece. Next, obtain a piece of wood about 10-inches long and 3/4-inch

square. Drill two holes near each end of the stick to match the holes in the metal rectangles. Attach the metal to the wood with machine screws. Don't forget to equip each side of your antenna with a soldering lug. Fasten the antenna to the baseboard with a couple of wood screws as shown in the photographs.

Finally, warm up your soldering iron, locate some heavy-gauge insulated hook-up cable, and wire up the oscillator. The high-voltage input terminals, the spark gap, and dipole antenna are all connected in parallel. Make certain that all wires are kept as far away from each other as possible. If the wires get too close, you are liable to wind up with an unwanted spark gap underneath the oscillator.

Operation. Locate your induction coil and connect the primary windings to an appropriate DC power supply. Most induction coils run on about 6 to 12 volts. The low-voltage input circuit should be provided with some sort of momentary switch; a tele-

graph key is ideal. Next, set the oscillator spark gap to a distance of about 1/4 inch. With a very small coil (like the one in the photograph), the best operational gap may be even smaller. With a larger transformer the distance may have to be increased. Finally, connect the high-voltage sec-
(Continued on page 98)

BY JOSEPH J. CARR

All About Optoisolators

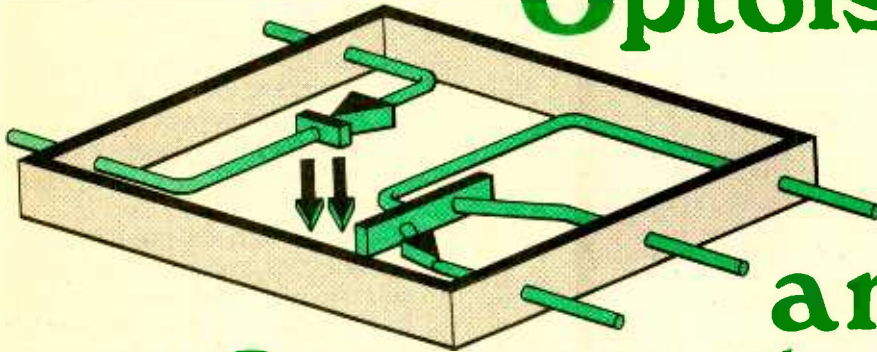

Learn how to use a versatile family of chips that could save you, or your next project, from disaster.

and Optocouplers

Optoisolators, optocouplers, and optoswitches form overlapping categories of electro-optical devices that have a wide range of applications. Typically they are used in situations where a portion of a circuit is operated at high voltage (and therefore dangerous to any low-voltage circuitry), or there is some inherent reason why two sections of a circuit must be kept apart from one another (for example, safety).

One example of a high-voltage application is when a 117-volt AC load must be controlled by a low-voltage circuit, such as a computer interface. The high-voltage AC line is inherently dangerous to the low-voltage circuit, so one should connect the two together via an optoisolator.

As another example, RS-232C serial communications circuits for computers need to be isolated from transistor-logic (TTL) circuits and 20 millampere current-loop communications circuits. In the latter case, high-voltage transients produced by older teletypewriter circuits on the current loop will damage (or at least confuse) a computer connected to the loop without the benefit of some optocouplers.

Optoisolators are also useful in medical electronics to ensure patient safety. For example, the amplifiers used for electrocardiograph (ECG), electroencephalograph (EEG), and other instruments are isolated from the AC-powered DC power supply. For that reason and others, a whole

class of industrial and medical amplifiers called isolation amplifiers use optoisolators as the isolation element.

Optoisolators and Optocouplers.

In common usage the terms optoisolator and optocoupler are interchangeable, although different usages are found in different literature. All of these devices include some sort of light source, such as an incandescent lamp, neon glow lamp, or light-emitting diode (LED), juxtaposed with an electro-optical sensor such as a photoconductive resistor, photodiode, phototransistor, or other device. Those devices are usually packaged so that only light from the internal source finds its way onto the active surface of the sensor.

Figure 1 shows four different optoisolators. In Fig. 1A, for example, we see an older form in which a small incandescent low-voltage lamp (1) is positioned to shine its light on a photoconductive cell (e.g., a CdS cell). When the lamp is turned off (i.e., no current flows), the photoconductive cell is dark, so its resistance is very high. But when the lamp is turned on, the photocell is illuminated and its resistance drops to a very low level.

The optoisolator of Fig. 1A is the oldest form, and commercial examples are nearly as old as photoconductive cells, but they are inefficient and unreliable. The inefficiency is due to the fact that the lamp takes a fair amount of current (40 to 500 mA) to glow to incandescence. Therefore, a

large amount of heat is generated. The lack of reliability is due to the fact that the lamp has a high burn-out rate, so it doesn't remain working for very long.

The problems of that device are nicely solved by the device of Fig. 1B. That device uses a light-emitting diode (LED) to illuminate the photoconductive cell. As current through the LED increases, its brightness also increases, so the photoconductive cell's resistance will drop.

Both of the devices in Figs. 1A and 1B are sometimes used as voltage-variable resistors. That is, as the voltage across the lamp or LED increases, the current through the device also increases, as does its light output. As the light output increases, the resistance of the photoconductive element drops. Therefore, the resistance seen across the element in both cases is inversely proportional to the voltage applied to its light source.

As with any LED, a current-limiting resistor should be connected in series with the LED in Fig. 1B in order to keep current from going higher than the maximum permissible level (typically 15 to 20 mA).

An optocoupler based on an LED and a phototransistor is shown in Fig. 1C. The LED is arranged to shine its light onto the active base region of the phototransistor. When the LED is bright, then a base current flows in the transistor, permitting current in the emitter-collector path to flow.

The next device, shown in Fig. 1D, is

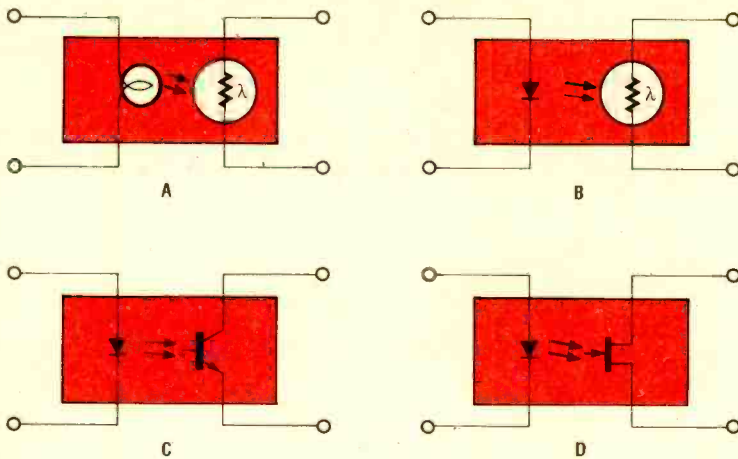

Fig. 1. As shown here, optoisolator/optocoupler devices can have any one of a number of different inputs or outputs. Your application will determine which you should use.

an optocoupler in which the active output device is a junction field-effect transistor (JFET). These devices will act as amplifiers, but also function as voltage-variable resistors. The JFET's channel resistance is a function of the current flowing in the LED.

Optoswitches. Figure 2 shows other devices that are generally classified as optoswitches. In all three cases, the light source is an LED. In Fig. 2A, the sensor is a light-sensitive silicon-controlled rectifier (SCR). Those devices are like gated diodes that don't pass current until a trigger current flows in the gate terminal. After triggering, the device operates like any diode (*i.e.*, it passes current when the anode is positive with respect to the cathode). In the case of Fig. 2A, the gate current is created by the light source.

A Triac is a special form of SCR-like device. However, while an SCR passes current in only one direction, a Triac uses a pair of back-to-back SCR's with a common gate to permit current flow in either direction. Figure 2B shows an optical switch that uses a photosensitive Triac as the sensor element. That kind of device is typically used when a load needs AC power.

Finally, in Fig. 2C we see an optoswitch that uses a digital-logic element called a Schmitt trigger. Those devices will not produce a high output until the input (in this case, the light level of an LED) rises above a certain threshold. The output will remain high until the light drops below another (lower) threshold. The Schmitt trigger is

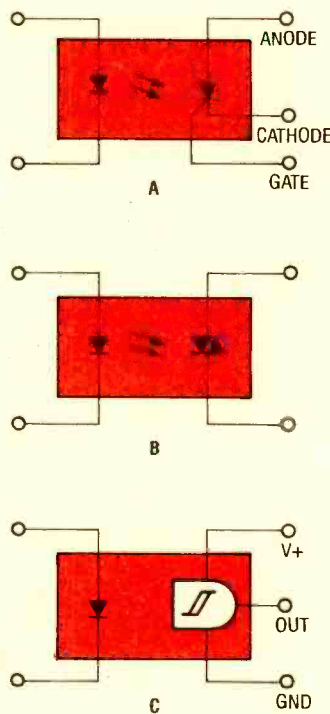

Fig. 2. These optocouplers form a family of devices often called "isolated switches."

used to clean up signals in noisy environments.

Optoisolator Styles. Figure 3 shows three different styles of optoisolators or optocouplers. The simplest type is the closed-pair in Fig. 3A. In that device, a light source (*e.g.*, an LED) is placed so that its principal axis is aimed into the lens of a photosen-

sitive device. When the LED is turned on, then the photosensor is illuminated. Those devices are typically used in circuits where isolation between two circuits is required.

You can build an optocoupler like that shown in Fig. 3A. Just place a red LED inside a drilled-out dowel, opaque plastic rod, piece of insulating "spaghetti," or heat-shrink tubing along with a phototransistor. If necessary seal the ends with opaque silicone seal.

A "transmission-slot" pair is shown in Fig. 3B. In that type of device, a slot is cut in the light path between the light source and the sensor. When an opaque object is placed in the slot, light transmission is interrupted so the photosensor is not illuminated. When the object is removed, the sensor is illuminated. Such devices are used in paper-out alarms in computer printers, in alarm circuits to indicate when a window or door is opened, and in other applications.

A reflective pair is shown in Fig. 3C. Those devices are used in proximity-detector circuits where the sensor/detector pair is not supposed to touch the object. The reflective pair is also

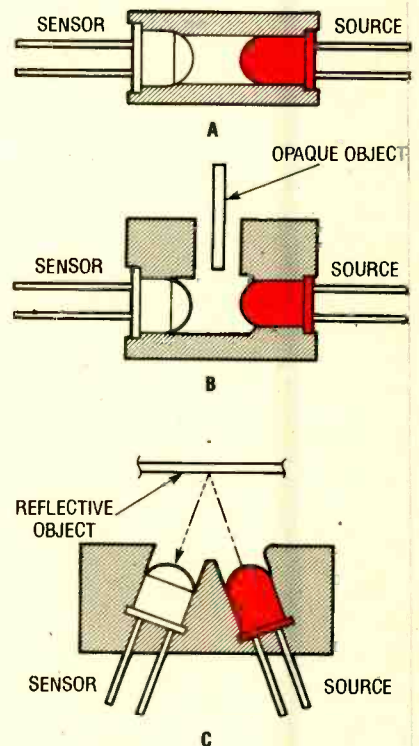

Fig. 3. There are a number of different optoisolator/optocoupler styles, which is independent of the device's sensor and light-source type.

used in a probe that is used to generate a blood-pressure waveform called a photoplethysmograph (PPG).

In PPG instruments, a red LED is used to emit light that is reflected off a thumb or finger toward the sensor. Blood pulsing through the tissue varies the tissue's optical density, so the intensity of the red light reaching the sensor varies with the heart's pumping action. The waveshape of the PPG signal is approximately the same as the human arterial blood-pressure waveform. Unfortunately, the sensor cannot be calibrated to accurately measure blood pressure. However, it can detect a human pulse for measuring heart rate. So PPG devices are used in a lot of aerobic-exercise heart-rate monitors.

Optoisolator/Optocoupler Circuits.

A circuit for isolating a variable resistor is shown in Fig. 4. In that application, an optoisolator that has an LED and a photoconductive cell (or photoresistor) is used. The current through the LED controls its brightness, which in turn determines the resistance between terminals A and B. The LED current is set by the voltage of the DC power supply, and the value of the two resistors (R1 and R2). The fixed resistor (R1) is used to limit the current to a maximum of 20 mA (when the resistance of the potentiometer, R2, is set to zero ohms), otherwise, the LED might burn out. So, the brightness of the LED, and thus the resistance of the photocell, is a function of the setting of potentiometer R2.

Figure 5 shows two circuits for excit-

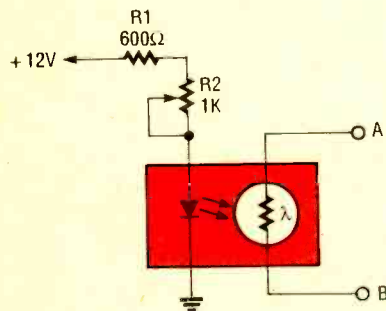

Fig. 4. Here is a simple isolated potentiometer. By adjusting the variable resistor, you change the brilliance of the LED, and thus the resistance of the photoresistor.

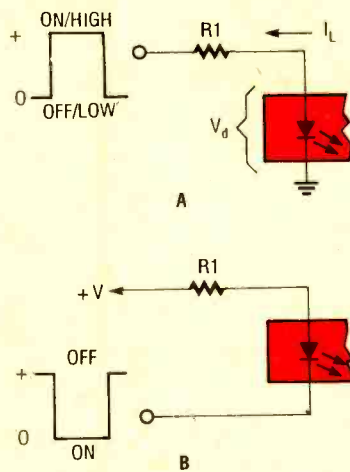

Fig. 5. Logic highs and lows can be used to control the input of an optoisolator.

ing the LED in any form of optoisolator, regardless of the type of sensor on the other side. In Fig. 5A, the cathode of the LED is grounded, and a positive voltage is applied to the current limiting resistor (R1) connected to the LED anode. The normal voltage drop across the LED (V_d) is about 1.7 volts, so the value of R1 is found from:

$$R1 = ((+V) - V_d) / I_L$$

The current I_L can be found on the specifications sheet for the specific device being used, but 10, 15, and 20 mA are typical values. Note that those values must be converted to amps before being used in the above equation.

When a digital signal is applied to the LED in Fig. 5A instead of a DC voltage, the LED is turned on when the signal is high (i.e., a positive voltage), and off when the signal is low (i.e., near ground potential).

A second variation of the circuit is shown in Fig. 5B. In this case, the cathode is not permanently grounded; a fixed potential (+V) is applied to the resistor at the anode side of the LED. When the cathode is low (grounded), the LED is turned on; when the cathode is high, the LED is turned off.

This concept of using either input for control can be applied to the output side of optocouplers and optoisolators as shown in Fig. 6. Note that each side (the LED side and the transistor side) of both circuits has its own power supply. In that way the circuits that are connected to either side of

the optoisolator are completely isolated from each other.

In Fig. 6A, the phototransistor is connected so that the output signal is taken from the collector of the transistor. The emitter is directly grounded, while the collector is connected to a DC power supply. That is a "common-emitter, collector-output" circuit configuration.

In Fig. 6B, the output signal is taken from the emitter. Note that a resistor is connected between the emitter and ground. This is called the "emitter-follower" output configuration.

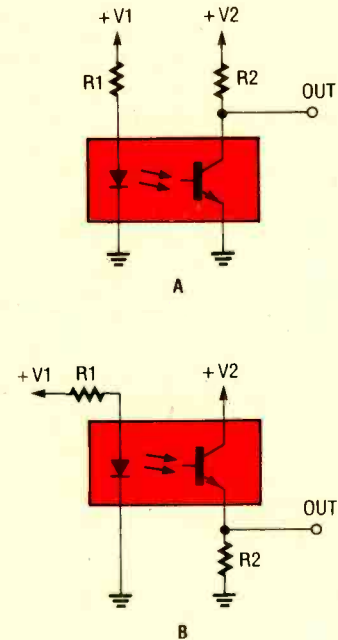

Fig. 6. Optoisolators allow circuits with separate power supplies to interact.

Packaging. Over the years these components have been housed in a wide variety of packages, including cylindrical ones. Modern devices, however, are typically packaged in integrated-circuit style dual in-line packages (DIP's), most of which are of the mini-DIP variety.

Figure 7A shows a typical six-pin mini-DIP optocoupler. That device uses an LED juxtaposed with a phototransistor, with the LED being between pins 1 and 2, and the phototransistor's collector and emitter connected to pins 4 and 5. Some models (like the one shown) have the transistor's base available at pin 6. These are "industry standard" pin-

outs, but don't accept them as "gospel" until you check the specific component that you obtain.

A different sort of package is shown in Fig. 7B. This device is in a four-pin mini-DIP package, and consists of a phototransistor as the sensor and a pair of LED's as the light source. The two LED's are connected back-to-back so that DC voltages of either polarity as well as AC can be accommodated.

A multiple-section device is shown in Fig. 7C. That device is essentially similar to the device shown in Fig. 7A, but the 16-pin DIP package contains four LED/transistor pairs. Versions with up to sixteen pairs are also on the market. Such devices can be used to control multiple circuits, or to isolate multi-line data busses (for example in an eight-bit computer).

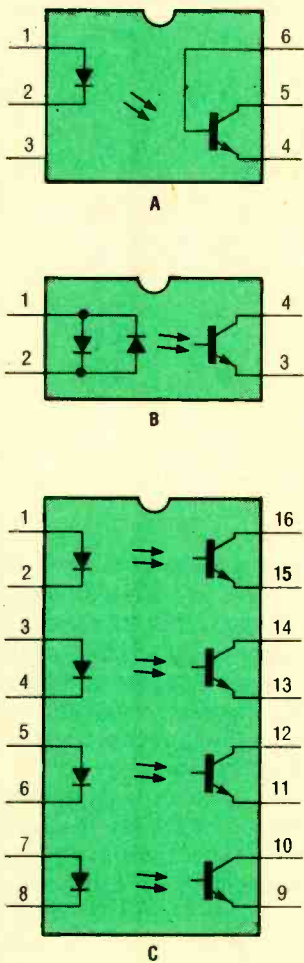

Fig. 7. Although only transistor-output optocouplers are shown here, optocouplers of every type are readily available in these package designs.

Optocoupler Circuits. Figure 8 shows a TTL-to-TTL isolator circuit. The driver circuit is an open-collector TTL inverter (U1). When the input is high,

then the output of the inverter is low. Thus, when the input is high, the output of U1 grounds the cathode end of the LED, causing the LED to turn on. Re-

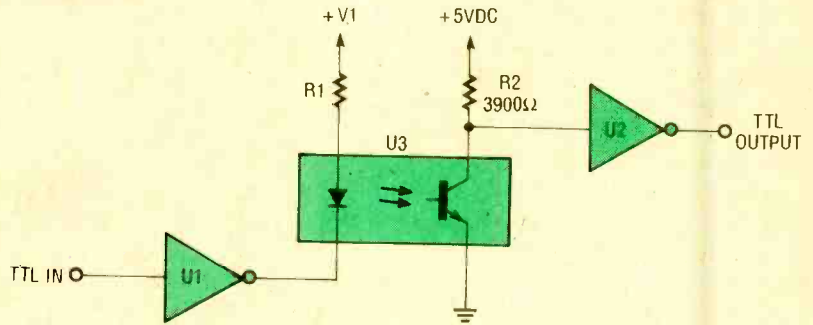

Fig. 8. A TTL to TTL interface is very easy to build using an optocoupler. Note how in this circuit there are four levels of inversion: in U1, in the LED (which is active when low), in the transistor, and in U2.

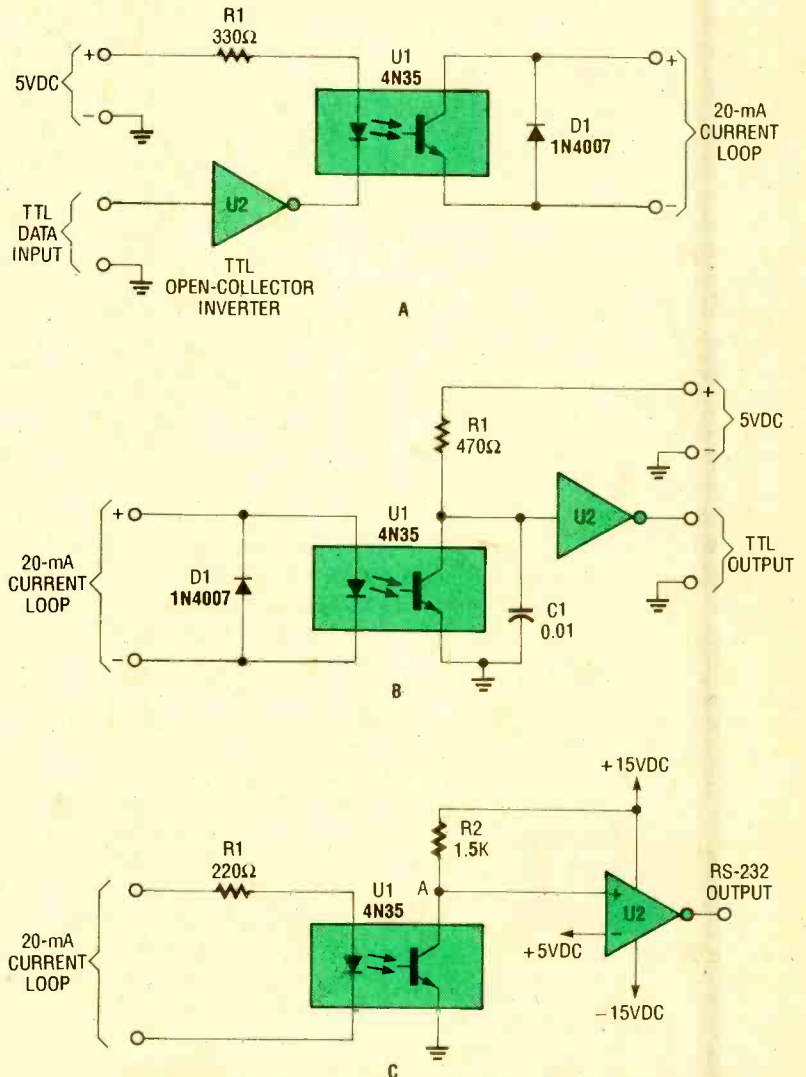

Fig. 9. Interfacing equipment, whether TTL, RS-232C, or 20-mA current-loop based can be a snap with optoisolators.

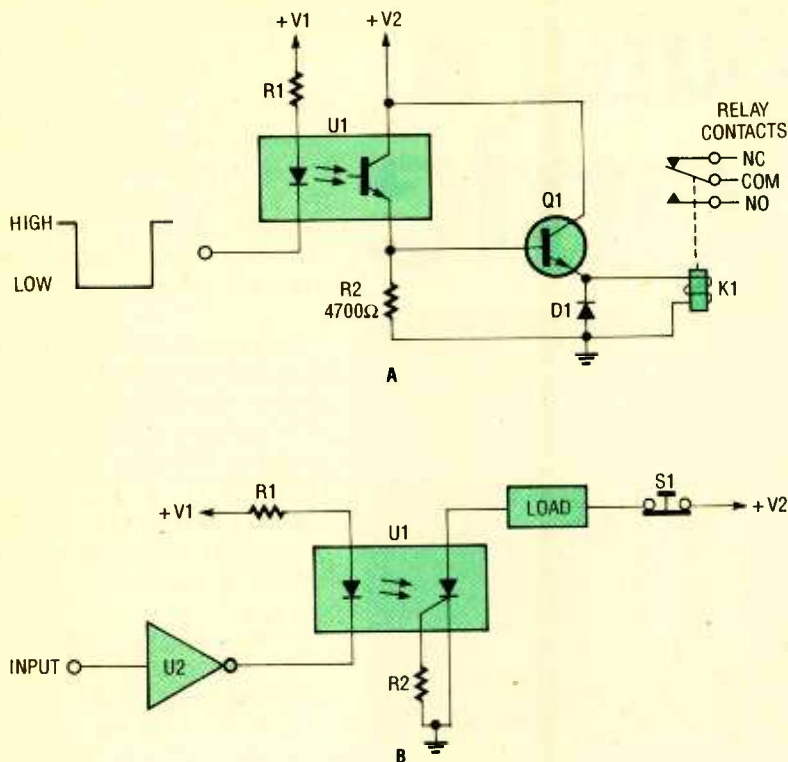

Fig. 10. Very heavy loads, which can't be powered directly by an optoisolator, might require the use of a relay as shown in A. You can sometimes get away with using a circuit like that shown in B, but it won't turn itself off.

sistor R1 limits the LED current to the maximum allowable value. To determine the correct value of +V1 for your circuit, consult the inverter specifications sheets.

The output circuit is of the collector-output form shown earlier, but in this case the collector is also connected to the input of a TTL inverter. A pull-up resistor (R2 in this circuit) to a +5 volt (+V2) power supply keeps the inverter's input high when the transistor is turned off.

Optoisolators are especially useful for safely interfacing different types of communications circuits with each other. Figure 9 shows three different optocoupler-based communications-interface circuits. In Fig. 9A, the 4N35 optocoupler is driven by a TTL signal, much like the previous circuit, and in turn drives a 20-mA current-loop communications circuit.

Circuits such as the one in Fig. 9A are commonly used in instruments or in teletypewriter systems. An open-collector TTL inverter is connected to the LED cathode. When the input is high, then the TTL inverter's output is low and the LED is turned on. When the LED is turned on, the phototran-

sistor is illuminated and is saturated. Thus the loop is closed when the LED is on and the input is high. On the other hand, when the input of the circuit is low, the inverter's output is high and the LED is turned off. The transistor is thus turned off so the loop is open.

The 1N4007 high-voltage diode across the phototransistor of the 4N35 optocoupler is used to suppress high-voltage transients. Teletypewriters used solenoids activated by direct current. When a solenoid is de-energized, it produces a counter-electromotive force or "inductive kickback spike" that can destroy or disrupt the circuits connected to it. The diode clips that spike to about 0.6 volts.

The complement to the circuit in Fig. 9A is shown in Fig. 9B. In that circuit, the input side is connected to a 20-mA current loop, which drives the LED. When the loop is closed, the LED is turned on, but when the loop is open the LED is turned off. Note that the input is polarity sensitive because of the LED. The output circuit is composed of the optoisolator's transistor output and a TTL inverter. The 0.01-μF capacitor (C1) is used to reduce noise

problems. Sometimes a 220-ohm resistor is placed in series with the LED in order to prevent overload of the LED if the 20-mA current is not well controlled.

A level-translator circuit for driving standard RS-232C serial-communications lines is shown in Fig. 9C. In that case, the input circuit is similar to the previous 20-mA circuit (except that a resistor is in series with the LED), but the output circuit is an operational amplifier that supplies the V- and V+ voltage levels that the RS-232C standard defines as high and low, respectively. A +5-volt bias applied to the inverting input of operational amplifier U2 sets a minimum-voltage threshold.

An isolated relay circuit for controlling high voltage or high current from a low-voltage electronic circuit is shown in Fig. 10A. The optocoupler's output transistor is connected to a driver transistor (Q1). When the optocoupler transistor is saturated because the LED is turned on, a voltage appears at the base of Q1, turning it on. The load for Q1 is the actuating coil of an electromechanical relay (K1). In the case shown, both normally open (NO) and normally closed (NC) contacts are used along with the common (COM). The diode placed across the coil is used for spike suppression.

An SCR version of the circuit is shown in Fig. 10B. In that case, the load is connected in series with the "diode" portion of the SCR. When the LED is turned on, the SCR is triggered causing halfwave-rectified current to flow through the load (if AC is needed, then use a Triac-output optoisolator instead of an SCR-output device). SCR's stay on once triggered, until the anode-cathode current drops below a certain minimum value. The normally closed switch (S1) is used to thus "commutate" the diode (turn it off) when necessary.

As you can see from this article, optoisolators and optocouplers are easy to use, and form a safe, reliable method for interfacing certain circuits or signal sources with each other. The devices are also very easy to come by, and so are suitable for hobbyist use. The applications we've shown you just scratch the surface of their potential—we're sure you can come up with many more ways to use these versatile devices. ■

Here's a fascinating variation on the ever-popular color-organ project. Sounds are collected by a condenser microphone and fed to band pass filters whose outputs are fed to dot/bar display drivers. The outputs of the drivers are connected to red, green, and yellow LED arrays which are arranged symmetrically around a common center-point. The result is a sound-activated kaleidoscope-like display that is a sight to behold!

How It Works. The schematic diagram for the *Sonic Kaleidoscope* is shown in Fig. 1. At the heart of that circuit is a 7809 9-volt 1-amp voltage regulator (U1), an LM324 quad op-amp (U2), and three LM3915 dot/bar display drivers (U3-U5), accompanied by a handful of support

Build a Sonic



lated by U1; regulation is necessary to keep power-line ripple from affecting the display. The supply pins of U2-U5 are bypassed by capacitors C14-C17 to further ensure stability. An on-off switch was deemed unnecessary, since the power supply should be unplugged when the unit is not in use.

Construction Considerations.

Note that the project contains a total of 108 LED's. Fortunately, LED's can be obtained rather cheaply in large quantities. Diffused LED's are recommended. You'll find the best bargains on LED's at hamfests, where all sorts of electronic "goodies" are sold.

Another thing to consider is the wall-mounted DC power supply. While the circuit requires at least 12 volts DC at 300 mA for proper

Kaleidoscope

Build a fascinating variation on the ever-popular color organ; its kaleidoscope-like display is a sight to behold.

BY DANIEL P. RAY

components. A voltage-divider network, formed by R1, R2, and C2, provides a "dummy ground" for the op-amps, which is set at half the supply voltage.

The microphone input, MIC1, is fed through C3 and R4 to inverting amplifier U2-a; the gain of U2-a is controlled by potentiometer R5. The output of U2-a is fed through C4 to the remaining op-amps (U2-b, U2-c, U2-d), which are all configured as band-pass filters. Each filter is tuned to pass a different range of frequencies by its resistor/capacitor combination. With the values shown, U2-b, U2-c, and U2-d have center frequencies of roughly 100, 1000, and 1500 Hz, respectively.

Resistors R6, R9, and R12 control the bandwidth and gain of their respective filter circuits, and can range in value from 10k to 15k. The output of U2-b is capacitively coupled via C11 to

the input of U3, with R15 serving as the load resistor for U2-b. That resistor also keeps U3's outputs from "floating" in the absence of a signal. Connected as shown, U3 uses its own internal voltage reference to make a full-scale display of 1.2 volts.

Each of the nine outputs of U3 (output 1 is not used) sinks four, series-connected (red) LED's. Op-amps U2-c and U2-d are similarly connected to U4 and U5, respectively driving green and yellow LED strings. Resistors R18, R19, and R20 control the brightness of their corresponding LED arrays, and must be adjusted accordingly; different color LED's usually vary in brightness. A lower value resistor will make the LED's glow brighter.

Power for the circuit is supplied by a 500-mA, 12-15-volt DC wall-pack transformer, via J1. The output of the transformer is filtered by C1 and regu-

operation, the author used a 9-volt DC, 500-mA unit (that was once used to power an Atari 2600 video game system) in his prototype. (Scrounging is a way of life in hobby electronics.) A good, used wall transformer can be had for a dollar or two at garage sales, flea markets, or hamfests. Just be sure that the unit you consider has a DC output, and that J1 is chosen to mate with the wall transformer's output plug.

It would be a good idea to assemble the printed-circuit portion of this circuit on an experimenter's breadboard before actually hard-wiring it. That way, you can determine the resistor values for R18, R19, and R20, and you can also select the frequency-determining components to set the flash rate of the circuit to your own liking. Resistors R6, R9, and R12 should be chosen to best balance the distri-

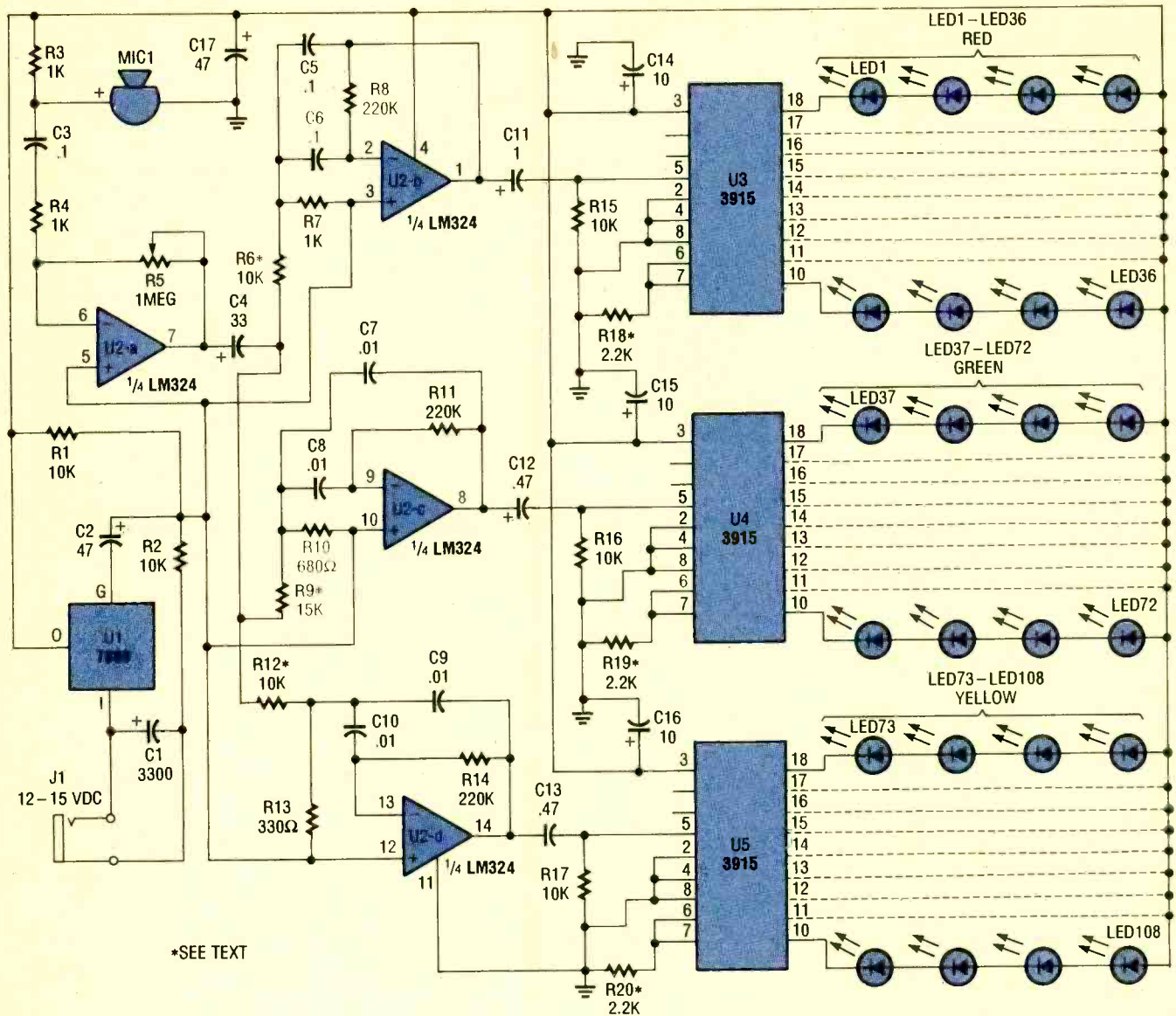

*SEE TEXT

Fig. 1. The Sonic Kaleidoscope is comprised of a 7809 9-volt 1-amp voltage regulator (U1), an LM324 quad op-amp (U2), and three LM3915 dot/bar display drivers (U3-U5), accompanied by a handful of support components.

bution of colors in the display, and should not be less than 10k. Also keep in mind that the microphone's response to lower frequencies will be somewhat better when it is mounted inside the enclosure.

Circuit Construction. The majority of the circuit elements for the Sonic Kaleidoscope were assembled on a printed-circuit board, measuring about 4 $\frac{3}{8}$ x 2 $\frac{1}{2}$ inches. The off-board components were connected to the board-mounted circuitry using wire-wrap techniques, however, point-to-point wiring can also be used.

Figure 2 shows a full-size template for the author's printed-circuit pattern.

Note that because of the many small contact points on the board, component holes must be drilled with a fine bit. A parts-placement diagram corresponding to the template in Fig. 2 is shown in Fig. 3.

Note that U1 (the 9-volt regulator), although not apparent from Fig. 3, is mounted to the foil side; the large copper area of the printed-circuit board serves as a heat sink for U1. The output pin of U1 was left extending through the component side of the board and is used as a wire-wrapping post for the LED supply bus. In assembling the project, the LED leads were cut to about $\frac{1}{2}$ inch and some of the cut-off leads were then soldered to

the board as wire-wrapping posts for connecting the off-board components.

The remainder of the printed-circuit assembly is pretty straightforward; just make sure that the IC's, LED's, and electrolytics are correctly oriented. Note that all of the resistors are vertically mounted with the exception of R7, R10, and R13.

The Enclosure. The enclosure can be built from scratch or you can use any suitable enclosure of sufficient size, such as an old speaker box. The following instructions detail the construction of the author's prototype, which was designed to be hung on a

wall, like a picture. Details on the construction of the author's custom-fitted enclosure are shown in Fig. 4.

Starting with a 20-inch square sheet of 1/8-inch thick hardboard (or panelling), make a small pencil mark at the center point of each side. With a long straight-edge, draw a line between those points horizontally and vertically, dividing the board into four equal quadrants. Using a protractor, mark points at 30 and 60 degrees in each quadrant. (Doing so places each line of LED's exactly 30 degrees from its nearest neighbor.)

Join those points through the center, extending them at least nine inches on either side of center. Mark nine points on each line at 1-inch intervals. Using those points as the centers, drill the LED mounting holes, using a 13/64-inch drill bit. Drill a 25/64-inch hole in the center of the display for the microphone. (Put a scrap piece of two-by-four underneath as you drill, to avoid marring your workbench or table.)

Cut four pieces of one-by-two strapping: two pieces 20 inches long and two pieces 18 1/2 inches long. From that, assemble a 20- by 20- inch frame (see Fig. 5), and then fasten the previously drilled hardboard to the frame, using small finishing nails. A hole should be drilled in one side of the frame for potentiometer R5, and another in the bottom for J1. Due to the thickness of the frame, you will probably have to counterbore the hole with a larger drill bit before drilling the mounting hole for R5. Likewise, you can mount J1 on a thin piece of metal or plastic, which can later be screwed in place over a larger hole.

Next, paint the entire assembly, (flat black provides the best contrast), making sure to get some paint inside the LED mounting holes. Then when it comes time to mount the LED's, they can be press fit into the holes.

Putting It Together. Place the completed enclosure face-down on a couple of two-by-fours and press the LED's into place with all cathode leads (flat edge of the LED) facing toward the center of the board. If the fit is too tight, you can ream the holes by hand with a 3/16-inch drill bit. Follow Figs. 6-8 for the proper positioning of the different color LED's. When all LED's are in place, start series wiring the red LED's

in a spiderweb-like pattern as shown in Figs. 6-8.

Wire the LED's strings exactly as

shown to keep connections to the circuit board, which will be mounted in the lower left corner, as short as possi-

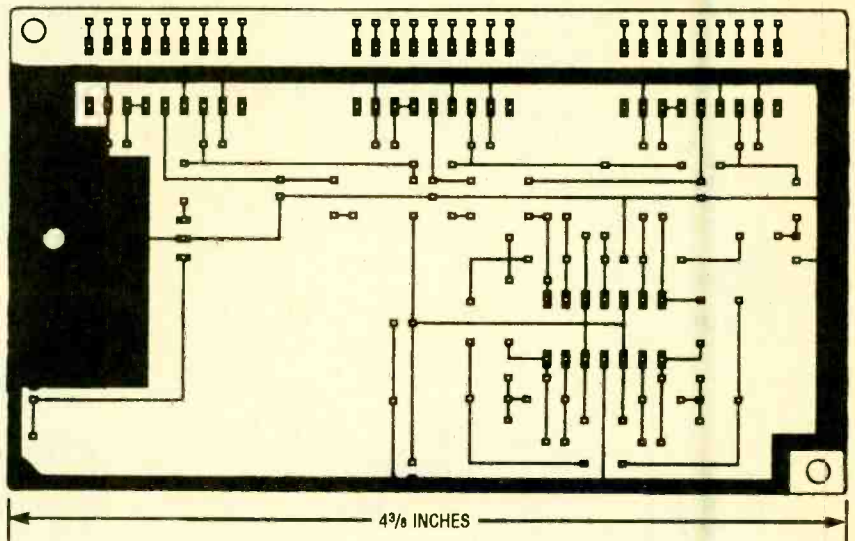

Fig. 2. The majority of the Sonic Kaleidoscope's elements were assembled on a printed-circuit board, measuring 4 3/8 x 2 1/2 inches. Here is a full-size template of the author's printed-circuit pattern. Because of the many small contact points on the board, component holes must be drilled with a fine bit.

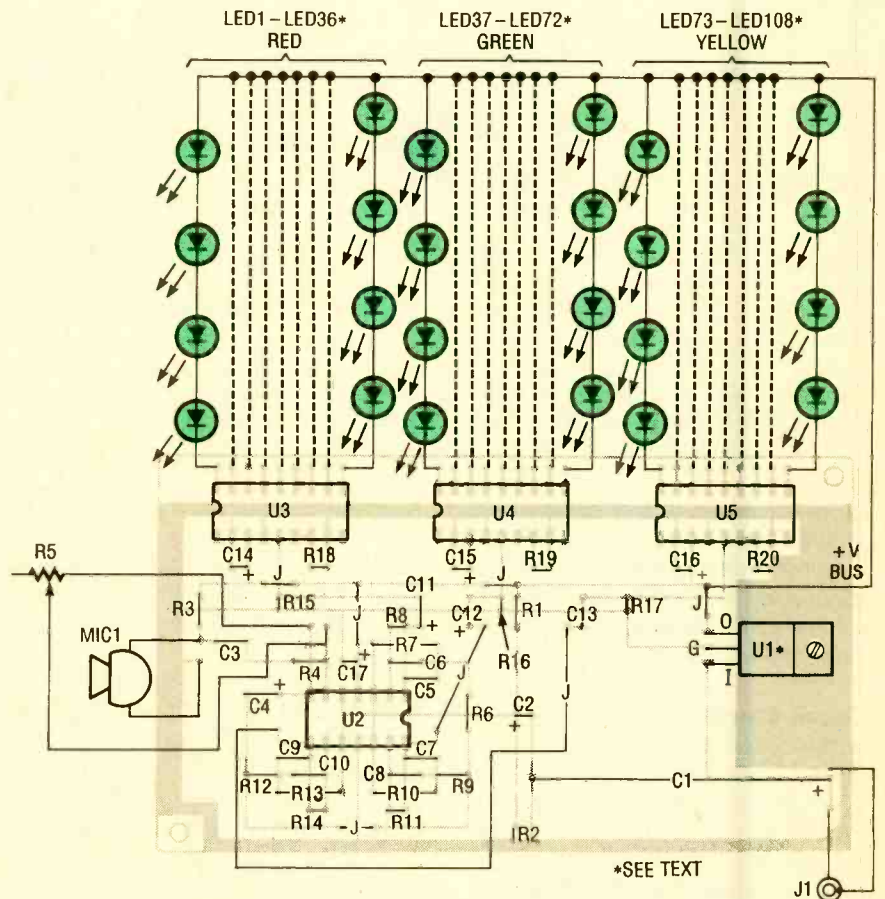

Fig. 3. Here's a parts-placement diagram corresponding to the template shown in Fig. 2. Note that U1 (the 9-volt regulator), although not apparent from this diagram is mounted to the foil side; the large copper area of the printed-circuit board serves as a heat sink for U1.

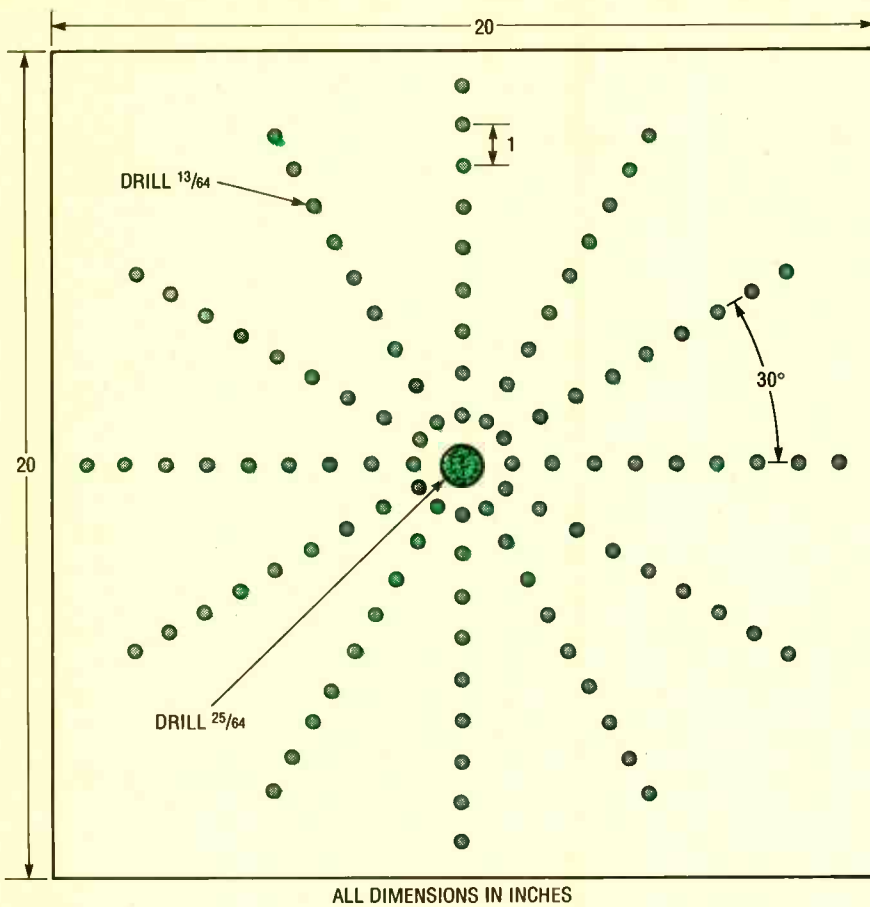

Fig. 4. Here are some details of the construction of the project's custom fitted enclosure. Begin by cutting the front panel of the enclosure as shown here.

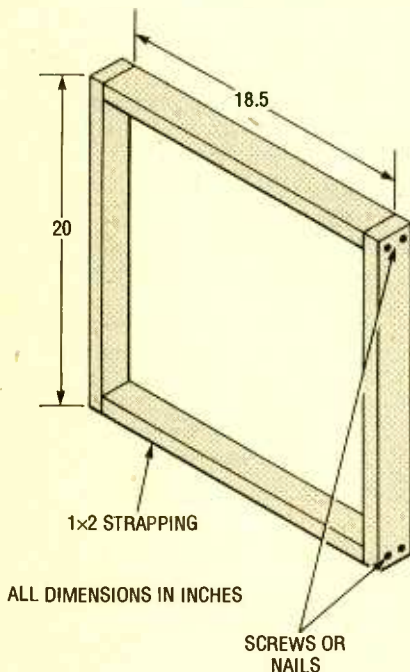

Fig. 5. Form the frame of the enclosure by cutting four pieces of one-by-two strapping, two pieces to 20 inches long and two to 18½ inches long, and then assembling the pieces as shown in this figure.

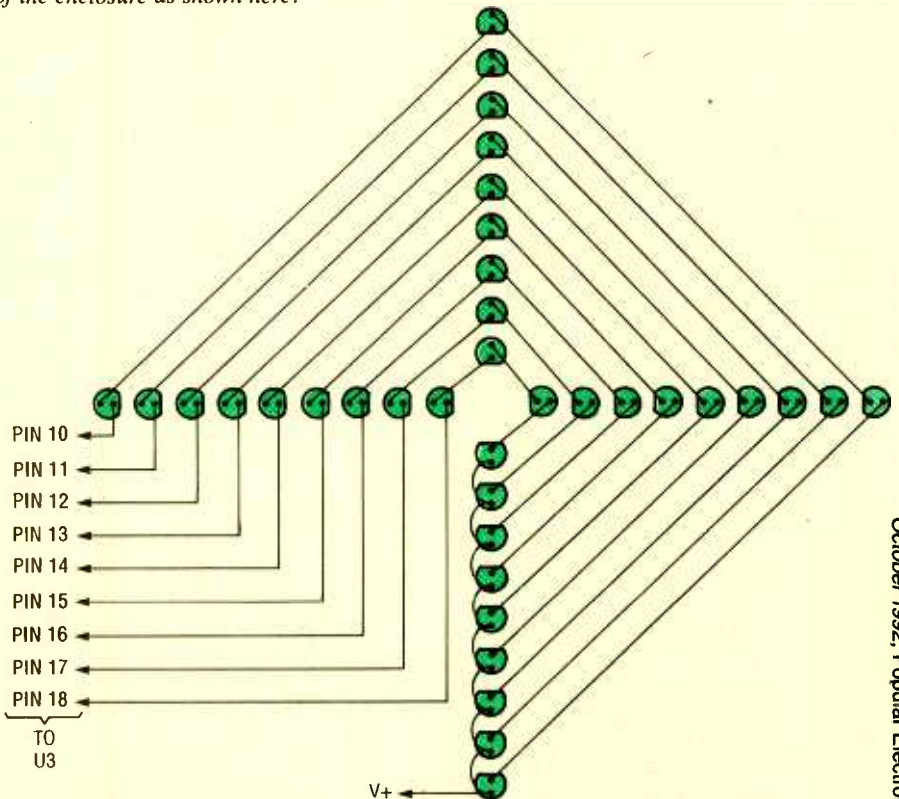

Fig. 6. The LED's in the Sonic Kaleidoscope must be positioned in a certain pattern; shown here is the positioning of the red LED's. Once in position, wire the LED's according to this diagram.

ble. After series wiring the LED's, connect the anode ends of each LED string together, creating an anode "bus." When finished, connect the anode buses of each color together, creating a common supply bus.

At this point, you can check your wiring by connecting the positive terminal of a 9-volt battery to the common-supply bus, while briefly touching the negative battery terminal to the cathode end of each individual LED string. You should see four LED's light (one in each quadrant), each time you touch the cathode lead of an LED string. Correct any wiring and/or orientation errors before proceeding.

When all the LED's are correctly wired, mount the printed-circuit board in the lower left-hand corner of the enclosure with a couple of small "L" brackets or other mounting system. Install J1, R5, and MIC1, and then wire them to the appropriate points on the circuit board. A dab of silicone sealer can be used to hold the microphone in place. Lastly, connect the LED arrays to the appropriate posts at the outputs of U3, U4, and U5. Refer to Figs. 1, 6, 7, and 8 to ensure the correct correlation between LED's and IC pins.

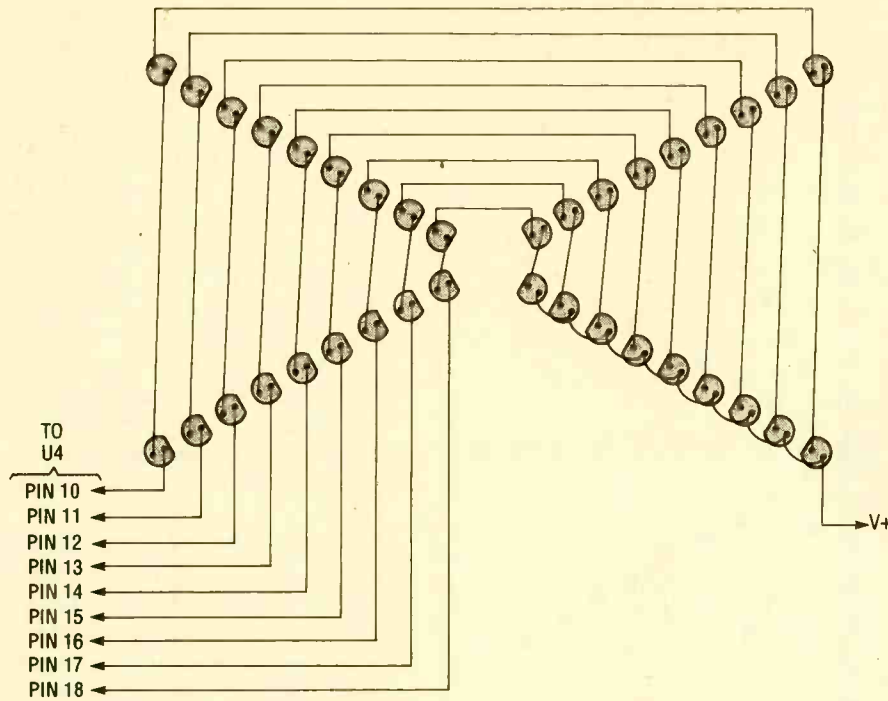

Fig. 7. The green LED's are positioned to form a pattern that resembles an X laying on its side.

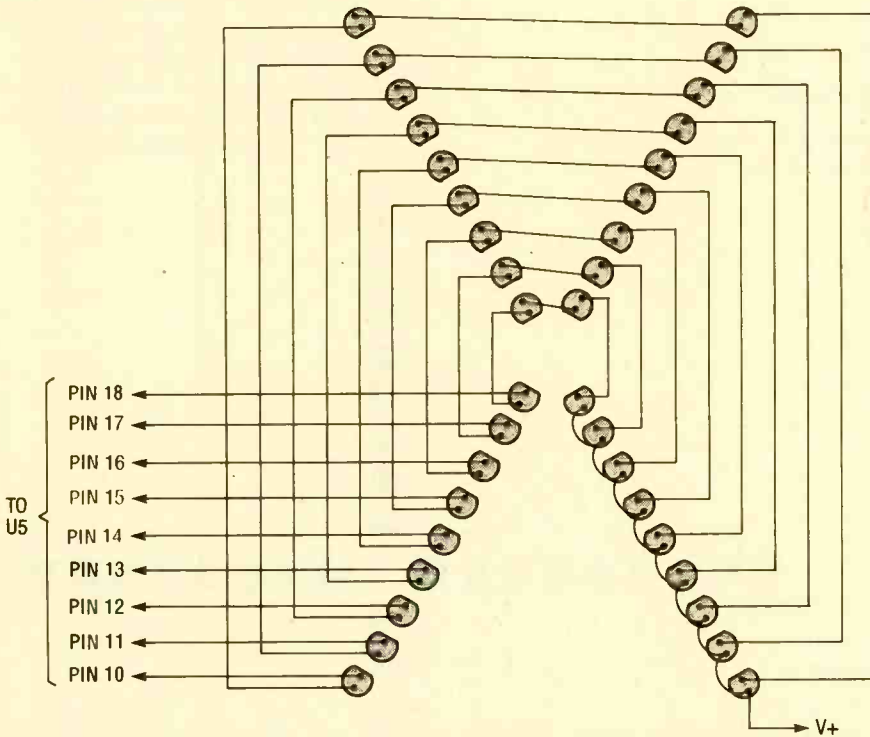

Fig. 8. Shown here is the positioning for the yellow LED's. The pattern that they form resembles an upright X. Once all of the LED's have been wire together in the proper pattern, connect leads from the LED strings to the points indicated.

Trying It Out. Since LED's do not emit large amounts of light, you can expect the display to be most vivid in a dimly lit room. In a quiet room, plug in the power supply and rotate R5 one way or the other until you find the point where all LED's just extinguish. At

that point, the slightest sound will be detected, causing one or several of the LED arrays to light. Now, turn on a radio, tape deck, CD player or other music source. If all is well, your project will "display" the various frequencies in a moving pattern of colors. Assum-

PARTS LIST FOR THE SONIC KALEIDOSCOPE

SEMICONDUCTORS

- U1—LM7809 9-volt, 1-amp, voltage regulator, integrated circuit
- U2—LM324 quad op-amp, integrated circuit
- U3-U5—LM3915 dot/bar display driver, integrated circuit
- LED1-LED36—Jumbo red light-emitting diode
- LED37-LED72—Jumbo green light-emitting diode
- LED73-LED108—Jumbo yellow light-emitting diode

RESISTORS

- (All fixed resistors are 1/4-watt, 5% units.)
- R1, R2, R15-R17—10,000-ohm
 - R3, R4, R7—1000-ohm
 - R5—1-megohm potentiometer
 - R6, R9, R12—10,000- to 15,000-ohm (see text)
 - R8, R11, R14—220,000-ohm
 - R10—680-ohm
 - R13—330-ohm
 - R18-R20—220- to 2200-ohm (see text)

CAPACITORS

- C1—3300- μ F, 25-WVDC, electrolytic
- C2, C17—47- μ F, 16-WVDC, radial-lead, electrolytic
- C3, C5, C6—0.1- μ F, monolithic
- C4—33- μ F, 10-WVDC, Tantalum
- C7-C10—0.01- μ F, monolithic
- C11—1- μ F, 16-WVDC, radial-lead, electrolytic
- C12, C13—0.47- μ F, monolithic
- C14-C16—10- μ F, 16-WVDC, radial-lead, electrolytic

ADDITIONAL PARTS AND MATERIALS

- MIC1—Condenser microphone (Radio Shack 270-090 or similar)
- J1—See text
- Printed-circuit materials, enclosure, 12-volt, 300-mA (or more) wall transformer, IC sockets, hardboard (or panelling), 1- by 2-inch strapping, hook-up wire, solder, hardware, etc.

ing that all LED's were checked, as described, any problem can be narrowed down to the circuit board. Cold solder joints; missing wires or jumpers; or improper orientation of the microphone, IC's, and/or electrolytics, can all cause problems. Once your project is working properly, use potentiometer R5 to adjust the sensitivity to compensate for very loud or very soft sounds. ■

Build The UNIVERSAL RS-232 CONNECTOR

BY JAMES E. TARCHINSKI

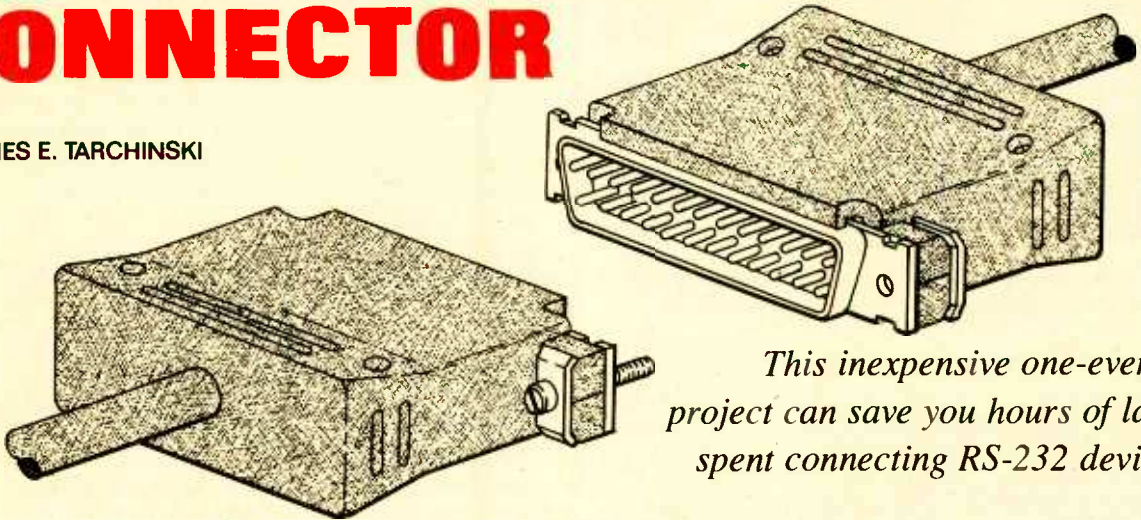

This inexpensive one-evening project can save you hours of labor spent connecting RS-232 devices.

The RS-232 serial communications standard is the electronic equivalent of Rubik's Cube. When you set out on a venture to connect two RS-232 devices, there is no obvious path to get from your starting point to where you want to be. But just like that insidious little cube, if you fiddle around with the devices long enough, you can generally arrive at your objective. Armed with the Universal RS-232 Connector described in this article, a little knowledge, and a little patience, you should be able to greatly shorten your journeys down the often bumpy RS-232 road.

The Universal Connector is a simple, one-evening project. It is essentially a dedicated break-out board that makes the important RS-232 signals easily accessible and reconfigurable. With it, you can debug a communications link by testing a multitude of different pin configurations very quickly. It saves you the time and trouble of wiring numerous "permanent" cables before you find the magical combination that will allow the two devices to talk to one another. Before discussing the Universal Connector and its construction in detail, however, let's first look at some of the causes of RS-232-phobia.

The Root of the RS-232 Problem.

There are many reasons why connecting two devices by the RS-232

protocol can be such a headache. First of all, no computer or peripheral manufacturer follows the true and complete standard! Of the 25 pins in the protocol's standard D-type connector, only three are not assigned functions. And of the 22 pins that do have assignments, in five years of searching the author has yet to encounter a piece of equipment that uses any more than eight of them. This is, of course, the reason why the industry is now moving to a 9-pin, D-connector version of the RS-232 standard—the complexity detailed in the original specification is not needed with today's electronics.

Another main source of RS-232 aggravation is the generally poor documentation that comes with modern computers and peripherals. Most manuals now days are written for non-technical users, people who neither know nor care to know the difference between a transmit signal and a receive signal. Those who do care about such things are forced to find other reservoirs of information besides the owner's manuals. Or, more often, they simply resort to the time-proven method of trial-and-error wiring.

A third cause of RS-232 connection problems, one that is really more a blessing than it is a curse, is the sheer number of devices that have the ability to communicate via RS-232. Be-

cause there is such a vast assortment of computers, printers, plotters, scanners, and such on the market today, there would be no way to fully document all the possible interconnections. People are therefore often left to fend for themselves. This situation is further complicated by the fact that different software packages sometimes require different signals to be present on the RS-232 cable before they will operate properly.

The Universal Connector. Figure 1 is a schematic diagram of the unit. It consists of two 25-pin, D connectors, each wired to a series of small solderless circuit board sections. To test a prototype cable design with the Universal Connector, all you need to do is connect one device to each side of the Universal Connector and then use small jumper wires to test different pin linkages. You'll no longer need to solder and unsolder countless pins to debug an RS-232 junction.

Note that not all of the 25 pins are used for the unit, this being a result of the market's trend to the "abbreviated" RS-232 standard mentioned previously. Table 1 lists the names of the eight RS-232 lines that are used in this project. Although some of the older devices may use some of the other 17 pins, the vast majority of today's devices can be connected with some combination of the eight lines

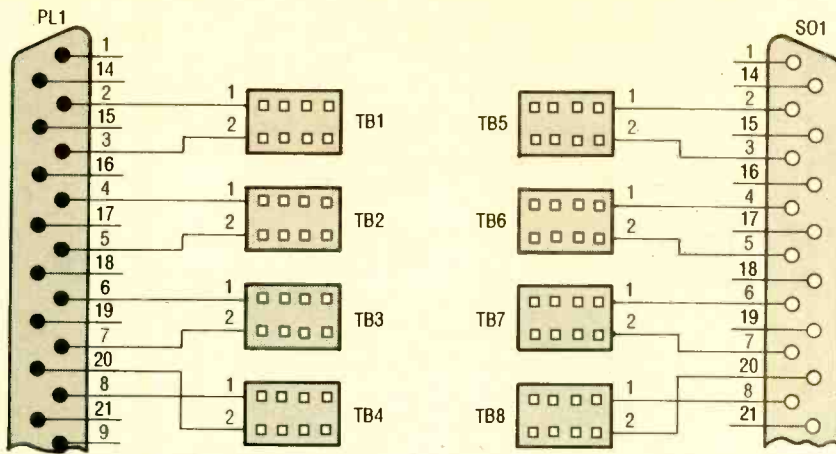

Fig. 1. The schematic for the Universal Connector reveals the simplicity of the project, but not its usefulness in debugging RS-232 interfaces.

TABLE 1—IMPORTANT SIGNALS

Signal Name	Abbreviation	Pin
Transmit Data	TX	2
Receive Data	RX	3
Request To Send	RTS	4
Clear To Send	CTS	5
Data Set Ready	DSR	6
Signal Ground	GND	7
Data-Carrier Detect	DCD	8
Data Terminal Ready	DTR	20

used by the universal connector. If you think you'll need to interface with any of those older devices, you may want to wire in some additional solderless circuit-board sections in your version of the project.

Construction. Being fairly simple,

this is an excellent project to learn to use the "iron-on PC pattern method" of board construction detailed in the July, 1990 issue of **Popular Electronics**. Another reason this project is an ideal candidate for the iron-on method has to do with the circuit's symmetry. Because of its inherent symmetry, the foil pattern given in Fig. 2 is the same as its mirror image—so there is no need to photocopy the pattern twice to obtain an inverted image.

Before you stuff the board, though, you should decide whether or not you'll want to install the finished unit in an enclosure. To facilitate easy access to all the tie-blocks, no enclosure was used for the author's prototype. Instead, rubber feet were placed on the

bottom of the PC board to prevent any accidental shorting of the board traces.

If you would like a more finished version of the Universal Connector, an enclosure would certainly be in order. One method worth considering is to use the "bottom" of a polystyrene enclosure. Such an enclosure could be configured so that the two D-connectors stick out through holes in opposing ends of the case, and the top could be quickly removed for access to the tie-block array.

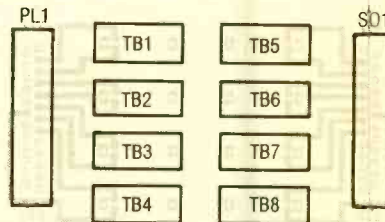

Fig. 3. The only important thing to keep in mind when stuffing the board is to place the male connector J1 (and thus the female connector J2) into the right set of holes on the board.

PARTS LIST FOR THE RS-232 UNIVERSAL CONNECTOR

- TB1-TB8—2 × 4-hole solderless circuit-board sections
- J1—25-pin, male D-connector
- J2—25-pin, female D-connector
- Printed-circuit board materials, project enclosure, labeling kit, solder, etc.

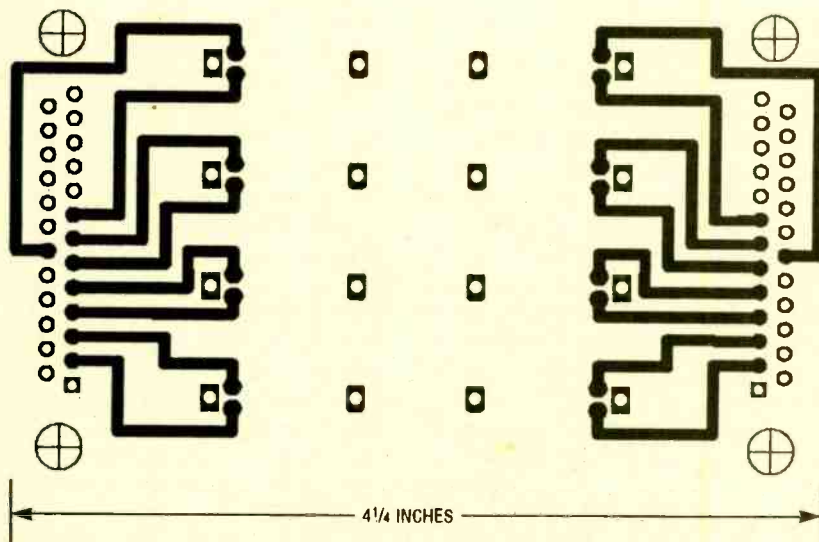

Fig. 2. This artwork can be copied onto translucent plastic for photographic board fabrication, or it can be easily duplicated directly on the PCB for the direct etch method.

Another important point to be made about the circuit is that one connector of each gender is used, and their placement is important. That may sound like a trivial point, but it could cost you hours of frustration if not attended to. Suppose, for example, you were to install two male connectors from your scrap box on a board made with the foil pattern given. Because the same genders were used, the pin numbers from the two connectors would not be aligned, and you would not be connecting the pins you thought you were.

With these simple considerations, you should be able to build your own Universal Connector easily enough. Once completed, it should simplify your next RS-232 job so you can move on to better things.

ANTIQUÉ RADIO

By Marc Ellis

Cleaning Up The Sky Buddy

Last month, we finally rolled up our sleeves and got started on the Sky Buddy restoration project that we've been talking about, off and on, since the May issue. For those who have just joined us, the Sky Buddy (otherwise known as the Model S-19R) was introduced in 1939 by Hallcrafters. As the bottom-of-the-line model, it was a very popular starter set for teenage hams and shortwave listeners during the late pre-World-War-II era. Though it sold for only \$29.50, the sturdy little radio offered professional features, wide



The partially cleaned main chassis. The area shown at the left has been washed and wiped; the area at the right is still "as found."

coverage, and good performance.

At the close of the last column, we had partially disassembled the set to gain access for cleaning and restoration—removing the speaker, the main tuning dial, the tuning/bandspread capacitor subchassis, and all front-panel knobs. This month, the cleaning/restoration process can actually begin—so let's get to it.

CLEANING STRATEGIES

While our S-19R was not really in bad condition cosmetically, it had obviously spent some time stored in a less-than-ideal location. The top surface of the chassis, as well as all of the above-the-chassis parts, were coated with heavy grime combined with a touch of corrosion. The first area to be cleaned was the chassis itself, which happens to be coated with black, semi-gloss paint.

I began by wiping down the chassis with a rag soaked in a mild solution of dishwasher detergent, using a small screwdriver to force the rag into difficult-to-reach corners. Following that were a couple of wipe-downs using rags dampened with plain water. This left the painted surface clean, but blotchy and dull looking. There were also a couple of small areas that were extra rough due to patches of corrosion under the paint.

Since I had some very fine (triple-zero) steel wool on hand, I decided to try that on the roughened areas. But as one might expect, the paint started to flake off rather than smooth out—exposing raw metal underneath. Accordingly, I decided to leave those areas alone—especially since they were in inconspicuous locations.

To get rid of the blotchy, dull-looking effect, I polished all of the painted surfaces with a cleaner/wax made for automotive use. That didn't exactly make the chassis look like new (which probably would be inappropriate, anyway), but the

overall impression was now much more uniform and attractive.

The unpainted metal components, such as the IF transformer cans and speaker housing, were a different problem. Those were coated with a yellowish deposit, slightly pitted in spots, that my detergent solution wouldn't budge. Even a rubbing with Brasso—normally very effective in restoring luster to grimy metal parts—didn't help a whole lot.

In an experimental mood, I dampened a piece of the triple-zero steel wool with Brasso and rubbed with that. It worked like a charm! With very little effort, I was able to remove the yellow deposit and buff the metal to a like-new appearance.

The IF transformer cans were a little easier to clean than the speaker housing, because the latter had many hard-to-reach nooks and crannies. Liberal use of Q-tips removed most of the loose dirt from the difficult spots around the housing. And I restricted the steel-wool-and-Brasso work to accessible areas that were in full view. While I can't say that the cleaned-up speaker looks absolutely perfect, the overall effect is quite convincing.

THE MAIN TUNING/ BANDSPREAD SUBCHASSIS

The subchassis holding the main-tuning/bandspread capacitor, the bandspread dial, and the main-tuning/bandspread dial drive systems was removed for reasons that

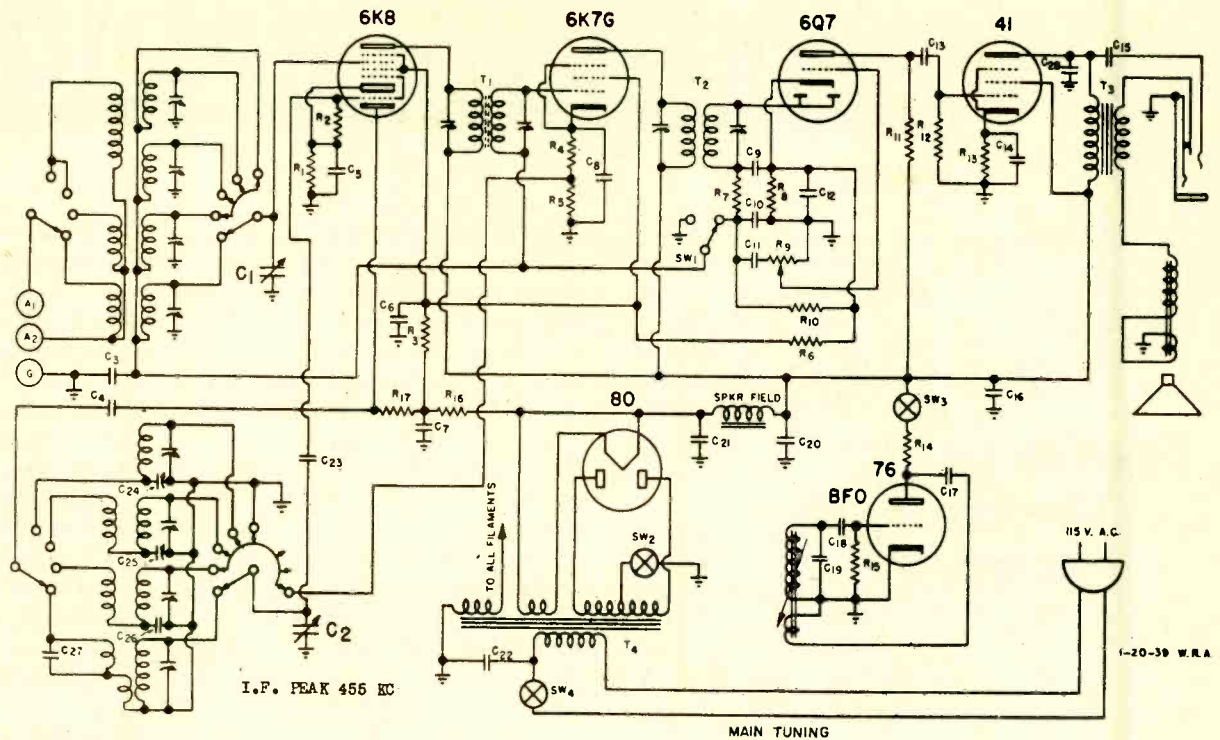

Figure 1. The Sky Buddy schematic shows the set's simplicity of design.

went beyond ease of cleaning. For one thing, removal of this unit would make it possible to replace the shock-absorbing grommets (now quite hardened) on which it was mounted.

Removing the unit would also make it possible to replace the dial cord in both the main-tuning and bandspread drives. While both drives were functioning when the radio came into my hands, experience has shown that dial cords in long-unused sets frequently break soon after being placed into service again.

As it happens, the Rider Manual data for the S-19R does not include a dial-cord stringing guide. So before taking off the old cords, I was careful to make an accurate diagram of their configuration. And after using the diagram for restringing, I slipped it into a labeled envelope—which I inserted in Riders at the S-19R page for possible future use.

To complete the work on this subchassis, I removed

the old shock-mounting grommets from the mounting holes in the main chassis, inserting a fresh set of grommets in their place. Finally, cleaning of the painted and unpainted parts on the subchassis proceeded as already described for the main chassis.

With the work on the subchassis completed, I turned my attention to the S-19R's rather tired-looking and grimy cabinet/front panel. A dishwasher-detergent-and-water sponge bath—followed up with a couple of plain-water rinses—did wonders for the appearance of the finish.

The Sky Buddy is now ready for reassembly and testing, but I haven't done that yet! More later.

SKY BUDDY CIRCUITRY

Since I don't have any more restoration news to report at this time, I thought I'd use my remaining space to talk about the Sky Buddy's circuitry. I haven't yet shown

a schematic diagram of the S-19R, and this looks like a good time to do so.

The schematic shown in Fig. 1 is for a slightly earlier version of the S-19R than the one I have; it doesn't show the plug for external battery power that is one of the features of my unit. However, it should be otherwise almost identical.

The first thing you might notice on the schematic is that this radio has a transformer power supply (utilizing the ubiquitous type-80 rectifier tube). That's a nice touch for an inexpensive radio. During the late 1930's, when the S-19R was released, transformerless (AD-DC) designs were very common among low-end sets. Such sets presented a definite electric-shock hazard, had shorter tube life than transformer sets, and, because of their lower operating voltages, did not perform quite as well.

Moving to the front end of the radio, you'll see that there are four sets each of

switch-selected antenna and oscillator coils. These provide the set with its four bands (540 kHz to 1700 kHz, 1.7 MHz to 5.5 MHz, 5.5 MHz to 17.0 MHz, and 16.0 MHz to 46.0 MHz).

A type-6K8 tube functions as the oscillator-mixer. The signal from the antenna circuit enters it and is mixed with a signal generated by the oscillator section of the tube to create a third signal equal to the difference in frequency between the original two. This lower frequency signal, known as the *intermediate frequency* (IF) is amplified by the IF tube.

The schematic shows a type 6K7G as the IF tube and a 6Q7 at the detector-first audio amplifier position. The latter tube removes (or "detects") the audio from the IF signal and provides some amplification.

In my slightly later model S-19R, these tubes were replaced, respectively, by types 6SK7 and 6SQ7. The latter are electronically

(Continued on page 88)

COMPUTER BITS

By Jeff Holtzman

Integrated Software Tools

For the last few issues, we've been talking about evolution in the computer industry. As hardware evolved from mainframe to mini to personal computer, software in turn evolved from batch to interactive to integrated tool sets. Integrated tool sets run in graphical environments (e.g., Windows, Macintosh, OS/2), and provide special capabilities for cooperation among applications. The third wave is just getting started; it is built on cooperation provided by technologies including Dy-

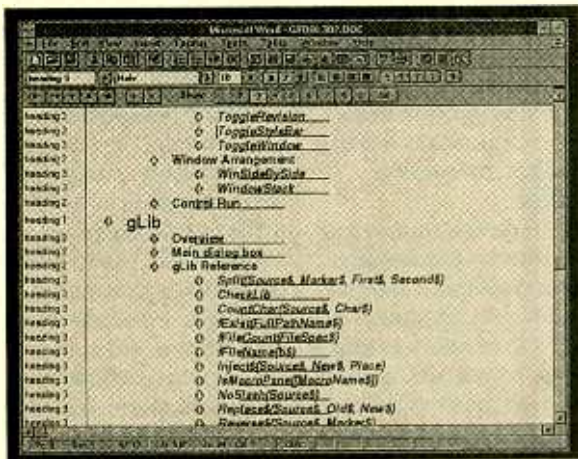

Microsoft's Word For Windows version 2.0 provides an outline mode that allows you to see the forest without getting lost in the trees.

namic Data Exchange (DDE), Object Linking and Embedding (OLE), and Inter Application Communications (IAC).

MY FRIEND THE PSYCHOLOGY PROFESSOR

"Who needs Windows? Who needs a 386? All I do is word processing, and my XT works just fine for that. I type up class handouts, write occasional journal articles and departmental memos,

and that's about it. Who needs all that technology?" So says a friend, a professor of psychology, and he got me thinking. Maybe I have become an unwitting dupe, eagerly embracing each new wave of technology. Maybe it's time to get back to basics. Maybe I should erase 100MB of Windows programs from my hard disk and go back to using my old faithfuls from the early and mid 1980's. Then I could forget about new hardware and software upgrade costs, not to mention the cost of learning new packages.

Then I started asking myself what I would have to give up to do so. And the more I thought about it, back to basics seemed less and less appealing. The reason is that I've grown accustomed to using tools (e.g., word processor, spreadsheet) in ways that far outstrip the real-world analogs they're based on (e.g., typewriter and calculator). In other words, I don't just use a word processor for typing. I don't just use spreadsheets for adding, subtracting, multiplying, and dividing.

I use my word processor as a planning and organizational tool, as a tool for integrating documents from multiple authors and with multiple types of data (text, graphics, and numeric tables) for occasional desktop publishing. I use my spreadsheet for budgeting and tax planning, for comparative equipment reviews, and as a miniature project-specific database. If I gave up the tools, I'd give up the ability to perform

that type of work (and many others as well). Then I'd have to become a hermit, because my livelihood depends on performing those tasks in that way.

But what about my friend the psychology professor? What about other people in other walks of life who have neither the time for nor the interest in learning deep usage of modern computer-based tools? Is there not a gap between what they could be doing and what they are doing? Assuming they recognize the gap and want to bridge it, how are they ever going to learn what they need to know, while maintaining their present positions?

Some will learn and some won't. The ones who won't will decide either that they can't do it or that they don't need to. They'll make cynical cracks about overblown technology, but secretly look on in envy as their younger colleagues master it and use it to produce superior work. As for the ones who will (this includes 99% of **Popular Electronics** readers), they'll start out slow, tentative, hesitant. They'll try something new and get burned by it. But they'll learn something. And they'll keep butting their heads up against the wall, gradually amassing a set of skills that will make them invaluable in today's troubled job market.

The ones who don't will sit back and wonder why they can't get good jobs, blaming society, school, and even family. Maybe someday they'll recognize that the "computer" way of doing things is not some

flash in the pan, nor is it something just for super *techies*. Those who get started early will lead in both job satisfaction and income. Those who don't will wonder what happened.

Enough sociology. Let's see what some of these advanced features are and how to use them. For the remainder of this column and for the next few months, I'll talk about the advanced capabilities of a core application that nearly all computer users use: the word processor. For purposes of discussion, I will use the world's most advanced word processor for PC's, Microsoft's Word for Windows 2.0 (WW2). I don't want to start a "religious war" over that statement. Understand that I have used all of the major and most minor word

processors, and I keep coming back to WW2. WinWord has its faults (particularly in graphics handling and desktop publishing), but it's still light-years ahead of all other PC-based word processors (except possibly AmiPro).

I'm not going to provide a laundry list of features; for that you can contact Microsoft directly. My focus here will be on features beyond basic typing and formatting. If you're interested in picking up a copy of WW2, call Microsoft at 800-323-3577, Dept. Y11. Although the list price is about \$500, the 800 number provides upgrades for \$129.

WINWORD 2.0

WW2 has four major features that are useful for advanced work: Outlining,

styles, templates, and the Word BASIC macro language. This time we'll talk about the first three of those features; we'll devote next month's column to Word BASIC.

Outlining allows you to zoom in and out on the structure (not the physical formatting) of a document, and it allows you to move things around in a simpler manner than using cut-and-paste or block moves, as in typical word processors. Outlining allows you to get organized, to stay organized, and to appear organized. Outlining allows you to start off with a random mass of notes and ideas, and gradually meld it into an organized jewel that's sure to impress your teacher, professor, or boss. By way of contrast, programs like WordPerfect allow you to print outline-like numbers in front of selected paragraphs, but these programs do not give you organizational capabilities.

In the outline mode, you can focus on the skeleton of your document, the hierarchy of heading levels that break topics into sub-topics, sub-sub-topics, etc. Special keystrokes and mouse clicks allow you to promote and demote heading levels; when you move text at one level, all subordinate text can optionally move with it. In addition, you can display just some heading levels, all heading levels, everything in the document—or anything in between.

Outlining works in close conjunction with styles. A style is a collection of formatting attributes, such as typeface (bold and italics), line spacing, and indentation. Every paragraph has a style; unfortunately, WinWord currently does not allow styles at larger (page, section) or smaller (sen-

tence, word, character) levels.

WinWord contains several built-in styles for normal text, outline levels 1-9, headers and footers, footnotes, table of contents, index, and more. You can customize the built-in styles in any way that the program allows. You can then combine specific collections of styles (and other information as well) into document templates. You can create different templates for different types of documents; e.g., business letters, personal letters, book reports, science reports, memos to your boss, weekly bowling scores, and so on. A little up-front planning and developing standard templates can save countless hours later on. Word comes with a set of templates that you can use as a starting point for developing your own.

Maybe now you can see why my friend, the psychology professor, is missing the boat. He's stuck in WordStar 3.3 (or is it WordPerfect, or MultiMate, or DisplayWrite?), using the tool as a fancy typewriter. He wastes time reformatting text over and over again as he rewrites it. He has no clean way of brainstorming and reorganizing his thoughts. And he has no significant macro language for really making his tool jump through hoops. And that's where we'll pick up next time. ■

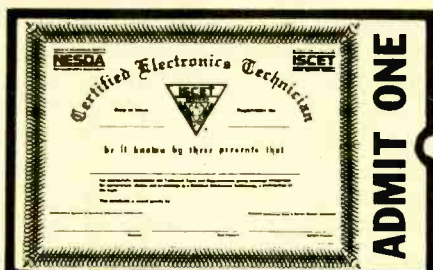

Your Ticket To SUCCESS

Over 28,000 technicians have gained admittance worldwide as certified professionals. Let your ticket start opening doors for you.

ISCET offers Journeyman certification in Consumer Electronics, Industrial, Medical, Communications, Radar, Computer and Video. For more information, contact the International Society of Certified Electronics Technicians, 2708 West Berry Street, Fort Worth, TX 76109; (817) 921-9101.

Name _____
Address _____
City _____
State _____ Zip _____

Send material about ISCET and becoming certified.

Send one "Study Guide for the Associate Level CET Test." Enclosed is \$10 (inc. postage).



"No, it's not an old fashioned floppy disk, it's called a record album."

CIRCUIT CIRCUS

By Charles D. Rakes

Fun With Tesla Coils

One of the most popular parts of the electronics hobby are high-voltage projects. So this time around, we're going to look into some of the aspects of high-voltage and wireless-energy transmission circuits. If you have always wanted to dabble with high voltage, but didn't want to spend a bundle for hard to get parts, then why not try Mr. Tesla's energy-transmission scheme—better known as the Tesla Coil.

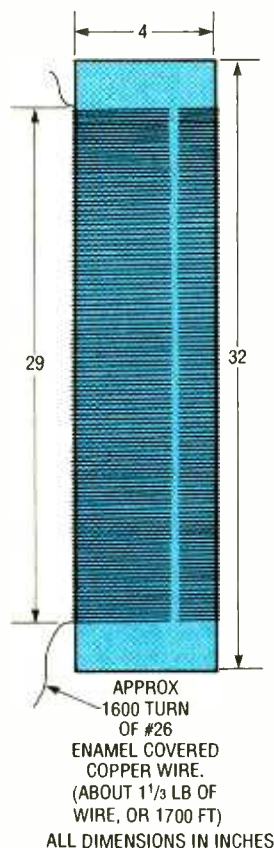

Fig. 1. The secondary coil was made by close winding 1600 turns of #26 enamel-coated copper wire over about 29 inches of a 32-inch length of 4-inch diameter plastic sewer pipe.

TESLA COIL

The most important part of the Tesla coil is the secondary coil, which produces the high-voltage (corona discharge) in the classic Tesla-coil circuit. A typical Tesla secondary coil consists of a low-loss coil form several inches in diameter wound with a single layer of small insulated wire with a winding length of 3 to 9 times the form's diameter.

Our coil (see Fig. 1), a $\frac{1}{4}$ -wavelength self-resonant hand-wound unit, was made by close winding 1600 turns of #26 enamel-coated copper wire over about 29 inches of a 32-inch length of 4-inch diameter plastic sewer pipe. After winding the coil, two small holes were drilled at each end of the form, and the ends of the wire were laced through the form to hold the windings in place. Next, several coats of a non-conductive, fast-drying, clear-plastic spray paint

WARNING!! This article deals with and involves subject matter and the use of materials and substances that may be hazardous to health and life. Do not attempt to implement or use the information contained herein unless you are experienced and skilled with respect to such subject matter, materials and substances. Neither the publisher nor the author make any representations as for the completeness or the accuracy of the information contained herein and disclaim any liability for damages or injuries, whether caused by or arising from the lack of completeness, inaccuracies of the information, misinterpretations of the directions, misapplication of the information or otherwise.

were placed on the windings—allowing at least 12 hours of drying time between each coat. Your coil's construction needn't be an exact duplicate of ours. Just about any 3- to 6-inch diameter plastic pipe (or other insulating material) may be used as the coil form.

Winding between 1500 and 1800 feet of wire on the form places the coil's $\frac{1}{4}$ -wavelength resonant frequency somewhere between 150 and 300 kHz. Any good-quality, enamel-covered copper wire from #24 to #32 may be used. In fact several different secondary coils were used in all of the experiments with similar results.

FREQUENCY CHECK

Figure 2 illustrates a simple method of determining the coil's $\frac{1}{4}$ -wavelength resonant frequency using an audio-frequency generator and a simple tuning-indicator circuit. To use that set-up, place the coil on an insulating object, such as a wooden chair, desk, or a stack of books, making sure that it is away from any metal objects. Connect the bottom end of the coil in series with one of the tuning-indicator circuits shown in Figs. 3 through 5; connect the other end of the tuning indicator to the output of an audio generator, as shown in Fig. 2. The generator should have a maximum frequency range of at least 200 to 300 kHz. The AF generator's ground or low output terminal is not used in this test.

Set the generator for maximum output amplitude

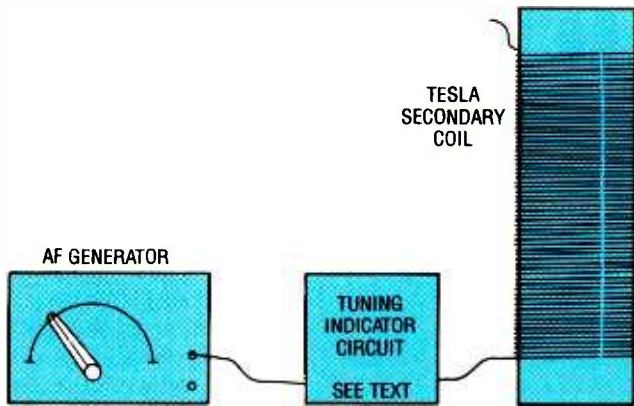

Fig. 2. You can use a set-up like the one shown here to determine the secondary coil's 1/4-wavelength resonant frequency.

and frequency of 100 kHz. Slowly increase the frequency until the tuning indicator produces a maximum output. At resonance, the current flowing into the coil will be at its maximum.

The 1/4-wavelength Tesla coil at resonance operates similarly to an open-ended 1/4-wavelength transmission line, which at resonance has a high impedance at its open end and a very low impedance at the opposite end. That's an almost ideal arrangement because the maximum voltage is produced at the open end or top end of the coil, where the losses are the least and the impedance is at its maximum. Since the coil's resonant frequency is set by its inductance and distributed capacitance, changing either will vary the coil's resonant frequency—adding either inductance or capacitance will lower the coil's frequency, and reducing either will increase the frequency.

The Tesla coil's main attraction is the fiery corona discharge that occurs at its top terminal. But to operate the Tesla coil in the wireless-energy transmission mode, the corona discharge must be eliminated. Corona occurs when the terminal area (at the coil's top) is small enough to allow the

top of the coil form. Re-tune the coil for maximum output and note the indicator's output as you bring your hand to and from the top of the coil. When the Tesla coil is tuned to resonance, it is very sensitive to nearby conductive objects.

Leaving the generator set to the coil's resonant frequency, take a fluorescent lamp and hold it near the top of the coil. If your generator is producing an output of at least 15 to 20

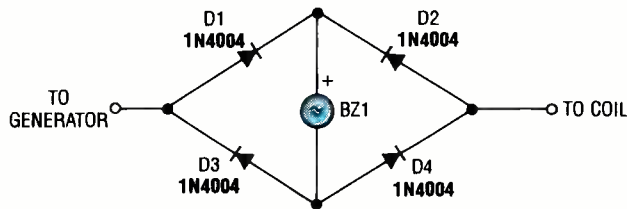

Fig. 3. This circuit can be used as a tuning indicator when attempting to determine the Tesla coil's resonant frequency. As the coil's resonant frequency is approached, the buzzer (BZ1) output should become louder.

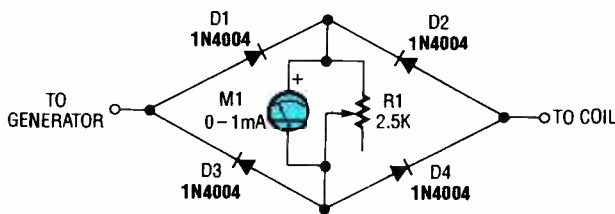

Fig. 4. As an alternative to the tuning indicator in Fig. 3, this circuit is designed so that resonance can be determined visually. Maximum current flows to the meter when the coil is at resonance.

energy to escape; that's what forms the corona. By increasing the area of the top terminal, the corona can be eliminated and energy transfer will occur in the wireless mode. Also, when the area of the top terminal is increased, the resonant frequency of the coil is reduced due to increased capacitance.

With the coil connected in the frequency-test mode, as shown in Fig. 2, connect a large metal object (say a 6- to 8-inch metal pan) to the discharge end of the coil and set the pan on the

volts, the lamp should glow indicating the transmission of energy from the coil. If not, carefully re-tune the AF generator for maximum output with the lamp close to the coil. If you can not get the lamp to light, it's most likely due to the low output of your generator.

VARIABLE-FREQUENCY OSCILLATOR

A simple Tesla-coil driver circuit can be made from a 567 tone decoder (U1) configured as a variable-frequency oscillator, as shown in Fig. 6. The os-

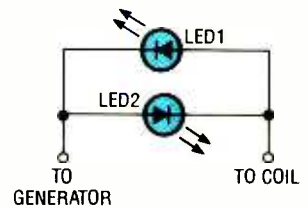

Fig. 5. The two-LED circuit shown here is a very low-cost alternative to the visual tuning indicator shown in Fig. 4. The LED's will glow their brightest, when the coil reaches resonance.

illator's frequency of operation is set by C5, R1, and R3. The squarewave output of the oscillator at pin 5 of U1, drives the gate of an IRF511 hexFET (Q1). The hexFET's drain is connected to the primary of a hand-wound step-up transformer.

A 7808 8-volt regulator supplies power to the 567 to keep its frequency stable during various loads and input voltages. The two LED's at the transformer's output serve as a built-in tuning indicator. Switch S1 is used to select between the low-power TUNE position or the full-power OPERATE position.

The output transformer was wound on an Amidon Associates, Inc. (2216 East Gladwick St., Dominguez Hills, CA. 90220) EA-77-250 ferrite "E" core, which is supplied with a bobbin. The coil was made by close winding 15 turns of #26 enamel-coated copper wire on the bobbin, and then covering it with a layer of plastic tape. That winding serves as the transformer's primary winding. After that, 120 to 150 turns of #26 wire were close-wound on top of the primary winding and covered with a layer of tape. The bobbin was then placed on the "E" core. Tape was snugly wrapped around the entire assembly to hold it together.

Once the Fig. 6 circuit is completed, connect the

PARTS LIST FOR THE TESLA COIL

SEMICONDUCTORS

U1—567 tone decoder, integrated circuit
 U2—7808, 8-volt, 1-amp, voltage regulator, integrated circuit
 Q1—IRF511 hexFET
 LED1, LED2—Light-emitting diode (any color)

RESISTORS

R1—1000-ohm, 1/4-watt, 5%
 R2—100-ohm, 1-watt, 10%
 R3—25,000-ohm potentiometer

CAPACITORS

C1—C4—0.1- μ F, 100-WVDC, ceramic-disc
 C5—680-pF, 100-WVDC, ceramic-disc
 C6—470- μ F, 50-WVDC, electrolytic

ADDITIONAL PARTS AND MATERIALS

T1—(see text)
 S1—SPDT switch
 Perfboard materials, Amidon EA-77-250 ferrite core and bobbin, enclosure, 32-inch length of 4-inch diameter plastic sewer pipe, about 1 1/2 pounds of #26 enamel covered copper wire, clear spray paint, IC socket, 18–24-volt power source, knob, wire, solder, hardware, etc.

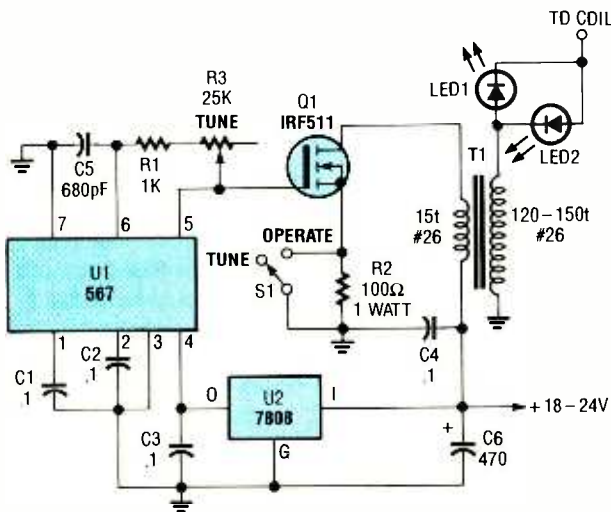

Fig. 6. This circuit, when coupled with the jumbo coil outlined in Fig. 1, produces a complete Tesla coil.

output of the circuit to the bottom end of the Tesla coil. Place S1 in the TUNE position and slowly increase the oscillator's frequency from its low end upward until the two LED's glow their brightest, indicating resonance. Switch S1 to the OPERATE position and bring a fluorescent lamp close to the top of the coil. Re-tune the circuit if necessary to maintain the maximum LED

output as you move the lamp around the coil. Just about any incandescent lamp will produce a beautiful colored display when positioned near the coil. Hold the lamp by the screw end connection and move the glass bulb to within an inch of the coil. If you would like to see more on the Tesla coil experiments just let me know via the magazine. ■

Be an FCC LICENSED ELECTRONIC TECHNICIAN!

Earn up to \$30 an hour and more!

Learn at home in spare time. No previous experience needed!

No costly school. No commuting to class. The Original Home-Study course prepares you for the "FCC Commercial Radio-telephone License." This valuable license is your professional "ticket" to thousands of exciting jobs in Communications, Radio-TV, Microwave, Maritime, Radar, Avionics and more...even start your own business! You don't need a college degree to qualify, but you do need an FCC License.

No Need to Quit Your Job or Go To School
 This proven course is easy, fast and low cost! **GUARANTEED PASS**—You get your FCC License or money refunded. **Send for FREE facts now. MAIL COUPON TODAY!**

COMMAND PRODUCTIONS
 FCC LICENSE TRAINING, Dept. 100
 P.O. Box 2824, San Francisco, CA 94126
 Please rush **FREE** details immediately!

NAME _____
 ADDRESS _____
 CITY _____ STATE _____ ZIP _____

PCB and SCHEMATIC C.A.D.

EASY-PC

\$195

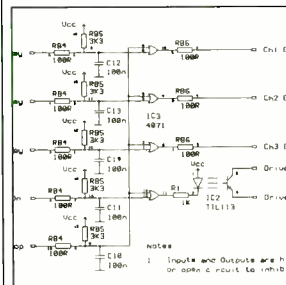

- Runs on PC/XT/AT/386/486 with Herc, CGA, EGA or VGA.
- Design Single sided, Double sided and Multilayer boards.
- Provides Surface Mount support.
- Exceptionally fast operation.
- Standard output includes Dot Matrix / Laser / Inkjet Printer, Pen Plotter, Photo-plotter and N.C. Drill.
- Award winning EASY-PC is in use in over 12000 installations in 70 Countries World-wide.
- Very easy to learn and use.
- Not Copy Protected.
- Dealer/Distributor enquiries welcome.

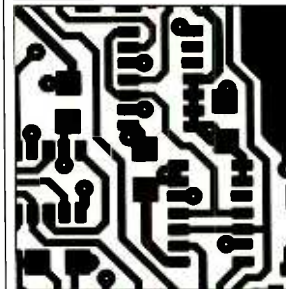

Options - 500 Piece Surface Mount Library \$112
 1000 Piece library \$75.00 Gerber Import facility \$195.00

For full details write, call, fax or use Inquiry #

Number One Systems Ltd. 1
 REF.- PEUSA, HARDING WAY, SOMERSHAM ROAD, ST. IVES, HUNTINGDON, CAMBS, ENGLAND, PE17 4WR

Telephone
 USA: 011 44 480 61778 (7 lines)
 Intrl: +44 480 61778
 FAX: 011 44 480 494042

BRITISH DESIGN AWARD 1989

AMERICAN EXPRESS, MASTERCARD and VISA WELCOME.

CIRCLE 5 ON FREE INFORMATION CARD

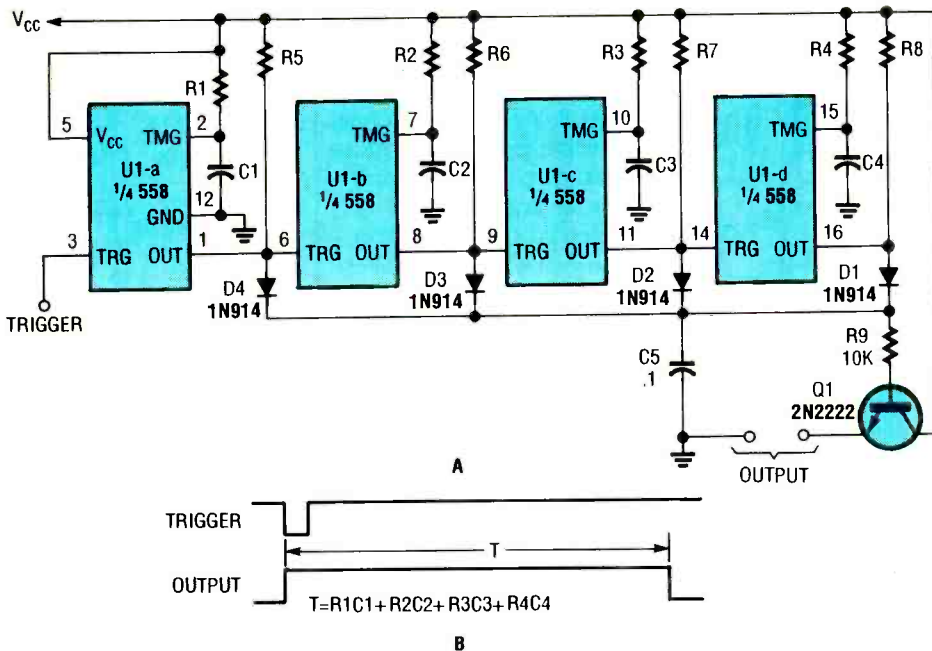

Fig. 2. This monostable circuit is ideal for generating extremely long output pulses: just the thing for an automatic shop-light, turn-off switch.

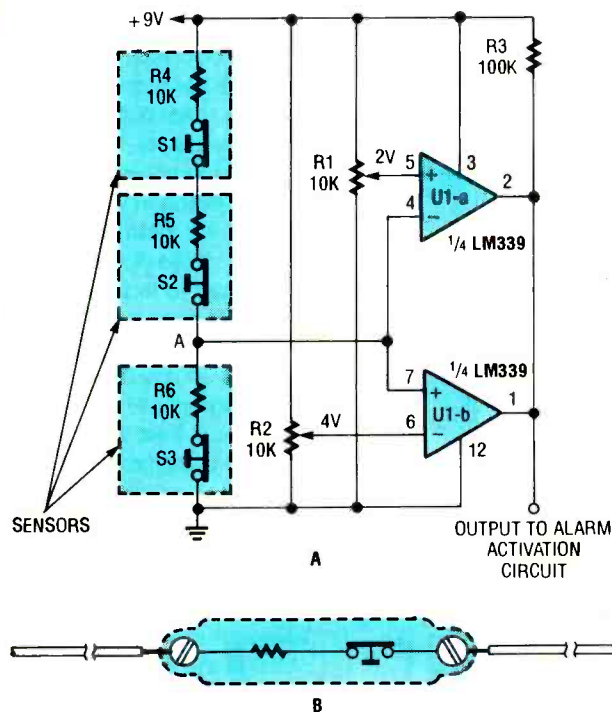

Fig. 3. This non-bypassable alarm system will stop even a moderately clever thief. Even if he's equipped with a multimeter and a variable resistor so he can replace the sensor resistance, he'll still have to do it without a lapse in the loop's correct current flow.

cue the devices you wish to sequence.

LONG-PERIOD MONOSTABLE

If you want to build a monostable timer with an

output that becomes active immediately after being triggered and remains that way for a prolonged period of time, check out the circuit in Fig. 2A. It is very much like the circuit back in

Fig. 1A, however the outputs are connected to diodes as well as to successive 555 sections. The diode config-

uration acts as a logical or gate, so if any one of the four outputs is high, that high is presented to Q1 via R9, activating the transistor. The resulting output is as long in duration as the sum of all four timing periods (see Fig. 2B).

Since it naturally takes a few nanoseconds for any of the sections to produce a high output once triggered (or even forward bias its diode), there will be brief moments during the timing period when no output is high. Capacitor C5 drives Q1 during those instants to heal over those small lapses.

Circuits like these are really pretty useful. For example, with a little additional circuitry (see the *Think Tank* entitled "Triacs and Power Control," December 1991), you can use



AN ECONOMICAL KEYBOARD-CONTROLLED KEPCO BENCH POWER SUPPLY 75 WATTS

Choose from four Digital Power Supplies: 0-12.5V @ 6A, 0-24V @ 3A, 0-40V @ 2A or 0-125V @ 0.5A. Each one offers precise, repeatable voltage control with two current ranges. Fully protected for overvoltage or overcurrent.

Bonus: You can program the output from your PC's serial port (RS232 software included) and read back too!

The DPS is an affordable professional instrument and belongs on your bench.

Want more info? Ask for "DPS" brochure, 146-1768. Call-write-fax: Dept. MXS-77, Kepco Inc. 131-38 Sanford Avenue, Flushing, NY 11352 USA • Tel: (718) 461-7000 • Fax: (718) 767-1102. Use your VISA or MASTERCARD. Immediate delivery, 5-year warranty.



CIRCLE 12 ON FREE INFORMATION CARD

it to activate a light in your workshop for say two hours and automatically shut it off if not re-triggered. However, using the last section to activate a lights-out warning indicator (an LED, buzzer, or other pesky device) is a good idea to keep you from finding yourself in the dark.

Next month, I'll continue to explore 558 timer applications by presenting some astable-timer circuits. As for now, let's get to your letters.

IT'S ALARMING

After studying various alarm projects in *Think Tank*, I can see that they all have the same drawback: a bypassed sensor will defeat the system. The circuit I've devised (see Fig. 3A) can be combined with many of the previously featured alarm circuits to eliminate that problem.

The circuit uses an LM339 quad comparator configured as a window comparator. For the circuit to work, the normally closed sensors you use must be modified as follows (see Fig. 3B): Each sensor must have a resistor concealed within its casing and in series with its switch. That way a sensor with a closed switch will act as a resistance and an open one will simply be left open as usual.

However many switches you use, they must be connected in series to form a "closed sensor loop." One lead of the loop must be connected to the supply voltage, the other lead goes to ground. The loop must be tapped at some point and connected to point "A," which is the junction of the - input for U1-a and the + input for U1-b. Each comparator has its threshold set by a variable resistor (R1 or R2) connected between the +V

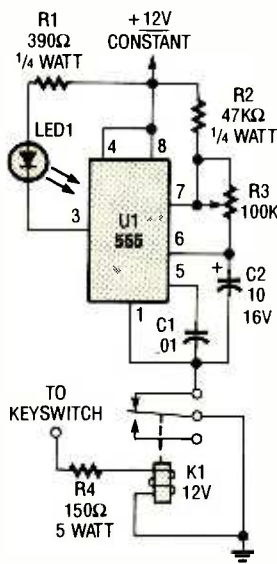

Fig. 4. An inexpensive LED flasher could save you the expense of having your car stolen. It fools a would-be thief into passing your car by.

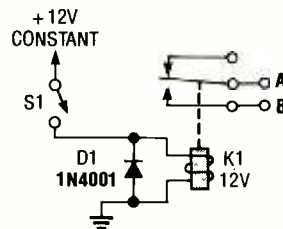

Fig. 5. Unless a car thief can find S1 (or K1 if he has some wire), any car with this circuit installed is not going to cooperate with him.

supply and ground. Since the LM339 has open-collector outputs, wiring them together and connecting them to R3 as shown allows the circuit to generate the logical OR of their outputs.

In the example circuit, there are three sensors each containing a 10k resistor. With a 9-volt supply, point "A" will be at 3-volts when all switches are closed. If we set R1 to supply 2 volts to U1-a and set R2 to supply 4 volts to U1-b, both the comparators will output a low.

If sensor-switch 1 or 2 is bypassed, point "A" will rise to 4.5 volts sending the output of U1-b high. If sensor-

switch 3 is bypassed, point "A" will drop to near ground sending the output of U1-a high. If any sensor switch is opened, point "A" will move towards ground or supply (depending on which switch is opened), setting one or the other of the comparators high. Any of those actions can be used to trigger an appropriate alarm-activation circuit.

The values of all the resistors—fixed and variable—can be experimented with except for R1. If the total loop resistance is at least 10k, then less than 1 mA will be drawn by the circuit with a 9-volt supply.

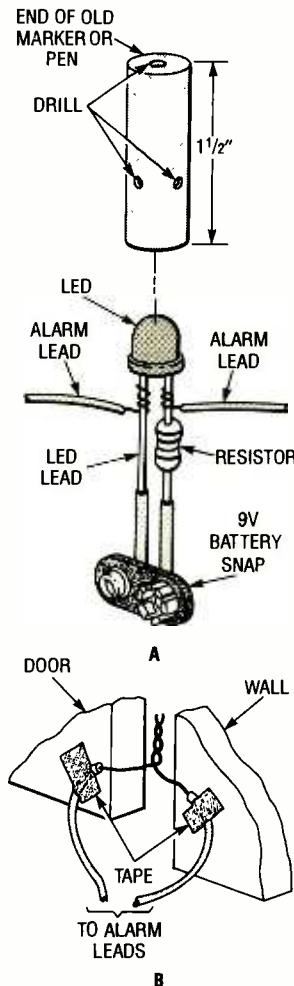

Fig. 6. This simple intrusion-indicator circuit can be made for mere pennies, but it effectively tells you if someone's been snooping around.

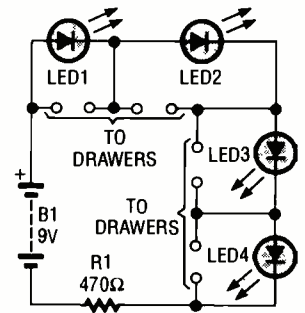

Fig. 7. This multi-point intrusion detector lets you know how adamant a busybody was and what areas have been breached.

The more sensors used, the smaller the change in voltage at point "A" when a sensor is bypassed. That means you will have to adjust R1 and R2 closer to the voltage at point "A" when the loop is complete. By the way, minor power supply variations will not effect operation because the comparator responds to voltage ratios rather than absolute values.

Don't worry about the sensors being in view as long as the internal resistors are not visible. You might even want to leave a clip-lead laying on the windowsill!

—Steven Jay Babbert, Worthington, OH

I like it. A thief would have to have a multimeter, a capacitor, a high-value resistor, and a variable resistor just to defeat this system. First he'd have to measure the voltage drop across the sensor, then the current through the sensor without breaking the loop. From that he could use Ohms law to calculate the value of the sensor's resistance and set the variable resistor accordingly, so that it can be used as a substitute for the sensor.

However, to keep the alarm from sounding during the swap, the voltage across the sensor leads should be maintained. To (Continued on page 88)

DX LISTENING

By Don Jensen

Exploring The Lower Shortwave Bands

If you like your DX'ing down and dirty, how about the 120-meter tropical band. It's "down" because that frequency segment, nominally 2,300 to 2,495 kHz, is the lowest of the shortwave bands. And it's "dirty" because it can be static plagued, a flat-out assault on your ears. In fact, some listeners have never heard anything way down here except for the time-ticking WWV on 2,500 kHz. But as ace Canadian DX'er

uses 2,390 kHz and sometimes can be heard at about 1200 UTC sunrise.

There are a few low-powered Brazilian stations on the 120-meter band that can be heard when conditions are right at about an hour or so after your local sunset, or when they sign on about 0700 to 0800 UTC.

The Australian Northern Territories Service has three domestic outlets in the outback that broadcast on 2,310, 2,325, and 2,485 kHz, Dave notes. All can be heard on occasion during your sunrise time slot. If the Australians are audible, try 2,410 kHz. You might be lucky enough to catch *Radio Enga*, one of the provincial stations of Papua, New Guinea. There are also one or two low-powered Indonesian stations still operating on 120 meters, but it's rare, indeed, that they are heard except near the pacific coast.

Mid-Winter should bring some early morning reception of Chinese regionals, such as the *Fujian Peoples Broadcasting Station* on about 2,340 kHz, *Jiangxi PBS* on 2,445 kHz, and *Zhejiang PBS* on 2,475 kHz. Dave also notes that you may also hear harmonic signals, unintended transmissions on multiples of their fundamental medium-wave frequencies. Examples: The second harmonic of *Radio HIN* in Santiago, Dominican Republic on 2,441 kHz (2 times 1220 kHz medium wave) or the third harmonic of *Radio Paradise* on the Caribbean island of St. Kitts on 2,475 kHz (3 times 825 kHz).

Good luck! It may not be

easy, but the challenge of tuning in the toughies can be a lot of fun.

BETHANY UPDATER

In the May, 1992 column, we profiled the *Voice Of America's* transmitter site at Bethany, OH. In response, we got a nice letter from station staffer John Vodenik, who wrote: "It is really great that we are getting so much media support. The staff here really enjoys seeing ourselves mentioned. I feel I should make a correction. The Bethany relay was never off the air. We remained on with the Collins transmitters while the old Crosley units were removed and the new transmitters installed. There never was a chance that Bethany would be shut down.

"We have now returned to our full complement of transmitters, six 250-kilowatt AM broadcast transmitters and two feeder transmitters. This brings our carrier power up to 1.6 megawatts. The Crosley transmitters were rated at 175 kW. The *Voice of America's* 50th anniversary was Feb. 24 of this year, and Bethany was the first VOA station on the air. We went on with the 10-kilowatt RF drivers connected to the antennas, while the power amplifiers were being built and tested. This has been told to me by former Crosley Broadcast people who were here when VOA started.

"The QSL card marks the 50th anniversary of the Bethany relay station. So far, some 500 cards have been mailed to listeners. I am in charge of the QSL program

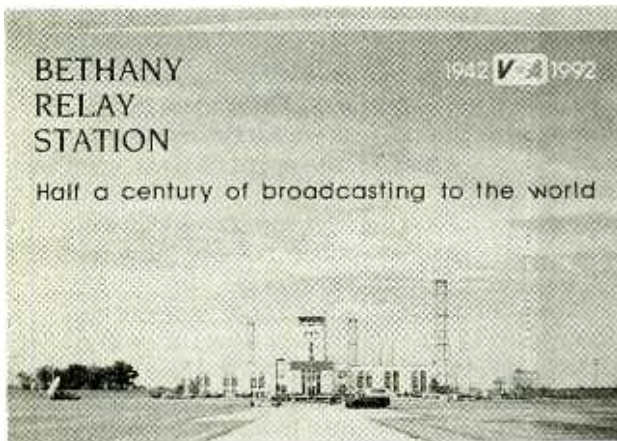

This special card is being sent by the *Voice Of America* to SWL's who send correct reports of their loggings of VOA's Bethany, OH relay station.

Dave Clark points out in a recent issue of the *North American Shortwave Association Journal*, they can offer a real challenge to the serious SW-listening enthusiast.

During the colder months ahead, Dave suggests, look for a couple of Guatemalan stations—*Radio Maya de Barillas* in Huehuetenango on 2,360 kHz and *Radio La Voz de Atitlan* in Santiago Atitlan on 2,390 kHz—that are usually heard during the evening hours. A Mexican outlet, *Radio Huayacocotla* also

GET SMART

Quick & Cheap With Books!

Order Today!



TALK!

Now you can get a ham license without a Morse code test!

All About Ham Radio

by Harry Helms

tells you how. It covers what hams do... how to select equipment and antennas... using packet radio and ham satellites... operating procedures... and contacting hams in foreign countries! Also includes an introduction to radio theory and electronics. Start talking to the world today! Only \$19.95.



LISTEN!

Listen to history as it happens via shortwave radio! Shortwave Listening Guidebook

by Harry Helms

tells you all about the shortwave bands, when and where to listen, reception patterns, and how to select the shortwave radio that's right for you. It also profiles major world broadcasters. Includes hundreds of frequencies for stations worldwide and times to hear them. Just \$16.95.



BUILD!

The Forrest Mims Engineer's Notebook by Forrest Mims (who else?) includes hundreds of

applications circuits using today's most popular linear and digital ICs! Forrest includes complete data for each IC, such as pin connections, logic tables, waveforms, & more! If you experiment with ICs, you gotta get this book! A steal at \$14.95.

You can get HighText books at your favorite technical bookstore, electronics parts dealer, or radio equipment dealer. Or order direct from HighText! Include \$3 per book for shipping (\$4 Canada, \$5 elsewhere). CA please add sales tax. U.S. funds only please.

HighText

publications inc

7128 Miramar Road, Suite 15L
San Diego, CA 92121

here and correct reports will be verified by Bethany."

Thanks John for the information. Some of the frequencies Bethany has used recently include 7,405, 9,575, 17,705, and 17,800 kHz. Reports may be sent to the Bethany Relay Station, P.O. Box 227, Mason, OH 45040.

MORE MAIL

A few months back (in the May, 1992 issue), we highlighted WWV and WWVH, the U.S. government's time/frequency standard shortwave stations. Now, George Hostovichar of Monaca, PA, writes to remind SWL's that Canada also operates a similar station, CHU, on 7,335 kHz. Indeed George, and CHU also broadcasts on 3,330 and 14,670 kHz. There are quite a few such time stations, which broadcast accurate time signals and, usually, voice announcements, too, around the world.

Most are not easy to hear in North America. However, you might wish to try for VNG, Llandilo, New South Wales, Australia, on 8,638 or 12,984 kHz, or HD2IOA, Guayaquil, Ecuador, on 3,810 or 7,600 kHz. George also asks why the letter "Z" is often used to designate Coordinated Universal Time (UTC), as in 1400Z.

The use of "Z" and more recently, the phonetic "Zulu," to designate Greenwich Mean Time began with the military, probably during World War II. I have heard several stories about the origin of this usage, but I can't vouch for the accuracy of them. Maybe one of our readers can help; if so, write in and give us the straight dope on how "Z" came to signify GMT/UTC.

Jim Lucente of Gahanna, OH, writes seeking recommendations for a small,

mid-priced SW portable receiver from among a list of Sony, Panasonic, and Radio Shack models. As I have frequently noted, I don't make specific receiver recommendations, but I refer anyone interested in straight-forward equipment reviews to the annual *Passport to World Band Radio*, available through most book stores.

Jim also asks about so-called grey market models. So what is "grey market?" Foreign electronic manufactures, notably the Japanese, export shortwave-receiver models and have set up distribution and service specifically for the U.S. market. However, some years ago, discount retailers found that they could obtain from overseas sources at lower prices similar sets manufactured for European or Far Eastern markets. The differences from the North American version were minimal, sometimes only the model number. Those retailers could then substantially undercut the price of other U.S. dealers who obtained their stock through authorized channels. There is nothing illegal about grey marketing, although electronics manufacturers have been less than happy about it.

Note, however, that while the SWL who buys a grey market set may save some bucks, if something goes wrong with the receiver, he shouldn't count on repairs by an authorized service center. It is my impression that grey marketing is not common today.

*Credits: Robert Ross, ONT; Tom Tabatowski, IN; Ernest Lawrence, NY; Marlin Field, MI; David Clark, ONT; Jerry Irvine, TX; Martin Peck, NY; North American SW Association, 45 Wildflower Road, Levittown PA 19057

Jack Brown of Enka, NC, writes to say **Popular Electronics** fills an informational gap and keeps him abreast of what's new in the world of electronics. He also says he has an issue of *Communications World* from the mid-1970's and wonders if that shortwave publication is still published.

No Jack, *Communications World*, a semi-annual, which yours truly once edited, died quietly about 15 years ago, joining other one-time publications for the shortwave hobbyist, such as *Electronics Illustrated*, *Radio-TV Experimenter*, *Communications Handbook*, *Science and Electronics* and others long gone.

DOWN THE DIAL

Give a try for some of these stations that others are reporting:

AUSTRALIA—2,325 kHz. VL78, Tennant Creek, Northern Territory, has been heard at 0930 UTC with coverage of a rugby match, and at 1012 UTC with big band music.

FRENCH GUIANA—5,056 kHz. RFO in Cayenne was noted at 0655 UTC with reggae music with French lyrics, and later with news.

INDIA—11,620 kHz. All India Radio's English-language transmission begins with news at 2200 UTC, followed by commentary and music.

MYANMAR—6,570 kHz. The *Defense Forces Broadcasting Station* in this south Asian nation, which was formerly known as Burma, has been logged in a local language, with talk and vocal music from 1245 until sign off at 1330 UTC.

NIGERIA—4,770 kHz. *Radio Nigeria* was noted recently at 0530 UTC with station identification and an ad for the Kaduna Chamber of Commerce. ■

NO COMPLICATED ELECTRONICS, NO EXPENSIVE INSTRUMENTS:

Home study course shows you how to make good money in VCR repair.

An amazing fact: you can do more than four out of five VCR repairs with ordinary tools and basic fix-it procedures. Our home study program shows you how.

Learn all of the systems, mechanisms, and parts of almost all brands of VCRs. With *no expensive instruments*. *No complicated electronics*. *No fancy workshop*. The step-by-step texts and close personal attention from your instructor make learning easy.



Texts, course materials, and tool kit are sent to your home. Graduate ready to make up to \$50.00 or more per hour in your own spare-time or full-time business.

Send today for your free career booklet. Or call 800-223-4542

Name _____
 Address _____
 City _____ State _____ Zip _____

The School of VCR Repair

2245 Perimeter Park, Dept. VL341, Atlanta, Georgia 30341

CIRCLE 7 ON FREE INFORMATION CARD

Enter A World Of Excitement with a Subscription to

Popular Electronics

Get the latest electronic technology and information monthly!

Now you can subscribe to the magazine that plugs you into the exciting world of electronics. With every issue of *Popular Electronics* you'll find a wide variety of electronics projects you can build and enjoy.

Popular Electronics brings you informative new product and literature listings, feature articles on test equipment and tools—all designed to keep you tuned in to the latest developments in electronics. So if you love to build fascinating electronics, just call toll free the number below to subscribe to *Popular Electronics* . . . It's a power-house of fun for the electronics enthusiast.



1 yr \$18.95 2 yrs \$36.95
 (Basic Subscription Rate—1 yr/\$21.95; 2 yrs/\$42.95)

FOR FAST SERVICE CALL TODAY

1-800-827-0383

APPK2

(7:30 AM-8:30 PM—EASTERN STANDARD TIME)

HAM RADIO

By Joseph J. Carr, K4IPV

Some More Spectrum Analyzer Stuff

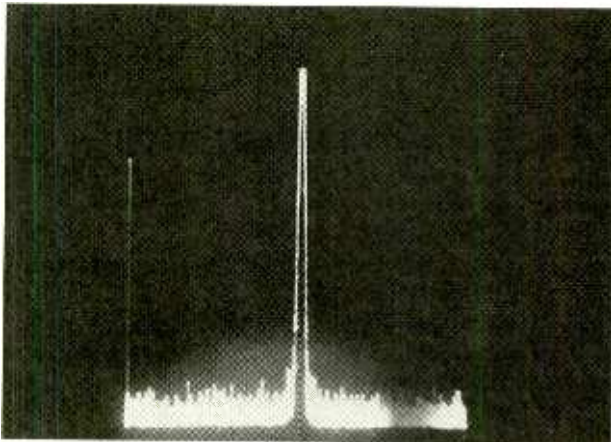

This trace is a signal from my old Measurements Model 80, 10-400-MHz signal generator operating near 100 MHz. Notice the noise and "spurs" along the baseline.

The spectrum analyzer seems to be one of the all-time favorite topics of you readers, so this month we're going to look at several different topics related to spectrum analyzers. In addition, I've received some more information on kit components from Murray Barlowe, WA2PZO (Science Workshop, P.O. Box 310, Bethpage, N.Y. 11714; 516-731-7628), who developed the "Poor Man's Spectrum Analyzer" (PMSA).

WHAT IS A SPECTRUM ANALYZER?

A spectrum analyzer is a specialized receiver that sweep tunes through the band of interest, and generates an output that, when viewed on an oscilloscope, is proportional to the amplitude versus the frequency of the signals encountered. A typical spectrum analyzer pattern consists of several spikes, representing the amplitude of the signals, rising up from the baseline.

A lot of people (including myself) have built the PMSA. Further, since Science

Workshop sells component subassemblies that can be selected at will, and many builders design some of the elements themselves, there are many variations to PMSA. My own contribution to the PMSA is the digital sawtooth generator, which has appeared in these pages (see Ham Radio, May 1992) and elsewhere.

WHAT'S THE PMSA?

The PMSA is a spectrum analyzer that is based on readily available voltage-controlled tuners of the type used in cable-ready television sets. The tuners generally cover 38 MHz or so on the low end to 900 MHz on the high end (to encompass all the VHF and UHF television channels). The particular frequency selected is a function of an internal voltage-controlled oscillator (VCO) that is tuned by an external voltage.

Science Workshop offers standard tuners, as well as modified tuners that (depending on which is selected) cover 0 to 500 MHz or 900 to 1,500 MHz. The output of the tuners are 45 MHz and 53 MHz, depending on the design and original application. If I recall correctly, I had a 66-MHz tuner in my PMSA. The 66-MHz intermediate-frequency (IF) output of the voltage-controlled tuner is heterodyned down to 10.7 MHz, thereby allowing standard IF filters from the communications and broadcast industries to be used to select signals.

Figure 1 shows a functional-block diagram of the PMSA in its simplest form.

The converted TV tuner is used in cascade with the IF receiver. A sawtooth generator provides a sweep voltage that drives the tuner from the low end to the high end of the band of interest. The output of the converted TV tuner is fed to an IF receiver, whose output is in turn applied to the vertical input of an X-Y oscilloscope—(i.e., an oscilloscope that allows an external signal to drive the horizontal sweep). The sawtooth generator also feeds the horizontal input of the X-Y oscilloscope. The maximum amplitude of the sawtooth sets the maximum frequency, while half of its amplitude sets the center frequency.

There is no reason why the converted cable-television tuner and IF receiver can't be used to make a general coverage 0 to 500 MHz, or 40 to 900 MHz receiver. For example, use a pair of precision potentiometers instead of the output of the sawtooth generator to vary V_t . In my own (still breadboarded) PMSA, there is a switch on the front panel that selects one of three modes: wide sweep (the normal sawtooth mode); an adjustable-fixed, but tunable receiver mode; and a third mode that provides a narrow sweep. In the last mode of operation, a pair of precision potentiometers are used to add a DC level to the sawtooth waveform; the sawtooth signal's amplitude is reduced for this mode. The idea is to sweep a smaller portion of the spectrum than is allowed by a full-amplitude sawtooth signal.

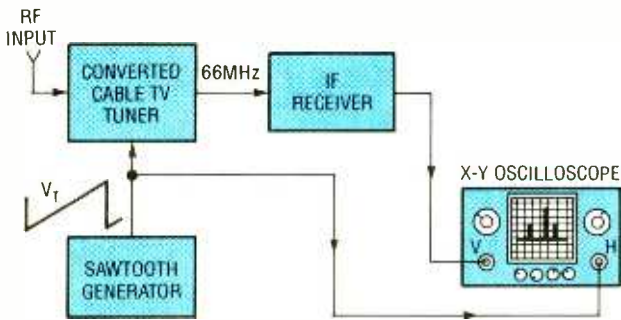
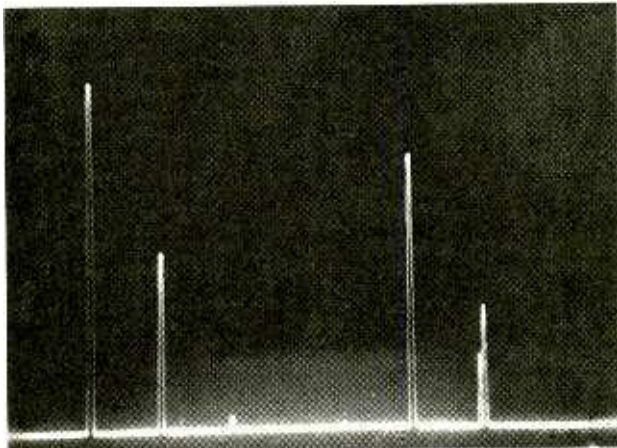
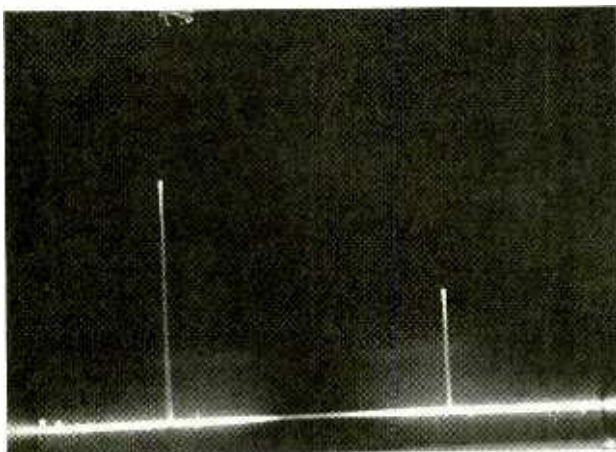

Fig. 1. Shown here is a functional block diagram of the PMSA. A sawtooth generator provides the sweep voltage that is used to drive the converted TV tuner—connected in cascade with the IF receiver—from the low end to the high end of the band of interest. The output of the IF receiver is applied to the scope's vertical input of an X-Y oscilloscope. The output of the sawtooth generator is also applied to the horizontal input of the oscilloscope.



Here is a spectrum display of a segment of the 2-meter amateur band, showing, I believe, the two closest active repeaters, along with the triggering mobile signal.



Here is the output of a 25-MHz (or so) voltage-tuned oscillator showing a second harmonic that is only -7 dB down from the main signal.

A significant criticism of the PMSA is that its filter system is too broad for practical use. The original

PMSA had a 200+ kHz filter intended for use in FM broadcast-radio receivers—indeed, too broad to be

useful for most applications. Science Workshop now offers a filter add-on kit that alleviates some of those problems. With currently available filters, you can follow the same route to provide resolutions down to a few hundred hertz.

Still, some purists are not happy unless a filter is provided for 1-Hz resolution. Of course they, too, can be accommodated, but not easily. One of the tasks that I've set for myself is to investigate a possible high-resolution add-on to the PMSA. A good high-resolution filter would permit the investigation of the spectrum in a single signal; e.g. look at the sidebands of an AM signal. You can't do that when the narrowest resolution available is wider than the AM signal being investigated. But what if you had a subsection that would look at the center of that band and sweep—pan-adaptor style—across the PMSA's 10.7-MHz, IF band-pass? Well, it's worth a thought or two (got any ideas?).

PMSA ADD-ONS

Additions to the PMSA over the years, some of which are offered as options by Science Workshop, include a tracking generator and a digital center-frequency display. A tracking generator is a VCO that outputs a signal frequency that is equal to the center frequency of the PMSA. A frequency-to-voltage converter can be used to convert the VCO frequency to a DC voltage that can then be read on either an analog or a digital voltmeter: the DC voltage will be proportional to the center frequency.

Other accessories include a marker generator that places "pips" in the trace at known frequency

intervals, and a comb generator, which does essentially the same thing but at narrower intervals. There is also a DC power supply that provides all of the needed voltages.

One of the surprising things about the PMSA is the small but growing following that has arisen. There are many who've built one variant or another of the PMSA. And those folks, including yours truly, have passed along a lot of good ideas to Science Workshop. Murray Barlowe has produced a book that bundles many of those ideas into one source, along with some of his own material (including a decent tutorial on spectrum analyzers in general, and the PMSA in particular). Science Workshop sells it for \$24.95. Even if you're not contemplating building a PMSA right now, there are a lot of neat circuits and ideas in the book.

One idea that's worth attempting is to use a high-grade, general-coverage communications receiver set to 10.7 MHz as is the IF amplifier of the PMSA tuner. The narrower bandwidth filters in the receiver would cure the problem of resolution. Well, it's worth a try—maybe I'll do it. ■



Let's close the book on forest fires.

Ad Council

A Public Service of This Magazine & The Advertising Council



SCANNER SCENE

By Marc Saxon

Scanning the Friendly Skies

There has been quite a bit of interest in air-to-ground telephone service, and some confusion about what it is and isn't. So we thought that this would be a good time to sort through the subject and pass along some frequencies and monitoring information.

As has been seen in a number of newspaper ads and TV commercials, many airlines now offer pas-

these are standard cellular phones. Not so. Cellular telephones aren't permitted to be used in aircraft in flight, because from the altitude at which they fly, the cellular signals might simultaneously access several different cellular systems on the ground. From a plane flying at an altitude of 15,000 feet, for instance, line of sight is 175 miles in all directions. That means that any cellular systems within a 350-mile-diameter circular shaped area beneath that plane would activate or suffer interference. With airliners normally cruising at 30,000 feet and above, those problems would affect an even wider area.

As a result, a separate non-cellular telephone service has been established specifically to handle those airline telephone calls. In this radio service, ground stations operate on voice channels in the 849.0055–849.9735-MHz and 850.0055–850.9765-MHz bands. Aircraft voice communications are in the 894.0055–894.9765-MHz and 895.0055–895.9375-MHz bands. Channel spacing is 6 kHz. Control and data channels are not listed here.

It appears that operations in this service are in SSB or digital modes that can't be received on standard scanners, although UHF communications receivers will be able to copy the SSB communications.

For those scanner owners who hanker to hear what air/ground telephone service is all about, there's still hope. Prior to the 800-MHz service being established, an air/ground telephone service had been instituted with ground stations operating with voice in the 454.70–454.975-MHz band and aircraft voice in the 459.70–459.975-MHz band. Channel spacing is 25 MHz. The data channels were established on 454.675 and 459.675 MHz.

Those older channels are still allocated, in full effect, and active. Moreover, they use NFM mode, which can be copied on any scanner. Even though the airlines have moved along to the 800-MHz band, the 454-MHz channels have remained in use aboard private and corporate aircraft. As such, listeners have reported hearing well-known business and entertainment personalities using those circuits for placing air-to-ground calls.

Unless a listener happens to be within almost local distance of a ground station in this band, there's little chance of picking up anything on the 454-MHz channels. Certainly, it doesn't hurt to search/scan them to see if any ground stations are within receiving range. Your best bet is to search/scan the 459-MHz aircraft channels since airborne activity there can be received from considerable distances, depending upon the altitude of the aircraft.



The old 454/459-MHz UHF air/ground telephone band is still popular with those who travel on private and corporate aircraft.

sengers the convenience of making phone calls during flights over North America. Some airlines even have a telephone installed right at each seat to save passengers the trouble of walking to a bank of phones located at the front or rear of the plane.

Many readers assume that, like telephones on passenger trains and those aboard some smaller passenger vessels that operate in rivers and coastal areas,

Private jets fly quite high.

Also, don't forget to monitor the king of all air/ground telephone circuits. That's the one used by Air Force One, Air Force Two, and VIP ("Sam") military, diplomatic, and governmental flights. The ground stations are on 407.85 MHz, with the aircraft on 415.70 MHz.

MORE ITEMS

A letter from Ron Bruckman, of Baltimore, MD, advises that new frequencies are in use by Baltimore Gas & Electric. Those are: 855.1875, 855.3625, 855.4125, 855.6125, 855.6375, and five trunked channels from 856.2875 through 860.2875 MHz. Ron also reports that 453.975 MHz is used by a Neighborhood Watch group in Baltimore, near Northern Parkway and Reistertown Road. What's strange, Ron says, is that the same frequency is used for surveillance by the state police.

Ron publishes the *Radio Monitors Newsletter of Maryland* (P.O. Box 394, Hampstead, MD 21074). Readers seeking additional information about Ron's attractive scanner newsletter are invited to contact him directly, furnishing a self-addressed stamped envelope for his reply.

Steve Ujfalussy, of Dart, Nova Scotia, asks about a scanner accessory that he once heard about that is used to permit reception of 800-MHz band signals on a scanner's 400-MHz band. Steve wants to know what it's called and how or where he can get one.

The same mail brought a letter from John Miller, telling us that he also wanted to monitor the 800-MHz band, but was hoping to avoid spending more than \$300 for a new scanner to

do so. He obtained an inexpensive GRE America "Super Converter," which he attached to the antenna connector of his scanner. Now the 800-MHz signals can be monitored on the 400-MHz band of his scanner. John wrote, "My problems were solved."

That is precisely the unit that Steve was asking about. We've been using one for a long time, too. We love the thing. It hooks up in seconds without any tools. It puts 806-912-MHz monitoring coverage in to the 406-512-MHz band of our scanner, and can be switched out of the circuit when desired. Models are available for use with base and handheld units. You can get more information on the Super Converter from CRB Research, P.O. Box 56, Commack, NY 11725.

Bill Reagan, of Galveston, TX, dropped us a letter expressing concern about a newspaper report he had seen. It noted that Galveston police hope to install a new non-voice communications system that uses keyboards and video screens. The story reported that the system is intended to stop the public from monitoring police transmissions.

Such systems are in use in many large cities, including Houston. They don't replace voice communications, only augment them. They are especially useful when it comes to providing descriptive data on wanted or missing persons or issuing bulletins, warrant information, vehicle data, etc.

Let's hear from you with your thoughts, frequencies, questions, ideas, and news clippings relating to VHF/UHF communications. Our address is *Scanner Scene*, **Popular Electronics**, 500-B Bi-County Blvd., Farmingdale, NY 11735. ■

DIGITAL VIDEO STABILIZER ELIMINATES ALL VIDEO COPYGUARDS



While watching rental movies, you will notice annoying periodic color darkening, color shift, unwanted lines, flashing or jagged edges. This is caused by the copy protection jamming signals embedded in the video tape, such as Macrovision copy protection. THE DIGITAL VIDEO STABILIZER: RXII COMPLETELY ELIMINATES ALL COPY PROTECTIONS AND JAMMING SIGNALS AND BRINGS YOU CRYSTAL CLEAR PICTURES.

WARNING

THE DIGITAL VIDEO STABILIZER IS INTENDED FOR PRIVATE HOME USE ONLY. IT IS NOT INTENDED TO COPY RENTAL MOVIES OR COPYRIGHTED VIDEO TAPES THAT MAY CONSTITUTE COPYRIGHT INFRINGEMENT.

FEATURES

- Easy to use and a snap to install
- State-of-the-art Microchip technology
- 100% automatic
- Compatible to all types of VCRs and TVs
- The best and most exciting Video Stabilizer in the market
- Light weight (8 ounces) and compact (1x3.5x5")
- Uses a standard 9 Volt battery (last 1-2 years)
- Fast UPS delivery
- Air shipping available
- UNCONDITIONAL 30 day money back guarantee
- 1 year warranty

(Dealers Welcome)

FREE 20P Catalog

To Order: **\$59.95** ea + \$5 for p & h
Visa, M/C, COD Mon-Fri: 9-6 EST

1-800-445-9285

ZENTEK CORP. DEPT. CPE10

3670-12 WEST OCEANSIDE RD. OCEANSIDE, NY 11572

CIRCLE 14 ON FREE INFORMATION CARD

CABLE TV DESCRAMBLERS How You Can Save Money on Cable Rental Fees Bullet Proof



1 Unit 5+

BEST Super Tri-Bi Auto/
Var. Gain Adjustment \$119.95...\$85
Jerrold Super Tri-Bi ... \$109.95...\$79
Scientific Atlanta \$109.....\$79
Pioneer \$109.....\$79
Panasonic TZPC145.... \$99.95...\$79
Stargate Converter..... \$95.....\$69
Digital Video Stabilizer..\$59.95...\$29
Wireless Video Sender..\$59.95...\$49.95

**US Cable'll Beat
Anyone's Price
Advertised in
this Magazine!**

30 Day Money Back Guarantee
FREE 20 page Catalog

Visa, M/C, COD or send money order to:
U.S. Cable TV Inc. Dept. KPE10
4100 N. Powerline Rd., Bldg. F-4
Pompano Beach, FL 33073

1-800-772-6244

For Our Record

I, the undersigned, do hereby declare under penalty of perjury that all products purchased, now and in the future, will only be used on Cable TV systems with proper authorization from local officials or cable company officials in accordance with all applicable federal and state laws. FEDERAL AND VARIOUS STATE LAWS PROVIDE FOR SUBSTANTIAL CRIMINAL AND CIVIL PENALTIES FOR UNAUTHORIZED USE.

Date: _____

Signed: _____

No Florida Sales!

CIRCLE 15 ON FREE INFORMATION CARD

ELECTRONICS LIBRARY

The New Stereo Soundbook

by F. Alton Everest
and Ron Streicher

Because of recent findings about audio perception and current developments in surround sound, the concept of stereophonics has expanded from sound coming from two loudspeakers to a complex system that wraps the listener in three-dimensional sound. This book provides a definition of stereophonics that incorporates both its practical and its aesthetic aspects, as well as a pragmatic guide to optimizing the sound from stereo systems. An historical perspective is achieved by interpreting contemporary advances in stereo

book also places a strong emphasis on the individuality of each listener's ear for stereo music.

The book explores all the varied aspects of the concept and production of stereo sound. It begins with a look at the directional encoding of sounds falling on the ear and how interaural differences in those sounds provide spatial texture to the stereo image. Five chapters are devoted to a detailed examination of modern-stereo microphone practices. Other chapters cover such topics as auditory spaciousness, coloration of sound, and improving the stereo listening environment. The book explains how to use microphones to achieve special stereo effects, record binaural signals with the use of a "dummy head," make a stereo signal from two or more mono signals, and control sound reflections for optimal stereo listening. For non-professional readers, the book's non-mathematical approach makes even the most technical aspects of stereo sound understandable.

The New Stereo Soundbook costs \$18.95 and is published by TAB Books, Division of McGraw-Hill Inc., Blue Ridge Summit, PA 17294-0850; Tel. 1-800-822-8138.

CIRCLE 98 ON FREE INFORMATION CARD

AN INTRODUCTION TO MICROWAVES

F.A. Wilson

There's more to microwaves than cooking. Much of the technology in everyday use in today's society—color television, and mobile communications, for instance—uses microwaves. As the use of microwaves expands, so does the need for some basic understanding of their nature. This

introductory book aims to provide that understanding. It requires no previous background in the field, although some elementary electronics background is assumed. The

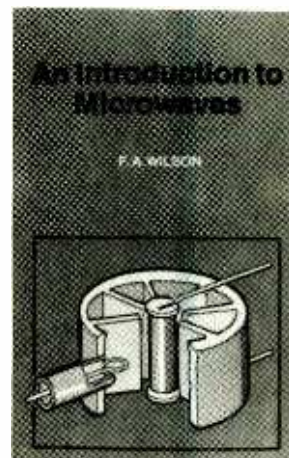

use of mathematics is kept to a minimum, and primarily involves little more than ordinary algebra. The book opens with an explanation of microwave basics along with brief technical explanations of those areas of electronics that are important for an appreciation of microwaves. Following chapters cover microwave generators and amplifiers. The practical uses of microwaves in general communications, mobile communications, and television are examined. Finally, the book takes a look at radar and heating. Of course, some notes on the microwave oven are also included.

An Introduction to Microwaves (order no. BP312) is available for \$5.95 plus \$2.50 shipping and handling from Electronics Technology Today Inc., P.O. Box 240, Massapequa Park, NY 11762-0240.

CIRCLE 97 ON FREE INFORMATION CARD

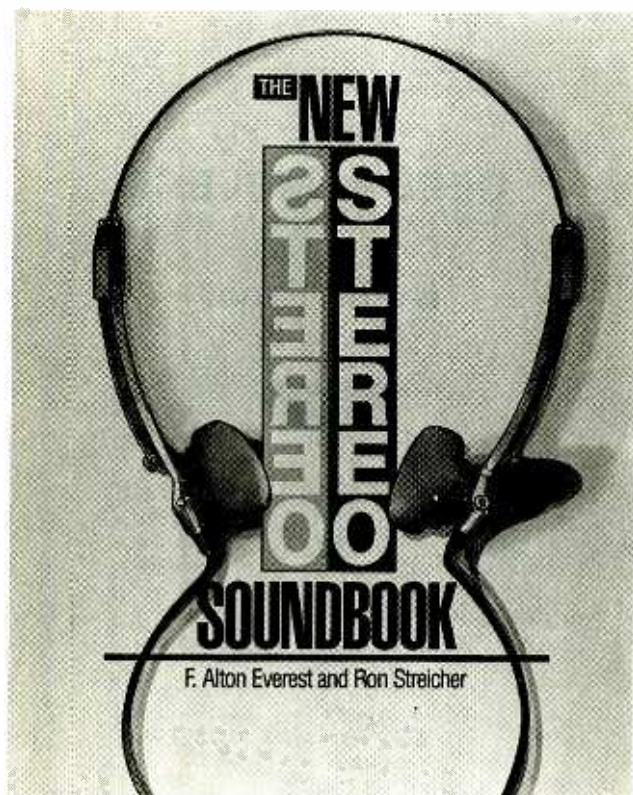

through a study of contributions of audio pioneers dating back to the 1930's. That perspective helps readers understand both current and future developments in stereo sound. The

HMC 1992 FULL-LINE CATALOG

from HUB Material Company

This detailed, fully-illustrated buying guide of electronic tools, test equipment, and supplies for the manufacture, assembly, and repair of electronics contains a large selection of brand-name, competitively priced products. It includes precision hand tools, test instruments, datacom/telecom equipment, tool kits, soldering/desoldering systems, lamps and magnifiers, static-control products, industrial chemicals and adhesives, measurement and inspection instruments, work stations, and PC-board handling equipment. The catalog features large photographs, clear copy, and easy-to-understand comparison tables of product features.

The HMC 1992 Full-Line Catalog is free upon request from HUB Material Company, 33 Springdale Avenue, Canton, MA 02021; Tel: 617-821-1870; Fax: 617-821-4133.

CIRCLE 85 ON FREE INFORMATION CARD

EARL WEAVER BASEBALL: HALL OF FAME LEAGUE

by Kevin Shafer

Earl Weaver Baseball, a popular computer game for IBM PC's, Mac's, and Amigas that was devised by former Baltimore Orioles manager Earl Weaver, allows players to build a dream team of players with Hall of Fame credentials from as far back as the 1890's. This book explains how to create your own dream team by providing little-known facts about favorite players and managers along with fact-filled biographies. The book

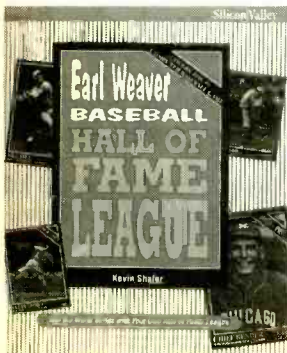

also explains how to set up a league, price players, conduct a "Draft Day," use "normalized" stats to choose among baseball greats from the past and present (so that Babe Ruth could face Goose Gossage, for example), and select or create the ballpark that best fits the talents of your team. In addition, the book provides insider tips on scheduling pitching rotations and making lineup changes and teaches the strategies that made Earl Weaver famous. You can wrap it all up with your own World Series.

Earl Weaver Baseball: Hall of Fame League costs \$19.95 and is published by Osborne McGraw-Hill, 2600 Tenth Street, Berkeley, CA 94710.

CIRCLE 96 ON FREE INFORMATION CARD

COMMUNICATIONS CATALOG 92-04

from Universal Radio Inc.

If your hobby is radio in any of its formats, you're sure to find plenty of interesting items in this 100-page catalog. Choose from communications receivers; amateur HF, UHF/VHF Multi, and UHF/VHF FM transceivers; antennas; wideband receivers;



automotive and specialty receivers; multi-mode decoders; clocks; computer interfaces and control software; antenna tuners; amateur study materials; cable, wire, and coax; and scanners and accessories. For those who are just getting started or are interested in learning more about their hobbies, the catalog provides short articles explaining the various facets of shortwave, RTTY, and amateur



Hold a piece of tape up to your eyes, dim the lights and try to fill out your taxes.

Now you're seeing things from her point of view.

Almost everybody has to file taxes, but not everyone can do it on their own. Volunteer and help make someone's taxes less taxing. Call 1 800 424-1040.

A Public Service of This Publication & **Ad Council** Internal Revenue Service 

SUPER LONG PLAY TAPE RECORDERS

12 Hour Model — USES 120 TAPE \$119.00*

Modified Panasonic Slimline. high quality AC-DC provide 6 continuous hours of quality recording & playback on each side of cassette for 12 hours total. Includes • Voice level control • Digital counter, etc. TDK — 120 Cassette Furnished.

PHONE RECORDING ADAPTER

Records calls automatically. All Solid state connects to your telephone jack and tape recorder. Starts recording when phone is lifted. Stops when you hang up. **\$28.50*** FCC APPROVED

VOX VOICE ACTIVATED CONTROL SWITCH

Solid state. Self contained. Adjustable sensitivity. Voices or other sounds automatically activate and control recorder. Uses either recorder or remote mike. **\$28.50***

* Add for ship. & handling. Phone Adapter & Vox \$2.00 each. Recordors \$5.00 each. Calif. Res. add tax. Mail order. VISA, M/C, COD's OK. Money Back Guarantee. Free data available. Dealer Inquiries invited.

AMC SALES INC. Dept. B 9335 Lubec Street
Box 928, Downey, CA 90241
Phones (310) 869-8519 1-800-926-2488
FAX (310) 923-1478
Mon-Fri 8-5 PAC. TIME

CIRCLE 8 ON FREE INFORMATION CARD

radio. In addition, it also offers an assortment of manuals and literature, books, logging supplies, maps, cases, globes, and atlases.

The Communications Catalog 92-04 is available for \$2.00 from Universal Radio Inc., 6830 Americana Pkwy., Reynoldsburg, OH 43068; Tel: 800-431-3939.

CIRCLE 86 ON FREE INFORMATION CARD

LENK'S RF HANDBOOK: OPERATION AND TROUBLESHOOTING

by John D. Lenk

Aimed at engineers, technicians, and hobbyists who work with today's radio-frequency equipment, this authoritative work is filled with practical how-to information that demonstrates precisely how to troubleshoot and repair the costly problems that can occur in timers, radios, and other RF equipment. Bridging the gap between the theoretical discussions of RF circuits found in engineering texts and the bare-bone service information included in service manuals,

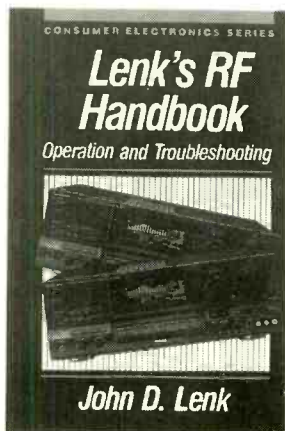

this book examines both the basics of circuit design and the RF testing and troubleshooting equipment used to diagnose trouble. The book describes RF-testing procedures that can be applied at any point during the design or experimentation period, either for a complete piece of equipment, such as a transmitter, or for specific circuits, such as the RF circuits of a receiver. RF testing tech-

niques are also described, with an emphasis on detailed checks of such sophisticated devices as mobile communications sets, including CB, amateur, business radio, and cellular phones.

Practical, step-by-step examples are used to illustrate the application of basic circuit-by-circuit troubleshooting techniques for locating and correcting common RF problems. Included are procedures for measuring the resonant frequency of LC circuits, the inductance of a coil, the Q of resonant circuits, and the impedance of resonant circuits. Discussions of advanced procedures tell how to pinpoint typical transmitting, receiving, and audio problems, and also offer proven solutions to those problems. Tests and checks used for transmitter frequency, transmitter modulation, receiver sensitivity, adjacent-channel rejection, and noise-blanker effectiveness are described.

Lenk's RF Handbook: Operation and Troubleshooting costs \$39.95 in hardcover and is published by McGraw-Hill, Inc., Professional Book Group, 11 West 19th Street, New York, NY 10011; Tel: 1-800-2-MCGRAW.

CIRCLE 96 ON FREE INFORMATION CARD

1992 PRODUCT HANDBOOK

from Power General

Complete electrical and mechanical specifications for a comprehensive line of switching power supplies and DC-DC converters are featured in this 152-page brochure. Included are single and multiple-output AC-DC switchers ranging in output power from 20 to 150 watts. Product features include universal input voltage range, VDE/FCC Class B line filters, UL/CSA/VDE safety approvals, and ultra-high MTBF. More than 200 DC-DC models range in output power from 1 to 150 watts, and offer such features as short-circuit protection, 500-VDC input/output isolation, six-sided continuous shielding, and ultra-high MTBF. The catalog also provides operations theory, application notes, and glossaries.

The 1992 Product Handbook is free upon request from Power General, 152 Will Drive, Canton, MA 02021; Tel: 617-828-6216; Fax: 617-828-3215.

CIRCLE 87 ON FREE INFORMATION CARD

ELECTRONIC MEASUREMENTS & TESTING: TIPS & TECHNIQUES FOR TECHNICIANS & ENGINEERS

by Eugene R. Bartlett

With a strong emphasis on the practical use of modern test instruments, this book provides practicing professionals and advanced hobbyists with sound guidance on measuring the parameters and performance of electronic components and systems. Various types of analog and digital test instruments are examined, including their development to present-day standards and configuration for a variety of uses.

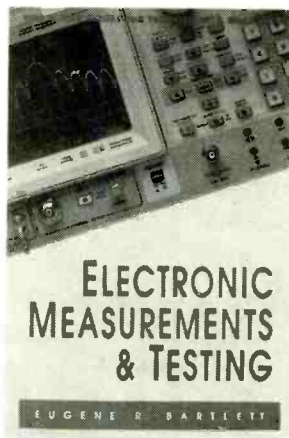

Step-by-step explanations are provided for test procedures, system tests, and performance verification for audio-frequency, radio-frequency, television, microwave, satellite, and radar systems; fiber-optic and cable communication systems; and digital systems, computers, and microprocessors. All of the test procedures are clearly outlined, fully illustrated, and enhanced by tips and techniques that can improve the speed and reliability of operations.

The book addresses the spe-

cial problems that might arise from testing specific systems, and introduces proven methods for checking and calibrating test instruments to ensure more consistent and accurate results.

Electronic Measurements & Testing: Tips & Techniques for Technicians & Engineers costs \$27.95 and is published by McGraw-Hill Publishing Company, 11 West 19th Street, New York, NY 10011; Tel: 1-800-2-MCGRAW.

CIRCLE 96 ON FREE INFORMATION CARD

1992 HAM CATALOG

from MFJ Enterprises, Inc.

This 20-page catalog is filled with amateur-radio products from MFJ and Ameritron. New MFJ products include an HF-antenna analyzer with a built-in 10-digit LCD frequency counter, two new SWR analyzers for commercial radio, a 20-meter QRP transceiver with a 5-watt rating, a 600-MHz 10-digit LCD frequency counter, a line of 2-meter antennas, a low-pass filter, two mini-speaker/microphones, a plug-in PC board with software for use in DX contests, a multi-mode computer interface, and a packet TNC for Commodore 64/138.

Updated items from MFJ include a 300-watt tuner with lighted cross-needle meter, an expanded range cross-needle SWR/wattmeter, and assorted antennas.

As if that wasn't enough; the catalog also describes a variety of antenna bridges, noise bridges, antenna current probes, keyers, code-practice oscillators, clocks, repeater controllers, RFI choke kits, dummy loads, line monitors, power outlets, filters, phone patches, antenna tuner/preamplifiers, indoor and outdoor active antennas, books about ham radio, Morse-code computer programs, tutorial computer programs, and packet-radio controllers.

The 1992 Ham Catalog is free upon request from MFJ Enterprises, Inc., P.O. Box 494, Mississippi State, MS 39762; Tel: 1-800-647-1800.

CIRCLE 88 ON FREE INFORMATION CARD

NEW PRODUCTS

Satellite Receiver

To keep the price of their Model TRX-1500 affordable, *Toshiba* did away with some non-essential features. At the same time, they maximized overall performance levels and added some convenience features. One of the elements eliminated was the RF modulator, which isn't necessary with televisions that offer audio and video inputs. (A reasonably priced outboard unit is available for use with older sets that do require an RF modulator.) The TRX-1500's standard features include the VideoCipher RS module, which represents the

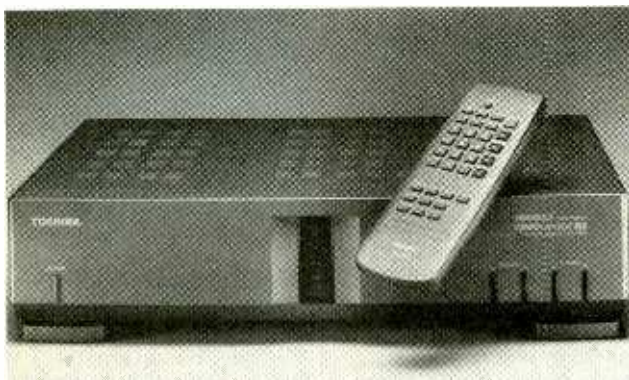

latest descrambling technology and which is designed to accept the TvPass card when it is introduced. The receiver also has built-in pay-per-view ordering capability that allows viewers to purchase programming with the push of a button. Design improvements include more accurate UHF remote-control functioning thanks to increased noise-rejection; extremely accurate Ku-band tuning with all satellites formatted in memory; and "Category-driven Program Selection," which lets viewers quickly find programs by browsing through as many as ten neatly organized subject menus. The TRX-1500 has the ability to receive both IR and UHF remote signals, depending on which type of remote is

used, eliminating the need to switch manually or use an expensive IR/UHF converter. A unique diagnostic feature alerts the user to the presence of random RF signals that can interfere with UHF-remote operation. Other features include a 20-favorite-channel menu, a built-in programmable antenna positioner with power supply, a baseband output that allows the unit to be connected to an external descrambler or other peripherals, and a built-in terrestrial interference filter.

The TRX-1500 satellite receiver has a suggested retail price of \$1795. For more information, contact Toshiba America Consumer Products, Inc., Video Communications Group, 1010 Johnson Drive, Buffalo Grove, IL 60089.

CIRCLE 101 ON FREE INFORMATION CARD

UNIVERSAL COUNTER/TIMER

An intelligent bench-top 1.3-GHz universal counter/timer from *Global Specialties*, the Model 5002 features a frequency range of 5 Hz to 1.3 GHz and measurement functions including frequency, time interval, period, ratio, pulse width, and event counting. It has gate times of 0.1, 1, and 10 seconds. A high-resolution reciprocal measurement technique gives the Model 5002 seven significant digits of accuracy. The counter/timer offers sinewave

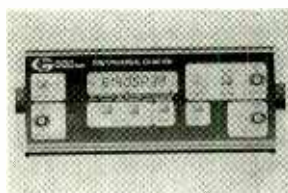

input sensitivity of 10mV up to 700 MHz, plus both high-impedance and 50-ohm inputs. Its large 8-digit LCD readout displays the measurement value

and the operating mode. Trigger level control and a lowpass filter are included, along with both internal and external timebase capabilities. The internal timebase is a 10-MHz ± 1 ppm crystal oscillator with an aging coefficient of less than 5-ppm per year. For a user-provided timebase, the external input performs automatic detection and changeover when a signal is present.

The Model 5002 counter/timer retails for \$495. For additional information contact Global Specialties, 70 Fulton Terrace, New Haven, CT 06512; Tel: 1-800-572-1028.

CIRCLE 102 ON FREE INFORMATION CARD

DIAGNOSTIC CARD

The *POST-PROBE*, a universal POST card from *Micro 2000 Inc.* that can diagnose all IBM-compatible computers that won't boot, is the only card available that can simultaneously display all the diagnostic signals. Users can watch the entire P.O.S.T. process and monitor all computer functions as they happen. That allows problems to be isolated even if the system BIOS doesn't emit P.O.S.T. codes and makes diagnosis easier and faster if the BIOS does emit P.O.S.T. codes. The *POST-PROBE* is also the only card that monitors the Hi-Low clock and oscillating cycles so that users can quickly distinguish between clock-chip and crystal failure; with a built-in logic probe; and with a 4-position DIP switch for easy selection of I/O ports during testing. The card's documentation also is unique. It explains what each post code means in layman's terms and outlines the whole test procedure so the user can more easily trace the problem back to its source.

The *POST-PROBE* uses LED's to indicate +5VDC, -5VDC, +12VDC, -12VDC,

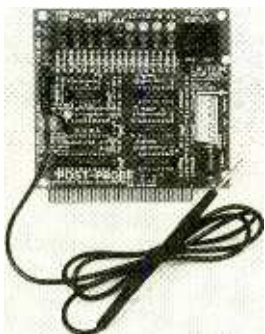

ALE for proper CPU/DMA operation, I/O write, memory read/write, and the reset function. Four pads are included for attaching a voltmeter for actual voltage testing under load.

The POST-PROBE diagnostic card has a suggested list price of \$399. For more information, contact Micro 2000 Inc., 1100 East Broadway, Third Floor, Glendale, CA 91205; Tel: 818-547-0125.

CIRCLE 103 ON FREE INFORMATION CARD

FUZZY-LOGIC VHS CAMCORDER

A six-position preset-mode high-speed shutter allows users of Fisher's FVC10 Camcorder to choose a videotaping situation rather than a number, eliminating the guesswork and making shutter-speed selection more intuitive. The high-speed electronic shutter offers six presets identified in the viewfinder as sports, auto high-speed, low-light, flicker, close-up, and normal. Fuzzy Logic technology,



which imitates the human thinking process, automatically adjusts the focusing, iris, and white balance. The automatic white balance corrects color for different lighting conditions by analyzing picture information from 64 separate image areas. The full-size VHS camcorder weighs just 1.8 pounds.

The FVC10 also features 1-lux low-light capability, a battery-saving standby switch, an 8:1 power-zoom lens with automatic macro for fast and accurate focusing from extreme closeups to wide-angle shots, an 11-key wireless remote control, and a built-in omnidirectional microphone. For editing, a flying erase head ensures clean scene transitions. Accessories supplied include a shoulder strap, a lithium battery, an antenna cable, a power connection cord, a rechargeable battery, an RF adaptor, and a battery charger/AC adaptor.

The FVC10 Fuzzy Logic VHS camcorder has a suggested retail price of \$799.95. For more information, contact Fisher, 21350 Lassen Street, Chatsworth, CA 91311-2329; Tel: 818-998-7322; Fax: 818-701-4149.

CIRCLE 104 ON FREE INFORMATION CARD

VHF WIRELESS MICROPHONE SYSTEM

According to *Audio-Technica*, its ATR45W VHF-wireless camcorder microphone system, which operates in the professional 170-MHz band, offers better sound quality than most other consumer wireless microphones, which use 49 MHz. The higher operating frequency provides an improved range of up to 500 feet in line-of-sight use, and extended professional-quality high-frequency response. Each unit actually has two selectable crystal-controlled frequencies, so that if there is noise or interference on one, the user can switch to the other.

The system includes a transmitter, a receiver, and an ATR35 omnidirectional condenser lavalier microphone. The ATR45W's receiver has a rubber-coated flexible antenna that can be rotated through a wide angle for best reception. Both the receiver and the transmitter feature a durable finish that is said to reduce the likelihood of light reflections from the transmitter. Both units operate on 9-volt batteries. The microphone features a tie clip and a windscreen. The system includes a host of accessories—a camera



shoe mount, Velcro strips for use when a shoe mount is unavailable, belt clips, and an earphone.

The ATR45W wireless microphone system costs \$239.95. For more information, contact Audio-Technica U.S., Inc., 1221 Commerce Drive, Stow, OH 44224-9971; Tel: 216-686-2600; Fax: 216-688-3752.

CIRCLE 105 ON FREE INFORMATION CARD

SHORTWAVE WIRE ANTENNA

Although every shortwave listener wants to receive the maximum signal possible from his location, quality SWL antennas that cover all the bands are often quite expensive. *Electron Processing's Basic Wire BW-60 SWL antenna* is designed to solve that price/performance dilemma by offering optimal performance without breaking the bank. The 60-foot-long antenna covers all SWL bands

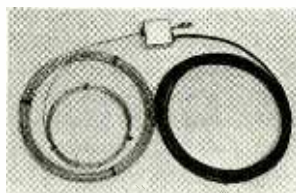

from 2 MHz to 30 MHz. It is comprised primarily of two wire elements of different lengths joined together at the feed point in a compact coupling box that has a built-in static bleed. The antenna can be installed in a variety of configurations requiring from one to three supports. It comes with 25-feet of coax feedline.

The Basic Wire BW-60 SWL antenna has a suggested list price of \$60, but is being offered

for a limited time at an introductory price of \$35, plus a \$5 shipping and handling charge. For further information, contact Electron Processing, Inc., P.O. Box 68, Cedar, MI 49621; Tel: 616-228-7020.

CIRCLE 106 ON FREE INFORMATION CARD

AMPLIFIED SPEAKERS

Delivering full and accurate sound reproduction in a small package, *Koss' SA/40* amplified speakers are intended for use at home, in the office, or on the go. Ideal for use with portable stereos, CD and cassette players, and TV's as well as with computer or video games, the compact speakers use four "C" batteries or a 6-volt DC power supply to deliver impressive am-



plified stereo sound. Dual 3/2-inch dynamic drivers produce a full frequency response of 50-20,000 Hz. An internal three-band stereo equalizer allows the user to adjust bass, mid-range, and treble levels individually, and a master volume control is provided.

The SA/40 amplified speakers have a suggested retail price of \$59.99. For further information, contact Koss Corporation, 4129 North Port Washington Avenue, Milwaukee, WI 53212; Tel: 414-964-5000.

CIRCLE 107 ON FREE INFORMATION CARD

SOUND-LEVEL METER

The pocket-sized, light-weight *Extech Sound Level Meter (model 407703)* provides an economical way to check OSHA ambient noise requirements in the 35 to 120-dB range. The meter measures sound in decibels via two scales—"Lo" (40-80 dB) and "Hi" (80-120



dB)—with accurate measurements to ± 5 dB. The meter features a built-in oscillator calibration (70 dB) and a capacitance microphone to insure high-reliability and stability. Designed for such applications as ambient noise measurement, quality inspection, or noise inspection for new devices, the Sound Level Meter also provides battery-check and field-calibration functions. The meter

is supplied with a wear-resistant case, a 9-volt battery, and an instruction manual.

The Sound Level Meter Model 407703 costs \$99. For further information, contact Extech Instruments Corporation, 335 Bear Hill Road, Waltham, MA 02154; Tel: 617-890-7440; Fax: 617-890-7864.

CIRCLE 108 ON FREE INFORMATION CARD

CRYSTAL-BALL SPEAKERS

Quest's unique line of speakers with crystal-ball-shaped enclosures offer advantages in both performance and aesthetics. Measuring from 6.3 to 12 inches in diameter, the speakers are small and decorative. With the addition of a variety of wall/ceiling mount hardware or decorative stands (including an illuminated base) the speakers can become a positive element of a room's decor. According to

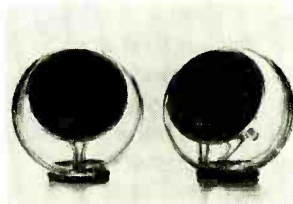

Quest, the spherical shape and rigidity of the glass enclosures result in wider sound-dispersion patterns, permitting greater flexibility in placement. With no sharp edges or corners, the standing wave problems, which require damping in standard features, are eliminated.

Three basic systems are included in the line: the *CB-160 Series*, the *CB-250 Series*, and the *CB-300 Series*. The three models in the CB-160 series differ basically only in their glass-finish characteristics: clear or hand-etched. All use a dual-cone, full-range, American-made driver. Two models in the series feature drivers that are specially shielded for inter-

ference-free use in proximity to a TV monitor/receiver. The *CB-250DX* is a two-way, two-speaker system that measures 10 inches in diameter. The enclosures are made of 0.4-inch-thick, hand-blown, leaded crystal. The *CB-250DX(LB)* adds a lighted base. The 12-inch-diameter *CB-300M* features a two-way coaxial driver that uses a 5¼-inch woofer and a 10-mm polycarbonate tweeter to produce a flat frequency response. The *CB-300MM* adds a black-light base that gives the speaker a warm orange glow when lit.

Prices for the crystal-ball speakers range from \$399.95 to \$429.95 each for the CB-160 Series, \$999.95 to \$1999.95 per pair for the CB-250 Series, and \$799.95 to \$999.95 each for the CB-300 Series. For more information, contact Quest Design & Technologies, Inc., 120 Woodridge Place, Leonia, NJ 07605; Tel: 201-947-1098. ■

CIRCLE 109 ON FREE INFORMATION CARD

Train at HOME to be an Electronics Technician!

As the demand for computers and microprocessors in business, manufacturing and communications continues to grow, so does the need for qualified technicians. It's not unusual for experienced technicians to earn from \$30,000 to more than \$40,000 a year.* Now through Peoples College of Independent Studies you can train for this exciting field without interrupting your job or home life.

Choose From Five Programs of Study

- Electronics & Microprocessor Technology
- Industrial Electronics & Microprocessor Technology
- Communications Electronics with Microprocessor Technology
- Computer Servicing & Electronics Technology
- Specialized Associate Degree In Electronics Technology

Professional Equipment is Included

Depending on the program you select, you'll perfect your skills using this advanced equipment, included in the price of tuition:

- IBM-Compatible Personal Computer
- Digital Multimeter
- Digital Logic Probe
- Elenco Oscilloscope
- Portable Cellular Telephone

(* Source: U.S. Bureau of Labor Statistics)



Exclusive Extras That Enhance Your Training

Peoples College introduces some training firsts to make your learning experience more complete:

- Accelerated Learning System — a scientifically proven study system that helps you learn faster and easier than ever before.
- Video Tutor Training Tapes — give you a permanent, visual record of informative lectures and close-up demonstrations.
- Experience Labs — professionally designed experiments that give you hands-on "bench" experience.
- Industry Certification Training Guide — provided with four of our programs. Prepares you for examinations you may take for your professional license or certification.

Easy Payment Plans — No Finance Charges

To help you get started on your education, Peoples College has reduced tuition rates and offers low monthly payment plans with no finance fees. So don't delay, call or write for more information today!

For COLOR CATALOG Mail Order Call TOLL FREE 1-800-765-7287

Programs offered only in United States, Canada, Puerto Rico and Virgin Islands. No Obligation. No sales person will call.

Our programs are accredited by the Accrediting Commission of the National Home Study Council

✂

YES! I would like to know more about your training programs. Send a catalog to:

Name _____

Address _____

City _____

State _____ Zip _____

Phone # _____

PEOPLES COLLEGE
OF INDEPENDENT STUDIES
233 Academy Drive • P.O. Box 421768
Kissimmee, FL 34742-1768
Member, D.I. Peoples Group E1092

CIRCLE 11 ON FREE INFORMATION CARD

THINK TANK

(Continued from page 74)

create a suitable voltage source, he'd next have to put the capacitor and a high-value resistor in series and connect them in parallel with the sensor. The resistor would keep the initially discharged capacitor from drawing enough current to trigger the alarm. Once the capacitor voltage is very close the sensor voltage, the high-value resistor can be shorted so the capacitor acts as a voltage filter across the sensor. Only then could the thief quickly disconnect the sensor from the loop (leaving the capacitor in the circuit) and substitute the potentiometer for the sensor. After that the capacitor could be removed if desired. All I can say is he'd have to be a patient thief!

FALSE ALARM

Can't afford a car alarm? Then try the circuit shown in Fig. 4. It gives people the impression that you have an alarm in your car provided that you mount the LED where it can be easily seen from outside the car.

It is basically an astable timer that becomes active when the ignition is off. The timer output causes LED1 to flash. You can adjust R3 to get the flash rate that you desire.

Here's another circuit that may (no guarantees) save your car from being stolen (see Fig. 5). It's a relay-based ignition cut-off switch controlled via S1. Locate your starter solenoid wire under the dash, cut it, and attach the wire from the key switch to point "A" and attach the solenoid wire to point B.

To use the circuit, flip off S1 whenever you leave your car unattended. Don't for-

get to flip it on to start the car, you wouldn't want to call a shop and then find out that you forgot about the switch. I hope these projects deserve a book.

—John W. Cahill Jr.,
Wilmington, NC

In fact, you deserve two books (two projects—two books, that's only fair). By the way, if you replace S1 with a normally open, momentary-contact switch and replace K1 with a DPDT relay, and wire the additional pair of normally open relay contacts in parallel with S1, the circuit becomes a self-activating (passive) cut-off switch. If you install a passive cut-off switch on your car, your insurance company might give you a discount (but check with them before fiddling with your car's wiring).

INEXPENSIVE ALARMS

I've been a fan of **Popular Electronics** for two years now. One of my favorite parts of the magazine is *Think Tank*—I'm always looking for more circuit ideas.

Out of all the circuits I make, some of my favorites are burglar alarms. When I was a little kid (age 6), I made burglar alarms out of clothes pins and buzzers. I would put two tacks in the jaws of the clothes pin, insert a Popsicle stick attached to a fishing line between the tacks, and connect a buzzer and battery in series with the tacks. When someone walked through the doorway and hit the fishing line attached to the Popsicle stick, the Popsicle stick would pop out from between the tacks. The tacks would then complete the circuit, causing the buzzer to go off.

As time went on, I started experimenting with relays and switches. My hobby was getting pretty costly. Then one day I sat down

with some paper and a pencil and designed a 10-cent burglar alarm. I didn't use any switches or fancy sirens since all I wanted was to find out if someone had been in my room, drawers, etc.

For a case I used a dried out marker (see Fig. 6A). (By the way, the really thin ones or a pen will do just fine.) I cut it about 1½ inches from the back end, took out the plug in the back, drilled two holes in it and installed my circuit. When the leads are twisted together and attached to a door as shown in Fig. 6B, if anyone opens the door the LED will light to inform you of an intrusion. That's because the twisted wires short out the power supply until an intrusion occurs. When the twisted wires are separated, the short is removed, and power is applied to the LED.

Later, I wanted to make one a little bigger, with four separate indicators that could monitor four separate points (one for each of my dresser drawers). I came up with the circuit in Fig. 7. If one pair of contacts are broken, it's corresponding (parallel) LED lights, indicating a breach.

By the way, although I'm only in grade nine, I'm getting a mark in the low nineties in a grade ten electronics course at St. Annes High School.

—Steve Lesperance,
Tecumseh, Ontario

Simple, yet effective. I hope you will send in some of your more complex circuits in the future. Good submissions from young hobbyists will always find a home here.

Anyway, no matter what your age, please send your better efforts to me here at *Think Tank*, **Popular Electronics**, 500-B Bi-County Blvd., Farmingdale, NY 11735. ■

ANTIQUE RADIO

(Continued from page 66)

identical to the former, but are unlike them in having no grid caps. Connections to all of the tube elements are brought out to pins in the base. (The "S" in the tube designations stands for "single ended.")

Between and below the 6Q7 detector-first audio amplifier and the type-41 power audio amplifier is the type-76 BFO (beat-frequency oscillator) tube. The BFO generates a radio signal that mixes with the signal at the IF amplifier to create an audio "beat note" equal in frequency to the difference between the BFO output and IF. The pitch of the beat note can be changed by varying the frequency of the BFO, which is accomplished by adjusting the variable inductor shown in the grid circuit of the type-76 tube.

The type-41 power amplifier feeds either the speaker or a set of headphones plugged into the jack shown to the right of audio transformer T3.

Note also that the speaker is a *dynamic* type, which means that the magnetic field required for its operation is supplied by an electromagnet. This electromagnet, also known as the speaker field, can be seen associated with the type-80 tube—where it receives its energizing voltage while serving as the choke coil in the power-supply filter circuit.

That concludes our tour of the Sky Buddy's circuitry, and our column for this month. We'll continue in the next issue, and in the meantime I'd enjoy hearing from you. Write me *c/o Antique Radio*, **Popular Electronics**, 500-B Bi-County Blvd., Farmingdale, NY 11735. ■



1367P \$29.95
Softcover



3804P \$19.95
Softcover

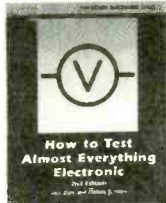

2925P \$10.95
Softcover

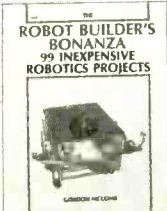

2800P \$16.95
Softcover



2613P \$17.95
Softcover

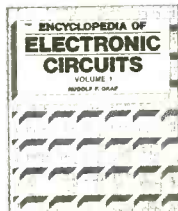

1938-XXX \$60.00
Counts as 3

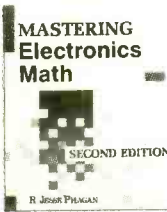

3589 \$27.95



586168 \$24.95

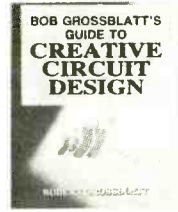

3610 \$28.95

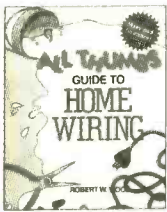

4000P \$9.95
Softcover

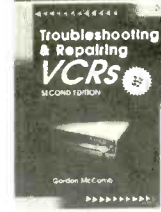

3777-XX \$32.95
Counts as 2



2867P \$18.95
Softcover



3540 \$26.95

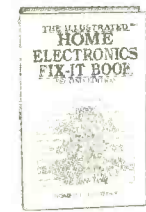

2883P \$18.95
Softcover



3374P \$16.95
Softcover



3671 \$29.95



3107P \$18.95
Softcover



10018 \$39.95



3922 \$26.95

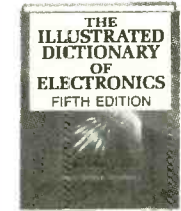

3345P \$26.95
Softcover



3627P \$19.95
Softcover



3765 \$29.95



3677-XX \$34.95
Counts as 2

As a member of the Electronics Book Club . . .

. . . you'll enjoy receiving Club bulletins every 3-4 weeks containing exciting offers on the latest books in the field at savings of up to 50% off of regular publishers' prices. If you want the Main Selection do nothing and it will be shipped automatically. If you want another book, or no book at all, simply return the reply form to us by the date specified. You'll have at least 10 days to decide. Your only obligation is to purchase 3 more books during the next 12 months, after which you may cancel your membership at any time. PE1092

©1992 EBC (Publishers' prices shown)

Your most complete and comprehensive source for the finest electronics books



3485 \$27.95

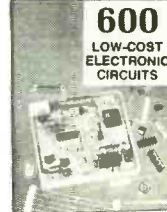

3219P \$18.95
Softcover



3778 \$26.95

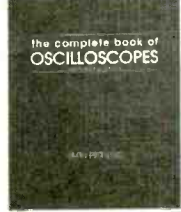

3825 \$26.95

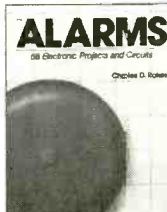

2396P \$14.95
Softcover

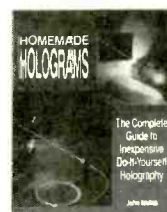

3460P \$14.95
Softcover



2258 \$28.95

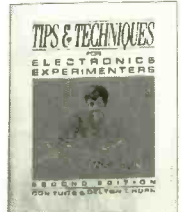

3145P \$12.95
Softcover

If you select a book that counts as 2 choices, write the book number in one box and XX in the next. If you select a Counts as 3 choice, write the book number in one box and XXX in the next 2 boxes. A shipping/handling charge and sales tax will be added to all orders. All books are hardcover unless otherwise noted. If card is missing, write to: Electronics Book Club, Blue Ridge Summit, PA 17294-0810

Select any 5 books

for only \$4.95

plus 1 book FREE upon prepayment

when you join the Electronics Book ClubSM

(values up to \$158.75)

GET THE LATEST ADVANCES IN ELECTRONICS

WITH A SUBSCRIPTION TO

Electronics

Radio Combined with
Electronics[®]

NOW

[®]

Electronics Now gives you exciting articles like:

- Buyer's Guide to Digital Oscilloscopes
- Build A Scanner Converter
- Single-Chip Voice Recorder
- Build A MIDI Interface for your PC
- Troubleshoot Microprocessor Circuits
- Build A High-Power Amplifier for your Car
- Add Music On Hold to your Phone
- All About Binaural Recording
- VGA-to-NTSC Converter

ENJOY THE WORLD OF ELECTRONICS EACH MONTH!

Subscribe to the best electronics magazine—the one that brings you the latest high-tech construction projects, feature articles on new technology, practical troubleshooting techniques, circuit design fundamentals, and much more.

Electronics Now looks to the future and shows you what new video, audio and computer products are on the horizon. What's more you'll find helpful, monthly departments such as Video News, Equipment Reports, Hardware Hacker, Audio Update, Drawing Board, Computer Connections, New Products, and more. All designed to give you instruction, tips, and fun.



FOR FASTER SERVICE CALL TODAY

1-800-999-7139

DON'T DELAY SUBSCRIBE TODAY!

Just fill out the order card in this magazine and mail it in today.

RING LAUNCHER

(Continued from page 44)

ground the AC line voltage to a metal chassis. In addition, an isolation transformer should be used when testing or troubleshooting the circuit to avoid a very serious shock hazard.

Apply power to the circuit; DISP1 should display a 9. Press S1 and monitor the display. The display should show a descending count. If the counter does not function (the display fails to count after pressing S1), check for a clock pulse on pin 3 of U5. If U5 is receiving the proper clock signal, check the BCD output wiring that feeds U4 (the latch/decoder/display driver) for a BCD output at pins 3, 2, 6, and 7 of U3. Confirm that those terminals are wired to pins 7, 1, 2, and 6, respectively, of U4. Also check U4 pins 5 and 16 for the proper supply voltage.

The monostable timer (U2) should trigger as soon as the counter reaches zero. A TTL logic probe or an oscilloscope can be used to check that Q1 pulls pin 2 of U2 low when the count of zero is reached. About one second later, the output of U2 at pin 3 should go low, resetting the flip-flop (U1-a/U1-b). Check for a low on pin 11 of U3; that disables the counter/display at a count of zero.

If the ring is not repulsed when the count reaches zero, check to make sure that pin 12 of U3 goes high, triggering U6, on the zero count. If that's okay, check that the gate of TR1 receives a trigger voltage from the optoisolator/coupler on the zero count. If all seems to be okay up to that point, check the interconnections to and from the Triac. If the Triac is wired correctly, but the ring is still not repulsed, try replacing the Triac. Continue checking the individual sub-circuits until the problem is located and corrected.

One final note on safety before we conclude: While the prototype does not propel the aluminum ring with any great force, you should, nonetheless, not point the unit at any person or against any object that may be harmed by contact with the ring. It would be a shame to ruin the fun this project could provide through a careless act. ■

Popular Electronics®

REPRINT BOOKSTORE

- | | |
|---|--|
| <ul style="list-style-type: none"> <input type="checkbox"/> 222 Popular Electronics (1992 back issues) \$5.00
Write in issues desired _____ <input type="checkbox"/> 221 Popular Electronics (1991 back issues, Jan., Mar. not available) \$5.00
Write in issues desired _____ <input type="checkbox"/> 220 Popular Electronics (1990 back issues) \$5.00
Write in issues desired _____ <input type="checkbox"/> 119 Popular Electronics (1989 back issues) \$5.00
Write in issues desired _____ <input type="checkbox"/> 118 Hands-On Electronics (1988 back issues) \$5.00
Write in issues desired _____ <input type="checkbox"/> 117 Hands-On Electronics (1987 back issues) \$5.00
Write in issues desired _____ <input type="checkbox"/> EH92 Experimenters Handbook (1992) \$5.00 <input type="checkbox"/> EH91 Experimenters Handbook (1991) \$5.00 <input type="checkbox"/> EH90 Experimenters Handbook (1990) \$5.00 <input type="checkbox"/> EH88 Experimenters Handbook (1988-89) \$5.00 <input type="checkbox"/> EH87 Experimenters Handbook (1987) \$5.00 <input type="checkbox"/> HH92 Hobbyist Handbook (1992) \$5.00 <input type="checkbox"/> HH91 Hobbyist Handbook (1991) \$5.00 <input type="checkbox"/> HH90 Hobbyist Handbook (1990) \$5.00 <input type="checkbox"/> HH89 Hobbyist Handbook (1989) \$5.00 <input type="checkbox"/> 212 Radio-Electronics (1992 back issues) \$5.00 <input type="checkbox"/> 211 Radio-Electronics (1991 back issues) \$5.00
Write in issues desired _____ <input type="checkbox"/> 210 Radio-Electronics (1990 back issues) \$5.00
Write in issues desired _____ <input type="checkbox"/> 109 Radio-Electronics (1989 back issues) \$5.00
Write in issues desired _____ <input type="checkbox"/> 108 Radio-Electronics (1988 back issues) \$5.00 | <ul style="list-style-type: none"> Write in issues desired _____ <input type="checkbox"/> 107 Radio-Electronics (1987 back issues) \$5.00
Write in issues desired _____ |
|---|--|
-
- | | |
|---|---|
| REPRINTS | REPRINTS |
| <ul style="list-style-type: none"> <input type="checkbox"/> 169 Think Tank (133 Circuits) \$3.50 <input type="checkbox"/> 169A Think Tank Vol. 2 \$3.00 <input type="checkbox"/> 168 Fact Cards (#34-66) \$4.00 <input type="checkbox"/> 168C Fact Cards (#67-99) \$3.50 <input type="checkbox"/> 168D Fact Cards (#100-132) \$3.50 <input type="checkbox"/> 167 Designing With IC's \$4.00 <input type="checkbox"/> 166 Collected Works of Mohammed Ulyses Fips (62 pages, April Fools Collection) \$5.00 <input type="checkbox"/> 165 How to Repair CD Disc Players \$5.00 <input type="checkbox"/> 164 Modern Electrics (April 1908) \$3.00 <input type="checkbox"/> 163 Receiving Satellite TV \$5.00 <input type="checkbox"/> 162 Build Your Own Satellite TV Receiver \$5.00 <input type="checkbox"/> 161 Descrambling (Feb. 1984) \$4.00 <input type="checkbox"/> 160 New Ideas - 42 Circuits \$3.50 <input type="checkbox"/> 159 Low Frequency Receiving Techniques Building and using VLF Antennas \$5.00 <input type="checkbox"/> 158 Electro Importing Co. Catalog (Circa 1918) \$5.95 <input type="checkbox"/> 157 All About Kits \$2.00 <input type="checkbox"/> 156 How To Make PC Boards \$2.00 <input type="checkbox"/> 155 IBM Typewriter To Computer \$2.00 <input type="checkbox"/> 154 How To Repair VCR's \$3.50 <input type="checkbox"/> 150 Pay TV Decoder (1981) \$3.00 | <ul style="list-style-type: none"> Write in issues desired _____ |

To order any of the items indicated above, check off the ones you want. Complete the order form below. **include your payment**, check or money order (DO NOT SEND CASH), and mail to **Claggg Inc.**, Reprint Department, P.O. Box 4099, Farmingdale, NY 11735. Please allow 4-6 weeks for delivery.

If you need a copy of an article that is in an issue we indicate is unavailable you can order it directly from us. We charge 50¢ per page. Indicate the issue (month & year), pages and article desired. Include payment in full, plus shipping and handling charge. Make checks payable to Claggg Inc.

ARTICLE _____

PAGES _____

MONTH _____

YEAR _____

TOTAL PAGES _____

@50¢ each

TOTAL PRICE _____

MAIL TO: **Claggg Inc.**

Reprint Bookstore, P.O. Box 4099, Farmingdale NY 11735

All payments must be in U.S. funds

SHIPPING CHARGES IN USA & CANADA

\$0.01 to \$5.00	\$1.50	\$30.01 to 40.00	\$5.50
\$5.01 to \$10.00	\$2.50	\$40.01 to 50.00	\$6.50
\$10.01 to 20.00	\$3.50	\$50.01 and above	\$8.00
\$20.01 to 30.00	\$4.50		

SORRY — We only ship to USA & Canada

Total price of merchandise	\$ _____
Shipping Charge (see chart)	\$ _____
Subtotal	\$ _____
Sales Tax (New York State Residents only)	\$ _____

Name _____

Total Enclosed \$ _____

Address _____

City _____ State _____ Zip _____

PE1092

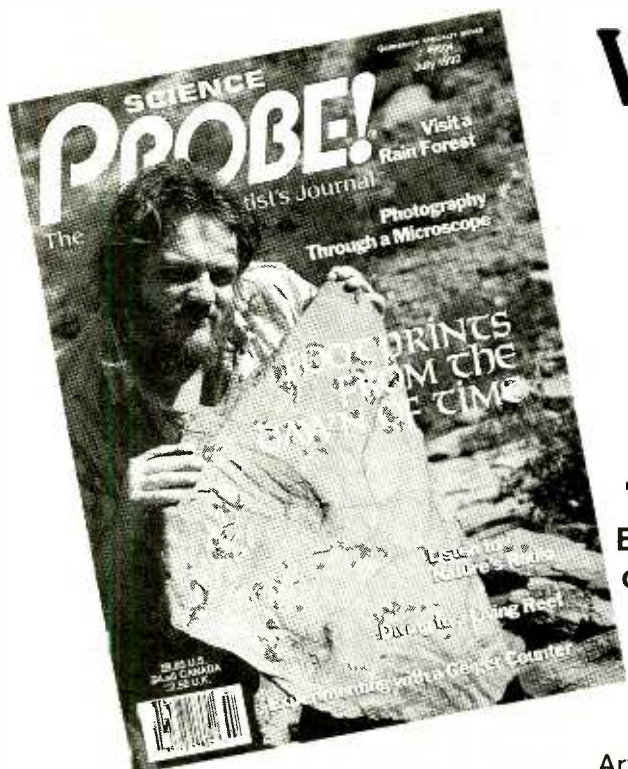

Welcome to . . .

SCIENCE PROBE!®

The Amateur Scientist's Journal

Embark on an irresistible new journey into the realm of mystery, challenge, and exploration! The perfect magazine for the budding scientist, the serious amateur, the professional who would like to relax, and those who simply want to gaze at the stars.

Science PROBE! — the *only* magazine devoted entirely to Amateur Scientists! If you are fascinated by science in all its many forms . . . if you can't stay away from a microscope, telescope, calipers, or test tube — we invite you to share the wonders in every issue of **Science PROBE!** You will join a community of Amateur and Student Scientists who enthusiastically seek scientific knowledge or follow scientific pursuits for their own sakes and not merely as a profession.

Obtain your next issue of **Science PROBE!** by visiting a quality Newsstand, Convenience Store, or Supermarket or by reserving your personal copy through the mail by completing the coupon below.

From your very first issue of **Science PROBE!** you will be involved in a world of scientific facts, experiments, and studies pursued by amateur scientists who are university students, investors, academicians, engineers, or office workers, salesmen, farmers—whose *quest* is to probe into the mysteries of science and reveal them to all.

Plan to become a **Science PROBE!** reader!

Articles to appear in upcoming issues of **Science PROBE!** are:

Inside Internet—A Scientific Computer Network
Make your own Seismometer
Operate a Solar-Powered Weather Station
Assemble a Solid-State Portable Barometer
The Bicycle—A Traveling Scientific Laboratory

If you're fascinated by science in all its many forms, if you are compelled to experiment and explore, then **Science PROBE!** is your kind of magazine!

For Faster Service—Call Today:
1-800-777-5489

Science PROBE!
 500-B Bi-County Boulevard
 Farmingdale, NY 11735

7PK22

Please forward my copy of **Science PROBE!** as soon as it comes off the press. I am enclosing \$3.50-U.S.A. (\$4.23-Canada-includes G.S.T.) plus \$1.00 for shipping and handling. Better still, please enroll me as a subscriber and send the next four (4) quarterly issues of **Science Probe**. I am enclosing \$9.95-U.S.A. (Canada: \$16.00—includes G.S.T.)

Next Issue Only Next Four Issues (1 Year)

Offers valid in the U.S.A. and Canada only. No foreign orders.

Name _____

Address _____

City _____ State _____ ZIP _____

All Orders payable in U.S.A. Funds only.

ON SALE AT QUALITY NEWSSTANDS, CONVENIENCE STORES AND SUPERMARKETS
GET YOUR COPY TODAY—\$3.50-U.S.A.—\$3.95-Canada

ELECTRONICS MARKET PLACE

FOR SALE

CABLE descrambler liquidation. Major makes and models available. Industry pricing! (Example: Hamlin Combo's, \$44 each... Minimum 10 orders). Call **WEST COAST ELECTRONICS**, 1 (800) 628-9656.

LONG play cassette recorder — Records 12 hours on a single standard cassette. Voice-activated. Also miniature long play recorders, mini microphones, telephone record controllers, stun guns, surveillance/countermeasures devices. Catalog \$3.00. **PRODUCTIVE ELECTRONICS**, Box 930024-E, Norcross, GA 30093.

SITELINE LASERS, INC. is offering its 5 — 8 milliwatt He-Ne lasers and power supplies for sale at manufacturers pricing. Supplies can be purchased in Do-It-Yourself kits. Send SASE and phone number for free catalog, or call (206) 481-9490.

SURPLUS solar panels, 105 watt set, \$469.99 unframed \$300.00. 35 watt \$189.99. All panels 5 year warranty. Visa, mastercard. **(602) 276-5083.**

POWER quality/UPS, line conditioners, surge suppression, ac/dc power supplies, inverters, battery chargers, alternate energy, gensets. **ZZAP POWER**, box 532, Champlain, NY 12919.

CLASSIFIED AD ORDER FORM

To run your own classified ad, put one word on each of the lines below and send this form along with your check to:

Popular Electronics Classified Ads, 500-B Bi-County Boulevard, Farmingdale, N.Y. 11735

PLEASE INDICATE in which category of classified advertising you wish your ad to appear. For special headings, there is a surcharge of **\$11.00.**

() Plans/Kits () Business Opportunities () For Sale
() Education/Instruction () Wanted () Satellite Television
() _____

Special Category: \$11.00

PLEASE PRINT EACH WORD SEPARATELY, IN BLOCK LETTERS.

(No refunds or credits for typesetting errors can be made unless you clearly print or type your copy.) Rates indicated are for standard style classified ads only. See below for additional charges for special ads. **Minimum: 15 words.**

1	2	3	4	5
6	7	8	9	10
11	12	13	14	15 (\$23.25)
16 (\$24.80)	17 (\$26.35)	18 (\$27.90)	19 (\$29.45)	20 (\$31.00)
21 (\$32.55)	22 (\$34.10)	23 (\$35.65)	24 (\$37.20)	25 (\$38.75)
26 (\$40.30)	27 (\$41.85)	28 (\$43.40)	29 (\$44.95)	30 (\$46.50)
31 (\$48.05)	32 (\$49.60)	33 (\$51.15)	34 (\$52.70)	35 (\$54.25)

We accept MasterCard and Visa for payment of orders. If you wish to use your credit card to pay for your ad fill in the following additional information (Sorry, no telephone orders can be accepted.):

Card Number _____

Expiration Date _____

PRINT NAME _____

SIGNATURE _____

IF YOU USE A BOX NUMBER YOU MUST INCLUDE YOUR PERMANENT ADDRESS AND PHONE NUMBER FOR OUR FILES. ADS SUBMITTED WITHOUT THIS INFORMATION WILL NOT BE ACCEPTED.
CLASSIFIED COMMERCIAL RATE: (for firms or individuals offering commercial products or services) \$1.55 per word prepaid (no charge for ZIP code)...**MINIMUM 15 WORDS.** 5% discount for same ad in 6 issues within one year; 10% discount for 12 issues within one year if prepaid. **NON-COMMERCIAL RATE:** (for individuals who want to buy or sell a personal item) \$1.25 per word prepaid...no minimum. **ONLY FIRST WORD AND NAME** set in bold caps at no extra charge. Additional bold face (not available as all caps) **30¢ per word additional.** Entire ad in boldface, \$1.85 per word. **TINT SCREEN BEHIND ENTIRE AD:** \$1.90 per word. **TINT SCREEN BEHIND ENTIRE AD PLUS ALL BOLD FACE AD:** \$2.25 per word. **EXPANDED TYPE AD:** \$2.05 per word prepaid. Entire ad in boldface, \$2.45 per word. **TINT SCREEN BEHIND ENTIRE EXPANDED TYPE AD:** \$2.55 per word. **TINT SCREEN BEHIND ENTIRE EXPANDED TYPE AD PLUS ALL BOLD FACE AD:** \$2.95 per word. **DISPLAY ADS:** 1" x 2 1/4"—\$205.00; 2" x 2 1/4"—\$410.00; 3" x 2 1/4"—\$615.00. **General Information:** Frequency rates and prepayment discounts are available. **ALL COPY SUBJECT TO PUBLISHERS APPROVAL. ADVERTISEMENTS USING P.O. BOX ADDRESS WILL NOT BE ACCEPTED UNTIL ADVERTISER SUPPLIES PUBLISHER WITH PERMANENT ADDRESS AND PHONE NUMBER.** Copy to be in our hands on the 18th of the fourth month preceding the date of issue (i.e.; Sept. issue copy must be received by May 18th). When normal closing date falls on Saturday, Sunday or Holiday, issue closes on preceding work day. Send for the classified brochure. Circle Number 49 on the Free Information Card.

FREE CATALOG

FAMOUS "FIRESTIK" BRAND CB ANTENNAS AND ACCESSORIES. QUALITY PRODUCTS FOR THE SERIOUS CB'er. SINCE 1962

FIRESTIK ANTENNA COMPANY
2614 EAST ADAMS
PHOENIX, ARIZONA 85034

JERROLD, Tocom and Zenith "test" chips. Fully activates unit. **\$50.00. Cable descramblers from \$40.00. Orders 1 (800) 452-7090. Information (310) 867-0081.**

PRINTED circuit boards — etched, drilled, tin plated. Single sided \$1.25/sq. inch. No setup charge. **CHELCO ELECTRONICS**, 61 Water Street, Mayville, NY 14757. 1 (800) 388-8521.

LASER & SOLAR ENERGY PRODUCTS Lasers from \$15.00. We specialize in laser and solar energy products for commercial, and hobbyist applications. Free catalog: **DESIGN IMAGES**, Dept. P7, Box 292125, Lewisville, TX 75029. (214) 221-9711.

CABLE TV DESCRAMBLERS
★ **CONVERTERS** ★
and ACCESSORIES.

SAVE MONEY.
DON'T RENT!

PANASONIC,
PIONEER, JERROLD, OAK,
SCIENTIFIC ATLANTA
AND MORE. LOWEST PRICES.
FREE CATALOG.
(800) 234-1006
CABLE READY COMPANY

TOCOM-Jerrold Impulse-Scientific Atlanta converters, two year warranties, also **test modules** for your converters. Contact **NATIONAL CABLE**, (219) 935-4128 full details.

CELLULAR Hackers Bible. Theory — Hacks — Modifications — Programming \$53.95. **TELECODE**, PO Box 6426-PE, Yuma, AZ 85366-6426.

CB RADIO OWNERS!

We specialize in a wide variety of technical information, parts and services for CB radios, 10-Meter and FM conversion kits, repair books, plans, high-performance accessories. Thousands of satisfied customers since 1976! Catalog \$2

CBC INTERNATIONAL
P.O. BOX 31500PE, PHOENIX, AZ 85046

CABLE Test Chips. S-A 8550, S-A 8500 — 310, 311, 320, 321 (specify) — \$33.95. S-A 8580/338 — \$69.95. TOCOM 5503/07 VIP — \$33.95. Starcom 6 — \$33.95. Starcom 7 — \$49.95. **TELECODE**, PO Box 6426-PE, Yuma, AZ 85366-6426.

SECRET Cable Descramblers! Build your own descrambler for less than \$12.00 in seven easy steps. Complete instructions \$10.00. Radio Shack parts list and **FREE** descrambling methods that cost nothing to try included. **HARRYWHITE**, PO Box 1790, Baytown, TX 77520.

OSCILLOSCOPE 50 MHz, dual channel, solid state calibrated, manual \$250.00. 1 (800) 835-8335 X-123.



Quality Microwave TV Antennas

WIRELESS CABLE - IFTS - MMDS - Amateur TV Ultra High Gain 50db(+) • Tuneable 1.9 to 2.7 Ghz.
• 55-Channel Dish System \$199.95
• 36-Channel Dish System \$149.95
• 20-Channel Dish System \$124.95
• Global Commercial Grid Antenna (not shown) Add \$30.00
• Yagi Antennas, Components, Custom Tuning Available
• Call or write (SASE) for "FREE" Catalog

PHILLIPS-TECH ELECTRONICS

P.O. Box 8533 • Scottsdale, AZ 85252
(602) 947-7700 (\$3.00 Credit all phone orders)
MasterCard • Visa • American Express • CDD's • Quantity Pricing

TEST-aids for testing units in full service mode. Starcom VII, \$40.00; Starcom VI, \$30.00; Starcom DPBB, \$50.00; Pioneer, \$75.00; Tocom VIP 5503/5507, \$25.00; S.A. call; Zenith, \$25.00; **N.E. ENGINEERING** (617) 770-3830.

FREE electronics catalog. Transistors, ICs, electronic components, etc. Call **INTERNATIONAL MICROELECTRONICS** (817) 561-2244. PO Box 170415, Dept. PE, Arlington, TX 76003.

EDUCATION/INSTRUCTION

VCR repair. Save money — make big profits! Learn how from *How to Keep Your VCR Alive*. "This detailed, step-by-step manual enables anyone with no previous knowledge or experience to fix most VCR problems easily, quickly, and inexpensively with a few simple tools." — *Small Press Review*. Highly recommended by *Electronic Servicing and Technology*, *Modern Electronics*, *Popular Electronics*, *Popular Communications*, *Videomaker*, *Video*, *Nuts and Volts*, and many other electronics and video magazines "Far better than Viejo at 1/7 the cost." 403 page book, with 704 illustrations, plus professional head-cleaning tool. Obtain from B. Daltons or send \$24.95 to **WORTHINGTON PUBLISHING**, 6907-202H Halifax River Drive, Tampa, FL 33617. Publisher pays S&H. Money-back satisfaction guarantee!

ELECTRONICS tutorial software. Nine diskettes. Over 1000 screens of information and help on DC, AC, analog and digital. Q&A format. IBM \$25.00. **TUTOR-TECH**, 5591 Kimberly St., San Jose, CA 95129. (408) 252-3223.

LEARN COMPUTERS!

Home study: become an expert with the personal computer for home or business use. **Free literature:** call 800-223-4542.

Name _____
Address _____
City _____ State _____ Zip _____
School of Computer Training, Dept. KL341
2245 Perimeter Pk., Atlanta, Georgia 30341

LEARN IBM PC assembly language. Disk \$5.00. Book \$18.00. **ZIPFAST**, Box 12238, Lexington, KY 40581-2238.

PLANS & KITS

HOBBY/broadcasting/ham/CB/surveillance transmitters, amplifiers, cable TV, science, bugs, other great projects! Catalog \$1.00 **PANAXIS**, Box 130-H10, Paradise, CA 95967.

BUILD — five-digit, ohms, capacitance, frequency, pulse, multimeter. Board, and instructions \$9.95. **BAGNALL ELECTRONICS**, 179 May, Fairfield, CT 06430.

FASCINATING Electronic Devices! Dazers! Lasers! Transmitters! Detectors! Free energy! Tesla! Kits/assembled! Catalog \$4.00. (refundable) **QUANTUM RESEARCH**, 17919-77 Avenue, Edmonton, Alberta T5T 2S1.

ANTIQUE RADIO CLASSIFIED

Free Sample!

Antique Radio's

Largest Circulation Monthly.

Articles, Ads & Classifieds.

6-Month Trial: \$15. 1-Yr: \$27(\$40-1st Class).
A.R.C., P.O. Box 802-L8, Carlisle, MA 01741



VOICE CHANGER change your voice from a man to woman, or child to adult and vice-versa. Complete with pcboard, kit \$39.95, assembled \$49.95 + \$3.50 s/h. Send payment to **JM ELECTRONICS**, Dept. P, Box 150454, Altamonte Springs, FL 32715-0454.

DESCRAMBLER kits. Complete cable kit \$44.95. Complete satellite kit \$49.95. Add \$5.00 shipping. Free brochure. No New York sales. **SUMMIT PE**, Box 489, Bronx, NY 10465.

SURVEILLANCE — **Counterspy** equipment! Guaranteed low prices! Catalog \$5.00. **SURVEILLANCE COUNTERMEASURE TECHNOLOGIES**, Box 520013-B, Salt Lake City, UT 84152.

VIDEOCIPHER II /Satellite/Scanner/Cable/Amateur/Cellular/Repair manuals, modification books & software. Catalog — \$3.00. **TELECODE**, PO Box 6426-PE, Yuma, AZ 85366-6426.

KENWOOD & ICOM service bulletins. 175 + pages covering all models. \$33.95. Catalog — \$3.00. CODs (602) 782-2316/ fax (602) 343-2141. **TELECODE**, Box 6426-RE, Yuma, AZ 85366-6426.



RECEIVING TUBES

OVER 3000 TYPES IN STOCK!

Also hard-to-find transformers, capacitors and parts for tube equipment.

Send \$2.00 for our 32 page catalog.

ANTIQUE ELECTRONIC SUPPLY

6221 S. Maple Ave. • Tempe, AZ 85283 • 602-820-5411

RAMP gen. 8 bit D/A with variable offset and Vpp. Freq. adj to 250hz. Plans and PC board \$24.95. Send check or m.o. to: **J. MONAZYM**, 7508 E. Papago Dr., Scottsdale, AZ 85257.

VOXBOARD stores 16 seconds of audio in four messages. Re-record anytime, 10 year retention without power. Play/record with pushbuttons. Kit: \$45.00, assembled: \$60.00. **GERALD FOGARTY**, 10 Navajo Trail, Branchburg, NJ 08876.

CIRCUIT boards etched and drilled for as low as .70 cents per square inch. **JM ELECTRONICS**, Dept. P, Box 150454, Altamonte Springs, FL 32715-0454 or (407) 767-8196.

KITS sound, light, and high tech. Send for free catalog. **JM ELECTRONICS**, Dept. P, Box 150454, Altamonte Springs, FL 32715-0454 or (407) 767-8196.

FREE! Catalog of fun and easy-to-build electronic kits. **LNS TECHNOLOGIES**, 20993 Foothill Blvd., Suite 307P, Hayward, CA 94541-1511.

SURVEILLANCE transmitter kits tune from 65 to 305 MHz. Mains powered duplex, telephone, room, combination telephone/room. Catalog with **Popular Communications**, **Popular Electronics** and **Radio-Electronics** book reviews of "Electronic Eavesdropping Equipment Design," \$2.00. **SHEFFIELD ELECTRONICS**, PO Box 377785-A, Chicago, IL 60637-7785.

CABLE descramblers, build your own, SSAVI, gated sync, sinewave. \$14.95. **CABLETRONICS**, box 30502PE, Bethesda, MD 20824.

RADIO controlled car starter. Build and assemble a remote control car starter. Start your car from inside the house. For plans and instructions send \$10.00 to **JEFF COX**, 1418-B Forestdale Blvd., #201, Birmingham, AL 35214-3016.

BUILD 0-50 volt regulated dual tracking power supply. Schematics and instructions. \$5.95. **SMS ENGINEERING** 5932 West Bell Road, Suite D106, Glendale, AZ 85308.

BUILD a very low noise "1mv pk/pk" wideband noise DC to DC converter or power supply. +5VDC or +12VDC source voltage with "Dual" outputs up to ±15VDC. "Guaranteed" schematics and instructions with complete partlist. Send \$19.95 cash or money order to: **SCI INC.**, 800 Fawn Valley Drive, Allen, TX 75002. Information on available "PCB" and assembly at phone: (214) 727-9385.

AUTOMOTIVE electrical monitor. Complete kit \$6.95. Assembled \$9.95. \$3.00 s/h. NY residents add tax. **VR ELECTRONICS CORPORATION**, 47-30 196 st., Flushing, NY 11358.

SATELLITE TV

FREE Catalog — Lowest prices worldwide. **SKYVISION**, 1048 Frontier, Fergus Falls, MN 56537. 1 (800) 334-6455. (See full page ad the Market Center)

SCPC Satellite Receiver, new microprocessor controlled tuning, 50 channel memory, LED read-out, receive hundreds of SCPC services. Affordable price, call 1 (800) 241-8171.

SATELLITE TV — Do It Yourself, major brands discounted, We'll beat everyone's price. Discount **LARRY**, (609) 596-0656.

VIDEOCIPHER II descrambling manual. Schematics, video and audio, \$18.95. Videocipher II 032, \$15.00. Videocipher II plus, \$20.00. Software, \$25.00. **CABLETRONICS**, Box 30502PE, Bethesda, MD 20824.

BUSINESS OPPORTUNITIES

YOUR own radio station! Licensed/unlicensed. AM, FM, TV, cable. Information \$1.00 **BROADCASTING**, Box 130-H10, Paradise, CA 95967.

EASY work! Excellent pay! Assemble products at home. Call toll free 1 (800) 467-5566 Ext. 5730.

MAKE \$75,000.00 to \$250,000.00 yearly or more fixing IBM color monitors. No investment, start doing it from your home (a telephone required). Information, USA, Canada \$2.00 cash for brochure, other countries \$10.00 US funds. **RANDALL DISPLAY**, Box 2168-H, Van Nuys, CA 91404, USA. Fax (818) 990-7803.

HOME assembly work available! Guaranteed easy money! Free details! **HOMEWORK-P**, Box 520, Danville, NH 03819.

JOBs in electronics. Companies are still hiring for positions in US and overseas. For a listing of 400 companies plus resume guide send \$10.00 to **BENTHOS-PE**, POB 23336, Barrigada, GU 96921.

\$800.00 weekly possible! Working at home! 37 different opportunities. Rush \$1.00 and self-addressed stamped envelope to: **INQUIRIES**, PO Box 310, College Park, MD 20740. U.S. residents only.

NEED money? Guaranteed employment! Assemble simple products at home. Easy work! Excellent income! 1 (800) 377-6000, ex7930.

FREE information! Research engineer earns living with stocks safely. HILL, PO Box 48194, Niles, IL 60648.

ELECTRONICS, stereo components and more! You can start an exciting importing business/hobby. How to deal directly with manufacturers and save\$...Guaranteed Easy! \$2.00 to MINTER ENTERPRISES, Box 8002-E, Westchester, Ohio 45069.

DON'T worry about unemployment! Run a home-based import-export business! Information \$4.00. SMO, Box 7592-A, Elgin, IL 60121.

FEDERAL loans for small businesses now available. (800) 777-6342 for free details.

ELECTRONICS dealers: Expand your product line, **Make \$\$\$!** Become an American Electronics dealer! Profit opportunities since 1965. Call **WAYNE MARKS**, 1 (800) 872-1373.

WANTED

HAVE an idea? Inventors for **free information package/free review** call **FREEDOM MARKETING, INC.** 1 (800) 932-4298.

T.V. FILTERS

T.V. notch filters, phone recording equipment, brochure \$1.00. **MICRO THinc.**, Box 63/6025, Margate, FL 33063. (305) 752-9202.

HOME EXTERMINATION

NEW book: "Become Roach-Free" Exterminator explains: in detail. \$20.00 EPE, POB 74C, Calhoun, LA 71225-0074.

RADON. THE HEALTH HAZARD IN YOUR HOME THAT HAS A SIMPLE SOLUTION.

Call
1-800-SOS-RADON
to get your Radon
test information.



FREE CATALOG!
1-800-648-7938
JERROLD HAMLIN OAK ETC
CABLE TV
DESCRAMBLERS

- Special Dealer Prices!
- Compare our Low Retail Prices!
- Guaranteed Prices & Warranties!
- Orders Shipped Immediately!

REPUBLIC CABLE PRODUCTS, INC.
4080 Paradise Rd. #15, Dept. PE1092
Las Vegas, NV 89109
For all other information (702) 362-9026

*****PRESENTING*****
CABLE TV
DESCRAMBLERS
*****STARRING*****
JERROLD, HAMLIN, OAK
AND OTHER FAMOUS MANUFACTURERS

- FINEST WARRANTY PROGRAM AVAILABLE
- LOWEST RETAIL / WHOLESALE PRICES IN U.S.
- ORDERS SHIPPED FROM STOCK WITHIN 24 HRS.
- ALL MAJOR CREDIT CARDS ACCEPTED

FOR FREE CATALOG ONLY **1-800-345-8927**
FOR ALL INFORMATION **1-818-709-9937**

PACIFIC CABLE CO., INC.
7325 1/2 Reseda Blvd., Dept. 2019
Reseda, CA 91335

BEST BY MAIL

Rates: Write National, Box 5, Sarasota, FL 34230

OF INTEREST TO ALL

ELECTRONIC ENGINEERING, 8 volumes complete. \$109.95. No prior knowledge required. Free brochure. **BANNER TECHNICAL BOOKS**, 1203 Grant Ave., Rockford, IL 61103.

RECYCLE PERSONAL COPIERS Cartridges, instructions \$14.95. Charles Bruns, Box 543, Applegate, CA 95703.

SECRET PAY TV Descrambler. Easy to build in 7 easy steps for less than \$10.00. Parts list and complete instructions included. \$5.00: **SEASONS ELECTRONICS**, 3305 Sycamore St., N. Little Rock, AR 72118.

YOU TOO CAN import from Taiwan and Hong Kong. Free information. Box 661, Dallas, GA 30132.

NEED SECOND INCOME??? Details \$9.98: Thomas, Box 16801, Jacksonville, FL 32245-6801.

ANALYZE YOURSELF AND Friends - Send \$9.95 plus \$1.50 S&H For Questionnaire To: "Prophecy", PO Box 1197, Canton, GA 30114.

CHINESE HOROSCOPE 1-900-448-0611 \$2.00 Per Minute 18+ LH Services Ft. Lauderdale, FL 33308 (305)564-3022.

BUY IT WHOLESALE

BURGLAR ALARMS! WHOLESALE. Send \$5.00 For Amazing Catalogue. Global Security, 672 Oldmill Road, Suite 320, DPT(A), Millersville, MD 21108.

BUY 30% - 90% Below Wholesale: Apparel - Electronics \$5.95 - **BOULOS**, Box 55027, Sherman Oaks, CA 91413.

HEALTH & BEAUTY

BALDING: PAUL ROBERTS "low cost do-it-yourself treatment." For information/instructions rush \$10.00 to: Paul Roberts, PO Box 1758, Media, PA 19063. **SPECIAL OFFER:** ACT WITHIN 30 DAYS OF COVER DATE SEND JUST \$5.00.

RECIPES

FREE CAJUN RED Beans and Rice Recipe, Color Brochure 1-800-354-6381.

UNLIMITED 2nd CREDIT FILE! VISA
CALL: 614-239-8284, Ext. 1
WRITE: 4th LIMITED • BOX 32431-PE • COL., OH 43232

WELCOME
VETERANS—SELF-EMPLOYED
ADC
IF FAST CASH GUARANTEED!

SPECIAL FROM ETT

TTL1 —
TTL POCKET GUIDE,
Volume 1,
7400 — 74200
..... \$18.95.



TTL2 —
TTL POCKET GUIDE,
Volume 2,
74201 — 74640
..... \$18.95.

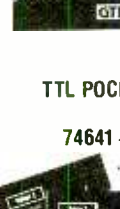

TTL3 —
TTL POCKET GUIDE,
Volume 3,
74641 — 7430640
..... \$18.95.



TTLX —
ALL THREE GUIDES,
Vols 1, 2, & 3
(save \$6.00)
..... \$50.85.

Each volume provides a comprehensive listing of all commonly used TTL integrated circuits within the range of types noted. The combination of three volumes covers 7400 through 7430640 TTL products from all major manufacturers. All current families are covered: standard, low power, Schottky, low power Schottky, advanced Schottky, advanced low powered Schottky, high speed and fast Schottky. There are eight sections to the book. Section 1 illustrates the device schematic using a clear and simple logic diagram. Next a brief description of the components, providing quick reference to the internal structure. The next section details input signals or levels at individual pins. The fourth section lists major applications and is followed by a summary of essential data. Below this, a table indicates the TTL families in which the device is available, and finally, device description and type number are highlighted for easy reference. A manufacturer's index at the back of the book shows in tabular form which companies manufacture each package.

MAIL TO: Electronic Technology Today, Inc.
P.O. Box 240
Massapequa Park, NY 11762-0240

SHIPPING CHARGES IN USA AND CANADA

\$0.01 to \$5.00... \$1.50 \$30.01 to \$40.00... \$5.50
\$5.01 to \$10.00... \$2.50 \$40.01 to \$50.00... \$6.50
\$10.01 to \$20.00... \$3.50 \$50.01 and above \$8.00
\$20.01 to \$30.00... \$4.50

SORRY, No orders accepted outside of USA and Canada

Total price of merchandise \$ _____
Shipping (see chart) \$ _____
Subtotal \$ _____
Sales Tax (NYS only) \$ _____
Total Enclosed \$ _____

Name _____
Address _____
City _____ State _____ Zip _____

ADVERTISING INDEX

POPULAR ELECTRONICS magazine does not assume any responsibility for errors that may appear in the index below.

Free Information No.	Page		
8	AMC Sales	83	— ISCET 68
—	Antique Electronic Supply	97	12 Kepco 73
—	Antique Radio Classified	96	6 MD Electronics 29
—	CBC International	96	— NRI Schools 11
—	CIE	25	5 Number One Systems Ltd. 71
—	CLAGGK, Inc.	30	— Pacific Cable 97
—	Cable Ready Company	95	11 People's College 87
—	Command Productions	71	— Phillips Tech 96
10	Cook's Institute	83	— R.E. Video Offer CV4
—	Electronic Tech. Today	97, CV2	— Republic Cable 97
—	Electronics Book Club	19, 91	— Science Probe 94
—	Firestik II	95	7 The School of VCR Repair 77, 96
—	47th St. Photo	13	15 U.S. Cable 81
—	Grantham College	28	9 Viejo Publications 26
13	Heathkit	26	— WJMK 4, CV3
—	HighText Publications, Inc.	26, 76	14 Zentek Corp. 81

ADVERTISING SALES OFFICE

Gernsback Publications, Inc.
500-B Bi-County Blvd.
Farmingdale, NY 11735
1-(516) 293-3000
President: Larry Steckler
Assistant to the President: Christina Estrada

For Advertising ONLY
516-293-3000
Fax 1-516-293-3115
Larry Steckler
publisher

Arline Fishman
advertising director
Denise Mullen
advertising assistant
Kelly McQuade
credit manager

Customer Service/Order Form
1-800-435-0715
1-800-892-0753
7:30 AM - 8:30 PM EST

SALES OFFICES

EAST/SOUTHEAST
Stanley Levitan, Eastern Advertising Sales Manager
1 Overlook Ave.
Great Neck, NY 11021
1-516-487-9357, 1-516-293-3000
Fax 1-516-487-8402

MIDWEST/Texas/Arkansas/Okla.
Ralph Bergen, Midwest Advertising Sales Manager
One Northfield Plaza, Suite 300
Northfield, IL 60093-1214
1-708-446-1444
Fax 1-708-559-0562

PACIFIC COAST/Mountain States
Marvin Green, Pacific Advertising Sales Manager
5430 Van Nuys Blvd, Suite 316
Van Nuys, CA 91401
1-818-986-2001
Fax 1-818-986-2009

ELECTRONIC WAVES

(Continued from page 48)

ondary of the coil to the terminals of the oscillator. Keep the low-voltage input wires at least 1 or 2 inches away from the high-voltage output cables. The system requires no ground connection.

Obtain an ordinary AM radio, turn it on, and set the tuner to almost any stationless position on the dial. Place the radio anywhere within several feet of the oscillator. Now, switch your system on and depress the telegraph key. You will hear a loud, scratchy, static buzz over the radio as sparks leap across the gap on the oscillator. If the radio doesn't buzz or if the sound is very weak, the oscillator spark gap is probably too big. A word of warning: **do not** under any circumstances attempt to adjust the spark gap when the oscillator is running.

Set the radio to some other place on the dial. When you press the key, you will still hear the buzz. That happens because the Hertz oscillator is not transmitting on a single frequency. The electromagnetic radiation you're

producing does not take the form of a smooth, continuous wave. It's a series of pulses, each of which consists of a highly damped sinewave. In a pulse of that kind, the amplitude of each successive oscillation is smaller than the amplitude of the preceding one. Typically, the decrease follows a logarithmic pattern.

A tiny modification will allow you to actually see the electromagnetic signal as well as hear it. Obtain a small fluorescent tube and lay it down within 3 or 4 inches of the oscillator's dipole antenna. Place the tube so that its length is parallel to the flat surface of the two upright metal sheets of the dipole. (If the tube is placed in a perpendicular position, you may not get the effect you're looking for.) Now, when you operate your oscillator, the tube will flash!

Once again, do not touch the oscillator when the system is in operation, the entire unit is alive with high-voltage; if you make contact with any of the conductors, you will receive a strong and possibly dangerous electric shock. So, please be very careful when performing this experiment.

Conclusion. Heinrich Hertz is sometimes credited with the invention of the first primitive system of wireless communication, *i.e.*, spark telegraphy. But that perception is actually a reflection of our modern historical vantage point in place of his own. Hertz never devoted a lot of attention to the practical potentials of electromagnetic-wave technology. The reason for that is clear. What Hertz was after from the very beginning was experimental proof of Maxwell's theories and a refutation of the theories of instantaneous action at a distance. The creation of a new type of communications device was never his goal or a part of his plan.

Of course, it didn't take long for other natural philosophers to begin thinking about things to come and the implications of Hertz' experiment. One such person was that master of speculation and Victorian visionary, William Crookes. In 1892, he wrote: "Here is unfolded to us a new and astonishing world—one which it is hard to conceive should contain no possibilities of transmitting and receiving intelligence." ■

The Amazing Maze.

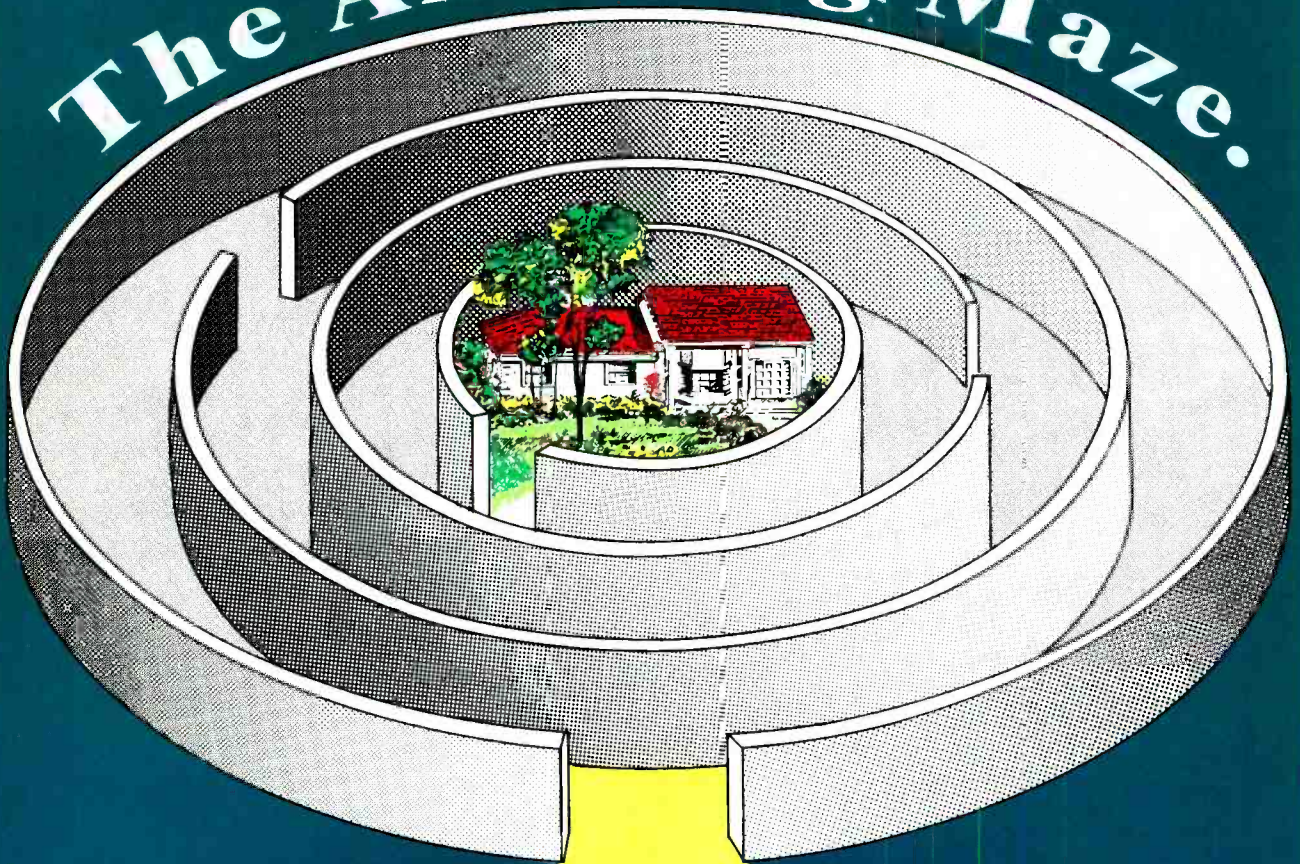

**YOUR HOME . . .
the television series,
will help guide you through it.**

For most families . . . our homes are the biggest purchase we'll ever make. From time to time we've all thought about making changes to our homes. By watching the YOUR HOME television series, you can catch all of the latest ideas and trends designed to get you through the maze of products that will enhance the beauty, functionality, and quality of the time that you spend at home. Whether you're building a dream kitchen or attempting to create the home theater experience, from the simple to the exotic, YOUR HOME has a wealth of great ideas. It's like going to the world's biggest home and garden store each and every week.

Tune into upcoming shows to check out the best and brightest in home products and services:

O.F. MOSSBERG

The HS 410—The ultimate in Home Security Firearms.

RUEGG FIREPLACES

Prism and Prismette beautifully styled, efficient fireplaces.

HEATH CO.

Quality products for inexpensive home security and home automation.

S.C. JOHNSON & SON

Pledge Household Cleaners. . . Today's contemporary cleaning products for all wood surfaces.

CAMERICA CORP.

Camérica. . . The Fantastic Adventures of Dizzy and 6 other games for the Nintendo Video System.

E-Z SOIL

For Perfect Potting and home plant care.

GROSFILLEX

Boutique, Laquer coated Resin Outdoor Furniture.

BARCO

High resolution large screen video projection Equipment.

Check your local cable listing for the time and channel number in your area.

A presentation of

WJMK • 2424 N. Federal Highway • Boca Raton, FL 33431 • (407) 367-0703

Countersurveillance

Never before has so much professional information on the art of detecting and eliminating electronic snooping devices—and how to defend against experienced information thieves—been placed in one VHS video. If you are a Fortune 500 CEO, an executive in any hi-tech industry, or a novice seeking entry into an honorable, rewarding field of work in countersurveillance, you must view this video presentation again and again.

Wake up! You may be the victim of stolen words—precious ideas that would have made you very wealthy! Yes, professionals, even rank amateurs, may be listening to your most private conversations.

Wake up! If you are not the victim, then you are surrounded by countless victims who need your help if you know how to discover telephone taps, locate bugs, or “sweep” a room clean.

There is a thriving professional service steeped in high-tech techniques that you can become a part of! But first, you must know and understand Countersurveillance Technology. Your very first insight into this highly rewarding field is made possible by a video VHS presentation that you cannot view on broadcast television, satellite, or cable. It presents an informative program prepared by professionals in the field who know their industry, its techniques, kinks and loopholes. Men who can tell you more in 45 minutes in a straightforward, exclusive talk than was ever attempted before.

Foiling Information Thieves

Discover the targets professional snoopers seek out! The prey are stock brokers, arbitrage firms, manufacturers, high-tech companies, any competitive industry, or even small businesses in the same community. The valuable information they filch may be marketing strategies, customer lists, product formulas, manufacturing techniques, even advertising plans. Information thieves eavesdrop on court decisions, bidding information, financial data. The list is unlimited in the mind of man—especially if he is a thief!

You know that the Russians secretly installed countless microphones in the concrete work of the American Embassy building in Moscow. They converted



CALL NOW!

1-516-293-3751

**HAVE YOUR
VISA or MC CARD
AVAILABLE**

what was to be an embassy and private residence into the most sophisticated recording studio the world had ever known. The building had to be torn down in order to remove all the bugs.

Stolen Information

The open taps from where the information pours out may be from FAX's, computer communications, telephone calls, and everyday business meetings and lunchtime encounters. Businessmen need counselling on how to eliminate this information drain. Basic telephone use coupled with the user's understanding that someone may be listening or recording vital data and information greatly reduces the opportunity for others to purloin meaningful information.

The professional discussions seen on the TV screen in your home reveals how to detect and disable wiretaps, midget radio-frequency transmitters, and other bugs, plus when to use disinformation to confuse the unwanted listener, and the technique of voice scrambling telephone communications. In fact, do you know how to look for a bug, where to look for a bug, and what to do when you find it?

Bugs of a very small size are easy to build and they can be placed quickly in a matter of seconds, in any object or room. Today you may have used a telephone handset that was bugged. It probably contained three bugs. One was a phony bug to fool you into believing you found a bug and secured the telephone. The second bug placates the investigator when he finds the real thing! And the third bug is found only by the professional, who continued to search just in case there were more bugs.

The professional is not without his tools. Special equipment has been designed so that the professional can sweep a room so that he can detect voice-activated (VOX) and remote-activated bugs. Some of this equipment can be operated by novices, others require a trained countersurveillance professional.

The professionals viewed on your television screen reveal information on the latest technological advances like laser-beam snoopers that are installed hundreds of feet away from the room they snoop on. The professionals disclose that computers yield information too easily.

This advertisement was not written by a countersurveillance professional, but by a beginner whose only experience came from viewing the video tape in the privacy of his home. After you review the video carefully and understand its contents, you have taken the first important step in either acquiring professional help with your surveillance problems, or you may very well consider a career as a countersurveillance professional.

The Dollars You Save

To obtain the information contained in the video VHS cassette, you would attend a professional seminar costing \$350-750 and possibly pay hundreds of dollars more if you had to travel to a distant city to attend. Now, for only \$49.95 (plus \$4.00 P&H) you can view *Countersurveillance Techniques* at home and take refresher views often. To obtain your copy, complete the coupon or call.

CLAGGK INC.	PE
P.O. Box 4099 • Farmingdale, NY 11735	
Please rush my copy of the Countersurveillance Techniques Video VHS Cassette for a total cost of \$54.95 each (which includes \$4.00 postage and handling)	
No. of Cassettes ordered _____	
Amount of payment \$ _____	
Sales tax (N.Y.S. only) _____	
Total enclosed _____	
Bill me <input type="checkbox"/> VISA <input type="checkbox"/> MasterCard	
Card No. _____	
Expire Date _____ / _____	
Signature _____	
Name _____	
Address _____	
City _____ State _____ ZIP _____	
All payments in U.S.A. funds. Canadians add \$4.00 per VHS cassette. No foreign orders.	