

BUILD YOUR OWN GEIGER COUNTER

# Popular Electronics®

JULY 1992

## THE GPS NAVIGATION SYSTEM

A look at this super-accurate, satellite-based radio-navigation system, and a new consumer product that let's you use it.



## A BUYER'S GUIDE TO LOW-COST OSCILLOSCOPES

This comprehensive guide to budget-saving oscilloscopes proves that low cost does not have to mean low quality.

A  
**GERNSBACK**  
PUBLICATION



## BUILD A LOW-COST PORTABLE FREQUENCY COUNTER

Measure frequencies up to 2 MHz with this high-precision device

## BUILD A CORDLESS-TELEPHONE LOCK

Prevent unauthorized use of your cordless telephone

3 NEW FactCards IN THIS ISSUE



\$3.50 U.S.  
\$3.95 CANADA

#BX3DCCH\*xxxxxx 5-DIGIT 60506  
#60506DHM997GA006# FEB93 86  
ROBERT DAHM RESP  
997 GRAND AVE 080 \*  
AURORA, IL 60506

# We Only Skimped On The Price.

Introducing The Fluke Series 10—From \$69.<sup>95</sup>

**Actual size:** Easy to carry, easy to use.

**New! V Chek™:** For fast accurate checks on power sources and supplies, set your meter on V Chek—and let it do the rest. V Chek will determine continuity/ohms; if voltage is present, it will *automatically* change modes to measure AC or DC volts, whichever is detected. For most initial troubleshooting checks, here's the only setting you need to make.

**Autoranging with manual option:** Your choice, depending on your situation.

**Sleep Mode:** Shuts itself off if you forget, extending long battery life even further.

**New! Slide switch and a few pushbuttons control all functions:** Designed for true one-hand operation.

**Fast, accurate tests and measurements:** AC and DC voltage measurements to 600 volts, ohms to 40 MΩ; audible continuity test; and diode test.

**Safety—a Fluke standard:** Designed to meet UL1244, IEC 1010, CSA and VDE safety requirements; extensive overload protection built in.

**New! TL75 Hard Point™ Test Leads:** Comfort grip with extra strong tips for extended service life.

**Fluke quality:** Made in the USA by Fluke, with the same rugged reliability that's made us the world leader in digital multimeters. Count on hard-working high performance—and a two-year warranty to back it up.

**Large, easy-to-read display:** 4000 count digital readout.

**New! Min/Max record with relative time stamp and Continuity Capture™:** Makes intermittent problems easier to find. Records highs and lows—and "time stamps" when they occurred. In continuity mode, opens or shorts as brief as 250 μs are captured and displayed.

**Capacitance:** Autoranging from .001 μF to 9999 μF. No need to carry a dedicated capacitance meter.

**For high performance at Fluke's lowest price, get your hands on the new Series 10.** Stop by your local Fluke distributor and feel what a powerful difference the right multimeter makes—at the right price. For a free product brochure or the name of your nearest distributor, call 1-800-87-FLUKE.

Fluke 10	Fluke 11	Fluke 12
\$69.95*	\$79.95*	\$89.95*
4000 count digital display	V Chek™	Capacitance, .001 to 9999 μF
1.5% basic dc volts accuracy	4000 count digital display	Min/Max recording with relative time stamp
2.9% basic ac volts accuracy	0.9% basic dc volts accuracy	Continuity Capture™
1.5% basic ohms accuracy	1.9% basic ac volts accuracy	Capacitance, .001 to 9999 μF
Fast continuity beeper	0.9% basic ohms accuracy	4000 count digital display
Diode Test	Fast continuity beeper	0.9% basic dc volts accuracy
Sleep Mode	Diode Test	1.9% basic ac volts accuracy
Two-year warranty	Sleep Mode	0.9% basic ohms accuracy
	Two-year warranty	Fast continuity beeper
		Diode Test
		Sleep Mode
		Two-year warranty

\* Suggested U.S. list price

Optional holster with tilt-stand available



The New Series 10.  
A Small Price For A Fluke.

FLUKE AND PHILIPS  
THE T & M ALLIANCE

©1991 John Fluke Mfg. Co., Inc. Prices and specifications subject to change. Ad no. 00130

**FLUKE®**

CIRCLE 9 ON FREE INFORMATION CARD

www.americanradiohistory.com



# Popular Electronics®

THE MAGAZINE FOR THE ELECTRONICS ACTIVIST!

## CONSTRUCTION ARTICLES

<b>BUILD A GEIGER COUNTER</b> .....	John Iovine	41
<i>This project can be used to detect and identify radiation sources in and around your home</i>		
<b>BUILD A CORDLESS-TELEPHONE LOCK</b> .....	Steve Sokolowski	44
<i>Give your older cordless telephone a modern security feature</i>		
<b>BUILD A PORTABLE 2-MHZ FREQUENCY COUNTER</b> .....	Anthony J. Caristi	53
<i>Here is a chance for you to add an accurate, but inexpensive, digital frequency counter to your electronics arsenal</i>		

## FEATURE ARTICLES

<b>THE GPS NAVIGATION SYSTEM</b> .....	Brian C. Fenton	31
<i>This satellite-based, radio-navigation system may revolutionize personal and commercial travel</i>		
<b>A BUYERS GUIDE TO LOW-COST OSCILLOSCOPES</b> .....	Marc Spiwak	35
<i>This guide to budget-priced oscilloscopes proves that low cost does not have to mean low quality</i>		
<b>FUN WITH ANALOG TACHOMETER CIRCUITS</b> .....	Joseph J. Carr	59
<i>Learn how analog tachometer circuits are designed and work, then try your hand at building some of your own</i>		
<b>ALL ABOUT ELECTRICAL NOISE</b> .....	Gary Eggleston	62
<i>Find out about the causes of electrical noise, and how to keep it out of your circuits and designs</i>		

## PRODUCT REVIEWS

<b>GIZMO</b> .....		5
<i>Including: Sony Pyxis GPS Receiver, Sansui Portable Notebook Stereo, Citizen Personal LCD TV, and lots more</i>		
<b>HANDS-ON REPORT</b> .....		26
<i>TSM Alarm-Clock/Chronometer Kit</i>		
<b>PRODUCT TEST REPORT</b> .....	Len Feldman	27
<i>Carver Surround-Sound Processor/Amplifier</i>		

## COLUMNS

<b>ANTIQUE RADIO</b> .....	Marc Ellis	66
<i>More collectors show off their collections</i>		
<b>COMPUTER BITS</b> .....	Jeff Holtzman	68
<i>Sizing up your PC needs</i>		
<b>CIRCUIT CIRCUS</b> .....	Charles D. Rakes	70
<i>Circuit grab-bag</i>		
<b>THINK TANK</b> .....	John J. Yacono	73
<i>Answering our reader's requests</i>		
<b>DX LISTENING</b> .....	Don Jensen	75
<i>Just "chill" out</i>		
<b>HAM RADIO</b> .....	Joseph J. Carr	77
<i>Ol' Sol—friend or foe?</i>		
<b>SCANNER SCENE</b> .....	Marc Saxon	79
<i>Vacation scanning</i>		

## DEPARTMENTS

<b>EDITORIAL</b> .....	Carl Laron	2
<b>LETTERS</b> .....		3
<b>FACTCARDS</b> .....		49
<b>POPULAR ELECTRONICS MARKET CENTER</b> .....		50A
<b>FREE INFORMATION CARD</b> .....		52
<b>ELECTRONICS LIBRARY</b> .....		82
<b>NEW PRODUCTS</b> .....		84
<b>ELECTRONICS MARKET PLACE</b> .....		93
<b>ADVERTISER'S INDEX</b> .....		96

Popular Electronics (ISSN 1042-170X) Published monthly by Gernsback Publications, Inc., 500-B Bi-County Boulevard, Farmingdale, NY 11735. Second-Class postage paid at Farmingdale, NY and at additional mailing offices. One-year, twelve issues, subscription rate U.S. and possessions \$21.95, Canada \$26.84 (includes G.S.T., Canadian Goods and Services Tax Registration No. R125186290), all other countries \$29.45. Subscription orders payable in U.S. funds only. International Postal Money Order or check drawn on a U.S. bank. U.S. single copy price \$2.95. © 1992 by Gernsback Publications, Inc. All rights reserved. Hands-on Electronics and Gizmo trademarks are registered in U.S. and Canada by Gernsback Publications, Inc. Popular Electronics trademark is registered in U.S. and Canada by Electronics Technology Today, Inc. and is licensed to Gernsback Publications, Inc. Printed in U.S.A.

Postmaster: Please send address changes to Popular Electronics, Subscription Dept., P.O. Box 338, Mount Morris, IL 61054-8932.

A stamped self-addressed envelope must accompany all submitted manuscripts and/or artwork or photographs if their return is desired should they be rejected. We disclaim any responsibility for the loss or damage of manuscripts and/or artwork or photographs while in our possession or otherwise.

As a service to readers, Popular Electronics publishes available plans or information relating to newsworthy products, techniques, and scientific and technological developments. Because of possible variances in the quality and condition of materials and workmanship used by readers, Popular Electronics disclaims any responsibility for the safe and proper functioning of reader-built projects based upon or from plans or information published in this magazine.

**Larry Steckler**

*EHF, CET*

*Editor-in-Chief and Publisher*

## EDITORIAL DEPARTMENT

**Carl Laron**

*Editor*

**Robert A. Young**

*Associate Editor*

**John J. Yacono**

*Associate Editor*

**Byron G. Wels, K2AVB**

*Associate Editor*

**Teri Scaduto**

*Assistant Editor*

**Kathy Terenzi**

*Editorial Assistant*

**Marc Spliwak**

*Editorial Associate*

**Joseph J. Carr, K4IPV**

**Marc Ellis**

**Len Feldman**

**Jeffrey K. Holtzman**

**Don Jensen**

**Chris F. O'Brian**

**Charles D. Rakes**

**Marc Saxon**

*Contributing Editors*

## PRODUCTION DEPARTMENT

**Ruby M. Yee**

*Production Director*

**Karen S. Brown**

*Production Manager*

**Marcella Amoroso**

*Production Assistant*

**Lisa Rachowitz**

*Editorial Production*

## ART DEPARTMENT

**Andre Duzant**

*Art Director*

**Injae Lee**

*Illustrator*

**Russell C. Truelson**

*Illustrator*

**Jacqueline P. Cheeseboro**

*Circulation Director*

**Michele Torrillo**

*P-E Bookstore*

## BUSINESS AND EDITORIAL OFFICES

Gemsback Publications, Inc.

500-B Bi-County Blvd.

Farmingdale, NY 11735

1-516-293-3000

Fax: 1-516-293-3115

President: **Larry Steckler**

**Customer Service/Order Entry**

1-800-435-0715

7:30 AM - 8:30 PM EST

## Advertising Sales offices listed on page 96

Cover photography by Travis Evans/Unicorn  
Stock Photos

Composition by  
Mates Graphics



The  
Audit  
Bureau

of Circulation



The publisher has no knowledge of any proprietary rights which will be violated by the making or using of any items disclosed in this issue.

## POSITIONING OURSELVES

This month, we look at a new navigation system that promises to revolutionize personal and commercial travel. Called the Global Positioning System, or GPS, it is a sophisticated, satellite-based, radio-navigation system.

GPS is an example of a technology that was developed for the military that has evolved a consumer application.

Unfortunately, in this country that seems to be the only way that new consumer technologies evolve.

Think about it. Try to come up with a list of new technologies, developed primarily in this country in the last 20 or so years, that did not evolve directly from a military application. Even our interest in something like HDTV stems from military concerns. Lagging behind the rest of the world, our government finally decided to fund HDTV research only after the Pentagon decided it could use the technology for displays in fighter planes, and elsewhere.

Such technology trickle-down is an extremely inefficient way to bring new products to consumers. Because of that, we are now in deep trouble. Like it or not, the rest of the World is passing us in areas such as electronics, transportation, science, and more. Our military-first legacy has left us with decaying plants and factories, a crumbling infrastructure, disappearing jobs, and a trade deficit that, political rhetoric aside, is most likely irreversible for the foreseeable future.

What's needed is a national agenda that calls for investment in industry, as well as education. Government support of civilian technology and industry, whether in the form of tax incentives or direct funding, is absolutely essential.

Despite the recession and the deficit, the money for that is there. What's missing is the proper perspective and direction. We desperately need to re-shuffle our priorities as we move into the 21st Century. If we do not, we are positioning ourselves for disaster.

Carl Laron

Editor



# LETTERS

## CODE-ALARM CORRECTIONS

While Code-Alarm greatly appreciates the inclusion of our Intercept product in the article "Electronic Tracking Foils Auto Thieves" (**Popular Electronics**, March 1992), it is necessary to correct some statements made about the product. It appears that the description of Intercept inadvertently became merged with that of another product called Locator.

First, Intercept is manufactured, sold, and distributed by Code-Alarm Security Systems of Madison Heights, MI, not Locator Industries of Newport Beach, CA, as reported in the article. Second, the article states that a callback feature will be available later this year. Intercept's two-way communication feature, which allows for instantaneous verification of a theft and the elimination of possible false notifications to the police, became available during 1991. Finally, the author of the article identified what he thought was a problem with the Intercept system—the unavailability of Loran C. Actually, Loran C became available nationwide during 1991. Thus, a vehicle equipped with Intercept can be tracked virtually anywhere in the United States and is not constrained by tower distances or state lines.

Thanks for giving me the opportunity to correct those misconceptions.

*Sheryl A. Gruener  
Public Relations Manager  
Code-Alarm, Inc.  
Madison Heights, MI*

## SURGE-SUPPRESSORS SET STRAIGHT

Robert Angus' article, "The Shocking Facts About Surge Suppressors" (**Popular Electronics**, February 1992), was a useful and overall accurate description of what those valuable devices can and cannot do. Regarding warranties, the author is mostly correct. However, Tripp Lite has what we feel is the best warranty in the industry for surge suppressors: our Gold Seal Warranty. If a Tripp Lite Gold Seal product fails to pro-

tect connected equipment against spikes and surges, the company will repair or replace both the surge suppressor and the connected equipment for life. That makes the investment in a surge suppressor a one-time affair.

*Marc C. Vernon  
Advertising Manager  
Tripp Lite  
Chicago, IL*

## APPLAUSE FOR THE PORCH-LIGHT CONTROL

My hat is off to David Ponting for the technical-writing ability exhibited in his "Build an Automatic Porch-Light Control" (**Popular Electronics**, March 1992). He presented a problem, envisioned a solution, overcame difficulties with the concept in a logical, outline-style format, and then pulled it all together in a theoretically (I haven't built the project yet) sound design. That is exactly the way that inventions and helpful products for the layman are achieved.

As stated in the article, extreme caution should be practiced when dealing with household current. The only other drawback to the project is filing the leads of the Triac—there should be an easier way.

I hope to see more such articles in the future. And please keep those FactCards coming!  
*F.M.M.*

*Versailles, PA*

## MORE COMPLIMENTS

I'd like to call your attention to a heart-warming part of Marc Ellis' *Antique Radio* column in the March 1992 issue of **Popular Electronics**. The first letter was a request from a 15-year-old boy. It's inspiring proof that President Bush is wrong: Our youth is interested in science and electronics. The second request in that column was from a senior electronics buff with a 1920 project. If Marc Ellis can draw

out 15-year-olds as well as late-starters, that means both young and old share a common interest with the rest of us who enjoy your high-caliber magazine.

My personal favorites are the articles and columns written by Charles D. Rakes. He explains each project in detail. Those projects are brief, affordable, and provide an easy way for me to attack my huge junk pile of electronics parts. If something's not in stock at my home, his articles tell where to send for it.

I am a disabled, house-bound veteran who has been reading **Popular Electronics** for years. I await each issue like a child waiting for Santa Claus. It's great to see something on the cover and know that—thanks to the easy, common-sense instructions—I'll be able to make it myself and show it off to my friends and relatives. I never throw away an issue, since they make such great reference sources. Congratulations on a fine, fun magazine!

*V.J.B.  
Ravena, NY*

## ADVICE FOR YOUNG ENGINEERS

I'm an engineer with 14 years experience; I also have seven years experience as an electronic technician. I recently subscribed to **Popular Electronics**, and was happy to read in my first issue (February 1992) the letters about young people who want to be engineers. My advice to them is to pursue their interests in engineering. I could tell them that no matter what career one chooses, one will find those who are discouraged with the field. Don't worry about it! If you want it and you enjoy it, then go for it! Remember, if it turns out that you don't like it, at least you'll know that you tried. But if you don't try, you'll never know, and you'll be missing a world full of challenges. Nothing quite matches the feeling of achievement that comes with

making your circuit design work!  
*J. G.  
Bridgeport, CT*

## NEEDED: CORRECT ADDRESS

Thank you for printing the letter in which I requested help in locating service information for a Dynaco SCA-50 stereo amplifier and FM-5 tuner in the "Haves & Needs" section of the *Letters* column (**Popular Electronics**, April 1992). However, my address as printed was incorrect and I have been informed by the Post Office that all correspondence sent there will be returned to sender. I'm sorry for any convenience caused to those kind people who might have tried to respond to my letter. The correct address appears below.

*Bill Graham  
7537 Tamarind Avenue  
Fontana, CA 92336*

## HAVES & NEEDS

I am in dire need of a schematic for an ADC home audio equalizer model #SS-100SL. The actual part I need is the transformer, but I haven't been able to find anyone who can identify the manufacturer. The only markings on the case read: 2-6032-2/EFU4821-22N. It has six secondary outputs. Any help in locating more information would be greatly appreciated.

*Clayton Whitehead  
2510(A) Stanford  
Rowlett, TX 75088*

I have a Scott Stereomaster Model 377 receiver/amplifier. I need help locating a schematic and service manual for it. H.H. Scott Company no longer carries the manual, which is about 20–25 years old. I'd appreciate any help your readers can provide.

*Don Richards  
RD 4, Box 113AB  
Slippery Rock, PA 16057*

COURTEOUS SERVICE • QUALITY PARTS • DISCOUNT PRICES • FAST SHIPPING

# ALL ELECTRONICS CORP.

## PC BOARD WITH RF MODULATOR (and lots of other parts)

We recently received a load of these PC boards which contain, among other things, a RF modulator. With a little desoldering you should be able to liberate a working unit from the board. Also contains a 7805T voltage regulator with a couple of heatsinks, 20 ICs, capacitors, resistors, diodes and connectors. No hook-up information available on the modulator. CAT# VMB-1

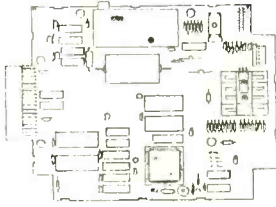

**\$275 each**

## INFRARED Remote A.C. SWITCH

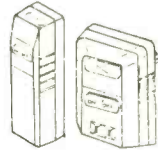

CAT# RC-1  
**\$9.95 each**  
2 for \$17.00

This infrared remote control device lets you turn on/off lamps, appliances or other 120 Vac devices using an IR transmitter similar to the one on your TV or VCR. Originally designed for use with a hydromassage unit, these transmitters and receivers will apparently operate most A.C. devices with 2 prong non-polarized plugs. Not recommended for use with heaters. Requires a 9 volt battery (not included).

## A.C. Line Cord



6' Black A.C. power cords. SPT-1 insulation. Polarized plug. Hanked.  
CAT# LCAC-7 2 for \$1.00 • 100 for \$45.00 • 1000 for \$400.00

## Wireless Remote Control FOR NINTENDO™

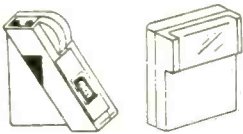

CAMERICA "Freedom Connection"™ Turns your wired Nintendo™ control paddle into a remote control unit. Infrared remote like those used on TVs and VCR's eliminates messy wires. Allows players more mobility. Two players can use one remote unit except on games where they play simultaneously. In those games two "Freedom Connections" units are required. A well-known national discount toy chain sells these for more than twice our price. Operates on 4 AAA batteries (not included). CAT# IR-1 \$9.95

## FLASH UNITS



NEW compact flash assemblies from a camera manufacturer. Operates on 3 Vdc. Measures 2 1/2" X 1 1/4". Ideal for use as a strobe, warning light or attention getter. Includes a hook-up diagram. CAT# FSH-1 \$3.75 each  
10 for \$35.00 • 100 for \$325.00

## L.E.D.'s

### Surface mount LED chip.

Clear when off, green when lit. Very tiny - whole unit is 0.115" X 0.055" X 0.05" thick. 1mm (0.04") lens diameter. Gold-plated mounting surfaces for superior conductivity. CAT# SMLED-2 10 for \$2.00  
100 for \$18.00  
1000 for \$140.00

### Standard JUMBO

Diffused T 1-3/4 size (5 mm)

RED CAT# LED-1 10 for \$1.50 • 100 for \$13.00  
GREEN CAT# LED-2 10 for \$2.00 • 100 for \$17.00  
YELLOW CAT# LED-3 10 for \$2.00 • 100 for \$17.00

### REDUCED PRICES FLASHING LED

W/ built in flashing circuit 5 volt operation. T 1-3/4 (5mm)

RED 50c each  
CAT# LED-4 10 for \$4.75  
GREEN 75c each  
CAT# LED-4G 10 for \$7.00  
YELLOW 75c each  
CAT# LED-4Y 10 for \$7.00

### LED HOLDER

Two piece holder. CAT# HLED 10 for 65c

## D.C. Wall Transformers (120 Vac INPUT)

Volt	Amps	Plug Style	Center	Cat#	Price
4 Vdc	70 ma.	2.5mm co-ax	negative	DCTX-470	\$2.00
6 Vdc	300 ma.	2.1 mm co-ax	positive	DCTX-632	\$2.75
8.3 Vdc	10 ma.	battery snap		DCTX-8310	\$1.50
9 Vdc	300 ma.	2.1 mm co-ax	positive	DCTX-932	\$3.00
12 Vdc	100 ma.	2.1mm co-ax	negative	DCTX-1210	\$2.50
12 Vdc	500 ma.	2.1mm co-ax	negative	DCTX-125	\$4.50
12 Vdc	1 Amp	none		DCTX-121	\$6.50
14 Vdc	700 ma.	1.3mm co-ax	negative	DCTX-1470	\$5.25
15 Vdc	400 ma.	2.5mm co-ax	negative	DCTX-1540	\$4.50

## ELECTROLUMINESCENT BACKLIGHTS

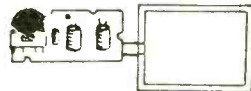

At last! A low cost electroluminescent glow strip and inverter. These brand-new units were designed to backlight small LCD TVs made by the Citizen Watch company. The inverter circuit changes 3 or 6 Vdc to approximately 100 Vac, the voltage required to light the glowstrip. Luminescent surface area is 1.7" X 2.25". The strip is a salmon color in its off state, and glows white when energized. The circuit board is 2.2" X 1". Glow strip and circuitry can be removed easily from plastic housing. Ideal for special lighting effects.

Citizen# 91TA operates on 3 Vdc  
CAT# BLU-91  
Citizen# 92TA operates on 3-6 Vdc  
CAT# BLU-92

LARGE QUANTITY AVAILABLE  
**\$3.50 each** 10 for \$32.00  
100 for \$275.00

## VERY SPECIAL DEAL 17 Vdc 210 ma. WALL TRANSFORMERS

New 17 Vdc, 210 ma wall transformers. 6 ft. cord. Unusual co-axial device on end of cord can be cut off and used for another application.

Large quantity available.  
CAT# DCTX-1721 \$1.50 ea.  
100 for \$1.25 each  
1000 for \$1.00 each

## 10 AMP SOLID STATE RELAY

(USED) 10 amp solid state relays, removed from equipment and tested. Control voltage: 250 volts AC at 10 amps. Standard "hockey-puck" size: 2.27" X 1.72" X 0.95". UL and CSA listed. CAT# SSR1Y-11U \$8.25 each • 10 for \$80.00

## Electret MIKE

High efficiency, omni-directional, miniature electret condenser microphone element. Low current drain, good signal to noise ratio, operates on 2 to 10 Vdc. Ideal for noise-activated alarms telephones, tape recorders, and other applications. 0.39" dia X 0.31" high. CAT# MIKE-10 200 pcs \$150.00 **85¢ each**

## HALL EFFECT SENSORS

Microswitch #SS41 Tiny, solid state switch reacts instantly to proximity of magnetic field. Operates at extremely high speeds, up to 100 khz. Case size: 0.12" X 0.17" X 0.06" thick. 4.5 Vdc to 24 Vdc supply voltage. 10 ma. sink type digital output. Operating gauss - 15 to 40. P.C. leads. CAT# HESW-2 75c each  
10 for \$6.50 • 100 for \$60.00

## SURFACE MOUNT STYLE

Sprague # UGN3075LT Operates on 4.5 - 24 Volts Can sink 10 ma. With suitable output pull up, can be used directly with bi-polar or CMOS logic circuits. Especially suited for electronic commutation in brushless D.C. motors using multiple ring magnets. Very tiny surface mount package 0.175" X 0.09" X 0.06" thick. CAT# HESW-5 2 for \$1.00  
100 for \$45.00  
LARGE QUANTITIES AVAILABLE

## RECHARGEABLE BATTERIES (nickel-cadmium)

Size	Volt	Amp	Model	1-9	10+
AAA	1.20	180 mAh	NCB-AAA	\$1.50	\$13.50
AA	1.20	500 mAh	NCB-AA	\$2.00	\$18.50
AA w/ Solder Tabs	1.20	500 mAh	NCB-SAA	\$2.20	\$20.00
Sub C w/ Solder Tabs	1.20	1200 mAh	NCB-SC	\$4.25	\$40.00
C	1.20	1200 mAh	NCB-C	\$4.25	\$40.00
C Heavy Duty	1.25	1800 mAh	HDNCB-C	\$5.25	\$42.50
D	1.20	1200 mAh	NCB-D	\$4.50	\$42.50
D Heavy Duty	1.25	4000 mAh	HDNCB-D	\$7.00	\$65.00

## Highest Quality METAL CASSETTES

Premium quality metal tape in C-60 style cassettes (30 or more per side). One of the finest "brand-name" tapes on the market, in durable, clear plastic transport mechanisms. Recorded and bulk erased, the record-protect tabs have been removed and therefore, need to be taped over to re-record. Audiophiles will appreciate the wide dynamic range of this tape. If your cassette deck has a "metal" setting you will hear the difference. A real bargain! 60 min. tape - CAT# C-600M 10 for \$10.00

**\$1.25 each**

## CASSETTE STORAGE CASE

Black, unbreakable plastic audio cassette storage case. CAT# CBOX 5 for \$1.00 • 100 for \$15.00

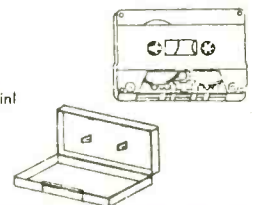

# ORDER TOLL FREE 1-800-826-5432

FAX (818) 781-2653 • INFORMATION (818) 904-0524

Call Or Write For Our Free 64 Page Catalog

Outside the U.S.A. send \$2.00 postage for a catalog.

Minimum Order \$10.00 • All Orders Can Be Charged To Visa, Mastercard Or Discovercard • Checks and Money Orders Accepted By Mail • California, Add Sales Tax • Shipping And Handling \$3.50 for the 48 Continental United States • All Others Including Alaska, Hawaii, P.R. And Canada Must Pay Full Shipping • Quantities Limited • No C.O.D. • Prices Subject to change without notice.

DISCOVER

VISA

MasterCard

MAIL ORDERS TO: ALL ELECTRONICS CORP • P.O. BOX 567 • VAN NUYS, CA 91408

CIRCLE 8 ON FREE INFORMATION CARD



# GIZMO

A CHRONICLE OF CONSUMER ELECTRONICS

JULY 1992

VOLUME 5,  
NUMBER 7

## Where in the World?

**SONY PYXIS GPS RECEIVER.** Manufactured by: Sony Corporation of America, Sony Drive, Park Ridge, NJ 07656. Price: \$1395

Among the lessons we learned from the tale "Hansel and Gretel" is that bread crumbs are not a reliable means for finding your way out of the woods. Unfortunately, we've yet to find a better way, and often end up lost on our "wilderness" treks, even when equipped with trail maps from the park rangers. Fortunately, the woods through which we hike are inhabited not by wicked, carnivorous witches, but by other hikers with more finely honed senses of direction.

Of course, for some people, staying on track is critical. Any captain of a ship at sea, for example, has to know precisely where he is at all times. Once you get outside the channel markers, you had better know how to navigate or you'll quickly end up lost at sea!

Airplane pilots also have to know where they are at all times. But small planes often lack the sophisticated navigation equipment that is commonplace on the big commercial jets.

There is an answer for anyone who needs to know where he is, whether on land, at sea, or in air: the GPS or Global Positioning System. The GPS relies on a cluster of orbiting satellites that, in a sense, become "stars" by which you can navigate. The primary user of GPS is the U.S. Department of Defense, which maintains the system to provide military aircraft and missiles with accurate navigation information. (See the article The GPS Navigation System elsewhere in this issue for a complete description of the global positioning system.) Many of the "smart" bombs that became media heroes during the Persian Gulf War used GPS technology, as did many of the desert troops.

Now, however, mere civilians can use the system (although not with the accuracy available to the military) to learn their lati-

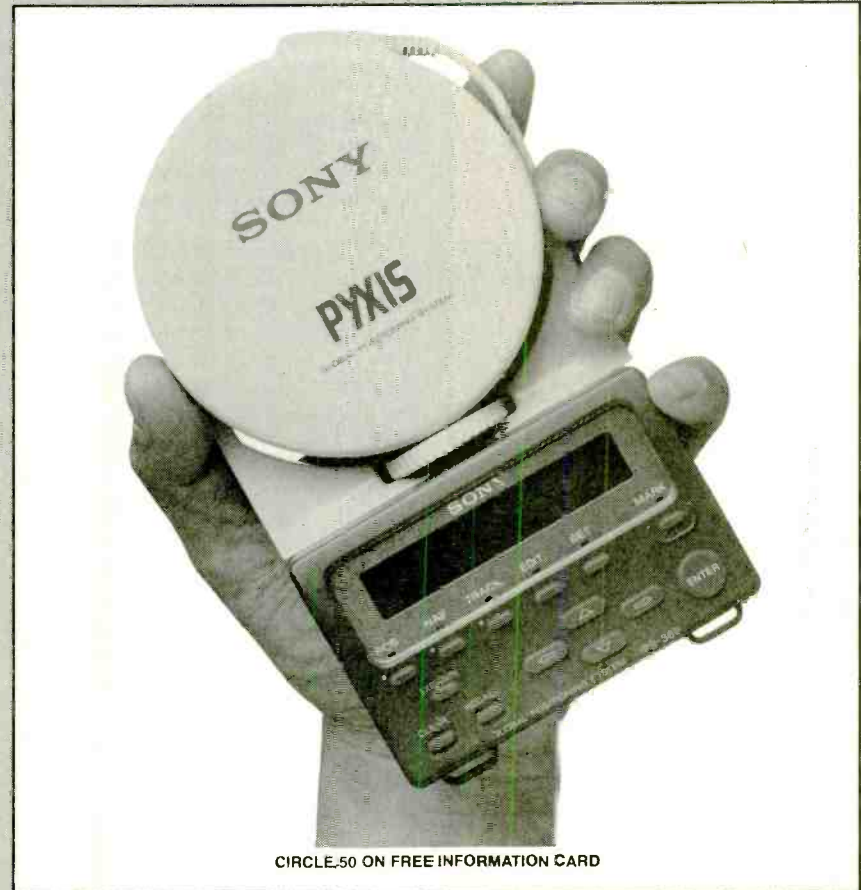

CIRCLE 50 ON FREE INFORMATION CARD

tude, longitude, and altitude thanks to Sony's Pyxis model IPS-360 GPS receiver. Sony calls the Pyxis "the industry's first recreational GPS receiver intended for a wide variety of outdoor leisure applications." They make the claim because other GPS receivers currently on the market are aimed either at industrial applications (truck fleets, and the like), or at maritime use. If you visit your local marine-electronics supply store, you'll likely find a number of GPS receivers for the maritime market. Our local marine retailer says in their sales flyer, "Someday soon you'll own a GPS receiver. GPS is here today. . . . The future of marine navigation certainly lies with GPS."

GPS receivers are so popular in the marine industry for two reasons. First, boaters need to know where they are—without the benefits of street signs, of course. Second, they are already familiar with using navigation technology that is similar to GPS to determine their position, namely Loran-C, a radio aid to navigation provided by the U.S. Coast Guard.

Sony's Pyxis is designed to take GPS out of the water for consumers. The portable unit weighs under 1½ pounds and measures about 100 × 175 × 39 mm. It can be powered by 4 "AA" batteries (as can some of the marine units), so it can fit in a backpack and be used on a hike in the mountains.

TURN PAGE FOR CONTENTS



# This month in GIZMO<sup>®</sup>

Sony PYXIS Global Positioning System Receiver . . . . .	pg. 5
DTI Phone Guard Anti-Bugging Device Handheld Color LCD TV . . . . .	pg. 6
V-Tech Tropez 900 DX 900-MHz Digital Cordless Telephone. . . . .	pg. 8
Sansui Audio Note A-4 CD/Radio/Cassette Recorder . . . . .	pg. 10
Citizen T530 Color LCD Pocket TV with AM/FM Radio . . . . .	pg. 16
Logitech FotoMan Digital Camera for PC's . . . . .	pg. 18
Digital Audio Tape Deck . . . . .	pg. 21
Handheld Blackjack . . . . .	pg. 21
Multi-Service Telephone . . . . .	pg. 21
Six-Language Translator . . . . .	pg. 21
CD-Player Lens Cleaner. . . . .	pg. 22
Projection TV . . . . .	pg. 22
Travel Guide CD-ROM Disc . . . . .	pg. 22

Gizmo is published by Gernsback Publications, Inc., 500-B Bi-County Blvd., Farmingdale, NY 11735. Senior Writers: Chris F. O'Brian and Teri Scaduto. ©Copyright 1992 by Gernsback Publications, Inc. Gizmo is a registered trademark. All rights reserved.

The receiver consists of two units. The bottom third of the receiver contains the display and keypad (14 keys on the front, and one on either side). The top two-thirds is the antenna, a round satellite dish with a diameter of about 4 inches. The antenna can be removed from the base and mounted in a remote location—a 23-foot cable is provided. That is necessary for most applications, because you cannot receive signals indoors, in a car, or in a boat cabin, unless the antenna is mounted outside.

When you turn Pyxis on for the first time—or if you turn it on after an extended period of inactivity, or after you've traveled a long distance—you must initialize it. That's done by turning the unit on, pressing the SET key, and scrolling down the menu to select INITIALIZE RCV. It can take a while—around a half hour—for Pyxis to automatically acquire the orbital data.

Usually, position data can be obtained much faster, since the receiver retains the orbital data for the satellites in its memory, and therefore knows which satellites should be above the horizon. The satellites that it receives are shown on the top line of the display—they are identified by a number from 1 to 24. The bottom line of the display becomes a signal-strength meter while the unit is trying to lock on to the satellite and acquire data. When the receiver receives a strong, stable signal, an "L" shows up on the bottom line to indicate that the receiver is "locked" on the GPS satellite signal. An "E" (for ephemeris, relating to orbits of celestial bodies) shows up to indicate that the receiver has acquired the orbital data. After three satellites have been locked onto and the data acquired, the receiver switches to its position mode.

In the receiver's position mode, the display shows your latitude and longitude, along with an indication of which geodetic system is in use. That's important if you want to compare the numbers given to a specific chart or map. For example, in the U.S., you would want to use NOAM 1, the North American 1927 geodetic system. In Europe, you might want to use EURO 3, the Ordinance Survey of Great Britain, 1936. Choosing the right system is done using the four menu buttons.

You can select the precision of your position measurements to be either low, medium, or high. In the high-precision mode, readings may take a little longer to acquire, because the receiver can't use all "visible" satellites to determine its position. (If readings are acquired from satellites that are close together, the precision decreases.) Thus, in the high-precision mode, the receiver has to search for data from more satellites. Of course, even in

(Continued on page 20)

## Someone Bugging You?

PHONE GUARD TELEPHONE SECURITY DEVICE. Manufactured by: DTI, 551 Madison Avenue, Tenth Floor, Dept. PE, New York, NY 10022. Price: \$199.

Everyone at one time or another has heard a click or some other noise on a telephone line and thought, "Someone's tapping my line." Of course, if someone was *really* tapping your line, you probably wouldn't hear anything—unless the extent of the tap is one of your kids picking up the extension to listen in on your conversation.

Yet, many people are certain that someone is watching or listening to them. We often get calls at *Popular Electronics* from people who want to know how to find out for sure whether someone is tapping their phones. Some have plausible reasons to be concerned—perhaps a business deal went sour because some information leaked out, or they're involved in a messy divorce. Some of the callers are simply paranoid—they have no reasonable explanation as to why someone would want to tap their phone. And still others claim to be concerned about eavesdropping as they call on cordless or cellular phones, oblivious that they're broadcasting every word they say to an audience of thousands.

Those people who really have something to lose are best off getting professional help to find any phone taps or bugs. There are plenty of private investigators who will—for a hefty fee—"sweep" your home or office for all sorts of eavesdropping equipment. (Because electronic surveillance is a tricky business, many investigators do a better job of putting on a high-tech show than actually doing a good job. It's not always that they don't *mean* well, but they just don't understand sophisticated surveillance methods.) For those who want to have reasonable protection without breaking the bank, there are alternatives to hiring a countersurveillance professional. We tried one, the *Phone Guard* from DTI.

The Phone Guard can alert you to taps on the line, and to RF transmitters or "bugs." It can also jam bugs, making them useless. If you are under surveillance from a government agency or police department, the Phone Guard will be essentially useless. Both agencies have access to your phone line from the telephone company's central office, where they can't be detected. But most unauthorized taps are, fortunately, not too sophisticated.

Tapping a telephone is the most popular form of electronic eavesdropping for a number of reasons. First, it's often possible to tap a phone without trespassing on





the premises—the phone wires lead right outside! Second, the phone is used solely for conversations—usually for a specific purpose. They're more focused and concentrated than in-person conversations.

The Phone Guard lets you counter bugs in three ways. First, it looks for changes in the electrical characteristics of the phone line that occur when an ordinary tap is connected. Second, it looks for levels of RF (radio-frequency) signals that are higher than normal. Third, it modifies the voltage available on the phone line, and interferes with many taps.

The Phone Guard installs between your phone and the telephone line; it's powered by a 9-volt battery. Its basic mode of operation is "privacy assurance." When you pick up your handset to receive or make a call, one of the four front-panel LED's lights. If someone picks up an extension—or if a bug is attached—the PRIV LED will turn off, and your phone will be disconnected from the line. While that prevents you from saying anything "sensitive," it also prevents you from saying, "Hey, I'm on the phone. Get off the extension." Of course, it doesn't tell the person to whom you're talking that anything is wrong, either.

The second mode of the Phone Guard adds RF (radio-frequency) detection. Any signal (from a wireless bug, for example) turns on the RF ALARM LED. You have to be looking at the unit to see the alarm—no other warning is given. To use the RF detector, you first have to set the unit's sensitivity by tuning a small, screwdriver-adjustable, multi-turn potentiometer for normal background RF (from computers and the like). Once set, any RF detected above the background level will light the LED. The RF detection mode uses the 9-

volt battery, so you have to remember to turn the unit back to privacy mode—which draws its power from the phone line—after you're done.

The third mode of the Phone Guard is "tap nullification." In that mode (which also uses the battery), telephone-tapping devices are not detected. But many of them will be disabled by a two-pronged attack. First, as in the privacy mode, the voltage on the phone line is clamped to a high level—higher even than the normal off-hook voltage. Second, high-frequency audio is sent over the line. Although the audio is not audible during phone conversations, the 18-kHz signals wreak havoc with FM bugs. Your conversations will be masked by loud hash.

Not being bugged ourselves, and not owning any illegal bugging devices, we had a difficult time doing realistic "hands-on" user tests. But we were able to verify that the device works as claimed.

To understand how the Phone Guard works, you first have to understand how the phone system works. Normally, when your phone is on-hook, the telephone line voltage is between 48 and 52 volts DC. (In our test area, we measured a constant 51.0 volts.) When the phone is off hook, the line voltage drops to about 8.5 volts.

Most taps use the difference between the on- and off-hook voltage to turn themselves on. As soon as the voltage on the line drops, the tap is triggered. The Phone Guard tries to disable the taps by not letting the phone-line voltage drop too far. When you pick up a phone attached to the Phone Guard, the line voltage drops to only about 30 volts. Surprisingly, that doesn't disturb phone service on most systems—it had no ill effect on ours. When a standard extension phone is placed on the

line, or if a standard tap kicks in, the Phone Guard senses the resulting voltage drop, and disconnects your phone from the line.

The RF-detection feature of the Phone Guard is basically a wide-band field-strength meter. It did a reasonably good job of detecting the standard RF sources that we had available. It was sensitive to wireless FM microphones, the favorite bug of low-tech espionage practitioners. It also did a good job detecting transmissions around 27 MHz (the CB band) and around 49 MHz (where a number of easily available transmitters work). It could not detect a 900-MHz cordless phone only inches from it. Fortunately, few bugs are located at that frequency. On our high-power bug (a 100-mW FM transmitter available for \$49.95 from Deco Industries, Box 607, Bedford Hills, NY 10507, 800-759-5553), it was able to detect the transmissions as long as the bug was within 15 feet of the Phone Guard.

The tap-nullification mode also worked as claimed on our test bug. However, we found that we were able to defeat the high-frequency interference with a couple of RF chokes. In the tap-nullification mode, it is also possible to adjust the DC clamping level, which might be necessary in some areas. Unfortunately, the privacy function doesn't work in the tap-nullification mode. So if you must change the clamping level to use your phone, you lose the privacy function.

The Phone Guard seems to offer reasonable protection from the most common taps. And most taps are pretty common. If you have reason to think that the FBI is after you, you should be looking for something more sophisticated!

Although they've done more than their share, the FBI doesn't set most taps. Usually it's a wife spying on her husband, or a husband on his wife—or private investigators on both of them. For most such unsophisticated bugs, the Phone Guard does a pretty good job, especially if you use it wisely. If you know you're bugged, for example, you could carry on most of your conversations normally. On a sensitive call, you could place the Phone Guard in its tap-nullification mode. Then whoever bugged you would think that the interference was a freak occurrence. If you jammed all calls, the eavesdropper would know that he had to find a more effective way to eavesdrop.

If someone wants to bug you, there's no guaranteed way of stopping it. Just as the strongest lock and best alarm system—or even an armed guard—can't stop a determined thief, no anti-bugging device will stop a determined eavesdropper. But the Phone Guard can offer reasonable security against the common, sleazy eavesdropper that you're likely to encounter. ■



# Private First-Class Communications

**TROPEZ 900 DX DIGITAL 900-MHZ CORDLESS TELEPHONE.** From V-Tech Communications, 8770 SW Nimbus Avenue, Beaverton, OR 97500; Price: \$299.

Cordless telephones do not have a spotless reputation. They're subject to interference—from computers, microwaves, and just about any other electrical appliance—which manifests itself in scratchy, static-ridden background noise. They rarely work at the full range promised on the box. They cost more than corded phones with similar features. And, worst of all, they afford the user no privacy whatsoever; anyone with a run-of-the-mill scanner can easily eavesdrop on cordless-phone conversations. We've even picked up one neighbor's phone calls on a baby monitor! That can be embarrassing during personal conversations, but much more damaging for business calls requiring confidentiality. The privacy problem isn't even covered by law—it's not illegal to monitor cordless phone conversations, as it is to

eavesdrop on cellular calls. (What kind of privacy can you expect when you're talking on what is, in effect, a walkie-talkie?)

Despite those drawbacks, 41% of American households currently own cordless phones. And, despite that already high level of household penetration, they are expected to account for more than 75% of all telephones purchased this year. Obviously, cordless phones have something going for them. In a word: convenience. It appears that there are plenty of folks out there (ourselves included) who are willing to trade off sound quality, price, and privacy for the sake of convenience.

A couple of recent happenings, however, have paved the way to high-quality, private, albeit high-priced, cordless conversations. First, the Federal Communications Commission opened up the 900-MHz band, once reserved for industrial, military, and scientific use, to consumer products such as cordless telephones. Second, digital technology has been adopted by cordless telephone manufacturers. V-Tech's Tropez 900 DX digital cordless phone has the distinction of being the first, and so far only, cordless phone to take full advantage of both. And the advantages are many.

Cordless phones using the 900-MHz band require shorter antennas, use less power, and provide more uniform coverage than those using the 46-49-MHz band.

Higher frequencies generally require shorter antennas. For instance, standard cordless phones would need an antenna 18-times longer than an equivalent antenna in the 900-MHz band. Unfortunately, that's not a practical solution. Most phones sacrifice some performance by using shorter antennas. On the 900-MHz band, a five-inch-long antenna is sufficient. The digital phone requires less power to transmit a signal a given distance, affording it more uniform coverage over a much greater range when using the same amount of power as a standard cordless phone—almost a half mile, according to V-Tech. Moreover, the phones are less susceptible to interference from such influences as microwave ovens or fluorescent lights—which means that as you walk around the house or office while chatting, you'll be much less likely to hit those "hot spots" of bad reception. With so few 900-MHz phones in use—for the present time, at least, only two other manufacturers are selling them—you'd also be less likely to intercept other conversations, even without the Tropez's digital security precautions.

Digital security codes have been used in recent years by several phone manufacturers to keep other cordless phone users from using your phone line. The system used by the Tropez automatically selects one of more than 65,000 possible digital security codes each time the handset is placed in the base unit.

But the Tropez uses digital technology for more than a simple security code. It actually digitizes the user's voice. That not only reduces interference, it also effectively *scrambles* your voice to potential eavesdroppers. Both incoming and outgoing conversations are digitized as they are transmitted between the handset and the base unit. In addition, it provides what V-Tech calls "digital clarity"—consistent high-quality sound over a wide range. Digital sound quality doesn't gradually deteriorate as the handset is moved away from the base. Instead, it remains constant until you near the range limit, and then quickly drops off.

We first tried the Tropez 900 at the 1991 Summer Consumer Electronics Show, before it had FCC approval. We didn't have high expectations for a cordless phone used in the noisy, crowded convention center. But we certainly were pleasantly surprised to encounter excellent reception no matter how far we wandered from V-Tech's booth. As soon as the 900-MHz band was allocated for cordless phone use, and the Tropez 900 became marketable, we requested one for review.

The Tropez 900 looks only slightly different from other cordless phones. There's a 5-inch flexible antenna on the handset and a rigid antenna of the same size on the



CIRCLE 52 ON FREE INFORMATION CARD



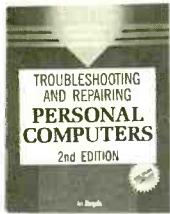

3677 \$34.95  
Counts as 2



3804P \$19.95  
Softcover

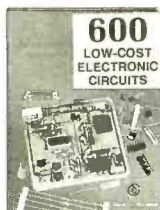

3219 \$27.95



2925P \$12.95  
Softcover

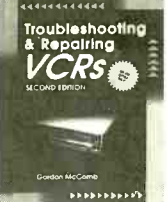

3777 \$32.95  
Counts as 2

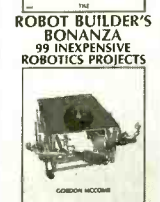

2800P \$16.95  
Softcover



2613P \$17.95  
Softcover

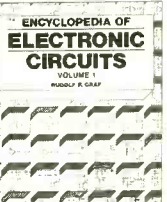

1938 \$60.00  
Counts as 3

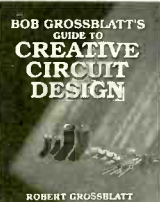

3610 \$28.95  
Counts as 2

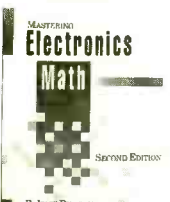

3589 \$27.95  
Counts as 2

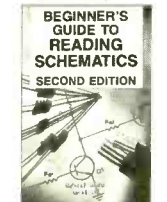

3632 \$18.95

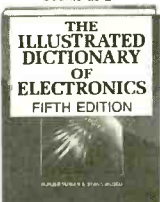

3345 \$39.95

# Select any 5 books

## for only \$4.95

(values up to \$126.75)

when you join the Electronics Book Club<sup>SM</sup>

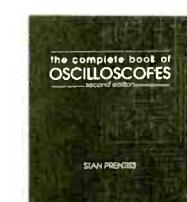

3825 \$26.95  
Counts as 2

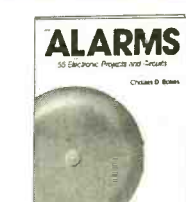

2996P \$14.95  
Softcover



2980P \$19.95  
Softcover



2947P \$13.95  
Softcover



3262 \$26.95  
Counts as 2

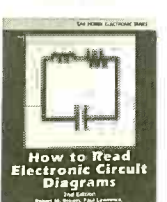

2880P \$14.95  
Softcover

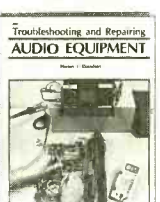

2867P \$18.95  
Softcover



2790P \$15.95  
Softcover

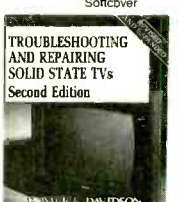

3700 \$36.55  
Counts as 2

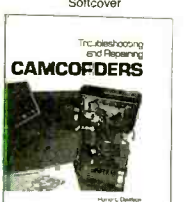

3337 \$35.95  
Counts as 2



3374P \$16.95  
Softcover

If coupon is missing, write to: Electronics Book Club, Blue Ridge Summit, PA 17294-0810

### As a member of the Electronics Book Club . . .

. . . you'll enjoy receiving Club bulletins every 3-4 weeks containing exciting offers on the latest books in the field at savings of up to 50% off regular publishers' prices. If you want the Main Selection do nothing and it will be shipped automatically. If you want another book, or no book at all, simply return the Reply Form to us by the date specified. You'll always have at least 10 days to decide. Your only obligation is to purchase 3 more books during the next 12 months, after which you may cancel your membership at any time. (Publishers' Prices Shown)

**Your most complete and comprehensive source for the finest electronics books**

Blue Ridge Summit, PA 17294-0810

**YES!** Please accept my membership in the **Electronics Book Club** and send the 5 volumes listed below for just \$4.95 plus shipping/handling and tax. If not satisfied, I may return the books within ten days without obligation and have my membership cancelled. I agree to purchase at least 3 books at regular Club prices during the next 12 months and may resign anytime thereafter. A shipping/handling charge and sales tax will be added to all orders.

--	--	--	--

Name \_\_\_\_\_

Address \_\_\_\_\_

City/State \_\_\_\_\_ Zip \_\_\_\_\_

Valid for new members only, subject to acceptance by EBC. Applicant: outside the U.S. and Canada will receive special ordering instructions. Canada must remit in U.S. funds. All books are hardcover unless otherwise noted. ©1992 EBC PE792



base. There are keypads, along with several convenience-feature buttons, on both the handset and the base unit. The phone provides all the features we'd expect from a high-end cordless phone. Besides the standard mute, hold, redial, two-way paging, and speed-dial (ten numbers can be stored in memory) functions, the phone also offers a few less-common features. For instance, the phone allows you to make calls either from the handset, or the base, using its speakerphone, and to initiate intercom conversations from either piece. The intercom can be used for a three-way conversation between the person on the other end, the person on the handset, and the person on the base unit. Of course, intercom conversations are also digitally coded and can't be picked up by scanners or other cordless phone users. If another person picks up on one set while you're speaking on the other, the phone lets you know with one short beep. To guard your privacy within the walls of your home or office, the Tropez 900 offers a privacy control that deactivates the base unit when you're speaking on the handset (or vice versa) at the touch of a button for the duration of the call. Once the call is ended, or when you press the PRG/PRV button again, the deactivated piece is automatically reset. Up to 4½ hours of continuous talk time is available on a fully-charged battery. In addition, the phone provides a choice of four different ringer types for both the base and the handset; you can opt to have different rings for each.

Actually, it's a good idea to learn some "phone-speak" when using the Tropez. Besides the adjustable "warbling" tones that indicate an incoming call, the phone uses other sounds to communicate. A page is indicated by a long series of beeps, and two short beeps means either that a call is on hold or that you are out of range. If you hear a short "buzz-buzz" when you press the PHONE button, or a "bleep" at regular intervals when the handset is off the base, the batteries need charging. A long buzzing tone when you try to pick up the phone indicates that the privacy mode is in effect.

The features that really set the Tropez 900 apart from the crowd are invisible to the eye—its digital technology, the use of the 900-MHz band, and its automatic 20-channel select to ensure line availability and clarity (most high-end cordless phones offer a maximum of ten channels). What is hidden from the eye is immediately obvious to the ear, however. The sound quality is excellent; when used around the house or office, it's difficult for the parties on the other end of the line to determine that a cordless phone is being used. However, the received handset audio, in our judgment, was significantly below corded quality, and at best, about

average for a cordless. We're used to avoiding certain areas that are highly subject to interference—forget about grabbing a snack from the fridge while talking on most cordless phones! We didn't experience that problem with the Tropez 900. And when we tried to "monitor" our own conversations, we found out that digital calls are picked up simply as "hash" on our scanner.

We were unable, however, to come anywhere near the manufacturer's claim of an 800-meter range: nor did we experience completely uninterrupted talk until we stepped out of range. We were able to walk about 250 feet from the base location before losing contact. Granted, that's a lot farther than any other cordless phone we've used, which fade out to static at about 50–60 feet. But it's nowhere near a half mile, and not even as far as we strolled at the CES convention center last summer. According to the manual, "The range quoted for this phone is based on open field measurements and under ideal conditions. The actual range you receive will depend on numerous factors such as building construction, interference, atmospheric conditions, location, etc."

What surprised us even more was the digital phone's behavior as we neared the end of its range. Again according to the manual, "If you move the handset out of range during a phone conversation, you will hear an out of range' tone ... if you do not move into range within 30 seconds, the call is disconnected." Until we reached that point, we expected the digital phone to retain its full clarity. Instead, after about 150 feet our conversation cut in and out as the person with the handset walked away from the base unit, even though the reception was crystal clear when he stood in one spot. As he neared the end of the range, the drop outs became more frequent, then nearly continuous, but no warning tone sounded.

For our personal and work-related purposes, however, the Tropez 900 more than met our needs. It also performed significantly better—and infinitely more privately—than any analog, 46–49-MHz band cordless phone we've ever used. Fifteen years after its introduction, the cordless phone seems finally ready to live up to its promise. ■

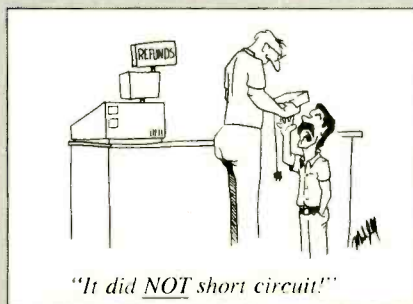

## Boom Book

**AUDIO NOTE A-4 NOTEBOOK STEREO.** From Sansui USA Inc., 1290 Wall Street West, Lyndhurst, NJ 07071. Price: \$499.95.

If you were to ask the average person when the portable radio was invented, he'd likely guess that it was after the invention of the transistor, sometime in the 1960's. He'd be wrong on two counts. Portable radios have actually been around since the early days of wireless, and the first transistor set was introduced in 1954.

As far back as the turn of the century, portable radios were championed by such visionaries as Hugo Gernsback, (the founder of Gernsback Publications, the publisher of *Popular Electronics*), who, looking back on his 1908 outdoor demonstration on the streets of New York of his Telimco wireless telegraph, called it "the first portable radio in the world." In the years since, portable radios of every imaginable shape and size have been seen. In the 1920's they ran the spectrum from vest-pocket receivers (priced between \$1 and \$10) to "valise" style portables, some with attached horn speakers. Home-brewed sets were often much smaller. It wasn't until the end of the 1930's (and the Depression), however, that portable sets became popular with consumers. With RCA's 1939 introduction of miniature tubes came a new wave of true portables, most weighing just five or six pounds. Zenith's 1949 announcement of sub-miniature radio tubes led to the creation of some handheld sets that bear a striking resemblance to today's Walkman. Problems in sound quality and expensive batteries kept the tiny radios from catching on back then. Transistor radios, which didn't sound any better, were smaller and much cheaper to keep powered up. The transistor revolution, and the 1961 introduction of stereo FM radio, resulted in an array of hugely popular handheld and box-style sets. As the awareness of high-fidelity audio grew, portables became better and still more firmly entrenched.

The combination of radio with other audio formats was a natural progression. Portable systems make up a significant portion of today's audio market, which for the most part, consists of two categories: pocket-sized personal stereos and have-musele-will-travel boom boxes. Some products in each category could also fit under the "convertible" heading: products that can be used either at home or on the go. Sansui's Audio Note A-4 CD/cassette/AM-FM stereo, though billed as a portable audio system, definitely is neither a personal stereo nor a boom box. It does,



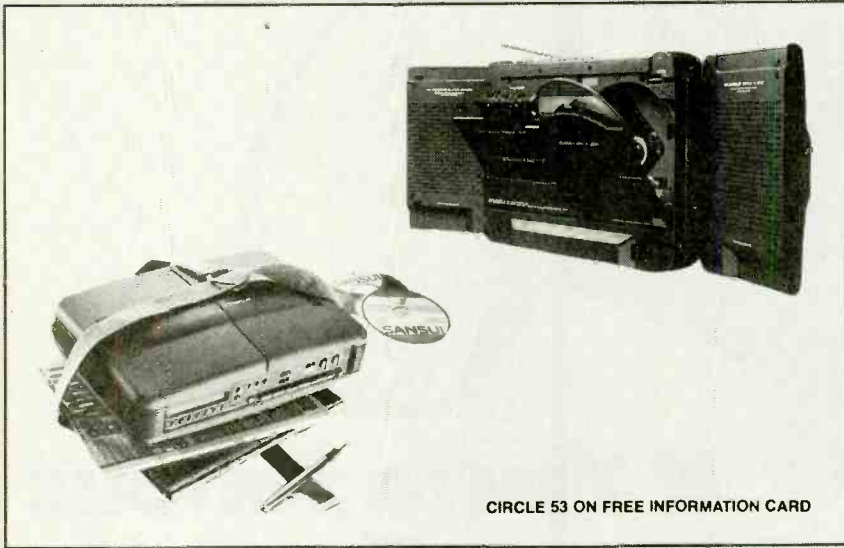

CIRCLE 53 ON FREE INFORMATION CARD

however, fit the convertible description. We decided to see how well it could meet our portable and at-home listening needs.

Actually, the A-4 looks like no other portable stereo we've seen; when we pulled it out of its box, it more closely resembled a laptop PC. Unlike a laptop, the Audio Note A-4 is intended to stand vertically. When closed, the unit's front is a smooth expanse of granite-finish gray

plastic, broken only by a pair of small speaker vents. Before its "doors" are opened, the portfolio-style unit measures 12¼ inches wide × 8¾ inches tall × 3¾ inches deep, and weighs less than five pounds. That's significantly heftier than a Walkman, but still light when compared to some of those back-straining boom boxes.

The system's 3-inch speakers are mounted in hinged, fold-out doors that are

vented so that the unit can be played whether they're open or closed. Because the display and virtually all of the controls are located on the top panel, you never *have to* open the A-4's doors other than to load cassettes or discs. But you'll probably want to—the sound is significantly better with the doors swung wide.

Opened up, the Audio Note A-4 finally starts to look like a small audio system. Inside the doors are recognizable speakers, grilles and all. Set flush with the unit's main body are the cassette and CD wells. A contoured battery compartment runs below the wells. An LED that indicates the direction of the tape, a small LCD readout for the CD player, a tiny built-in microphone for recording, and the CD-eject button are the only other features inside the A-4.

The back of the unit is also cleanly streamlined. A telescoping antenna when compressed, fits into a horizontal slot. There are jacks for the AC-power adaptor, mini headphones, and a microphone—for karaoke sing-alongs. A three-position switch can be set for BEAT (for "beat cutting"), to reduce noise during AM reception; FM; or KVC, or "karaoke voice canceller." As you might suspect, with such featureless outside, inside, and back

(Continued on page 16)

# GET THE LATEST ADVANCES IN ELECTRONICS

WITH A SUBSCRIPTION TO



Radio-Electronics gives you exciting articles like:

- DSP in Consumer Electronics
- Build a Tesla Coil
- Analog-to-Digital Conversion
- Build a Spectrum Analyzer
- All About Fuel Cells
- Build an EKG
- Voltage Doublers
- PC-Based Test Equipment
- VGA-to-NTSC Converter

# Radio Electronics®

ENJOY THE WORLD OF ELECTRONICS EACH MONTH!

Now you can subscribe to the best electronics magazine. The only one that brings you articles on—electronics projects, technology, circuit design, communications, new products and much more. Radio-Electronics looks to the future and shows you what new video, audio and computer products are on the horizon. What's more you'll find helpful, monthly departments such as Video News, Equipment Reports, Hardware Hacker, Audio Update, Drawing Board, Computer Connections. All designed to give you instruction, tips, and fun.

## Radio Electronics®

### SUBSCRIPTION ORDER FORM

P.O. Box 51866, Boulder CO 80321-1866

**YES!** I want to subscribe to Radio-Electronics for 1 Full Year—12 Issues for only \$19.97. That's a savings of \$15.43 off the newsstand price.

Payment Enclosed  Bill me later  
Please charge my:  Visa  Mastercard

Acct. #

Signature \_\_\_\_\_

Exp. Date \_\_\_\_\_

PLEASE PRINT BELOW:

NAME \_\_\_\_\_

ADDRESS \_\_\_\_\_

CITY \_\_\_\_\_ STATE \_\_\_\_\_ ZIP \_\_\_\_\_

Allow 6 to 8 weeks for delivery of first issue. U.S. Funds only. In Canada add \$7.82 Postage. (Includes G.S.T.) All Other Foreign add \$9.00 Postage

5PGG8

# If You're Serious About a Future in Electronics, Ensure that Future with the Best Educational Training Available.

**FREE!**

SEND FOR YOUR CIE HOME STUDY COURSE CATALOG AND RECEIVE A FREE 24 PAGE CIE ELECTRONICS SYMBOL HANDBOOK!

Includes hundreds of the most frequently used electronic symbols. Published by CIE exclusively for our students and alumni. Yours free when you request a CIE Course Catalog.

electronics

ESSENTIAL SYMBOLS HANDBOOK

Fig. 16 Circuit for Experiment 2

Fig. 17 Pin diagram for 74151A

**Procedure**

Figure 16 shows the circuit diagram for this exercise. You will need the pin numbers for the IC aren't included on the diagram. You should refer to Fig. 17 which shows pertinent pin numbers. For the data inputs, you'll use an eight pole DIP switch in association with 10K pull-up resistors. For the Select and Strobe lines, finally, you'll use the appropriate switches.

1. With the power off, install the 74151A IC and the DIP switches on the breadboard.
2. Connect the eight 10K resistors to the DIP switch positions. Connect the opposite end of each of these resistors to the positive supply. The ground terminal of each switch is to be connected to a common train ground.
3. Connect the IC V<sub>CC</sub> pin 13 to +5V, connect the GND pin 14 to ground.
4. Next, connect the trainer data switches to the Select and Strobe inputs on the IC using a 10K pull-up resistor on each switch.
5. Connect the trainer 12 LED to the 1 output, and connect the other end to the IC output.
6. Set all eight poles of all DIP switch 1's. The high

7. Turn the power on. The LED on your trainer should be off, and the 12 LED should be on. If you don't observe these conditions, turn off the power and check your connections.
8. From the present input conditions on the inputs, you can see that the input will be enabled.
9. Set the appropriate DIP switch 1's open, and verify your prediction. Record your results in terms of the selected input D, where D is the number of the selected data line in the appropriate space in the truth table in Fig. 18.



If you want to learn about electronics, and earn a good income with that knowledge then CIE is your best educational value.

CIE's reputation as the world leader in home study electronics is based solely on the success of our graduates. And we've earned that reputation with an unconditional commitment to provide our students with the very best electronics training.

Just ask any of the 150,000-plus graduates of the Cleveland Institute of Electronics who are working in high-paying positions with aerospace, computer, medical, automotive and communication firms throughout the world.



They'll tell you success didn't come easy...but, it did come....thanks to CIE. And today, a career in electronics offers more opportunities and greater rewards than ever before.

### CIE's COMMITTED TO BEING THE BEST....IN ONE AREA....ELECTRONICS.

CIE isn't another be-everything-to-everybody school. We teach only one subject and we believe we're the best at what we do. Also, CIE is accredited by the National Home Study Council. And with more than a 1,000 graduates each year, we're the largest home study school specializing exclusively in electronics. CIE has been training career-minded students like yourself for nearly 60 years and we're the best at our subject .....  
**ELECTRONICS ... BECAUSE IT'S THE ONLY SUBJECT WE TEACH!**

#### WHY CHOOSE CIE FOR YOUR TRAINING?

- 150,000 successful graduates from every country around the world.
- Only CIE rewards you for fast study. CIE offers an Associate Degree program based on actual study time used. The faster you complete your degree the less your overall tuition.
- State-of-the-art laboratory equipment is yours to keep and it comes assembled, ready for hands-on experiments.
- Approved for educational benefits under the G.I. Bill for veterans and other eligible persons.
- Upon graduation, CIE offers free preparation to pass the Certified Electronics Technician Exams.

### CIE PROVIDES YOU WITH A LEARNING METHOD SO GOOD, IT'S PATENTED.

CIE's Auto-programmed lessons are a proven learning method for building valuable electronics career skills. Each lesson is designed to take you step-by-step and principle-by-principle. And while all CIE lessons are designed for independent study, CIE's instructors are personally available to assist you with just a toll-free call. The result is practical training... the kind of experience you can put to work in today's marketplace.

### LEARN BY DOING...WITH STATE-OF-THE-ART FACILITIES AND EQUIPMENT.

In 1969, CIE pioneered the first Electronics Laboratory course and in 1984, the first Microprocessor Laboratory course. Today, no other home study school can match CIE's state-of-the-art equipment and training. And all your laboratory equipment, books, and lessons are included in your tuition. It's all yours to use while you study at home and for on-the-job after graduation.

### PERSONALIZED TRAINING....TO MATCH YOUR BACKGROUND.

While some of our students have a working knowledge of electronics others are just starting out. That's why we've developed twelve career courses and an A.A.S. Degree program to choose from. So, even if your not sure which electronics career is best for you, CIE can get you started with



core lessons applicable to all areas of electronics. And every CIE course you take earns you credit towards completion of your Associate in Applied Science Degree. So you can work toward your degree in stages or as fast as you wish. In fact, CIE is the only school that actually rewards you for fast study, which can save you thousands of dollars.

**SEND TODAY FOR YOUR CIE COURSE CATALOG AND WE'LL SEND YOU A FREE 24 PAGE CIE ELECTRONICS SYMBOL HANDBOOK!**

**YES!** I want to get started.  
Send me my CIE school catalog including details about the Associate Degree Program. (For your convenience, CIE will have a representative contact you - there is no obligation.)

AH30

Name: \_\_\_\_\_

Address: \_\_\_\_\_

City: \_\_\_\_\_ State: \_\_\_\_\_

Zip: \_\_\_\_\_ Age: \_\_\_\_\_

Phone No. ( \_\_\_\_\_ ) \_\_\_\_\_

Check box for G.I. Bulletin Benefits

Veteran  Active Duty



**CLEVELAND INSTITUTE OF ELECTRONICS**  
1776 East 17th Street  
Cleveland, Ohio 44114  
(216) 781-9400



A school of thousands.  
A class of one.  
Since 1934



## BOOM BOOK

(Continued from page 11)

surfaces, the only place left for radio, tape, and CD controls is the  $1\frac{1}{2} \times 9\frac{1}{4}$ -inch top panel. Sure enough, Sansui managed to squeeze into that relatively tight area power, band, and function switches; eight pushbutton tape-deck controls; nine dual-function pushbuttons that are used either to tune the radio or control the CD player; and three more dual-function buttons for setting the clock/timer and advanced CD programming; and an LCD readout. As much as we disliked the cramped controls, we wish they had put the CD display on that top panel instead of behind the speaker doors, where it seemed to be added as an afterthought.

The tape player allows one-touch recording from the radio or the CD player (after the source is selected and set up, of course). No line-level inputs or outputs are provided. When recording from a CD you can program the tracks in any order you prefer. Although the CD player doesn't display the track time or time remaining, it is a fairly easy unit to program, and allows you to play back programmed tracks in order or randomly, to delete or add tracks to the program, and to check the programmed tracks on the CD display. The CD player also lets you repeat a single track or a section of the disc, and to hear the first ten seconds of each track, using the MUSIC SCAN button. We experienced no problems with mistracking in normal use, which including carrying the unit under our arm on a brisk walk.

When in its karaoke mode, the A-4 removes most of the vocals from any stereo CD, tape, or radio source. By inserting the mini-plug of a handheld microphone into the jack at the back of the unit, you then can substitute your own voice. Such karaoke mixing cannot be recorded, however, although it is possible to record using the built-in microphone on the inside of the unit.

The radio provides up to 10 AM- and 20 FM-station presets, which are accessed using seven buttons: five numbered 1-5, a +5 button, and a TUNING UP button. To call up preset channel 17, for instance, you could either hit the TUNING UP button to scan the dial, or press the +5 button three times (to equal 15) and then the 2 button once (for a total of 17). Reception was not great; we had a hard time tuning in some of our favorite FM stations, especially when using the A-4 around the computers in our office. There is no provision for using an external antenna, which would have helped.

Timer operation lets you turn the radio or tape deck on or off or set the tape deck to record from the radio at a specified time.

A sleep timer will automatically turn off the radio or tape deck after a set period of time ranging from 1 minute to 90 minutes in 10-minute increments. Neither timer function works with the CD player.

That is a lot of functions to be controlled from those close-set top-panel buttons, knobs, and switches. While that top-panel arrangement allows you to use the A-4 with its doors open or closed, you have to be careful not to accidentally press the wrong button. This isn't one of those systems that you can operate blindfolded. In fact, you really should be close enough to read the (tiny) labels before you start pushing buttons. That led to a problem when we kept the A-4 on our desk—we couldn't see the top panel when we were sitting down. That might not sound like a big deal, but it's inconvenient to have to stand up every time you want to change a station, fast forward to the next track, check the time, etc. The same problem would arise if you kept the A-4 on your night table as a clock-radio—and with the speakers vented out the front, you couldn't even lay the unit face down so that the display would be visible, right-side-up, from the bed. Plus, the display is not backlit.

Besides the inconvenience caused by crowding, many of the controls had a "cheap" feel to them. That's especially true for the undersized volume and tone knobs and the tape deck buttons; we think that that is unforgettable in a unit that lists for \$499.

After living with the A-4 for a few weeks, we still haven't discovered its niche in our lives. We require controls on our office audio equipment that are easier to use. We'd like a quick mute button that we could hit as we answer a phone call, for example. Neither its sound quality from its 5-watt amplifier nor its controls are up to our general at-home listening standards, and for portable use, we prefer a Walkman-type unit.

Perhaps if we'd used it in the summer instead of in March we'd have found more uses for it. While doing yard work the sound carried well, and our neighbors were impressed by the A-4's unique styling and compact size.

We have a feeling that many of our complaints about the A-4 are due to our (relatively) advanced age. We'd imagine that high-school and college students would find the most uses for the A-4. Its book-like shape makes it easy to carry along with a stack of books, such as when walking home from school or between classes. The A-4 would provide music during lunch hour or when just hanging out, and it would certainly meet the requirements of many dorm residents. From a historical—or should we say futuristic—perspective, however, we doubt that portfolio-style audio is the shape of things to come. ■

## Travelin' TV

**CITIZEN T530 COLOR LCD POCKET TV WITH AM/FM RADIO.** Manufactured by: CBM America Corporation, 2020 Santa Monica Blvd., Suite 410, Santa Monica, CA 90404. Price: \$299.99.

There's no question that portable audio is found everywhere in our society. Walking down city streets, you pass school kids, joggers, cyclists, business people, and delivery men, all plugged into their walk-about stereos. Riding the buses, planes, trains, and subways—often sitting right under the "No radios allowed" signs—there are more of the same—and, on a bad day, there's also someone blasting hip-hop tunes on a boom box.

Portable television, however, has not achieved anywhere near that level of popularity, for practical as well as technical reasons. You simply can't take television everywhere you can take radio—driving, cycling, or jogging are activities that are well-suited to music as they are ill-suited to video. And, historically speaking, tiny televisions provided poor picture quality. Ironically, the same technology that may hold the key to affordable home projection TV's—liquid crystal displays—has also been used in a new generation of high-quality, small-sized televisions. Yet even though today's pocket-sized LCD sets offer good picture quality, the audio portion still lags far behind.

So when we read in a press release that Citizen had introduced a 2.9-inch LCD TV with a built-in AM/FM stereo receiver, we decided to give the T530 a try. We figured that by taking it, instead of our personal stereo, along, we could get video-on-the-go and good stereo audio as well.

When we pulled the unit out of its box and began to play around with it, it certainly appeared to be designed with that dual use in mind. The granite-gray T530 is larger than most personal stereos—measuring approximately  $7 \times 3\frac{3}{4} \times 1$  inches and weighing just over one pound without batteries—but still portable by any definition of the word. The television screen folds down when not in use, so that you can safely carry the unit in a pocket, and the volume and radio-tuning controls are easily accessible even when the screen is retracted (although you can't read the tuning dial with the cover closed).

A single speaker is on the left top of the unit; from illustrations we'd seen, we expected to see another speaker when we flipped open the right two-thirds of its top to reveal the LCD screen. But what we'd mistaken for a speaker was simply part of the Citizen logo that resembled a speaker





CIRCLE 54 ON FREE INFORMATION CARD

grille. Okay, we thought, so maybe the set provides stereo only through headphone listening. Wrong again. Totally perplexed, we decided it was time to read the blurbs on the T530's box and its description in the manual.

Perhaps there was a misunderstanding between Citizen's main office in Japan and the press office in California. (After all, communications between engineers in Japan and marketing offices in the States are often troublesome: Just look at some of the gibberish found in owner's manuals.) In any case, as far as the T530 is concerned, nowhere in the user's manual or specifications, or on the box, is the word "stereo" mentioned. Similarly, the press release called the set "both NTSC and PAL compatible," whereas the manual suggests that two separate versions are available for use in either NTSC- or PAL-equipped countries.

We've been around long enough to know better than to believe everything that we read. So, putting aside our expectations (and trying not to allow our disappointment color our judgment), we resumed anew our examination of Citizen's portable combination LCD and AM/FM *monaural* radio

When the hinged panel housing the LCD screen is flipped open, you have access to slide controls for tint, color, and brightness; up and down buttons for tuning

the TV; a CHANNEL CALL button; a slide switch to select between AM and FM, and UHF and VHF; and the radio dial. Besides the volume and radio-tuning dials, the front of the unit offers a three-position RADIO/OFF/TV switch and the button used to open the flip top. Along the left side are jacks for an external antenna, an AC or DC adapter, audio/video input, and earphones—none of which are supplied with the TV. The T530's three-way power supply allows it to run on five AA batteries or, with the optional adapters, AC or DC power. A telescoping antenna extends from the back of the unit.

There's nothing tricky about using either the TV or the radio. When the TV is turned on, a vertical, red channel-indicator bar, whose position corresponds to the VHF and UHF channel charts under the screen, immediately appears on screen, and the set automatically begins scanning for a signal. When the system locks into a station, the bar disappears a few seconds after the picture appears. To check what channel is being viewed, a press of the CHANNEL CALL button brings the bar back on screen. When no signal is strong enough, the set will continuously scan up and down. In such a case, either the batteries need replacing, or the optional external antenna is required.

When a picture is obtained, a little fiddling with the brightness, color, and tint

## DIGITAL VIDEO STABILIZER ELIMINATES ALL VIDEO COPYGUARDS



While watching rental movies, you will notice annoying periodic color darkening, color shift, unwanted lines, flashing or jagged edges. This is caused by the copy protection jamming signals embedded in the video tape, such as Macrovision copy protection. THE DIGITAL VIDEO STABILIZER: RXII COMPLETELY ELIMINATES ALL COPY PROTECTIONS AND JAMMING SIGNALS AND BRINGS YOU CRYSTAL CLEAR PICTURES.

### WARNING

THE DIGITAL VIDEO STABILIZER IS INTENDED FOR PRIVATE HOME USE ONLY. IT IS NOT INTENDED TO COPY RENTAL MOVIES OR COPYRIGHTED VIDEO TAPES THAT MAY CONSTITUTE COPYRIGHT INFRINGEMENT.

### FEATURES

- Easy to use and a snap to install
- State-of-the-art Microchip technology
- 100% automatic
- Compatible to all types of VCRs and TVs
- The best and most exciting Video Stabilizer in the market
- Light weight (8 ounces) and compact (1x3.5x5")
- Uses a standard 9 Volt battery (last 1-2 years)
- Fast UPS delivery
- Air shipping available
- UNCONDITIONAL 30 day money back guarantee
- 1 year warranty

(Dealers Welcome)  
**FREE 20P Catalog**

To Order: \$59.95 ea + \$5 for p & h  
Visa, M/C, COD Mon-Fri: 9-6 EST

**1-800-445-9285**

ZENTEK CORP. DEPT. CPE7

3670-12 WEST OCEANSIDE RD. OCEANSIDE, NY 11572

CIRCLE 5 ON FREE INFORMATION CARD

## CABLE TV DESCRAMBLERS How You Can Save Money on Cable Rental Fees Bullet Proof

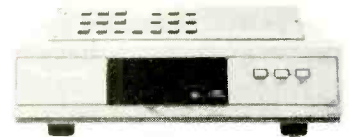

1 Unit 5+

BEST Super Tri-Bi Auto/  
Var. Gain Adjustment \$119.95...\$85  
Jerrold Super Tri-Bi... \$109.95...\$79  
Scientific Atlanta... \$109...\$79  
Pioneer... \$109...\$79  
Panasonic TZPC145... \$99.95...\$79  
Stargate Converter... \$95...\$69  
Digital Video Stabilizer... \$59.95...\$29  
Wireless Video Sender... \$59.95...\$49.95

**US Cable'll Beat  
Anyone's Price  
Advertised in  
this Magazine!**

**30 Day Money Back Guarantee**  
FREE 20 page Catalog

Visa, M/C, COD or send money order to:  
**U.S. Cable TV Inc. Dept. KPE7**  
4100 N. Powerline Rd., Bldg. F-4  
Pompano Beach, FL 33073

**1-800-772-6244**

### For Our Record

I, the undersigned, do hereby declare under penalty of perjury that all products purchased, now and in the future, will only be used on Cable TV systems with proper authorization from local officials or cable company officials in accordance with all applicable federal and state laws. FEDERAL AND VARIOUS STATE LAWS PROVIDE FOR SUBSTANTIAL CRIMINAL AND CIVIL PENALTIES FOR UNAUTHORIZED USE.

Date: \_\_\_\_\_

Signed: \_\_\_\_\_

**No Florida Sales!**

CIRCLE 6 ON FREE INFORMATION CARD



controls brings it in quite clearly—as clearly as you can expect from a screen that has a resolution of 146 × 648 pixels. The T530's hinged lid can be adjusted up to 120 degrees to find the best viewing position. In addition, the set uses an ultra-small fluorescent tube to light the screen uniformly. The tube is said to last for about five years if the set is used on average of one hour a day, and must be factory replaced when it wears out. When the batteries run low, the tube does not light. To save batteries you can listen only to the audio portion of the TV by closing the unit's lid, which shuts off the tube's light.

We live in an area notorious for its poor portable-TV reception. Using just the attached telescoping antenna, we were able to pick up just one VHF station and three UHF channels. Our sample unit didn't come with the optional antenna adapter, so we jerry-rigged our own. Using it, we obtained a clean, sharp, realistically colored picture on all the same stations we normally receive over the air on our 27-inch set.

The radio portion of the unit is as straightforward as the TV section: The only controls are an AM/FM selector switch, a tuning knob, and the volume control. Although the tuning knob is on the outside of the T530, the numbered tuning dial is under the lid, making it difficult to tune in a particular station without opening the unit. Both the tuning and volume knobs tend to get jostled if you carry the unit in a pocket, making the unit difficult to use as a carry-around radio.

With the optional A/V adapter, the T530 can be used as a monitor for a camcorder—which could come in handy for some shooting situations—or a VCR.

The Japanese/American communications gap is evident in the user's manual. Actually, calling the scanty instruction sheet a "user's manual" is somewhat misleading—it's just a single piece of paper, printed on both sides and folded several times. It also contains such contradictory statements as "This TV set works on four "AA" size batteries. Please use five brand-new alkaline batteries...". Luckily, using the T530 really didn't require any detailed directions.

We here at **Gizmo** have at least a dozen Walkman-type stereos. We've yet to find a real need for a pocket-sized television in our lives, but we can visualize a few places where it might come in handy. One is for viewing those vacation videos while you're still traveling. Others include watching shows in the garage, basement, or laundry room; keeping the kids occupied on a car trip (as long as the reception is good); and as a bedside TV that you can watch without disturbing your spouse. The T530 would make a good contender for any of those jobs. ■

## Photos Go Digital

**FOTOMAN DIGITAL CAMERA FOR COMPUTERS. Manufactured by: Logitech, Inc., 6505 Kaiser Drive, Fremont, CA 94555. Price: \$799.**

Although the cameras we use today are quite a bit different from those that were used in the mid 1800's when photography was invented, the actual process we use to turn what we see into photographs is very

similar. Basically, photographic film is coated by light-sensitive silver-halide crystals. The changes in the crystals become visible when the film is developed.

The sign of a great invention is that it remains relatively unchanged over time, much as the basic camera has. But digital technology has changed so many other great inventions. Take, for example, the way we tell time, or the way we listen to music, or the way we type a letter. Now it seems that digital technology is destined to change the way we take snapshots, too.

Digital photography—where images are stored as data bits in memory instead of



CIRCLE 55 ON FREE INFORMATION CARD



as chemical changes on film—isn't brand new. Scientists have been using digital techniques to receive pictures from space probes for years. Large news organizations use digital cameras for reporting when time is of the essence. *Sports Illustrated*, for example, uses digital cameras to cover the Olympics. Photos taken with digital cameras can be transmitted by phone to make deadlines that would be impossible to meet if the pictures had to be physically delivered. The major weekly news magazines also use digital cameras to get the latest breaking news into each issue. Beating the competition to a scoop can mean not only increased prestige, but dramatically increased newsstand sales, as well.

PC users who want to get the photos of the latest breaking news into their documents and desktop-published newsletters can enter the age of digital cameras with *Logitech's FotoMan*. The system includes a camera, a charging/interface base, and FotoTouch software. Photos—up to 32 of them—are stored in memory in the camera. After you've filled the memory, you can download the images into your computer through its serial port, and store them on your hard disk.

Besides an open serial port, your PC-compatible computer must have at least an 80286 processor, 1 megabyte of RAM, Microsoft Windows 3.0 or higher, MS-DOS 3.1 or higher, and EGA, VGA, or Hercules graphics. (VGA or higher is required for gray-scale display.)

When you take the camera out of the box, the built-in rechargeable nickel-cadmium battery must be charged for at least 30 minutes before using the camera for the first time. (Six hours are required for a full charge.) We used the half hour to install the FotoMan software on our hard disk, as well as the FotoTouch image-editing software supplied with the camera.

Once the camera's battery is sufficiently charged, you can download the necessary software into the camera, a relatively automated process. You connect the camera to the computer's serial port using the 9-pin cable (or the 9-to-25-pin adapter supplied with the camera). The camera end of the cable is an 8-pin mini-DIN plug, which plugs into the camera's charging/interface base. When the camera is inserted in the base, contacts on its bottom edge mate with pins in the base to provide both power (recharging) and communications connections. When you launch the FotoMan software, it first tests the in-camera software. If it finds none (such as the first time you plug it in), it will automatically load or reload the in-camera software. After the software is loaded and the battery is charged, you're ready to take pictures!

Using the camera is deceptively simple. A single button on the front panel is all you

have to work with—simply point and shoot! The fixed-focus lens has a depth of field from 3 feet to infinity. The built-in flash fires automatically if it's required. Any feedback from the camera comes from tones that it produces. For example, one long, high-pitched tone signals that the camera is ready to take the next picture. (You must wait several seconds between successive photos.) Six short tones, alternating between high and low pitches means that you have room for six more photos in the camera's memory. Five alternating short tones means you have room for five more photos, and so on.

The camera's optics are equivalent to those of an Instamatic camera, and the camera's sensitivity is equivalent to ASA 200 film. A supplied neutral-density filter (which is sometimes required for close-up flash pictures that would otherwise be washed out), reduces the sensitivity to about ASA 25. The shutter speed ranges from 1/30 second to 1/1000 second, although it is not manually adjustable.

The camera shape takes a little getting used to. It's quite strange—for a camera, that is—because of its vertical shape. The shutter-release button is on the front panel, below the lens. We found the viewfinder to be inaccurate, but we were able to compensate for that by aiming slightly to the left. Once we took a few test photos, we were ready to download them, using FotoTouch image-editing software.

When you "acquire" photos from the camera, you first get "previews" of the pictures in the camera. Up to twenty pictures at a time are displayed on the screen, in a form much like a photographic proof sheet. You can then tag the photos that you want to download, and discard the rest.

Nothing happens very quickly, mainly because the serial port is used to transfer data. Our pictures ranged in size from about 40K to 120K bytes, and took, on average, three to four minutes to transfer. Obviously, to download all 32 photos from the camera, you'll need plenty of time—and plenty of disk space. Fortunately, you can set-up the download procedure, and then walk away from the computer.

Pictures can be stored as TIFF (tagged image file format) files, the most popular image-file format. They can also be stored as BMP (Windows, Microsoft Paintbrush, OS/2) or PCX (ZSoft PC Paintbrush) files. FotoTouch also lets you convert images to EPS (encapsulated PostScript) files.

Just as an Instamatic (or even a disposable) camera can take perfectly good photos, so can the FotoMan, despite its run-of-the-mill optics. But your best pictures will be limited to an image of 376 × 240 pixels (which is converted to 376 × 284 by FotoMan software to maintain the proper aspect ratio) with 256 gray levels. That works out to an equivalent resolution of 75

## Earn Your B.S. Degree in ELECTRONICS or COMPUTERS



### By Studying at Home

Grantham College of Engineering, now in our 42nd year, is highly experienced in "distance education"—teaching by correspondence—through printed materials, computer materials, fax, and phone.

No commuting to class. Study at your own pace, while continuing on your present job. Learn from easy-to-understand but complete and thorough lesson materials, with additional help from our instructors.

Our Computer B.S. Degree Program includes courses in BASIC, PASCAL and C languages — as well as Assembly Language, MS DOS, CADD, Robotics, and much more.

Our Electronics B.S. Degree Program includes courses in Solid-State Circuit Analysis and Design, Control Systems, Analog/Digital Communications, Microwave Engr, and much more.

An important part of being prepared to *move up* is holding the right college degree, and the absolutely necessary part is knowing your field. Grantham can help you both ways—to learn more and to earn your degree in the process.

Write or phone for our free catalog. Toll free, 1-800-955-2527, or see mailing address below.

Accredited by  
the Accrediting Commission of the  
National Home Study Council

**GRANTHAM**  
**College of Engineering**  
Grantham College Road  
Slidell, LA 70460



## SPECIAL FROM ETT

TTL1 —  
TTL POCKET GUIDE,  
Volume 1,  
7400 — 74200  
..... \$18.95.



TTL2 —  
TTL POCKET GUIDE,  
Volume 2,  
74201 — 74640  
..... \$18.95.



TTL3 —  
TTL POCKET GUIDE,  
Volume 3,  
74641 — 7430640  
..... \$18.95.



TTLX —  
ALL THREE GUIDES,  
Vols 1, 2, & 3  
(save \$6.00)  
..... \$50.85.

Each volume provides a comprehensive listing of all commonly used TTL integrated circuits within the range of types noted. The combination of three volumes covers 7400 through 7430640 TTL products from all major manufacturers. All current families are covered: standard, low power, Schottky, low power Schottky, advanced Schottky, advanced low powered Schottky, high speed and fast Schottky. There are eight sections to the book. Section 1 illustrates the device schematic using a clear and simple logic diagram. Next a brief description of the components, providing quick reference to the internal structure. The next section details input signals or levels at individual pins. The fourth section lists major applications and is followed by a summary of essential data. Below this, a table indicates the TTL families in which the device is available, and finally, device description and type number are highlighted for easy reference. A manufacturer's index at the back of the book shows in tabular form which companies manufacture each package.

MAIL TO: Electronic Technology Today, Inc.  
P.O. Box 240  
Massapequa Park, NY 11762-0240

### SHIPPING CHARGES IN USA AND CANADA

\$0.01 to \$5.00	... \$1.50	\$30.01 to \$40.00	\$5.50
\$5.01 to \$10.00	... \$2.50	\$40.01 to \$50.00	\$6.50
\$10.01 to \$20.00	... \$3.50	\$50.01 and above	\$8.00
\$20.01 to \$30.00	... \$4.50		

**SORRY, No orders accepted outside of USA and Canada**

Total price of merchandise	..... \$	_____
Shipping (see chart)	..... \$	_____
Subtotal	..... \$	_____
Sales Tax (NYS only)	..... \$	_____
Total Enclosed	..... \$	_____

Name \_\_\_\_\_  
Address \_\_\_\_\_  
City \_\_\_\_\_ State \_\_\_\_\_ Zip \_\_\_\_\_

dots per inch for a photo that is about 3½ × 5 inches. That certainly limits the applications for which FotoMan would be acceptable. It wouldn't, for example, be acceptable for use in this—or virtually any other—magazine. But we can think of a few professional applications for it. (A friend suggested using it for making those chatty family Christmas letters complete with photos, but we have to focus on professional applications. Despite its consumer-friendly looks, FotoMan—with its suggested list price of almost \$800—certainly isn't aimed at casual users.)

Real-estate professionals are the first users who come to mind. Although the real-estate market has slowed down considerably in recent years, only a few years ago, it wasn't unusual for a house to sell the same day it went on the market. Real-estate brokers now have to work quite a bit harder to get someone interested in a house. Photographs—even poor ones—can help. If you can edit the photo—to get the garbage cans out of the picture, for example—you can do even better. We tried such editing to take some Christmas decorations, unwanted bushes, and even a car out of a sample house photo. With only a limited amount of practice, we were able to do a convincing job.

Someone producing a company newsletter could use the FotoMan to get late-breaking news into print. There's no need to take a traditional photograph, process the film, scan the photo to put it in electronic form, and then import it into your document. And a company with security restrictions could make "instant" photo identification passes to allow visitors access to given areas.

Whether the potential applications can justify the \$800 price of the FotoMan is open to question. If the average production unit is constructed as shoddily as our evaluation unit, we doubt that anyone could justify the expense. The camera stand broke apart the first time we set the camera in it. That wasn't too big a deal—a little super glue repaired the seam that had split. More troublesome was the poor connection between the camera base and the camera. The software constantly notified us that our camera was not connected. We could make things work by keeping pressure on the cables, or by turning the unit upside-down so that the cables would keep pressure on the contacts. On the bright side, a Logitech spokesperson has assured us that our unit was in the first production batch of cameras, and the problem has since been rectified.

For \$800, we'd certainly hope so. But then again, for that price, we'd expect some friendlier common-sense features, too. How about an LCD to show how many pictures are in memory? How about some manual control over shutter speed? How about the ability to focus manually with a quality lens?

Products that are the first of their kind tend to be pricy. FotoMan is the first digital camera available to PC consumers, and Logitech should be congratulated for bringing the product to market. But we wouldn't be surprised to see it superseded soon by something that is more flexible, and less expensive. We have no pressing need for medium-resolution digital photographs. While we wait for Logitech's next model, we'll stick to the old—but proven—silver halide technology. ■

## SONY GPS

(Continued from page 6)

the high-precision mode, the accuracy of the reading is limited by several factors, but the primary cause is data errors deliberately introduced by the Department of Defense, which is responsible for maintaining the GPS system.

Once you have acquired your position, you can store it in memory, if you like—up to 50 points can be stored, along with the time you were there. If you prefer, you can replace the time (which is automatically stored) with a six-character title (such as "harbor," or the name of a town).

The Pyxis also has a track mode, in which you can display the distance, direction, and points you have passed from your starting point to your present position. You can display a rough graphic description of your journey, or you can display an alphanumeric description of your journey, which contains the distance from the start

point to your present position (in meters, miles, or nautical miles), the direction of the present position from the start point (in degrees or descriptive direction, ENE, for example), and your altitude relative to the start point or in absolute numbers.

While the track mode lets you check the distance from, and direction to points you have passed, the navigation mode lets you check the distance and direction to your destination. You can store way points—places you will pass en route to your destination—in memory as well. The Pyxis will beep as you approach your stored point (within 300 meters or up to 9000 meters, depending on your preference). You can store up to nine different routes in the receiver, but the total number of way points you can store is 99.

The maximum velocity that you can travel while still obtaining accurate navigation is 588 miles per hour (530 knots), so you can use Pyxis for any type of land or sea travel, and it can also be used in many airplanes. ■



For more information on any product in this section, circle the appropriate number on the Free Information Card.

# ELECTRONICS WISH LIST

## Travel Translator

If you're en route to the Olympics this summer, you'll probably appreciate the *TM15 Travel Mate* from *Royal Consumer Business Products* (Olivetti Office USA, 756 U.S. Highway 202, Bridgewater, NJ 08807). The pocket-sized Travel Mate can translate over 100,000 words and phrases among six languages: English, Spanish, French, German, Italian, and Dutch. Any of the six languages can be used as the translator's base language. For people who never got the hang of the metric system, the translator automatically converts U.S. measurements to their metric equivalent. Price: \$109.95.

CIRCLE 56 ON FREE INFORMATION CARD



Travel Mate Translator

## Home DAT Deck

It's bad enough for consumers who have to wait for some indication that digital audio recorders will become real products that will be accepted by the recording companies, Congress, and consumers themselves. We can just imagine how the manufacturers feel. But *Sony* (Sony Drive, Park Ridge, NJ 07656) isn't waiting. They've added the *DTC-670 digital audio tape deck* to their current lineup. The deck offers 200x and 400x fast-forward and rewind, and optical and coaxial digital outputs, as well as a full complement of standard features. Price \$750.

CIRCLE 57 ON FREE INFORMATION CARD

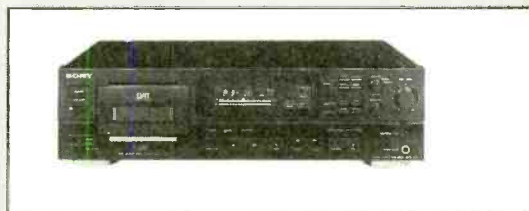

Home DAT Deck

## Multi-ID Phone

The phone company has sure changed over the years. Now they offer more services than ever. Caller ID is perhaps the best-known feature, because of the privacy issues that it raises, but it's only one of a host of new ways that your phone company can increase your monthly service charge. Call waiting, distinctive ringing, call trace, message waiting, and call forwarding are other popular services. Of course, using all of those features can get a little confusing because of the codes that have to be entered to access the services. Now phone companies can offer you a solution to that, too. *Northern Telecom's* (4001 Chapel Hill Nelson Highway, Research Triangle Park, NC 27709) *QuickTouch 200*. The phone offers up to 16 user-programmable autodialers and a display for outgoing number, date, and time. It can be tailored at the factory to serve different needs. One button, for example, could access call-forwarding services. A blinking light could indicate that a voice-mail message was waiting. (Usually such message-waiting services require the customer to pick up the handset and listen for a tone.) Price: \$149.95.

CIRCLE 58 ON FREE INFORMATION CARD



Multi-ID Telephone

## Private Gambling Hall

If you're tired of losing your shirt every time you visit Las Vegas or Atlantic City, you might want to try *Pro Blackjack* from *Saitek* (2291 West 205th Street, Suite 101, Torrance, CA 90501). Unlike the casinos, it gives you a choice of how many card decks to play with, from one to six. Up to four people can play against the dealer. The dealer is friendlier than most we've encountered—it gives hints on betting, and even introduces you to the skill of card counting, which is frowned upon in real-life casinos. You can bet high or low stakes, and just as in a real casino, you can be bothered (or excited) by the sound effects it offers. Price: \$69.96.

CIRCLE 59 ON FREE INFORMATION CARD



Pro Blackjack Game



# ELECTRONICS WISH LIST

For more information on any product in this section, circle the appropriate number on the Free Information Card.

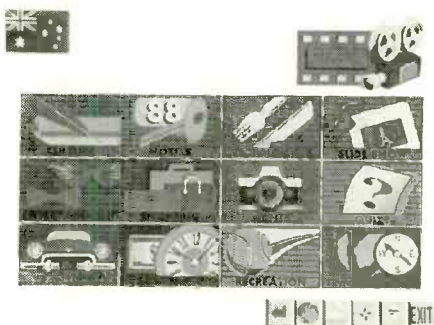

Great Cities of the World CD-ROM Disc

## Desk-chair Tourist

Most of us have cut back on vacation travel during the current recession. But that doesn't mean we can't learn about foreign cities in a relaxing, entertaining way. *Interopica Publishing's* (300 Montgomery Street, 2nd Floor, San Francisco, CA 94104) *Great Cities of the World Volume 2* lets you use your PC to tour 10 world cities: Berlin, Buenos Aires, Chicago, Jerusalem, Johannesburg, Rome, San Francisco, Seoul, Singapore, and Toronto. The CD-ROM disc is available in Macintosh, DOS, and MPC versions. Each disc contains over two hours of audio, 300 photographs, 300 maps, and the equivalent text of ten travel-guide books. Users can look in detail at city neighborhoods by clicking on the city map to zoom in for a closer look, or simply watch a slide show that features a narration by a native of the city with local music in the background. Users can find hotels, transportation information, entertainment locations, and more. Price: Not available.

CIRCLE 60 ON FREE INFORMATION CARD



Vidikron Projection TV

## A TV To Look At

Projection TV's are meant to be seen—that's why they have such large screens. *Vidikron* (150 Bay Street, Jersey City, NJ 07302) thinks that people aren't going to just watch the screen when they're in the same room as the "videoprojector of the future," the *VPF 40*. They'll also be captivated by the projector itself. Designed by Pininfarina (the Italian automotive design firm famous for styling the Ferrari), the *VPF 40* looks to be a step ahead of other projectors. That's even more evident when you consider its specifications. The projector can handle virtually any signal you can throw at it. It accepts composite video, S-video, and RGB inputs. Its multisync capability allows it to lock on different video signals regardless of their horizontal and vertical frame rates. It will display computer video signals as well as NTSC, PAL, and SECAM video. What's more, because of the projector's high scanning frequency (up to 54.5 kHz), it should be capable of displaying HDTV signals when a standard is reached. The *VPF 40* can project images up to 25 feet diagonal. The aspect ratio of the picture can be changed by the user, and even stored in memory. So every time you watch a letterboxed videodisc, for instance, you can recall the proper settings with the touch of a button. Price \$15,000.

CIRCLE 61 ON FREE INFORMATION CARD



CD-Player Lens Cleaner

## Laser Lens Cleaner

Although unknown to most people, CD players aren't completely maintenance-free, and need occasional cleaning. The laser lens, through which the laser beam must focus on the information stored on a CD, is highly susceptible to such airborne contaminants as dust, smoke, and moisture, all of which can cause distortion, mistracking, and slower access time. *AudioSource* (1327 North Carolan Avenue, Burlingame, CA 94010) helps you keep the laser lens clean in any of your CD players—home players, portables, stacking changers, and car audio units, with the *LLC-2*, a compact disc with two laboratory-grade brushes protruding from its inner edge. The brushes are configured to clean the lens safely and effectively, and digitally encoded instructions tell the player to precisely align the laser lens under the path of the brushes as the cleaning cycle is executed in less than 20 seconds. Price: \$29.95.

CIRCLE 62 ON FREE INFORMATION CARD



# With NRI hands-on training, you can experience the rewards of a career in computer programming

Now you can get the practical training and experience you need to succeed in computer programming, today's top-growth computer career field.

NRI at-home training gives you real-world programming skills in four of today's hottest computer languages: BASIC, Pascal, C, and COBOL. You get hands-on training that now includes a powerful 386sx/20 MHz mini-tower computer, modem, and programming software ... all yours to train with and keep! Best of all, NRI gives you the programming know-how you need to succeed on the job, in a new career, or in a business of your own.

Job opportunities for the skilled computer programmer will increase by 71.7 percent over the next 10 years according to Bureau of Labor Statistics forecasts. And now, with NRI training, you can be one of the increasing number of computer programmers using their skills to build a top-paying career — even a business of their own — in this professionally and financially rewarding high-tech field.

## ▼ The only programming course that includes a powerful 386sx-based computer system and programming software you keep

Right from the start, NRI training gets you actively involved in the challenge of real-world programming. You learn how to create the kinds of full-featured, powerful programs today's employers and clients demand.

And, unlike any other school, NRI lets you experience first-hand the power of an IBM PC/AT-compatible, 386sx-based computer system, complete with modem, a full megabyte of RAM, disk drive, and monitor — all yours to train with and keep!



Plus you explore the extraordinary capabilities of not one or two but four in-demand computer languages.

You learn to design, code, run, debug, and document programs in BASIC, Pascal, C, and COBOL. In the process you become uniquely prepared for the wide variety of programming opportunities available today.

## ▼ No previous experience necessary

Immediately, you start getting the money-making job skills you need to secure a future in computer programming — no matter what your background. NRI's unique Discovery Learning Method guides you swiftly from computer novice to computer professional with step-by-step lessons covering program design techniques used every day by successful PC programmers.

You'll find no heavy textbooks to plow through. No night classes to attend. Instead, NRI's at-home, step-by-step training covers all the bases, guiding you

from the important fundamentals to real-world methods and techniques. Backed up throughout your course by your experienced NRI instructor, you quickly gain the skills you need to handle a wide variety of programming tasks with confidence. You even use your modem to "talk" to your instructor, meet other NRI students, and download programs through NRI's exclusive programmers network, PRONET.

## ▼ Send today for your FREE catalog

Now you can experience the professional and financial rewards of a career in computer programming. See how NRI at-home training gives you the know-how, the computer, and the software you need to get started in this top-paying field. Send today for your FREE catalog!

If the coupon is missing, write to us as the NRI School of Computer Programming, McGraw-Hill Continuing Education Center, 4401 Connecticut Avenue, NW, Washington, DC 20008.

**SEND FOR YOUR FREE NRI CATALOG TODAY!**

## **NRI** Schools

McGraw-Hill Continuing Education Center  
4401 Connecticut Avenue, NW, Washington, DC 20008



### Check one free catalog only

- |                                                     |                                                          |
|-----------------------------------------------------|----------------------------------------------------------|
| <input type="checkbox"/> Computer Programming       | <input type="checkbox"/> Programming in C++ with Windows |
| <input type="checkbox"/> Microcomputer Servicing    | <input type="checkbox"/> Desktop Publishing & Design     |
| <input type="checkbox"/> PC Applications Specialist | <input type="checkbox"/> Bookkeeping and Accounting      |

Name \_\_\_\_\_ Age \_\_\_\_\_  
(please print)

Address \_\_\_\_\_

City \_\_\_\_\_ State \_\_\_\_\_ Zip \_\_\_\_\_

Accredited Member, National Home Study Council

5413-072







## TSM 6-DIGIT ALARM CLOCK/CHRONOMETER KIT

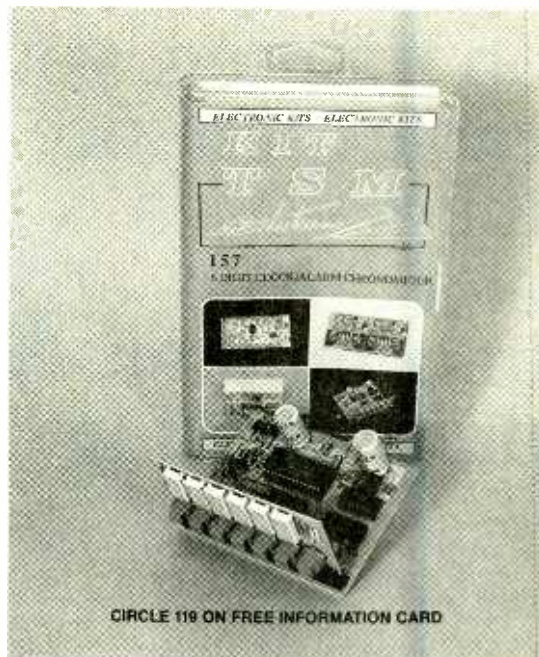

*A feature-filled project perfect for the timepiece enthusiast with a moderate knowledge of electronics.*

I bet mankind has been fascinated by the flow of time and methods for measuring it from its early beginnings. And that's as it should be; Time is one of those intangible, yet ever-present and all-powerful forces of nature. Somewhere, perhaps in some antiseptic corner of the heavens, there is a giant clock ticking away the untold centuries as entire star systems are born, live, and die. I suppose it's romantic thoughts like those that turn some people into clock collectors.

As for me, I just like machines of almost any kind, clocks included. I find electronic clocks particularly interesting because their method of operation is just as invisible and silent as the phenomenon they attempt to gauge. Being an avid electronics hobbyist, the more whistles and bells an electronic clock has, the more I like it. And if I can build the clock myself, I'll like it all the more. Luckily, I chanced upon the TSM 6-Digit Alarm Clock/Chronometer Kit, which suits all of my likes: It was moderately easy to build, has a number of operating modes, and, of course, it silently measures the passage of time—until the alarm sounds.

The kit was not without its peculiarities, however. I'll mention what

they were as I proceed, but they shouldn't hamper a fairly experienced kit builder (especially after I point out what they are).

**Features.** As mentioned, the clock has a variety of useful operating modes. For example, it can be used as a 6-digit alarm clock that displays the hour, minute, and seconds (although you must supply the alarm circuitry). It can also be used as a chronometer that displays minutes, seconds, and hundredths and tenths of a second, without losing track of the time of day. When you return to the clock-mode from the chronometer mode the chronometer's last readout is saved in memory. So, if you request the chronometer mode again, the readout will display the last chronometer reading unless you reset it to zero.

The unit can also count down from a preset time (again without losing track of the real time, or the last chronometer reading) in hours/minutes/seconds format. Just as in the chronometer mode, when you return to the clock mode the last count-down mode readout is saved in memory. In fact, unless halted, the count-down timer will continue to operate in the background when the unit is in either

clock mode, or chronometer mode. So the clock-mode circuitry can keep track of the time, while the count-down timer operates in the background and the chronometer has control of the display.

As if that much versatility isn't enough, there is yet another mode: seconds-count mode. As you might have guessed, the unit counts the passing seconds, minutes, and hours in that mode. While this mode can be active at the same time as both the chronometer and count-down modes, it replaces the clock mode. The clock and seconds-count modes are mutually exclusive—you can't have one while you run the other.

That one exclusivity notwithstanding, I have never seen a clock capable of so many time-display modes, let alone one that could perform most of its functions simultaneously. Since the clock's timekeeping circuit is based on a 320-kHz crystal oscillator, it can perform those functions with excellent accuracy.

For all its capability, the circuit's power-supply requirements are very forgiving. While they are listed as 9 to 12 volts DC at a ½ amp, the circuit contains a bridge rectifier, permitting

*(Continued on page 89)*



# PRODUCT TEST REPORTS

by Len Feldman

## Carver DPL-33 Surround Sound Processor/ Amplifier

**M**ost people believe that in order to have a "home-theater" system that's worthy of the name, they have to spend upwards of \$30,000 to \$40,000! That misconception probably arises from the many slick publications that show pictures of custom-installed and custom-built home-theater systems that do, indeed, cost that much. The fact is, though, that if you already own a decent large-screen TV set (25-inches or greater), a video-program source that incorporates stereo sound (a stereo VCR, laser-disc player, or MTS-stereo TV), and a reasonably good stereo audio system with a pair of good speakers, you are more

and a surround-sound processor/amplifier such as Carver's DPL-33. The Carver DPL-33 is a Dolby Pro Logic decoder and spatial processor with a built-in three-channel amplifier; it provides up to 25-watts for the center-channel speaker (in a Pro-Logic set up), and 15-watts each for the two surround-sound rear channels. It can be easily added to any existing stereo system to create a five-channel surround-sound home theater with total remote control. When the DPL-33 is attached to the processor or in the tape-loop of a companion stereo amplifier or stereo receiver, all five channels can be controlled using the remote control, and their output levels can be directly monitored on a five-channel LED display. (A handheld remote control is supplied with the unit.) The unit also features automatic balance adjustment for the optimum decoding of movie sound tracks. For "concert-hall" ambience, when used with un-encoded stereo program sources, the DPL-33 also has switchable 20- and 30-millisecond time-delay circuits.

Matrix button provides a simulated stereo sound for monophonic program sources. A Hall button provides an airy, three-dimensional effect to non-Dolby-encoded stereo programs. The Surround button engages the Dolby decoding circuitry. The remaining four buttons handle a choice of time delay for the surround channels (20 or 30 milliseconds), normal or "phantom" center channel (the latter used in four-speaker setups that lack a center-channel speaker), and activate a "Test" noise signal that enables you to properly adjust the levels of all channels for best surround-sound balance.

Four vertical rows of LED's serve as level indicators for the left-, center-, right-, and surround- (rear-) channel outputs. An input-level control sets the input levels for all channels, and prevents possible overload of the input stages. Further to the right are two rocker-type controls that adjust rear channel and center channel levels upward or downward relative to the front channels. Finally, at the extreme right is a master volume control that raises and lowers the volume of all four channels: center, left, right and surround.

The rear panel is equipped with Line In, Tape Out, Tape In, Line Out (Front), and Surround Out pairs of jacks; a Center output jack; and a Subwoofer output jack. Normally, the Surround Out and Center Out jacks would not be

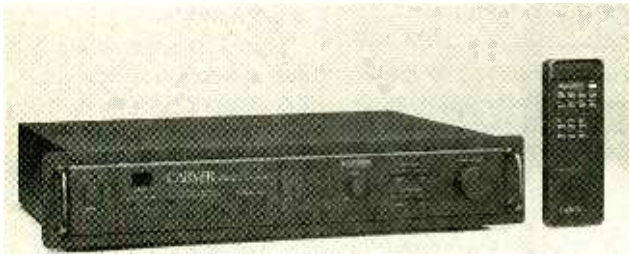

CIRCLE 120 ON FREE INFORMATION CARD

*The Carver DPL-33 Surround-Sound Processor/Amplifier.*

than two-thirds of the way towards having your own "home-theater" installation.

All you need in order to recreate the excitement and thrill of watching motion pictures and other programming the way you experience Dolby Stereo sound in a movie theater are at least two more speakers (preferably three)

### CONTROL LAYOUT

The main power switch for this unit is at the extreme left end of the panel. Next, come eight small pushbuttons, each surmounted by an indicator light. The first of these is a tape-monitor button (the DPL-33 includes a tape loop to replace the one it uses in the companion stereo amplifier). A



used, since the DPL-33 contains amplifiers needed for driving those channels. However, just in case you find that the power provided by the DPL-33 for those channels is inadequate for the speakers you use (or for the room in which the installation is made), those outputs allow you to drive separate amplifiers for those channels and speakers. The rear panel also contains a small slide switch that selects the crossover frequency for the subwoofer output (either 80 Hz or 150 Hz) and an associated small subwoofer-level control. Finally, at the right end of the rear panel there are spring-loaded sets of speaker terminals for direct connection of center-channel and rear-channel (left and right) speakers.

## TEST RESULTS

Measuring the performance of a unit such as the Carver DPL-33 is a bit tricky, since with similar signals applied to left and right inputs, (in effect, mono), no outputs will be decoded for the surround channels. Still, by tailoring our input signals for specific tests, we were able to plot some response and power output results graphically. Figure 1 shows the frequency response obtained for the front channels when L-only and R-only signals are applied to the Line Input jacks. Response was virtually flat, exhibiting approximately 0.5-dB roll-off at 20 Hz and -0.3 dB at 20 kHz. When equal signals are applied to the line inputs, a center-channel output appears, as one would expect, even when in the Dolby Surround mode. In this mode, response is flat from around 200 Hz all the way out to 20 kHz, but a deliberate bass roll-off is introduced. This tends to add clarity and

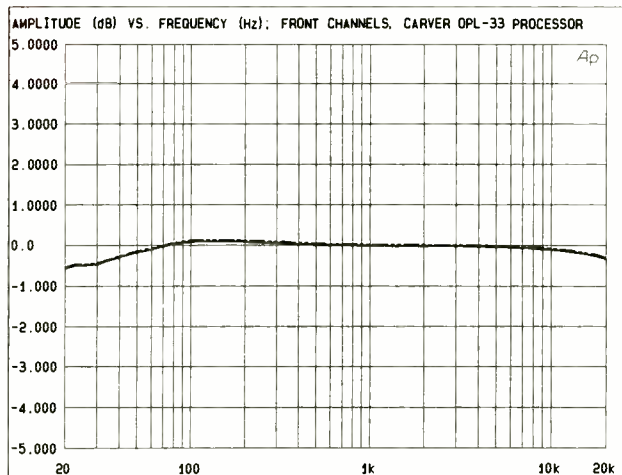

Fig. 1. The frequency-response plots obtained for the front channels when L-only and R-only signals were applied to the Line Input jacks shows the response to be virtually flat.

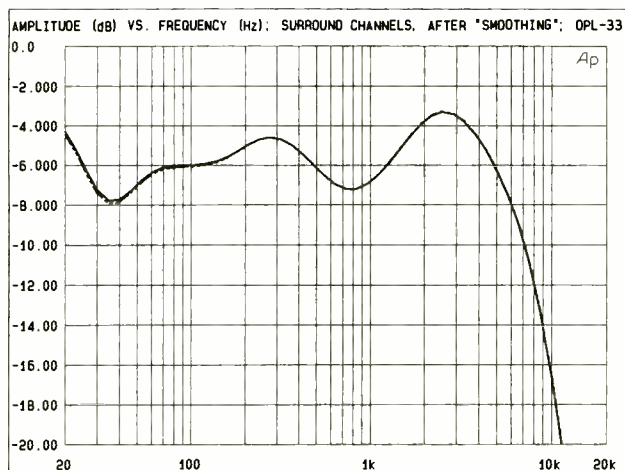

Fig. 2. The surround channels have a deliberate roll-off above around 5 or 6 kHz. This is in accordance with the requirements of Dolby Surround decoding. The variations in the plot prior to the roll-off point were introduced by the unit's time delay.

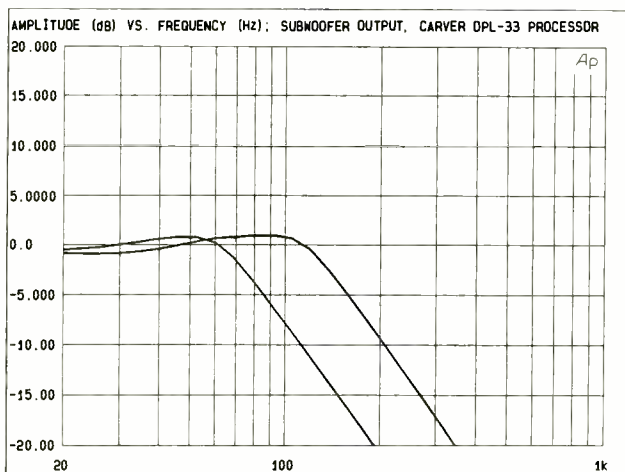

Fig. 3. This plot shows the response of the unit at the Subwoofer-Out jacks.

intelligibility to spoken dialogue, which, essentially, is steered to the center channel as it should be.

Don't be too dismayed by the response plotted for the surround or rear channels, shown in Fig. 2. The reason for the extreme undulations in response has to do with the time delay introduced by the decoder (20 or 30 milliseconds), making it impossible for our Audio Precision Test System to track the sweep as it normally would. We show this curve only to indicate that the surround channels have a deliberate roll-off above around 5 or 6 kHz. This is in accordance with the requirements of Dolby Surround decoding.

Figure 3 shows the response of the unit at the Subwoofer Out jack. Depending upon how the subwoofer-crossover switch is set on the rear panel, the -3-dB point in the response at this output corresponds very closely to the 80-Hz and 150-Hz nominal crossovers suggested by the labeling of the subwoofer switch.

Signal-to-noise ratios for this unit varied widely depending upon which channels were being measured and under what conditions. Following the EIA standard, in all cases 500-millivolt input signals were applied to the line inputs and the outputs were adjusted either for 1 watt across 8-ohm loads, (in the case of center-channel and surround-channel outputs), or to 0.5 volts (in the case of the front-channel outputs). For those front-channel outputs, signal-to-noise measured 65 dB. For the center channel, S/N was more than 88 dB, while for the surround channels, S/N measured 89.6 dB on one channel and 89.2 dB for the other channel.



## TEST RESULTS—CARVER DPL-33 SURROUND SOUND PROCESSOR

Specification	Manufacturer's Claim	PE Measured
Frequency response (20-20 kHz)	+0, -0.3dB	-0.5, -0.3 dB
THD	Less than 1%	Confirmed
S/N (IHF weighted)		
Front channels	55 dB	65dB
Surround/center	85 dB	88/89 dB
Power at 8 ohms		
Center channel	25 watts	40 watts
Surround channels	15 watts	15 watts
Weight	14 lbs	Confirmed
Dimensions (H x W x D, inches)	3.8 x 19 x 12.75	Confirmed
Price	\$449.95	

While it was difficult to measure frequency response using sweep signals, we had no problem measuring distortion as a function of power output, so long as single test tones were used. Thus, Fig. 4 shows how distortion varied as a function of power output for the center-channel output, while Fig. 5 shows how distortion varied with power output for the surround-channel outputs. Three test frequencies were used in each case: 100 Hz, 1 kHz, and 10 kHz. As is usually the case, the lowest distortion was noted for the 1-kHz test signal. At rated power output (25 watts, in the case of the center-channel output), THD was only 0.1%. At 100 Hz, THD was slightly

higher at 0.12%; at 10 kHz, THD rose to just under 0.2%. Those results are shown in Fig. 4. For the surround-channel outputs (Fig. 5), distortion at 1 kHz was 0.6% at its rated output of 15 watts, and approximately 0.8% for that power output at test frequencies of 100 Hz and 10 kHz.

### HANDS-ON TESTS

Hooking up a unit such as the DPL-33, in order to create a "home theater" audio/video entertainment center proved to be easier than I thought it would be. We quickly discovered that, using reasonably efficient speakers for the center and surround channels, the power provided by the DPL-33's amplifiers was

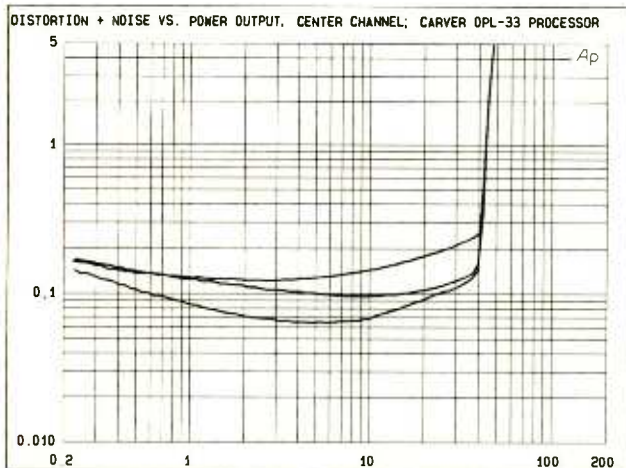

Fig. 4. At the unit's rated power output (25 watts), THD for the center-channel output was only 0.1%. At 100 Hz, THD was slightly higher at 0.12%; at 10 kHz, THD rose to just under 0.2%.

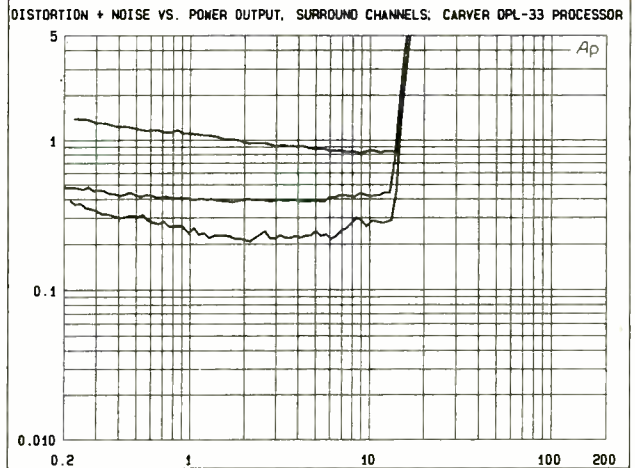

Fig. 5. For the surround channel outputs, distortion at 1 kHz was 0.6% at its rated output of 15 watts, and approximately 0.8% at 100 Hz and 10 kHz.

completely adequate. Adjusting levels so that sounds were balanced was a snap, too, thanks to the "white noise" test tones that automatically move from channel to channel. If anything, the duration that the test tone sounds from each speaker might be shortened a bit—the tones don't have to stay on each channel as long as they do to give the user an idea as to whether that channel is too loud or too soft.

Of course, the real thrill comes when you watch your first Dolby Surround-encoded movie. Our's was on a laser video disc, so that we not only had good surround sound but as good a picture as can be had with our present NTSC color-TV system. Our viewing was done on a 32-inch direct-view Sony TV, and we turned off the internal speakers, since the front channels were powered separately from our regular reference stereo system.

While we did not incorporate a subwoofer into our test setup we strongly recommend that you do use a center-channel speaker. The Phantom setting on the DPL-33 (in which the center channel sound is derived

from the left and right front speakers), while reasonably good as long as you sit exactly mid-way between the front speakers, is seriously deficient if you move off-center. By contrast, using a center-channel speaker (even a small, inexpensive one, since it's only expected to handle dialogue), makes your seating and viewing position far less critical and keeps that dialogue firmly planted "on screen" where it belongs.

The Hall setting of the DPL-33, when used with non-Dolby encoded stereo material worked reasonably well, though there were some sorts of program material that we felt might have wanted less reverberation and perhaps less time delay than even the lowest setting of 20 milliseconds provided. Some processors offer many more varieties of simulated environments than the DPL-33, but of course, they cost more, too. In short, the Carver DPL-33 is well worth its \$449.95 list price.

For more on the DPL-33 contact Carver (20121 48th Ave, West, PO Box 1237, Lynnwood, WA 98036) directly, or circle No. 120 on the Free Information Card. ■



# The Amazing Maze.

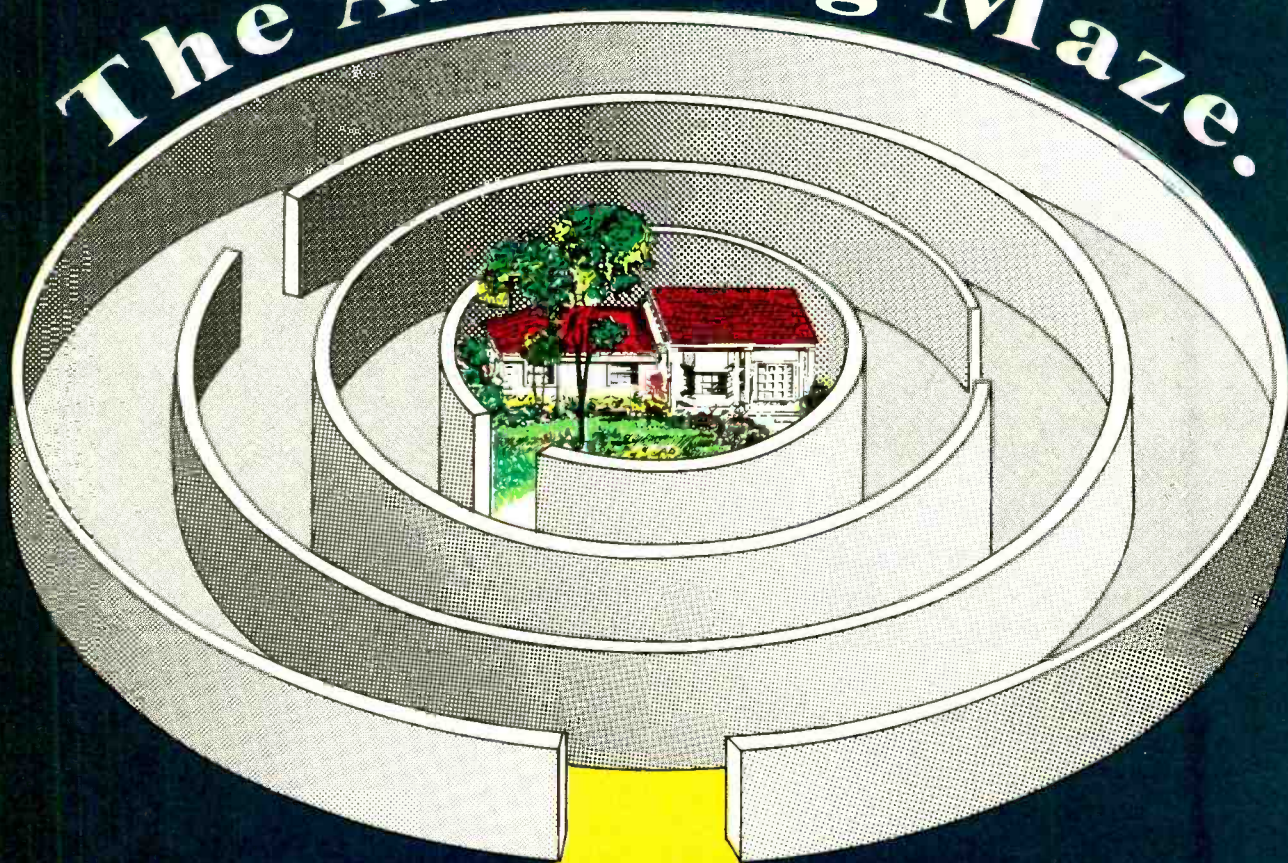

**YOUR HOME . . .  
the television series,  
will help guide you through it.**

For most families . . . our homes are the biggest purchase we'll ever make. From time to time we've all thought about making changes to our homes. By watching the YOUR HOME television series, you can catch all of the latest ideas and trends designed to get you through the maze of products that will enhance the beauty, functionality, and quality of the time that you spend at home. Whether you're building a dream kitchen or attempting to create the home theater experience, from the simple to the exotic, YOUR HOME has a wealth of great ideas. It's like going to the world's biggest home and garden store each and every week.

Tune into upcoming shows to check out the best and brightest in home products and services:

#### **LAGUNA TOOLS**

The X-31, Multi purpose wood working machine.

#### **PRIMESTAR**

The finest in direct broadcast satellite entertainment.

#### **APOGEE ACCOUSTICS**

Ribbon Technology Audio Speakers for the true home theater sound experience.

#### **TAG INTERNATIONAL**

Stainless Steel flatware and holloware.

#### **ROYAL CROWN FIREPLACES**

European Style Masonary Fireplaces.

#### **STERLING DOMESTIC APPLIANCES**

The latest in downdraft Cooktops for the kitchen of the 90's.

#### **SWIM-X SYSTEMS**

The latest in compact, year round lap swimming pools.

*Check your local cable listing for the time and channel number in your area.*

A presentation of

WJMK • 2424 N. Federal Highway • Boca Raton, FL 33431 • (407) 367-0703



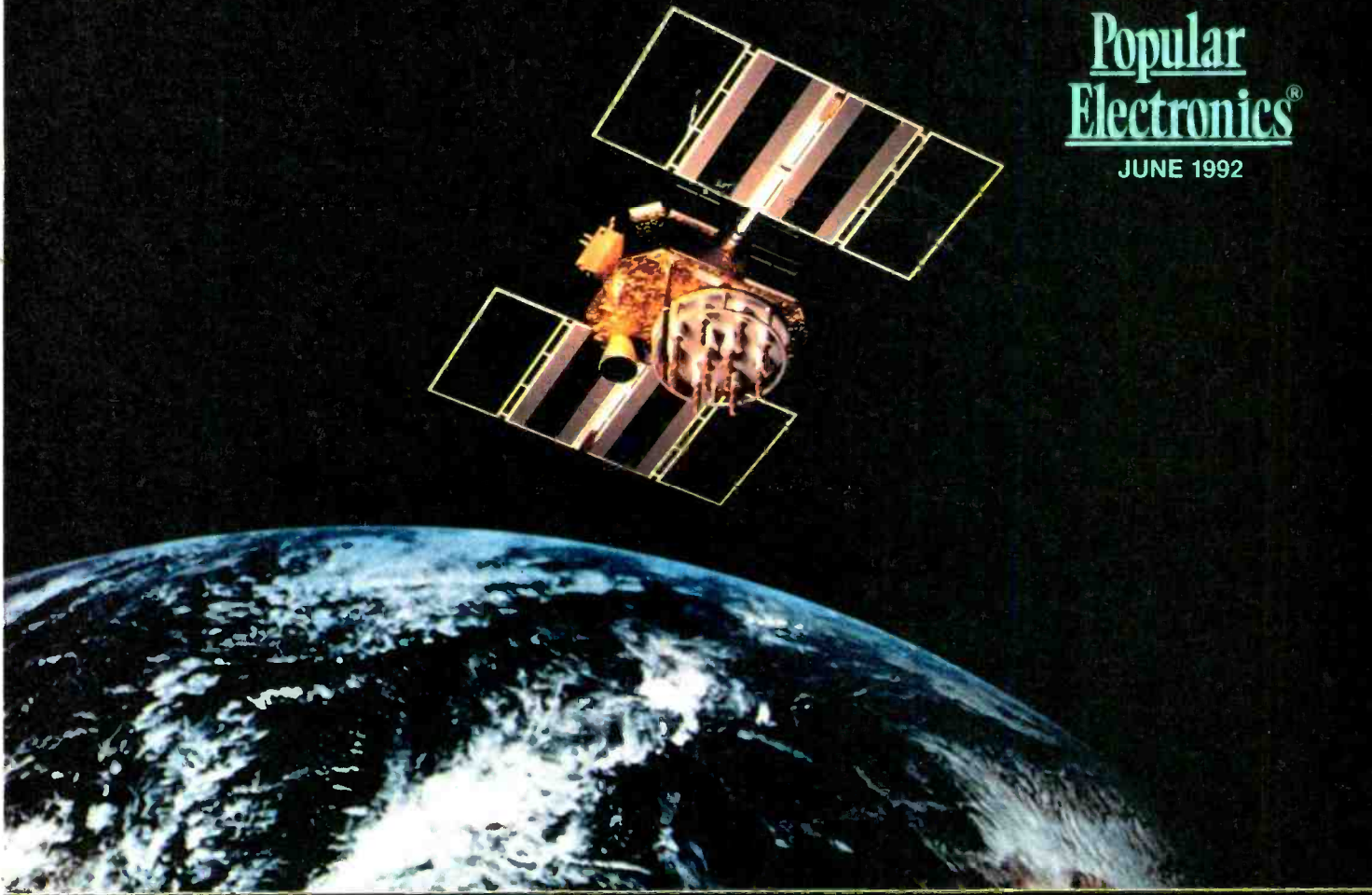

# THE GPS NAVIGATION SYSTEM

BY BRIAN C. FENTON

*GPS—the global positioning system—offers unprecedented positioning and navigation accuracy on land, at sea, or in the air.*

Everyone knows what it's like to be lost—even those of us who don't like to admit it. But imagine if your car could tell you exactly where you were at all times. Imagine a system that could tell you the location of the nearest Mexican restaurant. Or in matters of greater urgency, imagine an emergency vehicle always knowing where to go when responding to a call. Think of the safety improvements that could come from a foolproof collision-avoidance system for air traffic. All of those things—and more—are made possible by GPS, the Global Positioning System.

Ever since people began to move

around—and the first “humans” were nomadic hunters and gatherers—we've needed some way to keep track of where we've been and where we're going. Today, we move around at unprecedented rates. Gone are the days when people died within a few miles of where they were born, never having left their villages. It's rare for people to live in the same place for their entire lives—many Americans leave their home towns every day just to go to work! Airplane travel has become commonplace, and has made the world smaller than ever. And it's made knowing where we're going more important than ever.

Ancient mariners learned to use the stars to determine their positions. As long as you don't need great accuracy, celestial navigation works well—that is, as long as the sky is clear, and as long as it's nighttime. The idea behind GPS is to set up a constellation of “stars” that can be “seen” by sophisticated receivers, twenty-four hours a day, regardless of the weather.

GPS is not the world's first radio-navigation system. Loran-C, Omega, and radio beacons have been maintained by the U.S. Coast Guard for decades. GPS isn't even the world's first world-wide satellite-based navigation system. The U.S. Navy-sponsored



Transit program (sometimes called SatNav) became operational in 1964 and is still in service today. GPS was developed to address some of the limitations of Transit. Table 1 compares the abilities of the major navigation systems available today.

The main force behind the development of GPS was the U.S. Department of Defense. Why? We have only to look at recent history for the answer. In the Persian Gulf War and in the U.S. attack on Panama, U.S. forces made extensive use of portable GPS receivers. (During the Gulf War, the military bought almost 10,000 receivers from one company alone!) Advanced weapons use GPS as part of their guidance systems. In the Tomahawk cruise missile, for example, GPS updates the missile's inertial guidance system and provides position information to the on-board digital scene-matching area-correlation system (DSMAC).

Full-scale development and testing of GPS took place between 1979 and 1985. The final phase—production and deployment—began in 1985, and should be complete next year, a few years behind schedule. The main cause of the delay was the Challenger space shuttle disaster in 1986—when only seven GPS satellites were in orbit—which put deployment of new satellites on hold for three years. Since the satellites have a life expectancy of less than eight years, new satellites will be continually launched to replace aging satellites.

**The GPS System.** GPS consists of three major segments, Space, Control, and User, as shown in Fig. 1. The Space Segment is the constellation of GPS satellites. When the system is fully implemented, the constellation will consist of 24 satellites—21 operational and three spares. As of this writing, 17 satellites are in operation. The

satellites operate in circular orbits 20,200 kilometers (12,500 miles) above Earth, and are arranged in six orbital planes, spaced 55° apart. They have an orbital period of about 12 hours. That arrangement ensures that at any given time, at least 5 satellites will be in view to users anywhere in the world. A minimum of four satellites are required for accurate positioning.

The Control Segment consists of a master control station in Colorado Springs, CO, and five monitor stations and three ground antennas located throughout the world. The monitor stations track all satellites in view, and send the accumulated data to the master control station, which computes precise satellite orbits. Any position updates are transmitted to each satellite via the ground antennas.

The GPS User Segment consists of antennas and receivers that allow land, sea, or airborne operators to determine their precise position and ve-

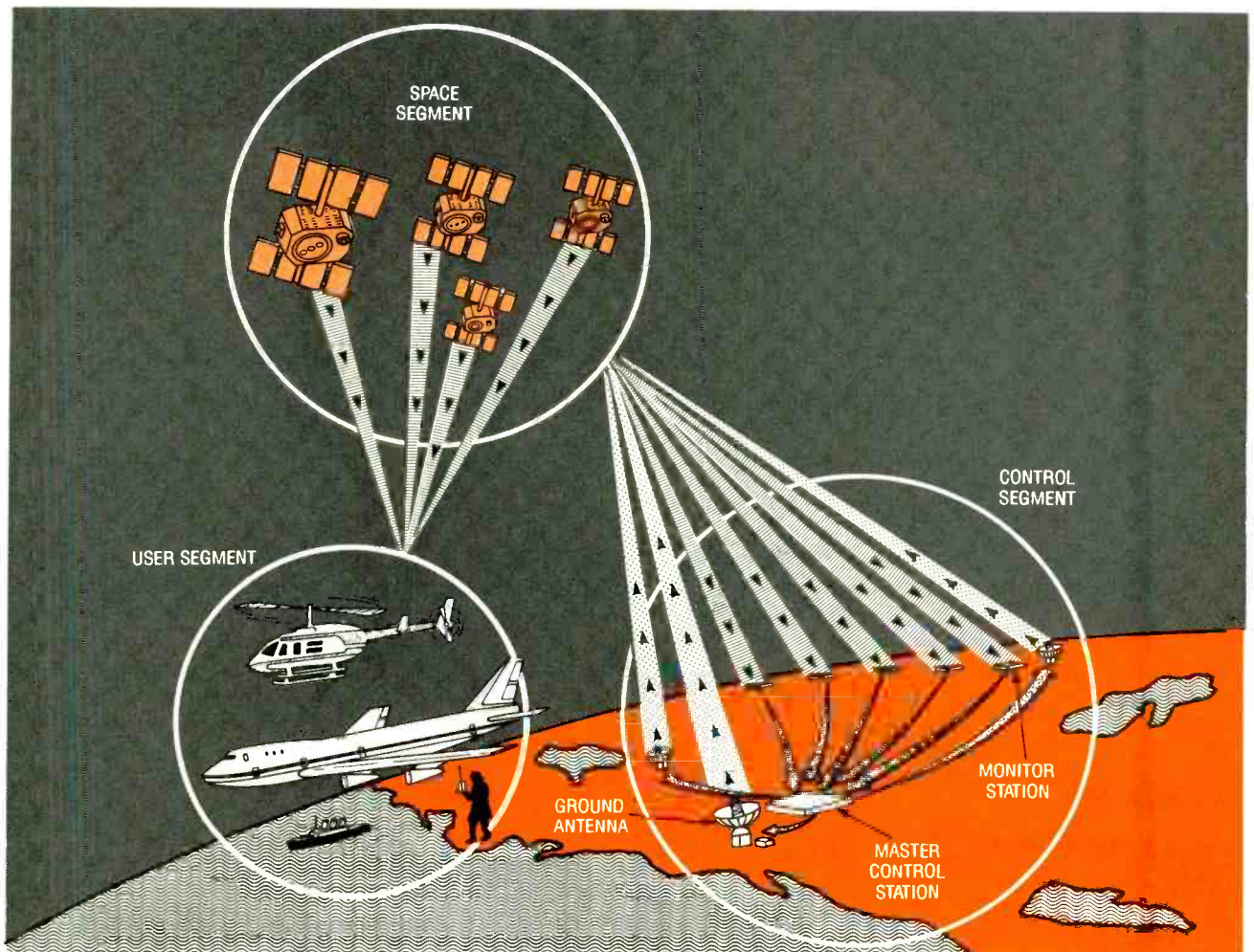

Fig. 1. The GPS navigation system consists of three segments, Space, Control, and User.



locity. Accurate time-of-day data can also be obtained. A wide variety of user equipment is available, including the consumer-friendly Pyxis receiver from Sony. (See GIZMO for further information.)

**How It Works.** The GPS concept is easy enough to grasp. If you know how far away you are from a number of orbiting satellites, and if you know exactly where those satellites are, you can determine your position using standard triangulation methods. Although the concept is simple, the operation isn't that simple in practice.

The first problem is determining how far away you are from the orbiting satellites. The distances are ascertained by measuring the length of time a radio signal takes to get from the satellite to your receiver. The distance from the satellite will be equal to the velocity of the signal multiplied by the time it takes the signal to arrive at the receiver. Since we know the velocity of the signal (the speed of light, or 300,000 km/sec) we need only to determine the travel time to find the distance to the receiver. Since each satellite broadcasts an accurate time signal, and each receiver contains a built-in clock, we can determine the signal's travel time.

That seems simple enough. But on closer examination, the problem becomes more complex. If a GPS satellite were directly overhead, its signal would take less than a tenth of a second to reach the receiver. It is essential that the receiver clock be extremely accurate. An error of even one millisecond would mean a position error of almost two hundred miles! Even worse, because the signals travel through the ionosphere and atmosphere, they don't travel at the speed of light. We have to find a way to compensate for the resulting delays.

Once you know how far you are from a satellite, you have to determine where the satellite itself is—that's not a trivial problem. Knowing how far you are from a single satellite, however, doesn't tell you much. If you know, for example, that you are some 22,000 kilometers from a satellite, all you know is that you are somewhere on the surface of a sphere with a radius of 22,000 kilometers, as shown in Fig. 2A. That's not exactly precision positioning!

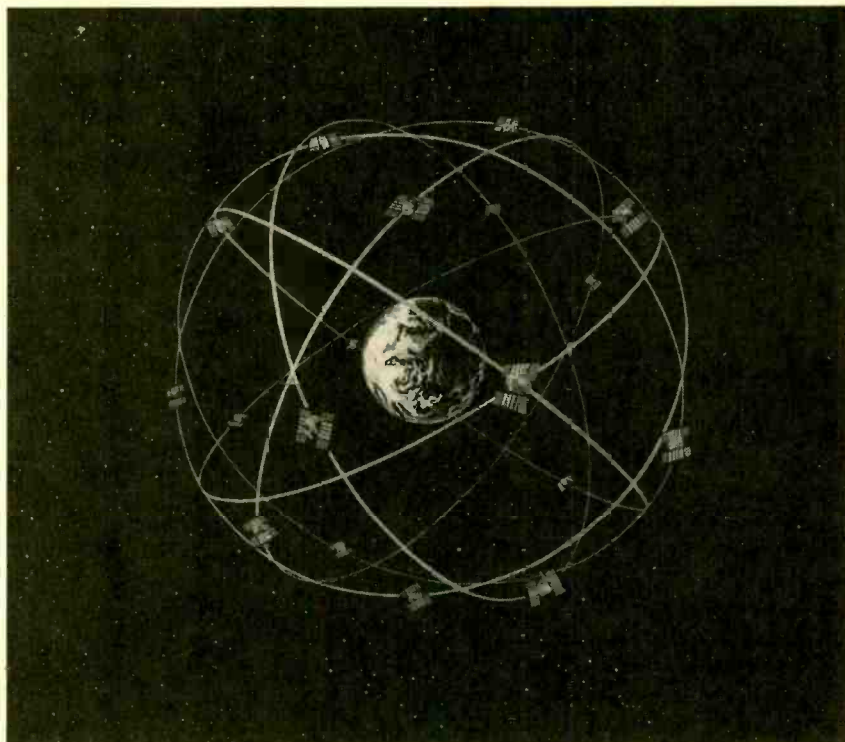

The GPS Space Segment is a constellation of 24 satellites—21 operational and 3 spares—orbiting Earth in six orbital planes.

TABLE 1—NAVIGATION SYSTEM COMPARISONS

System	Position Accuracy	Velocity Accuracy	Time Accuracy	Operating Range	Operation
GPS (P Code)	16m	0.1 m/s	100 ns	Worldwide 24 hours All weather	Longitude, Latitude
Transit	200 m	—	—	Worldwide	Longitude, Latitude
Loran	180 m	—	—	Regional (10% of world)	Longitude, Latitude
Omega	2,200 m	—	—	Nearly 90% worldwide	Longitude, Latitude
ILS/MLS	5-10 m	—	—	Line of sight At properly equipped airports	Altitude, Angle of approach
Inertial Systems	1500 m (after first hr)	0.8 m/s (after 2 hrs)	—	Worldwide 24 hours All weather	Longitude, Latitude, Altitude

If you know how far you are from two satellites, your situation improves somewhat. As you can see from Fig. 2B, you can determine that you're somewhere on the circle where the two spheres intersect. Add a third satellite, and your ability to determine your position improves even more. As shown in Fig. 2C, three measurements put you at one of two points where all three spheres intersect.

In many cases, that's all you need, because one of the answers turns out to be unreasonable and can be ig-

nored. To eliminate all uncertainty, you can take a measurement from a fourth satellite to tell you which of the two points is correct. (The fourth sphere could be Earth. If you know your altitude—if you're on the sea, for example—you could use the diameter of the planet as the fourth sphere.) We'll see shortly that using four satellites is not essential for determining your position, but using four satellites is essential for correcting timing errors.

Knowing the range from four satellites won't tell you anything unless you

know where those satellites are. Fortunately, the satellites orbit in a predictable way—just as the planets have been orbiting with reasonable predictably for millennia. That's not to say that we can predict the satellite orbits without errors. Things such as the pressure of solar radiation on the satellite or the gravitational pull of the sun and moon can lead to slight errors. That's the reason for the monitor stations in the Control Segment of GPS. Every time a satellite passes over a monitor station—and that happens twice each day—its altitude, speed, and position are measured by the Department of Defense. The data is then sent from the monitor station to the master

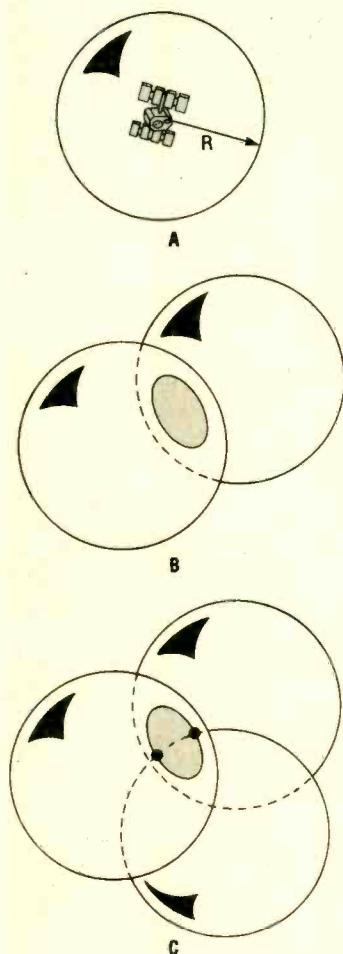

Fig. 2. Knowing how far we are from one satellite tells us only that we're somewhere on the sphere in A. Knowing the distances from two satellites puts us somewhere at the intersection of the two spheres as in B. Knowing distances from three satellites (C) can tell us that we are at one of two points. That's usually enough, because one of the points yields an absurd answer.

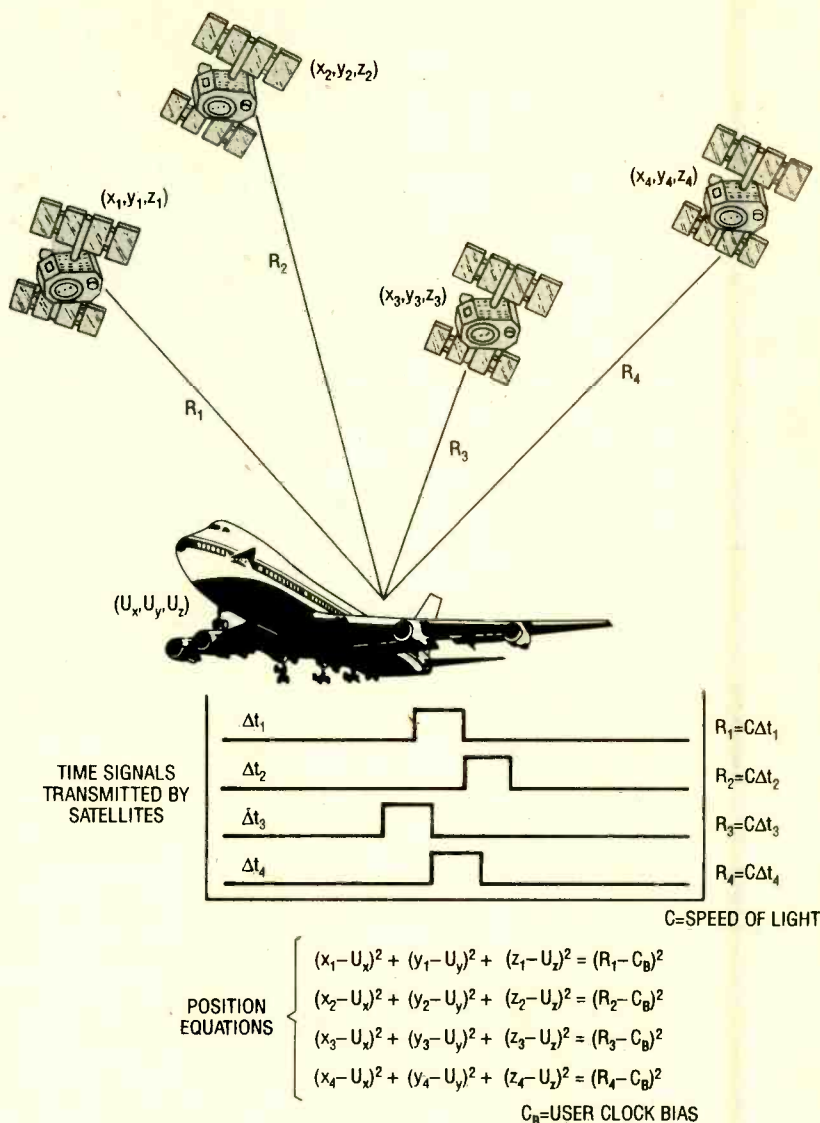

Fig. 3. Using four satellites lets us determine our position and eliminate any error caused by an inaccurate receiver clock. Note that taking measurements from four satellites results in a system of four equations in which there are four unknowns.

control station, which then transmits the data to the satellite. The satellite, in turn, broadcasts its ephemeris (or orbital) information—including the corrections—to the users, along with its timing information.

Even if a satellite is transmitting accurate information regarding its position, there are other potential sources for errors. The ionosphere—a layer of charged particles high above the Earth's surface—can have an affect on the speed of the signals. (Remember: The speed of light is constant only in a vacuum.) Multipath errors—caused when the signal travels to the receiver by bouncing off objects rather than in a straight line—are another potential problem.

Even without external problems, geometry can conspire to make measurements less accurate. If you obtain position data from closely spaced satellites, you will not be able to determine your position accurately. Such errors are referred to as GDOP or geometric dilution of precision. A better consumer GPS receiver will warn you that it is basing its measurements on satellites that are spaced too closely for optimum accuracy.

Timing errors are also a concern. As previously noted, even small timing errors can cause huge errors in distance. The GPS satellites use on-board atomic clocks, the most accurate clocks available. If receivers also had

(Continued on page 96)



# A Buyer's Guide To

BY MARC SPIWAK, EDITORIAL ASSOCIATE

**A**s we all know, whether you are an engineer, a technician, or tinkerer, an oscilloscope is one of the most important and versatile electronic tools you can own. Obviously, if you are an engineer or technician, an oscilloscope is absolutely essential, but for hobbyists and tinkerers, an oscilloscope may seem less crucial. While it is true that for some basic hobby activities you can get by without one, the information that an oscilloscope can provide during circuit design or troubleshooting makes having one very desirable.

Anyone considering buying an oscilloscope should think of it not as an expense, but as an investment. The investment can be in the form of education, as a lot can be learned about electronics with the aid of an oscilloscope. Or it can be an investment in one's career either at the present time or in the future. If you enjoy electronics as a hobby, then an oscilloscope is a great investment for many years to come, with payment in the form of hours saved at the bench.

But for hobbyist, and even small-business use, the usefulness of an oscilloscope must be balanced by its cost. Advanced, sophisticated oscilloscopes can cost several thousand dollars each. However, if your needs are more modest, basic analog oscilloscopes can be had for under \$500, and some surprisingly sophisticated units can be had at near the thousand-dollar mark.

But who makes those oscilloscopes? How do they perform? Which one is right for my needs? Those

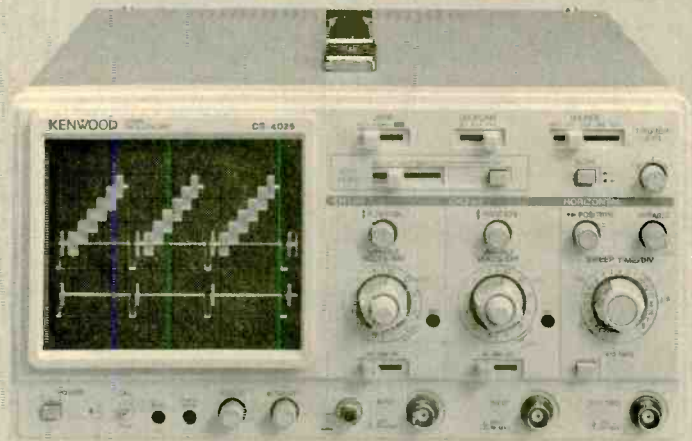

## Low-Cost

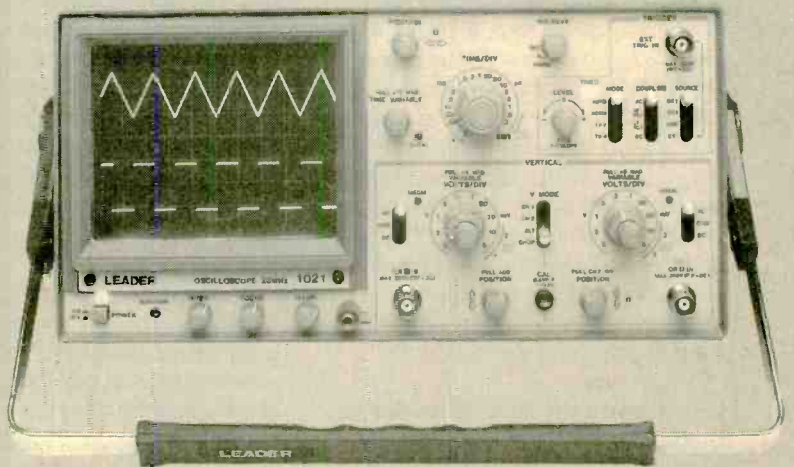

# OSCILLOSCOPES

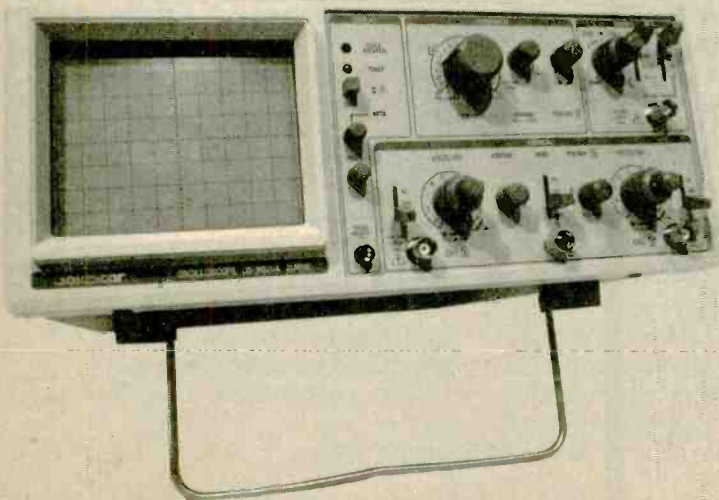

*Looking for a low-cost oscilloscope for hobbyist or other applications? Here's the perfect place to start.*

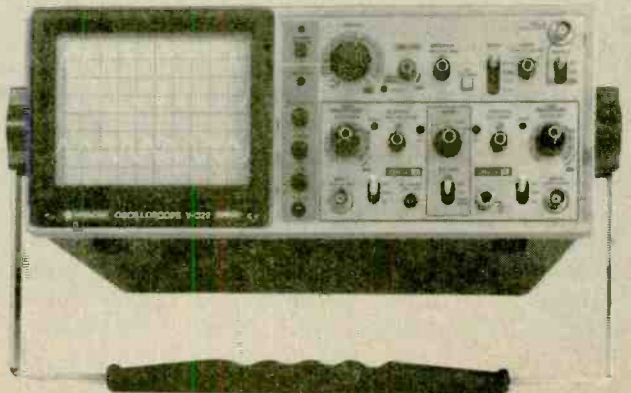



are just some of the questions that must be answered whether you're thinking of replacing an outdated oscilloscope or buying one for the first time.

All-in-all, finding the one that best suits your needs can be frustrating. After all, there are hundreds of models of oscilloscopes on the market. To make your job of finding the right oscilloscope as easy as possible, we've done some digging for you and gathered together the important specs to assemble this Buyer's Guide to Low-Cost Oscilloscopes.

This guide is a compendium of oscilloscopes currently available that carry suggested list prices of \$1200, or less. In addition to listing the manufacturer and price, we have provided some basic specifications for each model. Note, however, that many of the scopes mentioned have enough additional features to fill an entire review. Because of that, if you're interested in a particular oscilloscope model, or if there is a particular feature you absolutely require, you should contact the manufacturers directly—we've provided addresses and phone numbers for you in a Manufacturers and Distributors Directory that you can find elsewhere in this article. You can also get more information by circling the appropriate number on the Free Information Card.

### Oscilloscope Specifications.

Within our \$1200 budget are scopes listed as having single, dual, or triple inputs. That's the number of input signals that can simultaneously be displayed on the CRT. A single-input scope can be used to analyze only one waveform at a time, while a dual-input scope can simultaneously display, say, a clock signal and some other related signal so that you can view their timing relationship. Of course, a triple-input scope can simultaneously display three related signals.

The bandwidth, or frequency response of an oscilloscope is the range of frequencies that it can accurately display. Most modern oscilloscopes have a bandwidth of at least 20 MHz. That means that the scope can display a waveform at any frequency between DC and 20 MHz, with some limitations (more on that in a moment). If you were to input a signal

higher than 20 MHz, the scope wouldn't be able to "keep up," and the display on the CRT would not be complete.

A bandwidth of 20 MHz is adequate for many applications. However, there are also many applications where higher bandwidths are needed. Our \$1200 budget extends our selection to scopes as fast as 60 MHz. But that's actually quite fast—if you should need an even faster scope, you'll have to shell out more than \$1200. Keep in mind though, that other specifications—which we'll get to in a moment—begin to drop off when a scope is pushed to the limits of its bandwidth. So if, for example, you need to see a 50-MHz signal, you should be using an even faster scope. It's a good bet that if one 50-MHz scope costs a lot more than another 50-MHz scope, then the more expensive one probably meets its rated specs with much less difficulty.

Vertical sensitivity is another important oscilloscope specification; it's the lowest voltage per vertical division that the scope can display. Vertical magnification can often be applied to an input signal, increasing the vertical sensitivity, but at the expense of reduced bandwidth.

The vertical sensitivity of an oscilloscope can be compared to the magnifying power of a microscope; a powerful microscope can reveal very small physical details and a scope with good vertical sensitivity can reveal very small voltage deviations. Let's say one oscilloscope has a vertical sensitivity of 1 mV/div. A signal of 8 mV p-p would fill eight vertical divisions on the CRT with lots of detail. Let's say that another scope is listed as 5 mV/div. That same 8-mV signal would now fill less than two divisions, with much less detail. Keep in mind though, that seeing details down to single millivolts is usually not important. But then again it might be, depending on your needs.

All scopes examined have an input impedance of 1 megohm. That's a relatively high resistance that usually won't load down a circuit too much. However, sometimes even 1 megohm is too much of a load, and a 10:1 probe must be used on a scope. Also, many scopes meet their rated bandwidth only when using a 10:1 probe. The trade off when using a 10:1 probe

is that vertical sensitivity is reduced by a factor of 10.

The horizontal section of a scope determines how much time each horizontal division on the CRT can be made to represent (how much a signal can be stretched out horizontally). That's important in order to reveal extremely brief pulses, or even glitches. For example, if the horizontal section of a scope is set at 1  $\mu$ s/div., a displayed 1- $\mu$ s pulse would fill one horizontal division. The same pulse displayed at 5- $\mu$ s/div. would fill only 1/5th of the division. As more and more time-per-division is displayed, the same pulse begins to appear as just a spike.

We have only touched upon some of the basic features of oscilloscopes. When spending up to \$1200 on anything, you should always do some investigative work of your own to figure out what you should buy. We have simply provided you with the fundamentals in choosing an oscilloscope. It's now easy for you to focus in on a few models that might suit your needs and take it from there.

Within our \$1200 budget you'll find fast scopes, sensitive scopes, scopes with three inputs, and so on. In order for you to know which scope is best for you, you'll have to sit down and figure out exactly what your present *and future* needs may be. For the average hobbyist, a good 20-MHz scope is probably all you'll ever need. However, it would be silly to buy a 20-MHz scope now for \$500 only to find out later on that you must spend \$800 on a 50-MHz scope—buy the 50-MHz scope now if you think there's a good chance you'll need it. After all, with the increasing operating speeds of today's electronics, a fast scope is probably a wise choice.

And now, let's look at the oscilloscopes.

### Under \$500

**COMPANY:** Kenwood

**MODEL:** CO-1303D

**DESCRIPTION:** Single-input oscilloscope

**FREQUENCY RESPONSE:** DC–5 MHz

**VERTICAL SECTION:** 10 mV/div

**HORIZONTAL SECTION:** 10  $\mu$ s/div

**MAXIMUM INPUT VOLTAGE:** N.A.

**DIMENSIONS/WEIGHT:** 18.6 × 13.1 × 28 cm/10 lbs

**PRICE:** \$299.00



**COMPANY:** Tenma  
**MODEL:** 72-720  
**DESCRIPTION:** Dual-input oscilloscope  
**FREQUENCY RESPONSE:** DC-20 MHz

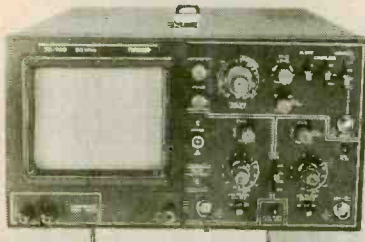

**VERTICAL SECTION:** 5 mV/div-20 V/div  
**HORIZONTAL SECTION:** 2  $\mu$ s/div-0.5 s/div  
**MAXIMUM INPUT VOLTAGE:** 300 V  
**DIMENSIONS/WEIGHT:** 12 x 6 $\frac{3}{8}$  x 13 $\frac{3}{4}$  inches/15.5 lbs  
**PRICE:** \$359.95

**COMPANY:** Goldstar  
**MODEL:** CS-9020A  
**DESCRIPTION:** Dual-input oscilloscope  
**FREQUENCY RESPONSE:** DC-20 MHz  
**VERTICAL SECTION:** 0.5 mV/div-5 V/div  
**HORIZONTAL SECTION:** 0.1  $\mu$ s/div-0.2 s/div  
**MAXIMUM INPUT VOLTAGE:** N.A.  
**DIMENSIONS/WEIGHT:** N.A.  
**PRICE:** \$399.00

**COMPANY:** Heath  
**MODEL:** SO-4552  
**DESCRIPTION:** Dual-input oscilloscope  
**FREQUENCY RESPONSE:** DC-25 MHz  
**VERTICAL SECTION:** 5 mV/div-5 V/div  
**HORIZONTAL SECTION:** 0.1  $\mu$ s/div-2 s/div  
**MAXIMUM INPUT VOLTAGE:** 400 V  
**DIMENSIONS/WEIGHT:** 5 $\frac{1}{4}$  x 12 $\frac{3}{4}$  x 17 $\frac{1}{4}$  inches/22 lbs  
**PRICE:** \$419.95

**\$500-\$750**

**COMPANY:** Hitachi  
**MODEL:** V-212  
**DESCRIPTION:** Dual-input oscilloscope  
**FREQUENCY RESPONSE:** DC-20 MHz  
**VERTICAL SECTION:** 5 mV/div-5 V/div  
**HORIZONTAL SECTION:** 0.2  $\mu$ s/div-0.2 s/div  
**MAXIMUM INPUT VOLTAGE:** 300 V  
**DIMENSIONS/WEIGHT:** 31 x 13 x 37

**Oscilloscope Manufacturers and Distributors**

A.W. Sperry  
P.O. Box 9300  
Smithtown, NY 11787  
800-645-5398  
NY, Hawaii, Alaska call collect  
516-231-7050  
**CIRCLE 138 ON FREE INFORMATION CARD**

B&K Precision  
6470 W. Cortland St.  
Chicago, IL 60635  
312-889-1448  
**CIRCLE 139 ON FREE INFORMATION CARD**

Component Specialties, Inc. (EMCO/SPECO)  
1172 Route 109, P.O. Box 624  
Lindenhurst, NY 11757  
800-645-5516  
516-957-8700  
**CIRCLE 140 ON FREE INFORMATION CARD**

Elenco Electronics, Inc.  
150 W. Carpenter Ave.  
Wheeling, IL 60090  
708-541-3800  
800-533-2441  
**CIRCLE 141 ON FREE INFORMATION CARD**

John Fluke Mfg. Co., Inc.  
PO Box 9090  
Everett, WA 98206  
206-347-6100  
800-443-5853  
**CIRCLE 142 ON FREE INFORMATION CARD**

Goldstar Precision Co., Ltd.  
13013 East 166th Street  
Cerritos, CA 90701-2226  
213-404-0101  
**CIRCLE 143 ON FREE INFORMATION CARD**

Hameg, Inc.  
20 Lumber Road  
Bldg. #2  
Roslyn, NY 11576  
516-484-7172  
**CIRCLE 144 ON FREE INFORMATION CARD**

Heath Company  
Benton Harbor, MI 49022  
800-253-0570  
**CIRCLE 145 ON FREE INFORMATION CARD**

Hitachi Denshi America, Ltd.  
150 Crossways Park Drive  
Woodbury, NY 11797  
516-921-7200  
**CIRCLE 146 ON FREE INFORMATION CARD**

Kenwood U.S.A. Corporation  
PO Box 22745  
2201 East Dominguez St.  
Long Beach, CA 90801-5745  
**CIRCLE 147 ON FREE INFORMATION CARD**

Leader Instruments Corporation  
380 Oser Avenue  
Hauppauge, NY 11788  
516-231-6900  
800-645-5104  
**CIRCLE 148 ON FREE INFORMATION CARD**

MCM/Tenma  
650 Congress Park Drive  
Centerville, OH 45459-4072  
513-434-0031  
**CIRCLE 149 ON FREE INFORMATION CARD**

Tektronix  
P.O. Box 1520  
Pittsfield, MA 01202  
800-426-2200  
**CIRCLE 150 ON FREE INFORMATION CARD**

cm/18.7 lbs  
**PRICE:** \$525.00

**COMPANY:** Kenwood  
**MODEL:** CS-4025  
**DESCRIPTION:** Dual-input oscilloscope  
**FREQUENCY RESPONSE:** DC-20 MHz  
**VERTICAL SECTION:** 1 mV/div-5 V/div  
**HORIZONTAL SECTION:** 0.5  $\mu$ s/div-0.5 s/div  
**MAXIMUM INPUT VOLTAGE:** 250 V  
**DIMENSIONS/WEIGHT:** 29 x 15 x 38 cm/22 lbs  
**PRICE:** \$539.00

**COMPANY:** Component Specialties, Inc.  
**MODEL:** OSC-10ST  
**DESCRIPTION:** Single-input oscilloscope  
**FREQUENCY RESPONSE:** DC-10 MHz  
**VERTICAL SECTION:** 0.01 V/div-10 V/div  
**HORIZONTAL SECTION:** 1  $\mu$ s/div-0.1 s/div



**MAXIMUM INPUT VOLTAGE:** 600 V p-p  
**DIMENSIONS/WEIGHT:** 6 $\frac{5}{8}$  x 11 $\frac{3}{4}$  x 16 inches/14 lbs  
**PRICE:** \$539.45

**COMPANY:** Leader  
**MODEL:** 1021  
**DESCRIPTION:** Dual-input oscilloscope  
**FREQUENCY RESPONSE:** DC-20 MHz  
**VERTICAL SECTION:** 5 mV/div-5 V/div  
**HORIZONTAL SECTION:** 0.2  $\mu$ s/div-0.2 s/div



**MAXIMUM INPUT VOLTAGE:** 300 V  
**DIMENSIONS/WEIGHT:** 11<sup>3</sup>/<sub>8</sub> × 5<sup>3</sup>/<sub>4</sub> × 14<sup>3</sup>/<sub>4</sub> inches/17.6 lbs  
**PRICE:** \$595.00

**COMPANY:** Hameg  
**MODEL:** HM 203-7  
**DESCRIPTION:** Dual-input oscilloscope  
**FREQUENCY RESPONSE:** DC–20 MHz  
**VERTICAL SECTION:** 5 mV/div–5 V/div  
**HORIZONTAL SECTION:** 0.2 μs/div–0.1 s/div

**MAXIMUM INPUT VOLTAGE:** 400 V  
**DIMENSIONS/WEIGHT:** 28.5 × 14.5 × 38 cm/7.5 kg  
**PRICE:** \$598.00

**COMPANY:** Elenco  
**MODEL:** S-1325  
**DESCRIPTION:** Dual-input oscilloscope  
**FREQUENCY RESPONSE:** DC–25 MHz



**VERTICAL SECTION:** 1 mV/div–5 V/div  
**HORIZONTAL SECTION:** 10 ns/div–0.5 s/div  
**MAXIMUM INPUT VOLTAGE:** N.A.  
**DIMENSIONS/WEIGHT:** N.A.  
**PRICE:** \$599.00

**COMPANY:** Heath  
**MODEL:** SO-4554  
**DESCRIPTION:** Dual-input oscilloscope  
**FREQUENCY RESPONSE:** DC–40 MHz  
**VERTICAL SECTION:** 5 mV/div–5 V/div  
**HORIZONTAL SECTION:** 0.1 μs/div–2 s/div  
**MAXIMUM INPUT VOLTAGE:** 400 V  
**DIMENSIONS/WEIGHT:** 5<sup>1</sup>/<sub>4</sub> × 12<sup>3</sup>/<sub>4</sub> × 17<sup>1</sup>/<sub>4</sub> inches/22 lbs  
**PRICE:** \$599.95

**COMPANY:** Tenma  
**MODEL:** 72-740  
**DESCRIPTION:** Dual-input oscilloscope  
**FREQUENCY RESPONSE:** DC–40 MHz  
**VERTICAL SECTION:** 5 mV/div–20 V/div  
**HORIZONTAL SECTION:** 2 μs/div–0.5 s/div  
**MAXIMUM INPUT VOLTAGE:** 300 V

**DIMENSIONS/WEIGHT:** 13<sup>3</sup>/<sub>8</sub> × 5<sup>7</sup>/<sub>16</sub> × 14<sup>1</sup>/<sub>16</sub> inches/20 lbs  
**PRICE:** \$599.95

**COMPANY:** Component Specialties, Inc.  
**MODEL:** OSC-20DT  
**DESCRIPTION:** Dual-input oscilloscope  
**FREQUENCY RESPONSE:** DC–20 MHz

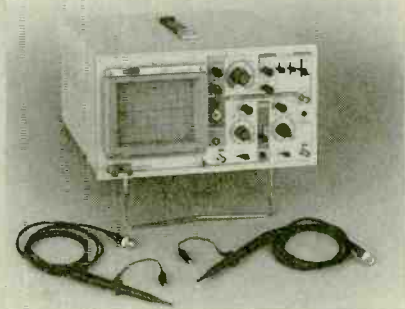

**VERTICAL SECTION:** 5 mV/div–20 V/div  
**HORIZONTAL SECTION:** 0.2 μs/div–0.5 s/div  
**MAXIMUM INPUT VOLTAGE:** 600 V p-p  
**DIMENSIONS/WEIGHT:** 6<sup>1</sup>/<sub>2</sub> × 11<sup>1</sup>/<sub>2</sub> × 14 inches/17<sup>1</sup>/<sub>2</sub> lbs  
**PRICE:** \$645.95

**COMPANY:** B&K Precision  
**MODEL:** 2125  
**DESCRIPTION:** Dual-trace oscilloscope  
**FREQUENCY RESPONSE:** DC–20 MHz

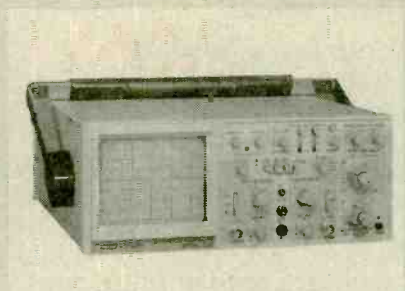

**VERTICAL SECTION:** 5 mV/div–5 V/div  
**HORIZONTAL SECTION:** 0.1 μs/div–50 ms/div  
**MAXIMUM INPUT VOLTAGE:** N.A.  
**DIMENSIONS/WEIGHT:** N.A./N.A.  
**PRICE:** \$646.00

**COMPANY:** A.W. Sperry  
**MODEL:** 620C  
**DESCRIPTION:** Dual-trace oscilloscope  
**FREQUENCY RESPONSE:** DC–20 MHz  
**VERTICAL SECTION:** 5 mV/div–20V/div

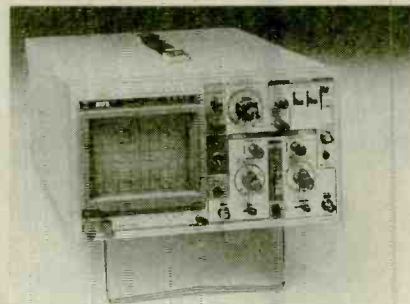

**HORIZONTAL SECTION:** 0.2 μs/div–0.5 s/div  
**MAXIMUM INPUT VOLTAGE:** 600 V p-p  
**DIMENSIONS/WEIGHT:** 6.4 × 11.6 × 13.9 inches/15.4 lbs  
**PRICE:** \$675.00

**COMPANY:** Goldstar  
**MODEL:** OS-9040D  
**DESCRIPTION:** Dual-input oscilloscope  
**FREQUENCY RESPONSE:** DC–40 MHz

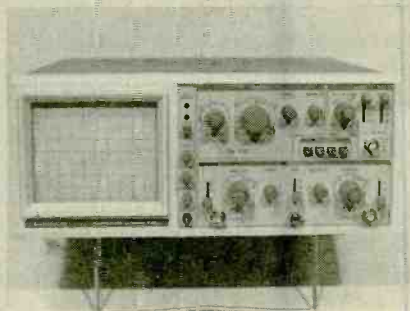

**VERTICAL SECTION:** 0.5 mV/div–5 V/div  
**HORIZONTAL SECTION:** 0.1 μs/div–0.2 s/div  
**MAXIMUM INPUT VOLTAGE:** N.A.  
**DIMENSIONS/WEIGHT:** N.A.  
**PRICE:** \$679.00

**COMPANY:** Tektronix  
**MODEL:** 2205  
**DESCRIPTION:** Dual-input oscilloscope  
**FREQUENCY RESPONSE:** DC–20 MHz  
**VERTICAL SECTION:** 5 mV/div–5 V/div  
**HORIZONTAL SECTION:** 0.1 μs/div–0.5 s/div  
**MAXIMUM INPUT VOLTAGE:** N.A.  
**DIMENSIONS/WEIGHT:** N.A./14.8 lbs  
**PRICE:** \$695.00

**COMPANY:** Hitachi  
**MODEL:** V-222  
**DESCRIPTION:** Dual-input oscilloscope with DC offset  
**FREQUENCY RESPONSE:** DC–20 MHz



**VERTICAL SECTION:** 5 mV/div-5 V/div  
**HORIZONTAL SECTION:** 0.2  $\mu$ s/div-0.2 s/div  
**MAXIMUM INPUT VOLTAGE:** 300 V  
**DIMENSIONS/WEIGHT:** 31 x 13 x 37 cm/18.7 lbs  
**PRICE:** \$715.00

**\$750-\$1000**

**COMPANY:** Kenwood  
**MODEL:** CS-4035  
**DESCRIPTION:** Dual-input oscilloscope  
**FREQUENCY RESPONSE:** DC-40 MHz  
**VERTICAL SECTION:** 1 mV/div-5 V/div

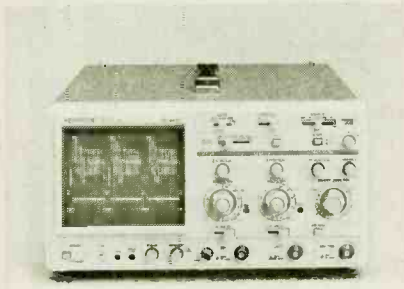

**HORIZONTAL SECTION:** 0.2  $\mu$ s/div-0.5 s/div  
**MAXIMUM INPUT VOLTAGE:** 250 V  
**DIMENSIONS/WEIGHT:** 29 x 15 x 38 cm/22 lbs  
**PRICE:** \$759.00

**COMPANY:** Elenco  
**MODEL:** S-1340  
**DESCRIPTION:** Dual-input oscilloscope  
**FREQUENCY RESPONSE:** DC-40 MHz  
**VERTICAL SECTION:** 1 mV/div-5 V/div  
**HORIZONTAL SECTION:** 10 ns/div-0.5 s/div

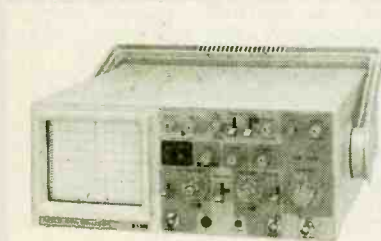

**MAXIMUM INPUT VOLTAGE:** N.A.  
**DIMENSIONS/WEIGHT:** N.A.  
**PRICE:** \$795.00

**COMPANY:** Tenma  
**MODEL:** 72-760  
**DESCRIPTION:** Dual-input oscilloscope  
**FREQUENCY RESPONSE:** DC-60 MHz

**VERTICAL SECTION:** 5 mV/div-20 V/div  
**HORIZONTAL SECTION:** 0.05  $\mu$ s/div-0.5 s/div  
**MAXIMUM INPUT VOLTAGE:** 300 V  
**DIMENSIONS/WEIGHT:** 14 x 5 $\frac{3}{4}$  x 15 inches/20 lbs  
**PRICE:** \$799.95

**COMPANY:** A.W. Sperry  
**MODEL:** 315P  
**DESCRIPTION:** Dual-trace portable oscilloscope  
**FREQUENCY RESPONSE:** DC-15 MHz  
**VERTICAL SECTION:** 2 mV/div-10 V/div  
**HORIZONTAL SECTION:** 0.5  $\mu$ s/div-0.5 s/div  
**MAXIMUM INPUT VOLTAGE:** 600 V p-p  
**DIMENSIONS/WEIGHT:** 4.4 x 8.8 x 11.7 inches/12.1 lbs (w/battery)  
**PRICE:** \$800.00

**COMPANY:** Goldstar  
**MODEL:** OS-904RD  
**DESCRIPTION:** Dual-input oscilloscope with cursors and readout  
**FREQUENCY RESPONSE:** DC-40 MHz



**VERTICAL SECTION:** 0.5 mV/div-5 V/div  
**HORIZONTAL SECTION:** 0.1  $\mu$ s/div-0.2 s/div  
**MAXIMUM INPUT VOLTAGE:** N.A.  
**DIMENSIONS/WEIGHT:** N.A.  
**PRICE:** \$839.00

**COMPANY:** B&K Precision  
**MODEL:** 1541B  
**DESCRIPTION:** Dual-trace oscilloscope  
**FREQUENCY RESPONSE:** DC-40 MHz  
**VERTICAL SECTION:** 5 mV/div-5 V/div  
**HORIZONTAL SECTION:** 0.2  $\mu$ s/div-0.5 s/div  
**MAXIMUM INPUT VOLTAGE:** N.A.  
**DIMENSIONS/WEIGHT:** N.A.  
**PRICE:** \$845.00

**COMPANY:** Kenwood  
**MODEL:** CS-5135  
**DESCRIPTION:** Dual-input os-

cilloscope with delayed sweep  
**FREQUENCY RESPONSE:** DC-40 MHz  
**VERTICAL SECTION:** 1 mV/div-5 V/div  
**HORIZONTAL SECTION:** 0.2  $\mu$ s/div-0.5 s/div  
**MAXIMUM INPUT VOLTAGE:** 250 V  
**DIMENSIONS/WEIGHT:** 29 x 15 x 38 cm/25 lbs  
**PRICE:** \$899.00

**COMPANY:** Hitachi  
**MODEL:** V-422  
**DESCRIPTION:** Dual-input oscilloscope  
**FREQUENCY RESPONSE:** DC-40 MHz  
**VERTICAL SECTION:** 5 mV/div-5 V/div  
**HORIZONTAL SECTION:** 0.2  $\mu$ s/div-0.2 s/div  
**MAXIMUM INPUT VOLTAGE:** 300 V  
**DIMENSIONS/WEIGHT:** 31 x 13 x 37 cm/18.7 lbs  
**PRICE:** \$910.00

**COMPANY:** Leader  
**MODEL:** 1041  
**DESCRIPTION:** Dual-input oscilloscope  
**FREQUENCY RESPONSE:** DC-40 MHz  
**VERTICAL SECTION:** 5 mV/div-5 V/div  
**HORIZONTAL SECTION:** 0.2  $\mu$ s/div-0.2 s/div  
**MAXIMUM INPUT VOLTAGE:** 300 V  
**DIMENSIONS/WEIGHT:** 11 $\frac{3}{8}$  x 5 $\frac{3}{4}$  x 14 $\frac{3}{4}$  inches/19 $\frac{3}{4}$  lbs  
**PRICE:** \$955.00

**COMPANY:** Hitachi  
**MODEL:** V-522  
**DESCRIPTION:** Dual-input oscilloscope  
**FREQUENCY RESPONSE:** DC-50 MHz

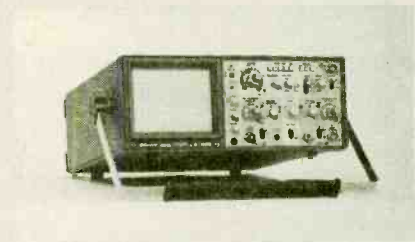

**VERTICAL SECTION:** 5 mV/div-5 V/div  
**HORIZONTAL SECTION:** 0.2  $\mu$ s/div-0.2 s/div  
**MAXIMUM INPUT VOLTAGE:** 300 V  
**DIMENSIONS/WEIGHT:** 31 x 13 x 37 cm/18.7 lbs  
**PRICE:** \$995.00

**\$1000-\$1200**  
**COMPANY:** Kenwood  
**MODEL:** CS-5155  
**DESCRIPTION:** Triple-input oscilloscope with delayed sweep

**FREQUENCY RESPONSE:** DC-50 MHz  
**VERTICAL SECTION:** 1 mV/div-5 V/div  
**HORIZONTAL SECTION:** 0.05  $\mu$ s/div-0.5 s/div  
**MAXIMUM INPUT VOLTAGE:** 250 V  
**DIMENSIONS/WEIGHT:** 31.9 x 13.2 x 38 cm/25 lbs  
**PRICE:** \$1049.00

**COMPANY:** Hameg  
**MODEL:** HM 604  
**DESCRIPTION:** Dual-input oscilloscope  
**FREQUENCY RESPONSE:** DC-60 MHz  
**VERTICAL SECTION:** 5 mV/div-20 V/div  
**HORIZONTAL SECTION:** 50 ns/div-1 s/div  
**MAXIMUM INPUT VOLTAGE:** 400 V  
**DIMENSIONS/WEIGHT:** 28.5 x 14.5 x 38 cm/8 kg  
**PRICE:** \$1076.00  
**COMPANY:** Hitachi  
**MODEL:** V-523  
**DESCRIPTION:** Dual-input oscilloscope with delayed sweep



**FREQUENCY RESPONSE:** DC-50 MHz  
**VERTICAL SECTION:** 5 mV/div-5 V/div  
**HORIZONTAL SECTION:** 0.2  $\mu$ s/div-0.2 s/div  
**MAXIMUM INPUT VOLTAGE:** 300 V  
**DIMENSIONS/WEIGHT:** 31 x 13 x 37 cm/18.7 lbs  
**PRICE:** \$1095.00

**COMPANY:** B&K Precision  
**MODEL:** 2160  
**DESCRIPTION:** Dual-trace oscilloscope  
**FREQUENCY RESPONSE:** DC-60 MHz  
**VERTICAL SECTION:** N.A.  
**HORIZONTAL SECTION:** N.A.  
**MAXIMUM INPUT VOLTAGE:** N.A.  
**DIMENSIONS/WEIGHT:** N.A.  
**PRICE:** \$1099.00

**COMPANY:** Kenwood  
**MODEL:** CS-5130  
**DESCRIPTION:** Dual-input oscilloscope with readout and cursors  
**FREQUENCY RESPONSE:** DC-40 MHz  
**VERTICAL SECTION:** 1 mV/div-5 V/div

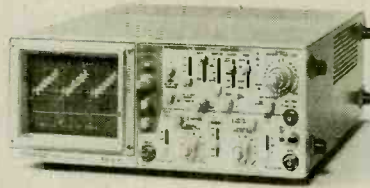

**HORIZONTAL SECTION:** 0.2  $\mu$ s/div-0.5 s/div  
**MAXIMUM INPUT VOLTAGE:** 250 V  
**DIMENSIONS/WEIGHT:** 31.9 x 13.2 x 38 cm/25 lbs  
**PRICE:** \$1099.00

**COMPANY:** Hitachi  
**MODEL:** V-525  
**DESCRIPTION:** Dual-input oscilloscope with cursors  
**FREQUENCY RESPONSE:** DC-50 MHz  
**VERTICAL SECTION:** 5 mV/div-5 V/div  
**HORIZONTAL SECTION:** 0.2  $\mu$ s/div-0.2 s/div  
**MAXIMUM INPUT VOLTAGE:** 300 V  
**DIMENSIONS/WEIGHT:** 31 x 13 x 37 cm/18.7 lbs  
**PRICE:** \$1145.00

**COMPANY:** Kenwood  
**MODEL:** CS-5165  
**DESCRIPTION:** Triple-input oscilloscope with delayed sweep  
**FREQUENCY RESPONSE:** DC-60 MHz  
**VERTICAL SECTION:** 1 mV/div-5 V/div  
**HORIZONTAL SECTION:** 0.05  $\mu$ s/div-0.5 s/div  
**MAXIMUM INPUT VOLTAGE:** 250 V  
**DIMENSIONS/WEIGHT:** 31.9 x 13.2 x 38 cm/25 lbs  
**PRICE:** \$1149.00

**COMPANY:** B&K Precision  
**MODEL:** 1422  
**DESCRIPTION:** Dual-trace portable oscilloscope

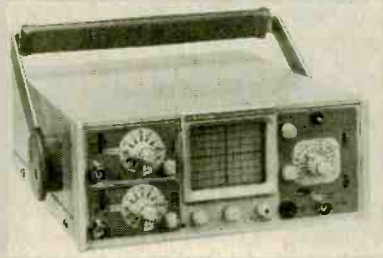

**FREQUENCY RESPONSE:** DC-20 MHz  
**VERTICAL SECTION:** 10 mV/div-20 V/div  
**HORIZONTAL SECTION:** 1  $\mu$ s/div-0.5 s/div  
**MAXIMUM INPUT VOLTAGE:** N.A.

**DIMENSIONS/WEIGHT:** 4.5 x 8.5 x 12 inches/N.A.  
**PRICE:** \$1195.00

**COMPANY:** Fluke  
**MODEL:** 93  
**DESCRIPTION:** Dual-input hand-held ScopeMeter  
**FREQUENCY RESPONSE:** DC-50 MHz



**VERTICAL SECTION:** 5 mV/div-100 V/div  
**HORIZONTAL SECTION:** 10 ns/div-5 s/div  
**MAXIMUM INPUT VOLTAGE:** 600 V  
**DIMENSIONS/WEIGHT:** 2.4 x 5.5 x 10.2 inches/3.3 lbs  
**PRICE:** \$1195.00

**COMPANY:** Hitachi  
**MODEL:** V-209  
**DESCRIPTION:** Portable dual-input oscilloscope  
**FREQUENCY RESPONSE:** DC-20 MHz  
**VERTICAL SECTION:** 5 mV/div-5 V/div  
**HORIZONTAL SECTION:** 0.5  $\mu$ s/div-0.2 s/div  
**MAXIMUM INPUT VOLTAGE:** 250 V  
**DIMENSIONS/WEIGHT:** 8.5 x 4.3 x 13.8 inches/11.7 lbs  
**PRICE:** \$1195.00

**COMPANY:** Tektronix  
**MODEL:** 2225  
**DESCRIPTION:** Dual-trace oscilloscope  
**FREQUENCY RESPONSE:** DC-50 MHz  
**VERTICAL SECTION:** 0.5 mV/div-5 V/div  
**HORIZONTAL SECTION:** 0.05  $\mu$ s/div-0.5 s/div  
**MAXIMUM INPUT VOLTAGE:** N.A.  
**DIMENSIONS/WEIGHT:** N.A.  
**PRICE:** \$1195.00



**W**e are surrounded by energy that we cannot detect using our senses. For instance, the electromagnetic signals that come alive through the magic of radio have been passing through you and your home completely unnoticed. You are not aware of the electromagnetic radiation because the human body lacks the capacity to detect those signals; you can't see, hear, feel, or taste electromagnetic radiation (unless it is in the visible-light portion of the spectrum). The same is true of many other forms of radioactivity.

Most people are concerned with radioactivity and ionizing radiation due to its relationship to atomic weapons and nuclear power plants. When a nuclear power plant has an accident—such as the ones that occurred at Three Mile Island and Chernobyl—the media and a few anti-nuclear groups go into a *feeding frenzy*. That pushes public fears to the point where nuclear power plants are forced to shut down before they have started producing power. That fear helped prevent the opening of LILCO's Shoreham nuclear power station on Long Island, New York.

That fear, while well founded, overlooks the medical, scientific, and economic benefits that nuclear technology has offered humanity. No one is advocating that anyone treat atomic radiation or nuclear materials lightly—you should not—but it is not a technological monster either, considering that life on this planet has evolved in a naturally-occurring, radiation-rich environment. Yes, radiation permeates our very being. For example, radioactive material can be found in food we eat (potassium-40 and carbon-14) and in the soil (uranium-238 and thorium-232).

**Radioactivity.** What is radioactivity? Radioactivity (a term coined by Pierre and Marie Curie) is defined as the spontaneous emission of energy and/or particles from the atomic nucleus of certain elements. The energy emit-

# Build a



# Geiger Counter

*This project can be used to detect and identify radiation sources in and around your home*

BY JOHN IOVINE

ted can take the form of electromagnetic energy (called gamma rays), while the particles are typically alpha and beta particles.

Alpha particles are helium-4 nuclei, consisting of two protons and two neutrons. When an atomic nucleus emits an alpha particle, it changes into another nuclide with an atomic number of two units less and a mass number of four units less.

Beta particles, which can be either electrons or positrons (positive electrons), are more penetrating than alpha particles. But they can be stopped by thin sheets of metal (such as aluminum) or a few feet of air.

Gamma rays are typically deep-

penetrating emissions; *i.e.*, they can go through several inches of metal. Gamma rays are photons of energy (quanta) emitted from excited atoms. When an atom (such as Uranium 238) emits an alpha particle, it becomes Thorium-234. The Thorium atom at this point has excess energy. It is said to be in an excited state. But by emitting a gamma ray, it drops to its ground (unexcited) state.

**Measuring Radiation.** Radiation is measured in curies, a quantity described as the amount of radiation given off by one gram of radium; a quantity that's equal to 37,000,000,000 ( $3.7 \times 10^{10}$ ) atomic breakdowns per second. Because the curie is a rather large number, many radioactive sources are measured in millicuries or microcuries.

In order to detect radioactivity, you need an instrument specifically designed to detect such energy. There are a number of ways to measure radioactivity; scintillation, PN junctions, autoradiography, and gas-ionization. The Geiger-Muller (GM) tube, which works on the gas-ionization principal, can detect alpha, beta, and gamma radiation. If you are concerned about possible exposure to radiation, then perhaps the *Geiger Counter* described in this article can help to put your mind at rest.

Our Geiger Counter, which is based on the gas-ionization method of detection, will give visual and audible indications of local radioactivity. It can be used to detect nuclear radiation or contamination in and around your home, to prospect for uranium, and measure background radiation. In fact, it can even be used to detect large solar flares.

Figure 1A shows the basic operating principal of the GM tube. The tube consists of a cylindrical electrode (cathode) surrounding a center electrode (anode). The tube is evacuated and filled with a neon- and halogen-gas mixture. A voltage of 500 volts is applied across the tube through a 10-







TIP120 NPN transistor), where it is amplified and clamped to 9 volts. The output of Q2 is inverted by gate U1-d, and then used to trigger U3 (the second 555, which is configured for monostable operation). The output of U3 at pin 3 causes LED1 to flash, and produces a click that can be heard through speaker SPKR1 or headphones.

The circuit is powered by a 9-volt alkaline battery and draws about 28 mA when not detecting radiation.

**Construction.** There is nothing critical about the circuit. In fact, if you are more comfortable with point-to-point wiring, there is no compelling argument against you going that route. The author's prototype of the Geiger Counter, however, was assembled on a printed-circuit board. A full-size template of the foil pattern is shown clearly in Fig. 3.

Once you've etched your printed-circuit board and gathered the parts, construction can begin. It is recommended that all of the IC's be socketed. Start by first installing IC sockets where indicated in Fig. 4. Then install the jumper connections, followed by the on-board components. After that, solder lengths of wire to the board for connection to the off-board components. When that is done, check your work for errors. Once you are satisfied that the circuit contains no errors, place the board to one side and prepare the project's enclosure.

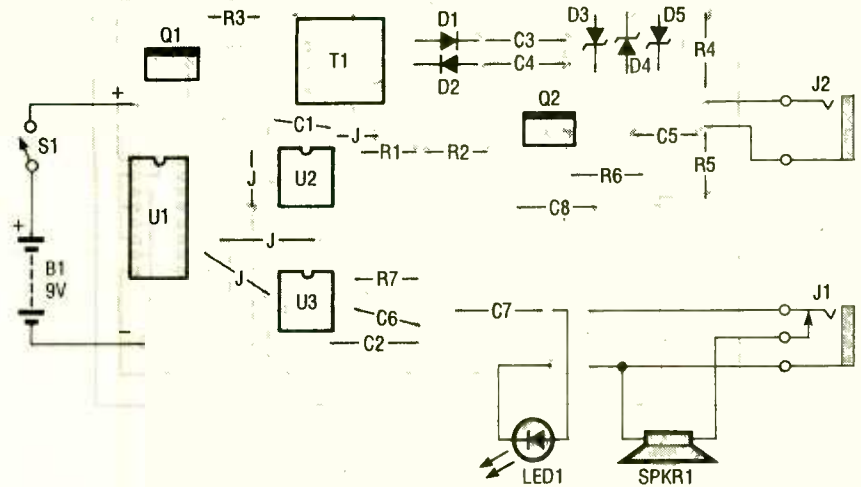

Fig. 4. Begin assembling the project by first installing the IC sockets where indicated, followed by the jumper connections, and then the on-board components. After that, connect lengths of wire to the board for connection to the off-board components.

Any plastic enclosure large enough to hold the circuit board and other components can be used to house the project. Prepare the enclosure by drilling holes for J1 and J2, LED1, and S1. Jack J1 is an enclosed, closed-circuit type selected to mate with a headphone plug. Jack J2 is a 1/8-inch open-frame, closed-circuit type. The center contact of J2 should be connected to R4 and the outer contact connects to R5. It will also be necessary to make an opening in the enclosure for the speaker, SPKR1. Mount all of the off-board components to the enclosure, and connect the circuit-board wires to the appropriate

components. Once that's done, place that assembly to one side and prepare a housing for the Geiger-Muller tube.

Although the circuit is designed around the LN-712 Geiger-Muller tube, it is possible to use other Geiger tubes by altering the power-supply output accordingly. The power supply used in our circuit can be used to power any tube requiring up to 700 volts by eliminating or substituting a Zener diode of the proper rating. For instance, if you have a tube that requires a 300-volt source, simply remove one of the 200-volt Zener diodes and replace it with a jumper wire. Or if the tube requires a 600-volt source, remove the 100-volt Zener diode and replace it with another 200-volt unit. In addition, using another tube may require that the value of the current-limiting resistor (R4 in the schematic diagram) be scaled accordingly.

The GM tube is delicate and should be handled carefully. The GM tube has a thin mica window on the front end that allows alpha and beta particles to penetrate and be detected. That window is easy to break, rendering the tube useless. The author housed the GM tube in a plastic coin tube. The coin tube was prepared by drilling several tiny holes in the lid. Those holes allow alpha and beta particles to get to the mica window unimpeded.

In the bottom of the coin tube, the  
(Continued on page 88)

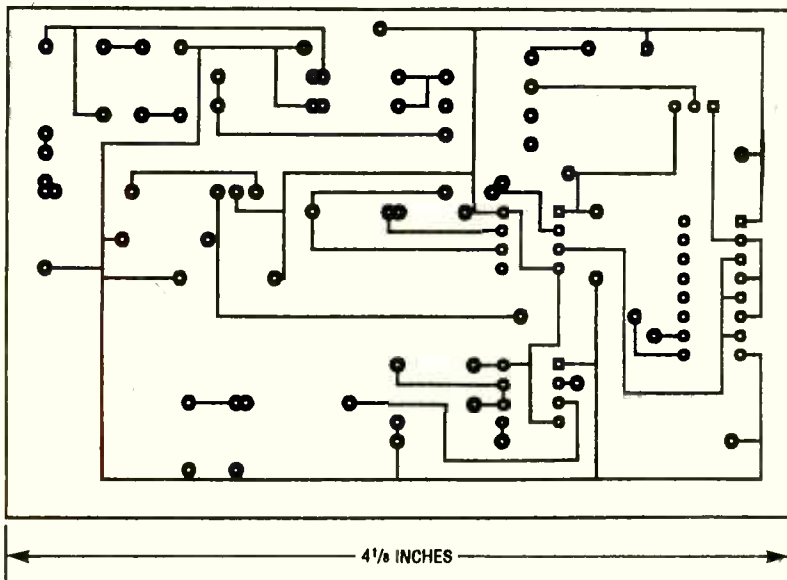

Fig. 3. The author's prototype was assembled on a printed-circuit board. A full-size template of the foil pattern is shown here.



In 1989, electronic retailers sold over one million cordless telephones, thousands of which were manufactured using the same RF frequency. That allowed anyone within a given radius of your base unit, operating on the same frequency (unknownst to them or yourself), to dial out on your line with the obvious consequence: you foot the bill. Now that's not so bad if the person only makes local calls; but what if that person calls Siberia or the Sudan? You guessed it! It's your problem.

The newer cordless telephones eliminated that problem by incorporating circuits that require the handset (through an ID code) to identify itself to the base unit before access to the telephone line is allowed.



*Give your old cordless telephone a security feature that is becoming standard in many of the modern cordless units*

that's used as a chip-enabling device.

A 2764 EPROM, U5, is also included in the circuit. The EPROM contains the program that instructs U1 to act as a telephone-line lock. The program listing as well as a programmed EPROM is available from the vendor given in the Parts List. The read (RD at pin 17) and the PSEN (pin 29) of U1 are ANDed together via U6-a ( $\frac{1}{4}$  74LS08 quad two-input AND gate), and used to enable the output of U5. Without the enabling signal, no data could be read into memory.

All cordless telephones can use a series of pulses (or a pulse train) to dial out. For that reason, an M959 dial-pulse counter (U7) is used as an interface between U1 and the telephone line. That unit counts the negative-going transitions produced when the phone is dialed, and outputs the results in

## Build a Cordless-Telephone Lock

The idea behind that is that, a handset (although operating on the same frequency) that sends the wrong ID would be denied access, thereby, preventing someone down the block from making calls on your telephone line.

Obviously that doesn't help you if you have an older unit. If you are still using one of the older cordless telephones and have been billed for calls that you or someone in your household never made, or you would simply like to have the peace of mind provided by a lock-out feature, perhaps the *Cordless Telephone Lock* described in this article is for you.

The Cordless Telephone Lock is a digital telephone-line locking circuit that requires the user to key in a 5-digit personal access code before gaining access to the telephone line. That prevents the frustrating, and illegal use of your private phone line by unauthorized persons.

**How it Works.** Figure 1 shows a complete schematic diagram of the

BY STEVE SOKOLOWSKI

Cordless Telephone Lock. The circuit is comprised of nine integrated circuits. The heart of the circuit—the brain, so to speak—is U1 (an 8052AH BASIC microcontroller). Residing within U1's internal memory (occupying 8K of internal ROM) is a BASIC interpreter that translates BASIC commands into assembly language. That particular microcontroller was chosen solely for its ease of programming. The command and statement package supported by the interpreter allows a simple statement like 10 PWM 100,100,25 to produce audio tones at pin 3 of U1. With statements such as 20 PORT1=254 or 20 IF X=2 THEN PORT1=230, one can easily control up to eight individual peripherals.

In addition to the microcontroller, the circuit also contains a 6264-15 SRAM (U3); a 74LS373 octal latch (U2), which is used to separate data and address information (both of which are output on pins 32–39 of U1); and a 3-to-8-line decoder/multiplexer (U4)

binary form at pins 8–11. The binary output of U7 is sent to the address/data bus of U1 (pins 36–39). The data output by U7 is either stored in memory as the secret access (unlocking) code or, once the circuit has been programmed, used to gain access to the telephone line. Counter U7 also provides a logic-level output at pin 13 that is used to tell U1 whether the telephone handset is on or off hook. When the phone is off hook, pin 13 goes high; when it's on hook, pin 13 is low. Since port 1 (pins 1–8) of U1 is programmed to interpret a logic 0 as an off-hook condition, the output of U7 at pin 13 is inverted by U8-b ( $\frac{1}{2}$  of a 4069 hex inverter).

It is also necessary at times to keep the binary output of U7 from accessing the data bus; otherwise data conflicts between chips will occur. To ensure the orderly transfer of data, a 74LS138 3-to-8 decoder/demultiplexer (U4) is pressed into service. The decoder/demultiplexer under program control, is used to enable any chip within the address range of 2000H to



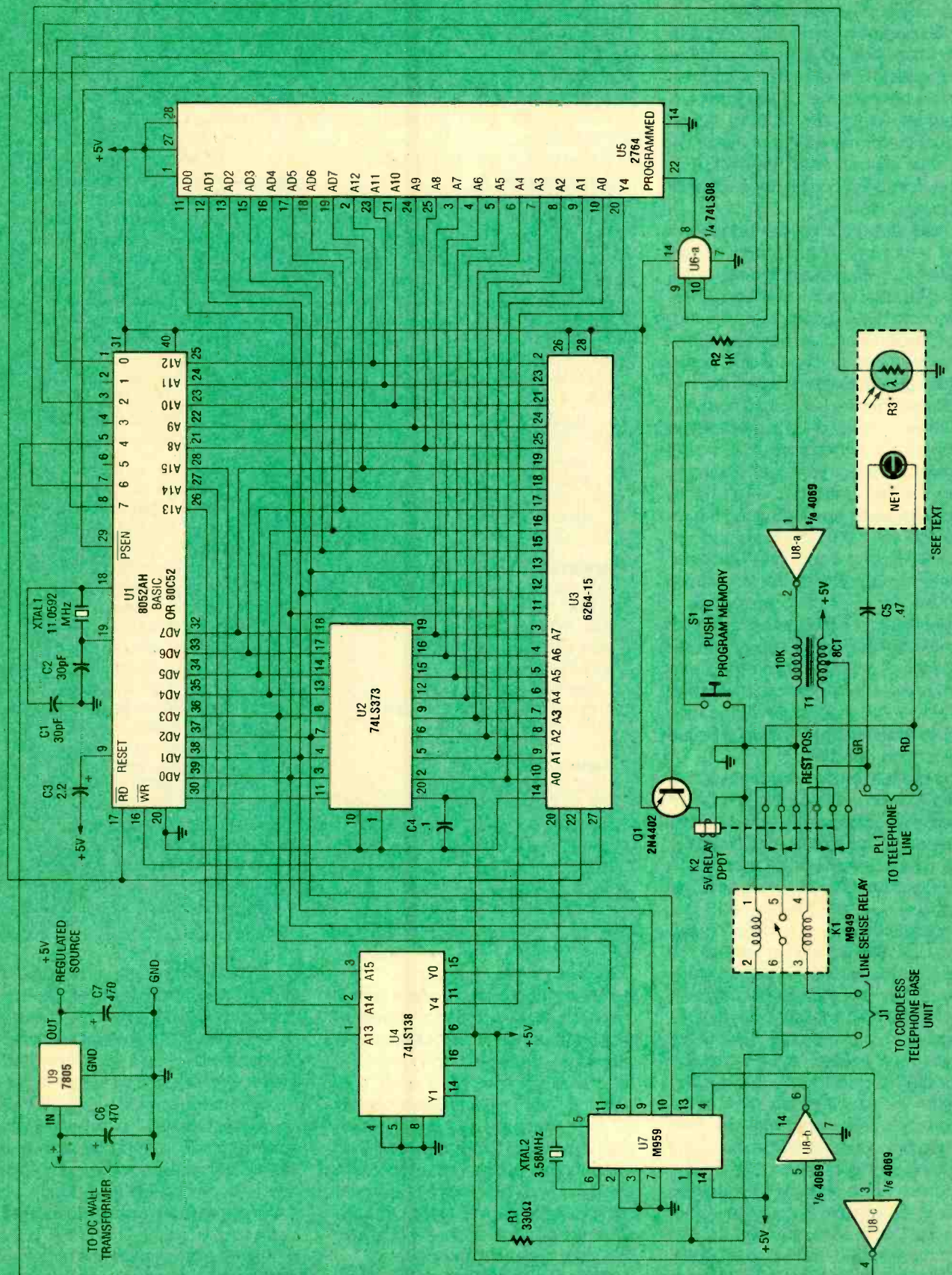

Fig. 1. At the heart of the Cordless Telephone Lock is a 8052AH BASIC microcontroller (U1).



0E000H. (The M959 dial-pulse counter is enabled at address 2000H.)

The negative-going output of U4 at pin 14 is inverted by U8-b and applied to pin 4 of U7 to enable the counter. Now whenever the U1 program encounters a B = XBY (2000H), B will equal the binary output of the M959 at that instant. From then on, just about anything can be done with that decimal number.

The locking control is interfaced to the telephone line through K1 (an M949 FCC approved line-sense relay). The relay, which is placed in series with both the red and green (tip/ring) conductors of the cordless-telephone's base unit, is used to sense dialing pulses and whether the phone's handset is on or off hook.

When a voltage is applied to the coils of K1, either from the circuit's power supply or from the telephone line (by taking the phone off hook), the relay energizes. Energizing the relay pulls pin 1 of U7 to ground, indicating to U7 that the phone has been taken off hook. The off-hook condition causes pin 13 of U7 to go to logic 1. When the lock is plugged in for the first time—but before a secret access code has been programmed into memory—U1 outputs an interrupted warble tone signal at pin 3. The tone signal is fed through U8-b and T1 to the telephone handset.

In order to make programming the circuit as easy as possible, the circuit uses the cordless phone's handset keypad for programming. Programming is accomplished by first pressing S1; that causes the warble tone to disappear. Next, using the handset keypad, a 5-digit access code is entered. As each digit is saved in memory, U1 feeds a steady tone—which we'll refer to as U1's dial tone—to the handset.

Once an access code is programmed into memory, the access code must first be keyed in via the handset keypad to gain access to the telephone line. The accessing of the protected telephone line can take place anywhere within the allowable ¼ mile of the base unit. When the phone is taken off hook, K1's contacts close, pulling pin 1 of U7 low. That causes U7 pin 13 to go to logic 1. That signal is inverted and fed to U1, which recognizes that signal as an off-hook condition, and awaits the proper access code.

## PARTS LIST FOR THE CORDLESS TELEPHONE LOCK

### SEMICONDUCTORS

- U1—8052AH (or 80C52) BASIC microcontroller, integrated circuit
- U2—74LS373 octal D-type latch, integrated circuit
- U3—6264-15 static RAM, integrated circuit
- U4—74LS138 3-to-8 line decoder/demultiplexer, integrated circuit
- U5—2764 EPROM (programmed), integrated circuit
- U6—74LS08 quad 2-input AND gate, integrated circuit
- U7—M959 dial-pulse counter (Teltone), integrated circuit
- U8—4069 hex inverter, integrated circuit
- U9—7805 5-volt, 3-amp voltage regulator (TO-3 package, see text), integrated circuit
- Q1—2N4402 general-purpose PNP silicon transistor

### RESISTORS

- (All fixed resistors are ¼-watt, 5% units.)
- R1—300-ohm
  - R2—1000-ohm
  - R3—Cadmium-sulfide light-dependent resistor (part of optoisolator/coupler, see text)

### CAPACITORS

- C1, C2—30-pF ceramic-disc
- C3—2.2- $\mu$ F, 16-WVDC, electrolytic
- C4—0.1- $\mu$ F, ceramic-disc
- C5—0.47- $\mu$ F, 250-WVDC, ceramic-disc
- C6, C7—470- $\mu$ F, 16-WVDC, electrolytic

### ADDITIONAL PARTS AND MATERIALS

- XTAL1—11.0592-MHz crystal
  - XTAL2—3.58-MHz crystal
  - NE1—Neon lamp with resistor (part of optoisolator/coupler see text)
  - S1—Spring return pushbutton switch
  - K1—M949 line-sense relay (Teltone)
  - K2—DPDT 5-volt relay
  - T1—10,000-ohm-to-8-ohm, center-tapped, audio-output transformer
  - J1—4-position modular jack (see text)
  - PL1—4-position modular plug (see text)
- Perboard materials, enclosure, 12-volt DC, 200–300 mA power adapter, quad telephone wire, heat sink, hook-up wire, solder, hardware, etc.

**Note:** The following parts can be purchased from Suncoast Technologies, P.O. Box 5835, Spring Hill, FL 34606: 8052AH BASIC microcontroller (U1), \$27.50; programmed 2764 (U5), \$8.50; M959 dial-pulse counter (U7), \$7.50; M949 line-sense relay (K1), \$5.75; telephone line cord (6-ft. spade lug terminations), \$1.75; all five parts for \$48.00. The 2764 BASIC program is also available on 5¼-inch floppy disk for \$6.50. A printed program listing is available for \$4.00. Please include \$2.75 shipping/handling. Canadian orders in Postal money orders/US funds only; add \$3.75 for Canadian shipping. Florida residents, please include 6% sales tax. Allow 3 to 4 weeks for delivery.

As the code is keyed in, each number of the 5-digit code is examined individually and compared to the programmed code that's stored in memory. If the keyed code matches the stored code, U1 pin 8 goes high, turning on Q1, which, in turn, energizes K2. That disconnects K1 and the telephone base unit from the circuit's internal power supply and reconnects them to the outside telephone line. At that point, the central-office dial tone will be heard in the handset and normal dialing can take place.

When the telephone call is terminated (the handset placed on hook), U7 pin 13 goes to logic 0. That logic

level is inverted by U8-c and applied to U1 at pin 5. That causes U1 pin 8 to go high, causing Q1 to turn off, which de-energizes K2. That disconnects the Cordless Telephone Lock from the outside line and reconnects it to the circuit's internal power supply. At that point, the Cordless Telephone Lock rearms itself to protect the line until the secret access code is again entered via the handset keypad.

If at any time the applied unlocking code *does not* match the programmed access code, the program stored in U5 branches to a subroutine that generates a third audio tone—a slow on/off tone that signifies a mis-



match. The mismatch tone is similar to a regular telephone busy signal; that signal is used to indicate that line access has been denied.

When that occurs, the access code must be re-entered. To re-enter the code, press the reset button on the handset keypad; pressing that button is equivalent to placing the handset on hook. Once released, U1's dial tone will replace the busy signal. At that point, you can re-enter the access code.

For incoming calls, there is no need to enter the access code. During normal on-hook conditions, the voltage across the telephone line is about 48 volts DC. That voltage does not reach the phone because an on-hook condition is essentially an open circuit; only the ring circuit is connect to the telephone line. But because the ring circuit is in series with a capacitor (which is an open circuit to DC), the phone does not ring.

When a call is placed to the protected station, the 48-volt on-hook voltage increases to 110 volts, which pulses at a frequency of 30 Hz. The pulsating DC is passed to the ring circuits, causing the telephone to ring. That voltage is also applied to an optoisolator/coupler through C5 (a 0.47- $\mu$ F 250-volt capacitor). Note that capacitor C5 performs the same function (blocks DC) as the capacitor in the telephone's ring circuit.

The ring signal applied to the optoisolator/coupler causes its internal neon lamp (NE1) to toggle on off at the frequency of the ring signal. Light from the neon lamp striking light-dependent resistor R3, causes its resistance to rise and fall at the same 30-Hz rate. The output of the optoisolator/coupler is used to signal U1 that there is an incoming call, by applying a 30-Hz signal to pin 7 of U1. That signal, recognized by U1's program as a ring signal, causes the U1 program to branch to a subroutine that bypasses the unlocking requirements of the circuit. At that point K2 energizes, connecting the cordless telephone's base unit (and K1) across the line, allowing normal ringing and answering to take place.

If the phone goes unanswered, and the call has been abandoned (the calling party has hung up), the circuit rearms itself. That's accomplished with the aid of U1's internal timer. Micro-

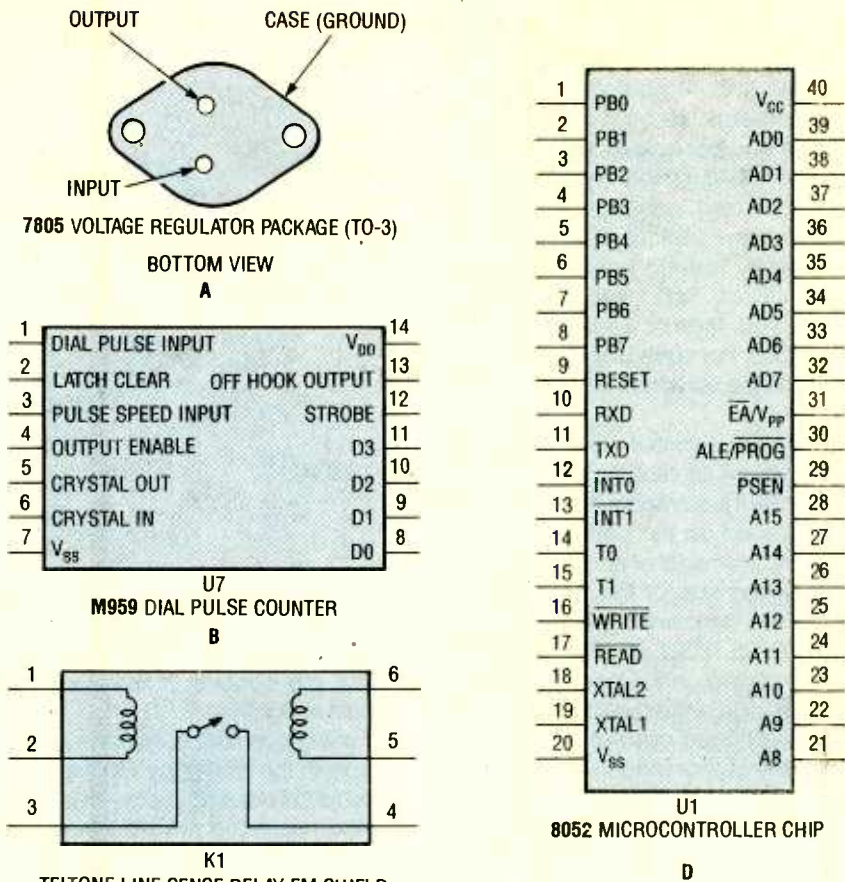

Fig. 2. The Cordless Telephone Lock, although a rather complex piece of equipment, was nonetheless assembled on a section of perfboard, with the component interconnections accomplished using point-to-point wiring techniques. These pinouts for the U9, U7, K1, and U1 are provided to help you to wire the circuit.

controller U1 determines the time between two ringing cycles (a ring cycle in the US is 2 seconds of ring voltage followed by a 4-second off period). If a ring signal is not detected at pin 7 by about 4.5 seconds after the preceding one, U1 exits the ring loop and reactivates the unlocking program.

Power for the circuit is provided by a three terminal 5-volt regulator (U9) that's fed from a 12-volt DC, 200-300-mA wall adapter. The pulsating DC voltage created by the wall adapter is filtered by C6 (a 470- $\mu$ F capacitor) before application to U9. Integrated circuit U9 provides a steady 5-volt output that is fed across C7, which is used to remove residual ripple from the power source.

**Construction.** The Cordless Telephone Lock, although rather complex, was nonetheless assembled on a section of perfboard with the component interconnections accomplished using point-to-point wiring

techniques. To aid in assembling the project, pinouts for U9, U7, K1, and U1 are shown in Fig. 2. When assembling the circuit, it is recommended that sockets be provided for all of the DIP IC's (U1-U8). Using IC sockets prevents thermal damage to the IC's during soldering.

Component placement should be well thought out before the wiring is begun. Be sure that all IC's and components supporting U1 are in close proximity to that device. That cuts down on long wire runs, which can introduce hum into the circuit and can cause erroneous data transmissions.

The FCC rules regarding user-installed equipment (including home-built projects like this one)—which states that any added equipment shall not introduce any foreign voltage on the line, and requires that normal line balancing be maintained—should also be kept in mind. The M949 line-sense relay (K1) and the M959

dial-pulse counter (U7), specified in the Parts List allow the Cordless Telephone Lock to conform to those requirements, so no substitutions of those components should be made.

The wiring of the circuit is straight forward and, although it's quite involved and tedious, should pose no problem. To help prevent miswiring the circuit, Fig. 1 should be photocopied. Then as wires are soldered in place, the corresponding connection on the schematic should be penciled out.

Another consideration is the proper orientation of all IC's and polarized devices. It is advisable that a small dot be placed on the perfboard next to the pin 1 terminal of each IC socket on the wiring side of the board. And, if possible, the component designation (U1, U2, U3, R1, R2, R3, etc.) should also be included on the board as well.

Although once available in IC form, the particular optoisolator/coupler that the author used in the prototype is no longer available. However, you can either make your own or try locating a unit of similar composition. All that is required is that the input be able to withstand a 110-volt AC ring signal and the output provides the proper output signal.

If you prefer to make your own, that can be easily accomplished using a neon lamp (the type that comes with its own resistor) and a cadmium-sulfide light-dependent resistor (LDR). To make the optoisolator/coupler, simply slide the neon lamp into one end of a small tube with both its leads protruding from the end. Then place the LDR in the other end with both its leads protruding from that end. Be sure to mark the neon end of the unit so that it is not installed backwards. (Actually, it doesn't really matter which end you mark so long as you know which end is which.) Make the assembly light-tight by sealing the ends temporarily with tape. Be sure that the leads do not short against one another.

It's a good idea to test your optoisolator/coupler before permanently sealing the tube ends. To test the assembly, connect an ohmmeter to the LDR leads. The ohmmeter should register a very high resistance. If so, apply a voltage to the neon end. The ohmmeter reading should drop dramatically. If that occurs, your coupler is okay. Permanently seal the ends

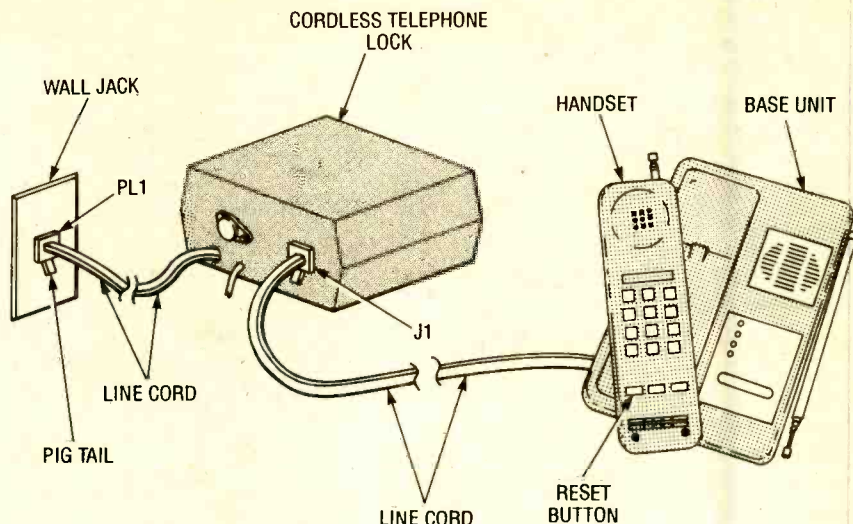

Fig. 3. This diagram shows how the circuit connects between your cordless telephone's base unit and the telephone line.

(tape and silicon caulk work well), and install the coupler in the circuit as shown in Fig. 1.

Turning our attention to the power supply, in the prototype the regulator used for U9 has a TO-3 case style. Regulators housed in the TO-3 package are typically high-current (3 amps and up) units. However, units housed in the TO-220 case style (which typically can handle currents of up to 1.5 amps with proper heat sinking) should suffice for this project.

In the prototype, heat sinking for the regulator was provided by the project's metal rear panel. If that scheme is followed, the regulator (regardless of which case style you use) should be insulated from the metal panel with a mica insulator (either the TO-3 or TO-220 type, depending on the regulator package). As for the filter capacitors (C6 and C7), in the prototype, they were mounted to a barrier strip, which was itself mounted to the rear panel of the enclosure.

Next we come to the input/output connectors (PL1 and J1, respectively). In the prototype, modular plug PL1 was connected to a length of quad telephone wire, and the other end of the wire (the red and green conductors) were connected to the appropriate points on the perfboard; but if you prefer, you can use a modular panel-mount jack and connect the Cordless Telephone Lock to the telephone line through a length of telephone quad cable that has modular plugs on both ends. By the same token, you also have some leeway with J1: You can

use a panel-mount jack or a modular extension cable. Such cables, which have a modular jack at one end and a plug at the other, are available from many local outlets, including Radio Shack. To use the modular extension cable, simply clip off the plug and connect the red and green wires to the appropriate points on the perfboard.

**Test and Installation.** Once you've finished assembling the Cordless Telephone Lock, inspect the board for solder splashes and bridges. Such carelessly placed shorts can be disastrous if located in sensitive areas. Note, the IC sockets should be empty at this time, and should remain so until you are instructed to install the IC's. You might also consider buzzing out the wire connections before proceeding to the next test phase.

Because the output port of U1 is programmed as an 8-bit word, incorrectly connected interface components will greatly affect the circuit's performance. You should double check that all components are soldered to their correct port locations. Make absolutely sure that the address/data (AD0-AD7) lines are properly wired. The wiring between U1 and U2, and U3 and U5 should, of course, be double checked with an ohmmeter before going on.

If all is okay, plug in the wall transformer. Using a DC voltmeter, check for +5 volts at each of the IC +V power-supply pins. If all is okay, re-

(Continued on page 90)



# Market Center™

## Paperback Books

GREAT PAPERBACKS AT SPECIAL PRICES

**COMPUTER HOBBYISTS HANDBOOK—BP251—\$8.95**

Subjects covered include microprocessors and their register sets; interfacing serial, parallel, monitor, games and MIDI ports; numbering systems, operating systems and computer graphics. While the book is aimed at the computer hobbyist, it should also prove useful to anyone who intends to use a computer to follow their interests.

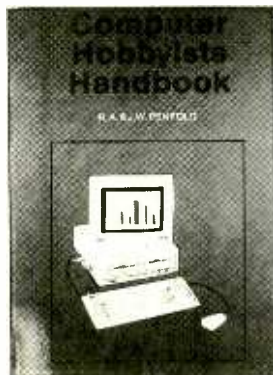

**INTERNATIONAL RADIO STATIONS GUIDE—BP255—\$9.95**

Provides the casual listener, amateur radio DXer and the professional radio monitor with an essential reference work designed as a guide for the complex radio bands.

Includes coverage on Listening to Short Wave Radio, ITU Country Codes, Worldwide Radio Stations, European Long Wave and Medium Wave Stations, Broadcasts in English and more.

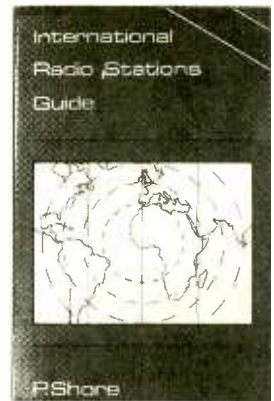

**Further Practical Electronics Calculations and Formulae**

I. A. WILSON



**FURTHER PRACTICAL ELECTRONICS CALCULATIONS—BP144—\$9.00**

450 pages crammed full of all the formulae you are likely to need. Covers Electricity, Electrostatics, Electromagnetism, Complex Numbers, Amplifiers, Signal Generation and Processing, Communications, Statistics, Reliability, Audio, Radio Systems, Transmission Lines, Digital Logic, Power Supplies. Then there's an appendix of Conversion Factors, Mathematical Formulae and more.



**WIRELESS & ELECTRICAL CYCLOPEDIA—ETT1—\$5.75**

A slice of history. This early electronics catalog was issued in 1918. It consists of 176 pages that document the early history of electricity, radio and electronics. It was the "bible" of the electrical experimenter of the period. Take a look at history and see how far we have come. And by the way, don't try to order any of the merchandise shown, it's unlikely that it will be available. And if it is, the prices will be many times higher.

**ELECTRONIC TECHNOLOGY TODAY INC.**  
P.O. Box 240, Massapequa Park, NY 11762-0240

Name \_\_\_\_\_  
Address \_\_\_\_\_  
City \_\_\_\_\_ State \_\_\_\_\_ Zip \_\_\_\_\_

P792

**SHIPPING CHARGES IN USA AND CANADA**

\$0.01 to \$5.00 . . . . .	\$1.50
\$5.01 to \$10.00 . . . . .	\$2.50
\$10.01 to 20.00 . . . . .	\$3.50
\$20.01 to 30.00 . . . . .	\$4.50
\$30.01 to 40.00 . . . . .	\$5.50
\$40.01 to 50.00 . . . . .	\$6.50
\$50.01 and above . . . . .	\$8.00

**SORRY No orders accepted outside of USA & Canada**

Total price of merchandise . . . . .	\$ _____
Shipping (see chart) . . . . .	\$ _____
<b>Subtotal</b> . . . . .	\$ _____
Sales Tax (NYS only) . . . . .	\$ _____
<b>Total Enclosed</b> . . . . .	\$ _____

All payments must be in U.S. funds

Number of books ordered

## ADVERTISERS INDEX

Free Information No.	Page
28	Ace Communications ..... 50C
34	Alfa Electronics ..... 50W
29	C&S Sales ..... 50D
—	Datak ..... 50R
—	EDE ..... 50V
—	Electronic Tech. Today ..... 50A
—	Highland ..... 50S
38	Hosfelt ..... 50K
—	Information Unlimited ..... 50Q
33	Interactive Images ..... 50L
25	Internt'l Micropower ..... 50V
31	JP Video ..... 50S
32	Kelvin ..... 50O
—	Microhinc ..... 50T
35	Optoelectronics ..... 50G
—	OWI ..... 50N
—	P.C. Boards ..... 50N
—	PE Reprint Bkst. .... 50H
39	Prairie Digital ..... 50H
—	Seattle Film Works ..... 50J
26	Silicon Valley Surplus ..... 50T
36	Tech Services ..... 50S
40	Tektronix ..... 50F
37	United Electronic Supply ..... 50I
50B 27	Viejo ..... 50T

# GET THE LATEST ADVANCES IN ELECTRONICS

WITH A SUBSCRIPTION TO

## Radio **Electronics**®

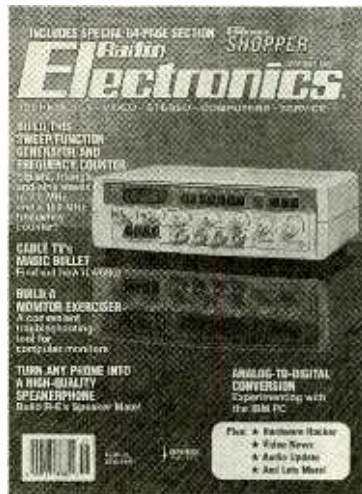

Radio-Electronics gives you exciting articles like:

- DSP in Consumer Electronics
- Build a Tesla Coil
- Analog-to-Digital Conversion
- Build a Spectrum Analyzer
- All About Fuel Cells
- Build an EKG
- Voltage Doublers
- PC-Based Test Equipment
- VGA-to-NTSC Converter

ENJOY THE WORLD OF ELECTRONICS EACH MONTH!

Now you can subscribe to the best electronics magazine. The only one that brings you articles on—electronics projects, technology, circuit design, communications, new products and much more.

Radio-Electronics looks to the future and shows you what new video, audio and computer products are on the horizon. What's more you'll find helpful, monthly departments such as Video News, Equipment Reports, Hardware Hacker, Audio Update, Drawing Board, Computer Connections. All designed to give you instruction, tips, and fun.



FOR  
FASTER SERVICE  
CALL TODAY  
1-800-999-7139

# SUBSCRIBE TODAY

Just fill out the order card in this magazine and mail it in today.

5PG29



## Communications Radios

### SCANNER & SHORTWAVE

**AOR  
AR1000XC  
\$429.00**

**AM Broadcast  
to Microwave  
1000 Channels**

500KHz to 1300MHz coverage in a programmable hand held. Ten scan banks, ten search banks. Lockout on search and scan. AM plus narrow and broadcast FM. Priority, hold, delay and selectable search increments of 5 to 995KC. Permanent memory. 4 AA ni-cads and wall plus cig charger included along with belt clip case and ant. & earphone.  
Size: 6 7/8 x 1 3/4 x 2 1/2. Wt. 12 oz.



**AR2500  
\$499.00**

**2016 Channels  
1MHz to 1300 MHz  
Computer Control**

62 Scan Banks, 16 Search Banks, 35 channels per second. Computer control for logging and spectrum display. AM, NFM, WFM, & BFO for CW/SSB. Priority bank, delay/hold and selectable search increments. Permanent memory. DC or AC with adaptors included.  
Size: 2 1/4 H x 5 5/8 W x 6 1/2 D. Wt. 1 lb. Mtng brkt & Ant incld.



**AR3000  
\$1095.00**

**100KHz to 2036MHz  
400 Channels**

Extreme coverage, excellent sensitivity, plus processor controlled band pass filtering and attenuation to eliminate interference. AM, NFM, Wide FM, LSB, USB, CW modes. RS232 control. Lockout in search. 4 priority channels. Delay & hold & Freescan modes.  
Size: 3 1/7 H x 5 2/5 W x 7 7/8 D. Wt. 2 lbs. 10 oz. Ant. & AC/DC pwr cords included.



**Free Shipping and Handling  
25 Day Satisfaction Guarantee  
Toll Free Service and Support  
No Credit Card Surcharges  
Full Warranties**

### SCANNERS

**AOR AR900  
\$269.00**

**Lo, Hi, Air, UHF, 800  
100 Channel Hand Held**

5 Scan & 5 Search banks with permanent memory. Extremely compact. Unrestricted 800 coverage. Permanent memory, Delay, Hold, Priority. Supplied with Antennas, Charger, Ni-Cad Batts, Belt Clip.



**Bearcat BC760  
\$269.95**

**Lo, Hi, Air, UHF, 800  
100 Channel Mobile**

Five banks of 20 channels, weather scan, delay, priority, and search. AC/DC power cords, Ant., and mtng brkt included.



Bearcat BC200XLT.....	\$259.95
AOR AR950.....	\$259.00
Bearcat BC55XLT.....	\$119.95
Bearcat BC560XLT.....	\$99.95
AOR AR880.....	\$149.00
Bearcat BC210XLT.....	\$149.95
Bearcat BC70XLT.....	\$129.95
Bearcat BC590XLT.....	\$199.95
Bearcat BC855XLT.....	\$199.95
Bearcat BC147XL.....	\$99.95
Bearcat BC172XL.....	\$139.95
Bearcat BC800XLT.....	\$249.95

### 2 - WAY

**RH256  
\$319.00**

**REGENCY/RELM**

Keyboard programmable 16 channel 25watt transceiver with receive scan. Program CTCSS tone, range 148-162MHz. Mic, mtng brkt, DC cord included.  
Size: 6 1/2 W x 10 1/2 D x 2 1/2 W Wt. 64 oz.



RSP Prog. Hand Held VHF.....	\$419.00
HR3500 10 mtr Mobile.....	\$249.00
Ranger Marine Mobile.....	\$159.00
Ranger Marine Hand Held.....	\$179.00

### SHORTWAVE

**SONY  
ICF2010  
\$349.00**

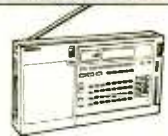

The top selling shortwave receiver. Covers 150KHz to 30.0MHz with 76 to 108 FM and 116 to 136MHz Air. Keyboard programmable with 32 memories. Synchronous detection and selectable IF bandwidth.  
Size: 6 1/4 H x 11 3/8 D x 2 1/16 D Wt. 3 lbs 12 oz.

Kenwood R5000.....	\$879.00
Grundig SAT650.....	\$849.00
Grundig SAT500.....	\$499.00
Kenwood RZ1.....	\$499.00
Sangean ATS803A.....	\$174.00

### ACCESSORIES

**Wide Band  
Preamp  
GW-2 \$89.00**



Improve sensitivity of any receiver. -3 to +25db gain, adjustable. GaAsFET design, >1.5db NF, 100KHz to 1500MHz coverage. 9VDC power, battery included.  
Size: 3H x 1 7/8 W x 1 1/8 D Wt. 5oz. BNC cnctrs.

**Interference Filter  
MPIF \$59.00**

Filters interference from TV, FM broadcast, Paging and Cellular.  
Size: 3 H x 1 7/8 W x 1 1/8 D Wt. 5 oz. BNC cnctrs.

**Wide Coverage Base Antenna  
DA300 \$99.50**

25-1200MHz RX. TX or RX. 37" high. N adaptor with 50 ft. of cable to BNC adaptor.

*Antennas, power adaptors, computer programs. Call for details.*

### WARRANTIES & SERVICE

Extended warranties available for many units. Call toll free for details. Service available for many scanners and transceivers by ex-factory technicians. Call toll free for cost estimates.

## To Order Call 1•800•445•7717

In All 50 States and Canada. 24 Hours a Day. Fax Orders: 1-800-448-1084, 24 Hours a Day.

ACE Communications Monitor Division 10707 E. 106th Street, Fishers, IN 46038

Int'l Voice# 317-842-7115. Int'l Fax# 317-849-8794.

Service and Support Lines: Mon-Fri 9 a.m. to 9 p.m., Saturday 10-4 EST

MasterCard, Visa, American Express, Check, Approved P.O.'s & C.O.D. (add 5.00)

Price, specifications and availability subject to change.





**CALL TOLL FREE**  
 1-800-292-7711  
 1-800-445-3201 (Can.)

# ELENCO PRODUCTS AT DISCOUNT PRICES

**48 HOUR  
 SHIPPING**

## DIGITAL METERS



**True RMS 4 1/2  
 Digit Multimeter  
 M-700T**  
**\$135**  
 .05% DC Accuracy  
 .1% Resistance  
 with Freq. Counter  
 Data Hold



**Multimeter with  
 Capacitance &  
 Transistor Tester**  
**\$55 CM-1500B**  
 Reads Volts, Ohms  
 Current, Capacitors,  
 Transistors and  
 Diodes / with Case  
 Big 1" Display



**Digital Capacitance Meter**  
**CM-1550B**  
**\$58.95**  
 9 Ranges  
 .1pf-20,000ufd  
 .5% basic accy.  
 Zero control w/ Case  
 Big 1" Display



**Digital LCR Meter**  
**LC-1801**  
**\$125**  
 Measures:  
 Coils 1uH-200H  
 Caps .1pf-200uf  
 Res .01-20M



**Digital Multimeter**  
**M-1000**  
**\$25**  
 3 1/2 Digit  
 .7% Accuracy  
 Reads:  
 AC/DC volts  
 resistance,  
 DC current & Diodes

## QUALITY AMERICAN MADE POWER SUPPLIES



**High Current Power Supply**  
**XP-800**  
**\$295**  
 Digital  
 Volt/Amp Meters  
 Fully regulated, 0-122VAC @ 2A, 0-  
 40VAC @ 10A or 0-30VDC @ 10A. Fully  
 variable, Short circuit protected.



**Digital Triple Power Supply**  
**XP-660**  
**\$289**  
 0-20V @ 1A  
 0-20V @ 1A  
 5V @ 5A  
 Fully regulated, Short circuit protected  
 with 2 limit control, 3 separate supplies  
**XP-660 with Analog Meters \$195**



**Quad Power Supply XP-580**  
**\$69.95**  
 2-20V @ 2A  
 12V @ 1A  
 5V @ 3A  
 -5V @ .5A  
 Fully regulated and short circuit protected



**Triple Power Supply XP-620**  
**Assembled \$75**  
**Kit \$49.95**  
 2 to 15V @ 1A  
 -2 to -15V @ 1A  
 (or 4 to 30V @ 1A)  
 and 5V @ 3A  
 All the desired features for doing experiments.  
 Features short circuit protection, all supplies.

## GENERATORS & VIDEO PRODUCTS



**Function Generator**  
**Blox**  
**#9600**  
**\$28.95**

Provides sine, triangle, square wave  
 from 1Hz to 1MHz  
 AM or FM capability  
**Kit \$26.95**



**Color Convergence Generator**  
**SG-250**  
**\$89.95**

**Kit \$69.95**  
 Finest in the industry  
 10 rock steady patterns  
 RF & Video output



**Wide Band Signal  
 Generators**  
**SG-9000**  
**\$129**

RF Freq 100K-450MHz AM Modulation  
 of 1KHz Variable RF output  
**SG-9500 w/ Digital Display &  
 150MHz built-in counter \$249**



**GF-8016 Function Generator**  
**with Freq. Counter**  
**\$249**

Sine, Square, Triangle, Pulse, Ramp,  
 .2 to 2MHz, Freq Counter .1-10MHz  
**GF-8015 without Freq. Meter \$179**

## EDUCATIONAL KITS - FUN & EASY TO BUILD

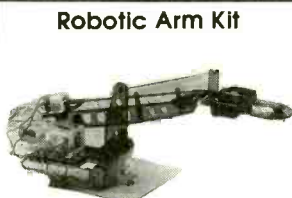

**Robotic Arm Kit**

**Model Y-01 \$48.95**

Teaches basics of robotics. Arm  
 grabs & releases, lifts & lowers, &  
 pivots from side to side



**AM/FM Transistor  
 Radio Kit**  
 with Training Course  
**Model AM/FM 108**  
**\$26.95**

14 Transistors ♦ 5 Diodes  
 Easy to build because  
 schematic is  
 printed right on the PCB  
**Makes a great school project**

**Learn to Build and Program  
 Computers with this kit**



**Includes: All Parts,  
 Assembly and  
 Lesson Manual**

**Model  
 MM-8000  
 \$129.00**

Starting from scratch you build a complete system.  
 Our Micro-Master trainer teaches you to write into  
 RAMs, ROMs and run a 8085 microprocessor, which  
 uses Similar machine language as IBM PC.

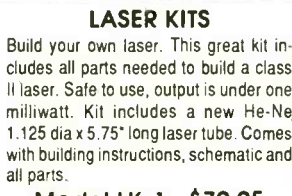

**LASER KITS**

**Model LK-1 \$79.95**

Build your own laser. This great kit in-  
 cludes all parts needed to build a class  
 II laser. Safe to use, output is under one  
 milliwatt. Kit includes a new He-Ne  
 1.125 dia x 5.75" long laser tube. Comes  
 with building instructions, schematic and  
 all parts.

Specifications LK-1:  
 Input voltage 12VDC @ 1.25 amp  
 Output voltage 2-3KV @ 3-4.5MA  
 Trigger voltage 6-8KV  
 Laser power 1 milliwatt  
 Laser tube type helium - neon  
 Laser tube size 1.125" dia x 5.75" long

**Mirror & Motor Kit**

This unique kit allows you to project  
 laser patterns on the ceiling or walls.  
 You change the patterns by varying the  
 speed of the motors. The kit comes com-  
 plete with 2 motors, 2 front surface mir-  
 rors, 2 motor brackets and 1 power  
 rheostat control to vary speed of the  
 motor.

**Model LM-1 \$19.95**

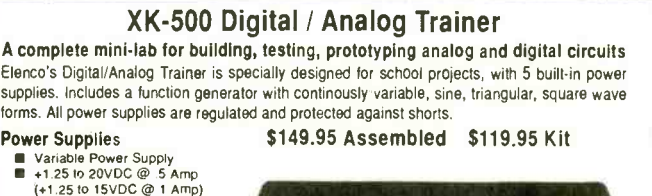

**XK-500 Digital / Analog Trainer**

**A complete mini-lab for building, testing, prototyping analog and digital circuits**  
 Elenco's Digital/Analog Trainer is specially designed for school projects, with 5 built-in power  
 supplies. Includes a function generator with continuously variable, sine, triangular, square wave  
 forms. All power supplies are regulated and protected against shorts.

- Power Supplies**
- Variable Power Supply
  - +1.25 to 20VDC @ 5 Amp
  - (+1.25 to 15VDC @ 1 Amp)
  - -1.25 to -20VDC @ .5 Amp
  - (-1.25 to -15VDC @ 1 Amp)
  - +12VDC @ 1 Amp
  - +5VDC @ 1 Amp
  - 30VAC Center tapped @ 15VAC at 1 Amp

- Analog - Section**
- Function Generator Sine, Triangular, Square wave forms
  - Frequency adjustable in five ranges from 1 to 100KHz
  - Fine frequency adjust
  - Amplitude adjust
  - DC offset
  - Modulation FM-AM

- Digital - Section**
- Eight data switches
  - Two no bounce logic switches
  - 8 LED readouts TTL buffered
  - Clock frequency 1 to 100KHz
  - Clock amplitude 5VPP square wave

- Breadboards**
- 2 breadboards, each contain: 640 tie points (total 1,680)

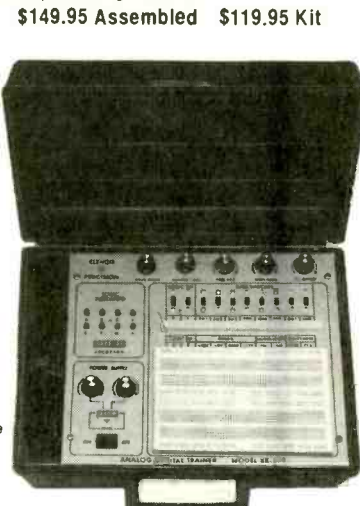

**\$149.95 Assembled \$119.95 Kit**

**WE WILL NOT BE UNDERSOLD**  
 UPS SHIPPING: 48 STATES 5%  
 IL RES 7.5% TAX (\$3 min \$10 max)  
 OTHERS CALL

**C&S SALES INC.**  
 1245 ROSEWOOD, DEERFIELD, IL 60015  
 FAX: 708-520-0085 • (708) 541-0710



**15 DAY MONEY BACK GUARANTEE**  
**2 YEAR WARRANTY**  
**WRITE FOR FREE CATALOG**  
 PRICES SUBJECT TO CHANGE

CIRCLE 29 ON FREE INFORMATION CARD

www.americanradiohistory.com

Popular Electronics, July 1992

50D



**LOWEST  
PRICES  
GUARANTEED**

# ELENCO & HITACHI SCOPES AT DISCOUNT PRICES

**48 HOUR  
SHIPPING**

## ELENCO OSCILLOSCOPES

- 25MHz and 40MHz Dual Trace, Dual Trigger
- 10 MS/S Sampling Rate (DS-203)
- Vert Sensitivity from 1mV/Div to 5V/Div
- Sweep Rate from 10nS/Div to 15/Div
- Hold-off, X-Y Operation
- TV Sync Triggering
- 6" CRT with Internal Graticule
- Includes Probes
- 2 Year Warranty



**S-1325 25MHz  
Dual Trace Oscilloscope**

**\$349**



**S-1340 40MHz  
Dual Trace Oscilloscope**

**\$495**

**DS-203 20MHz, 10MS/S  
Digital Storage Oscilloscope**

**\$775**



**S-1360 60MHz Delayed Sweep (not shown) \$775**

All scopes include probes, schematics, operators manual and 3 year (2 years for Elenco scopes) world wide warranty on parts and labor. Many accessories available for all Hitachi scopes. Call or write for complete specifications on these and many other fine scopes. 1x, 10x scope probes: P-1 65MHz \$17.95 P-2 100MHz \$21.95

## SPECIAL BUY HITACHI V-212



20MHz  
2 Channel  
Includes probes

**\$409**

### Hitachi Popular Series

A favorite of field service personnel and education institutions around the world, these scopes have a reputation of quality and reliable performance. With dual channels,  $\pm 3\%$  accuracy and 1mV/div sensitivity they have become the standard in portable analog oscilloscopes.

V-525 - 50MHz, Cursors	\$995
V-523 - 50MHz, Delayed Sweep	\$975
V-522 - 50MHz, DC Offset	\$875
V-422 - 40MHz, DC Offset	\$775
V-223 - 20MHz, Delayed Sweep	\$695
V-222 - 20MHz, DC Offset	\$625

### Hitachi Compact Series Scopes

This series provides many new functions such as CRT Readout, Cursor measurements (V-1085/1065/665), Frequency Ctr (V-1085), Sweeptime Autoranging, Delayed sweep and Tripper lock using a 6-inch CRT. You don't feel the compactness in terms of performance and operation.

V-660 - 60MHz, Dual Trace	\$1,149
V-665 - 60MHz, DT, w/cursor	\$1,345
V-1060 - 100MHz, Dual Trace	\$1,395
V-1065 - 100MHz, DT, w/cursor	\$1,649
V-1085 - 100MHz, QT, w/cursor	\$1,995
V-1100A - 100MHz, Quad Trace	\$2,195
V-1150 - 150MHz, Quad Trace	\$2,695

### Hitachi RSO Series

(Portable Real-time Digital Storage Oscilloscopes)

RSO's from Hitachi feature roll mode, averaging, save memory, smoothing, interpolation, pretriggering, cursor measurements. These scopes enable more accurate, simpler observation of complex waveforms, in addition to such functions as hardcopy via a plotter interface and waveform transfer via the RS-232C interface. Enjoy the comfort of analog and the power of digital.

VC-6023 - 20MHz, 20MS/s	\$1,695
VC-6024 - 50MHz, 20MS/s	\$1,995
VC-6025 - 50MHz, 20MS/s	\$2,195
VC-6045 - 100MHz, 40MS/s	Call
VC-6145 - 100MHz, 100MS/s	Call

**C&S SALES INC.**

1245 Rosewood  
Deerfield, IL 60015  
708-541-0710 Fax: 708-520-0085



**CALL TOLL FREE**

**1-800-292-7711**

**1-800-445-3201 (Can)**

**15 Day Money Back Guarantee**

**2 Year Warranty** Price: Subject to Change

**WRITE FOR FREE CATALOG**

CIRCLE 29 ON FREE INFORMATION CARD

[www.americanradiohistory.com](http://www.americanradiohistory.com)

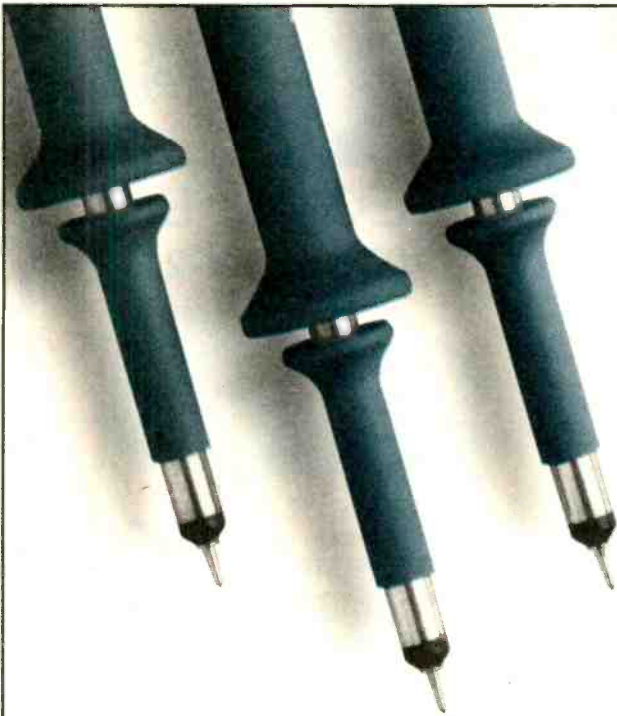

# EVEN AT \$39, THE BLUES CAN LAST A LONG, LONG TIME.

Conventional wisdom says if you spend less than forty bucks on a probe, it won't be long until the thrill is gone. But Tektronix Duraprobes™ start at \$39, live practically forever, and work with almost any scope around, so it won't surprise us if you pick up a whole case. After all, some folks were just born to have the blues.

## Tektronix

Test and Measurement

63W-188581 Copyright © 1992, Tektronix, Inc.

CMI-Metermaster, Tempe, AZ, (602) 431-0880 / Jensen Tools, Inc., Phoenix, AZ, (602) 968-6241  
 Marshall Industries, El Monte, CA, (800) 522-0084 / ITC, Los Angeles, CA, (213) 388-5416 / Zack Electronics,  
 Milpitas, CA, (408) 942-5432 / Dow Electronics, Inc., Norcross, GA, (404) 446-2620 / Joseph Electronics, Niles, IL,  
 (312) 297-4200 / Contact East, North Andover, MA, (508) 682-2000 / R.S. Electronics, Livonia, MI, (313) 525-1155  
 INOTEK, Dallas, TX, (214) 243-7000 / ENTEST, Dallas, TX, (214) 980-9876 / Radar Electric, Seattle, WA, (206) 282-2511

CIRCLE 40 ON FREE INFORMATION CARD

# FACTCARDS



■ ALL YOU NEED to know about electronics from transistor packaging to substitution and replacement guides. FACTCARDS numbers 34 through 66 are now available. These beautifully-printed cards measure a full three-by-five inches and are printed in two colors. They cover a wide range of subjects from Triac circuit/replacement guides to flip-flops, Schmitt triggers, Thyristor circuits, Opto-Isolator/Coupler selection and replacement. All are clearly explained with typical circuit applications.

■ WANT TO EXPAND your knowledge of electronics? Do it the easy way

by studying the Electronics Fact Cards. Do you travel to and from your job each day? Drop a handful of cards in your pocket before you leave, and the bus becomes a schoolroom! At home, you can build some of the projects and not only have fun building and using them, but learn how they work at the same time.

■ YOU'LL BE AMAZED both at how rapidly you learn with these cards, and how easy it is to understand. These new cards are available right now. Don't miss out. Send your check or money order today.

## FACTCARDS—Facts at your fingertips for Experimenters and Project Builders!

Please send one copy of FACTCARDS at \$3.50. Shipping \$1.00 (U.S. and Canada only).

Please send \_\_\_\_\_ copies of FACTCARDS. Total cost is sum of copy price and First Class postage and handling cost multiplied by number of card sets ordered.

New York residents add sales tax to total cost of each order.

Please print

Allow 6-8 weeks for the material to arrive.

\_\_\_\_\_  
(Name)

\_\_\_\_\_  
(Street Address)

\_\_\_\_\_  
(City)

\_\_\_\_\_  
(State)

\_\_\_\_\_  
(Zip)

Detach and mail today:  
 Popular Electronics Bookstore  
 P.O. Box 4079  
 Farmingdale, NY 11735

All Payment must be in U.S. Funds!

**Jampacked with  
information at your  
fingertips**



# DON'T GAMBLE

## when you want the best

### 21 Reasons To Buy OPTOELECTRONICS' MODEL 3000

1. RANGE- 10Hz to 3GHz.
2. Hi-Speed ASIC (Application Specific Integrated Circuit) State-Of-The-Art.
3. 256 Times Faster than other hand held counters.
4. 10 Digit LCD. Readability even in Bright Sunlight.
5. 6 Functions - Frequency, Period, Ratio, Time Interval, Average and Prescale.
6. RF Signal Strength Bargraph - 16 Segment, Zero & Full Scale Adjust. Excellent for locating Hidden Transmitters.
7. Four extremely Fast Gate Times .01, .1, 1, 10 sec.
8. Dual High Impedance Amplifiers.
9. Maximized Sensitivity
10. Hold Switch - Locks in measurements FAST.
11.  $\pm$  1PPM Accuracy
12. Direct Count - 1Hz resolution to 220MHz
13. Sensitivity <1mv 10MHz - 200MHz, <5mv - 2GHz.
14. Single Shot Time Interval 100ns, .1ns averaged.
15. Push-button Input, Gate & Function selection.
16. Extruded Aluminum Enclosure.
17. NiCad & Charger Included.
18. Low Battery Indicator.
19. 1 Year Parts & Labor Warranty
20. 30 day Money Back Guarantee.
21. OPTOELECTRONICS backs this with our 18 Years of Dependability & Service.

**All this and more for the Low Price - \$375.**

### Also Available at Special Package Price:

For A Limited Time Only  
Model 3000, Backlight/Beeper, Carry Case & TA-100s Whip Antenna

**All this for only \$449.**

#### OPTIONS:

<b>TCXO 30</b> $\pm$ .2ppm TCXO .....	\$100.
<b>BLB30</b> Back light & two step audible signal level indicator ..	\$ 75.
<b>CC30</b> Carry Case .....	\$ 15.
<b>TA100S</b> Telescoping Whip Antenna .....	\$ 12.

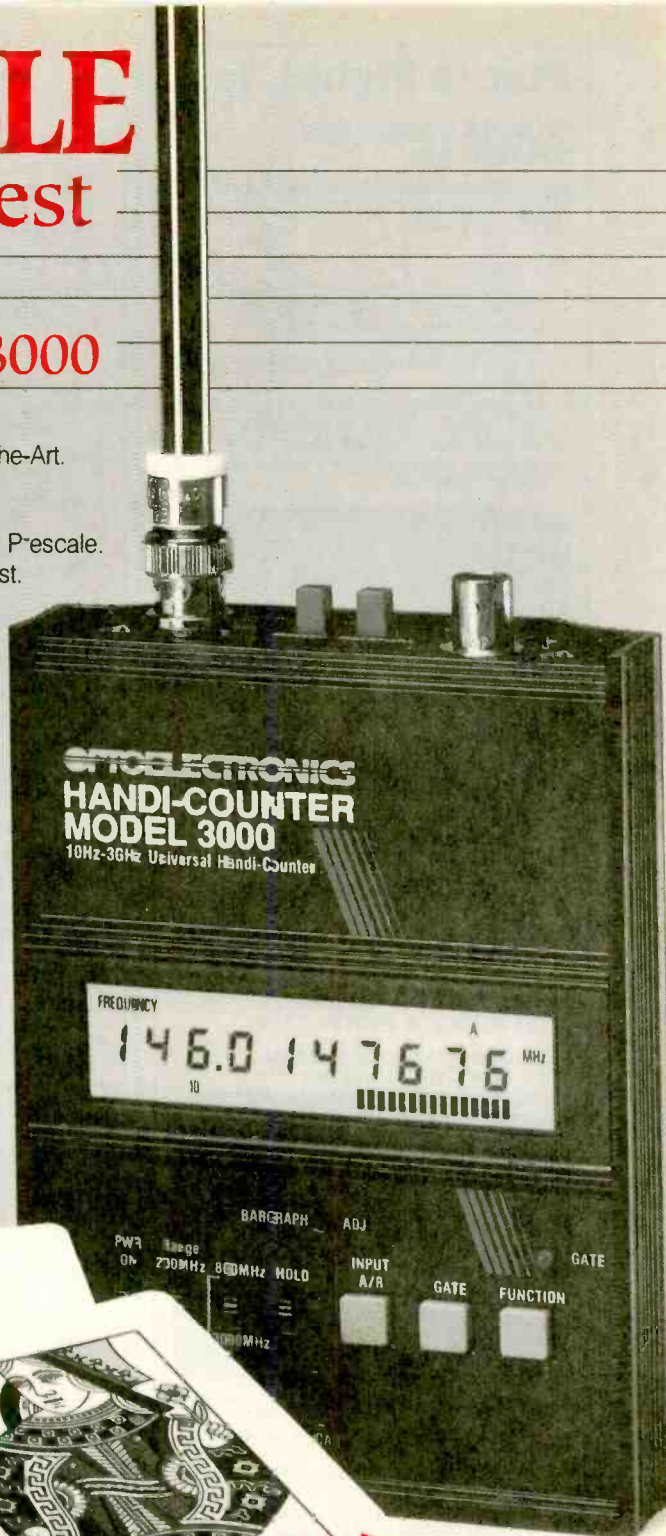

# OPTOELECTRONICS

Factory Direct Order Line

## 1-800-327-5912

(305)771-2050 • FAX(305) • 2052 5821 NE 14th Ave. • Ft. Lauderdale, FL 33334

5% Ship/Shandling (Max. \$10) U.S. & Canada. 15% outside continental U.S. Visa & Master Card Accepted.

CIRCLE 35 ON FREE INFORMATION CARD

www.americanradiohistory.com

## YOU CAN'T LOSE!

# Prairie Digital, Inc.

## PC DATA ACQUISITION SYSTEM - \$79

INCLUDES SOFTWARE ON 5.25" FLOPPY  
MODEL 30-FOR 386'S, XT'S, AT'S, PS2  
MODEL 25 & 30'S.

### FEATURES:

- \* 24 LINES OF PROGRAMMABLE INPUT/OUTPUT
- \* 8 BIT ANALOG TO DIGITAL CONVERTER
- \* 8 CHANNEL ANALOG MULTIPLEXOR
- \* 12 BIT CMOS COUNTER
- \* PC BUS CARD ELIMINATES USING THE SLOW RS232 PORT
- \* EASY INTERFACE TO ALL POPULAR LANGUAGES
- \* HIGH QUALITY PCB AND COMPONENTS
- \* A/D CHANNELS SELECTED BY SOFTWARE
- \* OPTIONAL 7 CHANNEL 50V DRIVER AVAILABLE FOR ADDITIONAL \$5

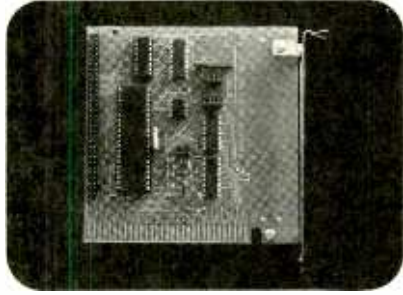

### APPLICATIONS:

- \* CONTROL RELAYS, LIGHTS & MOTORS
- \* MEASURE TEMPERATURE, PRESSURE, LIGHT LEVELS, & HUMIDITY
- \* INPUT SWITCH POSITIONS, THERMOSTATS, & LIQUID LEVELS
- \* GREAT FOR ROBOTICS, SERVO CONTROL LOOPS

## MODEL 150 TRUE RMS DMM W/RS232 PORT - \$149

INCLUDES RS232 PC CABLE AND SOFTWARE ON 5.25" FLOPPY

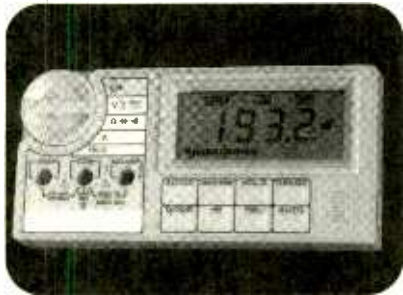

- \* LARGE 3 3/4 DIGIT DISPLAY (3.999 VS. 1.999 FOR 3 1/2 DIGIT METERS)
- \* RS232 SERIAL INTERFACE COMMUNICATES WITH COMPUTERS AND PRINTERS
- \* MEASURES AC-DC VOLTAGE AND CURRENT, FREQUENCY, RESISTANCE
- \* 20 AMP CURRENT RANGE, 30 HZ TO 40 KHZ FREQUENCY RANGE
- \* DIODE TEST AND AUDIBLE CONTINUITY
- \* AUTO-RANGING SELECTION CAN BE DEFEATED USING RANGE BUTTON
- \* TRUE RMS READING ELIMINATES ERRORS DUE TO NON-SINUSOIDAL SIGNALS
- \* DATA HOLD, MAX/MIN, AND RELATIVE READING MODES WITH INDICATORS
- \* ANALOG BAR GRAPH DISPLAY - UPDATES AT 5X THE RATE OF DIGITAL DISPLAY
- \* OVERALL SIZE 6.4 x 3.1 x 1.2"
- \* INCLUDES 9V BATTERY AND TEST LEADS

SEND CHECK, MO, VISA, MC  
INCLUDE \$5 FOR SHIPPING & HANDLING

## Prairie Digital, Inc.

846 Seventeenth Street  
Prairie du Sac, Wisconsin 53578  
Tel: (608) 643-8599 Fax: (608) 643-6754

# Popular Electronics®

## REPRINT BOOKSTORE

- 222 Popular Electronics (1992 back issues) \$4.00  
Write in issues desired \_\_\_\_\_
- 221 Popular Electronics (1991 back issues, Jan., Mar. not available) \$4.50  
Write in issues desired \_\_\_\_\_
- 220 Popular Electronics (1990 back issues) \$4.75  
Write in issues desired \_\_\_\_\_
- 119 Popular Electronics (1989 back issues) \$5.00  
Write in issues desired \_\_\_\_\_
- 118 Hands-On Electronics (1988 back issues) \$5.25  
Write in issues desired \_\_\_\_\_
- 117 Hands-On Electronics (1987 back issues) \$5.50  
Write in issues desired \_\_\_\_\_
- EH92 Experimenters Handbook (1992) \$4.50
- EH91 Experimenters Handbook (1991) \$5.00
- EH90 Experimenters Handbook (1990) \$5.50
- EH88 Experimenters Handbook (1988-89) \$6.00
- EH87 Experimenters Handbook (1987) \$6.50
- HH92 Hobbyist Handbook (1992) \$5.00
- HH91 Hobbyist Handbook (1991) \$5.50
- HH90 Hobbyist Handbook (1990) \$6.00
- HH89 Hobbyist Handbook (1989) \$6.50
- 212 Radio-Electronics (1992 back issues) \$4.00
- 211 Radio-Electronics (1991 back issues) \$4.50  
Write in issues desired \_\_\_\_\_
- 210 Radio-Electronics (1990 back issues) \$4.75  
Write in issues desired \_\_\_\_\_
- 109 Radio-Electronics (1989 back issues) \$5.00  
Write in issues desired \_\_\_\_\_
- 108 Radio-Electronics (1988 back issues) \$5.25

- Write in issues desired \_\_\_\_\_
- 107 Radio-Electronics (1987 back issues) \$5.50  
Write in issues desired \_\_\_\_\_

### REPRINTS REPRINTS

- 169 Think Tank (133 Circuits) \$3.50
- 169A Think Tank Vol. 2 \$3.00
- 168 Fact Cards (#34-66) \$4.00
- 168C Fact Cards (#67-99) \$3.50
- 168D Fact Cards (#100-132) \$3.50
- 167 Designing With IC's \$4.00
- 166 Collected Works of Mohammed Ulyses Fips (62 pages, April Fools Collection) \$5.00
- 165 How to Repair CD Disc Players \$5.00
- 164 Modern Electrics (April 1908) \$3.00
- 163 Receiving Satellite TV \$5.00
- 162 Build Your Own Satellite TV Receiver \$5.00
- 161 Descrambling (Feb. 1984) \$3.00
- 160 New Ideas - 42 Circuits \$3.50
- 159 Low Frequency Receiving Techniques Building and using VLF Antennas \$5.00
- 158 Electro Importing Co. Catalog (Circa 1918) \$5.95
- 157 All About Kits \$2.00
- 156 How To Make PC Boards \$2.00
- 155 IBM Typewriter To Computer \$2.00
- 154 How To Repair VCR's \$3.50
- 150 Pay TV Decoder (1981) \$3.00

To order any of the items indicated above, check off the ones you want. Complete the order form below, include your payment, check or money order (DO NOT SEND CASH), and mail to **Claggg Inc.**, Reprint Department, P.O. Box 4099, Farmingdale, NY 11735. Please allow 4-6 weeks for delivery.

If you need a copy of an article that is in an issue we indicate is unavailable you can order it directly from us. We charge 50¢ per page. Indicate the issue (month & year), pages and article desired. Include payment in full, plus shipping and handling charge. Make checks payable to Gernsback Publications, Inc.

ARTICLE

PAGES

MONTH

YEAR

TOTAL PAGES

@50¢ each

TOTAL PRICE

MAIL TO: **Claggg Inc.**

Reprint Bookstore, P.O. Box 4099, Farmingdale NY 11735

All payments must be in U.S. funds

SHIPPING CHARGES IN USA & CANADA

\$0.01 to \$5.00	\$1.50	\$30.01 to 40.00	\$5.50
\$5.01 to \$10.00	\$2.50	\$40.01 to 50.00	\$6.50
\$10.01 to 20.00	\$3.50	\$50.01 and above	\$8.00
\$20.01 to 30.00	\$4.50		

SDRRY — We only ship to USA & Canada

Total price of merchandise \$ \_\_\_\_\_  
Shipping Charge (see chart) \$ \_\_\_\_\_  
Subtotal \$ \_\_\_\_\_  
Sales Tax (New York State Residents only) \$ \_\_\_\_\_

Name \_\_\_\_\_

Total Enclosed \$ \_\_\_\_\_

Address \_\_\_\_\_

City \_\_\_\_\_ State \_\_\_\_\_ Zip \_\_\_\_\_

PE 792



# WHOLESALE SPECIALS

LIMITED QUANTITIES

## CABLE CONVERTERS

### Blow Out!!

### XL - 103

550 MHZ - 86 Channel **\$89.95** each

TOP CHANNEL ROLLOVER,  
LAST CHANNEL MEMORY, SUB-  
CHANNEL 0+1 CAPABILITY,  
FAVORITE CHANNEL, SURGE  
PROTECTION, 4 db AMP,  
DECODER COMPATABLE,  
STD/HRC SWITCHABLE, ONE  
YEAR REPLACEMENT  
WARRANTY, A/B TWINLINE  
OPTIONAL

**\$70.00** each - 5 Lot

**\$65.00** each - 10 Lot

**\$57.00** each - 20 Lot

**\$52.00** each - 50 Lot

**\$50.00** each - 100 Lot

### VIEWSTAR IS HERE

MXC-2520-525 MHZ remote volume  
remote volume control  
Audio/video Baseband **\$119.95** ea.  
Output, decoder loop **\$90.00** 5 lot  
Parental Lockout **\$85.00** 10 lot  
Favorite channel **\$80.00** 20 lot  
Remote Fine tuning  
'Universal' Decoder Compatible

### NEW "NORTH COAST"

'Excel' 66 channel remote **\$99.95** ea.  
Fine tune remote,  
60 min. Sleep timer **\$80.00** 5 lot  
Display dimmer  
Favorite channel **\$75.00** 10 lot  
Parental Lockout,  
HRC/STD Remote **\$70.00** 20 lot  
Selectable Twinline A/B Select Optional  
**AMERICAN MADE** Keep *OUR* People Working

## UNITED ELECTRONIC SUPPLY

P.O. BOX 1206 PE • ELGIN, ILLINOIS 60121

24 Hour Service

**(708) 697-0600**

Mon - Fri 8:30 - 5 pm - CST

CIRCLE 37 ON FREE INFORMATION CARD

[www.americanradiohistory.com](http://www.americanradiohistory.com)

# FREE

## 2 ROLLS 35mm Film



Try this Exciting New Film!  
"While (this film) has sharpness and fine grain competitive with other films of its speed, its main forte is color reproduction. Nuances of color are held in the prints; You can see the difference between cherry red and tomato red"  
Photographic Magazine

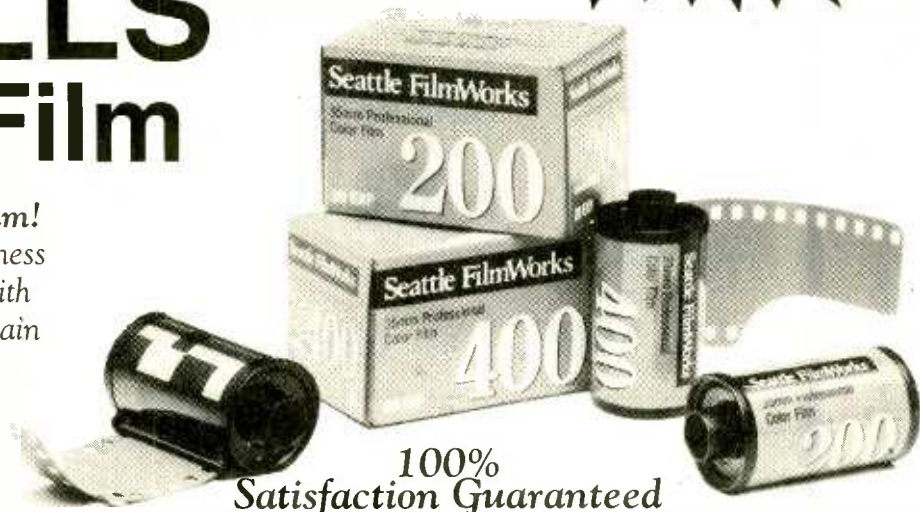

100% Satisfaction Guaranteed

Now you can try the 35mm film *Photographic Magazine* calls the best 200 ASA print film in the World! For Free. To introduce you, we'll send you two rolls Free. Fine grain, rich color, wide exposure latitude — perfect for everyday shots. Shoot in bright or low light — indoors or outdoors. And you can order prints, slides, or both, from the same roll — without the high cost of slide film! Try this remarkable film today.

### Prints or Slides from the same roll

## SEND ME 2 ROLLS FREE!

Rush me two 20-exposure rolls of your highly acclaimed 35mm film, one each at 200ASA and 400 ASA. Enclosed is \$2.00 for shipping. Limit 2 rolls per household.

FIRST NAME

LAST NAME

ADDRESS

CITY

STATE

ZIP

24526

Mail to: Seattle FilmWorks

1260 16th Ave. W.

P.O. Box 34056

Seattle, WA 98124-1056

©1991 Seattle FilmWorks. Free film offer does not include developing. Process SFW-XL.





# HOSFELT ELECTRONICS, INC.



## LINEARS

PART #	PRICE
TL072CN	\$.35
TL082CP	\$.49
TL084CN	\$.89
LM301N	\$.34
LM301H	\$.59
LM307	\$.40
LM308	\$.65
LM308H	\$.99
LM309H	\$2.95
LM309K	\$1.25
LM311N	\$.49
LM312H	\$1.75
LM317K	\$1.99
LM317T	\$.55
LM318H	\$2.95
LM318N	\$.99
LM319N	\$.99
LM320K-12	\$.99
LM322N	\$1.49
LM323K	\$2.95
LM324N	\$.29
LM324P	\$.39
LM329D2	\$.59
LM331N	\$3.79
LM334Z	\$.99
LM335Z	\$1.99
LM336Z	\$.99
LM339N	\$.35
LM340K-12	\$.99
LM340T12	\$.59
LM348N	\$.59
LM350K	\$3.49
LM350T	\$2.75
LM358N	\$.39
LM376	\$2.99
LM380	\$.75
LM386N	\$.89
LM387N	\$1.09
LM389	\$1.35
LM392N	\$.69
LM393N	\$.39
NE531T	\$1.49
NE555	\$.22
NE556	\$.29
NE558N	\$.65
NE564N	\$1.49
NE565N	\$.99
NE566CN	\$1.19
NE567V	\$.59
NE571N	\$1.49
NE590N	\$1.49
NE592N	\$.79
LM709N	\$.49

## PART #

## PRICE

LM710N	\$.75
LM711N	\$.79
LM723H	\$.99
LM723N	\$.39
LM733CN	\$.55
LM741CN	\$.24
LM741H	\$.59
LM747CN	\$.49
LM748CN	\$.59
MC1330	\$1.39
MC1350P	\$.79
MC1372N	\$2.19
MC1414N	\$1.25
LM1458	\$.32
MC1488N	\$.32
MC1489N	\$.39
LM1558H	\$2.60
LM1877N	\$2.75
LM1889N	\$3.49
LM1896N	\$1.49
LM2900N	\$.85
LM2901N	\$.29
MPQ2907N	\$1.19
LM2917N-8	\$1.19
LM2917N-14	\$.89
LM3900N	\$.49
MC3373N	\$1.29
LM3914N	\$2.09
MC4044N	\$3.75
RC4151T	\$3.95
LM4250N	\$1.29
LM4250H	\$2.19
RC4558N	\$.69

## VOLTAGE REGULATORS

PART #	PRICE
78L05	\$.35
78M05	\$.39
7805	\$.49
7806	\$.59
7808	\$.49
7809	\$.69
78C12	\$.49
7812	\$.49
78L15	\$.49
7815	\$.59
7824	\$.49
7905	\$.59
7912	\$.59
7915	\$.59
LM317K	\$1.99
LM317T	\$.55

## CMOS

PART #	PRICE
CD4001	\$.17
CD4007	\$.25
CD4011	\$.17
CD4012	\$.21
CD4013	\$.25
CD4015	\$.25
CD4016	\$.25
CD4017	\$.35
CD4018	\$.45
CD4020	\$.35
CD4021	\$.49
CD4023	\$.21
CD4024	\$.35
CD4025	\$.21
CD4027	\$.25
CD4028	\$.35
CD4029	\$.55
CD4030	\$.29
CD4040	\$.49
CD4042	\$.49
CD4043	\$.45
CD4044	\$.55
CD4046	\$.49
CD4049	\$.19
CD4050	\$.19
CD4051	\$.51
CD4052	\$.45
CD4053	\$.45
CD4060	\$.49
CD4066	\$.23
CD4067	\$1.15
CD4069	\$.19
CD4070	\$.19
CD4071	\$.19
CD4073	\$.19
CD4076	\$.39
CD4077	\$.25
CD4078	\$.29
CD4081	\$.19
CD4093	\$.29
CD4094	\$.75
CD4098	\$.89
CD4099	\$.75
CD4502	\$.79
CD4503	\$.29
CD4510	\$.49
CD4515	\$.65
CD4516	\$.69
CD4520	\$.55
CD4526	\$.55
CD4528	\$.55
CD4538	\$.65
CD4541	\$.85
CD4572	\$.49

## EPROMS

12.5 VOLT	* = CMOS
PART #	PRICE
2764-15	\$4.99
2764-2	\$4.49
27C64-15*	\$3.95
27128A-2	\$4.50
27C128-2*	\$4.50
27C128-15*	\$5.49
27256-2	\$4.50
27C256-2*	\$4.50
27512-2	\$5.95
27C512-2*	\$6.95
27C512-12*	\$7.95
27C010-12*	\$8.95

## T1 BI-POLAR LED

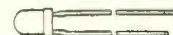

Green/red, typ luminous intensity = 1 mcd. Diffused.

No. 91-145 \$2.20

## T 1-3/4 BI-POLAR LED



Green/red, short dome, typ luminous intensity = 1 mcd. Diffused.

No. 91-146 \$2.20

## T 1-3/4 LED

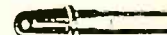

5 mm

No. 25-123 Red \$0.08  
No. 25-124 Green \$0.08

## T-1 LED



.12" (3mm)

No. 25-125 Red \$0.08  
No. 25-126 Green \$0.09  
No. 25-127 Yellow \$0.09



**TO PLACE YOUR ORDER  
CALL TOLL FREE  
1 800 524 6464  
or Fax 614-264-5414**



2700 SUNSET BOULEVARD  
STEUBENVILLE, OH 43952  
MAIL ORDERS ALLOW \$3.75 SHIPPING

# The Electronics Lab in a Computer!

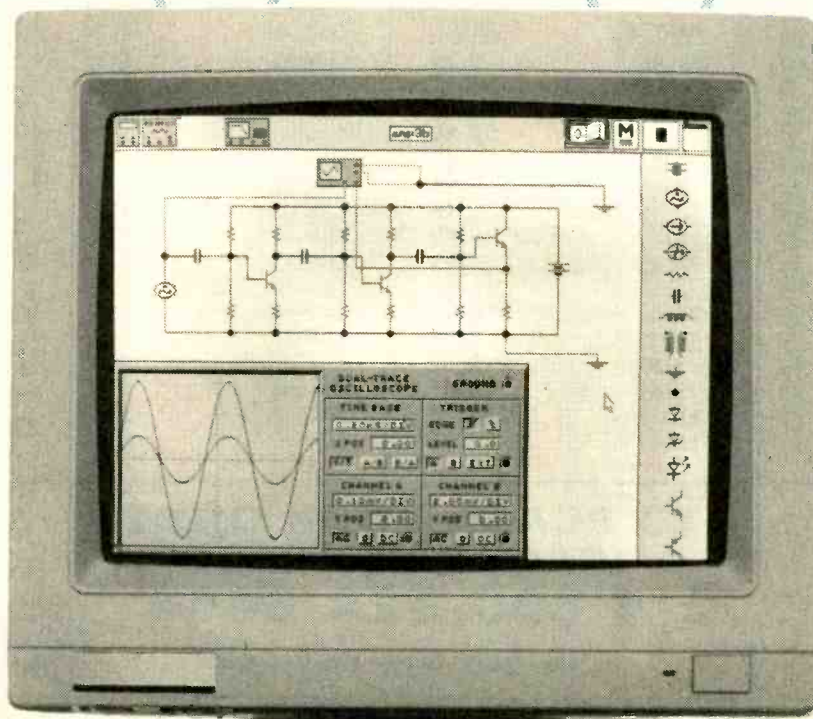
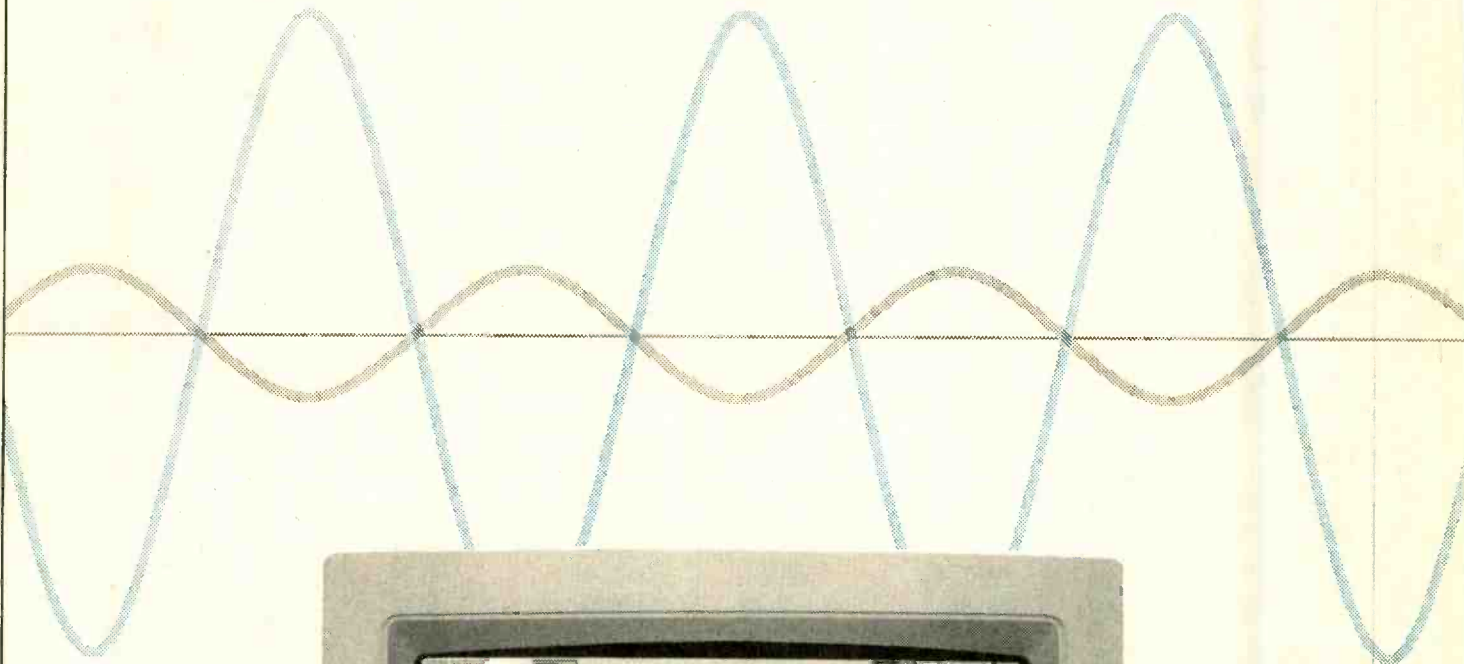

*Testing an analog three-stage amplifier with the simulated oscilloscope.*



# Electronics Workbench<sup>®</sup>

Powerful software to build and simulate  
analog and digital circuits.

Building and testing circuits is fast and easy with *Electronics Workbench*. Just click-and-drag with a mouse to add parts, run wires, and adjust instruments. The traces on the simulated instruments are the same as you'd get on real equipment.

*Electronics Workbench* really is an electronics lab in a computer. It's ideal for learning about electronics, experimenting, and prototyping circuits.

#### Includes:

- **Analog Module** with passive and active components including transistors, diodes, and op-amps; a function generator, an oscilloscope, a multimeter and a Bode plotter.
- **Digital Module** with gates, flip-flops, adders, a word generator, a multimeter, a logic analyzer and a unique logic simplifier.

DOS Professional Version - \$299

Macintosh Version - \$199

## (416) 361-0333

Interactive Image Technologies Ltd.

908 Niagara Falls Boulevard,

North Tonawanda,

NY 14120-2060

Fax (416) 368-5799

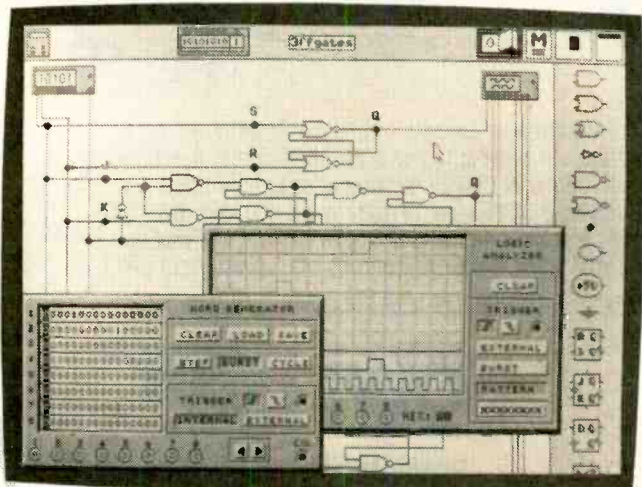

Testing a gate implementation of three different flip-flops.

**"Electronics Workbench is pretty amazing."**

- Jerry Pournelle, Ph.D., *InfoWorld*

**"... Electronics Workbench is a marvelous learning and teaching tool for the study of electronics."**

- Art Salsberg, Editor-in-Chief,  
*Modern Electronics Magazine*

**"Building a circuit is simple and intuitive."**

- Jeff Holtzman, Computer Editor,  
*Radio-Electronics Magazine*

**"... if you're trying to learn electronics, you can do 10 times as many experiments with Electronics Workbench ..."**

- Jerry Pournelle, Ph.D., *BYTE*



*Electronics Workbench* Professional Version runs on any IBM AT or PS/2 or true compatible with 640 KB RAM; Microsoft-compatible mouse; EGA/VGA graphics; hard disk; MS-DOS 3.0 or later. Monochrome version also available. Macintosh Version (monochrome only) runs on Macintosh Plus or greater. All trademarks are the property of their respective owners. Prices are in US dollars. Offer valid in the USA and Canada only.

# R 'U' ↑ 2 the Challenge?



From budding enthusiasts to electronic whizzes, robot fanciers won't be able to resist the challenge to assemble our new series of OWI's educational electronic robot kits.

If you liked MOVITS, you're ready for the next step. OWIKITS have NO pre-assembled parts. It's up to you to solder your own circuit boards and create one the many kits available from OWI.

*Take the Challenge. Let the adventure begin.*



## OWI Incorporated

1160 Mahalo Place  
Compton, CA 90220  
310.638.4732  
FAX: 310.638.8347  
1.800.638.1694  
E & K Kroeger, Inc.  
416.752.4382

Canadian Distributor:

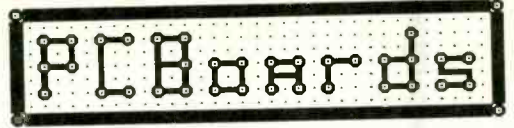

**P-C-B ARTWORK MADE EASY !**  
Create and Revise PCB Art in a Flash

- \* For IBM's & COMPATIBLES
- \* HERC, CGA, EGA, VGA, SUPER-VGA
- \* AUTO GROUND PLANES
- \* DOT- MATRIX, LASER and PLOTTER ART
- \* GERBER and EXCELLON OUTPUT
- \* CREATE YOUR OWN FILMS with 1XART
- \* LIBRARIES \* HELP SCREENS \* MENUS
- \* DOWNLOAD DEMOS from 24hr. BBS!

**PCBoards - layout program 99.00**

PCBoards HP or HI PEN PLOTTER DRIVER 49.00

PCBoards GERBER & EXCELLON Disk 49.00

**PCRoute - autorouter 99.00**

**SuperCAD - schematic ...starts at 99.00**

Demo Pkg. - (demos of all 3 programs) 10.00

Call or write for more information

**PCBoards**

2110 14th Ave. South, Birmingham, AL 35205

1(800)473-PCBS / (205)933-1122

BBS / FAX (205)933-2954



“Plant a tree  
for your  
tomorrow”

People often ask me what they can do to help the environment.

Well, there's a simple thing that each one of us can do. Plant a tree.

Trees clean the air we breathe, and help keep the atmosphere in balance, which makes life possible.

Plant a tree for your tomorrow... for your children... and for the earth.

For your free brochure, write: Trees for America, The National Arbor Day Foundation, Nebraska City, NE 68410.



John Denver for  
**The National  
Arbor Day Foundation**





**KELVIN** Electronics

UP TO **50% OFF**

**LED CENTER**

SPECIAL SPECIAL SPECIAL

**RED LED**  
As Low As  
**5¢** ea/1000+ Qty

**JUMBO LED**

TYPE - T 1 3/4, 5mm  
STOCK NO. YOUR COST 1000+ Qty  
260020 Red \$.06 ea/100+ \$.05 ea  
260027 Green \$.08 ea/100+ \$.07 ea  
260026 Yellow \$.08 ea/100+ \$.07 ea

**LED HOLDER**  
for T 1 3/4 SIZE, BLACK  
Stock No. 250019  
\$.10 ea / 100+ Qty

\$.06 ea / 1000+ Qty

**0.37" 7 SEGMENT LED READOUT**

STOCK NO. TYPE COST 20+ Qty  
260022 Anode \$.95 ea \$.75 ea  
260090 Cathode \$1.25 ea \$.99 ea

**0.6" 7 SEGMENT LED READOUT**

STOCK NO. Anode Jumbo COST 20+ Qty  
260021 \$1.15 ea \$.99 ea

**RED LED DISPLAY Bar Graph**

STOCK NO. COLOR YOUR COST 10+ Qty  
260058 Red \$1.99 ea \$1.79 ea  
260088 Green \$1.99 ea \$1.79 ea  
260089 Yellow \$1.99 ea \$1.79 ea

**MOVING SIGN DISPLAY**  
for Fabricating Your Own Moving Sign Display

50 mm STOCK NO. 260091 \$5.95 ea \$5.45 ea/20+

**TEST ACCESSORIES**

**IC CLIPS**  
SOLDER TYPE SPRING LOADED

STOCK NO. COLOR COST 25+ Qty  
990104 BLACK \$.65 ea \$.50 ea  
990105 RED \$.65 ea \$.50 ea

**IC TEST LEAD SET**  
5 COLOR CODED 18" LEADS WITH MINATURE HOOK-ON PROD AT BOTH ENDS

STOCK NO. YOUR COST 3+ Qty  
990108 \$8.95 ea \$8.25 ea

AUTHORIZED DEALER

FLUKE 87



FLUKE 70 Series II  
FLUKE 3 YEAR WARRANTY

**DISCOUNTED PRICES!**

BEST BUY ..... NEW Series II

- FLUKE 70 Series II ..... \$ 63
- FLUKE 73 Series II ..... \$ 89
- FLUKE 75 Series II ..... \$127
- FLUKE 77 Series II ..... \$149
- FLUKE 79 Series II ..... \$169
- FLUKE 83 ..... \$219
- FLUKE 85 ..... \$259
- FLUKE 87 True RMS ..... \$289
- FLUKE 86 AUTOMOTIVE ..... \$367
- FLUKE 88 AUTOMOTIVE ..... \$423
- FLUKE 45 ..... \$599



FLUKE 97 SCOPeMETER

**NEW! SCOPeMETER™ SERIES**

HAND HELD, 50 MHz, DUAL CHANNEL  
FLUKE 93 ..... \$1095  
FLUKE 95 ..... \$1395  
FLUKE 97 FULLY LOADED ..... \$1695

**SCOPES**



**20 MHz SCOPE** ..... \$345  
Dual Trace 2 Yr Warranty-Parts & Labor  
Stock No. 740005

**SCOPE PROBES**  
60 MHz, X1 & X10  
SPECIAL  
700072 ..... \$18.95  
150 MHz, X10  
700073 ..... \$39.95

**BATTERIES**

Duracell / Eveready  
**9V Alkaline Battery**  
\$1.95 ea  
\$1.75 ea/10+

**9V Battery SNAP & HOLDER**  
Snap \$.15 ea \$.10 ea/100+  
Holder \$.20 ea \$.10 ea/100+

**DOUBLE BANANA JACK**

Stock No. YOUR COST 3+ Qty  
600056 \$2.30 ea \$2.07 ea

**FEMALE BNC TO DUAL BANANA PLUG**

STOCK NO. YOUR COST 3+ Qty  
990103 \$2.95 ea \$2.75 ea

**DUAL BANANA BINDING POST TO MALE BNC PLUG**

STOCK NO. YOUR COST 3+ Qty  
600058 \$5.95 ea \$4.95 ea

**BNC TEST CABLES 3 FT.**

MALE TO MALE  
STOCK NO. YOUR COST 3+ Qty  
990101 \$3.45 ea \$2.95 ea

**PROJECT PARTS**

**Soldering IRON**  
with STAND, BLUE LONG LIFE TIP  
Stock No. 990098  
\$4.50 ea

**Project Speaker**  
2", 8 Ohm, 1 Watt  
Stock No. 350009  
**59¢**

**Project BUZZER**  
3 - 9 Volt DC, 80 db  
Stock No. 680089  
\$1.59 ea  
\$1.39 ea / 10+ Qty

**HORN ALARM**  
Loud Penetrating Sound  
Stock No. 640001  
\$.75 ea  
\$.69 ea / 10+ Qty

**DC MOTOR**  
for SOLAR/ROBOTIC  
Stock No. 852211  
\$.50 ea  
\$.45 ea / 20+ Qty

**XENON STROBE TUBE**  
Stock No. 260050  
\$2.95 ea  
\$2.50 ea / 20+ Qty

**TRIGGER COIL**  
for XenonStrobe Tube  
Stock No. 320037  
\$1.25 ea  
\$.89 ea / 20+ Qty

**INFRARED LED**  
IR Pair, LED infrared transmitter and receiver  
Stock No. 260061  
\$2.79 ea

**NEON LAMP**  
NE2, Long Leads  
Stock No. 260003  
\$.15 ea  
\$.12 ea / 100+ Qty

**PHOTO CELL**  
CADMIUM SELENIDE  
Stock No. 260017  
\$.99 ea

**PHOTO CELL**  
SULPHIDE  
Stock No. 260018  
\$.99 ea

**PUSH-BUTTON SWITCH**  
PUSH-ON, PUSH-OFF  
Stock No. 270021  
\$.55 ea  
\$.49 ea / 100+ Qty

**SUB-MINIATURE MOMENTARY SWITCH**  
Stock No. 990002  
\$.35 ea  
\$.28 ea / 100+ Qty

**MINIATURE TOGGLE SWITCH**  
Stock No. 270034  
\$.90 ea Type - SPST  
\$.79 ea / 50+ Qty

CIRCLE RESPONSE CARD or WRITE for our CATALOG full of WHOLESALE PRICED ITEMS.

OVER 10,000 ITEMS IN STOCK

ELECTRONIC COMPONENTS & TECHNOLOGY ACTIVITIES

VISA & MASTERCARD ACCEPTED \$20 MINIMUM ORDER MINIMUM FREIGHT \$5

**KELVIN DIGITAL MULTIMETERS**

Kelvin Meters backed by a 2 Yr Warranty - Parts & Labor

PRO 400 with 20MHz Freq Counter

100 Basic 150 Basic+ 200 Advanced

DC VOLTAGE AC VOLTAGE DC CURRENT RESISTANCE CONTINUITY - Test-Buzzer DIODE TEST BATTERY TEST 3 1/2 Digit LCD LOW BATTERY ACCURACY +/- 0.5% RDG IMPEDANCE-1 Meg

DC VOLTAGE AC VOLTAGE DC CURRENT RESISTANCE CONTINUITY - Test-Buzzer DIODE TEST TRANSISTOR hFE BATTERY TEST 3 1/2 Digit LCD LOW BATTERY ACCURACY +/- 0.5% RDG IMPEDANCE-1 Meg

DC VOLTAGE AC VOLTAGE DC CURRENT RESISTANCE CONTINUITY - Test-Buzzer DIODE TEST TRANSISTOR hFE BATTERY TEST 3 1/2 Digit LCD LOW BATTERY ACCURACY +/- 0.5% RDG IMPEDANCE-10 Mega Ohm

FREQUENCY COUNTER TO 20MHz IDEAL FOR TROUBLE SHOOTING AC/DC VOLTAGE RANGES AC/DC CURRENT RANGES 5 FREQUENCY RANGES 5 CAPACITANCE RANGES LOGIC TEST CONTINUITY TESTERBUZZER DIODE CHECK TRANSISTOR hFE TEST LED TEST verify 0000390 DISPLAY - 3 1/2 DIGIT LCD ACCURACY - 0.5% IMPEDANCE - 10 Mega Ohm

**KELVIN 100 Basic \$19.95**  
**KELVIN 150 Basic+ \$29.95**  
**KELVIN 200 Advanced \$39.95**  
**KELVIN PRO 400 \$69.95**

Protective Cases For Models 100, 150, 200 \$4.95 Case For Model Pro 400 \$9.95

**DIGITAL TRAINER**

Trainer Manual (100 Pgs) gives detailed instructions. An excellent training tool covering topics for High School (Beginner - Advanced), Trade School (Beginner - Intermediate) & College.

A PERFECT FIT WITHIN ANY DIGITAL CURRICULUM & YOUR CLASSROOM TEXTBOOK

FEATURES

- ONE DIGIT TRUE HEXADECIMAL DISPLAY WITH BUILT IN LOGIC (MEMORY, DECODER, DRIVERS) FULL ALPHA CHARACTERS
- TWO INDEPENDENT CLOCKS - USER ADJUSTABLE FREQUENCY & DUTY CYCLES
- BREADBOARD-500 FT. PROTOTYPE AREA
- TWO POWER DISTRIBUTION BUSES (GND, VCC)
- 4 DATA BIT SWITCHES
- MOMENTARY PUSH BUTTON SWITCH (SPDT)
- 4 LED DISPLAYS w/IC DRIVERS
- POWER SUPPLY: WALL PLUG-IN TYPE, U.L. LISTED
- VOLTAGE REG: 5 VOLTS, SHORT CIR. OVERLOAD PROTECT
- HOOK-UP WIRES
- COMPACT CARRYING CASE
- INSTRUCTION MANUAL FOR BEGINNER TO ADVANCED USERS

MADE WITH PRIDE IN THE USA

FREE COMPREHENSIVE TEACHER/STUDENT LAB MANUAL

**THE KELVIN LDT™ Laptop Digital Trainer**

ONLY **\$99.95**

Stock No. 840460



**WALL TRANSFORMERS**

**WALL TRANSFORMER**

STOCK NO. TYPE - Female

220069 9V DC/500 mA ..... \$3.95 ea  
220068 12V DC/500 mA ..... \$4.25 ea

**MALE JACK**

STOCK NO. TYPE

370048 2.1 mm Male  
\$.49 ea ..... \$.39 /10.

**BREADBOARDS**

680093 680097

680098 680100

Stock No. Post Contacts ... YOUR COST

680093 0 500 ..... \$ 4.25  
680097 0 840 ..... \$ 5.95  
680098 2 1380 ..... \$11.75  
680100 4 2390 ..... \$22.95

**WIRE JUMPER KIT**  
Pre-cut, Pre-Stripped  
330289 140 Piece Set ... \$ 4.75  
330290 350 Piece Set ... \$ 7.75

**COMPONENTS**

Stock No. TYPE YOUR COST

600021 555 TIMER ..... \$.20 ea  
600029 556 DUAL TIMER ..... \$.40 ea  
600038 LM566 PLL ..... \$.60 ea  
600018 741C OP-AMP ..... \$.30 ea INTERNALLY COMPENSATED  
600026 1458 OP-AMP ..... \$.35 ea DUAL 741C OP-AMP DIP

630041 2N2222 ..... \$.18 ea  
630383 PN2222 ..... \$.08 ea  
600023 7805 VOLTAGE REG ..... \$.36 ea

SILICON CONTROLLED RECTIFIER (Similar to GE C105C1) 4.0 AMP, 100 PIV  
600014 ..... \$.89 ea ..... \$.79 ea/50+

**KELVIN** Electronics

Established 1945 Call: 1(800) 645-9212

1(516) 756-1750

10 Hub Drive, Melville, NY 11747

Fax 1(516) 756-1763

July 1992, Popular Electronics



# Enter A World Of Excitement with a Subscription to **Popular Electronics**<sup>®</sup>

## Get the latest electronic technology and information monthly!

Now you can subscribe to the magazine that plugs you into the exciting world of electronics. With every issue of Popular Electronics you'll find a wide variety of electronics projects you can build and enjoy.

Popular Electronics brings you informative new product and literature listings, feature articles on test equipment and tools—all designed to keep you tuned in to the latest developments in electronics. So if you love to build fascinating electronics, just fill out the subscription form below to subscribe to Popular Electronics... It's a power-house of fun for the electronics enthusiast.

### EXCITING MONTHLY FEATURES LIKE:

- CONSTRUCTION**—Building projects from crystal sets to electronic roulette
- FEATURES**—Educational training on digital electronics, Ohm's Law, Antennas, Communications, Antique Radio, Simplified Theory
- HANDS-ON-REPORTS**—User test comments on new and unusual consumer products
- SPECIAL COLUMNS**—Think Tank, Circuit Circus, Computer Bits, DX Listening, Antique Radio, Amateur, Scanner Scene

### PLUS: ALL OUR GREAT DEPARTMENTS!

You'll get 12 exciting and informative issues of Popular Electronics for only \$18.95. That's a savings of \$16.45 off the regular single copy price. Subscribe to Popular Electronics today! Just fill out the subscription order form below.



FOR FASTER SERVICE CALL TODAY

**1-800-827-0383**

(7:30AM-8:30PM)

EASTERN STANDARD TIME

## Popular Electronics SUBSCRIPTION ORDER FORM

P.O. Box 338, Mt. Morris IL. 61054

APEG2

**YES!** I want to subscribe to Popular Electronics for 1 Full year (12 Issues) for only \$18.95. That's a savings of \$16.45 off the newsstand price.

Payment Enclosed  Bill me later  
Please charge my:  Visa  Mastercard

Acct. #

Signature  Exp. Date

PLEASE PRINT BELOW:

NAME

ADDRESS

CITY  STATE  ZIP

Allow 6 to 8 weeks for delivery of first issue. U.S. Funds only.  
In Canada add \$6.68 Postage (Includes G.S.T.). All Other Foreign add \$7.50 Postage.



# AMAZING

# ELECTRONIC PRODUCTS and KITS

## NEW CONCEPT! Mystery Levitating Device



**Remember War of the Worlds?** Objects float in air and move to the touch. Defies gravity, amazing gift, conversation piece, magic trick or great science project.  
**ANT1K Easy to Assemble Kit / Plans . . . . \$19.50**

## Combination Solid State Tesla Coil & Variable 100,000VDC Generator

Operates 12-19 VDC for 1 Field Use or 115 VAC For Laboratory Use



**HVM7 Plans Complete System . . . . \$15.00**  
**HVM7K Complete System Kit/Plans . . . \$174.50**  
**TCL4K Tesla Coil Only Kit/Plans . . . \$99.50**  
**115/19AC Wall Adapter for 115AC . . . \$15.50**

**Experiments Using Tesla Coil:**  
• Plasma in a Jar/Tomado, Furnace  
• Kirlian Photography  
• Wireless Energy Transmission  
• Induction Fields • Pyrotechnic Effects  
• Corona and Brush Discharge  
• Energizer for Neon Plasma Tubes

**Experiments Using Hi Volts DC:**  
• Plasma Blaster Driller/Cutter  
• Anti-Gravity/Force Fields  
• Ion Reaction Motors  
• Lightning Generation  
• High Ion Source  
• Ozone For Air Purification  
• Electrification of People & Objects  
• Particle Accelerators/Atom Smashing  
• High Energy Capacity Charging

## Table Top Tesla Coil

**Spectacular - A Real Attention Getter!**  
• 250,000 Volts! • 7-10' Sparks!  
Energy even passes through windows. Great for science projects, displays, advertising.



Highly spectacular devices produces visible, audible bolts of lightning appearing to flash in the air. Causes certain materials to burn from within and glow, lights bulbs without wires, produces induction fields, St Elmo's fire corona. Clearly demonstrates high frequency high voltages yet terminal may be touched by user during operation with a metal object. 115VAC operation only.  
**BTC3 Plans . . \$15.00 BTC3K Kit/Plans \$299.50**  
**BTC30 Assembled and Tested . . . . \$399.50**

## Plasma Fire Saber



Produces the spectacular effect that captured the fantasy of millions of movie fans. Visible plasma field is controlled by grip pressure and adjusts saber length. Active energy field produces weird & bizarre effects. Excellent for special effects. Specify photon blue, neon red, phasor green, or starfire purple.  
**PFS2 Plans . . . \$8.00 PFS2K Kit/Plans \$49.50**  
**Special Offer PFS20 Assembled reg \$89.50, \$59.50**

## Solar Power Devices

Build a fence shocker, solar motor, light, bug zapper, batt charger, etc. **SOL1 4", 2 Amp Cell w/Plans . . \$8.50**  
**SOL2 6x12", 14 V Cell w/Plans . . . . . \$7.50**

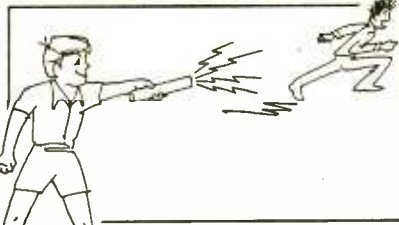

## Shocker Force Field / Vehicle

**Electrifier** - Neat little device allows you to make hand and shock balls, shock wands and electrify objects, charge capacitors. Great pay back for those wise guys who have wronged you!  
**SHK1KM Easy To Assemble Electronic Kit . \$24.50**

## 100,000V Intimidator / Shock Wand Module

Build an electrical device that is affective up to 20 feet. May be enclosed for handheld, portable field or laboratory applications.  
**ITM2KM Easy to Assemble Electronic Kit . . \$49.50**  
**ITM2 Plans Only; Credit-able to Kit . . . . \$10.00**

**Ion Ray Gun** - Projects charged ions that induce shocks in people & objects without any connection! Great science project as well as a high tech party prank.

**IOG3 Plans . . . . \$10.00 IOG3K Kit/Plans \$69.50**

## Invisible Pain Field Generator

Shirt pocket size electronic device produces time variant complex shock waves of intense directional acoustic energy capable of warding off aggressive animals, etc.  
**IPG7 Plans . . . \$8.00 IPG7K Kit / Plans \$49.50**  
**IPG70 Assembled . . . . . \$74.50**



## Homing / Tracking Transmitter

Beeper device, 3 mile range.  
**HOD1 Plans . . . \$10.00 HOD1K Kit/Plans \$49.50**

## Listen Thru Walls, Floors

Highly sensitive stethoscope mike.  
**STETH1 Plans . . \$8.00 STETH1K Kit/Plans \$44.50**

## 3 Mile FM Wireless

**Mike - Subminiature!**  
Crystal clear, ultra-sensitive pickup transmits voices and sounds to FM radio. Excellent security system, warns of intrusion. Become your neighborhood disk jockey! Monitor children and invalids.  
**FMV1 Plans . . . \$7.00 FMV1K Kit/Plans . \$39.50**



## Telephone Transmitter - 3 Miles!

Automatically transmits both sides of a telephone conversation to an FM radio. • Tunable Frequency  
• Undetectable on Phone • Easy to Build & Use  
• Up to 3 Mile Range • Only transmits during phone use  
**VWPM7 Plans . . . \$7.00 VWPM7K Kit/Plans \$39.50**



## ElectroMagnetic Coil Gun

Projects a metal object over a considerable distance. Become part of and perhaps contribute to this exciting new concept of weaponry.  
**EML2 Plans . . . . \$8.00 EML2K Kit/Plans \$99.50**



## NEW! Amazing GlowTron!

Projects visible energy. Operates on safe, low voltage to produce spectacular lighting effects. Neon & fluorescents glow without wires!  
**GTRON Ready to Use . . . . . \$29.50**



**TV & FM Joker / Jammer** - Shirt pocket device allows you to totally control and remotely disrupt TV or radio reception. Great gag to play on family or friends. Discretion required.  
**EJK1KM Easy to Assemble Electronic Kit . \$19.50**

## Visible Beam Laser

High brightness red HeNe laser visible for miles. Produce your own light show! Projects a beam of red lite clearly visible under most circumstances. Can be used to intimidate by projection of a red dot on target subject. Also may be used to "listen in" utilizing our laser window bounce method #LLIS1 below. Easy to Build Modules Produce A Working Visible Laser.  
**LAS1KM Kit w/1mw Laser Tube, Class II . \$69.50**  
**LAS3KM Kit w/2.5mw Laser Tube, Class IIIA \$99.50**

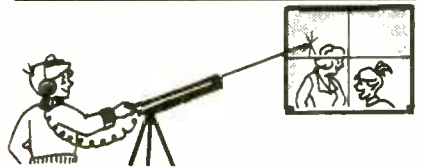

## "Laser Bounce" Listener System

allows you to hear sounds from an area via a lite beam reflected from a window or other similar object. System uses our ready-to-use LATR1 Laser Terminator gun site as the transmitter. The receiver section is supplied as an easy-to-build kit, including our cushioned HS10 headsets. Order # LLIST20 System, includes our LATR1 Ready-to-Use Laser Gun Site, LLR1K Special Receiver Kit, and HS10 Headset, all for only \$299.50

## 5mw Visible Red Pocket Laser

Utilizes our touch power control!  
**VRL3KMX Kit / Plans . . . . . \$119.50**



## See In The Dark Viewing

Device uses invisible infrared illumination for seeing in total darkness. Excellent for low cost night vision, along with observing lasers and other IR sources. Functional unit, many useful applications.  
**SD5 Plans . . . . \$10.00**  
**SD5K Kit / Tube / Plans . . . . \$299.50**  
**GPV10 Ready to Use Viewer . . . . \$499.50**  
**6032A Tube / Plans to build your own . . \$99.50**



## INFORMATION UNLIMITED

Dept PEM10, Box 716, Amherst, NH 03031  
Phone: 603-673-4730 FAX 603-672-5406  
MC, VISA, COD, Checks Accepted. Please Add \$5.00 Shipping & Handling

**Catalog**  
with many more items  
**FREE with Order,**  
Or Send \$1 P&H



Order by Mail,  
or by 24 Hour  
Orders-Only Phone:  
**800-221-1705**

# PE MARKET CENTER CLASSIFIEDS

## MISCELLANEOUS ELECTRONICS FOR SALE

**REMOVE TAMPER** resistant security screws, deluxe 30-pc. set \$29.95 plus \$4.50 S&H. Send SASE for more information. **Sunset Electronics**, 12145 Alta Carmel Ct., Suite 250-139, San Diego, CA 92128.

**AMAZINGLY BRIGHT LED** flashlights, hundreds of uses, photographers, astronomers, cyclist, etc. Great attention getter, super long battery life, six models flashing or continuous beam. Send \$1.00 for brochure to: Visioneering, Box 538, Columbia Station, OH 44028.

**THERMOPLASTIC MOLDING!** Multipurpose mold forming machine for project cases, prototyping, crafts and many other uses. Send \$1.00 for sample and more information. The Formworks, PO Box 721, Glendora, CA 91740.

## PRINTED CIRCUIT KIT

**ER-4 PHOTO ETCH™** kit lets you copy art from this magazine onto your PC board. Includes everything but exposure bulbs. Shipped UPS to your street address for \$41.00.

**ER-19 EXPOSURE BULB SET FOR ER-4.** Contains 3400°K reflector flood and 4800°K long wave UV lamp for ordinary 120V socket. Shipped UPS to your street address for \$18.45.

**FREE CATALOG** of dry transfers and PC supplies. Write or phone **DATAK**, 55 Freepoint Blvd, Sparks, NV 89431. 702-359-7474 FAX: 702-359-7494.

## PLANS-KITS-SCHEMATICS

**BUILD OR buy assembled**, four digit SWR & power meter, with alarm & set points. Plans available. **Free information.** **RUPP ELECTRONICS**, 5403 Westbreeze, Fort Wayne, IN 46804. (219) 432-3049.

**HAM RADIO KITS & ASSEMBLIES** for various QST & 73 construction articles. For catalog, send legal size SASE w/52 cents postage to A & A Engineering, 2521 W. LaPalma #K, Anaheim, CA 92801.

**REBUILD TONER CARTRIDGES** — How To booklet for all makes!! It's easy! Mention Popular Electronics with your order and receive the Tips and Tricks Guide free! Both in hard print. You will also receive a free game, free utility program (our choice), and our rental & shareware catalog on 360K disk free!! Only \$19.95 postpaid! **BEACH RADIO**, 1148 Center Street, Office #269, Dept. P E, Newton Center, MA 02159. Or send \$4.00 (refundable) for all the freebies alone.

**SURVEILLANCE SCHEMATICS.** State of art designs. Large selection. **Free literature.** Stackhouse, POB 502, Dayton, OH 45401-0502.

## CB-SCANNERS

**ANNUAIRE DE FREQUENCES DU QUEBEC POUR SCANNER.** plus de 7000 frequences incluant RCMP & Govt. federal. Seulement \$17.95 plus \$3.50 (shipping) to: Gilles Thibodeau, PO Box 193, Lac-Megantic, Quebec G6B 2S6.

**COMMUNICATION AT ITS BEST.** AR-900/950 \$245.00, AR-1000XC \$399.00, AR-2500 \$469.00, AR-3000 \$969.00, BC-200XL \$269.00. Extended warranties. We carry a variety of CB's, scanners, radar detectors, SWL and accessories. **FREE SHIPPING.** Visa/MC/Diners. Turbo Electronics, PO Box 8034, Hicksville, NY 11802. Inquiries: (516) 938-1946. Orders: 1 (800) 33-TURBO.

## COMPONENTS

**HV CAPACITORS**, parts, kits. \$1.00 brings catalog and coupon. Two Fox, POB 721, Pawling NY 12564.

## INSTRUCTION FOR PLACING YOUR AD!

### HOW TO WRITE YOUR AD

**TYPE or PRINT** your classified ad copy CLEARLY (not in all capitals) using the form below. If you wish to place more than one ad, use a separate sheet for the additional ads (a photocopy of this form works well). Choose a category from the list below and write that category number into the space at the top of the order form. If you do not specify a category, we will place your ad under Miscellaneous or whatever section we deem most appropriate.

We cannot bill for classified ads. Payment in full must accompany your order. We do permit repeat ad or multiple ads in the same issue, but in all cases, full payment must accompany your order.

### WHAT WE DO

The first two words of each ad are set in bold caps at no extra charge. No special positioning, centering, dots, extra space, etc. can be accommodated.

### RATES

Our classified ad rate is 40¢ per word. Minimum charge is

\$6.00 per ad per insertion (15 words). Any words that you want set in bold or caps are 10¢ each extra. Bold caps are 20¢ each extra. Indicate bold words by underlining. Words normally written in all caps and accepted abbreviations are not charged as all-caps words. State abbreviations must be Post Office 2-letter abbreviations. A phone number is one word.

### CONTENT

All classified advertising in the **PE Market Center** is limited to electronics items only. All ads are subject to the publisher's approval. We reserve the right to reject or edit all ads.

### DEADLINES

Ads received by our closing date will run in the next issue. For example, ads received by June 18 will appear in the October issue that is on sale in August. No cancellations permitted after the closing date. No copy changes can be made after we have typeset your ad. **NO REFUNDS.** advertising credit only. No phone orders.

**AD RATES: 40¢ per word, Minimum \$6.00.**

Send your ads with payment to:

**Popular Electronics Market Center, 500-B BI-County Blvd. Farmingdale, NY 11735**

## CATEGORIES

100 — Antique Electronics	330 — Computer Software	570 — Plans-Kits-Schematics
130 — Audio-Video-Lasers	360 — Education	600 — Publications
160 — Business Opportunities	390 — FAX	630 — Repairs-Services
190 — Cable TV	420 — Ham Gear For Sale	660 — Satellite Equipment
210 — CB-Scanners	450 — Ham Gear Wanted	690 — Security
240 — Components	480 — Miscellaneous Electronics For Sale	710 — Telephone
270 — Computer Equipment Wanted	510 — Miscellaneous Electronics Wanted	720 — Test Equipment
300 — Computer Hardware	540 — Music & Accessories	

## CLASSIFIED AD COPY ORDER FORM

Ad No. 1—Place this ad in Category # \_\_\_\_\_

1 - \$6.00	2 - \$6.00	3 - \$6.00	4 - \$6.00	29 - \$11.60	30 - \$12.00	31 - \$12.40	32 - \$12.80
5 - \$6.00	6 - \$6.00	7 - \$6.00	8 - \$6.00	33 - \$13.20	34 - \$13.60	35 - \$14.00	36 - \$14.40
9 - \$6.00	10 - \$6.00	11 - \$6.00	12 - \$6.00	37 - \$14.80	38 - \$15.20	39 - \$15.60	40 - \$16.00
13 - \$6.00	14 - \$6.00	15 - \$6.00	16 - \$6.40	<b>Ad No 1—Total words</b> _____ × .40 per word = \$ _____			
17 - \$6.80	18 - \$7.20	19 - \$7.60	20 - \$8.00	All Caps words _____ × .10 per word = \$ _____			
21 - \$8.40	22 - \$8.80	23 - \$9.20	24 - \$9.60	Bold words _____ × .10 per word = \$ _____			
25 - \$10.00	26 - \$10.40	27 - \$10.80	28 - \$11.20	Bold Cap words _____ × .20 per word = \$ _____			
<b>TOTAL COST OF AD No. 1 \$</b> _____							

Total classified ad Payment \$ \_\_\_\_\_ enclosed.

[ ] Check [ ] MasterCard [ ] Visa (\$15.00 minimum credit card order)

Card # \_\_\_\_\_ Expiration Date \_\_\_\_\_ / \_\_\_\_\_

Signature \_\_\_\_\_

Name \_\_\_\_\_

Phone \_\_\_\_\_

Address \_\_\_\_\_

City State Zip \_\_\_\_\_



*A recession-proof business!*  
**Computer maintenance/service  
 can double your income!**

If you are not servicing microcomputers or printers, **TechServ** can put you into the computer maintenance and repair business *quickly, economically and efficiently*. National research indicates that during a period of recession, computer maintenance and repair businesses will grow at twice the rate of hardware sales.

We provide a complete support program including a *proven marketing plan*.

**RECOGNITION**

Nationally recognized trademarks and logos give you immediate recognition as a professional computer repair specialist by being a **TechServ Authorized Computer Repair Center**.

**DOCUMENTATION**

We provide manuals, schematics, documentation and advanced diagnostic software.

**NEW HARDWARE**

CPU's: IBM, Apple, Compaq, and others.  
 Printers: Okidata, Epson, HP Lasers and others at huge discounts.

**PARTS AND BOARD REPAIR**

Single source for OEM/generic parts and board repair.  
 Order 7 days a week/24 hours a day. \$45 million in parts in stock, ready to ship anywhere, overnight if required.

**TRAINING**

Hands on training IBM/Compaq/Apple and all compatibles.

Level 1: 8088, 286, 386, and 486 trouble-shooting, configuration upgrades, advanced diagnostics

Level 2: High Impact/Laser Printers/Fax Machines

Level 3: Networking/Novel/Unix/Multi-user/Multi-tasking configuration/Installation/Maintenance/Repair.  
 Prepare for C.N.E. (Certified Network Engineer) test

**FINANCING**

Available for qualified buyers.

**OVER 275 DEALERS WORLDWIDE**

Find out why more electronic professionals are adding computer repair to their businesses or starting their own computer repair businesses.

**Call TechServ at (212)967-1865 now.**

**techserv** AUTHORIZED DEALER <sup>SM</sup>

*America's largest chain of independent, licensed computer repair centers*

©1992 Tech/Serv Corp.

253 West 28th Street, New York, NY 10001

CIRCLE 36 ON FREE INFORMATION CARD

**CONSUMER  
 ELECTRONIC  
 AND APPLIANCE  
 REPLACEMENT  
 PARTS HOTLINE**

**MOST MAJOR BRANDS STOCKED!  
 SPECIAL ORDERS WELCOMED**

**New parts for Major Appliances  
 (Washers, Dryers, Dishwashers,  
 Ranges, Refrigerators), VCRs,  
 Speakers, Camcorders, Audio,  
 Television, Remote Controls, If not  
 in stock we can order it for you!**

**1-800-676-7000**

**ALL MAJOR CREDIT CARDS ACCEPTED. TX & MA  
 customers call 313-451-3521. HIGHLAND PARTS,  
 909 N. SHELDON, PLYMOUTH, MI 48170**

**CABLE TV  
 DESCRAMBLERS!**

**CABLE KINGDOM!**



**\*JEROLD\* \*OAK\* \*HAMLIN\* \*ZENITH\*  
 \*PIONEER\* \*SCIENTIFIC ATLANTA\***

IN STOCK

6 MONTH WARRANTY! WE SHIP COD!  
 ABSOLUTELY LOWEST WHOLESALE/RETAIL PRICES!

.....FREE CATALOG.....

**J.P. VIDEO**

1470 OLD COUNTRY RD., SUITE 315  
 PLAINVIEW, NY 11803  
 NO N.Y. SALES

**CALL NOW! 1 (800) 950-9145**

CIRCLE 31 ON FREE INFORMATION CARD

July 1992, Popular Electronics

50S

## Tunable Notch Filters and Telephone Recording Equipment

### Eliminates...

- Beeping and Buzzing
- Severe Interference

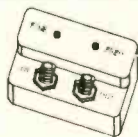

Assembled and Tested Filters  
as low as \$16 each  
in quantities of 10 or more

Kit Filters  
as low as \$8 each  
in quantities of 21 or more

Micro Thinc.

P.O. Box 63-6025

Margate, Fl 33063

Brochure \$1

(305)-752-9202

# BIG PROFITS IN VIDEO REPAIR!

**WORK FROM HOME-EARN \$85 HR!  
-NO EXPERIENCE NECESSARY-**

**Only requirement: That you possess average mechanical ability and a desire to learn**

With the tens of millions of VCRs and Camcorders in use, there currently is a serious shortage of trained techs to perform cleaning and repair jobs on these popular devices... Learn how you can start your own highly profitable, Home-Based video servicing business...

And since up to 95% of all VCR and Camcorder malfunctions are due to a simple mechanical or electro-mechanical failure, you need not spend months or even years of complicated study before starting paid, professional service work!

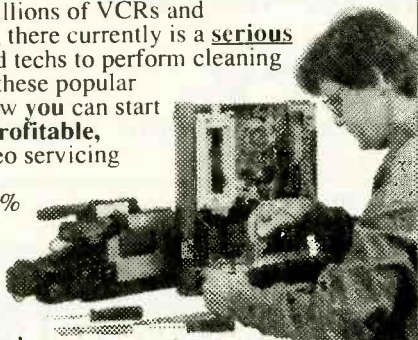

Train at Home in your Spare Time!

Let Viejo's Training Program show you how!

CALL TOLL-FREE

**1-800-537-0589**

24 HRS-7days a week  
or mail coupon today!

## VIEJO PUBLICATIONS, INC.

4470-107 Sunset Blvd., Suite 600  
Los Angeles, CA 90027-6304

Yes! **Rush** me your **FREE OPPORTUNITY KIT** today!  
(Check appropriate box)

- VCR Repair
- Camcorder Repair
- Advanced VCR Repair
- Fax Machine Repair
- Complete Training in Electronics

Name \_\_\_\_\_

Address \_\_\_\_\_

City/State \_\_\_\_\_ Zip \_\_\_\_\_

Dept. UPMC

CIRCLE 27 ON FREE INFORMATION CARD

\$49

Four motor

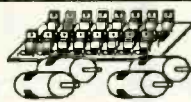

kit with computer interface



High speed  
Closed loop Galvo kit Squares  
to 180 hz, & Circles to 900 hz

\$99

**FREE**  
catalog of Kits

## Silicon Valley Surplus

1273 Industrial Prkwy West  
Bldg 460

Hayward, Ca .94544-7025

**510-582-6602**

CIRCLE 26 ON FREE INFORMATION CARD

## PE MARKET CENTER CLASSIFIEDS

### COMPUTER HARDWARE

**IBM PC** and laptops video digitizer. Connects to camcorder. 640 by 480 resolution. 256 gray levels \$89.98. Demo disk \$3.00. Information \$1.00. Colorburst, Box 3091, Nashua, NH 03061. Phone (603) 891-1588.

**PC PARTS**, Mbs, disk drives, hard drives etc. Overstocks, reconditioned. Multiwatt Systems, Box 1147, Burlington, MA 01803. (617) 229-9798.

### ANTIQUE ELECTRONICS

**TUBES, PARTS** (Old stock from closed or bankrupt Radio-TV stores). 16 page illustrated catalog: \$2.00. DIERS, 4276 North 50th Street #MC3, Milwaukee, WI 53216-1313.

### AUDIO-VIDEO-LASERS

**IBM PC** and laptops video digitizer. Connects to camcorder. 640 by 480 resolution. 256 gray levels \$89.98. Demo disk \$3.00. Information \$1.00. Colorburst, Box 3091, Nashua, NH 03061. Phone (603) 891-1588.

**VACUUM TUBE AUDIO SPECIALTIES.** Unconventional designs. Individually hand crafted, sonically superb, custom units for home, stage or studio. Stereo and monoblock tube amplifiers, any output, up to one kilowatt (or more if needed). Awesome, tube driven, motion feedback speakers for any critical listening or sound reinforcement application. Tube equalizers, electronic crossovers, preamps, mixers, etc. Finest quality at factory direct prices. Professional modification and repair services also available for vintage tube audio equipment. For further information, send LSASE to: Pneumatron, PO Box 99, Bethel, PA 19507.

**MASTERCARD AND VISA** are now accepted for payment of your advertising. Simply complete the Classified Ad order form and we will bill you.



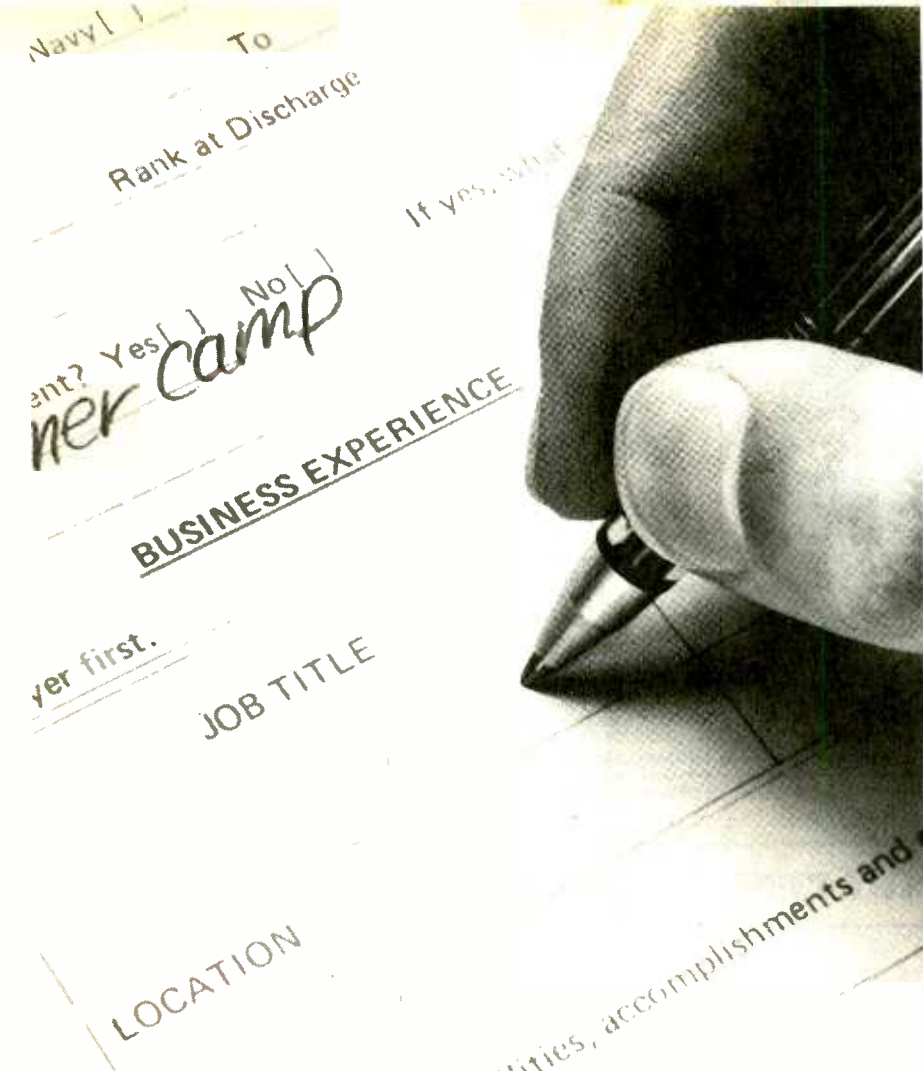

## A QUESTION EVEN STRAIGHT "A" STUDENTS FIND TOUGH TO ANSWER.

You're probably going to need help filling in some of the blanks about your future.

That's why there's Cooperative Education. A nationwide program that helps college students get real jobs for real pay, while they're getting an education.

Write Co-op Education, Box 999, Boston, MA 02115 for some answers to how to pay your way through college. And afterwards.

### Co-op Education.

You earn a future when you earn a degree.



A Public Service of This Publication ©1987 National Commission for Cooperative Education

**50% OFF**  
**A \$100 Savings Bond Costs Just \$50.**

It's easy to save with Bonds. You don't need a lot to start saving, and the money you invest will earn competitive interest rates for 30 years—guaranteed. Bonds bought today can even be tax free when used for college. For more information, call 1-800 US BONDS.



A public service of this publication

THE WORLD'S ONLY HOBBY  
KITS FOR CALLER I.D.

# CALLER I.D. AND FM TRANSMITTER KITS

WE ARE THE SOURCE FOR  
CALLER I.D.

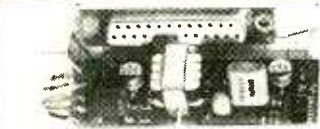

**WORLD'S ONLY CALLER I.D. ELECTRONICS KIT**  
SEE WHO'S CALLING BEFORE ANSWERING PHONE.  
DESIGNED FOR IBM-LIKE COMPUTERS, OUTPUTS RS-232  
SERIAL TO COM1 OR COM2 (1200,N,8,1). INTERFACES TO  
COMPUTER/PRINTER - DOES NOT HAVE ITS OWN DISPLAY.

DECODER & CABLES - KIT. IMPC-CID-1K \$39.95  
ASSEMBLED AND TESTED. IMPC-CID-1A \$45.50

IBM-COMPATIBLE SOFTWARE "TSR" POP-UP WINDOW  
PROGRAM SAVES CALL DATE, TIME & CALLING NUMBER  
TO DISK. IMPC-CID-SW \$7.50

"PRINCIPLES OF CALLER IDENTIFICATION"  
BOOKLET - COMPLETE EXPLANATION OF  
CALLER I.D. INCLUDES FREQUENCIES,  
DATA FORMATS, SIGNAL WAVEFORMS,  
& SEVERAL DECODER CIRCUIT DIAGRAMS.  
CALLER I.D. GUIDE - 36 PAGES, 8 ILLUSTRATIONS

IMPC-CID-1B \$18.50  
(WITH PURCHASE OF ANY CALLER I.D. PRODUCT - \$13.95)

**1-800-992-3511**  
ORDERS ONLY  
(SORRY, NO CATALOGS)

FULL SCHEMATICS AND PARTS LIST ALWAYS INCLUDED

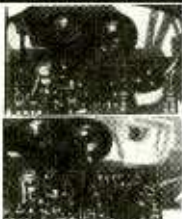

**EASIEST TO TUNE - BEST SOUND QUALITY**  
THESE ARE THE ONLY FM TRANSMITTERS  
WITH MULTI-TURN TUNING AND TRUE  
VARACTOR-DIODE OSCILLATORS.  
PRE-EMPHASIS NETWORK GUARANTEES  
PROFESSIONAL SOUND QUALITY. SURFACE  
MOUNT COMPONENTS ARE PRE-ASSEMBLED  
TO THE BOARD.

SUPERSENSITIVE MICROPHONE  
TRANSMITTER. IMPC-WM-1 \$39.95

UNDETECTABLE PHONE TRANSMITTER  
AUTOMATIC SHUTOFF WHEN TELEPHONE IS  
NOT IN USE. IMPC-WTT-1 \$39.95

Caller I.D. not yet available everywhere. Check with your local phone company.

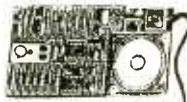

### RF FIELD-STRENGTH DETECTOR/METER

YOU CAN USE ANY FM RADIO TO TUNE THE  
FREQ. OF FM TRANSMITTERS, BUT YOU NEED  
THIS DEVICE TO TUNE THE OUTPUT TANK AND  
ANTENNA. SHOWS RELATIVE STRENGTH OF  
RF FIELDS FROM 60 TO 180 MHz. USE WITH  
ANY TRANSMITTER KIT TO TUNE FOR MAX  
OUTPUT AND CHECK FOR EFFECTIVE ANTENNA  
PLACEMENT.

VISUAL RF FIELD-STRENGTH CHECKER,  
ADJUST YOUR TRANSMITTER FOR BRIGHTEST  
LED OUTPUT. IMPC-RFV-1 \$24.95

AUDIO-VISUAL VERSION, ADJUST YOUR  
TRANSMITTER FOR BRIGHTEST LED OUTPUT  
OR HIGHEST PITCH TONE. IMPC-RFA-1 \$29.95



### ADD A COMPUTER INTERFACE TO YOUR CALLER I.D. BOX

EASY TO INSTALL KIT ADDS RS-232 DATA  
OUTPUT PORT TO YOUR EXISTING CLASSIC  
CALLER I.D. OR ICLID® DISPLAY BOX. USE  
WITH OPTIONAL SOFTWARE OR WRITE YOUR OWN  
PROGRAMS TO STORE THOUSANDS OF INCOMING  
PHONE NUMBERS TO AN ASCII DISK FILE. COMPLETE  
INSTALLATION INSTRUCTIONS & DIAGRAMS.

COMPUTER INTERFACE KIT, OPTO-COUPLED  
DESIGNED TO COMPLY WITH FCC PARTS 15 AND 68.

IMPC-CID-1M \$39.95  
OR SHIP YOUR UNIT TO US, WE INSTALL AND TEST, 6  
Mo. WARRANTY. IMPC-CID-2M \$62.50

COMPLETE MODIFIED UNIT, 1 YEAR WARRANTY.  
IMPC-CID-3M \$139.50

**INTERNATIONAL MICROPOWER CORP.**  
3305 W. Spring Mountain Road, Suite 60  
Las Vegas, NV 89102  
VISA/MC (COD add \$6. All others add \$2.50 S/H)

CIRCLE 25 ON FREE INFORMATION CARD

## PE MARKET CENTER CLASSIFIEDS

### SURVEILLANCE

COUNTERSURVEILLANCE Electronic Devices

Miniature Transmitter Kits... \$29.95

Voice Changers, Phone Scramblers, Vehicle Tracking, Phone  
Recording Systems, Bug & Phone Tap Detectors, & More!

CALL IDENTIFIER device \* displays callers phone number  
before you answer with date & time of call... \$49.95

FOR CATALOG SEND \$5.00 TO...  
P.O. Box 337, Buffalo, NY 14226 (716) 691-3476

### REPAIRS-SERVICES

**CAMERA OWNERS.** Enjoy your hobby, save big  
money. Professional camera repairman shows  
you how. Make your own repairs. Easy once you  
understand. Only \$9.00 plus \$1.00 S&H. C. Tate,  
Box 550, Okay, OK 74446. Guaranteed.

### COMPUTER SOFTWARE

**ELECTRONIC CIRCUIT and construction project  
references.** PC/MSDOS software database,  
1500 circuit and project citations compiled from 5  
electronics magazines, 27 years publication.  
Search by subject or keyword, both disks in-  
cluded, HD required. \$19.95. JRH & Associates,  
4255 S. Buckley Rd. 181, Aurora, CO 80013. (303)  
699-5835.

**ELECTRONICS SOFTWARE.** From \$2.00 per  
disk. IBM 5.25". Free catalog on disk.  
Stackhouse, POB 502, Dayton, OH 45401-0502.

"XFMR" TRANSFORMER DESIGN PROGRAM  
FOR AN IBM - 50 HZ TO 500KHZ STEP BY  
STEP GUIDANCE, FOR THE ENGINEER OR  
TECHNICIAN WHO DESIGNS ONE OR TWO  
TRANSFORMERS PER YEAR. You input fre-  
quency, primary voltage, secondary voltages, cur-  
rents, topology, core type, current and winding  
densities. Outputs include core number, wires size  
turns, temperature rise, Leakage L, core dimen-  
sions, layers, turns/layer etc. Disk data includes  
details on dozens of cores. \$59.50 Nationwide  
Engineering Co. Inc., 14181 Bent Tree Ct., Orlan-  
do, FL 32826. Phone (407) 277-6424.

**US CONSTITUTION,** on-line, complete, for PC  
compatibles. Independently study YOUR rights  
using interactive search and indexing features.  
On-line helps. More. Four 360K or two 720K di-  
skette set. Only \$9.95. Specify size. TCnbp Com-  
pany, PO Box 516, Olla, LA 71465.

**CROSS PART DATABASE SOFTWARE:**  
Crosses common electronic component part  
numbers to SYLVANIA and PHILIPS replace-  
ments. Contains approximately 31,000 part num-  
bers. 3-3 1/2 inch disks. **CROSS PART IDENTIFY  
SOFTWARE:** Crosses prefixes of electronic com-  
ponent part numbers to their manufacture.  
**DATABASE** - \$35.00 **IDENTIFY** - \$10.00 MC,  
Visa, check, money orders accepted. **CPS SOFT-  
WARE,** PO Box 28, Blackwell, OK 74631. (405)  
363-4330.

### TEST EQUIPMENT

**TEST EQUIPMENT.** Used scopes, generators  
etc. Must clean out shop to make room for more  
modern test equipment. SASE for list. C. Tate,  
Box 550, Okay, OK 74446.

### BUSINESS OPPORTUNITIES

**LET THE Government** finance your small busi-  
ness. Grants/loans to \$500,000.00. Free  
recorded message: (707) 448-0270. (KJ8)

# TODAY'S THE DAY

Stop Smoking.



American Heart Association

# RADON. THE HEALTH HAZARD IN YOUR HOME THAT HAS A SIMPLE SOLUTION.

Call  
**1-800-SOS-RADON**  
to get your Radon  
test information.





# ALFA ELECTRONICS

QUALITY TEST EQUIPMENT  
AFFORDABLE PRICE



**DMM 2360**  
**\$129.95**  
**DMM + LCR Meter**  
**Most Versatile DMM**  
Inductance: 1 $\mu$ H-40H  
Capacitance: 1pF-40 $\mu$ F  
Frequency: 1Hz - 4MHz  
Temperature: -40 - 302°F  
Logic Test: 20MHz  
Diode, Continuity  
Volt, Amp, Ohm  
3999 count display  
Peak Hold  
Auto power off



**DMM 135**  
**\$69.95**  
**DMM measures Temperature**  
0° - 1400°F, -20°-750°C,  
0.1°, 1° resolution  
Capacitance: 1pF-20 $\mu$ F  
Resistance: 0.1 $\Omega$ -2000M $\Omega$   
Volt, Current, Continuity  
Diode, hFE tests  
Type K thermocouple included



**Clamp Meter**  
**3012 \$79.95**  
**AC current**  
**10mA-1000Amp**  
AC current range 20, 200 1000A,  
good for both high and low current  
ACV: 200V, 750V, DCV: 1000V  
Resistance: 200 $\Omega$ , 20k $\Omega$ , Continuity,  
diode check  
Line frequency test: 0 - 2000Hz, with  
1Hz resolution  
Peak Hold, Data Hold  
Comes with leads, hard carrying  
case



**LCR Meter 814**  
**\$199.95**  
**The Best Handheld LCR**  
Inductance: 0.1 $\mu$ H-200H  
Capacitance: 0.1pF-20,000 $\mu$ F  
Resistance: 1m $\Omega$ -20M $\Omega$   
1% basic accuracy  
Dissipation factor indicates leakage  
in capacitor and Q factor in inductor  
Zero adjustment to reduce  
parasitics from test fixture  
Very good for high frequency RF  
and surface mount components.



**LCR Meter 195**  
**\$119.95**  
**Very popular LCR**  
Inductance: 1 $\mu$ H-200H  
Capacitance: 0.1pF-200  $\mu$ F  
Resistance: 0.01 $\Omega$ -20M $\Omega$   
Basic accuracy: R: 1%, C: 2%,  
L: 3%  
Test frequency 1 kHz

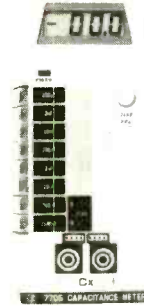

**Capacitance Meter**  
**7705 \$57.95**  
0.1 pF-20,000 $\mu$ F in 9 ranges  
0.5% basic accuracy  
Zero adjustment  $\pm$  20pF to  
compensate parasitics from test  
fixture



**20 MHz Oscilloscope with Delay Sweep PS-205**  
**\$419.95**  
Dual Trace, Component test, 6" CRT, X-Y Operation, TV Sync, Z Modulation, CH2 Output, Graticule Illum, 2 probes x1, x10  
**PS-200 20MHz BASIC \$339.95**  
**PS-405 40MHz DELAY \$559.95**  
**PS-605 60MHz DELAY \$749.95**

**20 MHz Digital Storage Oscilloscope DS-203**  
**\$749.95**  
Switchable between digital and analog  
2 K word per channel storage  
Sampling rate: 10 M sample /sec  
8 bit vertical resolution (25 Levels/div)  
Expanded Timebase 10ms/div - 0.5 s/div  
Refresh, Roll, Save all, Save CH2, Pre-Trig  
Plotter Control

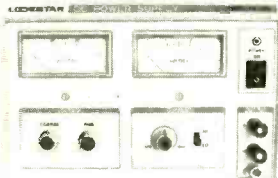

**Power Supply**  
**PS-303 \$169.95**  
**0-30 VDC, 0-3A output**  
0.02% + 2mV line regulation  
0.02% + 3mV load regulation  
1 mVrms noise and ripple  
Short circuit and overload protected

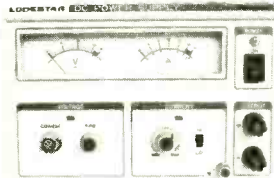

**Power Supply**  
**PS-1610 \$299.95**  
**0-16 VDC, 0-10A output**  
Constant voltage & constant current mode  
0.2%+2mV line regulation  
0.04% +2mV load regulation  
1mVrms noise and ripple  
Short circuit and overload protected

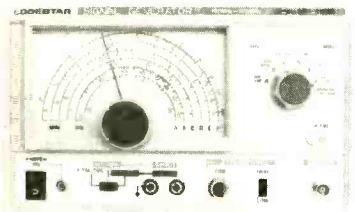

**RF SIGNAL GENERATOR**  
**SG-4160B \$124.95**  
100 kHz-150MHz sinewave in 6 ranges  
Output 100mVrms to 35 MHz  
Internal 1kHz, External 50Hz-20kHz modulation  
Audio output 1 kHz at 1 Vrms

**AUDIO GENERATOR**  
**AG-2601A \$124.95**  
10Hz - 1MHz in 5 ranges  
Output: 8Vrms sine, 10Vp-p squarewave  
Synchronization:  $\pm$ 3% of oscillation  
frequency per Vrms  
Output distortion: 0.05% 500Hz - 50kHz  
0.5% 50Hz - 500kHz  
Output impedance: 600 ohm

**FUNCTION GENERATOR**  
**FG-2100A \$169.95**  
0.2 Hz - 2 MHz in 7 ranges  
Sine, square, triangle, pulse and ramp  
Output: 5mV-20Vp-p  
1% distortion  
DC offset  $\pm$  10V  
VCF: 0-10V control frequency to 1000:1



**RF SIGNAL GEN./COUNTER**  
**SG-4162AD \$239.95**  
Generates RF signal same as SG-4160B  
Frequency counter 1Hz-150MHz  
Sensitivity <50mV  
For internal and external sources

**AUDIO GEN./COUNTER**  
**AG-2603AD \$239.95**  
Generates audio signal same as AG-2601A  
Frequency counter 1Hz-150MHz  
Sensitivity <50mV  
For internal and external sources

**FUNCTION GEN./COUNTER**  
**FG-2102AD \$239.95**  
Generates signal same as FG-2100A  
Frequency counter 4 digits  
Feature TTL and CMOS output

**ALFA ELECTRONICS**  
P.O. BOX 8089 Princeton, NJ 08543

**(800) 526-ALFA**  
**(609) 275-0220**  
15 DAY MONEY BACK GUARANTEE  
1 YEAR WARRANTY  
Visa, Master Card, American Express, COD, Purchase Order Welcome

CIRCLE 34 ON FREE INFORMATION CARD

# Welcome to. . .

# SCIENCE PROBE!

The Amateur Scientist's Journal

Embark on an irresistible new journey into the realm of mystery, challenge, and exploration! The perfect magazine for the budding scientist, the serious amateur, the professional who would like to relax, and those who simply want to gaze at the stars.

Articles to appear in upcoming issues of **Science PROBE!** are:

**How an Amateur Mapped the Milky Way**  
**Make your own Seismometer**  
**Operate a Solar-powered Weather Station**  
**Grow Crystals Automatically**  
**Experiment with a Saltwater Aquarium**  
**How to Keep a Science Notebook**

If you're fascinated by science in all its many forms, if you are compelled to experiment and explore, then **Science PROBE!** is your kind of magazine!

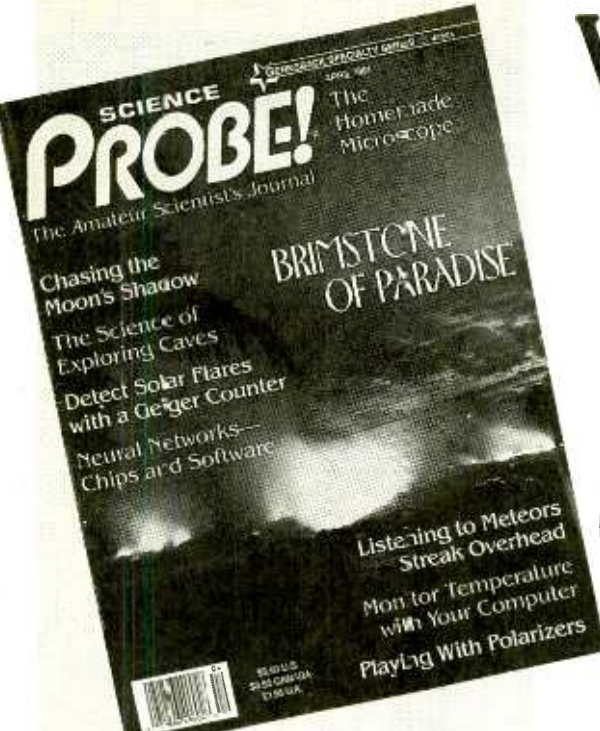

**Science PROBE!** — the *only* magazine devoted entirely to Amateur Scientists! If you are fascinated by science in all its many forms . . . if you can't stay away from a microscope, telescope, calipers, or test tube — we invite you to share the wonders in every issue of **Science PROBE!** You will join a community of Amateur and Student Scientists who enthusiastically seek scientific knowledge or follow scientific pursuits for their own sakes and not merely as a profession.

Obtain your next issue of **Science PROBE!** by visiting a quality Newsstand, Convenience Store, or Supermarket or by reserving your personal copy through the mail by completing the coupon below.

From your very first issue of **Science PROBE!** you will be involved in a world of scientific facts, experiments, and studies pursued by amateur scientists who are university students, investors, academicians, engineers, or office workers, salesmen, farmers—whose *quest* is to probe into the mysteries of science and reveal them to all.

Plan to become a **Science PROBE!** reader!

**Science PROBE!**  
500-B Bi-County Boulevard  
Farmingdale, NY 11735

Please forward my copy of **Science PROBE!** as soon as it comes off the press. I am enclosing \$3.50-U.S.A. (\$4.23-Canada-includes G.S.T.) plus \$1.00 for shipping and handling. Better still, please enroll me as a subscriber and send the next four (4) quarterly issues of **Science Probe**. I am enclosing \$9.95-U.S.A. (Canada: \$16.00—includes G.S.T.)

Next Issue Only       Next Four Issues (1 Year)

Offers valid in the U.S.A. and Canada only. No foreign orders.

Name \_\_\_\_\_

Address \_\_\_\_\_

City \_\_\_\_\_ State \_\_\_\_\_ ZIP \_\_\_\_\_

All Orders payable in U.S.A. Funds only.

7PG27

**ON SALE AT QUALITY NEWSSTANDS, CONVENIENCE STORES AND SUPERMARKETS**  
**GET YOUR COPY TODAY—\$3.50-U.S.A.—\$3.95-Canada**



Here is a chance for you to add an accurate, but inexpensive, digital frequency counter to your electronics arsenal

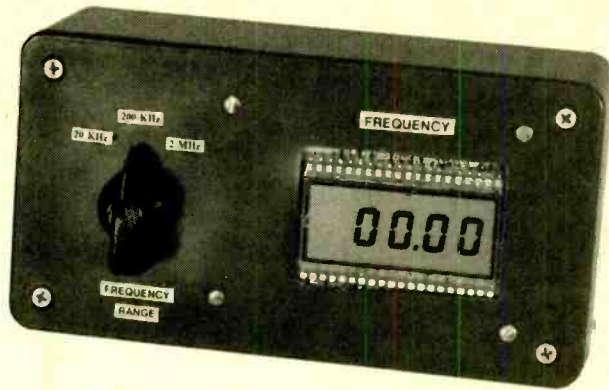

# Build a Portable 2-MHz Frequency Counter

BY ANTHONY J. CARISTI

Frequency counters have been available to electronics engineers and technicians for many years. But for the electronics hobbyist, particularly the newcomer, the cost of such frequency-measuring instruments—usually upwards of \$100 for a basic unit—can be prohibitive. Fortunately, even those on a meager budget can afford the *Portable Frequency Counter*. The counter is an easy-to-build, basic (no-frills) unit that can measure frequencies up to 2 MHz with a resolution of 1 Hz. That makes it a handy instrument for audio, ultrasonic, and low radio-frequency applications.

**About the Circuit.** Figure 1 shows a functional block diagram of the frequency counter. The counter is made up of several subassemblies: a crystal oscillator, a pair of divide-by-10 counters, a 16-stage binary counter, a trigger circuit, a latching circuit (RS flip-flop), an analog amplifier, a counter/display-driver circuit, and, of course, an LCD readout.

The crystal oscillator, which provides a timing reference, generates a high-frequency signal that is twice divided by ten to provide three selectable frequencies. The selected frequency is fed to the 16-stage binary counter (which further divides the selected frequency by  $2^{16}$ ). The output

of that binary counter is fed to the latching circuit as a stop (or reset) signal.

A low-frequency trigger oscillator periodically generates a start (or set) signal, which is also fed to the latch. The latch, in turn, outputs a pulse of known width (called a gate), which is fed to the counter/display driver and is used to initiate the measurement.

The input to the circuit (a signal of unknown frequency) is fed to an analog amplifier, which boosts the signal sufficiently to operate the input to the counter/display driver. The counter/display driver counts the number of pulses applied to its input during the time that the gate is active. The total number of pulses is then decoded and used to light the appropriate segments of a large  $3\frac{1}{2}$ -digit LCD readout.

**A Closer Look.** Figure 2 is a complete schematic diagram of the frequency counter. The crystal oscillator, comprised of NOR gate U3-c and its associated components, is biased linearly by resistor R5, while crystal XTAL1 (connected from U3-c's input to its output), causes U3-c to oscillate at the crystal's series-resonant frequency. The output of U3-c is buffered by U3-d and divided along two paths. In one path, the signal is delivered to one terminal of S2-b (half of a double-

pole, three-throw switch); in the other path, the signal is fed to U6-a ( $\frac{1}{2}$  of a CD4518 dual synchronous up counter), which is configured for divide-by-10 operation.

The output U6-a is also divided along two paths, with one path going to a second terminal of S2-b, and the other going to U6-b (also configured for divide-by-10 operation). Together, the two halves of the synchronous counter provide a total frequency division of 100. The output of U6-b is fed to a third terminal of S2-b, providing three selectable frequency ranges. Those selectable frequencies determine the gate time of the counter (10, 100, or 1000 milliseconds). The selected frequency is fed to U4, the first of two CD4040B ripple-carry binary counters. The output of U4 is fed to U5 (the second CD4040B ripple-carry binary counter). Together U4 and U5 provide a frequency division of  $2^{16}$ , or 65,536.

The output of U5 is fed to pin 6 of U3-b, which with U3-a forms a bistable multivibrator (RS flip-flop), that is used to control the start/stop sequence of the counter. The RS flip-flop is reset by the output of U5 and set by the output of U1, a CMOS 555 oscillator/timer that is configured for low-frequency, astable operation. The set and reset inputs of the flip-flop are labeled "start" and "stop," respectively.

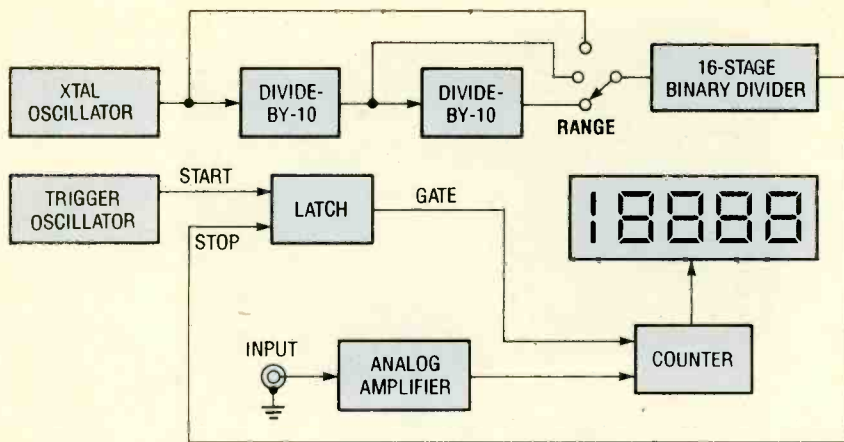

Fig. 1. The frequency counter is made up of several subassemblies: a crystal oscillator; a pair of divide-by-10 counters; a 16-stage binary counter; a trigger circuit; a latching circuit (RS flip-flop); an analog amplifier; a counter/display driver circuit; and, of course, an LCD readout.

The negative-going output of U1, which is used to initiate the count sequence to periodically update the frequency display, is inverted by U2-d before application to U3-a. (The inversion is accomplished by tying one input to U2-d high, and applying a low to the other pin. That forces the output of U2-d to go high, each time a U1 outputs a low.) The resulting positive-going pulse drives the output of U3-a at pin 3 low. That low, which is applied to pin 11 of both U4 and U5, causes U4 and U5 to begin the count sequence. The output of U3-a remains in a low state until the flip-flop is reset at the end of the count (65,535).

At the end of the count, pin 5 of U5 goes high. That high is applied to pin 6 of U3-b, forcing its output high, which divides along two paths. In one path, the signal is fed to pin 2 of U3-a, forcing its output high. That inhibits U4 and U5, resetting them to zero to await the next trigger pulse. In the other path, the signal (a positive-going pulse of precise width—10, 100, or 1000 milliseconds, depending on the selected clock frequency) is fed to pin 31 of U8 as a gate-control signal.

Switch S2-a (the second half of the DP3P switch) is used to set the decimal point for the higher frequency ranges (200 kHz and 2 MHz). Decimal-point activation is accomplished through two XOR gates (half of a CD4030B quad 2-input XOR gate, U2-a and U2-b), which are used as conditional inverters. (An XOR gate produces a logic 1 output only when the logic levels at its two inputs are different from each other.) Depending upon the setting of S2-a, the selected unit inverts the

no decimal point since the 4½-digit readout will display frequency directly in hertz. When the counter is set to the 20 kHz range, S2-a activates field-effect transistor (FET) Q1. Activating Q1 places C3 in parallel with C4, thereby lowering the operating frequency of U1 to about 0.5 Hz to accommodate the 1-second gate time that is required for the 20-kHz range.

The input frequency is fed through J1 to an analog amplifier, built around Q2 and Q3. Transistor Q2 (a FET that provides a high input impedance to the signal source) is used to drive Q3 (which is configured as a common-source amplifier). The total gain provided by Q2 and Q3 is sufficient to

## PARTS LIST FOR THE PORTABLE FREQUENCY COUNTER

### SEMICONDUCTORS

- U1—LMC555CN CMOS oscillator/timer, integrated circuit
- U2—CD4030B quad 2-input XOR gate, integrated circuit
- U3—CD4001B quad 2-input NOR gate, integrated circuit
- U4, U5—CD4040B 12-stage ripple-carry binary counter, integrated circuit
- U6—CD4518B dual decade counter/divider, integrated circuit
- U7—AN78L05 5-volt, 100-mA, voltage regulator, integrated circuit
- U8—ICM7224IPL counter/display-driver, integrated circuit
- Q1—BS170 N-channel enhancement MOSFET
- Q2—MPF102 (or SK9164) N-channel JFET
- Q3—2N3906 general-purpose PNP silicon transistor
- DISP1—4½-digit LCD readout (Digi-Key LCD-004 or equivalent)

### RESISTORS

- (All fixed resistors are ¼-watt, 5% units.)
- R1, R2—220,000-ohm
  - R3—100,000-ohm
  - R4—470,000-ohm
  - R5—10-megohm
  - R6, R8—1-megohm
  - R7—10,000-ohm
  - R9, R10—1000-ohm

- R11—470-ohm
- R12—4700-ohm
- R13—47,000-ohm

### CAPACITORS

- C1, C2, C5, C7—0.1-μF, ceramic-disc
- C3—2.2-μF, 10-WVDC, electrolytic
- C4—1-μF, 10-WVDC, electrolytic
- C6—270-pF, ceramic-disc
- C8—330-μF, 6-WVDC, electrolytic

### ADDITIONAL PARTS AND MATERIALS

- B1—9-volt transistor radio battery
- XTAL1—3.2768-MHz crystal
- S1—SPST toggle or slide switch
- S2—DP3T rotary switch
- J1—Phono or BNC jack
- Printed-circuit materials, enclosure (Radio Shack 270-223 or similar), 9-volt battery connector, #24-gauge insulated stranded hook-up wire, solder, hardware, etc.

**Note:** The following parts are available from A. Caristi, 69 White Pond Road, Waldwick, NJ 07463. Digital and counter boards, \$11.95 each; U1, U2, U3, and U7, \$2.00 each; U4, U5, U6, \$2.75 each; U8, \$21.50. Please add \$3.00 postage/handling. New Jersey residents please add appropriate sales tax.

backplane signal, which is then fed to its connected decimal point when required.

The lowest range, 20 kHz, requires

drive U8 (an ICM7224IPL high-performance 4½-digit counter) with input signals as low as .25-volt rms.

Integrated circuit U8 contains a



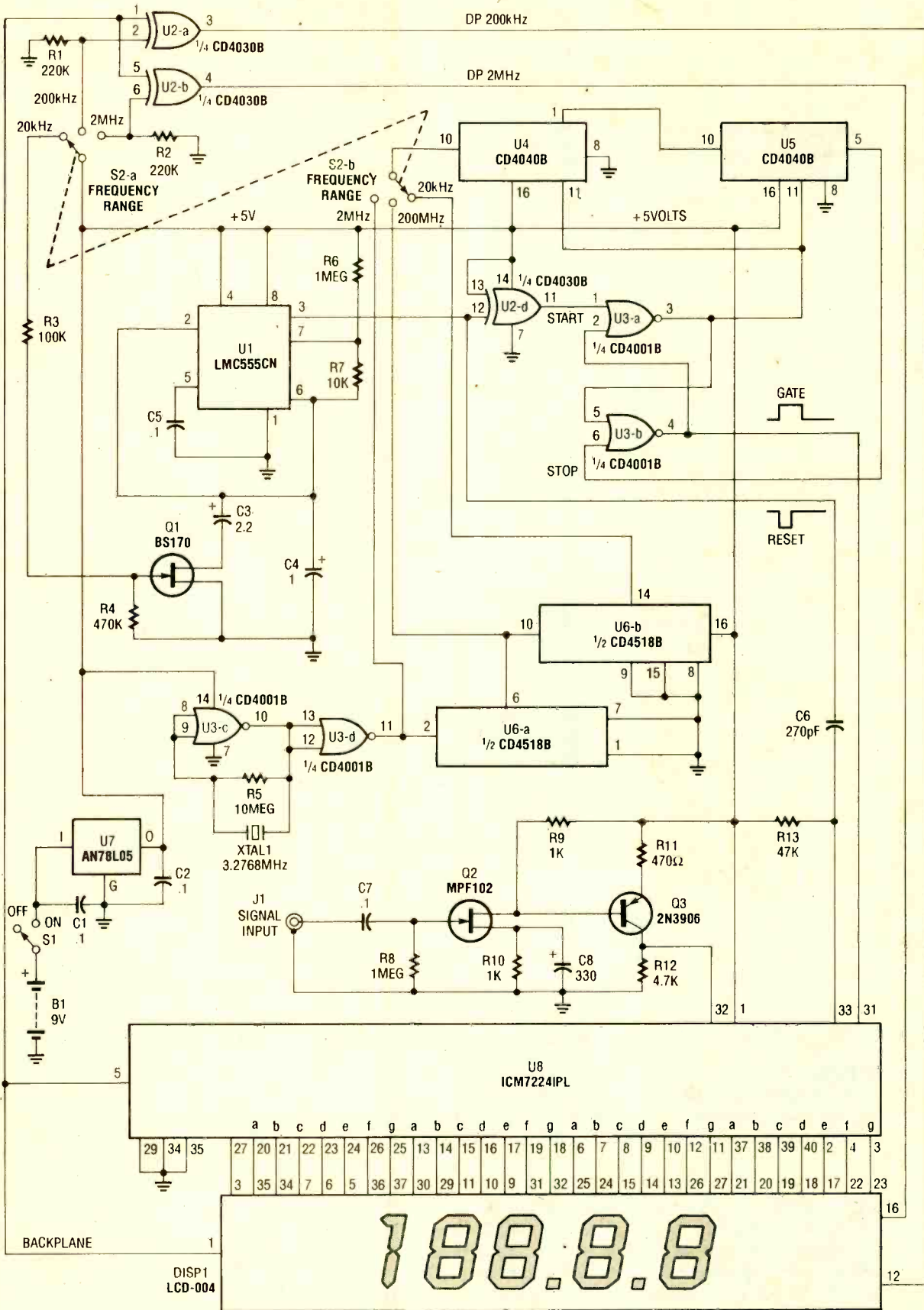

Fig. 2. The circuit contains a crystal oscillator that's built around U3-c and XTAL1, which provides the primary timing-reference signal. That signal is then divided twice to provide two additional timing references, giving the circuit three selectable timing references.

counter, decoders, output latches, and LCD display drivers. When the count sequence is initiated by U1, U8 is reset to a count of zero by the narrow, differentiated, negative pulse fed to its reset terminal, pin 33. At the same time, the positive gate pulse generated by the flip-flop (U3-a and U3-b) is fed to pin 31, allowing U8 to accumulate any pulses that appear at the clock input, pin 32.

The decoders and latch circuits within U8 are continuously enabled so that the LCD readout provides an instantaneous indication of the accumulated count. That can easily be demonstrated by applying a relatively low frequency, such as 100 Hz, to the input of the counter. A steady display of measured frequency is maintained during the 1/2 to 1-second time between trigger pulses, providing a digital readout similar to that of a DVM.

Counter U8 is capable of counting beyond its full-scale display of 19999. That feature enables the circuit to measure frequencies as high as 2 MHz with a resolution of 1 Hz using the lowest scale of the circuit (1 second gate time). That permits the four least significant digits to properly indicate the last four digits of the incoming frequency. If an overflow condition occurs, the most-significant digit of the display remains 1.

The circuit is powered by a common 9-volt transistor-radio battery. Current consumption is about 7 milliamperes, which allows 20 or more hours of operation using an alkaline battery. A fixed 5-volt regulator, U7, ensures a constant power-supply voltage to the entire circuit as the terminal voltage of the battery falls with use.

**Construction.** The author's prototype of the frequency counter was assembled on two printed-circuit boards, which the author refers to as the digital board and the counter/display board. Full-size templates of the circuit-board patterns are shown in Fig. 3 and Fig. 4, respectively. Parts placement diagrams for the digital board and the counter/display board are shown in Fig. 5 and Fig. 6, respectively.

When assembling the boards, be sure that all parts are correctly placed, paying special attention to

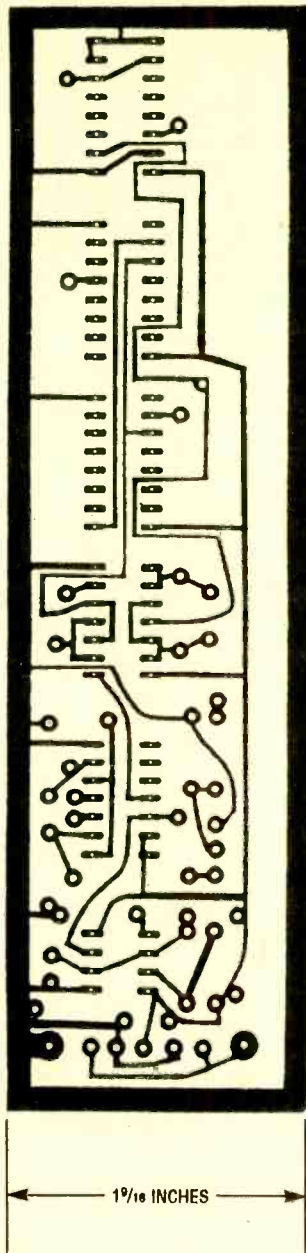

Fig. 3. The author's prototype of the frequency counter was assembled on two printed-circuit boards; the digital board and the counter/display board. A full-size template of the digital board is shown here.

the polarized components. Double check to be sure, since just one misplaced component will result in an inoperative circuit and may cause damage to itself or other parts.

Assemble the digital board first, since it is the simplest of the two boards. It is recommended that sockets be provided for all of the DIP IC's. Sockets are worth the small extra expense should the circuit ever need servicing. Start by installing the appropriate size IC sockets at the locations

indicated in Fig. 5. Do not install any of the IC's in their sockets until instructed to do so (which will be during the checkout procedure). Don't forget to install the board's only jumper connection, which stretches from pin 6 of U3 to pin 5 of U5. Figure 7 gives pinout diagrams for the three transistors and the LCD readout listed in the Parts List.

After all the components have been installed on the digital board, connect a 9-volt battery clip to the board. Check the board for the usual construction errors; solder bridges, cold solder joints, misconnected or misoriented components, etc. Once that is done, lay the digital board to the side and go to work on the counter/display board.

Turning your attention to Fig. 6, note that the counter/display board's assembly is a two-part operation; component placement and jumper connections. Separate placement diagrams are provided for the two operations; Fig. 6A for the component placements and off-board wiring, and 6B for the jumper connections. Socketing the LCD module is optional. If a socket is desired, one can be fabricated from a 40-pin DIP socket by cutting it in half lengthwise. If you opt to socket the display, use a wire-wrap type, since longer terminals will be required to allow room for soldering the socket to the copper side of the board.

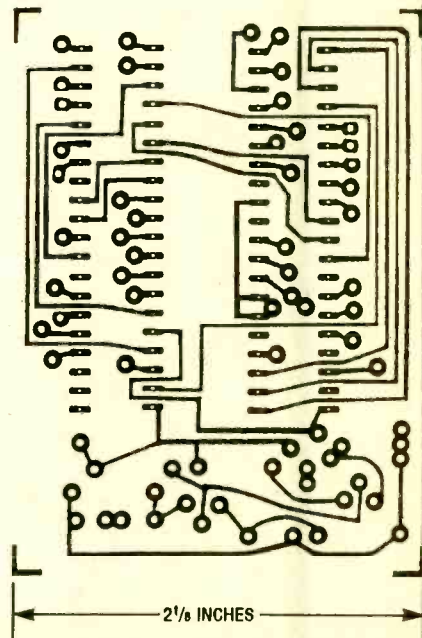

Fig. 4. Here's the full-size template for the counter/display board.



Begin the display-board assembly by first installing a 40-pin socket at the position labeled U8. Then install all the board-mounted components, as shown, with the exception of the display (DISP1), which is indicated in Fig. 6A by a dashed line. Because the display (or a cut socket as mentioned) is to be mounted to the foil side of the board, it must be installed last.

Once the board-mounted components (with the exception of DISP1) have been installed, connect the jumpers as shown in Fig. 6B. Be very careful—there are 19-jumper connections, making it very easy to misconnect one or two. After installing the jumpers, connect lengths of insulated hook-up wire (5- or 6-inch lengths should be sufficient) to the points indicated for connection to the digital board. Use shielded microphone wire (near C7) for connection to the input jack, J1. Shielded microphone wire is specified for that connection to help prevent unwanted

as not to touch the component connections from the parts mounted to the other side. It is necessary to handle things that way to provide sufficient room for soldering. Mounting the display in that manner allows the board assembly to be mounted directly to the panel of the selected enclosure so that the readout can be viewed through a rectangular opening.

In any event, do not install the display until the rest of the board has been completely assembled, and checked. Visually check your work, and then do a continuity check for possible shorts, opens, bad solder joints, and misconnected jumper wires. That precaution is necessary because if the display board has an assembly or wiring defect, it may be necessary to remove the LCD module in order to repair the fault. If you find no defects in the assembly or the wiring, install the display.

Once that's done, begin preparing

enclosure). The display board may be attached to the cover of the enclosure using suitable hardware.

In the author's prototype, the range switch (S2) was mounted to the front panel of the enclosure, just to the right side of the counter/display board. The power switch and input jack were mounted to a side panel of the enclosure. It is best to mount J1 as close to the board's input as possible to reduce the length of the wire that connects J1 to the circuit board.

Once the project is completed, inspect it thoroughly for any possible wiring mistakes or bad solder joints. It is far easier to correct a fault at this time rather than later on if you discover that your counter does not work.

**Checkout.** Checking out the counter will require at least a digital voltmeter or VOM with an input resistance of 1 megohm or more. A signal source, such as an audio or RF oscillator, or a function generator, can be used to

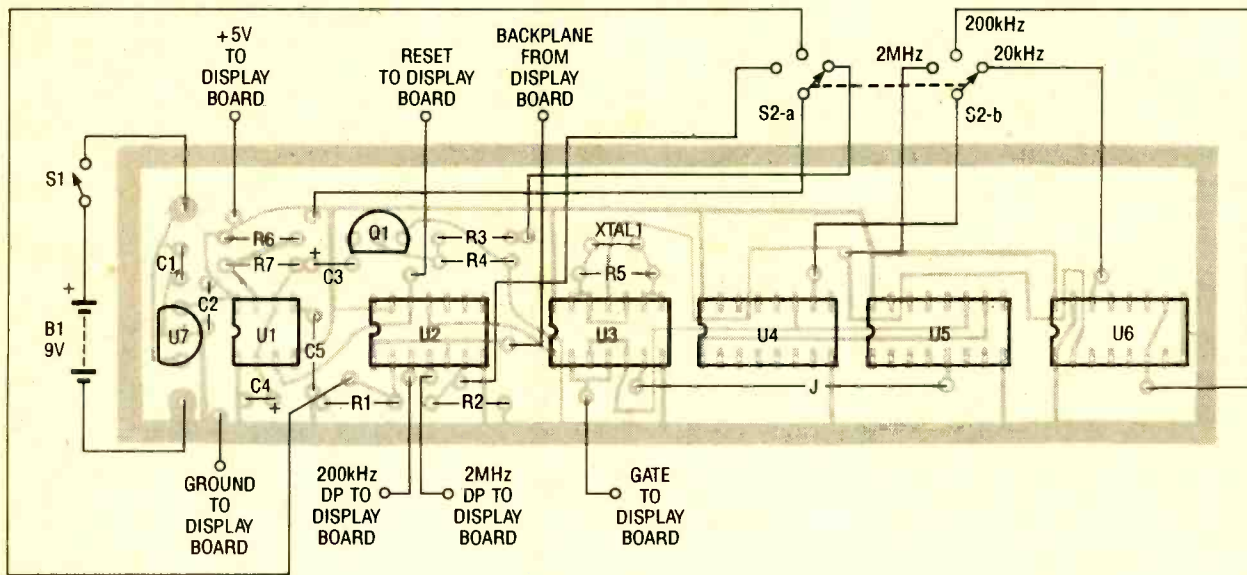

Fig. 5. Assemble the digital board first, guided by this parts placement diagram. It is recommended that sockets be provided for all of the DIP IC's, and make sure that all parts are correctly placed, paying special attention to the polarized components.

pickup from the high-frequency circuits in the unit. It's a good idea to label each wire as it's installed in order to avoid confusion later when the wires are connected to the digital board.

Once all components, jumper connections, and lengths of wire are in place, mount the display (or a cut socket as mentioned) to the foil side of the board with enough elevation so

the enclosure. The digital board was designed to fit into the enclosure—which has molded PC slots—that is specified in the Parts List. As for the display board, it will be necessary to cut a 1 $\frac{3}{8}$ - by 2 $\frac{1}{16}$ -inch rectangular opening into the cover through which to view the readout. Try to keep the display board more-or-less centered, top-to-bottom, to one side of the lid (which serves as the front panel of the

provide an input signal to check the operation of the counter on all ranges. If necessary, a general-purpose oscilloscope may be required to troubleshoot the circuit in the event that it malfunctions.

At this point, there should be no IC's occupying the DIP sockets. Connect a fresh 9-volt battery to the battery connector. Turn on the power and measure the regulated DC voltage at the

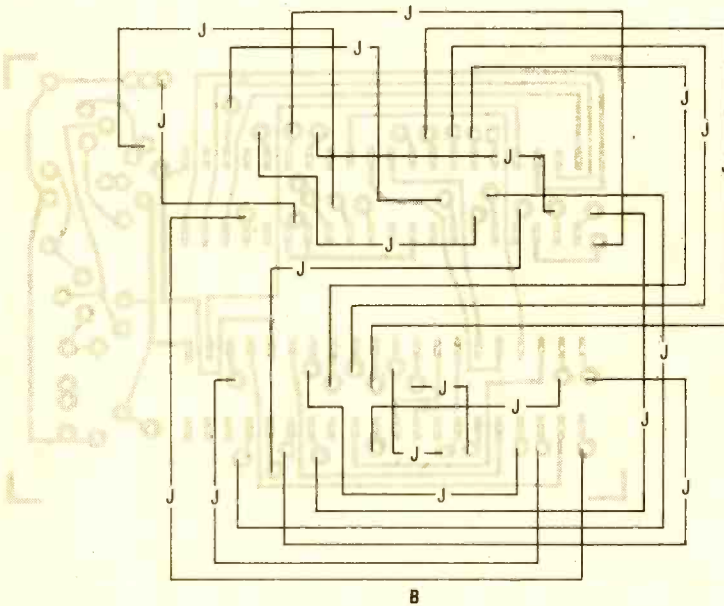
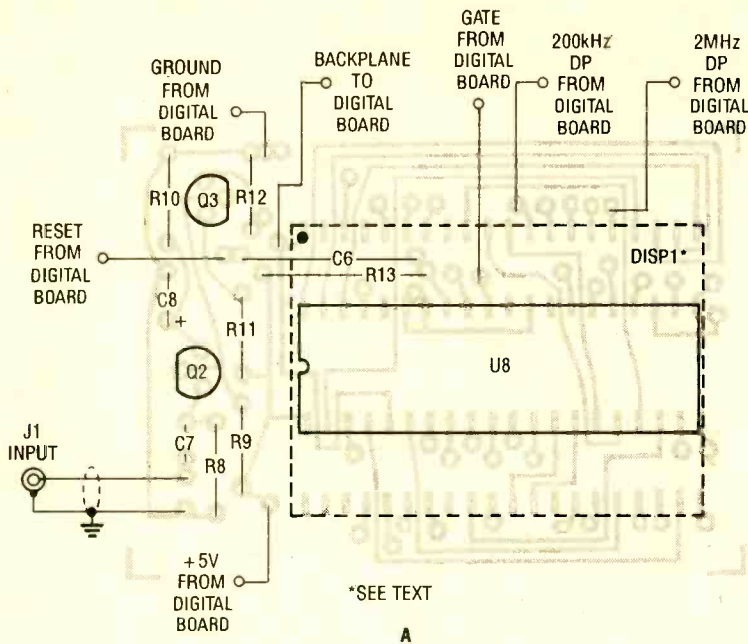

Fig. 6. Note that the counter/display board's assembly is a two-part operation; component placement (A) and jumper connections (B). Socketing the LCD module is optional. If a socket is desired, one can be fabricated from a 40-pin DIP socket by cutting it in half lengthwise.

output of U7. A reading of +4.75 to +5.25 volts is normal. If an incorrect voltage is indicated and the battery is delivering at least 7 volts to the circuit, troubleshoot the circuit and repair the fault before proceeding with the checkout.

Check the orientation of U7. With the battery disconnected, measure the resistance between the +5-volt bus and ground to make certain that there is no short circuit in the wiring. A

normal indication is 1000 ohms or more. Any reading that's much lower than that indicates a short or defective component. After the fault has been located and corrected, and the 5-volt regulated supply is operating properly, continue with the checkout.

Remove power from the circuit, and insert the IC's into their respective sockets. Be careful to orient each properly, and make sure that they are properly seated. Set the range switch

to 2 MHz. With no signal applied to the input jack, apply power to the circuit and observe the display. After the power has been on for at least a second, you should get a 000.0 indication. Set the range switch to 200 kHz. This time the display should read 00.00. Set the range switch to 20 kHz, and the display should now show 0000.

If the unit does not give the correct displays, troubleshoot the circuit before proceeding. The display should indicate the probable area of fault. For example, if the digits are activated, but do not form perfect zeros, the fault probably lies with the wiring of the associated segments that are incorrect. The same comment holds for the decimal points. If the display is totally blank, check that the LCD module is installed correctly.

A totally blank display can also be caused by lack of backplane signal generated at U8 pin 5. Check the wiring associated with pin 5 to be sure that it is not open, or shorted. An oscilloscope may be used to verify the presence of the backplane signal, which is a 5 volt peak-to-peak square-wave of about 200 Hz. Check pin 1 of U5 for the proper 5-volt input. Check

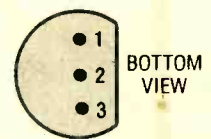

DEVICE	PIN FUNCTION		
	1	2	3
AN78L05 (U7)	O	G	I
BS170 (Q1)	D	G	S
MPF102 (Q2)	S	D	G
QN3906 (Q3)	E	B	C

A

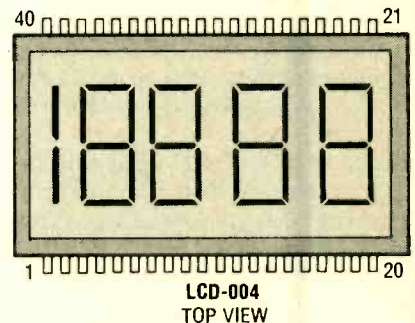

B

Fig. 7. Here are the pinout diagrams for the three transistors and the LCD readout listed in the Parts List.

(Continued on page 92)



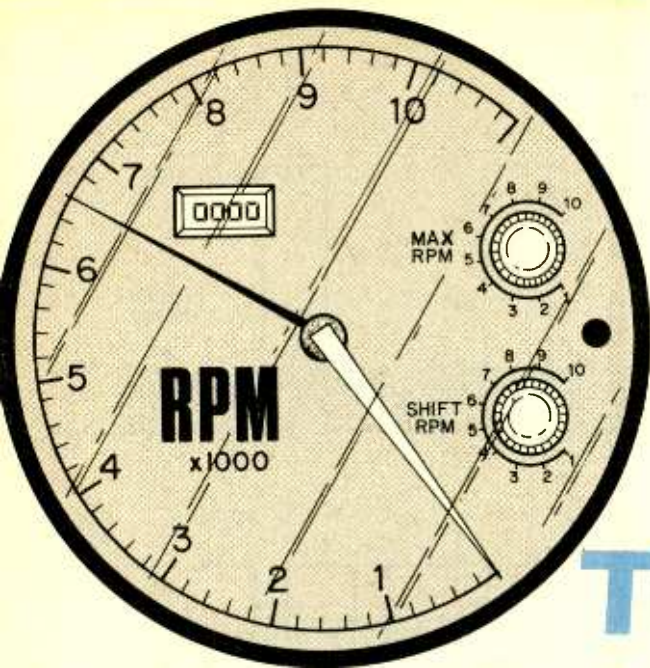

BY JOSEPH J. CARR

**T**here are a lot of electronic-instrument projects that must be able to measure the speed of a rotating shaft, the number of events that happen per unit of time, or some other parameter that can be expressed in terms of a pulse-repetition rate (PRR) or frequency.

There are also many real world applications where sensitivity to repetitive events is important: Automobile mechanics use instruments that measure engine RPM by counting spark-plug firings. In medical electronics, the heart rate or breathing rate of patients is measured by sensing an event (e.g. an ECG signal) and then passing it to a cardiometer. Some people use circuits to measure the rotating speed of shafts, fans, and so forth. In many such applications, a white dot or stripe is placed on the rotating device and a photocell or phototransistor is used to sense its presence each time it passes. The key element in all of these instruments is a tachometer circuit.

Although one could buy a digital frequency counter to fill-in for a tachometer, that approach is expensive. Furthermore, a frequency counter doesn't always yield the information required or display it in the most useful form.

Figure 1 shows the block diagram for a common tachometer circuit. The circuit consists of four main sections: an input-signal conditioner, a monostable multivibrator (a "one-shot"), an

integrator or "time-averager," and a display device (which might be a simple DC voltmeter). Basically speaking, circuits of this type generate a DC voltage that is proportional to the input frequency, which can then be displayed by a calibrated voltmeter.

**Signal Conditioner.** The signal conditioner stage is used to clean up the input signal to make it compatible with the triggering-input requirements of the one-shot stage that follows. In some cases, the signal conditioner will contain frequency-selective filtering and level translation or a trigger-level function. However in most cases, signal conditioning is provided by a simple voltage-comparator (such as the LM311).

The comparator will clean up the input signals by making them into quasi-square waves. A comparator has two inputs for voltage signals ( $V_1$  and  $V_2$ ). It can provide three output values based on the input voltages: A high when  $V_1 > V_2$ , a low when  $V_1 < V_2$ , and a voltage exactly between high and low when  $V_1 = V_2$ .

The most common comparator signal-conditioning circuit is connected as a "zero-crossing detector." One input is grounded, so the output snaps back and forth between high and low as the input signal crosses above and below zero volts.

**The Monostable Multivibrator.** The monostable multivibrator (or one-

shot) circuit is used to produce a single output pulse, with constant duration and constant amplitude, for each input trigger pulse. Figure 2 shows the basic operation of the one-shot circuit. When the input pulse drops low, the output of the one-shot snaps high. The output remains high for a fixed time ( $T$ ), and then drops low again. Note that the duration of the output is independent of the duration of the input.

There are two basic forms of one-shot circuit. The non-retriggerable one-shot will not respond to additional trigger pulses until the circuit "times out," (i.e. time  $T$  expires and the output drops low again). The retriggerable one-shot will respond to additional trigger pulses that occur during time  $T$ . Each pulse received at the trigger input extends the duration of the high period by an additional time  $T$ .

So why is the one-shot circuit needed? Look at Fig. 3 for the answer. There are two cases, but in both the output pulse duration,  $T$ , is the same; only the pulse repetition rate (PRR), or in other words the frequency, is different. Also note that the pulses all have the same amplitude ( $V_{CC}$ ). Thus, the area under each pulse is the same for both graphs:

$$\text{Pulse area} = V_{CC} \times T$$

That being true, the area under the curve during some interval is equal to the number of pulses occurring ( $n$ )

*Learn how to design your own tachometer circuits and try your hand at building some of ours.*

# Fun with Analog Tachometer Circuits

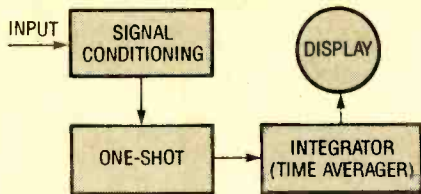

Fig. 1. This block diagram of a simple analog tachometer belies how it functions. The input signal is conditioned to become a trigger signal for a one-shot multivibrator whose output is integrated and displayed.

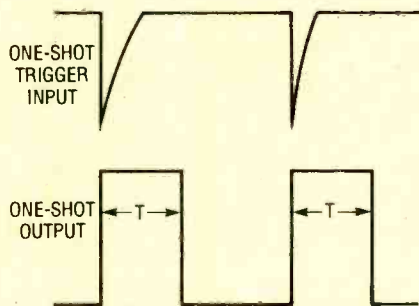

Fig. 2. Regardless of the width of the trigger input, the one-shot outputs a pulse of constant duration.

times the area of one pulse:

$$\text{Total area} = n \times \text{Pulse area}$$

The number of pulses occurring over a time interval ( $t$ ) is equal to the pulse repetition rate (PRR) times the total time interval:

$$n = \text{PRR} \times t$$

That means the area over an interval is proportional to the PRR:

$$\text{Total area} = (\text{PRR} \times n) \times \text{Pulse area}$$

Further, it can be shown that the average voltage is proportional to the area under the curve, so the average voltage must be proportional to the PRR, too. So, by measuring the average voltage we can obtain a relative measure of the frequency.

This relationship is only possible if the pulses have the same duration ( $T$ ). The one-shot is necessary because it provides pulses of the same duration regardless of changes in the trigger-input duration or frequency.

**Integrator Circuits.** The average voltage of the pulse train is found by applying the pulses to an integrator circuit. Those circuits can either be passive or active. The passive form of integrator (see Fig. 4A) consists of a resistor in series with the signal line,

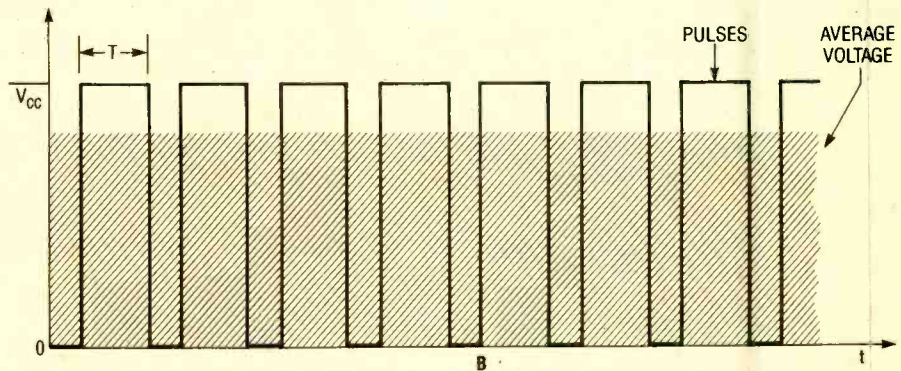
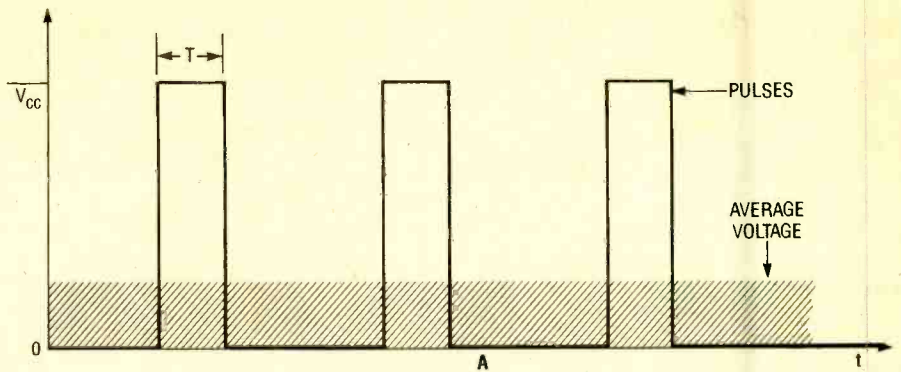

Fig. 3. The average voltage of a constant-duration, constant-amplitude pulse train varies only with the repetition rate. Shown here are a low PRR (A), and a high PRR (B).

TABLE 1—CAPACITANCE VS. FREQUENCY

C1 ( $\mu\text{F}$ )	Frequency (Hz)	Maximum Cx ( $\mu\text{F}$ )
0.0001	100,000	0.0001
0.001	10,000	0.001
0.01	1,000	0.01
0.1	100	0.1
1.	10	1.0
10.	1	10.

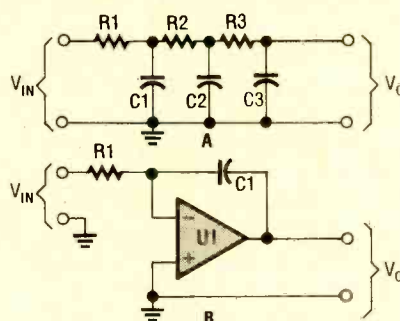

Fig. 4. A passive integrator (A) consists of one or more RC sections, while an active Miller integrator (B) uses an op-amp and one RC section.

and a capacitor across the line. The circuit in Fig. 4A consists of three sections of passive integration. That is because in most applications the DC

input cannot be smoothed out properly using only one section. For those familiar with DC power-supply theory, using too few stages is equivalent to using too little filter capacitance, thus permitting output ripple.

An active-integrator circuit depends on an operational-amplifier. The Miller integrator, as the circuit in Fig. 4B is often called, uses a capacitor in the negative feedback loop around the op-amp, and a resistor in series with the inverting input. The operation of the circuit is beyond the scope of this article.

The RC time constant is important in both forms of integrator circuit. In general, the rule of thumb is to provide an RC time constant that is long compared with the one-shot pulse duration ( $T$ ). Some authorities specify that the RC product should be at least five times the duration, although some experimentation will yield the optimum time constant in any given situation.

The gain of an active integrator is  $-1/(R1C1)$ . That makes finding reasonable parts values for an active integrator a little bit of a problem. For example if  $R1$  is 10,000 ohms and  $C1$  is 0.001- $\mu\text{F}$  the gain is 100,000! Because the maximum output voltage will be,



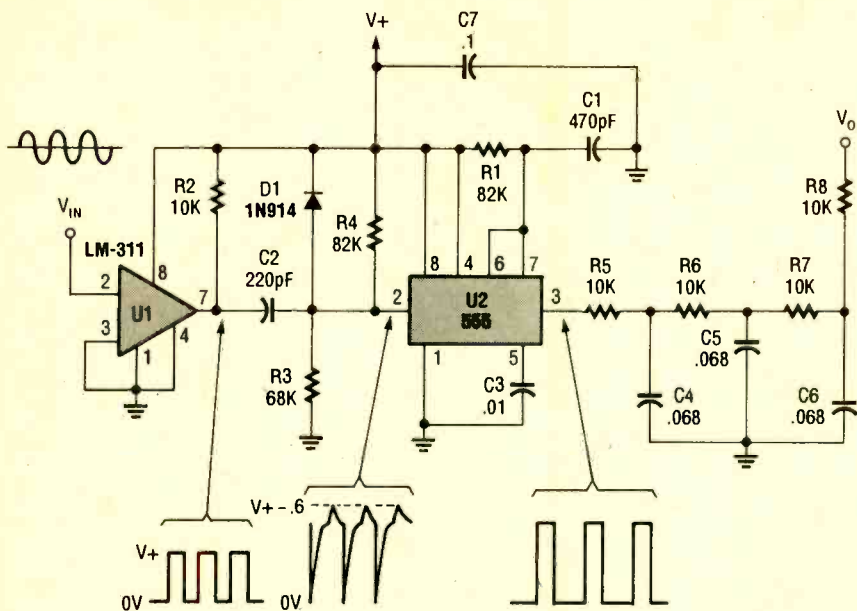

Fig. 5. This is a typical audio-frequency range, analog tachometer. The LM311 acts as a signal conditioner, the 555 is a one-shot, and the RC network on the right is an integrator.

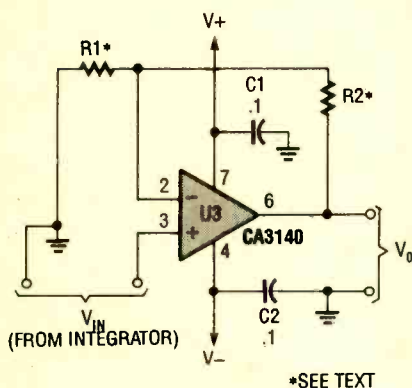

Fig. 6. Use this circuit to scale the integrator output if needed. Select R1 and R2 according to the equation given in the text.

say, 10 volts when the DC power supplies are  $\pm 12$  VDC, the output of the op-amp will saturate when the input voltage exceeds 10 volts/100,000, or 0.0001 volts.

**Display.** The integrator circuit outputs an average DC-voltage level that is proportional to the PRR, or frequency, of the input signal. Thus, the proper display device is a DC voltmeter, oscilloscope, chart recorder, or any other DC voltage-reading device. In the projects discussed in this article, the DC meter is an old-fashioned analog meter movement. They sometimes work a little better in these applications than digital meters because the inertia of the meter

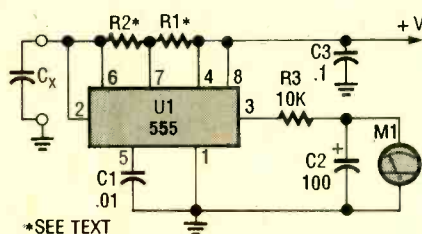

Fig. 7. This is a not-so-good capacitance meter. The value of the capacitor alters the operating frequency of the 555 astable oscillator, thus altering the average voltage reaching the meter.

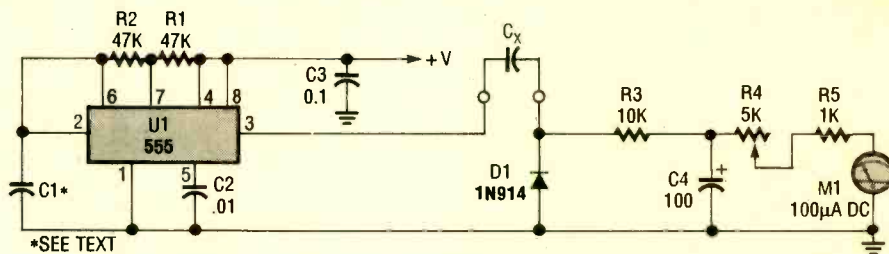

Fig. 8. This capacitance-meter design actually places the unknown capacitor in the integrator. That improves the overall accuracy of the circuit.

movement will provide a little additional integration. Now, let's look at some actual circuits.

**Analog Tachometer/Frequency Meter.** The circuit shown in Fig. 5 is a tachometer and audio-frequency meter. Signal conditioning is provided by an LM311 voltage comparator (U1) connected as a zero-crossing detec-

tor. (Note: the LM311 is a special IC that can be used as a zero-crossing detector even with a single-sided power supply.) The circuit depends on the input signal actually crossing zero once per cycle. If that is not the case (e.g. if the input signal has a DC component), then pin 3 on the IC can be moved from ground by connecting it to the wiper of a 10,000-ohm potentiometer that has its ends connected to  $V^-$  (a negative supply not normally needed in the circuit shown) and  $V^+$ . By setting the potentiometer, you can determine the voltage that the input signal must cross to cause a change in the comparator's output.

Capacitor C2, in combination with resistors R3 and R4, form a differentiator network. That portion of circuit responds only to changes in the input signal. It produces a negative-going, spiked output on the trailing edge of each square-wave from U1.

The 555, which is wired as a one-shot, needs to see a negative-going trigger signal that drops from a voltage that is  $>2/3 V^+$  to one that is  $<1/3 V^+$ . So diode D1 is used to pull up the positive-going portion of the spike to about  $V^+ - 0.6$  volt, while permitting it to drop low enough to trigger the 555.

Other one-shot circuits might need a different trigger signal, so the diode may be reversed in some other applications where 555 devices are not used for the one-shot.

The duration of the output pulse (T) is set by R1 and C1, and is:

$$T = 1.1R1C1$$

For the case shown,  $T = 0.000024$  sec = 24  $\mu$ s.

The integrator circuit is a passive type consisting of resistors R5 through R7, and capacitors C4 through C6. The time constant of each section of the network is about ten times the

(Continued on page 92)

# ALL ABOUT



BY  
GARY EGGLESTON

## ELECTRICAL NOISE

*We discuss the causes of electrical noise  
and provide some helpful tips to keep noise out of your circuits.*

**T**here is one phenomenon that anyone who works in electronics must become familiar with sooner or later: noise. Generally speaking, noise is any signal that interferes with or masks a desired signal. Noise can be either periodic or non-periodic in nature. Normally, however, electrical noise is of a random nature that is indicative of a combination of both periodic and non-periodic waveforms.

Electrical noise can be broken down into three categories: erratic, man-made, and circuit noise. Let us start with erratic-noise sources.

**Erratic Noise.** Understanding erratic noise is very important because of the interference it causes with radio and television broadcasts. Erratic disturbances can be attributed to either space or atmospheric noise.

Space noise is caused by radiation from the sun and other stars. The level of radiation coming from our sun goes through cyclic increases in its radiation due to sunspots—dark areas on the corona of the sun. This sunspot cycle repeats every 11 years.

The noise emitted by distant stars is called blackbody or thermal noise since it is due to the high temperature

of these stars. The amount of such noise is uniform over a considerable part of the frequency spectrum.

Atmospheric noise, often called "static," is caused by the discharge of static electricity from a lightning strike or other natural electrical disturbance.

It has been estimated that there are about 2000 thunderstorms taking place on Earth at any given moment. Since the frequency makeup of lightning pulses overlap the frequency allocation of the radio-television transmission spectrum, these storms cause disturbances to radio and television



reception. For this reason, it is worthwhile to discuss how lightning occurs.

**Lightning.** To understand how lightning occurs, we first need to know something about the subject of "static electricity," which deals with charges at rest. From basic physics, you probably know that electrons have a negative charge and a body lacking sufficient electrons has a net positive charge. Further, like charges repel and unlike charges attract.

During a thunderstorm, high winds tend to break up water droplets into various sizes. One theory states that the smaller droplets become negatively charged and that the larger droplets become positively charged. Areas of charge accumulate in the clouds and when the potential difference between areas is high enough, a discharge (lightning) takes place.

Of course, lightning can also occur between clouds and the Earth, although the mechanism for the discharge is more complex. The Earth has been found to be at  $-300,000$  volts with respect to the ionosphere. That is due to cosmic rays that are continuously charging the various layers of the atmosphere. The result is that electrons are constantly being pulled from the ground to zoom up into the sky.

Naturally, there are clouds in this electrical path. The water droplets and ice crystals in the clouds become charged or polarized by the current. The cloud base usually becomes negatively charged because it has absorbed electrons. The negative charges along the bottom of the cloud attract positive charges in the ground directly below. This causes the ground to become positively charged with respect to the cloud bottom. As time goes by, the charge on the cloud increases, which causes the charge on the ground to increase. This sets the stage for a lightning discharge.

Since the storm clouds move, the positive charge on the ground level moves as well because of their attraction to the cloud. The negative cloud charge cannot simply move to the positive ground area because the air between them is a very poor conductor of electricity. An excessively large voltage must exist between the Earth

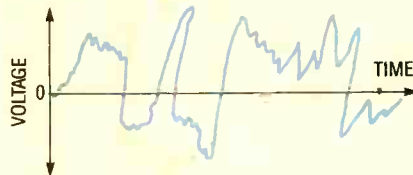

Fig. 1. This is a typical noise waveform in the time domain. It is probably composed of many different waveforms.

and a cloud before a discharge can take place. This voltage may be as much as 100 million volts or even higher. However, once the required voltage has been reached, or the ground charge has moved to a point closer to the cloud (such as a hill or tree), the electrical discharge—lightning—takes place.

Due to the violent change in the air pressure as the air "explodes" along the discharge path, lightning produces acoustical noise, which is called thunder. However, the lightning bolt creates another type of noise that is electrical in nature. In fact, lightning can quickly induce sizable voltages in wires. A lightning-induced voltage reaches a peak in about 1.2 microseconds, then decays from maximum to 50 percent of the maximum in about 48.8 microseconds. About 150 microseconds later, the pulse has decayed to nearly zero volts.

As mentioned earlier, that plays havoc with transmissions, particularly with amplitude-modulated radio communications. Of course, the disturbance from a local thunderstorm is more severe than that of storms taking place at other locations. However, static from distant storms is more severe at night.

**Man-Made Noise.** Whenever an

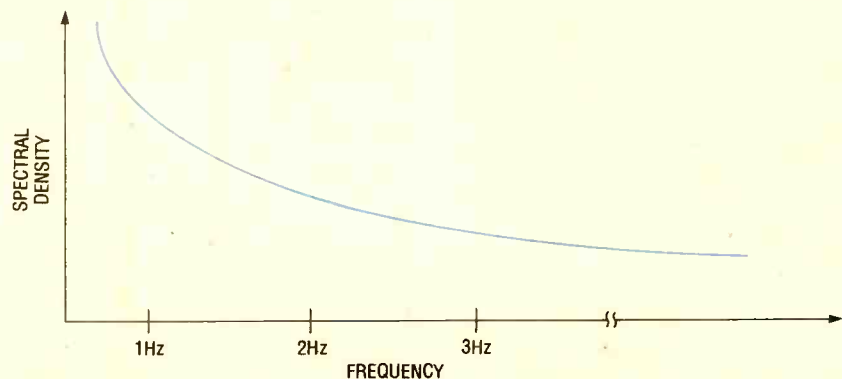

Fig. 3. Unlike white noise, the spectral density of pink noise drops with increasing frequency.

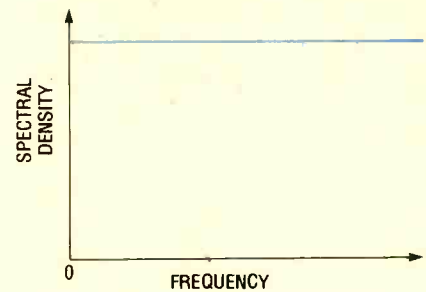

Fig. 2. The spectral density of white noise, as shown here, is flat over the bandwidth being observed.

electrical machine or ignition system is activated some undesirable electrical wave is created. That causes what is called "man-made noise."

Man-made noise can come from a multitude of sources. Ignition coils and distributor systems may cause electromagnetic radiation whenever there is a spark. The old time spark-gap transmitters were excellent sources of man-made noise because they generated a wide noise-rich frequency spectrum. Electrical motors and fluorescent lights are also sources of man-made noise. Even closing and opening an electrical switch to a spark that will have a frequency in the RF range.

**Noise Terminology.** There are a number of important terms commonly used when discussing electrical noise, so it's a good idea to introduce them before going further. Perhaps the most common phrase is "spectral density." Consider the graph of noise amplitude shown in Fig. 1. If we could examine the makeup of that signal, we would see it consists of a group of waves of various frequencies. Furthermore, these frequency

components may vary in amplitude. The frequency makeup of the noise signal constitutes the frequency spectrum of the noise. The height or magnitude of the frequencies that are found in the spectrum is called the "spectral density."

If the frequency spectrum has a flat (equal for all frequencies) spectral density, such as that shown in Fig. 2, the noise is considered "white" noise. That terminology arises from the observation that white light is said to be made up of all colors and white noise is said to have components of all frequencies.

In many cases, spectral density falls off at the rate of  $1/f$ , which means that the spectral density is inversely proportional to frequency. Figure 3 illustrates this idea. In effect the noise is made up of signals whose frequency components have their greatest magnitude at lower frequencies, just like red light. For that reason, noise with a spectrum that falls off as  $1/f$  is called "pink" noise. Pink noise has

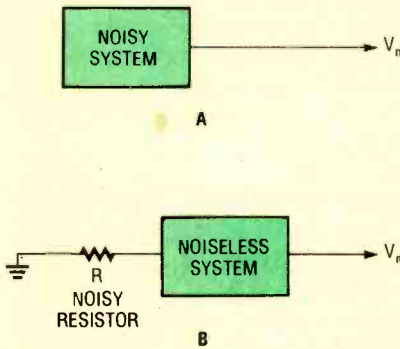

Fig. 4. A noisy system (A) can be modeled by a noiseless system that has a noisy resistor at its input (B).

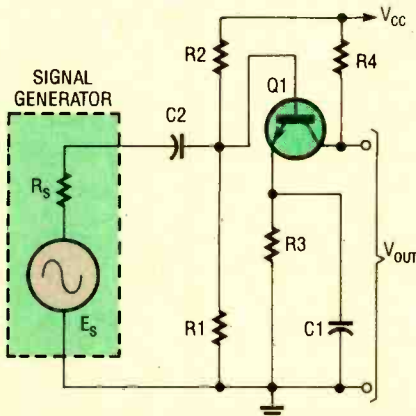

Fig. 5. This voltage amplifier with a bipolar transistor can be noisy if the source resistance is not of an optimum value.

been studied at frequencies as low as  $10^{-9}$  hertz (Hz), which is about 1 cycle in 30 years!

Another common term is "signal-to-noise ratio." That is the ratio of signal power to noise power, or the ratio of signal voltage to noise voltage at some particular point in a circuit. It is more common to determine signal-to-noise ratio in terms of power.

Why is signal-to-noise ratio used? The signal-to-noise ratio gives us information about the noise strength at a particular point in a circuit. Assuming

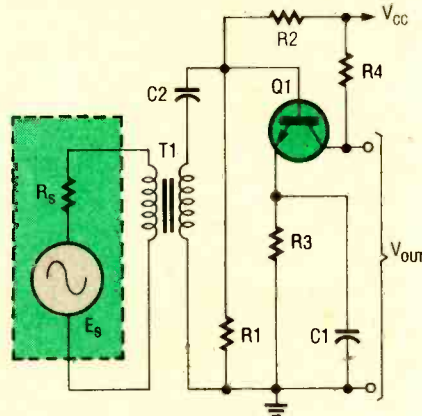

Fig. 6. The transformer changes the generator's internal resistance to produce an optimum source resistance for the bipolar transistor voltage amplifier.

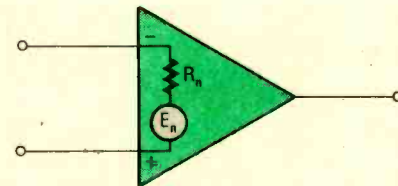

Fig. 7. This is a good way to model noise in an operational amplifier.

a power ratio is being used, suppose the signal-to-noise ratio is five. That means that the signal power is five times as great as the noise power. When designing a circuit, it is desirable to make the ratio as large as possible to ensure a good quality output signal.

One final term to concern yourself with is "equivalent noise resistance." Although the noise produced by a circuit is created by all its components, we can draw a model of the circuit that attributes all the noise to an equivalent noise resistance—a fictitious resistor that would produce the same amount of noise. The greater

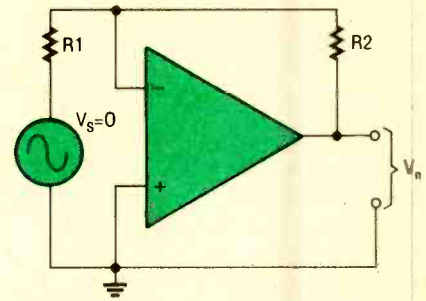

Fig. 8. The circuit shown can be used for determining the noise gain and equivalent input noise of an op-amp.

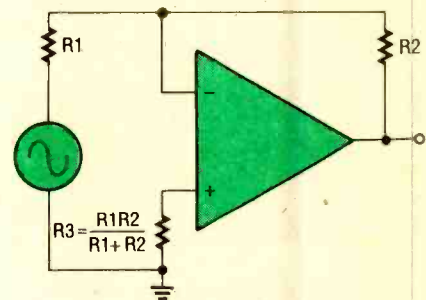

Fig. 9. To avoid having unequal resistive paths for the currents in the inverting and non-inverting input terminals, you should connect a compensating resistor.

the noise, the larger the resistance should be.

For example, the system shown in Fig. 4A is noisy and produces a noise output  $V_n$ . In Fig. 4B, an equivalent system is thought of as being noiseless, but its output has the same noise voltage because a noisy resistor ( $R$ ) has been connected at the circuit's input. The resistor is considered to be the source of thermal noise and represents the thermal-noise generating properties of the entire system. We must remember that this resistor is not physically present in the circuit. The resistance must not be thought of as drawing any current, just adding noise.

**Thermal and Shot Noise.** The most frequent causes of noise in circuits are the thermal and shot effects. Thermal noise, as you may have guessed, is related to temperature. It is the result of electrons randomly moving about in resistive materials due to thermal agitation. Electrons, when moving in this way, constitute a current flow and develop an overall voltage drop in the resistive material that varies from instant to instant. Since all materials have some resistance at normal tem-



peratures, all components contribute some thermal noise. The actual amount of thermal-noise power depends on the resistance of the material (*i.e.*, the temperature) and the bandwidth being observed.

Shot noise is due to random variations of a direct current through a component, typically an active device. For the sake of example, consider the flow of electrons between a cathode and a plate in a vacuum tube. Electrical current is defined as the amount of charge moving per unit time. Of course, the charge is being carried by the electrons themselves. So the current depends on the average velocity of the electrons. However, a few electrons will have velocities that differ from the average, so the current will fluctuate around some average value. If we could hear this variation, it would sound like lead shot striking a concrete wall; thus, the term "shot noise." By the way, shot noise can be considered a "white noise process" since its spectral density is flat.

**Noise in Bipolar Transistors.** A bipolar transistor adds both thermal noise and shot noise to the circuit it's in. The thermal noise is caused by the thermal agitation of electrons in the base-spreading resistance of the transistor. The shot-noise is the result of two mechanisms: the recombination of electrons and holes in the base region, and the random motion of charges across the PN junctions.

Bipolar transistors generate other forms of noise as well. For example, they also contribute "flicker noise" to a circuit. The flicker effect results from fluctuations in carrier density due to various leakage effects. The fluctuations cause the conductivity of the semiconductor material to vary, resulting in a varying noise voltage when direct current is flowing through the junction. The spectrum of the noise varies inversely with frequency, so it is classified as pink noise. Flicker noise is most serious at low frequencies because (since it's pink noise) its spectral density is highest at low frequencies.

Another form of noise arises in transistors whenever current must divide between two or more paths. That results in random fluctuations in the division of the current. The result is "partition noise," which has a flat

spectrum, and so is considered white noise.

Furthermore, it takes a finite amount of time for a charge carrier (electron or hole) to cross the base-emitter or base-collector junction in a transistor. When this time is comparable to the period of an input signal in the transistor circuit, some of the charge carriers diffuse back to their origin. The result is that the input admittance of the transistor is somewhat frequency dependent—as frequency rises, admittance also rises. That produces more noise current and allows the spectral density of the noise to rise.

We have discussed a number of topics regarding electrical noise. We will now attempt to show how to use these ideas to design low-noise circuits. It must be remembered that this is a very broad subject and only a few examples will be given.

### **A Low-Noise Voltage Amplifier.**

Since bipolar transistors generate a lot of noise, a voltage amplifier based on one is a prime candidate for our discussion. In Fig. 5 we show a voltage amplifier using a bipolar transistor in the common-emitter configuration. Emitter stability is governed by resistor R3, and capacitor C1 bypasses the AC signal around R3 to prevent degeneration. Resistors R4, R1, and R2 set the transistor biasing and resistor R4 also acts as the collector load resistor. The output signal ( $V_{OUT}$ ) is available between collector and ground. The signal generator has an open-circuit voltage  $E_s$  and internal resistance  $R_s$ . Coupling of the source to the amplifier is provided by capacitor C2.

There are two methods of minimization of the noise figure for this type of circuit. One is to design the bias network for a particular value of collector current. The other is to design for a particular value of source resistance.

Figure 6 shows how a transformer could be used to transform the generator's internal resistance to produce the actual optimum resistance and obtain the minimum noise figure.

### **Noise Reduction for Op-Amps.**

Since operational-amplifier circuits are popular, it's worthwhile to examine some techniques for reducing noise in them. Noise is generated in all integrated circuits, whether they are analog or digital in nature, simply

because they contain transistors and resistors. The transistors generate both shot and thermal noise, while the resistors generate thermal noise.

A noise model for an operational amplifier can be drawn as shown in Fig. 7. This model shows a noise-voltage generator connected in series with the amplifier's input resistance. The noise-voltage generator is another equivalent noise source. The fictitious generator output represents the noise voltage of the amplifier over a particular frequency range. If you wish to study the noise current instead of noise voltage, a current source of noise could be shown in parallel with the input resistance instead. In application notes, the noise current or noise voltage of an amplifier is typically stated for a particular bandwidth or as a spectral density.

The noise generated by the op-amp is amplified by a quantity that is called the noise gain. Figure 8 shows a circuit for determining noise gain. Although the circuit is a basic inverting amplifier configuration, the noise gain of the op-amp would be the same in non-inverting mode.

The closed-loop voltage gain of the circuit ( $A_{CL}$ ) is given by:  $A_{CL} = -R2/R1$ . The minus sign on the right side indicates the phase inversion of the output. If the input is zero, the output can only be composed of noise. If you divide the output noise voltage (shown as  $V_n$ ) by the gain, then you will get the equivalent input noise.

To design low-noise op-amp circuits, there are a couple of simple guidelines to follow: First be sure to use a bias-compensating resistor if possible. That greatly reduces the offset current in many applications, which reduces noise currents since they are proportional to the offset current.

To help illustrate this point, look at Fig. 9. If R3 was not in place, the resistive path between the inverting input and ground (which is composed of R1 and R2 in parallel) would not equal the resistance into the inverting input. That would cause offset current to flow, thus creating noise. Setting R3 equal to the parallel combination of R1 and R2, as shown in the figure, solves that problem. Taking things one step further, placing a small capacitor across resistor R2 will reduce the noise gain at high frequencies by feeding it back to the inverting input. ■

# ANTIQUÉ RADIO

By Marc Ellis

## Collectors Contest Encore

**W**hen announcing (in the February, 1992 column) the results of the recent "With The Collectors" contest, I wondered out loud about why I had received so few entries. It seemed to me that a contest encouraging people to tell about their involvement with radio collecting ought to be at least as popular as one designed to solicit information about a relatively obscure electronic musical instrument. Yet our prior theremin contest drew dozens of letters, compared to the five I received for "With the Collectors."

and I'd like to acknowledge these before too much more time goes by. So let's take a short break from the Sky Buddy project and do just that!

### CONTEST COMMENTS

**Shayne Trowsse** (Casselman, Ontario, Canada) didn't venture an opinion about the lack of reader response, but he shared my surprise at it. "You would think," he wrote, "that there would be many interesting stories describing how an avid collector was able to convince a fed-up spouse that just one more radio wouldn't make any real difference."

Another Canadian, **Jason Ingraham** (Windsor Jct., Nova Scotia), was also amazed at the limited response. In fact, he decided not to send an entry himself because "I figured that so many people would respond that I wouldn't have a chance getting a letter from here to there on time."

**David Booth** (Westminster, MD) takes Jason's comment a step further. "I didn't enter your contest earlier because I was sure that my collection simply wasn't displayed well enough to compete with what I was certain would be a large quantity of museum-quality layouts." Happily, all three of the above readers decided to send entries this time.

Adding to the international tenor of this collection of comments was a letter from **Jorge Resines** (Buenos Aires, Argentina). In a word, Jorge feels that the lack of response was caused by

shame! Speaking of his workroom, he said, "You will never get a photo—even a drawing—on what it looks like: Were anybody to try getting in, I would cling so tightly to the door that hitting me all over my body wouldn't make me budge."

And I can really relate to Jorge's comments. Most of the time, my own workroom looks like I imagine his must. When it's in that condition, I really don't like people to see it. And I usually have to do some heavy-duty cleaning and reorganizing before I can even use it for taking project pictures.

Explaining the heavy response to the theremin contest, Jorge felt that readers were anxious to pool whatever information they had in order to obtain a comprehensive picture of a little-known device. **Tony duBourg** (Martinsville, NJ), who contributed the theremin that gave rise to the contest and subsequent series of articles, expands on that theme. "I would suspect that people are always intrigued by the arcane, and that it pleases them to be able to provide some inside information ... It's great fun to reminisce, to try to set the record straight, or to help solve a problem."

I really appreciate receiving these thoughtful comments, and will definitely be guided by them the next time I plan a contest! Now let's get to the latest entries to "With The Collectors."

### OUR LATEST WINNERS

There were eight letters in the new batch of entries, and we'll discuss them all—



*Here's a good representation from Shayne Trowsse's interesting collection. Not shown are several other sets displayed elsewhere in the house.*

At that time, I solicited reader comments about the disparity in participation between the two contests. And I also offered to keep the Collectors contest open until the three prizes as yet unclaimed could be awarded. Several readers immediately sent in entries and/or comments,



beginning with the three judged to be the winners. These are the folks who will receive the as-yet-undistributed reprint copies of *100 Radio Hookups*, a 1924 Gernsback publication detailing virtually every radio-receiving circuit in use at that time.

I selected the three winners on the basis of the amount of detail in their write-ups and photos (particularly about how radio collecting was integrated with home life). But let me hasten to say that *all* of the entries were interesting, and the choice was difficult. Two of the winners sent contest comments that were discussed earlier, and we'll begin with them.

Readers of last month's column previewed the workroom of **Shayne Trowsse**, our first winner. This month, we'll run another of Shayne's photos, showing a good sample of his collection. Shayne has been working with old radios since his high-school days. His parents were the first family members to have to put up with his hobby, but were quite tolerant "provided I promised not to blow up the house."

Now in his mid-thirties, Shayne is married to "a very understanding woman." His collection numbers about 45 sets, and there's at least one radio in every room of the house. He's currently finishing a room in the basement to be used for radio display and "that way I can begin to fill up my workshop all over again."

**David Booth's** entry was a veritable media blitz, including no less than ten good photos of individual radios, work areas, and storage areas. I have room for only one of them this month, but hope to be able to get some of the others into future columns. Dave

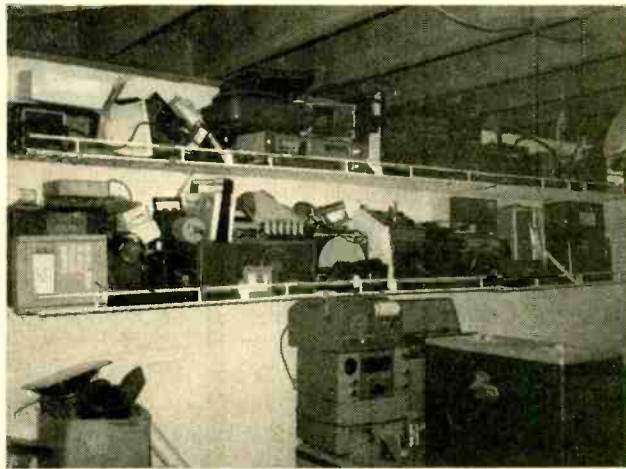

*Dave Booth created more storage in his basement by adding some eight-foot-long wire shelves.*

included a complete list of his collection, which numbers well over 60 items.

He has tried previous winner (February, 1992) Mike Starin's ploy of trying to convince his wife that the basement is an electronic orphanage for radios bereft of home and family. But she "says she knows obsession when she sees it, and this certainly is it." She must be a pretty good sport, though, because Dave has virtually filled the basement with his prizes. Luckily for the family finances, he has acquired most of the sets free of charge or for under ten dollars.

**Neil Wiegand** (Austin, TX) is another collector with an understanding wife. His vintage ham shack is located



*Neil Wiegand beams from the operating position of his vintage ham shack, which is located in the family library/guest room.*

in the family library/guest room. His 1920's radio collection has found a home in the kitchen, where it sits atop the cabinets. Thanks to the high ceilings, there's even room to accommodate horn speakers up there. Since Neil's house has no basement, half of his two-car garage is devoted to housing the remainder of the collection.

Neil didn't mention how he convinced his wife that so much prime household space should be devoted to radios. Perhaps she likes the old sets as much as he does. At last count, his collection (which also includes novelty transistor sets) numbered over 100 items. However, Neil tells us that he is running out of room

and would now rather acquire radios by trade rather than by purchase. Otherwise, he may have to begin selling sets to make room for new acquisitions.

## HONORABLE MENTIONS

Now that we've identified the three winners, let's spend some time discussing the other newly-arrived contest letters. **Jason Ingraham's** (see "Contest Comments" section above) collection features military, commercial, and ham gear, but also includes some consumer models. He also has a nice array of test equipment.

At age 21, Jason is recently graduated from college and still living at home. His large collection of radio gear has caused occasional problems with the family, but they accept it as long as he keeps things neat and tidy. Jason could use schematics for some of his gear, and we'll try to include a detailed want list in the next "mail-bag" column.

**Gary Arnold** (Marion, NC) has about 275 old radios in his collection, and has set up a computer file for each one. His basement "could be considered a museum," and the photo he included with the letter certainly backs up that claim.

When friends learned that **Terry Schwartz** (Shoreview, MN) was in electronics school, they often presented him with old radios and other odds and ends of electronics equipment "maybe just for parts." One of those sets was a beautiful old wood-cabinet Zenith in working condition. That was the set that turned Terry on to radio collecting.

Later, after he graduated from school, got married, (Continued on page 86)

# COMPUTER BITS

By Jeff Holtzman

## Sizing Up Your PC Needs

If you're reading **Popular Electronics**, you've obviously got a taste for sexy electronic games, gizmos, gadgets, and other gear. But if you've never bought a PC before, the thought of laying out a thousand, two thousand, or even more dollars can be daunting. You've probably heard the buzzwords—megahertz, megabytes, RAM, CPU, 386, 486, ISA, EISA, MCA, VGA, SVGA, TIGA, SCSI, ESDI, IDE, MFM, RLL, . . . . How do you sort through them and find the best compromise between what you need, what you want, and what you can afford? And after you do, how do you buy?

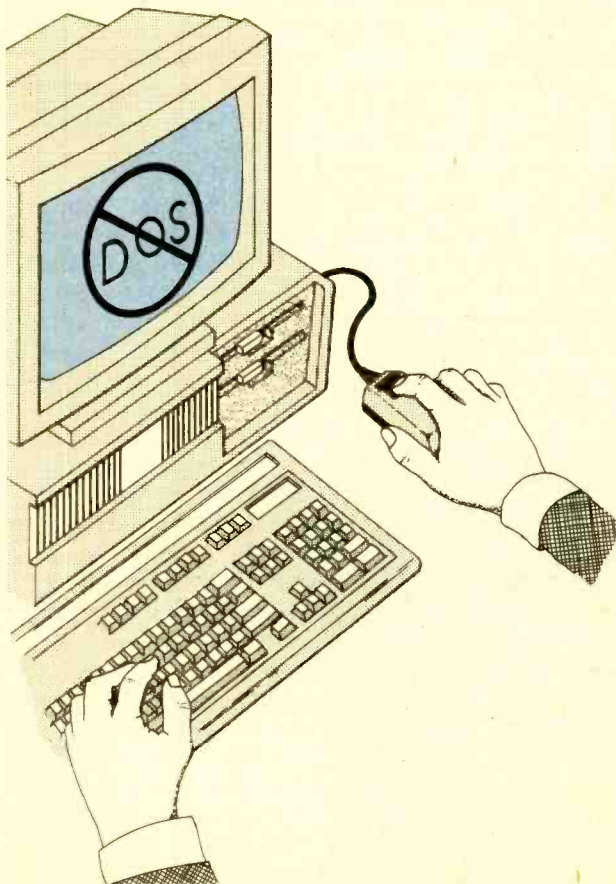

*Don't buy your first (or next) PC myopically. Graphical oriented operating environments are taking the world by storm.*

Should you stick to high-end name brands, or do lower-cost clones provide better value? Is it safe to buy mail order?

It's easy and tempting to get lost in all the technical specifications, but first it makes sense to ask yourself why you want to buy. The better you understand why, the easier it will be to zero in on what. Then it's easy enough to figure out how. This time, we'll mostly talk about why and what; later installments will cover more what and how.

### WHY BUY?

The first thing to do (and here's where honesty is most important) is to ask yourself why you want to buy a PC. Do you want it or need it? If you want it for nonspecific purposes, the decision may be determined strictly by budget. If you need it for a specific purpose (school or work), you'll have to weigh cost/feature tradeoffs carefully. The remainder of this column assumes that you need a computer, and that use of one will be a central portion of your life both at work and at home.

When asking why, don't limit yourself simply to your immediate perceived needs. If you and the computer "take" to each other, there's a good chance that you'll find more and more things you need from your PC. So ask yourself both what you need to accomplish the job today, how that might evolve over the next two years, and how it might evolve over the next five years.

For example, say you're

just starting college and know you'll need some sort of computer. What will you be doing with it? You'll almost certainly need a word processor to write papers. If you'll be taking any science classes, you may want to get a spreadsheet with graphing so that you can plot experimental data. If you're planning a career in almost any branch of engineering, you'll want to plan on writing programs, which means you'll need compilers in the languages you expect to study. You'll probably also want a modem and telecommunications software to dial into your campus mainframe system.

By being a little bit clever, you can really make a PC pay off in that type of environment. For example, a few years back, I took a class that required writing numerous Pascal programs. Did I hang around the University computing center and work on slow, quirky terminals that might or might not be available when I got there? No way! I did most of my assignments in the comfort of my own home, using a fast, friendly compiler. Typically, I'd write code in Turbo Pascal and get it to run correctly. Then I'd log in the University system, upload my code, and make some editorial changes to account for the hardware (I/O) differences between my PC and their VAX. The day an assignment was due, I'd go in to the computing center just before class and pick up a printout to hand in to my instructor. I and several other classmates followed that type of procedure. Ev-



everyone else looked on in envy.

Anyway, try to analyze both present and future needs. The latter is hard, but use your imagination. Think about all the things you'd like to do on a computer: balance your checkbook and pay your taxes; create databases of your videos, CD's, books; do job-related work; write programs; keep the books for your neighborhood association, church, or club; entertain your younger siblings, cousins, friends; control electrical devices in your home; experiment with PC interfacing; write The Great American Novel; track stocks and bonds; download software from electronic bulletin board systems; run your own BBS; sketch plans for your dream house; correspond via E-mail with friends around the world; build multimedia entertainment extravaganzas, etc. You should be able to increase the size of that list.

Make your own list. Then prioritize it. What's critical? What would you like to do? What goes in the "eventually" category?

#### WHAT TO BUY

After some soul-searching, you'll come up with a list of things you'd like to be able to do on your PC. The next step is to figure out which software products will meet your needs, and then what kind of hardware you'll need to run the software. Note that this is precisely the opposite of how most people buy. Typically they buy a machine and start asking what they can do with it, and often find out that: A) There's a great deal they could do, but B) The machine is simply not powerful enough to do it. Then they have a feeling that they've been burned, when it's really their own

fault for not planning properly.

At this point in time, one of the biggest questions you have to ask yourself is whether you primarily want to run DOS or Windows programs. You can buy software for virtually all types of applications to run in either environment. The difference is that Windows applications universally require more computer power (CPU speed, RAM, and disk space) than DOS applications. But that increased computer power translates into greater power for you.

You'll be able to get up to speed faster with a new program, because many user-interface conventions are predefined by the operating environment. And once you get up to speed with a few applications, you'll start learning how to make them work together. For example, gather acceleration and impact data from a physics experiment via an A/D converter interfaced to your PC. Send the data via DDE to a spreadsheet for analysis and graphing, then send the graphs (again via DDE) to a word processor for your final report. Sound far-fetched? I know of one big-three auto manufacturer that uses that process to capture and distribute manufacturing data. You might be able to do it in DOS, but you'd have to work much harder at it, and you'd probably end up using highly specialized tools rather than off-the-shelf applications.

That's why I believe that for all intents and purposes, DOS is dead. Virtually all innovative software is now being developed for graphical environments. If your intended PC purchase is part of a long-term ca-

*(Continued on page 86)*

## SUPER LONG PLAY TAPE RECORDERS

12 Hour Model — USES 120 TAPE  
**\$119.00\***

Modified Panasonic Slimline, high quality AC/DC provide 6 continuous hours of quality recording & playback on each side of cassette for 12 hours total. Includes • Voice level control • Digital counter, etc. TDK — 120 Cassette Furnished.



### PHONE RECORDING ADAPTER

Records calls automatically. All Solid State connects to your telephone jack and tape recorder. Starts recording when phone is lifted. Stops when you hang up. **\$28.50\*** FCC APPROVED



### VOX VOICE ACTIVATED CONTROL SWITCH

Solid state. Self contained. Adjustable sensitivity. Voices or other sounds automatically activate and control recorder. Uses either recorder or remote mike. **\$28.50\***



\* Add for ship. & handling. Phone Adapter & Vox \$2.00 each. Recorder \$5.00 each. Calif. Res. add tax. Mail order, VISA, M/C, C/D's OK. Money Back Guarantee. Quantity discounts available. Dealer inquiries invited. Free data.

**AMC SALES INC.** Dept. B 9345 Lubez Street  
Box 928, Downey, CA 90241  
Phones (310) 869 8519 1 800 325 2488  
FAX (310) 923 1478  
Mon-Fri 8-5 \*PAC TIME

CIRCLE 7 ON FREE INFORMATION CARD

FULL- OR PART-TIME BUSINESS:

## You can make good money in VCR repair!

Professional-level home study program. You will master easy-to-learn high-profit repairs *without* investing in high-tech instruments or an expensive workshop.



Send or call today for more information on our approved home study career course.

## Free career kit: 800-223-4542

Name \_\_\_\_\_

Address \_\_\_\_\_

City \_\_\_\_\_ State \_\_\_\_\_ Zip \_\_\_\_\_

**The School of VCR Repair**  
2245 Perimeter Park, Dept. VH341  
Atlanta, Georgia 30341

CIRCLE 19 ON FREE INFORMATION CARD

# CIRCUIT CIRCUS

By Charles D. Rakes

## Circuit Grab-Bag

**T**his time around, we are going to squeeze as many circuits into our allotted space as we can. So drag out the junkbox, heat up the soldering iron, and get ready to circulate the electrons.

### TOUCH SWITCH

Our first entry is a touch-on/touch-off, AC, light-control circuit. That circuit (see Fig. 1) is built around half of

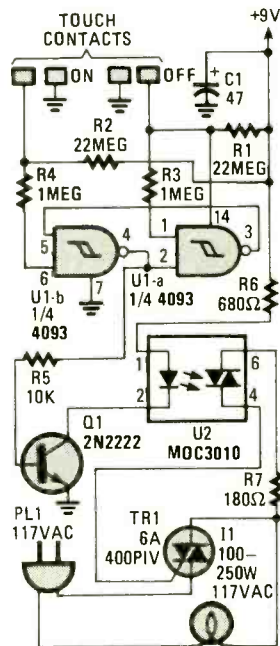

Fig. 1. The Touch Switch is built around half of a quad NAND Schmitt trigger, a transistor, an optoisolator/coupler Triac driver, a Triac, and a few support components.

a quad NAND Schmitt trigger, a transistor, an optoisolator/coupler Triac driver, a Triac, and a few support components. Two gates of the NAND Schmitt trigger (U1-a and U1-b) are configured as a set-reset (RS) flip-flop.

When the touch-on contacts are bridged, pin 6 of U1-b goes low, forcing its

### PARTS LIST FOR THE TOUCH SWITCH

#### SEMICONDUCTORS

U1—4093 quad 2-input NAND Schmitt trigger, integrated circuit  
 U2—MOC3010 optoisolator/coupler, Triac driver, integrated circuit  
 Q1—2N2222 general-purpose silicon, NPN transistor  
 TR1—6-amp, 400-PIV Triac

#### RESISTORS

(All resistors are 1/4-watt, 5% units.)  
 R1, R2—22-megohm  
 R3, R4—1-megohm  
 R5—10,000-ohm  
 R6—680-ohm  
 R7—180-ohm

#### ADDITIONAL PARTS AND MATERIALS

C1—47-μF, 16-WVDC, electrolytic capacitor  
 Perfboard materials, enclosure, molded AC power plug with line cord, 9-volt power source, metal touch contacts, wire, solder, hardware, etc.

output (the set output) at pin 4 to go high. That high divides along two paths: In one path, the output is applied to pin 2 of U1-a, causing its output at pin 3 to go low. That low is, in turn, applied to pin 5 of U1-b, latching the gate in a high output state. In the other path, the output of U1-b is used to drive Q1. When Q1 turns on, U2's internal LED lights, turning on its internal, light-sensitive, Triac-driver (diac) output element. The Triac driver feeds gate current to TR1, causing it to turn on, and light the lamp (L1).

When the off contact is bridged, U1-a's output switches and latches high, causing U1-b's output to go low, turning off the lamp.

### SINEWAVE-TO-SQUAREWAVE CONVERTER

Next up is a circuit that turns a sinewave into a squarewave. That circuit, see Fig. 2, is comprised of a

single 2-input NAND Schmitt trigger that's configured as an inverter with a trigger level adjustment at its input. As the input voltage rises above the gate's trigger point, the output snaps to its alternate state, producing a squarewave output.

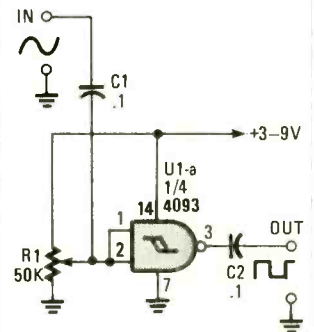

Fig. 2. The Sinewave-To-Squarewave converter is comprised of a single 2-input NAND Schmitt trigger that's configured as an inverter with a trigger-level adjustment at its input.

The gate's switching voltage depends on the supply voltage and the setting of



## PARTS LIST FOR THE SINEWAVE-TO-SQUAREWAVE CONVERTER

U1—4093 quad 2-input NAND Schmitt trigger, integrated circuit  
 R1—50,000-ohm potentiometer  
 C1, C2—0.1- $\mu$ F, ceramic-disc capacitor  
 Perfboard materials, enclosure, 3–9-volt DC power source, IC socket, wire, solder, hardware, etc.

R1 (a 50k potentiometer). The input peak-to-peak sinewave signal should be at least  $\frac{2}{3}$  of the supply voltage. The 50k potentiometer allows the output of the circuit to be adjusted for a 50/50 duty cycle.

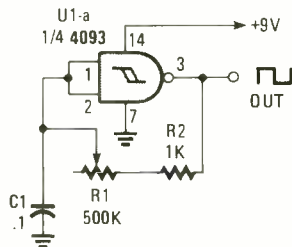

Fig. 3. Built around a NAND Schmitt trigger, this square-wave oscillator has an adjustable (via a 500k potentiometer, R1) frequency range of about 35 Hz to over 20 kHz.

## SQUAREWAVE OSCILLATOR

Our next entry (see Fig. 3), again built around a NAND Schmitt trigger, is a square-wave oscillator with an adjustable (via a 500k potentiometer, R1) frequency range of about 35 Hz to over 20 kHz. The Schmitt trigger gives the output a fast rise and fall waveform, but does not produce a 50/50 output duty cycle. The circuit, with its fast turn-on/turn-off characteristic, can serve as an excellent clock generator.

By altering the square-wave oscillator, the oscillator can be manually controlled, as shown in Fig.

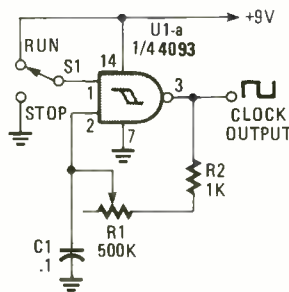

Fig. 4. The squarewave oscillator can be manually controlled, by altering as shown here.

## PARTS LIST FOR THE SQUAREWAVE OSCILLATOR

U1—4093 quad 2-input NAND Schmitt trigger, integrated circuit  
 R1—500,000-ohm potentiometer  
 R2—1000-ohm  $\frac{1}{4}$ -watt, 5% resistor  
 C1—0.1- $\mu$ F, ceramic-disc capacitor  
 Perfboard materials, 9-volt power source, wire, solder, hardware, etc.

## PARTS LIST FOR THE MODIFIED SQUAREWAVE OSCILLATOR

U1—4093 quad 2-input NAND Schmitt trigger, integrated circuit  
 R1—500,000-ohm potentiometer  
 R2—1000-ohm  $\frac{1}{4}$ -watt, 5% resistor  
 C1—0.1- $\mu$ F, ceramic-disc capacitor  
 S1—SPDT toggle switch  
 Perfboard materials, 9-volt power source, wire, solder, hardware, etc.

# 38.370 ELECTRONIC COMPONENTS

Whether you order 1 part or all 38,370...MOUSER stocks and...can ship today!!  
 MOUSER also makes it easy to do business.

CALL...  
 (800) 992-9943  
 for your FREE CATALOG  
 2401 Hwy 287 N.  
 Mansfield, TX 76063

**MOUSER ELECTRONICS**  
 Sales & Stocking Locations Nationwide

CIRCLE 14 ON FREE INFORMATION CARD

## BIG PROFITS IN VIDEO REPAIR!

WORK FROM HOME-EARN \$85 HR!  
 With the tens of millions of VCRs and Camcorders in use, there currently is a **serious shortage** of trained techs to perform cleaning and repair jobs on these popular devices... Learn how you can start your own highly profitable, **Home-Based** video servicing business... And since up to 95% of all VCR and Camcorder malfunctions are due to a simple **mechanical or electro-mechanical** failure, you need not spend months or even years of complicated study before starting paid, **professional service work!**

Let Viejo's Training Program show you how!

CALL TOLL-FREE **1-800-537-0589** or mail coupon today!

VIEJO PUBLICATIONS, INC.

4470-107 Sunset Blvd., Suite 600  
 Dept. PE Los Angeles, CA 90027

Yes! Rush me your **FREE OPPORTUNITY KIT** today!  
 (Check appropriate box)

- VCR Repair
- Camcorder Repair
- Advanced VCR Repair
- Fax Machine Repair

Name \_\_\_\_\_  
 Address \_\_\_\_\_  
 City/State \_\_\_\_\_ Zip \_\_\_\_\_

Dept. PE

CIRCLE 11 ON FREE INFORMATION CARD

4, or driven from other logic circuitry by applying a signal to pin 1 of the Schmitt trigger.

### MICROPHONE AMPLIFIER

Our next entry, see Fig. 5, is a handy little remote microphone amplifier that can be used in many monitoring applications. The electret mike, MIC1, is direct coupled to Q1 (a 2N3906 PNP transistor that is configured as an emitter-follower amplifier). That transistor increases the out-

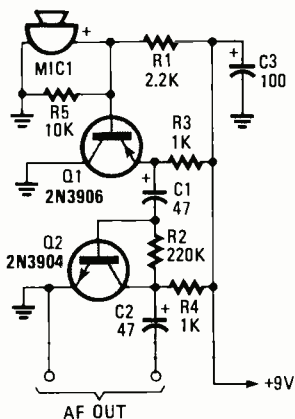

Fig. 5. In the microphone amplifier, MIC1 is direct coupled to Q1, which increases the output voltage of MIC1 by a factor of about 60, before outputting the signal to the Class-A voltage amplifier, Q2.

### PARTS LIST FOR THE MICROPHONE AMPLIFIER

#### SEMICONDUCTORS

Q1—2N3906 general-purpose silicon PNP transistor  
Q2—2N3904 general-purpose silicon NPN transistor

#### RESISTORS

(All resistors are 1/4-watt, 5% units.)  
R1—2200-ohm  
R2—220,000-ohm  
R3, R4—1000-ohm  
R5—10,000-ohm

#### CAPACITORS

C1, C2—47-µF, 16-WVDC, electrolytic capacitor  
C3—100-µF, 16-WVDC, electrolytic capacitor

#### ADDITIONAL PARTS AND MATERIALS

MIC1—Electret microphone element  
Perfboard materials, enclosure, 3-conductor shielded microphone cable, 9-volt power source, wire, solder, hardware, etc.

put voltage of MIC1 by a factor of about 60. In addition to amplifying the microphone output, Q1 is also used to match MIC1's output impedance to the input impedance of Q2.

The output of Q1 is capacitively coupled to the base of Q2 (a 2N3904 NPN transistor), which is configured as a Class-A voltage amplifier (effectively a pre-amplifier stage). The output of the circuit can be fed to an audio-power amplifier, which would, in turn, provide sufficient current to drive a speaker or headphones.

An appropriate length of three-conductor, shielded microphone cable can be used to connect the circuit to an amplifier at the monitoring location.

### AUDIO AMPLIFIER

Our next circuit is an audio-power amplifier that can be used in conjunction with the circuit in Fig. 5. The amplifier circuit in Fig. 6 is based on the LM386 low-voltage audio-power amplifier. The amplifier, whose gain is adjustable via R1, can provide a gain of up to 20. The output of the amplifier is sufficient to drive a speaker or headphones.

### PARTS LIST FOR THE AUDIO AMPLIFIER

#### RESISTORS

(All fixed resistors are 1/4-watt, 5% units.)  
R1—5000-ohm potentiometer  
R2—10-ohm

#### CAPACITORS

C1, C2—100-µF, 16-WVDC, electrolytic  
C3—0.1-µF, ceramic-disc

#### ADDITIONAL PARTS AND MATERIALS

U1—LM386 low-voltage, audio-power amplifier, integrated circuit  
S1—SPST switch  
Perfboard materials, enclosure, IC socket, 9-volt power source, wire, solder, hardware, etc.

### PARTS LIST FOR THE AC LINE MONITOR

#### SEMICONDUCTORS

SCR1—2N5060, or similar, sensitive-gate, silicon-controlled rectifier  
D1—IN4002 general-purpose silicon rectifier diode

#### RESISTORS

(All resistors are 1/4-watt, 5% units.)  
R1—2200-ohm  
R2—10,000-ohm  
R3—1000-ohm

#### CAPACITORS

C1—0.47-µF, ceramic-disc  
C2—0.05-µF, ceramic-disc

#### ADDITIONAL PARTS AND MATERIALS

BZ1—Piezo sounder, self-generating type  
S1—Normally open pushbutton switch  
Perfboard materials, enclosure, 12-volt AC wall transformer, wire, solder, hardware, etc.

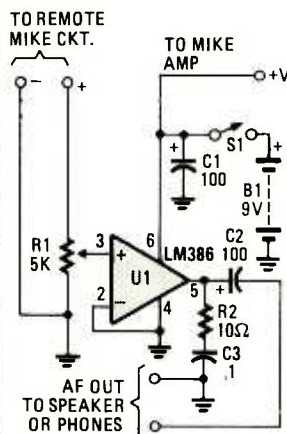

Fig. 6. This audio-power amplifier circuit (based on the LM386 low-voltage audio-power amplifier) provides an adjustable gain of up to 20.

The amplifier can be powered from a battery or from any AC-derived DC supply that can furnish a minimum of 50 mA.

For some extra listening fun, the circuit in Fig. 5 and this one can be mounted at the focal point of a 10- to 20-inch parabolic reflector for a way-out sound gathering instrument.

### AC-LINE MONITOR

Our next circuit is an AC Line Monitor. If the loss of AC power, even for a couple of seconds, causes your electric clocks or other equipment to do strange things, the circuit shown in (Continued on page 86)



# THINK TANK

By John J. Yacono

## Readers Requests

In this month's column, I'd like to do something a little different: answer some questions sent in by you readers. Let me know if you would like (or dislike) to see more of this question-and-answer format from time-to-time in the future—remember I'm here to suit your tastes, so let's all work to make this the best column possible.

As always, this month's participants will receive a "Think Tank II" or other book from our library. If you would like to contribute to these pages, please send your letter(s) to *Think Tank*, **Popular Electronics**, 500-B Bi-County Blvd., Farmingdale, NY 11735. If it makes it here, you'll be likewise rewarded. And now on with the show . . .

### NEW HEIGHTS

I am a model-rocketry hobbyist and I am very interested in electronics, too. I

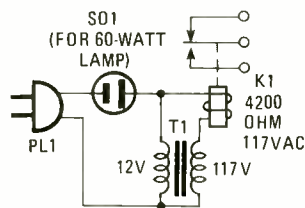

Fig. 1. When a bulb in a lamp plugged into S01 blows out, the relay activates an alarm. The big question is "How does it work?"

found a circuit for a pressure detector in your September 1991 issue of **Popular Electronics**, but I'm not sure if it would make a good rocket altimeter, even with a little circuitry around it. I was hoping for something that would record the peak altitude and

indicate it on an LCD or 7-segment LED display when it returned to the ground.

Maybe a circuit design with one portion that would emit a voltage after the pressure changed by a certain amount and an adder that would add the number of times the voltage had been applied. Maybe you have another idea or an addition to the one I had. My biggest rocket is a two-stage model with an approximate diameter of 3 inches and a payload section.

Thank you very much; hoping to receive an operating circuit soon.

—Eric Veilleux, N. Stratford, NH

*You're in luck. Our sister publication Radio Electronics published just such a circuit in their October, 1990 edition. The story, called "Rocket Altimeter," appeared on page 37 of that issue. I'm not sure of the device's payload requirements, but you could check it out when you look up the article.*

*Sorry, but I typically don't design very involved circuits without receiving handsome remuneration—the second commandment of consulting engineers, the one right after "Thou shalt over-estimate the time any job will take"—and I would never except money from a reader seeking help. Furthermore, there's no point in re-inventing the wheel (which is commandment number three, of course).*

### NEEDS A BOOST

I read about your Line Booster circuit in the *Think*

*Tank* of the November 1991 issue of **Popular Electronics**. The information came at just the right time; I needed to make an alarm system turn on when a lamp with a 60-watt light bulb failed. I changed the connection as shown in Fig. 1. As you can see, the transformer has the 12-volt side wired as the primary. All parts came from Radio Shack and it works very well. The problem is that I don't know why it works. I was hoping you could explain.

Thank you,

—J. Prado, Aiea, HI

*You didn't tell me whether the alarm is activated by the normally closed or normally open contacts of the relay, which would have been helpful, but I'll take a shot at the circuit anyway. Since the socket for the lamp is in series with the rest of the circuit, when the bulb fails (opens), the relay coil, as well as the rest of the circuit, is deprived of power. So the relay allows current to flow between the alarm circuit and its power source (both not shown) via its normally closed contacts, sounding the alarm.*

*When a bulb is good, most of the line voltage is dropped across the bulb, which keeps the 12-volt transformer winding at a low voltage (the AC line voltage minus the drop across the bulb). The voltage across the 12-volt winding is increased by a factor of about ten (due to the turns ratio between the primary and secondary windings) and appears at the 117-volt winding. Since the potential at the 117-volt*

winding will always be much greater than the voltage at the 12-volt winding, current flows between the primary and secondary via the relay coil. That holds the normally closed relay contacts open, depriving the alarm of power.

Note that the potential between the transformer windings may be so great that improper phasing of the windings might not affect the circuit's operation. However, I'm curious to know what the phasing of your windings is and if you have tried reversing it. If you have the time, please write in and let me know.

## SEEING IS BELIEVING

A couple of months ago, I accidentally discovered a fast and simple way to test my infrared (IR) remotes. While looking through the viewfinder of my camcorder, I caught a friend using a TV remote. What I saw intrigued me; as my friend pushed buttons on the remote I could actually "see" the IR light pulses emitted by it. After some experimentation, I determined that this phenomenon was not exclusive to my equipment. It worked with all camcorders and IR remotes I could get my hands on.

This is a great way to test IR remotes and projects using IR LED's. After all, "seeing is believing." The only problem I have is understanding why the camcorder can "see" infrared light. Can you help me out?

Thanks,

—Kevin L. Young, Vandenberg AFB, CA

You've stumbled upon something the military has known and taken advantage of for some years now: The photo-electric devices that pick up images in camcorders and closed-cir-

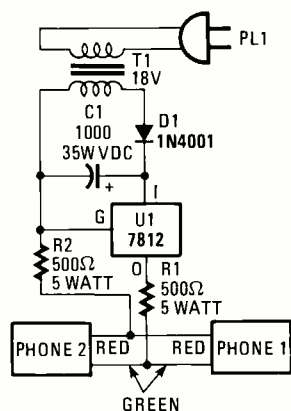

Fig. 2. This circuit is useful for checking out old telephones by providing them with the DC voltage they require for operation.

cuit cameras—called charge-coupled devices or simply CCD's—have a spectral range that extends well into the infrared region.

Since you like experimenting, try powering several infrared LED's off a 9-volt battery and viewing them with a camcorder in the dark. By adding a lens or two, you may be able to create a suitable solid-state "infrared flashlight" for surveillance purposes.

You could also modify a regular flashlight for that same purpose. Just cover the lens of the flashlight with an unexposed Kodachrome negative. The dark negative is transparent to infrared, but keeps visible light from leaving the bulb chamber.

## THE KITCHEN SINK

Your articles in **Popular Electronics** are great—continue the great work. There are three areas which I'd like information on, perhaps you could present them in the magazine or, if you have the time, you could send me the information.

First of all, I've built many digital circuits using integrated circuits, but have read about several small

microprocessors with software within the chips themselves. That would cut down on the parts count and power requirements, increase speed, provide much versatility to projects, etc. I haven't been able to come up with part numbers, data sheets, or applications. Could you inform me as to where this information might be available? I would like to develop a circuit with such a chip for a model railroad. I think a lot of readers would be interested in that.

Second, I have several telephones (donated by friends) in need of repair, but am having difficulty tracing circuits without the required telephone-line signals—DC, ring signal, dial tone, etc. Have you got a telephone test-circuit design that can provide those signals? I'd appreciate something along those lines and am sure **Popular Electronics's** followers would, too.

Third and last, I am looking for information regarding cable-TV channel conversion (converting cable channels down to channel 3). In particular, I'd like to find out if the National NE604 RF convertor chip can be used in this application. If so, do you have any details or suggestions? I'd really appreciate any information and help you could give me on these subjects.

Thank you for your assistance,

—Dan Marcek, Nashua, NH

To borrow a line from Rosanne Rosannadana of the old Saturday Night Live show, "You sure do ask a lot of questions!" Unlike that character, I'll try to answer your questions and as briefly as possible.

Taking your first inquiry first, the chips in question are called "microcon-

trollers." National Semiconductor sells a popular variety of these devices bearing the COP and HPC IC prefixes. I suggest that you call one of your local National distributors (Bell Industries, Tel. 1-603-882-1133; Arrow Electronics, Tel. 1-603-668-6968; or Hamilton/Avnet, Tel. 1-603-624-9400) and request National's Microcontroller Data Book. They may not have them on hand, but they should be able to tell you who to call to get one.

Taking your third set of questions next, you could pick up the data for the NE604 in the manner just described to see what frequencies it could cover. However, I believe that

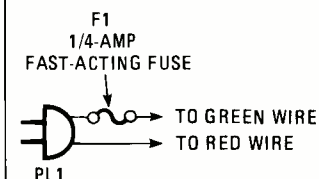

Fig. 3. This simple device can be used to provide a ring signal to test a phone's ringer circuit.

there are some electronic circuits that are better purchased than bought, and a cable-TV converter is definitely one of them. In fact, if you shop around, you'll likely discover that a manufactured unit is probably more cost effective than building your own. I'm all for the Yankee spirit of "I'll build it for myself" (in fact, I feel we need more of that spirit now than ever), but I can't help but wonder if you'll get more satisfaction out of moving on to a dozen other electronic projects and taking breaks to watch cable TV via a store-bought and warrantied, MTS-stereo capable, dBx-expanded, remote-controlled converter that costs around \$80.

(Continued on page 80)



# DX LISTENING

By Don Jensen

## Just "Chill" Out

The way to stay cool is think cool. That's good advice when the summer temperatures climb and the thermometer's red line pushes ever upward. A glass of iced tea and a lounge chair under a shady tree helps. Add to that my own special "keep cool" trick: Put on a cassette of Ralph Vaughn William's *Sinfonia Antartica*, a classical version of the chilly theme music written by the British composer for the film, "Scott Of The Antarctic." But now there might be an

The station, which transmits on SW with 1000 watts from an Argentine military base called Esperanza, is located near the tip of the Antarctic Peninsula. To locate that area on your globe, head due south from the tip of South America. Specifically, it's geographical coordinates are 63-degrees, 24-minutes South latitude, 56-degrees, 59-minutes West longitude.

While announcements, in Spanish, have claimed it to be the "first and only radio broadcaster installed on the Antarctic continent," it is, in fact, neither. The other Antarctic station, the *American Forces Antarctic Network* (AFAN), operating on 6,012 kHz in the 49-meter shortwave band, began broadcasting some years earlier, although it too, has a spotty on-air, off-air record. AFAN, at the United States' McMurdo base, has been logged in North America, but receptions have been rare and the signals generally poor.

The Argentine Antarctic broadcaster, on the other hand, has been quite regularly logged in the U.S. and Canada on 15,475.7 kHz since the station returned to the air some months ago. Its daily schedule is rather brief, airing from 2100 to 2305 UTC sign off.

Interestingly, while LRA36 programming is primarily in Spanish, there are a number of announcements in English, Italian, French, and Portuguese. In contrast to the very American-sounding AFAN McMurdo station, whose programs are clearly aimed at entertaining U.S. military and

civilian personnel stationed in Antarctica, the Argentine broadcaster seems directed to listeners elsewhere. Some SWL's have suggested that the station's purpose is to "show the flag" on a continent where territorial claims by a number of nations, while currently on hold, have not really been resolved.

For instance, a multilingual program, *Horizontes de Hielo*, or Ice Horizons, includes an English announcement explaining its purpose; i.e., to help listeners know "the life and mysteries of the Antarctic." Presumably, a local Argentine GI Audience already would know more than they care to know about their remote and icy outpost.

Whatever its purpose, SWL's are not complaining since LRA36 seems anxious to hear from listeners everywhere, promising to send QSL cards to those who report reception and enclose return postage. Reports should be sent to Sr. Cristian Omar Guida, in care of Radio Nacional Arcangel San Gabriel, Base Antartica Esperanza, Territorio Antartico Argentino, Codigo Postal 9411, Argentina. Return postage, in the form of several International Reply Coupons, which are available at your post office, should be acceptable.

### THAT OL'RADIO HYPE

Dan L Smith's column in *Contact*, the monthly newsletter of the World DX Club of Great Britain, includes an off-beat collection of vintage items from advertising, magazines, and newspapers ballyhooing the

REPUBLICA ARGENTINA	
<b>LRA 36</b> RADIO NACIONAL	
"ARCANGEL SAN GABRIEL"	
BASE DE EJERCITO ESPERANZA - ANTARTIDA ARGENTINA	
UBICACION GEOGRAFICA	CONFIRMO SUS DATOS DE FECHA. 03 Nov 79
Lat 56° 24' Sur Long 53° 59' Oeste	 HECTOR ROBERTO IGLESIAS GENERAL DE BRIGADA COMANDO EN JEFE DE COMUNICACIONES CDS 2 EJ EME
FRECUENCIA: 6030 KHz Apartado Postal 9411 Buenos Aires	
MUCHAS GRACIAS	

Here is an example of the QSL card sent out by LRA36 Radio Nacional Arcangel San Gabriel as acknowledgement of a reception report.

even better hot weather mind game that adds a good measure of DX'ing fun as well; tuning in on shortwave.

Tuning in Antarctica is possible because LRA36, *Radio Nacional Arcangel San Gabriel* is back on SW after a several-year absence. And, it's signal is substantially better than before its old transmitter broke down back in 1989. LRA36 is one of only two shortwave broadcasters—and surely the most likely to be heard—operating from the southernmost continent, Antarctica.

then-young medium of radio. I can't resist passing along some of them for your amusement and edification.

From a 1936, Radiolympia commercial jingle: "Oh! oh, you radio! oh, what I owe to you my radio. I listen in and you dispel the gloom, for you bring all the stars into my room! "Oh! oh, you radio! You're the most entertaining friend I know. You give me music, dancing, joys I never knew. Radio, I'm radiating thanks to you!"

In 1929, author Rebecca West wrote: "The ultimate of luxury is listening to opera in bed, in the dark when one has retired early and dined off a boiled egg on a tray." Yet, in the early days of broadcasting there were a few discouraging words. From a 1924 British newspaper classified ad:

"Wireless set for sale, or would exchange for an intelligent parrot."

### IN THE MAIL

On the top of this month's stack is a letter from 15-year-old Brad Cobo of Duncanville, TX. Brad says he's writing with a question because "I'm the only short-wave elder" that he knows. Thanks, Brad, I think. Since I've been DX'ing shortwave since the late 1940's, maybe "elder" fits, but I'd quickly point out that I started out as a very young listener.

Brad has a good question, though, one that I'll bet a number of other readers also have been wondering about. "How exactly," writes Brad, "do you give the date of your reception when writing to a station? For instance, at 11 P.M. central daylight time here, it is 0400 UTC, after the next 24-hour

UTC time period has begun. Do you report today's date in Texas, or tomorrow's?"

It is confusing, Brad. But just remember to make the date match the UTC time. It may be 10 P.M., July 15, in Duncanville, but your reception—using the standard 24-hour UTC (Coordinated Universal Time) system—occurred at 0400 UTC, July 16. Similarly, when a European station announces that its DX program will be aired at 0200 UTC next Thursday, that you'd better tune in Wednesday night if you want to hear it, subtracting the appropriate number of hours to correspond to your local time.

Those conversion factors are: UTC minus 4 hours for Eastern Daylight Time, minus 5 hours for CDT, subtract 6 hours for MDT, and 7 hours for PDT. When standard time returns this fall, you will subtract 5, 6, 7, or 8 hours from UTC, respectively, to get your local time.

"There are a lot of strange sounds I'm hearing on the shortwave frequencies besides the regular programs," writes Earl Hoffman, Baltimore, MD. "A ham friend of mine says that some of those noises are what he calls CW, or what I'd call Morse code, all dits and dahs. And some, he says, are RTTY (radioteletype) signals. But I'm confused."

I recently read, in a European DX Bulletin, about a cassette called *Audio Guide To The Sounds Of Shortwave*, which includes sound examples of more than 30 different sorts of transmissions, many of the odd bits of 'noise' commonly noted on shortwave. These include the oft-noted CW and RTTY, plus the more exotic, but frequently heard fax and SITOR encryption signals.

I haven't had the opportunity yet to review this audio cassette, but it sounds like just what you and other SWL's may be looking for to sort out those strange SW sounds. The tape is available from Interbooks, 8 Abbot Street, Perth, PH2 OEB, Scotland, for 9.25 Pounds Sterling. Your bank, no doubt, can help you with an international money order or sell you a British 10 pound note.

The cassette also may be available on this side of the Atlantic. If any reader knows a U.S. source and price, please pass along the information. Our address, as always, is *DX Listening, Popular Electronics*, 500-B Bi-County Blvd., Farmingdale, NY 11735.

### DOWN THE DIAL

Here are a few shortwave stations for you to try.

**BOTSWANA**—The *Voice of America* now has a relay station in this southern African country. The VOA's 100-kilowatt SW relay transmitters, operating from Moepeng Hill, near Selebi-Phikwe, went on the air for the first time last December. The frequencies used for the 0300 to 0430 UTC English transmission include 6,130, 7,265, and 11,775 kHz. But the VOA does alter frequencies periodically, so you might want to write to the Voice of America, United States Information Agency, Washington, DC 20547 for a current schedule.

**VENEZUELA**—*Radio Nacional* in Caracas has been noted at 2135 UTC on 9,540 kHz with English news and calypso music. ■

\*Credits: Dan Ferguson, VA; Ken MacHarg, Ecuador; HCJB's DX Party Line; World DX Club, C/O Richard D'Angelo, 2216 Burkey Drive, Wyoming, PA 19610; North American SW Association, 45 Wildflower Road, Levittown, PA 19057

## Forrest Mims Knows ICs!

Over 750,000 readers of earlier editions of

### The Forrest Mims Engineer's Notebook

agree—nobody knows practical IC applications like Forrest Mims! This newly-revised edition contains hundreds of proven, tested circuits—hand-drawn by Forrest—using today's most popular linear, TTL, and CMOS ICs. Forrest gives you full data for each device and circuit—pin numbers, logic tables, supply voltages, and signal waveforms—so you can quickly duplicate each circuit. There's also practical information on construction methods, troubleshooting, and interfacing different IC families. If you work with ICs you gotta get this book!

Only \$14.95 at bookstores or electronic parts dealers. Or order direct from HighText! Add \$3 shipping (\$4 to Canada, \$5 elsewhere). CA please add sales tax U.S. funds only please

**HighText**  
PUBLICATIONS, INC.

7120 Miramar Road  
Suite 15L  
San Diego, CA 92121

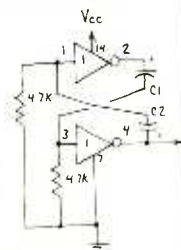



# HAM RADIO

By Joseph J. Carr, K4IPV

## Ol' Sol— Friend or Foe?

**R**adio propagation is a popular subject for amateur-radio operators and shortwave listeners alike. Indeed, even VHF/UHF operators (and scanner/monitor buffs) have an interest in the propagation of radio signals... some of their most interesting DX catches are due to abnormalities in radio propagation that make VHF/UHF communications more than merely local "line of sight."

In April, 1992, we looked at some of the different modes of propagation that aren't normally seen. In this

month's column, we are going to look at the downside; *i.e.*, some of the things that make life a little more "interesting." The effects that we'll look at are principally due to variations and disturbances in the ionosphere.

nals on Earth. The ionosphere is an extremely dynamic region of the atmosphere, especially from a radio operator's point of view, for disturbances in that region significantly alter radio propagation. The dynamics of the ionosphere are conveniently divided into two general classes: regular variation and disturbances. We will look at both types of ionospheric change.

### IONOSPHERIC VARIATION

There are several different forms of variation seen on a regular basis in the ionosphere: diurnal (daily), 27-day (monthly), seasonal, and 11-year cycle.

*Diurnal (daily) variation.* The Sun rises and falls on a 24-hour cycle, and because it is a principal source of ionization of the upper atmosphere one can expect diurnal variation. During daylight hours E and D levels exist, but they disappear at night. The height of the F2 layer increases until midday, and

then decreases until evening when it disappears or merges with other layers. As a result of higher absorption in the E and D layers, lower frequencies are not useful during daylight hours. On the other hand, the F layers reflect higher frequencies during the day. In the 1 to 30 MHz region, higher frequencies (greater than 11 MHz) are used during daylight hours and lower frequencies (less than 11 MHz) at night.

*27-Day Cycle.* Approximately monthly, this variation is due to the rotational period of the Sun. Sunspots are localized on the surface of the Sun, so they will face the Earth only during a portion of the month. As new sunspots are formed, they do not show up on the Earthside face until their region of the sun rotates Earthward.

*Seasonal Cycle.* The Earth's tilt varies the exposure of the planet to the sun on a seasonal basis. In addition, the Earth's yearly orbit is not circular, but elliptical. As a result, the intensity of the Sun's energy that



*Sudden Ionospheric Disturbances (SID's, also known as Dellinger Fade), which rarely give any warning, are believed to occur in correlation with solar flares (bright solar eruptions).*

month's column, we are going to look at the downside; *i.e.*, some of the things that make life a little more "interesting." The effects that we'll look at are principally due to variations and disturbances in the ionosphere.

The Sun, it appears, is the source of many effects in radio propagation. Sunspots and solar eruptions are highly correlated to very serious changes in the ionosphere and, therefore, profoundly affect radio sig-

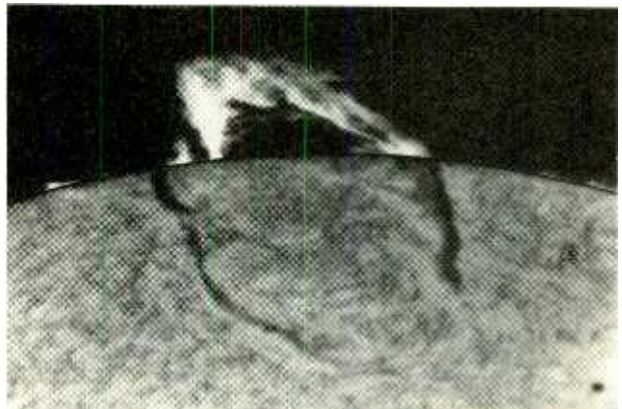

*Sunspots (like those pictured here) and solar eruptions cause serious changes in the ionosphere, a condition which can profoundly affect radio signals on Earth.*

ionizes the upper atmosphere varies with the seasons of the year. In general, the E, D, and F layers are affected, although the F2 layer is only minimally affected. Ion density in the F2 layer tends to be highest in winter, and less in summer. During the summer, the distinction between F1 and F2 layers is less obvious.

**11-Year Cycle.** The number of Sunspots, statistically averaged, varies on an approximately 11-year cycle. As a result, the ionospheric effects that affect radio propagation also vary on an 11-year cycle. Radio propagation in the shortwave bands is best when the average number of sunspots is highest.

### IONOSPHERIC DISTURBANCES

*Sporadic E-Layer.* A reflective cloud of ionization

sometimes appears in the E-layer of the ionosphere; this layer is sometimes called the "E's" layer. It is believed that the E's layer forms from the effects of wind shear between masses of air moving in opposite directions. That action appears to redistribute ions into a thin a layer that is radio reflective.

Sporadic-E propagation is normally thought of as a VHF phenomenon, with most activity between 30 and 100 MHz, and decreasing activity up to about 100 MHz. However, about 25 to 50 percent of the time sporadic-E propagation is possible on frequencies down to 10 or 15 MHz. Reception over paths of 1400 to 2600 miles are possible in the 50-MHz region when sporadic-E is present.

In the northern hemisphere, the months of June

and July are the most prevalent sporadic-E months. On most days when sporadic-E is present, it lasts only a few hours at a time.

**Sudden Ionospheric Disturbances (SID's).** The SID, or "Dellinger Fade," mechanism occurs suddenly, and rarely gives any warning. The SID may last from a few minutes to many hours, and is believed to occur in correlation with solar flares or "bright solar eruptions" that produce immense amounts of ultraviolet radiation that impinge on the upper atmosphere. The SID causes a tremendous increase in D-layer ionization, which accounts for the radio-propagation effects. The ionization is so intense that all receiver operators on the sunny side of the Earth experience profound loss of signal strength above about 3 MHz. It is not uncommon for receiver owners to think their receivers are malfunctioning when that occurs. The sudden loss of signals on sunny side receivers is called Dellinger fade. The SID is often accompanied by variations in terrestrial electrical currents and magnetism levels.

**Ionospheric Storms.** The ionospheric storm appears to be produced by an abnormally large rain of atomic particles in the upper atmosphere, and are often preceded by SID's 18 to 24 hours earlier. The storms tend to last from several hours to a week or more, and are often preceded by two days or so by an abnormally large collection of sunspots crossing the solar disk. They occur most frequently, and with greatest severity, in the higher latitudes, decreasing toward the Equator.

When the ionospheric storm commences, short-wave-radio signals may begin to flutter rapidly and

then drop out altogether. The upper ionosphere becomes chaotic, turbulence increases and the normal stratification into "layers" or zones diminishes. Radio propagation may come and go over the course of the storm, but it is mostly dead. The ionospheric storm, unlike the SID (which affects the sunny side of the Earth), is worldwide.

An ionospheric disturbance observed by the author in the 1960's was preceded by about 30 minutes of extremely good, but abnormal propagation. At 1500 hours EST, European stations were noted with S9+ signal strengths in the 6000 to 7500-kHz region, which is an extremely rare occurrence. (I worked a GM3 in Scotland on 40-meter CW at 1510 EST.) After about 30 minutes, the bottom dropped out and even AM broadcast-band skip (later that evening) was nonexistent.

At the time, the National Bureau of Standards radio station, WWV, was broadcasting a "W2" propagation prediction at 19 and 49 minutes after each hour. It was difficult to hear even the 5-MHz WWV frequency in the early hours of the disturbance, and it disappeared altogether for the next 48 hours. Unfortunately, that was the weekend of the ARRL "Sweepstakes" contest (sigh)!

Additional information on radio propagation can be found in my book, *Practical Antenna Handbook* (TAB Books, Cat. No. 3270, \$21.95, Blue Ridge Summit, PA 17284; 1-800-233-1128), and the forthcoming *Receiving Antenna Handbook* (HighText Publications, 7128 Miramar Road, San Diego, CA 92121). ■

\*I am indebted to Jean Dragasco for the solar photographs.

## FCC LICENSE PREPARATION

General Radiotelephone  
Radiotelegraph  
Amateur Radio Licenses

We offer the most up-to-date study materials available. Our formats include: tests, audio programs, and video programs.



### WPT PUBLICATIONS

7015 N.E. 61st Ave.  
Vancouver, WA 98661  
(206) 750-9933

CIRCLE 12 ON FREE INFORMATION CARD



# SCANNER SCENE

By Marc Saxon

## Vacation Scanning

**H**ere's a hot little fire-cracker for the Fourth of July: the *Realistic PRO-58*. It's a mid-priced (\$129.95), ten-channel scanner that looks like a good bet for use in your vacation cabin, or as a stand-by set. The PRO-58 covers the standard 30–54 MHz, 138–174-MHz, and 380–512-MHz bands, and offers channel lock-outs, scan delay, and provision for manual channel selection. The LCD readout indicates the channel number as well as the actual frequency. The scanner has a built-in



*Radio Shack's 10-channel PRO-58 makes a good extra scanner for your summer vacation home.*

telescoping whip, and can use an external antenna. It operates from 117VAC using the supplied AC adapter, and you can also use it with an optional 12-VDC accessory cord. You can check out the PRO-58 at any Radio Shack store.

### LISTEN FOR THIS

A few months ago, newspapers announced that the FCC was allocating a chunk of spectrum for wireless Interactive Video and Data Services (IVDS). IVDS turns home TV sets into two-way communications tools in order to allow the public to perform such tasks as shopping, polling, banking, and bill paying without using computers or telephones. Licenses are now being processed, and IVDS services soon should be active, with home transmitters and also those at local cell-sites that interact with the home TV's to collect the data and send it, via Ku-band satellite, to a distant headquarters for processing.

As soon as that announcement appeared, we began to receive letters asking for information on the specific frequency band to be used for IVDS. The frequencies used between the cell-sites and home TV sets (and vice versa) will all be in the 218–219-MHz band. That band can be received on many scanners, but no IVDS communications will be in voice.

### VACATION BAND

A reader from Hawaii who wishes to remain nameless wrote to say that many summer tourists arrive on the islands with their scanners and then complain that they have a difficult time digging up the better frequencies to

monitor. He suggests Oahu Police on 155.37, 155.43, and 155.685; and Oahu Fire on 154.22 and 154.34 MHz. Try Maui Police on 154.725, 154.77, 155.55, 155.67, and 155.73 MHz; Big Island Police on 154.695, 154.83, and (Kona) 155.31 MHz; Big Island Fire on 154.385 MHz; Kahului Airport Security on 155.76 MHz; United Airlines on 460.725; Aloha Air on 129.9 and 460.70 MHz; and Maui Game Wardens on 154.995 MHz. Ambulances make good listening, too. Listen for Oahu on 453.70 and 453.925 MHz, Maui on 453.25 MHz, and Big Island on 453.40 MHz. Finally, you can hear the Haleakala Rangers on 169.55 MHz.

### MORE FREQUENCIES!

From Reading, PA, we heard from Walter Pfrommer about a good frequency to monitor while driving east/west on the Pennsylvania Turnpike. He said the 159.075 MHz really comes in at his location like a rock through a window.

We heard from another Walter, too. Walter J. Kibler, of Cedar Rapids, IA, wrote that the local detectives in Cedar Rapids used to operate on 156.03 MHz, but he hasn't heard any activity on that channel in a long time. So, what happened? Beats us, Walt, but you might put an ear on 460.175, 460.25, 460.30, 460.35, and 460.40 MHz, which are also Cedar Rapids Police frequencies. Maybe the detectives will show up on one of those channels.

Calvin Moriarty, of Trenton, NJ, told us to listen for New Jersey statewide fire activity on 154.265 MHz. The 800-MHz band New Jersey State Police frequencies are 856.7125, 857.7125, 858.7125, 859.7125, 860.7125, 856.4625, and 878.4125 MHz. The *Trenton Times* newspaper uses 173.265 MHz.

Jock Preston, of Flint, MI, wrote to say that he hears the remote vans of WEYL (TV-25) operating on 450.75 MHz. He also mentioned hearing Genesee County Fire on 154.145 MHz (North) and 154.19 MHz (South), and the county's Parks Department on 155.745 MHz. The Tuscola County Sheriff is on 39.60 MHz, with the car-to-car channel on 39.82 MHz.

In West Virginia, reports Red Keyser, of Elkins, many county sheriffs can be monitored on 155.925 MHz.

Roger A. Ferris, of Lakeland, FL, advises that he monitors 443.1 MHz when there is a Space Shuttle launch or other activity. We assume that this frequency is used by an area ham group to rebroadcast some of the more interesting Shuttle communications. Try it if you're in range.

## IN THE NEWS

A 48-year-old Ohio scanner owner made unhappy headlines recently when it was discovered that he had supposedly made a number of tape recordings of cellular-phone conversations made by the local sheriff, a member of the sheriff's department, and a clergyman. Armed with a search warrant, sheriff's deputies entered the man's home and took several tapes as evidence, intending to press charges of wiretapping in violation of Ohio laws.

It wasn't revealed how the possible existence of

recorded cellular conversations was discovered by the authorities. There was also no reason given for what possible use or value such tapes might have had to the scanner owner, or why he might have made them, if the charges are proven to be true. The scanner owner's attorney claimed that the charges were politically motivated, inasmuch as his client had been an unsuccessful candidate for several offices, including that of sheriff.

## KEEP IT LOW, JACK!

In the March, 1992 issue of **Popular Electronics**, Robert Angus had a fascinating feature story called "Electronic Tracking Foils Car Thieves." In the story, he mentioned the LoJack system that is becoming so popular across the nation. Vehicles equipped with LoJack transmit a tracking signal when they are stolen. That signal can be received on special direction-indicating receivers located in the vehicles of those police departments participating in the LoJack system.

Although my own local police don't use LoJack yet, I thought it might be interesting to put the national LoJack tracking frequency into my scanner. It wasn't specified in the March article, so write it down. It's 173.025. Sure enough, I have heard signals there! I suppose that they are coming from the vehicles of people from other areas who happened to be unlucky enough to be visiting in my area when someone decided to filch their wheels. Give a listen.

Let's hear from you with your frequencies, questions, etc. at *Scanner Scene*, **Popular Electronics**, 500-B Bi-County Blvd., Farmingdale, NY 11735. ■

## THINK TANK

(Continued from page 74)

*Taking your second item last, the circuit in Fig. 2 (which some of you might recall from the June, 1991 edition of this column) will provide the DC voltage and allow conversation between two phones. A suitable ring signal can be obtained using the circuit in Fig. 3. Last, a dial tone is available from any phone line not in use and not left off-hook for too long. And there you have it.*

## AIR-WAVES GUITAR

Being an electronics hobbyist and musician, I've been reading *Think Tank* for years now. Over that time, I've been looking for a practical circuit that could take the output of an electronic-guitar pickup, and transmit it to an FM radio for clean reproduction. The circuit I need must contain a frequency-adjust control. Ronco's "Mr. Microphone" is an example of such a circuit, and I tried using one for this purpose, but the sound was extremely distorted. Please print this or write me with the information. Maybe we could be on to something, perhaps the "Mr. Guitar."

Your loyal *Think Tank* fan,  
—Michael D. McKenna,  
Milwaukee, WI

*I think I know of just the thing. Back in the April, 1989 issue of our magazine, we presented an article on page 44 called "Cord Buster." The article contains a circuit for more or less the application you have in mind, although you might have to experiment with the value of R1. (I won't present the schematic here because you'll need tuning details and other information presented in the article anyway.)*

*I had great success with*

*the author's (Charles D. Rakes) prototype circuit when it was in the office, although I didn't try it with a guitar. It's range and clarity are excellent, and its one of the few RF projects that you can build using neat (no insulating spaghetti required) point-to-point wiring, without fear of stray component-coupling problems. I've even built one on solderless breadboard (with its notorious stray capacitance) with first-class results. Hats-off to Mr. Rakes for an admirable design.*

*There is one thing I should mention though. I don't know if this holds true for the Cord Buster, but hobbyist-level FM transmitters tend not to work to well, if at all, when used with digitally-tuned radios. Apparently, they cannot track a frequency that is modulated too far above or below the center frequency, so they lose stations that swing over too much of the FM band or drift over time. Their predecessors have automatic frequency-control (AFC) circuits that allow them to track a locked frequency up and down the dial like a hound. So much for progress.*

Well that brings us to the end of another month of interaction. I hope I've been helpful and informative. Until next time we meet, may your soldering iron be busy and your mind active. ■



"Hello Dearies, want to play Nintendo?"



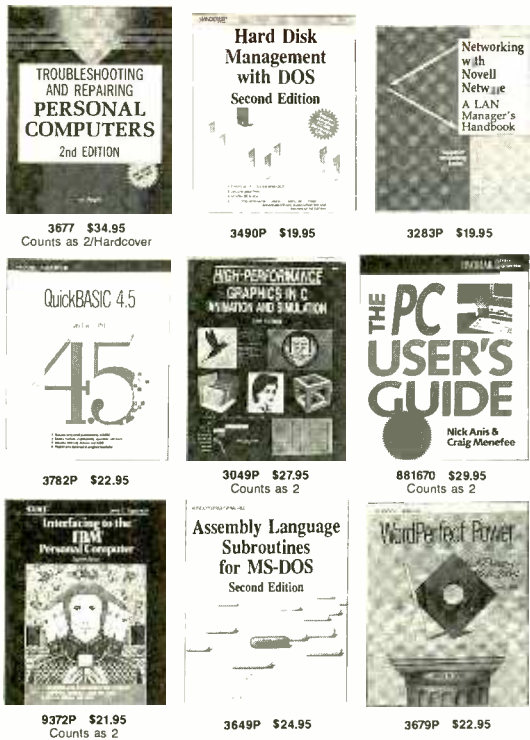

# Select any 5 books

## for only \$4<sup>95</sup>

(Values up to \$164.75)

when you join  
The Computer Book Club<sup>SM</sup>

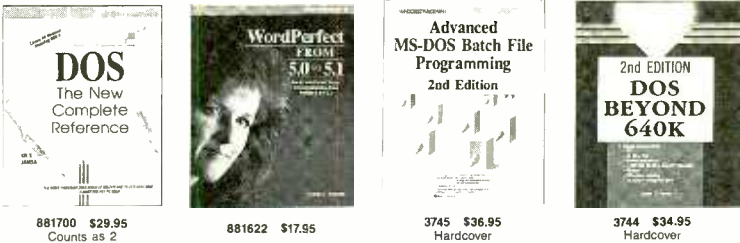

### As a member of The Computer Book Club . . .

. . . you'll enjoy receiving Club bulletins every 3-4 weeks containing exciting offers on the latest books in the field at savings of up to 50% off of regular publishers' prices. If you want the Main Selection do nothing and it will be shipped automatically. If you want another book, or no book at all, simply return the Reply Form to us by the date specified. You'll always have at least 10 days to decide, and if you ever receive a book you don't want, due to late mail delivery of the News, you can return it at our expense. Your only obligation is to purchase 3 more books during the next 2 years, after which you may cancel your membership at any time. All books are softcover unless otherwise noted. (Publishers' Prices Shown) ©1992 CBC

## Special Book/Disk Offers

**Computer Viruses**  
3382P \$29.95  
Counts as 2

**WINDOWS 3 SHAREWARE UTILITIES**  
3917P \$29.95  
Counts as 2

**MS-DOS BATCH FILE UTILITIES**  
3915 \$36.95  
Counts as 2/Hardcover

### The Computer Book Club<sup>SM</sup>

Blue Ridge Summit, PA 17294-0820

**YES!** Please rush me the books indicated below for just \$4.95 plus \$4.95 shipping/handling- and sales tax, and enroll me as a member of **The Computer Book Club**. If not satisfied, I may return the books within 10 days for a full refund and my membership will be cancelled. The Club Bulletin will be sent to me once every 3-4 weeks, and I will have at least 10 days to make my decision. Return postage is guaranteed on books received due to late mail delivery of the News. If I want the Main Selection, I need do nothing, it will be shipped automatically. If I want a different book or no book at all I will notify the Club by returning the card provided. I agree to purchase just 3 more selections at regular Club prices within the next 2 years and may resign anytime thereafter.

--	--	--	--

You may choose any combination (including "Counts as 2") for a total of 5 selections.

Check or money order enclosed payable to: The Computer Book Club  
 Please charge my  VISA  MasterCard  American Express

Acct.# \_\_\_\_\_ Exp. Date \_\_\_\_\_

Signature \_\_\_\_\_ (required on all credit card orders)

PAYMENT MUST ACCOMPANY ORDER

Name \_\_\_\_\_ Address \_\_\_\_\_

City /State \_\_\_\_\_ Zip \_\_\_\_\_

Offer valid for new members only, subject to acceptance by CBC. U.S. orders are shipped 4th Class Book Post. Canada must remit in U.S. funds. -Canadian orders shipped International Book Post--add \$9.95 shipping/handling. PPICT92

If coupon is missing write to: The Computer Book Club, Blue Ridge Summit, PA 17214-0820

# ELECTRONICS LIBRARY

## Troubleshooting and Repairing Solid-State TVs; Second Edition

by Homer L. Davidson

The second edition of this complete workbench reference retains the original's valuable information on older sets, but has been expanded to cover high-definition television, stereo sound circuitry, modular chassis, and large-screen sets as well. Intended to help repair technicians pinpoint and fix TV malfunctions quickly and easily, the book is filled with case study examples, photographs, and diagrams for virtually every type of television circuit, including the latest solid-state circuitry used by all major TV manufacturers. It describes the warning

any problem confronted by repair technicians, including defective horizontal-sweep circuits, faulty remote controls, high- or low-voltage power supply, brightness and picture-tube problems, and defective tuners. Also included are pointers on how to locate defective transistors and color processors in various color chassis.

*Troubleshooting and Repairing Solid-State TVs, Second Edition, costs \$24.95 and is published by TAB Books, Division of McGraw-Hill Inc., Blue Ridge Summit, PA 17294-0850; Tel. 1-800-822-8138.*

**CIRCLE 98 ON FREE INFORMATION CARD**

### BEAT THE BOOK WITH FLUKE MULTIMETERS

from John Fluke Mfg. Co.

Designed for the professional automotive mechanic, this 16-page color brochure describes time-saving procedures for servicing electrical systems safely and accurately with Fluke digital multimeters. The instruments featured in the booklet are the Fluke 73 and 23 Series II meters, the Fluke 87 DMM and the Fluke 52 digital thermometer. The rugged digital multimeters offer several features that make them well-suited for automotive technicians, including an analog/digital display, automatic Touch Hold, automatic polarity and range selection, and a continuity beeper. The updated application note on automotive electrical troubleshooting includes fully illustrated sections explaining the use of DMM's in the testing of the ignition system, starting system, charging system, lighting and accessories, computer sensors, and cooling system, as well as their use in the diagnosis of current drains and shorts.

*Beat the Book With Fluke Meters is available at no charge at Fluke authorized distributors locations nationwide or by contacting John Fluke Mfg. Co., Inc., Service Equipment Group, P.O. Box 9090, M/S 250-E, Everett, WA 98206; Tel: 800-87-FLUKE.*

**CIRCLE 93 ON FREE INFORMATION CARD**

### VOODOO DOS: TIPS & TRICKS WITH AN ATTITUDE

by Kay Yarborough Nelson

More than just a catchy title, the magic behind the tips and tricks presented in this book is that they get results quickly. No complex theory is presented, and all of the pointers are short and relatively easy to use. The book shows DOS users (through version 5.0) how to get started, with upgrading and set-up tips, and explanations of how to customize DOS, including the HELP command, and how to find disk space. It goes on to show readers how to "master the secret of the Shell," by presenting menu shortcuts, and pointers on how to decide whether or not to use a mouse, switch from the Shell to the command line, navigate through lists, and select files. The book presents file attribute tricks, and explains how to run programs from the Shell, switch between

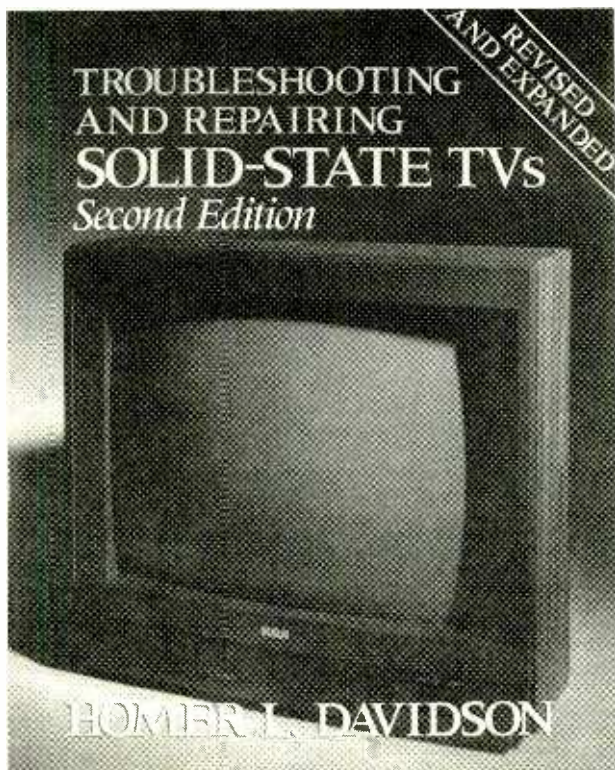

symptoms of problems in solid-state TVs, and directs the reader to the circuits and individual components that are most likely causing the trouble. The book explains how to repair virtually



programs, set up program groups, and use keyboard shortcuts. "Command sleight-of-hand" covers command line basics, editing commands, the new and improved DIR command, wildcard tips and traps, and special symbols and commands. In terms of managing disks and hard drives, the book explains formatting and using disk utilities and presents tricks for undeleting files, copying disks, and organizing disk files. Pointers are included for everything from getting screen dumps to deleting files, from making backups to printing from DOS. In addition, the book shows how to create, run, stop, and organize batch files; get the most from Doskey; understand arcane commands, and manage DOS memory. A comprehensive index provides quick access to tips on any particular topic.

*Voodoo DOS: Tips & Tricks With an Attitude costs \$19.95 and is published by Ventana Press, P.O. Box 2468, Chapel Hill, NC 27515; Tel: 919-942-0220; Fax: 919-942-1140.*

**CIRCLE 92 ON FREE INFORMATION CARD**

## MOUSER ELECTRONICS CATALOG #570

from Mouser Electronics

In its 200 pages of small print, Catalog #570 includes up-to-date product data and pricing on more than 36,000 electronic components from more than 80 manufacturers. Product categories include resistors, capacitors, potentiometers, inductors, transformers, semiconductors, connectors and cables, switches, relays, speakers, cabinets and knobs, fuses, batteries, tools, equipment, and books. A "New Product" section features NEC optoelectronic devices, IC's, capacitors, and CMOS static RAM's; microprocessor crystals and oscillators; photo-conductive cells; modular telephone connectors, cable, and ganged jacks; Tripp Lite power protection devices; 3M communications connectors and splice kits; and Global Specialties Circuit Simulator software. Product index tabs are provided for fast and easy product location.

*Catalog #570 is free upon request from Mouser Electronics, P.O. Box 699, Mansfield, TX 76063; Tel: 800-992-9943.*

**CIRCLE 91 ON FREE INFORMATION CARD**

## ECG INSTANT CROSS MASTER GUIDE DISKETTES

from Philips ECG

ECG semiconductors distributors and their customers can now conveniently access the full ECG replacement semiconductors data base of more than 262,000 industry part numbers on their IBM-PC's or compatibles. The Instant Cross software allows users to instantly call up the ECG replacement device for any of



the industry numbers on file. Typical access time is under one second. More than 4000 ECG components are available in the program, making it the largest available semiconductor cross-reference data base. The software operates on PC-compatible computers that have 640K of RAM, a hard drive, and a 3½- or a 5¼-inch floppy drive. The program versions that are available will support 360K/1.2M and 720K/1.44M floppy disk drives; and monochrome, CGA, EGA, and VGA monitors.

Besides crossing the original part number, the program displays the full ECG device description, case style, and a reference to any special or general note that applies. The note or a screen printout can be called up with one keystroke. Another feature of the software allows the user to select foreground and background colors from a palette of eight hues, which can be used to customize the display from the various possible combinations.

*The Instant Cross program is available through authorized Philips ECG distributors nation-*

*wide. To locate the nearest distributor, call 1-800-526-9354.*

**CIRCLE 90 ON FREE INFORMATION CARD**

## HARD DRIVE ENCYCLOPEDIA: THE GUIDE TO PC COMPATIBLE HARD DRIVES

by Adrian Alting-Mees

In almost 600 pages in a three-ring binder, this book describes how hard drives work, how they are interfaced to the computer, and how the computer knows how to make use of them. The complete reference work includes a companion diskette full of useful utilities, and detailed instructions for installing a hard drive in your computer. It is divided into sections covering ST506, ESDI, SCSI, and IDE specifications; five other types of interfaces; hard-drive characteristics; electrical characteristics; logical-encoding schemes; and file formats. Ex-

tensive lists are provided in sections covering controller parameters, hard-disk parameters, and manufacturers. Another section lists the BIOS hard-drive-type tales for a number of popular BIOS's, and explains how to see the drive-type tables in your own BIOS using the utilities on the companion disk. The book provides directions on how to install a drive that is not specifically in your drive-type table. More than 1600 model numbers are listed by manufacturer, so if you have to install a drive but don't have a spec sheet, you can find the important parameters in the tables.

*The Hard Drive Encyclopedia: The Guide to PC Compatible Hard Drives costs \$89.00 plus shipping and is published by Annabooks, 12145 Alta Carmel Court, Suite 250-262, San Diego, CA 92128; Tel: 1-800-462-1042 or 619-271-9526; Fax: 619-592-0061.*

**CIRCLE 89 ON FREE INFORMATION CARD**

## BOOK II HOW TO GET ANYTHING ON ANYBODY



### ALL NEW LEE LAPIN!

**Best Bugs On A Budget** to super secret CIA fine wire kits. How the FBI sees thru walls to low cost starlight scopes. Electronic and mechanical tailing tricks, surveillance photography, intelligence kits. **Cutting edge** audio/video surveillance, HOW TO crack computers, bypass passwords, obtain unlisted phone numbers, intercept cellular calls, pagers, and faxes, trace and track anyone, surveillance proof any room, tap any phone, and more! **WHEW!** "Really scary stuff." Charles Jaco CNN. \$38.50 postpaid.

### ORDER TODAY!

ISECO, 2228 El Camino Real, #349-31, San Mateo, CA 94403. 415-513-5549.

**CIRCLE 13 ON FREE INFORMATION CARD**

# NEW PRODUCTS

## PC Weather Station

You can put your PC's joystick interface to more serious use than computer game-playing with the *WindStation WS-10* from *WeatherPort*. The weather-monitoring system includes a rugged, pole-mounted anemometer/weather vane and 40 feet of connecting cable. Measurements are displayed in either monochrome or in color. The basic model measures average wind speed, wind direction, and peak gust value. Outside temperature measurements, displaying 24-hour extremes and wind-chill values, are available optionally. The data can be gathered for real-time display and/or transferred to a spreadsheet for tabular logging and analysis of weather trends.

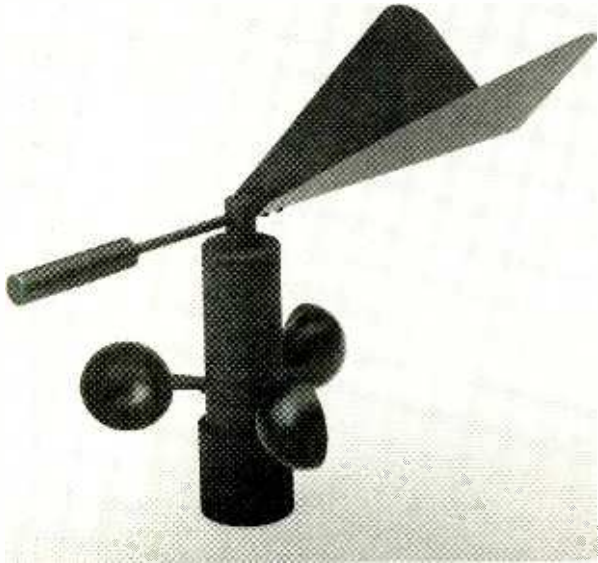

The vane assembly fits on the end of a standard one-inch pipe of the type commonly used for rooftop TV antennas. The cable is terminated in a standard RJ-11 connector that mates with an adapter that plugs into a standard joystick port. All signal processing and data-logging functions are performed within your MS-DOS PC, resulting in easier installation and increased reliability, eliminating the need for external power, and leaving the serial ports free for other uses. An optional extension ca-

ble increases the cable length to 150 feet.

The *WindStation WS-10* costs \$129.50. For further information, contact *WeatherPort, Inc.*, 12036 Nevada City Highway, Grass Valley, CA 95945; Tel: 800-992-8110.

**CIRCLE 100 ON FREE INFORMATION CARD**

## DIGITAL CALIPER

For making precise outside, inside, depth, and step measurements from 0–6 inches and 0–15mm, *Extech's Model JAC787090 Digital Caliper* features a fast response time of 60



inches (1.5 meters) per second and repeatability of 0.0005 inches (0.01mm). It makes accurate measurements to 0.001 inch (0.03mm). The instrument features a 0.18-inch, 6-digit LCD readout and a low-battery indicator. The digital caliper is powered by a 1.5-volt silver-oxide battery with an 8000-hour life. The battery and a wooden case are included.

The *Model JAC787090 Digital Caliper* costs \$99. For additional information, contact *Extech Instruments Corporation*, 335 Bear Hill Road, Waltham, MA 02154; Tel: 617-890-7740.

**CIRCLE 101 ON FREE INFORMATION CARD**

## SPEAKER/DTMF DECODER

The *Silencer Model ARE-10* from *Amateur Radio Engineering* combines an external speaker with a 2- to 4-digit DTMF decoder for use with VHF/UHF radios. The device provides a way for family members or coworkers to have selective calling, or to avoid everything being said on today's busy frequencies. Rather than turning off the radio to eliminate



the annoyance, the user can just set the toggle switch to decode and the *Silencer* will eliminate all of the chatter while still allowing the user to receive calls.

A user-programmable DTMF code enables (opens) the speaker for approximately ten seconds when the proper tone is received. An LED lights to let the user know that a call has been received. The *ARE-10* allows the user to set the front toggle switch to "monitor" when they want to hear everything being said on the frequency. The toggle switch is also used to turn off the LED after a call has been received. Setup is simple: The *ARE-10* plugs into the radio's external speaker jack, and its power leads must be connected to 12 volts DC.

The *Silencer ARE-10* costs \$99.95. For more information, contact *Amateur Radio Engineering, Inc.*, P.O. Box 169, Redmond, VA 98073; Tel: 206-882-2837.

**CIRCLE 102 ON FREE INFORMATION CARD**

## CELLULAR ANTENNA

Cellular phones are susceptible to dropped calls, poor reception, and vandalism. The *Tranceptor Model CFR900* cellular antenna is intended to address all three problems. According to *Terk Technologies*, it delivers better performance than currently available cellular antennas, and is designed to be mounted to the *inside* surface of a vehicle's rear window (or any other non-metallic surface) where it won't



attract the attention of would-be thieves. The device consists of a compact (2.5 × 5 × 0.4-inch) black rectangular reception/transmission module hard-wired to a specially tuned cable in a single-piece design. The module adheres to any non-metal surface in a car or boat, making it easy to install. It is not affected by a window's defroster



elements, and its cabling prevents the signal loss that occurs in conventional antennas due to wire braid separation. The unit radiates in a 360-degree pattern, dramatically reducing the incidence of dropped calls and noisy transmissions. Compared to "stick" antennas, which must be tuned to one specific frequency, the Transceptor covers the entire cellular communications bandwidth (from 800 to 1000 MHz) with uniformly high efficiency. And while standard cellular antennas have a Voltage Standing Wave Ratio (VSWR), which is a comparison of a given signal's strength at transmission to its strength at reception, of 1.9:1 under ideal conditions, the Transceptor boasts a VSWR of 1.0:1.

The CFR900 Transceptor has a suggested retail price of \$79.95. For more information, contact Terk Technologies Corporation, 233-8 Robbins Lane, Syosset, NY 11791; Tel: 800-942-TERK or 516-942-5000; Fax: 516-942-TERK.

**CIRCLE 103 ON FREE INFORMATION CARD**

### MODULAR OSCILLOSCOPE-PROBE KITS

A new family of *Oscilloscope Probe Kits* from *ITT Pomona*, containing interchangeable probes and accessories for the professional oscilloscope user,



come in three configurations: 100, 200, and 300 MHz. The kits feature modular designs which allow maximum flexibility and interchangeability of tips and interface connections. Each kit is packaged in a reusable plastic case.

The 100-MHz kits can be used with any scope up to 100 MHz and are available in three attenuation ranges: *Model 5792* has ×1 attenuation, *Model 5795*, ×10; and *Model 4550*, switchable ×1–×10 attenuation. Each probe is modular, has readily available replacement parts, features flexible cable for handling ease, and includes a variety of accessories. The 200-MHz professional oscilloscope probe kits offer stainless-steel probes, and economical replacement parts. Four 200-MHz kits are available: the ×1-attenuation *Model 5800*, the ×1–×10 switchable *Model 5803*, the ×1–×100 switchable *Model 5806*, and the ×100-attenuation *Model 5827*. Two 300-MHz, high-frequency oscilloscope-probe kits provide maximum safety and durability and can be used with any oscilloscope. *Models 5809* and *5812* have ×10 attenuation; the latter also has a readout actuator.

The oscilloscope-probe kits cost between \$30 and \$84. For further information, contact ITT Pomona Electronics, Customer Service, 1500 East Ninth Street, P.O. Box 2767, Pomona, CA 91769; Tel: 714-469-2900; Fax: 714-629-3317.

**CIRCLE 104 ON FREE INFORMATION CARD**

### PORTABLE CAR ALARM

The *MRAS-300* automobile alarm features the same over-the-window design of previous models from *Maxon*, but is smaller and provides longer battery life. The highly sensitive alarm emits a piercing, siren-like noise at 100 dB for 40 seconds when activated by motion or vibration. If the

disturbance does not continue—if it was caused, for instance, by another car tapping the bumper while parking—the unit will automatically rearm itself unless it is deactivated by the keychain remote-control transmitter. The *MRAS-300* measures 5¼ × 2¾ × 3½ inches and is powered by four "AA" batteries, which give it an average battery life of six months.

The alarm system is easy to use. It can be armed and disarmed by remote control. In addition, it features a panic button, providing a way to attract attention in a dangerous situation. No wiring or installation is required; the 10-ounce unit can be mounted in seconds. It is hung on the window by its mounting bracket and the window is then closed over the bracket. The electronics, including the motion- and vibration-sensing circuitry and the controls, hang inside the vehicle. The alarm hangs on the outside. The alarm signal sweeps



from 2500 to 3300 Hz at a level of 10 dB. A continuously variable sensitivity slide-switch allows the unit to be set for different conditions. Because the unit is portable, it can also be used as an alarm in a hotel room, where it can be hung from the doorknob using its accessory hanger.

The *MRAS-300* portable car alarm has a suggested retail price of \$69.95. For further information, contact Maxon Systems Inc., 8610 NW 107th Terrace, Kansas City, MO 64153; Tel: 800-922-9083.

**CIRCLE 105 ON FREE INFORMATION CARD**

# Be an FCC LICENSED ELECTRONIC TECHNICIAN!



**Earn up to \$30 an hour and more!**

Learn at home in spare time. No previous experience needed!

No costly school. No commuting to class. The Original Home-Study course prepares you for the "FCC Commercial Radiotelephone License." This valuable license is your professional "ticket" to thousands of exciting jobs in Communications, Radio-TV, Microwave, Maritime, Radar, Avionics and more...even start your own business! You don't need a college degree to qualify, but you do need an FCC License.

**No Need to Quit Your Job or Go To School**  
This proven course is easy, fast and low cost! **GUARANTEED PASS**—You get your FCC License or money refunded. **Send for FREE facts now. MAIL COUPON TODAY!**

**COMMAND PRODUCTIONS**  
FCC LICENSE TRAINING, Dept. 100  
P.O. Box 2824, San Francisco, CA 94126  
Please rush **FREE** details immediately!

NAME \_\_\_\_\_  
ADDRESS \_\_\_\_\_  
CITY \_\_\_\_\_ STATE \_\_\_\_\_ ZIP \_\_\_\_\_

## ANTIQUE RADIO

(Continued from page 67)

and acquired a home with space for a workshop, he began to collect in earnest. Terry really enjoys refinishing and repairing the old sets, finding them a refreshing change from the state-of-the-art electronic circuits he deals with at work. He now has about 20 sets, which he displays around the house and in his workshop.

Terry's wife pretends to be annoyed when he brings home another radio. But, underneath it all, she appreciates the old sets and enjoys it when Terry brings them back to life.

Whereas Terry began acquiring cast-off sets as a result of attending electronics school, **Steve Kalista** went to electronics school as a result of working with cast-off sets. His interest began when, as a boy, he repaired radios salvaged from the town dump.

According to the local newspaper write-up that Steve submitted as his entry, he went on to technical school in Newark, NJ and, after graduation (and the outbreak of World War II), he served in the U.S. Army Signal Corps. After completing Army radio school in 1942, he repaired airborne

radios and other electronics equipment in the China-Burma-India theater.

After the war, he studied at Penn State, receiving a bachelor's degree in electronic engineering. Then began a career in electronics culminating with 21 years' service as a civilian employee of the Army Signal Corps research and development facility at Fort Monmouth, NJ.

Now retired, Steve (who is also an active radio amateur as well as an artist who works in stained glass and acrylic paints) began collecting old sets less than two years ago. He already has over 115!

**Jerry Toth** (Maple Ridge, British Columbia, Canada) sent several shots of his relatively small (39 items) but choice collection. These are beautifully displayed in what appears to be a basement playroom. As with David Booth's photos, we'll run one now and try to find room for more in a future column.

Jerry seems to have avoided the battery-set era, concentrating on radios dating from about 1928 to 1954. He also harbors some old citizens-band radios. Repairing and restoring the old sets is as important to Jerry as collecting them, and he



*Jerry Toth's acquisitions are artistically laid out along the floor and walls of his cozy display area.*

spends a lot of time on chassis repair and cabinet refinishing.

As to the reaction of other family members to his trophies, Jerry gives us just one hint at the end of his letter: "P.S. My wife tells me to polish my own junk'."

That's all for now. Until next time, you can write me c/o *Antique Radio*, **Popular Electronics**, 500-B Bi-County Blvd., Farmingdale, NY 11735. ■

## COMPUTER BITS

(Continued from page 69)

reer strategy, buy the best you can afford, perhaps just a bit more. Chances are whatever you buy will be outdated in two or three years, and virtually unusable in five. Eventually the cycle of obsolescence will stretch out, but not yet.

If you're buying on a cost-only basis, you can get DOS-only hardware (8088- or 80286-based) and software much cheaper. But there is no future in it. If you see yourself having a long-term relationship with computers, DOS-only is a dead-end purchase. The good news is that powerful Windows-capable PC's are now available for prices less than what a few years ago premium DOS-only machines commanded. ■

## CIRCUIT CIRCUS

(Continued from page 72)

Fig. 7 may be of some use to you. The circuit will let you know that the power temporarily failed while you were away or asleep. The circuit won't tell you how long the power was off but will give a warning so you can check on your AC-operated equipment.

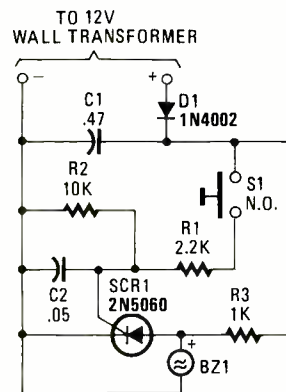

*Fig. 7. The AC Line Monitor, whose dominant component is SCR1, will let you know if the power temporarily failed while you were away or asleep.*

A 12-volt wall transformer supplies an AC voltage to the anode of D1. The rectified output is slightly filtered by C1 (a 0.47- $\mu$ F, 50-WVDC, capacitor), producing a raw DC voltage at the anode of the sensitive-gate SCR. The piezo sounder receives power through the 1k resistor (R3) and sounds until S1 is pressed. When S1 closes, current flows into the SCR's gate, activating it. That diverts power that would otherwise be used to sound BZ1, thus the buzzer remains quiet until a temporary power failure. When the power fails, the SCR's anode current goes to zero, causing the SCR to turn off. When power is restored, power (that was previously diverted through the SCR) is delivered to BZ1, causing it to sound until the circuit is reset via S1. ■



*Gary Arnold's basement display room is a mini-museum of radio history.*



# Electronics Paperback Books

GREAT PAPERBACKS AT SPECIAL PRICES

**BP248—TEST EQUIPMENT CONSTRUCTION** ..... \$5.95. Details construction of simple, inexpensive, but extremely useful test equipment. AF Gen. Test Bench Ampl, Audio Millivoltmeter, Transistor Tester and six more.



**BP267—HOW TO USE OSCILLOSCOPES AND OTHER TEST EQUIPMENT** ..... \$6.95. Mastering the oscilloscope is not really too difficult. This book explains all the standard controls and functions. Other equipment is also described.



**BP265—MORE ADVANCED USES OF THE MULTIMETER** ..... \$5.95. Use these techniques to test and analyze the performance of a variety of components. Also see how to build add-ons to extend multi-meter capabilities.



**BP256—INTRO TO LOUDSPEAKERS AND ENCLOSURE DESIGN** ..... \$5.95. We explore the variety of enclosure and speaker designs in use today so the reader can understand the principles involved.



**CMOS1—CMOS POCKET GUIDE 1** ..... \$18.95. Works like the TTL Guides but covers all commonly used CMOS standard devices. Six major sections. The first shows the device schematic. Next is a brief description of the component and is followed by full operating details. The fourth section lists major applications, while the 5th and 6th sections present essential data for that device and a list of the relevant manufacturers. The final two sections are a valuable cross-reference.



**BP299—PRACTICAL ELECTRONIC FILTERS** ..... \$6.95. Presents a dozen filter-based practical projects with applications in and around the home or in the constructor's workshop. Complete construction details are included.



**BP249—MORE ADVANCED TEST EQUIPMENT CONSTRUCTION** ..... \$6.95. Eleven more test equipment construction projects. They include a digital voltmeter, capacitance meter, current tracer and more.



Digital Audio Projects

**BP245—DIGITAL AUDIO PROJECTS** ..... \$5.95. Practical circuits to build and experiment with. Includes A/D converter, input amplifier, digital delay line, compander, echo effect and more.



**BP247—MORE ADVANCED MIDI PROJECTS** ..... \$5.95. Circuits included are a MIDI indicator, THRU box, merge unit, code generator, pedal, programmer, channelizer, and analyzer.



**BP257—INTRO TO AMATEUR RADIO** ..... \$6.95. Amateur is a unique and fascinating hobby. This book gives the newcomer a comprehensive and easy to understand guide to the subject.

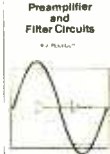

**BP309—PREAMPLIFIER AND FILTER CIRCUITS** ..... \$6.95. Provides circuits and background info for a range of preamplifiers, plus tone controls, filters, mixers and more. All are high-performance circuits that can be built at a reasonable cost.

**BP303—UNDERSTANDING PC SOFTWARE** ..... \$6.95. This book will help you understand the basics of various types of business software in common use. Types of software covered include word processors, spelling checkers, graphics programs, desktop publishing, databases, spreadsheets and utilities.



**BP251—COMPUTER HOBBYISTS HANDBOOK** ..... \$8.95. A wrapup of everything the computer hobbyist needs to know in one easy to use volume. Provides a range of useful reference material in a single source.



**PCP115—ELECTRONIC PROJECTS FOR HOME SECURITY** ..... \$10.00. 25 projects ranging from a single-door protection circuit that can be completed in an hour or two, to a sophisticated multi-channel security system. Each project is described in detail with circuit diagrams, explanations of how it works, instructions for building and testing, and how to adapt circuits to meet special requirements.



**BP195—INTRODUCTION TO SATELLITE TV** ..... \$9.95. A definitive introduction to the subject written for the professional engineer, electronics enthusiast, or others who want to know more before they buy. 8 x 10 in.

**BP190—ADVANCED ELECTRONIC SECURITY PROJECTS** ..... \$5.95. Includes a passive infra-red detector, a fiber-optic loop alarm, computer-based alarms and an unusual form of ultrasonic intruder detector.

**BP235—POWER SELECTOR GUIDE** ..... \$10.00. Complete guide to semiconductor power devices. More than 1000 power handling devices are included. They are tabulated in alpha-numeric sequence, by technical specs. Includes power diodes, Thyristors, Triacs, Power Transistors and FETs.

**BP234—TRANSISTOR SELECTOR GUIDE** ..... \$10.00. Companion volume to BP235. Book covers more than 1400 JEDEC, JIS, and brand-specific devices. Also contains listing by case type, and electronic parameters. Includes Darlington transistors, high-voltage devices, high-current devices, high power devices.

**BP99—MINI-MATRIX BOARD PROJECTS** ..... \$5.50. Here are 20 useful circuits that can be built on a mini-matrix board that is just 24 holes by ten copper-foil strips.

**BP117—PRACTICAL ELECTRONIC BUILDING BLOCKS—Book 1** ..... \$5.75. Oscillators, Timers, Noise Generators, Rectifiers, Comparators, Triggers and more.

**BP184—INTRO TO 68000 ASSEMBLY LANGUAGE** ..... \$6.95. The 68000 is a great new breed of microprocessor. Programming in assembly language increases the running speed of your programs. Here's what you need to know.

**BP179—ELECTRONIC CIRCUITS FOR THE COMPUTER CONTROL OF ROBOTS** ..... \$7.50. Data and circuits for interfacing the computer to the robot's motors and sensors

**BP239—GETTING THE MOST FROM YOUR MULTIMETER** ..... \$5.95. Covers basics of analog and digital meters. Methods of component testing includes transistors, thyristors, resistors, capacitors and other active and passive devices.

**BP97—IC PROJECTS FOR BEGINNERS** ..... \$5.50. Power supplies, radio and audio circuits, oscillators, timers, switches, and more. If you can use a soldering iron you can build these devices.

**BP37—50 PROJECTS USING RELAYS, SCR'S & TRIACS** ..... \$5.50. Build priority indicators, light modulators, warning devices, light dimmers and more.

**RADIO—100 RADIO HOOKUPS** ..... \$3.00. Reprint of 1924 booklet presents radio circuits of the era including regenerative, neutrodyne, reflex & more.

**BP42—SIMPLE LED CIRCUITS** ..... \$5.50. A large selection of simple applications for this simple electronic component.

**BP127—HOW TO DESIGN ELECTRONIC PROJECTS** ..... \$5.75. Helps the reader to put projects together from standard circuit blocks with a minimum of trial and error.

**BP122—AUDIO AMPLIFIER CONSTRUCTION** ..... \$5.75. Construction details for preamps and power amplifiers up through a 100-watt DC-coupled FED amplifier.

**BP92—CRYSTAL SET CONSTRUCTION** ..... \$5.50. Everything you need to know about building crystal radio receivers.

**BP45—PROJECTS IN OPTOELECTRONICS** ..... \$5.50. Includes infra-red detectors, transmitters, modulated light transmission and photographic applications.

**BP255—INTERNATIONAL RADIO STATIONS GUIDE** ..... \$7.95. Provides the casual listener, amateur radio DXer and the professional radio monitor with an essential reference work designed to guide him or her around than ever more complex radio bands

CHECK OFF  
THE BOOKS YOU WANT

ELECTRONIC TECHNOLOGY TODAY INC.  
P.O. Box 240, Massapequa Park, NY 11762-0240

SHIPPING CHARGES IN  
USA AND CANADA

SORRY No orders accepted  
outside of USA & Canada

Number of books ordered

Name \_\_\_\_\_  
Address \_\_\_\_\_  
City \_\_\_\_\_ State \_\_\_\_\_ Zip \_\_\_\_\_

\$0.01 to \$5.00 ..... \$1.50  
\$5.01 to \$10.00 ..... \$2.50  
\$10.01 to 20.00 ..... \$3.50  
\$20.01 to 30.00 ..... \$4.50  
\$30.01 to 40.00 ..... \$5.50  
\$40.01 to 50.00 ..... \$6.50  
\$50.01 and above ..... \$8.00

Total price of merchandise ..... \$ \_\_\_\_\_  
Shipping (see chart) ..... \$ \_\_\_\_\_  
Subtotal ..... \$ \_\_\_\_\_  
Sales Tax (NYS only) ..... \$ \_\_\_\_\_  
Total Enclosed ... \$ \_\_\_\_\_

All payments must be in U.S. funds

PE792

## BUILD A GEIGER COUNTER

(Continued from page 43)

author drilled a hole just large enough to pass the end of a 3-foot length of two-conductor shielded cable through. The conductors within the cable are color coded, greatly simplifying the proper wiring of the GM tube. One end of the shielded cable was then connected to the GM tube and the other end to a 1/8-inch plug that connects the GM tube to the circuit board through J2.

Connect one conductor of the cable to the anode (center lead) of the GM tube, and connect the other end of the same conductor to the center contact of the plug. Connect the other conductor to the cathode (outer lead) of the Geiger-Muller tube, and the other end of that conductor to the outer contact of the plug, so that the cathode is tied to ground (through R5) when the GM tube is plugged in.

The GM tube was cushioned on the sides and bottom using soft non-con-

ductive foam rubber. **Note:** If conductive foam is used, do not allow the foam to touch the electrodes of the GM tube. That will put a short across the GM tube, rendering the unit inoperative. A small amount of velcro was then used to secure the GM housing to the case.

### Checkout and Troubleshooting.

Before plugging in the GM tube, it's a good idea to see if the circuit is functioning properly. Turn on the circuit and measure the voltage from the D3/C3 junction to ground; it should be approximately 500 volts DC.

If the voltage is too low, or you get none at all, check the primary side of T1; There should be a pulsating DC signal across the primary of the transformer. Also check the orientation of the Zener diodes. Continue backtracking in that manner, checking the base of Q1. You should be getting a 5-kHz squarewave signal. Check pin 3 of U2 using a scope.

Once the circuit is working, power it down and plug in the GM tube. Then turn it on again, and note whether it

begins to click. The author gets a reading of approximately 11 pulses per minute from background radiation. As each particle is detected, the speaker will click and the LED will flash. If you have acquired some radioactive material (we'll present some sources shortly) bring the GM tube close to it to test for activity.

**Radioactive Sources.** An easy source of a radioactive material—approximately one microcurie of Americium 241—can be found in a ionization-type smoke detector. Americium is a strong alpha-particle source. To use the Americium as a source, it must be removed from the smoke detector. The alpha particles only travel an inch or so through the air so you'll have to get pretty close with the GM tube to detect anything.

To get to the radioactive source, first remove the plastic top of the smoke detector. The Americium is inside a small ventilated metal can. Remove the can with pliers. The Americium is embedded in a metal plate underneath the can. Remove the entire plate with the Americium from the detector. Leave the radioactive material attached to the plate, and use the material on the plate. Bringing the GM tube within 1/2-inch of the source, the reaction of the Geiger Counter will become furious.

A more reliable source of radioactive materials is the Nucleous Company (601 Oak Ridge Turnpike, Oak Ridge, TN 37830; Tel. 615-483-8405 or 800-255-1978). The company sells calibrated and uncalibrated radioactive materials for students, schools, and industry. (I purchased a Cesium-137 gamma-ray source for \$25.00. The material is rated at 5 microcuries with a 30-year half life. It was enlightening when I placed a 3/4-inch solid block of aluminum in front of the Cesium-137, and found there was no noticeable decrease in radiation.) ■

## PARTS LIST FOR THE GEIGER COUNTER

### SEMICONDUCTORS

U1—4049 hex inverting-buffer, integrated circuit  
U2, U3—555 oscillator/timer, integrated circuit  
Q1—1RF511 N-channel enhancement MOSFET  
Q2—TIP120 silicon NPN transistor  
D1, D2—1N4007 general-purpose silicon rectifier diode  
D3, D4—1N5388B 200-volt Zener diode  
D5—1N5271B 100-volt Zener diode  
LED1—Light-emitting diode (red)

### RESISTORS

(All resistors are 1/4-watt, 5% units.)

R1—22,000-ohm  
R2—1000-ohm  
R3—10-ohm  
R4—10-megohm  
R5, R7—100,000-ohm  
R6—10,000-ohm

### CAPACITORS

C1, C2—.01- $\mu$ F, polyester  
C3, C4—.01- $\mu$ F, 2000-WVDC, ceramic-disc  
C5—1- $\mu$ F, 16-WVDC, electrolytic  
C6—.047- $\mu$ F, polyester  
C7, C8—220- $\mu$ F, electrolytic

### ADDITIONAL PARTS AND MATERIALS

SPKR1—8-ohm speaker  
T1—6-volt to 330-volt, step-up transformer  
B1—9-volt alkaline battery  
S1—SPST toggle switch  
J1, J2—see text  
Printed-circuit materials, LN-712 Geiger-Muller tube (see text), enclosure, battery clip, etc.

**Note:** The following items for the Geiger Counter are available from the following vendors: The step-up transformer (T1), part # C-2B, is available from Allegro Electronics (3 Mine Mountain Road, Cornwall Bridge, CT 06754; Tel. 203-672-0123) for \$3.99, plus \$2.00 shipping and handling. Connecticut residents, please add appropriate sales tax.

The LN-712 Geiger-Muller tube is available from Images Company (P.O. Box 140742, Staten Island, NY 10314-0024; Tel. 718-698-8305) for \$48.00, plus \$3.00 shipping and handling. New York State residents, please add applicable sales tax.

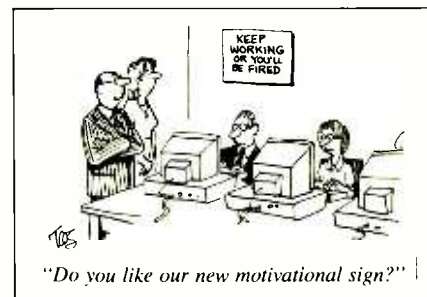



## TSM CLOCK

(Continued from page 26)

it to run off AC as well. Furthermore, the clock really only draws a little more than 0.15 amps.

Another section of the instructions claims that the unit is capable of running off 7.5 to 9 volts as is, but that for 12-volt operation you must place the unit in series with a 15-ohm 3-watt resistor (not provided with the kit). These specifications are probably more accurate than the ones presented earlier in the instructions as the unit does have an on-board Zener-diode regulator to keep the board's voltage to a reasonable level, but it doesn't look like it's capable of handling a very wide range of voltage without an extra current-limiting resistor.

Well, after reading about all the different operating modes, high accuracy, and loose power-supply requirements, I was eager to build the kit. So, let's talk about how that went.

**Assembly.** The kit should contain everything you'll need to get the clock up and running with the exception of the power-supply and case. Unfortunately, a 1k resistor was missing from my kit (so be prepared for that possibility if you want to build one). Also, the wire supplied with the kit is insufficient to make all the jumper connections required so you'll have to supply some of your own. The only other problem I had as far as the components were concerned was the presence of 1N4003 diodes in place of the "1N4004 or equivalent" specified in the parts list. While the 1N4003 diodes will work fine in the circuit, they are definitely not the equivalent of 1N4004 units, so the parts list can lead to a little confusion.

On a better note, the materials that were supplied were all of the highest quality. The two PC boards (a main board and a display/control board) are single sided and have two-color silk-screen patterns—one color for component outlines and designations, another color to indicate the connections made by the foil traces.

While I like the color-coding, the information contained on the silk screening was a little incomplete. On the main board the outline of a jumper as well as the designations for

a transistor, two capacitors, and three pads used for off-board connections were missing. Similarly, some of the jumper outlines on the display/control board were also missing. However, those omissions will not prevent anyone from building the kit as two clear and complete parts-placement diagrams are provided.

Apart from the silk-screening, there are a couple of mechanical errors on the main board. For instance, two components (a resistor and a capacitor) on the main board were too long to lay flat with their leads in the appropriate holes. While I admit this is a "nit-picky" point to make, I would feel remiss not to at least mention it.

Also the jumper that had no outline was also missing a hole. As a quick fix, you could drill the missing hole or tie the free end of the jumper to a component lead running to the same foil.

With those few exceptions, the assembly went rather smoothly. The instructions basically tell you how to install and solder a general component into the board, and then tells you to follow suit with all of the components in the parts list, following the order in which they are presented. If you don't follow that advice you might cover up the holes for some of the jumpers with the 7-segment displays or an IC socket.

If you build the kit you should be mindful of a couple of things: First, you should use a fine-tip soldering iron, especially on the display board; on that board the traces are very close together. Second, since some of the jumpers are left off of the silk screening, count them to be sure you've installed them all (the right number of jumpers for each board are listed in the instructions) before proceeding. Use the parts-placement diagram to locate any jumpers you might have missed.

**Calibration.** While the clock does require some calibration, there are no calibration instructions provided. The instructions do mention "an adjustment . . . allowing the flashing of displays to be omitted," unfortunately that's all they say. Considering there are two trimmers on the board (one capacitor and one resistor), the instructions are left a little wanting. Suffice it to say that the variable resistor determines the rate at which the dis-

play is updated. To set it, turn the potentiometer completely counter clockwise, apply power, place the clock in one of its operating modes according to the instructions, and turn the potentiometer clockwise until the display begins to flicker or stops working properly. Disconnect power, back the potentiometer off a little, re-apply power, place the clock in one of its modes, and check the display. Repeat this procedure as necessary.

To calibrate the capacitor you will have to observe the clock over several days of operation. If it runs to slow, turn the trimmer capacitor to decrease the capacitance, do the opposite if it runs to fast. Repeat this procedure until the clock keeps good enough time.

The TSM 6-Digit Alarm Clock/Chronometer, Kit No. 157, is available from American Design Components (815 Fairview Ave., Fairview, NJ 07022; Tel. 1-800-776-3700) as item No. 21350 for \$39.95. Contact them for further information or circle No. 119 on the Free Information Card. ■



ADMIT ONE

## Your Ticket To SUCCESS

Over 28,000 technicians have gained admittance worldwide as certified professionals. **Let your ticket start opening doors for you.**

ISCET offers Journeyman certification in Consumer Electronics, Industrial, Medical, Communications, Radar, Computer and Video. For more information, contact the **International Society of Certified Electronics Technicians, 2708 West Berry Street, Fort Worth, TX 76109; (817) 921-9101.**

Name \_\_\_\_\_

Address \_\_\_\_\_

City \_\_\_\_\_

State \_\_\_\_\_ Zip \_\_\_\_\_

\_\_\_\_\_ Send material about ISCET and becoming certified.

\_\_\_\_\_ Send one "Study Guide for the Associate Level CET Test." Enclosed is \$10 (inc. postage).

## CORDLESS LOCK

(Continued from page 48)

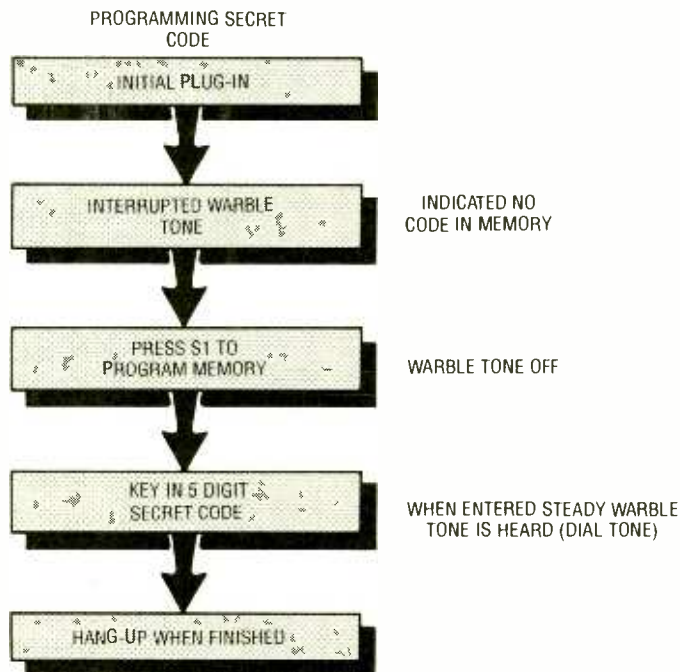

Fig. 4. When the Cordless Telephone Lock is first plugged in or after a power failure, U1's memory will not contain a user-selected access (unlocking) code. This diagram illustrates the sequence that takes place during programming (see text for full programming details).

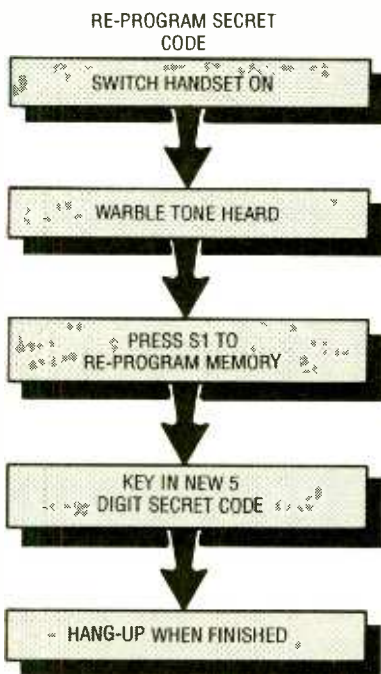

Fig. 5. To the user, reprogramming the Cordless Telephone Lock is just like the initial programming. As before, pressing switch S1 causes the microcontroller to branch to a programming subroutine.

move power, insert all IC's in the appropriate sockets, and reapply power. Then connect the telephone's modular plug to J1, and plug PL1 into the telephone line jack (see Fig. 3). That's all there is to the installation pro-

cedure. It is time now to turn our attention to programming our unit.

**Programming.** Refer to Fig. 4. When the Cordless Telephone Lock is first plugged in, or after a power failure, the memory of U1 will not contain a user-selected access (unlocking) code. To program an access code, take the phone off hook (using the reset switch or whatever you normally would do to get a dial tone). You should hear the interrupted warble tone in the handset, indicating that no unlocking code is presently residing in memory.

When you hear that tone, press S1; the warble tone will stop. At that point, using the handset keypad, enter your 5-digit code (for example, 41053). Once the code is saved to memory, the 8052 dial tone (steady warble tone) will be heard. Hang up the handset (by operating the reset but-

ton). Reprogramming the Cordless Telephone Lock (see Fig. 5) is pretty much like the initial programming of the device. As before, press S1; that causes the U1 program to branch to a subroutine that will take you through the same programming procedure as before. When complete, hang up the handset.

**Outgoing Calls.** Refer to Fig. 6. Now that the project has an access code stored in memory, access to the telephone line will only be allowed upon

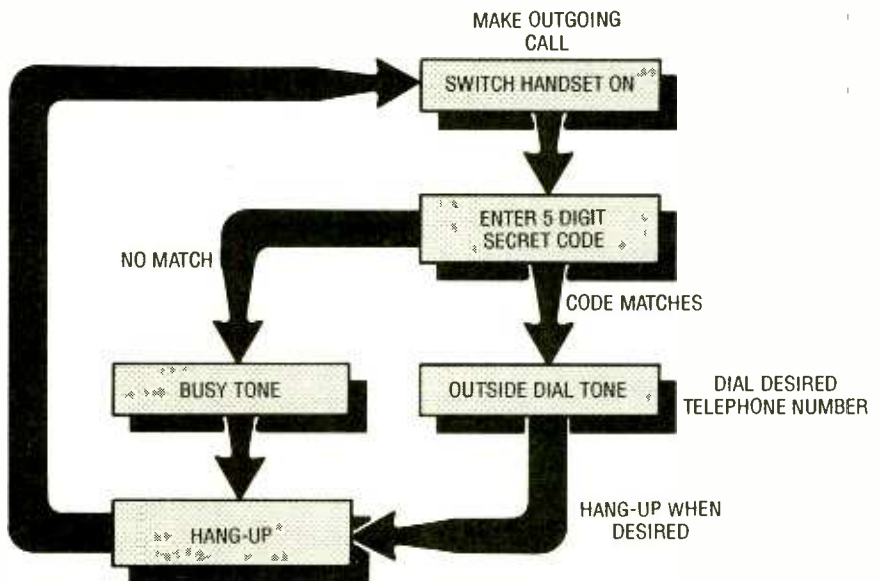

Fig. 6. To make an outgoing call, the proper access code must be entered via the handset keypad. If it is entered incorrectly, the circuit will deny access.



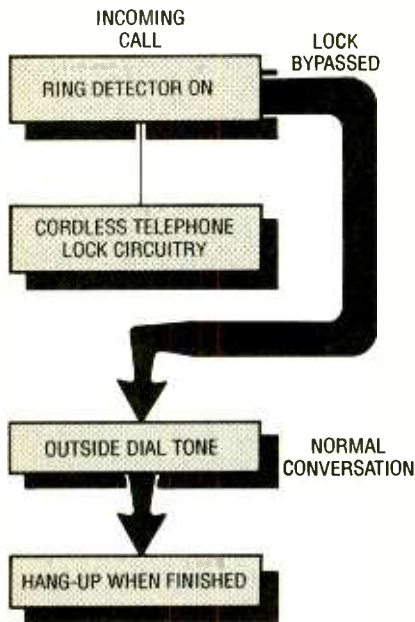

Fig. 7. This is the sequence that takes place when a call is made to your location. When a ring signal is detected, the circuit is instructed to bypass the unlocking procedure. At that point, the phone is connected to the telephone line, so that the phone may be answered, allowing normal conversation to take place.

entry of the proper code. To make a call, take the phone off hook: You should hear the 8052 dial tone. Then using the handset keypad, key in the access code (in the above example, 41053). The program contained in U1 compares each number as it's keyed against to the stored code. When all 5 digits have been correctly entered, you'll hear the central office dial tone, and normal dialing can take place. When the call is complete, just hang up the cordless telephone in the normal fashion.

If the entered code *doesn't* match the programmed code (for example, you accidentally key in 40553), U1 indicates a mismatch by emitting a slow on/off audio tone (similar to a normal busy signal) that can be heard in the handset. The Cordless Telephone Lock continues to deny access until the correct code is entered. Whether you enter the correct code or not, hanging up the phone causes the Cordless Telephone Lock to automatically rearm itself.

**Incoming Calls.** Figure 7 illustrates the sequence that takes place when

a call is made to your location. When a ring signal is detected, the circuit is instructed to bypass the unlocking procedure. At that point, the phone is connected to the telephone line, so that the phone may be answered, allowing normal conversation to take place.

If, on the other hand, the phone is not answered and the caller abandons the call, the absence of the ring signal is sensed by U1, causing the Cordless Telephone Lock to automatically rearm itself. If the phone is answered after rearming the lock will react if an outgoing call is to be placed so it will be necessary to enter the access code to gain access to the line.

If at any time, the circuit behaves in a manner other than that described above (abnormal audio signal or action), disconnect the power immediately and begin troubleshooting by buzzing out all connections, as outlined above.

Once you have your project up and running, you'll appreciate, if not the savings, the security that Cordless Telephone Lock provides. ■

## Popular Electronics

WE  
**HAVE THE**  
**RIGHT**  
**ANSWER**



Audit Bureau of Circulations

Advertisers who want to place their print ads in a quality publication ask the question: "Is your circulation audited?"

We're very proud to answer "Yes."

We are a member of the Audit Bureau of Circulations because we share ABC's belief that circulation audits are an essential assurance of value.

ABC is the premier circulation auditing organization in the world, and has been since 1914. Each year, ABC auditors test and verify that our circulation figures are facts, not claims. An ABC audit is the sign of a sound investment for advertisers.

Not all publications are audited, but they should be. Because when advertisers ask "Is your circulation audited?" there's only one answer.

"Yes."

## FREQUENCY COUNTER

(Continued from page 58)

pins 29, 34, and 35 of U8 to be sure they are tied to ground.

When the display properly indicates all zeros with no input to the counter, apply a signal to the input and note the display response on all ranges. Use an audio or RF oscillator, or function generator if available. Any wave shape is fine; the amplitude of the signal should be at least 0.5-volt rms, but not more than 5 volts.

Set the oscillator to about 1.9 MHz and check the frequency on the highest range of the counter; it should read close to 1900.0 kHz. Set the frequency to 190 kHz and switch the unit to the 200-kHz range. The display should read about 190.00 kHz. Finally, set the oscillator to 19 kHz and counter's range switch to 20 kHz. The counter should read about 19000 Hz.

If the counter does not give the proper indication, use an oscilloscope to locate the fault. First check pin 11 of U3-d for 3.2768 MHz at 5-volts peak-to-peak. If the signal is absent, check the wiring and components associated with U3-c and U3-d. Try a new IC if possible. Check U1 pin 3 for the presence of the trigger pulse on the two highest ranges of the counter. There should be a 7-millisecond wide, negative-going pulse, repeating about once every half second. When the range switch of the counter is set to the 20-kHz position, the pulsewidth triples, and repeats every 2 seconds. The absence of a trigger pulse indicates a problem with U1 and its associated components. Check R3, R4, R6, R7, C3, C4, and Q1 for proper values and orientation.

Check pin 4 of U3-b for a periodic 10-, 100-, and 1000-millisecond, positive-going gate signal for each of the positions of the range switch. The absence of that pulse could be caused by a failure of the flip-flop (U3-a and U3-b), U6, U4, or U5. The decade dividers can easily be checked by observing the wave shapes at pins 6 and 14 of U6—a rectangular wave shape at a frequency of 327.68 and 32.768 kHz, respectively is normal.

The binary divider can be checked by observing any of the 12 output terminals of U4, and pins 9, 7, and 6 of U5. Each succeeding output terminal

should produce a squarewave of half the frequency of the previous stage. If the binary dividers are not operating, and there is a clock signal present at pin 10 of U4, the fault may be with the latch circuit. In order for the binary dividers to count, the logic level at pin 11 of U4 and U5 must be zero for a period of 10, 100, or 1000 milliseconds after each trigger pulse from U1.

The operation of U8 should be checked by examining the input signals at pins 31, 32, and 33 of U8. At pin 32, the amplified signal-generator signal should appear as a 5-volt peak-to-peak waveform. Pin 31 should exhibit the positive-going gate signal generated by U3-b at pin 4. Pin 33 should have a narrow, negative-going (5 microseconds), differentiated pulse.

The absence of a waveform at pin 32 of U8 indicates that the analog amplifier is defective. Check the orientation of Q2 and Q3 carefully, and be sure that they are not interchanged. Check all the parts associated with those transistors to be sure they are of the correct values. Also check the orientation of C8.

**Using the Counter.** The operation of the frequency counter is simple. The only operating control is the frequency-range switch, which allows full-scale readings of 19,999 Hz, 199.9 kHz, and 1999.9 kHz. Note that the resolution of the counter for the ranges is 1, 10, and 100 Hz, respectively.

The circuit is not sensitive to the level of input voltage or wave shape, but it should be within the range of about 0.5- to 5-volts rms. The circuit is usable at frequencies of 10 Hz to 2 MHz, but the counter will respond to frequencies somewhat outside that range.

The counter's 1-Hz resolution on the 20-kHz range can be exploited on higher frequencies by taking advantage of the overflow characteristic of the counter. That feature permits the 1-second gate time of the 20-kHz range to be used to indicate the last 4 digits of the frequency even though the first digit, 1, is not a valid digit on overflow.

The circuit draws about 7 milliamperes, which allows in excess of 20 hours use from a fresh alkaline battery. At the end of battery life, the display will become dim and/or the frequency count will become erratic. ■

## ANALOG TACHOMETER CIRCUITS

(Continued from page 61)

pulse width. If the circuit fails to work properly at some frequency, then play with the pulse duration and the integrator time constant.

The output voltage may be on the order of only a few dozen millivolts at some frequencies. As a result, it might be necessary to add a noninverting amplifier to the output of the integrator (Fig. 6). The gain of the amplifier should be adjusted to permit a reasonable voltage for the display ( $V_o$ ) by selecting resistor values according to:

$$V_o = V_{in}(1 + R2/R1)$$

where  $V_{in}$  is the voltage from the integrator.

With or without the amplifier, you'll need to choose a meter movement that will suit the output current you get from your circuit. Measure the maximum output current and choose a meter accordingly.

**Capacitance Meter.** The tachometer circuit is suited to measuring the capacitance of capacitors in the ranges normally encountered by electronic hobbyists. The circuit in Fig. 7 is a limited capacitance meter. In this case, the 555 is used as an astable multivibrator, or square-wave oscillator. The output frequency is:

$$f = 1.44/((R1 + 2R2)C_x)$$

The output waveform is integrated by R3, C2, and the inertia of the meter pointer.

A better approach is shown in Fig. 8. The 555 is still used as an astable multivibrator, and produces a frequency determined by R1 and R2, and C1 as shown in Table 1.

The unknown capacitor,  $C_x$ , charges when the 555 output is high, and discharges when the 555 output drops low again. Because the charge in a capacitor is proportional to the capacitance and applied voltage, the current passed to the integrator (R3/C4) and the meter movement (M1) is proportional to the capacitance. Potentiometer R4 can be used to trim the meter to full-scale when the maximum capacitance is applied. The range of the capacitance meter can be changed by selecting C1 according to Table 1. ■



# ELECTRONICS MARKET PLACE

## FOR SALE

**CABLE descrambler liquidation.** Major makes and models available. Industry pricing! (Example: Hamlin Combo's, \$44 each... Minimum 10 orders). Call **WEST COAST ELECTRONICS**, 1 (800) 628-9656.

**SECRET Cable Descrambler.** Build your own descrambler for **LESS** than \$12.00 in seven **EASY** steps. Complete instructions \$10.00. Radio Shack parts list and **FREE** descrambling methods that **COST NOTHING** to try included. **HARRYWHITE**, PO Box 1790G, Baytown, TX 77520.

**JERROLD, Tocom and Zenith "test" chips.** Fully activates unit. \$50.00. Cable descramblers from \$40.00. Orders 1 (800) 452-7090. Information (310) 867-0081.

**PRINTED** circuit boards — etched, drilled, tin plated. Single sided \$1.25/sq. inch. No setup charge. **CHELCO ELECTRONICS**, 61 Water Street, Mayville, NY 14757. 1 (800) 388-8521.

## CLASSIFIED AD ORDER FORM

To run your own classified ad, put one word on each of the lines below and send this form along with your check to:

**Popular Electronics Classified Ads**, 500-B Bi-County Boulevard, Farmingdale, N.Y. 11735

**PLEASE INDICATE** in which category of classified advertising you wish your ad to appear. For special headings, there is a surcharge of **\$11.00**.

( ) Plans/Kits ( ) Business Opportunities ( ) For Sale  
( ) Education/Instruction ( ) Wanted ( ) Satellite Television

Special Category: \$11.00

### PLEASE PRINT EACH WORD SEPARATELY, IN BLOCK LETTERS.

(No refunds or credits for typesetting errors can be made unless you clearly print or type your copy.) Rates indicated are for standard style classified ads only. See below for additional charges for special ads. **Minimum: 15 words.**

1	2	3	4	5
6	7	8	9	10
11	12	13	14	15 (\$23.25)
16 (\$24.80)	17 (\$26.35)	18 (\$27.90)	19 (\$29.45)	20 (\$31.00)
21 (\$32.55)	22 (\$34.10)	23 (\$35.65)	24 (\$37.20)	25 (\$38.75)
26 (\$40.30)	27 (\$41.85)	28 (\$43.40)	29 (\$44.95)	30 (\$46.50)
31 (\$48.05)	32 (\$49.60)	33 (\$51.15)	34 (\$52.70)	35 (\$54.25)

We accept MasterCard and Visa for payment of orders. If you wish to use your credit card to pay for your ad fill in the following additional information (Sorry, no telephone orders can be accepted.):

Card Number \_\_\_\_\_ Expiration Date \_\_\_\_\_

PRINT NAME \_\_\_\_\_

SIGNATURE \_\_\_\_\_

**IF YOU USE A BOX NUMBER YOU MUST INCLUDE YOUR PERMANENT ADDRESS AND PHONE NUMBER FOR OUR FILES. ADS SUBMITTED WITHOUT THIS INFORMATION WILL NOT BE ACCEPTED.**

**CLASSIFIED COMMERCIAL RATE:** (for firms or individuals offering commercial products or services) \$1.55 per word prepaid (no charge for ZIP code)...**MINIMUM 15 WORDS.** 5% discount for same ad in 6 issues within one year; 10% discount for 12 issues within one year if prepaid. **NON-COMMERCIAL RATE:** (for individuals who want to buy or sell a personal item) \$1.25 per word, prepaid...no minimum. **ONLY FIRST WORD AND NAME** set in bold caps at no extra charge. Additional bold face (not available as all caps) **30¢ per word additional.** Entire ad in boldface, \$1.85 per word. **TINT SCREEN BEHIND ENTIRE AD:** \$1.90 per word. **TINT SCREEN BEHIND ENTIRE AD PLUS ALL BOLD FACE AD:** \$2.25 per word. **EXPANDED TYPE AD:** \$2.05 per word prepaid. Entire ad in boldface, \$2.45 per word. **TINT SCREEN BEHIND ENTIRE EXPANDED TYPE AD:** \$2.55 per word. **TINT SCREEN BEHIND ENTIRE EXPANDED TYPE AD PLUS ALL BOLD FACE AD:** \$2.95 per word. **DISPLAY ADS:** 1" x 2 1/4" — \$205.00; 2" x 2 1/4" — \$410.00; 3" x 2 1/4" — \$615.00. **General Information:** Frequency rates and prepayment discounts are available. **ALL COPY SUBJECT TO PUBLISHERS APPROVAL. ADVERTISEMENTS USING P.O. BOX ADDRESS WILL NOT BE ACCEPTED UNTIL ADVERTISER SUPPLIES PUBLISHER WITH PERMANENT ADDRESS AND PHONE NUMBER.** Copy to be in our hands on the 18th of the fourth month preceding the date of issue (i.e.; Sept. issue copy must be received by May 18th). When normal closing date falls on Saturday, Sunday or Holiday, issue closes on preceding work day. Send for the classified brochure. Circle Number 49 on the Free Information Card.

**FREE CATALOG!**  
**1-800-648-7938**  
**JERROLD HAMLIN OAK ETC**  
**CABLE TV**  
**DESCRAMBLERS**

- Special Dealer Prices!
- Compare our Low Retail Prices!
- Guaranteed Prices & Warranties!
- Orders Shipped Immediately!

**REPUBLIC CABLE PRODUCTS, INC.**  
4080 Paradise Rd. #15, Dept. PE792  
Las Vegas, NV 89109  
For all other information (702) 362-9026

**ATTENTION Hobbyists:** Project boards, bread boards, prototyping boards. Top quality at low prices. Send for free information and price lists. **R AND S ELECTRONICS**, Box 91963, Elk Grove, IL 60009.

**UNIQUE gifts for the electronics enthusiast!** High quality, handcrafted **circuit board key rings** and **electronic component tie tacks**. \$13.95 each plus \$4.00 S&H. Free color brochure with order. **RANDOM ACCESS**, Dept. PE, 219E Cosby Manor Road, Utica, NY 13502.

**LOW Cost Logic Analyzer** — A must for companies and serious hobbyists: 8 digital inputs, sampling rate from 50 nsec to 1 msec. Connects to PC or compatible via RS-232. Only \$250.00 US. For info: **OPENTEK**, PO Box 71, Sorel, Quebec, Canada, J3P 2T6.

**SOLAR SYSTEM CONTROLS** — 6 amp shunt regulator — Alternate battery charge control — Low voltage battery disconnect. \$49.95 ea. + \$5.00 s/h. **MPS ENERGY**, R.R. #2, Marmora, Ont., Canada K0K 2M0.

**FREE CATALOG**  
**FAMOUS "FIRESTIK" BRAND CB ANTENNAS**  
**AND ACCESSORIES. QUALITY PRODUCTS**  
**FOR THE SERIOUS CB'er. SINCE 1962**  
**FIRESTIK ANTENNA COMPANY**  
2614 EAST ADAMS  
PHOENIX, ARIZONA 85034

**TOCOM-Jerrold Impulse-Scientific Atlanta** converters, two year warrantys, also **TEST MODULES** for your converters. Contact **NATIONAL CABLE**, (219) 935-4128 full details.

**CELLULAR Hackers Bible Theory** — Hacks — Modifications — Programming \$49.95. **TELECODE**, PO Box 6426-PE, Yuma, AZ 85366-6426.

**CABLE Test Chips.** S-A 8550, S-A 8500 — 310, 311, 320, 321 (specify) — \$33.95. S-A 8580/338 — \$69.95. **TOCOM** 5503/07 VIP — \$33.95. **TELECODE**, PO Box 6426-PE, Yuma, AZ 85366-6426.

## CB RADIO OWNERS!

We specialize in a wide variety of technical information, parts and services for CB radios, 10-Meter and FM conversion kits, repair books, plans, high-performance accessories. Thousands of satisfied customers since 1976! Catalog \$2.

**CBC INTERNATIONAL**

P.O. BOX 31500PE, PHOENIX, AZ 85046

**HUGE 92 page communications catalog** of short-wave, amateur and scanner equipment. Antennas, books and accessories too. Send \$1.00 to: **UNIVERSAL RADIO**, 1280 Aida Dr., Dept. PE, Reynoldsburg, OH 43068.

**ELECTRONIC assembly services.** We assemble printed circuit boards in small quantities or production runs. Mechanical assembly also available. Compare our cost and quality. **TEXANA**, (512) 572-3381.

**Quality Microwave TV Antennas**

**WIRELESS CABLE - IFTS - MMDS - Amateur TV**  
Ultra High Gain 50db(+) • Tunable 1.9 to 2.7 Ghz.

- 55-Channel Dish System \$199.95
- 36-Channel Dish System \$149.95
- 20-Channel Dish System \$124.95
- Optional Commercial Grid Antenna (not shown) Add \$50.00
- Yagi Antennas, Components, Custom Tuning Available
- Call or write (SASE) for "FREE" Catalog

**PHILLIPS-TECH ELECTRONICS**  
P.O. Box 8533 • Scottsdale, AZ 85252  
(602) 947-7700 (\$3.00 Credit all phone orders)  
MasterCard • Visa • American Express • CDD's • Quantity Pricing

Dish System  
LIFETIME WARRANTY

**LASER & Solar Energy Products** Lasers from \$15.00. We specialize in laser and solar energy products for commercial, and hobbyist applications. Free catalog: **DESIGN IMAGES**, Dept. P7, Box 292125, Lewisville, TX 75029.

## CABLE TV DESCRAMBLERS ★ CONVERTERS ★ and ACCESSORIES.

**SAVE MONEY.  
DON'T RENT!**

**PANASONIC,  
PIONEER, JERROLD, OAK,  
SCIENTIFIC ATLANTA  
AND MORE. LOWEST PRICES.  
FREE CATALOG.**

**(800) 234-1006  
CABLE READY COMPANY**

### SATELLITE TV

**FREE** — Catalog — Do-it-yourself save 40%-60%. Lowest prices worldwide. Systems, upgrades, parts. All major brands factory fresh and warrantied. **SKYVISION**, 1048 Frontier, Ferguson Falls, MN 56537. 1 (800) 334-6455.

**SATELLITE TV** the lowest prices guaranteed. Tracker V \$899.00, Startrack 6 \$725.00. All major brands sold & serviced. Used equipment available. Phone, quote, & tech service: **SATELLITE TV**, 120 W. Centennial, Muncie, IN 47303. (317) 288-0074 11-5 E.

★★★ PRESENTING ★★★  
**CABLE TV  
DESCRAMBLERS**  
★★★ STARRING ★★★  
**JERROLD, HAMLIN, OAK**  
AND OTHER FAMOUS MANUFACTURERS

- FINEST WARRANTY PROGRAM AVAILABLE
- LOWEST RETAIL/WHOLESALE PRICES IN U.S.
- ORDERS SHIPPED FROM STOCK WITHIN 24 HRS
- ALL MAJOR CREDIT CARDS ACCEPTED

**FOR FREE CATALOG ONLY 1-800-345-8927  
FOR ALL INFORMATION 1-818-709-9937**

**PACIFIC CABLE CO., INC.**  
7325 1/2 Reseda Blvd., Dept. 2016  
Reseda, CA 91335

**SATELLITE** — Cable descrambling secrets — Surveillance transmitters. Send \$2.00 for catalogs. **COMMUNICATIONS ENGINEERING**, 76 Boulevard, Hudson Falls, NY 12839.

**SATELLITE** dish, earth plumb adjustable mount! Never dig second concrete hole. Great for earthquakes, hills, loose settling ground. Easy plans. Send \$5.00 LSASE to B & N, Dept. B9012E, Box 1155, Fremont, CA 94538.

**SATELLITE TV  
BUYING  
GUIDE**

**NAME BRANDS AT 50% DISCOUNT**  
This FREE 24 page Consumer Buying Guide tells all about Satellite TV and lists guaranteed lowest prices.

Satman, Inc.  
6310 N University No. 3798 • Peoria, IL 61612  
CALL FOR 1-800-472-8626

### T.V. FILTERS

T.V. notch filters, phone recording equipment, brochure \$1.00. **MICRO THINC.**, Box 63/6025, Margate, FL 33063. (305) 752-9202.

### PLANS & KITS

**HOBBY/broadcasting/ham/CB/surveillance** transmitters, amplifiers, cable TV, science, bugs, other great projects! Catalog \$1.00 **PANAXIS**, Box 130-H7, Paradise, CA 95967.

**BUILD** — five-digit, ohms, capacitance, frequency, pulse, multimeter, Board, and instructions \$9.95. **BAGNALL ELECTRONICS**, 179 May, Fairfield, CT 06430.

**FASCINATING** Electronic Devices! Dazers! Lasers! Transmitters! Detectors! Free energy! Tesla! Kits/Assembled! Catalog \$4.00. (refundable) **QUANTUM RESEARCH**, 17919-77 Avenue, Edmonton, Alberta T5T 2S1.

**ANTIQUE RADIO CLASSIFIED**  
Free Sample!  
Antique Radio's  
Largest Circulation Monthly.  
Articles, Ads & Classifieds.

6-Month Trial: \$15. 1-Yr: \$27(\$40-1st Class).  
A.R.C., P.O. Box 802-L8, Carlisle, MA 01741

**DESCRAMBLER** kits. Complete cable kit \$44.95. Complete satellite kit \$49.95. Add \$5.00 shipping. Free brochure. No New York sales. **SUMMIT PE**, Box 489, Bronx, NY 10465.

**KITS**, sound, light, high tech and unusual. Send for free catalog. **JIM ELECTRONICS**, Box 150454, Altamonte Springs, FL 32715-0454.

**CIRCUIT BOARDS** etched and drilled for 70 cents per square inch. Send your requirements to **JM ELECTRONICS**, Box 150454, Altamonte Springs, FL 32715-0454 or call (407) 767-8196.

**FM stereo transmitter kit.** Broadcast any audio signal, CD player, VCR to FM stereo radios throughout home/yard. PC board and components: \$24.00. **TENTRONIX**, Dept. PC792, 3605 Broken Arrow, Coeur d'Alene, ID 83814.

**ETCH PCB's** yourself, no chemicals, easy, cheap, full instructions. \$2.00, **SASE, NICKNAP PRODS.**, PO Box 593, Howell, NJ 07731-0593.

**SURVEILLANCE-Counterspy Equipment!** Guaranteed low prices! Catalog \$5.00. **SURVEILLANCE COUNTERMEASURE TECHNOLOGIES**, Box 520013-B, Salt Lake City, UT 84152.

**CONVERT** any flashlight into a 660 nm simulated laser. Send \$2.00 to: **D.M.S.**, Box 538, Columbia Station, Ohio, 44028.

**VIDEOCIPHER II /Satellite/Scanner/Cable/Amateur/Cellular/Repair manuals, modification books & software.** Catalog — \$3.00. **TELECODE**, PO Box 6426-PE, Yuma, AZ 85366-6426.

**KENWOOD & ICOM** service bulletins. 175+ pages covering all models. \$33.95. Catalog — \$3.00. CODs (602) 782-2316/fax (602) 343-2141. **TELECODE**, Box 6426-RE, Yuma, AZ 85366-6426.

**SENSATIONAL Kits!** Send for free catalog. **LNS TECHNOLOGIES**, 20993 Foothill Blvd., Suite 307P, Hayward, CA 94541-1511.

**CAR Alarm system. Complete plans and instructions. Low cost. No false alarms.** Send \$10.00. **SEQUENTIAL ELECTRONICS**, 345 Lincoln Street, Manchester, NH 03103.

**VHF-FM amplifier kit.** 75-110 Mhz, 15-25 watts. Includes all parts, schematics, instructions. For information send SASE to: **PROGRESSIVE CONCEPTS**, 1313 North Grand Ave. #291, Walnut, CA 91789.

**COMPUTERS** — Learn to build computers and earn money. Send \$12.00 for manual. **MICROSTAR CORPORATION**, PO Box 737, New York, NY 10274.

**BUGGED? Telephone Tapped?** Find out fast! Free catalog of fantastic counter-surveillance equipment! (800) 732-5000.

**AUXILIARY** generator blueprints, alternate energy source. \$10.00. **DEE CHA CO.**, Box 6025, Columbia, MO 65205.

### EDUCATION/INSTRUCTION

**LEARN IBM PC assembly language.** Disk \$5.00. Book \$18.00. **ZIPFAST**, Box 12238, Lexington, KY 40581-2238.

**VCR repair.** Save money — make big profits! Learn how from *How to Keep Your VCR Alive*. "This detailed, step-by-step manual enables anyone with no previous knowledge or experience to fix most VCR problems easily, quickly, and inexpensively with a few simple tools." — *Small Press Review*. Highly recommended by *Electronic Servicing and Technology, Modern Electronics, Popular Electronics, Popular Communications, Videomaker, Video, Nuts and Volts*, and many other electronics and video magazines "Far better than Viejo at 1/7 the cost." 403 page book, with 704 illustrations, plus professional head-cleaning tool. Obtain from B. Daltons or send \$24.95 to **WORTHINGTON PUBLISHING**, 6907-202H Halifax River Drive, Tampa, FL 33617. Publisher pays S&H. Money-back satisfaction guarantee!

**BUILDING A Robot: A Straightforward Approach.** 152 pages fully illustrated. Instructions how you can easily construct a robot. **Check or money order.** \$19.95 plus \$3.00 shipping. **HUMANFORM ROBOTICS**, PO Box 158486, Nashville, TN 37215.

**CRANIAL** electrotherapy prevention of insomnia, anxiety, depression, with simple circuit diagram for less than \$30 worth of parts, with circuit theory of operation. Education use only. Send \$1.50 for info., brochure to **E. HANSEN**, 177 Telegraph Rd., Suite 635, Bellingham, WA 98226.



FREE information available for annual cross reference index to electronics articles printed in several magazines. Send sase to **LOCK-TRONICS PRINT**, 5207 Sherwood, Lawton, OK 73505.

**COMPUTER**, fax machine, laser printer service and maintenance. In one training package. Call today 1 (800) 568-3362.

FCC Study Handbooks! Why pay \$300-\$600 for a study program? Send \$3.00 for information about an inexpensive, home study course to: **BUSSER DEBARR** Production and Design, PO Box 902, Dept. J, Webster Station, Alameda, CA 94501-8902.

**ELECTRONICS** tutorial software. Nine diskettes. Over 1000 screens of information and help on DC, AC, analog and digital. Q&A format. IBM \$25.00. **TUTOR-TECH**, 5591 Kimberly St., San Jose, CA 95129. (408) 252-3223.

**CATCH** the hottest wave in telecommunications and prepare for the future now. Laser/fiber optics, photonics and electronics. It's all part of the exciting **MEDIA/TELECOMMUNICATIONS TECHNOLOGY** Program at **The Art Institute of Dallas**. For further information write 8080 Park Lane, Dept. 34, Dallas, TX 75231 or call 1 (800) 275-4243.

## BUSINESS OPPORTUNITIES

**YOUR own radio station!** Licensed/unlicensed. AM, FM, TV, cable. Information \$1.00 **BROADCASTING**, Box 130-H7, Paradise, CA 95967.

**EASY work!** Excellent pay! Assemble products at home. Call toll free 1 (800) 467-5566 Ext. 5730.

**MAKE \$75,000.00 to \$250,000.00** yearly or more fixing IBM color monitors. No investment, start doing it from your home (a telephone required). Information, USA, Canada \$2.00 cash for brochure, other countries \$10.00 US funds. **RANDALL DISPLAY**, Box 2168-H, Van Nuys, CA 91404, USA. Fax (818) 990-7803.

**HOME** assembly work available! Guaranteed easy money! Free details! **HOMEWORK-P**, Box 520, Danville, NH 03819.

**MAKE \$\$\$!** Become an American electronics dealer! Profit opportunities since 1965. Call **WAYNE MARKS**, 1 (800) 872-1373.

**COMPUTER** service business. New market, great profits. Information \$4.00. **CC ELECTRONICS**, Box 1441, Hereford, TX 79045.

**JOB**s in electronics. Companies are still hiring for positions in US and overseas. For a listing of 400 companies plus resume guide send \$10.00 to **BENTHOS-PE**, POB 23336, Barrigada, GU 96921.

"**MAKING** It rich in the 1990's." For more information write to: **DATALAB**, PO Box 1722, Imperial Beach, CA 91933.

**\$800.00** weekly possible! Working at home! 37 different opportunities. Rush \$1.00 and self-addressed stamped envelope to: **T.M.**, 763 A. St., N.F., NY 14304.

## WANTED

**HAVE** an idea! Inventors for free information package/free review. Call **FREEDOM MARKETING, INC.** 1 (800) 932-4298.

**ROBOTS:** Heathkit Hero, Omnibot, Maxx Steele, Androbot, Personal Robotic, or equivalent personal robots. **BOB**, (708) 576-7194.

**WANTED!** Temperature Control MFG! Patented. Narrowest, safest adjustable automatic changeover temperature range between loads, in US. Any volts — any switches. Call, **201-854-9846**.

**MASTERCARD AND VISA** are now accepted for payment of your advertising. Simply complete the Classified Ad order form and we will bill you.

## LEARN COMPUTERS!



Home study. Become a personal computer expert at home and in business. Learn at your own pace. Exciting and easy to follow. Send or call today for free literature. **800-223-4542**

Name \_\_\_\_\_  
Address \_\_\_\_\_  
City \_\_\_\_\_ State \_\_\_\_\_ Zip \_\_\_\_\_  
**SCHOOL OF COMPUTER TRAINING**  
2245 Perimeter Park  
Dept. KH341, Atlanta, Georgia 30341

## CABLE TV "BOXES"

**Converters-Descramblers**  
**Remote Controls-Accessories**

- ★ Guaranteed Best Prices ★
- ★ 1 Year Warranty - C.O.D.'s ★
- ★ Immediate Shipping ★
- ★ FREE CATALOG ★

Call or Write  
**NAS/TRANS-WORLD CABLE CO.**  
3958 North Lake Blvd. • Suite 255  
Lake Park, Florida 33403  
1-800-442-9333  
1-800-848-3997

## HOME EXTERMINATION

**NEW book: "Become Roach-Free"** Exterminator explains: in detail. \$20.00 EPE, POB 74C, Calhoun, LA 71225-0074.

**ROACHES**, earwigs, ants. Learn what the pro's know and save \$. Home pest control manual, \$9.95. **B and J MARKETING**, PO Box 3, Kan-ville, IL 60144.

## BEST BY MAIL

Rates: Write National, Box 5, Sarasota, FL 34230

### OF INTEREST TO ALL

**RETIRE EARLY** 1-900-776-3348 CODE AB 5180 Mention Code (\$6.95).

**HAIR PROBLEMS? THINNING, FALLING, BREAKING.** Hair Helpers promises results. 1-800-4-HAIR-10.

**RECYCLE PERSONAL COPIERS Cartridges. Instructions** \$14.95. Charles Bruns, Box 543, Applegate, CA 95703.

**DOOR CHAIN ALARM** provides double duty security for your home. Chain protects against intruder. Alarm sounds if chain is forced. Great for front or back doors. Send \$11.49 to: William J. Gay, PO Box 13931, Jackson, MS 39236.

### BOOKS-CATALOGS-MAGAZINES

**ELECTRONIC ENGINEERING.** 8 volumes complete. \$109.95. No prior knowledge required. Free brochure. **BANNER TECHNICAL BOOKS**, 1203 Grant Ave., Rockford, IL 61103.

### HELP WANTED

**URGENT! MANUFACTURER NEEDS** Assemblers Nationwide! Immediately (505)821-6365 Ext.1500 or SASE to: NMCD, Box 27417(PE), Albuquerque, NM 87125.

**OPPORTUNITIES IN KUWAIT!** Rebuilding in progress. Excellent pay. 516-929-0341 Ext. 301.

### MONEYMAKING OPPORTUNITIES

**"EASY MONEY" TAKING** Snapshots. Send LSASE To: Global, 1404-(PE) Ouachita 67, Camden, AR 71701.

**AMAZING PROFITS IN** mailorder books. AK-P, Box 11651, Edmonton, AB T5J 3K8.

**EARN FULL-TIME Money For Part-Time Work!** Free Details. E&R Distributors, PO Box 20407-(PE), N.Y., N.Y. 10028.

## FUN WITH ELECTRONICS



◀  **160—COIL DESIGN & CONSTRUCTION MANUAL** ... \$5.95. How to make RF, IF, audio and power coils; chokes and transformers. Practically every possible type is discussed.

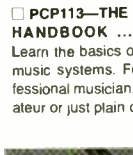

▶  **PCP113—THE PC MUSIC HANDBOOK** .... \$13.95. Learn the basics of computer music systems. For the professional musician, gifted amateur or just plain curious.



◀  **BP297—LOUDSPEAKERS FOR MUSICIANS** .... \$6.25. Loudspeaker design from the musician's point of view! All you need to know, and you should be able to design your own after reading this.



▶  **BP277—HIGH POWER AUDIO AMPLIFIER CONSTRUCTION** .... \$6.25. Here's background and practical design information on high power audio amplifiers capable of 300 ± 400 watts r.m.s. You'll find MOSFET and bipolar output transistors in inverting and non-inverting circuits.



◀  **BP302—A CONCISE USER'S GUIDE TO LOTUS 1-2-3 RELEASE 3.1** .... \$6.25. If you are a PC user and want to upgrade to Lotus 1-2-3 release 3.1, this book can teach you how to do that in the shortest and most effective way.

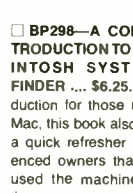

▶  **BP298—A CONCISE INTRODUCTION TO THE MACINTOSH SYSTEM AND FINDER** .... \$6.25. This introduction for those new to the Mac, this book also serves as a quick refresher for experienced owners that have not used the machine in some time.

MAIL TO: **Electronic Technology Today, Inc.**  
P.O. Box 240  
Massapequa Park, NY 11762-0240

### SHIPPING CHARGES IN USA AND CANADA

\$0.01 to \$5.00... \$1.50    \$30.01 to \$40.00... \$5.50  
\$5.01 to \$10.00... \$2.50    \$40.01 to \$50.00... \$6.50  
\$10.01 to \$20.00... \$3.50    \$50.01 and above... \$8.00  
\$20.01 to \$30.00... \$4.50

**SORRY, No orders accepted outside of USA and Canada**

Total price of merchandise ..... \$ \_\_\_\_\_  
Shipping (see chart) ..... \$ \_\_\_\_\_  
Subtotal ..... \$ \_\_\_\_\_  
Sales Tax (NYS only) ..... \$ \_\_\_\_\_  
Total Enclosed ..... \$ \_\_\_\_\_

Name \_\_\_\_\_  
Address \_\_\_\_\_  
City \_\_\_\_\_ State \_\_\_\_\_ Zip \_\_\_\_\_

## ADVERTISING INDEX

**POPULAR ELECTRONICS magazine does not assume any responsibility for errors that may appear in the index below.**

Free Information No.	Page		
7	AMC Sales . . . . .	69	— IS CET . . . . . 89
8	All Electronics . . . . .	4	13 ISECO, Inc. . . . . 83
—	Antique Radio Classified . . . . .	94	14 Mouser . . . . . 71
—	CBC International . . . . .	94	— NAS/TransWorld . . . . . 95
—	CIE . . . . .	12	— NRI Schools . . . . . 25
—	Cable Ready Company . . . . .	94	— Pacific Cable . . . . . 94
—	Command Productions . . . . .	85	— Phillips Tech . . . . . 94
—	Computer Book Club . . . . .	81	— R.E. Video Offer . . . . . CV4
—	Elec. Industry Association . . . . .	CV3	— Republic Cable . . . . . 93
—	Electronic Tech. Today . . . . .	20, 87	— Satman, Inc. . . . . 94
—	Electronic Tech. Today . . . . .	95	— The School of VCR Repair . . . . . 69, 95
—	Electronics Book Club . . . . .	8, 9	6 U.S. Cable . . . . . 17
—	Firestik II . . . . .	93	11 Viejo Publications . . . . . 71
9	Fluke Manufacturing . . . . .	CV2	12 WPT Publications . . . . . 78
—	Grantham College . . . . .	19	— Your Home . . . . . 30
—	HighText Publications, Inc. . . . .	76	5 Zentek Corp. . . . . 17

### ADVERTISING SALES OFFICE

**Gernsback Publications, Inc.**  
 500-B Bi-County Blvd.  
 Farmingdale, NY 11735  
 1-(516) 293-3000  
 President: **Larry Steckler**  
 Assistant to the President: **Christina Estrada**

**For Advertising ONLY**  
 516-293-3000  
 Fax 1-516-293-3115  
**Larry Steckler**  
 publisher  
**Arline Fishman**  
 advertising director  
**Denise Haven**  
 advertising assistant  
**Kelly McQuade**  
 credit manager

**Customer Service/Order Form**  
 1-800-435-0715  
 1-800-892-0753  
 7:30 AM - 8:30 PM EST

#### SALES OFFICES

##### EAST/SOUTHEAST

**Stanley Levitan**, Eastern Sales Manager  
 1 Overlook Ave.  
 Great Neck, NY 11021  
 1-516-487-9357, 1-516-293-3000  
 Fax 1-516-487-8402

##### MIDWEST/Texas/Arkansas/Okla.

**Ralph Bergen**, Midwest Sales Manager  
 One Northfield Plaza, Suite 300  
 Northfield, IL 60093-1214  
 1-708-446-1444  
 Fax 1-708-559-0562

##### PACIFIC COAST/Mountain States

**Marvin Green**, Pacific Sales Manager  
 5430 Van Nuys Blvd, Suite 316  
 Van Nuys, CA 91401  
 1-818-986-2001  
 Fax 1-818-986-2009

### GPS SYSTEM

*(Continued from page 34)*

to use atomic clocks, the system would be too expensive—even for the Pentagon.

Remember that we said that three measurements were theoretically enough to find your position, but that four were essential for correcting timing errors caused by an inaccurate receiver clock. The fourth satellite's data completes a set of four equations with four unknowns (your x, y, and z coordinates, and the timing error). See Fig. 3. Such a system of equations can always be solved.

**Deliberate Errors.** Now that we've examined how we can reduce or eliminate the potential errors encountered in GPS, you may be surprised to know that the largest source of error, by far, is deliberately added to GPS by the Department of Defense! The reason that the DoD designed the S/A (selective availability) mode of operation was to make the system less accurate for non-military (or hostile military) users.

The GPS satellites transmit two sig-

nals. First is a C/A or coarse-acquisition signal on a frequency of 1575.42 MHz. Civilian receivers can receive only the C/A transmissions. The second signal is a P (precision) signal that is transmitted on 1227.6 as well as 1575.42 MHz. (Spread-spectrum techniques permit both signals to be transmitted on the same frequency.)

Both codes are sent in a pseudo-random format. As we described earlier, that format helps receivers determine the travel time of signals. It is also a very efficient way to send data—even low-power signals can be detected. The code also lets the Department of Defense keep tight control over the system. In the event of a war, for example, the DoD could change the code so that enemy receivers would be useless.

The precision code is encrypted, so that only military users have access to it. It is also very difficult to jam. The C/A code is not encrypted, but the S/A mode degrades the inherent accuracy of 20–30 meters to 100 meters or more. The government claims that the S/A is necessary for national security. We question, however, whether that degradation is helpful, because it is possible to accurately determine

your position using differential GPS.

We know that any uncertainty in knowing the position of GPS satellites causes position errors. But what if you had a stationary GPS receiver that was in a known location? If you know the location of the fixed receiver precisely, then you can determine what errors are being introduced from the satellites. Then you can process the data from the GPS satellites to filter out the error. That's obviously not a trivial task, but it's not impossible, either. We question whether it is justifiable to degrade the accuracy for all users of the C/A code. Our contact at DoD agreed with our assessment.

GPS is only in its infancy. In the coming years, we will undoubtedly see more applications for the system, especially when receiver prices come down. GPS will likely play an important part of any intelligent-vehicle highway system. But if receiver prices can be made low enough, there's no reason that every car couldn't be equipped with one. A car that knows its location could broadcast that information to the authorities if it were stolen. Or it could help you correlate your position to a map or a CD-ROM-based navigation system. ■



# ASAP · JIT · MRP

OUR DISTRIBUTORS HELP  
ABBREVIATE YOUR  
PROCUREMENT CYCLE!

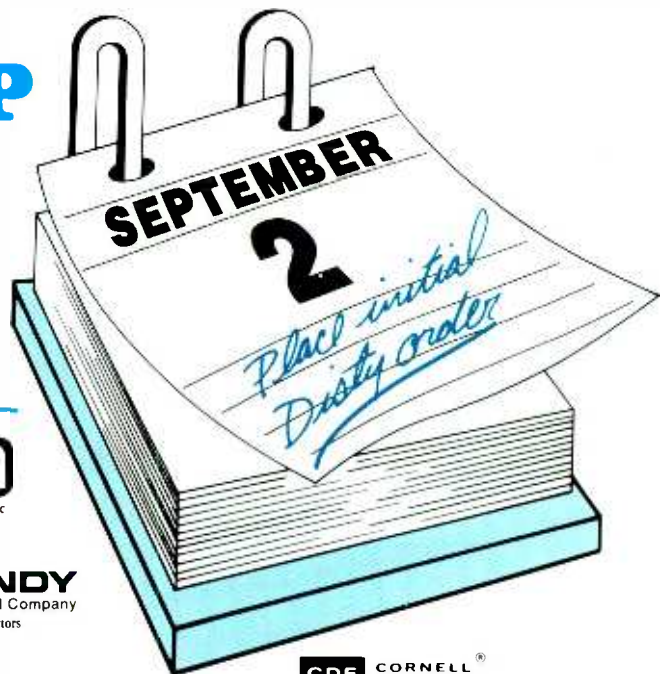

**Aero M, Inc.**

Aluminum Electrolytic Capacitors for DC Applications and AC Motor Starting

**Aerovox\***

DC Film and RFI Suppression Capacitors, AC Oil Capacitors, EMI Filters

**alpha**

Wire, Cable, Tubing, Electronic Interconnect Products

**AMP**

Electrical/Electronic Connectors, IC Sockets, PCB Switches

**AVX CORPORATION**  
A KYOCERA GROUP COMPANY

M.L.C. Tantalum and Thin Film Capacitors, Resistors, Networks, Trimmers, Oscillators, Resonators, Filters and Piezo Devices

**BURNDY**  
an FCI Company

Electronic Connectors

**CAROL**

CAROL CABLE COMPANY INC.

Electronic and Electrical Wire and Cable and Power Supply Cords

**COLE FLEX**

Tubing, Conduits, Hose, Sleeveings, Splices, Insulation and Cable Harness Products

**COOPER**

**Bussmann**  
Fuses, Fuseholders, Fuse Blocks, and Fuse Accessories

**CDE CORNELL DUBILIER®**

Capacitors — Aluminum Electrolytics, MICA, AC Oil, Film and Relays

**Du Pont Connector Systems**

**DU PONT**

An expanding line of reliable Interconnections, Packaging, and Subsystems

A COMPANY OF  
**DALE**

**Dale Electronics, Inc.**

Resistors, Networks, Oscillators, Displays, Inductors & Thermistors

**DI DANTONA INDUSTRIES, INC.**

BATTERIES: Computer, Cordless Phone, Scanner & R/C.

ANTENNAS: Cordless Phone (metal & rubber), Scanner Bumpers, Grommets and Stick-On Feet

**DEARBORN WIRE AND CABLE INC.**

A Division of Wire Lions

Wire, Cable and Tubing

**EATON**

Eaton Corporation, Commercial & Military Controls Operation  
Switches, Relays, Displays and Keyboards

**GERNSBACK PUBLICATION**  
Electronics Now Magazine

**GENERAL DEVICES**

Electronic Hardware Manufacturers  
Slides, Chassis, Cable Carriers, Shelves, Racks, Cabinets, Enclosures

**KOA SPEER ELECTRONICS, INC.**

Resistors, SMT Tantalum Capacitors Inductors, Resistor Networks, SMT Thermistors

**Manhattan**  
ELECTRIC CABLE CORPORATION

Electrical and Electronic Wire, Cable and Connectors

**NTE**

**NTE ELECTRONICS, INC.**

A WORLDWIDE REPUTATION FOR QUALITY SERVICE AND VALUE

Semiconductors, Resistors, Capacitors, Relays

**KEMET®**

Electronics Corporation  
Solid Tantalum, Multi-Layer Ceramic, and Surface Mount Capacitors

**MALLORY**

North American Capacitor Company  
Tantalums, Aluminums, Sonalerts Ceramics, Films, AC's and RFI Filters

**muRata ERIE®**  
MURATA ERIE NORTH AMERICA

Monolithics, Discs, Variable Capacitors, Oscillators Potentiometers, RFI/EMI Filters, Microwave, Surface Mount Capacitors

**Philips ECG**

A North American Philips Company  
Semiconductors, Test Equipment, Relays, A/V Parts and Chemicals

**Quam**

Loudspeakers and Commercial Sound Products

**ROEDERSTEIN**

Film, and RFI Suppression Capacitors, Aluminum and Tantalum Electrolytic Capacitors, and Resistors

A COMPANY OF  
**SPRAGUE**

Tantalum Capacitors, Wet & Foil Capacitors, Resistor Networks, Resistor Capacitor Networks, Filters

**Switchcraft**

A Raytheon Company  
Switches, Connectors, Jacks, Plugs, Jackfields & Audio Accessories

**TECH SPRAY**

Cleaners/Degreasers, Swabs/Wipes, Brushes and Wick

**Thomson Consumer Electronics, Inc.**

Distributor and Special Products  
Replacement parts for RCA and GE consumer electronics products

Whenever you need electronic products, make your initial call to a distributor. Distributors help speed up your time to market, providing the convenience, the economy, the value, and above all, the service that helps make you competitive.

The sponsors of this message know how important it is — to us and to your MRP — to get product ASAP or JIT. Another important abbreviation is EIA. Our participation in the Electronic Industries Association's Components Group makes us all more competitive, through

fostering better working relations and coherent industry standards, and through the sharing of ideas to help both buyers and sellers.

In choosing your component supplier, look for the marks of leadership — availability through distribution and membership in the EIA.



**Electronic Industries Association/Components Group**  
2001 Pennsylvania Avenue, N.W. 11th Floor  
Washington, D.C. 20006  
Phone: (202) 457-4930 Fax: (202) 457-4985

Committed to the competitiveness of the American electronics producer

# Countersurveillance

**Never before has so much professional information on the art of detecting and eliminating electronic snooping devices—and how to defend against experienced information thieves—been placed in one VHS video. If you are a Fortune 500 CEO, an executive in any hi-tech industry, or a novice seeking entry into an honorable, rewarding field of work in countersurveillance, you must view this video presentation again and again.**

*Wake up!* You may be the victim of stolen words—precious ideas that would have made you very wealthy! Yes, professionals, even rank amateurs, may be listening to your most private conversations.

*Wake up!* If you are not the victim, then you are surrounded by countless victims who need your help if you know how to discover telephone taps, locate bugs, or “sweep” a room clean.

There is a thriving professional service steeped in high-tech techniques that you can become a part of! But first, you must know and understand Countersurveillance Technology. Your very first insight into this highly rewarding field is made possible by a video VHS presentation that you cannot view on broadcast television, satellite, or cable. It presents an informative program prepared by professionals in the field who know their industry, its techniques, kinks and loopholes. Men who can tell you more in 45 minutes in a straightforward, exclusive talk than was ever attempted before.

## Foiling Information Thieves

Discover the targets professional snoopers seek out! The prey are stock brokers, arbitrage firms, manufacturers, high-tech companies, any competitive industry, or even small businesses in the same community. The valuable information they filch may be marketing strategies, customer lists, product formulas, manufacturing techniques, even advertising plans. Information thieves eavesdrop on court decisions, bidding information, financial data. The list is unlimited in the mind of man—especially if he is a thief!

You know that the Russians secretly installed countless microphones in the concrete work of the American Embassy building in Moscow. They converted



**CALL NOW!**

**1-516-293-3751**

**HAVE YOUR VISA or MC CARD AVAILABLE**

what was to be an embassy and private residence into the most sophisticated recording studio the world had ever known. The building had to be torn down in order to remove all the bugs.

## Stolen Information

The open taps from where the information pours out may be from FAX's, computer communications, telephone calls, and everyday business meetings and lunchtime encounters. Businessmen need counselling on how to eliminate this information drain. Basic telephone use coupled with the user's understanding that someone may be listening or recording vital data and information greatly reduces the opportunity for others to purloin meaningful information.

The professional discussions seen on the TV screen in your home reveals how to detect and disable wiretaps, midget radio-frequency transmitters, and other bugs, plus when to use disinformation to confuse the unwanted listener, and the technique of voice scrambling telephone communications. In fact, do you know how to look for a bug, where to look for a bug, and what to do when you find it?

Bugs of a very small size are easy to build and they can be placed quickly in a matter of seconds, in any object or room. Today you may have used a telephone handset that was bugged. It probably contained three bugs. One was a phony bug to fool you into believing you found a bug and secured the telephone. The second bug placates the investigator when he finds the real thing! And the third bug is found only by the professional, who continued to search just in case there were more bugs.

The professional is not without his tools. Special equipment has been designed so that the professional can sweep a room so that he can detect voice-activated (VOX) and remote-activated bugs. Some of this equipment can be operated by novices, others require a trained countersurveillance professional.

The professionals viewed on your television screen reveal information on the latest technological advances like laser-beam snoopers that are installed hundreds of feet away from the room they snoot on. The professionals disclose that computers yield information too easily.

This advertisement was not written by a countersurveillance professional, but by a beginner whose only experience came from viewing the video tape in the privacy of his home. After you review the video carefully and understand its contents, you have taken the first important step in either acquiring professional help with your surveillance problems, or you may very well consider a career as a countersurveillance professional.

## The Dollars You Save

To obtain the information contained in the video VHS cassette, you would attend a professional seminar costing \$350-750 and possibly pay hundreds of dollars more if you had to travel to a distant city to attend. Now, for only \$49.95 (plus \$4.00 P&H) you can view *Countersurveillance Techniques* at home and take refresher views often. To obtain your copy, complete the coupon below or call toll free.

**CLAGGK INC. PE**  
**P.O. Box 4099 • Farmingdale, NY 11735**

Please rush my copy of the Countersurveillance Techniques Video VHS Cassette for a total cost of \$53.95 each (which includes \$4.00 postage and handling).

No. of Cassettes ordered \_\_\_\_\_  
 Amount of payment \$ \_\_\_\_\_  
 Sales tax (N.Y.S. only) \_\_\_\_\_  
 Total enclosed \_\_\_\_\_  
 Bill my  VISA  MasterCard  
 Card No. \_\_\_\_\_  
 Expire Date \_\_\_\_ / \_\_\_\_  
 Signature \_\_\_\_\_  
 Name \_\_\_\_\_  
 Address \_\_\_\_\_  
 City \_\_\_\_\_ State \_\_\_\_\_ ZIP \_\_\_\_\_

All payments in U.S.A. funds. Canadians add \$4.00 per VHS cassette. No foreign orders.