

CREATE A HIGH-VOLTAGE MINIATURE TORNADO

Popular Electronics

MAY 1992

NEW GEAR COMING AT YOU

Get your first look at wide-screen TV's, recordable video-discs, "full-motion" picturephones, "shock-proof" CD players, and the rest of the new generation of high-tech electronic products

POP-UP OUTDOOR LIGHTS

Build a walkway lighting system that ducks out of your way for mowing and other gardening chores

WIRE BEAMS: GAIN ON THE CHEAP

These antenna designs work where others fail

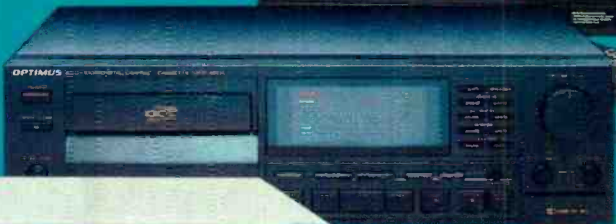
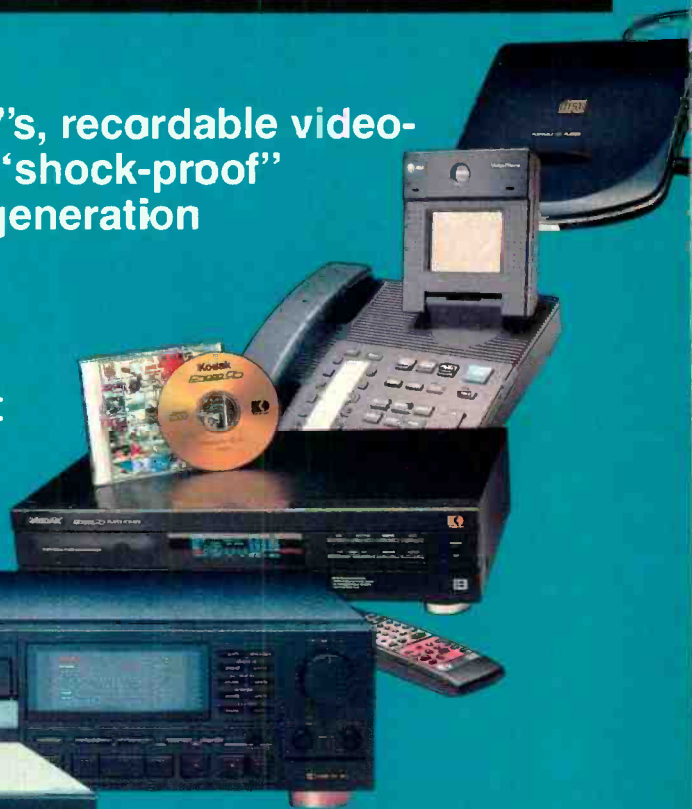

BUILD YOUR OWN HIGH-VOLTAGE CAPACITORS

Can't find or afford that special capacitor for your Telsa coil or other high-voltage project? Then build your own using our easy-to-duplicate, low-cost designs



CERNESBACK PUBLICATION

3 NEW FactCards IN THIS ISSUE

#BXBDCC CAR-RT SURT *# CR24
#60506DM997GAD06# FEB93 49
ROBERT DAHM RESP 078 *
997 GRAND AVE 60506
AURORA, IL



\$3.50 U.S.
\$3.95 CANADA

We Only Skimped On The Price.

Introducing The Fluke Series 10—From \$69.⁹⁵

Actual size: Easy to carry, easy to use.

Fluke quality: Made in the USA by Fluke, with the same rugged reliability that's made us the world leader in digital multimeters. Count on hard-working high performance—and a two-year warranty to back it up.

Large, easy-to-read display: 4000 count digital readout.

New! Min/Max record with relative time stamp and Continuity Capture™: Makes intermittent problems easier to find. Records highs and lows—and "time stamps" when they occurred. In continuity mode, opens or shorts as brief as 250 µs are captured and displayed.

New! V Chek™: For fast accurate checks on power sources and supplies, set your meter on V Chek—and let it do the rest. V Chek will determine continuity/ohms; if voltage is present, it will *automatically* change modes to measure AC or DC volts, whichever is detected. For most initial troubleshooting checks, here's the only setting you need to make.

Capacitance: Autoranging from .001 µF to 9999 µF. No need to carry a dedicated capacitance meter.

Autoranging with manual option: Your choice, depending on your situation.

For high performance at Fluke's lowest price, get your hands on the new Series 10. Stop by your local Fluke distributor and feel what a powerful difference the right multimeter makes—at the right price. For a free product brochure or the name of your nearest distributor, call 1-800-87-FLUKE.

Sleep Mode: Shuts itself off if you forget, extending long battery life even further.

New! Slide switch and a few pushbuttons control all functions: Designed for true one-hand operation.

Fast, accurate tests and measurements: AC and DC voltage measurements to 600 volts, ohms to 40 MΩ; audible continuity test; and diode test.

Safety—a Fluke standard: Designed to meet UL1244, IEC 1010, CSA and VDE safety requirements; extensive overload protection built in.

Audible Continuity: To perform fast continuity checks, just listen for the beep; no need to watch the display.

New! TL75 Hard Point™ Test Leads: Comfort grip with extra strong tips for extended service life.

Fluke 10	Fluke 11	Fluke 12
\$69.95*	\$79.95*	\$89.95*
4000 count digital display	V Chek™	V Chek™
1.5% basic dc volts accuracy	Capacitance, .001 to 9999 µF	Min/Max recording with relative time stamp
2.9% basic ac volts accuracy	4000 count digital display	Continuity Capture™
1.5% basic ohms accuracy	0.9% basic dc volts accuracy	Capacitance, .001 to 9999 µF
Fast continuity beeper	1.9% basic ac volts accuracy	4000 count digital display
Diode Test	0.9% basic ohms accuracy	0.9% basic dc volts accuracy
Sleep Mode	Fast continuity beeper	1.9% basic ac volts accuracy
Two-year warranty	Diode Test	0.9% basic ohms accuracy
	Sleep Mode	Fast continuity beeper
	Two-year warranty	Diode Test
		Sleep Mode
		Two-year warranty

*Suggested U.S. list price.

Optional holster with tilt-stand available.



The New Series 10.
A Small Price For A Fluke.

FLUKE AND PHILIPS
THE T & M ALLIANCE

©1991 John Fluke Mfg. Co., Inc. Prices and specifications subject to change. Ad no. 00130.

FLUKE®

CIRCLE 10 ON FREE INFORMATION CARD

www.americanradiohistory.com

Popular Electronics®

THE MAGAZINE FOR THE ELECTRONICS ACTIVIST!

CONSTRUCTION ARTICLES

MAKE YOUR OWN HIGH-VOLTAGE CAPACITORS	Anthony Charlton	31
<i>Build capacitors that really pack a punch for high-voltage fun</i>		
BUILD A POP-UP OUTDOOR-LIGHTING SYSTEM	David Schmiedeberg	38
<i>Give your lawn an uncluttered look by day and a well-lighted appearance by night with a hideaway lighting system</i>		
BUILD A SOLDERING-IRON CONTROLLER	John J. Yacono and Marc Spiwak	53
<i>Turn any standard soldering iron into a precision, temperature-controlled unit</i>		
BUILD THE QUICKIE BREAKOUT BOX	John J. Yacono	61
<i>This feature-packed breakout box makes putting together computer cables a breeze</i>		

FEATURE ARTICLES

WIRE BEAMS: GAIN ON THE CHEAP	Joseph J. Carr	45
<i>Nothing gives your ham rig better bang per buck than a good antenna</i>		
CREATE A HIGH-VOLTAGE MINIATURE TORNADO	R. A. Ford	55
<i>Create a high-voltage discharge with some unusual properties</i>		
AUDIO INDICATORS AND ACOUSTICS	Vaughn D. Martin	56
<i>Explore what goes into creating acoustic transducers, and learn how to get the most out of them</i>		

PRODUCT REVIEWS

GIZMO		5
<i>Featuring a report from the Winter CES, and loads of product reviews</i>		
HANDS-ON REPORT		22
<i>Heathkit IM-2410 Digital Frequency Counter</i>		
PRODUCT TEST REPORT	Len Feldman	27
<i>Sansui Model AV-7000 Audio/Video Amplifier</i>		

COLUMNS

ANTIQUE RADIO	Marc Ellis	66
<i>The Sky Buddy saga</i>		
COMPUTER BITS	Jeff Holtzman	68
<i>Tuning up</i>		
THINK TANK	John J. Yacono	70
<i>Microclips and more</i>		
CIRCUIT CIRCUS	Charles D. Rakes	73
<i>Experimenter's test-bench helpers</i>		
HAM RADIO	Joseph J. Carr	76
<i>The digital sawtooth generator</i>		
DX LISTENING	Don Jensen	78
<i>WWV and WWVH offer more than you think</i>		
SCANNER SCENE	Marc Saxon	80
<i>Getting to the bottom of the mailbag</i>		

DEPARTMENTS

EDITORIAL	Carl Laron	2
LETTERS		3
FACTCARDS		49
POPULAR ELECTRONICS MARKET CENTER		50A
FREE INFORMATION CARD		51
ELECTRONICS LIBRARY		82
NEW PRODUCTS		85
ELECTRONICS MARKET PLACE		93
ADVERTISER'S INDEX		96

Popular Electronics (ISSN 1042-170X) Published monthly by Gernsback Publications, Inc., 500 B Bi-County Boulevard, Farmingdale, NY 11735. Second-Class postage paid at Farmingdale, NY and at additional mailing offices. One-year, twelve issues, subscription rate U.S. and possessions \$21.95, Canada \$28.84 (includes G.S.T. Canadian Goods and Services Tax Registration No. R125166280), all other countries \$29.45. Subscription orders payable in U.S. funds only. International Postal Money Order, or check drawn on a U.S. bank. U.S. single copy price \$2.95. © 1992 by Gernsback Publications, Inc. All rights reserved. Hands-on Electronics and Gizmo trademarks are registered in U.S. and Canada by Gernsback Publications, Inc. Popular Electronics trademark is registered in U.S. and Canada by Electronics Technology Today, Inc. and is licensed to Gernsback Publications, Inc. Printed in U.S.A.

Postmaster: Please send address changes to Popular Electronics, Subscription Dept., P.O. Box 338, Mount Morris, IL 61054-9932.

A stamped self-addressed envelope must accompany all submitted manuscripts and/or artwork or photographs if their return is desired should they be rejected. We disclaim any responsibility for the loss or damage of manuscripts and/or artwork or photographs while in our possession or otherwise.

As a service to readers, Popular Electronics publishes available plans or information relating to newsworthy products, techniques, and scientific and technological developments. Because of possible variances in the quality and condition of materials and workmanship used by readers, Popular Electronics disclaims any responsibility for the safe and proper functioning of reader-built projects based upon or from plans or information published in this magazine.

Larry Steckler

EHF, CET

Editor-In-Chief and Publisher

EDITORIAL DEPARTMENT

Carl Laron

Editor

Robert A. Young

Associate Editor

John J. Yacono

Associate Editor

Byron G. Wels, K2AVB

Associate Editor

Teri Scaduto

Assistant Editor

Kathy Terenzi

Editorial Assistant

Marc Spiwak

Editorial Associate

Joseph J. Carr, K4IPV

Marc Ellis

Len Feldman

Jeffrey K. Holtzman

Don Jensen

Charles D. Rakes

Marc Saxon

Contributing Editors

PRODUCTION DEPARTMENT

Ruby M. Yee

Production Director

Karen S. Brown

Production Manager

Marcella Amoroso

Production Assistant

Lisa Rachowitz

Editorial Production

ART DEPARTMENT

Andre Duzant

Art Director

Injae Lee

Illustrator

Russell C. Truelson

Illustrator

Jacqueline P. Cheeseboro

Circulation Director

Michele Torriello

P-E Bookstore

BUSINESS AND EDITORIAL OFFICES

Gernsback Publications, Inc.

500-B Bi-County Blvd.

Farmingdale, NY 11735

1-516-293-3000

Fax: 1-516-293-3115

President: **Larry Steckler**

Customer Service/Order Entry

1-800-435-0715

7:30 AM - 8:30 PM EST

Advertising Sales offices listed on page 96

Composition by
Mates Graphics



The
Audit
Bureau
of Circulation



The publisher has no knowledge of any proprietary rights which will be violated by the making or using of any items disclosed in this issue.

MADE IN JAPAN

There's a new game in this country, and it threatens to replace baseball as our national pastime. The game is "Japan Bashing," and it seems as if everyone is playing. The rules are simple: If a company fails, it's Japan's fault; if the economy falters, it's Japan's fault; if taxes rise, it's Japan's fault . . .

The game's origins are quite easy to understand. When things do not go as planned, it is human nature to blame some outside person or force instead of admitting some personal shortcoming or error. And that tendency appears to be magnified when the person in question is someone of power—such as a politician or business leader.

Unfortunately, things are rarely that easy. Instead, this country's current plight is largely the result of decades of neglect by the government and bottom-line-only thinking by industry. Consider the consumer-electronics field. It was not so much captured by Japanese and other foreign manufacturers, as abandoned by U.S. companies. Bottom-line thinking led most U.S. electronics concerns to forsake the tough competition and slim profit margins of retail marketing in favor of the higher profits offered by government and industrial contracts. At the same time, our government has done little to encourage research and development in technologies that did not promise some type of military pay-off.

Taking protectionist measures now, such as erecting trade barriers, is short-sighted. First of all, it ignores the reality of a global economy. Secondly, "protecting" industries that are either essentially non-existent or that are unable to effectively compete without such drastic measures would do little outside of raising prices and limiting the availability of goods.

Instead, we should follow the lead of Japan, as well as other industrialized countries, where government is often a full partner with industry, providing generous funding and incentives to develop new and potentially profitable technologies, and state-of-the-art production and quality-control facilities and techniques. Two-way trade will only become a reality when we have products that are unique, or are better than anything available elsewhere. It is a lesson that the Japanese have already learned.

Incidentally, I saw a report the other day about the launching of a new type of boat that uses superconducting magnets to generate high-pressure water jets for propulsion. It should come as no surprise that the boat was made in Japan.

Carl Laron
Editor

FACTCARD FAN

I wanted to use this opportunity to thank you for including Fact Cards in every issue of **Popular Electronics** for the last few years. The FactCards definitely come in very handy on many occasions. Without them, some projects would have been absolutely impossible to assemble! Thank you!
P.A.L.
Oxford, OH

MAIL BAG MATCH

A letter I wrote to Marc Ellis was mentioned in a recent *Antique Radio* column titled "Reading The Mail" (**Popular Electronics**, August 1991). So far I've gotten one response to my request for help in antique-radio repair—believe it or not, from right here in Rochester! A gentleman who lives fairly close to me and has repaired old radios for quite a long time wrote to me and offered to help me rebuild my sets for the cost of parts only. I would not have known that a fellow hobbyist lived in my area if my letter hadn't been mentioned. Thank you very, very much for helping me. I really appreciate it.
L.V.L.
Rochester, NY

POWER BLOCK CORRECTION

During the editing process, some errors were apparently introduced into Fig. 1 of my article "Protect Your Equipment

with the Power Block" (**Popular Electronics**, February 1992).

That figure should have appeared as shown below.

On a different note, the switch on the Power Block should never be turned off while the switches for the plugged-in equipment are on. The switch is only meant to provide extra isolation from the AC line, not to act as a master power switch!—John Yacono

HAVES AND NEEDS

I am writing in hopes that one of your readers might be able to help in my search for a service manual/schematic and operating manual for an oscilloscope that was manufactured by Industrial Television Inc., Clifton, NJ, for the Department of the Navy, Bureau of Aeronautics. The numbers on the identification plate on the front panel are OS-4A/AP; NOas 52-639-1; and 1279: CBZO. The number NOas 52-639-1 would appear to be the contract number, so I would assume that the oscilloscope was manufactured in 1952. The scope and another small case that holds the probes and an extra crystal all fit into a waterproof case that has the number AN/USM-25A on the top. Any help would be much appreciated, and, of course, I would be more than happy to cover any

photocopying and postage costs.

Bill Joy
55 Evergreen Drive
Nepean, Ontario
Canada K2H 6C5

I need a manual or schematic for the Heathkit Utility Voltmeter, model 1M-17, recently purchased at a garage sale. Of course, I'll pay copying and mailing costs. Any help with the matter would be greatly appreciated.

Dominick L. Verdigi
2005 Northwest 4th Avenue
Delray Beach, FL 33444

I have a Dynaco 416 stereo amp that I'd like to get working when I have the time, but I don't want to start on it until I have a

schematic. If any of your readers might have built one in years past and still have their manual around, I'd appreciate a copy. I'd gladly pay the cost of its reproduction and postage. Thank you.

Roger Elmore
Route 4, Box 414
Martin, TN 38237

I'm looking for a parts diagram and a schematic for my Dynaco PAS-2 preamp. I've already tried Sams and Hi-Manual, with no luck. If any of your readers know where I could obtain the parts diagram and schematic, I'd like to hear from them.

Thank you.
Karl G. Maeder
2340 Tahoe Circle
Hemet, CA 92545

LETTERS

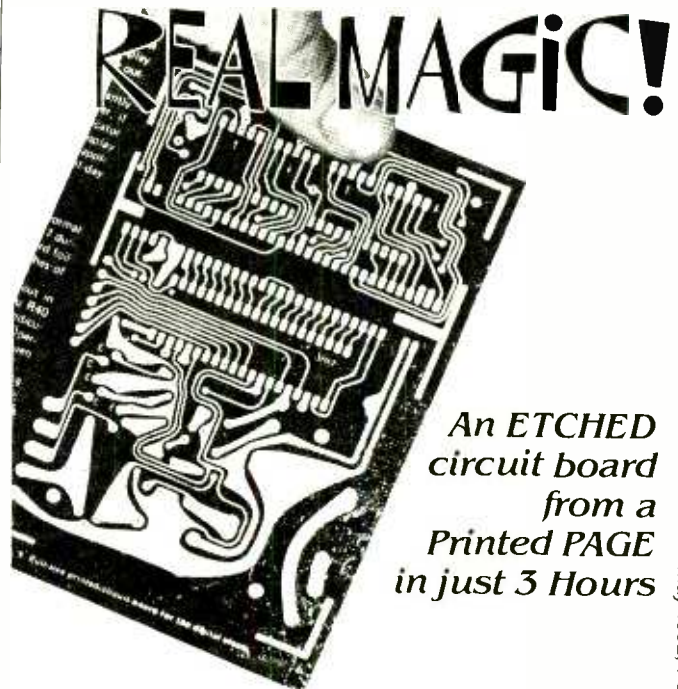
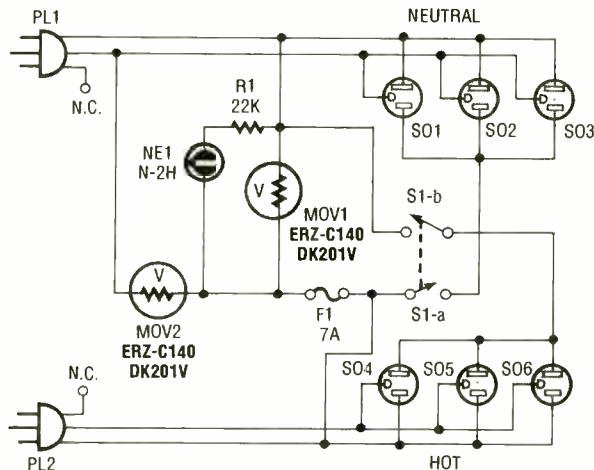

An ETCHED
circuit board
from a
Printed PAGE
in just 3 Hours

The ER-4 PHOTO ETCH™ KIT gives you the tools, materials and chemicals to make your own circuit boards from the artwork printed in magazines like this one. You can also do original 1X art using the enclosed patterns, tapes and drafting film. Or try the DIRECT ETCH™ system (also included) to make single circuit boards without artwork.

You'll need a reflector photoflood and a UV light source (or sunlight). Why search? Get an ER-19 bulb set with your ER-4. Bulbs use an ordinary 120V socket. The ER-4 and ER-19 are stocked by electronic parts distributors or order direct. Add \$4.50 for shipping. NV and CA residents must add sales tax.

ER-4 PHOTO ETCH SET \$38.00
ER-19 LIGHT BULB SET 16.45

DATAK Corporation • 55 Freeport Blvd. • Sparks, NV 89431

CIRCLE 9 ON FREE INFORMATION CARD

COURTEOUS SERVICE • QUALITY PARTS • DISCOUNT PRICES • FAST SHIPPING

ALL ELECTRONICS CORP.

PC BOARD WITH RF MODULATOR (and lots of other parts)

We recently received a load of these PC boards which contain, among other things, an RF modulator. With a little desoldering you should be able to liberate a working unit from the board. Also contains 7805T voltage regulator with a couple of heatsinks, 20 ICs, capacitors, resistors, diodes and connectors. No hook-up information available on the modulator. CAT# VMB-1

\$275
each

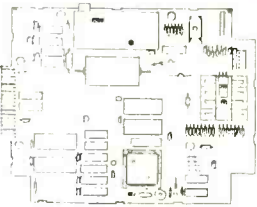

INFRARED Remote A.C. SWITCH

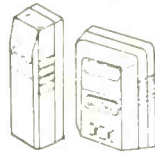

CAT# RC-1
\$9.95
each
2 for \$17.00

This infrared remote control device lets you turn on/off lamps, appliances or other 120 Vac devices using an IR transmitter similar to the one on your TV or VCR. Originally designed for use with a hydromassage unit, these transmitters and receivers will apparently operate most A.C. devices with 2 prong non-polarized plugs. Not recommended for use with heaters. Requires a 9 volt battery (not included).

UV "Invisible" INK

When the ink dries the writing of these felt tip pens is visible only under a UV "black light". Originally for marking personal belongings in case of theft, these pens might also be used for writing secret messages or marking merchandise for inventory control. Large quantities available.

CAT# UVP 3 for \$1.00 - 100 for \$25.00

Wireless Remote Control FOR NINTENDO™

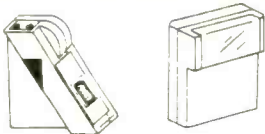

CAMERICA "Freedom Connection"™ Turns your wired Nintendo™ control pad into a remote control unit. Infrared remote like those used on TV's and VCR's eliminates messy wires. Allows players more mobility. Two players can use one remote unit except on games where they play simultaneously. In those games two "Freedom Connections" units are required. A well-known national discount toy chain sells these for more than twice our price. Operates on 4 AAA batteries (not included). CAT# IR-1 \$9.95

FLASH UNITS



NEW compact flash assemblies from a camera manufacturer. Operates on 3 Vdc. Measures 2 1/2" X 1 1/4". Ideal for use as a strobe, warning light or attention getter. Includes a hook-up diagram. CAT# FSH-1 \$3.75 each
10 for \$35.00 • 100 for \$325.00

L.E.D.'s

Surface mount LED chip.

Clear when off, green when lit. Very tiny - whole unit is 0.115" X 0.055" X 0.05" thick. 1mm (0.04") lens diameter. Gold-plated mounting surfaces for superior conductivity.

CAT# SMLED-2 10 for \$2.00
100 for \$18.00
1000 for \$140.00

Standard JUMBO

Diffused T 1-3/4 size (5 mm)



RED CAT# LED-1
10 for \$1.50 • 100 for \$13.00
GREEN CAT# LED-2
10 for \$2.00 • 100 for \$17.00
YELLOW CAT# LED-3
10 for \$2.00 • 100 for \$17.00

FLASHING LED

W/ built in flashing circuit 5 volt operation. T 1-3/4 (5mm)



RED \$1.00 each
CAT# LED-4 10 for \$9.50
GREEN \$1.00 each
CAT# LED-4G 10 for \$9.50
YELLOW \$1.00 each
CAT# LED-4Y 10 for \$9.50

LED HOLDER

Two piece holder.
CAT# HLED
10 for 65c

D.C. Wall Transformers (120 Vac INPUT)

Volts	Amps	Plug Style	Center	Cat#	Price
4 Vdc	70 ma.	2.5mm co-ax	negative	DCTX-470	\$2.00
6 Vdc	300 ma.	2.1 mm co-ax	positive	DCTX-632	\$2.75
9 Vdc	10 ma.	battery snap		DCTX-8310	\$1.50
9 Vdc	300 ma.	2.1 mm co-ax	positive	DCTX-932	\$3.00
9 Vdc	500 ma.	2.5mm co-ax	positive	DCTX-950	\$3.50
9 Vdc	1 Amp	2.1 mm co-ax	negative	DCTX-910	\$5.00
12 Vdc	100 ma.	2.1 mm co-ax	negative	DCTX-1210	\$2.50
12 Vdc	500 ma.	2.1 mm co-ax	negative	DCTX-125	\$4.50
12 Vdc	1 Amp	none		DCTX-121	\$6.50
14 Vdc	700 ma.	1.3mm co-ax	negative	DCTX-1470	\$5.25

ELECTROLUMINESCENT BACKLIGHTS

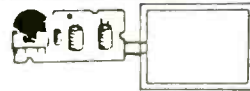

At last! A low cost electroluminescent glow strip and inverter. These brand-new units were designed to backlight small LCD TVs made by the Citizen Watch company. The inverter circuit changes 3 or 6 Vdc to approximately 100 Vac, the voltage required to light the glowstrip. Luminescent surface area is 1.7" X 2.25". The strip is a salmon color in its off state, and glows white when energized. The circuit board is 2.2" X 1". Glow strip and circuitry can be removed easily from plastic housing. Ideal for special lighting effects.

Citizen# 91TA operates on 3 Vdc

CAT# BLU-91

Citizen# 92TA operates on 3-6 Vdc

CAT# BLU-92

LARGE QUANTITY AVAILABLE
\$3.50 each • 10 for \$32.00
100 for \$275.00

DIP RELAYS

Miniature Relays With Pin Configuration To Fit 14 DIP.



5 Vdc - S.P.S.T.

GI Clare # PRMA-1A05B.
Normally open reed relay.
500 ohm coil. U.L. listed.
Diode protected.

CAT# DRLY-57 \$1.50 each

12 Vdc - S.P.S.T.

Gordos# 846A-412
575 ohm coil. Sealed.
Internal clamping diode.

CAT# DRLY-12 \$1.25 each

24 Vdc - S.P.D.T.

GI Clare # PRMA 1C24
2,150 ohm coil.
10 vA switching power.

CAT# DRLY-1C24 \$1.00 ea.

48Vdc - S.P.D.T.

Aromat # DS1E-A DC48V
5,750 ohm coil.
2 amp contacts.
CAT# RLY-788 \$1.00 each

Electret MIKE

High efficiency, omnidirectional, miniature electret condenser microphone element.



Low current drain, good signal to noise ratio, operates on 2 to 10 Vdc. Ideal for telephones, tape recorders, noise-activated alarms and other applications. .039" dia X 0.31" high.

CAT# MIKE-10 85c each
200 pcs \$150.00 (75c each)

HALL EFFECT SENSORS

Microswitch #SS41

tiny, solid state switch reacts instantly to proximity of magnetic field. Operates at extremely high speeds. up to 100 khz. Case size: 0.12" X 0.17" X 0.06" thick. 4.5 Vdc to 24 Vdc supply voltage. 10 ma. sink type digital output. Operating gauss - 15 to 40. P.C. leads.

CAT# HESW-2 75c each
10 for \$6.50 • 100 for \$60.00

SURFACE MOUNT STYLE

Sprague # UGN3075LT Operates on 4.5 - 24 Volts Can sink 10 ma. With suitable output pull up, can be used directly with bi-polar or CMOS logic circuits. Especially suited for electronic commutation in brushless D.C. motors using multiple ring magnets. Very tiny surface mount package 0.175" X 0.09" X 0.06" thick.

CAT# HESW-5 2 for \$1.00
100 for \$45.00
LARGE QUANTITIES AVAILABLE

RECHARGEABLE BATTERIES (nickel-cadmium)

Size	Volt	Amp	Part	1-4	10+
AAA	1.20	180 mA	NCB-AAA	\$1.50	\$13.50
AA	1.20	500 mA	NCB-AA	\$2.00	\$18.50
AA w/ Solder Tabs	1.20	500 mA	NCB-SAA	\$2.20	\$20.00
Sub C w/ Solder Tabs	1.20	1200 mA	NCB-SC	\$4.25	\$40.00
C	1.20	1200 mA	NCB-C	\$4.25	\$40.00
C Heavy Duty	1.25	1800 mA	HDNCB-C	\$5.25	\$42.50
D	1.20	1200 mA	NCB-D	\$4.50	\$42.50
D Heavy Duty	1.25	4000 mA	HDNCB-D	\$7.00	\$65.00

Highest Quality METAL CASSETTES

Premium quality metal tape in C-60 style cassettes (30 or more per side). One of the finest "brand-name" tapes on the market, in durable, clear plastic transport mechanisms. Recorded and bulk erased, the record-protect tabs have been removed and therefore, need to be taped over to re-record. Audiophiles will appreciate the wide dynamic range of this tape. If your cassette deck has a "metal" setting you will hear the difference. A real bargain! 60 min. tape - CAT# C-600M
10 for \$10.00

CASSETTE STORAGE CASE

Black, unbreakable plastic audio cassette storage case.
CAT# CBOX 5 for \$1.00 • 100 for \$15.00



ORDER TOLL FREE 1-800-826-5432

FAX (818) 781-2653 • INFORMATION (818) 904-0524

Call Or Write For Our
Free 64 Page Catalog

Outside the U.S.A. send \$2.00
postage for a catalog.

Minimum Order \$10.00 • All Orders Can Be Charged To Visa, Mastercard Or Discovercard • Checks and Money Orders Accepted By Mail • California, Add Sales Tax • Shipping And Handling \$3.50 for the 48 Continental United States - All Others Including Alaska, Hawaii, P.R. And Canada Must Pay Full Shipping • Quantities Limited • No C.O.D. • Prices Subject to change without notice.

DISCOVER

VISA



MAIL ORDERS TO: ALL ELECTRONICS CORP • P.O. BOX 567 • VAN NUYS, CA 91408

CIRCLE 8 ON FREE INFORMATION CARD

GIZMO

A CHRONICLE OF CONSUMER ELECTRONICS

MAY 1992

VOLUME 5,
NUMBER 5

1992 Winter Consumer Electronics Show

A look at the trends and products that will define the consumer-electronics industry in the coming year.

We've just returned from the 1992 Winter Consumer Electronics Show (WCES) in Las Vegas, where everyone involved seemed happy to put 1991—which started with a war and ended in recession—behind them, and where outlooks for 1992 were cautiously optimistic. Attendance at the show, which kicked off the 25th year of CES, was up: Almost 80,000 people attended over four days, and close to a third of those attendees were buyers. Further fueling that optimistic feeling were strong growth in the home-office and home-theater fields and excitement over several soon-to-be-released (we hope) technologies. Those include hardware and software for digital compact cassettes (DCC), some new entries in the interactive/multimedia arena, Photo CD, a portable CD-player that incorporates an anti-skip mechanism, a full-motion videophone, a recordable videodisc, cordless phones that operate on the 900-MHz band, and televisions with 16:9 aspect ratios. And everyone was buzzing about this summer's CES in Chicago, which will be admitting consumers for the first time.

A NEW ERA IN AUDIO TAPE

Garnering the most attention and support was digital compact-cassette technology. Tandy and Memorex staged an "Is it live or ..." demonstration featuring Peter Nero playing on stage and, sometimes, on DCC. The demonstration was impressive despite the poor acoustics of the demo room. Philips showed home, portable, and car DCC players; Technics displayed their "Imagine" series, which included a vertical pedestal DCC/CD system, as well as a car DCC deck under the



This winter's Consumer Electronics Show was dominated by feelings of caution (because of the economy) and hope that '92 would bring renewed strength to the industry.

Panasonic brand; Memorex and BASF had sample blank DCC tapes; Marantz, Carver, and Denon featured DCC decks; and Sharp and Fisher/Sanyo showed prototypes but didn't have any definite marketing schedules. The other companies are planning to get their products to market by the fall of this year—assuming, of course, that Congress passes the Audio Home Recording Act in June. (With support from all the major players—the Recording Industries Association of America, musicians, and hardware and software manufacturers—the bill is expected to pass with no trouble.) Philips has an aggressive pre-release promotional schedule for its home DCC deck planned to start this spring, with demonstration units sent to select markets.

"What's the big deal?" you might be thinking. After all, there was all sorts of hoopla written about DAT over the past few years, and that format probably had no impact on your listening. (Actually, DAT has become quite popular among music-industry professionals, and has had some limited success with audiophiles.) So, what's different about DCC?

There are several major factors that should help DCC achieve commercial success. First is its "backward compatibility." Standard analog audio cassettes will play on DCC decks, so you won't have to replace your entire music collection with a new medium immediately. And when you bring that new DCC deck home, you'll already have an extensive library of tapes to play. Should you want to immediately buy some pre-recorded tapes, however, about 500 DCC titles are expected to be available as DCC decks are being launched. (That wasn't—and still isn't—the case with DAT). And you'll still be able to afford those titles (which should cost the same as CD's), since the decks are slated to cost between \$600 and \$800 at introduction. (Marantz's top-of-the-line deck is to cost \$799.) Those prices should drop sharply as production picks up, because DCC decks are manufactured using many of the same parts and processes as analog cassette decks and shouldn't cost much more to make. Blank tapes are expected to cost between \$6 and \$9, and to be available in 60-, 90-, and 120-minute lengths. With the

TURN PAGE FOR CONTENTS

This month in GIZMO

- 1992 Winter CES Round-Up . . . pg. 5
- Zenith Sound by Bose
Digital System 3 Color TV . . . pg. 10
- Sole Control Universal
Replacement Remote Control
(Model SC-2000) pg. 12
- Plug 'N Power Computer Interface
with DeskMate Automatic House
Software pg. 17
- Memorex CDX-605 Extended-Play
Personal Stereo pg. 18
- Casio Weather Watch pg. 20
- Voice-Activated Car Stereo/Cellular
Phone pg. 21

Gizmo is published by Gernsback Publications, Inc., 500-B Bi-County Blvd., Farmingdale, NY 11735. Senior Writers: Chris F. O'Brian and Teri Scaduto. ©Copyright 1992 by Gernsback Publications, Inc. Gizmo is a registered trademark. All rights reserved.

combination of backward compatibility, recording-industry backing, and affordable prices, manufacturers are hopeful that DCC will penetrate the market even faster than compact discs did. Actually, there's still quite a bit of resistance to CD, particularly in middle America. Only about 21% of households in the U.S. owned a CD player in 1991, while audio cassettes remain by far the most popular music medium. Could the other 79% be waiting for an affordable digital tape technology?

INTERACTIVE/MULTIMEDIA DEVICES

Now that Commodore and Philips have launched their CDTV and CD-I players, respectively, and the Multimedia PC Group (MPG) is pushing interactive computers and a wide assortment of software,

the interactive/multimedia field appears firmly established. WCES saw some upgrades, a few new entries, and some rumors of new entries.

We like taking photos much more than we like organizing them in albums or frames, so most of our snapshots end up thrown in a large dresser drawer, still in their folders. That's why Photo CD, a developing process in which up to 100 photographs can be stored digitally on a compact disc by the developer, to be "played back" on a CD-I player or a stand-alone Photo CD deck and viewed on a television—or played and viewed on a personal computer with a CD-ROM XA drive—appealed to us when it was first discussed last year. At this winter's CES, Kodak demonstrated the finished product—a \$400 Photo CD player that's slated to begin shipping this summer—and it's already become "new and improved." Actually, it's the development process that's been upgraded, allowing Photo CD photofinishers to record up to 72 minutes of full CD audio or up to 800 digitally recorded (at TV resolution) images, or any combination thereof, on a Photo CD disc. That will allow developers to create custom discs, playing the Wedding March or "Happy Birthday" on special events discs, for example. Philips is also producing pre-recorded Photo CD's, low-cost titles in specialized fields including sports, art, and nature. Photo CD decks can, of course, play back standard audio compact discs as well. And Photo CD can be used as a negative should you want an old-fashioned photo print.

Philips also showed a portable CD-I player. The compact device has a 5.8-inch color LCD screen, and is scheduled to be shipped this fall. Sanyo displayed a similar prototype, but had no definite marketing plans.

Meanwhile, Apple is preparing for entry into the consumer-electronics field with several products, including, according to Apple Chairman and CEO John Scully, "electronic books, electronic organizers, [and] multimedia players." A



DCC decks won't do too much without tapes on which to record. BASF was one company to announce availability of blank tape, but they did not announce a price.

Sony-made CD-ROM-equipped Macintosh dubbed the "Edutainment Machine," is expected to be introduced by Apple at SCES in May. And rumor has it that Tandy is trying to beat Apple to it, with their own interactive CD player. Unconfirmed reports say that it will be called the "Gryphon" and will be priced at \$699, significantly less than CD-I or CDTV.

COMPACT DISCS FOR YOUR EARS ONLY

Not all the news in CD technology involves interactive devices. Sanyo/Fisher debuted a portable CD player with their

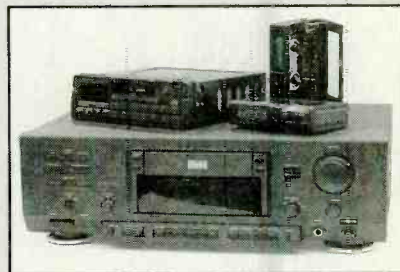

Digital Compact Cassette or DCC is ready and raring to go—pending congressional action on a royalty agreement. Home, car, and portable players were demonstrated by Philips.

"Optitrac FMT" anti-skip system. Like Sony's MiniDisc (MD), Sanyo's model PCD7 has a buffer to store information from the disc in RAM—but the Optitrac FMT stores all the data uncompressed, as it is on the CD. The anti-skip circuitry works by spinning the disc at twice the normal speed, and storing a steady stream of information in memory, which is then accessed for playback at the normal rate. If the laser mistracks because of bouncing or jarring, the buffer provides enough time for the laser to get back to the right place. At the demonstration that we attended, the music was not affected even when the unit was dropped. Continual bouncing—as in jogging—would be too much for it to handle, but the \$499 CD player should perform well when walking or driving.

RECORDABLE VIDEO DISCS

The compact disc in all its various forms wasn't the only disc in the news at CES. Pioneer grabbed a share of the spotlight with the introduction of the world's first videodisc recorder. Note that we didn't say "laserdisc." The VDR-V1000 isn't compatible with laserdiscs, the format that Pioneer kept alive through some rather lean years.

Although the recordable videodisc might eventually work its way down to the consumer, it make take quite a while. The machine currently sells for almost \$40,000, with each disc commanding almost \$1300. Even with those high prices,



Kodak's Photo-CD system will change the way you look at photographs. Up to 100 photos will fit on a disc.

there are many expected customers in professional broadcasting for commercials, archival storage, instant replay, and more.

The discs, which can be rewritten up to a million times, according to Pioneer, store 57,600 frames or 32 minutes of full-motion video. They use a magneto-optical recording process, in which the magnetic polarization on the disc affects the polarization of light (in this case, from a laser) reflected off it.

TELEPHONE TALK

Let's face it: Telephones are not usually considered exciting from either a technological or a consumer point of view. At WCES, however, there were some notable exceptions. AT&T introduced the VideoPhone 2500, which provides full-color, "full-motion" video at about 10 jerky frames per second. The FCC-approved phone transmits voice and video via a high-speed modem over regular phone lines, so no special installation is required. The 3.3-inch LCD screen sits on an adjustable mount and the lens has a privacy screen for those times when you'd rather be heard and not seen. A self-view mode lets you compose the picture, and there are three clarity settings. The higher the number of frames per second, the poorer the picture clarity. So if you want to show off your new living-room furniture, you'd set it at the slowest setting. If you wanted your daughter to show Grandma her latest ballet routine, you'd use 10-frames per second. The VideoPhone 2500 is said to be

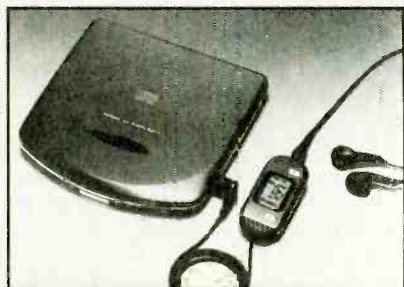

A portable CD player that's really portable, Fisher's model PCD7 features Sanyo's "Optitrac FMT" anti-skip system.

NAMES AND ADDRESSES

AT&T
Consumer Products Division
5 Wood Hollow Rd. 3L11
Parsippany, NJ 07054
CIRCLE 50 ON FREE INFORMATION CARD

BASF
Information Systems
Crosby Drive
Bedford, MA 01730
CIRCLE 51 ON FREE INFORMATION CARD

CARVER CORP
20121 48th Ave West
Lynnwood, WA 98036
CIRCLE 52 ON FREE INFORMATION CARD

CODE-A-PHONE CORP
P.O. Box 5656
Portland, OR 97228
CIRCLE 53 ON FREE INFORMATION CARD

COMMODORE BUSINESS MACHINES, INC.
1200 Wilson Dr.
West Chester, PA 19380
CIRCLE 54 ON FREE INFORMATION CARD

DENON AMERICA, INC.
222 New Rd.
Parsippany, NJ 07054
CIRCLE 55 ON FREE INFORMATION CARD

FAROUDJA LABORATORIES
675 Palomar Ave.
Sunnyvale, CA 94086
CIRCLE 56 ON FREE INFORMATION CARD

JVC CO. OF AMERICA
41 Slater Dr.
Elimwood Park, NJ 07407
CIRCLE 57 ON FREE INFORMATION CARD

EASTMAN KODAK CO.
343 State St.
Rochester, NY 14650
CIRCLE 58 ON FREE INFORMATION CARD

MARANTZ USA
1150 Feehanville Drive
Mount Prospect, IL 60056
CIRCLE 59 ON FREE INFORMATION CARD

MEMOREX
P.O. Box 901021
Fort Worth, TX 76101
CIRCLE 60 ON FREE INFORMATION CARD

PANASONIC CO.
One Panasonic Way
Secaucus, NJ 07094
CIRCLE 61 ON FREE INFORMATION CARD

PHILIPS CONSUMER ELECTRONICS CO.
One Philips Drive
Knoxville, TN 37914
CIRCLE 62 ON FREE INFORMATION CARD

PIONEER ELECTRONICS (USA) INC.
2265 E 220th Street
P.O. Box 1720
Long Beach, CA 90801
CIRCLE 63 ON FREE INFORMATION CARD

SANYO FISHER (USA) CORP.
21350 Lassen St.
Chatsworth, CA 91311
CIRCLE 64 ON FREE INFORMATION CARD

SHARP ELECTRONICS CORP.
Sharp Plaza
Mahwah, NJ 07430
CIRCLE 65 ON FREE INFORMATION CARD

TANDY CORP.
700 One Tandy Center
Fort Worth, TX 76102
CIRCLE 66 ON FREE INFORMATION CARD

THOMSON CONSUMER ELECTRONICS
600 N. Sherman Dr.
Indianapolis, IN 46201
CIRCLE 67 ON FREE INFORMATION CARD

TOSHIBA AMERICA
9740 Irvine Blvd.
Irvine, CA 92718
CIRCLE 68 ON FREE INFORMATION CARD

US ORDER
13873 Park Center Rd.
Herndon, VA 22071
CIRCLE 69 ON FREE INFORMATION CARD

VIDIKRON OF AMERICA, INC.
150 Bay Street
Jersey City, NJ 07302
CIRCLE 70 ON FREE INFORMATION CARD

VTECH COMMUNICATIONS
8770 SW Nimbus Ave.
Beaverton, OR 97005
CIRCLE 71 ON FREE INFORMATION CARD

aimed at consumers—particularly those with young children and distant relatives—but its \$1499 price tag seems a bit prohibitive. To stimulate consumer market penetration, AT&T is considering videophone rentals through its retail shops, and hopes to convince hotels frequented by business travellers, hospitals, college dormitories, and nursing homes to install videophone booths.

Cordless phones that operate on the 900-MHz band were shown at last summer's CES but, pending FCC approval, no concrete marketing plans were released. At WCES, two companies claimed to be the first to receive that approval—and they're both right. VTECH Communications' Tropez 900DX, due to hit store

shelves in March with a \$299 price tag, will be the first 900-MHz digital cordless phone, and Panasonic's KX-T9000 will be the first analog one, available in May. Phone calls on the relatively uncrowded 900-MHz band should be subject to much less RFI (radio-frequency interference) than those on the 46-49-MHz band used by conventional cordless phones. Code-A-Phone hopes to get their Epic 9000 analog phone to market this summer, and other manufacturers are sure to follow.

The digital circuitry in VTECH's phone provides improved reception and extended range between the handset and base (up to 800 meters, according to the company). We tried it and were impressed: With digital circuitry the reception remains steady;



AT&T's Videophone 2500 attracted a lot of attention at this winter's show.

there is no dropout at the edges of the range. Security is also improved, with the signal scrambled between the handset and the base, and as many as 65,000 security codes possible.

At a list price of \$499, Panasonic's 900-MHz phone is being aimed at business users. It has a 2000-foot range, 1000 security codes, 30-channel scanning capability, and two sets of rechargeable batteries. Its folding handset is small enough to fit in a jacket pocket.

Another telephone item that caught our interest is currently available only in selected West Coast markets, and is being leased (at about \$10 a month), not sold. US Order's ScanFone home shopping and bill-paying system resembles the credit-card verification devices used in retail shops, but includes a phone handset and a light pen for scanning bar codes. Customers receive a personally designed sheet of bar codes that correspond to their financial accounts: phone and utility companies, credit cards, loan institutions, and other monthly bills. To pay a bill, you scan its bar code and then use the keypad to enter the amount and date of payment. At-home grocery shopping can be done using a bar-coded catalog supplied by the local market (Safeway, in some California markets, for example). Payment is made by running your credit card through the magnetic-stripe reader; there is an additional charge for home delivery, of course. And several



US Order's ScanFone home shopping and bill-paying system makes it easier than ever to never leave your house!

major mail-order companies can be accessed using ScanFone. It keeps getting easier to never leave the comfort of home!

CHANGING ASPECT RATIOS

While you're hanging out at home, you won't have to watch the same old TV. That old TV has a 4:3 aspect ratio. Tomorrow's TV will have an aspect ratio similar to that used in motion pictures—16:9. Thomson showed several models of 16:9 sets, including 31- and 35-inch ProScan IDTV models that are expected to be in stores this fall. IDTV? What happens when HDTV shows up two or three years down the road? (Six different proposed HDTV standards are now being tested at the Advanced Television Technology Center in Virginia, and the FCC is expected to decide on a format sometime in 1993.) The 16:9 ProScan sets will be adaptable for HDTV via an RGB input for a future HDTV decoder. In the meantime, you can make 16:9 8mm or VHS videos on Thomson-made camcorders, and play them back on a Thomson VCR. All are dual-mode (switchable between 4:3 and 16:9) devices, and are expected to be available this summer. Most prerecorded 16:9 program-

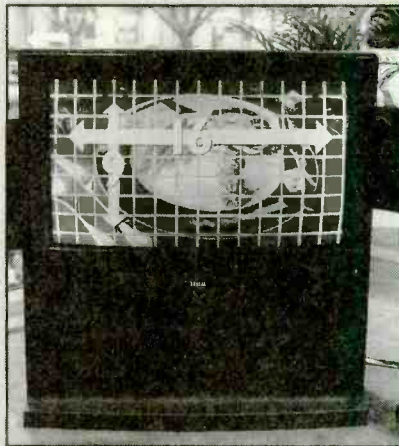

Wide-screen TV's are coming! The new 16x9 aspect ratio makes a dramatic difference.

ming is available on laserdiscs, and Thomson is also planning to sell a 16:9 LD player this year. Plans are in the works for a dual mode LD player, an S-VHS VCR, and smaller-screen 16:9 TV's. No prices are available yet, but the 34-inch sets are selling for around \$6000 in Japan and \$6000-\$7000 in Europe. Toshiba, JVC, and Philips also plan to market 16:9 sets in the U.S.

HOME THEATER

Of course, there's more to the home-theater experience than aspect ratio. In fact, home theater is one of the selling



If you've ever wanted to see what the Consumer Electronics Show is really like, this summer's show, open to the public for the first time, might be your chance!

concepts that kept retailers afloat in the stagnant 1991 market. Sales of 30-inch and larger TV's are expected to increase by 62% this year, with stereo TV sales going up by 8.5%, according to EIA predictions. And 1991 WCES saw 66 exhibitors of home-theater equipment, up from last year's 47. Several home-theater demonstrations at CES were quite impressive—especially one that used a Vidikron projection TV coupled with a \$15,000 SuperNTSC line-doubler from Faroudja. Seeing that demonstration and the coming wide-screen TV's makes us wonder whether high-definition TV has a chance to make it in the marketplace. If a manufacturer is able to put Faroudja's SuperNTSC system into a couple of chips, the price could be expected to be reduced significantly. Since the rest of the technology exists today, wide-screen SuperNTSC TV's would give consumers just about everything they need. Tests have shown that consumers want the wide screen more than the improved definition.

SEE YOU IN THE SUMMER

This summer's Consumer Electronics Show in Chicago will differ from every previous summer show in two ways. The show runs from Thursday May 28 through Sunday May 31, a departure from the usual Saturday through Tuesday of the first week in June. That change was made to allow the last two days to fall on a weekend—because for the first time in its 25 year history, the Consumer Electronics Show is being opened to the public.

The EIA's decision to keep the show trade-only on Thursday, Friday, and in the morning on Saturday, and open it to the public also from noon to 9 PM on Saturday and all day Sunday, has proven quite controversial. The consumer portion of the show (which costs \$10 for adults, \$5 for kids aged 6 to 10, and free for younger kids) is being heavily promoted in the Chicago area. Anywhere from 50,000 to 100,000 consumers are expected to show

(Continued on page 20)

SELECT 5 BOOKS for only \$4.95

(values to \$155.75)

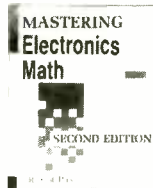
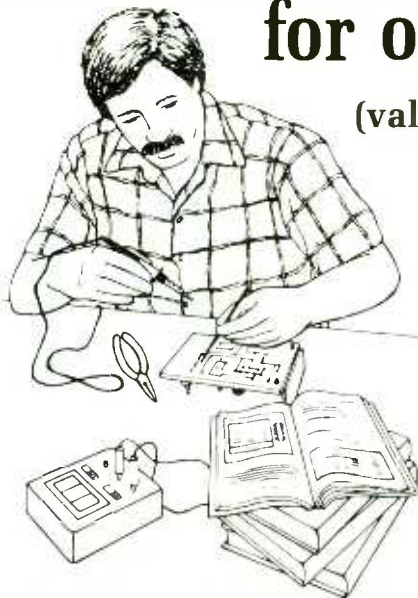

3589 \$27.95



3669 \$27.95

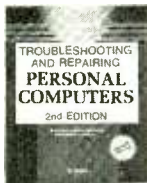

3677 \$34.95
Counts as 2



3258 \$28.95
Counts as 2



3671 \$29.95

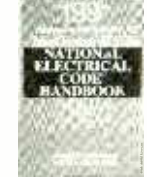

041904-5 \$29.95



3414 \$39.95
Counts as 2

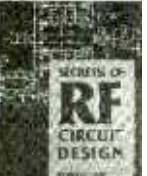

3710 \$32.95
Counts as 2



3627 \$29.95
Counts as 2



3374P \$16.95



2947P \$13.95



2181P \$18.95



3485 \$27.95



2980P \$19.45



2790P \$15.95



2E13P \$17.45



2893P \$18.95



2867P \$18.95



1938 \$60.00
Counts as 3



2925P \$10.95



3532 \$18.95



3922 \$26.95

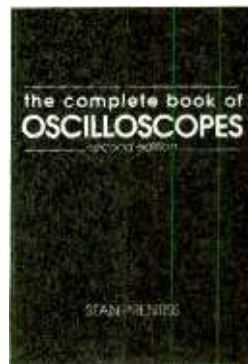

3825 \$26.95

Your most complete source for electronics books for over 25 years.

Membership Benefits • Big Savings. In addition to this introductory offer, you keep saving substantially with members' prices of up to 50% off the publishers' prices. • **Bonus Books.** Starting immediately, you will be eligible for our Bonus Book Plan, with savings of up to 80% off publishers' prices. • **Club News Bulletins.** 15 times per year you will receive the Book Club News, describing all the current selections—mains, alternates, extras—plus bonus offers and special sales, with scores of titles to choose from. • **Automatic Order.** If you want the Main Selection, do nothing and it will be sent to you automatically. If you prefer another selection, or no book at all, simply indicate your choice on the reply form provided. You will have at least 10 days to decide. As a member, you agree to purchase at least 3 books within the next 12 months and may resign at any time thereafter. • **Ironclad No-Risk Guarantee.** If not satisfied with your books, return them within 10 days without obligation! • **Exceptional Quality.** All books are quality publishers' editions especially selected by our Editorial Board. (Publishers' Prices Shown)

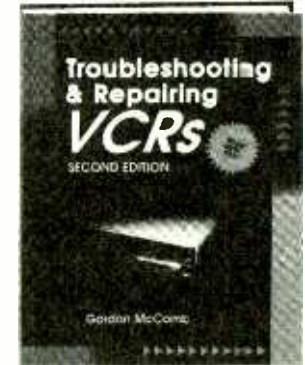

3777 \$32.95
Counts as 2



385928-9 \$24.95



3550 \$34.95
Counts as 2



2880P \$14.95

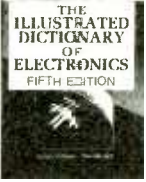

3345 \$39.95



9540 \$26.95



9290 \$36.00
Counts as 2

ELECTRONICS BOOK CLUBSM
Blue Ridge Summit, PA 17294-0810

Please accept my membership in the Electronics Book Club and send the 5 volumes listed below, billing me \$4.95. If not satisfied, I may return the books within ten days without obligation and have my membership cancelled. I agree to purchase at least 3 books at regular Club prices during the next 12 months and may resign anytime thereafter. A shipping/handling charge and sales tax will be added to all orders.

--	--	--	--

Name _____

Address _____

City _____

State _____ Zip _____ Phone _____

Valid for new members only. Foreign applicants will receive special ordering instructions. Canada must remit in U.S. currency. This order subject to acceptance by the Electronics Book Club. PE592

All books are hardcover unless number is followed by a "P" for paperback.

Simple Surround Sound

ZENITH SOUND BY BOSE DIGITAL SYSTEM 3 COLOR TV MODEL ZB2794BG. Manufactured by: Zenith Electronics Corporation, 1000 Milwaukee Avenue, Glenview, IL 60025. Price: \$1299

Just as food means more to most people than mere sustenance, television has become more than simply an entertaining way to pass the time. Both food and television can provide an emotional lift, and these days, we're just as likely to socialize around the TV as around the dining table—watching sporting events or rented movies with friends and family. And just as your standard culinary fare could be anything from Hamburger Helper to elaborately sauced French cuisine—depending on your time, expertise, facilities, budget, and, of course, your taste—your video equipment could be anything from the simple to the elaborate depending on the same five factors.

If you have a large media room, the money to equip it to the hilt, and the time and patience to set up a sophisticated home-theater system, you might indulge your taste in foreign films, recorded on laserdisc, on a 120-inch projection set with full surround sound. At the opposite end of the spectrum, you might spend your afternoons sitting at the kitchen table watching the *World Wrestling Federation* on a 13-inch black-and-white TV.

Most people fall somewhere in the middle in terms of taste, skill, and resources. They're aware of home theater and, although they might not be quite sure what it entails, they do like the idea. But once a consumer does the necessary research and decides to go for broke on audio/video gear, if his viewing room measures just 13 × 15 feet, a huge projection set simply isn't the right choice. Maybe he's blessed with a 20 × 25-foot space—but someone still has to set up all that equipment, and learn how to use it properly, and teach the rest of the family to do so as well.

Zenith is aiming their Model ZB2794BG television directly at the upper end of that middle group of video consumers who want the home-theater experience, but aren't willing to rearrange (or refinance) their homes, or take a course in electronics, to get it. The 27-inch set incorporates a sound system designed by Bose and comes with a pair of external surround speakers. Besides the hookups required for any standard television (some type of antenna and, probably, a VCR), those two small speakers are the only additional components that must be connected. And



all of the audio settings are easy to adjust using on-screen menus and the infrared remote control.

The ZB2794BG uses Bose-patented Waveguide technology to get big bass sound from a small space. It consists of a dedicated amplifier for the bass speaker, which reproduces the low frequencies at fairly high sound-pressure, and the Waveguide itself, which works something like the way a pipe organ does. The shape and length of the tube is resonant at low frequencies, which increases the strength of the sound. In the Zenith TV, the 80-inch pipe is tightly folded inside the cabinet. Bass tones emanate from both ends of the waveguide tube, located at the back of the set, and travels unattenuated around the cabinet. That system provides surprisingly big sound from a compact 27-inch set. The bass exits the cabinet in the rear, and is designed to be reflected from a wall or cabinet behind the set.

In addition to the bass driver and waveguide, two "Twiddler" (combination mid-range and tweeter) drivers are built into the front of the set in the curved panel under the picture tube. Powered by separate left- and right-channel amplifiers, the speakers provide stereo separation. Each power amplifier channel is actively equalized, and each power amplifier has an active compressor that maintains low distortion at all listening levels.

The set's "VideoStage Logic" (not Dolby) surround-sound system uses a Bose-patented logic-steering system to properly direct the sounds to the various speakers, allowing for an audio image that corresponds to what is happening on-screen. We never missed the lack of a separate center-front channel speaker. However, we did miss having a rear-channel delay, which allows the sound to reach viewers at the time the producer intended regardless of how close the rear speakers are mounted

to the viewing position. The Zenith-Bose system provides no delay.

Instead, it uses a proprietary phase detector to drive a precision voltage-controlled variable-gain amplifier that keeps the sound-pressure level essentially constant throughout the listening area. Bose compares that constant sound-pressure level to the effect in movie theaters of placing the rear-channel speakers across the back and down each side of the theater, and claims that their constant-power algorithm makes it possible to recreate movie-theater sound from any seat in the room using only two small rear-channel speakers. Subjectively, they seem to have achieved their goal.

In one of our listening tests, the rear speakers were set side-by-side close to the floor at the rear of the room—not the ideal setup, but one of the four options illustrated in the manual. When watching the adventure film *Robin Hood: Prince of Thieves*, reactions were mixed. All agreed that the surround-sound was dramatic, and added significantly to the overall viewing experience. Only one listener—a self-admitted audiophile accustomed to a full home theater—strongly objected to the lack of delay, and we can't help wondering how much of his dissatisfaction stemmed from the lack of a control to fiddle with. Other listeners, also familiar with component surround-sound systems, didn't think the missing delay detracted significantly from the listening experience, but worried that it might make the system's setup less flexible. Finally, there were those who were never quite sure what to do with the delay control anyway, and who were glad not to see one on this set!

That range of reactions is quite favorable, especially considering the target market for the set—people who are more likely to appreciate ease of use than complex parameter controls.

Of course, the "Sound by Bose" is only half of this TV by Zenith. The set's picture is as impressive as its sound, retaining its clarity in various ambient light settings. And the ZB2794BG offers a host of advanced features, including picture-in-picture.

Despite its sophistication, the set is quite easy to use. On-screen menus and a full-function remote control allow you to adjust all the audio and video parameters without leaving the comfort of your couch. The "Source" menu is used to select either antenna, cable, VCR, or S-Video as the video source. The "Setup" menu is used to have the set automatically select all available channels or to manually set just those channels desired, and to set the tuner to match your antenna or cable-TV system. The "Audio" menu allows you to choose between stereo, mono, and second audio program (SAP); and adjust the balance and bass, treble, and surround levels. When we say that the surround system is easy to use, we're not exaggerating: The only fiddling you can do is to raise or lower the level of the surround-channel, or mute it entirely.

Two menus for setting video parameters are provided. The "Features" menu is used to set the clock and to turn on or off the video filter (which acts like a sharpness control to reduce interference in the dark areas of the picture) and the "light sentry." Using a sensor located on the TV's control panel to monitor the light level in the room, the light sentry continually adjusts the brightness of the picture to the correct level for the ambient light. Contrast, brightness, color, sharpness, and tint are adjusted via the "Video" menu, which also allows you to set the "Video Sentry" to one of two modes. In "preset" mode, the factory presets for all video parameters are used; in "custom" mode, the video adjustments that you've previously made are retained for future use.

With 39 keys—some rather cryptically labeled—the remote control that's used to set all of those audio and video parameters isn't among the easiest we've seen. But it's definitely worth taking the time to learn to use it properly; doing so makes the couch potato's life a breeze. Besides operating all the standard features (volume, power, channel select), the on-screen menus, and picture-in-picture, the remote has been pre-programmed to operate a Zenith-manufactured cable box and VCR. If you don't own either of those, you can "teach" the remote all the functions of your own VCR's remote, and those of any other piece of remote-controlled audio or video equipment.

In our case, it took less than a half hour to teach the Zenith remote to control our Sanyo VCR and each component in the Sharp CD-C900 compact stereo (reviewed

in GIZMO last month). The "lessons" involve pressing a specific series of key-strokes, then placing the VCR or audio-system ("teaching") remote head-to-head with the TV ("learning") remote, and then continually pushing one button on the learning remote and then quickly pressing the corresponding button on the other remote until all its lessons are learned.

Three buttons at the top of the remote are used to select AUX, VCR, or TV mode. The bottom two rows of buttons on the remote directly correspond to standard VCR functions, including record, stop, pause, play, fast-forward, and rewind, so when you're using the remote in VCR mode, it's easy to remember which button does what. (The only key substitution necessary was for calling up our on-screen programming menu; we opted to use the MENU button.) When it came to the stereo system, it was much more difficult to assign keys to corresponding audio functions, and we had some hard choices as to which functions we'd omit. (The stereo's remote has 64 keys!) We did manage to program in all of the basic tuner/CD/tape functions. Charts provided in the user's manual can be used to record the auxiliary functions for each key. We would have liked to see a clear plastic pocket on the back of the remote, into which a "remote-control cheat-sheet" could be inserted for quick reference. After all, it's more inconvenient to keep the manual laying around than an extra remote.

For those who prefer their remotes simple, Zenith offers an "Everyday Remote." It has only seven buttons—power, volume up and down, channel up and down, mute, and recall. Some are concave and others are convex, making them easy to identify in the dark. That optional remote costs about \$20.

The programmable remote, however, is one of the best we've ever used. In addition to its learning ability, the remote allows you to set "macros"—sets of up to five key strokes that can be performed by pressing just two keys. For instance, you could program it to turn on the TV, turn on the VCR, tune each to the desired channels, and turn on picture-in-picture, simply by pressing MACRO and A. As if all of those features didn't make life simple enough, the remote's range is exceptionally wide. We were able to point it at the ceiling or floor and still operate the television. It must be pointed toward the general vicinity of the stereo, but still provides much more leeway than most remotes (including the one provided with the stereo system).

At the risk of disillusioning some GIZMO readers, we'll admit that much of our "real-life" listening and viewing tests are done in a real room, not a fancy studio.

(Continued on page 20)



FISHER m-SCOPE

FREE

Metal Detector Catalog

Models for underwater Treasure Hunting, beachcombing, relic hunting and gold nugget prospecting. High performance, lightweight, easy to use. The very latest from the world's oldest and proudest name in metal detectors. Write:

FISHER RESEARCH LABORATORY
200 W. Willmott Rd., Dept. PE
Los Banos, CA 93635
Ph.(209)826-3292, FAX(209)826-0416

FISHER m-SCOPE

CIRCLE 12 ON FREE INFORMATION CARD

LEARN to CLEAN/ MAINTAIN/ REPAIR CAMCORDERS



EARN \$85 AN HOUR!

HUGE EXPANDING MARKET!

Work from your home - part-time or full-time! No prior experience needed - Average mechanical ability only requirement for your success! Over 15 million camcorders in use - Over 5 million expected to be sold in 1991 alone!

It is a fact that the vast majority of camcorder malfunctions (just like VCRs!) are due to simple mechanical failure... We can show you how to easily fix those breakdowns and earn an average of \$85.00/Hr. while working at home!

Get In Now - Soon camcorders will be like VCRs, i.e., one in almost every home.

For a camcorder cleaning job you can earn \$65.00 or less than 30 minutes work.

For a camcorder repair job you can earn over \$100.00.

FREE INFORMATION PACKAGE call or write:
Toll-Free 1-800-537-0589
Viejo Publications, Inc.
4470-107 Sunset Blvd. #600
Los Angeles, CA 90027, Dept. PEC

CIRCLE 15 ON FREE INFORMATION CARD

Out of Control

SOLE CONTROL UNIVERSAL REPLACEMENT REMOTE CONTROL (MODEL SC-2000). Manufactured by Infrared Research Labs, Inc., 820 Davis Street, Suite 444, Evanston, IL 60201. Price: \$129.95.

If you've just finished reading our review of the Zenith-Bose TV, you know that we've finally come across an audio/video combination that works quite well together. Life is never perfect, however, and we soon ran into trouble deciding who would get to use the remote control that came with the TV.

That power struggle is just one of the problems caused by even the best remote controls. The primary trouble, as far as we're concerned, might be called remote glut—that confusing clutter of almost identical remotes, each used to operate a separate piece of equipment. The next most common complaint is the way that remote controls never seem to stay in the spot where you're sure you left them. Somehow they always manage to crawl under furniture, behind pillows, beneath a stack of magazines, or into some other obscure niche. And then there's the bother and expense of replacing a broken, or particularly well-hidden, remote with a new one from the same manufacturer.

Over the years, we've seen quite a few gadgets and gizmos intended to ease some of those problems. There are plastic holders to be hung on the wall for remote-control storage, keeping the units conveniently distant from couch cushions and newspaper piles. But chances are if you're organized enough to always return a remote to its wall-mounted holder, you're not the type who always loses it. There are similar holders that hang off the side of the coffee table, which seem a bit more likely to be used. There's even a "remote caddy"—a rectangular piece of black plastic with Velcro stuck on each side so that you can place your television and VCR remotes back-to-back, keeping them both on hand (or both lost, we'd imagine).

Sole Control SC-2000 is a much more ambitious extension of that general idea. Although it's shaped like a conventional remote control, by cleverly making use of both sides of the unit, the SC-2000 can control up to 16 separate audio/video components. Codes for more than 1500 devices have been preprogrammed into the Sole Control, so it isn't necessary to "teach" it to operate gear from various manufacturers. *Infrared Research Labs* guarantees that their product will control any brand of TV, VCR, cable decoder, audio receiver, CD player, cassette deck, laserdisc player,

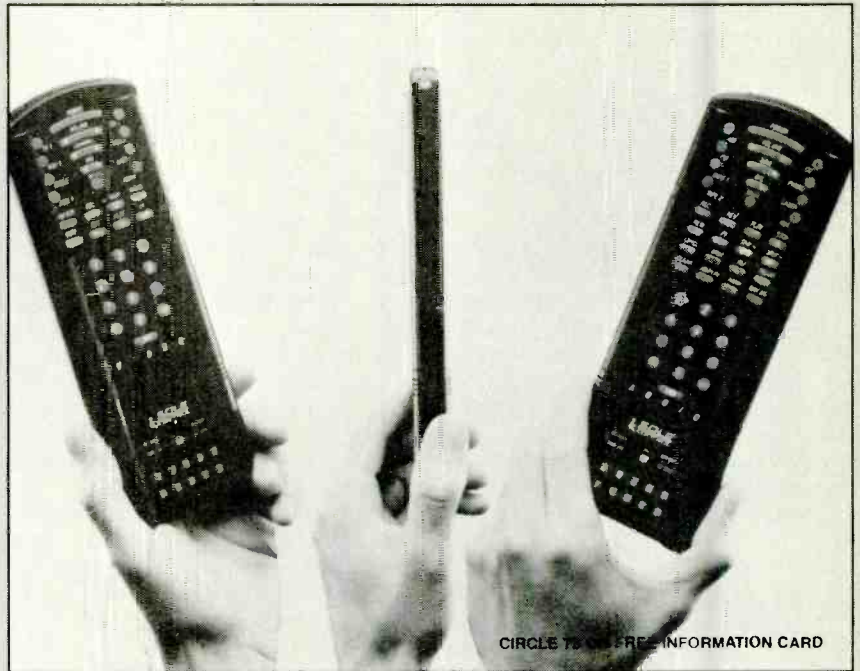

CIRCLE 75 FOR FREE INFORMATION CARD

satellite receiver, and sound-processing component. Furthermore, the Sole Control is said to be able to perform such fine-tuning functions as adjusting color, tint, bass, and treble, and it should be compatible with on-screen menus. That unique combination of features earned the Sole Control a Design and Engineering Award at the 1991 Summer Consumer Electronics Show.

The two sides of the remote look quite similar. One side is used to control as many as eight video devices (two TV's, two VCR's, a cable box, a laserdisc player, and two auxiliary units), while the other controls the same number of audio devices (AM, FM, Tape 1, Tape 2, CD, Phono, Laser, and Aux). At the top of each side are keys for selecting the device under control; up/down controls for volume, channel, and balance; and power and mute buttons. Standard VCR functions (play, record, pause, etc.) are controlled by eight keys that appear below those on the video side. In the same area on the audio side there are 16 keys used for tape and CD player functions. Each side also has a numeric keypad (0-9), a LOCK key that is used to lock in the side in use (and thus lock out the opposite side so that its buttons aren't pressed accidentally), and a SERV key (also used for programming) that's surrounded by four LED's intended to keep you informed of the status of the device. The bottom portion of each side is devoted to function keys labeled A through J.

Four "AAA" batteries power the unit. Two batteries slide vertically into each of the two battery compartments, which are located on either side of the unit.

According to the manual, programming the Sole Control is a simple matter. The

manual contains three-digit codes corresponding to more than 1500 different audio/video components, arranged first by type of equipment—TV, VCR, Cable/CATV converters, CD players, and a general audio category—and then alphabetically by manufacturer. For most televisions, more than one possible code is listed; there were 13 different codes listed for Sylvania televisions. Two or three codes are the norm for other components. Three keys are pressed to activate programming and select the device to be controlled, and then the three-digit code is entered. All in all, it should be a simple procedure.

To program our Sanyo VCR, the manual told us we should try first 690 and, if the Sole Control didn't respond properly, to then try 655. If a code is entered incorrectly, a red NO CODE LED lights. If an acceptable code is entered, the green CODE ENT light and the yellow SET MODE light flash briefly. That was the case when we entered 690. We were quite surprised, therefore, when we tried to turn on the VCR and got no response.

We turned to the manual, which contains charts detailing precisely what controls the A to J function keys should operate for all equipment that falls under each code, for an explanation. We were even more surprised to learn that there was no chart for 690—the 600's stopped at 678.

We decided it was time to try the other code—655—next. This time, everything seemed to be working fine, at least in terms of operating power, volume, channel, play, record, and the other basic VCR functions. When we turned to the function key chart to learn how to perform more advanced operations like programming

Why take chances in today's job market?

Graduate as a fully trained electronics professional.

To get ahead and stay ahead in today's economy, you need the electronics training CIE has been providing its 150,000-plus successful graduates with for nearly 60 years.

Meet the Electronics Specialists.

When you pick an electronics school, you're getting ready to invest time and money. And your whole future depends on the education you receive in return. That's why it makes so much sense to go with number one... with the specialists... with CIE!

There's no such thing as a bargain education.

If you talk to some of our graduates, and we recommend you do, chances are you'd find a lot of them shopped around for their training. Not for the lowest priced, but for the best training available. They pretty much knew what was available when they picked CIE as number one.

Because we're specialists we have to stay ahead.

At CIE we have a position of leadership to maintain. Here are just a few of the ways we hang onto it...

Programmed Learning.

That's exactly what happens with CIE's Auto-Programmed Lessons*. Each lesson uses famous "programmed learning" methods to teach you important electronics principles. You explore them, master them completely, before you start to apply them. You thoroughly understand each step before you go on to the next. You learn at your own pace

And, beyond theory, some courses come fully equipped with electronics equipment to actually let you perform hundreds of hands-on experiments.

Experienced specialists work closely with you.

Even though you study at home, CIE's faculty and staff stand ready to assist via CIE's toll free number. And, each time you return a completed exam you can

be sure it will be reviewed, graded and returned with the appropriate instructional help, you get it fast and in writing from the faculty technical specialist best qualified to answer your question in terms you can understand.

Pick the pace that's right for you.

CIE understands people need to learn at their own pace. There's no pressure to keep up...no slow learners hold you back. If you're a beginner, you start with the basics. If you already know some electronics, you move ahead to your own level.

"Same Day" grading cycle.

When we receive your lesson, we grade it and mail it back the same day. You find out quickly how well you're doing!

State-of-the-art laboratory equipment.

Some courses feature the CIE Microprocessor



Training Laboratory. An integral part of computers, microprocessor technology is used in many phases of business, including service and manufacturing industries. The MTL gives you the opportunity to program it and interface it with LED displays, memory devices and switches. You'll gain all the experience

needed to work with state-of-the-art equipment of today and tomorrow.

New Courses!

CIE now offers two new career courses: Automotive Electronics and Computer Operation and Programming.

CIE offers you an Associate Degree.

One of the best credentials you can have in electronics — or any other career field — is a college degree. That's why CIE offers an Associate in Applied Science in Electronics Engineering Technology. And all CIE career courses earn credit toward your degrees.

Which CIE training fits you?

Beginner? Intermediate? Advanced? CIE home study courses are designed for ambitious people at all entry levels. People who have: No previous electronics knowledge, but do have an interest in it; Some basic knowledge or experience in electronics; In-depth working experience or prior training in electronics.

At CIE you start where you fit and feel comfortable where you start, then go on from there to your Diploma, Associate Degree and career!

Today is the day. Send now.

Fill in and return the postage-paid card attached. If some ambitious person has already removed it, cut out and mail the coupon below. You'll get a FREE CIE school catalog, plus complete information on independent home study. Mail in the coupon below or, if you prefer, call toll-free 1-800-321-2155 (in Ohio, 1-800-523-9109).

YES! I want to get started. Send me my CIE school catalog including details about the Associate Degree program. (For your convenience, CIE will have a representative contact you — there is no obligation.) **AH28**

Print Name _____

Address _____ Apt. _____

City _____ State _____ Zip _____

Age _____ Area Code/Phone No. (_____) _____

Check box for G.I. Bulletin on Educational Benefits Veteran Active Duty

CIE CLEVELAND INSTITUTE OF ELECTRONICS, INC.
1776 East 17th Street • Cleveland, Ohio 44114 • (216) 781-9400



A school of thousands.
A class of one.
Since 1934.

timed recordings, everything seemed quite clear. The A key called up the on-screen programming menu, as promised. A bit of experimenting revealed that the ENTER key was used to move from one parameter (date, start time, end time) to the next. According to the chart, the B and C keys were used to adjust those parameters up and down, respectively. But, even though the green CODE ENT light came on, indicating that those were active keys, absolutely nothing happened when we pressed them. Nor did pressing D, E, or F yield any visible results. The G key performed its intended function (clear), but H did not operate the counter (or anything else) as promised, and I and J were not supposed to (and did not) have any functions under code 655. We couldn't get any of the other keys on the remote to adjust the timer programming parameters, so it was impossible to use that function with the Sole Control.

We might have considered that a fluke, except that the two codes listed for Zenith televisions gave equally spotty results. One allowed us to operate only a few of the set's features, so we stuck with the other, even though the function keys' actual functions didn't correspond with those listed in the chart. Unfortunately, that wasn't the only glitch. Although the Sole Control allowed us to see each of the on-screen menus, and scroll between them, there was no way to scroll between items to select options within the menus. (The only exception was the source menu.) So, now we had a VCR that we could use only to play back tapes, and a TV that we could watch but whose audio and video features we couldn't adjust.

Next, we tried programming the SC-2000 to operate a three-year-old Panasonic television. The results were much more promising. Not only did all the basic functions work properly, but the lettered function keys actually performed as stated in the manual. Granted, the set is nowhere near as complex as the Zenith, but at least everything it offered could be controlled by the Sole Control—if you are sitting directly in front and quite close to the set, that is.

Our sample SC-2000 has what just might be the narrowest range of any remote control that we've ever used—and we've used quite a few. It also has some of the mushiest, most sluggish keys that we've seen. Even when it controlled the functions that it promised to, that control was anything but effortless. "Simply" raising or lowering the volume, from a distance of three feet away, was quite a chore and took much longer than we consider acceptable.

Luckily, at the end of the manual's troubleshooting guide a toll-free problem-solving number is listed. When we called (acting as ordinary consumers) with our

list of complaints, hoping for a quick fix, we reached one of the most friendly, helpful customer-service reps that we've ever encountered. He was technically knowledgeable, yet his advice was never obscure or condescending. From him we learned that Infrared Research Labs is currently in the midst of a complete update of all its codes and manuals. That complex project requires the company to obtain manufacturers' remote controls for as many models as possible, so that they can directly copy the codes from each of those remotes into a computer-interfaced device that records the frequency data and duplicates it for use by the Sole Control. We also learned that some glitches are caused by slight mismatches of either the original or the duplicated codes.

Unfortunately, correct codes weren't available for our late-model Zenith-Bose TV and Sharp stereo (in fact, the last Zenith revision was in 1986). And we had no luck with the rep's suggestion that we try using the Fisher codes for our Sanyo VCR. But that doesn't mean that we have to wait for the updated version to become available before we can use a Sole Control.

Considering how frequently new models of audio and video equipment are introduced, keeping the Sole Control completely up to date is virtually impossible. Realizing that, Infrared Research offers its unsatisfied customers the option of having their Sole Controls "customized." To do so, you must mail (at your own cost) your Sole Control and the manufacturer's remote control(s) to the company, where the precise codes are copied onto your Sole Control. Of course, almost all of today's equipment includes functions that can be operated only by the remote control, leaving you somewhat helpless while your remotes are gone. Although it takes up to eight weeks for the customizing to be done, Infrared Research promises one-day turn-around on your original remotes. The company picks up the return postage on both the original remotes and the Sole Control.

According to the customer-service rep, the Sole Control should have a range of 20 feet, and the one he uses at home (an earlier model) works from up to 30 feet. The problem with ours, he said, could stem either from faulty codes or from a scratched lens (a problem not unheard of, but quite rare). If we wanted, they could customize a *new* unit to replace ours when we send it in with the manufacturers' remotes.

We'll let you know what happens in a couple of months, when we get back our customized Sole Control, which should work as perfectly as possible according to the company. Meanwhile, we're still arguing over who gets to hold that Zenith-Bose remote! ■

Home Control

PLUG 'N POWER COMPUTER INTERFACE WITH DESKMATE AUTOMATIC HOUSE SOFTWARE. Manufactured by: Radio Shack, 700 One Tandy Center, Fort Worth, TX 76102. Price: \$69.99. (Requires DeskMate, \$99.95)

When people look back on the 1990's, we expect that they will recognize the decade as the time when home automation became a reality. Of course, the *promise* of home automation has been around for some time. The National Association of Home Builders has been working on what they call "Smart Houses" for more than five years. And the Consumer Electronics Group of the Electronic Industries Association has been working on CEBus, the Consumer Electronics Bus home-automation standard for about seven years. They've been publicly demonstrating the concept for about two years, and the interim standard should become official this year.

Even when the standard is finally approved, it's unclear how quickly manufacturers—even those who were instrumental in defining the standard—will incorporate home-automation compatibility in their products. (After all, the "multiport" standard, which eliminates the incompatibility between scrambled cable services and cable-ready televisions, has been an approved standard for years. But you'd never know it by looking at TV's and cable boxes.) It's likely that home automation will come just as slowly.

As we wait for automation-ready products from manufacturers, we should keep in mind that other automation solutions exist today. We've seen plenty of custom, computer-controlled homes that impressed us, and some simpler timer-controlled homes that were based on the X-10 standard, the *de facto* standard for remote carrier-current control. Radio Shack has arranged a marriage between the power of computer control and the convenience and availability of X-10 compatible modules. Their *Plug 'n Power Computer Interface* and *DeskMate Automatic House* software let you automate your home today. And unlike most computer-controlled solutions, the interface does not tie up your computer. In fact, after it's programmed, it doesn't even have to be connected to the computer at all!

You can set the system to turn on some lights and a coffee pot in the morning, turn on the air conditioner before you return home from work, and shut everything off at bedtime. When you're away from home, you can have lights come on and off—or even dim—to make it appear as if someone is home. Modules are available to control



CIRCLE 74 ON FREE INFORMATION CARD

everything from lamps and wall outlets to set-back thermostats and low-voltage loads.

The interface doesn't look particularly high tech. It's a simple cream-colored box with eight front-panel rocker switches. The rear panel holds a 5-pin DIN connector, a compartment for a 9-volt battery, and a power cord for connection to an AC outlet. The package includes two versions of software. One is a set of stand-alone DOS programs. The second requires Tandy's DeskMate graphical user interface. Both do essentially the same thing, but since we wanted to see just how easy it could be to automate our home, we used only the DeskMate software, whose graphical interface promises to make using a computer easy for everyone. At \$99.95, DeskMate costs more than the interface itself, however.

Installing both DeskMate and the Automatic House Companion is very simple. A single INSTALL command gets DeskMate installed from five 3½ inch or nine 5¼ inch floppies. The Automatic House software, which runs under DeskMate, is also installed from DeskMate. DeskMate is easy to use—it's more intuitive than other graphical interfaces we've seen. Other members of the family should have little trouble learning how to use the necessary functions.

First-time users will be greeted by a tutorial that explains the basic use of the software, and on-line help is always available. Interestingly, no paper manual is available for Automatic House. Two manuals do come with the computer interface, however. One covers the hardware and DOS software. The second covers advanced programming from EOS. We

didn't find the lack of written material to be a problem, however. The tutorial completely explained everything that we needed to get started.

The interface connects to the host computer via a supplied cable, which goes from the 5-pin DIN connector on the rear panel to a 9-pin "D" serial port. (We had to use a 9-to-25 pin adapter so that we could use our second serial port to control the interface.) Once it's connected, you can run the Automatic House software, which greets you with the three screen icons that are used to call up the three main functions of Automatic House: the Floor Plan, Scheduler, and Routine Maker.

The Floor Plan module is used to define your house's layout and the devices in it that you want to automate. You can draw a simple outline of your house or apartment, and add rectangles that represent rooms. Rooms can't be made to follow odd shapes, but they can overlap, so you can simulate some shapes other than rectangles. You can add devices to a room (chosen from a menu of pictures with such device types as lights, appliances, remote control, security instrument, or a customized device.) The devices are then added to a room where they are represented by the picture of the devices when you are "zoomed in" on that room. When you zoom back to see the entire floor plan, each device is represented by a single letter. You can have up to four floors in a given plan.

The Scheduler module lets you schedule actions for the devices that you set up under the floor plan. You can set devices to come on every day, weekdays only, weekends only, or on any combination of specific days. So, for example, if you come home late on Tuesday and Thursday

DIGITAL VIDEO STABILIZER ELIMINATES ALL VIDEO COPYGUARDS



FEATURES

While watching rental movies, you will notice annoying periodic color darkening, color shift, unwanted lines, flashing or jagged edges. This is caused by the copy protection jamming signals embedded in the video tape, such as Macrovision copy protection. THE DIGITAL VIDEO STABILIZER: RXII COMPLETELY ELIMINATES ALL COPY PROTECTIONS AND JAMMING SIGNALS AND BRINGS YOU CRYSTAL CLEAR PICTURES.

WARNING

THE DIGITAL VIDEO STABILIZER IS INTENDED FOR PRIVATE HOME USE ONLY. IT IS NOT INTENDED TO COPY RENTAL MOVIES OR COPYRIGHTED VIDEO TAPES THAT MAY CONSTITUTE COPYRIGHT INFRINGEMENT.

- Easy to use and a snap to install
- State-of-the-art Microchip technology
- 100% automatic
- Compatible to all types of VCRs and TVs
- The best and most exciting Video Stabilizer in the market
- Light weight (8 ounces) and compact (1x3.5x5")
- Uses a standard 9 Volt battery (last 1-2 years)
- Fast UPS delivery
- Air shipping available
- UNCONDITIONAL 30 day money back guarantee
- 1 year warranty

(Dealers Welcome)

To Order: \$59.95 ea. + \$4 for p & h
 Visa, M/C, COD Mon-Fri: 9-6 EST
1-800-445-9285 ext. 6315
 FREE 20 Page Catalog
 SCO Electronics Inc. Dept. 6315
 581 W. MERRICK RD. VALLEY STREAM, NY 11580

CIRCLE 5 ON FREE INFORMATION CARD

CABLE TV DESCRAMBLERS

How You Can Save Money on
Cable Rental Fees

Bullet Proof



1 Unit \$+ 5+

BEST Super Tri-Bi Auto/
 Var. Gain Adjustment \$119.95...\$85
 Jerrold Super Tri-Bi... \$109.95...\$79
 Scientific Atlanta..... \$109.....\$79
 Pioneer..... \$109.....\$79
 Panasonic TZPC145..... \$99.95...\$69
 Stargate Converter..... \$95.....\$69
 Digital Video Stabilizer. \$59.95...\$29
 Wireless Video Sender. \$59.95...\$49.95

US Cable'll Beat
 Anyone's Price
 Advertised in
 this Magazine!

30 Day Money Back Guarantee
FREE 20 page Catalog

Visa, M/C, COD or send money order to:
U.S. Cable TV Inc. Dept. 5315
 4100 N. Powerline Rd., Bldg. F-4
 Pompano Beach, FL 33073

1-800-772-6244 ext. 5315

For Our Record

I, the undersigned, do hereby declare under penalty of perjury that all products purchased, now and in the future, will only be used on Cable TV systems with proper authorization from local officials or cable company officials in accordance with all applicable federal and state laws. FEDERAL AND VARIOUS STATE LAWS PROVIDE FOR SUBSTANTIAL CRIMINAL AND CIVIL PENALTIES FOR UNAUTHORIZED USE.

Date: _____

Signed: _____

No Florida Sales!

CIRCLE 6 ON FREE INFORMATION CARD

nights, you can set lights to come on to welcome you home.

The Routine Maker helps you to tailor schedules to the way you live. For example, you could use the Scheduler module to separately turn on the coffee pot and kitchen light in the morning. The Routine Maker lets you group the events into routines that can then be scheduled as a single event. So you might create a "wake-up" routine to get you started in the morning, and a "good-night" routine to turn off most lights and appliances—and perhaps turn on the bedroom TV and electric blanket.

Once you're satisfied with everything you have scheduled on-screen, you can download it to the interface via the computer's serial port. Once the interface is programmed, you can disconnect it from the computer. You must, however, leave it connected to the power line—it is through the power lines that the signals are sent to the various modules.

Although X-10-compatible systems such as this are extremely easy to set up—no additional wires need be run—they do have some inherent "problems." For example, the system works in only one direction. The controller might send out a turn-on signal to the module controlling a lamp. But if the module doesn't hear the signal (because of noise, or because it's unplugged, for example) or if the bulb is blown, the controller will never know.

Another "problem" is that such systems turn devices on and off by connecting them to or disconnecting them from the power lines. While that works for lamps and many other devices, it might not work as well for an item such as a TV or VCR where channel and timer-program memories could be lost if it's disconnected from the power line for any length of time.

We've been planning to automate our house for years now. We've experimented with schemes where a central computer controlled devices to which it was hard-wired. It worked, but was not very elegant. We've also tried using individual timers to control devices. But every time we would leave town on vacation or business, reprogramming the timers made us give up that scheme—the convenience just wasn't worth the effort.

The Automatic House Companion software coupled with Radio Shack's Plug 'n Power computer interface has changed our mind about current home-automation solutions. We've gotten used to waking up to the smell of hot coffee, and taking a shower in a bathroom that's pre-warmed by an electric heater.

We're looking forward to the day when manufacturers embrace a single home-automation standard—it will undoubtedly happen soon. But now we have something to do while we wait. ■

Call out the Reserve ... Batteries

MEMOREX CDX-605 EXTENDED-PLAY PERSONAL STEREO. From: Memtek Products, P.O. Box 901201, Fort Worth, TX 76102. Price: \$159.95

One of the most outstanding consumer-electronics success stories in recent memory has been the "personal portables" or "headphone" stereos, beginning in 1979 with the introduction of the Sony *Walkman*. Although we liked the idea of personal stereos, we originally thought that they were more of a solution looking for a problem than the other way around. (After all, the loud, shoulder-carried "boom boxes" were decidedly in fashion in those days.)

The phenomenal success of personal portables certainly proved us wrong. It's estimated that in 1990, personal audio, including receivers, tape players, and CD players, was worth more than half a billion dollars to manufacturers, with some 21-million units sold to dealers. As big as those numbers may seem, however, that's down from the previous year. In fact, sales of personal stereos have been declining for the last five years, as the market became

saturated and the personal stereo became a commodity.

Because of the declining sales, it's become increasingly difficult to sell personal stereos. One thing that manufacturers have done to hold onto or increase market share has been to specialize their products. We now have "sports" stereos, FM-only, cassette-only, and other models. The strategy has certainly worked. We've even lost count of our personal stereos. We have one AM/FM cassette model that is rugged enough and water resistant (including "O"-ring seals) so that we can take it to the beach with little worry. We also have a similar non-cassette model that we sometimes like to use because it's considerably smaller and lighter. Unfortunately, neither of those rugged models are digitally tuned. So we have a digitally tuned model that we prefer to use most of the time. And we have an AM/FM cassette model that features the ability to record, which occasionally comes in handy for our work. And then we have a couple of dead or dying units, the victims of being dropped.

We'll admit that we're not your average personal-stereo consumers. But as confirmed gizmo freaks, at least we have a good excuse for owning such an extensive collection. We thought that we had become jaded. But we've recently come across yet another personal stereo that we want to add to our collection: the *Memorex CDX-605* AM/FM cassette player.



CIRCLE 75 ON FREE INFORMATION CARD

We first saw a mock-up of the CDX-605 in a "back room" at the Consumer Electronics Show in January 1991. Although the products weren't officially on display, Memorex showed us some of their "concept" products to give us an idea of what they were working on. We fell in love with the concept of the CDX-605 immediately, especially the "long play" battery case, which lets you piggyback extra batteries on the case, and switch to the "backup" batteries simply by throwing a switch.

Batteries are, of course, what make personal stereos work. But like anything else, batteries don't last forever. (Hardly!). And they seem to run out at the worst time, which is when we travel. That means that when we're on the road, we have to add a few extra batteries to our luggage. A minor inconvenience? Perhaps ... if you're using standard batteries.

But we prefer to use rechargeable batteries for a number of reasons. (Save your dead batteries instead of throwing them away. You'll see how quickly they pile up. Then add up the cost of all those batteries. And finally, think of how much heavy metal you're adding to the solid-waste stream.) Rechargeables also have their problems. They don't put out as long as non-rechargeable batteries, and their initial cost is higher. And they don't make the best traveling companions for two reasons. First, batteries are easy to lose when on the road, and losing expensive batteries hurts. Second, the rechargers are too heavy and bulky to carry along. Those problems disappear when you use the CDX-605.

The Memorex stereo is normally powered by a single "AA" battery mounted in a battery compartment in the bottom rear of the case. But an auxiliary "extended-play" case can be attached to the rear panel of the CDX-605. The additional battery carrier holds one or two "AA" batteries, each of which can be put into service with a small 3-position slide switch. The extended-play case is held on to the main unit with a single screw, which can be tightened conveniently with a coin (even one as thick as a nickel) or a key. Two additional alkaline batteries bring the total playing time up to 25 hours (less, of course, if you're using rechargeables.)

Although we like having the extra battery case, we have some complaints about its design. The main battery is always connected in the circuit. That means that when your main battery runs down, you must remove it from the main-battery compartment. If you don't, the dead battery will be placed in parallel with the next battery that you put in service, decreasing its life.

Without the extended-play case attached, the Memorex stereo is quite compact—only slightly larger than a standard cassette carrier. With dimensions of $4\frac{1}{4} \times 3 \times 1$ inches, it's the same width, less than

a quarter of an inch taller, and less than 50% thicker. Without any batteries or cassettes installed, it weighs just eight ounces.

With such a diminutive case, you might expect that the controls are small and cramped. You'd be right. On the plus side, the small, flat slide switches aren't likely to get switched accidentally. On the minus side, you're not going to have an easy time using them.

We like that the volume control is recessed. But it's so close to the cassette PLAY button that it's very difficult to adjust. The tuning control is well located, but it's difficult to tune accurately because of the extremely small slide-rule dial. The dial on our evaluation sample was inexcusably inaccurate on the AM band; it was off by almost 100 kHz! Fortunately, FM tuning was not similarly affected.

Although there's no provision for a belt-hook (the extended battery case precludes that) the CDX-6005 does come equipped with a vinyl case that includes a belt loop. You can't adjust any of the controls when the stereo is in its case, however.

We found the tuner performance to be acceptable on both AM (except for the aforementioned accuracy) and FM. An FM mono switch, a sensible feature often omitted from personal stereos is available. The cassette performance was also acceptable, although not for jogging, where wow and flutter became a problem, as is to be expected for such a compact unit. We did like the sound of the CDX-605, which is equipped with Dolby B noise reduction. The "XBB" bass-boost circuitry does a good job of filling in the low end, and the supplied pair of ear-bud stereo earphones provided respectable performance.

If we were to be stranded on a desert island with only one personal portable stereo, we probably wouldn't choose the CDX-605 (unless, of course, we were limited to only the number of batteries that the unit could hold!). But it makes a worthy addition to our stable of portable stereos. ■

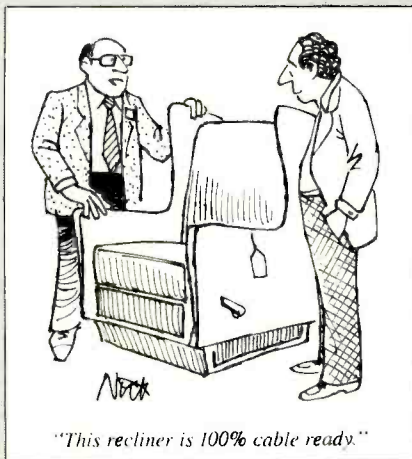

Earn Your B.S. Degree in ELECTRONICS or COMPUTERS



By Studying at Home

Grantham College of Engineering, now in our 42nd year, is highly experienced in "distance education"—teaching by correspondence—through printed materials, computer materials, fax, and phone.

No commuting to class. Study at your own pace, while continuing on your present job. Learn from easy-to-understand but complete and thorough lesson materials, with additional help from our instructors.

Our Computer B.S. Degree Program includes courses in BASIC, PASCAL and C languages — as well as Assembly Language, MS DOS, CADD, Robotics, and much more.

Our Electronics B.S. Degree Program includes courses in Solid-State Circuit Analysis and Design, Control Systems, Analog/Digital Communications, Microwave Engr, and much more.

An important part of being prepared to *move up* is holding the right college degree, and the absolutely necessary part is knowing your field. Grantham can help you both ways—to learn more and to earn your degree in the process.

Write or phone for our free catalog. Toll free, 1-800-955-2527, or see mailing address below.

Accredited by
the Accrediting Commission of the
National Home Study Council

GRANTHAM
College of Engineering
Grantham College Road
Slidell, LA 70460

WINTER CES

(Continued from page 8)

up at the McCormick Place Convention Center that weekend, putting quite a strain on exhibitors, sales personnel, and crowd-control and security arrangements.

On the plus side, the EIA points out, consumer attendance could spur enthusiasm (and spending), increase exposure to new items, and provide exhibitors with immediate feedback on their products. Those factors, the EIA hopes, might even draw some major manufacturers, who have been exhibiting in private showrooms at recent shows, back to the main floor. To help ease the transition, the EIA set up the

CES Resource Center at the Las Vegas Convention Center, where they handed out how-to kits regarding security and other changes needed for SCES exhibits.

But there are some pretty big negatives, too, with fears of over-crowding and theft at the top of the list. "A security nightmare!" is a lament we heard frequently. In addition to increased security expenses, exhibitors are anticipating higher staffing costs due to the Saturday-night hours. Other concerns center on the practice of displaying products that won't come to market for several months (or even years); exhibitors expressed concern that consumers might put off buying current models in anticipation of the new ones viewed at the show. Finally—and this is especially true

for smaller exhibitors who rely on CES for a large percentage of their sales—many feel that 2½ days simply isn't enough time to meet with dealers, since it will be virtually impossible to do any business when the booths fill up with consumer browsers. And while the EIA hoped to lure big exhibitors back to the floor, several major companies either won't be attending at all, or will display their wares in expensive (\$22,000) private showrooms off the main floor, but still at the Convention Center.

We have mixed feelings about the new arrangement. Two things are certain: First, we won't be anywhere near the Nintendo exhibits on that weekend; second, SCES 1992 will be quite an interesting show. Maybe we'll see you there! ■

SIMPLE SURROUND SOUND

(Continued from page 11)

Calling that room "average" would be too kind; it is a difficult room in which to properly set up audio and video equipment for optimum use. Actually, it's probably a lot like the imperfect rooms in which many of our readers watch TV, listen to CD's, pay the bills, and watch the kids play video games (and for our purposes, that makes it an "ideal" room!).

With the Zenith-Bose ZB2794BG television and our own VCR (and that on-loan compact stereo), we happened upon a serendipitous combination in which comfort

and convenience are matched by quality. Even without ideal rear-speaker placement, we experienced theater-like surround sound. The television provides a big picture without taking up a lot of space—and is quite attractive, as well. And the remote provides the ability to control all of the audio and video components we would need for everyday use without leaving the couch.

To go back to our food analogy, the addition of the ZB2794BG and its two small speakers quickly and painlessly transformed our burgers-and-fries living room into something closely resembling a champagne-and-caviar media room—albeit on a small scale.

Post Script: They say "All good things must come to an end." That's certainly the case here. Just before press time—five days before the Super Bowl!—the television picture all but gave out. The picture tube appeared to be overdriven, and we noted some arcing in the rear of the set. The problem, according to Zenith officials, is not an inherent one with the model. To be fair, the set definitely did not receive careful handling in shipping, and the experience hasn't affected our generally favorable impression of the set. That is, after all, why manufacturers provide warranties on their equipment. Zenith's is 90 days. We'll report back in a couple of months to let you know what happens. ■

ELECTRONICS WISH LIST

For more information on any product in this section, circle the appropriate number on the Free Information Card.

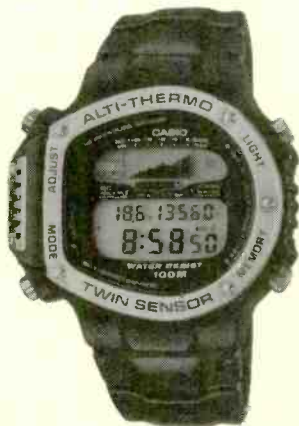

Casio Weather Watch

Weather Watch

Containing a built-in altimeter, barometer, and thermometer, the *ALT-6100-IV* watch "puts a weather station on your wrist," according to *Casio Inc.* (570 Mt. Pleasant Avenue, P.O. Box 7000, Dover, NJ 07801). The altimeter has a measuring range from zero to 19,680 feet, in 20-foot increments. It has both manual memory and automatic memory functions that can remember up to 50 sets of altitudes with dates and temperatures, and provides a target altitude alarm, a graphic display for target altitude, and maximum and minimum altitude memories. As a barometer, the watch has a measuring range of 13.55 inchHg to 32.45 inchHg with a display unit of 0.05 inchHg. It features a display that allows you to track changes in barometric pressures that coincide with changes in the weather, and can be switched to give readings in millibars. The watch also measures temperatures from -4°F to 122°F, switchable to Celsius. In addition, the watch can serve as a one-hundredth of a second stopwatch. Price: \$149.95.

CIRCLE 76 ON FREE INFORMATION CARD

For more information on any product in this section, circle the appropriate number on the Free Information Card.

ELECTRONICS WISH LIST

Voice-Activated Car Stereo/Cellular Phone

Blaupunkt's (Robert Bosch Corporation, Mobile Communications Division, 2800 South 25th Avenue, Broadview, IL 60153) *Las Vegas* combination car stereo and cellular phone allows the driver to use voice commands to operate all the controls of the radio, tape deck, and CD changer, and to place and receive cellular telephone calls. The unit installs in a standard DIN dashboard opening; the remote cellular transceiver can be mounted in the trunk, along with an optional remote CD changer, if desired. A clip-on noise-canceling microphone can be attached to the dashboard or visor for phone conversations and hands-free activation of all systems. For privacy (hands-free calls are normally heard over the audio system), an infrared handset can be used. The phone has 85 memory locations, including 15 preprogrammed "800" numbers for five hotel chains, five airlines, and five car-rental firms. Besides a high-quality FM tuner, an auto-cassette deck with Dolby B and Dolby C, and full-function CD-changer control capability, the car stereo features RBDS capability. The Radio Broadcast Data System allows digital data to be transmitted on an inaudible subcarrier of a conventional FM radio signal—but it's not available in the U.S. yet. Price: N/A.

CIRCLE 77 ON FREE INFORMATION CARD



Blaupunkt Voice-Activated Car Stereo

RADON. THE HEALTH HAZARD IN YOUR HOME THAT HAS A SIMPLE SOLUTION.

Call
1-800-SOS-RADON
to get your Radon
test information.



Be an FCC LICENSED ELECTRONIC TECHNICIAN!



No costly school. No commuting to class. The Original Home-Study course prepares you for the "FCC Commercial Radio-telephone License." This valuable license is your professional "ticket" to thousands of exciting jobs in Communications, Radio-TV, Microwave, Maritime, Radar, Avionics and more... even start your own business! You don't need a college degree to qualify, but you do need an FCC License.

No Need to Quit Your Job or Go To School
This proven course is easy, fast and low cost! **GUARANTEED PASS**—You get your FCC License or money refunded. **Send for FREE facts now. MAIL COUPON TODAY!**

COMMAND PRODUCTIONS

FCC LICENSE TRAINING, Dept. 100
P.O. Box 2824, San Francisco, CA 94126
Please rush FREE details immediately!

NAME _____
ADDRESS _____
CITY _____ STATE _____ ZIP _____

SUPER LONG PLAY TAPE RECORDERS

12 Hour Model —
USES 120 TAPE
\$119.00*

Modified Panasonic Slimline, high quality AC-DC provide 6 continuous hours of quality recording & playback on each side of cassette for 12 hours total. Includes • Voice level control • Digital counter, e.t.c. TDK - 120 Cassette Furnished.



PHONE RECORDING ADAPTER

Records calls automatically. All Solid state connects to your telephone jack and tape recorder. Starts recording when phone is lifted. Stops when you hang up. **\$28.50*** FCC APPROVED



VOX VOICE ACTIVATED CONTROL SWITCH
Solid state. Self contained. Adjustable sensitivity. Voices or other sounds automatically activate and control recorder. Uses either recorder or remote mike. **\$28.50***



* Add for ship. & handling Phone Adapter & Vox \$2.00 each Recorders \$5.00 each. Call Res. add tax. Mail order. VISA/M/C, COD's OK. Money Back Guarantee. Quantity discounts available. Dealer Inquiries invited. Free data.

AMC SALES INC. Dept. B 9335 Lubec Street
Box 928 Downey, CA 90241
Phoncs (310) 869-8519 1-800-926-2488
FAX (310) 923-1478
Mon-Fri 9-5 PAC TIME

CIRCLE 7 ON FREE INFORMATION CARD



CIRCLE 119 ON FREE INFORMATION CARD

THE HEATHKIT IM-2410 DIGITAL FREQUENCY COUNTER

A few evenings of your time and a minimum of effort can save you quite a bit of money and yield a high quality piece of test gear.

A well-stocked electronics workbench is almost like a remote control—you can certainly get along just fine without one, but once you have one, it's hard to imagine ever having gone without it. The only problem is that a well-stocked workbench is a lot harder to obtain, and more expensive, than a remote control.

If you save up money for test equipment, you're likely to buy each piece in order of importance, so the first lump of money saved will usually go toward the most needed item. As an example, an oscilloscope is probably the first or second piece of equipment sought by electronics hobbyists.

There are, however, many other slightly less-important tools, that nonetheless must be present before a workbench can be called complete. For example, a frequency counter is a moderately important piece of equipment that would be welcome on any workbench. It's true that some multimeters have frequency counters built-in, but their range and accuracy are usually nothing to brag about. And the range of frequency counters are becoming increasingly more important as the operating frequencies of circuits climb. Take PC's as an exam-

ple, some of which are now operating at 50 MHz!

That fact also affects how you should shop for a discrete frequency counter: the maximum frequency, or range, that can be measured is of utmost concern. And, as you may have guessed, the higher the range, the higher the price. There are many ways to try and save money when buying test equipment, such as buying second-hand test gear or buying something that better fits your budget than what you truly desire. But there is another way to save money on a frequency counter that may not come to mind: You can *build* the Heathkit IM-2410 frequency counter (Heath Company, Benton Harbor, MI 49022 1-800-253-0570). Obviously it comes as a kit, but don't let that fool you into thinking that this frequency counter is anything less than a serious piece of test gear. And it's actually fun to build!

Features. The IM-2410 Digital Frequency Counter can measure frequencies from 10 Hz to 225 MHz over two frequency ranges and two gate times—both switch-selectable. The 8-digit display always reads out directly in MHz with 10-Hz resolution at 225 MHz. The unit is housed in a rugged

cabinet with a swing-down bracket to elevate the display for a better viewing angle. Accuracy and simple operation are combined to make a valuable instrument for the engineer, technician, or hobbyist. And you get that performance for just \$149.95. If you take a look at the prices of frequency counters that can go as high as 225 MHz, you'll see why the IM-2410 is such a good value—many cost more than twice that price.

Let's cover the individual specifications in greater detail. To begin with, the unit has an 8-digit LED display. A front-panel switch lets you select between two frequency ranges: one from 10 Hz to 50 MHz, and the second from 20 MHz to 225 MHz. The unit's input sensitivity from 10 Hz to 50 MHz is 25 mV rms maximum, and is typically 10 mV from 10 Hz to 30 MHz. From 30 MHz to 50 MHz, the sensitivity is 50 mV rms maximum. From 20 MHz to 225 MHz, the sensitivity is 25 mV rms maximum, and 10 mV is typical.

The input impedance of the IM-2410 is 1 megohm shunted by less than 24 pF. The input is protected up to 150 volts AC at up to 100 kHz. However, from 160 MHz to 225 MHz, the input is protected only up to 5 volts AC. The manual includes a maximum input-

5 sure steps to a fast start as a high-paid computer service technician

1. Choose training that's right for today's good jobs

Jobs for computer service technicians will almost double in the next 10 years, according to the latest Department of Labor projections. For you, that means unlimited opportunities for advancement, a new career, or even a computer service business of your own.

But to succeed in computer service today, you need training—complete, practical training that gives you the confidence to service any brand of computer. You need NRI training.

Only NRI—the leader in career-building, at-home electronics training for more than 75 years—gives you practical knowledge, hands-on skill, and real-world experience with a powerful 386sx/20 MHz computer you keep. Only NRI gives you everything you need for a fast start as a high-paid computer service technician.

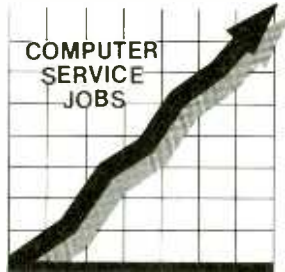

Plus, now you train with and keep the latest in diagnostic hardware and software: the R.A.C.E.R. plug-in diagnostic card and QuickTech diagnostic software, both from Ultra-X. Using these state-of-the-art diagnostic tools, you learn to quickly identify and service virtually any computer problem on IBM-compatible machines.

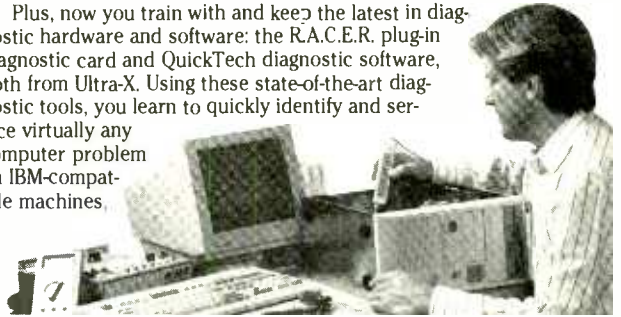

4. Make sure you've always got someone to turn to for help



Throughout your NRI training, you've got the full support of your personal NRI instructor and the entire NRI technical staff. Always ready to answer your questions and help you if you should hit a snag, your instructors will make you feel as if you're in a classroom of one, giving you as much time and personal attention as you need.

5. Step into a bright new future in computer service—start by sending for your FREE catalog today!

Discover for yourself how easy NRI makes it to succeed in computer service. Send today for NRI's big, full-color catalog describing every aspect of NRI's one-of-a-kind computer training, as well as training in TV/video/audio servicing, telecommunications, industrial electronics, and other growing high-tech career fields.

If the coupon is missing, write to: NRI School of Electronics, McGraw-Hill Continuing Education Center, 4401 Connecticut Avenue, NW, Washington, DC 20008.

R.A.C.E.R. and QuickTech are registered trademarks of Ultra-X, INC.



2. Go beyond "book learning" to get true hands-on experience

NRI knows you learn better by doing. So NRI training works overtime to give you that invaluable practical experience. You first read about the subject,

studying diagrams, schematics, and photos that make the subject even clearer. Then you do. You build, examine, remove, test, repair, replace. You discover for yourself the feel of the real thing, the confidence gained only with experience.

3. Get inside a powerful computer system

If you really want to get ahead in computer service, you have to get inside a state-of-the-art computer system. That's why NRI now includes the powerful new West Coast 386sx/20 MHz mini tower computer as the centerpiece of your hands-on training.

As you build this 1 meg RAM, 32-bit CPU computer from the keyboard up, you actually see for yourself how each section of your computer works. You assemble and test your computer's "intelligent" keyboard, install the power supply and high-density floppy disk drive, then interface the high-resolution monitor. But that's not all.

You go on to install a powerful new 40 meg IDE hard disk drive—today's most-wanted computer peripheral—included in your course to dramatically increase the data storage capacity of your computer while giving you lightning-quick data access.



NRI School of Electronics

McGraw-Hill Continuing Education Center
4401 Connecticut Avenue, NW, Washington, DC 20008

CHECK ONE CATALOG ONLY

- | | |
|--|--|
| <input type="checkbox"/> Microcomputer Servicing | <input type="checkbox"/> Computer Programming |
| <input type="checkbox"/> TV/Video/Audio Servicing | <input type="checkbox"/> PC Applications Specialist |
| <input type="checkbox"/> Telecommunications | <input type="checkbox"/> Desktop Publishing & Design |
| <input type="checkbox"/> Industrial Electronics/Robotics | <input type="checkbox"/> Programming in C++ with Windows |
| <input type="checkbox"/> Basic Electronics | <input type="checkbox"/> Bookkeeping & Accounting |

Name _____

Address _____

City _____ State _____ Zip _____

Accredited Member, National Home Study Council

18-052

voltage derating curve to help you determine the maximum input-voltage level at any frequency.

The internal time-base frequency is 3.58 MHz with setability at ± 1 ppm. Temperature stability is ± 10 ppm from 0°C to 40°C. The unit has two gate times, 1 second or 0.1 second; you select the one that best suits the application. The power requirement of the IM-2410 is either 108 to 132 volts AC or 216 to 264 volts AC, at 50 to 60 Hz, with a maximum power dissipation of 25 watts.

The unit measures a compact 3 $\frac{3}{8}$ inches high by 7 $\frac{1}{4}$ inches wide by 9 $\frac{1}{2}$ inches deep (8.57 \times 18.42 \times 24.13 cm). That means that it won't take up too much space on your workbench. It weighs about 5 pounds, (2.3 kilograms).

Building the Kit. As anyone who has ever built a Heathkit will tell you, they are probably the best-thought-out kits you can buy, and that certainly applies to the IM-2410. A clearly written manual guides you through the assembly of the unit, and the parts are easy to identify. For people who are simply interested in getting the unit together and working, the instructions are all you'll need. But if you're also interested in knowing how the unit works, the manual provides complete circuit descriptions, schematics, and even pinout diagrams for all parts that require one. One complaint, though, is that the unit doesn't come with any kind of input cable or probe—just a front-panel BNC connector. But standard oscilloscope cables can be used.

When building any kind of kit there are often instructions that some people may be confused by. So we'll now point out anything that we felt was confusing, even though these points may be on the borderline of nit-picking.

To begin with, we ended up with five extra 1N914 diodes. Extra parts aren't really a problem, but you can't help but think that you missed a step somewhere until you actually power up the unit at the end. Another diode-related puzzle—an easy one to solve though—was that 1N4003 diodes were substituted for the 1N4002 diodes specified in the instructions. Most hobbyists should know that you can almost always substitute a higher

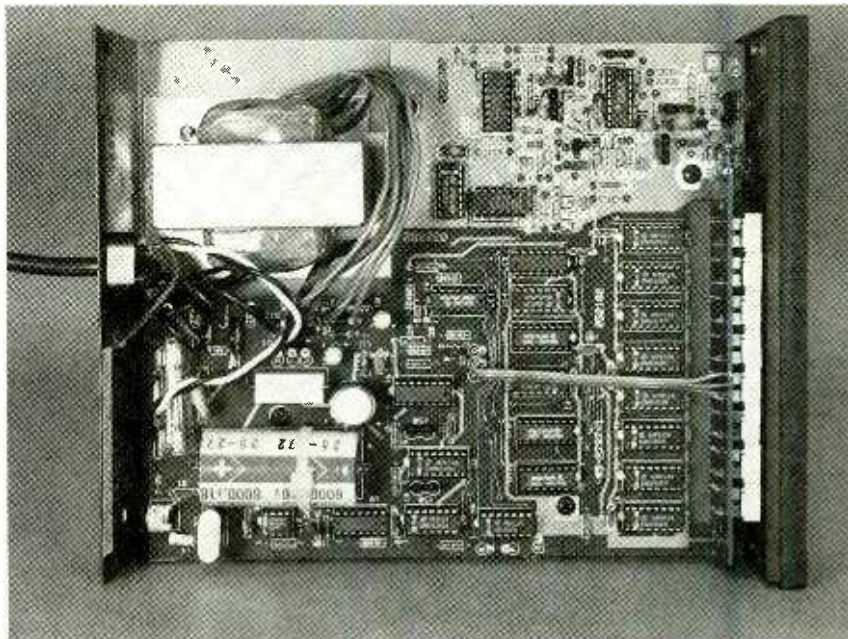

This interior view of the frequency counter reveals the high quality of its components and the elegant layout typical of a Heathkit. Fortunately, it is as easy to build as it is to look at.

numbered 1N400x-series diode for a lower one. But to some, the missing 1N4002's may be a mystery, and there seems to be no mention of the substitution anywhere. One last confusing bit is that all of the screws are drawn as regular slotted-type screws, even if the included part is Phillips-headed. But as we said before, these complaints are minor, and you shouldn't have any trouble building the IM-2410.

Calibration and Use. Calibration of the unit is easiest if you *don't* have any test instruments at all to calibrate it to. In that case, all you have to do, after a 30-minute warm-up, is set one variable capacitor to a certain position—and that's all. But the accuracy will suffer and may vary by as much as ± 50 ppm if you do it that way.

A better way to calibrate the unit is against another already calibrated frequency counter and/or a frequency source. Simply adjust that same capacitor until the Heathkit counter agrees with the calibrated equipment. However, even doing it that way is only as accurate as the counter or frequency source you are calibrating with.

The best way to calibrate the IM-2410 is against a fixed laboratory-standard frequency. You then adjust

that same capacitor until the display shows the exact frequency. Only then will the unit achieve the maximum possible accuracy.

Operating the unit is as simple as can be. You turn on the power, connect the input, and set the range and gate-time switches to achieve a steady reading.

We feel that the Heathkit IM-2410 is a fine piece of equipment for the money. It's also a wise investment for any electronics enthusiast.

For more information on the IM-2410, contact Heath directly, or circle No. 119 on the Free Information Card. ■



PRODUCT TEST REPORTS

By Len Feldman

Sansui Model AV-7000 Audio/Video Amplifier

Not everyone who wants to install a surround-sound home-theater system needs a complete receiver. Many of us already own perfectly good AM/FM tuners that can be used, along with other audio and video program sources, in our home-entertainment rooms. If you are in that category, an integrated audio/video amplifier may be a suitable alternative. Until recently, Sansui was known as an "audio only" company, but with the increased interest in integrating audio



CIRCLE 120 ON FREE INFORMATION CARD

Sansui's AV-7000 Integrated Audio/Video Amplifier

and video into a complete home-entertainment system, the company has moved into the audio/video arena with introductions of complete audio-video receivers as well as audio-video integrated amplifiers; the AV-7000 reviewed here is in that latter category. That amp offers six surround modes including Dolby Pro Logic and Dolby 3-Channel (or "Dolby-3") Stereo, four surround memories, on-screen display, and a 2-page, 66 key programmable learning remote.

The AV-7000 uses five amplifiers to accomplish its six surround-sound functions. To capture the full flexibility of Dolby Pro Logic, front, rear, and center preamp outputs as well as front or rear-plus-center power amp inputs are provided. The unit's surround memory permits independent setting of rear- and center-channel volume levels, bass and treble, and digital delay for later recall at the touch of a single pushbutton. All programming functions, whether accomplished at the front panel of the unit or with the supplied remote, can be viewed as a video display on the associated TV monitor or TV receiver. There's also a built-in test-tone generator that can be used for accurate channel balancing.

In addition to decoding Dolby-processed video programs, Dolby Pro Logic provides three surround modes, depending upon the number of speakers used: normal, wide, and phantom, as well as Dolby-3 Stereo. Additional surround sound modes include "Hall" for large room ambience, "Natural" to create a surround-sound simulation from monaural material, "Stadium" for synthesizing stadium or arena performances, and "Matrix" for creating surround ambience using only two speakers. Variable digital delay of from 15 to 30 milliseconds is available for Dolby Pro Logic and from 0 to 100 milliseconds for the other surround modes.

Five audio inputs and four video inputs are provided. A "digital direct" circuit and control are provided for minimum signal processing of CD program material. An independent video-record selector permits dubbing while listening or viewing other program source material. Parallel AV dubbing makes it possible to dub audio and video material independently and simultaneously. "Video 3" inputs (S-VHS, Video, and L and R Audio) are located on the front panel to permit easy temporary connection of a camcorder, VCR, or videodisc player without disturbing the normal rear-panel hookups. A special circuit automatically balances audio input levels so that volume adjustments are unnecessary when switching from one sound source to another. Finally, the "2-page," 66-key remote control supplied with the AV-7000 is programmable and can learn the functions necessary to operate audio and video equipment made by other manufacturers. The AV-7000 is styled in black with a fluorescent display that indicates source and surround modes.

CONTROL LAYOUT

The power switch, front speaker on/off switch, and a headphone jack are located at the left end of the all-black front panel of this amplifier. A row of large pushbuttons spread across the lower portion of the panel are used to select

program sources (four video inputs, a pair of tape inputs, phono, tuner, and CD). Just above those is a row of smaller buttons that are used to select the type of surround-sound or stereo operation that you want. A multi-function display area is located above these smaller buttons, and to the right are three sets of + and - buttons that are used to adjust delay time (in the surround modes), center-channel level, and rear-channel level. A large, rotary, master volume control at the extreme right of the panel is calibrated in an arbitrary numbering scale from 0 to 30. Below this control are three more pushbuttons. The first of these, labeled "CD Direct," when pressed, bypasses all tone controls and feeds the CD player's output signal directly to the power amplifiers, governed only by the master volume control. A "Video Processor" button allows connection of an external video processing component such as a video enhancer in much the same way that a tape monitor button permits connection of external audio components in the audio-signal path. The third button transfers "Video 3" functions from rear-panel jacks to the front-panel jacks for convenient connection of a camcorder or portable VCR.

Additional rotary knob controls along the lower section of the panel include bass, midrange, and treble controls, a "Center Off" button, a "Mono Level" control (for controlling the output level to a "mono out" jack that you might want to use when using a powered subwoofer in the system), an input-level control, a video-record output selector, and a channel balance control.

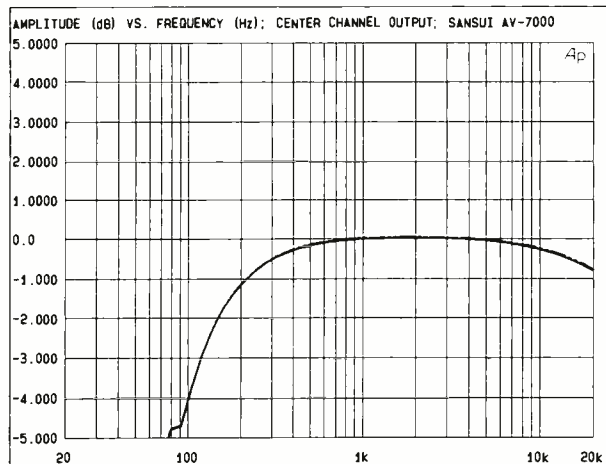

Frequency response of the front channel amplifiers, measured via the CD inputs, was flat from below 10 Hz to 20 kHz, with a very slight drop of 0.2 dB at the 20 kHz point. The -3-dB cutoff point extended to 80 kHz.

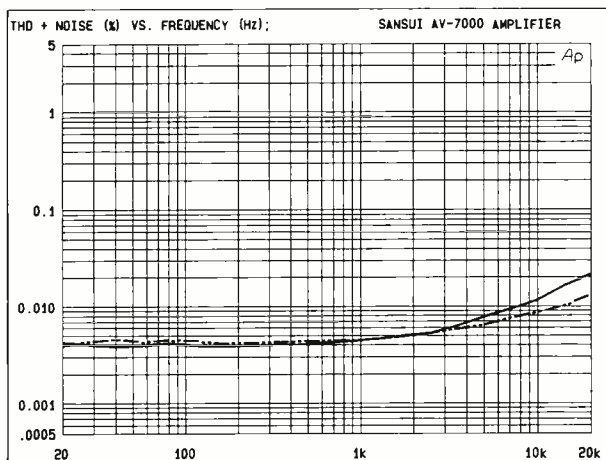

The measured harmonic distortion plus noise was far lower than specified by Sansui over much of the audio range.

The remote control supplied with the AV-7000 duplicates many of the control functions found on the front panel and adds several more. For example, there are a series of buttons intended for controlling a connected CD player, as well as number buttons that are used to control compatible Sansui components. The test-tone buttons used for balancing outputs when in the Dolby Pro Logic mode are also found on this multi-function remote and, as indicated earlier, this remote is a "learning" type that can be taught the command codes of non-Sansui components con-

nected in the system. An "On-Screen" button, when pushed, displays operation mode on the screen of a connected TV monitor/receiver. An audio-muting button is also found on the remote.

The rear panel is equipped with the necessary audio- and video-input jacks; color-coded speaker terminals for front-, rear-, and center-channel speaker connections; preamp-output jacks; and a series of jumpers between jacks that permit you to use external amplifiers for rear-channel speakers if you deem them desirable in a given installation. All video inputs and

outputs are augmented with S-type connectors in addition to the usual RCA-type jacks.

TEST RESULTS

Frequency response of the front-channel amplifiers, measured via the CD inputs, was flat from below 10 Hz to 20 kHz, with a very slight drop of 0.2 dB at the 20-kHz point. The -3-dB cutoff point extended to 80 kHz. In the Dolby Pro Logic mode, the center-channel output extended from just over 100 Hz to well above 20 kHz. This response is deliberately introduced in the Dolby decoder, since the center channel is intended for on-screen dialog when using Dolby Pro Logic. During such use, lower bass is reproduced by the front and rear speakers and by a subwoofer, if one is used in the set up.

The Sansui AV-7000 has a power rating of 70-watts-per-channel for the front-left and -right channels. In fact, when using the two-channel mode (ordinary stereo), harmonic distortion plus noise was far lower than specified by Sansui over much of the audio range. At 1 kHz, for that rated output, THD plus noise was a mere 0.0045% as against 0.02% claimed. Left-channel THD plus noise did, however, reach the rated value of 0.02% when delivering 70 watts at a frequency of 20 kHz. We measured distortion-plus-noise versus power output for the front channels at three frequencies (1 kHz, 20 Hz, and 20 kHz) and obtained good correlation with the earlier tests, noting that for all but the highest of these test frequencies, the amplifier delivered nearly 90-watts-per-channel for its rated THD (as opposed to the 70 watts claimed).

TEST RESULTS—SANSUI AV-7000 AUDIO/VIDEO AMPLIFIER

Specification	Manufacturer's Claim	PE Measured
Power Output		
Front	70 watts, 8 ohms	90 watts*
Rear	35 watts, 8 ohms	Confirmed
Center	70 watts, 8 ohms	90 watts
Frequency Response		
High-level inputs	5 Hz to 100 kHz, -3 dB	<10 to 80 kHz
Phono	RIAA ±0.3 dB	RIAA ±0.3 dB
Input Sensitivity		
CD, tuner, etc.	150 mV	150mV
Phono	2.5 mV	2.5 mV
Phono overload	140 mV @ 1 kHz	150 mV
Tone control range		
Bass	+10 dB @ 50 Hz	Confirmed
Treble	±10 dB @ 15 kHz	±10 dB @ 20kHz
Midrange	+6 dB @ 1 kHz	Confirmed
Signal-to-noise ratio		
Phono	72.0 dB	72.7 dB
High level	90.0 dB	79.7 dB**
Video input/output		
Composite	1.0 V p-p	Confirmed
S-Video	0.286 V p-p	Confirmed
Video freq. response	5 Hz to 10 MHz, -3 dB	5 Hz to 5 MHz
Power requirements	120V, 60 Hz, 450 W	
Dimensions (W × H × D, in.)	16 ¹ / ₁₆ × 6 ⁵ / ₁₆ × 17 ³ / ₁₆	
Weight	32.0 lbs. (14.5 kg)	
Suggested retail price	\$999.95	

* At all but highest frequencies, at which maximum rated power decreased to published figure of 70 watts per channel.

** Sansui measures S/N relative to rated power output; we measure in accordance with EIA Standards (re: 1 watt output).

Similar measurements were made for the center-channel output, using a single 8-ohm load. (The unit also allows you to use two center-channel speakers, should you wish to flank your TV set with a center-channel speaker on each side of it.) With only the center channel of the amplifier driven, power output exceeded 90 watts at all three test frequencies before any evidence of clipping was noted.

Since all of the earlier measurements involved distortion plus noise, we wanted to isolate the actual distortion components from the residual noise. To do this, we used the digital Fast Fourier Transform capability of our Audio Precision Test System to run a spectrum analysis of a 1-kHz test signal when the amplifier was producing its rated power of 70-watts-

per-channel (front-channel mode). The most significant harmonic components (at 2 kHz, 3 kHz, and 5 kHz) were down some 87 dB, 98 dB and 100 dB, respectively. Calculating the equivalent harmonic distortion percentage yielded a figure of 0.00475%, in almost perfect agreement with our earlier reading of 0.0045%. These results suggest that the residual noise plays virtually no part in the THD-plus-noise readings that were noted earlier.

The bass, midrange, and treble controls operated pretty much as one would expect, with the bass and treble control providing as much as 10 dB of boost or cut at 50 Hz and 20 kHz, respectively. The action of the midrange control was more moderate, providing a maximum boost or cut of approximately 6 dB at 1 kHz, exactly as specified in San-

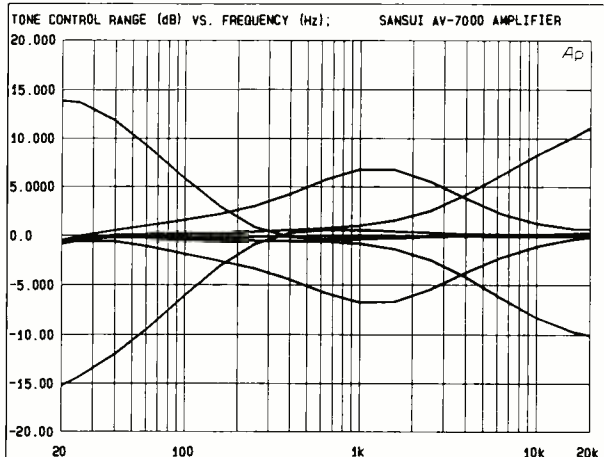

The bass, midrange, and treble controls operated pretty much as one would expect, with the bass and treble control providing as much as 10 dB of boost or cut at 50 Hz and 20 kHz, respectively; the action of the midrange control was more moderate, providing a maximum boost or cut of approximately 6 dB at 1 kHz.

sui's published specifications for the amplifier.

Input sensitivity for the high-level audio inputs was approximately 18 millivolts for a 1-watt output, (150 mV at the rated output), while input sensitivity for the low-level phono inputs was approximately 0.3 millivolts for a 1-watt output. Phono RIAA equalization was close to perfect, deviating by no more than ±0.3 dB at any audio frequency from 20 Hz to 20 kHz. Phono overload occurred with an input of 150 mV, for a 1-kHz test signal. Any overload figure above 100 mV is considered by us to be more than adequate for even the highest output magnetic cartridges tracing heavily recorded passages in a vinyl disc.

High-level signal-to-noise ratio measured 79.6 dB, referred to an output level of 1 watt and an input of 0.5 volts. For the phono inputs, using a reference input signal of 5 millivolts and adjusting the master volume control to produce an output of 1 watt, the signal-to-noise ratio was an adequate 72.7 dB. We plotted a spectrum analysis of re-

sidual noise versus frequency, using a 1/3-octave band pass filter, and concluded that the power supply of the amplifier was well designed and well shielded, since there was virtually no evidence of noise contribution at the power-line frequency or its harmonics.

CONCLUSIONS

Our own hands-on evaluation of this A/V amplifier, when hooked up to suitable loudspeakers and when fed with good audio program material from audio-only, or A/V sources such as laser disc players, VCR's, and the like, confirmed the results that were obtained in the lab. Considering the number of features incorporated in the AV-7000, we found the unit easy to operate and particularly enjoyed the on-screen displays that made using the amplifier easy and logical.

For more information on the Sansui AV-7000, contact the manufacturer (Sansui, 1290 Wall Street West, Lyndhurst, NJ 07071) directly, or circle no. 120 on the Free Information Card.

Electronics Paperback Books

GREAT PAPERBACKS AT SPECIAL PRICES

BP248—TEST EQUIPMENT CONSTRUCTION \$5.95. Details construction of simple, inexpensive, but extremely useful test equipment. AF Gen, Test Bench Ampl, Audio Millivoltmeter, Transistor Tester and six more.



How to Use Oscilloscope and Other Test Equipment



BP267—HOW TO USE OSCILLOSCOPES AND OTHER TEST EQUIPMENT \$6.95. Mastering the oscilloscope is not really too difficult. This book explains all the standard controls and functions. Other equipment is also described.

BP265—MORE ADVANCED USES OF THE MULTIMETER \$5.95. Use these techniques to test and analyze the performance of a variety of components. Also see how to build ad-ons to extend multimeter capabilities.



BP256—INTRO TO LOUDSPEAKERS AND ENCLOSURE DESIGN \$5.95. We explore the variety of enclosure and speaker designs in use today, so the reader can understand the principles involved.

CMOS—CMOS POCKET GUIDE 1 \$18.95. Works like the TTL Guides but covers all commonly used CMOS standard devices. Six major sections. The first shows the device schematic. Next is a brief description of the component and is followed by full operating details. The fourth section lists major applications, while the 5th and 6th sections present essential data for that device and a list of the relevant manufacturers. The final two sections are a valuable cross-reference.



BP299—PRACTICAL ELECTRONIC FILTERS \$6.95. Presents a dozen filter-based practical projects with applications in and around the home or in the constructor's workshop. Complete construction details are included.



BP249—MORE ADVANCED TEST EQUIPMENT CONSTRUCTION \$6.95. Eleven more test equipment construction projects. They include a digital voltmeter, capacitance meter, current tracer and more.



BP245—DIGITAL AUDIO PROJECTS \$5.95. Practical circuits to build and experiment with. Includes A/D converter, input amplifier, digital delay line, compander, echo effect and more.



BP247—MORE ADVANCED MIDI PROJECTS \$5.95. Circuits included are a MIDI indicator, THRU box, merge unit, code generator, pedal, programmer, channelizer, and analyzer.



BP257—INTRO TO AMATEUR RADIO \$6.95. Amateur is a unique and fascinating hobby. This book gives the newcomer a comprehensive and easy to understand guide to the subject.



BP309—PREAMPLIFIER AND FILTER CIRCUITS \$6.95. Provides circuits and background info for a range of pre-amplifiers, plus tone controls, filters, mixers and more. All are high-performance circuits that can be built at a reasonable cost.

BP303—UNDERSTANDING PC SOFTWARE \$6.95. This book will help you understand the basics of various types of business software in common use. Types of software covered include word processors, spelling checkers, graphics programs, desktop publishing, databases, spreadsheets and utilities.



BP251—COMPUTER HOBBYISTS HANDBOOK \$8.95. A wrapup of everything the computer hobbyist needs to know in one easy to use volume. Provides a range of useful reference material in a single source.



PCP115—ELECTRONIC PROJECTS FOR HOME SECURITY \$10.00. 25 projects ranging from a single-door protection circuit that can be completed in an hour or two, to a sophisticated multi-channel security system. Each project is described in detail with circuit diagrams, explanations of how it works, instructions for building and testing, and how to adapt circuits to meet special requirements.



BP195—INTRODUCTION TO SATELLITE TV \$9.95. A definitive introduction to the subject written for the professional engineer, electronics enthusiast, or others who want to know more before they buy. 8 x 10 in.

BP190—ADVANCED ELECTRONIC SECURITY PROJECTS \$5.95. Includes a passive infra-red detector, a fiber-optic loop alarm, computer-based alarms and an unusual form of ultrasonic intruder detector.

BP235—POWER SELECTOR GUIDE \$10.00. Complete guide to semiconductor power devices. More than 1000 power handling devices are included. They are tabulated in alpha-numeric sequence, by technical specs. Includes power diodes, Thyristors, Triacs, Power Transistors and FETs.

BP234—TRANSISTOR SELECTOR GUIDE \$10.00. Companion volume to BP235. Book covers more than 1400 JEDEC, JIS, and brand-specific devices. Also contains listing by case type, and electronic parameters. Includes Darlington transistors, high-voltage devices, high-current devices, high power devices.

BP99—MINI-MATRIX BOARD PROJECTS \$5.50. Here are 20 useful circuits that can be built on a mini-matrix board that is just 24 holes by ten copper-foil strips.

BP117—PRACTICAL ELECTRONIC BUILDING BLOCKS—Book 1 \$5.75. Oscillators, Timers, Noise Generators, Rectifiers, Comparators, Triggers and more.

BP184—INTRO TO 68000 ASSEMBLY LANGUAGE \$6.95. The 68000 is a great new breed of microprocessor. Programming in assembly language increases the running speed of your programs. Here's what you need to know.

BP179—ELECTRONIC CIRCUITS FOR THE COMPUTER CONTROL OF ROBOTS \$7.50. Data and circuits for interfacing the computer to the robot's motors and sensors.

BP239—GETTING THE MOST FROM YOUR MULTIMETER \$5.95. Covers basics of analog and digital meters. Methods of component testing includes transistors, thyristors, resistors, capacitors and other active and passive devices.

BP97—IC PROJECTS FOR BEGINNERS \$5.50. Power supplies, radio and audio circuits, oscillators, timers, switches, and more. If you can use a soldering iron you can build these devices.

BP37—50 PROJECTS USING RELAYS, SCR'S & TRIACS \$5.50. Build priority indicators, light modulators, warning devices, light dimmers and more.

RADIO—100 RADIO HOOKUPS \$3.00. Reprint of 1924 booklet presents radio circuits of the era including regenerative, neutrodyne, reflex & more.

BP42—SIMPLE LED CIRCUITS \$5.50. A large selection of simple applications for this simple electronic component.

BP127—HOW TO DESIGN ELECTRONIC PROJECTS \$5.75. Helps the reader to put projects together from standard circuit blocks with a minimum of trial and error.

BP122—AUDIO AMPLIFIER CONSTRUCTION \$5.75. Construction details for preamps and power amplifiers up through a 100-watt DC-coupled FED amplifier.

BP92—CRYSTAL SET CONSTRUCTION \$5.50. Everything you need to know about building crystal radio receivers.

BP45—PROJECTS IN OPTOELECTRONICS \$5.50. Includes infra-red detectors, transmitters, modulated light transmission and photographic applications.

BP255—INTERNATIONAL RADIO STATIONS GUIDE \$7.95. Provides the casual listener, amateur radio DXer and the professional radio monitor with an essential reference work designed to guide him or her around than ever more complex radio bands.

CHECK OFF
THE BOOKS YOU WANT

ELECTRONIC TECHNOLOGY TODAY INC.
P.O. Box 240, Massapequa Park, NY 11762-0240

Name _____
Address _____
City _____ State _____ Zip _____

SHIPPING CHARGES IN
USA AND CANADA

\$0.01 to \$5.00 \$1.50
\$5.01 to \$10.00 \$2.50
\$10.01 to 20.00 \$3.50
\$20.01 to 30.00 \$4.50
\$30.01 to 40.00 \$5.50
\$40.01 to 50.00 \$6.50
\$50.01 and above ... \$8.00

SORRY No orders accepted
outside of USA & Canada

Total price of merchandise \$ _____
Shipping (see chart) \$ _____
Subtotal \$ _____
Sales Tax (NYS only) \$ _____
Total Enclosed ... \$ _____

Number of books ordered

All payments must be in U.S. funds

P592

*Build capacitors that
really pack a punch
for high voltage fun!*

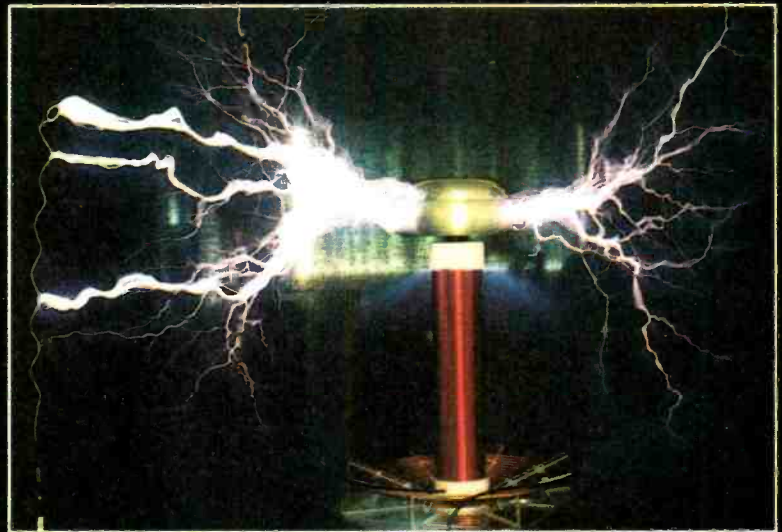

BY ANTHONY CHARLTON

MAKE YOUR OWN HIGH- VOLTAGE CAPACITORS

As one who supplies parts to those who experiment with high voltage, I get a lot of letters and phone calls from frustrated builders that go like: "Can you supply an inexpensive XXX microfarad capacitor at a working voltage of YYV? My only source wants \$249 for one." Sometimes, a high price is justified; other times, a seller has the only capacitors of a special value available, and will soak you for the maximum dollar.

It is feasible to build your own ca-

pacitors of any voltage and energy storage size for either AC or DC use. The process involves a step-by-step logical approach that we'll present here. We'll explain how to plan and construct a capacitor, where to get materials, safety considerations, tips and hints, and include a few simple projects.

A Capacitor's Description. A capacitor consists of two or more plates of a conductive material separated by an insulating substance called a

dielectric. A dielectric may be solid, gel, liquid, or gas. A capacitor's ability to store energy is measured in either microfarads (μF), nanofarads (nF), or picofarads (pF). Micro means one millionth, nano stands for one billionth, and pico for one trillionth (farads are also used, but in high voltage work they are impractically large units). Several factors affect capacitance. The formula for determining capacitance is:

$$C = (0.224KA/d)(n-1)$$

where C is the capacitance in picofarads, K is a constant that depends on the insulator (or dielectric) between the plates (called the dielectric constant), A is the area of one conductive plate in square inches, d is the separation between adjacent plates in inches, and n is the number of plates. As you may know, different insulators have different dielectric constants. Table 1 shows the values of K for some common materials and the peak voltage they can withstand per $\frac{1}{1000}$ inch (called a mil) of thickness. This rating is called the puncture or breakdown voltage.

Dielectrics. The better the insulating property of the dielectric, the higher its resistance, and the less dielectric leakage loss present. In low current, high voltage power supplies, minimizing all sources of loss is important to prevent undue power-supply loading. For that reason, plastics are by far the best materials for large capacitors. A serious project should involve one of the plastics.

Lexan, Polystyrene, and Plexiglas in particular are easy to glue, and can be cut with a table saw using a plastics blade, or a carborundum impregnated all-purpose cutting blade like *Zippity-Do* (which is cheaper). A sabre saw with a really coarse wood blade will also work (other blade types clog or chip). Such plastics may be drilled

WARNING!! This article deals with and involves subject matter and the use of materials and substances that may be hazardous to health and life. Do not attempt to implement or use the information contained herein unless you are experienced and skilled with respect to such subject matter, materials, and substances. Neither the publisher nor the author make any representations as for the completeness or the accuracy of the information contained herein and disclaim any liability for damages or injuries, whether caused by or arising from the lack of completeness, inaccuracies of the information, misinterpretations of the directions, misapplication of the information or otherwise.

with high quality steel drill bits or special plastic bits. They must be drilled at 300 RPM or slower to prevent chipping and melting, and be sure to leave the protective film or paper on the plastic when working with it.

Mylar, Polyethylene, Nylon, and especially Teflon are difficult to work with as they are very slippery. The best way to attach plates to any of those materials is to use a glue specifically designed for the material. Polyvinyl chloride (or just PVC) is moderately slippery. It can be glued with a PVC cement, or foil plates can be attached using silicone RTV.

Glass is, in principle, an even better

dielectric. It also has the advantage of being easy to glue to with Silicone RTV or *Krazy Glue*, and it is readily available and cheap. However, it is fragile, and may contain impurities that allow conductive paths for destructive arcs. Contradictorily, for your first capacitor or two, we suggest that you try a type made with glass to gain experience, since they go together easily and are cheap.

Many industrial capacitors are oil filled. Oil has an extremely high resistance, so it does not measurably increase leakage. Silicone transformer oil is the best liquid insulator, but is rather hard to obtain. Mineral oil, on the other hand, is readily available from most pharmacies. Although it has a low dielectric constant, it can be used in a variety of simple ways to make very good high voltage capacitors.

For example, a dandy variable DC capacitor can be made by immersing a junked AM-radio tuning capacitor of the movable-plate type in mineral oil so its shaft and connection leads come out of the container's top. If you wish to try this idea, make absolutely certain the "cold" plates of the capacitor (the moving plates) are at ground potential. Use a good, large, non-metal knob for adjustment. A 100- to 365-pF variable capacitor with a 1-kVDC breakdown voltage (*i.e.*, a plate spacing of 1 mm) becomes a 270- to 985-pF unit with 7500-VDC breakdown rating. Try pricing a 7500-volt variable capacitor sometime, and you'll see the advantage to this approach!

You can use mineral oil in designs of your own, too. Immersion of a home-made capacitor in mineral oil will greatly improve its voltage rating and lifetime.

Paper is an excellent dielectric when saturated with mineral oil. Try 20-lb. bond computer paper which has a 4 mil thickness. Prepare this inexpensive capacitor by interleaving layers of dry paper with aluminum foil, and then immerse the capacitor in oil until the paper gets saturated.

One disadvantage to using oil in home-made capacitors is that the tape or glue used to bond the assembly must be oil-resistant. Silicone RTV is the best glue for these purposes.

Design Considerations. There are

TABLE 1—DIELECTRIC CONSTANTS AND BREAKDOWN VOLTAGES

Insulator	Dielectric Constant	Puncture Voltage per 0.001 Inch	Notes
Air	1.0	30	1
Window glass	7.8	200	
Polyethylene	2.3	450	
Paper (bond)	3.0	200	
Polycarbonate (Lexan)	2.96	400	
Teflon	2.1	1000	
Polystyrene	2.6	500	
Epoxy circuit board	5.2	700	2, 3
Pyrex	4.8	335	
Plexiglas	2.8	450	
PVC (rigid type)	2.95	725	
Silicone RTV	3.6	550	
Polyethylene terephthalate (Mylar)	3.0	7500	
Nylon	3.2	407	4
Mineral Oil, Squibb	2.7	200	2, 5
Shellac	3.3	200	

NOTES: All measurements at 1 MHz unless otherwise noted.

¹Tested with dry air.

²Tested at 300 HZ using a Heathkit IM-2320 Multimeter and homemade capacitor.

³Estimate, based on experiences.

⁴Lowest value of 3 types.

⁵Estimate. Probably higher. A 0.040" gap withstood over 10,000 volts DC before breakdown in one test.

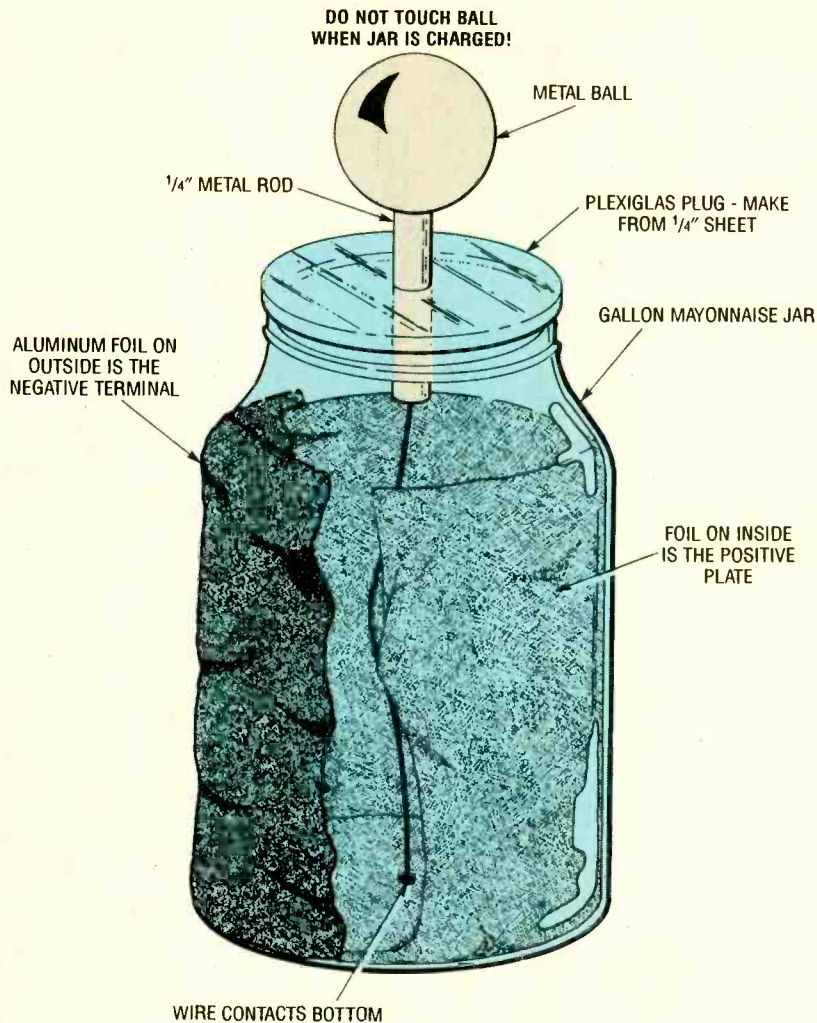

Fig. 1. The classic Leyden jar is the oldest storage capacitor we know of. They are easy to make and the materials only cost around \$2.

several things to consider when designing and constructing your own capacitor. Let's point out each one before moving to the construction details. The first and most important thing to concern yourself with is safety. Despite the romance of high voltage, it is foolish to needlessly risk your life. Since you will probably be working with lethal voltages, observance of all safety practices for high voltage (or HV) is **absolutely essential**. For some guidelines, see the boxed text entitled "High Voltage Safety."

The next aspect to consider is capacity. If you have a specific capacitance in mind, you can design a capacitor using the information provided elsewhere in this article. Try one of the designs described later. Or perhaps you prefer experimenting instead. Either way, when building for the first time, we suggest making small

designs first to get used to techniques and quirks before you invest lots of time and money.

You must also take into consideration the voltage that will be applied to the capacitor. That will affect your choice of a dielectric and thus its required thickness. Should you use an inadequate dielectric or thickness, sparks or arcs can result. A spark is a temporary breakdown that a lot of capacitors will survive, but an arc is serious: it is a path burned into the dielectric or other component. Arcs carbonize materials, producing a highly conductive channel that often renders an apparatus useless and very likely dangerous. Except in special cases where the insulator is a "self-healing" type (like air, oil, and some plastics), a single arc will ruin the capacitor.

To compensate for the impurities

High Voltage Safety.

High voltage is considered any value over 500 volts AC or DC. When you attach a capacitor to high voltage, you are multiplying its hazard manifold. Therefore, experimenters must take extra precautions to avoid painful shocks and possible electrocution. Here are a few guidelines to follow when working with high voltage:

- Label your project in several locations with: "Danger, High Voltage" where appropriate. Such a warning label is provided here for you to copy (see Fig. A). Keep children, pets, and curiosity seekers away from the apparatus. Cover all bare leads, wires, connection terminals, and possible points of contact with high voltage putty or a cover fabricated from thick clear plastic.
- Work in a dry location. Working in a damp basement or workshop courts disaster. Wear rubber-soled boots or sneakers. Stand on a thick rubber mat.

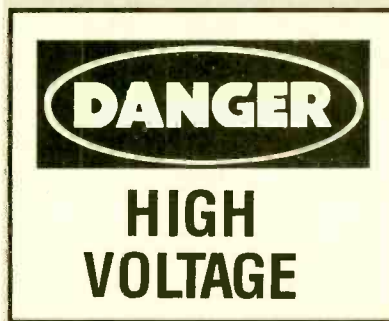

Fig. A. Curiosity can hurt more than just felines, so use this warning label on all your high voltage projects to protect the unwary from harm.

- Never put your body in a position to become a conductor. Locate your apparatus away from appliances, metal doors and windows frames, heating ducts, vents, radiators, sinks, or water pipes. All these items can become a deadly ground if your body comes between them and high voltage.

- Always pull the plug when working on a high voltage circuit unless you must test it. When testing a live circuit, use utmost caution. Keep one hand in your pocket. Use clip-on test leads that are rated twice the voltage of the live circuit. Use a high voltage probe whenever possible—its insulating handle will help protect you.

- Use NE-2 neon lamps to indicate live or stored high voltage. Bleed off the charge on capacitors with a power resistor before performing adjustments.

- Adequate ventilation must be provided for circuits that produce large amounts of ozone such as Jacob's ladders or Tesla coils.

that often appear in materials that are not highly refined for capacitor use, we must add a safety margin to the thickness of the dielectric. In the

case of DC, a good rule of thumb is a 50% margin. For example, say you need a 500-volt DC capacitor using polystyrene. Consulting Table 1, note polystyrene's breakdown is 500 volts per mil, thus 1 mil is required. Adding 50% gives you 1.5 mils, which is adequate for pure DC. You can always use a thicker dielectric if it's expedient, providing that you adjust the number of plates or their size to accommodate the wider plate separation. It should be mentioned that when making a paper capacitor, you should use a healthy safety margin since paper is not always uniform in thickness.

In comparison to AC, DC puts relatively little stress on a capacitor. By contrast, AC reverses the dielectrics' polarity every cycle. So the dielectric in an AC capacitor must have twice the thickness required in an equivalent DC capacitor. Further, when considering dielectrics in AC applications, you must deal with the *peak voltage*—not rms (Root Mean Square) voltage—that they will be exposed to. If you wish to convert an rms voltage to its equivalent peak sinewave value, multiply it by 1.414.

So, to roughly calculate the proper voltage rating needed for an AC capacitor, you first double its required rms voltage rating then multiply by 1.414. To further simplify this calculation, all one needs to do is multiply the AC (rms) voltage in question by 2.828. Now divide the voltage by the puncture-voltage rating to get a preliminary thickness value. Finally, you must add a safety margin of 50% to 100%. The actual percentage depends on the characteristics of the applied AC voltage. For a pure sinewave AC, we suggest a 50% safety margin whereas high frequency, non-sinusoidal applications such as Tesla coils require a full 100% extra thickness.

If one is available, equip an oscilloscope with a high voltage probe to visually observe exactly what the circuit is doing so you can determine the proper safety margin. An oscilloscope will also enable you to detect destructive voltage spikes and superimposed AC (also called AC ripple) so you can design a capacitor to handle those harmful excursions.

Of course physical size, weight, and fragility are also important characteristics of capacitor design. If you have size limitations, Mylar is the best

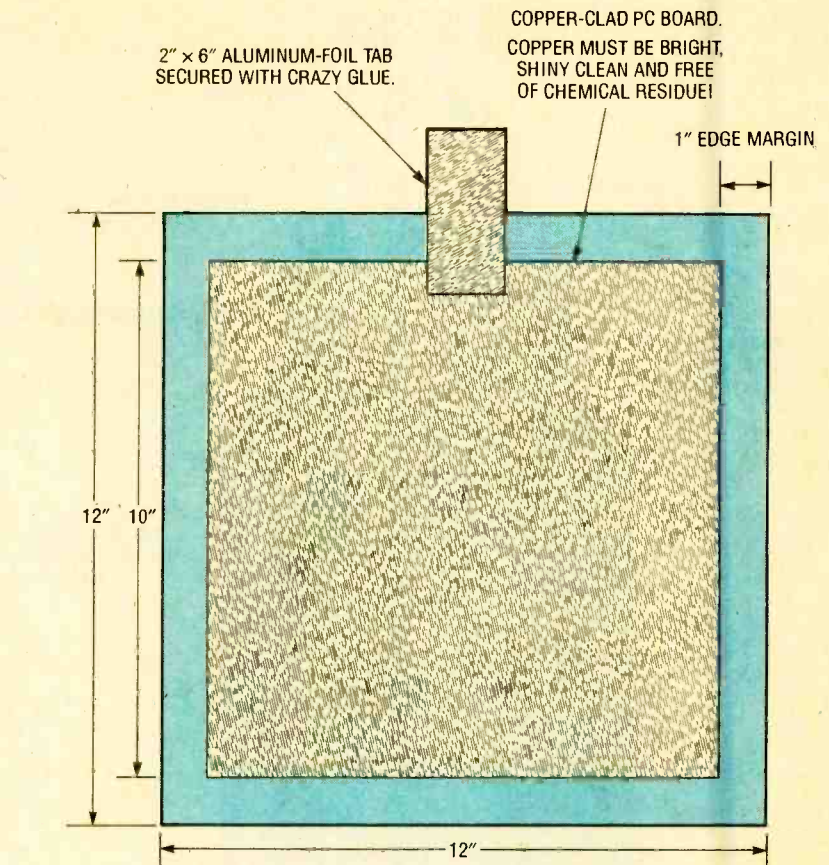

Fig. 2. For a single-section capacitor, use one double-sided PC board. For multiple sections, use several single-sided boards clamped together or bolted together with nylon screws.

dielectric material to use since it has a very high puncture voltage per mil, and thus makes a very compact capacitor. Plastics are light, so most capacitors will weigh less than ten pounds. The toughest plastic is Lexan, which is difficult to crack even with a hammer and is often used for vandal-proof windows. Glass is the worst material for a lightweight, durable capacitor, and can even crack under its own weight when lifted. Take all this into account when selecting your materials.

Of course, the overall cost in labor and materials should also be considered before constructing a capacitor. Calculate beforehand the cost of your materials. Paper and polyethylene are the cheapest. Glass is the next higher price. Labor time is about the same with Plexiglas, Lexan, and glass sheet capacitors. Exotic plastics such as Teflon are not needed unless your application demands extreme chemical and thermal deterioration resistance. Polyethylene has excellent chemical resistance, but

breaks down gradually upon exposure to ozone gas (always present around high voltage) becoming brittle and less resistant to arc puncture.

That brings us to another important consideration: the capacitor's useful life. To enhance a capacitor's life keep the working voltage at or below the rated specification in both DC and AC applications. We discovered that charging at no more than 70% of a capacitor's working voltage resulted in an amazing 10-fold increase in lifetime for one type of commercial capacitor. Also, for DC capacitors, watch out for voltage reversals. If your system has a lot of inductance, reverse voltage swings are always produced. Increase the safety margin if a lot of inductance is in the circuit. Furthermore, the temperature should be kept below 120°F. As mentioned earlier, watch out for superimposed AC, voltage spikes, and ringing. These types of AC waves can drastically shorten lifetime. Tesla coils have notorious ringing. To repeat: if feasible, use an oscilloscope to visually analyze

your circuit. Often a power resistor inserted in the current path to the capacitor quenches ringing. With this criteria under our belts, let's look at some problems your design and construction methods should prevent.

Signs of Trouble. Your assembly techniques should seek to minimize the likelihood of a few possible problems. Luckily, all of them can be prevented at least in part by using ample amounts of insulating material such as No-arc or Corona Dope and/or high voltage putty on all exposed areas. A plastic case to enclose the apparatus is also recommended (more on that later).

Still and all, you should know what problems the insulation is preventing. The first problem insulation relieves is the possibility of electrical shock.

Insulation also minimizes the production of ozone—a gas created when high voltage causes three oxygen atoms to join together. Ozone has a tart, sweet “electrical” smell, and is 100 times as poisonous as carbon monoxide. Beware: it quickly causes headache, nausea, vomiting, and respiratory irritation. In addition to insulating all the exposed HV areas, you should also operate your equipment with good ventilation if it produces any ozone.

Closely linked to ozone generation is corona leakage. It is produced by a charge being leached off a highly charged object by the air. That typically produces ozone. However, sometimes a device (such as a Van deGraff generator) is constructed specifically to display corona discharge, and insulating it would defeat that purpose. In such cases, good ventilation is the only practical means of hazard prevention.

Ozone can also be created by arcing, which can occur anywhere. However, ozone production is not the greatest hazard arcing presents. At 50 kV, a spark can arc between an uninsulated contact and your body if you come within 2 inches of the contact. Arcing commonly takes two forms: directly through a capacitor's dielectric (as mentioned earlier), or across the edges of a capacitor's plates to an adjacent plate. A snapping sound indicates the presence of arcing, so keep your ears open.

Arcing from the edges of a capaci-

tor plate, or anywhere the shape of a conductor changes abruptly (such as the tip of a nail) is called point discharge. It can be readily observed in a dark room at very high voltages. Small, bright blue pinpoint(s) are seen leaking electrons into the air, accompanied by a hissing sound and copious ozone production.

Once again, insulation and proper ventilation are the proper solutions to all these problems, and there are some specialized techniques to insulate your capacitors and otherwise improve the safety of your high voltage projects. Let's get to those now.

Construction Requirements. A key ingredient in a good assembly is a proper case. Your capacitor's housing must protect it against moisture, dirt, and accidental discharge. Plastic cases for dry capacitors are easy to make with acrylic sheets glued at all corners with Silicone RTV. Oil-proof cases can be made for immersed models, but you will need to rough-up the plastic at the sealing edges with sandpaper and use both a bonding and second fillet glue coating for a liquid-proof seal. Metal cases can be made from PC boards cut on a shear or large paper cutter and soldered at the edges. Copper roof flashing (available at hardware stores) works well too. However when using metal, always beware of contamination by solder rosin, solder bits, and other crud, which can short out plates or otherwise reduce efficiency.

Whether a capacitor is enclosed or exposed, discharge paths must be wide enough to avoid arcs to the case, adjacent plates, terminals, connections, or components. That is especially important in situations where conductors must be left uninsulated. Note that the space from each plate to the edge of the dielectric must be wide enough to stop any spark from “crawling” over the edge of one plate to another.

Power leads must be capable of withstanding the full voltage of the charge plus at least a 50% safety margin. TV anode wire, which comes rated up to 40-kVDC, makes great leads. Vinyl tubing or aquarium air hose may be slipped over leads to increase their voltage rating.

Make sure the plates are securely mounted or they will tend to shift, or make a noisy rattle when used with AC. Glue or compress the assembly to hold it secure. With regard to mounting, keep in mind that glues that dry by evaporation of a volatile chemical might not set properly if “buried” inside an assembly away from air, and could thus become a fire hazard.

Rolled-up capacitors may be held securely by wrapping the interleaving layers of foil and insulator tight around an insulating mandrel and then taping with a clear PVC tape. Where necessary, coat the ends with Silicone RTV. That will eliminate end-arcing flash-over and corona loss. Alternatively, although it is somewhat brittle, paraffin (with a puncture voltage of 250 volts/

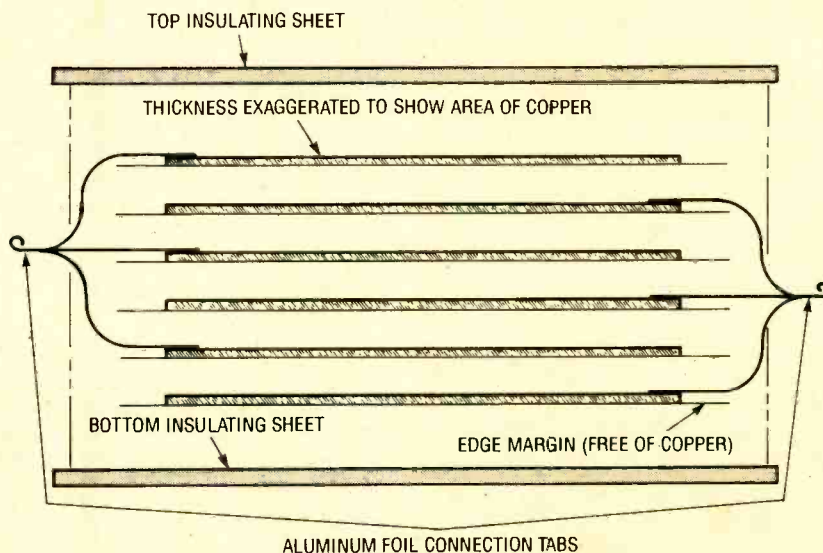

Fig. 3. With this design, you may stack as many plates as you wish, provided there are an equal number of plates attached to each lead.

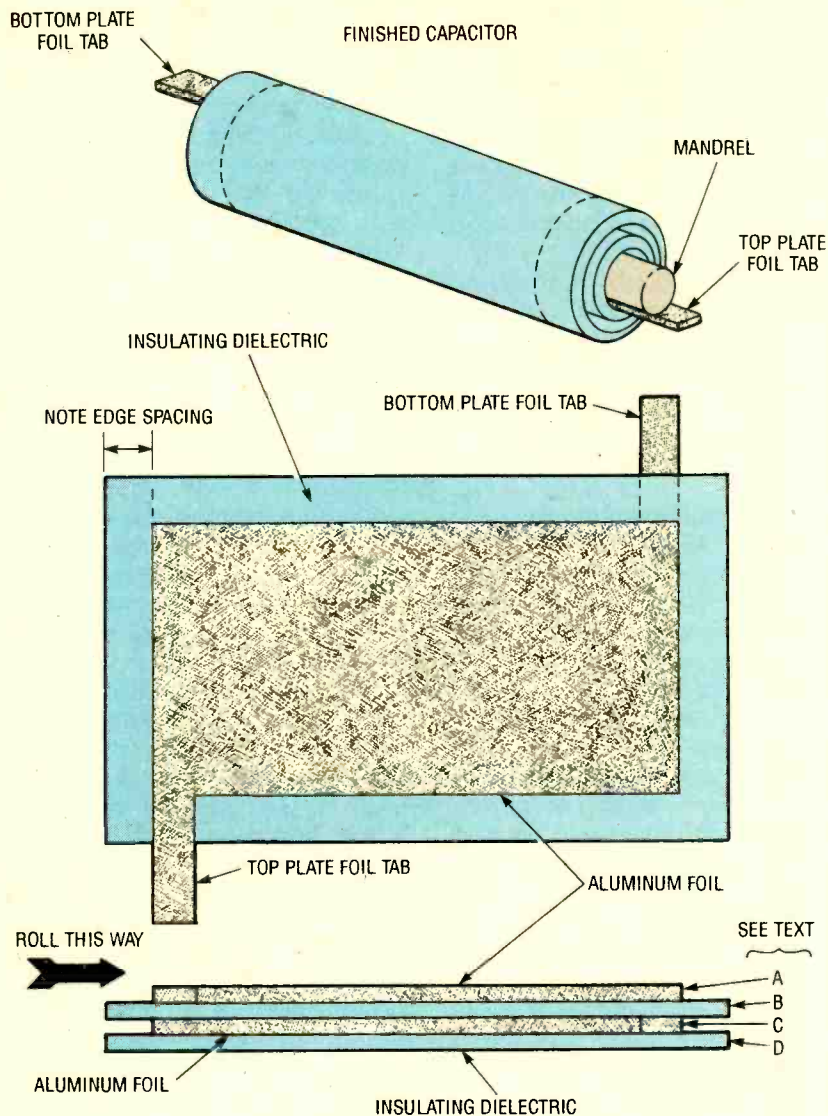

Fig. 4. A rolled-up capacitor, like that shown here, can provide the greatest capacitance in the smallest space. Note that the dimensions in the side view have been greatly exaggerated for the sake of clarity.

mil) is an excellent insulator for the ends of rolled-up capacitors and the edges of flat-plate type capacitors. If you want to use melted paraffin wax, heat the wax only in a double-boiler pan, since if it gets too hot it can catch fire. Be sure to apply several coats, allowing the wax to harden between each coat. Liquid electrical tape also makes a great end seal, however it is somewhat hard to find. Try mail-order distributors for that product.

High voltage terminals for your projects can be made from plastic rods drilled through to accept connection wires. You may add a nut and bolt on top for convenience. However, beyond about 3,000 VDC this method suffers from point discharge. Metal

balls make good terminals. Clean them up with a wire brush or steel wool to eliminate rough spots. The author uses fishing floats covered with either aluminum foil or nickel print paint for up to 10 kVDC. Split the bobbin first with a razor blade, remove the line holder and spring, and glue it together again with epoxy.

Furthermore, as you work, keep all materials as clean as possible. Not only will your work have a better appearance, but arcs and burn-throughs due to contaminants will be prevented. High voltage easily tracks along dust, surface contamination, and even finger oil (which contains salt). Also, we shall refer to a "section" as consisting of two conductive plates

with an insulating dielectric between them.

By now, we hope you have a good understanding of the principles and techniques involved in making your own capacitors. Without forgetting safety, let's talk about how to build some simple capacitors, any of which can be modified for your application.

A Leyden Jar Capacitor. Leyden Jars are one of the first types of capacitors made, having been invented nearly two and a half centuries ago. Their development was first recorded in 1745 by Ewald von Kliest. In 1746, Peter van Musschenbroeck of Leyden, Holland experimented further with the invention. We can build our own modernized units with a gallon-size wide-mouthed mayonnaise jar. The project only costs about \$2, and is good to at least 10 kVDC at 2.5 nF. Units we've tested at 15 kVDC did not fail; at that voltage, the capacitors stored just under 1/3 joule each.

First select a jar without bubbles, cracks, or blemishes and that has a mouth large enough to comfortably slip your hand through. Next, carefully clean it out. You'll use aluminum foil inside and out as the conductive plates (see Fig. 1). Cut a foil disk 1-inch bigger than the bottom of the jar. Now coat the dull side of the foil and inside jar bottom with a thin, even layer of rubber cement. Let both dry for 10 minutes, and press together. Smooth with firm hand pressure. Avoid excess wrinkles. Do the rest of the inside except the top inch of the bottle using three or four pieces of foil. (It is easiest to do the plate in pieces instead of all at once, since rubber cement "grabs" and it is difficult to reposition the foil once contact has been made.) Now do the outside foil plate in pieces, leaving the top inch bare. Check the foils with a continuity tester to determine if the pieces are in good electrical contact. Areas of foil not in contact can be bridged with strips of foil or nickel-print paint.

For the top cover, cut two disks of clear plastic, one slightly smaller than the rim, the other 1/4-inch larger than the rim. Glue the two pieces together to form a plug. Drill a 1/4-inch hole through the plug's center. Cut and insert a length of 1/4-inch (outer diameter) metal rod or tubing through this hole. Attach a ball to its top, and sol-

der a wire or small-link chain to its bottom. The wire must make good electrical contact with the foil. Let the assembly dry for a day with the cover off, to allow vapors from the rubber cement to dissipate, then cement the cover on with silicone or *Krazy Glue*.

PC-Board Capacitor. Some nifty low inductance capacitors can be made from pieces of copper-clad epoxy circuit board (see Fig. 2). For a simple two-plate capacitor, you can use one double-sided sheet. For multiple sections, use single-sided board.

To prepare each board, start by etching away a 1-inch strip from around all its edges. That process can be simplified by first masking off the strip, spraying the bare copper with an etch-resistant paint, removing the masking tape, and then etching.

Clean the board after etching, and rinse with de-ionized or distilled water. Thoroughly air-dry the sections, or use a blow dryer. Attach strips of aluminum foil to each plate.

If you are building a multiple-section capacitor, connect the aluminum foil strips together as shown in Fig. 3 and secure them using glue or nylon bolts at each corner. Spray the finished assembly with several coats of an insulating product, or paraffin.

If you use the dimensions shown in Fig. 2 and a 0.060-inch gap between plates, you can achieve a capacitance of 1.94 nF (1940 pF) per section. When deciding on the gap width to use, keep in mind that the greater the space between successive plates the lower the chance of arcing. For example, a 1-inch spacing gives you a 30% larger gap than a 20-kV spark can jump. Insulation will further improve that margin.

The Stacked Sheet Design. This type is virtually identical to our PC board capacitor, but it can be designed to handle considerably more voltage. You simply substitute sheet plastic or glass dielectrics, and glue aluminum foil in place of the copper for each section (refer to the PC board capacitor drawing in Fig. 3 as needed). All in all, it's an easier design to build, as it does not involve the effort of etching copper, and you can continue to add sections to your original prototype to increase its capacity as future demands require.

Sources

All types of plastics: United States Plastics Corporation, 1390 Neubrecht Lane, Lima, OH, 45801; Tel. 800-537-9724. Catalog: \$4.50. Minimum Order: \$5. NOTE: Verify that your order will ship UPS to avoid an expensive trucking charge!

High voltage rectifiers and meters: MCM Electronics, 858 E. Congress Park Dr., Centerville, OH 45459-4072; Tel. 513-434-0031. Free catalog.

Sheet and formed metals, plastics, and precision tools: Small Parts, Inc., PO Box 381966, Miami, FL 33238-9980; Tel. 305-751-0856. Free catalog.

Information, technical assistance, high voltage parts, and kits: Allegro Electronic Systems, 3 Mine Mountain Road, Cornwall Bridge, CT 06754; Tel. 203-672-0123 (9 AM-12 noon EST weekdays). Free catalog.

When building a large capacitor of this type, we suggest that you use nylon bolts at the corners to hold it all together. The bolt holes should be pre-drilled before assembly, and all chips cleared away. Make sure the plate-to-edge spacing is adequate for the voltage you will subject the capacitor to. Add extra spacing if you intend to use bolts at the edges.

Glue foil carefully to the top of the first plate using a small amount of spray adhesive, *Krazy Glue* or RTV silicone. Press it smooth and let it dry. A photographic finishing roller is handy for flattening foil. Repeat the procedure for the second sheet, orienting the foil connection tab in the opposite direction. Keep the plates and dielectrics aligned as assembly proceeds. Repeat this procedure for as many sections as you want. Always keep the final number of plus and minus plates equal.

Put an insulating sheet above and below the last plate and secure the assembly with nylon bolts. Do not over tighten or the center of the assembly will "bow." Finally, clean the ends with a very small amount of isopropyl (rubbing) alcohol and wipe dry. Smear a coating of silicone RTV over all the edges.

Roll-Up Design. The kind of capacitor depicted in Fig. 4 can provide large capacitance in a small size. They are a little trickier to make than stacked-section type capacitors, so you might want to try a few small pro-

totypes first. The design uses a layered approach (as shown), and we suggest using only one section as it is difficult to align and wrap multiple sections. By contrast, a single section several feet long is not too unwieldy.

Aluminum foil works great in these capacitors. You'll find the oven/broiler type, which is heavy-duty foil, far easier to work with than the plain variety. Polyethylene and Mylar are the most common dielectrics, but you can experiment with other materials.

Looking at the figure, note the orientation and shape of the foil plates (A) and (C). They can be easily secured to the dielectric (B) using double-sided Scotch tape. Note also the edge spacing. An outer covering of dielectric (D) will prevent the finished capacitor from having a "hot" case, which might be a hazard. With those points in mind, lay the foil out on a smooth sheet of paper, which in turn should be laid out on a smooth, hard surface to prevent wrinkling. Carefully assemble the four layers as shown in the drawing. Strive to make them flat and smooth.

Wrap the capacitor "sandwich" around a non-conductive mandrel or spool—ideally made of plastic or glass rod (be careful not to break a glass rod). Try to make the roll straight and free of lumps and wrinkles. When it's all rolled up, secure it with plenty of tape. The author uses clear package-sealing tape for this. Now secure the positive foil tab (assuming it's going to be for DC) to the mandrel using tape. Finally, coat the exposed ends with an insulating product like silicone RTV.

The remaining foil connection tab may be reinforced by rolling it around a small metal dowel. A nail, or a cut-off piece of 1/8-inch uncoated brazing rod is suggested. Apply glue to hold the assembly together.

Foil tabs can be strengthened by adding "ribs" of adhesive from a hot glue gun. Similarly, the tabs can be made tear-resistant by applying hot glue where they enter the capacitor.

Note most problems with this design come from particle contaminants that stretch a dielectric thin in spots where they are trapped by the tightly rolled dielectric. Another trouble is inadequate edge spacing, causing arcing across the ends. Careful planning and assembly will eliminate both headaches.

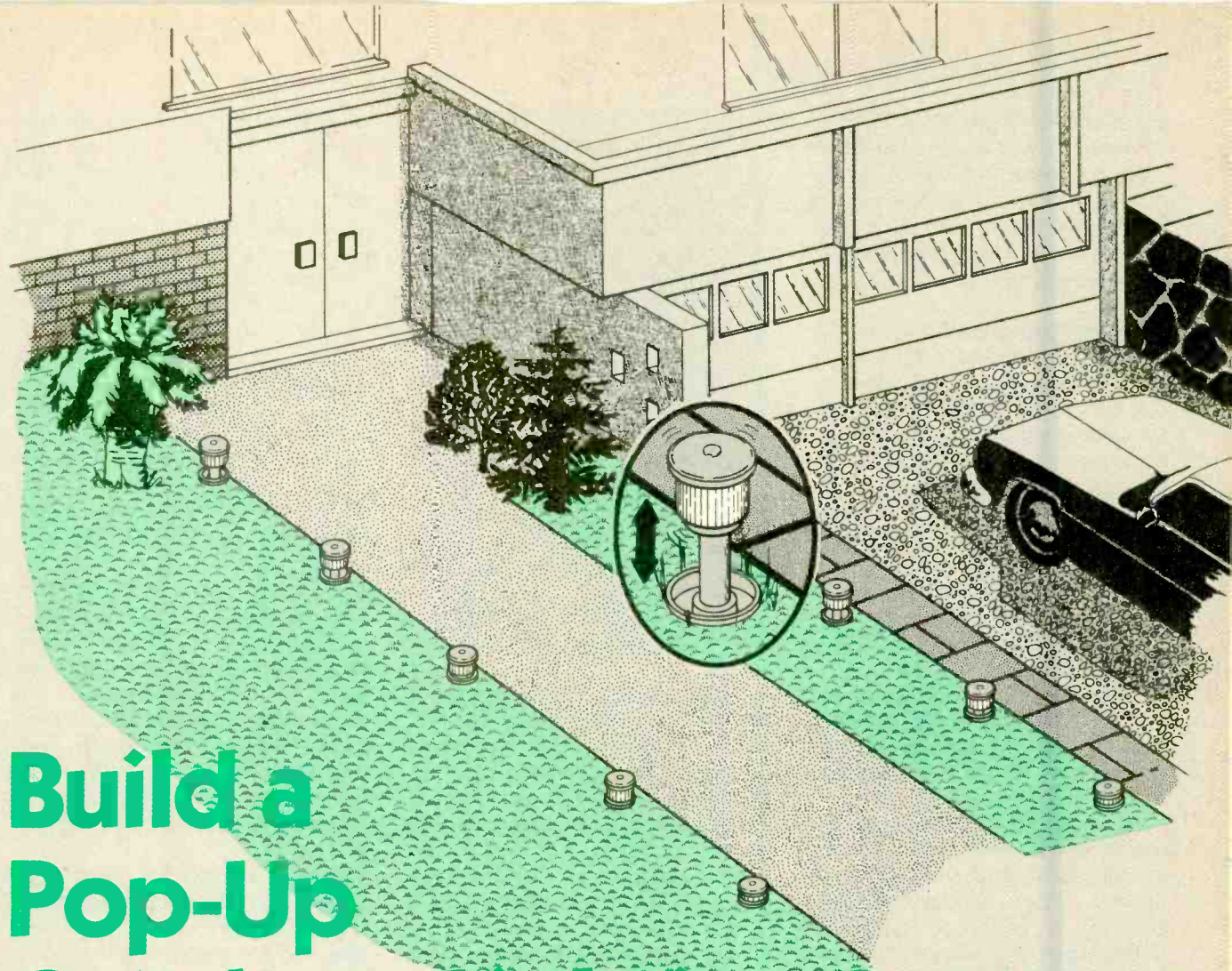

Build a Pop-Up Outdoor-Lighting System

Give your lawn an uncluttered look by day and a well-lighted appearance by night with this hide-away lighting system.

You've probably seen those low-voltage, outdoor pathway lights in yards throughout your neighborhood. They're popular because they're easy to install, cheap, safe, and effective. But they have a down side: when the time comes to groom your lawn, they're hard to mow around, they're easy to trip over, and they are not what you would call attractive (despite what manufacturers say).

Wouldn't it be nice if you could install pathway lighting that would come out at night or when needed, and "disappear" when not needed? That's just what the *Pop-Up Lighting System* described in this article is designed to do. The system consists of little more than a modified, off-the-

BY DAVID SCHMIEDEBERG

shelf, low-voltage lighting set, some home-brew electronics, and plumbing hardware.

The Big Picture. A block diagram of the Pop-Up Lighting System is shown in Fig. 1. The system's operation is simple, when the lights are turned on (either manually or by a timer), valve A opens, allowing water to fill an underground PVC pipe that goes to each of the light fixtures in the system. The pressure produced by the build-up of water within the pipe forces the light fixtures to extend above ground. When the lights are turned off, valve A is closed and valve B is opened, allowing the trapped water to escape. The

pressure reduction resulting from the discharge of water allows the fixtures to retract.

The light fixtures are an amalgamation of various components taken from standard low-voltage tier lights and pop-up impulse sprinklers. The valves used in the system are automatic irrigation sprinkler valves. The 12-volt transformer—which has a built-in timer—is a standard part of the tier-light set. And the electronics circuit used to control the two valves is easily assembled from readily available parts. What could be simpler?

About the Circuit. A schematic diagram for the system's control electronics is shown in Fig. 2. The circuit is built around a 7805 voltage regulator

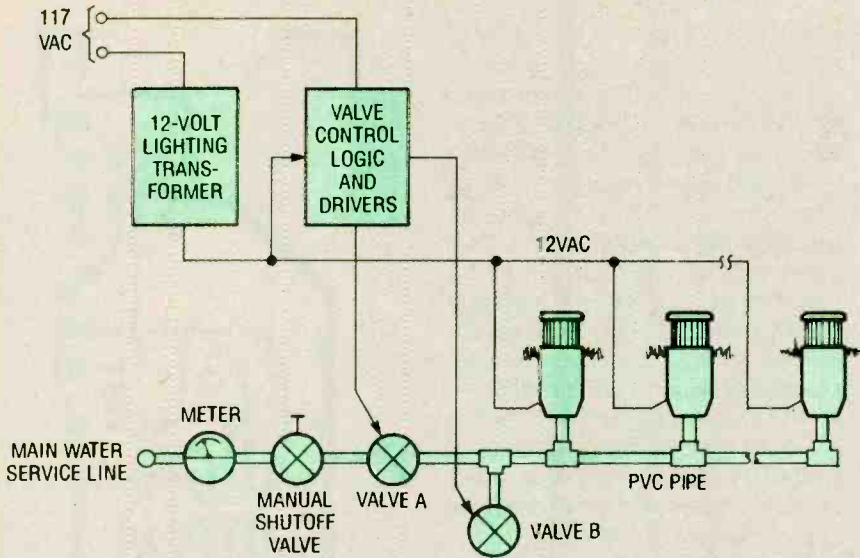

Fig. 1. The Pop-Up Light-Control System uses the build-up of water pressure produced by an underground PVC pipe to force the light fixtures to extend above ground. When the lights are turned off, the water is evacuated from the pipe, allowing the fixtures to retract.

(U1), a 4538 dual monostable (U2), a 4050 hex buffer (U3), a 74LS00 2-input NAND gate (U4), and two MOC3010 Triac-driver optoisolator/couplers (U5 and U6). Playing a supporting role are

T1 (a 24-volt stepdown transformer), T2 (which comes with the tier lights), BR1 (a 1-amp, 100-volt bridge rectifier), and a few additional components: TR1, TR2, SOL1, SOL2, etc.

Transformer T1 supplies 24 volts to MT1 of both TR1 and TR2 (the importance of that will become apparent later) and 12 volts, via its center tap, to BR1, which rectifies the AC voltage to supply DC to U1 (the 5-volt regulator). Regulator U1's only purpose is to supply operating power to the control circuit. Half of the dual precision monostable (U2-a) is used to detect the 12-volt AC output of the lighting transformer, which is only present when the lights are switched on. The 12-volt AC output supplied by T2 is half-wave rectified by D1. The resulting DC voltage is clamped to 5.1 volts by Zener diode D2. Capacitor C1 filters out minor transients, thereby preventing U2-a from being falsely triggered.

When the lights are switched on, 5.1 volts is applied to U2-a at pins 4 and 8, causing its output at 7 to go low and its output at pin 6 to go high. Those pins remain in that state as long as 5.1-volt input is present pins 4 and 8 of U2-a. The output of U2-a at pin 6 branches into two paths. In one path, the signal is fed to pin 11 of U2-b, forcing its

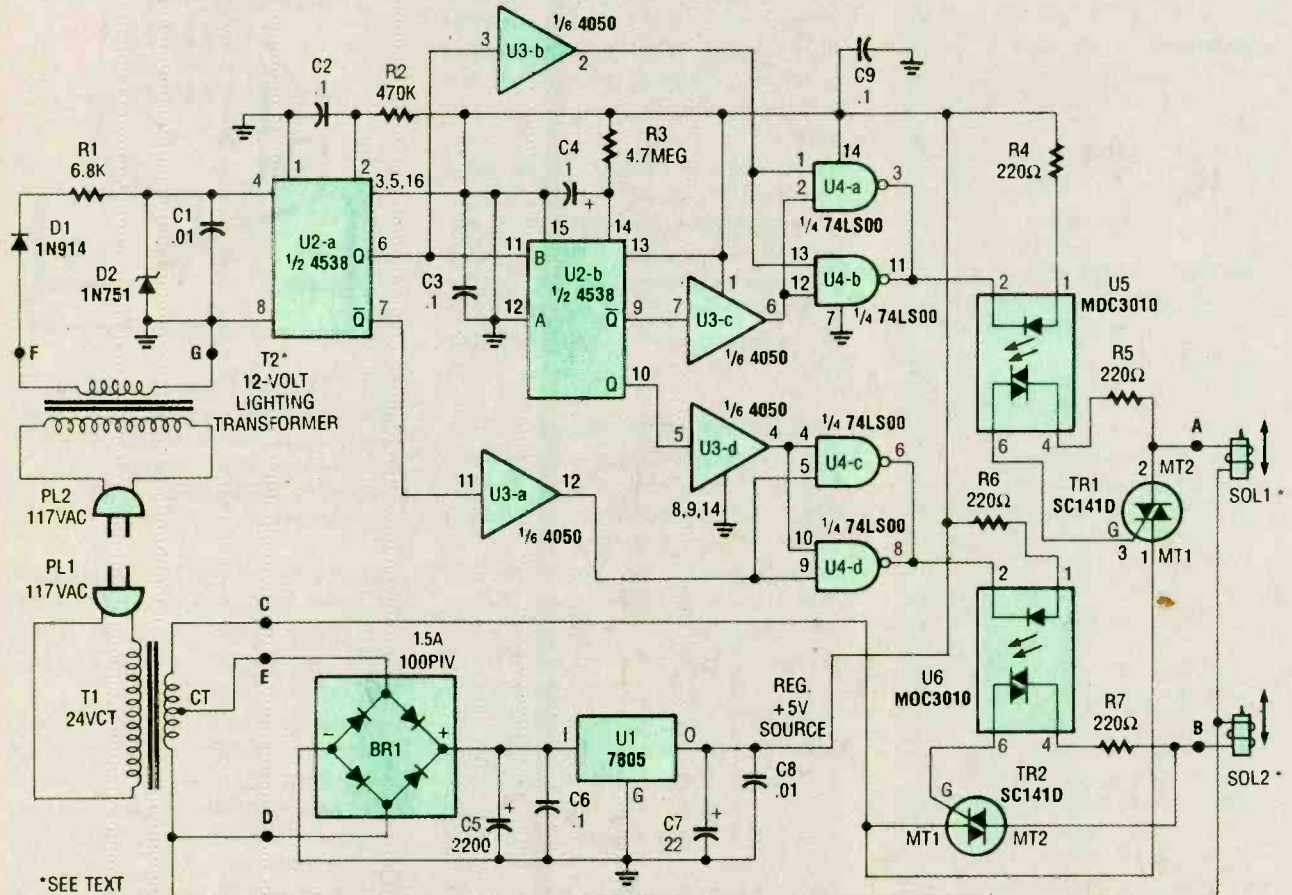

Fig. 2. The Pop-Up Light's control circuitry is built around six integrated circuits, which are supported by two power sources and a few additional components.

PARTS LIST FOR THE POP-UP LIGHTING SYSTEM

SEMICONDUCTORS

- U1—LM7805 5-volt, 1-amp voltage regulator, integrated circuit
 U2—4538B dual precision monolithic-multivibrator, integrated circuit
 U3—4050B hex buffer, integrated circuit
 U4—74LS00 quad 2-input NAND gate, integrated circuit
 U5, U6—MOC3010 Triac driver, optoisolator/coupler, integrated circuit
 TR1, TR2—SC141D 6-amp, 400-PIV Triac
 BR1—1.5-amp, 100-PIV full-wave bridge rectifier
 DI—1N914 general-purpose silicon diode
 D2—1N751 5.1-volt, 400-mW Zener diode

RESISTORS

- (All fixed resistors are 1/4-watt, 5% units.)
 R1—6800-ohm
 R2—470,000 ohm
 R3—4.7 megohms
 R4-R7—220-ohm

CAPACITORS

- C1, C8—.01- μ F, ceramic-disc
 C2, C3, C6, C9—0.1- μ F, ceramic-disc
 C4—1- μ F, 35-WVDC, tantalum
 C5—2200- μ F, 35-WVDC, radial lead, electrolytic
 C7—22- μ F, 16-WVDC, tantalum

ADDITIONAL PARTS AND MATERIALS

- T1—24-volt, 1-amp, center-tapped transformer
 SOL1, SOL2—See text
 PL1, PL2—117-volt AC with line cord
 Printed-circuit board materials, Intermatic Malibu model LV28712T Tier II low-voltage light set, Lawn Genie model 711DLG automatic anti-siphon valve, Rain Bird model LG-3 or MG-4 pop-up sprinkler, 1/2-inch schedule 40 PVC pipe, PVC pipe fittings, cement, Drip Mist model P32000 47-psi pressure regulator (see text), Rain Bird and PVC pipe automatic drain valves (see text), manual gate-shutoff valve, 1/2-inch sprinkler risers, 1/2-inch diameter acrylic rod, acrylic cement, glue, project enclosure, TO-220 heat sink, grommet, 18-gauge, plastic-jacketed thermostat or sprinkler wire, solder, hardware, etc.

output at pin 9 high, and its output at pin 10 low. The high output at pin 9 is fed through buffer U3-c to pins 2 and 12 of U4-a and U4-b, respectively. In the other path, the high output of U2-a is fed through a buffer (U3-b) to pins 1 and 13 of U4-a and U4-b, respectively. With both inputs to the NAND gates high, their outputs (which are summed) go low, pulling the cathode of U5's internal LED low. That causes U5's internal Triac driver to turn on, applying gate current to TR1. That causes TR1 to turn on, energizing SOL1 (which is part of an automatic valve). Solenoid SOL1 causes valve A to open, allowing water to fill the PVC pipe and causes the lights to extend.

When the lights are turned off, U2-a pin 7 goes high and pin 6 goes low, forcing pin 10 of U2-b to go high, and pin 9 to go low. The high output of U2-a at pin 7 is fed through U3-a to pins 5 and 9 of U4-c and U4-d, respectively. The high output of U2-b at pin 10 is fed through U3-d to pins 4 and 10 of U4-c and U4-d, respectively, forcing their outputs low. That low triggers U6's internal Triac driver, causing current to flow to the gate of TR2, turning it on. With TR2 turned on, SOL2 causes valve B to open, discharging water from the PVC pipes, which causes the lights to retract.

The NAND (U4-a through U4-d) gates are there to prevent the fixtures from changing their position (either extended or retracted) if the lights are switched on and off quickly, or vice versa. The buffers (U3-a through U3-d) are used to boost U2's output current drive.

Assembling the PC Board. The author's prototype of the control electronics for the Pop-Up Light Control System was assembled on a printed-circuit board, measuring 5¹⁵/₁₆ × 1¹/₁₆ inches. A full-size template of for that circuit board is shown in Fig. 4.

Begin assembly by installing the passive components (resistors, capacitors, and jumpers) first, followed by the semiconductors (diodes, bridge rectifier, Triacs, and IC's). Be sure that the polarized components are properly oriented before soldering. It is recommended that sockets be provided for the IC's: Doing so will allow for easy replacement of the IC's

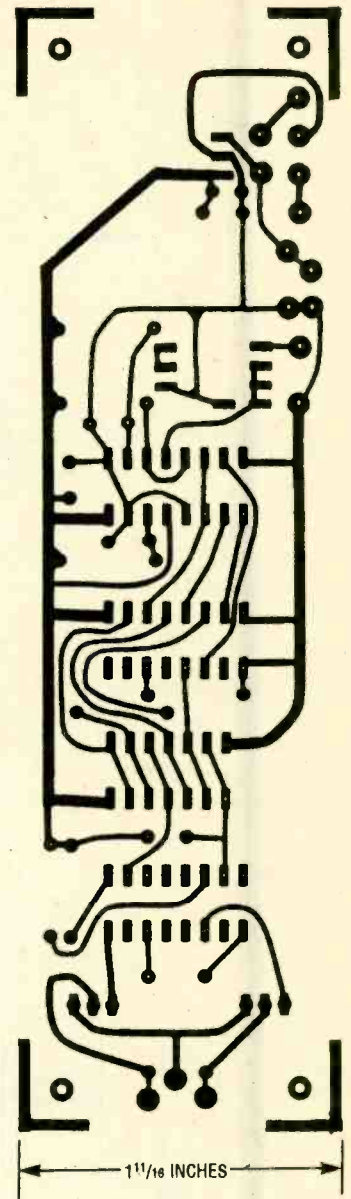

Fig. 3. The author's prototype of the control electronics for the Pop-Up Light Control System was assembled on a printed-circuit board measuring 5¹⁵/₁₆ × 1¹/₁₆ inches. Shown here is a full-size template of that circuit board.

should they fail. The two optoisolator/couplers, U5 and U6, can be installed in a single 16-pin socket. Be careful when handling the CMOS circuits—they are static sensitive.

The two Triacs should be mounted upright on the board. The voltage regulator (U1), however, should be mounted with its leads bent at a right angle so that its tab lies flat against the board. After bending, a heat sink should be slid under the regulator's tab, and a screw used to secure the heat sink/tab to the board. It will be

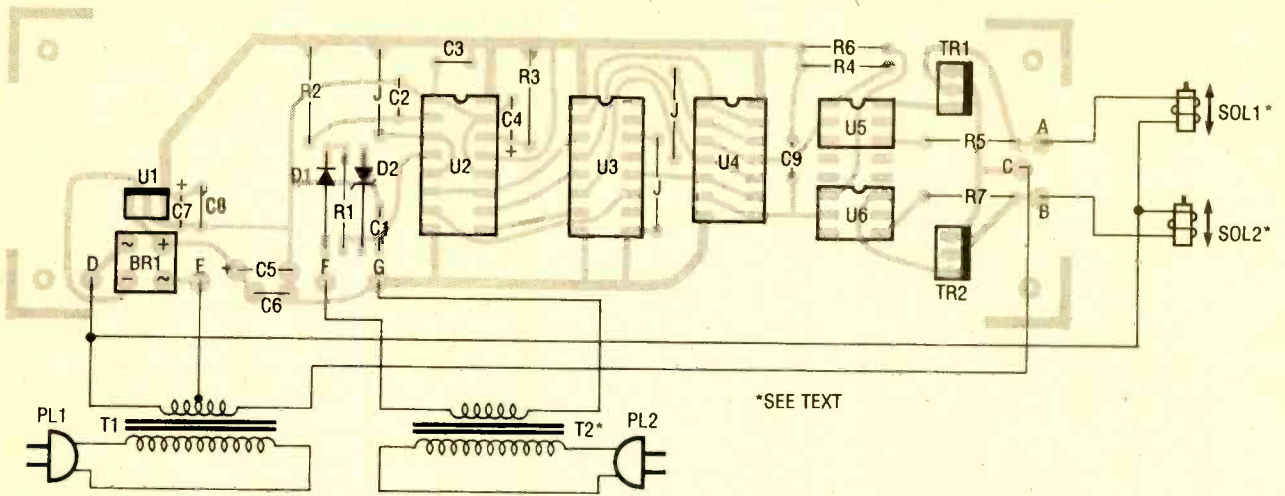

Fig. 4. Assemble the printed-circuit board using this parts-placement diagram as a guide. Before soldering the polarized components in place, make absolutely sure that they are properly oriented.

necessary to drill a hole through the board for the regulator's tie-down hardware.

Once the circuit board has been assembled, the next step is to prepare the enclosure that will house the circuit. The finished printed-circuit board can be housed in almost any enclosure of sufficient size. Once selected, drill holes in the enclosure for the power cord and cabling that will connect the circuit board to the off-board components of the system. Holes should also be drilled in the cover for ventilation.

Once the enclosure has been prepared, feed a line cord through the enclosure, and connect it to the primary of T1. Then connect lengths of 18-gauge plastic jacketed sprinkler wire (the kind designed for direct burial) to the appropriate points on the circuit board, and feed them through the holes in the enclosure. Mount the board and transformer T1 in the enclosure. The control circuitry can now be mounted in any convenient location. The author's unit was mounted in the garage. Connect the 18-gauge sprinkler wire to the valve solenoids (SOL1 and SOL2) and the lighting transformer, as shown in Fig. 4. After checking your work, move on to the next phase of the installation.

Area of Illumination. Since the pop-up lights are closer to the ground when extended than are standard tier lights, they illuminate a somewhat smaller area. Because of that, it will be necessary to space them a little

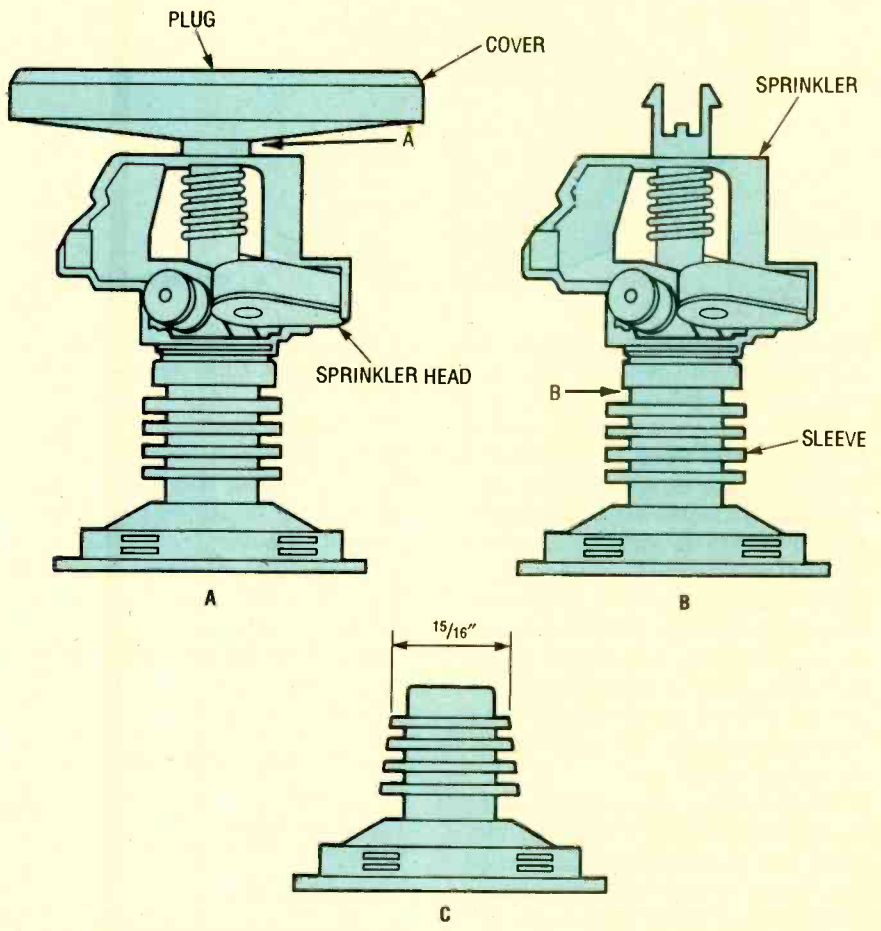

Fig. 5. Remove the cover from the sprinkler head (A) by pinching point A with long-nose pliers. Carefully saw the sprinkler head/sleeve assembly at point B with a hacksaw (B). Taper the top portion of the sleeve (C) slightly to accommodate the light fixture.

closer together. You can get an idea of how closely spaced they should be before installing the PVC pipe by temporarily installing the standard tier lights with the modified diffuser/sprin-

kler so that the fixtures are about three inches above ground level. That should give you an idea of the illumination level you'll have with the pop-ups.

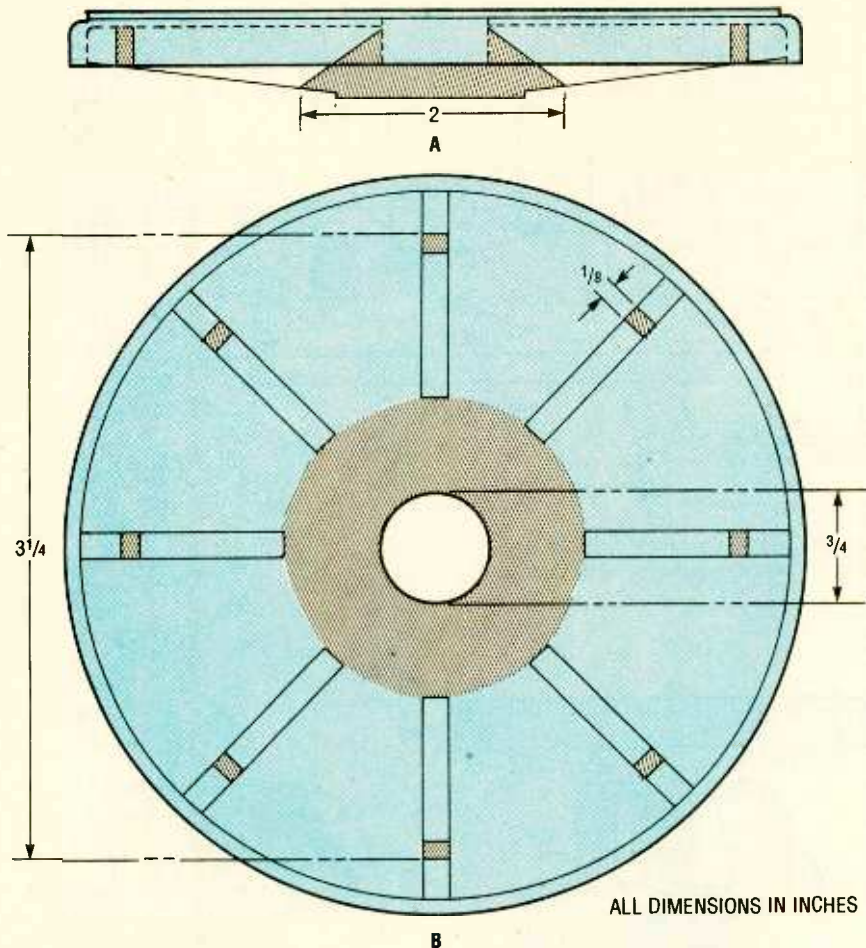

Fig. 6. The underside of the sprinkler head cover will have to be modified. The side view in A shows the portion of the cover that is to be modified. Using diagonal cutters, make the cuts indicated in B.

PVC Pipe and Valve Installation. If you've had any experience at installing garden sprinkler systems, this part should be child's play for you. And even if you haven't, you shouldn't have much trouble. First, check with the appropriate local authority to see if any permits are required for installing underground sprinkler systems. (Although this isn't a sprinkler system, it is similar to one, and the same restrictions may apply.)

The next task is to measure the static water pressure at your location. Ideally, it should be between 35 and 80 psi. If the pressure is higher than 80 psi, you'll have to install a pressure regulator, such as a Drip Mist model P32000 47-psi pressure regulator or a similar unit. If the pressure is lower than 35 psi, you may not have enough pressure to extend the lights.

Now find a place to tap into your main water-service line, on the down side of the water meter. On a piece of graph paper, sketch your yard, show-

ing the proposed locations of the valves and lights, and the routing of the PVC pipe. It's a good idea to install a shutoff valve ahead of the two automatic valves, as shown in Fig. 1. Once you've mapped everything out, it's time for the physical part.

Begin by digging a narrow trench,

about 10- to 12-inches deep from the water source to the proposed fixture locations. After that start laying in the PVC pipe. The author used 1/2-inch schedule-40 PVC pipe in his installation, but you can use 3/4-inch stock if you choose. The PVC pipe can be cut as needed with a hacksaw or a specially made ratchet tool, and joined with PVC fittings. The PVC pipe sections and the fittings can then be secured using fast-drying PVC cement. Once the pipe has been laid, it's time to tap into the water main. First turn off the water main, and make the connection.

Since each installation will be different, no attempt will be made to go into the details of running the pipe from the source to the valves. If you need help, the store at which you purchase the sprinkler-system hardware should be able to provide it, or you may want to have a professional do the job for you.

In any event, choose a location for the valves that is out of the flow of traffic, and yet easily accessible. The author used automatic Lawn Genie valves for SOL1 and SOL2, but any irrigation valve that's controlled by a 24-volt AC solenoid should work. The valve should also have a built-in back-flow preventer. In order for the back-flow preventer to work, the valve must be installed at least six inches above ground. Take note, according to valve manufacturers, the valve should not be left on continuously for more than twelve hours.

At each fixture location, place a PVC fitting into which you can screw a half-inch riser. Each fixture will be enclosed in a Rain Bird pop-up sprinkler case. The riser screws into the bottom of the Rain Bird case. If you live in an area where freezing occurs, it will be necessary to use the side hole in the Rain Bird for the plumbing, and the bottom hole for an automatic drain valve. An automatic drain valve will also be required at the lowest point of the PVC run.

After you've run all the pipe, let the cement cure for a few hours, then cap the risers and give the system a pressure test for leaks. That can be done by manually opening valve A via the bleeder screw. Once that is done, remove the caps from the risers and flush out any material that might have gotten into the pipe.

MANUFACTURERS

Lawn Bird Sprinkler
Lawn Bird Sprinkler Manufacturing Corp.
P.O. Box 37
Glendora, CA 91740

Lawn Genie Valves and Drip Mist Products
GardenAmerica Corp.
P.O. Box A
Carson City, NV 89702-1170

Tier II Lighting System
Intermatic Corp.
Intermatic Plaza
Spring Grove, IL 60081

Light Fixture Modification. Each fixture is made up of a pop-up impulse irrigation-sprinkler case with the sprinkler head removed and replaced by a modified low-voltage tier light. The author used the Intermatic Malibu model LV28712T Tier II low-voltage lighting set in his installation. The set contains 12 lights, 50-feet of cable, a 12-volt power pack (transformer T2 in the schematic and parts-placement diagrams). Tier II lights, model LV181, can also be bought separately. The Tier II lights are combined with the Rain Bird model LG-3 pop-up sprinkler in the author's system, but the MG-4 type sprinkler can be substituted.

First remove the sprinkler head/sleeve assembly from the case. That task will be a lot easier if you use the Rain Bird wrench (model 42064), which can be purchased separately for about \$4. To remove the sprinkler head/sleeve assembly, pry open the lid with a thin screwdriver, then insert the wrench (as per the instructions that come with the sprinkler) and unscrew the assembly. Remove the cover from the sprinkler head by pinching point A in Fig. 5A with a pair of long-nose pliers. Remove and discard the dime-size plug in the cover.

Remove the two metal trip collars from the sprinkler. Take the sprinkler head/sleeve assembly and carefully saw it with a hacksaw at point B in Fig. 5B. Remove the filter from the bottom of the sleeve. The sawed-off piece that falls through the bottom and the sprinkler head can be discarded. Replace the filter screen.

The sleeved portion that screws into the case will be used to extend and retract the modified fixture. It will be necessary to plug the hole in the top of the sleeve to keep the water from reaching the light fixture. A 1/4-inch length of half-inch diameter acrylic rod works nicely for this. Glue it in position with a liberal amount of acrylic cement. The top portion of the sleeve, as shown in Fig. 5C, will have to be slightly tapered to accommodate the light fixture.

Enlarge at least two of the drain holes in the Rain Bird case with a screwdriver. One of the holes will be used to pass the electrical wires through. It will be necessary to modify the underside of the Rain Bird cover so that it will fit snugly on the light diffuser and leave room for the bulb. The cuts,

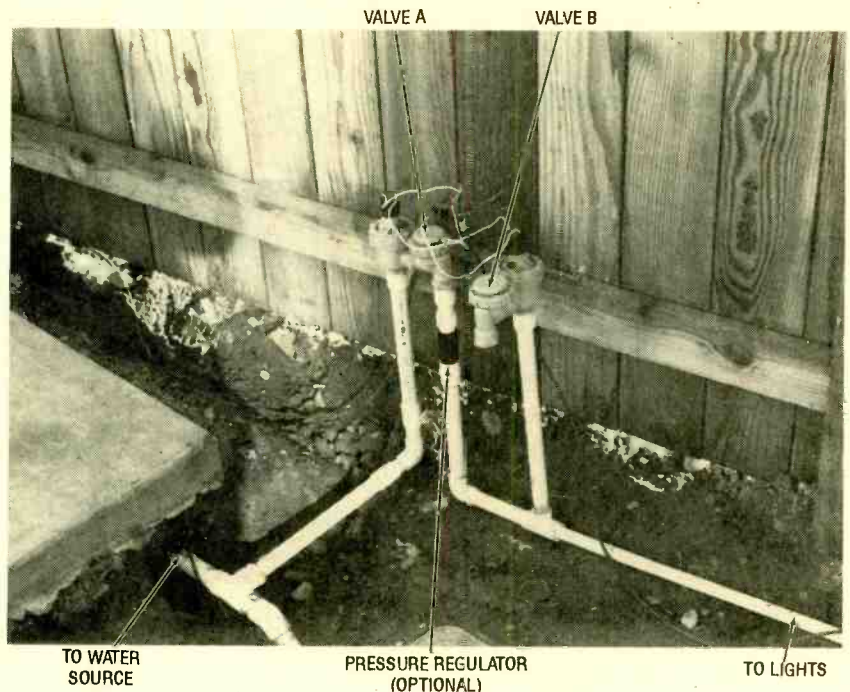

Choose a location for the valves that is out of the flow of traffic, and yet easily accessible.

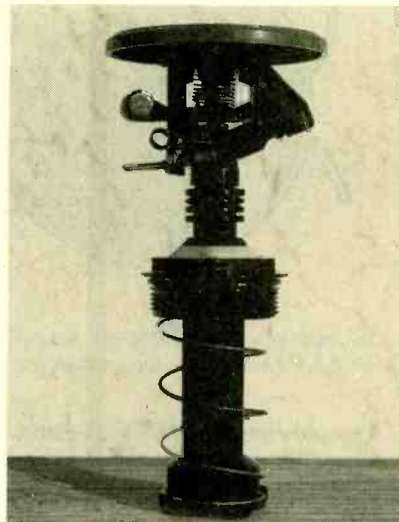

Each fixture consists of a pop-up impulse irrigation-sprinkler case with the sprinkler head removed and replaced by a modified low-voltage tier light. The sprinkler, prior to modification, is shown here.

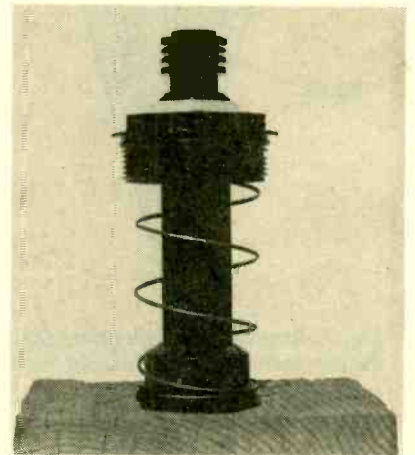

Once the head/sleeve assembly is removed, separate the sprinkler-head assembly from the sleeve by cutting at the appropriate point. Shown here is the sleeve with the sprinkler head removed. It will be used to extend and retract the modified fixture.

which can be easily made with a pair of diagonal cutters, are shown in Figs. 6A and 6B. The gaping hole in the top of the cover now needs to be plugged with something. A disc about the size of a quarter covers the hole nicely. In fact, why not use a quarter? Glue it to the top of the cover.

It is now time to modify the light fixture, as shown in Fig. 7A. Remove and discard the stake and riser, and

then snap off the two shades on the light diffuser. Be careful that you do not crack the diffuser while removing the shades.

The bulb-holder part of the fixture must be trimmed and slotted, as shown in Fig. 7B, so that it will fit on the sprinkler sleeve. It will also be necessary, as is shown in Fig. 7C, to drill a couple of 1/64-inch holes in the bulb holder through which to route the fixture wires. Cut the fixture wires at

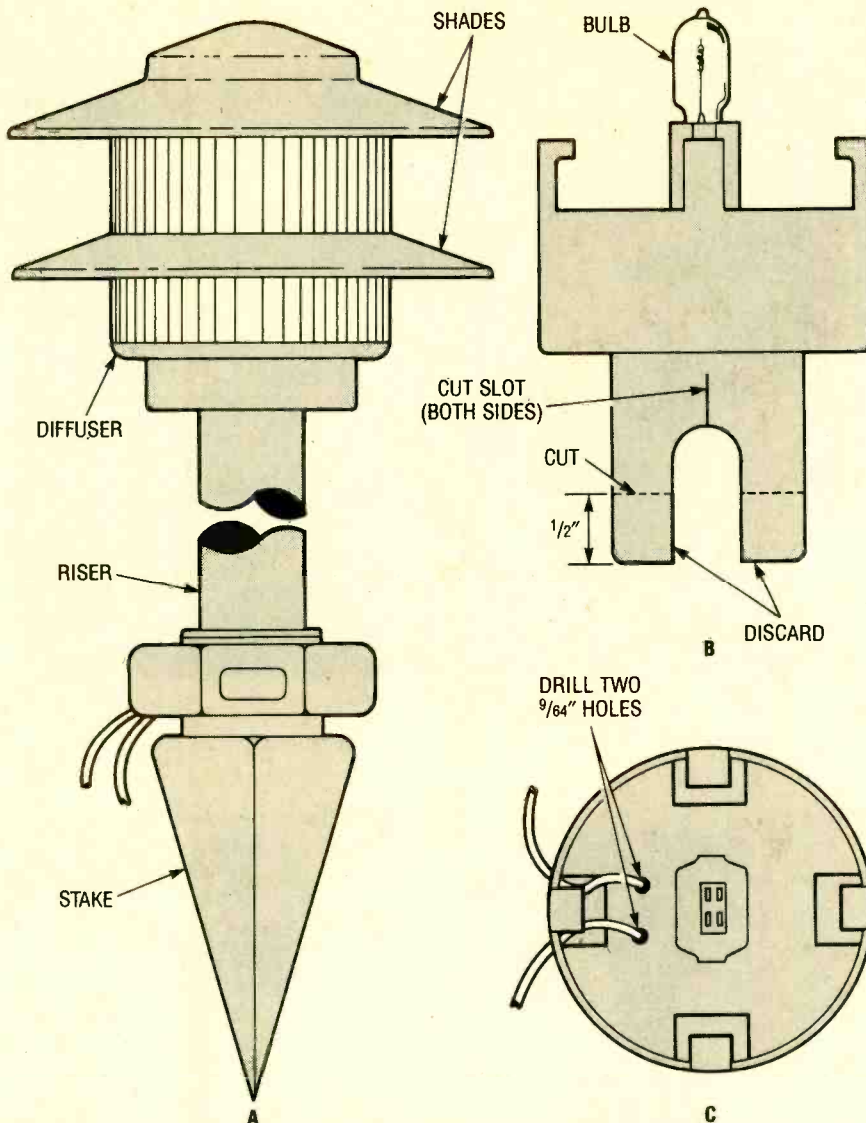

Fig. 7. To modify the light fixture (A), remove the bulb-holder assembly (B) and make the cuts indicated. It will also be necessary to drill two holes (C) in the assembly to route the fixture wires through.

about mid-length and save the piece with the cable connector on it. In order for the fixture to retract completely, a portion of the diffuser must be sliced off the top, using a circular saw with a plywood blade. First determine how much of the defuser will have to be removed. To cut away the unneeded portion of the defuser, hold the saw still, while rotating the diffuser into the blade. The cut should be made at about $\frac{3}{16}$ -inch above the finished height, and then sanded.

You are now ready to install the sprinkler cases. Select a riser length so that the top of the case is at ground level. Place Teflon tape at both ends of the riser to prevent leakage. As per the Rain Bird instructions, the area around the case should be packed with gravel to allow for drainage.

Manually turn on valve A to check for leaks. The sleeves—which may need tightening—should extend within the sprinkler cases.

Run the lighting cable and hang the transformer, as per the light-set instructions. Install the modified light fixture with diffuser onto the sprinkler sleeve. The fixture should fit snugly enough so that gluing is unnecessary. That will allow for easy removal if necessary. Again extend the sprinkler sleeve by manually opening valve A. Firmly place the cover on the diffuser. That will eventually be glued on, but not yet. Now, close valve A and open valve B, allowing the fixtures to retract. If they don't seat completely, you may need to push them down a little.

Extend the fixtures one more time to connect the fixture leads to the cable.



The author used the Interatic Malibu model LV28712T Tier II low-voltage lighting set (shown here), which must be modified, in his installation.

Use the pieces that you cut from the fixture wires to connect between the cable and fixtures. Make your splice inside the sprinkler case for easy access. The lid can now be glued onto the diffuser.

Testing. Now comes the moment of truth. Check the connections between the printed-circuit board, transformers, and fixtures against Fig. 4. After checking that the water main is on, turn on the lights from transformer T2. There may be a slight discharge of water from the release valve. That is normal. The fixtures should extend immediately, and start to retract as soon as the lights are turned off. If they don't, check to see that all the IC's are getting power. With 5.1 volts applied to U2, pin 6 of U2 should be high and the outputs of U4 at pins 3 and pin 11 should be low. When you turn off the lights, U2 pin 10 should go high for about five seconds. If all that checks out, put an AC voltmeter or scope across SOL1 (points A and D) to ensure that 24 volts AC is present when U4, pins 3 and 11 go low. If the proper voltage is missing from the solenoid, but is present across transformer T1, check Triac TR1.

If everything works okay, quickly turn the lights on and off again. The fixtures should stay down. With the lights on, quickly cycle them off and on again. The fixtures should remain extended. If they don't, you have a problem with U4. Once everything is working, fill in the trench and you are done. ■

WIRE

BEAMS:

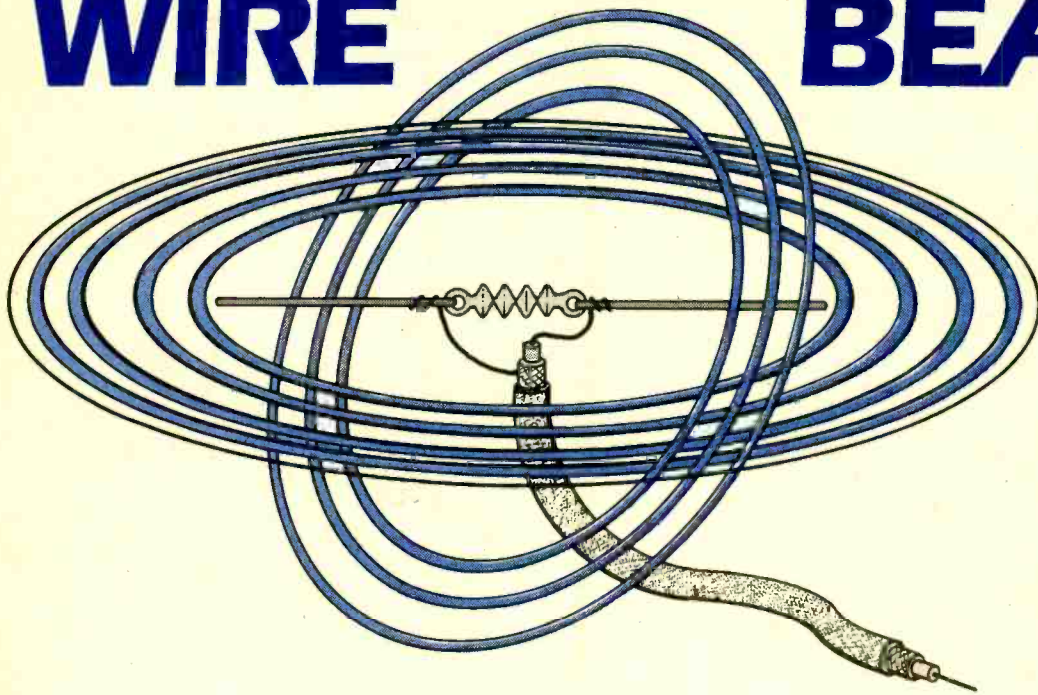

Gain on the Cheap

*Nothing can give your ham rig
better bang per buck or labor than a good antenna.*

BY JOSEPH J. CARR, K4IPV

Antenna design is a perennial topic for radio buffs. Whether you are a shortwave listener, amateur-radio operator, scanner monitor, or a citizen's bander, the antenna is probably the most important aspect of your set-up. While a great deal can be done to improve receivers, transceivers, and transmitters, for the radio buff's dollar there is nothing that will produce as much benefit per nickel as a good antenna system. And the antenna need not be terribly expensive. While a multi-kilobuck rotatable beam antenna is certainly a wonderful thing to have, not all of us can afford such an antenna or have the space to put one up. In some areas, a really nice commercial antenna isn't even legal because of local zoning regulations, etc.

Fortunately, wire antennas can be built for less than commercial antennas. They can be installed in areas where a tower cannot, or where one

would be prohibitively expensive to install. A wire antenna is also well worth considering because it provides convenience and low cost, and some designs can provide a surprising degree of gain and directivity.

Gain and Directivity. Gain and directivity are the two interrelated aspects of antenna design that make a good antenna so important to a radio system. These two concepts are essentially the same because antennas obtain "gain" by focusing the RF energy into limited directions rather than all directions. Gain is measured by comparing the strength of a signal radiated by an antenna in each direction to the signal strength that would be produced by an ideal isotropic radiator (*i.e.*, a uniform sphere). The signal produced by such an ideal antenna could be viewed as an ever-expanding series of spheres with the antenna at the center (something like

the layers of an onion). The larger a sphere's radius, the greater its surface area. Since all the spheres should have the same amount of RF energy but different surface areas, signal strength is measured in milliwatts per square centimeter (mW/cm^2).

A directional antenna focuses all of its energy into a limited direction, so more energy is found in each unit of area along that direction. In other words, the signal strength in mW/cm^2 increases along that direction. Because of its inherent directivity, such an antenna provides the following:

- Increased received signal strength from distant transmitters (*i.e.*, makes a received signal louder).
- Freedom from strong interfering signals from directions not the same as the signal of interest.
- Increased transmitted signal strength at distant locations (*i.e.*, makes your signal louder).
- The Law of Reciprocity makes the

antenna perform during reception as it does on transmission, so the same design can benefit both types of user.

The first two items on the list benefit all users of radio equipment, while the final one helps CB'ers and hams. The first benefit (*i.e.*, making distant signals stronger) is probably not the advantage it seems at first blush except to a small percentage of radio amateurs. Increasing the received strength of "Radio Zlotplatz" is only of marginal benefit if it is already audible at your location and your receiver has both an automatic gain control and reasonable selectivity. The gain is of use, however, when attempting to listen to stations that are so weak that they are near the noise threshold. Increasing antenna gain may well bring such a station up enough to hear audibly without also increasing the overall noise as much as would a pre-amplifier.

So what use is a gain antenna if a random length of wire tied to a convenient tree will give us a strong enough signal? Recall that gain and directivity are merely restatements of the same thing. The selectivity of your receiver will help eliminate adjacent channel interference. You can narrow the passband down, use "single signal" techniques (where appropriate) and otherwise shunt unwanted adjacent channel signals off to oblivion.

Co-channel interference is a different matter. If the offending signal is on the same channel, then the receiver will "hop around" trying to eliminate it. But, if the offending signal is coming from a different direction than the desired signal, it is possible to place the low-gain "null" of the directive antenna in that direction. Thus, the offending signal is attenuated by the antenna's directionality.

The trick of using an antenna to select signals is well known to those who use rotatable antennas. What is perhaps a less popular fact is that you can derive the same benefit from a judiciously placed fixed antenna. For example, an "east coaster" might want to aim an antenna so that it picks up shortwave transmissions from Africa, South America, Europe, or Oceania, while at the same time eliminating signals from other regions (you might be surprised by what's buried underneath the North American Service of Radio Moscow). The null could

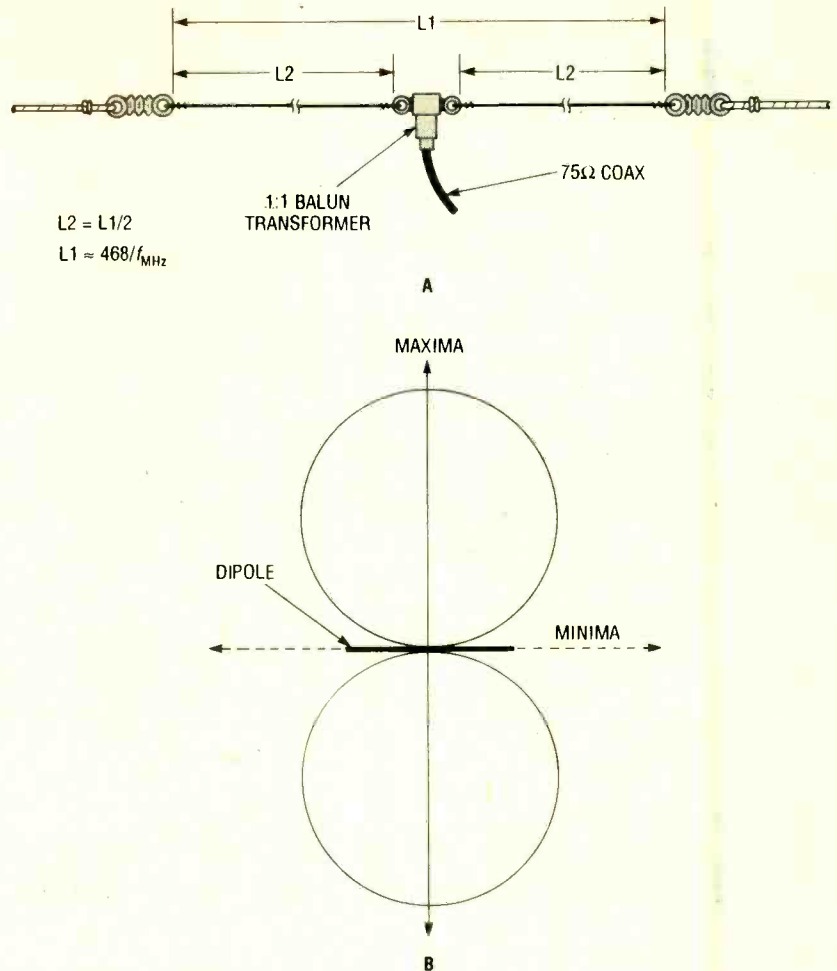

Fig. 1. In "A" is a simple half-wavelength dipole antenna. Ideally it should produce a radiation pattern like the one shown in "B."

be placed in the direction of the offending signal (or cacophony of signals), even though the main lobe (*i.e.*, direction of maximum gain) is not directly on the area of interest.

The phenomenon is not limited to shortwave listeners and hams. Indeed, scanner users and FM-band DX'ers may have even greater need for directivity and gain. If you are far removed from a station, then the gain feature of an antenna may be attractive to you as well. Or, if you want to listen to a distant station on the same channel as a stronger, nearby station, then directivity may be just what you need. A friend of mine used to listen to a bluegrass music station 90 miles away with usable, if noisy, reception... until another station occupied the same channel closer in. Fortunately, the new station was about 40 miles distant in a different direction, so a gain antenna with a good directivity did the trick. Before we discuss the various antennas you can use to im-

prove your own set-up, another topic deserves attention: Safety!

Rules to Follow. Erecting antennas can be a dangerous affair. Every year the radio community is saddened by stories of people who were killed or seriously injured in the act of erecting antennas. The most serious threat comes from foolishly attempting to erect a wire antenna by tossing it over AC power lines. While it may be tempting to do so, especially when the most convenient support structures are on opposite sides of the power line, this feat **must never be attempted!** The argument that both antenna and power wires are insulated does not help, for insulation can and does deteriorate and falls apart with remarkably little force. It is *never* safe to do that trick, so **don't!**

Also, keep in mind where the antenna will go if it breaks. Look around the yard and determine whether or not it will be capable of "wind-whipping"

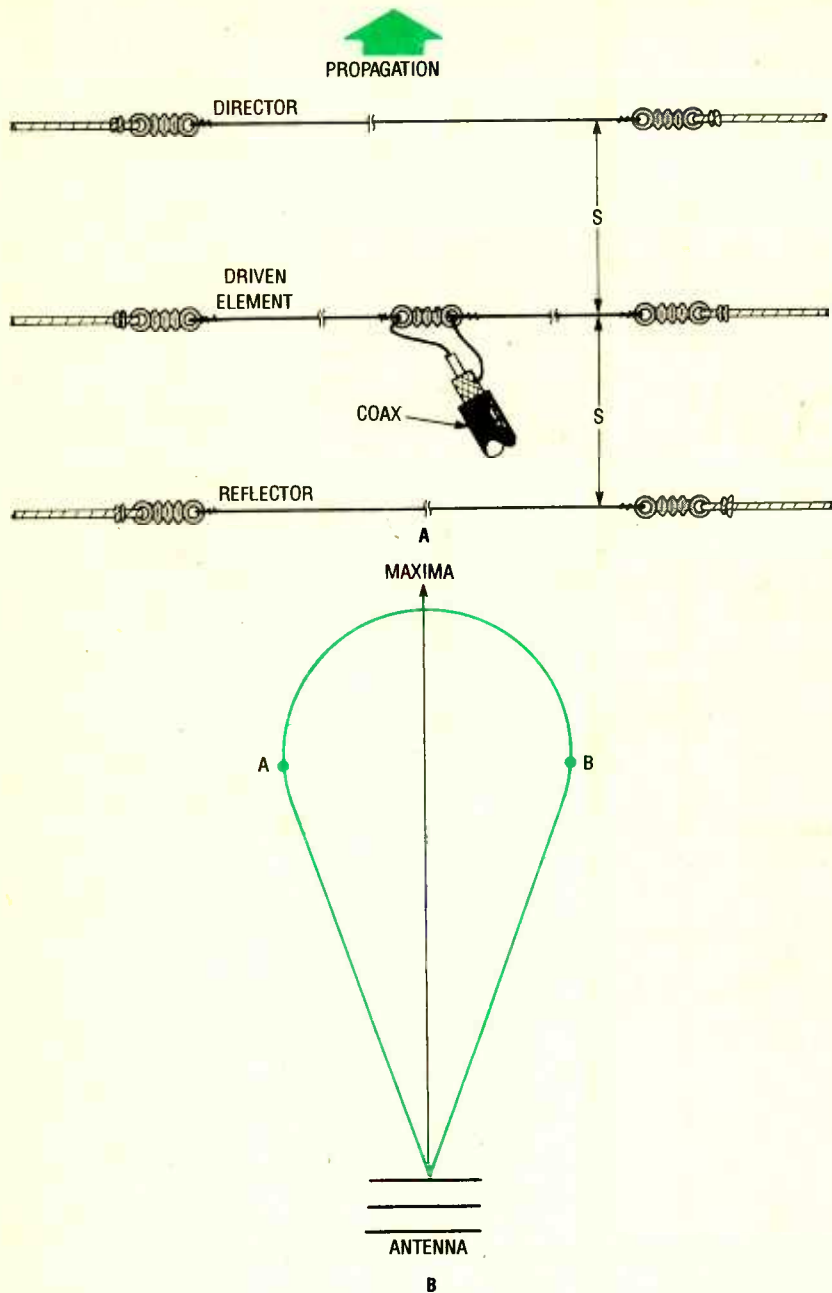

Fig. 2. You can improve the performance of a dipole by adding director and reflector elements that force the RF energy to move in a given direction.

into a power line, or if it will become a hazard on a path or sidewalk, or if it will crash into a window or vehicle (insulators and baluns will break glass when wind whipped).

Use properly designed insulators, not *ad hoc* substitutes, for the end and center insulators. The rope should be sufficiently strong to hold the antenna under all wind conditions, and should be tied to a spring or counterweight to permit some give. Use good quality No. 12- or No. 14-gauge wire. Copper-weld is a steel core, copper-clad wire intended for this purpose.

Finally, when erecting the antenna, especially if standing on a ladder, be aware of where the wire is at *all* times. It can easily become entangled in your feet or ladder support, and cause a serious fall. Always work with another person so that help is near at hand; young readers should work with a knowledgeable adult until they are also experienced in the antenna-erection process. Wire antennas *seem* very easy to erect alone, but that's a fool's game from a safety perspective. With these important points covered, let's get to those antennas.

The Half-Wavelength Dipole Antenna. Although disdained by the technically sophisticated (without good reason), and despised by owners of super-arrays, the "lowly" dipole (Fig. 1) is the least expensive and most common form of directional wire antenna. It is a horizontal half-wavelength radiator fed at its center. Although the feedpoint impedance varies with height above ground, the dipole usually makes a good impedance match for 75-ohm coaxial cable. The overall length of the antenna (L1) can approximately be found by using the equation in Fig. 1 where L1 is in feet, and f is the frequency of interest in megahertz. The length is only approximate because local conditions can conspire to alter the electrical length a bit, so some tuning must be done on any antenna once it is erected. The length of each element (L2) is about one-half of L1 as shown.

The ends of the dipole are supported by end insulators and lengths of rope. The rope can be attached to trees, masts, buildings, or other structures. The feedpoint of the dipole can be constructed with another end insulator such that the center conductor of the coaxial cable is connected to one L2 radiator element, while the shield is connected to the other radiator. A better result, and a more consistent pattern, will result if the coaxial cable is connected to the antenna through a 1:1 balun (which stands for *balanced-unbalanced*) transformer. They are readily available from radio-supply outlets, or can be homemade from toroidal transformer cores following instructions given in various texts (see the boxed copy entitled "For Further Reading" appearing with this article).

Figure 1B shows the radiation pattern for the dipole antenna. This view is from above. Note that the pattern is a figure eight with the main-lobe maxima perpendicular to the radiator element. The minima, or nulls, are the directions of minimum gain and are in line with the radiator element. In other words, if you want to null a station to the west or east, and receive along a north-to-south line, then run the antenna east to west. The antenna pattern in both the horizontal and vertical directions is best for most applications when the antenna is at least one half-wavelength from the ground, and is

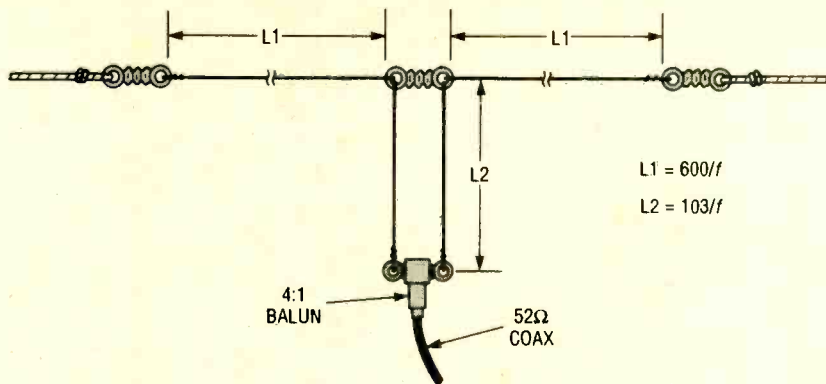

Fig. 3. The double-extended Zepp antenna is similar to a plain dipole, but it has a matching section and a balun at its feed point.

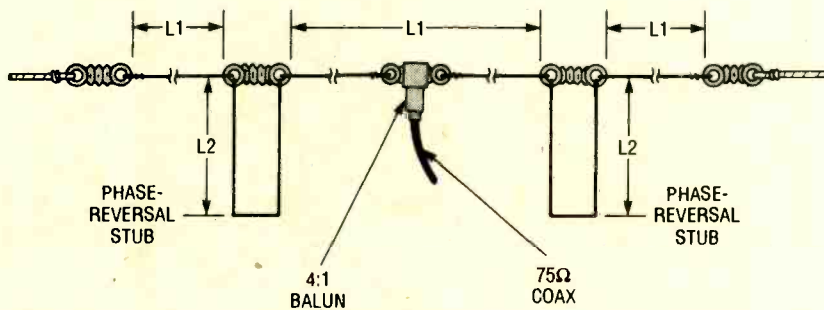

Fig. 4. The collinear Franklin-array antenna, shown here, can be extended to contain any number of elements. The number is only limited by the weight your rope can handle.

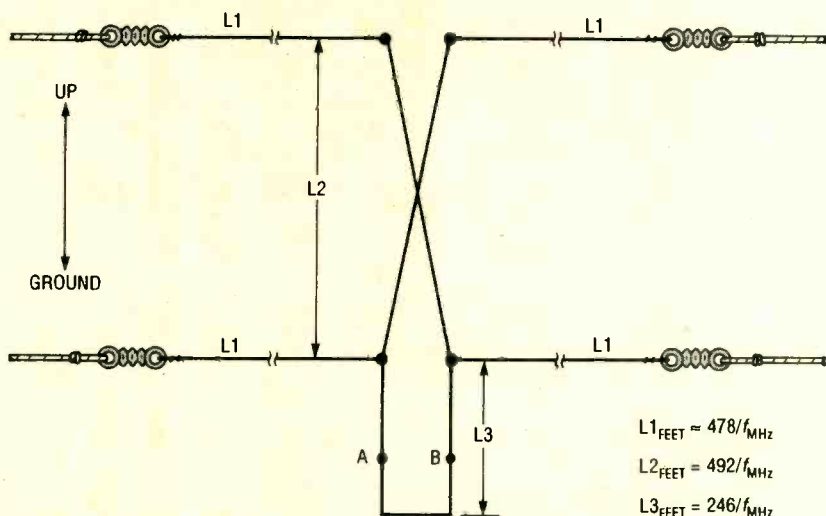

Fig. 5. The lazy-H antenna consists of two dipoles pointed in opposite directions. The feed points for the antenna (points A and B) need to be determined by experiment.

preferably several wavelengths above ground (which is nearly impossible on lower frequencies).

The dipole is the easiest directional antenna to build and use, and it is also the most well behaved when it comes to tuning. It has a gain of approximately 1.7 decibels (dB) above the ideal isotropic radiator mentioned above.

antenna is a directional beam antenna that is made from dipole elements (see Fig. 2A). Most of the large rotatable antennas used on shortwave and VHF bands are basically tubing-based versions of the Yagi concept. The pattern for the Yagi beam antenna is monodirectional, as shown in Fig. 2B. This pattern is, incidentally, idealized and doesn't show sidelobes and backlobes that represent wasted energy, but hopefully those are kept low

enough to not be a problem. The beamwidth of the antenna is the angle between points "A" and "B" where the gain falls off - 3 dB from the gain at the maxima.

It is possible to make a fixed Yagi beam antenna from wire and insulators, as shown in Fig. 2A. The driven element is a half-wavelength dipole similar to the one in Fig. 1A; its approximate length (before tuning) is found from the equation for L1 presented earlier. The driven element can be fed either directly as shown, or through a 1:1 balun transformer to 52-ohm (not 75-ohm) coaxial cable. The element in the direction of maximum radiation is called a director, and is about 4% shorter than the driven element. Similarly, a reflector is behind the driven element and is about 4% longer than the driven element. Although the antenna in Fig. 2A has one director and one reflector, it is possible to use any number of reflectors and directors (and each one narrows the beamwidth and therefore increases the gain of the antenna.

The spacing (S) between elements can vary from approximately 0.15 wavelength to 0.25 wavelength, or 0.3L1 to 0.5L1 to use the half-wavelength element lengths as a frame of reference (many builders try to make the spacing 0.2 wavelengths). The spacing is difficult to maintain, especially as the wind blows . . . but it is not strictly necessary to always have the spacing exact.

Double-Extended Zepp Antenna.

The double-extended Zepp antenna, shown in Fig. 3, provides a gain of about 2 dB at right angles to the antenna wire plane. It consists of two sections of wire, each one of a length based on the desired frequency of use as shown in the figure.

The D.E. Zepp antenna can be fed directly with 450-ohm twin-lead (available from Wire Antenna Supplies Radio Works, P.O. Box 6159, Portsmouth, VA, 23703), especially if a balanced antenna tuner is available at the receiver or transmitter end. Alternatively, it can be fed from a matching section of twin lead (or parallel line) as shown if coax is preferred. Use the equation shown in the figure to determine the length of the matching section (L2).

(Continued on page 91)

Build a

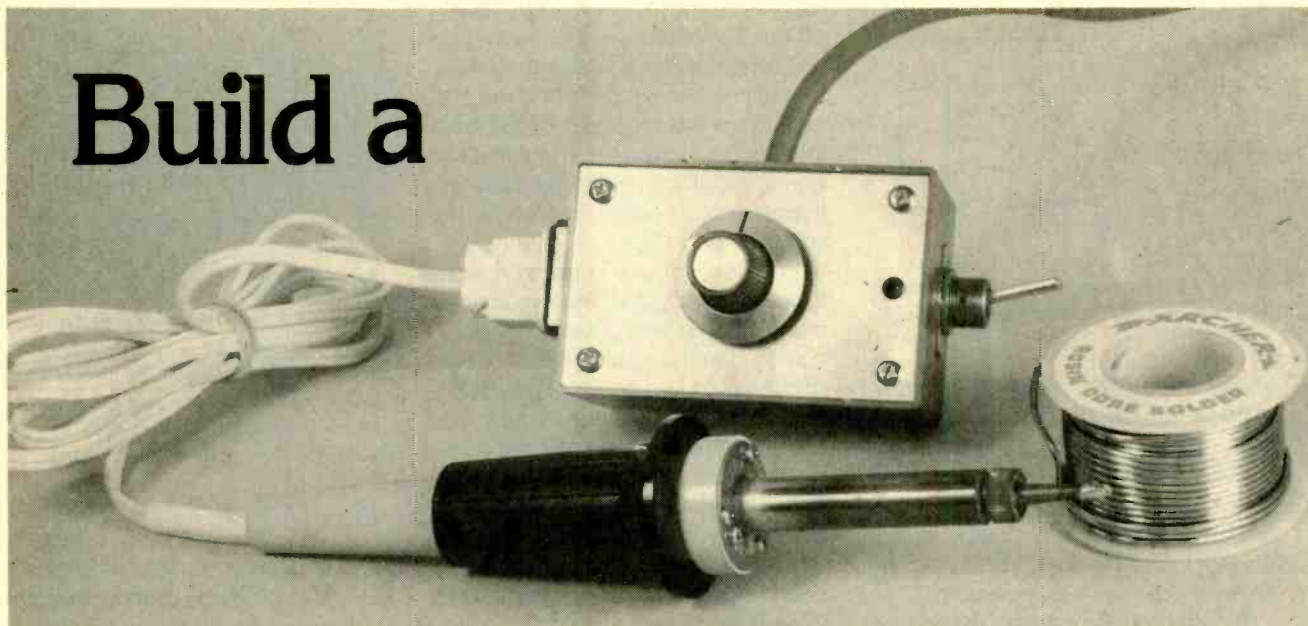

Soldering-Iron Controller

Tone down the temperature of any soldering iron with this precision controller

BY JOHN J. YACONO AND MARC SPIWAK

Soldering has always been something that requires a bit of experience to do properly. However, even for the experienced, too-hot a soldering iron can lead to trouble. Sure you can go out and buy an adjustable-temperature soldering station, but at great expense. Now this is where the *Iron Leash* described in this article comes into play; it will let you adjust the temperature of any old soldering iron, although it's best with an iron of 25 watts or less—at least with the parts we've chosen. And the best thing about the Iron Leash is that the circuit can be built for under 10 dollars, depending on what parts you may have on hand already.

Not only is the device handy and inexpensive, but it also uses some ordinary parts in an extraordinary manner. So let's take a look at the circuit and see what makes it tick.

Current Regulation and More.

Many of the circuits that appear in these pages contain voltage regulators, and that's as it should be. All circuits require power, and most circuits require it in the form of well behaved (read that "constant") DC, and

no IC is better at supplying tame DC than the common voltage regulator. They provide excellent ripple rejection. They are also very safe devices and most shut off if overheated. Regulators often have a short-circuit shut-down feature as well; if the load shorts out, the device's output shuts off.

As you may be aware, a subset of this important family of IC's are adjustable. By using two resistors, you can "program" such a unit to supply voltage at a desired level... at least that's their typical use. Many of them can be used as current regulators and they can even play a role in AC applications.

In the normal course of operation, an adjustable regulator tries to maintain a specific voltage called the reference voltage (typically between 1.2 and 1.5 volts, depending on the regulator type) across an external resistor. The resistor in question is shown as R1 in Fig. 1. It does that by producing current flow between its output and adjust terminals. However, it limits the current flow through the adjust pin to a bare minimum (typically from 40 to 100 μ A depending on the temperature and the particular regulator.) The

remainder of the current is forced through R2. The combined resulting voltage drop across R1 and R2 is the desired output voltage.

By Ohm's law, since the regulator tries to maintain the voltage across R1 at a specific value, the current through that resistor (which is essentially equal to the current through R2) depends on R1's value. If we know the regulator's reference voltage (V_{ref}) we can set the value of R1 to deliver a precise amount of current to R2 as follows:

$$I = V_{ref}/R1$$

If R2 is actually the load for the circuit, then the regulator and R1 form a current regulator for the load.

That technique should only be tried with "floating" adjustable regulators. Floating regulators do not need to be referenced to ground, so the load can be light or even shut off without causing harm to the regulator. Many common adjustable regulators are floating, so that is not a difficult requirement to fill.

To see how such a regulator might be used in an AC application, look at Fig. 2. That is the circuit for the Iron

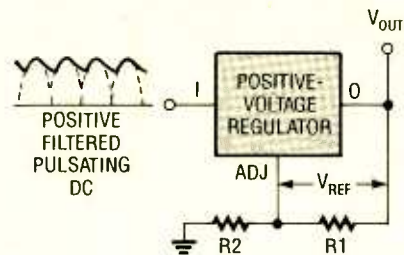

Fig. 1. Floating adjustable regulators can be used as current limiters. Resistor R1 programs the current flowing through R2.

Leash. Integrated circuit U1 (a high-voltage regulator) is configured as a current regulator just as we've described. Resistor R1 limits the current flow to an absolute maximum value and R2 (a variable 5-watt wire-wound resistor) allows the user to set the value of current below that maximum.

The current regulator is placed between the DC terminals of a bridge rectifier composed of D1–D4. That means the regulator is only exposed to DC. However, the AC socket (SO1) and AC plug (PL1) are both outside the bridge (i.e., in the AC portion of the circuit). That allows the current regulator to be in series with the AC legs of the circuit, and even control the current through them, without direct exposure to AC.

That is how the Iron Leash does it's

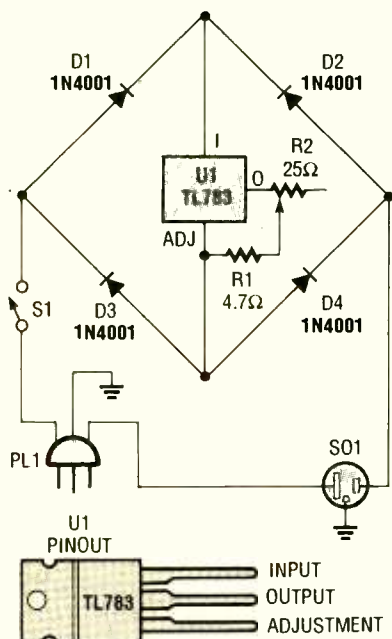

Fig. 2. This is the Iron Leash in the buff. The application is unusual, but functional. With the component values specified, the circuit should be used with a soldering iron of 25 watts or less (see text).

job. As you may know, the heat given off by a resistive element, such as a soldering iron tip, is equal to its resistance times the square of the rms current. Since the regulator circuit limits the maximum current through the soldering iron, it limits the rms current and therefore the heat dissipated by the iron tip.

There are some interesting advantages to this scheme: The circuit emits less RFI than a Triac power-control circuit. To control power output, a Triac circuit would turn on 120 times a second and generate harmonics that can interfere with delicate test instruments or ham-radio equipment. On the other hand, the Iron Leash just curtails current flow to a set maximum, it doesn't turn anything on or off, so you can leave your iron hot while testing RF sensitive circuits.

PARTS LIST FOR THE IRON LEASH

SEMICONDUCTORS

- U1—TL783 high-voltage regulator, integrated circuit
- D1–D4—1N4001 1-amp rectifying diode

ADDITIONAL PARTS AND MATERIALS

- R1—4.7-ohm, 1/2-watt, 5% resistor
- R2—25-ohm, 2-watt, wirewound potentiometer
- PL1—3-terminal AC power plug with line cord
- S1—SPST power switch
- SO1—3-terminal AC socket
- Project case, high-efficiency heat sink (or case with a metal lid, see text), heat-sink compound, regulator-mounting hardware (including mica insulator), rubber grommet, potentiometer knob, solder, wire, etc.

Construction. The circuit for the Iron Leash is so simple that it would be silly to go through the trouble of making a PC board for it, so we decided to go with point-to-point wiring. We didn't even use any perfboard; connections were twisted together and insulated with heat-shrink tubing. The line cord enters the case through a rubber grommet, and the AC outlet, control potentiometer, and on/off switch are mounted in holes drilled in the case.

Choosing a case to house the circuitry should be carefully thought out.

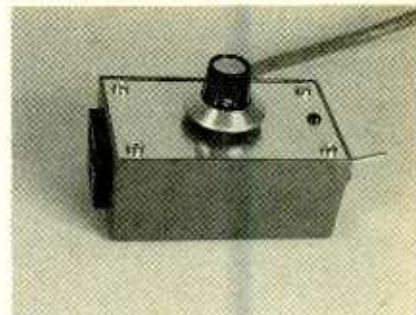

Everything fits inside this small project case; the metal lid is being used as a heat sink. Mounting an AC socket to the side of the enclosure allows the Iron Leash to be used for more than a soldering-iron temperature control.

We built the unit as a stand-alone device—in other words, it's basically a variable-current outlet. Therefore, the device can also be used for things like dimming a low-wattage light bulb—again, it's best if it's 25 watts or less. However, if you feel that you will use it only for a soldering iron (as will be the case with most people), you may want to incorporate a soldering-iron stand and sponge into the case. You can even hard wire the iron directly to the circuit to avoid purchasing an AC socket. Before we get down to "choosing" a case, let's talk about why it's best to power a load of 25 watts or less with the parts we've chosen.

Most voltage regulators, unless called upon for extremely light-duty work, do require heat sinking (you know, the little metal tab with the screw hole in it must be secured to some kind of heat-dissipating material). And regulator heat sinking is a must for the Iron Leash; it would simply overheat and either shut down or destroy itself after a short time in use.

Knowing that our Iron Leash would require heat sinking, we found a small plastic project case that all of the parts could be crammed into—but it has a metal lid that we used as a heat sink. If it were not for the metal lid, a separate heat sink would not have fit into the case. We'll get into how you use the lid as a heat sink in a moment, but as for why a 25-watt load is a maximum, this is the reason: The metal lid gets too hot for comfort with anything over 25 watts.

So, if you can find a similar case that all of the parts you choose will fit into, then use it. However, keep in mind that the metal tab on the regulator is elec-

(Continued on page 91)

Create A High-Voltage Miniature Tornado

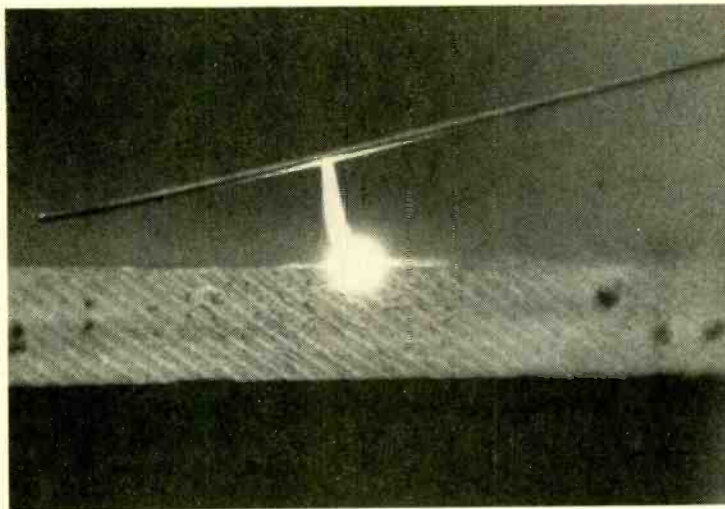

Fig. 1. Note the tornado-like vortex shape and the fireball at the tip of the discharge. The cathode here is a slate tile.

Create a high-voltage discharge with some unusual properties.

BY R.A. FORD

When performing some experiments with high-voltage DC discharges a few years back, I discovered a most interesting phenomenon. I was able to create a small, tornado-like vortex with a fireball-like tip. The vortex would slowly traverse a surface in a snake-like motion, just as is seen in a full-scale tornado.

A Miniature Electric Tornado. To create the tornado, an unglazed clay flower pot or a slate tile is moistened and used as a cathode. The anode is a short section of plain steel piano wire or brass wire, .015 inches to .030 inches in diameter and well-polished.

In the photo in Fig. 1, the cathode is a piece of unglazed red-slate tile. Note the vortex shape and the bright fireball at the tip. An unglazed red clay flower pot is used as the cathode in Fig. 2. Once the vortex and the fireball forms, it will move about the cathode in a seemingly random manner. However, in fact what the discharge is doing is seeking the path of least resistance.

Another interesting phenomenon seen in Fig. 2 are two fireballs, one without a vortex, that have formed spontaneously within fissures in the clay's surface. The lifetimes of such fireballs vary from a few seconds to five minutes.

Cautions. If you, like I, enjoy experimenting with high-voltage electricity,

you may want to try to recreate these effects for yourself. However, there are some warnings and cautions you must observe. For one thing, the power supply used to create the tornadoes and fireball shown in this article was 16,800-volts DC at 30 milliamps and is **exceptionally dangerous**. We will not detail the supply further here. Suffice it to say that **if you are not familiar with suitable supplies, you probably do not have the needed experience to work with these types of voltages and we do not recommend that you attempt to duplicate these experiments.**

Further, note that **the dazzling white fireball is hot enough to permanently etch black tracks into clay**, as is shown in Fig. 2. You can imagine what it might do to skin and fabric. Also, remember that the cathode is moistened; **the heat gener-**

WARNING!! This article deals with and involves subject matter and the use of materials and substances that may be hazardous to health and life. Do not attempt to implement or use the information contained herein unless you are experienced and skilled with respect to such subject matter, materials and substances. Neither the publisher nor the author make any representations as for the completeness or the accuracy of the information contained herein and disclaim any liability for damages or injuries, whether caused by or arising from the lack of completeness, inaccuracies of the information, misinterpretations of the directions, misapplication of the information or otherwise.

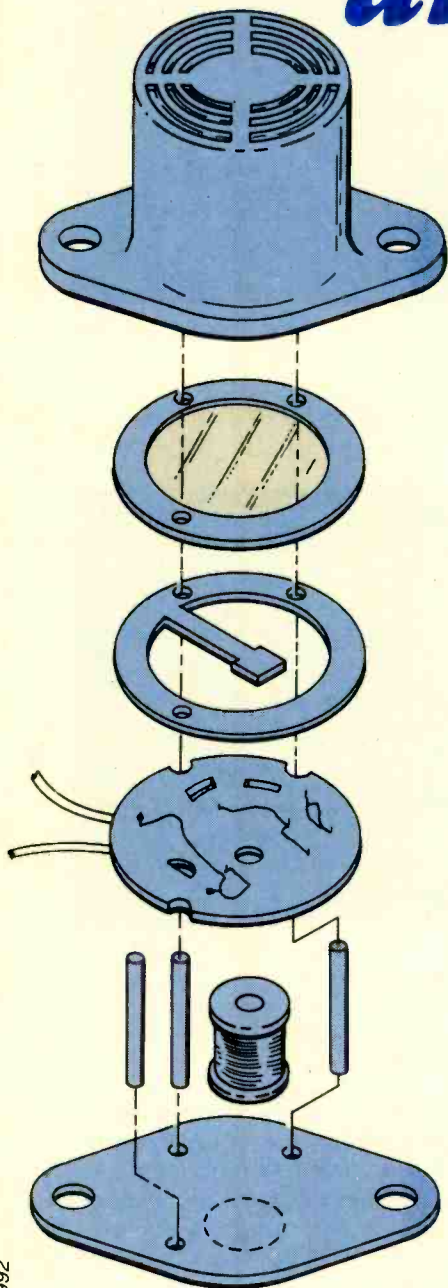

Fig. 2. Two fireballs have spontaneously formed within fissures in the clay pot's surface. Note that the discharge is hot enough to permanently etch black tracks in the clay.

ated may cause flash steam explosions so some type of eye protection is a must. Also, for best results make sure that the wire anode does not vibrate; such vibrations can prevent a vortex from forming, or disrupt one that has already formed.

If you are interested in learning about or performing other high-voltage electrostatic experiments, you may want to refer to my book *Homemade Lightning: Creative Experiments in Electricity*. Published by Tab Books (Blue Ridge Summit, PA 17294-0850), it offers a combination of science history, electronics theory, and hands-on experiments and projects in that fascinating field. ■

AUDIO INDICATORS and ACOUSTICS



BY VAUGHN D. MARTIN

We explore all that goes into creating acoustic transducers and provide useful tips for getting the most out of them in your circuits.

All electronics hobbyists have used audio indicators in their projects, but few know just how much goes into designing one. There are many factors that affect how well an acoustic transducer performs. Some are not obvious, even to an electronics hobbyist. For example, should an annunciator be designed to produce pure or harmonic-rich tones? This is an important consideration since pure tones seem to attract attention better than tones rich in harmonics. Research into human hearing shows that pulsating tones in the 2 to 4 kHz range are the best attention getters. However, sound waves of a pure tone form standing waves. That causes dead spots. That is why audio indicators are usually designed to be rich in harmonics.

Loudness. A more obvious measure of transducer performance is loudness. However, loudness is difficult to characterize. For example, the loudness of sound is partly a function of its duration. The shorter the sound, the less the ear notices it. For that reason a sound of a duration of less than one second is called an "impulse sound."

Loudness is also difficult to define because the human ear is not equally sensitive to all audio frequencies. This lack of fidelity becomes even more pronounced at low sound levels. That being so, the primary "instrument" used for measuring loudness is the human ear!

The loudness level of any sound is defined by having a group of people compare it to the sound-pressure level of a standard tone. The standard sound is a pure 1-kHz tone or narrow-band noise centered around 1 kHz. A sound which is judged to be as loud as a 40 dB 1 kHz tone is said to have a loudness level (commonly denoted L_s) of 40 "phons," which is a unit of measure for loudness. Because of the nature of the ear, the phon scale is logarithmic.

Figure 1 contains a family of curves indicating the sound pressure level required at any frequency within the

range of human hearing to produce the same apparent loudness (number of phons) as a 1-kHz pure tone. As you can see, the ear is most sensitive to sounds in the 2–5 kHz range.

As accommodating as the phon scale is, it does not completely describe how we hear sound. For example, it is difficult to add "loudnesses" in phons. If you were to have two sound sources, say one at 200 Hz with a loudness of 70 phons and the other at 4 kHz at 70 phons, does the total equal 140 phons? No, unfortunately it does not; it equals 80 phons.

In an effort to obtain a quantity proportional to the intensity of the loudness sensation, another loudness scale was defined. This scale has a unit of loudness called a "sone." One sone corresponds to a loudness level of 40 phons. For loudness levels of 40 phons or greater, the relationship between the numerical values of loudness level, L_s (in phons) and loudness, S (in sones) was developed as follows:

$$S = 2^{(L_s - 40)/10}$$

Sound Levels. The measurement of a transducer's sound output, as opposed to apparent loudness, has also been tailored to the human capacity to hear. Sound output is measured as the sound pressure level (SPL), and is specified in dB. Zero dB is usually specified as sound that produces a pressure of 2×10^{-4} dynes/cm², which is the smallest, barely detectable sound the ear can hear. So, to convert the measured pressure of a sound wave into dB's, you would use:

$$\text{dB} = 20 \text{ Log (measured pressure}/0.002 \text{ dynes/cm}^2)$$

The sound pressure at which the ear experiences pain is 3,000,000 times greater than that (130 dB's), which is why a logarithmic scale is used.

Some manufacturers list SPL in terms of "dBA." The letter "A," means that a particular frequency-weighting method of measurement was used. Weighted measurements are taken using meters that have networks that pur-

posedly act like filters that approximate the sensitivity of the ear. The "A" network, the most commonly used one, approximates equal loudness curves at 40 phons. It has a peak response at 1,700 Hz with roll off above and below that frequency. There are "B" and "C" networks also, but they respond to pure tones differently than A networks. But you may wonder how these measurements are taken. Read on . . .

Taking Measurements. To make accurate measurements of the sound produced by a transducer, you would have to take them in an "anechoic" room—a room without echos. Such a room has all its walls and ceilings covered with highly absorbent material (with that familiar egg-carton look). Figure 2 is an illustration of a typical set-up for plotting SPL versus frequency in such a room.

There are various precautions that must be taken when making such measurements. For example, the piezo transducer and the microphone must be mounted to minimize the reflections caused by objects in the source field (the room).

Further precautions must be taken when choosing the microphone (which is usually mounted on a tripod): it must be equally sensitive to all frequencies in a totally omnidirectional fashion. It should not discriminate against any possible paths of sound reaching it.

The last consideration is the distance between the microphone and the transducer. Sound propagation in free standing air can be compared to waves in water; the waves uniformly disperse in all directions, so they decrease in amplitude as they move away from their source or origin. This decrease in amplitude is one-quarter as the distance doubles. Since the sound pressure depends on the distance from the source, the distance from the buzzer to the microphone is kept constant for the test.

The oscillator is made to sweep a range of frequencies. As it does, the microphone transforms the varying sound pressure into proportional voltage signals. These signals are amplified and a sound-level meter determines their true RMS value. An RMS-to-DC converter is used to interface the output of the sound-level meter to the Y input of the chart recorder. The control voltage of the sweep generator is si-

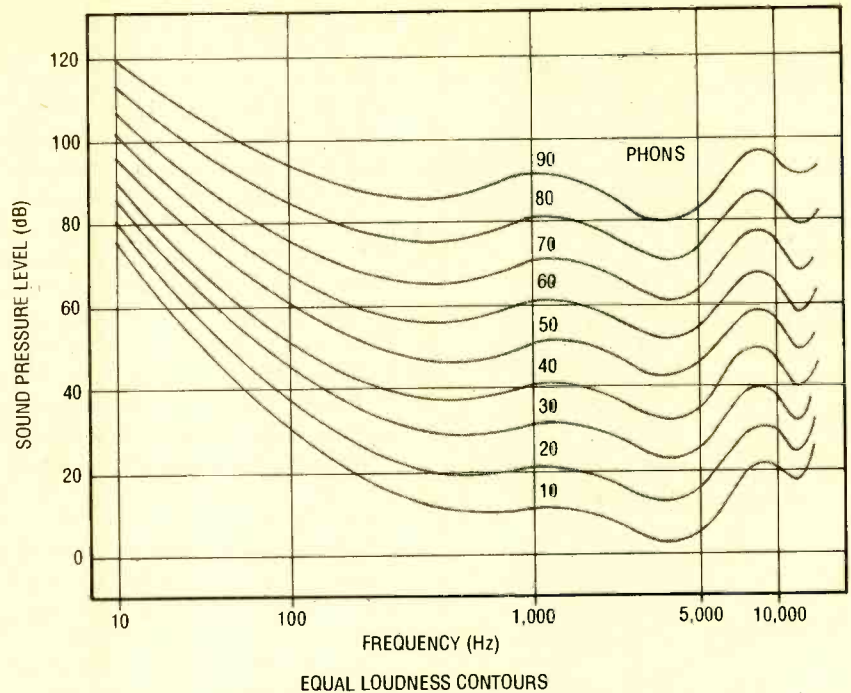

Fig. 1. The loudness of sound depends on its frequency as indicated by this graph showing how humans perceive loudness measured in phons.

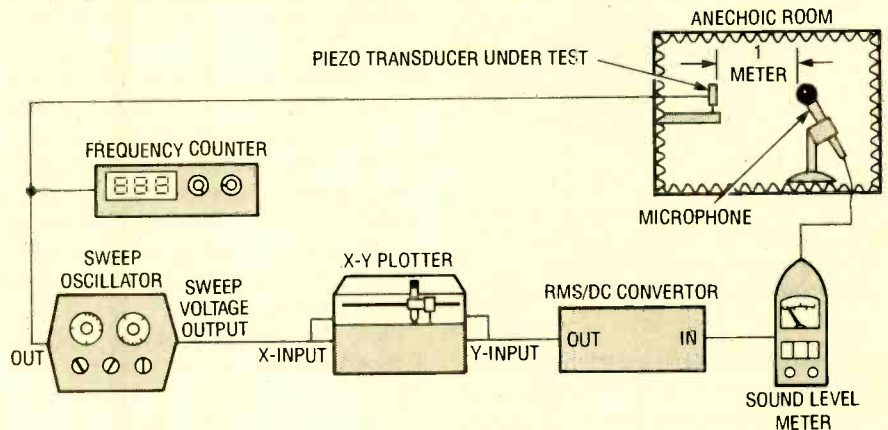

Fig. 2. A transducer's SPL rating is determined in a special room using a setup similar to that shown here. The plotter will record the SPL of the transducer over a range of frequencies.

multaneously fed to the X-input of the chart recorder. So, as the sweeper sweeps through a band of frequencies, the X-Y chart recorder plots pressure versus frequency.

Audio Indicator Types. There are three main types of audio indicators: electromechanical, electromagnetic, and piezoelectric. These terms refer to the method by which electrical energy is converted to pressure waves.

Electromechanical buzzers, also known as "bangers," are similar to old fashioned electric buzzers. They both use a movable spring-loaded striker arm and a fixed sounder to generate the audible buzz. Take a look at the

electromechanical buzzer in Fig. 3. In it, the striker arm is alternately attracted and then repelled by the field generated by the electromagnet. This causes the striker to bang into a plastic film drum head to produce sound.

Electromagnetic buzzers are similar to electromagnetic units but they don't have a striker arm. That reduces the RF hash associated with mechanical buzzers. They operate on the same principle as a loudspeaker. In fact, some of these buzzers actually use miniature speakers as their audio transducers. Most of them are broadband sounders so they are well suited for warbling or up/down sounds.

Another type electromagnetic buzz-

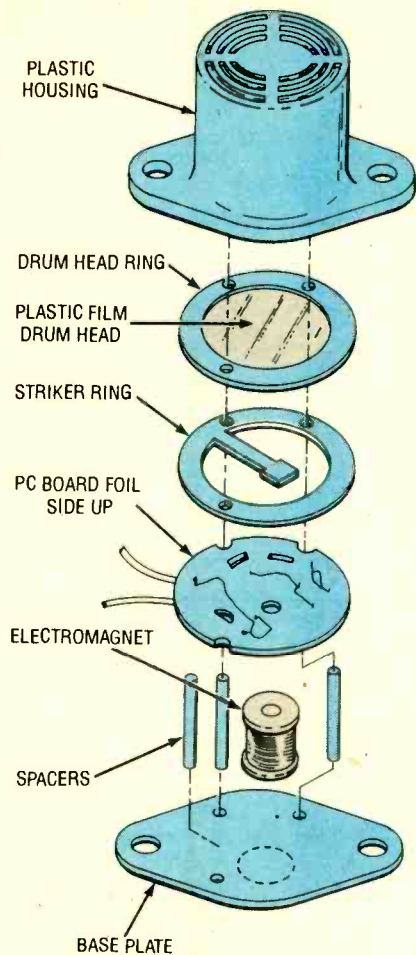

Fig. 3. This is an assembly diagram for a typical small electromechanical buzzer. It is really a small drum beaten by an electromagnetically driven striker.

er uses a thin, flexible metallic disc seated across the mouth of a cup-core permanent magnet; refer to Fig. 4. This surrounds an electromagnet. The on-board oscillator induces varying DC currents to flow through the electromagnet. This attracts and repels the disc and sound results.

Piezoelectric buzzers are the most popular audio indicators in use today. Before we discuss how they work, let's take a look at the "piezoelectric effect" that they operate on, and how it was discovered.

Some History. The term piezo comes from the Greek word *piezein*, which means to press. So piezoelectricity describes the ability possessed by certain materials (some crystals to be exact) to produce a voltage in direct proportion to applied pressure. Conversely, applying voltage to such a substance deforms or changes its shape. Piezo-

electricity occurs in certain natural materials such as: Rochelle salts, tourmaline, and quartz crystals, however, it can be induced into other polycrystalline materials such as lead titanate zirconate and barium titanate.

This "piezoelectric effect" was discovered in 1880 at the Sorbonne by the Curie brothers, Pierre and Jacques. Pierre was just 21 and Jacques was 24 at the time of this discovery. Marie Curie, wife of Pierre and discoverer of radium, pointed out in her biography of Pierre that the discovery was no youthful accident. She stated that it was a result of careful, planned, methodical study of the physical structure of crystalline matter.

No practical engineering uses were made of their observations until 1916 when Paul Langevin of France constructed an underwater ultrasonic source. It consisted of a piezoelectric quartz element sandwiched between steel plates. During WW I the crude device was used in the earliest submarine-detection experiments.

We've Come a Long Way. Today, polycrystalline ceramics are fast becoming more popular in audio-frequency and ultrasonic applications than the naturally occurring materials used in the old days. That is due to their hardness, ease of machining, chemical inertness, and almost total immunity to moisture and atmospheric conditions.

Their greatest advantage, though, is that their molecules can be precisely oriented during manufacture so that maximum deformation can be achieved with minimal voltage. This is achieved by a process called "poling" in which a high voltage is used to polarize the atoms in the crystal.

Furthermore, the poling process is typically necessary because many polycrystalline ceramics will not exhibit piezoelectric properties without it. The poling process creates a permanent change in the crystal's dimensions. Once a crystal has undergone poling, if a DC voltage is applied to it, the material undergoes deformation. An expansion occurs when you apply a DC voltage in the same direction as the poling voltage. A contraction occurs when you apply a DC voltage in opposition to the poling voltage. Applying AC will cause an oscillating motion. Piezoelectric buzzers take advantage of that phenomena, as you'll soon see.

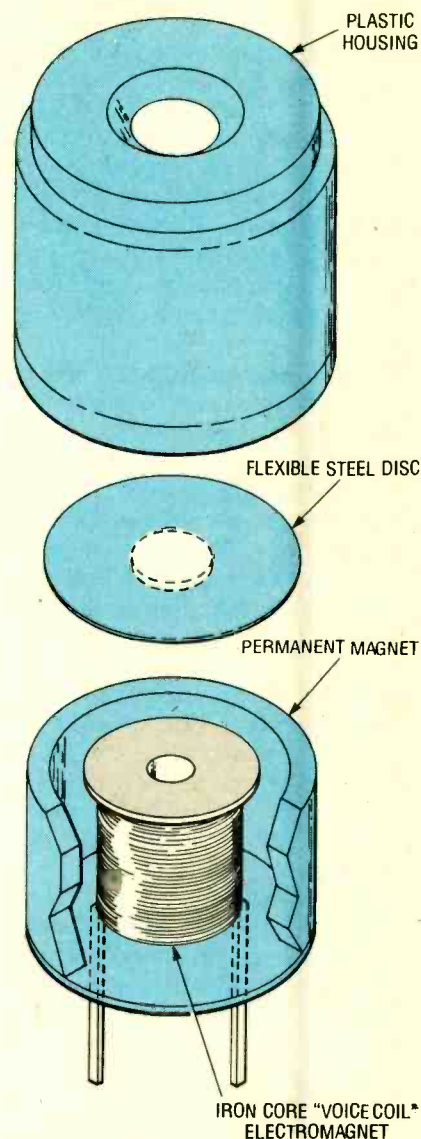

Fig. 4. An electromagnetic buzzer uses a small disc like a cone in a speaker, but the disc must be magnetized by a permanent magnet.

Piezo Buzzers. The actual sounder in a piezo buzzer consists of a metal disc (typically made of brass) that has a thin coating of piezoelectric material, called a "bender element," laminated onto one surface. Electrical connections are made to the assembly by carefully soldering a small flexible wire lead to the brass disc and another to the coating (as in Fig. 5A).

If a voltage is applied to the leads, the piezoelectric material changes its physical size. That change in size causes the assembly to deform or flex, as shown in Fig. 5B. Reversing the polarity of the applied voltage causes it to flex in the opposite direction (see Fig. 5C). An AC signal understandably then

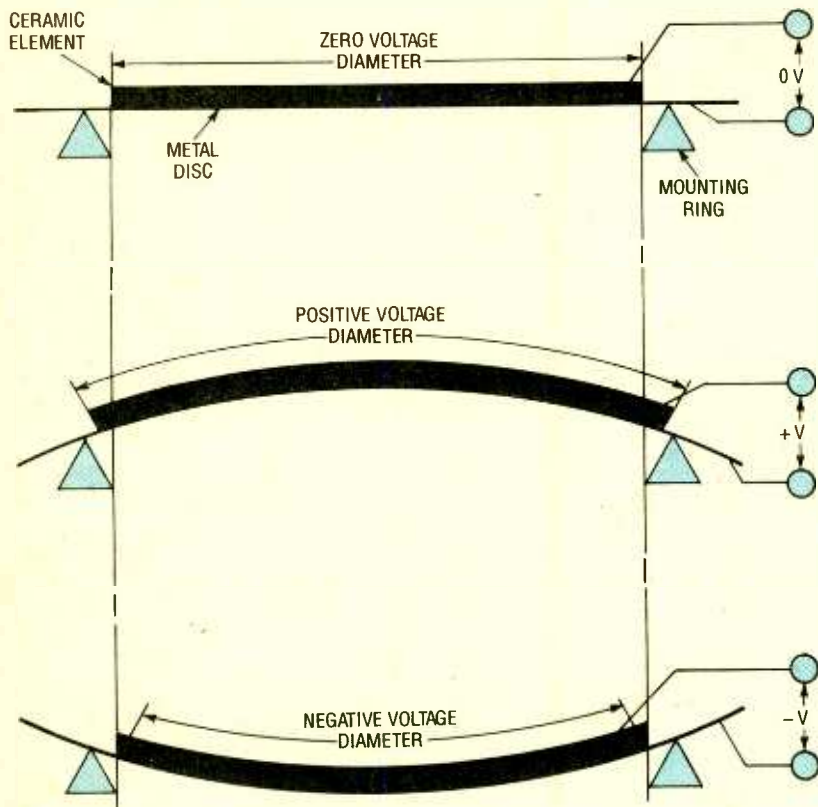

Fig. 5. This represents the flexing action of a transducer consisting of a metal disc to which a piezoelectric material is bonded.

causes a bowing in one direction, followed by a bowing or deflection in the opposite direction. If you change the

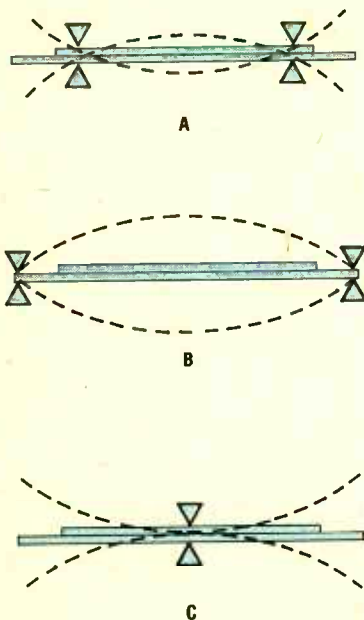

Fig. 6. Here are the three physical mounting configurations used for piezoelectric-ceramic discs: nodal mounting (A), edge mounting (B), and center mounting (C).

voltage polarity at an audio frequency, the disc oscillates at that frequency, thus creating an audible tone.

The metallic disc is required because the resonant frequency of the ceramic element by itself would be above the audio range. By attaching a disc, the element must move a mass (the thin disc) and also experiences greater wind resistance. That lowers the ceramic element's resonant frequency into the 2-3 kHz range. The concave/convex flexing action is dampened above 3 kHz.

Despite this upper bandwidth limitation, piezoelectric elements exhibit superb efficiency: They convert approximately 80% of the applied electrical energy into sound. Some piezoelectric buzzers draw as little as 750 μA , which makes them ideally suited to be directly driven by CMOS logic. These little beauties are so useful, we'll continue to discuss them for the remainder of this article.

Mounting Considerations. How a piezo element is mounted in its enclosure is very important. There are three different configurations (all shown in Fig 6): nodal mounting (Fig. 6A), edge

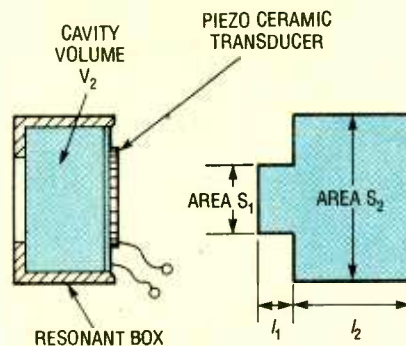

Fig. 7. The cavity dimensions of a piezoelectric transducer are a major design consideration. They are chosen to provide maximum coupling between the element and the air.

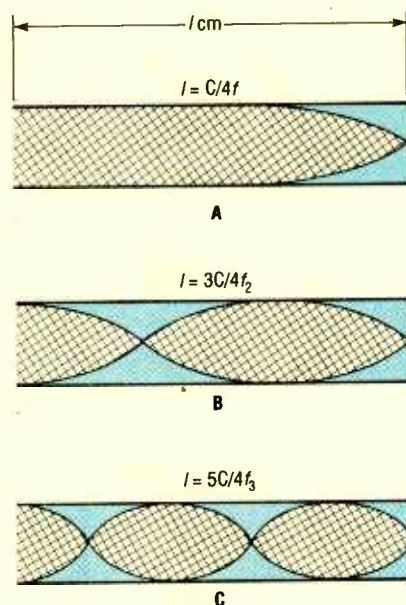
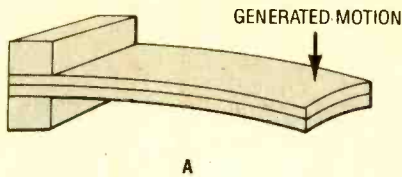

Fig. 8. If a transducer element is placed in a tube of the right length, standing sound waves will be formed in the tube.

mounting (Fig. 6B), and center mounting (Fig. 6C). The alignment is critical since misalignment drastically affects both impedance and resonant frequency. The first two methods are the most common. In a nodal-mounting assembly, the benders are supported at the nodal points by flexible adhesives such as silicon rubber. In an outer-edge assembly, the disc is typically supported by Cyanoacrylate or "910" as it is sometimes called.

The case style and dimensions are also important for getting the most out of a piezo element. For example, an air cavity called a "Helmholtz resonator" on one side of the bender assembly greatly aids in enhancing its SPL (see Fig. 7). A Helmholtz resonator maximizes



A

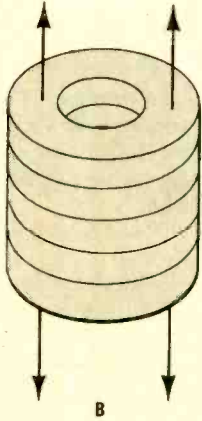

B

Fig. 9. Here we show a bimorph-configured piezoelectric transducer (A), and a stack-configured piezoelectric transducer. They offer improved performance over the single-substrate units.

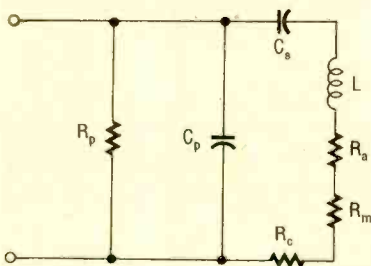

Fig. 10. This equivalent circuit for a piezoelectric ceramic transducer looks complex, but many of its components disappear at resonance.

the propagation of the audio indicator's sound by matching the acoustic impedance of the piezoelectric transducer to the acoustic impedance of the air. The resonant frequency is described as:

$$f_r = C / (2\pi \sqrt{S_1 / (l_1 V_2)})$$

where C is the velocity of sound (344 meters/sec.), S_1 is the air-hole area in cm^2 , l_1 is the air-hole length in cm, and V_2 is the volume of the cavity in cm^3 , and the assumption must be made that all dimensions are much smaller than the wavelength of sound at the frequencies of interest.

Simple tubes can also be used as

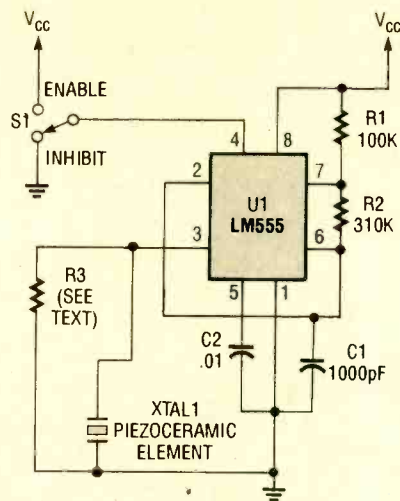

Fig. 11. A 555-timer oscillator is perhaps one of the most popular circuits for driving a piezoelectric transducer.

acoustically tuned enclosures. If a piezoelectric audio indicator or sound producing element covers one end of the tube, stationary waves are set up within the tube, regardless of the transducer's frequency. However, if the tube's length is some multiple of half the wavelength of the sound produced by the transducers, the tube will resonate. Figures 8A-8C show the stationary-(standing-) wave pattern within tubes of the lengths indicated.

Enhancing the Discs. Thus far we have concentrated on maximizing the enclosure design for piezoelectric ceramic devices, but what about the devices themselves? Can they be enhanced so they produce more sound? Yes. In fact, there have been a series of improvements over the years that have led to products called "bimorphs," and "stacks."

The type of piezo element we have been discussing so far is called a "unimorph" because it has only single layer of ceramic material. On the other hand, a bimorph contains two layers sandwiched together, and are polarized so that when one layer expands the other contracts. That produces a sort of lever action, as shown in Fig. 9A. They develop more voltage under stress and more sound when a voltage is applied to them. A one-inch bimorph can develop about a 0.035 to 0.050-mil displacement per volt.

A stack consists of several piezoelectric elements connected mechanically in series but electrically in parallel, as shown in Fig. 9B. The displacement of

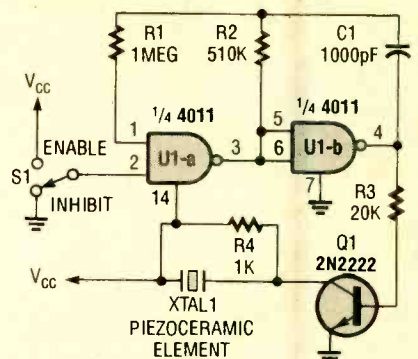
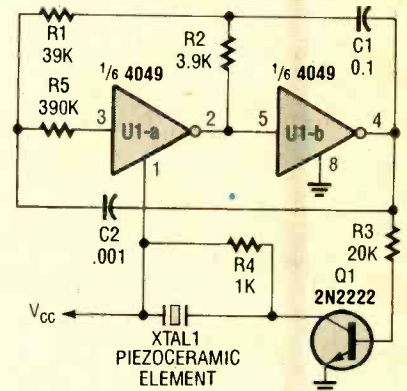

Fig. 12. A CMOS-Gate and transistor buffer can be used as an effective driver for a piezoelectric transducer. However, this circuit does have its problems.



$$f_0 = 1 / (1.3 R_3 C_2)$$

$$C_1 = 100 C_2$$

$$R_1 = 10 R_2$$

$$R_2 = 10 R_3$$

Fig. 13. This is a sure-fire CMOS driver which has no ambiguity in its transition switching regions, eliminating the problems of the circuit in Fig. 12.

the whole stack assembly is equal to the sum of the individual displacements. Stacks are capable of displacements of as much as 1,000 microinches.

An Element Model. Before we discuss actual drive circuits, it's a good idea to show how a piezo element "looks" to a circuit. The bender assembly or piezoelectric transducer can be modeled as the equivalent circuit shown in Fig. 10. The equivalent circuit is not as complicated as it appears. The capacitance, C_p is due to the capacitance of the disc plus the stray capacitance of the housing, R_p is caused by the dielectric loss of the ceramic disc (typically several tens of megohms), R_a represents the acoustic load, R_m is due to the mechanical load of the housing, R_c is caused by the mechanical loss of the disc, and C_s and L are contributed by the rigidity and mass of the disc.

(Continued on page 88)

Build a

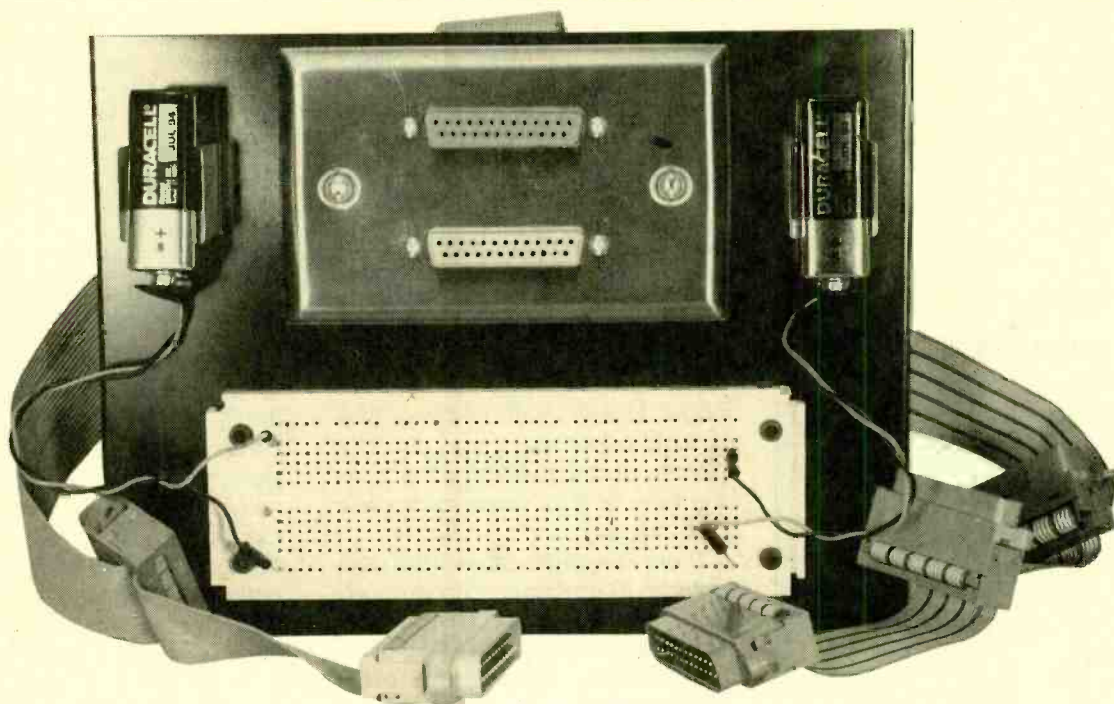

Quickie Breakout Box

You needn't spend a lot of money to build your own breakout box. In fact, you can make one with a built-in design platform for much less than a store-bought unit.

BY JOHN YACONO

Working in a hi-tech environment has its advantages. For example, getting to keep used computer equipment is one of the perks that I enjoy as a technical consultant. Peripherals and computers that might be out-dated for businesses, make fine additions to my growing family of devices.

However, not everyone gets such "goodies" so easily. In fact, most computer enthusiasts have to plunk down hard-earned money for the sake of their hobby. Every dollar saved when purchasing a piece of equipment is a dollar that can go in the bank, or toward yet another piece of hardware (you can tell I'm a compu-holic).

One way to save money on computer gear would be to make your own cables. Unfortunately, if the device's documentation is poor or un-

available (as is often the case for me), you'll need to use a breakout box that would cost you much more than a ready-made cable.

An alternative is to build your own breakout box; doing so can actually be easy and inexpensive. All you'll need for a basic breakout box are a few connectors, some ribbon cable, and a frame or cabinet of some kind. The *Quickie Breakout Box* that I'll describe here has some additional frills—a design platform, a special face plate, some battery clips, and tricolor logic-state indicators—that, while not absolute necessities, you might find useful and won't cost too much to add.

Before I discuss how you can build a Quickie of your own, some remarks about serial and parallel signals (that will help illustrate the usefulness of a

couple of the frills I've mentioned) are in order. However, this won't be a tutorial on interfacing standards. For more information on standard interfaces, see the books listed in the boxed text entitled "References."

Parallel Signals. Most parallel peripherals have a Centronics-standard 36-pin Amphenol connector. That type of connector can sometimes be found on the back of computers, but most IBM-compatible computers use a DB-25. A summary of parallel signals, their source, and the pins they occupy on the 36-pin Centronics-style connector is provided in Table 1. Table 2 shows the equivalence between pins on a DB-25 connector used for parallel interfacing and a standard 36-pin Amphenol connector.

TABLE 1—COMMON CENTRONICS CONNECTOR SIGNALS

Signal Name	Pin(s)	Source	Use	Description
Signal Ground	1	Computer	Control	A brief low pulse to clock data.
Data 0–Data 7	2-9	Computer	Data	Carry the 8-bits that make up each character.
Acknowledge	10	Peripheral	Control	A low pulse indicates reception of a character.
Busy	11	Peripheral	Control	High if peripheral is not ready for more data.
Paper Empty	12	Peripheral	Control	High if peripheral needs more paper.
Select	13	Peripheral	Control	High if the peripheral is on line.
Auto Linefeed	14	Computer	Control	Low if peripheral must generate linefeeds.
Signal Ground	16, 33	—	Ground	0-volts signal reference.
Chassis Ground	17	Peripheral	Ground	Frame ground.
+ 5 volts	18, 35	Peripheral	—	Positive pull-up voltage.
Ground Returns	19-30	—	—	Shield wires between pins 1-12.
Input Prime	31	Computer	Control	Low pulse resets the peripheral.
Fault	32	Peripheral	Control	A low indicates a general error condition.
Select	36	Computer	Control	Enables DC1/DC3 protocol when high.
Not used	15, 34	—	—	Undefined.

TABLE 2—PIN EQUIVALENCE

IBM DB-25S	36-Pin Amphenol
1-14	1-14
15	32
16	31
17	36
18	33
19	19
20	21
21	23
22	25
23	27
24	29
25	30

Taking first things first, there are three types of grounds present on the standard 36-pin Centronics connector. Those at pins 16, and 33, are "signal" grounds. They permit the signal grounds of the two devices being connected to form a common ground or signal reference. Pin 17 is typically a chassis ground, which is sometimes internally connected to the neutral power line in computers and peripherals. The remaining grounds are called "ground returns," and they are used to shield the more important signal lines from one another.

All the signals are represented by standard TTL voltage levels: a signal between 2.4 and 5 volts is a high or a binary 1, anything between 0 and 0.8 volts is a low or binary 0. Signals between 0.8 and 2.4 volts are considered invalid.

Taking the "data-strobe" first, the computer generates a momentary low signal on that line to tell the peripheral that there is data ready and waiting to be picked up from the data lines ("Data 0–Data 7"). The data lines (pins 2–9) carry the eight bits that make up a byte of data. When a pe-

ripheral has picked up the data and is ready for more, it pulls the "acknowledge" line momentarily low. Alternatively, a peripheral can also stop the flow of data by holding the "busy" line high until it's ready for the next byte of data.

There are some other lines dedicated to indicating a peripheral's status. For example, if a peripheral needs to tell the computer that it's out of paper, it can do so by holding the "paper empty" line high. A peripheral can indicate some general error by holding the "fault" line low.

Some peripherals can be taken off line or "deselected" by sending them a special character (denoted "DC3"), and brought on line with another character (denoted "DC1"). So, a peripheral can tell the computer it's powered-up and on line by holding the "select" line at pin 13 high (note there are two select lines, don't confuse them).

The computer can control the actions of the peripheral as well. For example, the select/deselect feature can be enabled by the computer port if it holds the select line at pin 36 high. Further, by holding the "auto-feed" line low, the computer can tell the peripheral to accompany each carriage return with a linefeed. If the computer sends a low-going pulse though the "input-prime" line (often called the "initialize" line), a peripheral that supports that line will reset its parameters to some default configuration. The default configuration is typically the device's power-up state.

That leaves us with the two 5-volt pins. They are supported by some peripherals to hold a handshaking line high if needed.

Serial Interfaces. Most serial interfaces hobbyists come across are of the RS-232C variety. That is the current Electronics Industry Association (EIA) standard for low-speed serial communication. It defines voltage levels, loading, signal types, timing relationships, and a lot of other communication parameters. Male and female DB-25 connectors are the standard RS-232C terminations.

There are two main classes of RS-232C devices, namely data-terminal equipment (or DTE's), such as computers or terminals, and data-communication equipment (or DCE's), such as modems.

The arrows in Table 3 indicate the direction in which each signal would flow if a DTE were connected to a DCE. For example, the signals on pin 2 are generated by the DTE, and received by the DCE. Keep in mind that the signal names are therefore from the viewpoint of the DTE.

All signal voltages are detected with respect to the "signal-ground" (SG) line. A voltage from 3 to 25 volts represents a 0 (called a space in RS-232C "lingo"); and -3 to -25 volts is a binary 1 (called a mark). Note that this is negative logic—the high-logic value corresponds to the more negative voltage. To further confuse things, a logic 0 corresponds to the signal being "true" (e.g., if the DTR line is at logic 0—in the +3 to +25 volt range—then the data terminal is ready).

There is another ground called the "chassis ground" (CG). Sometimes called the "frame ground," it is used to insure that the chassis of the devices being connected are at the same potential.

The "transmit data" (TD) line allows

TABLE 3—RS-232 PINS AND FUNCTIONS

DB-25 PIN	MNEMONIC	SIGNAL DIRECTION		FUNCTION
		DTE	DCE	
1	CG	NA		Chassis Ground
2	TD	--->		Transmit Data
3	RD	<---		Receive Data
4	RTS	--->		Request To Send
5	CTS	<---		Clear To Send
6	DSR	<---		Data Set Ready
7	SG	NA		Signal Ground
8	DCD	<---		Data Carrier Detect
9-11	—	NA		(usually not used)
12	SCDC	<---		Secondary Data-Carrier Detect
13	SCTS	<---		Secondary Clear To Send
14	STD	--->		Secondary Transmit Data
15	TC	--->		Transmit Clock
16	SRD	<---		Secondary Receive Data
17	RC	<---		Receive Clock
18	—			(not usually used)
19	SRTS	--->		Secondary Request To Send
20	DTR	--->		Data Terminal Ready
21	SO	<---		Signal Quality
22	RI	<---		Ring Indicator
23	—	--->		Data Rate Selector (DTE)
	—	<---		Data Rate Selector (DCE)
24	XTC	--->		External Transmit Clock
25	—	NA		(usually not used)

data to be sent from a DTE to a DCE. The complement to the TD line is the "receive data" (RD) line. That circuit is used to take serial data from a DCE to a DTE.

The "request to send" (RTS) line carries a signal that indicates that the DTE wishes to send data to the DCE. When the DTE has data to send, it will set the RTS line to on (logic 0) and awaits an on condition on the "clear to send" (CTS) line. When the CTS turns on, the DTE sends its data, and when finished it will reset the RTS line to off.

The logic present on the "data set ready" (DSR) line informs the DTE if the DCE is alive and well. It is normally set to the on state by the DCE upon power-up and left there. The complement of DSR line is the "data terminal ready" (DTR) line. It provides a signal that informs the DCE that the DTE is up and running.

The "data carrier detect" (DCD) line is used by the DCE to tell the DTE that it has an incoming carrier. It may be used by the DTE to determine if the DCE is idle, before using the the RTS line.

For synchronous data transmission (in which data is sent without stop bits to synchronize the devices), the transmitter and receiver need clock signals to synchronize them to each other. To that end the DCE in such a system must maintain a "transmit

clock" (TC) signal and a "receive clock" (RC) signal. The two clocks need not run at the same speed. Some DTE's also produce clock pulses for synchronization on the "external transmit clock" line.

If a DCE detects a high probability of errors during communication, it turns the signal quality (SQ) line off. That lets the DTE know that there's probably some trouble in the link. The DTE can then tell a "smart" DCE to change its communication speed via the "data rate selector" line. Sometimes pins 11 and 25 are also used to select the desired data rate, although they are not supported by the standard. Note that there are DCE's that tell DTE's what data rate it's using on that line, so the origin of the signal on that line depends on the hardware, which is why it has two entries in Table 3.

When a DCE detects a phone-line ringing signal, it turns the "ring indicator" (RI) line on. That helps the DTE to "wake up" and get ready when it's in an auto-answer application.

Sometimes, when a serial link is set up for half-duplex operation (in which data can only travel in one direction at a time), a secondary channel is used to provide a very slow (5 to 10 bits-per-second) path for return information. That permits the device currently receiving data to report on its

status without having to stop the incoming flow of data to free up the data channel. That secondary data channel has its own data-carrier detect (SCDC), clear to send (SCTS), transmit data (STD), receive data (SRD), and request to send (SRTS) lines, as shown in Table 3.

Although we've only discussed connecting DTE's to DCE's, this is not the only interconnection possible. For example, it is possible to connect two DTE devices together using a "null-modem" cable. With such a cable, the outputs of one DTE are connected to their corresponding inputs on the other DTE. For example, the TD signals on one DTE will be routed to the RD input on the other DTE, and vice versa. In a similar manner, two DCE's can be interfaced to each other.

Many AT- and 386-class computers are now using DB-9 connectors on their serial-communications ports. Obviously the 9-pin connectors only carry a subset of the RS-232C standard signals. The correspondence between pins on the DB-25 and DB-9 connectors is shown in Table 4.

Troubleshooting Tricks. While serial communications equipment should obey the rules of RS-232C standard, they almost never do. I get the feeling that's why interface breakout boxes were invented in the first place. However, there are a few simple design twists that you can put in your Quickie that will make serial troubleshooting easier. Oddly, these frills are seldom incorporated in manufactured units, and when they are,

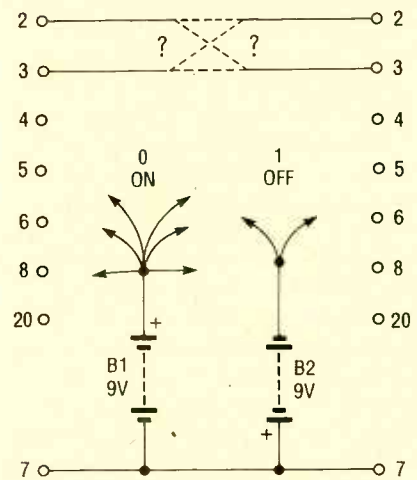

Fig. 1. On RS-232C ports, you can use 9-volt batteries to hold lines high or low. They will do no harm to the equipment.

TABLE 4—DB-9 TO DB-25 EQUIVALENCE

DB-9 Pins	DB-25 Pins
1	8
2	3
3	2
4	20
5	7
6	6
7	4
8	5
9	22

the buyer pays dearly for them.

For example, it can be extremely useful to force serial handshaking lines to a desired state. Then you could connect the data lines on the two devices together and concentrate on setting the transmission parameters (data rate, parity, stop bits, etc.)

That is a particularly useful technique if you're not sure whether you should cross-connect the transmit and receive pins of the two devices like a null-modem cable would. With the handshaking lines tied to permit unobstructed communication, you could try a cross-connection (pin 2 to pin 3 and vice versa) and if it doesn't work try a straight-thru connection (pin 2 to pin 2, and pin 3 to pin 3).

Two 9-volt batteries are all you need to tie lines high or low (see Fig. 1). One battery will provide a positive voltage (which is an on or logic-0 signal), and the other furnishes a negative voltage (for mocking off or logic-1 signals). The batteries are more than a match for any outputs, so they can be used to override outputs that are already tied to inputs. By the way that treatment will not damage any outputs either.

Another shortcoming of many breakout boxes deals with their indicators. To reduce the overall cost of a breakout box, manufacturer's use as few LED indicators as necessary. I think that's okay, since you normally need to monitor only a few lines at any given time. However, that economic philosophy, which is taken to an extreme in some lower priced units, leads to a drawback in design: if you use only one LED for each line that a box monitors, you can't tell when a line is floating. For example, let's say you wire an LED to some line so that it turns on when the line has positive voltage on it. If the LED is off, it could mean that the line voltage is negative or that the

line is not supported. Thus, the actual condition of the line is unclear when the LED is off.

There is a pleasant (and colorful) compromise that you can make between expense and clarity of operation: You can wire a few tri-color LED gimmicks as shown in Fig. 2. Since a tri-color LED can glow either red, green, yellow or just be off, each gimmick can indicate whether a line is high, low, alternating, or grounded/floating. To cut costs, you can make as few of them as you need. I find that four of

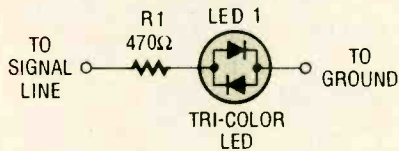
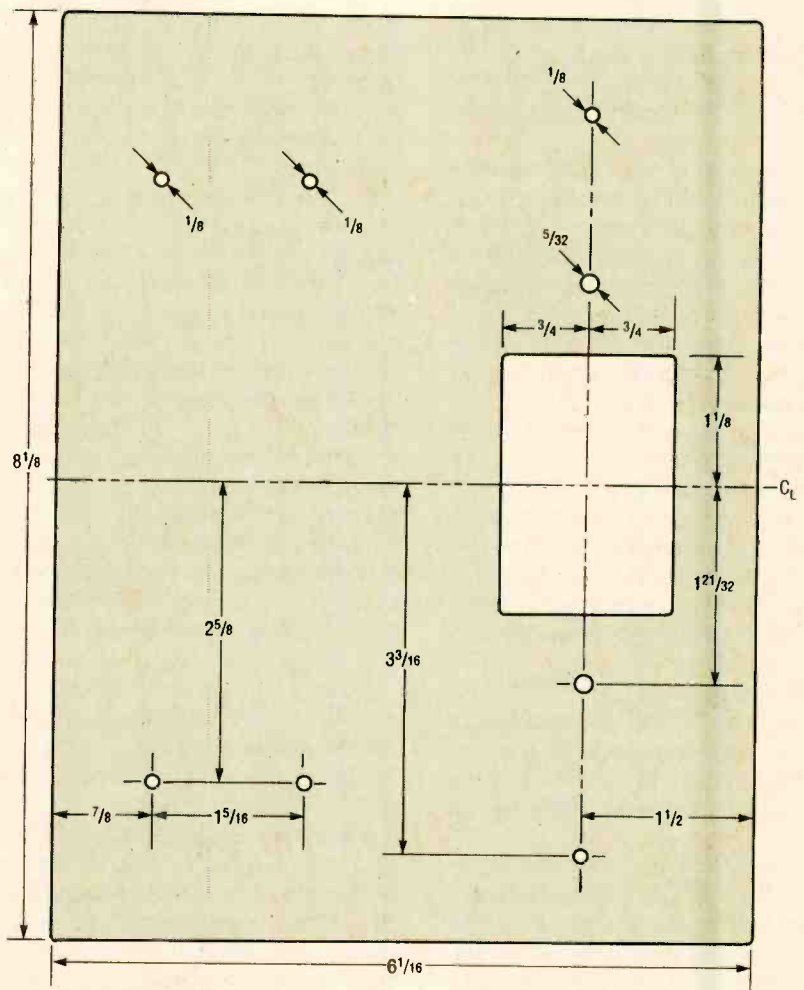

Fig. 2. A simple RS-232C line monitor can be made from a resistor and a tri-colored LED. This type of indicator is a little more informative than what you find on most commercially built units.

them is typically plenty, and there have even been times that I've needed only one. Since I'll tell you how to make them as stand-alone components, you can always add more to your arsenal without reworking the cabinet.

Your Options. The working portion of the Quickie is made of two sections of ribbon cable with some connectors on the ends. Both pieces of ribbon cable have a female DB-25 connector on one end, and an assortment of connectors at the other end. The ends with the variety of connectors on them run to the devices that you are trying to interconnect. I'll call that the "equipment end" of the cables. The ends with the lone female connectors (or the "break out" ends) are mounted on a dual-slot, DB-25 wall plate. You can use small pieces of buss wire as jumpers to make connec-



ALL DIMENSIONS IN INCHES

Fig. 3. You can use this template as a guide to cutting your cabinet. Of course the breadboard holes can be eliminated if you don't want that option.

ANTIQUE RADIO

By Marc Ellis

The Sky Buddy Saga

As promised last month, this column introduces a brand-new restoration project. We're going to be working on an inexpensive Hallicrafters shortwave receiver of the late 1930's—the *Sky Buddy*. It was the kind of set that a radio-minded teenager of the era could reasonably expect to buy with the profits from a part-time job.

The *Sky Buddy*, like its well-known postwar descendent the S-38, was nothing but a consumer broadcast radio fitted up with extra coils for

the shortwave bands and a few additional controls. But even though the radio was a bottom-of-the-line model, the Hallicrafters designers succeeded in achieving a high-powered and businesslike appearance.

The engaging little receiver was the starter set for a whole generation of ham operators and shortwave listeners. Later, those with the means and interest might upgrade to more advanced models like the *Sky Champion* and *Skyrider*. The radios in this series have become strongly tinged with 1930's nostalgia, not only for those who used them at the time but also for hobbyists of succeeding generations.

THE ORIGINAL SKY BUDDY

Thanks to Max De Henseler's book, *The Hallicrafters Story*, just published by Antique Radio Club of America (see review in the April column), we have a definitive picture of the *Sky Buddy*'s evolution. A set bearing that name (and also the model designation 5T) first appeared in 1936, not quite three years after the founding of the Hallicrafters firm. It used the old tall glass ("G"-type) tubes in a four-tubes-plus-rectifier configuration typical of inexpensive superheterodyne broadcast receivers of the period.

The radio covered the frequency range 545 kHz through 16 MHz in three bands, which was similar to the coverage offered by the better consumer "all-wave" receivers of the time. The tuning dial, with its

clock-style design and concentric scales was also reminiscent of consumer all-wave designs. However, De Henseler tells us that the dial had a 36-to-1 tuning ratio in order to provide bandspread action. And pictures of the set seem to indicate that there was an extra "second-hand" type of pointer that probably worked with a separate bandspread scale.

But the resemblance to consumer radios ended right there. The no-nonsense, black-crackle-finished metal cabinet, plain round speaker grill, phone jack, and toggle switch controls made it clear that this was a radio for the serious hobbyist. The cost: \$29.50 in 1936 dollars.

Interesting as the original *Sky Buddy* is from an historical point of view, it doesn't seem to have had a great deal of impact on the ham/SWL community. Few examples of it survive today, and it's definitely not the radio people associate with the *Sky Buddy* name. That set appeared a couple of years later, in 1938.

THE S-19 OF 1938

The improved *Sky Buddy* of 1938 (model S-19) was really quite similar electrically and physically to its predecessor. The 545-kHz to 18.5-MHz (as opposed to the original's 16.0-MHz) tuning range was also divided into three bands. Circuitry was quite similar, employing the usual four-tubes-plus-rectifier design. But the tubes were now types using the newly-introduced octal base.

Both sets were housed in



This October 1937 Hallicrafters advertisement in QST Magazine shows the original *Sky Buddy* (lower right) and other members of its product line.

black-crackle-finished metal cabinets, but aesthetically they were quite different. The original model 5T set had a generic, up-tight, early-thirties appearance. Contributing to this image were such things as the sharp square edges of the cabinet, the toggle switches, and the all-in-a-row mounting of the controls. The radio looked like it could have been designed and built by a skilled amateur in his basement.

By contrast, the S-19 presented a modern, sleek, finished appearance. For one thing, the left and right edges of the front panel were gently rounded rather than sharp. (In fact, the cabinet front and sides were actually formed of one piece of metal, wrapped at the corners.) For another, the toggle switches (except for the

"send-receive" control) were now gone, with all functions controlled by attractive round knobs formed of Bakelite.

But the biggest change in appearance stemmed from improvements in the radio's tuning system. The old clock-style pointer dial was replaced by Hallicrafters' attractive "German silver" dial, which rotated under a fixed top-mounted cursor. This arrangement was previously found only in the more expensive sets in the line. Another feature taken from the more expensive sets was the bandspread indicator.

Mechanically, bandspread in the S-19 was accomplished just as it was in the old 5T—by gearing down the tuning rate so that the dial moved slowly with respect to the knob.

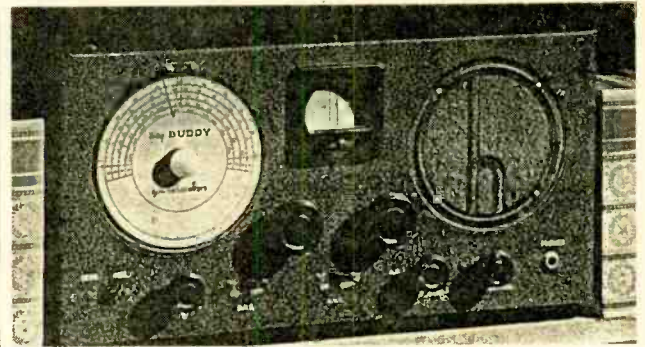

A detail from an October 1939 QST ad shows features of the improved (S-19R) Sky Buddy.

However, now there was a separate bandspread dial that would allow the user to accurately track the smallest tuning adjustment.

The dial was mounted behind a large meter-style window—the same one used in the top-of-the-line Super Skyrider, where it balanced the signal-strength meter mounted on the other side of the panel. The much smaller, porthole-style, bandspread dial window from the intermediate sets in the 5T's product line could have been used, but wasn't.

The new bandspread window was positioned between, and slightly above, the speaker and tuning dial—which were moved farther apart to accommodate it. That made the front panel of the S-19 seem wider and more expansive than that of the 5T, even though the width of the two radios was almost identical. In addition, the tuning knob, formerly in the row of controls at the bottom of the front panel, was moved upward and centered under the bandspread window.

The new positioning of the window and tuning knob did much to break up the compulsive, row-oriented organization of the original front panel, making for a much more pleasing appearance. And as a finishing touch, the speaker opening—formerly plain grillwork—was adorned

with the now famous stylized "h" Hallicrafters logo.

Of course, all those design changes weren't made solely for the purpose of improving the Sky Buddy. They also applied to most of the other new radios introduced during 1938, including the S-19's big brother, the eight-tube S-20 Sky Champion.

It's an interesting commentary on both the ingenuity of the Hallicrafters designers and the flat economic times in which the radio was introduced that this much improved Sky Buddy sold for \$29.50, exactly the same price as the original model!

ENTER THE S-19R!

Though the S-19 received quite a bit of acceptance in the amateur and SWL community, selling about 10,000 units during its short lifetime of less than a year, it did have one important drawback. Its highest frequency range cut off at 18.5 MHz—too low to reach the amateur-radio 10-meter band, which was just becoming popular. Early in 1939, that was remedied with the release of a revised version, the S-19R.

The S-19R Sky Buddy had a fourth tuning range covering 16 to 44 MHz—which would handle the ten-meter band and then some. Another striking change was the substitution (Continued on page 90)

Introducing 2 NEW Hallicrafters Receivers the SKY BUDDY and the SKY CHAMPION

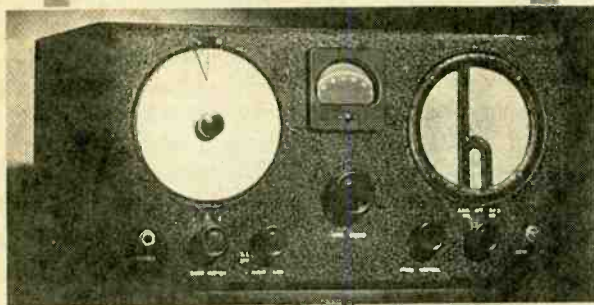

A PRACTICAL, QUALITY BUILT COMMUNICATIONS RECEIVER AT A NEW LOW PRICE

Only an organization with the facilities, experience and resources of the Hallicrafters could build a practical communications receiver to sell at this low price. The NEW SKY BUDDY is an amateur receiver in every respect, covering everything on the air from 18.5 MHz to 315 K.C., including the 20, 40, 80 and 160 meter amateur bands, with a degree of sensitivity and selectivity usually found only in communications receivers selling at many times its modest price. It is an all-arc set, of conventional Power Transformer construction. All the components of the SKY BUDDY are top of the line, and it has all the basic controls required for amateur communications, including built-in speaker—there is nothing else to buy! The separate Bandspread is better than the A.S.M.C. Handbook recommendations for hand-spread against wack calibration on all the amateur bands. Any experienced amateur will be delighted at its fine performance—it has all the painstaking careful engineering, the thorough workmanship found in all Hallicrafters receivers. See the New 1938 SKY BUDDY at your Hallicrafters dealer today.

THE SKY BUDDY

• 5 Tubes • Composite Cartridge I.R.A. 5K, to 315 K.C. • Built-in speaker • Phone Jack • Bandspread Switch • A.C. Switch • 5 Bands • Separate Bandspread Dial • Best Frequency Oscillator • Wave Control • Easily adapted for Ham-1939 conversion.

AMATEUR'S NET PRICE

\$29.50

Including speaker and tubes

FOR DETAILS OF THE SKY CHAMPION

SEE NEXT PAGE . . .

the hallicrafters inc.

2511 Indiana Ave., Chicago, U.S.A. • Cable Address: "HALCRAFT," Chicago

"WORLD'S MOST BUILT UP OF AMATEUR COMMUNICATIONS RECEIVERS"

In May 1938, this ad appeared in QST to announce the S-19 Sky Buddy and its big brother, the S-20 Sky Champion.

COMPUTER BITS

By Jeff Holtzman

Tuning Up

About twice a year, I get fed up with the hardware and software mess that accumulates in and around my PC. That happened recently: What follows is how I dealt with that situation.

NEW CHASSIS AND CABLES

The first item was a new enclosure. I had been using a traditional AT-style chassis with several problems that had been grating on my nerves for years. My first

tape backup, a CD-ROM drive, and two players to be named at a later date). And the fifth sticking point was that it couldn't (and shouldn't) cost more than the components that were to reside inside!

I decided to get a new tower case. But on looking around, I found the prices for the really large units to be exorbitant (on the order of \$350 and up). Eventually I located a company called Wetex International. I called and listed my requirements. The young lady said that they had something that should fit the bill, the EYE-919, and faxed a spec sheet immediately; a few days later a flyer arrived by mail. The company claimed that the chassis would meet all my specs, at a cost of \$200 with a 250-watt power supply. They also offered a 30-day money-back guarantee.

After stewing over it for a few weeks, I finally took the plunge and placed my order; the chassis arrived about a week later. After backing up my hard disk, I spent about half a day moving all the components over and mounting them securely in the new chassis. The chassis accepts baby and AT sized motherboards; has six exposed 5.25-inch drive bays and four more internal ones; has front-panel switches and LEDs for power, reset, and turbo mode; a two-digit speed-display; four casters for easy moving; a swing-out front panel that conceals all drives, switches, and indicators; and allows super-easy access to internals via two swing-out side panels, each

of which is secured by a pair of screws. It also comes with one 3.5-inch drive adapter (for a 5.25-inch bay), speaker, all mounting hardware, an extra cooling fan, and extra-long power-supply cables. The back panel has 14 cutouts for 9-, 15-, and 25-pin connectors. Unlike some foreign clones, everything fits together well.

I'm really happy with my new chassis, and with Wetex. The company has a wide range of cases in all popular configurations, as well as reasonably priced motherboards, keyboards, expansion cards, disk drives, etc. Incidentally, the company accepts only cash and bank checks, no credit cards.

Because I moved the case to the floor, I needed extension cables for the keyboard, monitor, printer, modem, and mouse. After a fair amount of searching, I located a company called National Computer Accessories that has simply incredible prices for some really quality items. For example, a local computer store wanted \$6.95 for a keyboard extension cable that NCA charged about \$1.25 for. The same local store wanted \$12.95 for a cable—just the cable—for a second serial port card (9-pin D connector to 10-pin dual-row header). NCA sells a complete card that has dual serial ports, and parallel and game ports, for a dollar less. I had just bought an outlet strip with surge protectors for the AC power and phone lines from another vendor; NCA had the same item for half the price—\$8.99. They have



Stacker is a hardware/software utility that doubles available disk space. It's compatible with DOS 5.0, Windows 3.0, and low-level disk utilities. For 80MB and larger drives, it's a cost-effective way to increase space.

"beef" was that it hogged so much desk space. The next problem was that its power supply was louder than the cheering crowd at a "Big Ten" football game. Gripe three was that because I'm constantly installing and uninstalling new hardware, I had been operating the thing without a cover. But I now wanted the best of both worlds: an enclosed system that would also allow easy access to the innards. Peeve number four was that I needed at least six exposed drive bays (for two floppy drives, a

A/B printer switches for \$7.99 that I've seen listed for four times the price. Anyway, you get the idea.

STACKER STACKS UP

With the chassis dilemma solved, I now turned my attention to an even more pressing problem: my hard disk. As you probably know, I'm a big Windows user. And as you probably also know, Windows applications eat disk space mercilessly. However, even though my disk space was almost gone, I wasn't up to buying a new, larger drive. Then I received information from Stac Electronics, which makes a product called Stacker.

What Stacker does is double your hard-disk space, almost transparently, with no loss in performance (for the hardware versions). Stacker comes in four versions: a software-only product (\$149), and three hardware-based units: Stacker XT/8 (\$199), Stacker AT/16 (\$249), Stacker MC/16 (\$299) (for MicroChannel machines). The software-only version is intended for laptops that have no expansion capability.

Stacker has been around for a couple of years; there were enough "gotchas" about the early version that I decided to pass it by. However, Stacker now has some impressive OEM sup-

port: most major vendors of hard-disk and tape-backup hardware and software have licensed Stacker's compression technology: Archive, Central Point Software, Colorado Memory, Compaq, Core, Everex, Norton/Symantec, Sytron, etc. Clearly, it was time to take a closer look. And am I glad I did!

My three main worries about this type of product had been: performance, compatibility, and security. My tests with the AT/16 model have alleviated all three worries. Performance: The company's literature shows a slight increase in disk access time—perhaps 10%. In practice, it's unnoticeable. Compatibility: In several weeks of testing, I've had no problems with numerous DOS and Windows applications, including low-level disk utilities, Irwin tape backup, and Lantastic network software. Security: I was worried about what would happen if the coprocessor card died. In that case, the software driver takes over and operation continues as before, albeit with a performance penalty of about 50%.

The software works by creating a hidden file on your physical drive; that file contains all of your "stacked" data; you refer to it as a drive letter. During the boot process, Stacker swaps drive letters, so that your physical drive C becomes drive D, and the Stacker volume becomes drive C. You can have several Stacker volumes.

When you install the software, you can "stack" everything on your disk or create an empty volume and add data to it at your leisure. Utility programs allow you to increase and decrease the size of stacker

(Continued on page 90)

VENDORS

Wetex International
1122 W. Washington Blvd., Suite D,
Montebello, CA 90640
800-798-7041
213-728-3119

National Computer Accessories
769 North 16th Street, Suite 200
Sacramento, CA 95814-0527
916-441-1568

Stac Electronics
5993 Avenida Encinas
Carlsbad, CA 92008
619-431-7474

LEARN VCR

CLEANING/MAINTENANCE/REPAIR

EARN UP TO \$1000 A WEEK, WORKING PART TIME FROM YOUR OWN HOME!



Secrets Revealed!

NO Special Tools or Equipment Needed.

EARN UP TO \$60 AN HOUR AND MORE!

THE MONEY MAKING OPPORTUNITY OF THE 1990'S

IF you are able to work with common small hand tools, and are familiar with basic electronics (i.e. able to use a voltmeter, understand DC electronics)...

IF you possess average mechanical ability, and have a VCR on which to practice and learn...then we can teach YOU VCR maintenance and repair!

FACT: up to 90% of All VCR malfunctions are due to simple MECHANICAL or ELECTRO-MECHANICAL breakdowns!

FACT: over 77 million VCRs in use today nationwide! Average VCR needs service or repair every 12 to 18 months!

Viejo's **400 PAGE TRAINING MANUAL** (over 500 photos and illustrations) and **AWARD-WINNING VIDEO TRAINING TAPE** reveal the **SECRETS** of VCR maintenance and repair - "real world" information that is **NOT** available elsewhere!

Also includes all the info you'll need regarding the **BUSINESS-SIDE** of running a successful service operation!

FREE INFORMATION
CALL TOLL-FREE 1-800-537-0589
Or write to: Viejo Publications Inc
4470-107 Sunset Blvd., Suite 600, Dept. PE
Los Angeles, CA 90027

CIRCLE 16 ON FREE INFORMATION CARD

FCC LICENSE PREPARATION

**General Radiotelephone
Radiotelegraph
Amateur Radio Licenses**

We offer the most up-to-date study materials available. Our formats include: tests, audio programs, and video programs.



WPT PUBLICATIONS
7015 N.E. 61st Ave.
Vancouver, WA 98661
(206) 750-9933

CIRCLE 11 ON FREE INFORMATION CARD

May 1992, Popular Electronics

69

www.americanradiohistory.com

THINK TANK

By John J. Yacono

Microclips and More

In the past few months, you readers have been very generous with helpful tips on everything from storing solder to using a DVM to determine transistor pinouts. I have saved many of those letters so I could present them together in a more-or-less planned fashion. So this month's column will be dedicated to your cleverness at making your hobby easier to practice. Of course, I'll start by throwing my own two cents in . . .

SIGNAL DETECTORS

After years of playing with electronics, I have adopted an eleventh commandment: "Thou cannot have too many microclips." The reason microclips are so useful is that they can be added to the leads of just about any electronic component to produce a useful gadget.

For example, if you connect a pair to a small speaker, you can test various points in a circuit for audio. By placing a capacitor in series with the speaker, the gadget can be used to detect low-voltage AC to help you troubleshoot the power supplies in your projects. Of course, the value of the capacitor that you use will depend on the voltages and frequencies present in your circuits. A piezo-buzzer element can also be used, but it will not reproduce audio faithfully. However, a piezo-based version is particularly well suited for detecting RS232 signals, since it will click and pop with each voltage transition.

A really good visual in-

dicator can be made by attaching microclips to a tricolor LED in series with a resistor. The color of the LED can tell you the direction of DC current flow, or indicate the presence of AC. That's particularly useful in situations where you haven't a clue as to what signals you'll find. Don't use a plain (one-color) LED because it will remain dark in both the reverse-bias and no-power states. Similarly, you can add microclips to a 12-volt bulb socket for use in automotive electronics.

You can make another good gadget by adding microclips to a 9-volt battery clip. Snap on a battery and you have a 9-volt power source. For troubleshooting, the battery source can be used to force-charge timing capacitors, provide power to only one section of a circuit, force an RS232 line high or low, or check the operation of various indicators. Not bad for a few minutes of labor.

An army of microclip-equipped jumper wires is not a bad idea either. For such applications microclips are better than alligator clips, which tend to come undone, don't fit into tight spaces, and can't be used on IC leads.

Unless you often work on projects where space is at a premium, I recommend that you use the round microclips instead of the flat ones. The round kind are less cumbersome to engage and disengage. They also have enough surface area to permit labels on their more visible areas.

Well, enough of my mi-

croclip send up. Let's get to your helpful suggestions. Keep in mind that all of this month's contributors will receive a *Think Tank II* or other book for their effort. If you would like to join in the fun, send your tips and circuit ideas to *Think Tank*, Popular Electronics, 500-B Bi-County Blvd., Farmingdale, NY 11735.

TOOLING A SPOOL

For awhile now, I've been using a little trick that makes storing solder neater. Most hobbyists buy solder that comes on a plastic spool. The spool is nice enough, but it doesn't keep the solder neat. The solder quickly becomes unraveled and gets tangled with anything present. However, a simple modification of the spool can end that frustration. Just cut four or five V-shaped slots in the edge of one of the spool's flanges as shown in Fig. 1.

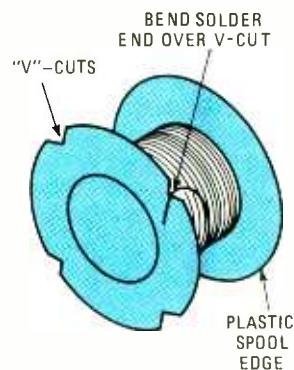

Fig. 1. Cutting notches in a solder spool can make solder easier and neater to pack away. That will help prevent a rat's nest of solder in your tool box.

Now, before you put away your solder, wrap it onto the spool as you normally would, but bend the

very end into one of the slot cuts. The tension in the coiled solder will hold it in place and no more mess.

—Brad Cobe, Duncanville, TX

This is one I have to try. Up to now, I've just been isolating my solder from my tools, making the solder easy to misplace and easy to forget when I carry my tool box to a waiting job.

TRANSISTOR TIP

It's pretty easy to use a DVM to distinguish the base from the collector or emitter leads on an unmarked transistor. A transistor acts like a pair of back-to-back diodes (see Fig. 2). The base of the transistor is the common point where the diodes are connected together. An NPN transistor looks like the anodes of the diodes are in common (Fig. 2A); a PNP looks like the cathodes are in common (Fig. 2B).

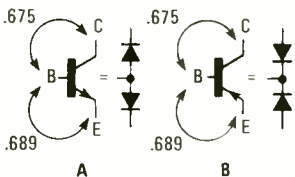

Fig. 2. Transistors are like pairs of diodes connected back-to-back. The "diodes" of an NPN transistor have their anodes connected (A), while the "diodes" in a PNP transistor are connected cathode-to-cathode (B).

But how do you tell the collector-base "diode" from the emitter-base "diode?" Well, the collector-base junction will have a lower junction voltage than the emitter-base junction. For example, if the junction voltages are 0.689 and 0.675 volts, the junction measuring 0.675 is the collector-base junction, and the other junction is the emitter-base junction. For a Darlington pair, the base-emitter junction voltage will

be about double the base-collector voltage.

—Jerome Knapp, Minooka, IL

A nice in-circuit test tip. It might be an interesting experiment to try to form a transistor from two diodes. If anyone wishes to try it, be sure to use one plain diode for the collector-base junction and one Zener diode for the emitter-base junction.

REGULATOR INFO

The Think Tank Column on the LMxx7 family was very informative, especially if one reads it in conjunction with the May, 1990 article entitled "Three-Terminal Regulators." The information couldn't have come at a better time since I'm in the process of building a dual power supply for troubleshooting things here at home.

However, a lot of us builders get our parts from surplus stores and mail-order houses that don't provide pinout data. Sometimes that information is not easy for the average hobbyist to find and I'm sure it would be appreciated if it was provided in any articles discussing such parts. A good example of this is the LM337, which, unlike the LM317, is not popularly documented. I blew an LM337 because I didn't know the pinouts, so I would like to pass along what I have learned the hard way (see Fig. 3).

—Jack Graham, Santa Fe, TX

Unfortunately, because of the variety of case styles used for semiconductor devices, providing all the pinouts possible for the various devices that you see in this magazine would leave a lot less room for information that cannot be looked up. However, when I extensively discuss any particular

Over 750,000 readers of earlier editions of

The Forrester Mims Engineer's Notebook

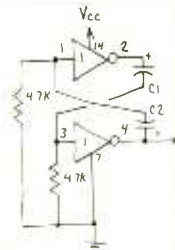

agree—nobody knows practical IC applications like Forrester Mims! This newly-revised edition contains hundreds of proven, tested circuits—hand-drawn by Forrester—using today's most popular linear, TTL, and CMOS ICs. Forrester gives you full data for each device and circuit—pin numbers, logic tables, supply voltages, and signal waveforms—so you can quickly duplicate each circuit. There's also practical information on construction methods, troubleshooting, and interfacing different IC families. If you work with ICs you gotta get this book!

Only \$14.95 at bookstores or electronic parts dealers. Or order direct from HighText! Add \$3 shipping (\$4 to Canada, \$5 elsewhere). CA please add sales tax. U.S. funds only please.

HighText
Publications, Inc.

7128 Miramar Road
Suite 151
San Diego, CA 92121

36,284

ELECTRONIC COMPONENTS

Whether you order 1 part or all 36,284...MOUSER stocks and...can ship today!!
MOUSER also makes it easy to do business.

CALL...

(800) 992-9943

for your
FREE
CATALOG

2301 Hwy 287 N.

Manefield, TX 75363

MOUSER ELECTRONICS

Sales & Stocking Locations Nationwide

CIRCLE 14 ON FREE INFORMATION CARD

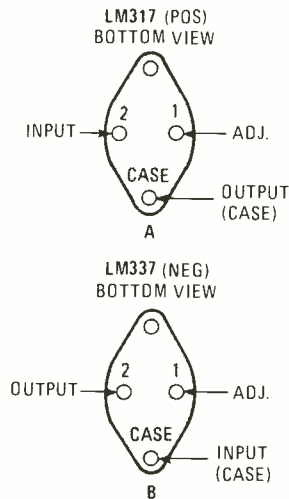

Fig. 3. Here are the pinouts for the LM317 (A), and LM337 (B) adjustable voltage regulators. Note that they are different because one (the LM317) is a positive voltage regulator and the other is a negative voltage regulator.

device in the future, I'll try to remember to provide all the pinout data I can find. Thanks for the information,

your point is well taken.

Incidentally, FactCard 22 shows pinouts for several regulator types and case styles.

A WEIGHTY ISSUE

I salvage whatever part I can from used and surplus PC boards. To aid in removing components, I like to use a gadget that reduces the amount of time (and thus heat) it takes to remove components. I use a medium-size fishing sinker attached to an alligator clip.

First I put a PC board solder-side-up in my PC-board holder with the alligator clip attached to the part that I wish to remove. As the weight dangles, I remove solder from each of the component's pads. If the part doesn't fall off, a touch of the soldering iron at each pad will release it

from any remaining solder. If the alligator clip is attached to the component properly, it can act as a heat sink to protect heat-sensitive components. The little helper can increase the success of your salvaging efforts and the amount of time that you spend doing more enjoyable work, and yet costs next-to-nothing to build.

—Mike Giamportone, Yale, MI

I have a couple of items in my tool box that I use for similar jobs. One is a simple pair of locking forceps. They are heavy enough to help pull components out and can be used as a heat sink, just like your helper.

The other item is a small alligator clip attached to a magnet. It can be used just as your helper, or the magnet can be placed on some convenient spot on a project's metal chassis to permit the alligator clip to hold wiring out of the way.

OFF THE SHELF

After years of fighting with masking tape, paint, etch-resist pens, etc. (with limited success), I feel I have finally found the ideal medium for masking off large (or even small) areas on circuit-board slugs. I am now using plastic self-adhesive shelf and drawer liner. The stuff is a dream to work with: It's inexpensive; you can draw on it; it slices, removes, and repositions easily; and is an excellent etch resist.

If you wish to try some, use the kind with the peel-off backing, but avoid the brands that claim they are easily removed. The brand that I prefer is Fabtac. It is also important to have your circuit board free of grease or oil and avoid getting any grit or hair under the paper, as that might allow etchant to flow into forbidden areas.

I usually cover an entire circuit board with liner, lay out the larger circuit traces, ground planes, etc., in pencil, and slice out and remove the unwanted areas. Although entire circuits can be laid out in that fashion, it is easier and faster to do the smaller circuit paths in dry-transfer rub-ons. Apply those *after* you have covered the larger areas with the liner, or you will peel off the transfers when you remove the liner.

By the way, air bubbles under the liner have little effect as long as the edges are firmly stuck down. I have also found that plastic straight edges, templates, etc. are less likely to tear or move the shelf paper. Thanks and keep up the great column.

—PG. Rissman, Quincy, CA

That's a neat idea! Anyone that gives this a try should be sure to clean the board thoroughly to remove all adhesive once the board has been etched—the adhesive could make soldering difficult.

CHEAP WIRE CUTTERS

Try this helpful hint the next time you stuff and solder a printed-circuit board. Instead of using wire cutters to clip off excess component leads, try using a standard pair of nail clippers. They provide a clean, flush cut, and are perfect for reaching into tight spots. I've clipped literally thousands of leads with the same nail clippers (total-cost \$1.49) and they're still clipping cleanly. For thicker, high current leads try using toenail clippers.

—Kevin L. Young, Vandenberg AFB, CA

While this tip may not make me throw out my wire cutters, it's nice to know about a substitute that I can use in a pinch.

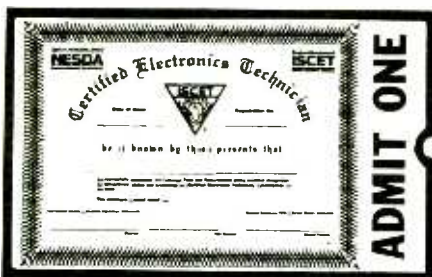

Your Ticket To SUCCESS

Over 28,000 technicians have gained admittance worldwide as certified professionals. Let your ticket start opening doors for you.

ISCED offers Journeyman certification in Consumer Electronics, Industrial, Medical, Communications, Radar, Computer and Video. For more information, contact the International Society of Certified Electronics Technicians, 2708 West Berry Street, Fort Worth, TX 76109; (817) 921-9101.

Name _____
Address _____
City _____
State _____ Zip _____

Send material about ISCED and becoming certified.

Send one "Study Guide for the Associate Level CET Test." Enclosed is \$10 (inc. postage).

CIRCUIT CIRCUS

By Charles D. Rakes

Experimenter's Test-Bench Helpers

How often has it happened? You've just finished wiring together the prototype for some new project. You connect a battery to the circuit as its power source and eagerly wait to see if the circuit performs as expected . . . but nothing happens, the battery is DOA. If the "battery-napper" is keeping you from checking out a new circuit by consuming every volt in sight, then the first item on our agenda this month might be the solution to your problem.

ure 1 is the schematic diagram for a dual-polarity, multi-voltage power supply that you can build for a very small investment; it will replace the majority of the batteries used in your circuit experiments.

Each output can supply up to 1 amp of current and all of the outputs can be used at the same time. The only requirement is that the overall current drain be within the limits of the power transformer (T1, a 24-30-volt, center-tapped, 2-6-amp unit) and diodes, D1-D4 (which are rated 3-amps, 100-PIV). The diodes form a full-wave bridge rectifier.

The 117-volt AC line is applied across T1, which reduces that voltage to a usable level (in this case, around 24 to 30 volts). That voltage is fed to the bridge rectifier, which, in turn, outputs a pulsating DC voltage. The output of the rectifier is filtered by capacitors, C1 and C2—C1 provides filtering for the negative voltage, while C2 takes care of the positive voltage. Those capacitors must have a value of no less than 5000- μ F (and should be larger if possible), and have a voltage rating greater than the applied voltage.

The filtered DC is fed to a group of voltage regulators, U1-U6. The 78xx-series units (U1-U3) are positive regulators, and the 79xx-series units (U4-U6) are negative regulators. The units shown in Fig. 1 will provide ± 5 -, ± 8 -, and ± 12 -volt outputs. Each regulator output is fed across a capacitor, which is used to reduce (or eliminate) any residual ripple

remaining in the output voltage. Those capacitors, C3-C8 (which are 0.1- μ F units), should be located close to the regulator body.

The regulators should be mounted to a heat sink. Warning: Do not tie the tabs of the positive regulators to the tabs of the negative regulators. On the positive regulators, the ground terminal (center lead) is common to the tab. On the negative regulator, the input (middle lead) is tied to the tab. If the tabs of the

PARTS LIST FOR THE POWER SUPPLY

SEMICONDUCTORS

- U1—7812 positive 12-volt, 1.5-amp voltage regulator, integrated circuit
- U2—7808 positive 8-volt, 1.5-amp, voltage regulator, integrated circuit
- U3—7805 positive 5-volt, 1.5-amp voltage regulator, integrated circuit
- U4—7905 negative 5-volt, 1.5-amp voltage regulator, integrated circuit
- U5—7908 negative 8-volt, 1.5-amp voltage regulator, integrated circuit
- U6—7912 negative 12-volt, 1.5-amp voltage regulator, integrated circuit
- D1-D4—3-amp, 100-PIV silicon rectifier diode

CAPACITORS

- C1, C2—5000- μ F, 35-WVDC, electrolytic
- C3-C8—0.1- μ F, ceramic-disc

ADDITIONAL PARTS AND MATERIALS

- T1—24-30-volt center-tapped 2-6-amp stepdown transformer
- F1—1-amp, fast-blow fuse
- S1—Power switch
- Perfboard materials, enclosure, molded AC power plug with line cord, connector, wire, solder, hardware, etc.

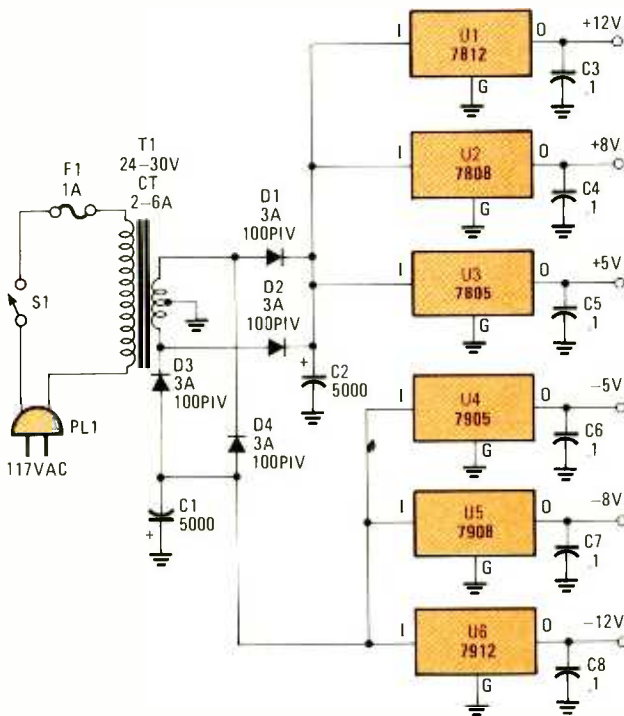

Fig. 1. Here is a dual-polarity, multi-voltage power supply that you can build for a very small investment. The circuit is built around 78xx and 79xx series 1-amp voltage regulators, four 3-amp diodes, a 24-30-volt, 2-6-amp transformer, and eight filter capacitors.

POWER SUPPLY

If you enjoy building and experimenting with electronic circuits, you no doubt know how handy a bench power supply can be. Fig-

two types of regulators are tied together, the negative DC voltage would be shorted to ground through the positive regulator. Because of that, the two regulator types can not share a common heat sink. However, you can mount all of the positive voltage regulators to a common heat sink and all of the negative regulators to a common heat sink. You can also use individual heat sinks for each of the regulators.

If the regulators shown do not provide the voltages needed, you can substitute or add other regulators to the circuit. For instance, if you need a ± 9 -volt power supply, the 7809 and 7909 regulators will provide the desired ± 9 -volt outputs.

It is also possible to produce a low-power version of the circuit—which can satisfy the needs of most CMOS and numerous other circuits—by using 78Lxx and 79Lxx series regulators. The 78Lxx and 79Lxx series offer the same voltages as their heftier cousins, but at a lower current capacity (100 mA). The low-power version also allows you to use a smaller and less-expensive transformer. And the 3-amp rectifiers (D1–D4) can be replaced with low-cost 1N4002 (1-amp) diodes.

SHUTDOWN CIRCUIT

All types of semiconductor devices have maximum voltage limitations. For example, a TTL device will go up in a puff of smoke if it is exposed to much more than 6 volts. Our next two circuits can be used to protect IC circuits that are operated from an AC power supply.

The circuit in Fig. 2 is designed to sense an overvoltage condition. That circuit is designed to be connected between the power supply and the cir-

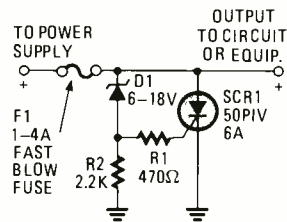

Fig. 2. Many modern devices have shutdown circuits that are designed to remove power from the device under power when the voltage rises above a predetermined threshold. This one blows a fuse to protect the device under power.

PARTS LIST FOR THE SHUTDOWN CIRCUIT

SCR1—6-amp, 50-PIV, silicon-controlled rectifier
 D1—6-18-volt Zener diode (see text)
 R1—470-ohm, 1/4-watt, 5% resistor
 R2—2200-ohm, 1/4-watt, 5% resistor
 F1—1-4-amp fast-blow fuse
 Perfbord materials, fuse holder, wire, solder, hardware, etc.

cuit being powered. Then, when an overvoltage condition occurs, the circuit shorts the power supply to ground, drawing massive amounts (comparatively speaking) of current through the fuse, causing it to open.

A Zener diode is used to set the disconnect voltage threshold. When that threshold is reached, the current applied to the gate of SCR1 causes it to turn on, shorting the supply to ground. That causes the current flow through the fuse to increase until the link (thin metallic filament) within the fuse burns out. No harm will come to the regulators, as they are protected by their own internal shutdown circuitry.

The SCR should be selected to have a current rating at least 25% greater

than the current rating of the fuse. In addition, the value of R1 should be selected to meet the gate-current requirement of the SCR.

RESETTABLE SHUTDOWN CIRCUIT

If your circuits experience frequent overvoltage conditions, continually replacing blown fuses can get pretty expensive. However, our next shutdown circuit overcomes that deficiency by replacing the fuse with a relay and a low-current SCR.

In the resettable shutdown circuit shown in Fig. 3, a Zener diode is once again used to set the circuit's trip point. When the input voltage rises above the threshold set by the Zener diode (D1), a current of sufficient magnitude is applied to the gate of SCR1, turning it on. That draws current through the relay coil, energizing it, which causes its commutator to swing to its normally open contact, dis-

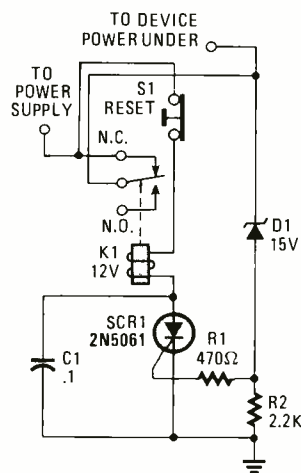

Fig. 3. If you live or work in an area where power-line surges occur often, continually replacing blown fuses can get pretty expensive. However, this resettable shutdown circuit overcomes that deficiency by replacing the fuse with a relay and a low-current SCR.

PARTS LIST FOR THE RESETTABLE SHUTDOWN CIRCUIT

SCR1—2N5061, 2N5062, or similar sensitive-gate, silicon-controlled rectifier
 D1—15-volt Zener (see text)
 R1—470-ohm, 1/4-watt, 5% resistor
 R2—2200-ohm, 1/4-watt, 5% resistor
 C1—0.1- μ F, 100, ceramic-disc capacitor
 K1—12-volt relay
 S1—Normally closed switch
 Perfbord materials, wire, solder, hardware, etc.

rupting power to the circuit under power. Switch S1, a normally closed pushbutton switch, is used to reset the circuit; it does so by interrupting power to the relay. When S1 is pressed, the relay's wiper arm returns to the normally closed position, restoring power to the connected circuit.

If you deal with a number of circuits that have different burn-out levels, try

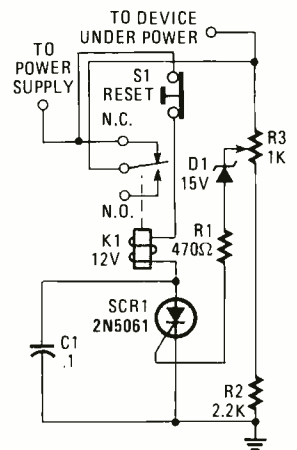

Fig. 4. This version of the circuit in Fig. 3 provides an adjustable threshold, with an approximately 30% variance.

the circuit in Fig. 4. That circuit variation, a variable trip-point shutdown circuit, allows you to adjust the shutdown threshold to whatever level is desired. The circuit adjustment allows for the 30% variance

PARTS LIST FOR THE VARIABLE TRIP-POINT SHUTDOWN CIRCUIT

RESISTORS

(All fixed resistors are 1/4-watt, 5% units.)

- R1—470-ohm
- R2—2200-ohm
- R3—1000-ohm potentiometer

ADDITIONAL PARTS AND MATERIALS

- SCR1—2N5061, 2N5062, or similar sensitive-gate, silicon-controlled rectifier
 - D1—15-volt Zener diode (see text)
 - C1—0.1- μ F, 100, ceramic-disc capacitor
 - K1—12-volt relay
 - S1—Normally closed switch
- Perfboard materials, wire, solder, hardware, etc.

in the trip point. The Zener diode should be selected to have a voltage rating that is slightly lower than the minimum desired threshold voltage.

TELE-TIMER

If you're in the habit of spending too much time on the phone, causing your bill to shoot up like the national debt, you might consider building the telephone "yak" timer shown in Fig. 5. The circuit is built around an old friend, the 555 oscillator/timer, which is connected in a dual-time timer circuit. The circuit provides two time periods. The long-running time period is adjustable from about one to ten minutes, and the short time period is pre-set to about three seconds.

Here's how the dual timer operates. When the power is switched on, C2 begins to charge through R3, R1, D1, and R4 to start the long-term time period. When the voltage across C2 reaches the 555's internal switching point, the long-term timer times out, discharging C2 through R2, D2, and pin 7 of the 555. During that time,

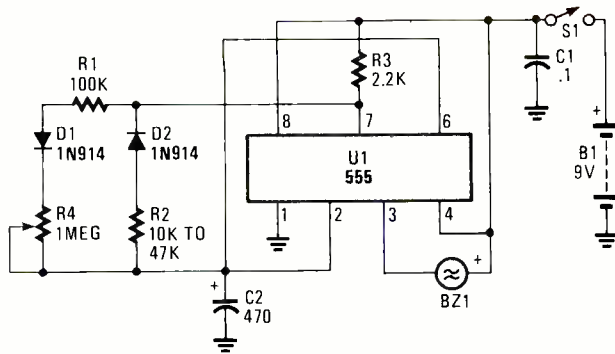

Fig. 5. The tele-timer is built around a 555 oscillator/timer, which is connected in a dual-time timer circuit.

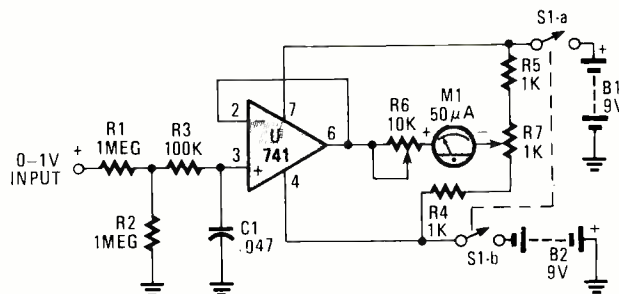

Fig. 6. The transistor checker is little more than a 0-1 volt DC voltmeter built around a 741 general-purpose op-amp that's configured as a voltage follower. The output of the 741 is used to drive a 50-microamp meter.

PARTS LIST FOR THE TELE-TIMER

SEMICONDUCTORS

- U1—555 oscillator/timer, integrated circuit
- D1, D2—1N914 general-purpose silicon diode

RESISTORS

- (All fixed resistors are 1/4-watt, 5% units.)
- R1—100,000-ohm
 - R2—See text
 - R3—2200-ohm
 - R4—1-megohm potentiometer

pin 3 of the 555 is pulled to ground, activating the piezo sounder.

To set the short time period to about four seconds, use a 10k resistor for R2, and for about twenty seconds use a 47k resistor. The timing capacitor, C2, should be a good quality, low-leakage unit.

TRANSISTOR CHECKER

If you spend time troubleshooting transistor

ADDITIONAL PARTS AND MATERIALS

- C1—0.1- μ F, ceramic-disc
 - C2—470- μ F, 16-WVDC, electrolytic
 - B1—9-volt transistor radio battery
 - S1—Power switch
 - BZ1—Piezo sounder
- Perfboard materials, knob, enclosure, IC socket, wire, solder, hardware, etc.

circuits and have to measure transistor-junction or bias voltages, the next circuit—a bias voltmeter—just might make the chore a little easier. A low-voltage, high-impedance voltmeter is a must when checking a transistor's base-emitter voltage or the collector-emitter saturation voltage. Just such a circuit, a 0-1-volt DC voltmeter, is shown in Fig. 6.

The circuit is built around a 741 general-purpose op-

PARTS LIST FOR THE TRANSISTOR CHECKER

RESISTORS

- (All fixed resistors are 1/4-watt, 5% units.)
- R1, R2—1-megohm
 - R3—100,000-ohm
 - R4, R5—1000-ohm
 - R6—10,000-ohm potentiometer
 - R7—1000-ohm potentiometer

ADDITIONAL PARTS AND MATERIALS

- U1—741 general-purpose op-amp, integrated circuit
 - C1—0.047- μ F, ceramic-disc capacitor
 - B1, B2—9-volt transistor-radio battery
 - M1—50- μ A meter
 - S1—DPST toggle switch
- Perfboard materials, enclosure, IC socket, knob, battery holders and connectors, wire, solder, hardware, etc.

amp that is configured as a voltage follower; with the components shown, the op-amp has a voltage gain of one. The output of the 741 is used to drive a 50- μ A meter movement. Potentiometer R7 is used to zero the meter and R6 sets the meter's full-scale reading.

Calibrating the meter is a snap. With no input applied to the circuit, set R6 to mid-position and adjust R7 to zero the meter. Once that is done, apply a positive 1-volt DC voltage to the input and adjust R6 for a full-scale reading. The voltmeter can be adjusted to read both positive and negative voltages by adjusting R7 for a center-scale reading and calibrating R6 for a negative 1-volt reading at the meter's zero position and a positive 1-volt reading at the meter's full-scale position.

It looks like we've about run our space for this visit so until next month, keep the parts handy and the old iron hot.

HAM RADIO

By Joseph J. Carr, K4IPV

The Digital Sawtooth Generator

A spectrum analyzer is a special radio receiver that sweeps through a set frequency range in order to display (on an oscilloscope) the signals that are active on the band. Spectrum analyzers can be used to examine band activity, the harmonics of a transmitter, and any other process where frequencies and relative amplitudes are important. For instance, commercial radio engineers sometimes use a

SOME BACKGROUND

Figure 1 shows the block diagram of a generic spectrum analyzer. From the mixer/local oscillator configuration, one can see that the circuit is basically a superheterodyne receiver. A superheterodyne receiver is one in which the signal from a local oscillator (f_2) is mixed with the incoming RF signal (f_1) to produce at least four output signals: f_1 , f_2 , $f_1 + f_2$, and $f_1 - f_2$.

A narrow-band filter is used to select one of those signals (usually $f_1 - f_2$). That signal, which is called an intermediate frequency (IF), is then amplified, detected, and applied to the vertical input (V) of an oscilloscope. The local oscillator circuit is tuned by a sawtooth waveform; i.e., a signal that starts at zero, rises linearly to a maximum amplitude and then snaps back to zero. The sawtooth waveform is applied to a frequency-setting network.

The frequency-setting network is comprised of an inductor and a few capacitors. In our block diagram, a Varactor (variable-capacitance diode, whose capacitance is a function of, in this case, the tuning voltage) is used as one of the capacitors. The local oscillator's frequency is a function of the capacitance of the Varactor. Thus, the oscillator frequency is a function of the sawtooth amplitude plus any DC offset used to tune the circuit.

The sawtooth not only tunes the local oscillator, but also supplies the time-base (X-input) of the oscilloscope. The sawtooth

sweeps the beam left to right, while the corresponding frequencies are detected and placed on the scope's vertical input.

In the December 1991 column, I mentioned some experiments that I'd done using the Signetics NE602 double-balanced mixer as a spectrum-analyzer front end. The NE602 contains a local oscillator (whose frequency can be set with external components) and a Gilbert transconductance-cell "double-balanced mixer" for the mixer. If a varactor diode is used for the tuning element, application of a sawtooth waveform causes it to sweep through the desired frequency spectrum.

SAWTOOTH GENERATOR

The classic sawtooth generator is comprised of an op-amp "Miller integrator" that is fed a constant DC signal and is reset at a specified signal amplitude. The problem with that type of circuit is that the sawtooth is curved (i.e., nonlinear) because it is essentially a capacitor-charged waveform. In the December 1991 column, I offered to make available (through the mail) a schematic diagram for a digitally controlled sawtooth generator for use with the spectrum analyzer (which appeared in that column). The response was so overwhelming, and questions about spectrum analyzers so many, that I decided to revisit the topic in this month's column.

Figure 2 shows a sche-

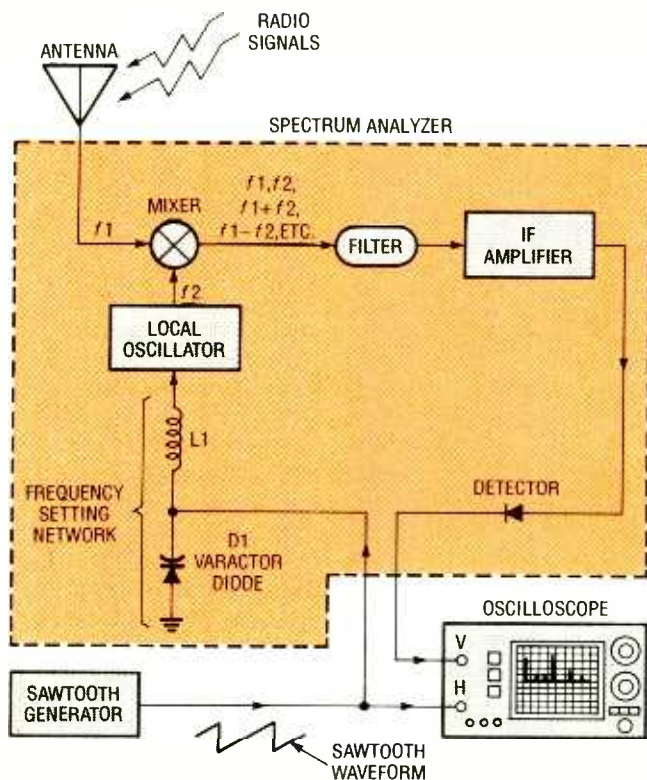

Fig. 1. Block diagram for a generic spectrum analyzer. From the mixer/local-oscillator configuration, one can see that the circuit is basically a superheterodyne receiver.

spectrum analyzer to locate channels with the least amount of activity in order to put a new station on the air.

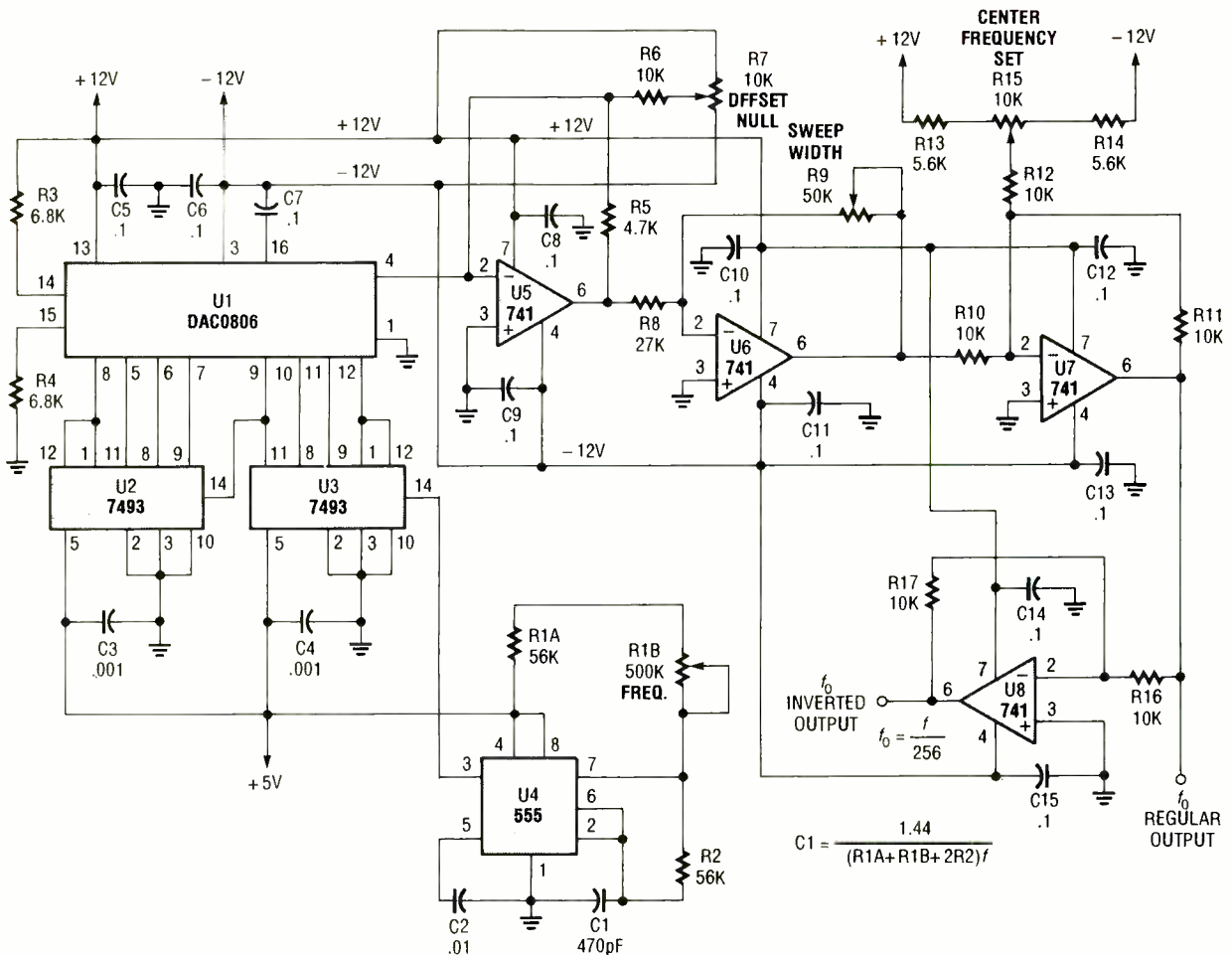

Fig. 2. One of the main components in this digital sawtooth generator is a DAC0806 digital-to-analog converter (DAC), U1. The DAC outputs a sawtooth current that is fed to U5, which, in turn, converts the signal current to a sawtooth voltage.

matic diagram for the digital sawtooth generator. One of the main components in that circuit is a DAC0806 digital-to-analog converter (DAC), U1. The digital inputs of U1 are driven by the outputs of a pair of cascaded 7493 TTL base-16 binary counters (U2 and U3). The DAC0806 outputs a sawtooth current (at pin 4) that is fed to the inverting input of op-amp U5, which converts the sawtooth current to a sawtooth voltage. Potentiometer R7, OFFSET NULL, is used to take care of any DC offsets that result from the conversion process. That control may be unnecessary if the inherent offsets are low.

From U5, the signal is sent

to a second op-amp (U6). Op-amp U6, coupled with potentiometer R9, forms a SWEEP WIDTH (or signal amplitude) control. Potentiometer R15, CENTER-FREQUENCY set, is used to add a DC-offset level to the sawtooth. The DC offset is, in turn, added to or subtracted from the sawtooth signal. The local-oscillator frequency swings back and forth across the frequency set by the DC level.

The sawtooth frequency is set by U4 (a 555 oscillator/timer), which is used as a clock for the 7493 counters. The output of the sawtooth generator (f_o) is 256 times lower than the frequency of the clock ($f_o = f/256$, where f is the timer frequency). For most spectrum analyzer ap-

plications, a sawtooth frequency of 20 to 40 Hz is necessary. Sweep rates lower than 20 Hz get into a region where scope flicker is apparent. Above about 40 Hz, the detected signals tend to "ring" the filter and cause distortion. With the values for R1A, R1B, and R2 shown, using a 470-pF capacitor for C1 yields about a 30-Hz sawtooth frequency when R1B is set to mid-range.

When the sawtooth generator's controls are adjusted correctly, the ramp rises linearly from zero, and then drops abruptly back to zero when the peak is reached. If the SWEEP WIDTH (R9) or CENTER FREQUENCY (R15) controls are set wrong, either the peak or

base of the waveform could be clipped. The clipping causes a problem for the spectrum analyzer, so that situation must be avoided.

SPECTRUM ANALYZER KITS

My friend, Murray Barlowe, operates Science Workshop (P.O. Box 393, Bethpage, N.Y., 11714). Murray produces the "Poor Man's Spectrum Analyzer" (PMSA) kits. The kits—which are available in VHF/UHF and 0- to 500-MHz designs—are based on DC-tuned cable-television tuners and some boards of his own design.

If you want to experiment with spectrum analyzers, (Continued on page 81)

DX LISTENING

By Don Jensen

WWV and WWVH offer more than you think!

There's hardly a short-wave listener in North America who isn't familiar with WWV, and its sister station, WWVH, operated by the U.S. Department of Commerce's National Institute of Standards and Technology (NIST). WWV in Fort Collins, CO, and WWVH, in Kauai, HI, tick away around the clock, offering standard time and frequency data on a series of shortwave frequencies.

located in Beltsville, MD, outside of Washington, DC) way back in 1923. The Hawaiian-based WWVH was added in 1948. WWV was moved to Colorado in 1966.

Voice announcements are made each minute. Since both WWV and WWVH can be heard in some locations, a man's voice—belonging to a fellow named Eric Smith—is used on the former, a

through Greenwich, England. For instance, UTC is equal to Eastern Daylight Time plus 4 hours. For others in the U.S. and Canada, UTC is equal to CDT + 5/ CST + 6; MDT + 6/MST + 7 and PDT + 7/PST + 8.

How precise are these stations? Their frequencies, *as transmitted*, are accurate to about one-part-per-billion and the time signals are accurate to about 0.01 milliseconds. The accuracies are a tad less, as received, because of various propagation effects. But a *received* frequency accuracy of one-part-per-10-million and time precision to about one millisecond is far better than most users will ever need.

The most frequent sounds heard on WWV/WWVH are the pulses that mark each second, except the 29th and 59th of each minute. Most of the second pulses, which sound like a clock ticking, are short audio bursts of slightly different pitch for the two stations.

While most SWLs are aware that WWV/WWVH offer time services, not so well known are the other broadcast-information services of those two stations. For instance, once per hour (except the first hour of the day), a 440-Hz musical tone is transmitted. For WWVH it is aired at 2 minutes after the hour, or at 3 past the hour for WWV. During alternate minutes during most of each hour, similarly accurate audio tones of 500 and 600 Hz are broadcast.

Who cares? Perhaps you do, if you're a musician tun-

Characteristics & Services:	WWV		WWVH	
Date Service Began	March 1923		November 1948	
Geographical Coordinates	40° 40' 49.0" N 105° 02' 27.0" W		21° 59' 26.0" N 159° 46' 00.0" W	
Standard Carrier Frequencies	2.5 & 20 MHz	5, 10, & 15 MHz	2.5 MHz	5, 10, & 15 MHz
Power	2500 W	10,000 W	5000 W	10,000 W
Standard Audio Frequencies	440 (A above middle C), 500, & 600 Hz			
Time Intervals	1 pulse/s; minute mark; hour mark			
Time Signals: Voice	Once per minute			
Time Signals: Code	BCD code on 100-Hz subcarrier, 1 pulse/s			
UT1 Corrections	UT1 corrections are broadcast with an accuracy of ±0.1 s			
Special Announcements	Omega Reports, Geoaerts, Marine Storm Warnings, Global Positioning System Status Reports			

While most SWLers are able to hear WWV's and WWVH's time and frequency services, there's a lot more to those stations than you might think. Complete information on the many services that they provide can be found in NIST Special Publication 432 (Revised 1990).

Both stations transmit on precise standard frequencies of 2,500, 5,000, 10,000 and 15,000 kHz. Additionally, WWV uses 20,000 kHz. Both stations also give precise time signals and voice announcements day and night.

NIST's predecessor agency began broadcasting time and frequency information from WWV (then

woman's—Gretchen Stahl—voice encoded in computer memory chips on the latter.

The time is announced in UTC, or Coordinated Universal Time. UTC differs from your local clock time by a specific number of hours, depending on the number of time zones between you and the zero meridian of longitude, which passes

ing your instrument; 440 Hz is, exactly, the musical note A above middle C. Scientists can rely on the NIST broadcasts for a binary-coded-decimal (BCD) time code, which is transmitted on a subcarrier inaudible on the typical SWL's short-wave receiver. Other technical users can tune in to receive correction data that allows them to convert the highly precise UTC to UTI, a special time standard that's based on the less stable rotation of the Earth.

The various voice announcements may be of more interest to the typical shortwave listener. For instance, there are the OMEGA navigation-system status reports at 16 minutes after the hour on WWV and H + 47 on WWVH. The announcement provides current data about this worldwide SW-radio (10–14-MHz frequency range) locator system, which aids maritime and aeronautical navigators.

At 14 and 15 minutes after the hour on WWV (H + 43 and H + 44 on WWVH), the U.S. Coast Guard sponsors voice announcements on the current status of the Global Positioning System (GPS), which provides satellite navigational aids to precisely determine their geographic coordinates.

Geophysical alerts (WWV, H + 18; WWVH, H + 45) can be of interest to the serious DX listener interested in the propagation of shortwave signals. Geomagnetic disturbances, for example, can, in extreme cases, completely block out SW signal transmission. The broadcast data is updated every three hours.

In addition, there are the often fascinating weather warnings that are intended for ocean-going mariners. A typical storm warning could

sound something like this: "North Atlantic weather West of 35 West at 1700 UTC; Hurricane Donna, intensifying, 24 North, 60 West, moving northwest, 20 knots, winds 75 knots; storm, 65 North, 35 West, moving east, 10 knots; winds 50 knots, seas 15 feet." Storm warnings for the Atlantic and eastern North Pacific are aired by WWV at 8, 9, and 10 minutes after the hour. WWVH has warnings for the western, eastern, southern, and north Pacific at 48, 49, 50, and 51 minutes past the hour.

There's a lot more to WWV and WWVH than you might think. Complete information on the broadcast services can be found in NIST Special Publication 432 (Revised 1990), which can be obtained from NIST, Mail Station 847, 325 Broadway, Boulder, CO 80303.

FEEDBACK

Your letters with comments, questions, or reports of what you are hearing on shortwave these days are always welcome. Do you have a photo of yourself listening to your shortwave receiver? If so, send it along and I will try to include it in a future column. Write me in care of *DX Listening*, **Popular Electronics**, 500-B Bi-County Blvd., Farmingdale, NY 11735.

Nick Abrams of Charleston, WV, writes to say that one of the main reasons he listens to SW is for the music. "Where else can you hear so many different kinds of music in a single evening?," Nick asks rhetorically. "I've regularly heard and taped programs of African, Latin and Mid Eastern music," he continues. "I presume that *Radio Beijing* would be the best source of traditional Chinese music. But when and where should I tune in?"

A.N. Thaleip, writing in *Contact*, the monthly publication of the World DX Club in the United Kingdom, suggests two regular musical programs in the English service of Radio Beijing. During the Saturday program segment, there is a 20-minute feature called "Music from China," and on Sunday, the 15-minute "Music Album." He says that the programs contain both traditional and modern Chinese music. A partial schedule of Radio Beijing broadcasts in English to North America is: 0000 to 0100 UTC on 15,000 and 17,705 kHz; 0300 to 0400 UTC on 9,690, 11,715, and 15,100 kHz; and 0400 to 0500 UTC on 11,685 and 11,840 kHz.

"The *Voice of America* station at Bethany, OH is back on the air," observes Dan Fedders in Toledo, OH. "I've noted it with VOA programming on 17,800 kHz."

Thanks, Dan! When the ancient Crosley shortwave transmitters at Bethany were taken out of service a few years ago, it looked like the mid-America relay station was gone for good. But the VOA has installed three new Swiss-made 250-kilowatt SW transmitters, which are now on the air. For a limited time, special QSL cards are being issued for reception reports of this station. The address is VOA, Bethany Relay Station, P.O. Box 227, Mason, OH 45040. Some of the frequencies used at certain hours for

*Credits: Brian Alexander, PA; Doug Robertson, CA; Tom Tabatowski, IN; Dan Ferguson, VA; Tony Orr, VA; North American SW Association, 45 Wildflower Road, Levittown, PA 19057; World DX Club, c/o North American Representative, Richard D'Angelo, 2216 Burkey Drive, Wyomissing, PA 19610; Ontario DX Association, P.O. Box 161, Station A, Willowdale, ONT. M2N 5S8 Canada.

relaying the Latin American and African VOA programs are 9,590, 11,830, 11,890, 17,800, 17,850, and 21,745 kHz.

DOWN THE DIAL

Here are some stations that have been recently logged on shortwave by some of your fellow readers. Why not write in to the address given earlier and share what you are hearing with others.

BENIN—This West African nation's regional SW voice on 5,025 kHz has been logged signing on the air at 0445 UTC with an interval signal, the country's national anthem, flute and drum music, and the French announcement: "*Ici Parakou, station regionale d'IORT du Benin.*"

NORTH KOREA—*Radio Pyongyang* has an English-language news broadcast on 9,325 kHz at 1505 UTC. That broadcaster also transmits on the parallel frequency of 9,977 kHz.

POLAND—Warsaw's *Radio Polonia* has an English transmission at 0630 UTC on 7,270 and 9,675 kHz. For those of you who speak Polish, you can find programs in the native tongue, which are primarily intended for Polish seamen, at 0400 UTC on either 7,145 or 9,525 kHz.

U.S.A.—Here is a sampling of when and where to tune some of the private shortwave broadcasts in the U.S.: *WYFR/Family Radio* (Florida), 0300 UTC on 9,505 kHz; *WWCR* (Tennessee), 0400 UTC on 7,435 kHz; *KVOH* (California), 1900 UTC on 17,775 kHz; *WHRI* (Indiana), 0100 UTC on 9,495 kHz; *WMLK* (Pennsylvania), 0400 UTC on 9,465 kHz; *WRNO* (Louisiana), 0000 UTC on 7,355 kHz; *WCSN* (Maine), 0200 UTC on 9,850 kHz; *KTVN* (Utah), 0500 UTC on 7,510 kHz. ■

SCANNER SCENE

By Marc Saxon

Getting to the Bottom of the Mailbag

Want to get an inexpensive and versatile backup scanner, or a reasonably priced gift for someone who you'd like to interest in scanning? We nominate *Radio Shack's Realistic PRO-59*.

For about \$100, you get a fully programmable, eight-channel scanner that offers coverage of 137–174 MHz and 406–512 MHz. It has a memory backup, channel lockouts, scan delay, and provisions for searching the 162-MHz weather channels for broadcasts. The PRO-59 scans at 14 channels per



Radio Shack's PRO-59 is priced just right for a second scanner to keep in your kitchen, bedroom, or basement, and covers the best frequencies.

second. Its sensitivity is $0.7\mu\text{V}$ in the VHF band and $1.0\mu\text{V}$ in the UHF band. Its selectivity is -6 dB at $\pm 11\text{ kHz}$, and -50 dB at $\pm 15\text{ kHz}$. The scanner weighs

one pound, ten ounces, and comes with an AC power adapter.

Those features make it a fine choice for taking along on vacation. Or you could use one as a second set for bedside, patio, basement, or kitchen, so you don't miss any of the action on the best frequencies when you're not at your primary monitoring location. At that price, why not?

THE FREQUENCY DOCTOR IS IN

Sometimes we get carried away writing about other topics here, and don't get around to dealing with all the mail we receive, either providing or asking for scanner frequencies. So, before we get sidetracked—and backlogged—let's dig right in to some of those letters.

We'll kick off with a request from Paul Chapman, N3KLO, of Edinboro, PA, who wants to know what frequencies are authorized for Edinboro University. We found 151.835, which we believe is for police and maintenance. The school's FM broadcast station, WFSE, has mobile units on 161.67 and 161.70 MHz.

J. Gluck, of Summit, NJ, tells us that he has tried several avenues of approach to find out the security frequency at the large Short Hills Mall, near his home. Those avenues turned out to be blind alleys, he tells us. See if 464.825 is the direct route to the mall.

A reader who identified

himself only as H.R.A. of Connecticut passes along some frequencies used by the police in Norwich, CT. Tactical operations are on 39.86, 155.07, 155.55, and 154.875 MHz. Other police operations are being monitored on 856.2375, 857.2375, 858.2375, 859.2375, and 860.2375 MHz. We assume that the 800-MHz operations are trunked, although our reader did not specify.

Allen Carswell, of Long Beach, CA, would like to know the best frequencies to monitor in the 125-cm ham band, which used to run from 220 to 225 MHz and went under the name of the $1\frac{1}{4}$ -meter band. The FCC reduced that band down to 222–225 MHz recently, and everything has been reshuffled, says Allen. He says that the old band was great fun to monitor on his scanner, but he can't quite get a grip on the way the stations are using the repackaged band.

Nationally, the FM simplex is now between 223.40 and 223.52 MHz; 223.50 MHz is the calling channel. Repeater outputs run from 223.85 to 224.98 MHz. Note that many hams using that band have horizontally polarized antennas.

We heard from Harry Stampleman, of Jackson, MI, with a lot of frequencies, including some recent changes and additions. The city police now dispatch on 460.15 and 460.25 MHz, and the detectives use 154.845 MHz. The city fire department is on 154.07

and 154.13 MHz, with rescue on 154.13 MHz. The Michigan State Police in Jackson use 42.64 MHz, while the state prison there can be monitored on 155.875 MHz. Of the county sheriffs in that area, the Leoni sheriff is on 154.49 MHz, the Jackson sheriff is on 154.95 MHz, the Hillsdale sheriff is on 155.31 MHz, and the Branch sheriff is on 155.52 MHz.

Many readers have written in to mention that some of the new cordless telephones and baby-room monitors on the market don't operate on the old, familiar 46- and 49-MHz frequencies. They hope we will mention where they have gone. The cordless phones appear to be spread out on frequencies in the 902-948-MHz band, while the baby monitors seem to be concentrated in the lower (902-928-MHz) portion of that band, along with a number of other assorted low-power users and devices.

A plea for help came in from Adam Blanquart, of Romeoville, IL. Adam is having trouble finding the local police and fire frequencies. He tells us that the frequency directories he has searched don't have what he's seeking. We would recommend that he first listen for the police on 155.43 MHz and for fire operations on 154.25 and 154.40 MHz. If those don't produce anything of value, try for either or both agencies on any of the following frequencies: 37.10, 37.18, 45.28, 45.36, 45.40, 45.44, 45.56, 153.875, and 155.025 MHz.

Monitors in the Baltimore, MD, area should listen in on 453.875 MHz. That, reports an anonymous reader in that city, is the Baltimore City Police Special Operations Division channel. Lots of surveillance and undercover activity there, with

quite a few big drug busts going down. That reader also reports hearing "bugs" on 154.65 MHz. Finally, he says that local neighborhood-security groups protecting religious buildings from vandalism can be monitored on 464.875 MHz.

Andy Mussnug, of Belgrade, MT, reports that bringing a handheld scanner to high-school sports events can produce interesting results if you search the 49.83-49.89-MHz range. The coaching staffs of many school teams use short-range communications equipment in that band, and you can listen in on their strategies, plays, and comments as you watch the game.

A note of thanks came in from Bob Curtis, Jr., of Curtice, OH. He monitored the "nobody cares" frequencies we discussed a few issues ago, and found all sorts of interesting chatter in the Toledo area. He recommends 151.625, 154.57, 457.575, 458.075, and 469.55 MHz as being in very active use by a wide assortment of communicators. Chances are excellent that those same frequencies are buzzing away in most areas of the nation!

We got a card from Peter Cardenas, Registered Monitor KNH1FE, of New Hampshire. Pete reminds us that his state's Mount Washington is about the highest, windiest, and most frigid mountaintop in the northeastern states. There's a weather station on top of this mountain, and Peter read that they send weather data via radio to Boston every couple of hours. Peter thinks that the signals can possibly be monitored throughout New England, and asks us to print the frequency they use. We understand they use 34.02 and 463.95 MHz. ■

HAM RADIO

(Continued from page 77)

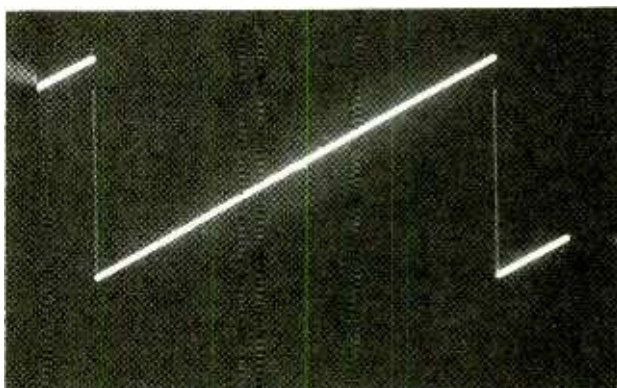

Here is what the output of the digital sawtooth generator looks like when controls are properly adjusted; note that the ramp rises linearly from zero and then drops abruptly back to zero when the peak is reached.

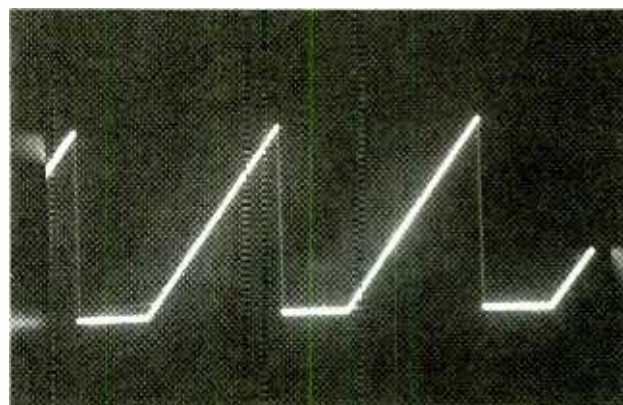

When the controls of the digital sawtooth generator are incorrectly adjusted, either the peak or base of the waveform may be clipped.

drop Murray a line and ask for the information. The kits don't include cabinets and other fancy "do-dads," but the heart is there . . . and they work.

There is a small, but growing, band of PMSA fans who build and improve on the PMSA. Murray told me some months ago that he is working on a book on the PMSA, which may be available by the time this column is published. The book will contain his own material, plus reprints of articles by a number of authors who have played with the PMSA.

Speaking of books, I am tremendously grateful for the response to my book *Practical Antenna Hand-*

book (TAB/McGraw-Hill, Cat. No. 3270; Blue Ridge Summit, PA, 17294; 1-800-233-1128). One major mail order ham/SWL dealer tells me that it out sells the other antenna books in his inventory. Also a major source of gratification came from an instructor who trains the U.S. Government radio technicians that run "service calls" all over the world. He tells me that he issues a copy to each student because " . . . it's the only book I can give to a secretary with no radio experience, and reasonably expect her to be able to successfully erect a working dipole two hours later." Thanks, people. ■

ELECTRONICS LIBRARY

International Encyclopedia of Integrated Circuits, Second Edition

by Stan Gibilisco

If you don't enjoy poring through stacks of manufacturers' data books in search of the circuits you need, this book offers a comprehensive solution. The 1000-page manual provides instant access for almost any IC or application question in one all-inclusive source. Arranged alphabetically by application, the book makes information easy to find. The in-depth table of contents includes a convenient listing of all the IC's covered in the book. In addition, there is a complete index and extensive cross-referencing by both application and manufacturer's part number.

Application categories include

what it is, what it does, and how it works, as well as explaining its relationship to other IC's and their applications. Concise descriptions of foreign and domestic IC's are featured, accompanied by more than 4000 illustrations, including pinout diagrams, internal block diagrams and schematics, and characteristic curves. The fully revised and updated second edition provides a broad overview of the latest IC's available from companies around the world.

The International Encyclopedia of Integrated Circuits, 2nd Edition costs \$69.50 and is published by TAB Books, Division of McGraw-Hill Inc., Blue Ridge Summit, PA 17294-0850; Tel: 1-800-822-8138.

CIRCLE 98 ON FREE INFORMATION CARD

ATV SECRETS

by Henry B. Ruh, KB9FO

In addition to other activities, amateur radio operators are allowed to transmit television pictures on their ultra-high-frequency bands, and the availability of low-cost video components such as camcorders and VCR's has created tremendous interest in Amateur Television, or ATV. Although an FCC license is required for ATV, the test is quite easy and no longer requires knowledge of the Morse code. The multiple choice exam is intended to demonstrate an understanding of the rules and requirements of Amateur Radio.

This book explains in simple terms exactly what is required to get on the air with ham television. It starts with an explanation of the basics of this "sub-hobby" of the Amateur Radio Service, and goes on to cover such details as reception, transmission, and even balloon-borne TV cameras. An index of more than 500 articles that have

appeared in the ham-TV publication *ATVQ* is also provided.

ATV Secrets costs \$9.98 (plus \$2 shipping) and is published by the National Amateur Radio Association, 16541 Redmond Way, Suite 232, Redmond, WA 98052; Tel: 206-896-8052.

CIRCLE 80 ON FREE INFORMATION CARD

QUE'S COMPUTER BUYER'S GUIDE 1992 Edition

by Joseph Desposito with Jamey Marcum and Doug White

Shopping for a computer is no easy task: There are so many choices that will affect both how much you pay and how well the computer will do the tasks for which you need it. This book shows you how to identify your computer needs and then find the system that is perfectly suited for those needs. Instead of offering long lists of technical features for you to compare—quite a time-consuming process, and almost impossible if



you're a beginner who isn't sure just what those features are—the book explains what different products can do, and which products are best for certain applications. Although this book is written with beginners in mind, those who are considering an update of their current

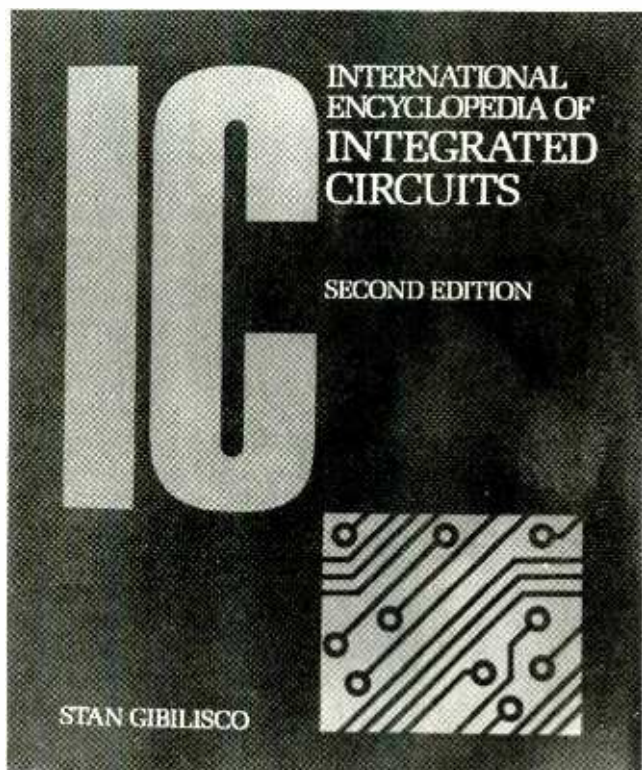

clocks, counters, timers, communications circuits, data-conversion and -processing, logic circuits, microcomputers, and power supplies. For each IC, the book explains precisely

Take One of these GIANT Handbooks for only \$9.95

when you join the ELECTRONICS ENGINEERS' BOOK CLUB

ELECTRONICS ENGINEERS' HANDBOOK, Third Edition

Edited by D.G. Fink and D. Christiansen

Completely revised, expanded, and updated, this third edition of the desktop reference is widely considered the definitive work in its field covering all aspects of today's electronics engineering. Written and compiled by more than 170 experts, this giant handbook shows you how to use the latest design and cost-cutting solutions at work in the industry today. You'll find a wealth of new material on electronic systems design, computer systems and digital recording, telecommunications, process control, laser technology, and CAD of electronic circuits. It deals with the full range of theory and practice, covering essential principles, data, devices, components, assemblies, circuits, functions, and applications. 2,624 pages 1,800 illustrations
Book No. 9255H \$97.50 Hardcover



A
\$97.50
Value

STANDARD HANDBOOK FOR ELECTRICAL ENGINEERS, Twelfth Edition

Edited by D.G. Fink and H.W. Beaty

This latest edition of the long-popular, widely-used classic Handbook reflects the many new changes in the field including the dramatic new advances in computer technology for power industry management, system planning, operation, plant monitoring and control, design, and construction. Completely revised and updated, the Handbook thoroughly covers the generation, transmission, distribution, control, conservation, and application of electrical power. Features a new section on project economics and important new material on high-voltage transmission systems and consumer end-user electrical energy. 2,416 pages 1,388 illustrations 430 tables
Book No. 020975-8 \$99.50 Hardcover

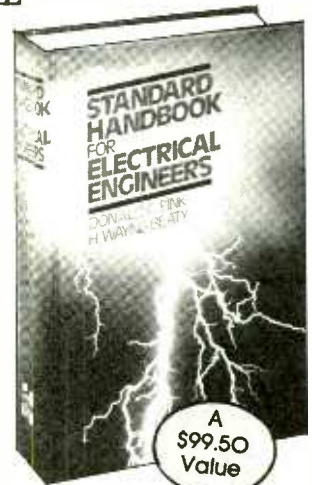

A
\$99.50
Value

How the Club Works:

YOUR BENEFITS: You get one book for \$9.95 plus shipping and handling when you join. You keep on saving with discounts of up to 50% off as a member.

YOUR PROFESSIONAL BOOKSTORE BY MAIL: Every 3-4 weeks, you will receive the ELECTRONICS ENGINEERS' BOOK CLUB News describing the Main Selection and Alternates, as well as bonus offers and special sales, with scores of titles to choose from.

CLUB CONVENIENCE & EASY RISK-FREE TERMS: If you want the Main Selection, do nothing and it will be sent to you automatically. If you prefer another selection, or no selection at all, simply indicate your choice on the reply form provided. You will have at least 10 days to decide. As a member, you agree to purchase at least 3 books within the next 2 years and may resign at any time thereafter. If not satisfied with your books, return them within 10 days without obligation.

BONUS BOOKS: Starting immediately, you will be eligible for our Bonus Book Plan, with savings of up to 80% off publishers' prices.

EXCEPTIONAL QUALITY: All books are quality publishers' editions from ALL the publishers in the field especially selected by our Editorial Board to ensure the information is reliable and specific enough to meet your needs.

(Publishers' Prices Shown)

©1992 EEBC, Blue Ridge Summit, PA 17294-0860

ELECTRONICS ENGINEERS'

BOOK CLUB

Blue Ridge Summit, PA 17294-0860

YES! Please accept my membership in the Electronics Engineers' Book Club and send the volume indicated below, billing me \$9.95. If not satisfied, I may return the book within ten days without obligation and have my membership cancelled. I agree to purchase at least 3 books at regular Club prices during the next 2 years and may resign any time thereafter. A shipping/handling charge and sales tax will be added to all orders.

#9255H Electronics Engineers' Handbook, Third Edition

#020975-8 Standard Handbook for Electrical Engineers, Twelfth Edition

Name _____

Address _____

City _____

State _____ Zip _____ Phone _____

Valid for new members only. Foreign applicants will receive special ordering instructions. Canada must remit in U.S. currency. This order subject to acceptance by the EEBC. PPIF592

system will also find quite a bit of valuable information in its pages. The book explains various system options, describes different software programs, and discusses add-ons that will make the system most productive. It shows how to find the best manufacturers and warranties, add more power to your system, find the best printer and monitor, and maintain and upgrade your computer's performance. Besides covering the latest products on the market, the 1992 edition includes some additional data tables that help you compare computer products and evaluate their benefits.

Que's Computer Buyer's Guide 1992 Edition costs \$14.95 and is published by Que, 11711 North College Avenue, Suite 140, Carmel, IN 46032; Tel: 1-317-573-2500.

CIRCLE 94 ON FREE INFORMATION CARD

THE EASY WIRE ANTENNA HANDBOOK

by Dave Ingram, K4TWJ

The least expensive and most effective way to equip your transceiver, QRP rig, or classic transmitter-and-receiver setup for world-wide amateur radio communications is to use a

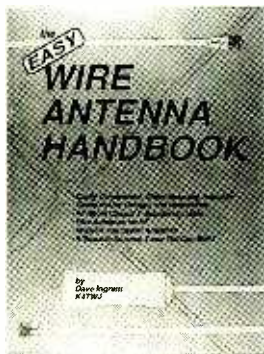

home-made wire antenna. This book is full of ready-to-use designs and dimensions for both basic and gain antennas, providing practical information instead of complicated formulas. It covers hidden and disguised antennas, tuners and baluns, SWR meters, noise bridges, and how to convert any antenna's dimensions to your favorite HF band. The text is accompanied by diagrams, tables, and photographs.

The Easy Wire Antenna Handbook is available for \$9.95 plus \$3 shipping from Universal Electronics, Inc., 4555 Groves Road, Suite 13, Columbus, OH 43232; Tel: 614-866-4605 (for orders only: 800-241-8171); Fax: 614-866-1201.

CIRCLE 81 ON FREE INFORMATION CARD

COMMUNICATIONS CATALOG 92-01

from Universal Radio Inc.

If your hobby is shortwave or amateur radio, this catalog is for you. Its 100 pages are filled with equipment and accessories for SWL and ham radio, including communications, commercial, wideband, portable, and automotive shortwave receivers; HF, UHF/VHF-FM, and UHF/VHF-multi amateur transceivers. Accessories include a variety of antennas, cables, wire, coax, audio filters, preamps, tuners, tape recorders, and amateur-radio power supplies. There are also dozens of products intended to help you get the most out of your hobby, such as study materials, books, logging supplies, SWL computer interfaces, maps, atlases, and globes. The catalog itself offers comprehensive introductions to the hobbies of shortwave radio and amateur radio, along with information about radioteletype and facsimile and a selection of RTTY and fax equipment. Each product's written description is accompanied by a photograph and complete pricing information, and in many cases, specifications and options and modifications.

Communications Catalog 92-10 is available for \$2 from Universal Radio Inc., 1280 Aida Drive, Reynoldsburg, OH 43068; Tel: 614-866-4267 (for orders: 800-431-3939).

CIRCLE 82 ON FREE INFORMATION CARD

THE ELECTRONICS WORKBENCH: Tools, Testers, and Tips for the Hobbyist

by Delton T. Horn

Anyone who's involved in electronics, from the casual hobbyist to the professional

technician, needs some sort of test equipment. There is a huge variety of equipment on the market, and this book is intended to help you determine which items you really need—as well as which would be nice to have if you could afford it, which items you could do without, and which would be a waste of money in terms of your needs.

All that gear has to be kept somewhere, and the book's first chapter explains how to set up a functional workbench and also includes a discussion of hand tools and other small items that you'll need. The next chapter focuses on soldering and construction techniques that will come in handy when



building various electronics projects. A chapter on electronics safety rounds out the "how-to" portion of the book.

Most of the book is divided into chapters that are each devoted to a specific type of test equipment: multimeters, oscilloscopes, LCR bridges and capacitance meters, frequency meters, signal generators, signal injectors and signal tracers, semiconductor testers, digital test gear, and computer-interfaced equipment. Because they account for 80% of most electronics work, multimeters and oscilloscopes are given extra coverage. Throughout the book, detailed explanations of the characteristics and capabilities of the various models are provided.

The Electronics Workbench: Tools, Testers, and Tips for the Hobbyist costs \$18.95 and is published by TAB Books, Division of McGraw-Hill Inc., Blue Ridge Summit, PA 17294-0850; Tel: 1-800-822-8138.

CIRCLE 98 ON FREE INFORMATION CARD

1992 INTERNATIONAL SEMICONDUCTOR DIRECTORY: The Master Type Locator

from D.A.T.A. Business Publishing

This comprehensive guide quickly and accurately identifies devices from more than 900 manufacturers worldwide, and can serve as a stand-alone reference tool for purchasing agents to use in component sourcing. Covering more than 600,000 IC and discrete devices, it provides a complete part number listing that directs the user to technical data when only a part number is known. Also listed with each part number is the manufacturer and a brief description of the device. The book provides package styles, pinouts, and descriptive listings that include the most valuable electrical parameters. A new appendix lists the names, addresses, and phone numbers of major electronic industry associations along with their part-numbering systems. Also new is the Distributor/

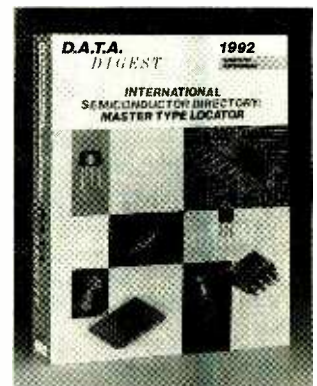

Sales Office appendix, which lists the distributors of each manufacturer and their sales offices worldwide. It is sequenced by manufacturer, country, state/province, and city and includes phone and fax numbers.

The International Semiconductor Directory is available for \$125 plus shipping and handling from D.A.T.A. Business Publishing, 15 Inverness Way East, P.O. Box 6510, Englewood, CO 80155-6510; Tel: 800-447-4666; Fax: 303-799-4082.

CIRCLE 83 ON FREE INFORMATION CARD

NEW PRODUCTS

10-Disc Car CD Changer

Featuring a digital output with the industry-standard SPDIF format, *Coustic's CC-55* 10-disc, dual single-bit CD changer will be compatible with future developments in digital technology. Its 8-times oversampling digital filter, a feature typically found in high-end home CD players, removes high-frequency "quantization noise" inherent in digital recording. A dual delta-sigma modulator transforms the standard 16-bit digital words into a one-bit data stream. An analog filter with a gentle slope then suppresses the remaining very

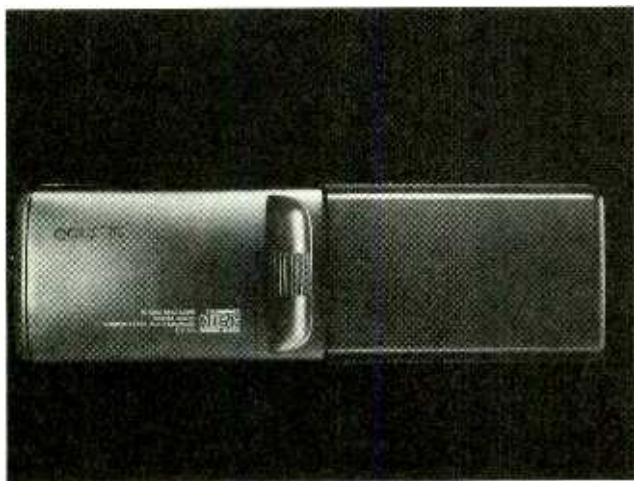

high frequency noise. That design is said to ensure ideal phase linearity and provide clarity in the reproduction soundstage. The *CC-55* comes with a remote control that operates advanced features such as shuffle play and intro scan for disc and track, repeat disc, repeat track, track and disc skip, and backward/forward music search, all without handling any CD's or taking your eyes off the road. It is possible to connect two changers together via an optional Dual Changer Interface and play 20 discs through the same remote.

The *CC-55* can be installed either vertically or horizontally. It can be directly connected to systems that have an auxiliary

input, or with an optional RF modulator its audio output can be connected to any existing audio system through the car's antenna loop. A specially engineered "free-float" suspension system maintains accurate disc tracking whether the unit is mounted vertically or horizontally, and a ground isolator is included to eliminate noisy hum or ground-loop whine.

The *CC-55* 10-disc CD changer has a suggested retail price of \$599. For further information, contact *Coustic*, 4260 Charter Street, Vernon, CA 90058-2596; Tel: 800-227-8879 or 213-582-2832; Fax: 213-582-4328.

CIRCLE 100 ON FREE INFORMATION CARD

POCKET FAX MODEM

Compatible with either IBM or Apple computers, the *Pocket Fax Modem* from *Solectek* is available in three models designed for all standard DOS, Windows, and Macintosh applications. Each model allows users to send a fax from within any application via a pop-up fax menu, by simply entering a telephone number and using normal printing commands. The included software further allows fax messages to be sent or received transparently in the background as the user continues to work within other applications. By creating and sending a fax message directly from a computer, users are able to send high-quality fax messages without the distortion and skewing often seen on scanned images from stand-alone fax machines. The DOS *Pocket FAX Modem* includes an embedded Epson printer emulation that allows users to send faxes with the same fonts and graphics used in an Epson FX printer. The Mac and Windows models have powerful graphical interfaces and feature text rotation, font substitution, and direct Adobe Type Manager support.

The *Pocket FAX Modem* fea-

tures a 9600/4800 bps send and receive fax and a 2400 bps data modem, and features the Class 1 standard chip set. It weighs just 3.5 ounces and measures 1¼ × 2¾ × 5 inches. It can be powered from an internal battery or an external power adaptor, and features a "sleep mode" to conserve batteries when the unit is not being used. A separate power adaptor, tele-



phone cable, and a two-foot computer cable are included.

The DOS *Pocket FAX Modem (Model FM-D)* costs \$299.95. The Windows (*Model FM-W*) and Macintosh (*Model FM-MAC*) versions each cost \$349.95. For more information, contact *Solectek Corporation*, 6370 Nancy Ridge Drive, San Diego, CA 92121; Tel: 800-437-1518.

CIRCLE 101 ON FREE INFORMATION CARD

RECEIVER INTERFERENCE FILTER

According to *Ace Communications*, their new *Model MPIF-1* IF filter eliminates most of the interference sources common with broad banded receivers. The compact external filter measures just 3-inches in height, 2 inches in width, and 1½ inches in depth. Filtering is fixed for elimination of signals in the 54-108-MHz range, the 174-220-MHz range, the 512-806-MHz range, and the range above 869 MHz. BNC connectors make the unit versatile—the filter can even be used on handheld receivers. A switchable notch will also elimi-



nate the 150–153-MHz range, a common source of interference in many areas. By filtering broadcast frequencies, the MPIF-1 solves many of the interference problems common with the new "high-IF" receivers, while the 869, 512, and 174 low-pass filters aid the older 10.7 and 10.8 IF receivers.

The MPIF-1 multipurpose interference filter has a suggested retail price of \$59. For additional information, contact Ace Communications, Monitor Division, 10707 East 106th Street, Fishers, IN 46038; Tel: 317-842-7115; Fax: 317-849-8794.

CIRCLE 102 ON FREE INFORMATION CARD

PC/AT INTERFACE DESIGNER/BREADBOARD

Designed specifically for the 16-bit IBM PC/AT bus, TMC's *Pcat Interface Designer and Breadboard System* plugs directly into the AT bus and can be used in building and testing interfaces. The system includes a plug-in isolation card, an interfacing/breadboard panel, and shielded 100-conductor molded cable set.

The interface/breadboard panels allows access to all AT bus signals using solderless tie-point blocks. Interface circuit



construction is on two high-quality, solderless breadboard sockets. Power-supply voltages can be brought to the panel through four binding posts. Bus signals are logically grouped into related functions for easy identification. For noise free operation at high circuit speeds, the interface panel is built on a multilayer PC board with a 100% coverage ground plane.

The isolation card, which plugs into any 16-bit expansion slot, buffers and isolates all internal IBM/AT bus signals. The card uses a four-layer PC board with gold-plated edge connectors. Address and data-bus drivers serve both to isolate the bus from external circuits and to eliminate the need to construct bi-directional drivers common in I/O and memory circuits. This approach doesn't restrict the designer to a particular port or memory address, and allows master/slave co-processing.

The Pcat Interface/Breadboard Designer costs \$495. For more information, contact TMC, Inc., 20 South Lakeshore Drive, Brookfield, CT 06804; Tel: 203-775-5167, Fax: 203-740-9313.

CIRCLE 103 ON FREE INFORMATION CARD

TEMPERATURE-CONTROLLED SOLDERING STATION

The Antex TCSU-1 temperature controlled soldering station from M.M. Newman offers the purchaser a choice of either a standard-size iron or a miniature soldering iron, and a wide selection of precision tips in a variety of shapes is available. The unit features a sliding potentiometer with a 1–10 setting that's used to maintain the desired soldering tip temperature anywhere from 160°F to 815°F with $\pm 2\%$ accuracy. It comes with either a 40-watt standard-size iron or a 30-watt miniature iron, each of which has the heating element under the tip for optimum thermal efficiency and recovery time. The tip is positively grounded, and zero-crossing electronic switching eliminates RF interference and magnetic fields. Developed for use with heat- and voltage-sensitive electronic components,



the Antex TCSU-1 soldering station is powered by 115 volts AC and converts the voltage to 24 volts DC. A sponge tray with a stable metal base and spring holder is provided.

The Antex TCSU-1 temperature-controlled soldering station has a list price of \$205.43, with either soldering iron. For more information, contact M.M. Newman Corporation, 24 Tioga Way, P.O. Box 615, Marblehead, MA 01945; Tel: 617-631-7100; Fax: 617-631-8887.

CIRCLE 104 ON FREE INFORMATION CARD

ATTENUATOR BOX

Aimed at electronic hobbyists and monitoring enthusiasts, *Electron Processing's SGR-1* attenuator box is a necessary tool for anyone involved in the fun of hidden-transmitter hunts. The SGR-1 allows up to 50 dB of RF attenuation to be switched into the antenna line. The device

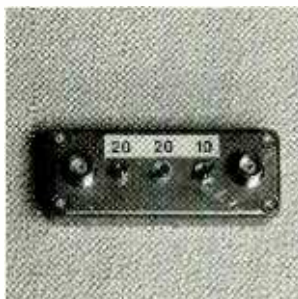

has several handy uses, including making accurate signal comparisons of strong signals and as a simple tool to aid in receiver alignment. The device is a three-section, 50-ohm attenuator box that allows the user to switch in or out up to 50 dB of attenuation in 10-dB increments. It is easy to use via three toggle switches, and easy

to connect via the two female BNC connectors provided.

The SGR-1 attenuator box costs \$50, plus \$5 shipping and handling. For further information, contact Electron Processing, Inc., P.O. Box 68, Cedar, MI 49621; Tel: 616-228-7020.

CIRCLE 105 ON FREE INFORMATION CARD

LIGHT ADAPTORS

Two models of light adaptor from *Extech Instruments* feature an improved design with wider ranges and accuracy to 5%. The *Foot Candle Adaptor Model 401021* measures from 0 to 5000 foot candles, and the *Lux Adaptor Model 401020* measures from 0 to 50,000 lux. Each model has three selectable ranges. The light adaptors are used by simply inserting



banana plugs directly into the multimeter, switching to the 200-mV DC range, and aiming the sensor. Results are read on the multimeter. A photo-diode sensor prolongs the instrument's life and allows it to cover much wider ranges. Each unit operates on a 9-volt battery.

The models 401021 (pictured) and 401020 light adaptors each cost \$49. For additional information, contact Extech Instruments Corporation, 335 Bear Hill Road, Waltham, MA 02154; Tel: 617-890-7440; Fax: 617-890-7864.

CIRCLE 106 ON FREE INFORMATION CARD

DIGITAL MULTIMETER

A 3½-digit, rotary-switch digital multimeter from A.W. Sperry is



aimed at cost-conscious technicians, hobbyists, and students. The pocket-sized DM-4100A features overload protection, a large half-inch LCD readout, and 150 hours of battery life. It performs 6 functions in 18 ranges, including AC and DC volts, ohms, current reading, diode check, and battery test.

The DM-4100A digital multimeter costs \$34.95. For additional information, contact A.W. Sperry Instruments Inc., 245 Marcus Blvd., Hauppauge, NY 11788; Tel: 516-231-7050.

CIRCLE 107 ON FREE INFORMATION CARD

WIRE IDENTIFIER

For use on the work bench or in the field, the *Qwik-Trace Model #91034 Touch-N-Tone Wire Identifier* leaves both of the user's hands free for identifying wires. Within seconds, it can identify a single wire in a group



of hundreds or thousands of unstripped wires by using the fingers of only one hand. The instrument works on body con-

ductance. A 1-megohm resistor sponge wrist strap is worn touching the skin; a lead running from it is plugged into the Wire Identifier. A second lead connects the unit to the unidentified wire or cable. Using one finger, the user can do isolation testing of coaxial cables, phone cables, semiconductors, capacitors, transformers, PC boards, etc. A three-position rocker switch provides two ways of identifying each wire. The LED and tone method identifies a wire with an audible tone as well as a bright red LED. The LED-only method allows the wires to be identified by the LED alone in areas where the tone might disturb others.

The Qwik-Trace Touch-N-Tone Wire Identifier has a suggested list price of \$119. For further information, contact Global Span Products, P.O. Box 145, Campbell, CA 95009; Tel: 800-828-0832 or 408-379-0187; Fax: 408-379-8757.

CIRCLE 108 ON FREE INFORMATION CARD

TWO-OUTLET SURGE PROTECTORS

Phones and fax machines are susceptible to damage from power surges and spikes, and should be protected just as other electronic products are. *Intermatic's Model EG23TC* (shown) includes built-in telephone-line protection and is designed to safeguard products ranging from telephone answering machines and fax machines to personal computers and modems. *Model EG23EC* fea-



tures built-in coaxial protection for safeguarding TV, VCR, and color-monitor TV-antenna and cable inputs. Both models offer a heavy-duty clamping level—

the voltage point at which the surge protector cuts off the power surge to prevent over-voltage in the line—of 400 volts. Both plug directly into a standard electrical outlet and, besides providing protection from surges and spikes on all three lines (hot, neutral, and ground), also filter noise. In the event of a power surge or spike, the surge protector responds in less than a billionth of a second by absorbing the excess voltage and dissipating it before it can harm the equipment being protected. An indicator light that, when lit, shows that the unit is working properly, and an optional audible alarm that sounds when the unit needs to be replaced is available for both surge-protector models.

EG23 Series surge-protector prices start at \$14.95. For more information, contact Intermatic Inc., Intermatic Plaza, Spring Grove, IL 60081-9698; Tel: 312-372-7090.

CIRCLE 109 ON FREE INFORMATION CARD

Need Information about Businesses? Call the Business INFOLINE!

There are over 9 million businesses in the U.S. — and finding information about them can be virtually impossible, especially when you need it *fast*. But now there's a way...a revolutionary new service called **Business INFOLINE!** Need to know the address and phone number for "XYZ Company" somewhere in Florida, or the name and phone number of a "Cadillac Dealer" in Palm Beach? Even telephone company directory assistance can't help you in these situations...but we can!

For example...

"Your BMW breaks down on the interstate, and you need to know if there's a dealer in the next town."

"An out-of-town company is trying to sell you vinyl siding for your house, and you need more information about them — how long the company has been in business, and how many employees they have."

"You're planning a vacation in the Pacific Northwest, and you want to line up things for the kids to do. So you need to find the amusement parks and zoos in Oregon and Washington."

"A friend gave you a tip that "Apex Industries" would be a good stock investment, but you want to know more. What do they do? What are their approximate annual sales?"

The Business INFOLINE is indispensable for home or office! And the cost is *only* \$3.00 for the first minute and \$1.50 for each additional minute, conveniently billed to your phone number. The service is available Monday through Friday, 7:00 a.m. to 6:00 p.m., Central Time.

Dial 1-900-896-0000

Ask for Ext. # 258

Money-back Guarantee if not satisfied

A Service of American Business Information • 5711 So. 86th Circle • Omaha, NE 68127

SPECIAL FROM ETT

PCP101—PRACTICAL DIGITAL ELECTRONICS HANDBOOK ... \$9.95. Introduces digital circuits, logic gates, bistables and timers, as well as micro-processors, memory and input/output devices. Special section on digital test gear projects.



PCP102—INTRODUCING DIGITAL AUDIO ... \$9.95 Shows what is involved in the digital part of audio signals, particularly in the newest devices such as CD, DAT and sampling. Bridges the gap of understanding for the technician and enthusiast.

PCP103—PRACTICAL MIDI HANDBOOK ... \$9.95. Covers all MIDI based equipment you can use—keyboards, drum machines, sequencers, effects units, mixers, drum pads and guitars. Also a section on computer music that covers software and more.

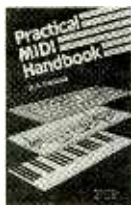

PCP104—ELECTRONICS BUILD & LEARN, Second Edition ... \$9.95. You start by assembling a circuit demonstrator that is then used to build and investigate a variety of useful circuits including oscillators, multivibrators, bistables and logic circuits.

PCP105—MAKE MONEY FROM HOME RECORDING ... \$10.00. Now that you've spent all that money on all that recording gear, wouldn't it be nice to get some of it back? Well here's the book that can show you how.



PCP106—SYNTHESIZERS FOR MUSICIANS ... \$10.00. All current popular forms of synthesis explained; LA, additive, phase distortion, FM and sampling. Get the sounds you want from your synth. Written especially for musicians.

MAIL TO: **Electronic Technology Today, Inc.**
P.O. Box 240
Massapequa Park, NY 11762-0240

SHIPPING CHARGES IN USA AND CANADA

\$0.01 to \$5.00 ... \$1.50	\$30.01 to \$40.00 ... \$5.50
\$5.01 to \$10.00 ... \$2.50	\$40.01 to \$50.00 ... \$6.50
\$10.01 to \$20.00 ... \$3.50	\$50.01 and above ... \$8.00
\$20.01 to \$30.00 ... \$4.50	

SORRY, No orders accepted outside of USA and Canada

Total price of merchandise	\$ _____
Shipping (see chart)	\$ _____
Subtotal	\$ _____
Sales Tax (NYS only)	\$ _____
Total Enclosed	\$ _____

Name _____
Address _____
City _____ State _____ Zip _____

AUDIO INDICATORS

(Continued from page 60)

However, R_p is very, very large and at the resonant frequency:

$$X_{C_S} + X_L = 0$$

therefore, the transducer appears essentially as C_p in parallel with the series combination of R_c , $R_{m'}$ and R_c . So the load that it presents to the driving circuit largely depends on the acoustical environment, such as the housing. Off resonance, or above and below that frequency, R_c and X_{C_S} or X_L become very large and lead to a noticeable power loss, so it is recommended that an element be operated at its designated frequency. Now let's look at some drive circuits to see how this can be accomplished.

Drive Circuits. A 555-based oscillator circuit makes an excellent piezo-element driver. As shown in Fig. 11, if configured as an oscillator, it can be gated on and off by switching its reset pin high or low, respectively. As you probably know, the operating frequency (f) of the circuit depends on the values of $R1$, $R2$, and $C2$ according to this relation:

$$f = 1.44/C1(R1 + 2R2)$$

The values of the components shown in Fig. 11 were found as follows: It was known that the crystal had a resonant frequency of 2 kHz, so that must be the oscillator frequency. A capacitor of 1000 pF was arbitrarily chosen to be $C1$. From the above equation then:

$$2000 = 1.44/10^{-9}(R1 + 2R2)$$

so:

$$1.44/2000 \times 10^{-9} = (R1 + 2R2)$$

$$720,000 = (R1 + 2R2)$$

So if we chose a 100k resistor for $R1$, $R2$ must be 310k.

Note the resistor across the piezoelectric audio indicator. Its function is to maximize output power. You can determine the best value for that resistor with the following equation:

$$R3 = 1/(6f C_p)$$

where, as you'll recall, C_p is the parallel capacitance of the audio transducer. Assuming C_p is around 20,000 pF and you use the above equation, $R3$ should be a 4.17k resistor. However, it should be mentioned that decreasing this resistor's value will result in a slightly higher

SPL, but more power would be wasted in the resistor. Conversely, an increase in this resistor's value will lower SPL and also lower power consumption.

An Alternate Design. Let's take a look at another popular and simple oscillator (see Fig. 12). In it two CMOS NAND gates are connected as inverters that operated together to alternately charge and discharge $C3$.

That is a nice circuit, but it suffers from a few subtle drawbacks, although they may not affect your particular application. First, it may not oscillate if the threshold points at which the inverter switches from one logic state to the other are too different. Second, it may oscillate at a frequency slightly lower than the calculated frequency due to the finite gain of the first inverter. Usually gates used are within the same IC package; therefore, there is only a few millivolt difference in threshold triggering points and no problem occurs. But, if gates from different packages are used, those problems may arise.

The circuit in Fig. 13 overcomes that problem by adding an additional resistor and capacitor to the network ($R5$ and $C2$). The RC network provides hysteresis or a difference in the upper and lower triggering points. This purposely delays the onset of inverter gate U3-a until $C1$ has enough voltage to push inverter gate U3-b well past its transition region. Capacitor $C2$ provides positive feedback. The only disadvantage with this improved circuit is that since we are using a single-input inverter we can't gate it on and off like the circuit in Fig. 12. Nonetheless, you can use the equations shown to select parts values for your own applications.

Varying Drive Voltages. SPL values are usually measured for a certain operating voltage. If you use a piezoelectric transducer at a voltage different than that specified, you can determine its SPL (SPL_x) from:

$$SPL_x = SPL_O + 20\log_{10}(V_x/V_O)$$

where V_x is the new voltage, and SPL_O is the SPL at the rated voltage, V_O .

With that in mind, let's consider an example: If a certain transducer has an SPL of 60 dBA at 15 volts, what will its SPL be if operated at only 10 volts? Taking $20\log_{10}$ of $2 \div 3$ yields -3.5 dBA. Subtracting 3.5 dBA from 60 dBA leaves 56.5 dBA which is the new SPL rating. ■

Welcome to...

SCIENCE PROBE!

The Amateur Scientist's Journal

Embark on an irresistible new journey into the realm of mystery, challenge, and exploration! The perfect magazine for the budding scientist, the serious amateur, the professional who would like to relax, and those who simply want to gaze at the stars.

Articles to appear in upcoming issues of Science PROBE! are:

How an Amateur Mapped the Milky Way
Make your own Seismometer
Operate a Solar-powered Weather Station
Grow Crystals Automatically
Experiment with a Saltwater Aquarium
How to Keep a Science Notebook

If you're fascinated by science in all its many forms, if you are compelled to experiment and explore, then Science PROBE! is your kind of magazine!

Science PROBE! — the *only* magazine devoted entirely to Amateur Scientists! If you are fascinated by science in all its many forms... if you can't stay away from a microscope, telescope, calipers, or test tube — we invite you to share the wonders in every issue of **Science PROBE!** You will join a community of Amateur and Student Scientists who enthusiastically seek scientific knowledge or follow scientific pursuits for their own sakes and not merely as a profession.

Obtain your next issue of **Science PROBE!** by visiting a quality Newsstand, Convenience Store, or Supermarket or by reserving your personal copy through the mail by completing the coupon below.

From your very first issue of **Science PROBE!** you will be involved in a world of scientific facts, experiments, and studies pursued by amateur scientists who are university students, investors, academicians, engineers, or office workers, salesmen, farmers—whose *quest* is to probe into the mysteries of science and reveal them to all.

Plan to become a **Science PROBE!** reader!

Science PROBE!
500-B Bi-County Boulevard
Farmingdale, NY 11735

Please forward my copy of **Science PROBE!** as soon as it comes off the press. I am enclosing \$3.50-U.S.A. (\$4.23-Canada-includes G.S.T.) plus \$1.00 for shipping and handling. Better still, please enroll me as a subscriber and send the next four (4) quarterly issues of **Science Probe.** I am enclosing \$9.95-U.S.A. (Canada: \$16.00—includes G.S.T.)

Next Issue Only Next Four Issues (1 Year)

Offers valid in the U.S.A. and Canada only. No foreign orders.

Name _____

Address _____

City _____ State _____ ZIP _____

All Orders payable in U.S.A. Funds only.

7PE29

ON SALE AT QUALITY NEWSSTANDS, CONVENIENCE STORES AND SUPERMARKETS
GET YOUR COPY TODAY—\$3.50-U.S.A.—\$3.95-Canada



One tree can make
3,000,000 matches.



One match can burn
3,000,000 trees.



A Public Service of This Magazine
& The Advertising Council

COMPUTER BITS

(Continued from page 69)

volumes, get statistics on the amount of free space and file compression ratios, and perform disk optimization. The default compression ratio is 2:1, but you can vary that if the files on your system mostly conform to some other ratio.

Does Stacker really double your disk capacity? In a word, yes. My 150-mega-byte SCSI drive had about 120 MB of information; after installing Stacker, it shows about 130 MB of free space. And this space was gained at about half the cost of an equivalent new drive. The current release of Stacker also works with floppies and removable media (Bernoulli boxes), and has the additional side benefit of doubling space in RAM disks and disk caches. ■

ANTIQUE RADIO

(Continued from page 67)

of an electrical band-spread system for the mechanical one employed in predecessor models. Now there were two tuning controls: the main tuning knob with an appropriate gear ratio for general-purpose work and the bandspread knob used to tune among closely spaced signals.

Perhaps as a result of the improved station separation possible with the electrical bandspread system, the new Sky Buddy's German silver tuning dial no longer carried frequency markings around its entire circumference. The frequency bands were compressed so that they fit onto the top half of the circle, making the markings easier to read.

Other changes included substitution of individual slide-type on-off switches for the single rotary switch previously used to control the beat-frequency oscillator (BFO) and automatic volume control (AVC) functions; redesign of the IF amplifier and BFO circuits around separate tubes rather than a single dual-purpose type; and (at least in the late S-19R models) the addition of a rear-apron socket for operation of the radio on an external power source.

Somehow, Hallicrafters managed to hold firm on the price, and the further-improved Sky Buddy was still selling for \$29.50.

A FIRST LOOK AT OUR SKY BUDDY

The Sky Buddy that we'll be working with is a late model S-19R. I say late because it's equipped with the rear-apron power socket—a feature that does not ap-

pear in the original Rider Manual schematic of the set, but is seen in the later schematic (dated 1942) in the De Henseler book.

Our S-19R's tube complement includes an 80 rectifier, a 6K8 oscillator-mixer, a 6SK7 intermediate-frequency amplifier, a 6SQ7 detector and automatic volume-control amplifier, a 76 beat-frequency oscillator, and a 41 audio-output amplifier. The presence of the 6SK7 and 6SQ7 is another indication of a later model because the original schematic for the radio indicated older 6K7 and 6Q7 tubes.

The presence of the 76 and 42 tubes is a bit puzzling. These are older-generation, tall-glass, non-octal tubes. In fact, a 6K6, which is a more modern equivalent of the type 41, was used as the audio output in the previous version (S-19) of the Sky Buddy. I can only guess that the company got a good deal on those older types.

My preconception about this set is that it was the 1930's equivalent of the famous postwar S-38 series. And, at least as far as its basic circuitry and position in the product line are concerned, that's true. But once I got an actual Sky Buddy into my hands, I formed quite a different impression.

First of all, it's several inches wider than the S-38, affording a much more spacious and impressive panel layout. It's also quite a bit weightier because of its larger chassis and cabinet as well as its transformer-type power supply (the S-38 series have AC-DC supplies, and thus no transformer). All-in-all, the S-19R was quite a formidable radio; I'm looking forward to getting into this set's restoration next time we meet! ■

GET THE LATEST ADVANCES IN ELECTRONICS

WITH A SUBSCRIPTION TO

Radio Electronics®



ENJOY THE WORLD OF ELECTRONICS EACH MONTH!

Radio-Electronics looks to the future and shows you what new video, audio and computer products are on the horizon. What's more you'll find helpful, monthly departments such as Video News, Equipment Reports, Hardware Hacker, Audio Update, Drawing Board, Computer Connections. All designed to give you instruction, tips, and fun.

SUBSCRIBE TODAY

Just fill out the order card in this magazine and mail it in today.

FOR FASTER SERVICE CALL TODAY

1-800-999-7139

5PE21

WIRE ANTENNAS

(Continued from page 48)

The D.E. Zepp will work on a lot of different bands. For hams, a 15-meter band D.E. Zepp will work as a Zepp on that band, a dipole below that band, and a four-lobed or "cloverleaf" antenna above the band.

Collinear Franklin Array Antenna.

Perhaps the cheapest approach to real gain is the Collinear Franklin array shown in Fig. 4. That antenna extends the dipole and D.E. Zepp concepts even further. It consists of a half-wavelength dipole fed in the center with a 4:1 balun and 75-ohm coaxial cable. At each end of the dipole is a quarter-wavelength phase-reversal stub that endfeeds another half-wavelength element. Each element is a half-wavelength long (L_1), and their length can be calculated from the equation given back in Fig. 1A. The phase reversal stubs are a quarter-wavelength long (L_2), or one-half the length calculated for L_1 .

The version of the Collinear shown in Fig. 4 has a gain of about 3 dB. There is no theoretical reason why you can't extend the design indefinitely, but there is a practical limit set by how much wire can be held by your supports, and how much real estate you own. A 4.5-dB version can be built by adding another half-wavelength section at each end, with an intervening quarter-wavelength phase-reversal stub in between. Once you get longer than five half-wavelengths, which provides the 4.5-dB gain, the size becomes a bother.

Lazy-H Antenna. The Lazy-H antenna (shown in Fig. 5) is called a "stacked" antenna because it consists of two antennas, one on top of another. That antenna provides gains as high as 5.5 to 6 dB just because of its configuration. In addition, the angle of radiation is lower, so it can put the "first hop" of a shortwave transmission a lot further out than a simple dipole antenna.

The phase-reversal harness between the elements should be made from either 450-ohm parallel transmission line, or 450-ohm twin-lead. Note that it is twisted over on itself in order to make the phase reversal

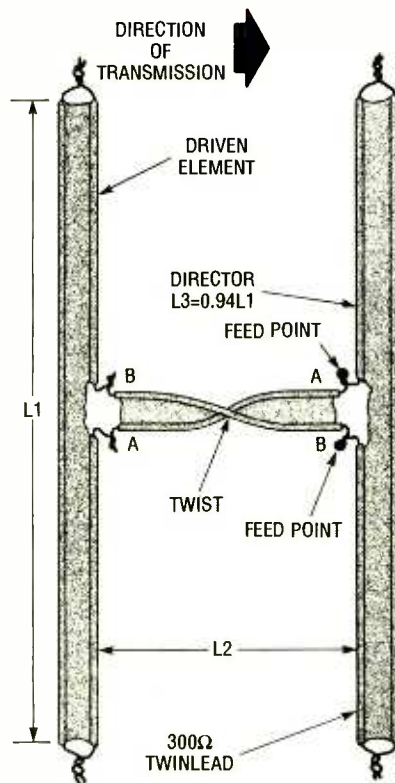

Fig. 6. The ZL-special antenna is sort-of a folded dipole version of the lazy-H antenna shown back in Fig. 5. However, it does not have a discreet matching section.

FOR FURTHER READING

ARRL Antenna Handbook (multiple editions), American Radio Relay League.

Wire Antennas For Radio Amateurs, William I. Orr, W6SAI Radio Publications, Inc.

Radio Handbook—23rd Edition, William I. Orr, W6SAI, editor. Howard W. Sams & Co., Inc. (Carmel, IN), Cat. No. 22424.

Practical Antenna Handbook, Joseph J. Carr, TAB Books, Inc. (Blue Ridge Summit, PA, 17294-0850; 1-800-233-1128), Cat. No. 3270., \$21.95 paperback, 439 pages.

happen (lack of this phase reversal is one reason why this antenna may seem to "fail" when built). The matching section (with length L_3) should also be made of 450-ohm line.

The 75-ohm coaxial-cable transmission line should be connected to points "A" and "B" through a 1:1 balun transformer. These points are found experimentally by moving the balun connection points up and down along the stub until a 1:1 SWR is achieved. The formulas for the lengths of the elements (L_1), their spacing (L_2), and the matching section (L_3) are shown in the figure.

ZL-Special Antenna. Figure 6 shows a ZL-Special antenna. It is a half-wavelength horizontal antenna (seen from above in Fig. 6). It consists of two folded-dipole elements built of 300-ohm television twin-lead wire coupled with a 135-degree phase-reversal harness (also made of 300-ohm twin-lead). The length of the driven element is found from the equation back in Fig. 1, while the director element length (L_3) is about 6% less than L_1 . The equation for the length of the phasing harness (L_2), which is also the spacing between elements, is the same as that for the double-extended Zepp antenna (look back at Fig. 3). The feedpoint impedance is about 100 ohms, so it is a reasonable (but not exact) match for 75-ohm coaxial cable. Alternatively, either a 2:1 broadband impedance transformer, or a quarter-wavelength matching section similar to the Lazy-H antenna can be added.

The selection of antennas here should give you plenty of ideas to experiment with. If you build them safely and wisely, they should perform very well. ■

SOLDERING-IRON

(Continued from page 54)

trically part of the circuit, so it must be isolated from the metal lid with a mica insulator. Drill a hole in the lid in a convenient location, put heat-sink compound on both sides of the mica insulator, and secure both the regulator and insulator to the lid with either a nylon screw or a metal one with a plastic insulator.

If you choose to use a separate heat sink, then you'll have to go with a bigger project case. But, it's a good idea to use a mica insulator even if you use a separate heat sink.

One last thing to keep in mind: The unit's output *increases* as the resistance of R2 *decreases*. So wire R2 accordingly for an increasing output with a clockwise rotation. Also, because most of the usable range of the unit is in the lower adjustment range of R2, try to use a potentiometer of 25 ohms or less. Using a higher-value potentiometer will result in a very small adjustment range at the very end of the potentiometer's rotation. ■

BREAKOUT BOX

(Continued from page 65)

clamp, move it back to the other end of the connector, and tighten the clamp till that end snaps in place and the connection is complete.

When finished with either the clamp or vise, remove the connector from the jaws. If the connector is at the end of the cable trim the excess nub of cable close to the body of the connector with wire cutters. Fold the length of ribbon cable over the back end of the connector and snap on the strain relief, which should hold the cable snugly in place.

If you are installing 36-pin Amphenol connectors on your cable, one further step is a good idea: Apply some hot-melt glue or epoxy to both sides of the cable where it meets the connector housing. That will keep the cable properly aligned for many uses to come. That latter step is not an absolute must (I've seen manufactured cables made without such a consideration), but I recommend it.

If you want to add DB-9 connectors to your ribbon cable, you will have to trim off the 16 unused wires before they enter the DB-9 connector. For that reason, if a DB-9 connector will be sharing a ribbon cable with connectors having more pins, the DB-9

PARTS LIST FOR THE QUICKIE BREAKOUT BOX

R1—470-ohm ¼-watt, 5% resistors (see text)
LED1—Tri-color LED (see text)
B1, B2—9-volt battery (optional, see text)
Male DB-25 connectors (see text)
Female DB-25 connectors (see text)
Male DB-9 connectors (see text)
Female DB-9 connectors (see text)
Male 36-pin Amphenol connectors (see text)

ADDITIONAL PARTS AND MATERIALS

Cabinet, two 3-foot lengths of 25-conductor ribbon cable, two 9-volt battery holders, two 9-volt battery clips, breadboard, dual-slot, DB-25 wall plate (see text), heat-shrink tubing, wire-wrapping posts (see text), flexible caterpillar grommet or electrical tape, hot-melt glue or epoxy, rub-on lettering, wire, mounting hardware, etc.

REFERENCES

Computer Connection Mysteries Solved, Graham Wideman, Howard W. Sams, 1987
Computer Hobbyists Handbook, R. A. & J. W. Penfold, Benard Babani LTD, 1989
Data Communications Testing and Troubleshooting, Gilbert Held, Howard W. Sams, 1989

should be placed at the end of the cable.

Cabinet Construction. With all those considerations in mind, assemble the two lengths of ribbon with the appropriate connectors. Mount the lone female DB-25 connectors onto the wall plate and set the assembly aside.

If you plan to machine a cabinet, you can make a template for the top surface using Fig. 3 as a cutting and drilling guide. Once that surface is finished, install the wall-plate/cable assembly, breadboard, and battery holders on it. Now engage the top of the cabinet with the bottom half, allowing the ribbon cables to exit from opposite sides of the cabinet, but don't screw the cabinet together.

On the bottom half of the cabinet, mark the two places where the cables exit. Disengage the two halves of the cabinet and nibble or otherwise cut ¼-inch deep notches about the width of the cable into the two opposite edges of the cabinet's bottom section. The notches allow the cable to exit the cabinet without being crushed.

If you have caterpillar grommets, cut the notches a little deeper and wider than specified to provide clearance for the grommets. Install each grommet so that it covers the three sharp surfaces of each notch and use epoxy or hot-melt glue to secure the grommets in place. If you don't have caterpillar-grommet stock, neatly cover the sharp edges with electrical tape. Once that is done, assemble the cabinet halves, making sure that the ribbon exits the cabinet from the notches, and is not pinched between exposed edges.

The Icing on the Cake. Now, with a few finishing touches, your Quickie will be complete. For example, if you want to take advantage of the battery trick, you'll need to add some long pins to a

pair of battery clips. You can use some wire-wrapping posts either pulled out of an unused IC socket or purchased as is. I prefer the IC kind because they are thicker and make better contact when inserted into the breadboard or a connector hole. The wrapping posts from cheap sockets can just be pulled out of the socket body with a pair of pliers. With more expensive sockets, it will be necessary to cut the post free of the plastic body with wire cutters.

In any event, take two wire-wrapping posts, and solder the top of each one to a lead of a 9-volt battery clip. Prepare a second battery clip in the same manner. Cover each soldered junction with a section of small diameter heat-shrink tubing and shrink it in place.

Now move on to making some LED gimmicks. Use Fig. 4 to assist you. Start by soldering a wire-wrapping post to one lead of a tri-color LED. Then wrap one lead of a 470-ohm resistor onto the remaining lead of the LED so that the resistor is very close to the body of the LED and rests parallel with the LED lead. Solder the connection and cut the LED lead at about the middle of the resistor body. Solder the remaining lead of the resistor to a short length of wire (about 2-inches) and trim any excess resistor lead.

Slide two pieces of small diameter heat-shrink tubing over the LED leads and the resistor as shown in Fig. 4. Shrink them in place, and then shrink a piece of large diameter heat-shrink tubing over the assembly as shown. Connect the free end of the wire to a wire-wrapping post just as you did the battery-clip leads (heat-shrink tubing and all) and you're done. Make as many of the LED gimmicks as you need, but make sure that they all glow with the same color when biased in the same direction as the first one for consistency.

As a final touch you can add rub-on lettering to the wall plate to make the pin numbering clear. Keep in mind that you might want to use two or three sets of numbers—one for each type of equipment-end connector you have. You can use the pin-out diagram in Fig. 5 as a guide for your numbering scheme.

Your Quickie breakout box should now be ready to make short work of cabling interfaces. Use it, expand it, and enjoy it. ■

ELECTRONICS MARKET PLACE

FOR SALE

CABLE descrambler liquidation. Major makes and models available. Industry pricing! (Example: Hamlin Combo's, \$44 each... Minimum 10 orders). Call **WEST COAST ELECTRONICS**, 1 (800) 628-9656.

SPEAKER repair. All makes — models. Stereo & professional kits available. Refoaming \$18.00. **ATLANTA AUDIO LABS**, 1 (800) 568-6971.

OSCILLOSCOPE 50MHz, dual channel, solid state calibrated, manual \$250.00 1 (800) 835-8335.

CLASSIFIED AD ORDER FORM

To run your own classified ad, put one word on each of the lines below and send this form along with your check to:

Popular Electronics Classified Ads, 500-B Bi-County Boulevard, Farmingdale, N.Y. 11735

PLEASE INDICATE in which category of classified advertising you wish your ad to appear. For special headings, there is a surcharge of \$11.00.

() Plans/Kits () Business Opportunities () For Sale
() Education/Instruction () Wanted () Satellite Television

Special Category: \$11.00

PLEASE PRINT EACH WORD SEPARATELY, IN BLOCK LETTERS.

(No refunds or credits for typesetting errors can be made unless you clearly print or type your copy.) Rates indicated are for standard style classified ads only. See below for additional charges for special ads. **Minimum: 15 words.**

1	2	3	4	5
6	7	8	9	10
11	12	13	14	15 (\$23.25)
16 (\$24.80)	17 (\$26.35)	18 (\$27.90)	19 (\$29.45)	20 (\$31.00)
21 (\$32.55)	22 (\$34.10)	23 (\$35.65)	24 (\$37.20)	25 (\$38.75)
26 (\$40.30)	27 (\$41.85)	28 (\$43.40)	29 (\$44.95)	30 (\$46.50)
31 (\$48.05)	32 (\$49.60)	33 (\$51.15)	34 (\$52.70)	35 (\$54.25)

We accept MasterCard and Visa for payment of orders. If you wish to use your credit card to pay for your ad fill in the following additional information (Sorry, no telephone orders can be accepted.):

Card Number

Expiration Date

PRINT NAME

SIGNATURE

IF YOU USE A BOX NUMBER YOU MUST INCLUDE YOUR PERMANENT ADDRESS AND PHONE NUMBER FOR OUR FILES. ADS SUBMITTED WITHOUT THIS INFORMATION WILL NOT BE ACCEPTED.

CLASSIFIED COMMERCIAL RATE: (for firms or individuals offering commercial products or services) \$1.55 per word prepaid (no charge for ZIP code)...**MINIMUM 15 WORDS.** 5% discount for same ad in 6 issues within one year; 10% discount for 12 issues within one year if prepaid. **NON-COMMERCIAL RATE:** (for individuals who want to buy or sell a personal item) \$1.25 per word, prepaid...no minimum. **ONLY FIRST WORD AND NAME** set in bold caps at no extra charge. Additional bold face (not available as all caps) 30¢ per word additional. Entire ad in boldface, \$1.85 per word. **TINT SCREEN BEHIND ENTIRE AD:** \$1.90 per word. **TINT SCREEN BEHIND ENTIRE AD PLUS ALL BOLD FACE AD:** \$2.25 per word. **EXPANDED TYPE AD:** \$2.05 per word prepaid. Entire ad in boldface, \$2.45 per word. **TINT SCREEN BEHIND ENTIRE EXPANDED TYPE AD:** \$2.55 per word. **TINT SCREEN BEHIND ENTIRE EXPANDED TYPE AD PLUS ALL BOLD FACE AD:** \$2.95 per word. **DISPLAY ADS:** 1" x 2 1/4"—\$205.00; 2" x 2 1/4"—\$410.00; 3" x 2 1/4"—\$615.00. **General Information:** Frequency rates and prepayment discounts are available. **ALL COPY SUBJECT TO PUBLISHERS APPROVAL. ADVERTISEMENTS USING P.O. BOX ADDRESS WILL NOT BE ACCEPTED UNTIL ADVERTISER SUPPLIES PUBLISHER WITH PERMANENT ADDRESS AND PHONE NUMBER.** Copy to be in our hands on the 18th of the fourth month preceding the date of issue (i.e.; Sept. issue copy must be received by May 18th). When normal closing date falls on Saturday, Sunday or Holiday, issue closes on preceding work day. Send for the classified brochure. Circle Number 49 on the Free Information Card.

Quality Microwave TV Antennas

WIRELESS CABLE - IFTS - MMDS - Amateur TV
Ultra High Gain 50db(+) • Tuneable 1.9 to 2.7 Ghz.

- 36-Channel System Complete \$149.95
- 12-Channel System Complete \$114.95
- Call or write (SASE) for "FREE" Catalog

PHILLIPS-TECH ELECTRONICS
P.O. Box 8533 • Scottsdale, AZ 85252
(602) 947-7700 (\$3.00 Credit all phone orders)

LIFETIME WARRANTY MasterCard • Visa • C.O.'s • Quantity Pricing

CABLE TV descramblers, converters, lowest prices guaranteed, best quality, free catalog. **CNC CONCEPTS INC.**, Box 34503, Minneapolis, MN 55434. 1 (800) 535-1843.

HUGE 92 page communications catalog of shortwave, amateur and scanner equipment. Antennas, books and accessories too. Send \$1.00 to: **UNIVERSAL RADIO**, 1280 Aida Dr., Dept. PE, Reynoldsburg, OH 43068.

JERROLD, Tocom and Zenith "test" chips. Fully activates unit. **\$50.00.** Cable descramblers from **\$40.00.** Orders 1 (800) 452-7090. Information (310) 867-0061.

OUR monthly picture flyer lists quality surplus parts at low prices. Send today for yours. **STARTRONICS**, Box 683, McMinnville, OR 97128.

**CABLE TV DESCRAMBLERS
★ CONVERTERS ★
and ACCESSORIES.**

**SAVE MONEY.
DON'T RENT!**

**PANASONIC,
PIONEER, JERROLD, OAK,
SCIENTIFIC ATLANTA
AND MORE. LOWEST PRICES.
FREE CATALOG.**

**(800) 234-1006
CABLE READY COMPANY**

PRINTED circuit boards — etched, drilled, tin plated. Single sided \$1.25/sq. inch. Free shipping. **CHELCO ELECTRONICS**, 61 Water Street, Mayville, NY 14757. (716) 753-3200.

IMPOSSIBLE cable systems. New user programmable units authorize any or all features of Pioneer or Jerrold descramblers. Take control 1 (800) 968-4041.

FREE CATALOG

**FAMOUS "FIRESTIK" BRAND CB ANTENNAS
AND ACCESSORIES. QUALITY PRODUCTS
FOR THE SERIOUS CB'er. SINCE 1962**

**FIRESTIK ANTENNA COMPANY
2614 EAST ADAMS
PHOENIX, ARIZONA 85034**

CB RADIO OWNERS!

We specialize in a wide variety of technical information, parts and services for CB radios. 10-Meter and FM conversion kits, repair books, plans, high-performance accessories. Thousands of satisfied customers since 1976! Catalog \$2.

CBC INTERNATIONAL

P.O. BOX 31500PE, PHOENIX, AZ 85046

20,000+ IBM-PC public domain and shareware programs. 1.2Mb diskette. Catalog — \$3.00. 400+ page catalog — \$17.95 (refundable). Individual programs/bulk. **TELECODE**, PO Box 6426-PE, Yuma, AZ 85366-6426.

CABLE test chips S-A 8550, S-A 8500 — 310, 311, 320, 321 (specify) — \$33.95. S-A 8580/338 — \$69.95. Tocom 5503/07 VIP — \$33.95. **TELECODE**, PO Box 6426-PE, Yuma, AZ 85366-6426.

THE most advanced hi-tech security, surveillance, and counter-surveillance equipment available anywhere. All affordable. Send \$10.00 for complete catalog, (refunded on first purchase over \$100.00) to: **COMCON SYSTEMS**, 501 Boston Post Rd., Dept. 153, Orange, CT 06477.

ANTIQUE RADIO CLASSIFIED

Free Sample!

Antique Radio's

Largest Circulation Monthly
Articles, Ads & Classifieds.

6-Month Trial: \$15. 1-Yr: \$27(\$40-1st Class).
A.R.C., P.O. Box 802-L8, Carlisle, MA 01741



CASSETTES: BASF/DC(C-92) (FeCrCo) Flexi-Bias PolyMedia. Priced: 10/\$17.99 + \$1.99(P&H). Mail Chk/MO: N-ta-IEs, 29 Robie Ave., Gorham, ME 04038.

AFFORDABLE diode lasers! Our small laser head (1.4" x 1.8") snaps right on top of a 9V battery. Includes drive electronics, collimating lens, & adjustable output power. Visible @670nm: 3mW (TOLD9200) \$79.95, or 5mW (TOLD9211) \$99.95. Detailed plans only — \$9.95. **SECURICOM**, PO Box 5227, Chatsworth, CA 91313-5227. S/H \$3.75. (818) 710-0110.

ARGON laser tubes, bluish green beam, 30 milliwatt. \$325.00. Includes plans for inexpensive power supply, \$10.00 separately. **TWIN CITY LASERS**, 720 Armstrong Street, St. Paul, MN 55102. Call (612) 227-5517.

SATELLITE
TV
BUYING
GUIDE

SATELLITE TV

NAME BRANDS AT 50% DISCOUNT
This FREE 24 page Consumer Buying Guide tells all about Satellite TV and lists guaranteed lowest prices.

6310 N. University No. 3738 • Peoria, IL 61612
1-800-472-8626

PLANS & KITS

HOBBY/broadcasting/ham/CB/surveillance transmitters, amplifiers, cable TV, science, bugs, other great projects! Catalog \$1.00 **PANAXIS**, Box 130-H5, Paradise, CA 95967.

BUILD — five-digit, ohms, capacitance, frequency, pulse, multimeter. Board, and instructions \$9.95. **BAGNALL ELECTRONICS**, 179 May, Fairfield, CT 06430.

KITS, light, sound, high tech and unusual. Send for free catalog. **JM ELECTRONICS**, Box 150454, Altamonte Springs, FL 32715-0454.

VHF amplifier plans. 75-110 MHz, 15-25 watts. Complete schematics, instructions, antenna designs. \$8.95. **PROGRESSIVE CONCEPTS**, 1313 North Grand Ave., Suite 291, Walnut, CA 91789.

PC boards etched and drilled for .70 cents per square inch. Send your requirement to **JM ELECTRONICS**, Box 150454, Altamonte Springs, FL 32715-0454.

FASCINATING Electronic Devices! Dazers! Lasers! FM/AM/phone transmitters! Detectors! Kits/assembled! Catalog \$2.00. **QUANTUM RESEARCH**, 16645-113 Avenue, Edmonton, Alberta T5M 2X2.

DESCRAMBLER kits. Complete cable kit \$44.95. Complete satellite kit \$49.95. Add \$5.00 shipping. Free brochure. No New York sales. **SUMMIT PE**, Box 489, Bronx, NY 10465.

SATELLITE TV descrambler. Build your own. Easy to follow instructions, parts list, circuit board and wiring diagram. Send: \$9.95. **ABG ENTERPRISES**, 20186C, Halifax, NS, Canada, B3R-2L1.

CABLE TV "BOXES"

Converters-Descramblers
Remote Controls-Accessories

- ★ Guaranteed Best Prices ★
- ★ 1 Year Warranty - C.O.D.'s ★
- ★ Immediate Shipping ★
- ★ FREE CATALOG ★

Call or Write

NAS/TRANS-WORLD CABLE CO.
3958 North Lake Blvd. • Suite 255
Lake Park, Florida 33403
1-800-442-9333
1-800-848-3997

BUILD — 0 to 15 volts programmable power supply. Includes schematics and instructions. Easy to build. \$2.00 — **JAS**, PO Box 8274, Westchester, OH 45069.

SURVEILLANCE transmitter kits tune from 65 to 305 MHz. Mains powered duplex, telephone, room, combination telephone/room. Catalog with **Popular Communications**, **Popular Electronics** and **Radio-Electronics** book reviews of "Electronic Eavesdropping Equipment Design," \$2.00. **SHEFFIELD ELECTRONICS**, PO Box 377785-A, Chicago, IL 60637-7785.

VIDEOCIPHER II/scanner/cable/satellite modifications books. Catalog — \$3.00. **TELECODE**, PO Box 6426-PE, Yuma, AZ 85366-6426.

FM stereo transmitter kit. Broadcast any audio signal, CD player, VCR to FM stereo radios throughout home/yard. PC board and components: \$22.00. **TENTRONIX**, Dept. PC592, 3605 Broken Arrow, Coeur d'Alene, ID 83814.

★★★★PRESENTING★★★★

CABLE TV DESCRAMBLERS

★★★★★ STARRING ★★★★★

JERROLD, HAMLIN, OAK

AND OTHER FAMOUS MANUFACTURERS

- FINEST WARRANTY PROGRAM AVAILABLE
- LOWEST RETAIL/WHOLESALE PRICES IN US
- ORDERS SHIPPED FROM STOCK WITHIN 24 HRS
- ALL MAJOR CREDIT CARDS ACCEPTED

FOR FREE CATALOG ONLY 1-800-345-8927

FOR ALL INFORMATION 1-818-709-9937

PACIFIC CABLE CO., INC.
7325 1/2 Reseda Blvd., Dept. 1014
Reseda, CA 91335

IR remote interface for your IBM or compatible PC. Control TV, VCR, CD etc. Simple construction, all parts available locally. Uses printer parallel port. Specify 3/8" or 5/16". Complete plans, software \$15.00. **LABSoft**, 36274 Bordman Rd., Memphis, MI 48041. (313) 392-3228.

BEST BY MAIL

Rates: Write National, Box 5, Sarasota, FL 34230

OF INTEREST TO ALL

RETIRE EARLY 1-900-778-3348 CODE AB 5180 Mention Code (\$6.95).

CASH FOR COLLEGE! Money Available Now! Free Information, Write: Sabron Educational Services, Dept. (E), Village Of Stony Run, Suite 54C, Maple Shade, NJ 08052.

TRAVEL

50% TRAVEL SAVINGS! INFORMATION \$1.00: 5236(PE) LUDLAM, CHICAGO, IL 60630-1424.

KENWOOD & ICOM service bulletins. 175+ pages covering all models. \$33.95 catalog — \$3.00. CODs (602) 782-2316 / Fax (602) 343-2141. **TELECODE**, Box 6426-PE, Yuma, AZ 85366-6426.

PROTOBOARD — full-featured. Design, Schematics, on disk. Great learning tool. \$8.00 parts also available. **CCS**, PO Box 24025, Dayton, OH 45424.

EASY to build lethal gas alarm. CO propane natural. Plans \$8.00. **RGM**, Box 2481, Hazelton, PA 18201.

SHADOWTALK Technology — the ultimate lie detector. Discover the subconscious voice. Hear the whole message. Convert your tape machine to play back any recorded speech for hidden messages, information and motives. Excellent for: surveillance, contract negotiations, court transcripts, interviews, religious and political speeches, confessions, songs. Unparalleled results. Hearing is believing. Schematics and parts — \$20.00 for easy conversion of tape players. Shadowtalk Tapeplayer — \$140.00. Infopak — \$7.00, also includes demotape. Check or MO to **SHADOWTALK TRUST**, 1561 S. Congress #205E, Delray Beach, FL 33445.

BUSINESS OPPORTUNITIES

YOUR own radio station! Licensed/unlicensed. AM, FM, TV, cable. Information \$1.00 **BROADCASTING**, Box 130-H5, Paradise, CA 95967.

EASY work! Excellent pay! Assemble products at home. Call toll free 1 (800) 467-5566 Ext. 5730.

MAKE \$75,000.00 to \$250,000.00 yearly or more fixing IBM color monitors. No investment, start doing it from your home (a telephone required). Information, USA, Canada \$2.00 cash for brochure, other countries \$10.00 US funds. **RANDALL DISPLAY**, Box 2168-H, Van Nuys, CA 91404, USA. Fax (818) 990-7803.

HOME assembly work available! Guaranteed easy money! Free details! **HOMEWORK-P**, Box 520, Danville, NH 03819.

MAKE \$\$\$! Become an American electronics dealer! Profit opportunities since 1965. Call **WAYNE MARKS**, 1 (800) 872-1373.

EARN money repairing microcomputers. Booklet lists suppliers of Apple, Compaq, IBM, and other parts and supplies. Send \$6.00 to **LGI COMPUTER SERVICES**, PO Box 711225, Houston, TX 77271. Texas residents add 6.25% tax.

EARN extra money working from home. Assemble products, mail brochures. Information: **LEE**, Box 2048, Winnetka, CA 91306-2048.

WANTED

INVENTORS! Confused? Need help? Call **IMPAC** for free information package. USA/Canada: 1 (800) 225-5800. (24 hours!).

INVENTIONS/new products/ideas wanted: Call **TLCI** for free information/inventors newsletter. 1 (800) 468-7200. 24 hrs/day-USA/Canada.

T.V. FILTERS

T.V. notch filters, phone recording equipment, brochure \$1.00. **MICRO THinc.**, Box 63/6025, Margate, FL 33063. (305) 752-9202.

EDUCATION/INSTRUCTION

LEARN IBM PC assembly language. Book \$18.00. Disk \$5.00. **ZIPFAST**, Box 12238, Lexington, KY 40581-2238.

VCR repair. Save money — make big profits! Learn how from *How to Keep Your VCR Alive*. "This detailed, step-by-step manual enables anyone with no previous knowledge or experience to fix most VCR problems easily, quickly, and inexpensively with a few simple tools." — *Small Press Review*. Highly recommended by *Electronic Servicing and Technology*, *Modern Electronics*, *Popular Electronics*, *Popular Communications*, *Videomaker*, *Video*, *Nuts and Volts*, and many other electronics and video magazines. "Far better than Viejo at 1/7 the cost." 403 page book, with 704 illustrations, plus professional head-cleaning tool. Check B. Daltons (ISBN 9618359-5-8), or send \$24.95 to **WORTHINGTON PUBLISHING**, 6907-202H Halifax River Drive, Tampa, FL 33617. Publisher says S&H. Money-back satisfaction guarantee!

MAKE a thing... Make a living... Study Industrial Design Technology and bring your ideas to life. Learn to problem-solve, sketch, render and design. Develop models, create prosthetic appliances. Build your future in movie and theater special effects, toy and product, exhibit, transportation, furniture/fixture, architectural and amusement environmental design at **The Art Institutes Of Pittsburgh, Fort Lauderdale, Seattle or The Colorado Institute Of Art**. For information write 526 Penn Avenue, Dept. 34, Pittsburgh, PA 15222 or call 1 (800) 525-1000.

FCC general radiotelephone operator license study material. Theories, formulas, and rules. Send \$27.00, check or M.O. to: **BUSSER DEBARR PRODUCTION AND DESIGN**, PO Box 902, Webster Station, Alameda, CA 94501.

BUILDING A Robot: A Straightforward Approach. 152 pages fully illustrated. Instructions how you can easily construct a robot. Check or money order. \$19.95 plus shipping. **HUMAN-FORM ROBOTICS**, PO Box 158486, Nashville, TN 37215.

FREE information available for annual cross reference index to electronics articles printed in several magazines. Send sase to **LOCK-TRONICS PRINT**, 5207 Sherwood, Lawton, OK 73505.

HOME EXTERMINATION

NEW book: "Become Roach-Free" Exterminator explains: in detail. \$20.00 EPE, POB 74C, Calhoun, LA 71225-0074.

ASSEMBLY SERVICE

ELECTRONIC circuit boards and mechanical boards assembled. Any quantity or size. Cable or harness assembly and unit assembly also available. All work guaranteed. Priced right. **ADVANCED CIRCUIT TECHNOLOGY**, Box 317128, Dayton, OH 45431.

You Need Tree City USA

City trees add the soft touch of nature to our busy lives. Support Tree City USA where you live. For your free booklet, write: Tree City USA, The National Arbor Day Foundation, Nebraska City, NE 68410.

 **The National Arbor Day Foundation**



DEALERS WANTED

- Phone Recorder Adapter
- Automatically records phone conversations when receiver is lifted
- Interfaces your phone with any tape recorder
- Meets all FCC requirements.



Fully assembled and guaranteed
Send \$24.95

Fully assembled and guaranteed but without case and cables (Diagram included) Send \$7.95

All prices include shipping and handling

ELECTRO TECH

627 Cherokee St. N.E., Suite #6, Dept. PE
Marietta, Ga. 30060

CABLE EQUIPMENT

DEALERS welcome! SB-3: \$39.00, Tri-Bi: \$49.00, SA-3: \$49.00, DRX-3-105: \$45.00. 1 yr. warranty. Low, low prices. **JEROLD EQUIPMENT SALES**. New: Add-on for impulse series, 1 (800) 676-7966.

FREE CATALOG! 1-800-648-7938 JEROLD HAMLIN OAK ETC CABLE TV DESCRAMBLERS

- Special Dealer Prices!
- Compare our Low Retail Prices!
- Guaranteed Prices & Warranties!
- Orders Shipped Immediately!

REPUBLIC CABLE PRODUCTS, INC.

4080 Paradise Rd. #15, Dept. PE592
Las Vegas, NV 89109

For all other information (702) 362-3026

SATELLITE TV

FREE — Catalog — Do-it-yourself. Save 40%-60%. Lowest prices worldwide, systems, upgrades, parts. All major brands, factory fresh and warrantied. **SKYVISION**, 1048 Frontier, Fergus Falls, MN 56537. 1 (800) 334-6455.

DIGITAL satellite imaging system. Receive pictures from outer space of planet earth! Works with any IBM compatible computer. Systems as low as \$499.00. Call or write now for free details: **MOON-BEAM SATELLITE**, 339 Neighborhood Rd., Mastic Beach, NY 11951. (516) 281-2669, (516) 281-8250-fax.

LEARN COMPUTERS!



Home study. Become a personal computer expert at home and in business. Learn at your own pace. Exciting and easy to follow. **Send or call today for free literature.**
800-223-4542

Name _____
Address _____
City _____ State _____ Zip _____

SCHOOL OF COMPUTER TRAINING
2245 Perimeter Park
Dept. VF341, Atlanta, Georgia 30341

SPECIAL FROM ETT

TTL1 —
**TTL POCKET GUIDE,
Volume 1,
7400 — 74200
..... \$18.95.**



TTL2 —
**TTL POCKET GUIDE,
Volume 2,
74201 — 74640
..... \$18.95.**



TTL3 —
**TTL POCKET GUIDE,
Volume 3,
74641 — 7430640
..... \$18.95.**



TTLX —
**ALL THREE GUIDES.
Vols 1, 2, & 3
(save \$6.00)
..... \$50.85.**

Each volume provides a comprehensive listing of all commonly used TTL integrated circuits within the range of types noted. The combination of three volumes covers 7400 through 7430640 TTL products from all major manufacturers. All current families are covered: standard, low power, Schottky, low power Schottky, advanced Schottky, high speed and fast Schottky. There are eight sections to the book. Section 1 illustrates the device schematic using a clear and simple logic diagram. Next a brief description of the components, providing quick reference to the internal structure. The next section details input signals or levels at individual pins. The fourth section lists major applications and is followed by a summary of essential data. Below this, a table indicates the TTL families in which the device is available, and finally, device description and type number are highlighted for easy reference. A manufacturer's index at the back of the book shows in tabular form which companies manufacture each package.

MAIL TO: **Electronic Technology Today, Inc.**
P.O. Box 240
Massapequa Park, NY 11762-0240

SHIPPING CHARGES IN USA AND CANADA

\$0.01 to \$5.00	.. \$1.50	\$30.01 to \$40.00	\$5.50
\$5.01 to \$10.00	.. \$2.50	\$40.01 to \$50.00	\$6.50
\$10.01 to \$20.00	.. \$3.50	\$50.01 and above	\$8.00
\$20.01 to \$30.00	.. \$4.50		

SORRY, No orders accepted outside of USA and Canada

Total price of merchandise \$	_____
Shipping (see chart) \$	_____
Subtotal \$	_____
Sales Tax (NYS only) \$	_____
Total Enclosed \$	_____

Name _____
Address _____
City _____ State _____ Zip _____

ADVERTISING INDEX

POPULAR ELECTRONICS magazine does not assume any responsibility for errors that may appear in the index below.

Free Information No.	Page	10	Fluke Manufacturing CV2
7	AMC Sales 21	—	Grantham College 19
8	All Electronics 4	14	Mouser 71
—	Antique Radio Classified 94	—	NAS/TransWorld 94
—	Business INFOLINE 87	—	NRI Schools 25
—	CBC International 94	—	Pacific Cable 94
—	CIE 15	—	Phillips Tech 93
—	Cable Ready Company 93	13	Radio Shack CV4
—	Command Productions 21	—	Radio-Electronics Video Offer . CV3
9	Datak Corporation 3	—	Republic Cable 95
—	Electro Tech 95	5	SCO Electronics 17
—	Electronics Book Club 9, 83	—	Satman, Inc. 94
—	Electronic Tech. Today 30	—	The School of VCR Repair 95
—	Electronic Tech. Today 88, 95	6	U.S. Cable 17
—	Firestik II 93	16,17	Viejo Publications 11, 71
12	Fisher M-Scope 11	11	WPT Publications 69

ADVERTISING SALES OFFICE

Gernsback Publications, Inc.
 500-B Bi-County Blvd.
 Farmingdale, NY 11735
 1-(516) 293-3000
 President: **Larry Steckler**
 Assistant to the President: **Christina Estrada**

For Advertising ONLY
 516-293-3000
 Fax 1-516-293-3115
Larry Steckler
 publisher
Arline Fishman
 advertising director
Denise Haven
 advertising assistant
Kelly McQuade
 credit manager

Customer Service/Order Form
 1-800-435-0715
 1-800-892-0753
 7:30 AM - 8:30 PM EST

SALES OFFICES

EAST/SOUTHEAST
Stanley Levitan, Eastern Sales Manager
 1 Overlook Ave.
 Great Neck, NY 11021
 1-516-487-9357, 1-516-293-3000
 Fax 1-516-487-8402

MIDWEST/Texas/Arkansas/Okla.
Ralph Bergen, Midwest Sales Manager
 One Northfield Plaza, Suite 300
 Northfield, IL 60093-1214
 1-708-446-1444
 Fax 1-708-559-0562

PACIFIC COAST/Mountain States
Marvin Green, Pacific Sales Manager
 5430 Van Nuys Blvd, Suite 316
 Van Nuys, CA 91401
 1-818-986-2001
 Fax 1-818-986-2009

Popular Electronics

WE
HAVE THE
RIGHT
ANSWER

Advertisers who want to place their print ads in a quality publication ask the question: "Is your circulation audited?" We're very proud to answer "Yes."

We are a member of the Audit Bureau of Circulations because we share ABC's belief that circulation audits are an essential assurance of value.

ABC is the premier circulation auditing organization in the world, and has been since 1914. Each year, ABC auditors test and verify that our circulation figures are facts, not claims. An ABC audit is the sign of a sound investment for advertisers.

Not all publications are audited, but they should be. Because when advertisers ask "Is your circulation audited?" there's only one answer.

"Yes."



Audit Bureau of Circulations

Never before has so much professional information on the art of detecting and eliminating electronic snooping devices—and how to defend against experienced information thieves—been placed in one VHS video. If you are a Fortune 500 CEO, an executive in any hi-tech industry, or a novice seeking entry into an honorable, rewarding field of work in countersurveillance, you must view this video presentation again and again.

Wake up! You may be the victim of stolen words—precious ideas that would have made you very wealthy! Yes, professionals, even rank amateurs, may be listening to your most private conversations.

Wake up! If you are not the victim, then you are surrounded by countless victims who need your help if you know how to discover telephone taps, locate bugs, or “sweep” a room clean.

There is a thriving professional service steeped in high-tech techniques that you can become a part of! But first, you must know and understand Countersurveillance Technology. Your very first insight into this highly rewarding field is made possible by a video VHS presentation that you cannot view on broadcast television, satellite, or cable. It presents an informative program prepared by professionals in the field who know their industry, its techniques, kinks and loopholes. Men who can tell you more in 45 minutes in a straightforward, exclusive talk than was ever attempted before.

Foiling Information Thieves

Discover the targets professional snoopers seek out! The prey are stock brokers, arbitrage firms, manufacturers, high-tech companies, any competitive industry, or even small businesses in the same community. The valuable information they file may be marketing strategies, customer lists, product formulas, manufacturing techniques, even advertising plans. Information thieves eavesdrop on court decisions, bidding information, financial data. The list is unlimited in the mind of man—especially if he is a thief!

You know that the Russians secretly installed countless microphones in the concrete work of the American Embassy building in Moscow. They converted



**HAVE YOUR
VISA or MC CARD
AVAILABLE**

what was to be an embassy and private residence into the most sophisticated recording studio the world had ever known. The building had to be torn down in order to remove all the bugs.

Stolen Information

The open taps from where the information pours out may be from FAX's, computer communications, telephone calls, and everyday business meetings and lunchtime encounters. Businessmen need counselling on how to eliminate this information drain. Basic telephone use coupled with the user's understanding that someone may be listening or recording vital data and information greatly reduces the opportunity for others to purloin meaningful information.

The professional discussions seen on the TV screen in your home reveals how to detect and disable wiretaps, midget radio-frequency transmitters, and other bugs, plus when to use disinformation to confuse the unwanted listener, and the technique of voice scrambling telephone communications. In fact, do you know how to look for a bug, where to look for a bug, and what to do when you find it?

Bugs of a very small size are easy to build and they can be placed quickly in a matter of seconds, in any object or room. Today you may have used a telephone handset that was bugged. It probably contained three bugs. One was a phony bug to fool you into believing you found a bug and secured the telephone. The second bug placates the investigator when he finds the real thing! And the third bug is found only by the professional, who continued to search just in case there were more bugs.

The professional is not without his tools. Special equipment has been designed so that the professional can sweep a room so that he can detect voice-activated (VOX) and remote-activated bugs. Some of this equipment can be operated by novices, others require a trained countersurveillance professional.

The professionals viewed on your television screen reveal information on the latest technological advances like laser-beam snoopers that are installed hundreds of feet away from the room they snoop on. The professionals disclose that computers yield information too easily.

This advertisement was not written by a countersurveillance professional, but by a beginner whose only experience came from viewing the video tape in the privacy of his home. After you review the video carefully and understand its contents, you have taken the first important step in either acquiring professional help with your surveillance problems, or you may very well consider a career as a countersurveillance professional.

The Dollars You Save

To obtain the information contained in the video VHS cassette, you would attend a professional seminar costing \$350-750 and possibly pay hundreds of dollars more if you had to travel to a distant city to attend. Now, for only \$49.95 (plus \$4.00 P&H) you can view *Countersurveillance Techniques* at home and take refresher views often. To obtain your copy, complete the coupon below or call toll free.

RADIO-ELECTRONICS VIDEO OFFER **PE**
500-B Bi-County Blvd.
Farmingdale, NY 11735

Please rush my copy of the Countersurveillance Techniques Video VHS Cassette for \$49.95 plus \$4.00 for postage and handling.

No. of Cassettes ordered _____
Amount of payment \$ _____

Bill my VISA MasterCard
Card No. _____
Expire Date _____ / _____

Signature _____
Name _____
Address _____
City _____ State _____ ZIP _____

All payments in U.S.A. funds. Canadians add \$4.00 per VHS cassette. No foreign orders. New York State residents add applicable sales tax.

RADIO SHACK

THE PARTS PLACESM

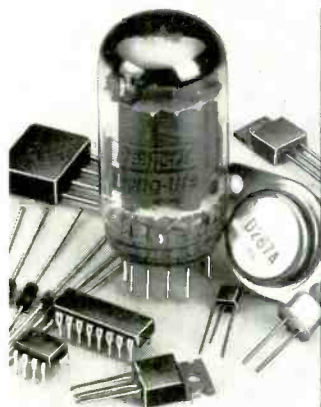

Try Our Exclusive Postage-Free Parts "Hotline"

Your Radio Shack store stocks over 1000 electronic components, and another 15,000 items are available fast from our Special-Order warehouse. Selection includes ICs, transistors and diodes, tubes, crystals, phono cartridges and styl, all sorts of accessories, SAMSSM service manuals and MUCH more. You pay no postage—we send your order direct to your nearby Radio Shack.

- (1) **Portable Shortwave Antenna.** DX grabber! Clips to portable's rod antenna. 23-ft. wire element stores on pocket-size reel. #278-1374 . . . 8.95
- (2) **Dial Cord Repair Kit.** Radio Shack exclusive! Includes six feet of high-strength dial cord and three tension springs. #274-435 . . . 99¢
- (3) **3" Brushless 12VDC Fan.** Exclusive! Brushless design and DC operation make it a great choice for cooling mobile equipment and circuits that are sensitive to hum or noise. 27 CFM airflow. #273-243 . . . 14.95
- (4) **UL-Recognized Power Transformer.** Exclusive! 120VAC primary. Center-tapped secondary provides 12VAC at 1.2A. #273-1352 . . . 5.99

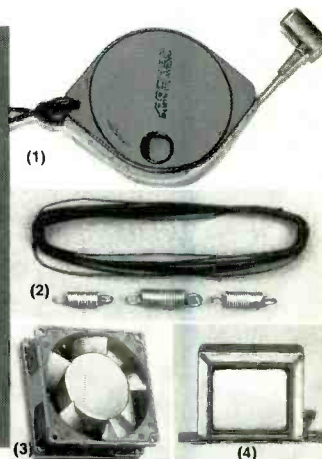

Micromini Toggle Switches. Reliability at low cost. Rated 3A at 125VAC. 1/4"-dia. stem.

- SPST. #274-624 2.29
- SPDT. #274-625 2.39
- DPDT. #274-626 2.59

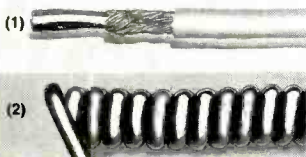

- (1) **Double-Shielded, 4 Conductor Cable.** For data or audio. The best! 30 ft. #278-777 7.95
- (2) **Coiled Mike Cable.** Replace CB, ham, marine radio cords. 4 conductors. 5 ft. #278-358 2.99

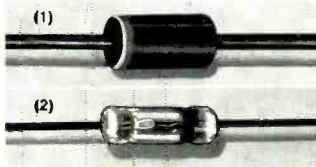

- (1) **1N914/4148 Switching Diodes.** Popular silicon type. Rated 75 PIV. #276-1122 Pkg. of 10/99¢
- (2) **1N34 Germanium Diodes.** Hard-to-find signal diodes. Rated 60 PIV. #276-1123, Pkg. of 10/99¢

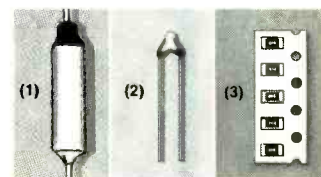

- (1) **Thermal Fuses.** 128° C. #270-1321, 141° C. #270-1320, 228° C. #270-1322 Each 1.19
- (2) **Thermistor.** Resistance is proportional to temperature. #271-110 . . . 1.99
- (3) **Surface-Mount Resistors.** 200 pieces, 15 popular values! Rated 1/8 watt, 5%. #271-313 Set 4.99

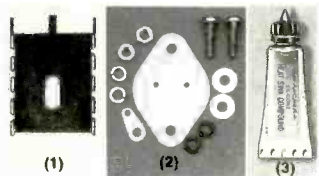

- (1) **TO-220 Heat Sink.** Ideal for PC board use. #276-1363 89¢
- (2) **TO-3 Mounting Hardware.** Complete kit. #276-1371 99¢
- TO-220 Mtg. Kit.** #276-1373 99¢
- (3) **Heat Sink Grease.** Assures maximum heat transfer. #276-1372 . . . 1.59

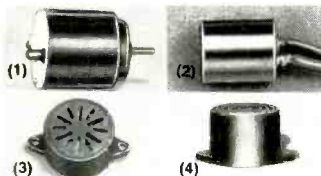

- (1) **1 1/2 to 3VDC Motor.** Use in solar power demos. #273-223 99¢
- (2) **Electret Element.** #270-092, 2.99
- (3) **12VDC Magnetic Buzzer.** A more pleasing tone! #273-026 2.19
- (4) **"Ding-Dong" Chime.** Classy entry alert. 6 to 18VDC. #273-071 8.99

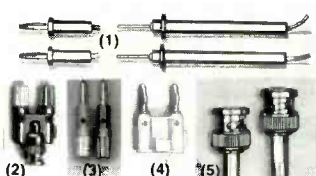

- (1) **Coiled 6-Ft. Test Leads.** Why put up with tangles? #278-750 . . . Set 4.99
- (2) **Posts to BNC.** #274-715 . . . 8.95
- (3) **Posts to Bananas.** #274-716, 4.95
- (4) **Stackable Dual Inline Banana Plug.** Versatile! #274-717 2.99
- (5) **6-Ft. BNC-to-BNC.** #278-964, 5.99

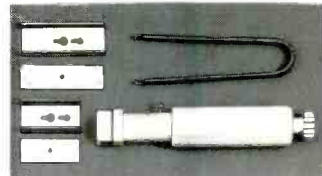

IC Inserter/Extractor Kit. Why risk bending or breaking pins on expensive chips? This kit makes it easy to install and remove any DIP-style IC from 6 to 40 pins. Both tools are groundable to prevent static "zaps". #276-1581 6.95



UL-Listed DVM. Micronta[®] makes electronics testing a snap! Autoranging, 1/2" LCD digits, bar graph to spot peaks, data hold to freeze display, continuity sounder, diode-check. #22-186 69.95

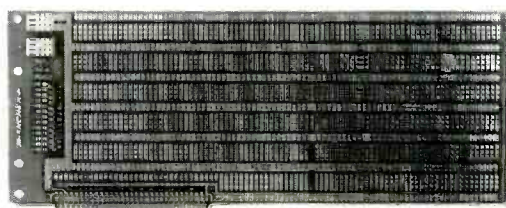

PC/XT Experimenter's Circuit Card. This premium-quality prototyping board fits a computer's XT expansion bus connector. Features durable epoxy glass construction and plated-through holes on standard 0.100" centers. Accepts D-sub connector shown at right. 3 7/8 x 10 1/16 x 1/16". #276-1598 29.95

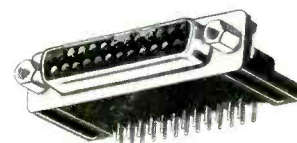

Right-Angle D-Sub 25 Female Connector. Ideal for use with PC/XT circuit card at left. Radio Shack also stocks a big selection of D-sub and IDC-type connectors for computer hookups. #276-1504 . . . 2.49

Since 1921 Radio Shack has been the place to obtain up-to-date electronic parts as well as quality tools, test equipment and accessories at low prices. Nearly 7000 locations are ready to serve you—NOBODY COMPARES

Prices apply at participating Radio Shack stores and dealers. Radio Shack is a division of Tandy Corporation

Radio Shack SINCE 1921
AMERICA'S TECHNOLOGY STORESM

CIRCLE 13 ON FREE INFORMATION CARD

www.americanradiohistory.com