

TUNE IN TO POLICE-BAND RADIO

48784

Popular Electronics®

JANUARY 1992

BUILD A SUBWOOFER

Add it to your stereo system and enjoy dramatically improved low-frequency performance

A NEGATIVE-ION GENERATOR

Build one and see for yourself if all the health claims are fact or fiction

ALL ABOUT PARALLEL-PORT SIGNALS

Learn what they do, and how they are used to control printers and more

ETCH YOUR OWN PC BOARDS

It's easy to do with this step-by-step method



Product Reviews

Radio Shack Wireless Video Transmitter, Onkyo Surround-Sound A/V Receiver, Sanyo Heart-Rate Monitor, Sony 8mm Camcorder, and many more

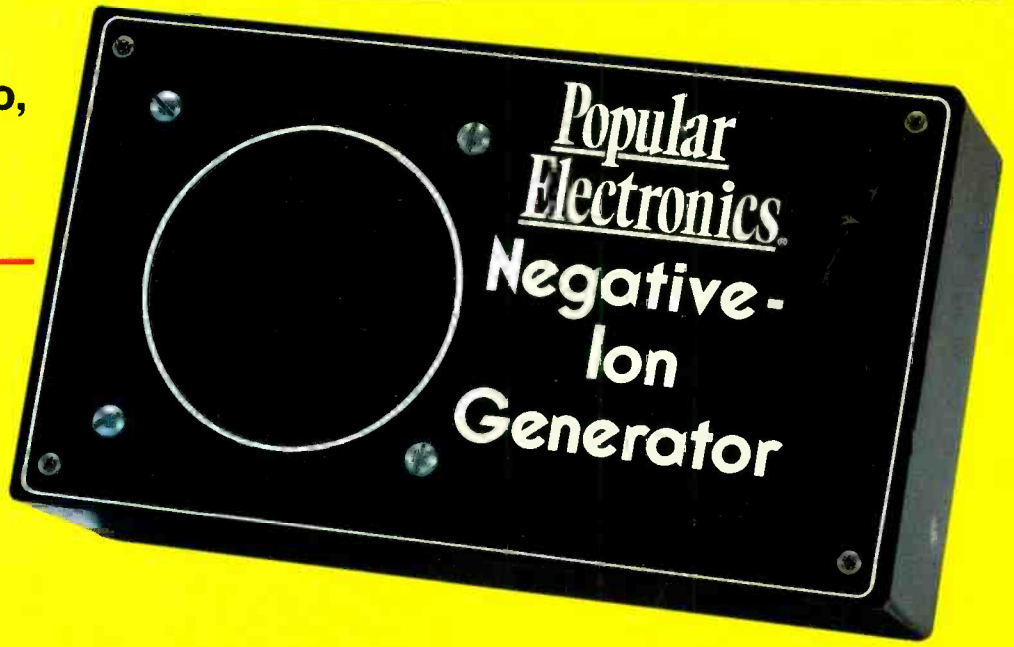

A GERNSBACH PUBLICATION



\$2.95 U.S.
\$3.75 CANADA

3 NEW FactCards IN THIS ISSUE

#BXBDCC***** 5-DIGIT 60506
#60506DHM997GAD06# FEB92 02
ROBERT DAHM RESP
997 GRAND AVE 074
AURORA, IL 60506

Electronics Paperback Books

GREAT PAPERBACKS AT SPECIAL PRICES

BP248—TEST EQUIPMENT CONSTRUCTION \$5.95. Details construction of simple, inexpensive, but extremely useful test equipment. AF Gen, Test Bench Ampl, Audio Millivoltmeter, Transistor Tester and six more.

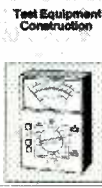

BP267—HOW TO USE OSCILLOSCOPES AND OTHER TEST EQUIPMENT \$6.95. Mastering the oscilloscope is not really too difficult. This book explains all the standard controls and functions. Other equipment is also described.



BP265—MORE ADVANCED USES OF THE MULTIMETER \$5.95. Use these techniques to test and analyze the performance of a variety of components. Also see how to build add-ons to extend multimeter capabilities.



BP256—INTRO TO LOUDSPEAKERS AND ENCLOSURE DESIGN \$5.95. We explore the variety of enclosure and speaker designs in use today so the reader can understand the principles involved.

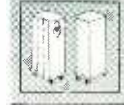

BP263—A CONCISE INTRO TO dBASE \$6.95. The dBASE series of programs are probably the best known database programs for microcomputers. This book is designed to help you get started working with them.



BP260—CONCISE INTRO TO OS/2 \$5.95. If you are a multitasking PC user and want to get the most out of your computer, then you must learn its OS/2 operating system. This book shows you just how to do that, quickly and easily.



BP249—MORE ADVANCED TEST EQUIPMENT CONSTRUCTION \$6.95. Eleven more test equipment construction projects. They include a digital voltmeter, capacitance meter, current tracer and more.



Digital Audio Projects



BP245—DIGITAL AUDIO PROJECTS \$5.95. Practical circuits to build and experiment with. Includes A/D converter, input amplifier, digital delay line, compander, echo effect and more.

BP247—MORE ADVANCED MIDI PROJECTS \$5.95. Circuits included are a MIDI indicator, THRU box, merge unit, code generator, pedal, programmer, channelizer, and analyzer.

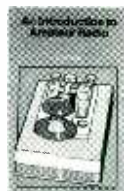

BP257—INTRO TO AMATEUR RADIO \$6.95. Amateur is a unique and fascinating hobby. This book gives the newcomer a comprehensive and easy to understand guide to the subject.



PCP102—INTRODUCING DIGITAL AUDIO \$9.95. Covers all kinds of digital recording methods—CD, DAT and Sampling. Bridges the gap between the technician and the enthusiast. Principles and methods are explained.

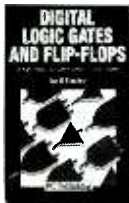

PCP107—DIGITAL LOGIC GATES AND FLIP FLOPS \$10.00. Thorough treatment of gates and flip-flops for enthusiasts, student and technicians. Only a basic knowledge of electronics is needed.

BP251—COMPUTER HOBBYISTS HANDBOOK \$8.95. A wrapup of everything the computer hobbyist needs to know in one easy to use volume. Provides a range of useful reference material in a single source.



PCP108—COMPUTERS AND MUSIC \$9.95. Explains the basics of computers and music with no previous knowledge of computers needed. Covers types of music software and explains how to set up your own computer music studio.

- BP195—INTRODUCTION TO SATELLITE TV**..... \$9.95. A definitive introduction to the subject written for the professional engineer, electronics enthusiast, or others who want to know more before they buy. 8 x 10 in.
- BP190—ADVANCED ELECTRONIC SECURITY PROJECTS**.....\$5.95. Includes a passive infra-red detector, a fiber-optic loop alarm, computer-based alarms and an unusual form of ultrasonic intruder detector.
- BP235—POWER SELECTOR GUIDE**.....\$10.00. Complete guide to semiconductor power devices. More than 1000 power handling devices are included. They are tabulated in alpha-numeric sequence, by technical specs. Includes power diodes, Thyristors, Triacs, Power Transistors and FET's.
- BP234—TRANSISTOR SELECTOR GUIDE**.....\$10.00. Companion volume to BP235. Book covers more than 1400 JEDEC, JIS, and brand-specific devices. Also contains listing by case type, and electronic parameters. Includes Darlingtons transistors, high-voltage devices, high-current devices, high power devices.
- BP99—MINI-MATRIX BOARD PROJECTS**.....\$5.50. Here are 20 useful circuits that can be built on a mini-matrix board that is just 24 holes by ten copper-foil strips.
- BP117—PRACTICAL ELECTRONIC BUILDING BLOCKS—Book 1**.....\$5.75. Oscillators, Timers, Noise Generators, Rectifiers, Comparators, Triggers and more.
- BP184—INTRO TO 68000 ASSEMBLY LANGUAGE**.....\$6.95. The 68000 is a great new breed of microprocessor. Programming in assembly language increases the running speed of your programs. Here's what you need to know.
- BP179—ELECTRONIC CIRCUITS FOR THE COMPUTER CONTROL OF ROBOTS** \$7.50. Data and circuits for interfacing the computer to the robot's motors and sensors.

- BP239—GETTING THE MOST FROM YOUR MULTIMETER**..... \$5.95. Covers basics of analog and digital meters. Methods of component testing includes transistors, thyristors, resistors, capacitors and other active and passive devices.
- BP97—IC PROJECTS FOR BEGINNERS**.....\$5.50. Power supplies, radio and audio circuits, oscillators, timers, switches, and more. If you can use a soldering iron you can build these devices.
- BP37—50 PROJECTS USING RELAYS, SCR'S & TRIACS**.....\$5.50. Build priority indicators, light modulators, warning devices, light dimmers and more.
- RADIO—100 RADIO HOOKUPS**.....\$3.00. Reprint of 1924 booklet presents radio circuits of the era including regenerative, neutrodyne, reflex & more.
- BP42—SIMPLE LED CIRCUITS**..... \$5.50. A large selection of simple applications for this simple electronic component.
- BP127—HOW TO DESIGN ELECTRONIC PROJECTS**.....\$5.75. Helps the reader to put projects together from standard circuit blocks with a minimum of trial and error
- BP122—AUDIO AMPLIFIER CONSTRUCTION**.....\$5.75. Construction details for preamps and power amplifiers up through a 100-watt DC-coupled FED amplifier.
- BP92—CRYSTAL SET CONSTRUCTION**..... \$5.50. Everything you need to know about building crystal radio receivers.
- BP45—PROJECTS IN OPTOELECTRONICS**..... \$5.50. Includes infra-red detectors, transmitters, modulated light transmission and photographic applications.

BP185—ELECTRONIC SYNTHESIZER CONSTRUCTION \$5.95. Use this book to learn how to build a reasonably low cost, yet worthwhile monophonic synthesizer. Learn a lot about electronic music synthesis in the process.

CHECK OFF
THE BOOKS YOU WANT

ELECTRONIC TECHNOLOGY TODAY INC.
P.O. Box 240, Massapequa Park, NY 11762-0240

SHIPPING CHARGES IN
USA AND CANADA

SORRY No orders accepted
outside of USA & Canada

Number of books ordered

Name _____
Address _____
City _____ State _____ Zip _____

\$0.01 to \$5.00 \$1.50
\$5.01 to \$10.00 \$2.50
\$10.01 to 20.00 \$3.50
\$20.01 to 30.00 \$4.50
\$30.01 to 40.00 \$5.50
\$40.01 to 50.00 \$6.50
\$50.01 and above \$8.00

Total price of merchandise \$ _____
Sales Tax (New York State Residents only) \$ _____
Shipping (see chart) \$ _____

All payments must
be in U.S. funds

Total Enclosed .. \$ _____

P-192

Popular Electronics®

THE MAGAZINE FOR THE ELECTRONICS ACTIVIST!

CONSTRUCTION ARTICLES

BUILD A NEGATIVE-ION GENERATOR	John Iovine	29
<i>Build one and decide for yourself if negative ions have any therapeutic value</i>		
BUILD YOUR OWN SUBWOOFER	William D. Whitehead	31
<i>A well designed enclosure and crossover will allow you to enjoy the low end of the audio spectrum</i>		
THE INCREDIBLE HOT CANARIES	John Clarke	42
<i>Amaze your friends and family with a circuit that emulates the sound of two birds singing together</i>		

FEATURE ARTICLES

ALL ABOUT PARALLEL-PORT SIGNALS	John Yacono	38
<i>Knowing what signals pass through parallel ports helps you to build circuits that take advantage of those ports</i>		
COP TALK: UNDERSTANDING POLICE COMMUNICATIONS	Laura Quarantiello	61
<i>Listen to and understand the airborne chatter of your local public servants</i>		
ETCH YOUR OWN PC BOARDS	Robert A. Young	68
<i>A few chemicals and a little know how will take any PC pattern from printed page to printed circuit</i>		

PRODUCT REVIEWS

GIZMO		45
<i>Including: Radio Shack Wireless Audio/Video Distribution System, Cobra Portable</i>		
HANDS-ON REPORT		72
<i>The OWI Grand Piano Kit</i>		
PRODUCT TEST REPORT	Len Feldman	73
<i>Onkyo TX-SV70 Pro Audio/Video Surround-Sound Receiver</i>		

COLUMNS

THINK TANK	John Yacono	22
<i>Fun with op-amps</i>		
ANTIQUÉ RADIO	Marc Ellis	76
<i>The Theremin plays again</i>		
CIRCUIT CIRCUS	Charles D. Rakes	78
<i>Alarm circuits</i>		
COMPUTER BITS	Jeff Holtzman	81
<i>Norton Utilities, Version 6.0</i>		
FUN SOFTWARE	Fred Blechman	83
<i>A real REC</i>		
DX LISTENING	Don Jensen	85
<i>Programming For SWLs</i>		
HAM RADIO	Joseph J. Carr	87
<i>Why not try a folded dipole?</i>		
SCANNER SCENE	Marc Saxon	89
<i>New kid on the block</i>		

DEPARTMENTS

EDITORIAL	Carl Laron	2
LETTERS		4
ELECTRONICS LIBRARY		6
NEW PRODUCTS		14
FACTCARDS		51
FREE INFORMATION CARD		53
ANNUAL INDEX		63
ADVERTISER'S INDEX		98

Popular Electronics (ISSN 1042-170X) Published monthly by Gernsback Publications, Inc., 500-B B-County Boulevard, Farmingdale, NY 11735. Second-Class postage paid at Farmingdale, NY and at additional mailing offices. One-year, twelve issues, subscription rate U.S. and possessions \$21.95, Canada \$28.84 (includes G.S.T. Canadian Goods and Services Tax Registration No. R125166280), all other countries \$29.45. Subscription orders payable in U.S. funds only. International Postal Money Order, or check drawn on a U.S. bank. U.S. single copy price \$2.95. © 1991 by Gernsback Publications, Inc. All rights reserved. Hands-on Electronics and Gizmo trademarks are registered in U.S. and Canada by Gernsback Publications, Inc. Popular Electronics trademark is registered in U.S. and Canada by Electronics Technology Today, Inc. and is licensed to Gernsback Publications, Inc. Printed in U.S.A.

Postmaster: Please send address changes to Popular Electronics, Subscription Dept., P.O. Box 338, Mount Morris, IL 61054-9832.

A stamped self-addressed envelope must accompany all submitted manuscripts and/or artwork or photographs if their return is desired should they be rejected. We disclaim any responsibility for the loss or damage of manuscripts and/or artwork or photographs while in our possession or otherwise.

As a service to readers, Popular Electronics publishes available plans or information relating to newsworthy products, techniques, and scientific and technological developments. Because of possible variances in the quality and condition of materials and workmanship used by readers, Popular Electronics disclaims any responsibility for the safe and proper functioning of reader-built projects based upon or from plans or information published in this magazine.

Larry Steckler

EHF, CET

Editor-In-Chief and Publisher

EDITORIAL DEPARTMENT

Carl Laron

Editor

Robert A. Young

Associate Editor

John J. Yacono

Associate Editor

Byron G. Wels, K2AVB

Associate Editor

Teri Scaduto

Assistant Editor

Kathy Terenzi

Editorial Assistant

Marc Spiwak

Editorial Associate

Fred Blechman

Joseph J. Carr, K4IPV

Marc Ellis

Len Feldman

Jeffrey K. Holtzman

Don Jensen

Charles D. Rakes

Marc Saxon

Contributing Editors

PRODUCTION DEPARTMENT

Ruby M. Yee

Production Director

Karen S. Brown

Production Manager

Marcella Amoroso

Production Assistant

Janice Box

Editorial Production

ART DEPARTMENT

Andre Duzant

Art Director

Injae Lee

Illustrator

Russell C. Truelson

Illustrator

Jacqueline P. Cheeseboro

Circulation Director

Michele Torrillo

P-E Bookstore

BUSINESS AND EDITORIAL OFFICES

Gernsback Publications, Inc.

500-B Bi-County Blvd.

Farmingdale, NY 11735

1-516-293-3000

Fax: 1-516-293-3115

President: **Larry Steckler**

Customer Service/Order Entry

1-800-435-0715

7:30 AM - 8:30 PM EST

Advertising Sales offices listed on page 98

Cover photography by Diversified Photo Services

Composition by
Mates Graphics



The
Audit
Bureau
of Circulation



The publisher has no knowledge of any proprietary rights which will be violated by the making or using of any items disclosed in this issue.

AN ACTION-PACKED ISSUE

We call ourselves the "Magazine for the Electronics Activist," and this month is a perfect example of why. No matter what your interest in electronics, you'll find something to get you up and going in **Popular Electronics**.

For instance, audio enthusiasts will want to build the two-octave Helmholtz subwoofer described in "Build Your Own Subwoofer." Complete mechanical and electrical details make it easy to turn the concepts described into a working unit, and the crossover and amplifier described let you use the subwoofer with virtually any audio system.

Computer enthusiasts will want to read and save "All About Parallel-Port Signals." It describes the various signals available at your computer's parallel port, and what they do. Armed with that information, you can build all sorts of projects that take advantage of those signals.

Scanner enthusiasts will want to read "Cop Talk: Understanding Police Communications." It looks at the exciting world of police communications, and how you can take part in the action.

In addition to "Build Your Own Subwoofer," project builders will have fun with "Build a Negative-Ion Generator" and "The Incredible Hot Canaries." The first is a high-voltage generator that lets you see for yourself if negatively charged ions have the beneficial health effects claimed, while the second is an easy-to-build, just-for-fun conversation piece. Further, the information presented in "Etch Your Own PC Boards," makes transferring PC patterns from **Popular Electronics'** pages, or from elsewhere, a much easier task.

And if you're not worn out from all of that, maybe you'll want to do some shopping. If so, the informative and honest reviews in "Product Test Report" and "Gizmo" will give you the facts you need to make intelligent decisions when buying consumer-electronics gear.

Throw in our usual line up of columns and you have an action-packed issue. But we're sure you can handle it; after all, you read the Magazine for the Electronics Activist!

Carl Laron
Editor

COURTEOUS SERVICE • QUALITY PARTS • DISCOUNT PRICES • FAST SHIPPING

ALL ELECTRONICS CORP.

"MAX" The Remote VCR Controller

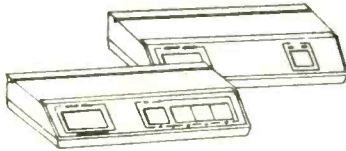

"MAX" allows you to watch and control a single VCR from other locations in the house. Transmits audio, video and IR signals up to 100 feet through mini-cable. Works on up to 4 television at a time, but a separate "MAX" receiver is required for each TV. Can also be used with other infrared controller devices such as CD players or stereos. Because it is hardwired, signal transmission is clearer than more expensive non-hardwired units. Includes transmitter, receiver, 100' cable, hook-up cables and wall transformer. These new units originally sold for over \$100.00
CAT# MAX \$40.00 each 4 or more \$35.00 each

WIRELESS REMOTE CONTROL FOR NINENDO™

ATTENTION
**NINTENDO™
 USERS!!!**

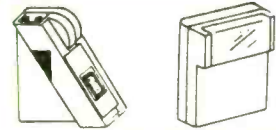

CAMERA "Freedom Connection"™ Turns your wired Nintendo™ control paddle into a remote control unit. Infrared remote like those used on TV's and VCR's eliminates messy wires. Allows players more mobility. Two players can use one remote unit except on games where they play simultaneously. In those games two "Freedom Connections" units are required. A well-known national discount toy chain sells these for more than twice our price. Operates on 4 AAA batteries (not included).
CAT# IR-1 \$9.95 each
 Set of 4 AAA batteries **CAT# BAT-4AAA \$2.40 per set**

TOUCH DIMMER

The "brain" part of the "LITE TOUCH" touch dimmer, when connected to any lamp, will turn it on and off and change the brightness level when any metal part is touched. We don't have the wiring harness that originally connected this to the lamp, but we can provide a simple hook-up diagram and instruction sheet. The solid-state circuitry is contained in a thermoplastic box 1.91" X 3.11" X 0.835".
CAT# DMR-1 \$3.50 each



L.E.D.'s

Standard JUMBO
 Diffused T 1-3/4 size (5 mm)

RED CAT# LED-1 10 for \$1.50 • 100 for \$13.00
GREEN CAT# LED-2 10 for \$2.00 • 100 for \$17.00
YELLOW CAT# LED-3 10 for \$2.00 • 100 for \$17.00

FLASHING LED
 W/ built in flashing circuit
 5 volt operation. T 1-3/4 (5mm)

RED \$1.00 each
CAT# LED-4 10 for \$9.50
GREEN \$1.00 each
CAT# LED-4G 10 for \$9.50
YELLOW \$1.00 each
CAT# LED-4Y 10 for \$9.50

LED HOLDER
 Two piece holder.
CAT# HLED 10 for 65¢

RECHARGEABLE BATTERIES

Nickel-Cad



AAA SIZE \$1.50 each
 1.2 volts 180 mAh
CAT# NCB-AAA
AA SIZE \$2.00 each
 1.25 volts 500 mAh
CAT# NCB-AA

AA SIZE \$2.20 each
 WITH SOLDER TABS
CAT# NCB-SAA
C SIZE \$4.25 each
 1.2 volts 1200 mAh
CAT# NCB-C

D SIZE \$4.50 each
 1.2 volts 1200 mAh
CAT# NCB-D

24 PIN ZERO INSERTION FORCE SOCKET

Textool # 224-3344. Protect 24 pin dip IC's from damage during test, burn-in or programming. Lever-operated mechanism locks part securely in place and releases it with no damage to component leads.
CAT# ZIF-24 \$4.50 each

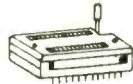

WALL TRANSFORMERS

12 Vdc 500 ma.
 2.1mm D.C. power plug with center negative. White case.
CAT# DCTX-125W \$4.50 each
12 Vdc 200 ma.
 2.1 mm D.C. power plug with center negative. **CAT# DCTX-122 \$3.00 each**



4PDT - 24 Vdc RELAY

24 Vdc, 650 ohm coil - 3 amp contacts Standard 14 pin (ICE CUBE) style. Plastic dust cover. Size: 1 1/4" X 1 3/4" X 7/8" **CAT# 4PRLY-24N \$4.00 each**



PHOTORESISTOR

1,000 ohms bright light.
 16K ohms dark.
 0.182" dia. X .08" high. 0.18" long leads.
CAT# PRE-7 2 for \$1.00
 100 for \$45.00 • 1000 for \$400.00



SWITCHES

Pushbutton Switch

SM Manufacturing 0.47" square black pushbutton. SPST normally open. 4 p.c. pins for mounting. Ideal for low current switching applications.
CAT# PB-29
 5 for \$1.00 • 100 for \$15.00



SPST N.O. Pushbutton

SPST normally open p.c. mount pushbutton. 0.47" square mounting pad. Plunger extends 0.47" above surface. No pushbutton cap available. Ideal, inexpensive switch where looks are not important. 4 p.c. pins on 0.2" X 0.5" mounting centers.
CAT# PB-35 5 for \$1.00



Mini Snap-Action

Omnrons #D2F-L Miniature snap-action switch with lever. Rated 1 amp @ 125 Vac. 0.50" L X 0.26" H X 0.22" W. Lever extends 0.05" beyond end of switch. **CAT# SMS-282**
 75¢ each • 10 for \$6.50



RFI/EMI LINE FILTER

Corcom #20B6 20 amp RFI/EMI general purpose common-mode filter. Controls line-to-ground noise. Small size, low leakage. 3.46" X 1.16" X 2.81". UL and CSA listed.
CAT# RF-201 \$8.50 each



HALL EFFECT SENSORS

Microswitch #SS41 Tiny, solid state switch reacts instantly to proximity of magnetic field. Operates at extremely high speeds, up to 100 khz. Case size: 0.12" X 0.17" X 0.06" thick. 4.5 Vdc to 24 Vdc supply voltage. 10 ma. sink type digital output. Operating gauss - 15 to 40. P.C. leads.
CAT# HESW-2 75¢ each
 10 for \$6.50 • 100 for \$60.00



SURFACE MOUNT STYLE

Sprague # UGN3075LT Operates on 4.5 - 24 Volts Can sink 10 ma. With suitable output pull up, can be used directly with bi-polar or CMOS logic circuits. Especially suited for electronic commutation in brushless D.C. motors using multiple ring magnets. Very tiny surface mount package 0.175" X 0.09" X 0.06" thick.
CAT# HESW-5 2 for \$1.00
 100 for \$45.00
LARGE QUANTITIES AVAILABLE



OPTO-SENSORS

GE H1381 U-shaped opto with 0.125" gap between emitter and sensor. 0.75" mounting centers.
CAT# OSU-11 2 for \$1.00



TRW/Optron # OPB5447-2 IR emitter/sensor pair in rectangular package with 28" color coded leads.
CAT# OSR-4 2 for \$1.00



ULTRASONIC CERAMIC MICROPHONE/TRANSDUCER

Panasonic (Matsushita) # EFR RCBK40K54 An ultrasonic microphone consisting of a bimorph type piezoelectric ceramic vibrator. Ideal for burglar alarms, auto door openers, flow rate detectors and remote control systems. Nom. Freq. 40kHz. Max input volts: 20 Volts. 15/16" dia. X 3/8" high. 5/8" long leads.
CAT# UST-1 \$1.00 each



HEAT SINK COMPOUND



G C Electronics # 10-8109 - For effective transfer of heat between components and heat sinks. Z9 silicone heat sink compound. **CAT# HSC-1 \$2.00 per 1 oz tube**

Highest Quality Metal Cassettes (Erased)

Premium quality metal tape in C-60 style cassettes (30 or more per side). One of the finest "brand-name" tapes on the market, in durable, clear plastic transport mechanisms. Recorded and bulk erased, the record-protect tabs have been removed and therefore, need to be taped over to re-record. Audiophiles will appreciate the wide dynamic range of this tape. If your cassette deck has a "metal" setting you will hear the difference. A real bargain! 60 min. tape - **CAT# C-600M \$1.25 each • 10 for \$10.00**

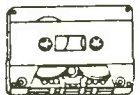

CASSETTE STORAGE CASE

Black, unbreakable plastic audio cassette storage case.
CAT# CBOX 5 for \$1.00 • 100 for \$15.00

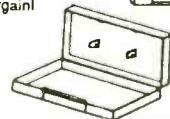

ORDER TOLL FREE 1-800-826-5432

FAX (818) 781-2653 • INFORMATION (818) 904-0524

Call Or Write For Our
Free 64 Page Catalog
 Outside the U.S.A. send \$2.00
 postage for a catalog.



Minimum Order \$10.00 • All Orders Can Be Charged To Visa, Mastercard Or Discovercard • Checks and Money Orders Accepted By Mail • California, Add Sales Tax • Shipping And Handling \$3.50 for the 48 Continental United States • All Others Including Alaska, Hawaii, P.R. And Canada Must Pay Full Shipping • Quantities Limited • No C.O.D. • Prices Subject to change without notice.



MAIL ORDERS TO: ALL ELECTRONICS CORP • P.O. BOX 567 • VAN NUYS, CA 91408

CIRCLE 7 ON FREE INFORMATION CARD

MULTIMEDIA ENCYCLOPEDIA

Jeff Holtzman's *Computer Bits* column titled "More on Hypertext" (*Popular Electronics*, July 1991) carried some mistaken impressions concerning the highly praised student reference, Compton's MultiMedia Encyclopedia. The multimedia work—cited by the American Library Association in May as one of 15 "Outstanding Reference Sources" among recent titles—is the compact-disc version of *Compton's Encyclopedia*. *Compton's Encyclopedia* has been a publication of Encyclopaedia Britannica, Inc., for 30 years and is a staple of the junior-senior high school market (among many other age groups).

Your reviewer cited no specifics in referring to the quality of articles. However, readers should know that Compton's recently has completed a six-year revision process that resulted in the editorial or graphic revision of more than 85% of the 26-volume work. The revision and

updating process continues, with additional editorial changes looming on the horizon. Compton's satisfies the unique information needs of upper elementary through high-school students, as well as adults. In both print and multimedia formats, it succeeds admirably in that latter mission, a point affirmed by the overwhelmingly positive reviews and the lengthening list of awards gleaned by Compton's MultiMedia.

Concerning Mr. Holtzman's technical comments, Compton's reflects a user interface that is designed to be friendly and attractive to non-technical persons. This has been borne out by the marketplace. The bit-mapped graphics mode was selected to make the use of graphics (and even a graphic

font) integral to the product.

At Compton's and Britannica, we believe that we are well on our way to fulfilling our goal of enhancing what is already the most advanced multimedia work.

Roald H. Haase
Manager, News Services
Encyclopaedia Britannica, Inc.
Chicago, IL

As I said in the article, basically I liked the CME, but more for its potential than its realization.

The user interface is built on a bit-mapped graphical substrate, but the latest user interface conventions, such as the operation of the scroll bars and windows, have been ignored, and there are numerous "gotcha's." For example, this message frequently appears at the bottom of

a screen: "Click 'Go On' when you are ready." The words "Go On" appear in a graphic icon, so it's reasonable to assume that you should click there—but no, there's another "Go On" icon in a bar on the bottom of the screen, and that's the one to click. I make the mistake frequently, as do several computer novices to whom I've shown the program. That message even appears on screen when there's no "Go On" icon in the control bar!

As for article quality, here's one objectionable sample from the definition of computer: "... computers process numbers, words, electrical pulses, and many other forms of information in specific ways that are especially useful to particular people and organizations." That

Train at HOME to be an Electronics Technician!

As the demand for computers and microprocessors in business, manufacturing and communications continues to grow, so does the need for qualified technicians. It's not unusual for experienced technicians to earn from \$30,000 to more than \$40,000 a year.* Now through Peoples College of Independent Studies you can train for this exciting field without interrupting your job or home life.

Choose From Five Programs of Study

- Electronics & Microprocessor Technology
- Industrial Electronics & Microprocessor Technology
- Communications Electronics with Microprocessor Technology
- Computer Servicing & Electronics Technology
- Specialized Associate Degree in Electronics Technology

Professional Equipment Is Included

Depending on the program you select, you'll perfect your skills using this advanced equipment, included in the price of tuition:

- IBM-Compatible Personal Computer
- Digital Multimeter
- Digital Logic Probe
- Elenco Oscilloscope
- Portable Cellular Telephone

(* Source: U.S. Bureau of Labor Statistics)



Exclusive Extras That Enhance Your Training

Peoples College introduces some training firsts to make your learning experience more complete:

- Accelerated Learning System — a scientifically proven study system that helps you learn faster and easier than ever before.
- Video Tutor Training Tapes — give you a permanent, visual record of informative lectures and close-up demonstrations.
- Experience Labs — professionally designed experiments that give you hands-on "bench" experience.
- Industry Certification Training Guide — provided with four of our programs. Prepares you for examinations you may take for your professional license or certification.

Easy Payment Plans — No Finance Charges

To help you get started on your education, Peoples College has reduced tuition rates and offers low monthly payment plans with no finance fees. So don't delay, call or write for more information today!

For COLOR CATALOG Mail Coupon or Call TOLL FREE 1-800-765-7247

Programs offered only in United States, Canada, Puerto Rico and Virgin Islands. No Obligation. No sales person will call.

Our programs are accredited by the Accrediting Commission of the National Home Study Council

YES! I would like to know more about your training programs. Send a catalog to:

Name _____
Address _____
City _____
State _____ Zip _____

Phone # _____
PEOPLES COLLEGE
OF INDEPENDENT STUDIES
233 Academy Drive • P.O. Box 421768
Kissimmee, FL 34742-1768
Member, D.L. Peoples Group E0192

CIRCLE 12 ON FREE INFORMATION CARD

www.americanradiohistory.com

might mean something to Mr. Haase, but I'm mystified.

On the other hand, I'm looking forward to the updated Windows version, a review of which will appear in these pages as soon as I receive a copy.—Jeff Holtzman

MUSIC-CIRCUIT MISTAKES

I hope everyone has a lot of fun building and using my "Super Simple Music Circuit" (Popular Electronics, November 1991). I'm sorry to say that I noticed two errors. U1 is priced at \$2 each plus shipping and handling, or five for \$11, postpaid. The Parts List mistakenly said six for \$11. I'm sorry for any inconvenience that this may have caused. A price change after the article was written created the confusion. The supplier has agreed to throw in a printed-circuit iron-on resist pattern as compensation for anyone who was inconvenienced by this.

Second, the PC pattern shown in Fig. 2 of the article had a break in one of the traces. The break is located on the left side of the board; if you compare the pattern to the parts-placement diagram, it is possible to see just where the break is.

For technical support or help in locating parts, send a self-addressed stamped envelope to Thumb Electronics at the address listed in the Parts List. They will forward all correspondence to me.

Mike Giamportone

LOOKING BACK

I just received my October issue of Popular Electronics, which contains Mr. Rybak's article, "How Wireless Got Its Voice." I was excited to see the article because, years ago, I was a "Commercial Brass Pounder" and worked for RCA Communications at their Tuckerton, NJ station. What is significant is the reference in the article to the early work done by Alexander-son on alternators designed to transmit "radio waves."

Well, to make what could be a long story short, Alexander-son (et. al.) pretty much perfected the alternator for RF transmission—at least for CW/Morse-code communications. At the station, I operated (among other things) a couple of those wonderful machines. Each alternator was capable of a transmitting (radiated) power of 200 kilowatts. Operating frequency was between 18 and 20

kHz. Feed current to the antenna system was around 200 amperes! The exact (assigned) frequency was maintained by a control loop that controlled the speed of the motor driving the alternator, to put it simply. After the alternator had been brought up to speed and "locked" into the control loop, frequency was checked by means of a hand-held tachometer shoved against the rotating shaft of the alter-

nator. The particular call letters for those two beauties were WCC and WGI. Those stations provided "ground wave" communications to Europe that were not affected by ionospheric "blockouts."

Anyway, the article was great, and (obviously) brought back a few good memories. Thank you, and keep up the fine work.

W.D.W.
Lafayette, CO

48 HOUR SHIPPING

ELenco & HITACHI PRODUCTS AT DISCOUNT PRICES

TO ORDER CALL TOLL FREE 1-800-292-7711

<h3>Hitachi RSO Series</h3> <p>(Portable Real-time Digital Storage Oscilloscopes)</p> <ul style="list-style-type: none"> VC-6023 - 20MHz, 20MS/s _____ \$1,095 VC-6024 - 50MHz, 20MS/s _____ \$1,995 VC-6025 - 50MHz, 20MS/s _____ \$2,195 VC-6045 - 100MHz, 40MS/s _____ \$2,995 VC-6145 - 100MHz, 100MS/s _____ \$4,495 <p>RSO's from Hitachi feature roll mode, averaging, save memory, smoothing, interpolation, pretriggering, cursor measurements. These scopes enable more accurate, simpler observation of complex waveforms. In addition to such functions as hardcopy via a plotter interface and waveform transfer via the RS-232C interface. Enjoy the comfort of analog and the power to digital.</p>	<h3>SPECIAL BUY</h3> <p>V-212 - 20MHz Scope \$425</p> <h3>Hitachi Portable Scopes</h3> <p>DC to 50MHz, 2-Channel, DC offset function, Alternate magnifier function</p> <ul style="list-style-type: none"> V-525 - CRT Readout, Cursor Meas. \$995 V-523 - Delayed Sweep _____ \$975 V-522 - Basic Model _____ \$875 V-422 - 40MHz _____ \$775 V-223 - 20MHz delayed sweep _____ \$695 V-222 - 20MHz deluxe _____ \$625 	<h3>HITACHI COMPACT SERIES SCOPES</h3> <p>This series provides many new functions such as CRT Readout, Cursor measurements (V-1085/1065A/855A), Frequency Cr. (V-1085), Sweep-time Autoringing, Delayed sweep and Trigger Lock using a 6-inch CRT. You don't feel the compactness in terms of performance and operation.</p> <ul style="list-style-type: none"> V-660 - 60MHz, Dual Trace _____ \$1,149 V-665A - 60MHz, DT, w/Cursor _____ \$1,345 V-1060 - 100MHz, Dual Trace _____ \$1,395 V-1065A - 100MHz, DT, w/Cursor _____ \$1,649 V-1085 - 100MHz, QT, w/Cursor _____ \$1,995 V-1100A - 100MHz, Quad Trace _____ \$2,195 V-1150 - 150MHz, Quad Trace _____ \$2,895 		
<h3>25MHz Elenco Oscilloscope</h3> <p>S-1325 \$349</p> <ul style="list-style-type: none"> • Dual Trace • 1mV Sensitivity • 6" CRT • X-Y Operation • TV Sync <p>• (2) 1x, 10x Probes Included</p>	<h3>PRICE BREAKTHRU</h3> <p>20MHz Digital Storage Oscilloscope</p> <ul style="list-style-type: none"> • Analog/Digital Scope _____ DS203 • 2K word per channel memory _____ \$795 • 10MS/s sampling rate • State-of-art technology • Includes probes 	<h3>Elenco 40MHz Dual Trace</h3> <p>Good to 50MHz \$495</p> <p>S-1340</p> <ul style="list-style-type: none"> • High Luminance 6" CRT • 1mV Sensitivity • 10KV Acceleration Voltage • 17ns Rise Time • X-Y Operation <p>• Includes (2) 1x, 10x Probes</p>		
<p>All scopes include probes, schematics, operators manual and 3 year (2 yrs for Elenco scopes) world wide warranty on parts & labor. Many accessories available for all Hitachi scopes. Call or write for complete specifications on these and many other fine oscilloscopes. 1x, 10x Scope Probes: P-1 65MHz \$19.95, P-2 100MHz \$26.95</p>				
<h3>B + K TEST EQUIPMENT</h3> <p>All Models Available</p> <p>Call for special price</p>	<h3>Digital Capacitance Meter</h3> <p>CM-1550B \$58.95</p> <p>9 Ranges 1pF-20,000f/d .5% basic acy. Zero control w/Case Big 1" Display</p>	<h3>Digital LCR Meter</h3> <p>LC-1801 \$125</p> <p>Measures: Coils 1uH-200H Caps .1pF-200uF Res .01-20M</p>	<h3>Multimeter with Capacitance & Transistor Tester</h3> <p>\$55 CM-1500B</p> <p>Reacts Volts, Ohms Current, Capacitors, Transistors and Diodes / with case</p>	<h3>FLUKE MULTIMETERS</h3> <p>All Models Available</p> <ul style="list-style-type: none"> Fluke 70-II _____ \$65 Fluke 77-II _____ \$145 Fluke 79-II _____ \$169 Fluke 87 _____ \$269 <p>Call for special price</p>
<h3>Quad Power Supply</h3> <p>XP-580 \$59.95</p> <p>2-20V @ 2A 12V @ 1A 5V @ 3A -5V @ .5A</p> <p>Fully regulated and short circuit protected</p>	<h3>Triple Power Supply</h3> <p>XP-620 Assembled \$69</p> <p>Kit \$45</p> <p>2 to 15V @ 1A, -2 to -15V @ 1A (or 4 to 30V @ 1A) and 5V @ 3A</p> <p>All the desired features for doing experiments. Features short circuit protection, all supplies</p>	<h3>AM/FM Transistor Radio Kit with Training Course</h3> <p>Model AM/FM 108 \$26.95</p> <p>14 Transistors • 5 Diodes Makes a great school project</p>	<h3>True RMS 4 1/2 Digit Multimeter</h3> <p>M-7000 \$135</p> <p>05% DC Accuracy 1% Resistance with Freq. Counter and Deluze Case</p>	
<h3>Soldering Station Temperature Controlled</h3> <p>SL-30 \$99</p> <p>Digital Display Temp. Range: 200F-800F Grounded Tip Overheat Protect</p>	<h3>Color Convergence Generator</h3> <p>SG-200 \$69.95</p> <p>Finest in the industry 10 rock steady patterns</p>	<h3>Four-Function Frequency Counters</h3> <p>F-100 120MH \$179</p> <p>F-1000 1.2GH \$259</p> <p>Frequency, Period, Totalize, Self Check with High Stabilized Crystal Oven Oscillator, 8 digit LED display</p>	<h3>Digital Triple Power Supply</h3> <p>XP-765 \$269</p> <p>0-20V at 1A 0-20V at 1A 0-5V at 5A</p> <p>Fully regulated, Short circuit protected with 2 limit control, 3 separate supplies XP-660 with Analog Meters \$195</p>	
<h3>GF-8016 Function Generator with Freq. Counter</h3> <p>\$249</p> <p>Sine, Square, Triangle Pulse, Ramp, .2 to 2MHz Freq. Counter: 1 - 10MHz Int'l operation</p> <p>GF-8015 without Freq. Meter \$179</p>	<h3>Function Generator Blox</h3> <p>#9600 \$28.95</p> <p>Provides sine, triangle, square wave from 1Hz to 1MHz AM or FM capability</p>	<h3>XX-500 Digital / Analog Trainer</h3> <p>A complete mini-lab for building, testing, prototyping analog and digital circuits. Elenco's Digital / Analog Trainer is specially designed for school projects, with 5 built-in power supplies. Includes a function generator with continuously variable, sine, triangular, square wave forms. All power supplies are regulated and protected against shorts.</p> <p>Power Supplies</p> <ul style="list-style-type: none"> • Variable Power Supply • +1.25 to 20VDC @ .5 Amp • (+1.25 to 15VDC @ 1 Amp) • -1.25 to -20VDC @ .5 Amp • (-1.25 to -15VDC @ 1 Amp) • +12VDC @ 1 Amp • +5VDC @ 1 Amp • 30VAC Center tapped @ 15VAC @ 1 Amp <p>Analog Section</p> <ul style="list-style-type: none"> • Function Generator Sine, Triangular, Square wave forms • Frequency adjustable in five ranges from 1 to 100kHz • Fine frequency adjust • Amplitude adjust • DC offset • Modulation Freq AM <p>Digital Section</p> <ul style="list-style-type: none"> • Eight data switches • Two no bounce logic switches • Eight LED readouts TTL buffered • Clock frequency 1 to 100kHz • Clock amplitude 5VPP square wave <p>Breadboards</p> <ul style="list-style-type: none"> • 2 breadboards, each contain: 840 tie points (total 1,680) 		
<h3>Learn to Build and Program Computers with this Kit</h3> <p>Includes: All Parts, Assembly and Lesson Manual</p> <p>Model MM-8000 \$129.00</p> <p>Starting from scratch you build a complete system. Our Micro-Major trainer attaches you to write into RAM, ROM and run a 6805 microprocessor, which uses simple machine language as IBM PC.</p>	<h3>Wide Band Signal Generators</h3> <p>SG-9000 \$129</p> <p>RF Freq 100K-450MHz AM Modulation of 1KHz Variable RF output</p> <p>SG-9500 w/ Digital Display & 150 MHz built-in Counter \$249</p>	<div style="text-align: center;">  <p>\$149.95 Assembled \$119.95 Kit</p> </div>		
<p>WE WILL NOT BE UNDERSOLD!</p> <p>UPS Shipping: 48 States 5% (\$3 Min \$10 Max) Shipping IL Res., 7.5% Tax FAX: 708-520-0085</p>				
<h2>C & S SALES INC.</h2> <p>1245 Rosewood, Deerfield, IL 60015 (800) 292-7711 (708) 541-0710</p>				
<p>15 Day Money Back Guarantee 2 Year Warranty Price Subject to Change WRITE FOR FREE CATALOG</p>				
<p>CIRCLE 5 ON FREE INFORMATION CARD</p>				

ELECTRONICS LIBRARY

Que's Macintosh Multimedia Handbook

by Tony Bove & Cheryl Rhodes

One of the hottest trends in consumer electronics today is multimedia, defined by the authors of this book as "a project or application that uses text, graphics, sound, animation, and video to describe information." The Macintosh computer, designed to be intuitive and easily understood by graphically oriented people, is particularly well-suited for multimedia. Multimedia (and desktop publishing)

software, including desktop publishing, graphics, slides, animation, sound, and desktop video. Organized according to the activities required to put together a multimedia project or publication, the book starts off with tasks that require little or no specialized skills, and progresses through increasingly sophisticated applications. The book explains how to choose the right medium for specific presentations; develop dynamic charts, graphs, and tables; create 3-D graphics; conduct multimedia presentation programs; record and edit audio tracks; and create real-time animation and commercial videos. At each stage, step-by-step instructions and real-world examples are provided. The book explores the various media categories, reviews each category's most popular software, and provides tips and strategies for producing dramatic presentations. Also included is a discussion on the use of HyperCard as a desktop media tool.

Que's Macintosh Multimedia Handbook costs \$24.95 and is published by Que, 11711 North College Avenue, Suite 140, Carmel, IN 46032; Tel: 1-317-573-2500.

CIRCLE 81 ON FREE INFORMATION CARD

1991 ELECTRICAL/HVAC-R: SERVICE EQUIPMENT CATALOG

from John Fluke Mfg. Co. Inc.

This 15-page catalog features an extensive line of Fluke multimeters, thermometers, and accessories for the electrical service industry. Highlighted is the new Fluke 20 Series II family of digital multimeters, which retain the features found in the original line of meters

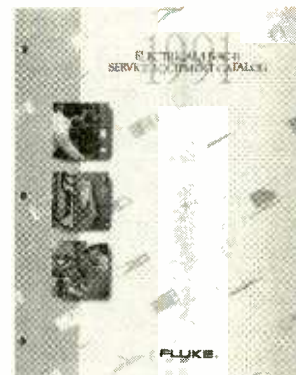

while adding increased accuracy and measurement capability. The catalog also provides descriptions and photos of the model 70 analog/digital multimeter, the 80 Series handheld DMM's, and the 51/52 digital thermometers. Several selection guides for the products and accessories are provided to help users make the right choices.

The 1991 Electrical/HVAC-R Service Equipment Catalog is available free of charge from electrical wholesalers nationwide, and further information is available from John Fluke Mfg. Co., Inc., P.O. Box 9090, Everett, WA 98206; Tel: 800-44-FLUKE.

CIRCLE 82 ON FREE INFORMATION CARD

A CONCISE USER'S GUIDE TO LOTUS 1-2-3 RELEASE 3.1

by N. Kataris & P.R.M Oliver

Written for those who are already using spreadsheets on their personal computers, this book explains how to upgrade to Lotus 1-2-3 Release 3.1. Depending on your current level of expertise, you can pick and choose which chapters to read. The more experienced user can start from any section, as each is self-contained. The book describes the basics: how to set

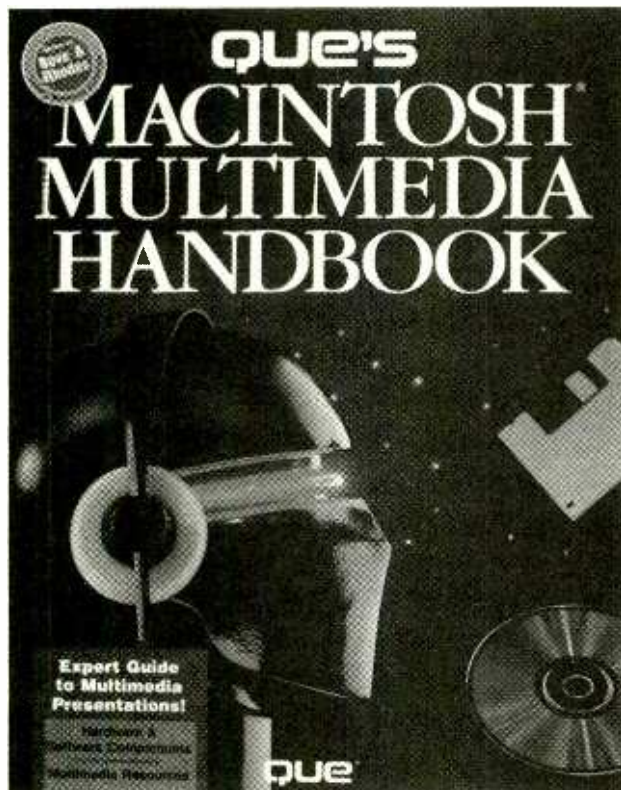

use graphical icons to represent information, and information is edited using the appropriate on-screen graphics.

This book (which was entirely written, edited, and produced on Macintosh computers) helps users transform their Mac's into media-presentation masters. It guides users through all aspects of Macintosh media

Why take chances in today's job market?

Graduate as a fully trained electronics professional.

To get ahead and stay ahead in today's economy, you need the electronics training CIE has been providing its 150,000-plus successful graduates with for nearly 60 years.

Meet the Electronics Specialists.

When you pick an electronics school, you're getting ready to invest time and money. And your whole future depends on the education you receive in return. That's why it makes so much sense to go with number one... with the specialists... with CIE!

There's no such thing as a bargain education.

If you talk to some of our graduates, and we recommend you do, chances are you'd find a lot of them shopped around for their training. Not for the lowest priced, but for the best training available. They pretty much knew what was available when they picked CIE as number one.

Because we're specialists we have to stay ahead.

At CIE we have a position of leadership to maintain. Here are just a few of the ways we hang onto it...

Programmed Learning.

That's exactly what happens with CIE's Auto-Programmed Lessons®. Each lesson uses famous "programmed learning" methods to teach you important electronics principles. You explore them, master them completely, before you start to apply them. You thoroughly understand each step before you go on to the next. You learn at your own pace.

And, beyond theory, some courses come fully equipped with electronics equipment to actually let you perform hundreds of hands-on experiments.

Experienced specialists work closely with you.

Even though you study at home, CIE's faculty and staff stand ready to assist via CIE's toll free number. And, each time you return a completed exam you can

be sure it will be reviewed, graded and returned with the appropriate instructional help, you get it fast and in writing from the faculty technical specialist best qualified to answer your question in terms you can understand.

Pick the pace that's right for you.

CIE understands people need to learn at their own pace. There's no pressure to keep up...no slow learners hold you back. If you're a beginner, you start with the basics. If you already know some electronics, you move ahead to your own level.

"Same Day" grading cycle.

When we receive your lesson, we grade it and mail it back the same day. You find out quickly how well you're doing!

State-of-the-art laboratory equipment.

Some courses feature the CIE Microprocessor



Training Laboratory. An integral part of computers, microprocessor technology is used in many phases of business, including service and manufacturing industries. The MTL gives you the opportunity to program it and interface it with LED displays, memory devices and switches. You'll gain all the experience

needed to work with state-of-the-art equipment of today and tomorrow.

New Courses!

CIE now offers two new career courses: Automotive Electronics and Computer Operation and Programming.

CIE offers you an Associate Degree.

One of the best credentials you can have in electronics — or any other career field — is a college degree. That's why CIE offers an Associate in Applied Science in Electronics Engineering Technology. And all CIE career courses earn credit toward your degrees.

Which CIE training fits you?

Beginner? Intermediate? Advanced? CIE home study courses are designed for ambitious people at all entry levels. People who have: No previous electronics knowledge, but do have an interest in it; Some basic knowledge or experience in electronics; In-depth working experience or prior training in electronics.

At CIE you start where you fit and feel comfortable where you start, then go on from there to your Diploma, Associate Degree and career!

Today is the day. Send now.

Fill in and return the postage-paid card attached. If some ambitious person has already removed it, cut out and mail the coupon below. You'll get a FREE CIE school catalog, plus complete information on independent home study. Mail in the coupon below or, if you prefer, call toll-free 1-800-321-2155 (in Ohio, 1-800-523-9109).

YES! I want to get started. Send me my CIE school catalog including details about the Associate Degree program. (For your convenience, CIE will have a representative contact you — there is no obligation.) **AH24**

Print Name _____

Address _____ Apt. _____

City _____ State _____ Zip _____

Age _____ Area Code/Phone No. (____) _____

Check box for G.I. Bulletin on Educational Benefits Veteran Active Duty

CIE CLEVELAND INSTITUTE OF ELECTRONICS, INC.
1776 East 17th Street • Cleveland, Ohio 44114 • (216) 781-9400



A school of thousands.
A class of one.
Since 1934.

up a database management system, sort and search a database, and extract and modify commands to query and edit the information held in a database. It explains how to generate and manipulate 3-dimensional worksheets and how to link different files together. It describes how to generate and add graphs to a worksheet, edit them, and then preview and print the worksheet. Macros are covered in detail, including how to create and use both macros and customized menus, use macro key words, and debug a macro. All of the Lotus 1-2-3 Release 3.1 indicators, functions, and macro commands are listed.

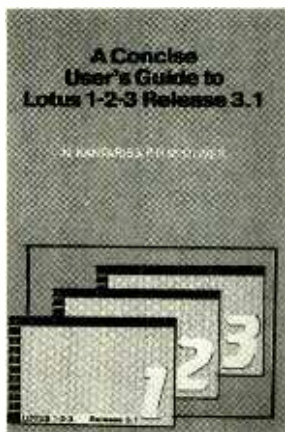

A Concise User's Guide to Lotus 1-2-3 Release 3.1 (order no. BP302) is available for \$8.75 (including shipping and handling) from Electronics Technology Today Inc., P.O. Box 240, Massapequa Park, NY 11762-0240.

CIRCLE 97 ON FREE INFORMATION CARD

HANDBOOK OF ELECTRONICS TABLES AND FORMULAS: Sixth Edition

compiled and edited by the Howard W. Sams Engineering Staff

Anyone with an interest—either professional, educational, or hobby—in electronics needs a terrific memory, or a ready reference to mathematical tables and formulas. This book contains a wealth of data, compiled in one handy volume. It includes formulas and laws used in all branches of electronics; hard-to-remember constants and

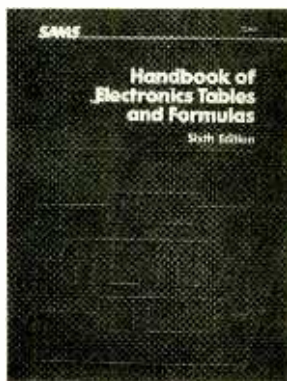

government- or industry-established standards; symbols and codes; service and installation data; data used in service design work; computer programs to simplify the calculations of electronics formulas; and general information such as conversions for weights and measures, a table of the elements, and temperature scales. An emphasis is placed on clearing up common misconceptions. For instance, the book presents the volt as a unit of work or energy rather than as a unit of electrical pressure or force, and it clearly distinguishes between the physical movement of a free electron and the guided-wave motion produced by the electron's field. New to this edition are sections on op-amps, resistor and capacitor color codes, laws of heat flow in transistors, and more.

Handbook of Electronics Tables and Formulas: Sixth Edition costs \$19.95 and is published by Howard W. Sams & Co., 4300 West 62nd Street, Indianapolis, IN 46268; Tel: 800-428-SAMS.

CIRCLE 95 ON FREE INFORMATION CARD

WORLD SATELLITE TV AND SCRAMBLING METHODS: The Technician's Handbook, Second Edition

by Frank Baylin, Richard Maddox, and John McCormac

Written for technicians, satellite professionals, and curious do-it-yourselfers, this book (which is intended as a companion volume to *Ku-Band Satellite TV: Theory, Installation, and Repair*) explores all components of home satellite systems from the perspective of a technician who

wants to understand their design, operation, and repair. Almost a third of the book is devoted to an in-depth study of broadcast formats including NTSC, PAL, SECAM, and MAC; digital audio; and basic scrambling and encryption methods. That material provides a background to a discussion of all current American and European satellite-TV technologies including the VideoCipher II and II+, Oak Orion, RITC, IRDETO, FilmNet, Sky Channel, VideoCrypt, and others. That is followed by chapters on troubleshooting and setting up a



test bench. Detailed illustrations accompany the advice on testing, servicing, and tuning, and more than 200 photos, diagrams, tables, and wiring schematics appear in the book's 352 pages. The revised second edition has been updated to include information on Smart Cards, duobinary encoding, and the VideoCipher II and II+ and SCART connectors. In addition, circuit descriptions of the GI 2400R and the Sakura receivers have been added, along with updates on scrambling systems such as VideoCrypt.

World Satellite TV and Scrambling Methods: The Technician's Handbook, 2nd edition, is available for \$40.00 plus \$3.00 for shipping and handling from Baylin Publications, 1905 Mariposa, Boulder, CO 80302.

CIRCLE 83 ON FREE INFORMATION CARD

GETTING HELP BY CB RADIO

from REACT International, Inc.

Citizen's band radio isn't just for chatting on the road to avoid construction, accidents, and

speed traps. It is also used for safety. Channel 9 is dedicated solely to emergency transmissions and is monitored by many police forces, REACT teams, and rescue services. It can be a life-saver in the event of severe weather conditions, car accidents, and other emergencies—if you know how to use it properly. To teach CB users the correct procedure for making emergency broadcasts on Channel 9 or other channels, REACT has prepared this safety leaflet. It outlines the four essential items that form the "CLIP" rule: You must provide precise information including Call sign or other identification, Location, Injuries, and Problem. The leaflet also explains how to broadcast your "CLIP" message most effectively.

Getting Help by CB Radio is available by sending a \$2.00 donation and a self-addressed stamped envelope to REACT Info, P.O. Box 998, Wichita, KS 67201.

CIRCLE 84 ON FREE INFORMATION CARD

ELECTRONIC CIRCUITS, SYSTEMS & STANDARDS

edited by Ian Hickman

Since 1956, *EDN* magazine has been widely read by electronics engineers, who have appreciated the useful information it presents on components, equipment, circuits, systems, and standards. This book is a collection of articles that have

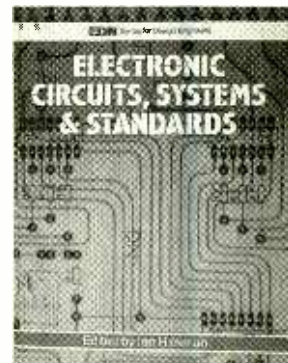

appeared in *EDN* over the past 35 years. The selection reflects the editor's interests as a long-standing analog circuit design engineer, but there's no skipping digital subjects either. The range of topics is diverse, in-

cluding articles in the areas of standards, tests and measurements, radio frequency, software and algorithms, systems, and power supplies. The articles are carefully cross-referenced and are indexed by subject to make the book easier to use.

Electronic Circuits, Systems & Standards costs \$32.95 and is published by Butterworth-Heinemann, 80 Montvale Avenue, Stoneham, MA 02180; Tel: 1-800-366-BOOK.

CIRCLE 85 ON FREE INFORMATION CARD

WORLD PRESS SERVICES FREQUENCIES Fifth Edition

by Thomas Harrington, W80MV

Containing comprehensive, up-to-date lists of world-wide radio teletype (RTTY) news stations, this book helps readers to locate and listen to news broadcasts from stations around the world, and receive uncensored and unedited information



faster than from local news sources. The station lists are provided in three formats: by transmitting time, by frequency order, and by country and press service. Besides the lists, the book contains other information valuable to those who enjoy monitoring RTTY news. It offers information intended to help you select antennas, receivers, video monitors, printers, and terminal units, including photographs and descriptions of many units currently on the market, and an explanation of the requirements that each piece of equipment should meet. The

book also provides an introduction to radioteletype world press services, explanations of how to effectively use the frequency lists, and other information to facilitate monitoring those stations. It includes information on RTTY reception, utility stations, codes used in RTTY, times of transmission, locations of stations, and shift and speed of transmission. In addition, the book provides a receiving log

for keeping track of all of your monitoring activities, and a convenient time-conversion chart.

World Press Services Frequencies, Fifth Edition costs \$8.95 and is published by Universal Electronics, Inc., 4555 Groves Road, Suite 13, Columbus, OH 43232; Tel: 614-866-4605; Fax: 614-866-1201.

CIRCLE 86 ON FREE INFORMATION CARD

THE FCC RULE BOOK: A Guide to the FCC Regulations

edited by Richard K. Palm, K1CE

As the complexity of communications technology has increased, the Federal Communications Commission's rules governing the use of that technology have kept pace—resulting in a huge amount of

Kepro Gets You Started! With Complete PCB Kits.

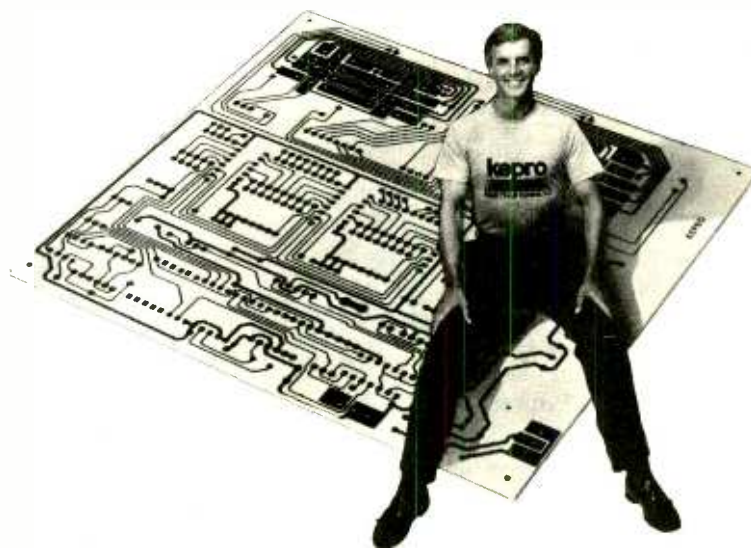

Get that electronic construction project started with professional-quality PCB's that you can make at home. Kepro makes it easy to produce your own etched circuit boards with all the quality materials and step-by-step instructions you'll need. Hobbyists really go for our complete kits for:

- Dry film photoresist
- Resist etched circuits
- Art layout
- Photo reversing
- Screen printing
- Nameplates
- And more

All Kepro products are easy to use and come with an unconditional guarantee. Call us for more information and to get your **FREE booklet** on how you can get started making your own PCB's with Kepro products.

**1-800-325-3878
1-314-343-1630 (St. Louis)**



630 AXMINSTER DRIVE • FENTON, MISSOURI 63026-2992

CIRCLE 6 ON FREE INFORMATION CARD

Earn Your B.S. Degree in ELECTRONICS or COMPUTERS



By Studying at Home

Grantham College of Engineering, now in our 41st year, is highly experienced in "distance education"—teaching by correspondence—through printed materials, computer materials, fax, and phone.

No commuting to class. Study at your own pace, while continuing on your present job. Learn from easy-to-understand but complete and thorough lesson materials, with additional help from our instructors.

Our Computer B.S. Degree Program includes courses in BASIC, PASCAL and C languages — as well as Assembly Language, MS DOS, CADD, Robotics, and much more.

Our Electronics B.S. Degree Program includes courses in Solid-State Circuit Analysis and Design, Control Systems, Analog/Digital Communications, Microwave Engr, and much more.

An important part of being prepared to *move up* is holding the right college degree, and the absolutely necessary part is knowing your field. Grantham can help you both ways—to learn more and to earn your degree in the process.

Write or phone for our free catalog. Toll free, 1-800-955-2527, or see mailing address below.

•
Accredited by
the Accrediting Commission of the
National Home Study Council
•

GRANTHAM
College of Engineering
Grantham College Road
Slidell, LA 70460

"legaleze" that's quite difficult for the average person to comprehend. If you're into amateur radio, however, understanding those regulations is crucial to your hobby. This book, newly revised and covering FCC activities through mid-1991, contains complete FCC rules with plain-language explanations. It includes the regulations concerning the new codeless amateur license and the recent changes in handicapped testing procedures. In addition, the book provides other useful and interesting information. It explains how FCC rules are made, and how you can have a voice in the process. On a historical note, the Communications Act of 1934, which, five decades later, still governs all U.S. telecommunications, is discussed. Also covered are international agreements that have an effect on your amateur radio operations, a list of countries permitting third-party traffic with the U.S., diagrams and explanations of the U.S. amateur bands, and call-sign assignments. The various classes of license, and the requirements and testing procedures for each, are covered. Pictures, photographs, and boxed text containing common questions and answers accompany the text.

The FCC Rule Book: A Guide to FCC Regulations costs \$9.00 and is published by the American Radio Relay League, 225 Main Street, Newington, CT 06111.

CIRCLE 87 ON FREE INFORMATION CARD

TANDY 1992 COMPUTER REFERENCE GUIDE

from Radio Shack

Radio Shack's full lines of computer hardware and software are described in detail in this 63-page catalog, along with computer-related accessories, books, and videos. Some highlights include the high-speed Tandy 486 Server Series PC's, the affordable 386SX-based 2500 SX, and an award-winning line of Multimedia PC's. For computerized home automation, the catalog features the Plug'n Power interface and DeskMate Automatic House software. Also

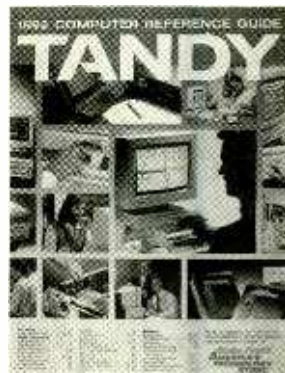

included in the catalog are the CDR-1000 CD-ROM drive; internal IDE and SCSI hard drives, notebook computers; and CD-ROM titles for entertainment, education, productivity, and business use.

The Tandy 1992 Computer Reference Guide is free upon request from Radio Shack stores and Computer Centers nationwide. For more information, contact Radio Shack, 700 One Tandy Center, Fort Worth, TX 76102.

CIRCLE 88 ON FREE INFORMATION CARD

DAT: THE COMPLETE GUIDE TO DIGITAL AUDIO TAPE

by Delton T. Horn

With the popularity of the compact disc, American consumers have become accustomed to the benefits of digital audio—low distortion, wide dynamic range, flat frequency response over a wide range, and low noise. Yet anyone who enjoys making their own recordings has been limited to doing so on analog audio-cassette tapes, until the recent advent of DAT, or digital audio tape. After years of promises, delays, and legal problems over copyrights, DAT recorders have hit the American market.

This book serves two purposes: It explains the historical and technical background of DAT, and it presents a roundup of available (and soon-to-be-available) DAT equipment. The book opens with a brief history of sound recording beginning with Edison's cylinder phonograph. It continues with a look at the theory and principles behind analog recording and a discussion of the basics of digital recording. The specifics of

the DAT format, as well as the legal issues that have delayed the introduction of DAT equipment, are covered. In terms of actual products, the book examines several specific units and then provides tips on maintenance and troubleshooting. Finally, the book describes the other formats that are DAT's competitors in the digital-audio marketplace.

DAT: The Complete Guide to Digital Audio Tape costs \$12.95 and is published by TAB Books, Division of McGraw-Hill Inc., Blue Ridge Summit, PA 17294-0850; Tel: 1-800-822-8138.

CIRCLE 96 ON FREE INFORMATION CARD

TEST INSTRUMENTS: ANALOG & DIGITAL

from *Simpson Electric Company*

This fully illustrated catalog details Simpson's extensive lines of handheld and benchtop multimeters, special function meters, clamp-on testers, and other specialized testers for electrical, electronic, and environmental applications. Included are special-function ohmmeters, voltmeters, and ammeters; insulation and temperature testers; testers for microwave and AC-current leakage; sound- and noise-



measurement instruments; and telephone industry test sets. One section of the catalog is devoted to a complete line of instrument test probes, cables, and test lead kits. Also described are protective cases that are tailored for individual instrument models. To assist the user, the catalog provides capsule descriptions of each model along with lists of features and ordering information for more than 50 models. Complete

specifications and operating range data are provided, along with a five-page summary of specifications and ranges. The summary data is organized by instrument type to help the reader make comparisons.

Test Instruments: Analog & Digital (catalog 5700-TE) is free upon request from *Simpson Electric Company*, 853 Dundee Avenue, Elgin, IL 60120-3090; Tel: 708-697-2260; Fax: 708-697-2272.

CIRCLE 89 ON FREE INFORMATION CARD

VIDEO & VIDEO EDITING "HOW-TO" BOOK

from *Chalange Sales and Mfg.*

To support the growing interest in do-it-yourself video productions, this book provides answers to common questions

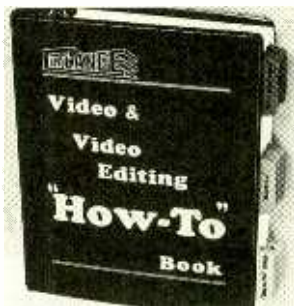

about each step of the video process. Its 524 pages come in a three-ring binder with tabs labeling the ten main sections. The book covers such areas as video editing and video-editing equipment, using VCR's and camcorders, proper connections for editing systems, and testing your set-up. It describes both the basics of copying and editing videos, and sophisticated editing techniques including audio enhancement and special effects. The book explains how to make affordable video school year books, training tapes, wedding videos, travel tapes, and home videos. Several chapters are devoted to descriptions of Chalange's own line of video-editing systems.

Video & Video Editing "How-To" Book costs \$49.95 and is published by *Chalange Sales and Mfg.*, P.O. Box 31086, St. Louis, MO 63131; Tel: 314-821-3711.

CIRCLE 90 ON FREE INFORMATION CARD

Safety, Security, Convenience, Entertainment and Energy Management

Home Automation from Heath, the catalog that has it all...

Enter the world of Home Automation. Remote lighting and appliance controls. Security alarms and lighting. Automated thermostats. Video monitoring systems. Whole-house security systems. They're all yours in the Heath Home Automation Catalog. To receive your FREE copy, call today toll-free.

1-800-44-HEATH
(1-800-444-3284)

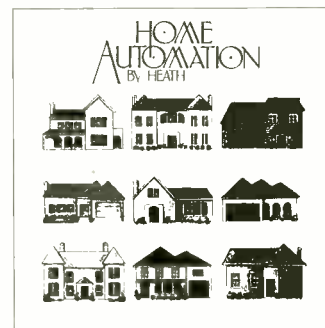

Heath Company

Marketing Dept. 107-130
Benton Harbor, MI 49022

CL-807R1

CIRCLE 15 ON FREE INFORMATION CARD

NEW PRODUCTS

8mm Camcorder

The top-of-the-line 8mm camcorder from Ricoh, the model R-105, features stereo sound, 10x power-zoom lens, infrared focusing, variable zoom control, and a sports finder for long-distance viewing. With the automatic power-zoom lens, which allows manual override, and an 8-80mm f/1.6 precision zoom lens, the camcorder has an extremely wide range. The lens focuses from 0.4 inches to 3.9 feet in macro for small subjects, and from 3.9 feet to infinity in autofocus for detailed closeups or wide-angle framing. The vari-



able two-speed zoom control allows smooth zooms at fast or slow speed. Images are recorded in lighting conditions as dim as 2 lux. The R-105's programmed auto-exposure has two special settings that automatically adjust the shutter speed when shooting portraits (portrait mode) and active subjects (sports mode).

The age/event feature lets the user store and superimpose up to three dates, such as the birth dates of three children. By pre-setting a starting date, you can record elapsed time in years and months to document your child's development and activities over the years. Once a date is entered, the R-105 automatically calculates and shows

the correct age when the mode is activated during recording. An 18-function wireless remote control operates many of the camcorder's record and playback functions from a distance of up to 16 feet.

A quick-connect AC adapter/battery charger with built-in A/V output contacts lets you semi-permanently connect the AC adapter to a TV or VCR via audio and video cables or the supplied RFU adapter. When the adapter is then attached to the camcorder, special built-in contacts simultaneously connect the camcorder's A/V outputs to the charger outputs. That eliminates the need to re-connect each of the camcorder's A/V outputs every time you want to play back through your television. The R-105 has four connector outputs, one each for video and mono audio and a pair (right and left) for stereo audio.

Other features include the ability to fade to or from black, along with fading sound in or out; two directional scrolling for scrolling superimposed titles in any of eight colors; six programmable shutter speeds, in-camera editing, and noiseless still and slow motion during playback.

The R-105 8mm camcorder has a suggested retail price of \$1699. For more information, contact Ricoh Consumer Products Group, 180 Passaic Avenue, Fairfield, NJ 07004.

CIRCLE 101 ON FREE INFORMATION CARD

LOW ELECTROMAGNETIC EMISSION MONITOR

In response to a growing awareness of the possible health hazards associated with monitor emissions, Philips has introduced the *Magnavox Super-VGA/LE* color monitor, which complies with the latest (1990) Swedish MPR2 VCT recommendations for electromagnetic emissions in

the very low frequency (VLF) and extremely low frequency (ELF) bands. The CRT also has a special coating to bleed off the electrostatic field.

The Super VGA/LE is a triple-format, analog, color display

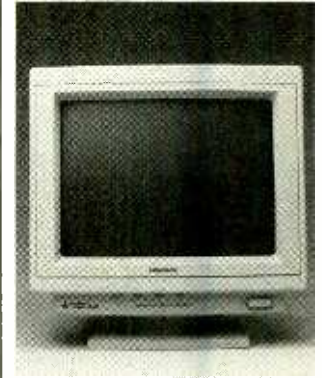

that automatically adjusts the scanning frequency to support IBM VGA, Super VGA, 8514/A, and XGA display modes. It has a maximum display resolution of 680 x 480 in VGA, 800 x 600 in Super VGA, and 1024 x 768 (interlaced) in 8514/A. The monitor uses an advanced 14-inch 0.28mm CRT for fine pitch image quality, and boasts a 50,000-hour mean time before failure, which is about twice as long as other Super-VGA models on the market. Its autoranging power supply allows the Super VGA/LE to be operated in any location worldwide.

The Super VGA/LE monitor, complete with an analog VGA cable that allows connection to a standard VGA connector, has a suggested retail price of \$799. For more information, contact Philips Consumer Electronics Company, One Philips Drive, P.O. Box 14810, Knoxville, TN 37914-1810.

CIRCLE 102 ON FREE INFORMATION CARD

DIGITAL MULTIMETERS

Designed for three types of users—the electronics repairperson, the electrical

SELECT 5 BOOKS for only \$4⁹⁵

(values to \$133.75)



2613P \$17.95

Your most complete source for electronics books for over 25 years.



3632 \$18.95



3804P \$19.95



2947P \$13.95

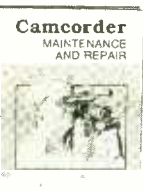

3157P \$16.95

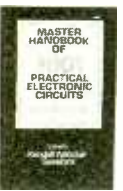

2980P \$19.95



3460 \$22.95



3374P \$16.95

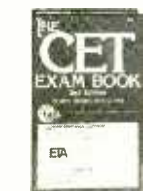

2950P \$13.95



3414 \$39.95
Counts as 2



3274 \$25.95
Counts as 2

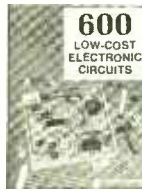

3219 \$27.95
Counts as 2



10018 \$39.95
Counts as 2

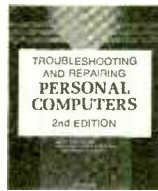

3677 \$34.95
Counts as 2

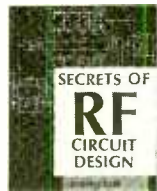

3710 \$32.95
Counts as 2



2883P \$18.95



2867P \$18.95

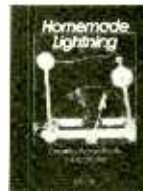

3576P \$14.95



3778 \$26.95



3627 \$29.95
Counts as 2

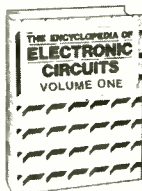

1938 \$60.00
Counts as 3

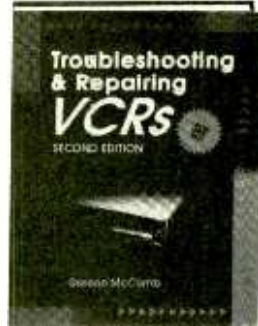

3777 \$32.95
Counts as 2



3485 \$27.95

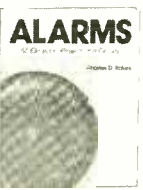

2996P \$14.95



3262P \$17.95



3531 \$26.95



2728P \$9.95



2887 \$16.95



3672 \$28.95
Counts as 2



3258 \$28.95
Counts as 2



2880P \$14.95



585928-9 \$24.95

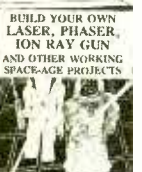

1604P \$17.95



2800P \$16.95

Membership Benefits • Big Savings. In addition to this introductory offer, you keep saving substantially with members' prices of up to 50% off the publishers' prices. • **Bonus Books.** Starting immediately, you will be eligible for our Bonus Book Plan, with savings of up to 80% off publishers' prices. • **Club News Bulletins.** 15 times per year you will receive the Book Club News, describing all the current selections—mains, alternates, extras—plus bonus offers and special sales, with scores of titles to choose from. • **Automatic Order.** If you want the Main Selection, do nothing and it will be sent to you automatically. If you prefer another selection, or no book at all, simply indicate your choice on the reply form provided. You will have at least 10 days to decide. As a member, you agree to purchase at least 3 books within the next 12 months and may resign at any time thereafter. • **Ironclad No-Risk Guarantee.** If not satisfied with your books, return them within 10 days without obligation! • **Exceptional Quality.** All books are quality publishers' editions especially selected by our Editorial Board.

PE192



3358 \$28.95
Counts as 2



10024 \$32.95
Counts as 2



2925P \$9.95



3738 \$26.95

©1992 ELECTRONICS BOOK CLUBSSM
A shipping/handling charge and sales tax will be added to all orders.

If card is missing, use this address to join:
ELECTRONICS BOOK CLUB, Blue Ridge Summit, PA 17294-0810

All books are hardcover unless number is followed by a "P" for paperback. (Publishers' Prices Shown)

troubleshooter, and the price-conscious general-purpose user—Fluke's Series 10 family of multimeters includes three low-priced, durable, multifunction units. The simplest one, *Model 10*, has the basic features needed to locate the vast majority of hard faults and to do first-line checks of AC and DC volts, continuity, diodes, and resistance. The *Model 11* adds capacitance-measuring ability with guaranteed specifications from 0.001 to 400 μF , and up to 9999 μF with a typical specification. *Model 11* also features Fluke's exclusive "V-Chek" function, an extension of the ohms/continuity position. The user simply turns the meter on, sets it to V-Chek, probes the power source or supply, and the meter automatically tells if the circuit is open, continuous, or if voltage is present. If voltage greater than 4.5 volts is detected, the meter will switch from continuity/ohms to volts, and display either AC or DC volts, whichever is greater. The low

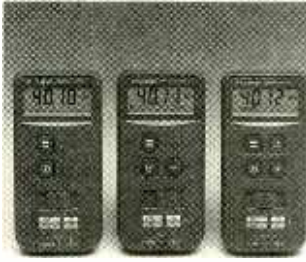

2k input impedance also allows the user to distinguish "real" voltage from false readings resulting from "ghosting" due to leakage.

The *Model 12* is intended for the more skilled service technician who needs to service difficult and intermittent problems. *Model 12* adds to the features of *model 11* min/max recording mode with a relative time clock. The min/max function records the highest and lowest voltages, and the meter's internal clock records the time when the minimum and maximum occurred during a 100-hour period. In addition, when the recording mode is activated

in the continuity position, the *model 12* will capture and provide a symbolic display of opens or shorts as brief as 250 μs .

Accessories for the Series 10 family include a holster with tilt-stand and a padded soft case. The DMM's are compatible with a wide range of Fluke test leads and temperature-measurement devices.

The *Model 10*, *Model 11*, and *Model 12* digital multimeters cost \$69.95, \$79.95, and \$89.95, respectively. For more information, contact John Fluke Mfg. Co., Inc., P.O. Box 9090, Everett, WA 98206.

CIRCLE 103 ON FREE INFORMATION CARD

PC TROUBLESHOOTING KIT

Making easy work of PC troubleshooting, *Sibex's PC Fixer* is a combination hardware and software tool that locates problems on the computer's motherboard, drives, display,

memory, and more. Developed for general computer users, but comprehensive enough for repair technicians, PC fixer comes with a detailed, easy-to-read manual. A step-by-step method of diagnosing and fixing computer problems is presented. The kit contains a circuit card that is used to test main board problems. Once the



card is installed in the computer, it displays the internal test codes as the computer powers up. In case of a problem, a fault code appears on the digital display. By looking up the code in the manual, the user can determine what the problem is and how to fix it. Also included is a diagnostic software package. The menu-driven program runs its test sequence automatically, and displays the results for easy interpretation. The PC Fixer can be used to test power-supply voltages, disk drives and controllers, serial and parallel ports, internal clocks, monitors, coprocessors, main-board components, keyboards, memory, and video drivers.

The PC Fixer diagnostic kit costs \$119. For additional information, contact Sibex Inc., 1040 Harbor Lake Drive, Safety Harbor, FL 34695; Tel: 813-726-4343; Fax: 813-726-4434.

CIRCLE 104 ON FREE INFORMATION CARD

SPEAKERPHONE/INTERCOM SYSTEM

Intecom's Telebel communications device turns an ordinary pushbutton telephone into a multi-use communications/control device. The device features an electronic telephone convert-

SUPER LONG PLAY TAPE RECORDERS

12 Hour Model — USES 120 TAPE \$119.00*

Modified Panasonic Simline, high quality AC-DC provide 6 continuous hours of quality recording & playback on each side of cassette for 12 hours total. Includes • Voice level control • Digital counter, etc. TDK - 120 Cassette Furnished



PHONE RECORDING ADAPTER

Records calls automatically. All solid state connects to your telephone jack and tape recorder. Starts recording when phone is lifted. Stops when you hang up.

\$28.50* FCC APPROVED

VOX VOICE ACTIVATED CONTROL SWITCH

Solid state. Self contained. Adjustable sensitivity. Voices or other sounds automatically activate and control recorder. Uses either recorder or remote mike.

\$28.50*

* Add for ship. & handling Phone Adapter & Vox \$2.00 each Recorders \$5.00 each, Calif. Pres. add tax. Mail order VISA M/C, CDD's OK Money Pack Guarantee Free data available. Dealer Inquiries Invited

AMC SALES INC. Dept. B 4935 Lubec Street
Box 928 Downey, CA 90241
Phones (213) 869-8512 1-800-926-2488
FAX (213) 923-1478
Mon-Fri 9-5 PAC TIME

CIRCLE 8 ON FREE INFORMATION CARD

LEARN to CLEAN/ MAINTAIN/ REPAIR CAMCORDERS



EARN \$85 AN HOUR!

HUGE EXPANDING MARKET!

Work from your home - part-time or full-time! No prior experience needed - Average mechanical ability only requirement for your success! Over 15 million camcorders in use - Over 5 million expected to be sold in 1991 alone!

It is a fact that the vast majority of camcorder malfunctions (just like VCRs!) are due to simple mechanical failure... We can show you how to easily fix those breakdowns and earn an average of \$85.00/hr. while working at home!

Get In Now - Soon camcorders will be like VCRs, i.e., one in almost every home.

For a camcorder cleaning job you can earn \$65.00 for less than 30 minutes work.

For a camcorder repair job you can earn over \$100.00.

FREE INFORMATION PACKAGE call or write:
Toll-Free 1-800-537-0589
Viejo Publications, Inc.
5329 Fountain Ave., Dept. PEC
Los Angeles, CA 90029

CIRCLE 11 ON FREE INFORMATION CARD

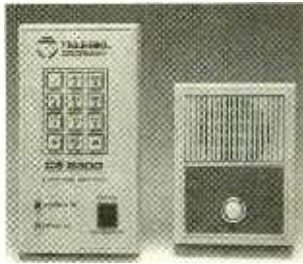

er that, when plugged into a 110-volt AC outlet and a standard RJ11 modular phone jack, converts all indoor telephones into intercoms for use with the *Telebel speakerphone*. If a person is at the door, any phone in the house can be used to speak with them simply by pressing the asterisk key on the telephone. The system allows users to screen visitors, page others in the house, or receive deliveries, all with the convenience of a standard telephone. The system features "door forwarding"—while you're away from the premises, the Telebel memory dialer calls the preprogrammed number when the doorbell is rung, to notify you that there's a visitor at the door. Other Telebel features allow you to open any electric door or gate from a telephone, using a closed-contact relay feature.

The Telebel system has a retail price of \$319.95. For additional information, contact Intelcom, 6488 Avondale Drive, Suite 125, Oklahoma City, OK 73116.

CIRCLE 105 ON FREE INFORMATION CARD

SURFACE-MOUNT TEST-LEAD KIT

Surface-mount work requires much smaller test leads and DMM accessories than those offered in standard kits. *Beckman Industrial's DL249* deluxe surface-mount test-lead kit is designed specifically for the surface-mount device (SMD) market. It includes surface mount tweezer probes; small-outline integrated-circuit (SOIC) clips; crimp-style spring hooks; a two-inch, needle-sharp tip extension; two high-quality, silicon-insulated lead wires; standard probe tips for non-

SMD applications; and a heavy-duty cordura carrying case. The tweezer probes have color-coded, electrically isolated tips, each having its own separate input jack to the meter. That makes it easier to make positive



connection with the contacts at each end of tiny SMD resistors and capacitors. Because alligator clips, ordinary J-style spring hooks, and standard probe tips are virtually impossible to use when I/O pins are on 0.050-inch centers. The SOIC clips and crimp-style spring hooks in the DL249 are intended to allow easy access to IC's with tight pin spacing.

The DL249 has a suggested

list price of \$72.00. For further information, contact Beckman Industrial Corporation, 3883 Ruffin Road, San Diego, CA 92123-1898; Tel: 619-495-3218.

CIRCLE 106 ON FREE INFORMATION CARD

MULTIPLE-DEVICE CONTROLLER

B&B Electronics' MULTI/O is a self-contained, intelligent, general-purpose control module that can be used to sense a variety of external conditions and control, via a host computer, a variety of external devices. The module has eight digital, user-defined input/output lines, two 8-bit analog-to-digital channels, and two 8-bit digital-to-analog channels. Up to 32 modules can be connected on a single RS-485 multi-drop line. PC-compatible communications and control software to set up module parameters are included. The control parameters are stored in EEPROM on each module. The MULTI/O is a 2¼

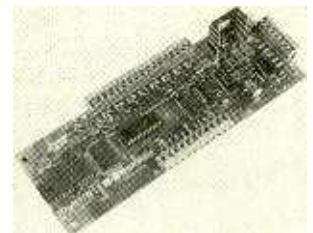

× 8-inch printed-circuit board with removable terminal blocks. It requires 10–30 volts DC at about 150 mA.

The MULTI/O package comes with a diskette containing an application program interface (API), which can be linked into your C program to give it access to the module. A demonstration program shows how to access the module using the API, and a configuration program provides an easy way to configure the MULTI/O module to meet your systems' requirements. A monitor program allows you to interact with individual modules on a multidrop link, which can be helpful while installing the modules. Also included is an

AMAZING ELECTRONIC PRODUCTS and KITS

Remember those Martian Space Ships in HG Wells *War of the Worlds*?



MYSTERY Levitating Device

Objects float on air and move to the touch. Defies gravity! Amazing gift, conversation piece, magic trick or great scientific project.

ANT1K Easy-Ass'y Kit/Plans \$19.50



3 MILE FM Wireless Microphone!

Crystal clear, ultra-sensitive pickup transmits voices, sounds to any FM radio. For security, monitoring children, invalids. Be the local DJ!

MVP1 Plans \$7.00

MVP1K Kit/Plans \$39.50

3 MILE Telephone Transmitter!



Automatically transmits 2 sides of phone conversation to any FM radio. Tunable, easy-assembly PC board. Operates only when phone is in use.

VWPM7 Plans \$7.00

VWPMK7 Kit/Plans \$39.50



TV & FM Joker/Jammer

Pocket size device lets you remotely disrupt TV or radio reception. Great gag! Discretion required. Easy-build electronic kit. **EJK1KM \$19.50**

100,000 V - 20' Range Intimidation Device!

Electronic module, may be enclosed for handheld, portable, or fixed uses. **ITM2 Plans (creditable to kit) \$10.00**

ITM2K Kit & Plans \$49.50

READY-TO-USE, AUTOMATIC Phone Recording System

Complete with extended play tape recorder & line interface switch. Automatically records both sides of conversation. *Check Local Laws on Proper Use!* Ready-to-Use System **TAP20X System \$149.50**

INFORMATION UNLIMITED

Dept PE-2, Box 716, Amherst NH 03031
Phone 603-673-4730 FAX 603-672-5406
MC, VISA, COD, Check Accepted. ADD \$5 S&H.

Order by Mail, or by
24 Hr Order Phone:
800-221-1705

Laser Pen

Pen sized laser, great for movies, drive-ins, pointer. Ready to use, with batt's. **LAPN1 Laser Pen . \$149.50**

Pocket Laser Kit

3mw or 5mw kits with solid state 670nm diode. Caution, Class IIIa item **VRL3KM 3mw Laser Kit . . . \$99.50**

VRL5KM 5mw Laser Kit . . \$119.50

MORE Laser Kits!

LAS1KM 1mw Laser, 632nm, HeNe Easy to Build Kit \$69.50

LAS4KM 3mw Version, Kit \$99.50

LATO5 Low Cost HeNe Laser Tube! .5mw Tube & Plans . . only \$24.50

Other parts available separately
Great Low Budget Science Project!

Shocker Force Field Vehicle Electrifier



Make hand shock balls, shock wands electrify objects, charge capacitors. Great pay back for those wise guys!
SHK1KM Easy-Assembly Kit \$24.50

CATALOG!

with many more items!
FREE with order, or send \$1 P&H

upgrade program that allows you to upgrade the firmware on site, and a user's manual.

The MULTI/O (MI485) costs \$174.95. A power supply (MIPS3) is available for \$14.95. For further information, contact B&B Electronics Mfg. Co., 4000 Baker Road, P.O. Box 1040, Ottawa, IL 61350; Tel: 815-434-0846.

CIRCLE 107 ON FREE INFORMATION CARD

FILM/SLIDE/PHOTO-TO-VIDEO TRANSFER SYSTEM

Home video enthusiasts can transfer film, slides and photographic prints to videotape easily using the CopyKit 3 from Sima Products. The unit has a large, fine-grain screen and a front-surface reflecting mirror to assure greater detail and more professional results. A computer-designed close-focus lens with a large aperture assures corner-to-corner sharpness of the video picture. Compatible

with all camcorders, CopyKit 3 has a complete range of set-up adjustments to make the copying process as easy as possible. To transfer film or slides to video, your projector is focused on a large screen while



your camcorder is set near the close-focus lens. Once the camcorder is focused, recording can begin. A print copyboard that pulls out is used for transferring photographs to video. The mirror used for film transfer pulls out of the way, allowing direct copying of the print through the CopyKit 3's close-focus lens. Retainer clips hold the prints flat against the

copyboard, and your camcorder can be used to fade in or out between pictures if desired.

The CopyKit 3 has a suggested retail price of \$139.95. For further information, contact Sima Products Corporation, 8707 North Skokie Blvd., Skokie, IL 60077; Tel: 708-679-7462; Fax: 312-286-7227.

CIRCLE 108 ON FREE INFORMATION CARD

MINIATURE SOLDERING IRON

For safe prototype and repair work on crowded PC boards, M.M. Newman Corporation's Antex Model G/3U miniature soldering iron features a positively grounded tip. Designed for optimum thermal efficiency, the heating element is located directly under the tip. It reaches its 735°F operating temperature in just 45 seconds and recovers instantly after soldering. The industrial-grade soldering iron provides power

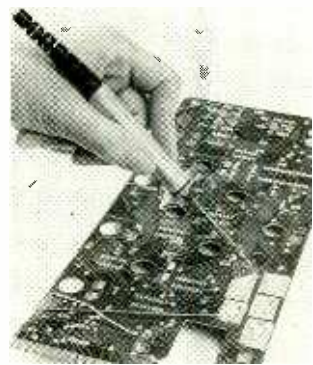

comparable to that of a conventional 30-watt iron. The 18-watt Antex Model G/3U weighs 3/4 ounces, and has a cool plastic handle and a safety finger shield. Appropriate for a wide variety of hand-soldering jobs, it accepts more than 40 types of slide-on tips, including needle points, spades, chisels, and cones.

The Antex Model G/3U miniature soldering iron, including one standard tip, costs \$19.95; replacement tips are priced from

Protel Easytrax 2™

Outstanding value in Printed Circuit Board/CAD for your Macintosh and PC

Protel Easytrax 2 is a new, low-cost design package for PC and Macintosh users that includes everything required to produce professional quality Printed Circuit Board artwork.

Our easy-to-learn menu-driven design system breaks the 'expert barrier'—you'll be designing in minutes, not hours. Our comprehensive tutorials guide you through the program's extensive features that take the tedium out of board layout.

- Comprehensive library of Through-hole devices
- Gerber photoplotting and N/C drill tapes
- On-the-fly library components creation
- Intelligent Pad to Pad autorouting
- Switchable Metric/Imperial grid
- Auto-panning
- PostScript™ printing
- Powerful user-definable Macros
- Independent print/plot program
- Multi-layer boards of up to 32 X 32 inches.

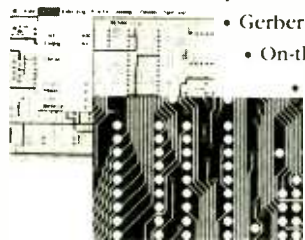

At Protel, we offer free technical support, 24-hour BBS, and 30-day money back guarantee. Prices start at

**Free Evaluation Package
Toll Free: 800-544-4186**

\$450

Protel Technology, Inc.
50 Airport Parkway, San Jose, CA 95110
Tel: 408-437-7771 Fax: 408-437-4913



CIRCLE 9 ON FREE INFORMATION CARD

LEARN ELECTRONICS BY VHS VIDEO TAPE

BEGINNER PREPARATION SERIES

- BP-1 Schematic symbols and component appearance 19.95
- BP-2 Symbols and components practice 19.95
- BP-3 Component functions Unit 1 19.95
- BP-4 Component functions Unit 2 19.95
- BP-SET Complete series 49.95

FUNDAMENTAL ELECTRONIC SERIES

- FE-1 AC-DC fundamentals 19.95
- FE-2 DC circuits and series parallel 19.95
- FE-3 AC circuits and reactance, impedance, resonance 19.95
- FE-SET Complete series 49.95

BASIC ELECTRONICS SERIES

- BE-1 (PS-1) Power supply rectification and filtering 19.95
- BE-2 (PS-2) Power supply doublers and regulators 19.95
- BE-3 (AF-1) Amplifier fundamentals 19.95
- BE-4 (AF-2) Amplifier configuration and biasing 19.95
- BE-5 (AF-3) Amplifier coupling and stabilization 19.95
- BE-6 (AF-4) Amplifier circuits AF, VF, IF, RF 19.95
- BE-7 (OC-1) Oscillator circuits 19.95
- BE-SET Complete series 99.95

Shipping & handling \$7.00

Total amount (Price includes tax)

Name _____
Address _____
City _____ State _____
Zip _____ Home phone _____ Work phone _____



Mail check or money order to
Enterprize Electronics
P.O. Box 551327
Dallas, Tx. 75355-1327

Videotext™ tapes are recorded on T-120 cassettes

THIS SPACE CONTRIBUTED AS A PUBLIC SERVICE

A defense against cancer can be cooked up in your kitchen.

There is evidence that diet and cancer are related. Follow these modifications in your daily diet to reduce chances of getting cancer:

1. Eat more high-fiber foods such as fruits and vegetables and whole-grain cereals.
2. Include dark green and deep yellow fruits and vegetables rich in vitamins A and C.
3. Include cabbage, broccoli, brussels sprouts, kohlrabi and cauliflower.
4. Be moderate in consumption of salt-cured, smoked, and nitrite-cured foods.
5. Cut down on total fat intake from animal sources and fats and oils.
6. Avoid obesity.
7. Be moderate in consumption of alcoholic beverages.

No one faces cancer alone

AMERICAN CANCER SOCIETY

\$1.48. For more information, contact M.M. Newman Corporation, 24 Tioga Way, P.O. Box 615, Marblehead, MA 01945; Tel: 617-631-7100; Fax: 617-631-8887.

CIRCLE 109 ON FREE INFORMATION CARD

PROGRAMMABLE CURRENT SOURCE

Converting analog voltages to current is made easy with the *Calex Model 930* on the *MK298 Mounting Kit*. The model 930 can convert any 0–10-volt signal to 4–20 mA. With a different mounting kit, you can use a 0–10-volt signal to obtain a constant output of 0.5 to 500 mA. With the constant current out-



put, the model 930 can be used as a transducer excitation source for transducers requiring only a few milliamps of excitation. With the variable output feature, the module can convert transducer outputs to 4–20 mA. Any instrumentation amplifier can be used with the model 930 to convert low-level millivolt signals to current.

The Model 930 voltage-to-current converter costs \$108 in quantities up to nine pieces. For additional information, contact Calex Mfg. Co. Inc., 3355 Vincent Road, Pleasant Hill, CA

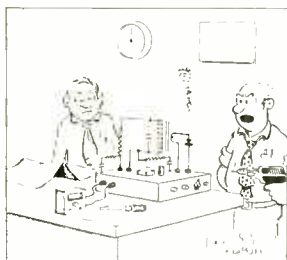

"I can't figure out what went wrong—I followed the schematic diagram exactly."

NO COMPLICATED ELECTRONICS, NO EXPENSIVE INSTRUMENTS:

Home study course shows you how to make good money in VCR repair.

An amazing fact: you can do more than four out of five VCR repairs with ordinary tools and basic fix-it procedures. Our home study program shows you how.

Learn all of the systems, mechanisms, and parts of almost all brands of VCRs. With *no* expensive instruments. *No* fancy workshop. The step-by-step texts and close personal attention from your instructor make learning easy.



Texts, course materials, and tool kit are sent to your home. Graduate ready to make up to \$50.00 or more per hour in your own spare-time or full-time business.

Send today for your free career booklet. Or call 800-223-4542

Name _____
 Address _____
 City _____ State _____ Zip _____

The School of VCR Repair

2245 Perimeter Park, Dept.VA341, Atlanta, Georgia 30341

94523; Tel: 415-932-3911; Fax: 415-932-6017.

CIRCLE 110 ON FREE INFORMATION CARD

DESKTOP PC

Designed for small-business, home-office, and education users, the *Tandy 2500 SX* is a low-profile, high-powered, 386SX-based personal computer that can be used as a stand-alone system or as a network workstation. The system comes with MS-DOS 5.0 and Tandy's DeskMate 3.5 personal-productivity software. DeskMate's "Graphical User Interface" features simple pull-down menus, pop-up dialog boxes, and the point-and-click convenience of a mouse. The software includes word-processing, spreadsheet, database, calendar, and address-book applications, plus communications, sound, music, and draw programs. The system lets users record, manipulate, store, and play

back high-fidelity voice and sound, and has a microphone jack for recording sound, music, or speech.

An enhanced version of the popular Tandy 2500 XL/2, the 2500 SX adds the increased performance of a 16-MHz 80386SX microprocessor and



Super-VGA graphics. It features one megabyte of standard memory, expandable to 16MB. It has one 3.5-inch 1.44MB floppy-disk drive and two additional bays for a second 3.5-inch and one 5.25-inch device. The 5.25-

inch bay could be used for an internal CD-ROM drive or a tape-backup device. Optional IDE SmartDrives (hard-disk drives), from 40MB to 105MB, plug directly into the computer, which also accepts 40MB to 440MB SCSI hard drives (adapter required). The PC also offers one bi-directional parallel printer port, one PS/2-style mouse port, one RS-232C serial port, and a 101-key keyboard.

The 2500 SX will also be available in a fully configured multimedia version, featuring 2MB RAM, 512K video RAM, Super-VGA, a Tandy CDR 1000 internal CD-ROM drive, and a 40MB SmartDrive.

The 2500 SX has a suggested retail price of \$1299 and the multimedia PC costs \$2799 at Radio Shack stores nationwide. For more information, contact Radio Shack, 700 One Tandy Center, Fort Worth, TX 76102.

CIRCLE 112 ON FREE INFORMATION CARD

THINK TANK

By John J. Yacono

Fun with Op-amps

Operational amplifiers (affectionately called op-amps) are perhaps one of the most popular circuit building blocks, due to their incredible versatility and how easy they are to use. Let's take a look at a couple of straightforward op-amp applications to set the pace of this month's column and then move onto some creative op-amp circuits provided by you readers.

OPERATION

The standard schematic symbol for an op-amp is shown in Fig. 1. An op-amp has only one output, but has two inputs: an "inverting" input (denoted with a

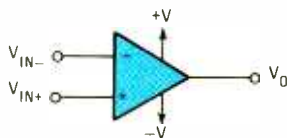

Fig. 1. For all their versatility, op-amps are rather simple devices (at least on the outside). This is the schematic symbol used for an op-amp.

minus sign), and a "non-inverting" input (which bears a plus sign). The output is located at the apex across from the inputs. There are two power-supply connections denoted +V and -V because op-amps typically require a dual power supply for reasons that will become clear shortly.

Op-amps operate on a very simple principle: take the voltage at one input (called the "inverting" input), subtract it from the voltage at another input (the "non-inverting" input),

amplify the result and place it at the output. (Sounds too simple to be useful doesn't it?) That can be stated mathematically like this:

$$V_O = A_{OL} (V_{in+} - V_{in-})$$

where V_O is the output voltage, A_{OL} is the natural amplification or gain of the op-amp (called the open-loop gain), V_{in+} is the voltage at the non-inverting input, and V_{in-} is the voltage at the inverting input. Note that if V_{in-} is larger than V_{in+} , the output must be negative. That is why the op-amp requires a dual supply in many circuits, so it can produce a negative output. However, the dual-supply requirement can be ignored as long as the signal inputs are both positive and you don't mind the output of the op-amp always being a positive voltage.

The open-loop gain of an op-amp is very, very large (on the order of tens-of-thousands), so a small difference in the two input voltages will generate a large output voltage. That makes the op-amp behave like a comparator: If the inverting-input voltage is greater than the non-inverting voltage, the output of the op amp swings down so that it is equal to the negative-supply voltage. On the other hand, if the non-inverting-input voltage is greater than the inverting voltage, the output of the device swings up so that it's equal to the positive-supply voltage. So an op-amp can be used like a comparator, but producing both a positive and negative output.

THE NON-INVERTING AMPLIFIER

Comparator-like action is useful, but if an op-amp's gain is reduced, it can be made into a very handy amplifier. Take a look at Fig. 2 to see how this is accomplished. The circuit there is called a non-inverting amplifier. In it, resistors R1 and R2 form a special voltage divider called a "feedback network" because it is used to feed some of the output back to the inverting input on the op-amp.

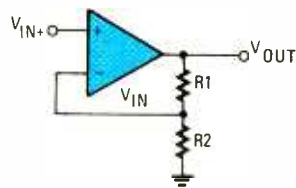

Fig. 2. To make a non-inverting amplifier with a reasonable gain, a voltage divider called a "feedback network" is added to reduce the overall gain.

Let's assume, just for the sake of discussion, that the op-amp is initially turned off and a small voltage is applied to the non-inverting input. For a brief moment when the op-amp is first turned on, the output voltage is zero (because the op-amp takes a little time to respond) so the inverting input is also about zero volts. The op-amp then subtracts zero from the non-inverting signal, amplifies the difference, and supplies the result to the output. Of course even a small non-inverting-input voltage would cause the output to swing to an incredibly large value. A proportionally large voltage will be sent from the output back to the

inverting input because of the action of the voltage divider:

$$V_{in-} = V_O R2 / (R1 + 2)$$

That new, rather large inverting input is now subtracted from the non-inverting input, the result (which is smaller than it was when the inverting input was zero) is again amplified and presented to the output.

This process of adjusting the output voltage continues until it is consistent with the feedback voltage at the inverting input (although the adjustment is effectively instantaneous). From a mathematical point of view, that means that the equations already presented for the output voltage and the inverting voltage must both be true. That also means that we can substitute the equation for the inverting voltage into the equation for the output voltage:

$$V_O = A_{OL} (V_{in+} - V_O R2 / (R1 + 2))$$

the reason for doing that will become clear with a little rearranging:

$$\begin{aligned} V_O / A_{OL} &= (V_{in+} - V_O R2 / (R1 + 2)) \\ 1/A_{OL} &= (V_{in+} - V_O R2 / (R1 + 2)) / V_O \\ 1/A_{OL} + R2 / (R1 + 2) &= V_{in+} / V_O \end{aligned}$$

Since A_{OL} is such a very large number, $1/A_{OL}$ is a very small number. So small, in fact, that it can be considered zero, so we can now say:

$$R2 / (R1 + 2) = V_{in+} / V_O$$

We can now flip both sides of the equation (which is like dividing both sides into the number one) to get:

$$(R1 + 2) / R2 = V_O / V_{in+}$$

That is important because V_O / V_{in+} is the voltage gain or amplification of the circuit. So that equation can

help you to choose resistors to tailor the gain of the op-amp to whatever you wish. For your information, the voltage gain is typically denoted A_V .

Of course, op-amps need some kind of signal to amplify. This month's contributors used infrared-sensitive devices as their signal sources. If you'd like to hack around with infrared, Radio Shack is currently selling a really great infrared module that demodulates pulses riding on a 40-kHz IR carrier. I built a really nifty bunch of IR remotes out of a couple of them (the article based on them appeared in the November 1991 issue). The modules are very easy to use as our next, rather opinionated, contributor points out.

IR DECODER

I've seen all kinds of infrared detector schemes lately in your column and others, but they are all worthless for testing IR remotes. Most of the IR detector circuits that I've seen have an LED that flickers in the presence of IR. Some click too, oh wow! But just because a VCR remote emits IR light doesn't tell the whole story. What is more important than the IR itself, is the information on the IR that the VCR's micro-processor must decode.

Throw-out those other detectors and build this one (see Fig. 3). It's built around the Sharp GPIU52X infrared demodulator (available from many mail-order suppliers or Radio Shack). The module contains everything for demodulating IR: a detector, amplifier, limiter, bandpass filter, demodulator, integrator, and comparator. It's PC-mountable and requires only 5 volts DC.

The overall circuit can be

DIGITAL VIDEO STABILIZER ELIMINATES ALL VIDEO COPYGUARDS



While watching rental movies, you will notice annoying periodic color darkening, color shift, unwanted lines, flashing or jagged edges. This is caused by the copy protection jamming signals embedded in the video tape, such as Macrovision copy protection. THE DIGITAL VIDEO STABILIZER: RXII COMPLETELY ELIMINATES ALL COPY PROTECTIONS AND JAMMING SIGNALS AND BRINGS YOU CRYSTAL CLEAR PICTURES.

WARNING

THE DIGITAL VIDEO STABILIZER IS INTENDED FOR PRIVATE HOME USE ONLY. IT IS NOT INTENDED TO COPY RENTAL MOVIES OR COPYRIGHTED VIDEO TAPES THAT MAY CONSTITUTE COPYRIGHT INFRINGEMENT.

FEATURES

- Easy to use and a snap to install
- State-of-the-art Microchip technology
- 100% automatic
- Compatible to all types of VCRs and TVs
- The best and most exciting Video Stabilizer in the market
- Light weight (8 ounces) and compact (1x3.5x5")
- Uses a standard 9 Volt battery (last 1-2 years)
- Fast UPS delivery
- Air shipping available
- UNCONDITIONAL 30 day money back guarantee
- 1 year warranty

(Dealers Welcome)

To Order: \$59.95 ea + \$4 for p & h
Visa, M/C, COD Mon-Fri: 9-6 EST
1-800-445-9285 ext. 6311
FREE 20 Page Catalog
SCO Electronics Inc. Dept. 6311
581 W. MERRICK RD. VALLEY STREAM, NY 11580

CIRCLE 16 ON FREE INFORMATION CARD

CABLE TV DESCRAMBLERS How You Can Save Money on Cable Rental Fees Bullet Proof

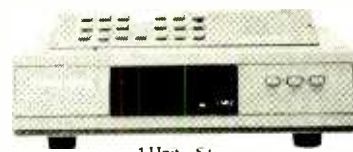

1 Unit 5+

BEST Super Tri-Bi Auto/
Var. Gain Adjustment \$119.95...\$85
Jerrold Super Tri-Bi ... \$109.95...\$79
Scientific Atlanta \$109.....\$79
Pioneer \$109.....\$79
Panasonic TZPC145.... \$99.95...\$79
Stargate Converter..... \$95.....\$69
Digital Video Stabilizer. \$59.95...\$29
Wireless Video Sender..\$59.95...\$49.95

**US Cable'll Beat
Anyone's Price
Advertised in
this Magazine!**

30 Day Money Back Guarantee

FREE 20 page Catalog

Visa, M/C, COD or send money order to:

U.S. Cable TV Inc. Dept. 5311
4100 N. Powerline Rd., Bldg. F-4
Pompano Beach, FL 33073

1-800-772-6244 ext. 5311

For Our Record

I, the undersigned, do hereby declare under penalty of perjury that all products purchased, now and in the future, will only be used on Cable TV systems with proper authorization from local officials or cable company officials in accordance with all applicable federal and state laws. FEDERAL AND VARIOUS STATE LAWS PROVIDE FOR SUBSTANTIAL CRIMINAL AND CIVIL PENALTIES FOR UNAUTHORIZED USE.

Date: _____

Signed: _____

No Florida Sales!

CIRCLE 17 ON FREE INFORMATION CARD

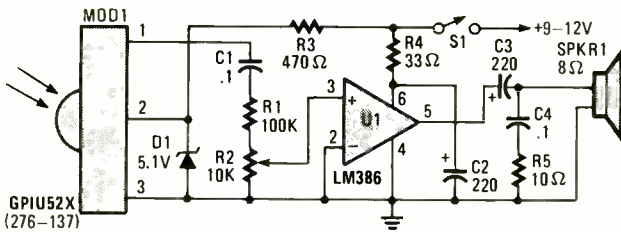

Fig. 3. If your ear is good you can use this IR-pulse-to-audio converter to troubleshoot infrared remote-controls. It is also a good project to just detect infrared-light sources.

powered by a 9-volt adapter, or, by replacing R4 with a short, you can run it off a battery. Resistor R3 and Zener diode D1 ensure that the module receives only 5 volts of power. The module's output at pin 1 is AC-coupled through C1 to volume control R2. From there, the demodulated signals pass to the non-inverting input of U1, an LM386 power-amplifier IC. The output of the amplifier drives a mini speaker.

Since the module recovers the information encoded on the IR signal, the speaker reproduces

code, maybe just a click indicating the presence of IR, if anything.

The first one that I built over a year ago was so handy that within 6 months I had to build another one to put at the front counter where I work to test customer remotes in front of them. In fact, my outside man/partner built one to keep around his house.

I fit the "guts" into a shirt-pocket size case. There is all kinds of IR out there you can "listen to." For example, neon lamps (such as beer signs and the like), IR alarm systems, IR range finders,

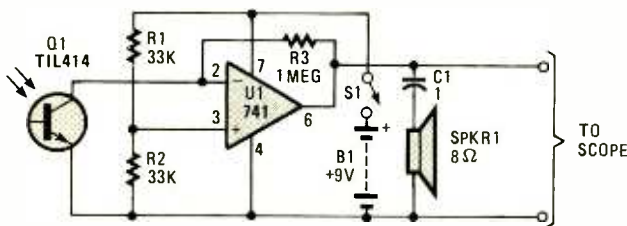

Fig. 4. This infrared detector gives you the option of listening to infrared hash, or viewing it on your scope. Imagine "listening" to a light bulb.

that code as audio. That is useful because each brand of remote emits its own distinct code. With very little practice, you can learn to distinguish the brand of remote you're testing by listening for the code "noise" that it produces at the speaker. If the code matches the brand, chances are that the remote is okay. I've yet to "see" a code wrong when only one key was malfunctioning. If a key is on the fritz, there's typically no

camcorder auto-focus systems, even light bulbs (which sound like Geiger counters)! By the way, thanks for the great articles over the years.

—John Ruso, Santa Maria, CA

What that circuit needs is an oscilloscope output. In fact, I built one for use with an oscilloscope some months ago (look for it in an upcoming issue of this magazine). If any of you decide to play around with the module, be sure to

ground the case. The device is very noise prone.

AN IR OP-AMP

Many people have either built or at least seen projects that detect infrared (IR) pulses. This circuit (see Fig. 4), however, can be used not only to detect IR pulses but to examine them as well. It can also be used as the receiver for a lightwave communications system.

It was originally designed to be used in conjunction with an oscilloscope, but you can use it with headphones if you do not have access to a scope. The circuit provides enough output power to drive most headphones or even a small speaker. The scope's display of the signal can help you to understand IR remote-control encryption so that you can design your own remote-control projects or just troubleshoot remote controls.

In the circuit, the 741 op-amp is configured as a transimpedance amplifier which converts current into voltage. Any IR striking Q1 (available as Radio Shack part number 276-145) will cause it to conduct, driving the op-amp's inverting input low. Resistor R1 and R2 form a voltage divider to keep the non-inverting input at half the supply voltage. The op-amp's output is, thus, a voltage between 4.5 and 9 volts and is proportional to the current through Q1. Capacitor C1 keeps DC from entering the speaker. Therefore, the speaker cannot be used to detect continuous IR sources.

To use the circuit with a scope, connect the output of the circuit to the oscilloscope. Set the scope to 0.5 volts per division, AC coupling, and a time base of 1 ms (milli-second) per division. Any settings can be

used, but those seem to yield the best results. Point an IR source at the phototransistor from about a foot away. At closer distances, the signal might appear clipped depending on the intensity of the incoming IR.

PS. You may be interested to know that I am 15-years old.

—Rob Joyce, Longmeadow, MA

In fact I'm very pleased to know that one of my readers is as bright as you at such an age. I'm sure that you'll have a great deal more to contribute to this column and our society as the years continue.

Note that the op-amp amplifies the signal at the inverting input. That's because it's configured as an inverting amplifier, which I'll discuss next month when I present some more op-amp design tips and applications.

Until then, if you have some neat op-amp-based circuits, or any other successful gadgets, send them to *Think Tank*, **Popular Electronics**, 500-B Bi-County Blvd., Farmingdale, NY 11735. If they're hot (infrared or not), they'll appear in these pages and earn you a book, too. ■

After you give something to your friends and family, may we suggest about 23 million other people?

When you support the Christmas Seal Campaign® you're benefitting research and programs that give over 23 million Americans with chronic lung disease the one thing they want this Christmas. Hope.

AMERICAN LUNG ASSOCIATION
The Christmas Seal People®

Learn to troubleshoot and service today's computer systems as you build a powerful 386sx/20 MHz computer!

NEW!
386sx/20 MHz
computer, 40 meg
hard drive!

Train the NRI way—and learn to service all computers as you build your own powerful West Coast 386sx/20 MHz computer, now with 1 meg RAM, 40 meg IDE hard drive, and exciting new diagnostic hardware and software!

Jobs for computer service technicians will almost double in the next 10 years according to Department of Labor statistics, making computer service one of the top growth fields in the nation.

Now you can cash in on this exciting opportunity—either as a full-time industry technician or in a computer service business of your own—once you've mastered electronics and computers the NRI way.

Get real-world skills as you train with and keep a powerful 386sx-based computer system plus Microsoft® Works software

Only NRI gives you hands-on training with the finest example of state-of-the-art technology: the powerful new West Coast 386sx/20 MHz computer. As you assemble this fully IBM PC/AT-compatible machine, you actually see for yourself how each section of your computer works.

You assemble and test your computer's "intelligent" keyboard, install the power supply and 5¼" high-density floppy disk drive, then interface the high-resolution monitor.

Your hands-on training continues as you install a powerful 40 meg IDE hard drive—today's most-wanted computer peripheral—now included in your course to dramatically increase your computer's data storage capacity while giving you lightning-quick data access.

Plus you now work with today's most popular integrated software package, Microsoft Works, learning to use its word processing, spreadsheet, database, and communications utilities for your own personal and professional applications.

But that's not all!

NEW! Ultra-X diagnostic hardware and software for fast, accurate troubleshooting

Now you train with and keep the latest in diagnostic hardware and software: the extraordinary R.A.C.E.R. plug-in diagnostic card and QuickTech menu-driven software, both from Ultra-X. Using these state-of-the-art tools, you learn to quickly identify and service virtually any computer problem on XT, AT 80286/80386, and compatible machines.

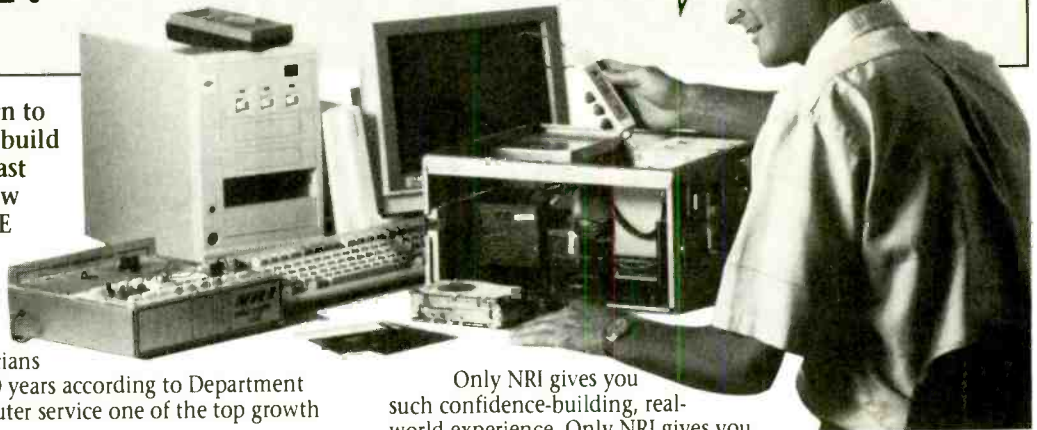

Only NRI gives you such confidence-building, real-world experience. Only NRI gives you both the knowledge and the professional tools to succeed as today's in-demand computer service technician.

No experience needed...NRI builds it in

With NRI training, you learn at your own convenience in your own home. No classroom pressures, no night school, no need to quit your present job until you're ready to make your move.

NRI starts you with the basics of electronics and computers, building on that foundation step by step until you have the knowledge and skills you need for success.

And all throughout your training you've got the full support of your personal NRI instructor and the entire NRI technical staff, always ready to answer your questions and help you achieve your training goals.

Send for your FREE catalog today!

Send today for NRI's big, free catalog that describes every aspect of NRI's innovative computer training, as well as hands-on training in other growing high-tech career fields.

If the coupon is missing, write to: NRI Schools, McGraw-Hill Continuing Education Center, 4401 Connecticut Avenue, NW, Washington, DC 20008.

IBM and AT are registered trademarks of the IBM Corporation. R.A.C.E.R. and QuickTech are registered trademarks of Ultra-x, Inc. West Coast is a member of the Syntax Group.

SEND CARD TODAY FOR FREE NRI CATALOG

NRI Schools

McGraw-Hill Continuing Education Center
4401 Connecticut Avenue, NW, Washington, DC 20008



- Check one FREE catalog only
- | | |
|--|---|
| <input type="checkbox"/> MICROCOMPUTER SERVICING | <input type="checkbox"/> Computer Programming |
| <input type="checkbox"/> TV/Video/Audio Servicing | <input type="checkbox"/> PC Software Engineering Using C |
| <input type="checkbox"/> Telecommunications | <input type="checkbox"/> Desktop Publishing & Design |
| <input type="checkbox"/> Industrial Electronics & Robotics | <input type="checkbox"/> Word Processing Home Business |
| <input type="checkbox"/> Security Electronics | <input type="checkbox"/> Bookkeeping & Accounting |
| <input type="checkbox"/> Electronic Music Technology | <input type="checkbox"/> Air Conditioning, Heating, & Refrigeration |
| <input type="checkbox"/> Basic Electronics | <input type="checkbox"/> Building Construction |
| | <input type="checkbox"/> Small Engine Repair |
| | <input type="checkbox"/> Automotive Servicing |

For career courses approved under GI Bill, check for details.

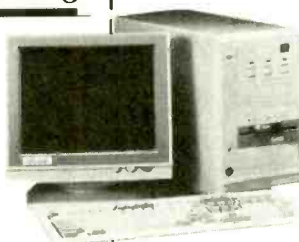

Name (please print) _____ Age _____

Address _____

City/State/Zip _____ Accredited Member, National Home Study Council 18-012

The Importance Of Setting Standards.

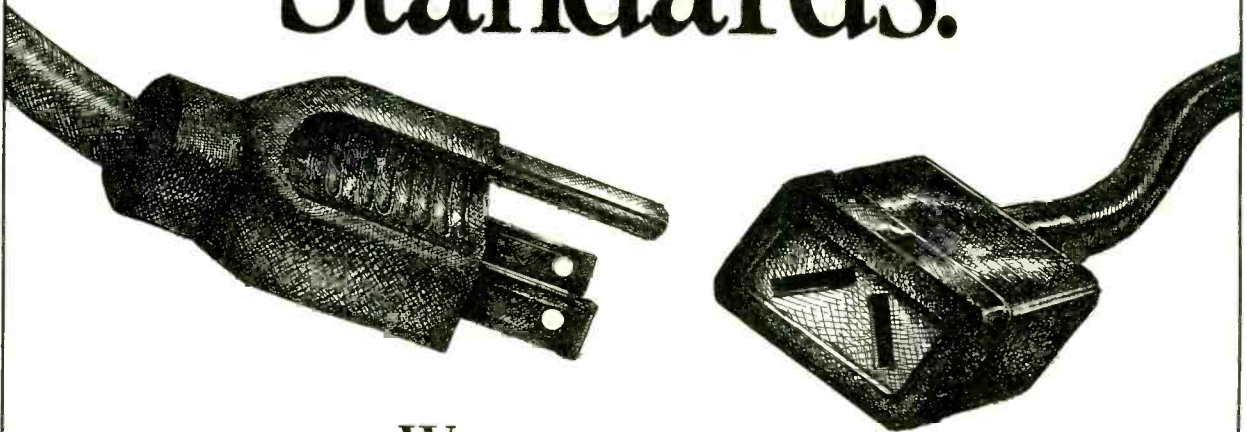

Without standardization in electronics, television wouldn't be seen, radio wouldn't be heard, computers wouldn't share information.

Fortunately the Electronic Industries Association (EIA) has been setting electronics standards since 1924 for everything from early tube radios to today's cellular telephones and stereo TV's.

Standards create *markets and jobs*. Today EIA, an internationally accredited standards making body, is helping to make HDTV a reality by working with the federal government and other industry organizations, to develop a timely, uniquely American transmission standard. For home automation,

EIA also is close to completing a standard which will permit all home electronic products to communicate with each other.

Our more than 1,000 member companies are manufacturers representing every facet of the American electronics industry—from defense to consumer products.

EIA is proud of the contributions it has made through its standards making process toward the growth and vitality of the U.S. electronics industries.

Setting the standard for more than 66 years.



ELECTRONIC INDUSTRIES ASSOCIATION

1722 Eye Street, N.W., Suite 300, Washington, D.C. 20006

Air is the most important ingredient to our survival. Think about it; you may survive a few days without water, a little longer without food, but, deprived of air, your survival time can be measured in minutes.

The quality of the air surrounding many cities has become so poor that many local news stations provide an air-quality report along with the weather forecast. Air pollution is so commonplace now that words have been created to describe it. The word "smog" for example, a contraction of the words "smoke" and "fog." As if smog wasn't enough, today there are new pollution concerns, not the least of which are the increasing CO₂ level, the green-house effect, the depletion in the ozone layer, and acid rain.

Research. Long before there was any talk or concern about air pollution and such, some scientists and experimenters noticed that the ionization of even clean air can improve its quality. Clean air (principally composed of 78% nitrogen and 21% oxygen) is typically full of positive and negative ions in approximately a 5-to-4 ratio. What researchers found was that when this ratio changes one way or the other it has an effect on biological systems.

This idea was popularized by Fred Soyka who, in the 1970's, wrote a book titled "The Ion Effect." Mr. Soyka studied natural occurrences of negative and positive ionized air. His findings and inquiries demonstrated that negatively ionized air had substantial health benefits.

WARNING!! This article deals with and involves subject matter and the use of materials and substances that may be hazardous to health and life. Do not attempt to implement or use the information contained herein unless you are experienced and skilled with respect to such subject matter, materials and substances. Furthermore, the information contained in this article is being provided solely to readers for educational purposes. Nothing contained herein suggests that the negative-ion generator described herein has any health benefits whatsoever. Neither the publisher nor the author make any representations as for the completeness or the accuracy of the information contained herein and disclaim any liability for damages or injuries, whether caused by or arising from the lack of completeness, inaccuracies of the information, misinterpretations of the directions, misapplication of the information or otherwise.

BY JOHN IOVINE

Build a Negative-Ion Generator

Make the very air you breathe healthier with an easy-to-build high voltage project.

To summarize a few points from his book, negative ions help elevate mood, enhance physical performance and training, and sterilize harmful airborne bacteria. An abundance of positive ions on the other hand can be held responsible for a number of low grade medical problems, such as fatigue, headaches, and anxiety.

There are detractors to this point of view. So before I started to design a negative-ion generator, I did some research to find out if it would be worthwhile. I surveyed approximately 100 world-wide scientific reports on the effects of negative ions from 1973 through the present. I can report that out of my survey approximately 80% of the citing's note the beneficial effects of

negative ions. Greater than 19% of the reports described no effect, and a few (less than 1%) detailed some detrimental effect. Since the preponderance of the evidence supports the beneficial effects of negative ions, I felt that building an ion generator was a worthwhile project. A summary of some of the beneficial effects reported by some researchers are listed in the boxed text entitled "The Positive Effects of Negative Ions." It is by no means an exhaustive list, it's just a sampling of the scientific benefits noted. But if this is the case it would be to our benefit to improve the quality of air that we breathe with a negative ion generator.

Despite the numerous scientific reports supporting the health benefits of

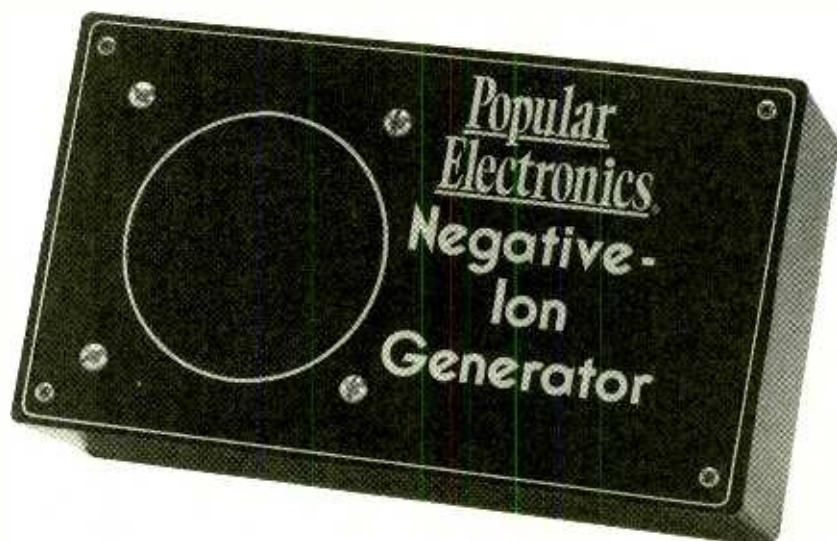

The Positive Effects of Negative Ions

- Learning enhancement in normal and learning-disabled children. The task used to test the children was a dichotic listening test.
- Negative ions can be used to decrease amounts of radon in a building atmosphere.
- In one animal study 1279 calves were broken into two groups, one of 649 head and the other of 630 head, negative air ionization was used to test for a prophylactic effectiveness against respiratory diseases. The results were remarkable: In the treated group (649 head) 45 calves became sick and 3 died. In the control group (630 head) 621 became sick and 33 died.
- A 40–50% reduction of microbial air pollution in dental clinics.
- A test using college students showed improved performance on a visual vigilance task.
- In 1983 it was reported that chickens raised in a negatively ionized atmosphere showed improved anabolic processes. The chickens raised in negatively ionized air had an overall greater weight than a control group fed the same quality and quantity of feed. The meat of the treated group had higher protein and essential amino-acid content. In addition, higher concentrations of vitamins E and A were found in their livers.

Bibliography

Negative Air Ion Effects on Learning Disabled and Normal Achieving Children, L.L. Morton and J.R. Kershner, University of Windsor, Faculty of Education, Ontario, Canada, 1990

Effect of Negative Ion Generators in a Sick Building, M.J. Finnegan, C.A. Pickering, F.S. Gill, I. Aston, and D. Froese, Department of Thoracic Medicine, Wythenshawe Hospital, Manchester, England, 1987

Aeroionization in Prophylaxis & Treatment of Respiratory Disease in Calves, T.I. Sologub, N.F. Borzenko, V.P. Zemlyanskiy, and K.F. Plakhotnyy, Russia 1984

Effect of Ionization on Microbial Air Pollution in the Dental Clinic, J. Gabby, O. Bergerson, N. Levi, S. Brenner, and I. Eli, Research Institute for Environment Health, Sackler School of Medicine, Tel Aviv, Israel, 1990

Effects of Ionized Air on the Performance of a Vigilance Task, G.C. Brown and R.E. Kirk, Systems research Laboratories, Inc., Brooks AFB, TX, 1987

"Negative Ions," J.E. Wright, *Muscle & Fitness Magazine*, January 1991

Effect of Artificial Air Ionization on Broilers, P. Stoianov, G. Petkov, and B.D. Baikov, Vet Med Nauki, Bulgaria, 1983

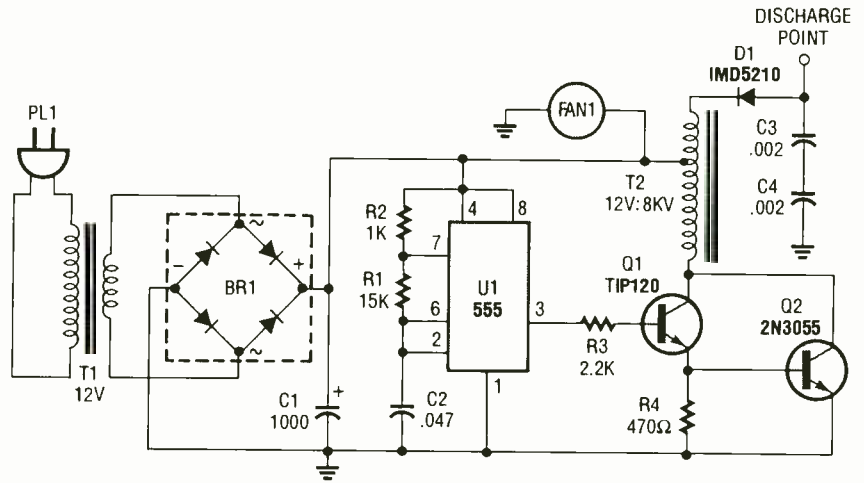

Fig. 1. This is the simple schematic for the Negative-Ion Generator. Note that it is basically a timer that induces a high voltage in the windings of T2.

ionized air, no manufacturer of negative-ion generators can make any health-benefit claims without running afoul of the FDA. For that reason I also will make no such claims. Instead, the

research papers supporting this article are listed in the text entitled "Bibliography" so you can do the research on your own and make your own decision.

PARTS LIST FOR THE NEGATIVE-ION GENERATOR

SEMICONDUCTORS

- U1—555 timer, integrated circuit
- Q1—TIP120 NPN Darlington transistor
- Q2—2N3055 power transistor
- D1—10,000-volt, 10-mA silicon rectifier diode (see text)
- BR1—4-amp, 50-PIV bridge rectifier

RESISTORS

- (All resistors are 1/4-watt 5% units.)
- R1—15,000-ohm
 - R2—1000-ohm
 - R3—2200-ohm
 - R4—470-ohm

CAPACITORS

- C1—1000-µF, 15-WVDC electrolytic
- C2—0.047-µF, polyester-film
- C3, C4—.002-µF, 6,000-WVDC, ceramic-disc

ADDITIONAL PARTS AND MATERIALS

- T1—12-volt, 1.2-amp power transformer
- T2—12 volt to 8 kilovolt autotransformer
- FAN1—12-volt DC fan
- Enclosure, line cord, switch, TO-3 socket and heat sink, perfboard, wire, solder, etc.

The following are available from Images Company (P.O. Box 140742 Staten Island, NY 10314-0024; Tel. 718/698-8305): D1 (\$1.50), C3 and C4 (\$1.50 ea.), and T2 (\$17.95). Include an additional \$2.50 for shipping and handling. NY residents must add appropriate sales tax.

The Ion Generator. The design of the Negative-Ion Generator is fairly straightforward (see Fig. 1). The circuit is a high voltage generator. It contains a standard 555 timer that's used to generate square-wave pulses. The pulses are applied to the base of the TIP120 NPN Darlington transistor. The Darlington provides sufficient current to the base of the 2N3055 power transistor to turn it on. Each time that happens, current flows through the high voltage autotransformer, T2. The high voltage lead of the transformer is connected to a 10 kilovolt high voltage diode. Notice the polarity of the diode. It is biased to place a negative charge on C3 and C4, leaving the discharge point negatively charged. The voltage at the discharge point negatively charges the air forced past it by the fan.

The author's prototype was built on sections of perfboard using point-to-point wiring. It is a suitable method that you can use in your own ion generator provided you follow some precautions: Make sure you place C3, C4, D1, and the discharge point (which we'll describe momentarily) on a piece of perfboard all their own. The junctions between those components should be at least a centimeter apart. Both this little high voltage board and the autotransformer should also be kept at least 1 centimeter away from the perfboard containing the other components, the fan, and the power transformer.

(Continued on page 98)

As I began to collect my notes to write this article, I wondered how many readers would think: "Another Dingbat trying to revolutionize the audio world with a subwoofer!" Be assured that my work was not an attempt to reinvent the wheel. Furthermore, my goal was not to develop a speaker that could "destroy the walls of Jericho," but just to enhance the lowest end of the audio spectrum (where my little speakers needed some reinforcement).

So in the course of this article I will not be introducing any Earth-shaking break-through in technology. I'll just be describing how I applied a bunch of known and proven laws of acoustics and electronics to a speaker (with which I am well pleased) to help anyone who may be tempted to give it a go. I'll also tell you how to build an active cross-over and an amplifier I use to power the speaker. The crossover and amplifier will allow you to connect the subwoofer to your audio amplifier's head-phone jack if it doesn't have a built-in subwoofer driver.

How it All Began.

Since I was aware that my speakers were only "solid" down to about 40 Hz., I figured a subwoofer that could work from about 100 Hz down to 20 Hz would enhance my audio system. I naturally went through all the "slick-page" catalogs and magazines to see what was available in the sub-woofer market, but nothing really enthused me. Luckily, fate stepped in and showed me another way to go.

One evening, I was sitting at a table in a small area off the end of our living room messing with one of those fancy air ionizers. This particular unit had a squirrel-cage blower that supposedly pushes all the nice clean ion-rich air into the room.

While it was operating, I heard a rumbling coming from the living room, and thought that maybe a large semi was passing by on a street near the house. However, the rumbling didn't let up, so I knew it couldn't be caused by a truck. My interest aroused, I got up and started wandering around the room trying to locate the source of the noise. I

build A

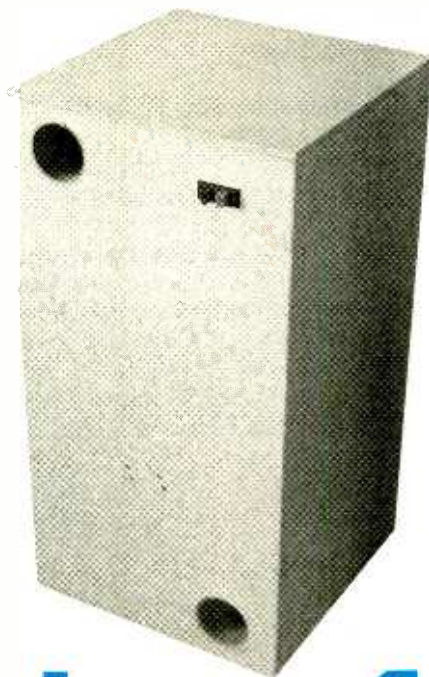

Subwoofer

A well-designed straight-forward enclosure and circuit will allow you to enjoy the low end of the audio spectrum as never before.

BY WILLIAM D. WHITEHEAD

stopped in a corner of the living room (where one of my stereo speakers is located) and the sound vanished. A very bright light came on in my head: A slight imbalance of the spinning squirrel cage was vibrating the table that, because of its heavy weight, coupled the vibrations to the floor where they were transmitted to the wall at the opposite end of the room. That innocent little blower was creating low frequency standing waves in the walls and floor twenty feet away without moving gobs of air!

This was analogous to the action of Helmholtz-resonator boxes I remembered playing around with in a physics lab many years ago. Simply put, a Helmholtz resonator is a cavity with a vent that when excited or driven by

some means, resonates the contained gas (usually air) at a particular frequency. The experience with the ionizer convinced me that a speaker enclosure based on this principle could couple very low frequencies from my stereo amplifier into the room. So I began searching through some of my old text books and references for information on Helmholtz resonators.

Using the information I found, I built various enclosures of different shapes. I tested each one with a monster 12-inch 8-ohm 100-watt speaker I had purchased some time ago. After many trials, I finally settled on an enclosure that was just right for the speaker (see Fig. 1). It contains two separate Helmholtz resonator chambers (each with a tubular "vent" for the sound to exit from) with a speaker mounted between them. If you're unfamiliar with resonators, that might seem like an odd design, so let's discuss some of the characteristics of resonators and the more nitty-gritty details of the enclosure design before going further.

Resonator Basics.

Some every-day examples of Helmholtz resonators are: automobile mufflers, ocarinas, "musical jugs," etc. The resonance frequency of any of these resonators depends on the speed of sound, the volume of gas in the resonating

chamber, and geometry of the vent. The actual formula for the resonance frequency is:

$$F_r = (c/2\pi)\sqrt{C/V}$$

where F_r is the frequency in Hertz, c is the speed of sound, C is the acoustic conductance (a characteristic of the vents geometry), and V is the inner volume of the enclosure.

The acoustic conductance of a cylindrical vent, like the type used in my subwoofer, can be calculated by knowing its length and diameter using this formula:

$$C = \pi d^2 / (4(l + 0.8d))$$

where l is the tube's length and d is its diameter. The relationship between the length, diameter, and acoustic conductance can be shown graphically as in Fig. 2.

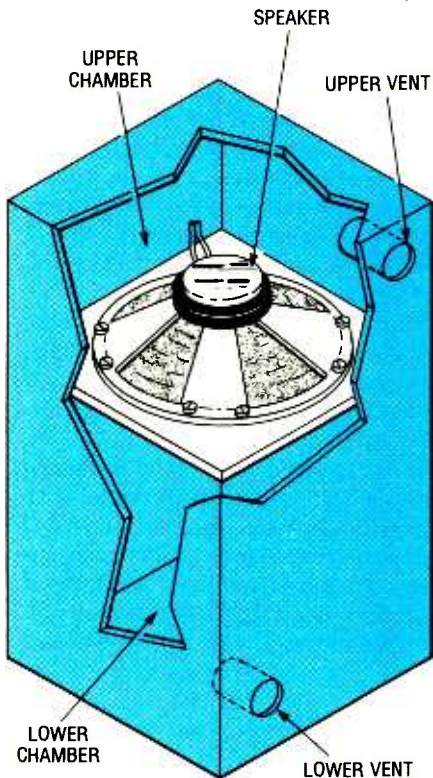

Fig. 1. This is a rough sketch of the dual-chamber enclosure I settled on. Note the speaker location.

The speed of sound I used in my calculations was 1100 feet/second, or 13200 inches/second. Those of you who like to "nit-pick" can alter this value to take into account altitude, humidity, temperature, time of day, smog, phase of the moon, or what's in the refrigerator if it makes you happy.

From all my testing I determined that an enclosure with two ports, one operating at 27 Hz and another at 54 Hz, would provide the best results. Of course each port needs its own volume of air, so I had to build an enclosure with two chambers and position the speaker between them to drive them both simultaneously (as shown back in Fig. 1).

With the frequencies determined, I had to decide on the volumes of the two chambers, and then calculate the dimensions of the ports. The volumes I calculated are rough approximations, but it can be shown that resonance varies rather slowly with small changes in volume.

The most advantageous dimensions for the upper chamber (with the 54 Hz resonance) came out to be $14\frac{3}{8} \times 14\frac{3}{8} \times 7\frac{7}{8}$. That yields a volume of 1575.6 inches³. Subtracting about 75 inches³ for the speaker frame and magnet structure leaves about 1500

inches³. The conductance required for that volume of air to achieve resonance at approximately 54 Hz is 1.015. So, according to the graph in Fig. 2, the conductance tube should be $4\frac{1}{16}$ -inches long with an inner diameter of 3 inches.

The dimensions of the lower chamber were decided to be $14\frac{3}{8} \times 14\frac{3}{8} \times 20\frac{7}{8}$, which has a volume of 4313.6 inches³. Subtracting about 61 inches³ for some speaker braces (which don't appear in Fig. 1) and adding about 100 inches³ for the speaker-cone void yields 4400 inches³. The conductance required for a 27 Hz resonant frequency for this volume is 0.742. From the graph in Fig. 2, the tube should be $7\frac{1}{8}$ -inch long with a 3-inch inner diameter. With the math behind us, we can build an enclosure.

Cutting the Cabinet. Construction of the enclosure can be accomplished in two ways. First, the lazy (and more expensive) way is to have a good cabinet shop cut all the individual parts, cut the round openings for the speaker and conductance tubes, and miter, dado, and rabbet the edges as necessary. The second way, which is less expensive, is to do it yourself. I built my enclosure in my garage-shop with little difficulty. However, you will need a good table saw and router, both equipped with carbide blades and cutters. Of course, some experience in this sort of work would be helpful, too.

Either way you go you will need to decide on the exterior look. To build a particle-board cabinet, you'll need to buy $\frac{3}{4}$ -inch high-density industrial-grade particle-board stock. For more

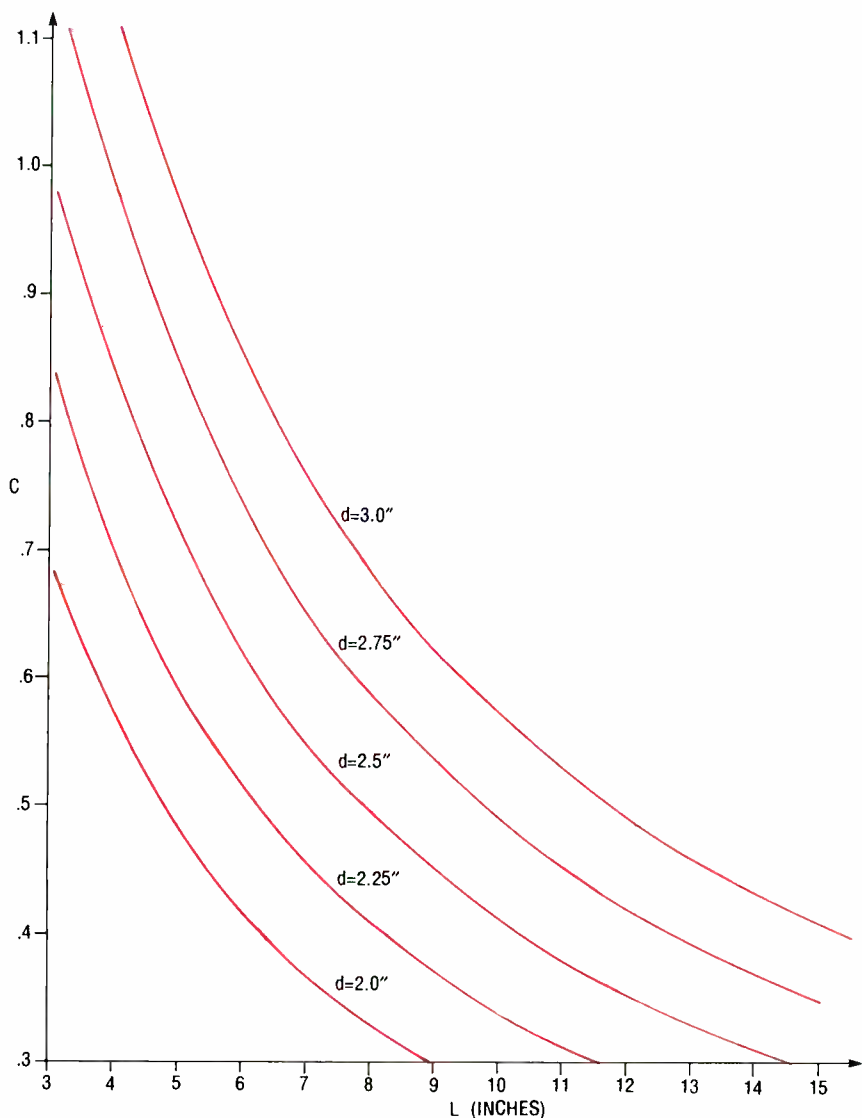

Fig. 2. The acoustical conductance (*c*) of an open tube depends on its geometry (specifically its inner diameter and length), as you can see from this series of plots.

of a "furniture look" get a 3/4-inch piece of MDF-grade hardwood stock (i.e., oak, walnut, etc.). A sheet of this high quality stuff goes for about \$110 (for walnut), and weighs in at 100 lbs.; this type of material was specifically developed for speaker cabinets.

If you wish to cut the stock yourself, then good, substantial clamping and jiggling is an absolute must. Especially for particle board, which cuts smoothly, but will tend to wander unless held firmly in place. I also recommend that you use a combination blade for all straight cutting.

Use Fig. 3 as a guide for roughly cutting the wood for the cabinet. As it takes into account saw kerf, the pieces you cut will likely be over-sized. You will have to further size-down the pieces as you square them so that you end up with four sections measuring 16 x 29 1/2-inches (the sides), two at 16 x 16-inches (the top and bottom), and one section of 15 1/4 x 15 1/4 (for the internal speaker shelf). After all the component parts of the enclosure have been cut to the correct dimensions, recheck each piece for squareness and accuracy of size.

With the pieces cut and squared, you must now miter and dado them. For the dado work I recommend an adjustable carbide-tipped dado blade. An alter-

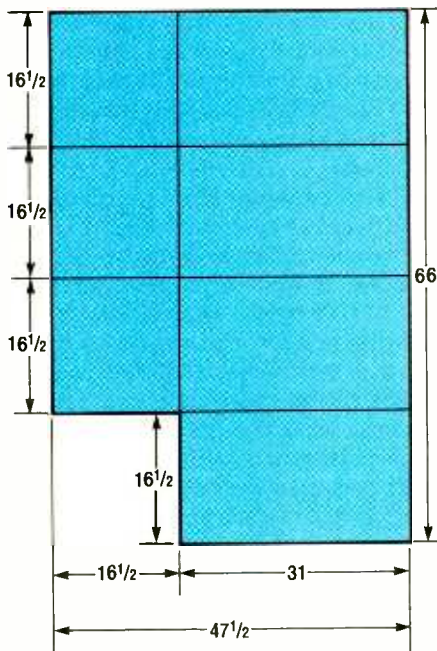

ALL DIMENSIONS IN INCHES

Fig. 3. Roughly cut the wood of your choice to match this diagram. You will need to further trim and square the pieces afterward.

PARTS AND MATERIALS LIST FOR THE SUBWOOFER

- 12-inch, 100-watt, 8-ohm speaker
- 1 8 x 4-inch sheet of 3/4-inch industrial-grade particle board or MDF hardwood
- 20-inch length of 2 x 2-inch hardwood
- 12-inch length of 3-inch inner diameter, PVC pipe
- 12 x 12-inch sheet of 3/8-inch thick neoprene
- 8 10-32 x 3/4-inch T nuts
- 8 10-32 x 1/4-inch round-head machine screws
- 8 No. 10 washers
- 24 No. 2 1 1/2-inch
- Dual-post speaker-terminal plate
- 30-foot spool of 16-gauge speaker wire
- Carpenter's glue and finishing materials

native to using a dado blade is, of course, a router. What you use only depends upon what tools you have available and are most comfortable with.

You will need to dado the top and bottom pieces to form 3/4-inch wide, 3/8-inch deep rabbet cuts that will form joints with the side sections as shown in Fig. 4A. You also need to dado notches into the side sections for the speaker shelf. They should be at least 3/4-inch wide and 3/8-inch deep and begin at 7 5/8 inches from one end of each board as shown in Fig. 4B. When a notch is cut, try inserting an edge of the speaker shelf into it. The fit should be snug and straight, but not too tight. There should be room for glue in the joint.

Now set up your saw to make miter cuts and spline grooves for the four cabinet sides (where the sides meet one another as shown in Fig. 4C). I usually set the miter angle for 46 or 47 degrees to insure that the outer corner edges "close" when the sides are glued and clamped during assembly. This is especially important if you are making the enclosure as a finished furniture piece.

Although I did not install the spline work on my first enclosure, the inclusion of these splines will greatly facilitate the alignment of the sides during the assembly process. Without them as alignment aids, it takes a fair amount of jockeying the cabinet clamps when the final gluing is started. With that in mind make spline cuts in each mitered edge. You can make the spline pieces later from hardwood scraps.

You now need to cut holes for the

vent tubes, and terminals in the front side. Cutting round holes with a router is very easy if you have a circle-guide attachment for your tool. However, cutting holes of the exact diameter for a tight fit around the vent tubes can be a little tricky. Try making a couple of "test-fit" holes in pieces of scrap plywood until you get the right size for a snug fit. Once you get the diameter just right, cut the vent holes in the front-side panel using Fig. 5 as a guide. In this same panel, locate and drill holes for the speaker terminal panel; their location and size are up to you.

Now take a 2 x 2-inch length of hardwood (oak, birch, or clear pine) and cut it into four 4 to 5-inch long sections. Miter the ends so they will fit in the speaker enclosure as shown in the bottom view of Fig. 5.

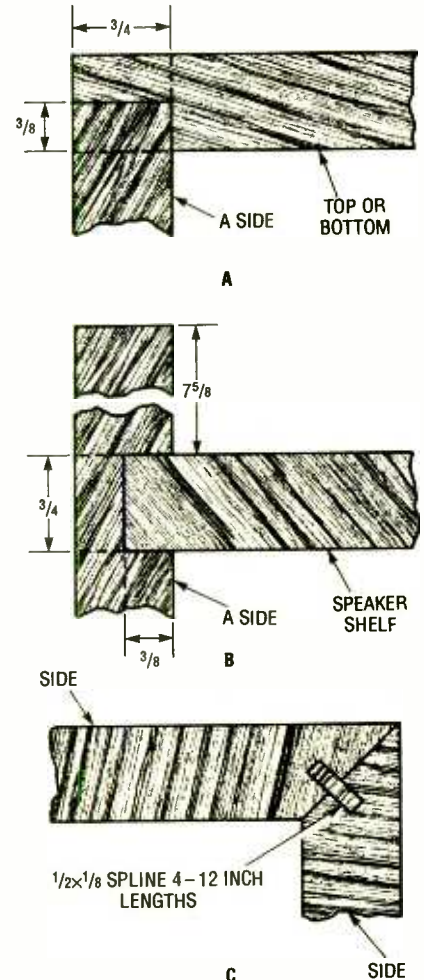

ALL DIMENSIONS IN INCHES

Fig. 4. The top and bottom will need rabbet edges to join with the sides (A). The sides need to be dadoed to accept the shelf (B) and mitered to attach to one another (C).

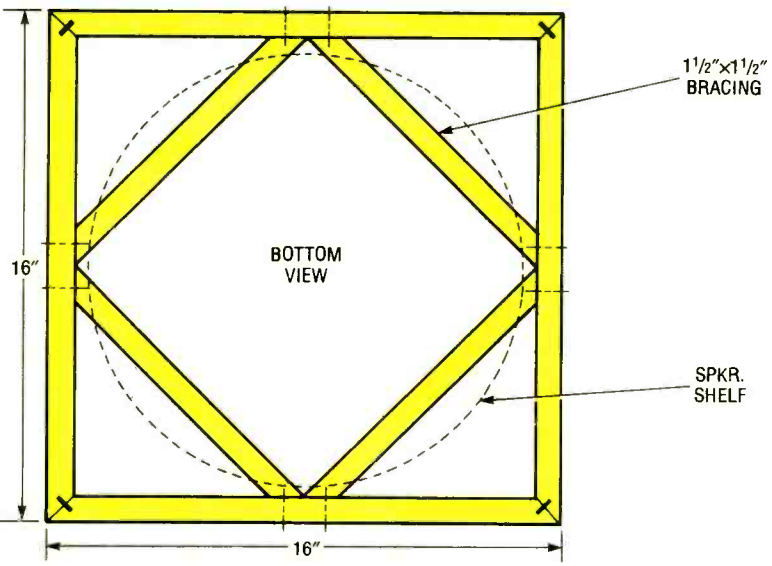
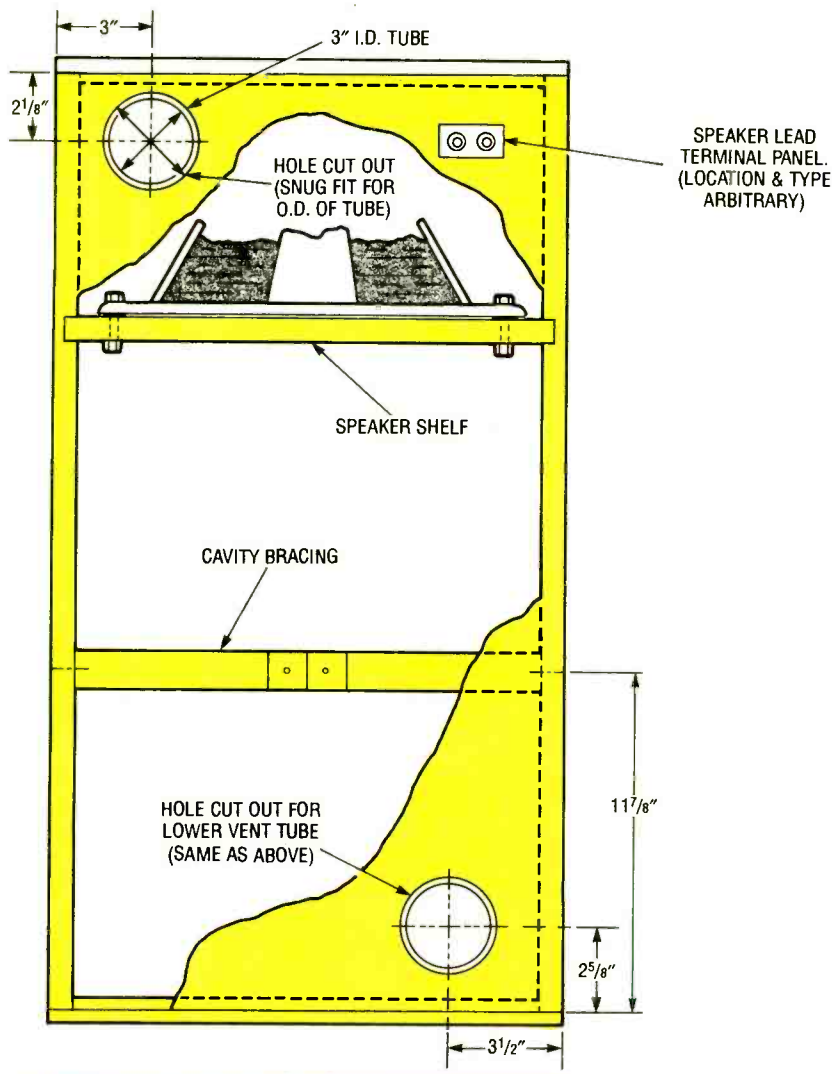

Fig. 5. This enclosure-construction detail shows the speaker shelf, lower bracing, and vent locations to help you machine and assemble your own. However, the speaker-terminal panel can be located wherever you wish.

Since you are working with hardwood, this is a good time to rip out a bunch of $\frac{1}{2} \times \frac{1}{8}$ -inch spline material from some of the scraps. Random lengths from 4 to 12 inches will work okay. Test fit the pieces in the spline

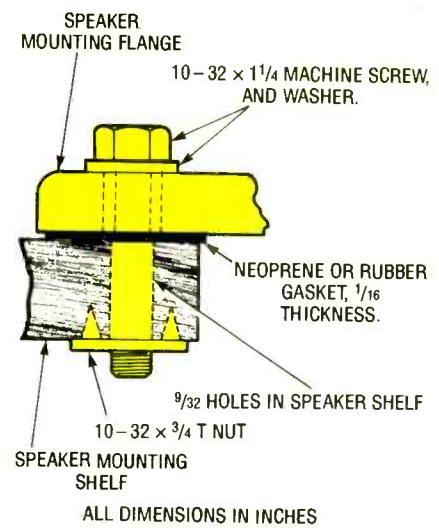

Fig. 6. This speaker-mounting detail should be used to install all eight screws that hold the speaker to the shelf. Don't forget to insert the neoprene gasket before attaching it, though.

grooves to make sure they go in easily but are not "sloppy." The extra room allows for some assembly adjustment later, and also leaves a gap for the glue to spread around in. It is also a good idea to form a corner with a couple of sides and verify that the splines are not too wide, which would prevent the joint from closing correctly.

If you are using pressed wood, locate and drill body-clearance holes for two No. 2 1 1/2-inch flat-head wood screws in each side panel for the internal braces (see Fig. 5 again). Countersink the holes so the screw heads will be flush when installed.

For the speaker-shelf preparation, start by drawing crossed diagonal lines on the shelf to locate the center. Set the speaker on the shelf, centering it using the lines as guides. Mark the wood under the holes in the speaker's flange, and put the speaker aside. Drill $\frac{9}{32}$ -inch holes at the eight locations you've marked. Mark and cut a speaker hole so that there is a sufficient flange support and the mounting-bolt holes are not too near the edge of the opening. On one side of the shelf, install a 10-32 T nut around each of the mounting holes you've drilled.

Assembly Procedure. Start putting the cabinet together by gluing up three sides (with the splines in place) and the speaker shelf. Position the top and bottom pieces as squaring guides at the ends (but do not glue them in place)

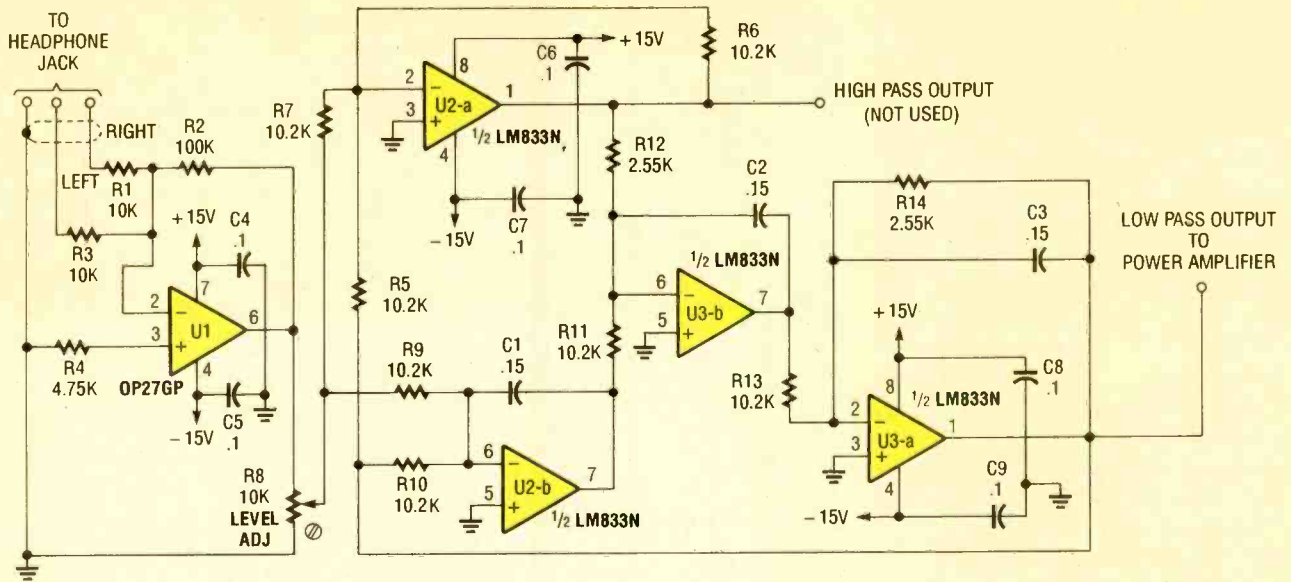

Fig. 7. The electronic-crossover circuit contains a summing amplifier that combines the left and right channels from a stereo's headphone jack.

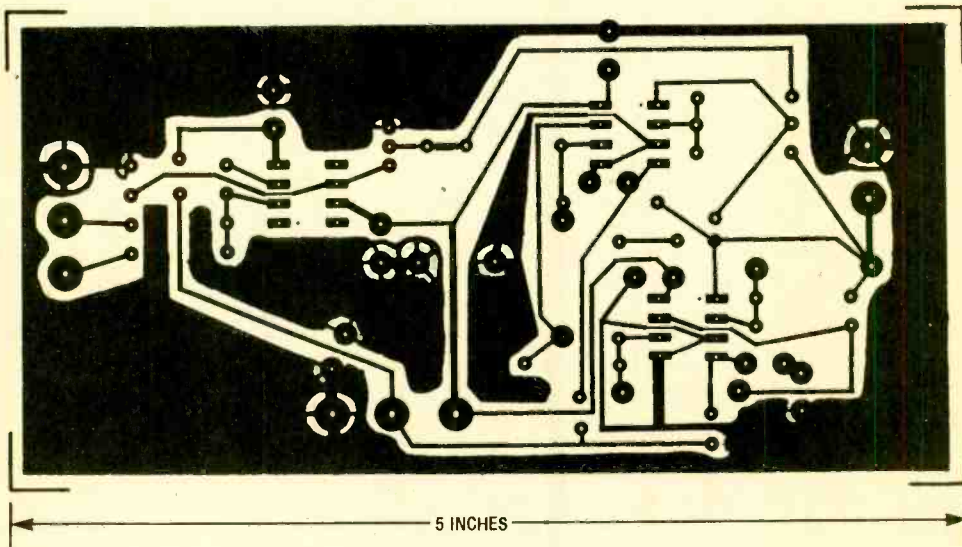

Fig. 8. If you want to make a PC board for the electronic-crossover circuit use this as a foil pattern.

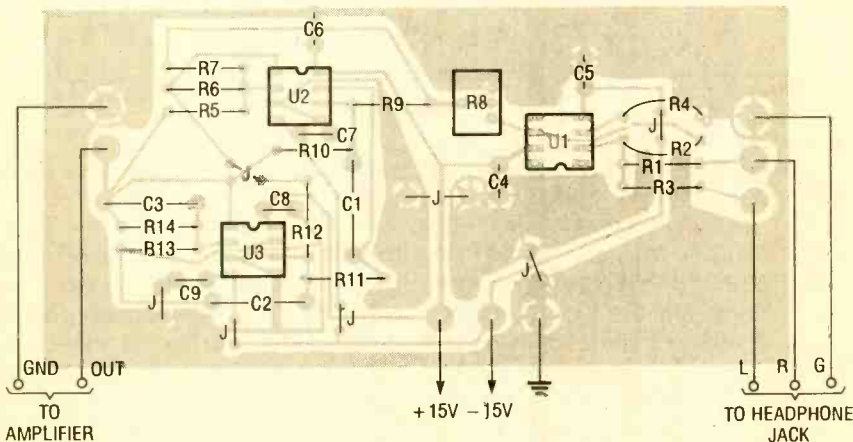

Fig. 9. Stuff the crossover's PC board using this as a guide. Don't forget to add the jumpers as shown.

and clamp the two corner joints so formed at the top and bottom with three cabinet clamps along the length, and two at the open ends. I use Jorgensen type clamps, which are easy to use and quick to adjust. Needless to say, if you are working with furniture-grade wood, use protection blocks on each clamp face. After the glue has set up, attach the fourth side following the same steps taken for the other sides.

Now you must install the four cabinet braces with screws and glue. If you are working with furniture wood, use short screws and install them from the inside.

Tap the conductance tubes into place. The longer tube should be mounted in the hole for the larger chamber. When finished, the outer ends of the tubes should be flush with the cabinet. Run small beads of glue where the tubes meet the inner cabinet surface.

Cut a ring with 11¼-inch inner diameter and 12-inch outer diameter from a 12 x 12-inch sheet of ¼-inch thick neoprene. That is to be used as a gasket for the speaker. Put the speaker (flange down) on the ring, and mark the area under the flange holes. Remove the speaker and cut out the neoprene at the marked locations. Attach wires to

PARTS LIST FOR THE SUBWOOFER CROSSOVER

RESISTORS

(All fixed resistors are 1/4-watt, 1% units.)

R1, R3—10,000-ohm
 R2—100,000-ohm
 R4—4750-ohm
 R5—R7, R9—R11, R13—10,200-ohm
 R8—10,000-ohm trimmer potentiometer
 R12, R14—2550-ohm

CAPACITORS

C1—C3—0.15- μ F, polypropylene
 C4—C9—0.1- μ F, stacked-film

ADDITIONAL PARTS AND MATERIALS

U1—OP27GP operational amplifier, integrated circuit (Motorola)
 U2, U3—LM833 operational amplifier, integrated circuit
 IC sockets, printed circuit-board materials, wire, solder, etc.

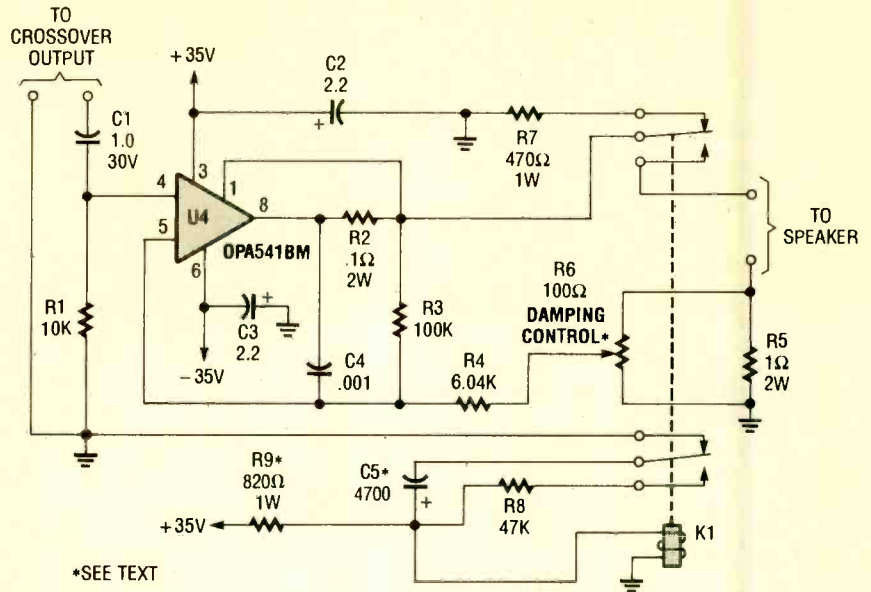

Fig. 10. The subwoofer amplifier comes with a turn-on delay circuit that prevents turn-on and turn-off thump.

the speaker terminals, then place the prepared gasket and the speaker onto the speaker shelf. Align the speaker-flange holes and gasket holes with the nut-plate holes, as shown in Fig. 6. Place machine screws with washers into the holes and tighten them evenly, alternating between bolts to prevent distorting the speaker structure. Finally, tighten each bolt securely.

Mount the speaker-terminal board on the cabinet through the holes previously drilled. Twist the speaker wires and connect them securely to the terminals. It is a good idea to use Ty-Wraps to fasten the wire run in a couple convenient places on the speaker frame.

Now glue and clamp the bottom piece in place. Attaching the top to the cabinet will involve a little more work than that. With the top in place and starting at two inches from any corner, drill pilot holes through the top piece into the side every four inches. Remove the top from the cabinet and then body drill and counter-sink the pilot holes for No. 2 1/2-inch flat-head screws. Glue and replace the top securing it in place with the screws.

If the enclosure is a furniture type, the counter-sink holes can be filled and stained, or veneered with plugs cut and fitted in place. The type and method of finishing is a matter of personal preference, so it is left up to you.

The Electronic Crossover Circuit.

The crossover I used for my speaker

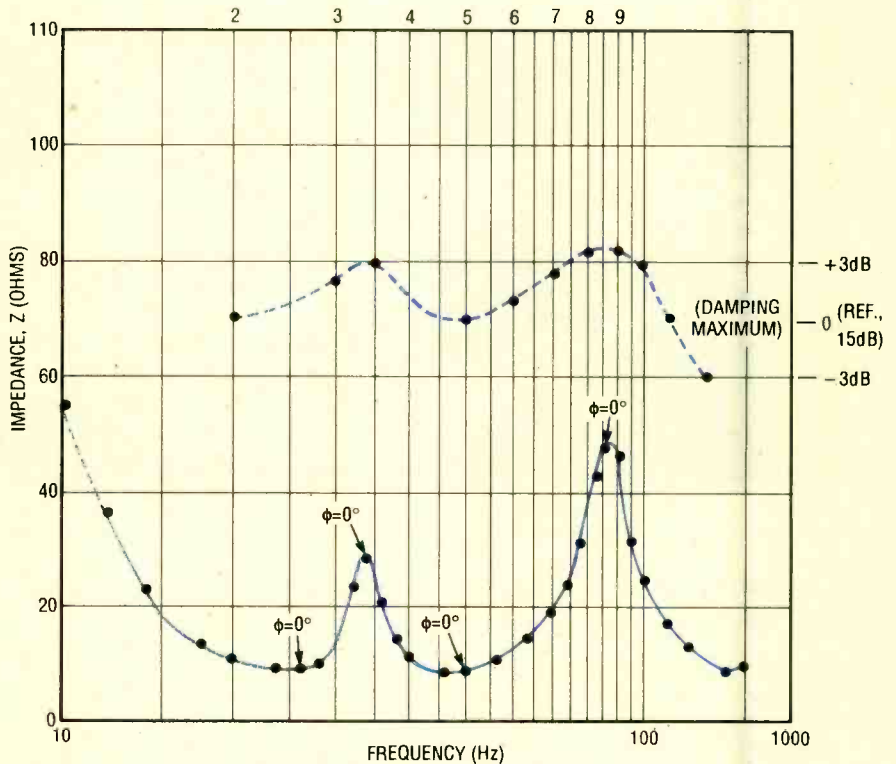

Fig. 11. The solid curve shows the changes in speaker impedance over various frequencies with 8 watts of input power. The dashed curve represents the relative speaker drive power.

(shown in Fig. 7) was an adaptation of a circuit I found in some applications literature. As presented in the application notes, it was designed for standard multi-driver systems. However, with a couple of modifications (like not using the high-pass output) I was able to adapt it to my particular needs. For example, I added the low noise op-amp,

U1, at the input, and configured it as a summing amplifier whose gain is adjusted with the "level-adjust" potentiometer. That portion of the circuit combines the left and right channels from a stereo's headphone output before sending them to the rest of the active crossover. In this way, the bass from both channels will be reproduced

PARTS LIST FOR THE SUBWOOFER AMPLIFIER AND POWER SUPPLY

SEMICONDUCTORS

U1—OPA541BM op-amp integrated circuit
 BR1—6-amp, 200-PIV bridge rectifier
 D1, D2—1N4744B, 15-volt, 1-watt Zener diode

RESISTORS

(All fixed resistors are 1/4-watt, 5% units unless otherwise noted.)

R1—10,000-ohm
 R2—0.1-ohm, 2-watt, wire-wound
 R3—100,000-ohm, 1%
 R4—6040-ohm, 1%
 R5—1-ohm, 2-watt, wire-wound
 R6—100-ohm, 1/2-watt potentiometer
 R7—470-ohm, 1-watt
 R8—47,000-ohm
 R9, R11, R12—820-ohm, 1-watt
 R10—5000-ohm 5-watt, wire-wound

CAPACITORS

C1—1- μ F, polypropylene
 C2, C3—2.2- μ F, Tantalum
 C4—.001- μ F, stacked-film
 C5—4700- μ F, 25-WVDC, electrolytic
 C6—.005- μ F, film
 C7, C8—9000- μ F, 50-WVDC, electrolytic

ADDITIONAL PARTS AND MATERIALS

F1—125-volt, 2-amp fuse
 K1—DPDT, 24-volt, 5-amp, 1100-ohm relay
 T1—24-volt, 3-amp, power-supply transformer
 Fuse holder, line cord, IC sockets, 8-pin TO-3 socket for U1, printed circuit-board materials, wire, solder, etc.
 Note: The OPA541BM operational amplifier is available for \$40.65 from the manufacturer: Burr-Brown, P.O. Box 11400, Tucson, AZ 85734; Tel. 800-548-6132. They have a \$75 minimum and you should contact them directly about shipping and handling charges.

by the subwoofer.

I decided to set the roll-off at about an octave above the higher resonant cavity of the Helmholtz enclosure. With the component values shown, the 3-dB point is 104 Hz, which was verified by tests I performed.

The foil pattern for the PC board I used is shown in Fig. 8. You can use this foil pattern for your own crossover circuit if you wish to assemble it on a PC board. If that route sounds appealing, stuff the circuit board using Fig. 9 as a guide. If making a PC board isn't your cup of tea, you can use point-to-point wiring instead.

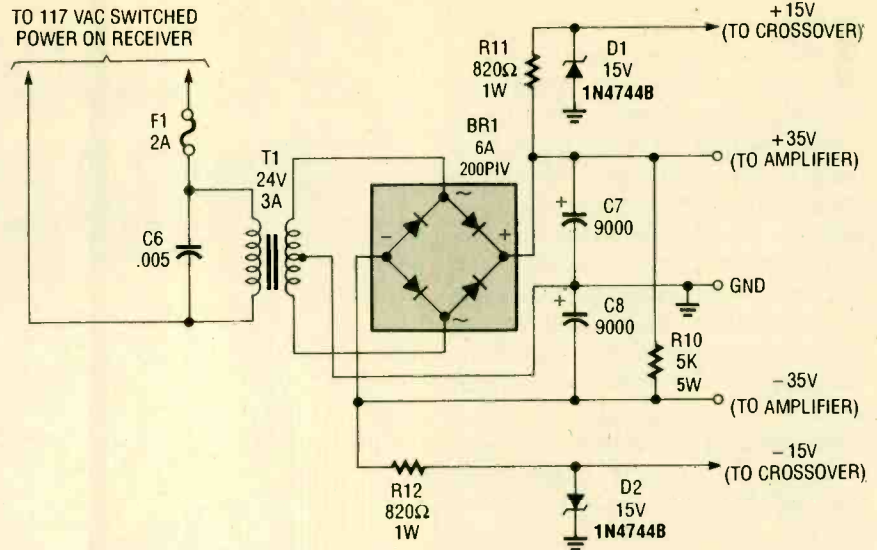

Fig. 12. This power supply is ample enough to drive the crossover and amplifier (and therefore the speaker).

The Amplifier. The signal from the active crossover needs some amplification before being sent to the subwoofer. An amplifier I "whopped" up (shown in Fig. 10) turned out to be nice for precisely that. In fact, with adequate heat sinking, the amplifier is capable of up to 100 watts into 8-ohms! Although the power op-amp, U4, is expensive (\$40.65), it makes the overall circuit less expensive than if a discrete amplifier were used.

Low frequency "rumble" is attenuated by the input-coupling network composed of C1 and R1. Since the amplifier is not called upon to amplify high frequencies, the values shown for C4 and R3 were chosen to roll-off the upper frequencies at 1.6 kHz. The output current of the amplifier is limited to about 5 amps by resistor R2.

A somewhat novel part of the circuit is the damping/feedback network, which consists of R4, R5, and R6. It accomplishes several things: First, (in conjunction with R3) it sets the gain of the stage to about +24 dB. (which is a voltage gain of 16.5) when the damping-control wiper is at ground. At the maximum setting of the damping control, approximately 6 dB of feedback is introduced, which reduces the stage gain to about +18 dB.

Second, when the wiper of the potentiometer is set at any point above ground, a portion of the AC load current is fed back (negative feedback). The effect is to equalize the drive signal delivered to the speaker load. For instance, as the speaker impedance

rises at the cavity resonant frequencies, the feedback is reduced and a higher drive results, which tends to yield constant power to the speaker. This effect is plotted in Fig. 11.

Third, the feedback improves the transient damping of the system. It does that by reinforcing the damping effect the op-amp's low output impedance has on the speaker. Audibly, that minimizes, or eliminates any "boominess" by stiffening the speaker response.

The remainder of the circuit (C5, R9, K1, R7, and R8) provides a turn-on delay. The circuit is fairly standard and allows all the electronics to "settle down" before the speaker is connected via K1—eliminating thumps at turn on and turn off. Resistor R7 initially acts as a load to U4, and R8 provides a discharge path for timing-capacitor C5 once the amplifier is on. You might need to alter the values of R9 and C5 to suit your relay.

The amplifier circuit was assembled using point-to-point wiring. The op-amp's large heat-sink is a handy mount for components such as the relay.

Of course, both the crossover and the amplifier require power. The power supply shown in Fig. 12 does the trick very well. The amplifier supply portion is a basic filtered, full-wave rectified type without active regulation. Dropping resistors (R11 and R12) and 15-volt Zener diodes (D1 and D2) receive power from the amplifier supply to power the crossover circuit. This circuit was also built using point-to-point wiring and mounted onto the amplifier's heat sink.

(Continued on page 94) 37

All about PARALLEL-PORT

It's pretty obvious to just about everyone nowadays that computers are pretty useful devices. However, if you're an electronics hobbyist that knows how to get them to talk to your projects, they can be great fun as well as functional. At this point, some of you who aren't too familiar with computers might think I'm about to launch into a "rocket-scientist level" discussion on computer buses, etc., but relax; I'm definitely *not* going to do that. Instead I'd like to explain how a basic parallel port works.

Parallel ports are easy to work with and can be hooked up to just about any project that you want to control with your computer. (For examples see *Build the Bitgrabber*, **Popular Electronics**, December 1990, and *The Portmaster Home-Automation System*, **Popular Electronics**, February 1991.) The trick is to know how they work.

Here I'll present some information on parallel-port signals and port operation so that the more ambitious among you can design and build parallel-interfacing projects. I'll also include some information on parallel peripherals so that at the very least, you should be able to diagnose parallel-cable problems. I'll also discuss a couple of basic and common wiring jobs to give you a feeling of how easy it can be to wire a simple cable. Keep in mind that the information and techniques presented here apply to just about any parallel device (plotters and special test equipment, for example) and not just printers.

The Common Computer Interface.

Since the parallel interfaces on most computers are pretty close to identical, for now let's take the most universal one (found on most IBM-compatible plug-in cards) as an example. The information should be sufficient to give you a good understanding of how any parallel interface operates—in fact, although the connectors may vary, almost every signal line is the same—so hang on even if you don't have a compatible.

By the way, **don't try to hook up parallel equipment on the basis of the pin descriptions alone; Doing so will more than likely damage your equipment. Please wait until after you've read all the cautions presented in the course of this article before getting under way.**

Oddly enough, most parallel ports on the back of IBM-compatible computers

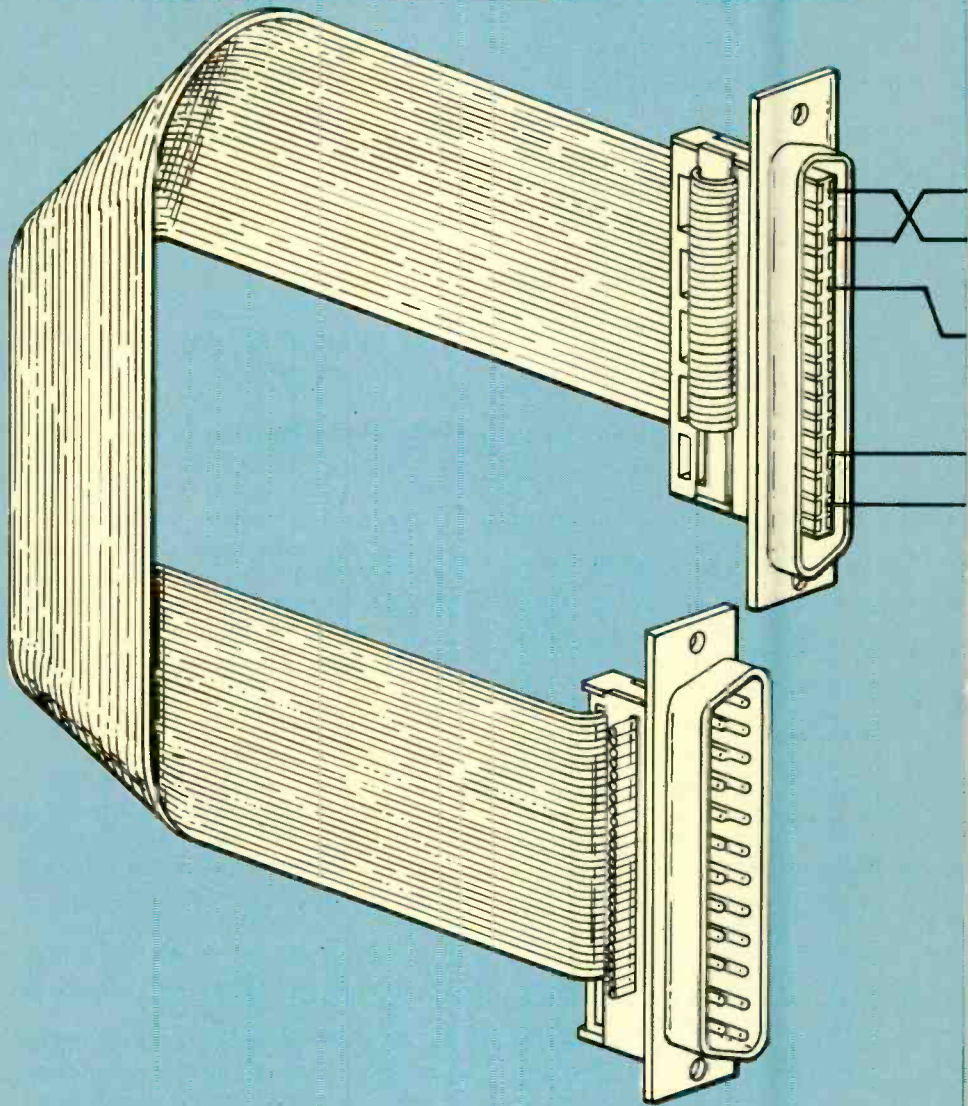

sport a DB-25 connector. That's odd because the DB-25 connector is the standard connector used for serial interfaces. The connector is usually female (having holes instead of pins) to distinguish it from any serial connectors, which are normally male, that may also be on the computer. The Amiga 1000, however, uses a male DB-25 connector for its parallel interface (anything to be different).

The function of each pin on the DB-25 connector is shown in Fig. 1. The signals that occupy those pins can be broken down into four basic groups: grounds, data outputs, handshaking in-

puts, and handshaking outputs. In Fig. 1, the grounds are denoted by circles, handshaking inputs are indicated by arrows pointing to the connector, and outputs (both for data and handshaking) have arrows pointing away from the connector. (Note that some of the lines have a standard abbreviation, which is shown in parenthesis.)

The Ground and Data Lines. The grounds perform two jobs: For one, they link the signal grounds of the two devices being connected so that they can share a common ground to use as a signal reference.

SIGNALS

BY JOHN YACONO

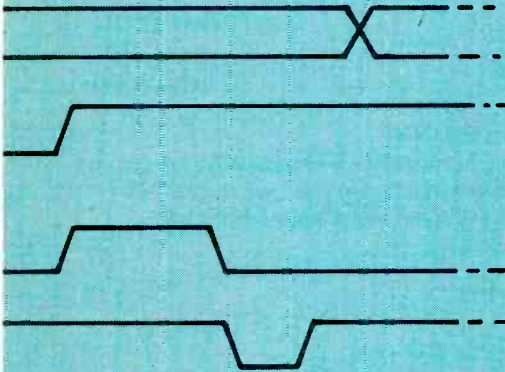

In order to build projects that take advantage of your computer's parallel port, you need a thorough understanding of what signals it transmits and receives, and how they are related.

Second, since the connection between the two devices is often made via ribbon cable, the grounds (often called ground returns when discussed in this context) act as shields for the more important lines. For example, the wire connected to pin 19 on a ribbon cable would shield pin 6 from pin 7, and vice versa. That prevents D4 signals (whose function I'll get to in a bit) from capacitively affecting the D5 line, and vice versa. In quality cables not made with ribbon cable, each ground return is twisted around a signal line, forming a twisted pair, to provide a little shielding.

As their name implies, the data out-

puts transfer information from the computer to a parallel peripheral. That is done eight bits (one byte) at a time using pins 2-9. Bit D0 is considered the least-significant bit (or LSB) and D7 is the most-significant bit (or MSB). (Note: some computer manuals use designations D1-D8 instead of D0-D7.)

Some computer ports don't support the MSB. Of course, in such cases, your projects should not be designed to look for it. Similarly, some peripherals only use 7-bit data. In such circumstances, the MSB is either ignored or sometimes used as a parity bit. You will need fairly sophisticated software to provide parity bits, so you may wish to disable the device's parity checking (see the owner's manual for doing so).

The bits, as well as all the other signals, are represented by standard TTL voltage levels: a signal between 2.4 and 5 volts is a high or a binary 1, anything between 0 and 0.8 volts is a low or binary 0. Anything between 0.8 and 2.4 volts is considered invalid data.

Data Handshaking. Since a computer is much faster than any peripheral it communicates with, it could easily transmit more data than a peripheral could handle. So peripherals use special signals to tell the computer to momentarily stop sending data when they have enough to work with. That gives the peripheral a chance to catch up and the computer can perform some other task in the meantime. Once sufficiently caught-up, the peripheral tells the computer to transmit more data and the process continues.

That computerized game of "red light, green light" is accomplished by sending signals along wires dedicated to that purpose. The process of using signals to control the flow of data is called "handshaking," so the signals used for that purpose are called "handshaking signals."

The strobe, busy, and acknowledge signals are the most important handshaking signals. To help explain how they are related and control data flow, take a look at Fig. 2. There the eight data lines are shown lumped together at the top as a single band. Don't let that throw you, the value of the individual bits is not important. What is important is the time at which data undergoes transitions (represented by the crossed lines) and the time it remains constant (the bands).

The data that is being output on lines D0-D7 starts to form at time t1, and it settles down and is ready for use by time t2. A moment later (at t3) the computer sends a momentary low-going pulse (called the "strobe signal") to the peripheral to indicate that the data is ready and waiting on the data lines. After t3, the peripheral may respond in one of two ways: it can pull the busy line high until it's ready for more data, or it can wait till it's used the new data and then send a low-going acknowledge pulse to the computer when it wants more. Either response keeps the computer from proceeding until the peripheral says it's ready. (There are a few peripherals that halt the computer in both ways, although to do so is a little redundant.) After the busy line goes low or an acknowledge pulse is received, the computer will set up the data lines for the next byte, and the procedure repeats.

The busy line is sometimes used to halt the computer for other reasons. For example, if it's out of paper or "off line" (which I'll explain momentarily).

Status Handshaking. Along similar lines, sometimes parallel peripherals (especially printers) use dedicated wires to indicate their status. Since the status of a peripheral can affect the flow of data, this can also be considered a form of handshaking. For example, if a printer, plotter, or oscillograph needs to tell the computer it's out of paper, it can do so by holding the "paper empty" line (look back at Fig. 1) high until its supply is replenished. That keeps the computer from sending data to the peripheral when the device is incapable of doing anything with it. This feature is supported by most IBM-style parallel ports, but not on many other home computers.

Also, a peripheral can tell the computer it's powered-up and on line by holding the "select" line at pin 13 high (note there are two select lines in Fig. 1, don't confuse them). This is sometimes a necessary signal line because some peripherals can be powered up, but taken off line by sending them a special "deselect" character (denoted in printer manuals as DC3 or XOFF, which has the ASCII value 19). Such equipment can be brought back on line by sending them a "select" character (denoted as DC1 or XON, which has the ASCII value 17). You should look in your

peripheral's owner's manual or programming manual to see if that feature is supported.

A peripheral can even cry out for help by holding the error line low. Like the busy line, sometimes peripherals use the error line to indicate that they are simply off line or just out of paper.

The computer can also make special requests or provide configuration data by sending signals from the remaining handshaking outputs. (Keep in mind that a peripheral may contain DIP switches that can configure it to ignore the computer's requests.)

For example, on some peripherals, the select/deselect feature can be enabled and disabled by the computer port. For those devices, if the computer holds the select output line at pin 17 (not to be confused with the select input line at pin 13) high, the DC1/DC3 feature is enabled. Holding that line low disables the feature.

Further, by holding the autofeed line low, the computer tells the peripheral to accompany each carriage return with a line feed (i.e., the computer informs the peripheral that it will probably not be sending line-feed characters so the peripheral should step in and add them).

Also, if the computer sends a low-going pulse through the initialize line (technically referred to as the "input-prime" or "IP" line), a peripheral paying attention to that line will reset itself. What that means is that the peripheral will enter some default configuration, and usually act as though it has just been turned on. As powerful as it is, this line is supported by IBM-compatibles but little else because there are often special commands that can be sent across the data lines to accomplish the same thing.

The Peripheral End. Although I've covered almost all of the signals that you're likely to encounter, there are still some things that you should know about what you might find on the peripheral side of a cable. The additional information should help you to make your own cables for already-built peripherals.

A female 36-conductor connector is the most common termination found on parallel peripherals. The standard pin functions for that connector are shown in Fig. 3. The arrows pointing toward the connector indicate the pin is

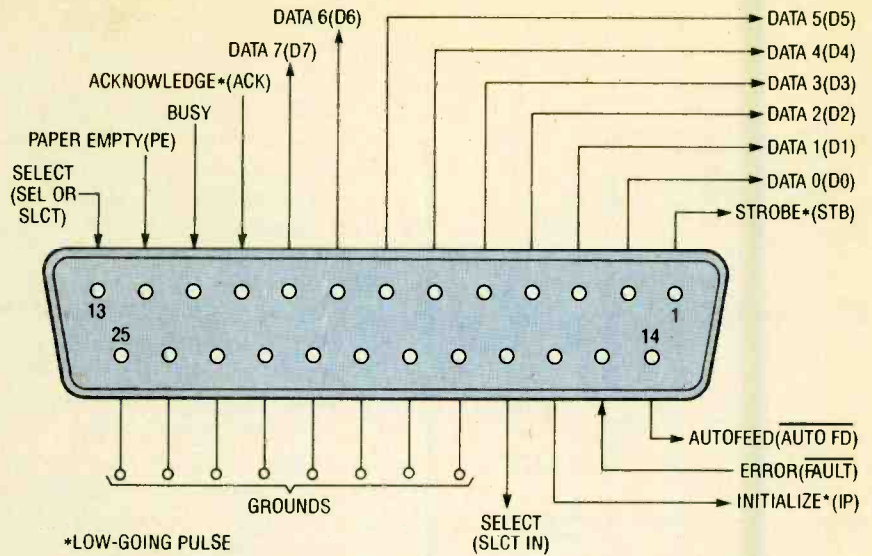

Fig. 1. The parallel port on most IBM-compatible (and some non-compatible computers) looks like this. The arrows pointing away from the DB-25 connector are outputs, the ones pointing to the connector are inputs, and the remaining pinouts (shown with circles) are grounds.

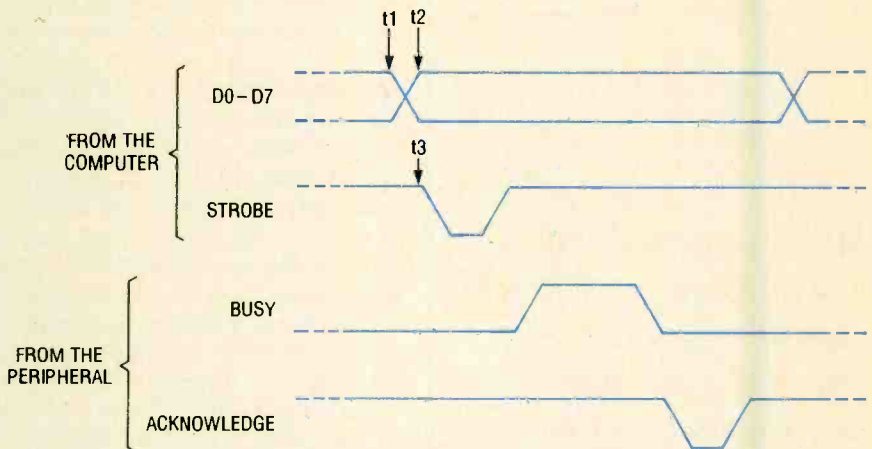

Fig. 2. Once a computer sets up the data on the parallel-data lines, it signals the peripheral with a low-going strobe pulse. The peripheral responds by sending the busy line high until it's ready for more, and/or it waits until its finished with the data and sends a low-going acknowledge pulse.

an input to the peripheral, arrows pointing away from the connector signify peripheral outputs, and the circles indicate grounds.

Note that this connector supports a few more functions than the DB-25 connector. To name them, there is a chassis ground and two 5-volt lines. They are not supported by all parallel equipment. Both the chassis ground and the 5-volt lines can cause trouble if connected unwisely, so later I'll present some tips on using them properly.

The 5-volt lines are provided by some peripherals to hold a handshaking line high if needed. For example, let's say that a computer port doesn't generate

a high for the autofeed signal, but the peripheral needs that line high to work as desired. The cable preparer can resolve the problem by tying the autofeed line to either pin 18 or 35 at the peripheral end of the cable.

Some parallel computer ports use this connector with the pin functions as shown (although the arrows in Fig. 3 should be reversed) instead of the DB-25 connector mentioned earlier. If you find that connector on both the computer and the peripheral, you may be tempted to use a straight-through cable (a cable that connects them pin-for pin)—don't! It can damage both pieces of equipment. I'll discuss how to

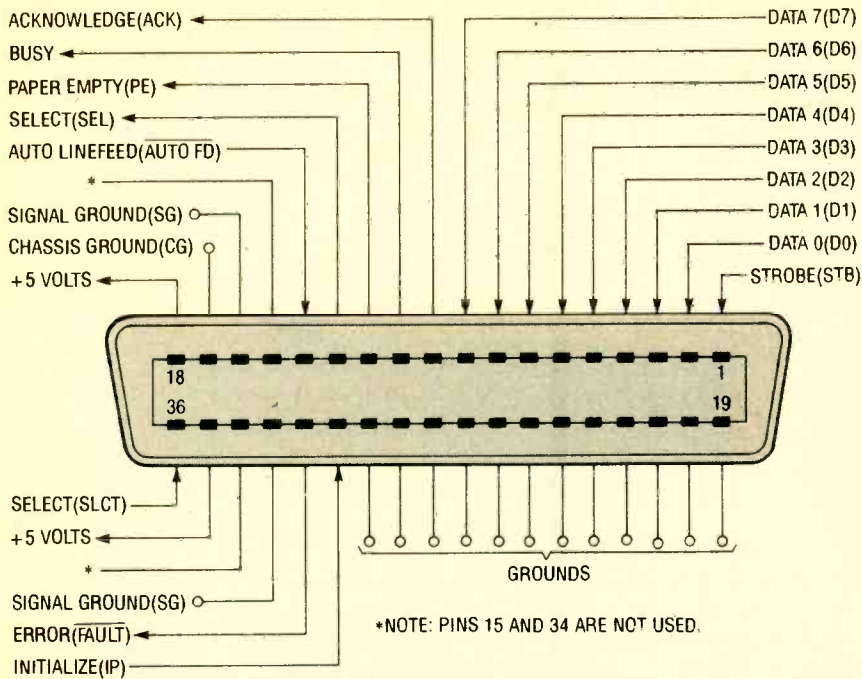

Fig. 3. These are the pin assignments for a Centronics-compatible peripheral. The functions are the same as those found on the DB-25 connector shown in Fig. 2, but there are a few more grounds and two 5-volt supply pins.

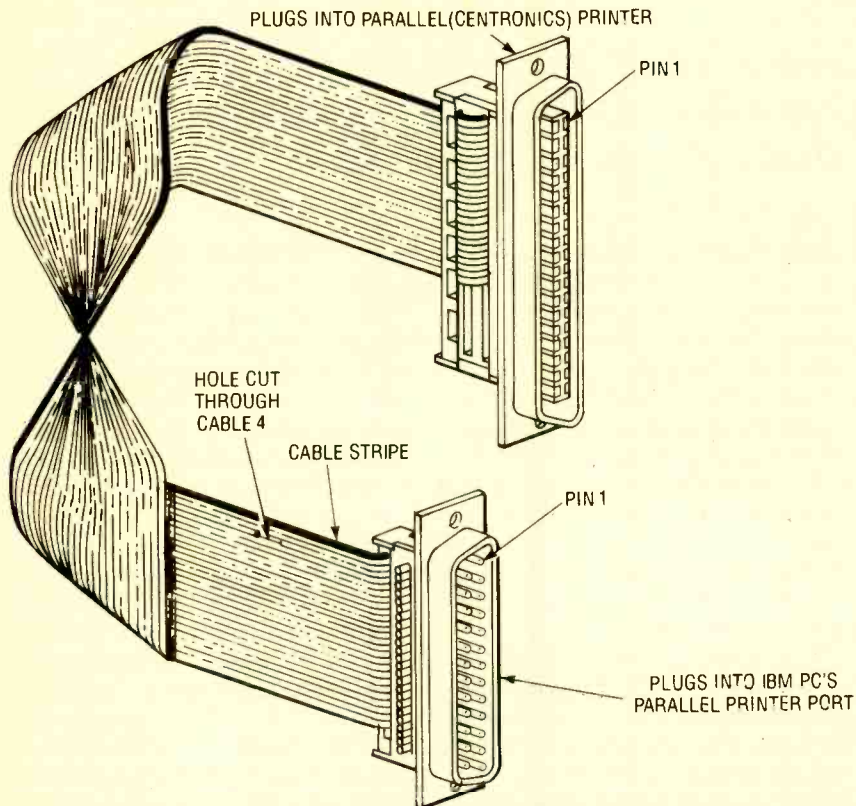

Fig. 4. It's very easy to wire up a gimmick cable to attach an IBM-compatible port with a Centronics-compatible peripheral using two IDC connectors and some ribbon cable. The trick is to cut a section out of the fourth wire in from the pin-1 wire.

build the right cable for that situation after I present a couple of safety tips.

Apply Caution. Before you jump right into cabling or building interface proj-

ects, a few words to the wise are in order: Caution should be used when dealing with a parallel interface. Although the handshaking lines of parallel ports are open-collector types (*i.e.*,

they can be shorted to ground) the data outputs of a PC can be harmed by short-circuits. Furthermore, all of the lines can be harmed by inordinate (greater than 5 volts) voltages.

The key to safely interfacing TTL equipment is to know the inputs from the outputs, so that you can connect the output of one device to the input of another, and *vice versa*. If you are wise, you'll always double-check your wiring before powering-up your equipment.

Two Standard Cabling Jobs. The simplest parallel job that you could ever do is to create what I call an "almost straight-through cable." Such a cable can be used to connect a computer to a peripheral as long as they both have a 36-pin parallel-style connector and conform to the Centronics standard as described earlier. If both devices have the right connector, but you are unsure about the pin functions, check the pins with a voltmeter to see if they conform to the standard. If they don't come very close, you might have to investigate their documentation for some help—an almost straight-through cable simply won't do.

If it looks like both devices are Centronics compatible, then wire a cable that will connect them pin-for-pin except for pins 17, 18, and 35. Leave those three pins unconnected at both ends. Pins 18 and 35 should not be connected between the devices because they might connect the 5-volt supply bus of both devices together. That causes their 5-volt supplies to duel for control, which can (at the very least) blow a fuse. It could even cause a fatal breakdown in both devices.

Leaving pin 17 on the two devices unconnected keeps their chassis grounds isolated from one another. That isolation improves the chances that one of the devices will survive in the unlikely event that the other one develops an internal short that pulls its chassis up to the line voltage before a circuit breaker or fuse has a chance to kick in. It also allows a device that has its chassis ground connected to its signal ground to be interfaced with equipment that must keep those grounds separate.

By the way, connecting pins 15 and 34 is optional as those pins are not supported by the standard. If you are using insulation-displacement connectors (Continued on page 94)

The Incredible Hot Canaries

BY JOHN CLARKE

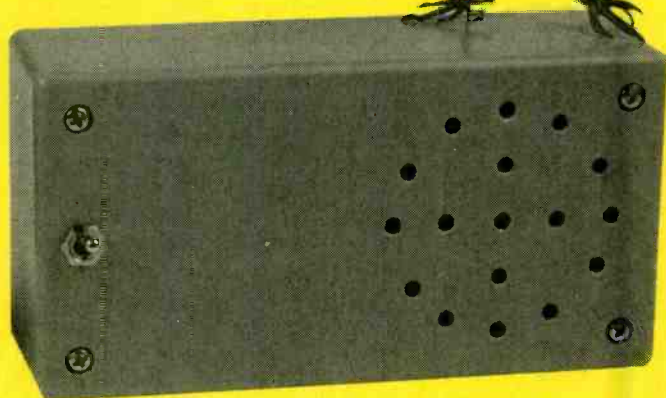

This novel circuit will emulate the sounds of two birds singing together in a way that will intrigue you. They start slowly and then sing rapidly increasing trills as they compete with each other for virtuoso supremacy.

Do you love the song of birds around your home, but hate the idea of caging birds? Perhaps you can't stand the thought of cleaning out the cage—birds can be messy little critters. Whatever the reason for not inviting our feathered friends into your home, you can still enjoy their melodic songs by building this electronic bird-song circuit. The dual-bird melody produced by this project will both entertain and amaze your friends, and when you don't feel like listening to them, you can simply turn them off.

The idea of producing artificial bird songs is not new; artificially produced bird song has been used in clocks dating back several centuries. And many bird-song circuits have been devised in the last decade or so. But it's been a while since we've seen or heard of any new arrivals, so we thought, "Why not build a new circuit?"

We could have been really clever and built the unit into a fancy gilt cage

This story first appeared in *Silicon Chip, Australia* (February, 1990); reprinted with permission.

complete with an ornamental bird. Instead, we built the circuit into a standard project box, bedecked with a couple of ornamental birds—and dubbed it *Hot Canaries*.

Using just two garden-variety IC's and a handful of resistors, capacitors, and other support components, our circuit can emulate the sound of two canaries happily chirping and trilling away. The period of trilling and chirping, and the pitch of each bird is different, creating a random effect as the birds come in and out of chorus.

One of the problems of producing such a bird-song circuit is that so many parameters have to be controlled—the pitch, rate of chirps and trills, and the duration of the trills. Such a circuit tends to be very complicated because certain sections of the circuit will have to perform more than one function. Our approach was to try and come up with a good compromise—produce an uncomplicated circuit that would also be reasonably easy to build and troubleshoot if necessary, while being powered from a battery.

About the Circuit. Figure 1 is a complete schematic diagram of the circuit, which is built around two LM324 quad op-amps. Essentially, the circuit consists of 7 oscillators connected in such a manner so as to emulate the sound of two canaries singing. One oscillator (built around U1-a) serves as a switching control, which turns the canary sounds off for a short while after a minute or so of chirping.

The remaining six oscillators make up two almost identical circuits—consisting of U1-d/U1-c/U2-c and U1-b/U2-a/U2-b—whose outputs are mixed together and amplified by a single transistor that is used to drive a small speaker. The circuits differ only in the values of two pairs of capacitors—C2/C3 and C8/C9.

Each op-amp is configured for Schmitt-trigger operation by the resistor connected between its output and its non-inverting input. Each Schmitt trigger was then made to operate as an oscillator by connecting a resistor/capacitor network between its output and inverting input. Voltage-divider net-

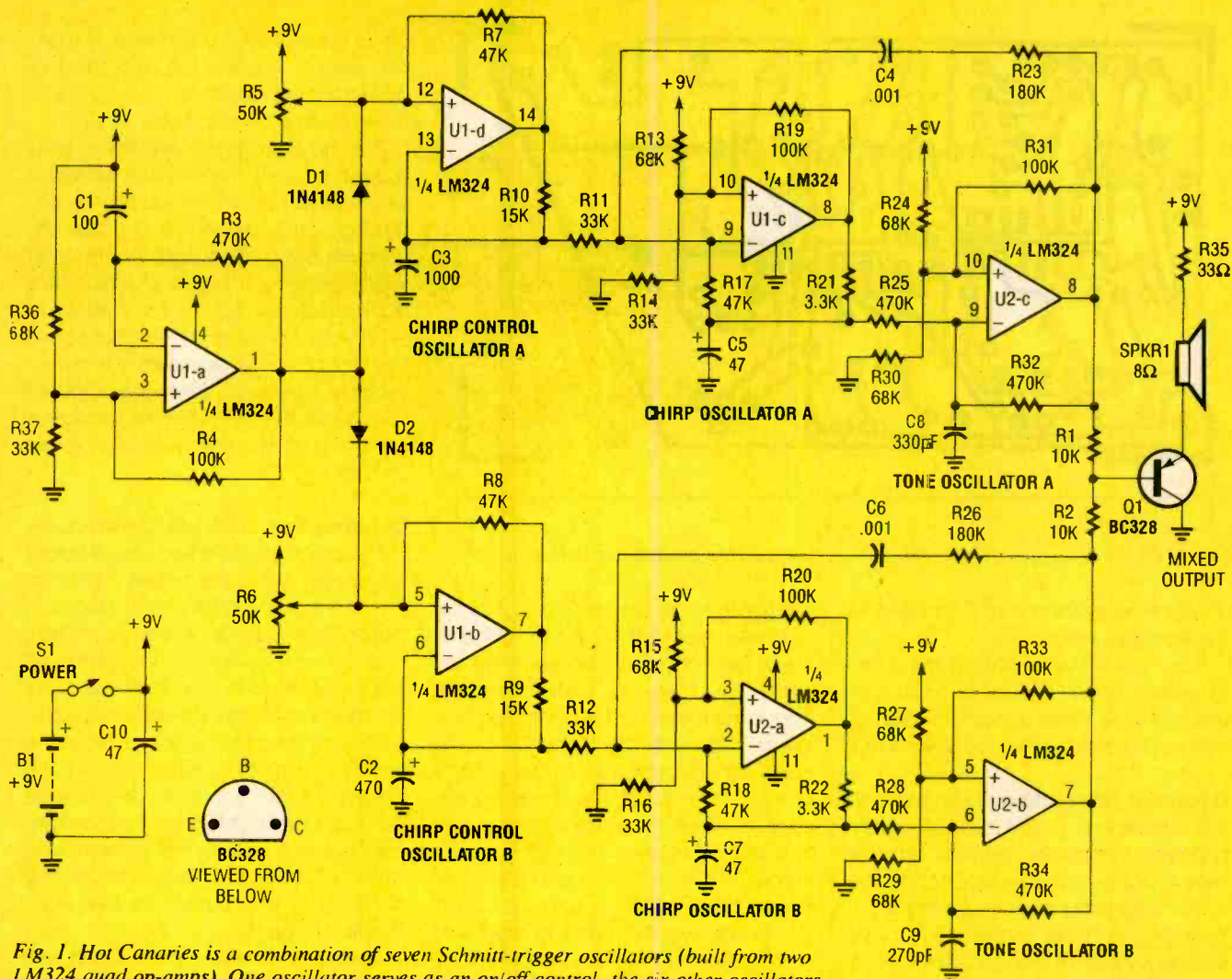

Fig. 1. Hot Canaries is a combination of seven Schmitt-trigger oscillators (built from two LM324 quad op-amps). One oscillator serves as an on/off control, the six other oscillators generate the sounds of two canaries.

PARTS LIST FOR HOT CANARIES

SEMICONDUCTORS

U1, U2—LM324 quad low-power op-amp, integrated circuit
 Q1—BC328, ECC-159, or equivalent, PNP silicon transistor
 D1, D2—1N914, 1N4148, or equivalent small-signal silicon diode

RESISTORS

(All fixed resistors are 1/4-watt, 5% units.)
 R1, R2—10,000-ohm
 R3, R25, R28, R32, R34—470,000-ohm
 R4, R19, R20, R31, R33—100,000-ohm
 R5, R6—50,000-ohm miniature PC mount trimmer potentiometer
 R7, R8, R17, R18—47,000-ohm
 R9, R10—15,000-ohm
 R11, R12, R14, R16, R37—33,000-ohm
 R13, R15, R24, R27, R29, R30, R36—68,000-ohm

R21, R22—3300-ohm
 R23, R26—180,000-ohm
 R35—33-ohm

CAPACITORS

C1—100-µF, 16-WVDC, electrolytic
 C2—470-µF, 16-WVDC, electrolytic
 C3—1000µF, 16-WVDC, electrolytic
 C4, C6—0.001-µF, metallized polyester
 C5, C7, C10—47-µF, 16-WVDC, electrolytic
 C8—330-pF, ceramic or polystyrene
 C9—270-pF, ceramic or polystyrene

ADDITIONAL PARTS AND MATERIALS

SPKR1—8-ohm speaker
 S1—SPDT toggle switch
 B1—9-volt transistor-radio battery
 Printed-circuit board materials, enclosure, 9-volt battery holder and connector, wire, solder, etc.

works, consisting of R13/R14 and R24/R30 for the upper half of the circuit, and R15/R16 and R27/R29 for the lower half, set the upper and lower thresholds of the chirp and tone oscillators.

Each oscillator then works as follows: When power is first applied, the capacitor at the inverting input has no voltage across it and the op-amp's output is high. The capacitor starts to charge via its associated resistor until it reaches the threshold level set at the non-inverting input.

When the charge on the capacitor equals the reference, the op-amp output goes low and the capacitor begins to discharge until it reaches the lower threshold voltage. When the lower threshold is reached, the op-amp's output again swings high and the cycle begins again, producing an approximate square-wave at the oscillator's output. That signal is then fed across a resistor/capacitor network, producing a

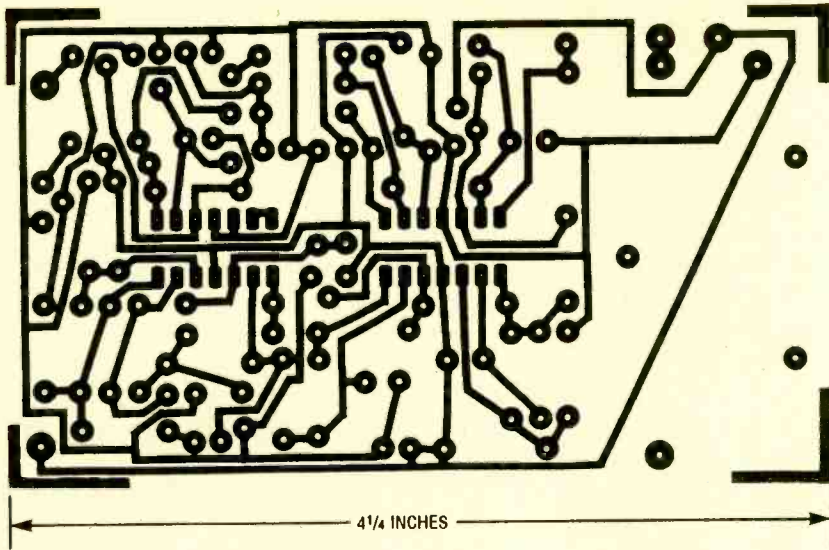

Fig. 2. Here's an actual-size foil pattern for Hot Canaries' printed-circuit board.

sawtooth waveform that is applied to the inverting input.

Now that we've discussed the basic operation of the individual oscillators, let's see how those oscillators interact with each other to produce bird a song.

Oscillator Interaction. To understand the interaction of the oscillators that produce the canary sounds, let's first look at U2-b—the last op-amp in the lower bird-song circuit—which is labelled as a "tone oscillator." Its basic frequency is set at around 2–3 kHz. Note that if R26 and R34 (which tie the oscillator output to other parts of the circuit) were removed, U2-b would just oscillate continuously at around 3 kHz or so. However, it wouldn't sound much like a canary.

To produce a chirping affect, U2-b is

modulated at a rate that starts at about 1 Hz and rises until U2-b runs continuously. The "chirp" frequency is generated by U2-a. To get the chirp frequency to rise, U2-a is controlled by a lower-frequency oscillator, U1-b (the chirp-control oscillator). As the voltage across C2 increases, the chirp frequency rises. When the chirp oscillator rises to its highest value, an RC network, consisting of R26 and C6 connected between pins 7 of U2-b and 2 of U2-a, causes the two oscillators to modulate each other so that the output of U2-b "warbles" just like a canary.

The circuit formed by op-amps U1-c, U1-d, and U2-c—which produces the second canary sound—is virtually identical to the one formed by U1-b, U2-a, and U2-b. The outputs of upper and lower halves of the circuit (at U2-c and

U2-b, respectively) are mixed via two 10k resistors (R1 and R2) and used to drive transistor Q1, which, in turn, drives a miniature 8-ohm speaker (SPKR1).

The 7th (and final) oscillator, built around U1-a, is the control oscillator and is used to turn the two sound-producing circuits on and off. Op-amp U1-a initially has a low output for about 60 seconds since the 100- μ F capacitor has to discharge from +9 volts down to +2.3 volts. From then on, its output goes high for about 20 seconds, low for 20 seconds, and so on. When the output of U1-a is low, the chirp-control oscillators (U1-b and U1-d) are enabled via diodes D1 and D2.

Construction. The Hot Canaries circuit was built on a printed-circuit board measuring 4 1/4 x 2 1/2 inches. A foil pattern for the printed-circuit board is shown in Fig. 2. Once you've etched and drilled your board, and gathered the parts listed in the Parts List, construction can begin. Start by installing IC sockets at the locations indicated in the parts-placement diagram (Fig. 3). It is suggested that you install the passive components (resistors and capacitors) first, beginning with the resistors and then the capacitors. Be sure to observe the proper orientation for the electrolytic capacitors.

Follow the passive components with the semiconductors, beginning with the two diodes; keep in mind that those units must be properly orientated. After that, install transistor Q1, but do not place the IC's in their sockets at this point. Next install a 9-volt, transistor-radio-battery holder on the board where indicated. Connect a 9-volt battery connector to the board. Connect S1 to the board through short lengths of hook-up wire. Do the same for the speaker. Now lay the board to the side and prepare the enclosure that will house the circuit.

The author chose to house the circuit in a plastic enclosure measuring about 6 x 3 1/8 x 1 7/8 inches. Prepare the enclosure by first marking the location of the speaker on the inside of the enclosure's lid using a permanent marker. Within that area, drill several holes in the lid to allow the sound to exit the enclosure. Also drill a hole in the lid away from the speaker location for switch S1. Mount S1 and glue the speaker to the inside surface of the lid. Install the IC's in

(Continued on page 94)

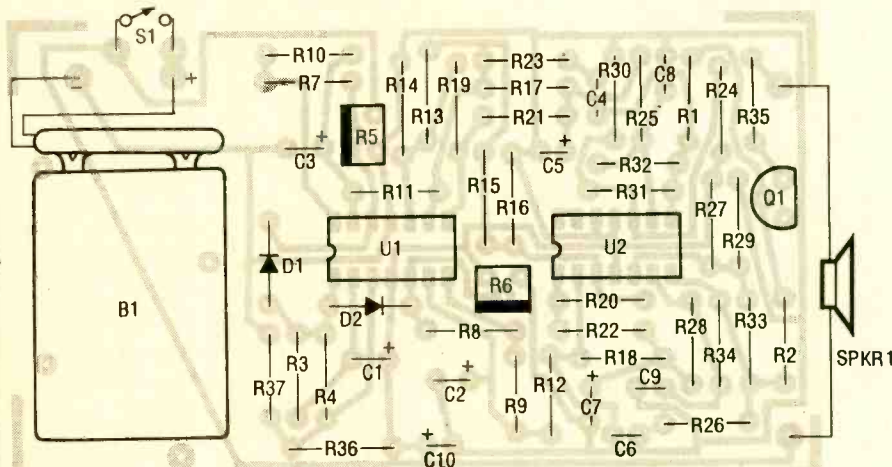

Fig. 3. Assemble the printed-circuit board using this parts-placement diagram as a guide. Take care to observe the proper orientation when installing the electrolytic capacitors and the other polarized components.

GIZMO

JANUARY 1992

VOLUME 5,
NUMBER 1

A CHRONICLE OF CONSUMER ELECTRONICS

Video is in the Air

ARCHER WIRELESS AUDIO/VIDEO DISTRIBUTION SYSTEM. From: Radio Shack, 700 One Tandy Center, Fort Worth, TX 76102. Price: \$99.95

There is a small segment of our population that isn't troubled by such tasks as setting up audio/video systems. Chances are, as a **Popular Electronics** reader, you belong to that select group of people who are adept at wiring electronics components and are relatively handy at the same time. But even though you aren't likely to leave the hooking up of a new VCR to someone else, the idea of running long lengths of cable—through rooms on different floors—probably doesn't appeal to you any more than it does to us. If you live in a leased apartment, you might even be forbidden to make such cable runs. There are occasions when a temporary run of cable would come in handy—when the big game is on but we can't neglect some chores that require that we work in the garage or the basement workshop, for instance.

Thanks to a recent FCC decision, there's now an easy, elegant solution to those wiring problems—wireless video transmitters and receivers. *Radio Shack* offers one such solution, their *Archer Wireless Audio/Video Distribution System*.

The system consists, naturally enough, of two units: a transmitter and a receiver. The transmitter accepts input from a VCR, cable box, laserdisc player, or other device, and transmits the audio and video signals to the receiver, which outputs the signals to a remote TV. Both the transmitter and receiver are quite small, about $6\frac{3}{4} \times 5 \times 1\frac{3}{4}$ inches, and each sports a small whip antenna, about 8 inches long when fully extended.

The transmitter has only a single control on the front panel: a power switch. The rear panel is a little busier, sporting four input connectors and three slide switches. Three of the inputs are for direct video and stereo-audio input. The fourth is an RF input for connection to a cable box, VCR,



CIRCLE 50 ON FREE INFORMATION CARD

or other device with an output on Channel 3 or 4. One of the rear-panel switches selects the input channel, a second selects between the RF and A/V line inputs, and the third selects the output frequency of the transmitter—two are available.

The receiver is equally simple. The front panel has two controls: a power switch and fine-tuning control. The rear panel features two switches and two "F"-type RF connectors. One RF connector is for output to your TV—on either Channel 3 or 4, as selected by one of the switches. The other "F" connector is for the antenna or Cable input, if any, that you would normally use for the remote TV. The second switch is to select the operating frequency; it should be set to the same position as the transmitter.

We certainly like the idea of the distribution system. We'd like to be able to occasionally watch a videotape in a room where we don't have a VCR. But, even better, we'd like to be able to use our portable TV in the basement and garage—nowhere near our cable-TV and antenna wires—especially as we head to the end of

the football season. (Rabbit ears are not much use in a fringe area.) With the Archer wireless A/V distribution system, we could easily add a TV to our kitchen or laundry room without running extra wires. And the system could be set up to work with a security camera, or even as an A/V baby monitor!

We found, however, that we have several reservations about the video-distribution system. First, its range, which is specified as being "up to 100 feet," is not that far in real-life situations. The 900-MHz signals seem to be attenuated as they pass through walls and floors. In our tests, the picture quality was excellent when the receiver was located in a room adjacent to (either directly next to, above, or below) the transmitter. In a room downstairs and across the house or two floors down, picture quality suffered. And in a detached garage roughly fifty feet from the house, you simply won't get the same picture as you would using wires. While it's better than missing the game, we were tempted to run into the house so that we could see whether the

(Continued on page 7)

TURN PAGE FOR CONTENTS

GIZMO/Page 1

This month in GIZMO

Radio Shack Archer Wireless Audio/Video Distribution System	pg. 1
FUNEX Motion Converter Exercise-Gear Interface	pg. 2
Cobra Model 39 Plus S.O.S. Portable CB Radio	pg. 3
Sanyo Pulse Meter Heart-Rate Monitor	pg. 4
Covox Sound Master II PC Sound Board	pg. 5
Sony CCD-F501 8-mm Camcorder	pg. 6
Compact Disc Polish	pg. 8
Personal Organizer	pg. 8
Headphones	pg. 9
In-Ceiling Speaker	pg. 9
Chopper Fone	pg. 10
Extra-Density Disks	pg. 10
LD/CD/CDV Player	pg. 10
Sensor SP-386SX PC	pg. 10
Anti-Glare Filter	pg. 11
DAT Recorder	pg. 11
MicroSmart Video Battery Charger	pg. 11
Stereo VCR	pg. 11
CD Traveler	pg. 12
Info Bank	pg. 12
Video Light	pg. 12
World Band SW Receiver	pg. 12

Gizmo is published by Gernsback Publications, Inc., 500-B Bi-County Blvd., Farmingdale, NY 11735. Senior Writers: Chris F. O'Brian, Teri Scaduto. © Copyright 1991 by Gernsback Publications, Inc. Gizmo is a registered trademark. All rights reserved.

Fun and Gains

MOTION CONVERTER EXERCISE-GEAR INTERFACE. Manufactured by FUNEX Inc., 118 West Chestnut Street, Lancaster, PA 17603-3518; Price: \$99.95.

It's an unfortunate fact of life that those things that are unhealthy—or, at best, totally unproductive—are the ones that are most appealing—or, in the worst case, addictive. For instance, there are no carrot commercials taunting, "Bet you can't eat just one." But just try to eat only one potato chip or refrain from polishing off the whole box of cookies. Similarly, think how hard it is to watch just one television show and get up before the next one starts—and how difficult it is to play one video game and not try to top your score by playing again, and again, and again . . .

On the other hand, we know very few people who've encountered the same problem when it comes to self-improvement. It's all too easy to skip that aerobics class, or decide not to go for today's jog because it's raining (or snowing, or too cold, or too hot . . .). And there are few modern American households that don't have fitness skeletons in their closets—old treadmills, stair-climbing machines, rowing machines, and exercise bikes gathering dust. The incentive to lose weight simply can't withstand the boredom of exercising in place, day after day.

That's why, year after pudgy year, "Lose weight, get into shape" appears at the top of so many New Year's Resolutions lists. If you're about to start trying (again) to lose those extra holiday pounds, there are plenty of methods from which to choose. You could join a health club, sample one of the thousands of quick-weight-loss diets advertised on daytime TV, or invest in yet another piece of equipment that *maybe* you'll be able to stick with this time. If only someone could come up with a way to make exercising as addictive as, say, Super Mario Brothers.

Someone has taken just that approach to exercise, by merging videogames with exercise equipment. FUNEX ("put the FUN into EXercise") Inc.'s *Motion Converter* links your exercise gear to your PC. It comes with a computer game called *Final Quest Challenge* and a *Fitness Tracking System*, both on one high-density diskette. To move your player in the game, you must pedal (or row, or ski, or walk—but we'll stick with the exercise bike example throughout). The faster you pedal, the faster the screen action moves, and the better your chances of getting a high score—a new incentive to fitness.

The *Motion Converter* requires a piece of exercise equipment with an electronic speedometer, and a PC with a high-density



CIRCLE 51 ON FREE INFORMATION CARD

disk drive and a VGA monitor. (We're not sure why—the graphics certainly aren't VGA-quality.) You must also have enough room directly in front of your PC to fit an exercise bike.

The package consists of the *Motion Converter* itself (which appears to have been made from a standard telephone wall-jack), computer cable, a female serial port connector, fastener strips, and three "Flex-Fire" buttons. The *Motion Converter* is attached to the wire for the bike's speedometer (replacing the speedometer) and is linked to your PC's COM 1 serial port via the provided cable. The Flex-Fire buttons come on stretchy black fabric bands that wrap snugly around the bike's handlebars. The green button controls left movement, the blue, right movement, and the pink, shooting and selecting game options.

A couple of problems got in our way. First, the machine we wanted to use for our tests is an older, XT-compatible computer. Although it has a 3½-inch drive, it's a low-density one. We had to convert the disk to low-density before we could use it. (We've never seen software distributed on 1.44-megabyte floppies before.) Second, our computer's serial port featured a standard 25-pin "D" connector. We had to go out and get a 25-to-9-pin adaptor before we could hook things up. We think that one should have been included in the package.

Once everything is properly connected and installed, the three Flex-Fire buttons are used to select game options and player information from the on-screen menus. By letting the *Motion Converter* know your sex and approximate weight, it will calculate the distance traveled and calories burned during each game. You can choose from three levels of skill, can calibrate the

(Continued on page 7)

A Helping Hand-held

COBRA MODEL 39 PLUS S.O.S. PORTABLE CB RADIO. Manufactured by Dynascan Corporation, Cobra Electronics Group, 6500 West Cortland Street, Chicago, IL 60635; Price: \$89.95.

There was a time, in the not-too-distant past, when, if your car broke down one night on the highway, you could be fairly certain that a good Samaritan would come along and offer either some mechanical help or a ride to the nearest service station. Today, unfortunately, it's just as dangerous for a would-be do-gooder to stop as it is for a stranded motorist to open the door to a stranger on a dark roadside. We've all heard horror stories of thieves posing as victims of flat tires or empty gas tanks to lure a good-hearted traveler to the side of the road where they can relieve him of his wallet, or even steal his car. And it's all too common, especially in urban areas, for stranded motorists to become victims of thieves while waiting for help, or for their cars to be "stripped" as they walk to the nearest gas station.

The problem isn't so pressing for those with cellular phones—help is just a call away. But not everyone can afford cellular phone service and many people (particularly those who work at home or who have teenaged children) welcome driving time as a respite from constantly ringing phones. There is an alternative: citizen's band (CB) radio.

Citizen's band radio has had its ups and downs. CB works like a wireless version of those old-fashioned telephone party-lines, allowing two or more people to converse over short distances. Introduced back in 1948, it got off to a rocky start, mainly because in its original form it used the UHF bands at a time when there was no affordable equipment that could use those frequencies. A decade later, the FCC opened up the Class D 27-MHz band, which was a step in the right direction. CB's became popular primarily with interstate truckers and other travelers who could use their radios to find out traffic and weather conditions on the road, or to call for help in an emergency. It took the gasoline shortage and truckers' strike in the mid-70's to bring CB to the public eye, and sales began to soar, peaking at about 11 million units in 1976. Some of the colorful CB dialect made its way into common usage, thanks in part to popular movies like *Smokey and the Bandit* (and its two sequels). But, as is all too common, the industry expanded too quickly. The FCC expanded the band to 40 channels and banned the sale of 23-channel units at the

end of 1977, resulting in sharp declines in sales and general upheaval in the industry. According to the Electronic Industries Association, much of the current popularity of CB stems from portable units designed primarily for emergency use.

Cobra, a leader in the citizens-band field for three decades, has responded to the changing times by introducing the *model 39 Plus S.O.S.*, a self-contained, handheld CB system for roadside emergencies. Actually, the unit is technically not a handheld, since it runs not on batteries but from the car's DC power. The S.O.S. plugs into the vehicle's cigarette-lighter receptacle via a cord that plugs into the bottom of the unit. The antenna wire also plugs into the bottom, and runs out the window to where the telescoping antenna is mounted on the roof by its magnetic base. A leatherette carrying case, which keeps everything clean and together when not in use, rounds out the package.

The 40-channel S.O.S. provides instant access to the Emergency Channel 9, which is monitored by many police forces and public-safety groups, via a pushbutton. Designed for simplicity, its only other controls are an up/down-tuning toggle switch (digital electronic tuning lets you scan through 40 channels in six seconds), a large red press-to-talk bar, and thumb-screw volume and range controls. The range (squelch) control reduces back-

ground noise in the absence of an incoming signal. The front panel also contains a built-in speaker and microphone, and an LED channel display.

While the S.O.S. could conceivably be used as an every-day CB radio, it's really intended primarily for emergency use. Handhelds, in general, don't have the range of base stations with large, outdoor antennas, or even of permanently installed mobile rigs. And this unit lacks many of the features that full-fledged "CB mike-jammers" or casual enthusiasts would consider important. The most likely customer for the S.O.S. is the well-prepared motorist who keeps it stored neatly in the trunk (with the fully-stocked tool kit, tire-repair kit, flashlight, working jack, and fully-inflated spare tire) to be pulled out only in the case of emergencies.

We've become accustomed to reviewing complex equipment with incomprehensible operating instructions. In this case, however, the opposite is true. The S.O.S. is simple enough to operate without reading *any* directions, yet its manual is quite comprehensive, informative, and easy to read. Besides the basic operating instructions, it explains some of the rules and courtesies of using CB radio in general, and Emergency Channel 9 in particular. For instance, the manual lists some of the regulations governing CB transmissions

(Continued on page 7)



CIRCLE 52 ON FREE INFORMATION CARD

The Telltale Heart Rate

PULSE METER HRM-5520 HEART-RATE MONITOR. From Sanyo, 21350 Lassen Street, Chatsworth, CA 21311-2329; Price: \$129.95.

As the baby-boomers move firmly into middle age, and the number of senior citizens continues to rise, America has become obsessed with trying to turn back the hands (or at least the physical effects) of time. There might not be a Fountain of Youth, doctors still haven't found a cure for baldness, and Retina-A sure bombed out as a wrinkle cream, but there is one way to counter the aging process: aerobic exercise—meaning a routine that raises your heart rate to 70%–80% of its normal maximum—for 30 minutes at a time, three times a week. Aerobic exercise has several proven benefits. It actually improves the efficiency of your heart, so that fewer beats are needed to support your body—your heart doesn't have to work so hard. In addition, it reduces stress, obesity, and blood pressure (by reducing low-density lipoprotein and cholesterol on artery walls), three major causes of heart disease. While health and aging are directly influenced by hereditary, environmental, and behavioral factors, researchers say that people who maintain a moderately high level of physical activity can lower the risk of coronary heart disease by about a third. There is also evidence that regular exercise improves a person's mental health, by giving a better self-image, and lowering stress. Regular exercise won't make you live forever (when your time is up, it's up), but it can allow you to live the time you do have to the fullest.

The flip side to the coin, however, is that those who are getting on in years, or are completely out of shape, or are suffering from cardiovascular disease can damage their hearts by jumping into a strenuous workout. Such people should consult their doctors before beginning an exercise regime, and the doctors are likely to recommend that they start with some mild form of aerobic exercise that raises their heart rates just a bit.

But how can you determine if your exercise routine is providing a good aerobic workout? How can you be sure that you're reaping all those healthful benefits and not straining your heart—and how can you keep track of your progress? The *Pulse Meter* from Sanyo is one answer. It lets you accurately measure your heart rate while you're exercising or at rest and it lets you set minimum and maximum rates—and provides a warning buzzer should you get out of bounds. The Pulse Meter even keeps

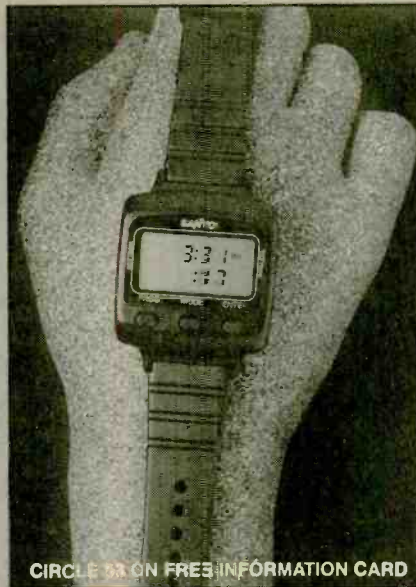

a record of your heart rate during previous exercise sessions.

The Pulse Meter, which uses the same measuring technology as in electrocardiographs, consists of a chest-strap/transmitter with electrical sensors and a wrist-watch/receiver. An adjustable elastic strap wraps around your chest, just under your arms, and holds the chest sensor in place. Two electrical contacts on the sensor pick up the electrical signals that trigger the heart muscle (which cause the heart to beat) and communicate them to the wrist-watch receiver by wireless radio signals. When the watch is in pulse-display mode, the pulse rate is displayed just below the time.

The receiver looks like your standard digital watch, although it's considerably larger. It has a black rubber strap and a black plastic face that features an LCD readout and three buttons that are used to set the time and other parameters. The strap has enough holes that it can be adjusted to fit just about any size wrist. The basic settings (time, date, alarm time), switching between modes, and even setting the minimum and maximum pulse criteria are easy enough to accomplish, following the scanty instructions in the "manual" (actually, just a leaflet). Attempting to set timer and memory programming, however, would be facilitated by more complete directions. As it stands, the leaflet should have a warning along the lines of: "Your pulse rate is likely to climb to dangerous levels due to frustration as you try to interpret the following."

Being impatient types, we devised our own memory recall system, consisting of a pen and paper, and began to chart our pulse rates. We learned that when sitting quietly it ranged from 60–70 and when standing at ease it was between 75 and 85.

Since the "normal" heart rate for an adult at rest is 72, we were pleased to find ourselves in the norm. Increasing our efforts, strolling slowly brought our heart rates up to about 90, walking down the stairs, from 95 to 105, and climbing the stairs, from 115 to 140. We would have liked to try out the Pulse Meter during our regular workouts—swimming laps and hydra-aerobics—but the system isn't intended to be submerged in water. Instead, we used it while cycling, both outdoors and on our stationary bike (while playing video games via the Motion Converter). We discovered that both forms of cycling brought our heart rates up to a maximum of just over 180, but that the stationary bike kept our hearts beating at a steadier rate than the regular bike, on which exertion depends on such factors as incline and wind.

Actually, it turned out to be a good idea to plot our normal heart rates, and to calculate our safe maximums during exercise, before programming the Pulse Meter's memory functions. Knowing those figures helps you program the device accurately. To help do that, a chart should have been provided in the manual. Instead, we had to do some basic research to learn that to figure out a safe maximum rate when just beginning to work out, you should subtract your age in years from 220 and take 70% of the result. For example, if you're 30 years old, you would take 70% of 190, and your safe maximum would be 133 beats per minute. If you're already an active person, you can use 80%, and if you're exceptionally sedentary, 60%. Once you have those figures in hand, it's time to start programming the Pulse Meter.

To set the record straight: It isn't difficult to use the Pulse Meter; it's just difficult to figure out how to do so from the instructions provided. While each step needed to activate each function is listed, no step is explained, and very scanty explanations of the functions themselves are provided. There is absolutely no information on what heart rates are normal; nor is there a warning to see your doctor before beginning an exercise regime. Add to that the facts that the function buttons are a little *too* easy to press (they tend to be pressed accidentally when putting the watch on or during exercise), and that it's easy to get confused as to whether the screen you are seeing is a PROG screen or a MODE screen, and frustration results.

We did eventually use each of the Pulse Meter's functions successfully, and those functions are both impressive and convenient. Four separate events (labeled E1–E4) can be programmed into memory. For each event you can set minimum and maximum heart-rate parameters as we described above. Each event can be either open-ended—you start the memory as you start exercising and end it when you

(Continued on page 8)

Sounding Board

SOUND MASTER II PC SOUND BOARD. Manufactured by: Covox, Inc., 675 Conger Street, Eugene, OR 97402. Price: \$229.95.

We've gotten used to good sound—and we're not the only ones. It's hard to believe that just a dozen years ago, the Walkman was still on Sony's drawing board, the standard music system in new cars was an AM radio, and stereo TV was unheard of. If you wanted to hear high-quality sound, you had to listen to your own stereo at home, or the costly optional FM stereo/cassette deck in your car. Now, however, not only are car stereo systems, personal stereos, and stereo TV's commonplace, but we also have compact disc players—at home, in the car, and on the go—surround-sound decoders, digital signal processing, and minisystems that bring hi-fi to any room in the house.

Why, then, do our computers sound so bad? The tiny, beeping, squawking speaker not only is less than hi-fi, it's downright annoying!

Just as good surround sound re-sparked our interest in TV and video, we figured that good computer sound might make us more likely to spend time in front of our computers. Typically, because we spend so much time there already, the last thing we're inclined to do after a day's work is to play a video game—or anything else that makes us stare at a computer screen and listen to that annoying speaker. But we've found something that we thought might change our mind: the *Sound Master II* sound board from Covox, Inc. The Sound Master II is more than a board to enhance video games, however. It is also a voice-recognition board that lets you control

your computer simply by speaking to it, and it contains an interface for any MIDI (Musical-Instrument Digital Interface) compatible equipment.

Covox claims that the Sound Master II is "the world's most compatible sound card" because it's compatible with the AdLib card (the industry's best-selling sound card), the MIDI standard, and several of Covox's other products, including the Voice Master, Speech Thing, Midi Maestro, and more. If you're new to the idea of sound boards and the software that supports them, you'll be happy to know that the Sound Master II is also compatible with the existing PC sound system.

Installing the board is a relatively simple process—just plug it in to any open slot. The only problems you're likely to encounter are possible port or interrupt conflicts with other boards in your system. How do you know if you have a conflict? With most cards, you find out when the card doesn't work after you install it, and then you try other addresses and interrupts on a trial-and-error basis. Covox has a better solution. After you install the card, you run SM2TEST, a program that checks for the presence of the sound board and any potential conflicts.

One other connection is required: A one-wire connector from the Sound Master II board is attached to your motherboard's speaker connector. (If your computer uses a board-mounted piezo buzzer instead of a chassis-mounted speaker, you won't be able to use this feature.) The great thing about using the sound board instead of your computer's speaker—besides the better sound quality—is that you get control over the volume. For best sound, you should connect the output of the Sound Master II to an audio amplifier—the supplied "hi-fi" speakers aren't exactly hi-fi. Once you

have the volume adjusted to a level that doesn't distort your amplifier, you can control the volume from the amplifier—the volume control on the rear panel of the Sound Master II is virtually impossible to use if your computer's rear panel has a full complement of printer, modem, and video cables and the like.

Getting better sound, and control over its volume, are only two of the features that the Sound Master II offers. After all, even at its best, the PC's sound is still pretty bad. Some software—most notably, games—have been produced to work with various sound boards. Instead of using the PC's sound capabilities, a synthesizer on the sound board takes over. For games designed to work with such boards, the results are impressive. (Interestingly, we had better luck telling some game software that we were using an AdLib board instead of a Sound Master.)

Games, of course, are only one group of applications that require sound. A program utility, CVSD.EXE, included with the Sound Master II enables it to play back speech encoded using the CVSD (Continuously Variable Slope modulation) technique. Some third-party software, such as IBM's educational software and Comptons Multimedia Encyclopedia (which we tried) use CVSD. In general, we weren't too impressed by the CVSD sound from Comptons Multimedia Encyclopedia, and would recommend using a CD-ROM drive that supports audio output instead of the sound board.

The Sound Master II is fully compatible with another Covox product, the Voice Master Key, a speech-recognition and macro program. With it, you can, for example, say, "Directory," and see a list of your disk's contents displayed on the screen. Or say, "Take a letter," and have your word-processing program called up, with your return address already inserted at the top of the document.

Before you can use the Sound Master II for speech recognition, you have to train it to understand your commands (by repeating your words or phrases three times) and teach it what you want it to do (by entering the keystrokes you want it to mimic when you say your phrases).

The voice-recognition software can be set up to listen continuously, or it can be set to listen only after the touch of a hot key. Like other voice-recognition devices we've seen, the Sound Master has its limitations—just as we all do. If you've ever given your name or address over the telephone, you've undoubtedly found that "B" sounds a lot like "D", and "F" sounds a lot like "S."

Other software supplied with the Sound Master II can help you understand why those sounds are hard to distinguish. First,

(Continued on page 9)

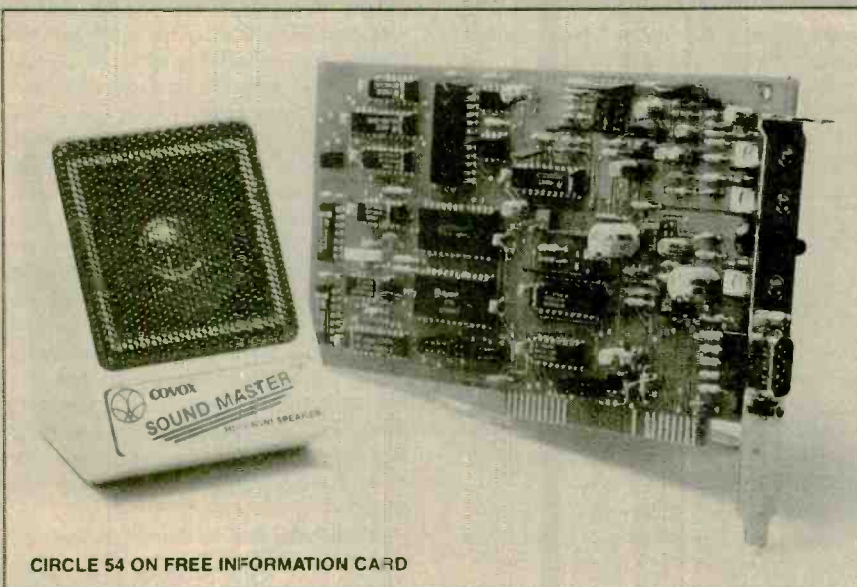

CIRCLE 54 ON FREE INFORMATION CARD

Look, Ma, No Gimmicks!

SONY CCD-F501 VIDEO CAMCORDER. Manufactured by: Sony Corporation of America, Sony Drive, Park Ridge, NJ 07656. Price: \$1400.

Even though camcorders were introduced less than a decade ago, they've already had a dramatic impact on our lives. The Los Angeles Police Department and the people of that city are still reeling from the social and political backlash from a brutal arrest captured on a home video. Remember the San Francisco earthquake of 1989? Even with all of the network cameras that were in town because of the World Series—including one mounted on a blimp—it was a camcorder that captured the collapse of the Bay Bridge. History is still writing the story of the role of the camcorder (and *vice versa*) in the transformation in Eastern Europe. And, while its lasting social significance is debatable, *America's Funniest Home Videos* has become a major force in American pop culture.

On a day-to-day basis, however, the camcorder is no longer considered very exciting. As they became a more familiar sight—almost three million camcorders were sold in 1990 alone—they've lost their "gee-whiz" appeal. And as people become more familiar with camcorders and their features, they are less likely to fall for a manufacturer's gimmicks. The people at Sony must have known that when they were designing their CCD-F501 8mm video camcorder. It's loaded with features, but short on gimmicks. At about $4\frac{3}{8} \times 5\frac{1}{2} \times 13\frac{3}{4}$ inches, it's not the world's smallest camcorder. And at about $2\frac{3}{4}$ pounds, it's not the world's lightest. It doesn't include every feature we've ever seen on a camcorder, but it does have every one that we consider important.

The CCD-F501 offers a 10× zoom, low-light capability of 2 lux, and hi-fi stereo sound. Again, that's not on the forefront of the industry's capabilities, but it is certainly a sensible assemblage of features.

As you might expect, the camcorder has a full auto mode. With the green AUTO LOCK switch turned on, the camcorder is as much of a point-and-shoot device as it can be. The focus and white balance are automatic, and the shutter speed is set at 1/60 second. Flip the switch off, and each feature remains locked in auto mode until you switch it into manual mode. So, for example, if foreground clutter starts interfering with the auto focus, you can switch focus into manual mode with the touch of the FOCUS button. Although it is located on the



CIRCLE 55 ON FREE INFORMATION CARD

left side of the camcorder with several other buttons and switches. Two bumps on the focus button allow your fingers to easily distinguish it from the white-balance button (which has one bump) and the shutter-speed button (which has none). Viewfinder icons let you determine immediately what mode the camcorder is in; an LCD panel above the switches does the same.

If your shooting circumstances dictate that autofocus is your better alternative, you can put the focus back into auto mode simply by hitting the focus button again, or you can go into autofocus mode temporarily by holding down a second button. It's a nice feature that adds a little versatility.

Setting the shutter speed manually is also possible. Settings of 1/60, 1/100, 1/250, 1/1000, 1/2000, and 1/4000 second are available. Three manual white-balance settings are available in addition to the auto mode. For situations where strong backlighting might be a problem—a subject indoors, in front of a brightly lit window, for example—a one-button backlight-compensation mode is useful.

Using the camcorder with full manual control is not the most difficult thing in the world, but, in most situations, who wants to be bothered? Unfortunately, many situations require that you take some control. That's where the two pre-programmed auto-exposure modes come in handy.

In the "Sports" mode, the camcorder automatically increases the shutter speed and adjusts the iris for proper exposure so that when you play back the scenes you'll have minimum blur in the slow and still modes. A "Portrait" mode automatically keeps the subject in focus while letting the background blur out of focus to minimize distraction.

A motorized "power zoom" can be used for switching between wide and telephoto angles, or, if you prefer, a manual zoom lever is available. The 10× zoom

lets you vary the lens's focal length from 8.5 to 85 mm. (That would translate to a 46–460-mm zoom range for a 35-mm still camera.)

A FADER control lets you fade-in or fade-out your scenes for smoother, more professional transitions. Both audio and video are affected in the fade mode.

Like other camcorders in its class, the CCD-F501 includes the ability to store a handwritten title in memory and superimpose it over your recordings. We've never found the feature to be particularly useful or convenient, because of the effort and planning it requires. First, you must make a clean, high-contrast title card, point the camcorder at it, and store the title in memory. Then before you start shooting, you call the image from memory. For such predictable events as birthdays, it works OK. For more spontaneous shooting, it's useless. One nice thing is that you can scroll the title up or down across your scene. We, however, usually settle for displaying the camcorder-generated date and/or time indicator, which you can also do with the CCD-F501. Our informal poll showed that we aren't alone: It seems that nobody uses a camcorder's ability to store and superimpose titles.

The CCD-F501 does have one feature that we think will get a lot of use—especially from parents. You can store up to three birthdates in memory and then, at the touch of a button or two, can call up the age so that it's superimposed on what you're recording for a permanent record. So instead of making up a title card saying "Baby Jim at 30 Months," you can simply hit the AGE button to display "2Y. 6M." in the lower right corner. (The current date can be displayed below that if you wish.) It may not be as elegant as a well-made title card, but it's a heck of a lot faster and easier!

An infrared remote control is supplied with the camcorder so that you can control it from a distance either during recording

or playback. It can be used to zoom, start, and stop recording. Although a small LED at the front of the camcorder lets you know when the unit is recording, it's hard to see in bright sunshine. An audible "beep" lets you know which mode the camcorder is in. (You have the option of switching the beep off if you prefer silence.) One beep means that the camcorder has entered the recording mode, two beeps means that it's back in standby. A string of beeps means that you've got battery or other problems.

The CCD-F501 feels comfortable in the hand, and because of the sensible location of the controls, it's easy to use. Its included features—from its two-mode auto exposure to its 10× zoom—are practical and complete without being overwhelming. If you're looking for a sensible, strong performer, whether to chronicle your kid's birthday party or more newsworthy events, then the CCD-F501 is a tough one to beat. ■

VIDEO IS IN THE AIR

(Continued from page 1)

receiver's foot was really out of bounds on the replay.

Second, even though the receiver lets your standard cable or antenna input pass through, it does so only when the receiver is turned off. That means that you can't use it to monitor a security camera by flipping to Channel 3 while you watch TV—unless you get up and manually switch the unit on. Our third suggestion for improvement is that we would prefer if the receiver offered discrete audio and video outputs instead of only RF. And, finally,—although we know this isn't a fair criticism—we'd love the video-distribution system to also handle our infrared remote-control signals so that we could pause the VCR, change channels, etc., from the remote viewing location.

Although we have some misgivings about the system, in a small house or apartment, the Archer Wireless Audio/Video Distribution System can provide results that are quite good. ■

FUN AND GAINS

(Continued from page 2)

software so that you have to pedal faster (or slower) to move the HeliBike on screen, and can set your initials so that you can see your standing compared to other players.

The Final Quest Challenge game is a typical game in terms of style—you must try to get off a hostile planet by picking up keys to open packages that give extra power, ammunition, etc., while trying to avoid and/or blast the alien spaceship, with the ultimate goal of reaching your own

ship. The protagonist is represented by a helicopter-like vehicle called the HeliBike. The Motion Converter translates your speed and torque on the exercise bike to movement of the HeliBike.

While we wouldn't rank Final Quest Challenge among the most exciting games we've tried, nevertheless it is also typical in its power of addiction. And that's the whole premise behind the Motion Converter. You can't move the HeliBike without pedaling, and the faster you pedal, the faster you move. That means that to get the most keys and packages (*i.e.*, the highest scores), you really do have to work up a sweat.

We aren't avid video-game players—not because we don't *like* playing, but because we find it hard to justify the time required. That time could be better spent doing plenty of other things for work or for relaxation. But, with the Motion Converter, we could play with no guilt or regrets.

As soon as we got up and running (or should we say pedaling?), we found it hard to stop. There's something to be said for the play-as-you-pedal philosophy, because we actually *forgot* we were pedaling as we focused on the game action. (And it's not as if we weren't exerting any effort. According to the readings on our Sanyo Pulse Meter, our heart rate was between 155 and 175, as opposed to a stationary 65–75 beats per minute.) You can display statistics at any time, although it seemed to make the most sense to do so at the end of each game, instead of interrupting the action. As your game improves, so do the numbers, and we were amazed to see that what seemed like a couple of minutes was actually closer to ten, and were happily surprised to see the number of calories burned during that time. (As determined by the software, that is. Since we can't accurately calibrate the readings, they are relative statistics only.) Being able to compare your score to those of other players gives the Motion Converter a distinctive edge over plain old at-home exercise routines—namely, the competitive edge.

Of course, if you want to play Final Quest Challenge with a friend and still get a good aerobic workout, you have to agree not to relinquish control until your turn has lasted at least 20, preferably 30, minutes. It's also a good idea to keep pedaling while you check your statistics and set up the next game, to keep the heart pumping strongly.

While we found ourselves playing Final Quest Challenge (and *exercising*) every chance we got, we've been using it for only about a week as we write this. Will it stand the test of time? To keep it from getting as tedious as regular exercise routines do, FUNEX is planning to release another game, "Renaissance Man" (or "RenMan") in the near future and has two

others in the works. Future versions of the Fitness Tracking System will have the ability to keep records that show a daily history of total miles, average speed, calories burned, and length of ride, over the course of several years, in data or graph form. In addition, within the next year, the company intends to release Motion Converter packages that will be compatible with major video-game systems. That means that you can take your exercise equipment out of the home office and move it back into the family room with the rest of the family's gadgets and toys. We hope that FUNEX is able to improve on the user-friendliness of its package.

They say "No pain, no gain." Well, it's been quite some time since we used our exercise cycle, and we could feel the effects of such concentrated effort in the form of sore legs, bottoms—and thumbs! Oh well, in time we're sure to build up some muscles in all those places, and, we hope, to tone up the first two. In the meantime, using the Motion Converter with our exercise bike is the least painful (in terms of tedium) form of at-home exercise we've ever tried. ■

A HELPING HAND-HELD

(Continued from page 3)

(no advertising, no profanity, no promotion of illegal activities, no "blasting" others off the air with illegally amplified transmitter power or high antennas) and the proper use of Channel 9. That includes the Radio Emergency Action Citizens Team's (REACT) "CB Distress Data" CLIP rule: When asking for aid on Channel 9, say "Break Channel 9 for a REACT base" and provide your Call sign (identify yourself and your car), Location, Injuries, and Problem. The manual also gives advice on upgrading your antenna (in the event that you plan to use the S.O.S. as a regular CB and want a wider transmission range than the "up to five miles under favorable conditions" from the provided antenna) and on avoiding ignition noise interference.

We tried out the S.O.S., with its standard antenna, driving around Long Island NY, and tuned into the usual assortment of chatter. Truckers accounted for the most talk by far, but there were quite a few local CB enthusiasts represented as well. You don't have to learn the lingo before getting on the air—but everybody else sure uses it. Sometimes it's hard to understand what's being said, particularly when the CB slang is spoken in a deep southern drawl—and for some reason, even up here where you'd expect to hear "Brooklynese" instead, there are a lot of southern accents on the CB bands.

The 3-inch diameter, round magnetic

base held the antenna firmly in place under normal traffic conditions. Even at 70 miles an hour, we had no problems.

We weren't able to try out the Emergency Channel, because we were somewhat more law-abiding when it came to FCC rules than with the speed limit. And Channel 9 is for emergency use only. If you transmit an emergency message on Channel 9, and no one is monitoring your transmission, Cobra recommends switching to Channel 19, the truckers' channel.

While we felt somewhat more at ease having the S.O.S. in our car, we did have some doubts. For instance, couldn't crooks monitor the emergency channel and find out where you were stranded? And what if the car battery dies, leaving no way to power the unit? And, finally, how can we be sure that anyone is really out there listening to us?

In spite of those misgivings, we know that CB's really can save lives. A story in the news this week told of a woman with

muscular dystrophy who was driving her specially equipped van in a rural area of Connecticut when she was cut off by another driver, sending her van over the guardrail and into a deep trench at the side of the road. When she regained consciousness after the accident, the battery went dead, leaving her CB inoperative. Instead of panicking or giving up hope, she managed to splice the cord from her CB to the battery of her wheelchair—but her ordeal was far from over. There was no one monitoring Channel 9 in her transmitting range, and none of the people she contacted on the truckers band would stop to help her. Finally, ten hours after going over the rail, a trucker came to her aid.

That story answered all of our questions. It might not get you help as quickly as dialing "911," but proper use of CB radios can save lives. Although we won't know for sure until the next time we break down, we like the idea of having the S.O.S. in our trunk in case of emergencies. ■

TELLTALE HEART-RATE

(Continued from page 4)

finish—or timed—you decide how long to exercise beforehand, and when the alarm sounds, your time is up and you press a button to store the information. While you're working out in memory mode, an alarm sounds each time your heart rate falls below or exceeds the set limits. Once your workout is over, the data recalled for each event includes the date of the event, how much time was spent above the high limit, how much time was spent within the set parameters, and how much time was spent below the low limit. If you use the Pulse Meter for the same activity on a regular basis, you can compare your past three performances to your current one. If you vary your routine—jogging three times a week and playing tennis twice a week, for instance—you could use E1 and E2 for jogging, and E2 and E3 for tennis. And if your wife and kids use the Pulse

ELECTRONICS WISH LIST

For more information on any product in this section, circle the appropriate number on the Free Information Card.



Royal Personal Organizer

Personal Organizer

Probably the second-most-common resolution found on New Year resolution lists, after "Lose weight," is "Get organized." *Royal Consumer Business Products'* (Division of Olivetti Office USA, 765 U.S. Highway 202, Bridgewater, NJ 08807-2597) *DM2160 Info to Go* personal organizer could help you stick to your resolution. According to Royal, the DM2160 is the most powerful personal organizer on the market. With 16K of memory, the unit can store more than 150,000 characters. Its functions are accessible through 24 different menus within three different modes. For example, the menus in "date" mode include schedule, telephone, business card, memo, and more. A sampling of those under "calculator" mode include check book, currency exchanger, expense report, size conversion, project planner, and standard calculator. "Function" mode offers a demo program and a dictionary along with set-up functions such as memory check, sound option, and the ability to enter a secret code to protect sensitive data. Price: \$299.95.

CIRCLE 56 ON FREE INFORMATION CARD



Bib Compact Disc Polish

Compact-Disc Polish

In the world of electronics, neatness counts. Dust and grime can compromise the performance of electronic hardware and software, and—although we often think of them as indestructible—can even damage CD's. To help keep your compact discs spic-and-span, *Bib America* (10497 Centennial Road, Littleton, CO 80127) has introduced the *Compact Disc Restorer Polish Pack (model A-655)*. The kit contains a specially formulated polish and a soft optical-grade polishing cloth, packed in a black-and-gold storage case. The non-abrasive, polymer based formula treats and removes light scratches on the surface of CD's. Left untreated, scratches can cause the player's laser beam to be deflected, resulting in mistracking that is heard as a skip or popping sound. The polish also removes dust, grit, and oily fingerprints that can cause similar playback problems, and provides antistatic protection. The ozone-safe, metered spray applicator holds enough polish for approximately 600 applications. Price: \$19.95.

CIRCLE 57 ON FREE INFORMATION CARD

Meter too, each of you can have your own event number to use (as long as you don't have more than two kids).

The Pulse Meter isn't going to inspire you to exercise—although maybe some of the information in this article will. But it does provide an accurate picture of how hard your heart is working, so that when you do exercise, you can tell if you're doing it right. ■

SOUNDING BOARD

(Continued from page 5)

there's an oscilloscope program that lets you see a rough graphic display of your voice, providing visual proof of how similar certain sounds are. Second, there's a sound editor that lets you capture, display, and even edit the sounds of your voice. The editor can handle up to 64K bytes of sound; the sound is recorded at sampling rates ranging from 4500 to 15,000 samples per second.

Just as you can define a block of text in a word processor, you can define a block of sound in the sound editor. You can then delete the block, move it, or copy it. We had fun getting a "Max Headroom" sound out of our recordings, and in varying parts of the recorded sound to change our voices rather dramatically.

For those more musically inclined, PC-Lyra, a music composition program that lets you take full control of the on-board 8-voice synthesizer and the MIDI interface, is also included with the Sound Master II. The graphics-based program lets you enter musical notes with the click of a mouse button (although a mouse isn't required to run the program). You can also enter notes using an external MIDI keyboard and output musical scores to a printer. Some 37 songs, from "The Maple Leaf Rag" to "The Danube Waltz," are included on disk. If you think you can improve on the masters, you are free to edit such parameters as time signatures, notes, rests, etc.

We had a lot of fun with the Sound Master II. But, then again, we have fun with *all* gizmos! Do we really *need* good sound from our computer? As multimedia becomes a real phenomenon, the answer will be, undoubtedly, yes—just as we really need good video now that PC applications make good use of it. But we think that the way to good audio is through a CD-ROM drive. (As more multimedia software becomes available—the Sound Master II is compatible with the MPC industry standard—we may get more convincing demonstrations of why a good sound board is worthwhile and how it can be used effectively. The games we played didn't convince us.) We also enjoyed playing around with speech editing, and putting our not-quite-forgotten musical training to work in PC-Lyra. But, if we were real musicians, we'd use more professional software and instruments. In the end, even though we hate our PC's speaker, for now it seems to do the job. ■

For more information on any product in this section, circle the appropriate number on the Free Information Card.

ELECTRONICS WISH LIST

In-Ceiling Speakers

Because design considerations usually take precedence over those of audiophiles, most in-wall speakers sold are actually mounted in ceilings, even though they are not designed to distribute the sound properly from that location. Sonance's (961 Calle Negocio, San Clemente CA 92672) S2R speakers are intended for ceiling or wall installations where a wide and uniform dispersion pattern is desired. (They're ideal for surround-channel speakers.) They have unique mounting brackets that provide instant adjustment for ceiling thickness. The brackets have wings that can handle standard stud spacing in walls; optional wing pieces accommodate the 24-inch joist-span conventionally found in ceiling construction. The shape also makes installation easier for sloppy workmen, since a circular speaker doesn't require precise alignment parallel to the edges of the room. The model S2R achieves uniform dispersion with a perforated mounting platform for the tweeter that holds the driver solidly in place above the woofer. The platform is acoustically transparent to the low-frequency sound waves generated by the woofer, which pass right through it, but the high frequencies reproduced by the tweeter benefit from the platform's reflective surface. Price: N/A.

CIRCLE 58 ON FREE INFORMATION CARD

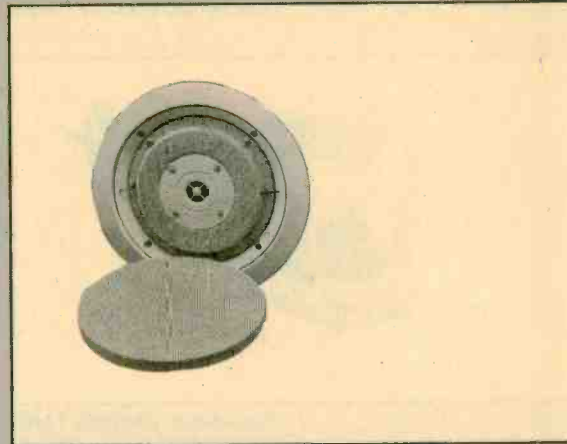

Sonance In-Ceiling Speaker

Dual-Function Headphones

It's not necessary to have one set of headphones for at-home listening and another for audio on the go. Sennheiser Electronic Corporation's (6 Vista Drive, P.O. Box 987, Old Lyme, CT 06371) model HD 490 is a low-impedance, open-air unit that is light enough for portable use without sacrificing sound quality. The headphones terminate in a 1/8-inch stereo mini plug, and a standard 1/4-inch stereo adapter is also supplied. The HD 490 uses a radial-bead diaphragm with a ridged structure that endows it with the stiffness necessary to resist distortion, even at high volume. In addition, the headphones feature powerful neodymium-ferrous magnets and aluminum voice coils, lighter than conventional copper coils. The diaphragm, voice coils, and magnets are said to result in tight bass tones and quick transient response. Sennheiser claims that the headphones are capable of substantial dynamic range even with the limited power available from personal portables. Price: \$119.

CIRCLE 59 ON FREE INFORMATION CARD

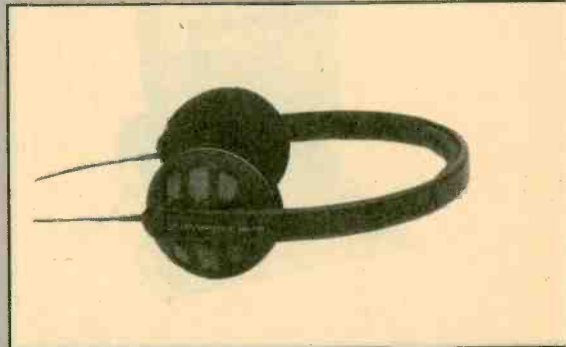

Sennheiser Headphones

57

ELECTRONICS WISH LIST

For more information on any product in this section, circle the appropriate number on the Free Information Card.



Fuji Extra-Density Disks

Extra-Density Diskettes

Remember the early days of computing, when the ability to store volumes of material electronically held out the promise of a paper-free world? Ever since, data storage devices have gotten smaller and their storage capacity has gotten larger. For example, *Fuji Photo Film U.S.A.* (555 Taxter Road, Elmsford, NY 10523) has introduced a 3.5-inch *MF2ED* (extra density) floppy disk. The disks provide extra storage capacity for users who create large files on a regular basis. The disks are compatible with 2.88-MB disk drives, and will store twice as much information as standard 3.5-inch, double-sided, high-density disks—about 1,400 double-spaced typed pages. We can't understand why we're still neck deep in papers!

CIRCLE 60 ON FREE INFORMATION CARD



Carver LD/CD/CDV Player

Laserdisc/CD/CDV Player

The line between audio and video components has become permanently blurred, resulting in a wide variety of components that fit both categories. For instance, *Carver's* (20121 48th Ave., West, Lynnwood, WA 98036) *MD/V-500* is an audio component, with the ability to play 3- and 5-inch compact discs; a video component for playing 8- and 12-inch video discs; and an A/V component that plays CDV's. The *MD/V-500* uses an 18-bit digital to analog converter with 8 times over sampling for CD playback, and a precision PCM audio system for near-CD sound quality with video discs. Its features include programmable access to 16 video chapters or CD tracks, full skip search, multi-speed scan, freeze and frame-by-frame access, and direct digital output. Price: \$699.95.

CIRCLE 61 ON FREE INFORMATION CARD



Ronosonic Chopper Fone

Calling all Helicopters

If plain, old telephones just don't do the trick for you, consider the *RON-125 Chopper Fone* from *Ronosonic Trading Corp.* (300 West 24th Street, New York, NY 10010). The novelty telephone looks like a helicopter. The handset with the keypad on it forms the rotor of the helicopter. A red LED lamp in the cockpit flashes during incoming calls and when the phone is in use. Features include an on/off ringer switch, a mute button, and last number redial. No, it doesn't fly—unless your two-year-old throws it across the room. Price: \$79.95.

CIRCLE 62 ON FREE INFORMATION CARD



Samsung Sensor SP-386SX PC

Personal Computer

Figuring that people who buy computers to use at home want the same power and utility that they've become accustomed to from the computers they use at work—and that many people actually *work* on their home computers—*Samsung Information Systems America, Inc.* (3655 North First Street, San Jose, CA 95134-1708) has introduced the *Sensor SP-386SX*. Designed specifically for home and home-office users, the system is easy to set up and comes with a videotape and on-screen tutorial to explain its use. Along with Microsoft Windows 3.0, the computer comes with an array of powerful software already loaded onto its 40MB hard drive, including The Norton Utilities 5.0, the Prodigy on-line service, and Windows applications such as a home financial package called Balance Point 2.0 and The Norton Back-Up 1.2. The streamlined unit features an 80386SX processor operating at 16 MHz, a 3.5-inch floppy-disk drive, a 40MB hard-disk drive (28 ms), and 2 megabytes of RAM—enough memory to run Windows in its enhanced mode—expandable to 8MB. The *Sensor SP-386SX* comes with a 2400-baud internal modem, Super-VGA card (with 512 KB video RAM), a matching 14-inch VGA monitor, a mouse, one parallel and one serial port, one analog VGA port, two 16-bit card slots, and a 101-key keyboard. Price: \$1995.

CIRCLE 63 ON FREE INFORMATION CARD

For more information on any product in this section, circle the appropriate number on the Free Information Card.

ELECTRONICS WISH LIST

Video Battery Chargers

Sanyo Energy (U.S.A.) Corporation's (2001 Sanyo Avenue, San Diego, CA 92173) Microsmart line of video-battery chargers includes the four-position model NCM01, which combines a video-battery charger, capacity analyzer, and battery reconditioner in one unit. It charges camcorder batteries in just 30 minutes. A built-in 4-bit microprocessor eliminates overcharging, undercharging, and abusive charging. Price: N/A.

CIRCLE 64 ON FREE INFORMATION CARD



Sanyo MicroSmart Video Battery Charger

Digital Audio Tape Recorder

While the future of DAT remains unclear, manufacturers are continuing to market both home components and portable units, such as the model DA-R100 from Casio, Inc. (570 Mt. Pleasant Avenue, P.O. Box 7000, Dover, NJ 07801). Sized to fit in the palm of your hand, the DA-R100 has 1/8-inch stereo audio in/out jacks, plus digital in/out (IEC 958 data format), and optical input. The Serial Copy Management System, which is designed to protect copyright holders from bootleggers by allowing one first-generation DAT copy from any compact disc, is implemented in the unit. The DA-R100 allows three types of recording: standard speed at 44.1 or 48 kHz and long play (32 kHz), which doubles the recording time to up to four hours. A wide-track playback mode is also available. Other features include an AC adapter, two connecting cords, a carrying case, and a Ni-Cd rechargeable battery pack that offers two hours of playback or recording on an 8-hour charge. Optional accessories include an automotive kit with cigarette-lighter adapter and cassette audio connector and a quick battery charge that allows two hours of use on a one-hour charge. Price: \$1,050.

CIRCLE 65 ON FREE INFORMATION CARD



Casio DAT Recorder

Anti-Glare Filter

Glare can be a big problem for anyone who spends long hours in front of a computer monitor. An optically coated glass filter from Fellowes Manufacturing Company (1789 Norwood Avenue, Itasca, IL 60173) is coated on both sides, so that it reduces glare from both the terminal and the surrounding area. At the same time, it increases the contrast of high-resolution color monitors. The anti-glare screen attaches to the top of a terminal with easy-on, easy-off clips that can be secured in place by two dots of Velcro. Price: \$59.95.

CIRCLE 66 ON FREE INFORMATION CARD

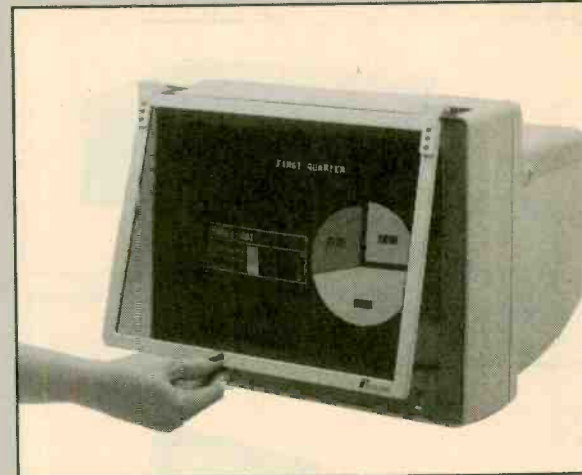

Fellowes Anti-Glare Filter

Four-Head, Stereo VCR

If you're setting up a home-theater system, or if you do a lot of tape dubbing, it makes sense to get a VCR that can meet the demands. Goldstar Electronics International's (1000 Sylvan Avenue, Englewood Cliffs, NJ 07632) model GVR-A465 VHS VCR has many of the requisite features, including a double-azimuth, four-head video system for improved special effects and an MTS stereo TV decoder with separate audio program (SAP) capability. The VCR also offers an on-screen display and on-screen programming, an eight-event/one-year timer with standby quick-set recording, an automatic head-cleaning system, a character titler, and "camcorder friendly" front-panel audio/video input jacks. The unit has a 181-channel, frequency-synthesized tuner and a quick-start, full-loading system. Price: \$429.95.

CIRCLE 67 ON FREE INFORMATION CARD

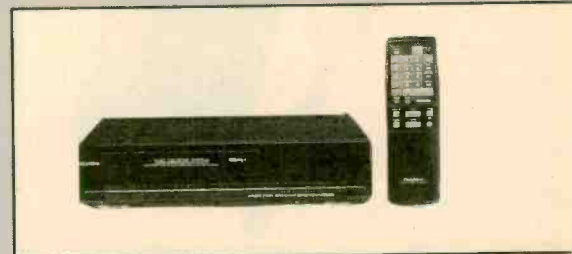

Goldstar Stereo VCR

ELECTRONICS WISH LIST

For more information on any product in this section, circle the appropriate number on the Free Information Card.

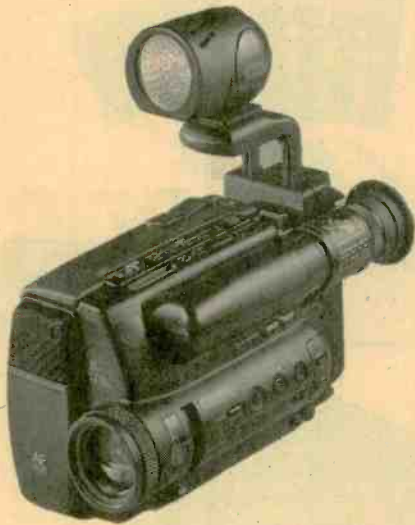

Sima Video Light

Video Light

Designed specifically for 8mm camcorders that use Sony NP-type camcorder batteries, *Sima Products Corporation's* (8707 North Skokie Blvd., Skokie, IL 60077) *CamPower Mini Video Light* attaches between the camcorder and its battery. Because it draws its power from the battery that powers the camcorder, no extra battery is needed. The result is a video light that adds only 5 ounces to the weight of a mini camcorder. The compact light also features a separate power switch on the light head. Tilt control and a variable height adjustment assure optimum direction and dispersion of the 15-watt light beam, which is especially effective when taping in the wide-angle mode. Price: \$39.95.

CIRCLE 68 ON FREE INFORMATION CARD

Accident-Free Traveling CD

Compact-disc jewel boxes are great for protecting CD's, but they're impossible to open with just one hand. If you have an in-dash CD player in your car, you'll like the *CD Traveler* from *Zak Enterprises, Inc.* (1348 Kenilworth Lane, Glenview, IL 60025), which makes one-handed disc access possible. The 5½ × 5½ × 2¼-inch storage case consists of a steel housing with styrene drawers, end caps, a dust cover, and a Velcro mounting bracket. Each unit holds up to six compact discs without their cases. Intended for use with car audio systems, portable stereo units, and CD-ROM drives, the *CD Traveler* mounts easily in the car or on the side of a computer or stereo system. Additional units can be interlocked for more storage. Price: \$24.95.

CIRCLE 69 ON FREE INFORMATION CARD



R.L. Drake World Band SW Receiver

World Band Shortwave Receiver

The Gulf War might not have revived the flagging American economy, as some predicted, but it did revive an interest in shortwave radio that was re-ignited by the revolutions in Eastern Europe and further bolstered by the rapid political and social changes in the Soviet Union. In response to America's new interest in shortwave, *R.L. Drake Company* (P.O. Box 112, Miamisburg, OH 45342) is selling a shortwave receiver for the first time since their line was discontinued back in the early 1980's. Their *R8* world-band shortwave receiver, with a frequency range from 100 kHz to 30 MHz, operates in the AM, LSB, USB, CW, RTTY, and NFM modes, covering all world-band frequencies as well as most amateur bands. With an optional module, the *R8* can also cover fire, police, public service, and additional amateur bands in VHF. The receiver's "E² ROM" non-volatile memory automatically writes stored information to a ROM memory chip, so that no back-up battery is required. With a 100-channel memory capacity, frequency, band, and mode data can be stored so that favorite broadcasts or frequencies can be recalled easily. A built-in RS-232C computer interface allows computer buffs to automate many receiver functions for unattended operation. Several features are included to enhance reception, including a synchronous detector to improve AM signals under fading conditions, a dual-mode noise blanker to minimize electrical interference and impulse noise, a built-in preamp and attenuator to process both weak and strong signals, a passband-offset system to help eliminate "adjacent" interference, and five switchable bandwidth filters. The front panel contains all controls, as well as an LCD readout and a signal-strength meter. Price: \$979.

CIRCLE 70 ON FREE INFORMATION CARD



Texas Instruments Info Bank

Calculator Plus

More than just a calculator, the *TI-2900 Info Bank* from *Texas Instruments* (Consumer Relations, P.O. Box 53, Lubbock, TX 79408) is also an electronic telephone directory and a schedule organizer. The device stores and recalls up to 125 names and numbers. With 72 characters available for each entry, there's plenty of room to record addresses, credit-card numbers, and long-distance access codes. Any confidential entry can be protected with a secret password. The compact unit can be carried in a pocket or briefcase, and data can be viewed even when its protective hinged cover is in place. Price: \$35.

CIRCLE 71 ON FREE INFORMATION CARD

COP TALK:

Understanding Police Communications

There is no public-safety service more monitored by scanner hobbyists than law-enforcement communications. Ninety percent of scanner owners have local-police frequencies stored somewhere within the memory of their scanners. Whether you live in a small town regulated by the County Sheriff's Office, or a large metropolis patrolled by city police, the law-enforcement channels are the most actively monitored band of frequencies you will encounter on your scanner.

"To Protect and Serve" has long been the police officer's motto and nowhere is this truism more evident than through the day-to-day communications of a modern police force at work. From the most heinous of crimes—murder—to burglary reports, to traffic control, to helping a lost youngster home after dark, the police officer's job is one of the most fascinating of services to monitor. It allows the scanner owner to listen in on the excitement, the danger, the boredom, and the drudgery of the serving officer on the beat. No one who listens can fail to come away with less than high respect for the men and women who wear "the badge."

Smaller Communications Systems.

Today's modern police department keeps in touch via two-way radio, an ever-present link between the dispatcher at headquarters and the uniforms on the street. Calls are dispatched instantly; license, registration, and warrant checks are just seconds away via the radio microphone; officers responding to calls can be up-



BY LAURA QUARANTIELLO

Listen in on and understand the communications of your local public servants to get the real scoop on what's happening in your area.

dated enroute; and cover units can be requested, all at the touch of a switch. The law enforcement officer is never far from information or help with a radio at hand.

Most police-radio systems are composed of one-frequency "simplex" equipment, in which all radios transmit and receive on the same frequency, and so are unable to do both at the same time. That presents a problem during moments of heavy communications traffic or emergency situations, where multiple units are all attempting to transmit at once, causing the characteristic "squeal" so often heard when units "step-on" and cover each other. That can be avoided by using a two-frequency semi-duplex system, which allows the dispatcher to receive incoming calls while transmitting.

Small police departments utilize one main dispatch frequency, while others such as the Los Angeles Police Department find it necessary to divide their channels up to cover different divisions and beat areas. In addition to dispatch, most departments utilize an inquiry channel through which officers request license, registration, wants, and warrant checks, freeing up the dispatch frequencies for other traffic.

Tactical or "Tac" channels are used by detectives and undercover officers for surveillance operations and by officers on high risk warrant service. Tactical frequencies may also be used for car-to-car communications between officers, however this is most often performed on a separate channel known and identified over the air simply as "Cars."

More Advanced Systems. Many communications systems today use repeaters. Repeater-based systems allow mobile-unit signals to be retransmitted, often from a higher elevation (such as a mountain top) permitting greater range. Vehicular-extender systems, which use a repeater in each mobile unit, serve the same function, but are prone to interference.

"Mobile Data Terminals" (or MDT's) are the latest wave of high-tech to hit law-enforcement communications. Mobile data terminals are laptop computers located in police patrol units from which license and vehicle-identification checks can be requested directly from the main computer rather than tying up a dispatcher. Routine calls can also be dispatched, allowing officers to see the complete call history on the laptop screen.

Since the communications occur in standard computer bursts, similar to packet-radio communications, they also free up a voice frequency. Baud rates of 9600 are common for MDT's. On a scanner radio, MDT signals sounds like the familiar buzz of a data channel—rather loud and annoying—however it has been speculated that with the proper computer software, MDT information can be monitored by civilians.

"Computer aided dispatching" (or CAD) systems also save dispatchers considerable time and effort by doing much of the work for them. A typical CAD system works something like this: First a police department receives a call for service from a citizen. Second, the police telephone operator who answers the call enters the basic information into a computer, which matches

TABLE 1—STANDARD 10-CODES

Code	Meaning	Code	Meaning
10-1	Receiving Poorly	10-18	Urgent
10-2	Receiving Well	10-19	Contact _____
10-3	Stop Transmitting	10-20	Unit Location
10-4	Okay	10-21	Telephone Call
10-5	Relay Information	10-22	Cancel
10-6	Busy	10-23	Arrived at Scene
10-7	Out of Service	10-24	Finished Assign.
10-8	In-Service	10-25	Meet _____
10-9	Repeat	10-26	ETA is _____
10-10	Negative	10-27	Request License Info
10-11	_____ in Service	10-28	Request Veh. Info
10-12	Stand by	10-29	Check Records
10-13	Report _____ conditions	10-30	Use Caution
10-14	Information	10-31	Pick Up
10-15	Message Delivered	10-32	Units Requested
10-16	Reply to Message	10-33	Officer Needs Help
10-17	Enroute	10-34	Correct Time

the call location with a geographic database file and routes it to the appropriate dispatcher. It is also possible that the computer might assess the availability of officers for that particular beat and might suggest assigning one to the call. The system might also be programmed to search local, state, or national databases to determine if the persons involved in the call are listed. Additionally, information about prior calls for service from that address are compiled. Last, the computer sends all of this information to the dispatcher responsible for that geographic area and the pertinent information is passed-on to the selected patrol unit by radio or MDT.

Those patrol units with the forest of antennae atop the roof are probably equipped with "automatic vehicle locating," or AVL. AVL is the pinnacle of dispatching control because it allows the headquarters dispatcher to see the

location of all units on a computer-generated map of the city. This is done through the use of Loran-C radio by comparing two or more signals and triangulating a position from them. The technology allows a dispatcher to instantly send the closest unit to a call and to know the location of an officer who is not answering his radio and possibly in need of assistance. This system is still experimental and many cities are unable to meet the costs of such technology.



There are a wide variety of tabletop and handheld scanners available that can be used to monitor police communications. So shop around to find the one that suits you best.

Law Enforcement Communications Frequency Ranges

- | | |
|---------------------|---------------------|
| 37.02 – 37.40 | 471.4625 – 471.8125 |
| 39.02 – 39.98 | 482.3125 – 483.1375 |
| 44.02 – 42.94 | 483.1625 – 483.4375 |
| 44.62 – 45.05 | 483.4625 – 484.8125 |
| 46.10 – 46.55 | 489.1625 – 489.4375 |
| 154.025 – 154.115 | 494.3125 – 495.1370 |
| 154.560 – 154.950 | 495.1625 – 495.8125 |
| 154.960 – 154.995 | 500.3125 – 501.1380 |
| 155.010 – 155.400 | 501.1625 – 501.4375 |
| 155.415 – 155.500 | 501.4625 – 501.8130 |
| 155.730 – 156.150 | 506.3125 – 507.1625 |
| 156.150 – 156.240 | 507.1625 – 507.3125 |
| 158.730 – 158.955 | 810.000 – 816.000 |
| 158.985 – 159.030 | 821.000 – 824.000 |
| 453.0125 – 454.000 | 855.000 – 861.000 |
| 460.0125 – 460.5625 | 861.000 – 869.000 |
| 471.1625 – 471.4625 | |

Many police departments are making a serious attempt to keep unwanted listeners from eavesdropping on their communications by installing scramblers. The National Security Agency recommends the DES (Digital Encryption System) encryption method, which changes voice to digital code, unrecognizable on a scanner and widely viewed to be an unbreakable means by which agencies can secure their communications. DES utilizes 720,000,000,000,000,000 different

(Continued on page 91)

The Magazine for the Electronics Activist!

© Gernsback Publications, Inc.

Abbreviations: (AR)Antique Radio, (C)Construction, (CB)Computer Bits, (CC)Circuit Circus, (D)Department, (DEC)Digital Electronics Course, (DX)DX Listening, (ED)Editorial, (FS)Fun Software, (HOR)Hands-On Report, (HR)Ham Radio, (LTR)Letter, (PTR)Product Test Report, (SS)Scanner Scene, (TT)Think Tank

× 4 Logic Probe (Spiwak and Yacono)(C) Mar 55
1930's-Style Radio Transmitter (Smolski)(C) Nov 57
20-Watt Stereo Amp (Young)(C) Jul 40
3 × 3 Alarm, The (Hampton)(C) Feb 67,(LET)May 3
386 Revolution Continues, The (Holtzman)(CB) Sep 70
The (Holtzman)(CB) Aug 68
555 Test Fixture (Yacono)(TT) Oct 22

A

AC/DC Indicator (Rakes)(CC) Feb 82
AC Pilot Light (Rakes)(CC) Oct 82
Access III Telephone-Operated Power Switch For Your Computer (Stephens)(C) Jun 53
ACE Communication's AR2500 (Saxon)(SS) Apr 88
Accolade's Strike Aces (Blechman)(FS) Feb 84
Test Drive III (Blechman)(FS) Mar 82
A/D Converters, Getting Familiar with (Young)(DEC) Apr 67,Mar 64
Add Shortwave Reception to Any Radio (Carr) Dec 56
Adjustable Regulators Can Control More Than Just Voltage (Yacono)(TT) Jul 20
Ad Lib Music's Synthesizer Card (Blechman)(FS) Apr 82
Alarm Circuit (Wels)(TT) Jan 22
The 3 × 3 (Hampton)(C) Feb 67
Albania, Change Comes to (Jensen)(DX) Aug 76
All About Cellular Telephones (Bigelow) Mar 58
Meters (Bigelow) May 28,(LET)Aug 4
Oscillators (Johnson) Aug 59
Oscilloscopes (Bigelow) Jul 34
Receiver Sensitivity (Carr) Sep 61
AM/FM Stereo Tuner, Yamaha TX-930 (Feldman)(PTR) Oct 80
American Heritage Electronic Dictionary, Houghton Mifflin's (Holtzman)(CB) Oct 90
Amplified DC Microammeter (Rakes)(CC) Apr 77
Amplifier, 20-Watt Stereo (Young)(C) Jul 40
Annunciator Circuit (Rakes)(CC) Jan 80

Answering Device (Wels)(TT) Feb 22
Machine Beeper (Yacono)(TT) May 20
the Mail (Wels)(TT) Jan 22

Antennas An Array of (Saxon)(SS) Jan 92
Homebrew Antenna for the Cheapskate (Carr)(HR) Feb 86
Improve Reception With a Dual-Band Loop Antenna (Hollander)(C) Dec 62
Wire, for Hams and SWL's (Carr) Aug 49
"Antique" Microphone (Czarnik)(C) Jan 69

ANTIQUY RADIO (Ellis)(D) Jan 78, Feb 78, Mar 78, Apr 86, May 69, Jun 66, Jul 66, Aug 66, Sep 72, Oct 85, Nov 74, Dec 68
Build the Cunningham Special! Collecting Antique Radio Gear Inside the Therman Mailbag Time Once More Making of a Collector, The More Tube Testing Power! Operating the Cunningham Special Reading the Mail Safety for Restorers: Part 1 Nov 74
Part 2 Dec 68
Therman A First Look Inside America's Six-Decade Love Affair With Contest Results! Sep 72
Jun 66
Apr 74

AOR Model AR3000 (Saxon)(SS)
Appliance Controller (Yacono)(TT)
Application Techniques' Pizazz Plus (Blechman)
Appoint's MousePen (Holtzman)(CB)
Are We Receiving Biological Signals from Outer Space? (Lawrence)
Array of Antennas, An (Saxon)(SS)
Asymetrix Corp's ToolBook 1.0 (Holtzman)(CB)
At Last! (Laron)(ED)

AUDIO

1930's-Style Radio Transmitter (Smolski)(C)
20-Watt Stereo Amp (Young)(C)
Ad Lib Music's Synthesizer Card (Blechman)(FS)
All About Receiver Sensitivity (Carr)
Audio-Frequency Generator (Rakes)(CC)
Audio-Noise Blanker, An (Carr)(HR)
AudioSource EQ Ten Graphic Equalizer/Spectrum Analyzer (Feldman)(PTR)
DAT Pact, The (Fenton)
How to Design Your Own Speakers (Honeycutt)
Inside Sony's New Mini Disc (Fenton)
JVC XD-2505 Digital Audio Tape Player (Feldman)(PTR)
Nakamichi CDPlayer2 CD Changer (Feldman)(PTR)
"Magic-Film" Speaker, The (Spiwak)(C)
Panasonic CQ-1090EU Car Audio Tuner/Cassette Deck (Feldman)(PTR)
Pioneer CLD-1080 Laserdisc/CD Player (Feldman)(PTR)
Scanner Companion, The (Piller)(C)
Super Simple Music Circuit (Giamportone)(C)
Wire Antennas for Hams and SWL's (Carr)
Yamaha TX-930 AM/FM Stereo Tuner (Feldman)(PTR)
AudioSource EQ Ten Graphic Equalizer/Spectrum Analyzer (Feldman)(PTR)
Automatic Fish Feeder (Axelson)(C)
Automotive AutoCommand Plus Remote Car Starter (HOR) Jun 61
Panasonic CQ-1090EU Car Audio Tuner/Cassette Deck (Feldman)(PTR) Feb 74
Auva Cordless Mouse, Byte-Size Stores (Blechman)(FS) Oct 87

B

B&B Electronics Model 232 Modern Security Device (HOR) Apr 69
Bandsweeper, Build a, Using the NE602 (Carr)(HR) Nov 80
Bank, Electronic The "Slot Machine" (Spiwak and Yacono)(C) May 35
Bargains for Your Workbench (Lisle) Jan 67
Battlehawks 1942, Lucasfilms Games (Blechman)(FS) Jan 84
Battery-Voltage Indicator (Yacono)(TT) May 20
Binary Clock (Blechman)(C) Jan 31,(LET)Oct 4
Comparators (Young)(DEC) Jan 72
Bioelectronics Electronic Limbs (Knight) Aug 53
Biological Signals from Outer Space, Are We Receiving? (Lawrence) Apr 58,(LET)Aug 4
Birth of the Vacuum Tube, The (Rybak) May 40
Bitgrabber Revisited, The (Yacono) Aug 20
Blind Aids (Wels)(TT) Jan 22
Borland International's SideKick 2.0 (Holtzman)(CB) Nov 76
Bug Off Pest Repeller, The (Yacono)(C) Apr 36

Mar 94 Build (See also CONSTRUCTION) a Bandsweeper Using the NE602 (Carr)(HR) Nov 80
Nov 18 the Cunningham Special! (Ellis)(AR) Feb 78
a Spectrum Analyzer (Carr)(HR) Dec 76
Nov 64 Your Own Picture
Feb 80 Phone (Pereleman and Yacono)(C) Jul 25
Burglar-Alarm Upgrade (Yacono)(TT) Apr 22
Buyer's Guide to DMM's, A Oct 55
Jan 92 Byte-Size Stores' Auva Cordless Mouse (Blechman)(FS) Oct 87
CTS-Pillow KB-101 EXT (Blechman)(FS) Oct 87

C

Camcorder Chinon Pocket 8 (Feldman)(PTR) Nov 67
Sony CCD-TR4 (Feldman)(PTR) Aug 64
Camera-Shutter Trigger (Wels)(TT) Jan 22
Capacitor Checker (Rakes)(CC) Feb 82
Cases, Custom (Schopp)(C) Apr 64
Casio TV-7500 Color-LCD TV (Feldman)(PTR) Jan 74
Catching Crooks, Scanner Style (Saxon)(SS) Jul 80
CD Changer Nakamichi CDPlayer 2 (Feldman)(PTR) Jun 63
Cellular Telephones, All About (Bigelow) Mar 58
Change Comes to Albania (Jensen)(DX) Aug 76
Changing of the Guard (Wels)(TT) Mar 24
Cheap-Link File-Transfer System (Blechman) Mar 70
Chinon Pocket 8 Camcorder (Feldman)(PTR) Nov 67
Christmas Display (Yacono)(TT) Sep 16
-Light Tester (Yacono)(TT) Jun 16
Chuck Yaeger's Air Combat Electronic Arts (Blechman)(FS) Sep 80
CIRCUIT CIRCUS (Rakes)(D) Jan 80, Feb 82, Mar 8E, Apr 77, May 74, Jun 72, Jul 70, Aug 72, Sep 74, Oct 82, Nov 71, Dec 86
Detector Circuits and More Indicators for All Occasions Meter-Range Extender Circuits More Circuits For Your Circuits Library NE602-Based Circuits, More Oscillator Round-Up Power-Control Circuits, and More Take an Electronics Holiday Test Gear for the Beginner Test Instruments and More! Voice Scrambler/Descrambler and More Jul 70
Classic Updated, A (Holtzman)(CB) Nov 76
Clock Binary (Blechman)(C) Jan 31
Most Accurate, Heathkit's (HOR) Mar 73
Collecting Antique Radio Gear (Ellis)(AR) Apr 86
Stamps, Business News on SW, and More (Jensen)(DX) Jan 90
Communications All About Cellular Telephones (Bigelow) Mar 58
Modems and Computer (Szelechter) Jan 64
Light-Beam Communicator (Penner)(C) Oct 41
Comparators, Digital (Young)(DEC) Jan 72
Component Tolerances, Calculating Dealing With Uncertainties (Tarchinski) Jun 56
Compressor-Mate (Jordan and Yacono)(C) Aug 35
Compton's Electronic Encyclopedia (Holtzman)(CB) Jul 68

H

HAM RADIO (Carr)(D)
 Jan 88, Feb 86, Mar 84
 Apr 86, May 78, Jun 76
 Jul 76, Aug 78, Sep 86
 Oct 92, Nov 80, Dec 76
 May 78

Audio-Noise Blanker, An Build a
 Bandsweeper Using the NE602 Spectrum Analyzer
 Improving Reception in Crowded VHF/UHF Bands
 Less Power to You
 New No-Code License, The Random Walk Through the Technical Mailbag, A
 Slaying Some SLJ's Using an RF Dip Meter
 Digital Frequency Counters
 Ham's Ham, A (Laron)(ED)
 Handheld Memories and X-Rated McDonald's Chatter (Saxon)(SS)

HANDS-ON REPORT (D)
 Jan 76, Feb 72, Mar 73
 Apr 69, May 65, Jun 61
 Jul 63, Aug 61, Sep 66
 Oct 78, Nov 70, Dec 64

AutoCommand Plus Remote-Control Car-Start System
 B&B Electronics Modem-Security Device
 EKI Mr. Circuit II
 Digital Magic Lab
 Heathkit
 Most Accurate Clock
 IC1001 Logic Analyzer
 Laser PC4 Portable Computer
 Okidata OL 400 LED Page Printer
 OWI, Inc. WAO II Mobile-Robot Kit
 PCBoards PC-Pattern Design Software
 Sams PhotoFact Series
 Suncom Technologies iCONtroller
 Zaphod Industries File Fetch Program

HARDWARE (See also COMPUTER BITS)
 B&B Electronics Modem Security Device (HOR)
 Helpers for Software Fun (Blechman)(FS)
 Heathkit IC1001 Logic Analyzer (HOR)
 Hauppauge Computer Works ATCL25-04 386 Board (Holtzman)(CB)
 H.C. Jacoby's EgoTrip (Blechman)(FS)

Heathkit IC1001 Logic Analyzer
 Most Accurate Clock, (HOR)
 Hello "New-Age" Scanner, Goodbye "Old Warhorse" (Saxon) (SS)
 High-Tech Scanner, A (Saxon)(SS)
 Turbo Scanner (Saxon)(SS)
 Hiss Eliminator Scanner Companion, The (Plier)(C)
HISTORY
 Experiments in Galvanism (Czarnik)
 First Shirt-Pocket Radio, The (Schiffer)
 How Wireless Got Its Voice (Rybak)
 History Lesson, A (Blechman)(FS)
 Holiday Gift Guide (Fenton and Scaduto)
 Home-Automation System, The Portmaster (Yacono and Spiwak)(C)
 Homebrew Antenna for the Cheapskate (Carr)(HR)
 Hot-Wire Glass Cutter (Dec 1990) (LET)Feb 4
 Houghton Mifflin's American Heritage Electronic Dictionary (Holtzman)(CB)

How To
 Choose A Computer (Blechman)
 Design Your Own Speakers (Honeycutt)
 How Wireless Got Its Voice (Rybak)
 HyperPad 2.0 (Holtzman)(CB)
Hypertext
 A Closer Look At (Holtzman)(CB)
 Hype or Text? (Holtzman)(CB)
 More on (Holtzman)(CB)

iCONtroller, Suncom Technologies (HOR)
 Improve Reception With a Dual-Band Loop Antenna (Hollander)(C)
 Improving Reception in Crowded VHF/UHF Bands (Carr)(HR)
 In Search of European DX (Jensen)(DX)
 Indispensable Software (Holtzman)(CB)
 Indicators for All Occasions (Rakes)(CC)
Inside
 Information, Microlytics (Holtzman)(CB)
 Sony's New Mini Disc (Fenton)
 the Theremin (Ellis)(AR)
 Intelligent Magic-Hand Remote-Controlled Outlet (Yacono and Spiwak)(C)
 Intercom Horn (Yacono)(TT)
 Intereference, Eliminating (Carr)

I

Introducing Market Center (Laron)(ED)
 Aug 2
 Intruder Detector Sentry Strobe Alert System (Charlton)(C)
 Feb 33
 Intrusion Alarm (Yacono)(TT)
 Apr 22
 Is Foolproof VCR Programming Finally Here? (Laron)(ED)
 Feb 2
 Isolating Telephone Extensions (Cooper)(C)
 Apr 41
 Isolation Transformer (Yacono)(TT)
 Nov 18
 It's Magic (Laron)(ED)
 Jan 2

J

Jameco Electronics JE3533 386 Board (Holtzman)(CB)
 Sep 70
 JDR Microdevices MCT-C386-25 386 Board (Holtzman)(CB)
 Sep 70
 Joysticks and Mice, New Homes for (Blechman)(FS)
 Oct 87
 JVC XD-Z505 Digital Audio Tape Recorder (Feldman)(PTR)
 Apr 71

K

Kit-building
 Heathkit IC1001 Logic Analyzer
 Most Accurate Clock (HOR)
 Oct 78
 OWI, Inc.'s WAO II Mobile-Robot Kit (HOR)
 Mar 73
 Klondike, Geoworks (Blechman)(FS)
 Aug 70

L

Lapel Pin, Flashing, for the Holidays (Baumeister)(C)
 Dec 61
 Laser PC4 Computer (HOR)
 May 65
 Laser Power Supply, Simple (Gray)(C)
 Sep 32
 Laserdisc/CD Player Pioneer CLD-1080 (Feldman)(PTR)
 Mar 76
 Latching Continuity Tester (Wels)(TT)
 Jan 22
 Lava Lamp (Hubscher)(C)
 Mar 31, (LET)May 3
 Leak Detector (Rakes)(CC)
 Jun 72
 Learning About the Hobby (Jensen)(DX)
 Oct 94
 Less Power to You (Carr)(HR)
 Oct 92

LETTERS (D)
 Jan 4, Feb 4, Mar 3, Apr 4
 May 3, Jun 3, Jul 3, Aug 4
 Sep 4, Oct 4, Nov 3, Dec 4

License, Ham Radio New No-Code (Carr)(HR)
 Jul 76
Light
 -Beam Communicator (Penner)(C)
 Oct 41
 Sensors, Looking at (Carr)
 Jan 61
 Limbs, Electronic (Knight)
 Aug 53
 Line Booster (Yacono)(TT)
 Nov 18
 Line-Monitor Adapter (Yacono)(TT)
 Nov 18
 List and Label Fun (Holtzman)(CB)
 Dec 68
Logic
 Analyzer, Heathkit IC1001 (HOR)
 Oct 78
 Probe, x 4 (Splwak and Yacono)(C)
 Mar 55
 Looking at Light Sensors (Carr)
 Jan 61
 Lotus Development Corp.'s Maneuvering With Magellan 2.0 (Holtzman)(CB)
 Apr 80
 Love Those Meeses (Holtzman)(CB)
 Feb 80
Low
 -Range Ohmmeter (Rakes)(CC)
 Apr 77
 -Voltage Voltmeter (Rakes)(CC)
 Apr 77

Lucasfilms Games Battlehawks 1942 (Blechman)(FS)
 Jan 84

M

Mac, Make Your Own (Kanter)(C)
 Sep 26
 Magellan 2.0, Lotus Development (Holtzman)(CB)
 Apr 80
 "Magic-Film" Speaker, The (Spiwak)(C)
 Aug 56
 Magic-Light Circuit (Wels)(TT)
 Mar 24
 Mailbag Time Once More (Ellis)(AR)
 Mar 78
 Make Your Own Mac (Kanter)(C)
 Sep 26
 Making of a Collector, The (Ellis)(AR)
 Oct 85
 Maneuvering With Magellan (Holtzman)(CB)
 Apr 80
 Mastering Your Computer's Sound (Blechman)(FS)
 Nov 78
 Metal Detector (Rakes)(CC)
 Mar 88, Jun 72
 Microlytics' Inside Information (Holtzman)(CB)
 Oct 90
 Microphone, "Antique" (Czarnik)(C)
 Jan 69
MicroProse
 Silent Service II (Blechman)(FS)
 Mar 82
 F-19 Stealth Fighter (Blechman)(FS)
 Jan 84
Microsoft
 Entertainment Pack (Blechman)(FN)
 Jun 70
 Mouse (Holtzman)(CB)
 Feb 80
 Microspeed's PC-TRAC Trackball (Blechman)(FS)
 Apr 82

(Holtzman)(CB)
 Feb 80
 MIDI
 Mastering Your Computer's Sound (Blechman)(FS)
 Nov 78
 Midland's WeatherMax 74-104 Weather Monitor (Saxon)(SS)
 Sep 82
 Minicom VHF FM Transceiver, Courier's (Saxon)(SS)
 Oct 96
 Mini Disc, Inside Sony's New (Fenton)
 Sep 39
 Mobile-Robot Kit OWI, Inc.'s WAO II (HOR)
 Sep 66
 Modem Security Device B&B Electronics Model 232 (HOR)
 Apr 69
 Modems and Computer Communications (Sziechter)
 Jan 64
 Modifications, and More! (Saxon)(SS)
 Nov 84
 Moisture Detector (Rakes)(CC)
 May 74

More
 Circuits for Your Circuits Library (Rakes)(CC)
 Jan 80
 on Hypertext (Holtzman)(CB)
 Jul 68
 Tube Testing Power! (Ellis)(AR)
 Jan 78

Multimedia
Hypertext
 A Closer Look At (Holtzman)(CB)
 Jun 68
 Hype or Text? (Holtzman)(CB)
 May 72
 More on (Holtzman)(CB)
 Jul 68

Multimeters
 All About (Bigelow) and More (Laron)(ED)
 May 28
 Buyer's Guide to DMM's
 Oct 2
 Does Your Multimeter Lie to You? (Carr)
 Oct 55
 Meter
 Calibration Circuit (Rakes)(CC)
 Apr 77
 Range Extender Circuits (Rakes)(CC)
 Apr 77
 Multiplexed Displays (Young)(DEC)
 Jun 58
 Multiplexing With Counters (Yacono)(TT)
 May 20
 Muramator, The Design Your Own Robot (Connell)(C)
 Aug 25
 Music Circuit, Super Simple (Giamportone)(C)
 Nov 61
 Music-on-Hold Box (Giamportone)(C)
 Dec 53
 Myxer Corp. MWS386-25 386 Board (Holtzman)(CB)
 Sep 70

N

Nakamichi CDPlayer2 CD Changer (Feldman)(PTR)
 Jun 63
 NE602-Based Circuits, More (Rakes)(CC)
 Aug 72

New
 Decade in Consumer Electronics, A (Scaduto and Fenton)
 Jun 34
 Homes for Joysticks and Mice (Blechman)(FS)
 Oct 87
 No-Code License, The (Carr)(HR)
 Jul 76
NEW PRODUCTS (D)
 Jan 14, Feb 14, Mar 14, Apr 14
 May 12, Jun 12, Jul 12, Aug 12
 Sep 14, Oct 14, Nov 12, Dec 12

No
 -Code License, The New (Carr)(HR)
 Jul 76
 -Frills Magic-Hand Remote-Controlled Outlet (Yacono and Spiwak)(C)
 Nov 33

Noise
 Limiter (Carr)(HR)
 May 78
 -on-Demand Circuit (Yacono)(TT)
 Apr 22
 Nuclear Computing's Windows Games (Blechman)(FS)
 Oct 87

O

Okidata OL 400 LED Page Printer (HOR)
 Jul 63
 Opening Up Your Gates (Yacono)(TT)
 Apr 22
 Operating the Cunningham Special (Ellis)(AR)
 May 69
 Optoisolators (Yacono)(TT)
 Sep 18
Oscillator
 -Driven Indicator (Rakes)(CC)
 Oct 82
 Round-Up (Rakes)(CC)
 Mar 88
 Oscillators, All About (Johnson)
 Aug 59
 Oscilloscopes, All About (Bigelow)
 Jul 34
 Outlet, Remote Controlled (Yacono and Spiwak)(C)
 Nov 33
 OWI, Inc. WAO II Mobile-Robot Kit (HOR)
 Sep 66

P

Panasonic CQ-1D90EU Car Audio Tuner/Cassette Deck (Feldman)(PTR)
 Feb 74
 Paying the Piper, and the Record Company (Laron)(ED)
 Nov 2
 PC-Board Repair When Disaster Strikes (Spiwak)
 Feb 64
 PCBoards PC-Pattern Design Software (HOR)
 Aug 61
 PDI Music Software's ENTER-tainer (Blechman)(FS)
 Feb 84
 Permanent Magnet Detector (Rakes)(CC)
 Jul 70
 Personal MicroCosm's Astronomy Lab (Blechman)(FN)
 Jun 70

Pest Repeller, The Bug Off (Yacono)(C) Apr 36
Phone (See also Telephone)
 -In-Use Indicator (Yacono)(TT) Jul 20
 -Line Tester (Yacono)(TT) Apr 22
 -Ring Detector (Yacono)(TT) Jun 18
Photography
 Camera-Shutter Trigger (Wels)(TT) Jan 22
 Shoot the Classic Milk Drop (Bailey)(C) Mar 40
 Picture Phone (Perleman and Yacono)(C) Jul 25
 Pilot Light (Wels)(TT) Mar 24
 Pioneer CLD-1080 Laserdisc/CD Player (Feldman)(PTR) Mar 76
Pizzazz Plus
 Application Techniques (Blechman) Nov 64
 Polarity Indicator (Rakes)(CC) Oct 82
 Portmaster Home-Automation System (Yacono and Spiwak)(C) Feb 59
 (LET)Apr 4,(LET)May 3
 Power Control, Triacs and (Yacono)(TT) Dec 17
 Power-Control Circuits, and More (Rakes)(CC) Nov 71
Power Supply
 Laser (Gray)(C) Sep 32
 Precision Dual (Yacono and Spiwak)(C) Oct 27
 Power Switch for Your Computer, Telephone Operated (Stephens)(C) Jun 53
 Precision Dual Power Supply (Yacono and Spiwak)(C) Oct 27
 Preparing for Stormy Weather (Saxon)(SS) Sep 82
 Preselector, Shortwave (Carr)(C) Jan 57
 Pressure Detector (Rakes)(CC) Sep 74
 Printer, Okidata OL 400 (HOR) Jul 63
 PRO-2022, Realistic (Saxon)(SS) Jul 80
 PRO-2024, Realistic (Saxon)(SS) Aug 80
 PRO-35, Realistic (Saxon)(SS) Nov 84

PRODUCT TEST REPORTS (Feldman)(D) Jan 74, Feb 74, Mar 76, Apr 71, May 67, Jun 63, Jul 64, Aug 64, Sep 68, Oct 80, Nov 67, Dec 65
 AudioSource EQ Ten Graphic Equalizer/Spectrum Analyzer Dec 65
 Casio TV-7500 Color-LCD Television Receiver Jan 74
 Chlnon Pocket 8 Camcorder JVC XD-Z505 Nov 67
 Digital Audio Tape Recorder Nakamichi CDPlayer2 CD Changer Panasonic CQ-ID90EU Car Audio Tuner/Cassette Deck Feb 74
 Pioneer CLD-1080 Laserdisc/CD Player Pulsar TVP 2000 "Prodigy" Projection TV Receiver Sep 68
 Sony CCD-TR4 Camcorder Sylvania RKS240CH TV/Monitor Receiver Jul 64
 Toshiba M441 VCR May 67
 Yamaha TX-930 AM/FM Stereo Tuner Oct 80
 ProtoMax Design Station, The (Yacono and Spiwak)(C) Jun 31
 Pulsar TVP 2000 "Prodigy" Projection TV Receiver (Feldman)(D) Sep 68
 Programmable Robot OWI, Inc. WAO II Mobile-Robot Kit (HOR) Sep 66
 Project Enclosures Custom Cases (Schopp)(C) Apr 64
 Proximity Detector (Rakes)(CC) May 74
 Pulse Generator (Rakes)(CC) May 74
 Pulse-Width Modulation Circuit (Wels)(TT) Feb 22

Q

Quad-Tracer (Rakes)(C) Jul 59
 Question of Balance, A (Laron)(ED) Mar 2

R

RADIO
 Add Shortwave Reception to Any Radio (Carr) Dec 56
 How Wireless Got Its Voice (Rybak) Radio Oct 30
 Bangladesh, Tune in to (Jensen)(DX) Jun 74
 Fare From Down Under (Jensen)(DX) Apr 84
 Regenerative Vacuum-Tube Receiver (Czarnik)(C) Apr 29,(LET)Jul 3
 Roll Your Own Radio (Davidson)(C) Jan 37
 Shortwave Preselector (Carr)(C) Jan 57
 Transmitter, 1930's-Style (Smolski)(C) Nov 57
 Random Walk Through the Technical Mailbag, A (Carr)(HR) Sep 86
 Reader Mail (Jensen)(DX) May 80
 Reading the Mail (Ellis)(AR) Aug 66
Realistic
 PRO-2022 (Saxon)(SS) Jul 80
 PRO-2024 (Saxon)(SS) Aug 80
 PRO-35 (Saxon)(SS) Nov 84

Receiver
 Sensitivity, All About (Carr) Sep 61
 Regenerative Vacuum-Tube (Czarnik)(C) Apr 29,(LET)Jul 3
 Reception, Improving in VHF/UHF Bands (Carr)(HR) Aug 78
 Red Baron, Sierra On-Line's (Blechman)(FS) Aug 70
 Regenerative Vacuum-Tube Receiver (Czarnik)(C) Apr 29,(LET)Jul 3
Remote
 Car Starter, AutoCommand Plus (HOR) Jun 61
 -Controlled Outlet (Yacono and Spiwak)(C) Nov 33
Repair
 PC-Board When Disaster Strikes (Spiwak) Feb 64
 Simple VCR Repairs that You Can Do! (Allen) May 57
 Resistor Color-Code Checker "Sure-Luck" Ohms (Rakes)(C) Apr 55
 Reviewing the Ground Rules (Wels)(TT) Feb 22
RF
 Detector (Rakes)(CC) Sep 74
 Dip Meter, Using a (Carr)(HR) Jan 88
 Gizmos, Useful (Carr)(C) Jul 55
 Sniffer (Carr)(C) Jul 55
 Voltmeter Probe (Carr)(C) Jul 55
 Ring Application (Yacono)(TT) Sep 18
Robotics
 Design Your Own Robot (Connell)(C) Aug 25
 OWI, Inc. WAO II Mobile-Robot Kit (HOR) Sep 66
 Roll Your Own Radio (Davidson)(C) Jan 37
 Royalty Agreement DAT Pact, The (Fenton) Nov 38

S

Safety for Restorers: Part 1 (Ellis)(AR) Nov 74
 Part 2 (Ellis)(AR) Dec 68
 Sams Photofact Series (HOR) Jan 76
 Scanner Companion, The (Pilier)(C) Jun 39
SCANNER SCENE (Saxon)(D) Jan 92, Feb 90, Mar 94, Apr 88, May 82, Jun 78, Jul 80, Aug 80, Sep 82, Oct 96, Nov 84, Dec 82
 Array of Antennas, An Catching Crooks, Scanner Style Digging into the Mailbag! Handheld Memories and X-Rated McDonald's Chatter Hello "New-Age" Scanner, Goodbye "Old Warhorse" Apr 88
 High-Tech Scanner, A High-Tech Turbo Scanner Modifications, and More! Preparing for Stormy Weather To Catch a Thief Sep 82
 Top Value in a Mid-Range Scanner Who Cares? We Do! Aug 80
 Screen Dump Scrimmage (Blechman) Nov 64
 Seeing the Stars (Blechman)(FN) Jun 70
Self
 -Resetting Alarm (Yacono)(TT) Jul 20
 -Test Interface (Wels)(TT) Mar 24
 Sensitive RF Detector (Carr)(C) Jul 55
 Sensors, Light (Carr) Jan 61
 Sentry Strobe Alert System (Charlton)(C) Feb 33,(LET)Jun 3
 Serious Problem and a "Sound" Solution, A (Laron)(ED) May 2
 Shirt-Pocket Radio, The First (Schiffer) Dec 35
 Shoot the Classic Milk Drop (Bailey)(C) Mar 40
 Shop Equipment (Yacono)(TT) Nov 18
Shortwave
 Preselector (Carr)(C) Jan 57
 Radio: It's No Laughing Matter! (Jensen)(DX) Sep 84
 Reception, Add to Any Radio (Carr) Dec 56
 SideKick 2.0. Borland International's (Holtzman)(CB) Nov 76
 Sierra On-Line's Red Baron (Blechman)(FS) Aug 70
 Signals From Space: Fact, Fiction, or April Fools? Laron (ED) Jul 2
 Signature Tracer (Yacono)(C) Dec 25
Simple
 Laser Power Supply (Gray)(C) Sep 32
 VCR Repairs that You Can Do! (Allen) May 57
 Sinewave Converter (Yacono)(TT) Nov 18
 Slaying Some SLJ's (Carr)(HR) Jun 76
 "Slot-Machine" Electronic Bank (Spiwak and Yacono)(C) May 35
 Socket Sentinel (Yacono and Spiwak)(C) Sep 63
SOFTWARE (See also FUN SOFTWARE)
 Hypertext A Closer Look At (Holtzman)(CB) Jun 68
 Hype or Text? (Holtzman)(CB) May 72
 More on (Holtzman)(CB) Jul 68
 Software, Indispensable (Holtzman)(CB) Mar 80

Solar Cell Communicator Light-Beam Communicator (Penner)(C) Oct 41
 Something For Everyone (Jensen)(DX) Nov 82
 Sonic Defender, The (Salas)(C) May 25,(LET)Aug 4,(LET)Jul 3
 Sony CCD-TR4 Camcorder (Feldman)(PTR) Aug 64
 Sentry Strobe Alert System, The (Charlton)(C) Feb 33
 Sound-Effects Gadget (Spiwak)(C) Oct 75
 Sound Master II, Covox's (Blechman)(FS) Nov 78
 Speaker, The "Magic-Film" (Spiwak)(C) Aug 56
 Speakers, How to Design Your Own (Honeycutt) Mar 34
 Spectrum Analyzer (Carr)(HR) Dec 76
 Spectrum HoloByte's Flight of the Intruder (Blechman)(FS) Mar 82
 SPOT, Virgin Mastertronic (Blechman)(FS) Jul 74
 Square-Wave Signal Generator (Rakes)(CC) Feb 82
 SSB, Does the Future of SW Lie in? (Jensen)(DX) Mar 86
 Staying Alive (Nov 1990) (LET)Jan 4
 Stereo Amp, 20-Watt (Young)(C) Jul 40
 Strike Aces' Accolade (Blechman)(FS) Feb 84
 Strobe Alert System, The Sentry (Charlton)(C) Feb 33
 Suncom Technologies ICONtronlier (HOR) Dec 64
Super Simple
 Frequency Counter (Stroncsek)(C) Jan 41,(LET)May 3
 Music Circuit (Giamportone)(C) Nov 61
 Supercharging a 555 (Yacono)(TT) Oct 22
 "Sure-Luck" Ohms (Rakes)(C) Apr 55,(LET)Jul 3
 Sweep Generator, FM (Carr)(HR) Nov 80
 Switch Debouncer (Wels)(TT) Jan 22
 Sylvania RKS240CH TV/Monitor Receiver (Feldman)(PTR) Jul 64
 Symantec Corp., GrandView 2.0 (Holtzman)(CB) Mar 80

T

Take an Electronics Holiday (Rakes)(CC) Dec 80
TELEPHONE
 Access III Telephone-Operated Power Switch for Your Computer (Stephens)(C) Jun 53
 All About Cellular Telephones (Bigelow) Mar 58
 Amplifier (Rakes)(CC) Jan 80
 Extensions, Isolating (Cooper)(C) Apr 41
 Intercom (Yacono)(TT) Jun 18, Sep 18
 Isolating Telephone Extensions (Cooper)(C) Apr 41
 Music-on-Hold Box (Giamportone)(C) Dec 53
 Phone
 -In-Use Indicator (Yacono)(TT) Jul 20
 -Line Tester (Yacono)(TT) Apr 22
 -Ring Detector (Yacono)(TT) Jun 18
 Picture Phone (Perleman and Yacono)(C) Jul 25
 Temperature Controller (Wels)(TT) Jan 22
TEST EQUIPMENT (See also NEW PRODUCTS)
 All About Meters (Bigelow) May 28
 Oscilloscopes (Bigelow) Jul 34
 Bargains for Your Workbench (Lisle) Jan 67
 Buyer's Guide to DMM's, A Oct 55
 Does Your Meter Lie to You? (Carr) Oct 36
 FM Sweep-Frequency Generator (Carr)(HR) Nov 80
 Frequency Counter, Super Simple (Stroncsek)(C) Jan 41
 Counters, Using Digital (Carr)(HR) Mar 84
 Low-Range Ohmmeter (Rakes)(CC) Apr 77
 Low-Voltage Voltmeter (Rakes)(CC) Apr 77
 Quad-Tracer (Rakes)(C) Jul 59
 Shop Equipment (Yacono)(TT) Nov 18
 Signature Tracer (Yacono)(C) Dec 25
 Super Simple Frequency Counter (Stroncsek)(C) Jan 41
 Test Gear for the Beginner (Rakes)(CC) Feb 82
 Test Instruments and More! (Rakes)(CC) May 74
 Using Digital Frequency Counters (Carr)(HR) Mar 84
 Workbench, Bargains for Your (Lisle) Jan 67
 The Software Toolworks' The Games People Play (Blechman)(FS) Sep 80
Theremin
 A First Look Inside (Ellis)(AR) Sep 72
 America's Six-Decade Love Affair with (Ellis)(AR) Jun 66
 Contest Results! (Ellis)(AR) Apr 74
 Inside the (Ellis)(AR) Jul 66
THINK TANK (Yacono)(D) Jan 22, Feb 22, Mar 24, Apr 22, May 20, Jun 18, Jul 20, Aug 20, Sep 18, Oct 22, Nov 18, Dec 17
 Adjustable Regulators Can Control More Than Just Voltage Jul 20
 Answering the Mail Jan 22
 BitGrabber Revisited, The Aug 20
 Changing of the Guard Mar 24
 Controlling Power Sep 18
 Current-Limiting Resistors and More Jun 18
 Multiplexing with Counters May 20
 Opening Up Your Gates Apr 22

Reviewing the Ground Rules Shop Equipment Supercharging a 555 Triacs and Power Control	Feb 22 Nov 18 Oct 22 Dec 17	Motion Detector (Rakes)(CC) Uniden MR-8100 Turbo Scanner (Saxon)(SS) Update Your PC or XT (Nov 1990)	Aug 72 May 82 (LET) Apr 4	Receiver (Rakes)(CC) Transmitter (Rakes)(CC) Voice Scrambler/Descrambler and More (Rakes)(CC)	Jun 72 Jun 72 Jul 70
Three Fun Games from England (Blechman)(FS)	Jul 74	Useful RF Gizmos that You Can Build (Carr)(C)	Jul 55	Voltage -Controlled Oscillator (Rakes)(CC) -Level Indicator (Rakes)(CC) Probe (Yacono)(TT)	Sep 74 Oct 82 Nov 18
Time-Delay Circuit (Yacono)(TT) Flash-Trigger Circuit (Bailey)(C)	May 20 Mar 40	Using an RF Dip Meter (Carr)(HR) Digital Frequency Counters (Carr)(HR)	Jan 88 Mar 84	W	
Time-Out Circuit (Rakes)(CC)	Jan 80	V		Water Detector (Yacono)(TT) -Level Control (Wels)(TT)	Sep 18 Mar 24
Timed Night Light (Yacono)(TT)	Oct 22	Vacuum Tubes Birth of (Rybak) More Tube Testing Power! (Ellis)(AR) Receiver, Regenerative (Czarnik)(C) Variable Resistance Box (Rakes)(CC)	May 40 Jan 78 Apr 29 May 74	Weather Alert Decoder (Rawlinson)(C) WeatherMax 74-104, Midland's (Saxon)(SS) What Do Electrical Engineers Do? (Trietley)	May 62 Sep 82 Sep 35
Tis the Season for DX Listening (Jensen)(DX) To Catch a Thief (Saxon)(SS)	Dec 78 Dec 82	VCR Repairs that You Can Do, Simple (Allen) Toshiba M-441 (Feldman)(PTR)	May 57 May 67	When Disaster Strikes (Splwak) Who Cares? We Do! (Saxon)(SS) Why Compute? (Holtzman)(CB)	Feb 64 Oct 96 Jan 82
FoolBook 1.0, Asymetrix Corp.'s (Holtzman)(CB)	May 72, Jul 68	VIDEO Casio TV-7500 Color-LCD TV Receiver (Feldman)(PTR) Chinon Pocket 8 Camcorder (Feldman)(PTR) Pioneer CLD-1080 Laserdisc/CD Player (Feldman)(PTR) Pulsar TVP 2000 "Prodiqy" Projection TV Receiver (Feldman)(PTR) Simple VCR Repairs that You Can Do! (Allen) Sony CCD-TR4 Camcorder (Feldman)(PTR) Sylvania RKS240CH TV/Monitor Receiver (Feldman)(PTR) Toshiba M-441 VCR (Feldman)(PTR) Yamaha TX-930 AM/FM Stereo Tuner (Feldman)(PTR)	Jan 74 Nov 67 Mar 76 Sep 68 May 57 Aug 64 Jul 64 May 67 Oct 80	Wideband RF Instrument Amplifier (Carr)(C) Wimhurst Machine (Dec 1990) Windows Games, Nuclear Computing's (Blechman)(FS) Wire Antennas for Hams and SWL's (Carr) Wireless, How it Got its Voice (Rybak) Wiring, Electronic, for the Home (Allen) Workbench, Bargains for Your (Lisle)	Jul 55 (LET) May 3 Oct 87 Aug 49 Oct 30 Feb 43 Jan 67
Fools for Writing (Holtzman)(CB)	Oct 90	Virgin Mastertronic's Deluxe Scrabble (Blechman)(FS) Monopoly (Blechman)(FS) SPOT (Blechman)(FS)	Jul 74 Jul 74 Mar 82, Jul 74	Yamaha TX-930 AM/FM Stereo Tuner (Feldman)(PTR)	Oct 80
Foolworks (Blechman)(FS)	Sep 80	Visual CW Decoder (Rakes)(CC)	Oct 82	Z	
"Top-Flight" Simulator, and More (Blechman)(FS)	Feb 84	VLF CW-SSB-AM Receiver (Rakes)(CC)	Aug 72	Zaphod Industries File Fetch (HOR)	Feb 72
Top Value in a Mid-Range Scanner (Saxon)(SS)	Aug 80				
Toshiba M-441 VCR (Feldman)(PTR)	May 67				
Touch Switch (Wels)(TT)	Feb 22				
Transistor-Driven Pilot Light (Rakes)(CC)	Oct 82				
Triacs and Power Control (Yacono)(TT)	Dec 17				
TTL Crystal Oscillator (Rakes)(CC)	Mar 88				
Tube Birth of the Vacuum (Rybak) Testing Power, More (Ellis)(AR)	May 40 Jan 78				
Tune in to Radio Bangladesh (Jensen)(DX)	Jun 74				
TV/Monitor Receiver, Sylvania RKS240CH (Feldman)(PTR)	Jul 64				
Two-Transistor Crystal Oscillator (Rakes)(CC)	Mar 88				
U					
Ultrasonic Frequency Generator (Yacono)(TT)	Oct 22				



"The computer made two-million dollars in the stock market last week. I didn't know it was programmed to do that."

A peek inside the Computer Revolution

By Harry Nelson



"What a coincidence! I used the same stock-market analysis program!"

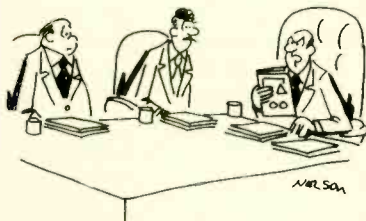

"Another computer report? Don't we have any people working here anymore?"



"This program is driving me ape."



"My hard disk is not too cluttered—it just has personality!"

ETCH your own PC BOARDS



With a few chemicals and a little know-how, you can take any circuit pattern directly off a printed page and turn it into a printed-circuit board.

Many recent entrants into the electronics hobby tend to shy away from making printed-circuit boards because of the perceived complexity (not to mention expense) involved. Even some seasoned hobbyists suffer from this affliction. One of the most frightening aspects of the hobby, particularly to the newcomer, is transferring the printed-circuit pattern from the printed page to a copper-clad "slug" (or unetched printed-circuit material). In this article, we'll describe an easy way to accomplish that task.

Materials. The technique described in this article uses a product known as "Lift-It film." Lift-It film is a clear-plastic acrylic film that has an adhesive backing. The film, which is available from many local and mail-order hobby-electronics suppliers, is similar to adhesive-backed laminating film (like that available from photographic supply outlets).

When the film's adhesive backing, which is water resistant, comes in contact with the ink of the pattern of interest, the ink bonds with the adhesive. When the paper on which the pattern was printed is removed, the ink is left on the film producing a photographic

BY ROBERT A. YOUNG

"positive" of the pattern—the areas covered by the ink are an exact duplicate of the copper pattern you wish to make.

Aside from Lift-It film, there are a few other things that you'll need. Two important items are pre-sensitized copper-clad slugs and an exposure frame—a jig that holds the foil pattern to the PC slug. Exposure frames are commercially available from many sources, although the commercial variety are not necessary, you can obtain comparable results using nothing more than a flat board and a piece of glass, weighted or clamped (if necessary) to the board to hold the pattern flat to the copper-clad slug.

You'll also need an ultraviolet light source and a light stand. However, I've had a lot of success using a photo-floodlamp and a Jerry-rigged stand. Another item that may be necessary, particularly in the case of magazine articles, is reversing film. Reversing film is a film that, when in contact with the image in question and exposed to ultraviolet light, reproduces the image, but with the image reversed—e.g., the

areas that were dark on the original become light and the areas that were light on the original become dark—so that a positive pattern can be changed to a negative one and vice-versa. We'll discuss the use of reversing film a bit later in this article.

In addition, you'll need a developing tray (glass or metal) and an etching tray (glass or plastic). Both developing and etching trays are commercially available, but you can use any glass dish or pan of suitable size to handle both jobs. Lastly, you'll need a few chemicals: etching solution, developing solutions (for both the reversing film and the photo-resist coating), and a solvent.

Using Lift-It Film. To use Lift-It film, you first cut a portion of the film of sufficient area to cover the pattern of interest with a little overlap. Peel off the Lift-It film backing, and position the film over the printed foil pattern. Carefully apply the film to the pattern, making sure that no air pockets form. Lift-It film can not be removed from the pattern and re-used, so it is very important that you perform this operation carefully. If small pockets do form, it is possible to remove them by poking small holes in the bubbles and burnishing them flat. Once the



Lift-It film, pre-sensitized slugs, an exposure frame, an ultraviolet light source, etching and developing solutions, and developing trays are all that are required to turn a pattern from printed-page into a printed circuit.

film is in full contact with the pattern, and any small air pockets have been removed, burnish the entire pattern to ensure the total transfer of the pattern.

Prepare a mixture of warm, soapy water. Place the artwork in the solution for 15 to 20 minutes. Then carefully rub off the paper with your fingers. Do not use an abrasive, such as steel wool or scouring powder as such materials may also remove the desired pattern. It may be necessary to soak the film in the soap and water solution several times to keep the paper moist while it is being removed.

Once all the paper has been removed, allow the film to dry on a flat surface. Once dry, the adhesive side of the Lift-It film will be very sticky, making it difficult to work with. Because of that, it will be necessary to back up the film with a clear sheet of Mylar film. Place the Lift-It film (adhesive side up) on a flat surface. Cut a piece of Mylar film to size, and place it on the Lift-It film. You now have a positive mask—dark areas where copper is to remain on the slug (unless the pattern was printed as a negative, which is extremely rare).

Magazine prints of positives are often weak; i.e., they may not have enough ink to produce opaque, high-density circuit patterns of the type required for photo-sensitive printed-circuit board manufacture. Hold your lift-It film up to the light, and inspect the dark areas. If the pattern is a weak gray (passing a good amount of light), it may be necessary to use reversing film to produce a negative. Reversing film is not as fussy about darkness and will produce a high-contrast negative from a mediocre positive.

Using Reversing Film. Before we describe how to use reversing film a word

PARTS LIST PRINTED-CIRCUIT MATERIALS

Etching solution (ferric chloride)
 Exposure frame and light stand (see text)
 Glass or metal developing tray (see text)
 Glass or plastic etching tray (see text)
 Lift-It film
 Photo-resist developing solution
 Pre-sensitized slugs
 Resist solvent (see text)
 Reversing film (optional, see text)
 Reversing film developing solution (optional, see text)
 Ultraviolet light (optional, see text)

Note: Lift-It film and the other printed-circuit supplies described in this article are produced by GC Electronics (1801 Morgan St., PO Box 1209, Rockford, IL 61105; Tel. 815-968-9661) and are available through their network of distributors. Contact them directly for a local distributor or mail-order supplier.

of caution is in order: Reversing film is light sensitive, and therefore must be handled under very subdued light or under a yellow bug light (also called a safelight).

Place the reversing film on a flat surface with the emulsion side down. It is difficult, especially in subdued light, to determine which side of the reversing film is the emulsion side, but there are two ways to do it: First there is a notch in the upper right corner when the emulsion side is facing you. If you can't see the notch in the dim light, try to scrape one corner of the film with an X-acto knife. If the emulsion (the thing that makes the film dark) comes off, then you have scraped the emulsion side.

Place the positive in the center of the reversing film. Without causing the positive to move on the reversing film, place a sheet of glass over the two films. With the positive pressed firmly against the reversing film, expose the films using a 15-watt fluorescent black light for about 25 minutes at a distance of about 12 inches or a 275-watt sunlamp for about 60 seconds. For other light sources, it will be necessary to experiment to obtain the best results.

Under the yellow or subdued incandescent light source, separate the positive from the reversing film, handling the film by the edges only. Place the exposed reversing film on a smooth clean surface, such as a piece of glass, with the emulsion side up. Pour a small

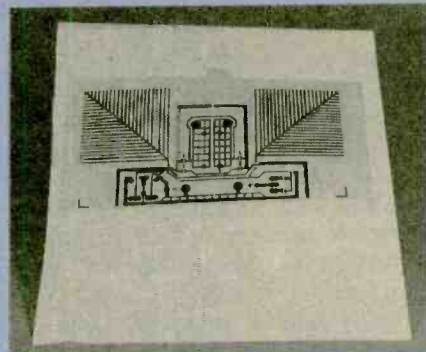

Magazine prints of foil patterns are often weak and may not have enough ink to produce opaque, high-density circuit patterns of the type required for photo-sensitive printed-circuit board production. If the pattern is a weak gray, it may be necessary to use reversing film to produce a negative.

amount of reversing-film developer onto the exposed reversing film. Soak a large cotton ball with the developing solution and rub the reversing film with a circular motion. The portion of the film that was not exposed to the light source will begin to dissolve, leaving behind the image. This piece of film (the negative) can now be used to etch your printed-circuit board using the "negative photo-resist" method.

However, you may repeat the process using the negative as the original to produce a refined positive. The positive can then be used to produce a board using the "positive photo-resist" method, provided you don't mind the extra step needed to make the final positive. The following instructions assume that you'll be using the negative photo-resist method.

Preparing the Board. The photo-resist method of printed-circuit board production involves the use of pre-sensitized slugs (unetched copper-clad material coated with a light-sensitive chemical) and intense light, to transfer the printed-circuit pattern from the mask to the slug.

To do this the mask is placed on a pre-sensitized slug and exposed to ultraviolet or high-intensity light. Under the light, the board's coating undergoes a chemical change, causing the masked areas to become resistant to a chemical developer. Ordinary light-bulbs or a slide projector don't put out a whole lot of energy in that part of the spectrum, but sunlamps do. If you don't have a sunlamp, you can use a fluorescent lamp or photographic flood lamp,

but the exposure times will vary. You'll have to experiment with exposure time to obtain the best results.

Once the exposure phase is complete, the next step is to develop the board; that must also be done while working under a subdued light. Make sure the developer that you get is made for the type sensitizer with which the board is coated.

Fill a glass or metal tray with developer to a depth of 1/2 inch. *Warning:* Do not place the developer in a plastic tray, the solvent action of the developer will eat right through most plastics. Lay the exposed board on the bottom of the tray containing the developing solution with the pattern side up. Gently agitate the solution. As the developing solution begins to react with the board coating, areas that were masked from the light during exposure will begin to chemically break down, leaving behind the desired pattern (the traces).

You can check to see how things are proceeding by removing the board from the solution. Handle the board by the edges only, and keep the pattern from touching anything. Also, be sure to hold the board so that any developer that remains on the board when it's removed can drain back into the tray. If the pattern appears clearly on the board, let the developer drain off and then dunk the board repeatedly in water. Do not let running water hit the board for the first twenty seconds or so because the resist is still very soft and easy to ruin, so there is a measurable risk of smearing it.

With the resist still swollen with developer, the pattern will be easy to see. The best time to tell if the board will etch well or not is when it's in the water and still full of developer. As the developer evaporates or is washed away, however, the pattern will disappear. If necessary, reimmerse the board in the developer, and give it another 30 or 40 seconds of gentle agitation and then wash it again as mentioned.

After you've washed the developer off, blow and shake the excess water off the board; **do not wipe the board.** Stand the board on end and allow it to dry thoroughly. An ordinary fan will speed the drying time considerably. Once the board is completely dry, it is ready for etching.

Etching the Board. Fill a glass or plastic tray with etching solution (ferric chlo-

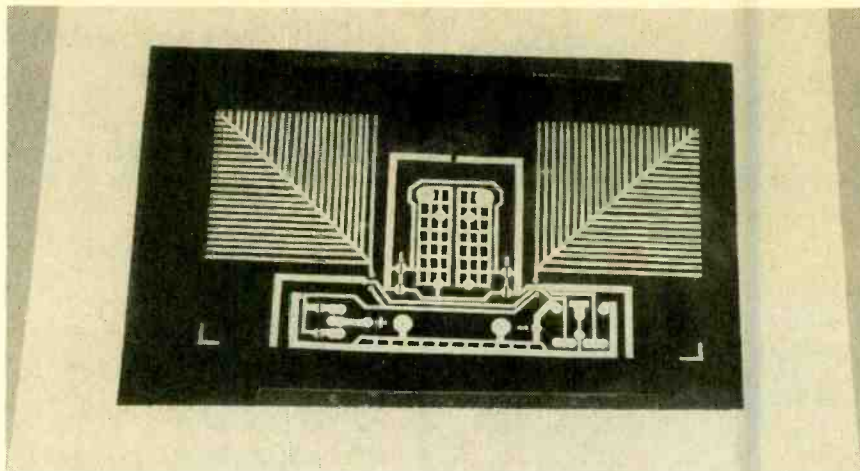

Once developed, reversing film produces a negative of the foil pattern, so that the areas of the original pattern that were light become dark and vice versa.

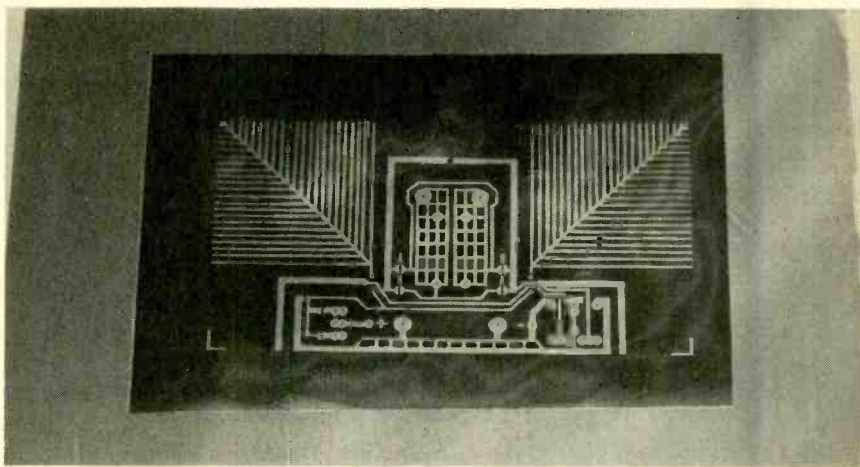

The film (photo-negative) is placed on an unetched pre-sensitized slug, and exposed to ultraviolet light. Under the light, the exposed areas of the sensitized board undergo a chemical change, which causes the exposed areas to become resistant to a photo developer.

ride is readily available from many sources) to about a half inch. Do not allow the etching solution to come in contact with any metal object; the solution will corrode metallic objects. Immerse the developed board in the solution, copper-side up, and agitate periodically by gently rocking the tray back and fourth.

The etching time can vary from about 20 to 60 minutes, depending on how often you agitate the tray and the temperature of the solution. The time required for etching can be reduced by heating the solution to between 90 and 120°F. If you decide to warm the solution, be sure that there is sufficient ventilation. Agitation also helps to speed the etching process. The board can be removed from the solution and rinsed under tap water from time to

time to check on the etching process. Once you are satisfied that all the unwanted copper has been removed, thoroughly rinse the board under tap water, and allow to dry.

The next step is to remove the etch resist from the etched board. There are several methods by which that can be accomplished: stripping solvent, scrubbing with fine steel wool, or even re-exposing the board to ultraviolet light for about 10 minutes and again immersing it in developing solution (assuming that you have not discarded the solution).

Producing your own printed-circuit boards from magazine print (or any other source) is a very simple task. All you need is a little patience and determination, and you too can make high-quality printed-circuit boards. ■



Give a Friend a Year of Electronics Fun this Christmas...

Does fighting the crowds at Christmas short-circuit your holiday fun? Don't blow a fuse this year. . . for the friend who shares your love of project-oriented electronics — or a youngster who may need only a spark to ignite a life-long interest — give a gift subscription to Popular Electronics.

. . . Because when you give him Popular Electronics, you're giving month after month of challenging construction projects — including complete plans for testing equipment, electronic worksavers for home and car, add-ons and modifications for hi-fi, computers, radio and TV.

He'll get the how-to he needs to build exciting, useful projects like these. . . a touch light dimmer. . . a traveler's theft alarm. . . an economy NiCd battery charger. . . a voice synthesizer. . . a wave form generator. . . the ultimate burglar alarm. . . a stereo graphic equalizer. . . and many, many more!

PLUS. . . testbench tips and techniques. . . circuit design. . . electronics fundamentals. . . book reviews, and new product news including our 12-page "Gizmo" section. . . regular columns on computers, scanners, dx'ing, ham and antique radio. . . the list goes on and on!

SAVE MONEY. . . A great gift to receive, Popular Electronics is also a great gift for *you* to give! The Special Holiday Rate saves you \$16.45 off the newsstand price on each gift. You can save another \$16.45 when you start or extend your own subscription at the same time. It's our "thank-you" for sharing Popular Electronics with a friend this Christmas.

Send no money, unless you prefer. We'll be glad to bill you in January, next year. Just take a brief moment to go over your gift list and make sure you haven't forgotten anyone who might appreciate the many benefits of Popular Electronics. Then write the names on the attached Gift Certificate and mail it back in the postage-paid reply envelope. . . we'll take it from there!

Your friends will receive a handsome gift announcement card signed with your name just before Christmas. And all through the new year they'll remember and appreciate your thoughtful gift!

So don't blow a fuse. . . take it easy and enjoy the holidays. Give Christmas gifts of Popular Electronics!

Popular Electronics[®]



THE OWI GRAND PIANO KIT



CIRCLE 119 ON FREE INFORMATION CARD

You'll have a grand old time building and playing this miniature electronic instrument that comes with built-in tunes and programmable memory.

If you're an electronics hobbyist and you're also into music, then here's something you might really appreciate: the Grand Piano kit (BT802) from OWI Incorporated. Although building the Grand Piano is quite easily a one-night project, the effort pays off since you wind up with a working project that has a beautiful appearance. The Grand Piano will earn its keep among all of your other electronic gadgets based on its good looks alone.

Another good thing about the piano is that it's perfect as a first electronic kit for a child—provided, of course, that you supervise them since there is soldering involved. Think about it: if you're into electronics, and you've got a technically inclined child, then what would make a better gift than a piano kit. (You do want your kid to have a head start in electronics, don't you?) But the unit can do more than just look pretty. . . .

What It Can Do. The unit is powered by two AA batteries controlled by an on/off switch located on the left side of the piano. Across the front of the piano is, of course, the "keyboard," which is composed of 15 micro-pushbuttons. In the "piano" mode (the basic configuration of the kit—we'll get to what that means in a bit), each of the 15 keys

plays a note ranging from low on the left to high on the right—just like a regular piano.

On the right side are two more micro-pushbuttons; one is reset and the other is replay. Pushing replay after playing up to 47 notes will replay those notes back to you in exactly the order that you originally played them; even the delays between notes will match (although there's a maximum replay delay of 6 seconds). The "reset" button does just what the name implies; whatever notes are stored in memory will be cleared. It will also halt a replay in progress while clearing the memory.

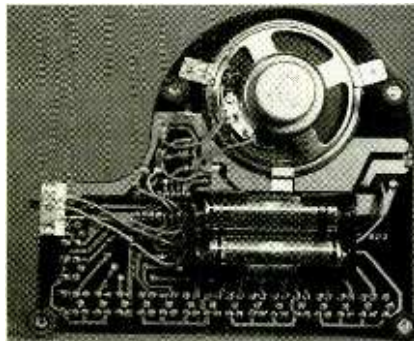

The legs of the piano, the speaker, and the battery holder attach to the underside of the board. The mode switch was held in place with a piece of double-sided tape on this unit.

A little while ago we mentioned a basic configuration; in the not-so-basic configuration (which requires a slight modification to the basic piano), you can switch the piano between piano mode and a "music-box mode." In the music-box mode, pressing each of the 15 keys causes the piano to play a different tune. Pressing replay will make the piano play all 15 songs in a row and pressing reset will stop the music.

Construction. The kit requires a little bit of mechanical and electrical assembly. As far as the piano's circuitry goes, there's not much to it—at least outside the single IC. In addition to the IC, you must solder in a couple of resistors, a couple of capacitors, a transistor, a slide switch, 17 micro-pushbutton switches, and 11 jumpers.

The slide switch, for turning the piano on and off, is extremely small, and solders right into place on the PC board. Don't confuse that switch with the larger slide switch that's also included with the kit. The larger switch is for the modification that allows it to have the two modes, as we mentioned earlier. That modification involves cutting a single trace on the PC board and attaching three leads from the switch to the
(Continued on page 91)

PRODUCT TEST REPORTS

By Len Feldman

Onkyo TX-SV70 Pro Audio/Video Receiver

The TX-SV70PRO Audio/Video receiver from Onkyo (200 Williams Dr., Ramsey, NJ 07446) provides all of the audio amplification and audio/video switching facilities that you need for a complete home-theater system. Unlike some AV receivers that provide only minimal power for the rear and center channels, this unit delivers a full 30-watts-per-channel to both the rear and the center-front speakers, while at the same time delivering 90-watts-per-channel to the

excellent FM tuner designs, and the FM-tuner section incorporated into this receiver was as sensitive as most better component (separate) tuners and offered stereo separation that was better than that found on most tuners or competing receivers.

The TX-SV70PRO incorporates full Dolby Pro Logic decoding, including an additional center channel amplifier for complete realization of Pro Logic's spatial benefits. The unit also provides Hall and Matrix surround-sound modes. A step-adjustable digital time delay, accessible in Dolby and Hall modes, allows modification of the perceived acoustical environment. The receiver also features a user programmable mode that allows "phantom" synthesis of center-channel information when the original sound source lacks specific directional information.

All five audio amplifier channels in this receiver feature discrete output devices. When used as a simple stereo amplifier, power output is rated at 90-watts-per-channel. When used in the surround mode, front channels are rated at 85 watts each, and rear and center channel power rating is 30 watts/channel.

There are three video inputs, and two of these are used to route VCR outputs, while the third is intended for a laser-disc player. The receiver has a front panel input for use with a cam-

order and video-dubbing capabilities are also provided. Audio inputs include two tape dubbing capability. Preamp-out/main amp in connections associated with the front channels facilitate bi-amplification (the addition of a separate amplifier) and the use of a subwoofer. Preamplifier output jacks for the rear and center channels allow easy substitution of high powered external amplifiers if you decide that your rear and center channel speakers require more power than is provided by the receiver's own amplifiers.

Up to 30 AM and FM presets can be set for the tuner section, so that your favorite radio stations can be accessed at the touch of a number button on the front panel or via the supplied programmable remote control. Also, the tuner section features Onkyo's "Classified Memory" system, that enables the user to assign each of the available AM or FM station presets to any of six classes, by type of programming (such as rock, classical, news, etc.).

The supplied remote is a universal type and can be "taught" command codes of audio and video products made by manufacturers other than Onkyo. Its 10-number keypad allows access of presets from the remote as well as from the front panel.

While the TX-SV70PRO is not the only receiver to

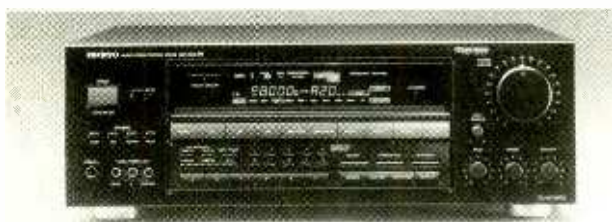

The TX-SV70PRO audiovideo control-center/receiver from Onkyo.

two main front speakers. Video frequency response and signal-to-noise ratios were far in excess of what you can expect from even the best video-program sources, so passing your video signals through this receiver for central switching control is not likely to degrade picture quality in any way.

As an audio-only receiver, this Onkyo product can handle analog phono inputs with excellent signal-to-noise ratios and accurately flat frequency response. Onkyo is particularly noted for their

incorporate extra front-channel outputs for connection to speakers in a secondary location, it is one of the few we have encountered that lets you play two different program sources at the same time; one in the main listening room and another in the second location. This receiver offers an additional feature if you own other compatible Onkyo components: Those other components can be controlled even from another room by means of an optional remote sensor. The receiver provides an on-screen display of control settings and adjustments, visible on any TV monitor/receiver that you connect to this receiver. Finally, the receiver has a sleep timed feature that's adjustable via the remote control for up to 90 minutes in 30-minute increments.

CONTROL LAYOUT

A power switch, four speaker-selector switches, and a stereo-headphone jack are at the extreme left of the front panel. A display area occupies a major section of that panel and has indicators for just about every function and status of the receiver. Ten pushbuttons arranged in a row below the display area are used to select audio or video program sources. To the right of the display area are an input-channel balance-control knob and a large, master volume-control knob that can be remotely driven using the remote control. An illuminated indicator light on the volume knob itself lets you see where the control is set even if you are sitting at a distance from the receiver.

Bass, treble, and channel-balance controls are at the lower right of the panel while the extra set of audio

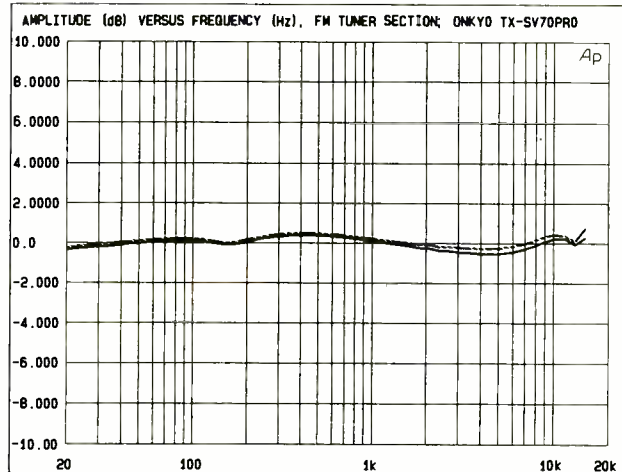

The FM tuner's frequency response varied by no more than 0.5 dB over its entire range.

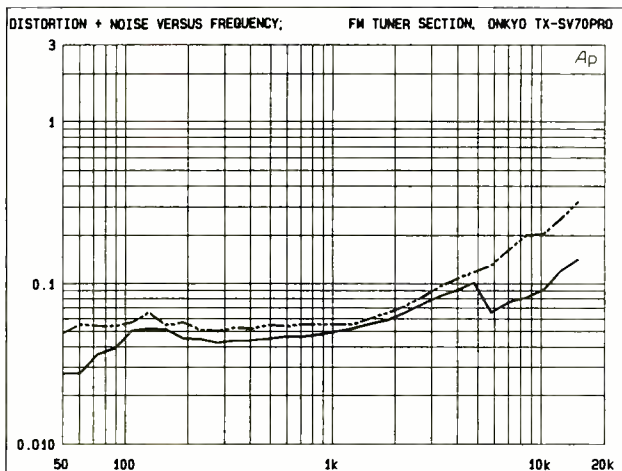

The FM tuner's THD-plus-noise performance was excellent over most of the frequencies measured. The solid trace is mono; the dashed curve is stereo.

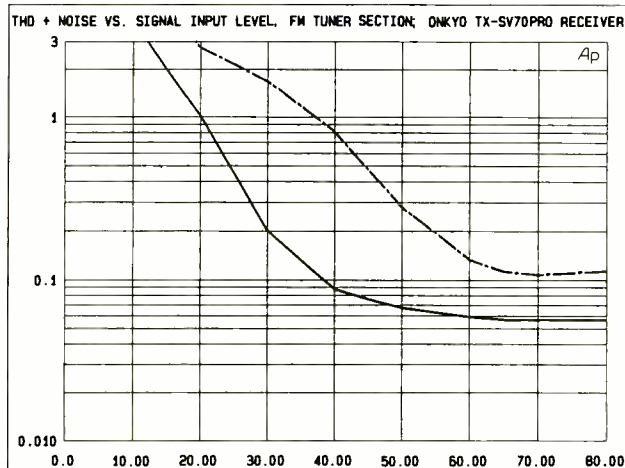

This plot of THD-plus-noise versus signal strength for a 1-kHz test signal provides us with "usable sensitivity" data, which was 12.5 dBf for mono and 18.2 dBf for stereo.

and video inputs mentioned earlier (for quick connection of a cam-

order) are at the lower left-end of the panel. Additional controls associated

with the surround-sound and Dolby Pro Logic functions are positioned on the lower section of the panel, along with preset number buttons, "up" and "down" tuning buttons, an FM-mode button (mono/stereo), an FM-mute button, a memory button used when storing frequencies for preset stations, the classified-memory buttons, a loudness-control button, a record-out selector button, two center-channel mode buttons, and a delay-time selector for rear channels when using one of the surround-sound modes.

As you might expect, judging by the number of available inputs and outputs provided on this receiver, there's practically no empty area on the rear panel of this versatile receiver. Nevertheless, all inputs, tape outputs, and speaker terminals are logically arranged and clearly labeled so that even if you refuse to refer to the owner's manual (something we don't recommend), you could probably hook up the receiver to your other components and speakers without too much trouble.

TEST RESULTS

As usual, we measured the performance of the tuner section first. The frequency response of the FM tuner section of the receiver was virtually flat; any variation over the useful range of FM broadcast audio was less than 0.5 dB in either direction, and, as we later learned, even this minimal deviation was more a function of the preamplifier/amplifier stages than of the tuner circuitry itself.

As little as 18.2 dBf of input signal for mono reception, and 35.6 dBf for stereo, was required to achieve 50-dB quieting. An abrupt drop in noise at low

TEST RESULTS—ONKYO TX-SV70 PRO A/V RECEIVER

Specification

	PE Measured
	FM Tuner Section
Mono usable sensitivity	12.5 dBf
50 dB quieting sensitivity	18.2 dBf
50 dB stereo quieting sensitivity	35.6 dBf
Stereo switching threshold	20.5 dBf
Signal/noise ratio, mono/stereo	75.5/71.0 dB
Capture ratio	1.5 dB
Distortion (THD + N), 1 kHz	
Mono	0.05%
Stereo	0.058%
Frequency response, 30 Hz–15 kHz	+0.3 dB, -0.4 dB
Stereo separation at 1 kHz	48 dB

AM Tuner Section

Frequency response (-6 dB)	85 Hz to 2.9 kHz
Sensitivity	45 μ V.
Signal-to-noise ratio	45 dB
Harmonic distortion	0.45%

Amplifier Section

Maximum output power (both front channels driven, 8 ohms)	
Front channels, 1 kHz	90 watts @ 0.0056% THD + N
Surround channels, 1 kHz	30 watts @ 0.031% THD + N
Center channel, 1 kHz	30 watts @ 0.031% THD + N
Input sensitivity (mV) for 1 watt output	
High level	16.0
Phono	0.28 mV.
Signal-to-noise ratio (re: 1-watt output)	
High level (500 mV input)	78 dB
Phono (5 mV input)	77 dB
Frequency response (front channels)	
Phono (RIAA EQ)	20–20 kHz, +0.50, -0.20 dB
High level inputs	20–20 kHz, +0.20, -0.60 dB
Bass control, 100 Hz	+9.5 dB, -8.3 dB
Treble control, 10 kHz	+8.0 dB, -9.2 dB
Loudness response	+11.0 dB @ 50 Hz, +2.6 dB @ 10 kHz
Video 1 & 2	0.5 MHz, 5 MHz, +0, -1.2 dB
Digital delay-time range	
In Hall Surround mode	From 5 to 40 mS, in 5 mS steps
In Dolby Pro Logic mode	From 15 to 30 mS, 5 mS steps

Additional Data

Dimensions (W x H x D, inches)	17 1/8 x 6 3/16 x 17
Weight	30.9 lbs.
Suggested Price:	\$900.00

signal levels was noted; that results from the fact that stereo can only be received when the mute switch is activated, and muting takes place at signal levels below about 20 dBf. Ultimate signal-to-noise ratio measured 75.5 dB in mono and 71 dB in stereo.

THD (total harmonic distortion) plus noise was extremely low for this tuner section, measuring well below the 0.1% mono specification and the 0.2% stereo specification quoted by Onkyo at all but the very highest audio frequencies.

The "usable sensitivity" was 12.5 dBf for mono and 18.2 dBf for stereo. Stereo FM separation was excellent, too, measuring 48 dB at mid-frequencies and remaining close to 40 dB at 100 Hz and 10 kHz.

Our only quarrel with the designers of this tuner section has to do with AM performance. While the AM-tuner section was certainly sensitive enough and offered about what we would expect in terms of distortion, its frequency response was very poor indeed. This is true of so

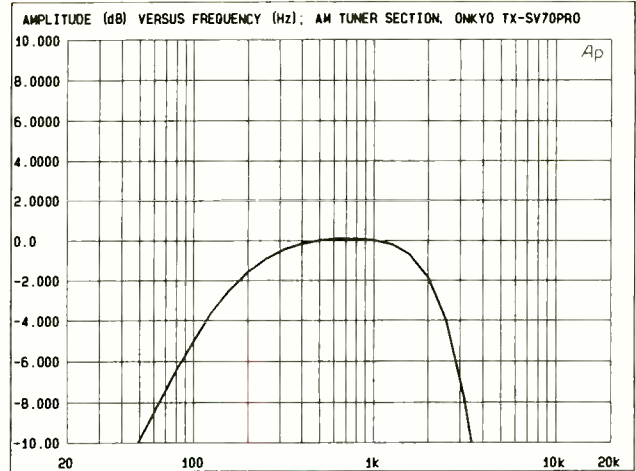

The frequency response of the receiver's AM tuner was poor. Unfortunately, this performance is typical of many otherwise excellent receivers.

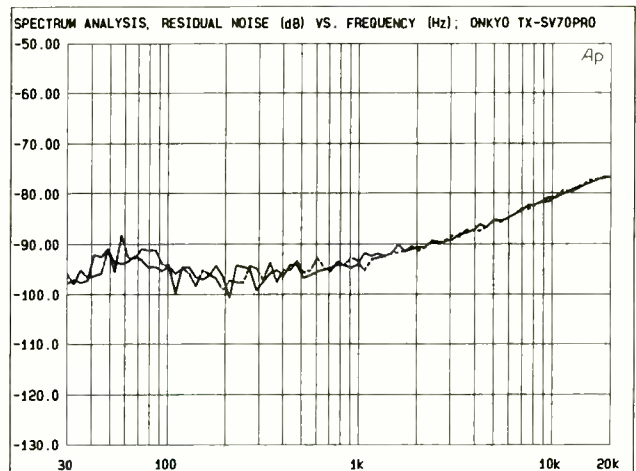

When residual noise was plotted against frequency (in 1/3-octave increments), the usual peaks caused by hum components from the AC power supply were virtually non-existent.

many of the so-called "high-fidelity" tuner and receivers that we measure, despite the fact that new standards have been set for AM-tuner performance that suggest that response should extend out to at least 7.5 kHz. In the case of this tuner section, response was down by 6 dB at just under 3.0 kHz, and also rolled off at the bass end, reaching the -6 dB point at just under 90 Hz!

Next, we measured the performance of the amplifier sections, treating the receiver, first, as though it were only a stereo receiver. The frequency response obtained using one of the

high level inputs closely mirrored the response that we observed when measuring FM tuner frequency response. Frequency response for the rear (surround) channels using the matrix mode with no time delay was down only 2 dB at 20 kHz. Next, we applied a low-level signal to the phono inputs and measured the deviation from the standard RIAA equalization curve. It amounted to less than +0.5 dB and -0.2 dB at any frequency from 20 Hz to 20 kHz.

Turning next to the amplifier stages themselves, we plotted harmonic distortion (Continued on page 93)

ANTIQUÉ RADIO

By Marc Ellis

The Theremin Plays Again!

This column finally provides some closure on a topic that's been occupying us—off and on—for a year or more. For me, the whole thing started in the winter of 1989–90, when I received a letter from reader Tony duBourg. Tony, who teaches physics at a private high school in New Jersey, had in his possession an original RCA Theremin. He offered to present me with the instrument if a series of articles could be developed covering its history and restoration.



Carolyn tests the theremin just after reassembly in my basement workshop. I never should have let her try it because now I have to keep it!

PROJECT HISTORY

I accepted with pleasure. And since my son Eric and I were making a van trip to the New York City area during Eric's high-school spring break, we scheduled a very pleasant side excursion to New Jersey to visit with Tony and pick up the Theremin.

With the Theremin safely back at our home in the midwest, I was now faced with the job of writing the promised articles. However, I knew next to nothing about this odd electronic

musical instrument, beyond the facts that it had been invented in the 1920's by a young Russian named Leon Theremin, had a spooky ethereal sound, and was controlled by changing the position of the hands in relation to a couple of antenna-like electrodes.

In the October, 1990 issue of this column I appealed to our readers for background information, offering reprints of a 1924-vintage Gernsback radio publication to the eight readers who sent the most informative letters. In return, I received a veritable avalanche of material—which was acknowledged, in detail, in the April, 1991 issue.

The first fruits of this gratifying reader response appeared in the June and July columns which, respectively, reviewed the Theremin's six-decade history in this country and presented a technical overview of the instrument's operation. In September, we took a first look inside the instrument and powered it up (with the speaker bypassed as recommended by the RCA service manual) for some preliminary tests.

Everything seemed to be in order except for one problem. The small pickup coil supplying RF energy to light the filament of the UX-120 volume-control tube (see July, 1991 issue for details) had apparently become loosened at some time in the past, and then subjected to a crude field repair. Its turns were disarrayed and jumbled, and probably improperly positioned on the large

resonance coil over which it was wound.

SOLVING THE COIL PROBLEM

My search for data on the size and positioning of this coil took me to San Francisco's Exploratorium museum, which was reputed to have a working Theremin on display. I was able to visit the Exploratorium during a business trip to the Bay City (October, 1991 issue), but was disappointed to find that their theremin's innards had been removed and replaced with modern transistorized circuitry.

That left me stymied for awhile because an experimental determination of the coil's characteristics would be very difficult. The RF voltages involved couldn't be measured by any instruments I had available. And if I were to guess wrong about the size and/or positioning of the pickup coil, I could easily burn out the fragile filament of an expensive and hard-to-replace UX-120.

The problem was finally solved through the offices of Mike Kitner, who operates a company (Mechanical Musical Instruments of Carlisle, PA) specializing in the repair and restoration of roll-played pianos and organs. Mike also owns a theremin, and had written an article about the instrument in *Antique Radio Classified* magazine (October, 1990 issue).

Remembering that article, I looked it up and gave Mike a call. Although he wasn't in, I left a message about my need on the an-

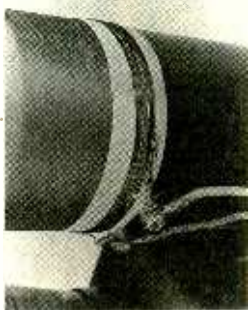

Here's that troublesome 9-turn coil, as rewound per Mike Kitner's specifications. Thanks a million, Mike!

swering machine (which treats callers to a rousing band-organ concert). The next day, I received a welcome call from Mike with complete information on the number of turns in the coil, the type of insulation on which it was wound, and its placement on the large resonance coil.

Carefully removing my jumbled-up pickup coil, I rewound it neatly and tightly according to Mike's information. Counting the number of turns, I found that I had ended up with nine—the same number Mike reported on his coil. That was reassuring, and I decided to fire up the theremin for more testing.

DISAPPOINTMENT, THEN ELATION!

Not wanting to risk the UX-120's filament right away, I substituted a flashlight lamp of similar voltage and current ratings that I'd used for earlier testing. Not a glimmer. Then I wired in an RF milliammeter I hap-

pened to have on hand. Still no indication.

It was beginning to look as if the problem was deeper than it seemed. I theorized that something other than a defective pick-up coil had originally interrupted the voltage supply to the UX-120 filament and that the coil had been disturbed as part of an earlier troubleshooting attempt.

However, before digging deeper into the theremin's circuitry, it seemed prudent to make a stab at operating the equipment under normal conditions. All indications were that I didn't have to be concerned about burning out the UX-120 tube's filament. It looked like I'd be lucky to get it to light at all. So I disconnected my test lamp and meter and plugged the tube into its socket.

I also wired the volume and pitch-control electrodes (which normally plug into sockets set into the cabinet) to the proper circuit points via clip leads, removed the speaker bypass wire and connected the theremin's RCA Model 106 speaker.

Readers of the September, 1991 column will remember that my original check of that speaker uncovered a low field-voltage condition, which suggested that the unit's copper-oxide rectifier stacks might be on the way out. However, the voltage increased to a normal value after about an

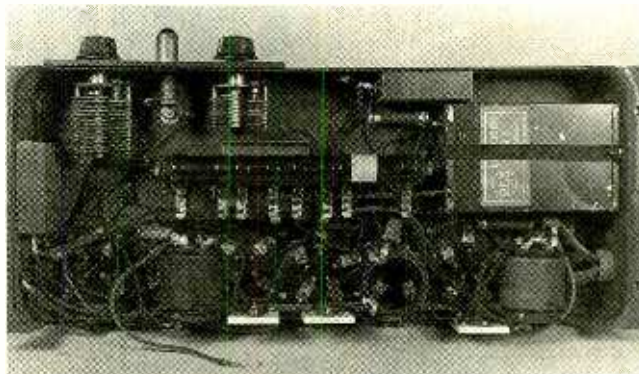

The bottom view of the theremin chassis shows battleship-like construction style.

hour of operation.

At the time, I wondered if some type of electronic healing had taken place—similar, perhaps, to the "forming" process that can rejuvenate old electrolytic capacitors. And I thought it would be interesting to observe the field voltage the next time that the speaker was activated after a period of disuse.

When I turned the speaker on this time, the field voltage had reverted to its original value (about 10% low), but I decided not to wait for it to rise again. I turned on the theremin's power supply and, after several seconds of warm-up time, I was amazed and delighted to hear a lusty squawk emanating from the speaker.

That immediately told me that the UX-120 filament was receiving power. Otherwise (since the tube is wired so that tone volume depends on filament brilliance) the theremin wouldn't produce an audible tone. Bringing my hand close to the volume-control electrode, I was further gratified to hear the volume decrease smoothly as the hand approached.

The tone-determining circuitry also appeared to be operating properly, with pitch increasing as my hand approached the pitch-control electrode.

Don't ask me why the pick-up loop supplied power to the UX-120 filament and not to a test lamp of similar voltage and current requirements. Perhaps there are impedance differences between the tube and lamp filaments that become important at the radio frequencies at which the power is delivered. I don't know. But I'm sure glad that I made that final test before wasting time with unnecessary troubleshooting!

REASSEMBLY AND FINAL ADJUSTMENT

Since I was now reasonably sure that the pickup coil was properly installed, I dabbed it in a few spots with clear nail polish to prevent future loosening. Then I was ready to install the theremin and power-supply chassis back in their cabinet.

That operation was uneventful, and I took care to follow the service manual's recommendation to keep the dress of the power cable as much like the original as possible.

Finally, I was ready to power up the unit for final testing. RCA's specs for the volume-control circuit call for complete tone cutoff (front-panel volume control in the fully clockwise position) to occur when the

(Continued on page 93)

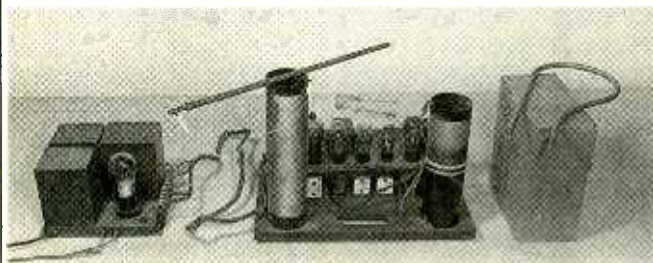

Theremin components connected for bench testing. I never thought that this lashup would work, but it did!

CIRCUIT CIRCUS

By Charles D. Rakes

Alarm Circuits

This time around, we're going to share a number of alarm circuits. In most alarm circuits, one or more sensors—each connected in some sort of detection loop—are positioned at strategic locations on or around the item to be protected. The detection circuit (consisting of a sensor loop and trigger circuit) controls an alarm sounder that, when activated, produces an audible or visual alert.

The sensor in an alarm circuit can be as simple as a single strand of fine copper wire, which functions as

activated switch. And, depending on the configuration of the trigger configuration, multiple sensors can be series or parallel wired into the circuit.

SILENT ALARM

Our first circuit, see Fig. 1, is built around half of a 4001 CMOS quad 2-input NOR gate, configured as a set/reset latch. With the circuit in the reset condition (at rest) and switch S1 open, gate U1-a's output is low. If the key (an LED mounted in

more current drain than would occur in the standby mode.

CLOSED-LOOP ALARM

Our next alarm circuit, see Fig. 2, uses a string of three series-connected normally-closed switches (the closed-loop configuration) connected to the gate of an SCR. Any number of sensors can be connected in series and used to trigger the circuit. In the standby mode, the circuit draws about 2 mA, but the current drain may rise to as high as

PARTS LIST FOR THE SILENT ALARM

- LED1—Light-emitting diode (any color)
 - U1—4001 CMOS hex inverter, integrated circuit
 - R1, R2—100,000-ohm, ¼-watt, 5% resistor
 - R3—1000-ohm, ¼-watt, 5% resistor
 - J1, J2—Miniature phone jack
 - PL1—Miniature phone plug
 - S1—normally open sensor switch (see text)
 - B1—9-volt transistor-radio battery
- Perfboard materials, enclosure, IC socket, battery holder and connector, wire, solder, hardware, etc.

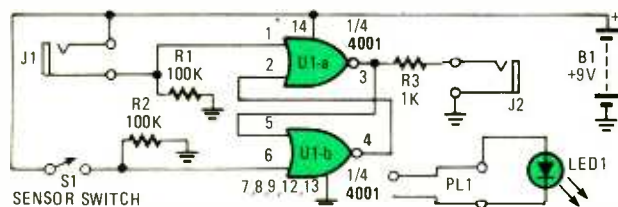

Fig. 1. The Silent Alarm is built around half of a 4001 CMOS quad 2-input NOR gate, configured as a set/reset flip-flop.

a sensor and is positioned around the perimeter of an object. As long as the wire remains intact, the alarm circuit is set. If an intruder severs the wire, the sensor sends a signal to the trigger circuit, causing an alarm to be sent out. That type of sensor is a one shot, non-resettable, device.

Such alarms require that the sensor wire be replaced after each breach. (They are referred to as closed-loop circuits.) However, most alarm circuits use some sort of magnetically-activated switch, which can be reset and used over and over again, as a sensor. The sensor can be either a normally-open or normally-closed magnetically-acti-

a mini phone plug, PL1) is plugged into J2, the LED will not light, indicating that no breach has occurred.

But, when S1 is closed, either momentarily or permanently, the output of U1-a at pin 3 goes high and remains high until the circuit is reset. By inserting the key into J2 after a breach, the LED will light. Inserting the key into J1 resets the circuit.

In the standby mode, the circuit draws almost no current, allowing it to keep an undaunted vigil for many months without attention. If the sensor (S1) is triggered by an intruder, the circuit will place the information in temporary storage with no

500 mA when the circuit is triggered, depending on the alarm sounder used.

The circuit's operation is very simple. With all sensor switches closed and power applied, the voltage at the SCR's gate is near zero; the only current drain is through R1 and the sensors. But when any one of the sensor switches opens, either momentarily or permanently, gate current is delivered to the SCR through R1. That turns on the SCR, providing a ground path for the sounder, causing it to let out a wail. Once triggered, the alarm continues to sound until the reset switch (S1) is activated. Capacitors C1

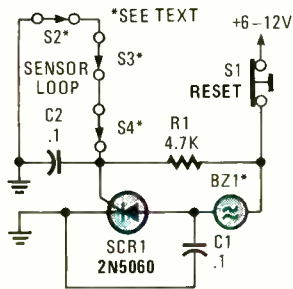

Fig. 2. The Closed-Loop Alarm uses a string of three series-connected normally closed switches (the closed-loop configuration) connected to the gate of an SCR.

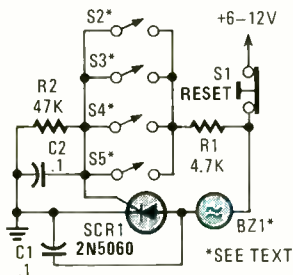

Fig. 3. The Parallel-Loop Alarm is almost identical to the circuit presented in Fig. 2, except that this time the sensors are parallel wired in what is referred to as an open loop.

and C2 are included in the circuit to prevent any transient voltages from falsely triggering the SCR.

PARALLEL-LOOP ALARM

Our next alarm circuit, see Fig. 3, is almost identical to the circuit presented in Fig. 2, except that this time the sensors are parallel wired in what is referred to as an open loop. As you can see, this circuit uses normally-open sensor switches. Any number of normally open switches can be wired in parallel and be used to trigger the alarm; they are connected to the SCR as shown in the schematic.

In the set condition, the alarm circuit draws almost no current, making it a good candidate for battery operation. But when any

SEMICONDUCTORS

SCR1—2N5060 sensitive-gate silicon-controlled rectifier

R1—4700-ohm, ¼-watt, 5% resistor

C1, C2—0.1-μF, 100—WVDC, ceramic-disc capacitor

S1—normally closed pushbutton switch

S2—S4—normally closed sensor switch

BZ1—Alarm sounder (see text)

Perfboard materials, enclosure, 6–12 volt power source, wire, solder, hardware, etc.

PARTS LIST FOR THE PARALLEL-LOOP ALARM

SCR1—2N5060 sensitive-gate silicon-controlled rectifier

R1—4700-ohm, ¼-watt, 5% resistor

R2—47,000-ohm, ¼-watt, 5% resistor

C1, C2—0.1-μF, 100—WVDC, ceramic-disc capacitor

S1—normally closed pushbutton switch

S2—S5—normally open sensor switch

BZ1—Alarm sounder (see text)

Perfboard materials, enclosure, 6–12 volt power source, wire, solder, hardware, etc.

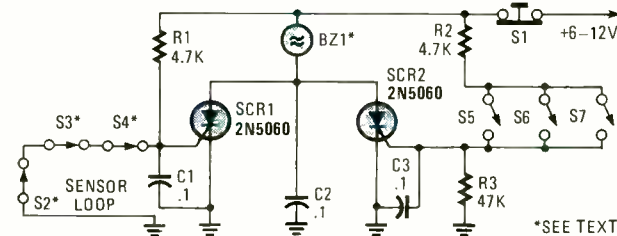

Fig. 4. The Series/Parallel-Loop Alarm combines the alarm in Fig 2 with the one in Fig. 3 to provide both series- and parallel-loop protection.

PARTS LIST FOR THE SERIES/PARALLEL-LOOP ALARM

SCR1, SCR2—2N5060 sensitive-gate silicon-controlled rectifier

R1, R2—4700-ohm, ¼-watt, 5% resistor

R3—47,000-ohm, ¼-watt, 5% resistor

C1—C3—0.1-μF, ceramic-disc capacitor

S1—normally closed pushbutton switch

S2—S4—normally closed sensor switch

S5—S7—normally open sensor switch

BZ1—Alarm sounder, see text

Perfboard materials, enclosure, 6–12 volt power source, wire, solder, hardware, etc.

one of the input sensors is closed, gate current flows through R1 to the SCR, turning it on and activating the alarm sounder. The sounder will continue operating until the circuit is reset or the battery fails.

SERIES/PARALLEL LOOP ALARM

Our next circuit, see Fig. 4, combines the alarm in Fig 2 with the one in Fig. 3 to provide both series- and parallel-loop protection. Here you may use both

normally-closed and normally-open sensors to trigger the same alarm sounder.

Note that the main difference between the two sensor loops lies in the way that each sensor switch relates to the others in the loop and the way each loop is wired into the circuit. The loop connected to SCR1 holds the SCR off by tying its gate to ground through the loop sensors. Opening any one of those switches (S2–S4) removes gate grounding, allowing gate current to be delivered to SCR1. That causes SCR1 to turn on and the alarm to sound.

Conversely, SCR2's gate is held low via R3. When any one of its sensors (S5–S7) are closed, the gate of the SCR is connected to the positive supply through R2, which in turn causes it to turn on, sounding the alarm. With one of the sensor switches closed, R2 becomes a gate pull-up resistor.

Once triggered by either sensor loop, the circuit continues to sound until reset by pressing switch S1, which is connected in series with the 9–12 volt power source. Note that removing the trigger source has no effect on conduction through the SCR, so long as current through the SCR remains at or above the holding level (I_H). Pressing S1 causes the current through the SCR's to drop below I_H , turning off the SCR's. Capacitors C1–C3 prevent the circuit from being falsely triggered by transient voltages.

HIGH-POWER ALARM DRIVER

The three circuits discussed so far are only suited for low- to medium-power sounders due to the current limitations of the SCR's associated with them.

COMPUTER BITS

By Jeff Holtzman

Norton Utilities, Ver. 6.0

MS-DOS 5.0 includes half a dozen new utility programs that at first glance seem to render several commercial utility programs unnecessary, foremost among them being undelete, unformat, keyboard enhancer, and memory management/disk display programs. Indeed, if you really had to, you could get by without any other utilities.

There are, however, a couple of exceptions. One is a low-level disk tuneup program; the other is a disaster recovery tool. The Norton Utilities traditionally excelled at undelete, unformat, tuneup, and recovery tools; Version 6.0, now sold by Symantec, continues the tradition. NU6 also continues its tradition of supplying other types of powerful utility programs, including a fetching replacement for COMMAND.COM, a disk cache, enhanced Macintosh-like file-erasing, file/disk encryption programs, and more. Table 1 lists all programs included in the package, and provides a brief description of each.

INSTALLATION

The program includes both 5¼- and 3½-inch disks that would occupy about 2.7 megabytes of disk space if you install everything. The installation program allows you to install only those utilities you really want. The program also includes "emergency" disks that you can use (in conjunction with a bootable floppy) to rescue a bum hard disk. After installation, many programs are stored

in a packed format, and are subsequently unpacked each time you run them. Owners of slow machines may wish to unpack all files, at the cost of storage space.

The file-rescue and disk performance-tuning utilities work well and provide little that's new over previous versions. Be aware that the initial release of the NCACHE utility had some problems that could damage a hard disk in certain circumstances (especially under Windows 3.0). Bug fixes should be out by the time you read this, but contact Symantec to make sure that you have the latest version before using it.

Probably the most innovative new utility is NDOS, Norton's replacement for COMMAND.COM. The program can function as a complete substitute for DOS's own command-line processor. NDOS can also run under COMMAND; conversely, COMMAND can run under NDOS as well. (The latter helps ensure compatibility with the few ill-behaved programs that depend on the presence of an actual copy of COMMAND.) If you're familiar with the shareware program 4DOS, NDOS will seem mighty familiar.

NDOS provides many enhancements over COMMAND, one of the nicest of which is its small 0.5–3.0K "footprint" in 386/486 systems or 8088/86/286 systems with true EMS 4.0 memory. The remainder is loaded into high memory. On systems without the requisite CPU or

memory hardware, NDOS requires about 80K in low memory to load.

NDOS provides enhanced versions of many DOS commands. DIR, for example, allows multi-column display and various sorting options. CD allows you to move up several levels at a time by appending additional periods (e.g., cd would move you up three levels). Many commands accept multiple arguments separated by semicolons. For example, the command COPY X;Y;Z A: would copy files x, y, and z to floppy drive A. Another nice feature is an enhanced batch-file processor. NDOS will run normal batch files as is; it will also run its own .BTM much more efficiently than DOS does .BAT files.

Delete will optionally prompt you before deleting, as well as delete hidden, system, and read-only files. Describe allows you to associate 40-character descriptions to file and directory names; the descriptions "move" with files when you copy, delete, move, or rename them. However, the descriptions only remain with files that are processed with NDOS commands; programs like DOS's XCOPY won't do it, nor will Norton's own NCD; pity. And yes, unlike DOS 5.0, NDOS includes an honest-to-goodness MOVE command.

NDOS includes a built-in equivalent of the Norton utility program, BE (batch enhancer), which allows you to build attractive screens (with lines, colors, boxes), get user input, and test for a wider variety of "if"

VENDOR

The Norton Utilities
Version 6.0 (\$179
\$39 for upgrade from previous
version)
Symantec Corporation
10201 Torre Avenue
Cupertino, CA 95014-2132
Tel. 800-441-7234
408-252-3570
408-253-9600

conditions.

Here are more miscellaneous commands: ESET allows interactive editing of environment variables (e.g., your PATH). EXCEPT provides for exceptions to the following command. For example, "except *.bak copy *.* A:" would copy all files in the current directory except backup files to drive A. GLOBAL performs the following command in the current directory and all

subdirectories. For example, running "global del *.bak" from the root directory would delete all backup files on a drive. GOSUB allows you to create subroutines in batch files. KEYSTACK feeds keys via batch file to running applications. LOADHIGH works like the DOS 5 equivalent (DOS 5 required).

All in all, NDOS enhances 24 DOS commands, and adds 48 new ones, all of which use the new DOS 5 help convention. The biggest question about NDOS is compatibility: Is it? Rather, how compatible is it? The program comes with a 60K text file describing compatibility issues; most of what's discussed is relatively esoteric. In my own testing, which consisted of several weeks of fairly heavy usage on two quite different systems with a wide variety of

TABLE 1—NORTON UTILITIES 6.0

Filename	Description
be.exe	Batch file enhancer, gets user input, builds attractive screens
calibrat.exe	Non-destructive interleave adjustment, low-level format (not for SCSI or ESDI)
diskedit.exe	Display/edit/compare disk structures (files, directories, FATs, boot record, partition table)
diskmon.exe	Park drive, write-protect drive, on-screen display of drive access
diskreet.exe	Encrypt individual files; create encrypted pseudo-volume; add password protection
disktool.exe	Make disk bootable, fix defective disk, create "rescue" disk, mark bad cluster
ds.exe	Sort/move directories by name, extension, time/date, size
ep.exe	Traps file-delete requests; puts deleted files in "trashcan" for recovery later. Also purge after time/size limits exceeded.
fa.exe	Display/edit file attributes (archive, hidden, read-only, system).
fd.exe	Alter file date/time stamps.
filefind.exe	Find files based on name or content, searches active and erased portion of disk.
filefix.exe	Diagnose/repair dBASE, 1-2-3, Symphony files.
fl.exe	Fast file find.
fs.exe	List file/directory sizes.
image.exe	Save systems areas in case of disaster.
lp.exe	Print text files; now supports PostScript printers.
ncache.exe	Disk cache utility (see text).
ncc.exe	Set screen colors, cursor size, keyboard/mouse speed, etc.
ncd.exe	Fast directory change/maintenance/display.
ndd.exe	Diagnose/repair damaged disks.
ndos.com	Replace/enhance COMMAND.COM.
nds2e.com	Support interrupt 2E under NDOS.
nhelp.exe	On-line help for NDOS.
norton.exe	Menu program for launching most Norton utilities.
nuconfig.exe	Configure some Norton utilities.
sformat.exe	Safe format floppy/hard drives.
speedisk.exe	Defragment disk files
sysinfo.exe	Display disk/memory usage, CPU/disk benchmark info, etc.
ts.exe	Search for text in files or erased space
unerase.exe	Unerase files
unformat.exe	Unformat floppy/hard drives
wipeinfo.exe	Completely erase files/drives

DOS and Windows programs, I found no serious problems.

CONCLUSION

I sleep better knowing I've got the disaster recovery tools available—just in

case. I appreciate the performance benefits provided by speedisk. I enjoy the ability to write fancy batch files, and to have a better command-line processor for DOS operations.

(Continued on page 93)

No costly school. No commuting to class. The Original Home-Study course prepares you for the "FCC Commercial Radiotelephone License." This valuable license is your professional "ticket" to thousands of exciting jobs in Communications, Radio-TV, Microwave, Maritime, Radar, Avionics and more...even start your own business! You don't need a college degree to qualify, but you do need an FCC License.

No Need to Quit Your Job or Go To School
This proven course is easy, fast and low cost! **GUARANTEED PASS**—You get your FCC License or money refunded. **Send for FREE facts now. MAIL COUPON TODAY!**

COMMAND PRODUCTIONS

FCC LICENSE TRAINING, Dept. 100
P.O. Box 2824, San Francisco, CA 94126
Please rush FREE details immediately!

NAME _____
ADDRESS _____
CITY _____ STATE _____ ZIP _____

FUN SOFTWARE

by Fred Blechman

A Real REC

This month we'll look at a unique newsletter, and then briefly describe some action simulations I haven't previously covered in any detail.

RECREATIONAL & EDUCATIONAL COMPUTING

If you have an interest in mathematics, recreation, and education as they relate to computers, you'll want to request a sample copy of *Recreational & Educational Computing (REC)*—A Mathematical Panoply of Computer Rec-



Their Finest Hour (Lucasfilm Games) lets you fly both German and British missions in the Battle of Britain.

reations for Involved Readers. This newsletter (usually 10-18 pages per issue) is a personal two-way communication of mathematics, recreation, education, and computer activity between subscribers and the editor, assisted by contributors.

The editor and publisher is Dr. Michael W. Ecker, prolific computer-magazine columnist, author of two books about number theory, and teacher in the

Mathematics Department at the Wilkes-Barre Campus of Pennsylvania State University.

This is the only publication I know of devoted to the playful interaction of computers and "mathemagic," from digital delights to strange attractors, from special number classes to computer graphics and fractals. REC features programs, challenges, puzzles, program teasers, art, editorial, humor, and much more, all laser-printed. REC supports many computer brands, as it has since its inception in January, 1986.

Just a quick survey of the articles in the issue released in August, 1991 (the latest as this review is being written) shows the broad array of subjects covered. After a discussion of a "First Number" contest, several pages are devoted to reader letters on various subjects and then the extensive, detailed editor's replies. "The Game of N" is analyzed, and one reader included a BASIC program for finding the greatest common divisor and the least common multiple of two numbers. A lengthy article called "Basically BASIC" is loaded with useful tips and techniques for improving your BASIC programming, and includes a simple program that allows you to program the IBM PC's twelve function keys to produce BASIC keywords with a single keystroke. The editor then offers his "Primitive Slot Machine Program," written in GW-BASIC.

Following a short book review of "Computers, Patterns, Chaos and Beauty:

Graphics From an Unseen World," a new St. Martin's Press book authored by Clifford A. Pickover, REC continues with a two-page story that describes a number of astronomical software programs in some detail. The editor then describes a source for a booklet listing over 150 programs of astronomy software organized by type (simulations, planetaria/star charts, databases, calculation aids, games, telescopes/observing aids, tutorials, lesson plans, and solar-system displays), with vendor information and a reading list.

This issue of REC finally concludes with a short IBM PC GW-BASIC program called "Computer String Art" that draws a complex screen pattern, and another short program that solves an equation by the process of iteration.

If you have any interest in the relationship of computers with mathematics, either working with numbers or graphically, you're certain to find several brain-teasers and items of interest in every issue.

(REC, 909 Violet Terrace, Clarks Summit, PA 18411, Editor's chat line:

717-586-2784. Published 8 times a year, annual subscriptions are \$27 in U.S., mailed First Class. Higher rates abroad. Sample issue \$2. Back issues available. REC also offers various program disks, including the programs in each issue. Call or write for details.)

SIMULATIONS GALORE

New simulators (flight, road race, submarine, bat-

fles with armored vehicles, etc.) keep coming out, faster than I can review them in detail here. For example, I have over fifty different flight simulators for the IBM PC alone, and more will soon be available! Just to catch up with those I have not reviewed in my previous columns, here's some information on each, listed by manufacturer. These are all IBM PC versions; some have versions available for other micros. They are all available from mail-order or local software dealers, usually at a discount, so no prices are given.

LHX Attack Chopper (Electronic Arts) is the first 3-D flight simulator to model the Light Helicopter Experimental and the Osprey tilt-rotor helicopter. You can also fly an Apache or Blackhawk in hundreds of missions in one of three global hotspots. Features include eleven exterior views and five skill levels.

Indianapolis 500 (Electronic Arts) realistically captures the excitement, appeal, and competition generated by the world's fastest cars and drivers. Compete against 32 cars in races from 10 to 200 laps, adjusting eight different car systems to your skill. You can view the last twenty seconds of action from six different perspectives.

Mario Andretti's Racing Challenge (Electronic Arts) lets you follow Andretti through twelve of the most exciting speedways in the world, such as Daytona, Le Mans, and Monte Carlo. You can be in the driver's seat of six high-performance racing machines—sprint cars, modifieds, stock cars, prototypes, Formula Ones, and championship cars, with instant replay from six camera angles.

Rules of Engagement (Mindcraft, distributed by

Electronic Arts) allows you to command the massive space fleet of the Federated Worlds in the late 24th century. Choose your enemies, design your Starship, and select your targets and weapons in ship-to-ship combat. Pilot your flagship and send orders to the rest of your fleet captains as you navigate by the stars. This is very complex, and involves far more than just flying!

Street Rod 2—The Next Generation (California Dreams, distributed by Electronic Arts) is Street Rod's big brother, with even more brilliant graphics, realistic race scenes, and authentic challenges. Sharp turns and narrow bridges keep you jockeying for the lead in your Ford Falcon or Fairlane, 'Vette, Shelby GT500, or a screamin' muscle machine you can put together with the expanded construction set.

Air Strike USA (Cinemaware, distributed by Electronic Arts) has you flying the ATF II (a new generation of high-technology aircraft designed for the 21st Century) into a series of dangerous attack missions in support of your ground and sea forces. Enemy interceptor aircraft will challenge you every step of the way. Eight world maps in full relief with fast 3-D action make this a blend of arcade action and strategy.

Their Finest Hour (Lucasfilm Games, distributed by Electronic Arts) lets you fly both German and British missions in the historic World War II confrontation, the Battle of Britain. It combines historical and technical accuracy with seat-of-the-pants flying action. Aircraft and visual effects such as smoke, explosions, and flying debris are bit-mapped for realism, and sound effects are particularly

good with an AdLib board. The 200-page manual is really a book about the Battle of Britain—history, background, photos, detailed maps, and eyewitness accounts.

Secret Weapons of the Luftwaffe (Lucasfilm Games, distributed by Electronic Arts) is a World War II air combat simulation that pits the U.S. Eighth Air Force against the awesome aerial weaponry of the Third Reich. You can fly classic warbirds or German superplanes as you clash over German skies in historically accurate bomber and fighter missions. Featured are authentically detailed planes, instruments, and weapons, with burning engines, oil leaks, bullet holes, and searing explosions—all with appropriate sound. A 200-page photo-packed book details the air war with specific maps.

Blue Max (Three-Sixty, distributed by Electronic Arts) is a World War I flight simulation. Action is immediate and relentless as you fly the most famous aircraft of the time against aces like Richthofen, Fonck, Man-nock, and Rickenbacker. Different playing modes let one or two players fly solo, as a team, or against each other using the same computer. Fly in full action dogfights, undertake missions to destroy bridges and observation balloons, or work out strategies a segment at a time in detail.

Armor Alley (Three-Sixty, distributed by Electronic Arts) combines the action and suspense of a combat action game with the planning and wit of a strategic wargame. One or two players engage in head-to-head confrontation between helicopters, paratroopers, tanks, missile launchers, and infantry. Your job is to lead convoys of

equipment and men through the enemy's lines and destroy his base. Opponents (or teams) are matched for equal strength and ability, either on the same computer or using two computers connected directly or by modem. The game offers four modes of difficulty, each with thirteen levels of play.

F-29 Retaliator (Ocean, distributed by Electronic Arts) has you flying the forward swept-wing F-29, whose advanced electronics are revolutionizing aviation history, or the explosively lethal F-22 ATF (Advanced Tactical Fighter). One hundred different missions in four battle scenarios involve dogfights and strikes against land and sea targets. A fast and detailed graphical environment is provided with real-time cockpits and multiple internal and external viewpoints. A two-computer multi-player option is also included.

Wing Commander (Origin) is a very sophisticated 3-D space combat simulator with state-of-the-art computer graphics and sound. You're a starfighter pilot, the best of the best, flying one of four Terran spacefighters—but nothing in your training prepared you for anything this hot! Deepspace dogfights against Kilrathi aces are deadly, and the future of humanity is on the line each time you fly. Detailed ray-traced bit-mapped images, a player-controlled camera, artificial intelligence, and a dynamic soundtrack make you feel like you're in an interactive movie. Additional missions are available in optional Secret Missions and Secret Missions 2 packages. In my opinion, this is the Cadillac of space combat simulators. ■

DX LISTENING

By Don Jensen

Programming For SWL's

Last year, a major budget crunch brought an end to most of *Radio Canada International's* own English shortwave programming. Many familiar RCI shows were replaced with offerings plucked from the C.B.C.'s domestic radio network. Probably the most missed of the former RCI programs—at least by North American shortwave listeners—is “SWL Digest.” The longtime host, Ian

to hear stations, new schedule information, receiver reviews, ham radio, and broadcast news and features.

Andy Reid writes a regular column on “SWL/DX Programs” for the Ontario DX Association's monthly bulletin, *DX Ontario*. The times, and days of the week, are given in Coordinated Universal Time (UTC), which is equivalent to EST + 5, CST + 6, MST + 7 or PST + 8 hours. Here's a sampling of those programs from one of Andy's recent lists:

SATURDAY:

“Calling DX'ers,” aired by Hungary's *Radio Budapest*, can be heard at 0130 UTC on 9,835 and 11,910 kHz. Don't forget that because of the time differences noted above, 0130 UTC Saturday is actually Friday evening in the U.S. and Canada.

Belgian Radio and Television (BRT) has its “Radio World” shortwave-listener program on the air at 1306 UTC on 21,810 kHz.

The *Voice of America's* entry in this type of hobby-listener programming is “Communications World.” It can be heard at 2110 UTC on 9,760, 11,760, 15,410, 15,580, and 17,800 kHz.

“World of Radio”—WRNO, New Orleans—can be heard at 2330 UTC on 13,730 kHz.

SUNDAY:

At 0027 UTC, *Spanish Foreign Radio* in Madrid airs “DX Spot” on 9,630 and 11,880 kHz. Again remember the difference between your UTC and your local time, which makes this Saturday evening listening in North America.

On the last Sunday of the month, Germany's *Deutsche Welle* presents “World DX Meeting” at 0122 UTC on 6,040, 6,145, 9,565, and 11,865 kHz.

A longtime SWL favorite is the “Shortwave Merry-Go-Round” program on *Swiss Radio International*. One of its several broadcast times is 0215 UTC on 6,135, 9,650, 9,885, 12,035, and 17,730 kHz.

Chuck Roswell, a regular reader of this column, is the frequency coordinator for *Trans World Radio-Bonaire*. He also is the presenter of TWR's “Bonaire Wave-lengths.” Try this one at 0330 on 9,535 and 11,930 kHz.

Other Sunday SWL programs include “Shortwave Feedback” on *Radio Korea* at 1245 UTC on 9,750 kHz; “Austrian Shortwave Panorama” on *Radio Austria International*, 1135 UTC, 21,490 kHz; and “DX Corner,” *Kol Israel*, 1924 UTC, 11,605, 15,640, and 17,685 kHz.

MONDAY:

Radio Japan's program for SWL's is called “DX Corner” and it can be tuned on 5,960 kHz at 0130 UTC.

Every other week, the “Mailbox” program, featuring listener mail, is broadcast by *Radio New Zealand International* at 0430 UTC on 17,770 kHz.

Aired fortnightly at 2130 UTC on 11,620 kHz is “DX'ers Corner” on *All India Radio*.

TUESDAY:

On the air for more than 40 years is the famous “Sweden Calling DX'ers” program from *Radio Sweden*. Look for it on the first and third Tuesdays of each

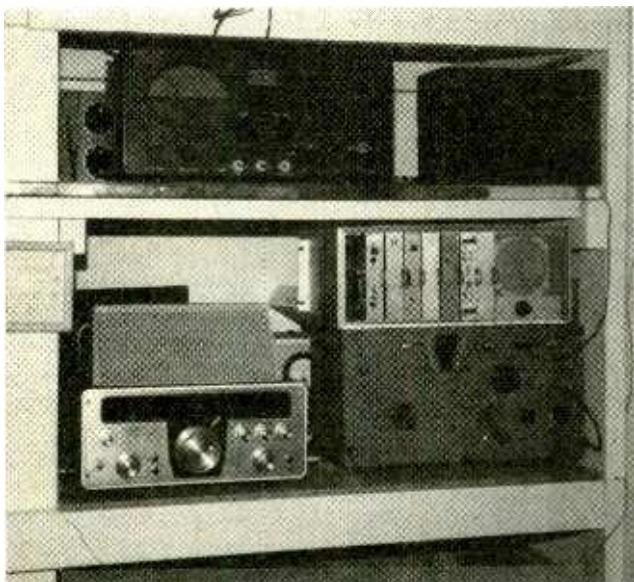

Proving that you don't have to pay top dollar to buy a shortwave receiver, Florida SWL Clinton Wills picked up these “golden oldies” at garage sales. On the top shelf rests a classic Hallicrafters S40B, with an Allied Radio SX190 (left) and a vintage military BC312 below.

McFarland, has moved on to *Radio Japan*, where his familiar voice can be heard on some of the English-language programs.

There are still, however, a good number of special SWL programs on the air from other international broadcasters. Those shows vary from station to station, but they typically include DX tips on where and when

month at 2346 UTC on 9,696 and 11,705 kHz.

Poland's *Radio Polonia* broadcasts its "DX Club" program at 2240 and 2334 UTC on 7,270 kHz.

WEDNESDAY

Radio Havana Cuba can be heard with its "DX'ers Unlimited" program on Wednesdays at 0140, 0340 and 0540 UTC on 11,950 kHz.

Two special broadcast for those who are licensed radio amateurs or who like to tune in on the ham bands are Quito, Ecuador's *HCJB*, "Ham Radio Today," 1930 UTC, 17,790 and 21,480 kHz, and *Radio Romania Internationals* "Special Programming for Radio Amateurs," 0245 UTC, 5,990, 9,510, 9,570, and 11,940 UTC.

THURSDAY

The *British Broadcasting*

Corp. World Service has its "Waveguide" program at 0130 UTC on a good selection of frequencies; 5,975, 6,175, 7,325, 9,410, 9,915, 12,095, 15,070, and 15,260 kHz.

Another good bet is *Radio Prague Internationals* "DX Special," aired at 0114 UTC on 5,930, 7,345, and 11,685 kHz and at 0314 UTC on the two former frequencies.

FRIDAY

Probably the most popular show for SWL's, with the departure of RCi's "SWL Digest," is "Media Network" on *Radio Nederland*. Listen at 0052 UTC on 6,020, 6,165, and 15,560 kHz; or at 0352 UTC on 6,165 and 9,590 kHz.

Bulgaria's *Radio Sofia* airs its "DX Programme" at 2345 UTC on 11,660, 15,330 and 17,825 kHz.

"Communicator," *Radio*

Australia's DX'er show, can be heard at 1030 UTC on 9,580 kHz.

Give a listen to some of these special SWL programs. They do vary a bit in quality and content. Some lean toward presenting the latest SW tuning tips, some focus on basic radio theory for beginners. Still others delve into satellite communications or computers. Chances are you'll find one or two that fit your radio interests.

GOOD LISTENING

While we're on the subject of shortwave programming, lets take a quick look at some other programs that you may have missed in your tuning around the SW dial.

U.S. hockey fans, unlike their Canadian counterparts, don't find all that much about their favorite sport on radio. If you like hockey, try tuning in CFRX, Toronto, the 6,070-kHz shortwave relay of AM'er CFRB. From 0200 UTC on Tuesdays, you can hear "Don Cherry Coast to Coast," two hours of open line hockey talk with the flamboyant former coach of the Boston Bruins.

If your dream is to escape to an island paradise, you can feed your fantasy by listening to "Travel Pacific," presented every other Thursday at 0830 UTC on 9,700 Hz by *Radio New Zealand International*. You'll have to forego some sleep, since that's some very early morning listening in North America.

*Credits: Robert Zilmer, NM; Mike Wolfson, OH; Dave Weinrich, ND; Hans Johnson, MD; Gerald Hart, MI; David Clark, ONT; North American SW Association, 45 Wildflower Rd., Levittown, PA 19057; Ontario DX Association, P.O. Box 161, Station A, Willowdale, Ont. M2N 5S8, Canada; World DX Club, c/o Richard D'Angelo, 2216 Burkey Dr., Wyoming, PA 19610.

Thanks for this program information goes to Edwin Southwell and his column in the World DX Club's "Contact."

MAIL CALL

Your comments, listening tips and SW'ing questions always are welcome. Drop me a line in care of *DX Listening, Popular Electronics*, 500-B Bi-County Blvd., Farmingdale, NY 11735.

One of the most common questions, unfortunately, is one I can't really answer. This month, for example, both Sam Weingart of Lafayette, LA, and Joseph Yanuzzi of Sherman Oaks, CA, have the same query, which shortwave receiver should they buy?

Like buying a suit or an automobile, there is no one right answer. There are many variables. What sort of SW listening do you do? How much do you want to spend? Are you concerned about audio fidelity? Do you want something with super sensitivity to drag in a barely readable signal from really weak stations? How important is ease of operation? There usually are tradeoffs when you select this set or that.

To help you make up your own mind, I recommend the receiver reviews in "Passport to World Band Radio," available at many book dealers, mail-order SW equipment firms, or from the publisher, International Broadcasting Services Ltd., Box 300, Penn's Park, PA 18943.

Clinton Wills, who lives in Orlando, FL, writes to say that he's picked up several SW receivers at bargain prices at garage and rummage sales in his hometown. "My receivers," writes Clinton, "include an old Hallicrafters S40B that I

(Continued on page 92)

LEARN VCR
CLEANING/MAINTENANCE/REPAIR
EARN UP TO \$1000 A WEEK, WORKING
PART TIME FROM YOUR OWN HOME!



Secrets Revealed!
NO Special Tools or Equipment Needed.

EARN UP TO \$60 AN HOUR AND MORE!

THE MONEY MAKING OPPORTUNITY OF THE 1990'S

IF you are able to work with common small hand tools, and are familiar with basic electronics (i.e. able to use voltmeter, understand DC electronics) . . . IF you possess average mechanical ability, and have a VCR on which to practice and learn. . . then we can teach YOU VCR maintenance and repair!

FACT: up to 90% of ALL VCR malfunctions are due to simple MECHANICAL or ELECTRO-MECHANICAL breakdowns!

FACT: over 77 million VCRs in use today nationwide! Average VCR needs service or repair every 12 to 18 months!

Viejo's **400 PAGE TRAINING MANUAL** (over 500 photos and illustrations) and **AWARD-WINNING VIDEO TRAINING TAPE** reveals the **SECRETS** of VCR maintenance and repair—"real world" information that is **NOT** available elsewhere!

Also includes all the info you'll need regarding the **BUSINESS-SIDE** of running a successful service operation!

FREE INFORMATION
CALL TOLL-FREE 1-800-537-0589
Or write to: Viejo Publications Inc.,
5329 Fountain Ave.
Los Angeles, CA 90029 Dept. PE

CIRCLE 10 ON FREE INFORMATION CARD

HAM RADIO

By Joseph J. Carr, K4IPV

Why Not Try A Folded Dipole?

Dipole antennas have long been favored by ham operators for several reasons. First, since they are bidirectional (see Fig. 1), they provide nearly 2 dB gain over isotropic radiators (which are omnidirectional). That gain provides increased radiated power in the transmission direction, which means that you are heard at least a little louder. Also as shown in Fig. 1, there is a null—possibly the dipole's greatest advantage, because you can null loud interference by placing the null in the direction of the

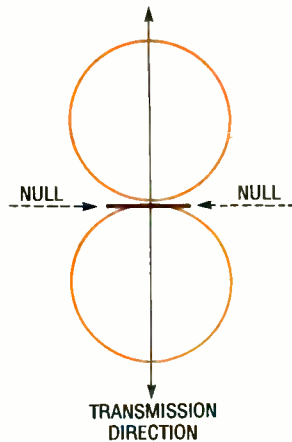

Fig. 1. Dipole antennas have long been favored by ham operators because they provide nearly 2 dB gain over isotropic radiators, and they have a null, which allows you to negate interference by placing the null in the direction of the interference.

interference. Hams on the east coast, for example, can null out an awful lot of stateside QRM by aiming the dipole a few degrees east of north to work Europe.

The other reason that dipoles are popular antennas

is their utter simplicity. They consist of just a bit of wire, some insulators, and (if you're smart) a balun transformer.

DIPOLE ANTENNAS

Most people are familiar with the simple dipole—a half wavelength wire radiator fed at the center (quarter wavelength) from a 75-ohm coaxial cable. However, there are variations on the simple dipole, not least among which is the folded dipole. The folded dipole, as shown in Fig. 2, consists of a pair of parallel radiator elements that are shorted together at the ends. Such antennas are typically broader band than conventional dipoles, so the VSWR remains lower across a wider portion of the band away from the resonance point. The length of the radiator element for a folded dipole is about the same as the length of a regular dipole for the same frequency:

$$L_{\text{feet}} = 468/f_{\text{MHz}}$$

where L is length in feet and f_{MHz} is the frequency in megahertz. For VHF, the di-

pole's length is best calculated in inches, using this modified equation:

$$L_{\text{inches}} = 5911/f_{\text{MHz}}$$

The lengths derived from the equations are approximate. The actual length depends on the electromagnetic environment at your QTH (location); nearby structures, trees, etc., and the antenna's height above the ground, all affect the resonance and feedpoint impedance.

In addition, when twin-lead is used, the velocity factor of the specific wire brand that you use may affect length. I've found equation 1 to be a very close approximation for a 15-meter folded dipole that was made from Radio Shack's house-brand twin-lead. The actual length is found by trimming or lengthening the antenna from the calculated length until minimum VSWR is reached at the desired frequency of operation.

The feedpoint is established by cutting one of the radiator elements, and attaching the transmission line. Because the free-

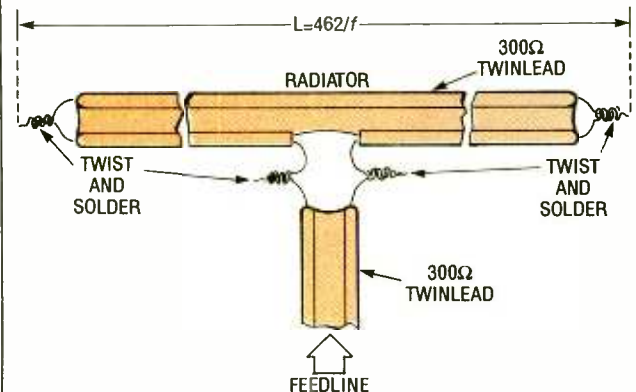

Fig. 2. The folded dipole consists of a pair of parallel radiator elements that are shorted together at the ends, and fed from a center-connected transmission line.

space impedance of the dipole is around 280 ohms, it is a good match to 300-ohm, television-type twinlead. When making a folded dipole, the twinlead is first stripped at the ends. The exposed wires are twisted together and then soldered, as shown in Fig. 2. Similarly, one of the wires in the twinlead is snipped at the center, and about one-half inch stripped back in either direction. A transmission line is prepared from a piece of twinlead and soldered to the radiator element.

Unfortunately, 300-ohm feedline is not a good match to the 50-ohm output impedance of most transmitters today. In addition, the twinlead is balanced, while the standard transmitter output is unbalanced (*i.e.*, designed

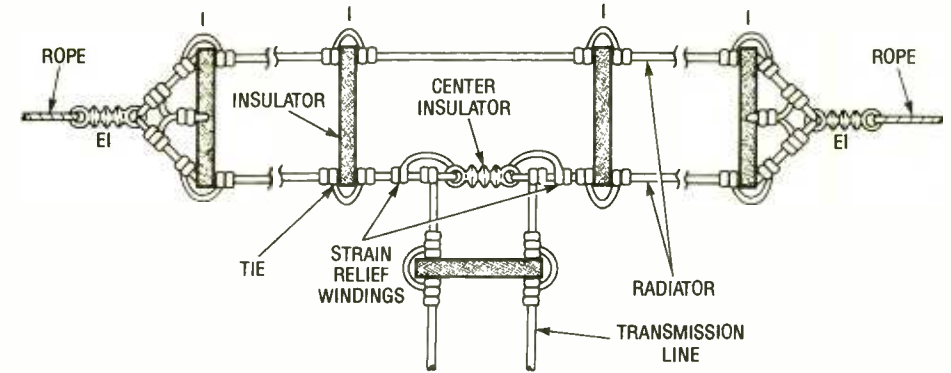

Fig. 3. The more traditional folded dipole, consists of #12 or #14 stranded copper-wire wherein the radiator wires are spread 4 to 6 inches by spreader insulators that are placed every five feet or so. Such antennas are more flexible and sturdier than the twinlead version.

for coaxial cable). That means that a folded dipole (made from either twinlead or parallel transmission line) would have to be fed by the transmitter through an antenna tuner that has a balanced output (in addition to the normal unbalanced coaxial output). Such tuners (of which,

most ham types are examples) have an internal 4:1 impedance ratio balun (*BAL*anced-*UM*balanced) transformer.

The folded dipole shown in Fig. 3 uses more traditional construction, the type used before the advent of twinlead. Many experienced amateurs prefer that type of construction—where the radiator element is made from #12 or #14 stranded copper wire (preferably copper-clad steel or Copperweld for strength)—to twinlead. The wires are spread 4 to 6 inches by spreader insulators (denoted "I" in Fig. 3) that are placed every five feet or so.

The best insulators are the ceramic types that are made for that purpose; except at hamfests, such insulators are hard to come by these days. Alternative insulators include segments of PVC plumbing pipe, plastic or plexiglass, or even old toothbrushes. Each insulator is secured in place by a tie wire made of the same wire stock as the antenna radiator.

The tie wires are twisted and then soldered. The feedpoint of the wire folded dipole is insulated with a standard antenna center insulator, which is easily available almost everywhere. The feedline is 300-ohm parallel transmis-

sion line, and it is connected to the radiator between the center insulator and the strain-relief winding. The strain-relief winding is made by looping a "tail" through the insulator, and around the radiator wire (back on itself), wrapping it around the radiator four or five times. Both the electrical connection from the transmission line and strain-relief wrapping are soldered.

The end insulator, designated "EI" in Fig. 3, is similarly handled. A spreader insulator at each end is wired in the normal way, but the ends of the radiator are twisted together in a normal insulator for support by a rope. If you use regular parallel-wire-antenna insulators, then it is possible to buy a type with a hole in the center. If these are used, then the support insulator can be eliminated, and the rope attached to the center hole. As with all antenna connections, the end connections and tie wires should be twisted tightly together and then soldered with 50/50 or 60/40 radio-TV/electronic solder (not acid-core plumbers or metal-worker's solder!).

When the antenna radiator elements are identical sizes, and the spacing is

(Continued on page 92)

Make the most of your general coverage transceiver with **Monitoring Times!**

Every month **Monitoring Times** brings everything you need to make the most of your general coverage transceiver: the latest information on international broadcasting schedules, frequency listings, international DX reports, propagation charts, and tips on how to hear the rare stations. **Monitoring Times** also keeps you up to date on government, military, police and fire networks, as well as tips on monitoring everything from air-to-ground and ship-to-shore signals to radioteletype, facsimile and space communications.

ORDER YOUR SUBSCRIPTION TODAY before another issue goes by. In the U.S., 1 year, \$19.50; foreign and Canada, 1 year, \$26. For a sample issue, send \$2 (foreign, send 5 IRCs). For MC/VISA orders (\$15 minimum), call 1-704-837-9200.

MONITORING TIMES

Your authoritative source, every month.

P.O. Box 98
Brasstown, N.C. 28902

SCANNER SCENE

By Marc Saxon

New Kid on the Block

It's been a long time (too long, if you ask me) since a new manufacturer entered the scanner field. But we can kick off the new year with a good omen: the announcement that Shinwa Communications of America is bringing out an all-new scanner called the SR-001.

The Shinwa SR-001 "All Wave Receiver" covers from 25 to 1000 MHz with a memory capacity of 200



Here's an entry from a newcomer to the scanner scene: Shinwa Communications of America. The SR-001 covers from 25 to 1000 MHz with a 200-channel memory capacity.

channels (10 banks of 20 channels each) on the AM, NFM, and WFM bands. It scans at 35 channels per second in frequency steps of 5, 10, 12.5, 20, 25, 50, or 100 kHz. Those steps are automatically selected for the band being received; they can, however, be manually changed by the user.

Especially interesting features of the SR-001 include

two antenna inputs—a BNC-type, and an N-type—and frequency and mode that can be selected either by front-panel control or via a remote-control accessory that operates from as far away as 22 feet by wireless infrared. There's also an RS-232C port for system expansion.

This receiver requires 13.6 VDC, so it can be operated from a mobile unit just as the unit comes from the carton. For desktop operation, an AC adaptor is supplied. A lithium battery supplies the power for memory retention.

For more information on the SR-001, contact Shinwa Communications of America, Inc., P.O. Box 26407, Oklahoma City, OK 73126.

CANADA CALLING

We received a letter from Dennis Wight, Maple Ridge, British Columbia, observing that the frequency coverage of his Bearcat 220 has a gap between 136 and 144 MHz, which is where a lot of Canadian communications services operate. He asks if we know of any modifications that will put those missing frequencies into his scanner. Dennis also requests that we list some frequencies for British Columbia, especially that of the Department of Communications.

As far as we have ever heard, there aren't any modifications that will put 136 to 144 MHz into a Bearcat that wasn't designed to receive that band. But, we

think that one of the Department of Communications frequencies in B.C. is 149.08 MHz, and that's within the operational range of most scanners.

A few other good frequencies in B.C. include the Royal Canadian Mounted Police, on 139.26 (Burnaby and Vancouver), 139.29 (Surrey, N. Vancouver, and Victoria), 139.32 (Port Moody, Coquitlam), 139.38 (Richmond), and 413.2875 and 414.54 (airports); the Department of Fisheries and Oceans on 143.145 and 144.08; the Army Provost on 149.65; the Army at Chilliwack on 149.35 and 149.23; and the Canadian Security International Service on 139.17 and 139.48 MHz.

TECH TIP

Does the microprocessor on your Bearcat BC-760XLT/950XLT lock up? We heard from B. Anoreno, of Bartlett, IL, who reports having encountered that problem. He tells us that he wrote to the manufacturer and was told that this can happen due to power fluctuations, which will also cause "SCN" to appear on the display in addition to the lock-up problem.

The manufacturer advised that to reset things, you need to press 2, 9, and "manual" while turning on the scanner. A word of caution: While this trick promptly unlocks the microprocessor, it also clears all of the memory banks. A

good idea is to keep a written record of all important frequencies that you have programmed before you launch them into oblivion.

THIS BEEP'S FOR YOU

Here's an inquiry from Jason Rowsell, Everett, WA, who shifted his scanner into search/scan mode and was greeted on 152.01 MHz by a voice that was paging for doctors. Near that frequency there were odd-sounding tones picked up on 152.02, 152.24, 152.48, 152.845, and 152.77 MHz. He hopes that we can offer some ideas on what he was monitoring.

The medical paging was actually taking place on 152.0075 MHz, to be precise—a frequency that is dedicated to medical paging. The other signals were non-voice radio-paging signals, although sometimes

voice-paging signals can also be monitored in this part of the spectrum in many areas throughout the U.S.A.

The following bands are usually rich with commercial paging-service signals (non-voice and/or voice): 35.20 to 35.66 MHz, 43.20 to 43.66 MHz, 152.03 to 152.84 MHz, 158.10 and 158.70 MHz, 454.025 to 454.65 MHz, and 931.0125 to 931.9875 MHz. In addition, try the private-company paging channels: 157.45, 157.74, and 158.46 MHz. Some large companies such as IBM operate these private paging services in order to contact their large staff of field representatives whenever needed.

JERSEY BOUNCE

Some New Jersey frequencies of interest are passed along by Joe Sammartino, of Clifton, NJ. Joe

reports the NJ State Troopers on the Garden State Parkway use 154.905 MHz, while the NJ Turnpike produces activity on 155.19 MHz. AAA auto club tow-truck dispatching in northern NJ may be monitored on 150.92 MHz. The NJ State Police Emergency Network uses 154.68 MHz. And the WCBS/880 traffic helicopter provides highway information on 450.0875 MHz.

LONG HAUL

Let's keep in mind that daylight hours during these winter months are known for producing long-range (F2-layer) "skip" reception in the 30–50-MHz band. From sunrise to mid-afternoon, begin searching through the 30–35-MHz portion of the band for DX signals. If you hear DX coming through, expand your search upwards to 40 MHz, and higher if the 35–40-MHz band segment produces DX.

Well, that's all the room we have for this month. As always, we look forward to hearing from you with photos, frequencies, questions, loggings, ideas, tips, news clippings, and your thoughts at *Scanner Scene*, **Popular Electronics**, 500-B Bi-County Blvd., Farmingdale, NY 11735. ■

CIRCUIT CIRCUS

(Continued from page 80)

powered sounder to be operated with the system.

The circuit's operation is simple. A 4049 hex inverting buffer is used to isolate each of the six input sensors. With S2 in its normally closed position, the input of U1-a at pin 3 is tied to the positive supply. The high input causes U1-a's output to go low. With a low output, LED1 remains dark, and no current passes through diode D1.

Opening S2 pulls the input of U1-a low through R14, forcing its output to go high, causing LED1 to light, while feeding a bias voltage to the base of Q1 (a 2N2222 NPN unit) through D1 and S8. The positive base bias causes Q1 to turn on, supplying gate current to SCR1 through R20 (a ½-watt unit). That causes SCR1 to turn on, activating the sounder, BZ1. Each of the remaining sensors/ buffers stages operate in a like manner. The transistor is connected in an emitter-follower configuration to isolate the buffer outputs and increase the SCR's gate current to ensure that it turns on.

The circuit is modified to provide series loop protection by substituting a string of sensors (say, three or four) switches for each normally closed switch used in the individual loop. You can also use the circuit as a status monitor only by eliminating the diodes (D1–D6) and all of the circuitry that follows. In addition, a piezo buzzer can be connected from the diode side of S8 to ground if an audible output is desired in the monitor-only position. If additional individual inputs are needed, it's easy to add another 4049 hex inverter to the circuit. ■



"This is really exciting! I heard you guys on my scanner!"

FCC LICENSE PREPARATION

General Radiotelephone
Radiotelegraph
Amateur Radio Licenses

We offer the most up-to-date study materials available. Our formats include: tests, audio programs, and video programs.

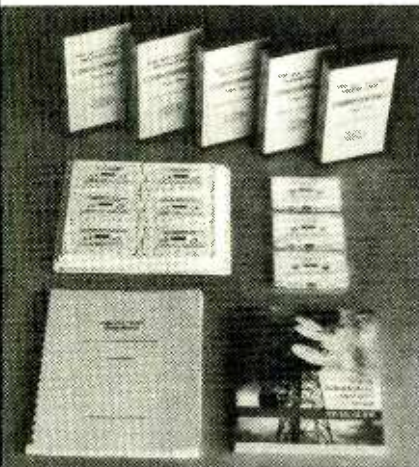

WPT PUBLICATIONS

7015 N.E. 61st Ave.
Vancouver, WA 98661
(206) 750-9933

CIRCLE 18 ON FREE INFORMATION CARD

COP TALK

(Continued from page 62)

computer codes, which can be changed hourly if desired to foil even the best computer hacker.

Scrambled communications are more the domain of federal agencies than city police departments, however you will recognize some of them by loud static that sounds like your squelch control has been turned off, or the high-pitched gibberish of speech inversion.

Another communication method becoming popular is the trunked system. More and more law-enforcement departments are making the move in order to reduce radio interference and allow clearer communications. Trunked radios are licensed in the 800-900-megahertz band, utilizing five to twenty channels.

Monitoring trunked police frequencies is not difficult, despite the claims of police departments that their systems are secure from listeners. Simply program all of the system frequencies into your scanner and lock out the data channel, which buzzes and howls so much that you'll easily identify it. That channel is changed daily and sometimes as much as twice a day so don't forget to lock out that channel and unlock the old one as necessary. Leave off the delay feature. As soon as communications end on one frequency they will shift to another immediately.

Frequencies. Public-safety 800-megahertz frequencies are usually full of activity because they are sometimes shared by various services (such as public works, and the fire and medical services) as well as the police. For that reason you'll need a quick hand to bypass the other conversations and stay with the police communications.

In addition to the 800-megahertz band, you will find police communications between 153-160 megahertz, 450-460 megahertz, and 500-512 megahertz (see boxed text entitled "Law-Enforcement Communications Frequency Ranges" for the specific ranges). A current volume of *Police Call* magazine for your area (available at any Radio Shack) will list the frequencies in use for your local department. General scanning through those frequency ranges, though more time consuming, is often the best way to find

active frequencies, including unlisted undercover or detective operations.

Departments across the country number their frequencies and many times refer to them as F1, F2, or Frequency 7, Frequency 10, etc. Very seldom will an officer or dispatcher mention a frequency on the air; for security, it is coded ("Unit 230 Sam, switch to Frequency 6."). A good amount of bandscanning will enable you to eventually track down the frequency.

Radio Codes. To the uninitiated, the sentence "35 Paul 3 is Code Four at this location with one 10-16. Roll an 11-85." is sheer nonsense, but to a monitor familiar with the codes of the San Diego County Sheriff's Department, Unit 35 Paul 3 (the number three City of San Marcos patrol unit on duty) just informed dispatch that no further help is needed, he has one prisoner in custody and is requesting a tow truck.

Radio codes like these provide dispatchers and police officers a short-hand way of getting their message across clearly. They also afford a certain amount of message security. Local radio hobbyists should have a list of codes used in your area (a good place to inquire about this is a Radio Shack store). Note that each county, and sometimes each department have their own codes.

In addition to standard 10-Codes, each state has their own vehicle codes, health and safety codes, and business and professions codes. Section 10851 of the California Vehicle Code pertains to stolen vehicles, therefore an officer referring to a stolen car over the radio would call it a "10-851." These codes are often available in the law section of your local library. Some of the more common codes appear in Table 1.

There is nothing quite so heart-stopping (or sad) as hearing the call "Officer Down!" come from the radio, but, thankfully, more often than not the calls you will listen to will be about routine alarms, abandoned vehicles, traffic stops, and field interrogations. An average day is never just an average day for a police officer.

You never can be sure of what you will hear and maybe that is part of the allure of monitoring police communications, a chance to glimpse behind the badge without actually being in the line of danger. So, turn on your scanner and ride along! ■

HANDS-ON REPORT

(Continued from page 72)

board. There's no place to solder the mode switch onto the board, so we used a small piece of double-sided tape to secure it in place.

The mechanical assembly involves installing some hardware and four rubber feet that make up the legs of the piano. You also have to attach the speaker, using three brackets, and the battery holder, using a couple of screws, to the underside of the board. All pretty simple stuff.

If we had to pick out the one thing that contributes the most to the quality and appearance of the finished piano, it would definitely be the PC board, which is shaped like a grand piano. Not only is the board etched, drilled, silkscreened, and solder masked (things you might expect in a kit), it also has a beautiful black finish on the component side—just like a real piano. The finished piano looks so good that it's a natural conversation piece that most people will want to pick up and play with.

Use. The piano is a blast to use, and it sounds great. Perhaps that's because a speaker is used (not just a piezo element), which has a more realistic sound to it.

If you don't know how to play a piano, don't worry; you can make up your own tunes and enjoy doing it. You'll also be able to let the piano play 15 songs all by itself. It's fun to try and figure out what all the songs are; you should recognize most of them, including the notes from *Close Encounters*. Notes are provided in the manual to help you play four songs yourself even if you don't know how to play the piano. Hitting a single key as fast as you can has a neat effect, and with the replay feature you can enjoy your efforts over and over again.

Everyone should enjoy the Grand mini Piano, but people who already know how to play the piano will immediately be delighted with this unusual toy. The Grand Piano kit is available from OWI Incorporated (1160 Mahalo Place, Compton, CA 90220; Tel. 213-638-4732) for \$38.95. For more information contact them directly or circle number 119 on the Free Information Card. ■

HAM RADIO

(Continued from page 88)

four to six inches, then the impedance transformation is 4:1, as for folded dipole antennas. Other values (from 0.1:1 to 16:1) can be achieved by varying the spacing and respective conductor diameters. (See *The ARRL Antenna Book* for design graphs and equations. The American Radio Relay League is located at 225 Main Street, Newington, CT 06111.)

An alternate method of

feeding a folded dipole is shown in Fig. 4. In this system, a 4:1 balun transformer is connected directly to the feedpoint, transforming the impedance to a value that's one-fourth of the twinlead's natural impedance (approximately 300 ohms). The result of transforming the feedpoint impedance is that the antenna can be fed from 75-ohm coaxial cable.

Using a balun transformer at the feedpoint also helps the antenna pattern by balancing the currents in the two halves of the radi-

ator. The pattern in Fig. 1 is idealized for a perfect antenna. In practical antennas, it can get quite ragged, but with a balun at the feedpoint, it becomes closer to the ideal.

A FOLDED DIPOLE FIX

As early as 1960, I learned the hard way that there is a major problem with twinlead folded dipoles. Because the typical twinlead uses #16 or #18 soft-drawn copper wire, rather than copper-clad steel, the antennas break a lot. All it takes is a little wind, or a bit of ice. And sometimes metal fatigue alone causes an antenna to simply drop to the ground. Regardless of the mechanism, you're off the air until repairs are made.

As a sad-faced teenager, I told my mentor, the late "Mac" Parker (W4II), of the problem. He chuckled, and then sketched out a little diagram that was somewhat like the one in Fig. 5. The end insulators and the center insulator are made from $\frac{1}{4}$ - or $\frac{5}{16}$ -inch plexiglass, lucite, or some other form of nonconductive plastic. A pair of $\frac{1}{4}$ -inch slots, about 2 inches apart, are cut into the center. The slots are easily made by drilling $\frac{1}{4}$ -inch holes at either end of the slot-to-be and then removing the material between them with a file. A series of five screw holes are made at the points indicated in Fig. 5.

The twinlead is prepared by using a drill, leather punch or ordinary paper hole punch to cut holes into the twinlead. The twinlead is then woven into the insulator and is fastened to the insulator block using nylon (**not** metal) machine screws and hex nuts. It might be useful to use a second nut on each screw; tighten it and then "super-glue" it in place. ■

DX LISTENING

(Continued from page 86)

found at a garage sale and repaired. Also a World War II vintage military set, a BC312 (that has been modified for AC operation), which I rescued from being junked 40-years ago and still use at times. I just located some replacement tubes in original boxes.

"My main receiver at the moment is one sold years ago by Allied Radio. It's the model SX-190—another acquisition from a garage sale. I need a copy of its schematic and alignment procedures. I'd be glad to pay for copying and postage if any reader has a manual for this set."

If anyone can help Clinton, you can write to him at 17 Capehart Drive, Orlando, FL 32807.

DOWN THE DIAL

Here are some interesting stations logged recently.

AUSTRALIA—*Radio Australia* is noted in English with identification and news broadcast at 2200 UTC on 17,715 kHz.

COSTA RICA—Heard in English at 0115 UTC is *Radio for Peace International*, operating on 13,630 kHz.

GHANA—*GBC-1* broadcasts from Accra, capital of this West African country once known in colonial days by the more exotic name "Gold Coast." Look for this one with programming both in English and African languages at around 0530 UTC on 4,915 kHz.

INDIA—*All India Radio* is heard in North America on 11,620 kHz with its English language transmission at 2100 UTC.

LUXEMBOURG—Bilingual English and French programming is noted from *Radio Luxembourg* at 0400 UTC on 15,350 kHz. ■

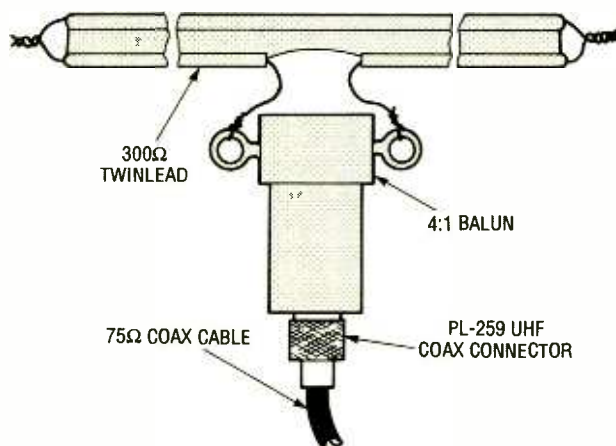

Fig. 4. An alternate method of feeding a folded dipole is to use a 4:1 balun transformer connected directly to the feedpoint, transforming the twinlead's natural 300-ohm impedance so that the antenna can be fed from 75-ohm coaxial cable.

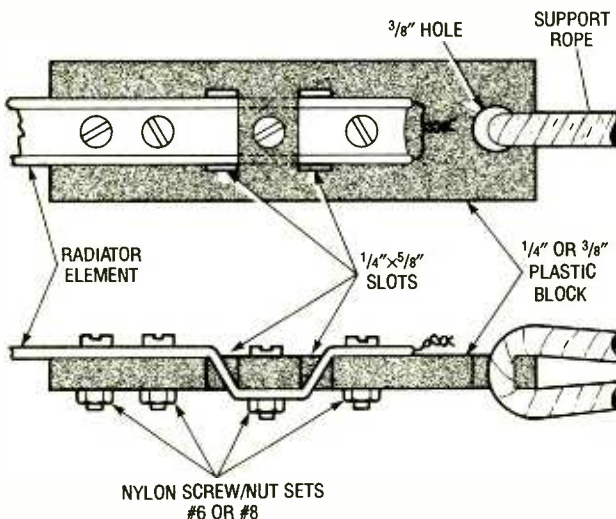

Fig. 5. The end and the center insulators for twinlead folded dipoles can be made from $\frac{1}{4}$ - or $\frac{5}{16}$ -inch plexiglass or other nonconductive plastic, by cutting a pair of $\frac{1}{4}$ -inch slots, about 2 inches apart, into the center.

ANTIQUE RADIO

(Continued from page 77)

operator's hand is about three inches from the volume-control electrode. That was already the case, and I had no further adjustment to make.

To check the pitch-generating circuitry, the operator stands directly in front of the theremin with his or her right arm extended and right hand closed. The distance from the body to the instrument is now adjusted so that the closed right hand just reaches the pitch-control rod.

With the front-panel pitch control at its midpoint position, the arm is now slowly pulled back to the shoulder. As this is done, the tone should gradually become lower in pitch, until it dies out (zero beats) just as the hand reaches its rear-most position. I wasn't originally able to achieve zero beat at any setting of the front-panel knob, but the problem was readily corrected through adjusting a chassis-mounted trimmer capacitor as recommended by the RCA service manual.

Finally, a check is made of the highest-pitch tone obtainable from the instrument. With the hand almost touching the pitch antenna (about one inch away), the pitch should be between C sharp and F sharp two octaves above middle C. My musician wife checked this and assured me that I was in the right ballpark. Otherwise, adjustment of another chassis-mounted trimmer would have been required, to get the proper pitch.

WHAT'S NEXT

Speaking of my wife Carolyn (who is a serious pianist and a fine musician), she became intrigued with the

theremin while helping me test it, and asked me to keep it around for a while. Who knows? If she masters the instrument, maybe I can offer interested readers a tape of a theremin recital!

Next month, look for the results of our latest contest—which challenged readers to tell us how they organize and display their acquisitions and how other members of the family relate to the collections. I have to warn you that only a handful of folks have responded to this one, but their stories will make very interesting reading.

The following month (March), we should probably have another mailbag column, so if you have a question or comment you'd like to pass along, be sure and send it soon! Write me *c/o Antique Radio, Popular Electronics*, 500-B Bi-County Blvd., Farmingdale, NY 11735. ■

COMPUTER BITS

(Continued from page 82)

It's ironic that we had to wait so long for a real command-line processor, now that Windows and the graphical look-and-feel is taking the world by storm. However, until DOS is completely replaced by a command shell in Windows or OS/2, I'm going to stick with NDOS.

As for the other utility programs, I wish they were better organized and better integrated. Because of unclear boundaries and overlap among various programs, I have trouble remembering which program performs which function. But that's really just a minor annoyance; overall, Version 6 of Norton Utilities is a definite winner, and must-have item. ■

ONKYO RECEIVER

(Continued from page 75)

plus noise as a function of frequency for the front channel, while maintaining a constant 90-watts-per-channel output, with 8-ohm speaker loads. At mid-frequencies, distortion was an amazingly low 0.0056% at that output; even at 20 kHz, THD was still well below 0.03%, far lower than the 0.06% specified by Onkyo.

A similar test was conducted for the rear channels, with the output maintained at the rated 30-watts-per-channel, again using 8-ohm loads. There, too, distortion remained well below the rated value of 0.08% at all but the highest frequency examined, measuring only 0.031% at 1 kHz.

Signal-to-noise ratio for the high-level inputs to the amplifier measured 78 dB referred to 500 millivolts of input, with the volume control adjusted to produce 1 watt of output into 8-ohm loads connected via the front speaker terminals. When we examined residual noise versus frequency, we noticed that the usual noise "peaks" that are attributable to hum components from the AC power supply were virtually non-existent, indicating superb shielding and layout of components within the chassis, as well as intelligent grounding of critical circuits. Phono signal-to-noise, referred to a 5 millivolt input and with the volume control once more adjusted to produce a 1-watt output, measured 77 dB.

The maximum boost and cut range of the bass and treble controls of the TX-SV70PRO receiver was typical for this type of tone control, and we were pleased to note that the tone

controls provided a "shelving" effect at ultra low frequencies rather than continuing to increase bass boost, which could cause amplifier and/or speaker overload.

The action of the unit's loudness control, provided by a "selective tone control/loudness control" was somewhat unusual: Loudness compensation was provided, to some extent, even when the master volume control was at its maximum setting. Normally, loudness-control action provides flat response under those conditions. Furthermore, at lower volume settings, while the usual bass and treble boost are provided, the peak in bass boost occurs at around 55 Hz. Below that frequency, bass compensation is attenuated. This last feature, though, strictly speaking, not in accordance with usual practice, is a welcome one as it will prevent speaker overload and possible speaker cone "bottoming."

Video frequency response for the video inputs extended out to 5.0 MHz with virtually no attenuation at that uppermost frequency. That should enable you to maintain horizontal resolution levels of up to around 400 lines or so, and you should experience no degradation of picture quality from either a VCR or a laser disk player connected to the receiver for central control purposes.

Considering the splendid features and performance of this do-it-all audio/video receiver, its suggested retail price of \$900 represents a real bargain. For more information on the Onkyo TX-SV70 PRO AV Surround-Sound Receiver, contact the manufacturer directly, or circle no. 120 on the Free Information Card. ■

BUILD A SUBWOOFER

(Continued from page 37)

Tests and Performance. The Subwoofer system was tested extensively. The tests I'll mention here were done either in my "basement lab," or in my living room. Although they yielded the best results in my particular room, you would most likely need to experiment to arrive at the best level and damping setting for your surroundings. However, you can still use these tests as a guide.

The tests were performed with a Realistic sound-level meter and an oscilloscope. The oscilloscope was used to view the wave shape of sounds, which were provided via a jack on the meter. Viewing the waveform on the oscilloscope can give you a rough idea of the level of distortion.

Placement of the enclosure in the room for testing is not at all critical. You can place the cabinet in a horizontal position if that is your preference. In monitoring the sound-wave shape, as previously described, the "eyeball" value for distortion at 5 to 10 watts drive input (i.e., loud), appears to be less than 1 to 3%.

I used the sound-level meter without the oscilloscope in a different test: For the test, the damping control was set at its maximum position. With the subwoofer turned off, I fed a 50 Hz signal into an auxiliary input on my receiver/amplifier and set the volume level to produce a +70 dB reading on the meter.

Next, I turned the subwoofer on and switched the main speakers off, and adjusted the level-adjust potentiometer on the crossover board to a setting where the sound meter was again reading +70 dB. Turning the main speakers back on, I checked the meter reading again. It was a little lower. I then reversed the speaker leads at the enclosure's terminal board and the meter reading rose a little high. I readjusted the level potentiometer to bring the sound level back down to +70 dB. The procedure proved that phasing is important.

The arrangement that has evolved for my system, and works quite well is to place the subwoofer toward the right corner of the room, and about 8-inches from the wall. Again a little experimentation will be useful in placing your own speaker. ■

HOT CANARIES

(Continued from page 44)

their sockets, but do not mount the board in its enclosure yet; it must still be tested.

Testing. To test the circuit, place a 9-volt transistor-radio battery in the holder, attach the snap-on connector to the battery, and turn S1 to the on position. You should hear chirping sounds not long after the circuit is powered up. Using a voltmeter, check the +V input of each chip at pin 4 for +9 volts. Once you established that the IC's are receiving power, potentiometers R5 and R6 must be adjusted.

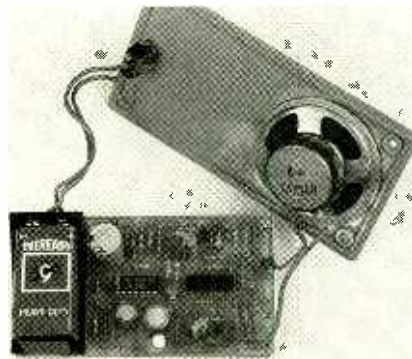

Once the printed-circuit board has been attached to the lid-mounted speaker and switch, it must be tested and adjusted to ensure proper operation, prior to being sealed in its enclosure.

Adjustments to R5 and R6 are best done by temporarily desoldering R1 and R2 in turn. Remove R1 first and adjust R6, so that chirping starts at a slow pace then increases to a faster rate, and then stops before starting again. If the trimmer is too far counterclockwise, the canary will hardly chirp at all, but if it's too far clockwise, it will not stop chirping. Once that adjustment is complete, reinstall R1, remove R2, and adjust R5 in the same manner. The chirping from the second half of the circuit should sound slightly different from the first.

Once the second half of the circuit has been adjusted, the printed-circuit board can be mounted in the enclosure, and the enclosure can then be sealed. As a final touch, you can attach a pair of artificial canaries to the lid of the enclosure to partially conceal the speaker holes and the switch lever in the lid. ■

PARALLEL-PORT SIGNALS

(Continued from page 41)

(or IDC's as they are commonly called) then disconnecting those pins is more trouble than it's worth. If you're using crimp-on or solder-type connectors, just ignore those pins to save yourself some time.

To disconnect any connections when using IDC's just attach the two connectors the way you normally would and carefully slice out a small section of each unwanted wire with an X-acto knife. Be careful not to cut through the insulation of any desired wires.

Another common cable job is to connect a DB-25 computer port to a 36-pin Centronics-compatible termination. If you will be using crimp-on or solder-type connectors, the connections you'll need to make are listed in Table 1.

TABLE 1—STANDARD IBM CABLE CONNECTIONS

DB-25 Connector	Centronics-Style Connector
1-14	1-14
15	32
16	31
17	36
19	19
25	30

Note that the connections for pins 1 to 14 are pin-for-pin connections. If you use IDC connectors and 25-conductor ribbon cable, you can take advantage of that and create a suitable cable in just a few minutes. Start by positioning pin 1 of both connectors over the same edge of the ribbon connector (see Fig. 4) before squashing them on. That will leave 11 pins on the Centronics connector unconnected, which is okay. The trick is to cut a little section out of the fourth wire in from the pin-1 wire. The open circuit will allow the computer's error input to float high (to the "no-error state") and that's all there is to it!

Between the information on parallel signals, their activity, and cabling, you should have a competent understanding of how a parallel interface does its job. Hopefully, you'll be able to design some nifty projects based on that information. Have lots of fun, and happy interfacing. ■

ELECTRONICS MARKET PLACE

FOR SALE

CABLE descrambler liquidation. Major makes and models available. Industry pricing! (Example: Hamlin Combo's, \$44 each... Minimum 10 orders). Call **WEST COAST ELECTRONICS**, 1 (800) 628-9656.

OUR monthly picture flyer lists quality surplus parts at low prices. Single & quantity prices. **STAR-TRONICS**, Box 683, McMinnville, OR 97128.

PRINTED circuit boards — etched, drilled, tin plated. Single sided \$1.25/sq. inch. Free shipping. **CHELCO ELECTRONICS**, 61 Water Street, Mayville, NY 14757. (716) 753-3200.

CABLE TV descramblers, converters, lowest prices guaranteed, best quality, free catalog, CNC CONCEPTS INC., Box 34503, Minneapolis, MN 55434. 1 (800) 535-1843.

HUGE 92 page communications catalog of short-wave, amateur and scanner equipment. Antennas, books and accessories too. Send \$1.00 to: **UNIVERSAL RADIO**, 1280 Aida Dr., Dept. PE, Reynoldsburg, OH 43068.

CLASSIFIED AD ORDER FORM

To run your own classified ad, put one word on each of the lines below and send this form along with your check to:

Popular Electronics Classified Ads, 500-B Bi-County Boulevard, Farmingdale, N.Y. 11735

PLEASE INDICATE in which category of classified advertising you wish your ad to appear. For special headings, there is a surcharge of \$11.00.

() Plans/Kits () Business Opportunities () For Sale
() Education/Instruction () Wanted () Satellite Television
()

Special Category: \$11.00

PLEASE PRINT EACH WORD SEPARATELY, IN BLOCK LETTERS.

(No refunds or credits for typesetting errors can be made unless you clearly print or type your copy.) Rates indicated are for standard style classified ads only. See below for additional charges for special ads. **Minimum: 15 words.**

1	2	3	4	5
6	7	8	9	10
11	12	13	14	15 (\$23.25)
16 (\$24.80)	17 (\$26.35)	18 (\$27.90)	19 (\$29.45)	20 (\$31.00)
21 (\$32.55)	22 (\$34.10)	23 (\$35.65)	24 (\$37.20)	25 (\$38.75)
26 (\$40.30)	27 (\$41.85)	28 (\$43.40)	29 (\$44.95)	30 (\$46.50)
31 (\$48.05)	32 (\$49.60)	33 (\$51.15)	34 (\$52.70)	35 (\$54.25)

We accept MasterCard and Visa for payment of orders. If you wish to use your credit card to pay for your ad fill in the following additional information (Sorry, no telephone orders can be accepted.):

Card Number

Expiration Date

PRINT NAME

SIGNATURE

IF YOU USE A BOX NUMBER YOU MUST INCLUDE YOUR PERMANENT ADDRESS AND PHONE NUMBER FOR OUR FILES. ADS SUBMITTED WITHOUT THIS INFORMATION WILL NOT BE ACCEPTED.

CLASSIFIED COMMERCIAL RATE: (for firms or individuals offering commercial products or services) \$1.55 per word prepaid (no charge for ZIP code). **MINIMUM 15 WORDS.** 5% discount for same ad in 6 issues within one year; 10% discount for 12 issues within one year if prepaid. **NON-COMMERCIAL RATE:** (for individuals who want to buy or sell a personal item) \$1.25 per word, prepaid...no minimum. **ONLY FIRST WORD AND NAME** set in bold caps at no extra charge. Additional bold face (not available as all caps) **30¢ per word additional.** Entire ad in boldface, \$1.85 per word. **TINT SCREEN BEHIND ENTIRE AD:** \$1.90 per word. **TINT SCREEN BEHIND ENTIRE AD PLUS ALL BOLD FACE AD:** \$2.25 per word. **EXPANDED TYPE AD:** \$2.05 per word prepaid. Entire ad in boldface, \$2.45 per word. **TINT SCREEN BEHIND ENTIRE AD PLUS ALL BOLD FACE AD:** \$2.95 per word. **DISPLAY ADS:** 1" x 2 1/4"—\$205.00; 2" x 2 1/4"—\$410.00; 3" x 2 1/4"—\$615.00. **General Information:** Frequency rates and prepayment discounts are available. **ALL COPY SUBJECT TO PUBLISHERS APPROVAL. ADVERTISEMENTS USING P.O. BOX ADDRESS WILL NOT BE ACCEPTED UNTIL ADVERTISER SUPPLIES PUBLISHER WITH PERMANENT ADDRESS AND PHONE NUMBER.** Copy to be in our hands on the 18th of the fourth month preceding the date of issue (i.e.: Sept. issue copy must be received by May 18th). When normal closing date falls on Saturday, Sunday or Holiday, issue closes on preceding work day. Send for the classified brochure. Circle Number 49 on the Free Information Card.

CABLE TV DESCRAMBLERS ★ CONVERTERS ★ and ACCESSORIES.

**SAVE MONEY.
DON'T RENT!**

PANASONIC,
PIONEER, JERROLD, OAK,
SCIENTIFIC ATLANTA
AND MORE. LOWEST PRICES.
FREE CATALOG.

**(800) 234-1006
CABLE READY COMPANY**

TOCOM and Zenith "test" chips. Fully activates unit. \$50.00. Cable descramblers from \$40.00. Orders 1 (800) 452-7090. Information (213) 867-0081.

SPEAKER repair. All makes — models. Stereo & professional kits available. Refoaming \$18.00. **ATLANTA AUDIO LABS**, 1 (800) 568-6971.

Quality Microwave TV Antennas

WIRELESS CABLE - IFTS - MMDS - Amateur TV
Ultra High Gain 50db(+) • Tuneable 1.9 to 2.7 Ghz.

- 36-Channel System Complete \$149.95
- 12-Channel System Complete \$114.95
- Call or write (SASE) for "FREE" Catalog

PHILLIPS-TECH ELECTRONICS
P.O. Box 8533 • Scottsdale, AZ 85252
(602) 947-7700 (\$3.00 Credit all phone orders)
MasterCard • Visa • COD's • Quantity Pricing

LIFETIME WARRANTY

TEST Aids 5 lots SA-8580 \$39.95. SA-8570/90 \$49.95. Starcom 6+7BB \$49.95. Zenith (all) \$19.95. Tocom (VIP) \$19.95. Dealers wanted. 1 (800) 74-CABLE.

CB RADIO OWNERS!

We specialize in a wide variety of technical information, parts and services for CB radios 10-Meter and FM conversion kits, repair books, plans, high-performance accessories. Thousands of satisfied customers since 1976! Catalog \$2.

CBC INTERNATIONAL
P.O. BOX 31500PE, PHOENIX, AZ 85046

T.V. FILTERS

T.V. notch filters, phone recording equipment, brochure \$1.00. **MICRO THinc.**, Box 63/6025, Margate, FL 33063. (305) 752-9202.

FREE CATALOG

FAMOUS "FIRESTIK" BRAND CB ANTENNAS AND ACCESSORIES. QUALITY PRODUCTS FOR THE SERIOUS CB'er. SINCE 1962
FIRESTIK ANTENNA COMPANY
2614 EAST ADAMS
PHOENIX, ARIZONA 85034

SPECIALIZED SECURITY

SURVEILLANCE — Audio/video/infra-red. Personal protection equipment. Public, private, corporate uses. Extensive book: \$9.00. Was "Security Systems" catalog. **TRI-TRON OF ATLANTA**, 1857F Fox Hollow, Lilburn, GA 30247-3363.

PLANS & KITS

HOBBY/broadcasting/ham/CB/surveillance transmitters, amplifiers, cable TV, science, bugs, other great projects! Catalog \$1.00 **PANAXIS**, Box 130-H1, Paradise, CA 95967.

BUILD — five-digit, ohms, capacitance, frequency, pulse, multimeter Board, and instructions \$9.95. **BAGNALL ELECTRONICS**, 179 May, Fairfield, CT 06430.

SURVEILLANCE transmitter kits tune from 65 to 305 MHz. Mains powered duplex, telephone, room, combination telephone/room. Catalog with **Popular Communications, Popular Electronics** and **Radio-Electronics** book reviews of "Electronic Eavesdropping Equipment Design," \$2.00. **SHEFFIELD ELECTRONICS**, 7223A Stony Island Ave., Chicago, IL 60649-2806.

FASCINATING Electronic Devices! Dazers! Lasers! FM/AM/phone transmitters! Detectors! Kits/assembly! Catalog \$2.00. **QUANTUM RESEARCH**, 16645-113 Avenue, Edmonton, Alberta T5M 2X2.

DESCRAMBLER kits. Complete cable kit \$44.95. Complete satellite kit \$49.95. Add \$5.00 shipping. Free brochure. No New York sales. **SUMMIT PE**, Box 489, Bronx, NY 10465.



ELECTRONIC STETHOSCOPE

Ultra-sensitive device picks up & amplifies sound through solid objects. Hear through glass, wood, plaster, brick or even 12" concrete. Use wherever audible sound is too faint for the unaided human ear. Picks up voices, machinery, bearings, valves, running water, even mice or insects. Can be attached directly to a tape recorder. Includes headphones, sensor & battery, \$69.95 check/MO to: **CLE**, Box 1913, Sarasota, FL 34230-1913 (813) 922-2633
Visa/MC accepted.

GERNSBACK — 1932, two tubes, plug-in coils, DX, shortwave radio. Free plan. **BOB RYAN**, PO Box 3039, Anaheim, CA 92803.

SATELLITE TV descrambler. Build your own. Easy to follow instructions, parts list, circuit board and wiring diagram. Send: \$9.95. **ABG ENTERPRISES**, 27081C, Halifax, NS, Canada, B3H-4M8.

AUTOMOTIVE electrical system monitor IC controlled with case. Complete kit \$6.95. Assembled \$9.95. S&H \$3.00. NY residents add tax. **V R ELECTRONICS CORP.**, PO Box 313, Flushing, NY 11365. (718) 357-9091.

CIRCUIT boards etched and drilled for .70 cents per square inch. **JM ELECTRONICS**, Box 150454, Altamonte Springs, FL 32715-0454. Call (407) 767-8196.

FM-stereo transmitter kit. Broadcast any audio signal, CD player, VCR to FM stereo radios throughout home/yard. PC board and components: \$22.00. **TENTRONIX**, 3605 Broken Arrow, Coeur d'Alene, ID 83814.

VIDEOCIPHER II/scanner/cable/satellite modifications books. Catalog — \$3.00. **TELECODE**, PO Box 6426-PE, Yuma, AZ 85366-6426.

SURVEILLANCE — countermeasures! Guaranteed lowest prices! Huge catalog \$5.00 (refundable). **PROTECTOR**, PO Box 520294-E, Salt Lake City, Utah, 84152.

KITS, sound, light, and high tech. Send for free catalog **JM ELECTRONICS**, Box 150454, Altamonte Springs, FL 32715-0454.

BUILD — 0 to 15 volts programmable power supply. Includes schematics and instructions. Easy to build. \$2.00 — **JAS**, PO Box 8274, West Chester, OH 45069.

CMOS/MOSFET Vehicle alarm. Simple digital circuit operates under 20 uA! Automatic arming; adjustable time delays; pre-alarm warning. Send \$8.00 for schematic and instructions. **MURPHY VEHICLE SECURITY**, PO Box 2751, Silver Spring, MD 20915-2751.

**Do You Know
Who's Calling
When Your Phone Rings?**

THE CALL IDENTIFIER* has the Answer

- displays callers phone number when your phone rings
- stores phone numbers with date and time of call

\$79.95 ppd
check/money order

SURVEILLANCE-COUNTERSURVEILLANCE EQUIPMENT CATALOG...\$5.00

NEW! X-TRA LONG RANGE FM (voice) TRANSMITTER KIT (\$39.95 ppd) (easy assembly)

P.O. Box 337, Buffalo, NY 14226 (716) 691-3476
* Check with your local Phone Co. for CALLER ID service availability.

BUG, telephone, FM, plans. Convert RadioShack device, easy. \$12.95 **ALLAN LABORATORIES**, PO Box 14302, 100 Allan Drive, Research Triangle Park, NC 27709.

UNIVERSAL IR remote controller. Trainable for most controllers. Options for Rs-232 interface, multiple event timer and LCD. Complete schematic and software \$18.00. **SUM WARE**, 1651 West Foothill Blvd., Suite 225, Upland, CA 91786.

SAVE money! Build a solar powered clothes dryer. Send \$10.00 for plans to **TURTLE ELECTRONICS**, 131 Haley Road, Kittery, ME 03904.

BUILD 6 simple low cost circuits to extend the functions and ranges of your meters and scope. Easy to build, useful! Send now for complete instructions. \$5.00. **BLUE BELL DESIGN INC.**, Dept. PEM, 524 White Oak Rd., Blue Bell, PA 19422.

ROBOTIC Arm computer controlled. Plans \$10.00, kit \$45.00, includes complete documentation on software, electronic control/feedback, plus mechanical design/analysis. Info & orders 1 (800) 645-2231 **APPLIED ROBOTICS**, 540 Kings Ave., Morro Bay, CA 93442.

X-Y Scanner Kit for your Laser

- 2 Lissajous Oscillators
- 2 Audio Inputs 2 Galvo's
- Computer interface
- Fun to build and use !!

99.00 4Lbs 900/20

Silicon Valley Surplus 1273 Industri-prkwy W bldg 460
415-582-6602 Hayward Ca. 94544-7025
CALL OR SEND FOR OUR FREE KIT CATALOG

REPAIR SERVICE

HEATH/Heathkit I can repair your audio, instruments, general and weather products no longer serviced by Heath. Factory trained. Call (219) 287-9373.

HOME EXTERMINATION

NEW book: "Become Roach-Free" Exterminator explains: in detail. \$20.00 **EPE**, POB 74C, Calhoun, LA 71225-0074.

TUBES - 2000 TYPES DISCOUNT PRICES!
Early, hard-to-find, and modern tubes. Also transformers, capacitors and parts for tube equipment. Send \$2.00 for 28 page wholesale catalog.

ANTIQUE ELECTRONIC SUPPLY
6221 S. Maple Ave. • Tempe, AZ 85283 • 602-820-5411

BEST BY MAIL

Rates: Write National, Box 5, Sarasota, FL 34230

OF INTEREST TO ALL

VCR REPAIR-TECHNICIANS' SECRETS REVEALED. Do it yourself, literally save hundreds. Complete easy to follow instructions. Includes 800 numbers of all major manufacturers for ordering parts direct. Simple Schematics/Directions. More. \$14.95 to: **ACME VCR REPAIR**, 2104 Renwick Lane, Antioch, CA 94509.

GLOW IN THE DARK Door Knob Covers, Four \$9.95. Shiny Tim, Post Office Box 92972, Lakeland, FL 33864.

FINANCIAL

SOLD YOUR HOME and taken back a mortgage? Trade your monthly payments for CASH NOW! R&P Capital Resources, 914-723-7795.

MONEYMAKING OPPORTUNITIES

WE PAY UP TO \$300.00 weekly Woodburning Picture Frames. Everything supplied. No experience or selling. Bay Frame, PO Box 1588-(PE), Jackson, TN 38302.

\$\$\$ HOMEWORKING! SASE Brings FREE details: **CMKT**, Box 40444-(PE), Raleigh, NC 27629.

EXCELLENT PAY! HOMEWORKERS Needed! Over 400 Companies need homeworkers/distributors NOW! Call for amazing recorded message 213-519-4192 Ext. PE.

HEALTH

HAIR LOSS? INFORMATION about new treatments. Peter Proctor, MD 1-800-926-1752.

ANTIQUE RADIO CLASSIFIED

Free Sample!

Antique Radio's
Largest Circulation Monthly.
Articles, Ads & Classifieds.
6-Month Trial: \$15. 1-Yr: \$27(\$40-1st Class).
A.R.C., P.O. Box 802-L8, Carlisle, MA 01741

WANTED

INVENTORS! Confused? Need help? Call **IMPAC** for free information package. USA/Canada: 1 (800) 225-5800. (24 hours!).

INVENTIONS/new products/ideas wanted: Call **TLCI** for free information/Inventors Newsletter 1 (800) 468-7200 24 hours/day — USA/Canada.

INVENTORS, circuit designer (MSEE) for hire. Affordable design, prototyping and fabrication. **CIRCUITS**, PO Box 80043, Valley Forge, PA 19485.

JOBS in Kuwait. Tax free construction workers \$75,000.00. Engineering \$200,000.00. Oil field workers \$100,000.00. Call 1 (800) 743-3440. Ext. 3012.

REMOTE unit for Advent Videobeam 1000A. Contact **G.J.**, 1106 South Palmetto Ave., Ontario, CA 91762.

EDUCATION/INSTRUCTION

VSWR, return loss, testing and troubleshooting guide. \$9.95. **MORGAN'S**, RD1, Box 1654, Moscow, PA 18444.

LEARN IBM PC assembly language. Book \$18.00. Disk \$5.00. **ZIPFAST**, Box 12238, Lexington, KY 40581-2238.

MASTERCARD AND VISA are now accepted for payment of your advertising. Simply complete the Classified Ad order form and we will bill you.

**CABLE DESCRAMBLERS
OAK M35B COMBO \$39.95**

Jerrold, Zenith, Hamlin, Sci. Atlanta, Pioneer
& MORE! OUR PRICES ARE BELOW WHOLESALE!

CABLE+PLUS
14417 Chase St. #481-B Panorama City, CA 91402
1-800-822-9955 • Other Info. 1-818-785-4500
NO CALIF. SALES — DEALERS WANTED

SATELLITE TV

FREE catalog — Do-it-Yourself save 40 — 60%. Lowest prices world wide, systems, upgrades, parts, all major brands discounted 40% and warranted. **SKYVISION**, 1048 Frontier, Fergus Falls, MN 56537. 1 (800) 334-6455.

VC-2 board exchange and repair service, tracker V satellite receiver \$869.00. Call for phone quotes. We will not be undersold. **SATELLITE TELEVISION**, 120 W. Centennial, Muncie, IN 47303. (317) 288-0074 tech support 11-5 E.

SATELLITE TV -Do It Yourself- systems. Upgrades. Parts. Major brands discounted 40% — 60%. We'll beat everyone's price. L.J.H. INC., call Larry (609) 596-0656.

BIG PROFITS ELECTRONIC ASSEMBLY BUSINESS

Start home. spare time. Investment knowledge or experience unnecessary. **BIG DEMAND** assembling electronic devices. Sales handled by professionals. Unusual business opportunity

FREE: Complete illustrated literature
BARTA PE-00 Box 248
Walnut Creek, Calif. 94597

**FREE CATALOG!
1-800-648-7938**

**JERROLD HAMLIN OAK ETC
CABLE TV
DESCRAMBLERS**

- Special Dealer Prices!
- Compare our Low Retail Prices!
- Guaranteed Prices & Warranties!
- Orders Shipped Immediately!

REPUBLIC CABLE PRODUCTS, INC.
4080 Paradise Rd. #15, Dept. PE192
Las Vegas, NV 89109
For all other information (702) 362-9026

*****PRESENTING*****
**CABLE TV
DESCRAMBLERS**
*****STARRING*****
**JERROLD, HAMLIN, OAK
AND OTHER FAMOUS MANUFACTURERS**

- FINEST WARRANTY PROGRAM AVAILABLE
- LOWEST RETAIL/WHOLESALE PRICES IN U.S.
- ORDERS SHIPPED FROM STOCK WITHIN 24 HRS.
- ALL MAJOR CREDIT CARDS ACCEPTED

**FOR FREE CATALOG ONLY 1-800-345-8927
FOR ALL INFORMATION 1-818-709-9937**

PACIFIC CABLE CO., INC.
7325 1/2 Reseda Blvd., Dept. 2010
Reseda, CA 91335

KELVIN 200

AC/DC VOLTAGE
AC/DC CURRENT
RESISTANCE DIODE TEST
LOW BATTERY Warning
ACCURACY ± 0.5%
CONTINUITY TEST/BUZZER
TRANSISTOR CHECKER
CAPACITANCE CHECKER

\$39.95

Stock No. 990091

KELVIN Electronics VISA M/C
7 Fairchild Ave., Plainview, NY 11803
(516) 349-7620 1(800) 645-9212

BUSINESS OPPORTUNITIES

YOUR own radio station! Licensed/unlicensed. AM, FM, TV, cable. Information \$1.00 **BROADCASTING**, Box 130-H1, Paradise, CA 95967.

EASY work! Excellent pay! Assemble products at home. Call toll free 1 (800) 467-5566 Ext. 5730.

MAKE \$75,000.00 to \$250,000.00 yearly or more fixing IBM color monitors. No investment, start doing it from your home (a telephone required). Information, USA, Canada \$2.00 cash for brochure, other countries \$10.00 US funds. **RANDALL DISPLAY**, Box 2168-H, Van Nuys, CA 91404, USA. Fax (818) 990-7803.

HOME assembly work available! Guaranteed easy money! Free details! **HOMEWORK-P**, Box 520, Danville, NH 03819.

MAKE \$\$\$! Become an American electronics dealer! Profit opportunities since 1965. Call Wayne Marks, 1 (800) 872-1373.

EARN money repairing microcomputers. Booklet lists suppliers of Apple, Compaq, IBM, and other parts and supplies. Send \$6.00 to **LGI COMPUTER SERVICES**, PO Box 711225, Houston, TX 77271. Texas residents add 6.25% tax.

EARN extra money working from home. Assemble products, mail brochures. Information: **LEE**, Box 2048, Winnetka, CA 91306-2048.

CABLE EQUIPMENT

CABLE TV secrets — the outlaw publication the cable companies tried to ban. HBO, Movie Channel, Showtime, descramblers, converters, etc. Suppliers list included. \$9.95. **CABLE FACTS**, Box 711-H, Pataskala, OH 43062.

Shortwave Listening Guidebook

by Harry Helms

The world is talking on shortwave radio, and here's the book that tells you how to listen in! In direct, nontechnical language, Harry explains how to get the most from your shortwave radio. Its 320 heavily illustrated pages are filled with practical advice on:

- antennas
- when and where to tune
- selecting the right radio for you
- accessories
- reception techniques



Learn how to hear the BBC, Radio Moscow, ham radio operators, ships at sea, even Air Force One! Includes hundreds of frequencies for stations around the world and the times you can hear them.

Only \$16.95 plus \$3.00 shipping (CA residents please include sales tax).

HighText
Publications Inc.
7128 Miramar Road
Suite 15L, San Diego, CA 92121

SPECIAL FROM ETT

PCP101—PRACTICAL DIGITAL ELECTRONICS HANDBOOK ... \$9.95. Introduces digital circuits, logic gates, bistables and timers, as well as microprocessors, memory and input/output devices. Special section on digital test gear projects.



PCP102—INTRODUCING DIGITAL AUDIO ... \$9.95 Shows what is involved in the digital part of audio signals, particularly in the newest devices such as CD, DAT and sampling. Bridges the gap of understanding for the technician and enthusiast.

PCP103—PRACTICAL MIDI HANDBOOK ... \$9.95. Covers all MIDI based equipment you can use—keyboards, drum machines, sequencers, effects units, mixers, drum pads and guitars. Also a section on computer music that covers software and more.



PCP104—ELECTRONICS BUILD & LEARN, Second Edition ... \$9.95. You start by assembling a circuit demonstrator that is then used to build and investigate a variety of useful circuits including oscillators, multi-vibrators, bistables and logic circuits.

PCP105—MAKE MONEY FROM HOME RECORDING ... \$10.00. Now that you've spent all that money on all that recording gear, wouldn't it be nice to get some of it back? Well here's the book that can show you how.



PCP106—SYNTHESIZERS FOR MUSICIANS ... \$10.00. All current popular forms of synthesis explained; LA, additive, phase distortion, FM and sampling. Get the sounds you want from your synth. Written especially for musicians.

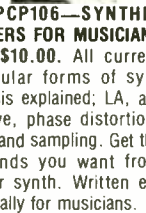

MAIL TO: **Electronic Technology Today, Inc.**
P.O. Box 240
Massapequa Park, NY 11762-0240

SHIPPING CHARGES IN USA AND CANADA

\$0.01 to \$5.00	... \$1.50	\$30.01 to 40.00	... \$5.50
\$5.01 to \$10.00	... \$2.50	\$40.01 to 50.00	... \$6.50
\$10.01 to 20.00	... \$3.50	\$50.01 and above	... \$8.00
\$20.01 to 30.00	... \$4.50		

SORRY, No orders accepted outside of USA and Canada

Total price of merchandise \$	_____
Shipping (see chart) \$	_____
Subtotal \$	_____
Sales Tax (NYS only) \$	_____
Total Enclosed \$	_____

Name _____
Address _____
City _____ State _____ Zip _____

ADVERTISING INDEX

POPULAR ELECTRONICS magazine does not assume any responsibility for errors that may appear in the index below.

Free Information No.	Page	—	Page
8	AMC Sales	18	12
7	All Electronics	3	13
—	Amazing Concepts	19	97
—	Antique Electronic Supply	96	97
—	Antique Radio Classified	96	97
—	Barta	97	97
5	C & S Sales	5	11
—	CBC International	95	88
—	CIE	9	27
—	Cable Plus	97	97
—	Cable Ready Company	95	4
—	CLE	96	95
—	Command Productions	82	20
—	E.D.E.	96	14
—	Elec. Industry Association	28	CV4
—	Electronic Tech. Today	CV2, 97	CV3
—	Electronics Book Club	17	97
—	Enterprize Electronics	20	97
—	Firestik II	96	23
			21
			23
			18, 86
			90

ADVERTISING SALES OFFICE

Gernsback Publications, Inc.
500-B Bi-County Blvd.
Farmingdale, NY 11735
1-(516) 293-3000
President: Larry Steckler
Assistant to the President: Christina Estrada

For Advertising ONLY
516-293-3000
Fax 1-516-293-3115
Larry Steckler
publisher

Arline Fishman
advertising director
Denise Haven
advertising assistant
Kelly McQuade
credit manager

Customer Service/Order Form
1-800-435-0715
1-800-892-0753
7:30 AM - 8:30 PM EST

SALES OFFICES

EAST/SOUTHEAST
Stanley Levitan, Eastern Sales Manager
1 Overlook Ave.
Great Neck, NY 11021
1-516-487-9357, 1-516-293-3000
Fax 1-516-487-8402

MIDWEST/Texas/Arkansas/Okla.
Ralph Bergen, Midwest Sales Manager
One Northfield Plaza, Suite 300
Northfield, IL 60093-1214
1-708-446-1444
Fax 1-708-559-0562

PACIFIC COAST/Mountain States
Marvin Green, Pacific Sales Manager
5430 Van Nuys Blvd. Suite 316
Sherman Oaks, CA 91401
1-818-986-2001
Fax 1-818-986-2009

NEGATIVE-ION-GENERATOR

(Continued from page 30)

In passing, if you chose not to buy D1 from the supplier mentioned in the Parts List an exact replacement may be difficult to locate. However, even though it has a lower current rating, an ECG-518 should work fine, although this substitution has not been tried.

The discharge point should be "pointy" to enhance the ionization of the air. You can use a sewing needle, for example. An alternate discharge point can be fashioned from a small piece of No. 22 stranded wire. Strip off about 1/2 inch from one end of the wire and separate the fine copper strands so that they are more or less evenly dispersed. When the wire is connected to the high negative voltage, the end of each strand will behave as a discharge point.

You can use any enclosure large enough to hold all the components. I'd recommend using a plastic enclosure if one is available. You should place a few air holes in the side or bottom of your enclosure for the fan to draw air in. The

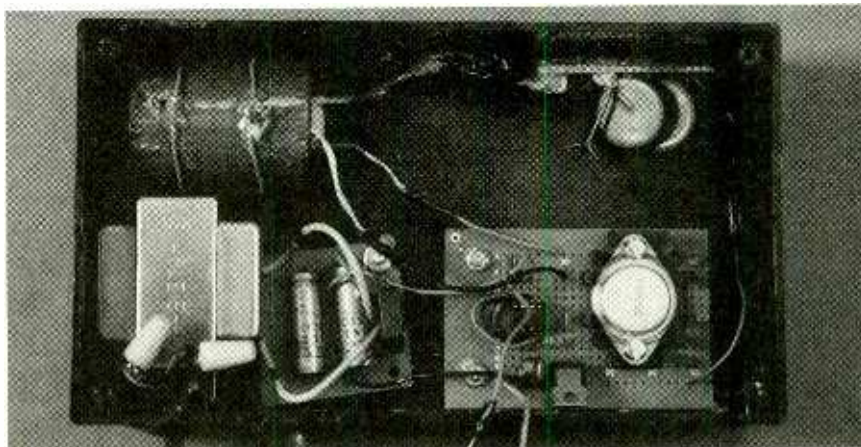

As you can see, there is some space left between components. Note that in the prototype two capacitors have been used to emulate C1.

fan should be situated in the enclosure to pull air in past the discharge point(s) and out through an opening hole at the top of the enclosure.

Any screen or covering on the fan-outlet hole should be non-metallic or plastic in nature. Using a metal screen would severely cut the efficiency of the generator because the negative ions that come into contact with the metal screen would be neutralized.

When testing the circuit, if you see any arcing or discharge from the high voltage transformer or high voltage capacitors, cut the power immediately. Let the project sit for awhile to let the capacitors discharge, and, without touching the project if possible, coat the faulty area with a little "No Arc" spray (available from Radio Shack). Allow the material to dry before testing the unit again.

Never before has so much professional information on the art of detecting and eliminating electronic snooping devices—and how to defend against experienced information thieves—been placed in one VHS video. If you are a Fortune 500 CEO, an executive in any hi-tech industry, or a novice seeking entry into an honorable, rewarding field of work in countersurveillance, you must view this video presentation again and again.

Wake up! You may be the victim of stolen words—precious ideas that would have made you very wealthy! Yes, professionals, even rank amateurs, may be listening to your most private conversations.

Wake up! If you are not the victim, then you are surrounded by countless victims who need your help if you know how to discover telephone taps, locate bugs, or “sweep” a room clean.

There is a thriving professional service steeped in high-tech techniques that you can become a part of! But first, you must know and understand Countersurveillance Technology. Your very first insight into this highly rewarding field is made possible by a video VHS presentation that you cannot view on broadcast television, satellite, or cable. It presents an informative program prepared by professionals in the field who know their industry, its techniques, kinks and loopholes. Men who can tell you more in 45 minutes in a straightforward, exclusive talk than was ever attempted before.

Foiling Information Thieves

Discover the targets professional snoopers seek out! The prey are stock brokers, arbitrage firms, manufacturers, high-tech companies, any competitive industry, or even small businesses in the same community. The valuable information they filch may be marketing strategies, customer lists, product formulas, manufacturing techniques, even advertising plans. Information thieves eavesdrop on court decisions, bidding information, financial data. The list is unlimited in the mind of man—especially if he is a thief!

You know that the Russians secretly installed countless microphones in the concrete work of the American Embassy building in Moscow. They converted



**HAVE YOUR
VISA or MC CARD
AVAILABLE**

what was to be an embassy and private residence into the most sophisticated recording studio the world had ever known. The building had to be torn down in order to remove all the bugs.

Stolen Information

The open taps from where the information pours out may be from FAX's, computer communications, telephone calls, and everyday business meetings and lunchtime encounters. Businessmen need counselling on how to eliminate this information drain. Basic telephone use coupled with the user's understanding that someone may be listening or recording vital data and information greatly reduces the opportunity for others to purloin meaningful information.

The professional discussions seen on the TV screen in your home reveals how to detect and disable wiretaps, midget radio-frequency transmitters, and other bugs, plus when to use disinformation to confuse the unwanted listener, and the technique of voice scrambling telephone communications. In fact, do you know how to look for a bug, where to look for a bug, and what to do when you find it?

Bugs of a very small size are easy to build and they can be placed quickly in a matter of seconds, in any object or room. Today you may have used a telephone handset that was bugged. It probably contained three bugs. One was a phony bug to fool you into believing you found a bug and secured the telephone. The second bug placates the investigator when he finds the real thing! And the third bug is found only by the professional, who continued to search just in case there were more bugs.

The professional is not without his tools. Special equipment has been designed so that the professional can sweep a room so that he can detect voice-activated (VOX) and remote-activated bugs. Some of this equipment can be operated by novices, others require a trained countersurveillance professional.

The professionals viewed on your television screen reveal information on the latest technological advances like laser-beam snoopers that are installed hundreds of feet away from the room they snoop on. The professionals disclose that computers yield information too easily.

This advertisement was not written by a countersurveillance professional, but by a beginner whose only experience came from viewing the video tape in the privacy of his home. After you review the video carefully and understand its contents, you have taken the first important step in either acquiring professional help with your surveillance problems, or you may very well consider a career as a countersurveillance professional.

The Dollars You Save

To obtain the information contained in the video VHS cassette, you would attend a professional seminar costing \$350-750 and possibly pay hundreds of dollars more if you had to travel to a distant city to attend. Now, for only \$49.95 (plus \$4.00 P&H) you can view *Countersurveillance Techniques* at home and take refresher views often. To obtain your copy, complete the coupon below or call toll free.

RADIO-ELECTRONICS VIDEO OFFER **PE**
 500-B Br-County Blvd.
 Farmingdale, NY 11735

Please rush my copy of the Countersurveillance Techniques Video VHS Cassette for \$49.95 plus \$4.00 for postage and handling.

No. of Cassettes ordered _____
 Amount of payment \$ _____

Bill my VISA MasterCard
 Card No. _____
 Expire Date ____ / ____

Signature _____
 Name _____
 Address _____
 City _____ State _____ ZIP _____

All payments in U.S.A. funds. Canadians add \$4.00 per VHS cassette. No foreign orders. New York State residents add applicable sales tax.

THE PARTS PLACESM



NEW! Now You're Talking!
This book will help you earn your first Amateur Radio license and get on the air. It includes all the questions on the new codeless Technician class exam and the Novice written exam. The book also provides helpful tips on equipment and antennas. Illustrated. Over 300 pages. #62-2414 . . . 16.95

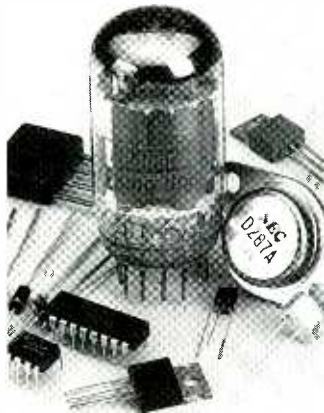

Special-Order Hotline. Your local Radio Shack stocks over 1000 popular electronic components. Plus, we can special-order over 10,000 items from our main warehouse—ICs, semiconductors, tubes, crystals, even SAMS[®] manuals. No postage charges or minimum requirements for this service. Come in for details!



NEW! PC/XT Experimenter's Circuit Card. This premium-quality prototyping board fits a computer's XT expansion bus connector. Features durable epoxy glass construction and plated-through holes on standard 0.100" centers. Accepts D-sub connector shown at right. 3 7/8" x 10 1/16" x 1/16". #276-1598 29.95

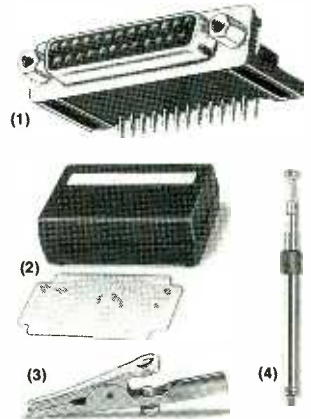

(1) **NEW! Right-Angle D-Sub 25 Female Connector.** Ideal for use with PC/XT circuit card at left. #276-1504, 2.49
(2) **Box/Board Combination.** Molded box and 2 x 3 1/8" circuit board. #270-291 . . . 4.99
(3) **2" Slim Alligator Clips.** #270-346 . . . Pkg. of 8/2.19
(4) **Cordless Phone Handset Antenna.** #270-1411 . . . 2.99

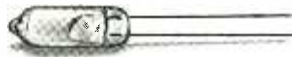

Mercury Bulb Switch. Just the thing for motion detectors, alarms, experiments and school science projects. Rated 2 amps at 12VDC. Compact T-1 1/2 size envelope. #275-040 1.29



(1) **Two-Tone Piezo Buzzer.** Extra-loud. Operates from 8 to 16VDC. #273-070 10.95
(2) **Electromechanical Buzzer.** Loud 12VDC buzzer in a sturdy metal case is great for alarms. #273-051 2.49



(1) **Stackable Banana Plugs.** Jack permits "chain" hook-ups. #274-734, Set of 2/1.59
(2) **Nylon Binding Posts.** #274-662 Set of 2/1.59
(3) **Micro-Clip Jumpers.** 20" long. #278-017 . . . Pair/3.49

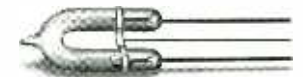

Super-Bright Strobe Tube. Perfect for photo replacement, hobby projects and experiments. Trigger: 4 kV. Anode: 200V min. Bulb is about 1 1/2" long and has 1 3/4" leads. #272-1145 3.29



(1) **High-Speed 12VDC Motor.** Up to 15,200 RPM! About 2" long. #273-255 2.99
(2) **Low-Voltage Motor.** For science projects and solar power demos. Requires 1 1/2 to 3VDC. #273-223 99¢



(1) **Lead-Free Solder.** 96% tin, 4% silver. 0.032" size. 0.25 oz. #64-025 1.99



(2) **Rosin Soldering Paste Flux.** 1 oz. #64-021 . . . 1.79
Over 100 soldering items and tools for electronics are in stock now at Radio Shack!



(1) **Hi-Precision Thermistor.** Resistance changes in proportion to temperature. #271-110 1.99
(2) **500-Piece Resistor Set.** 1/4-watt, 5% tolerance. Includes 54 popular values. #271-312 Set 7.95



Car Electrical System Tester. Spot problems before you're stranded! Plug this analyzer into your vehicle's lighter socket. Color-coded LEDs pinpoint problems in your battery, alternator and regulator. #22-1635 5.95

Since 1921 Radio Shack has been the place to obtain up-to-date electronic parts as well as quality tools, test equipment and accessories at low prices. Our nearly 7000 locations are ready to serve you—NOBODY COMPARES

Prices apply at participating Radio Shack stores and dealers. Radio Shack is a division of Tandy Corporation

Radio Shack[®] SINCE 1921
AMERICA'S TECHNOLOGY STORESM

CIRCLE 14 ON FREE INFORMATION CARD

www.americanradiohistory.com