

HOW RADIO GOT ITS VOICE

# Popular Electronics

OCTOBER 1991

## A Buyer's Guide to DMM's

Explore the digital-multimeter marketplace at a glance in our handy round up

## Does Your Meter Lie To You?

Even the best meter can lead you astray if you don't fully understand what you are measuring

## Build a Precision Dual-Output Power Supply

An inexpensive, adjustable, dual-output supply that's packed with features

## The Light-Beam Communicator

Talk on a beam of light with this just-for-fun project

### Product Reviews

Canon L1 Camcorder, Yamaha AM/FM Stereo Tuner, Heath Logic Analyzer, Neo-Geo Video Arcade System, and more

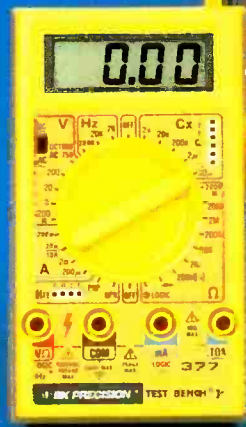
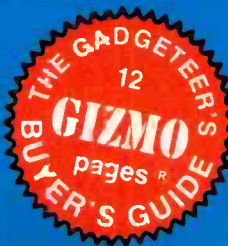

GERNSBACK PUBLICATION

3 NEW FactCards IN THIS ISSUE

#BXBD0CH CAF-RT SORT \*\* CR24  
#60506DH1997GADDS# FEB92 20  
ROBERT DAHM RESP 071 X  
AURORA, IL 60506



\$2.95 U.S.  
\$3.75 CANADA

# Electronics Paperback Books

GREAT PAPERBACKS AT SPECIAL PRICES

**BP248—TEST EQUIPMENT CONSTRUCTION** ..... \$5.95. Details construction of simple, inexpensive, but extremely useful test equipment. AF Gen, Test Bench Ampl, Audio Millivoltmeter, Transistor Tester and six more.

Test Equipment Construction



How to Use Oscilloscopes and Other Test Equipment



**BP267—HOW TO USE OSCILLOSCOPES AND OTHER TEST EQUIPMENT** ..... \$6.95. Mastering the oscilloscope is not really too difficult. This book explains all the standard controls and functions. Other equipment is also described.

**BP265—MORE ADVANCED USES OF THE MULTIMETER** ..... \$5.95. Use these techniques to test and analyze the performance of a variety of components. Also see how to build ad-ons to extend multimeter capabilities.

More Advanced Uses of the Multimeter



An Introduction to Loudspeakers and Enclosure Design

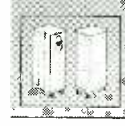

**BP256—INTRO TO LOUDSPEAKERS AND ENCLOSURE DESIGN** ..... \$5.95. We explore the variety of enclosure and speaker designs in use today so the reader can understand the principles involved.

**BP263—A CONCISE INTRO TO dBASE** ..... \$6.95. The dBASE series of programs are probably the best known database programs for microcomputers. This book is designed to help you get started working with them.

A Concise Introduction to dBASE

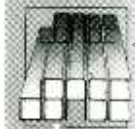

**BP260—CONCISE INTRO TO OS/2** ..... \$5.95. If you are a multitasking PC user and want to get the most out of your computer, then you must learn its OS/2 operating system. This book shows you just how to do that, quickly and easily.

A Concise Introduction to OS/2



**BP249—MORE ADVANCED TEST EQUIPMENT CONSTRUCTION** ..... \$6.95. Eleven more test equipment construction projects. They include a digital voltmeter, capacitance meter, current tracer and more.

More Advanced Test Equipment Construction

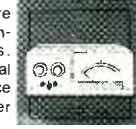

Digital Audio Projects



**BP245—DIGITAL AUDIO PROJECTS** ..... \$5.95. Practical circuits to build and experiment with. Includes A/D converter, input amplifier, digital delay line, compander, echo effect and more.

**BP247—MORE ADVANCED MIDI PROJECTS** ..... \$5.95. Circuits included are a MIDI indicator, THRU box, merge unit, code generator, pedal, programmer, channelizer, and analyzer.



**BP257—INTRO TO AMATEUR RADIO** ..... \$6.95. Amateur is a unique and fascinating hobby. This book gives the newcomer a comprehensive and easy to understand guide to the subject.



**PCP102—INTRODUCING DIGITAL AUDIO** ..... \$9.95. Covers all kinds of digital recording methods—CD, DAT and Sampling. Bridges the gap between the technician and the enthusiast. Principles and methods are explained.

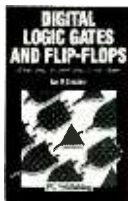

**PCP107—DIGITAL LOGIC GATES AND FLIP-FLOPS** ..... \$10.00. Thorough treatment of gates and flip-flops for enthusiasts, student and technicians. Only a basic knowledge of electronics is needed.

**BP251—COMPUTER HOBBYISTS HANDBOOK** ..... \$8.95. A wrapup of everything the computer hobbyist needs to know in one easy to use volume. Provides a range of useful reference material in a single source.



**PCP108—COMPUTERS AND MUSIC** ..... \$9.95. Explains the basics of computers and music with no previous knowledge of computers needed. Covers types of music software and explains how to set up your own computer music studio.

**BP195—INTRODUCTION TO SATELLITE TV**..... \$9.95. A definitive introduction to the subject written for the professional engineer, electronics enthusiast, or others who want to know more before they buy. 8 x 10 in.

**BP190—ADVANCED ELECTRONIC SECURITY PROJECTS**.....\$5.95. Includes a passive infra-red detector, a fiber-optic loop alarm, computer-based alarms and an unusual form of ultrasonic intruder detector.

**BP235—POWER SELECTOR GUIDE**.....\$10.00. Complete guide to semiconductor power devices. More than 1000 power handling devices are included. They are tabulated in alpha-numeric sequence, by technical specs. Includes power diodes, Thyristors, Triacs, Power Transistors and FET's.

**BP234—TRANSISTOR SELECTOR GUIDE**.....\$10.00. Companion volume to BP235. Book covers more than 1400 JEDEC, JIS, and brand-specific devices. Also contains listing by case type, and electronic parameters. Includes Darlington transistors, high-voltage devices, high-current devices, high power devices.

**BP99—MINI-MATRIX BOARD PROJECTS**.....\$5.50. Here are 20 useful circuits that can be built on a mini-matrix board that is just 24 holes by ten copper-foil strips.

**BP117—PRACTICAL ELECTRONIC BUILDING BLOCKS—Book 1**.....\$5.75. Oscillators, Timers, Noise Generators, Rectifiers, Comparators, Triggers and more.

**BP184—INTRO TO 68000 ASSEMBLY LANGUAGE**.....\$6.95. The 68000 is a great new breed of microprocessor. Programming in assembly language increases the running speed of your programs. Here's what you need to know.

**BP179—ELECTRONIC CIRCUITS FOR THE COMPUTER CONTROL OF ROBOTS** ..... \$7.50. Data and circuits for interfacing the computer to the robot's motors and sensors

**BP239—GETTING THE MOST FROM YOUR MULTIMETER**..... \$5.95. Covers basics of analog and digital meters. Methods of component testing includes transistors, thyristors, resistors, capacitors and other active and passive devices.

**BP97—IC PROJECTS FOR BEGINNERS**.....\$5.50. Power supplies, radio and audio circuits, oscillators, timers, switches, and more. If you can use a soldering iron you can build these devices.

**BP37—50 PROJECTS USING RELAYS, SCR'S & TRIACS**.....\$5.50. Build priority indicators, light modulators, warning devices, light dimmers and more.

**RADIO—100 RADIO HOOKUPS**.....\$3.00. Reprint of 1924 booklet presents radio circuits of the era including regenerative, neutrodyne, reflex & more.

**BP42—SIMPLE LED CIRCUITS**.....\$5.50. A large selection of simple applications for this simple electronic component.

**BP127—HOW TO DESIGN ELECTRONIC PROJECTS**.....\$5.75. Helps the reader to put projects together from standard circuit blocks with a minimum of trial and error.

**BP122—AUDIO AMPLIFIER CONSTRUCTION**.....\$5.75. Construction details for preamps and power amplifiers up through a 100-watt DC-coupled FED amplifier.

**BP92—CRYSTAL SET CONSTRUCTION**.....\$5.50. Everything you need to know about building crystal radio receivers.

**BP45—PROJECTS IN OPTOELECTRONICS**..... \$5.50. Includes infra-red detectors, transmitters, modulated light transmission and photographic applications.

**BP185—ELECTRONIC SYNTHESIZER CONSTRUCTION** ..... \$5.95. Use this book to learn how to build a reasonably low cost, yet worthwhile monophonic synthesizer and learn a lot about electronic music synthesis in the process

CHECK OFF  
THE BOOKS YOU WANT

ELECTRONIC TECHNOLOGY TODAY INC.  
P.O. Box 240, Massapequa Park, NY 11762-0240

SHIPPING CHARGES IN  
USA AND CANADA

**SORRY No orders accepted  
outside of USA & Canada**

Number of books ordered

Name \_\_\_\_\_  
Address \_\_\_\_\_  
City \_\_\_\_\_ State \_\_\_\_\_ Zip \_\_\_\_\_

\$0.01 to \$5.00 ..... \$1.50  
\$5.01 to \$10.00 ..... \$2.50  
\$10.01 to 20.00 ..... \$3.50  
\$20.01 to 30.00 ..... \$4.50  
\$30.01 to 40.00 ..... \$5.50  
\$40.01 to 50.00 ..... \$6.50  
\$50.01 and above ... \$8.00

Total price of merchandise ..... \$ \_\_\_\_\_  
Sales Tax (New York State Residents only) ..... \$ \_\_\_\_\_  
Shipping (see chart) ..... \$ \_\_\_\_\_

All payments must  
be in U.S. funds

Total Enclosed .. \$ \_\_\_\_\_

P-1091

# Popular Electronics®

THE MAGAZINE FOR THE ELECTRONICS ACTIVIST!

## CONSTRUCTION ARTICLES

<b>BUILD A PRECISION DUAL-OUTPUT POWER SUPPLY</b> .....	John Yacono and Marc Spiwak	27
<i>Build this feature-packed, adjustable, dual-output power supply</i>		
<b>BUILD A LIGHT-BEAM COMMUNICATOR</b> .....	Jerry Penner	41
<i>Here's an experimental circuit that allows you to communicate over short distances using an ordinary flashlight</i>		
<b>BUILD A SOUND-EFFECTS GADGET</b> .....	Marc Spiwak	75
<i>This unusual gadget will give your voice an android-like quality for the perfect Halloween sound effect</i>		

## FEATURE ARTICLES

<b>HOW WIRELESS GOT ITS VOICE</b> .....	James P. Rybak	30
<i>When Reginald Fessenden demonstrated radiotelephony in 1906, few thought it would have any practical use</i>		
<b>DOES YOUR METER LIE TO YOU?</b> .....	Joseph J. Carr	36
<i>Learn what to expect from your meter</i>		
<b>A BUYER'S GUIDE TO DMM'S</b> .....		55
<i>With so many meters on the market, choosing one is no easy task, but our buyer's guide can help you make an informed choice</i>		

## PRODUCT REVIEWS

<b>GIZMO</b> .....		43
<i>Including: Canon L1 Camcorder, V-Tech Video Painter, Neo-Geo Videogame System, and much more</i>		
<b>HANDS-ON REPORT</b> .....		78
<i>Heathkit IC1001 Logic Analyzer</i>		
<b>PRODUCT TEST REPORT</b> .....	Len Feldman	80
<i>Yamaha TX-930 AM/FM Stereo Tuner</i>		

## COLUMNS

<b>THINK TANK</b> .....	John Yacono	22
<i>Supercharging a 555</i>		
<b>CIRCUIT CIRCUS</b> .....	Charles D. Rakes	82
<i>Indicators for all occasions</i>		
<b>ANTIQUÉ RADIO</b> .....	Marc Ellis	85
<i>The making of a collector</i>		
<b>FUN SOFTWARE</b> .....	Fred Blechman	87
<i>New homes for joysticks and mice</i>		
<b>COMPUTER BITS</b> .....	Jeff Holtzman	90
<i>Tools for writing</i>		
<b>HAM RADIO</b> .....	Joseph J. Carr	92
<i>Less power to you</i>		
<b>DX LISTENING</b> .....	Don Jensen	94
<i>Learning about the hobby</i>		
<b>SCANNER SCENE</b> .....	Marc Saxon	96
<i>Who Cares? We Do!</i>		

## DEPARTMENTS

<b>EDITORIAL</b> .....	Carl Laron	2
<b>LETTERS</b> .....		4
<b>ELECTRONICS LIBRARY</b> .....		6
<b>NEW PRODUCTS</b> .....		14
<b>FACTCARDS</b> .....		37
<b>POPULAR ELECTRONICS MARKET CENTER</b> .....		54A
<b>FREE INFORMATION CARD</b> .....		71
<b>ADVERTISER'S INDEX</b> .....		106

**Popular Electronics** (ISSN 1042-170X) Published monthly by Gernsback Publications, Inc., 500-B B-County Boulevard, Farmingdale, NY 11735. Second-Class postage paid at Farmingdale, NY and at additional mailing offices. One-year (twelve issues) subscription rate U.S. and possessions \$21.95, Canada \$28.64 (includes G.S.T. Canadian Goods and Services Tax Registration No. R125166260), all other countries \$29.45. Subscription orders payable in U.S. funds only. International Postal Money Order, or check drawn on a U.S. bank. U.S. single copy price \$2.95. © 1991 by Gernsback Publications, Inc. All rights reserved. **Hands-on Electronics** and **Gizmo** trademarks are registered in U.S. and Canada by Gernsback Publications, Inc. **Popular Electronics** trademark is registered in U.S. and Canada by Electronics Technology Today, Inc. and is licensed to Gernsback Publications, Inc. Printed in U.S.A.

Postmaster: Please send address changes to **Popular Electronics**, Subscription Dept., P.O. Box 338, Mount Morris, IL 61054-8932.

A stamped self-addressed envelope must accompany all submitted manuscripts and/or artwork or photographs if their return is desired should they be rejected. We disclaim any responsibility for the loss or damage of manuscripts and/or artwork or photographs while in our possession or otherwise.

As a service to readers, **Popular Electronics** publishes available plans or information relating to newsworthy products, techniques, and scientific and technological developments. Because of possible variances in the quality and condition of materials and workmanship used by readers, **Popular Electronics** disclaims any responsibility for the safe and proper functioning of reader-built projects based upon or from plans or information published in this magazine.

**Larry Steckler**

*EHF, CET*

*Editor-In-Chief and Publisher*

## EDITORIAL DEPARTMENT

**Carl Laron**

*Editor*

**Robert A. Young**

*Associate Editor*

**John J. Yacono**

*Associate Editor*

**Byron G. Wels, K2AVB**

*Associate Editor*

**Teri Scaduto**

*Assistant Editor*

**Kathy Terenzi**

*Editorial Assistant*

**Marc Spiwak**

*Editorial Associate*

**Fred Blechman**

**Joseph J. Carr, K4IPV**

**Marc Ellis**

**Len Feldman**

**Jeffrey K. Holtzman**

**Don Jensen**

**Charles D. Rakes**

**Marc Saxon**

*Contributing Editors*

## PRODUCTION DEPARTMENT

**Ruby M. Yee**

*Production Director*

**Karen S. Brown**

*Production Manager*

**Marcella Amoroso**

*Production Assistant*

**Janice Box**

*Editorial Production*

## ART DEPARTMENT

**Andre Duzant**

*Art Director*

**Injae Lee**

*Illustrator*

**Russell C. Truelson**

*Illustrator*

**Jacqueline P. Cheeseboro**

*Circulation Director*

**Michele Torrillo**

*P-E Bookstore*

## BUSINESS AND EDITORIAL OFFICES

Gernsback Publications, Inc.

500-B Bi-County Blvd.

Farmingdale, NY 11735

1-516-293-3000

Fax: 1-516-293-3115

President: **Larry Steckler**

Customer Service/Order Entry

1-800-435-0715

7:30 AM - 8:30 PM EST

Advertising Sales offices listed on page 106

Cover photography by Diversified Photo Services

Composition by

Mates Graphics



The  
Audit  
Bureau  
of Circulation



The publisher has no knowledge of any proprietary rights which will be violated by the making or using of any items disclosed in this issue.

## METERS, AND MORE

This month, **Popular Electronics** turns its attention to one of the most popular and most important pieces of test equipment, the DMM. No matter what your interest or background, if you do any kind of electronics troubleshooting, design work, project building, or just plain old hacking around, you almost certainly own or use a digital multimeter of some type.

With literally hundreds of multimeters available, there's sure to be one that's perfect for you. But, with literally hundreds of meters available, finding that perfect meter may prove to be a difficult task.

That's where the *Buyer's Guide To DMM's* comes in. It can greatly simplify the task of finding a meter. By listing key specifications for the majority of DMM's currently available, all in one place, prospective buyers can narrow their choices to a more manageable number. The guide begins on page 55.

But that's not where our meter coverage ends. In *Does Your Meter Lie to You?*, veteran hobbyist and **Popular Electronics** columnist Joe Carr looks at some very common errors that crop into meter measurements, and ways to avoid them. It's an information-packed article, and you'll find it on page 36.

Don't worry, though, we haven't gone totally meter mad. This month's lineup also includes articles on an experimental light-beam communicator, a high-precision power supply for your workbench, the early days of voice communications, and more. And, of course, there's our regular lineup of features and columns, including *Gizmo*, and our bi-monthly Market Center—a special advertising section highlighting mail-order merchants who want to help you get the most from your hobby. All-in-all, it's a feature-packed issue, so enjoy!

Carl Laron  
Editor

# Take Any 3 PROFESSIONAL BOOKS for only \$9<sup>95</sup>

when you join the **ELECTRONICS ENGINEERS' BOOK CLUB**

values to \$132.40



9255 \$97.50  
Counts as 3

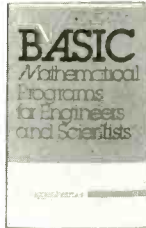

8225P \$19.95



053570-1 \$64.95  
Counts as 2

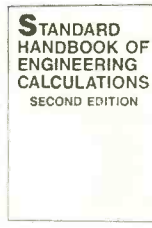

028735-X \$79.50  
Counts as 3



9305 \$59.50  
Counts as 3



057537-1 \$39.95



10016 \$39.95  
Counts as 2

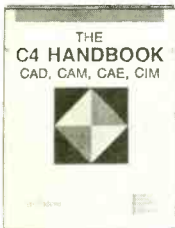

3098 \$44.50  
Counts as 2



3205 \$24.95

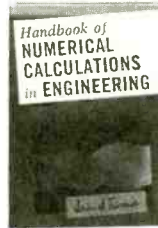

9321 \$57.50  
Counts as 2

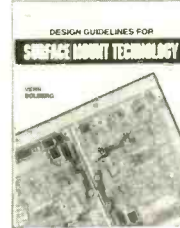

3199 \$52.00  
Counts as 2



5147 \$38.95

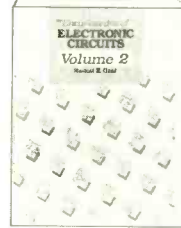

3138 \$60.00  
Counts as 2



2672 \$49.50



033559-1 \$27.95

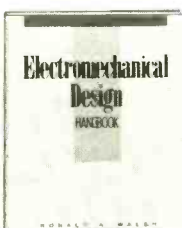

3102 \$49.95  
Counts as 2

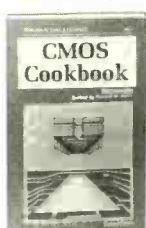

9244P \$18.95



3203 \$46.95  
Counts as 2



3375 \$32.95

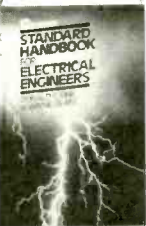

020975-8 \$99.50  
Counts as 3



9245 \$46.95  
Counts as 2

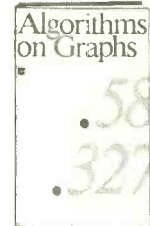

3429 \$29.95



3151 \$42.95



3241P \$16.95

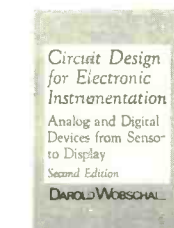

071231-X \$54.95  
Counts as 2



10037 \$44.95  
Counts as 2

## How the Club Works

**YOUR BENEFITS:** You get 3 books for \$9.95 plus shipping and handling when you join. You keep on saving with discounts of up to 50% off as a member.

**YOUR PROFESSIONAL BOOKSTORE BY MAIL:** Every 3-4 weeks, you will receive the Electronics Engineers' Book Club News describing the Main Selection and Alternates, as well as bonus offers and special sales, with scores of titles to choose from.

**AUTOMATIC ORDER:** If you want the Main Selection, do nothing and it will be sent to you automatically. If you prefer another selection, or no selection at all, simply indicate your choice on the reply form provided. You will have at least 10 days to decide. As a member, you agree to purchase at least 3 books within the next 2 years and may resign at any time thereafter.

**BONUS BOOKS:** Starting immediately, you will be eligible for our *Bonus Book Plan*, with savings of up to 80% off publishers' prices.

**IRONCLAD NO-RISK GUARANTEE:** If not satisfied with your books, return them within 10 days without obligation!

**EXCEPTIONAL QUALITY:** All books are quality publishers' editions especially selected by our Editorial Board. (Publishers' Prices Shown)

The Electronics Engineers and Designers Book Club and the Electronics and Control Engineers' Book Club have joined forces to bring you *all* the best titles from the most prominent electronics publishers.

## ELECTRONICS ENGINEERS' BOOK CLUB

Blue Ridge Summit, PA 17294-0860

**YES!** Please accept my membership in the ELECTRONICS ENGINEERS' BOOK CLUB and send the 3 volumes listed below, billing me \$9.95. If not satisfied, I may return the books within ten days without obligation and have my membership cancelled. I agree to purchase at least 3 books at regular Club prices during the next 2 years and may resign any time thereafter. A shipping/handling charge and sales tax will be added to all orders.

--	--	--

Name \_\_\_\_\_

Address \_\_\_\_\_

City \_\_\_\_\_

State \_\_\_\_\_ Zip \_\_\_\_\_ Phone \_\_\_\_\_

Valid for new members only. Foreign applicants will receive special ordering instructions. Canada must remit in U.S. currency. This order subject to acceptance by the Electronics Engineers' Book Club. PPIF1091

## CHEMICAL IMBALANCE

As a teacher of high-school chemistry, I was intrigued by the article "Experiments in Electrochemistry" by Stanley A. Czarnik (**Popular Electronics**, June 1991). The suggested experiments are interesting and can easily be performed by an experienced chemistry teacher. Students can also carry out the exercise under appropriate supervision.

There does appear to be an error, however, in the explanation of the formation of sodium hydroxide during the electrolysis of brine. The sodium ions are *not* discharged at the cathode forming metallic sodium, which then immediately reacts with water to form the base.

According to *Chemistry: Experiment and Theory* by Bernice G. Segal, "If an aqueous solution of NaCl is electrolyzed using inert electrodes, chlorine is produced at the anode, but sodium metal is not produced at the cathode. Instead,  $H_{2(g)}$  is formed at the cathode. The reason is simply that water contains hydronium ions, and  $H^+_{(aq)}$  ions are a stronger oxidizing agent than  $Na^+$  ions, and are therefore more easily reduced. The cathode reaction for the electrolysis of an aqueous solution of NaCl (or  $ZnCl_2$ ,  $CaCl_2$ ,  $ScCl_3$ , KCl, and so on) is:

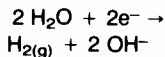

so that the products of the electrolysis of aqueous NaCl are  $H_{2(g)}$ ,  $Cl_{2(g)}$ , and a solution of NaOH."

I hope that the above quote serves to clarify the chemistry occurring during the electrolysis of alkali or alkaline earth cations.

A.W.F.  
New York, NY

## SAFETY FIRST

I have just finished reading Jim Stephens' article, "A Telephone Operated Power Switch for Your Computer" (**Popular Electronics**, June 1991). It seems like a useful project, but I have to take exception with the line voltage wiring instructions.

The instructions on the bottom of page 54 concerning not connecting the green ground

wire to the metal case is wrong—possible *dead* wrong! *The green wire (safety ground) must always be directly connected to a metal case switching or containing line voltage.* That is to make sure that if a line-voltage carrying wire or component comes in contact with the case, the fuse or circuit breaker will open, removing line voltage from the case. If the case is left unconnected, it is very likely that a deadly electric shock could happen if someone were to touch the case while touching some grounded point, such as a computer, typewriter, calculator, or metal desk.

There are some other comments about safety that also apply to the line-voltage wiring. A fuse or circuit breaker should be installed in the power cord wire leading to switch S1. That is needed since the project is left "on" at all times, particularly overnight and weekends, when the possibility of an overload inside the box could result in a fire when no one is present. The cord manufacturer has to obtain UL approval for their cord, and they will tell the user what the cord rating is in amps; the rating of the fuse or breaker should be that size or smaller. The internal wiring should be the same gauge size or larger (smaller number) as the cord.

In addition, the neon indicator lights need a correct-size series resistor for proper operation (none are listed in Fig. 1 of the article), and should be housed in an appropriate lamp holder. Alternately, use a neon indicator assembly that includes a resistor. That will protect users from electric shock in case the tip of the lamp is broken off and the internal electrodes are exposed. And the line cord needs to have a strain relief to prevent internal damage to the wiring in case of a strong pull to the cord and also to guard against the eventual cutting and short circuiting of the cord at the case entry point.

All of the above corrections are for the personal safety of

anyone coming into contact with the project. These suggestions really apply to any line-voltage-powered project. To ignore them is to invite a needless, and possibly lethal, hazard where none need exist.

D.S.  
Addison, IL

## APPEARANCES COUNT

I have just completed building a binary clock, following the instructions in the article in the January 1991 issue of **Popular Electronics** and using the kit sold by Electronic Kits International, Inc. The kit is certainly complete in every detail, and the instructions are more than adequate. I found the assembly to be quite straightforward, and free of any special problems.

The finished clock works flawlessly, and is quite impressive in appearance. I have had a lot of fun with it since it is most puzzling to my friends, few of whom know anything about binary numbers. Once the number system is explained to them, most think it is clever, and a nice addition to the household. However, a few have said, sourly, "Why don't you use an ordinary clock?" I enjoy their reactions.

I do have one suggestion for improvement, however. I don't think the quality of the wooden case supplied is a match for the rest of the clock. Mine was not square, and was 1/8-inch wider at one end than at the other. In addition, it was made of pine, which is not widely perceived to be a cabinet wood. I would suggest the use of Philippine mahogany, which costs the same as pine around here and is a much prettier wood. In addition, it can be finished very simply with a clear wood sealer, since it already has some natural color—particularly the variety called "Narra." I made my own case, giving it a very neat, finished appearance. The skills required were not significantly greater than those used

in making the pine case supplied with the kit. My wife and my friends think the finished clock is beautiful and well deserving of a place on our mantel.

Thank you for your efforts in putting together and writing about the binary clock. I consider it to be one of the most satisfying electronic devices I have ever built, and I would expect many others to feel the same way.

W.P.H.  
Richland, WA

## SETTING THE RECORD STRAIGHT

I have a few corrections and comments on two articles that appeared in the April issue of **Popular Electronics**.

In "dBm Debate," which appeared in the "Letters" column, both letter-writer T.L. and author Joe Carr are wrong. Allow a Bell Labs retiree to set the record straight. The term dBm is defined by the Bell System *et al.* as the decibel ratio of some power level with reference to one milliwatt. *It has no relation to impedance.* In my 36-plus years in the Bell System, I observed that misuse and misunderstanding of dB and dBm was rampant. When working on telephone circuits, it was common to use meters with a 600-ohm impedance, but on some carrier systems the dBm meters had 135-ohm impedances and the dBm-reading power meters had no defined impedance at all. And (Joe Carr not withstanding), VU is not another term for dBm. The VU, or volume unit, is used to measure peaks of power in complex waves, such as speech, relative to some specified reference level. In general, that reference level, 0 VU, indicates no precise electrical quantity, but the volume indicator is calibrated to read 0 VU on one mW of 1000-Hz power dissipated in a 600-ohm resistance. The VU level is read on a D'Arsonval meter with

specified dynamic characteristics. The calibration is such that it may be used as a dBm meter for steady 1000-Hz signals in 600-ohm circuits, but the conventional dBm meter may *not* be used to measure volume units.

Also in the April issue, in "Think Tank," there is a phone-line tester that is said to indicate correct polarity when the ring probe is positive with respect to the tip probe. That is reversed; the ring lead is negative under most conditions relative to the tip lead. That is correctly described in the second paragraph of an article called "Isolating Telephone Extensions" that appears later in the same issue. But that author goofed in the fourth paragraph, saying that the ringing signal is a 90-volt peak-to-peak AC signal. It is essentially a 90-volt RMS signal that is superimposed on the 50-volts DC on the ring lead. That is the voltage there can really bite.

K.E.S.  
Cherryvale, KS

## MORE SIGNALS FROM SPACE

L. George Lawrence's article in the April issue was very thought provoking to me, since I had done some overlapping experimentation with crystals at NASA's Space Sciences Laboratory at Redstone Arsenal.

However, there were a few sentences that were not clear. I am interested in knowing Mr. Lawrence's techniques; I might possibly be able to do some similar experimentation to seek correlation of signals and video. Is he the only one doing this work? If not, has anyone else received similar signals, especially at the same time? Has he ever operated two or more receivers at the same time? Has an effort been made to correlate signals with storms, sunspots, humidity, dust storms, etc.?

It might require a large array or network of receivers to further identify the nature of the signals. I have proposed to NASA that we study every known variable of nature until it

is understood. I have served as a UFO investigator under that belief.

Again, referencing the article, I did not understand the purpose of the shutter on the Faraday tube. Is it a motor-driven nutator as on some radar sets, or is it operated manually as needed? On page 59, paragraph 3, what does the two minutes refer to? Is that the time of incoming signal to fill a frame of video, or the unusable signal before it can be synchronized? What evidence is there for "expanding" images? How sensitive is the astro-alignment requirement? Can the signal strength be varied and controlled with the shutter? Is there any evidence for reflection of the signal?

I am a retired electronics engineer/physicist/space engineer. My experience has been heavy in radar, astronomy, optics, solar astronomy, and the natural sciences. I hold the degrees of BSEE, D.Sc., and Ph.D. I hope you can supply the information I requested, so that I might be

able to set up an experimental receiver to help correlate this phenomena.

E.H.W.  
Huntsville, AL

## HAVES & NEEDS

I am looking for the owner's manual for my Wollensak stereo tape recorder, model T-1515, serial number 103460. It is a good quality, old reel-to-reel machine, and I'd really appreciate if someone could send me a copy of the manual.

Mike Daley Jr.  
36 North Shore Avenue  
Danvers, MA 01923

I need the service manual for a Realistic (Radio Shack) Cassette Recorder Deck, model SCT-7, Cat. #14-897. Radio Shack no longer has any information available on this unit. Of course, I am willing to pay any reasonable amount for the manual or a copy of it. Thank you.

William B. Paulus, WA60CJ  
55 North Kiowa Drive  
Fort Myers Beach, FL 33931 ■

# Train at HOME to be an Electronics Technician!

As the demand for computers and microprocessors in business, manufacturing and communications continues to grow, so does the need for qualified technicians. It's not unusual for experienced technicians to earn from \$30,000 to more than \$40,000 a year.\* Now through Peoples College of Independent Studies you can train for this exciting field without interrupting your job or home life.

### Choose From Five Programs of Study

- Electronics & Microprocessor Technology
- Industrial Electronics & Microprocessor Technology
- Communications Electronics with Microprocessor Technology
- Computer Servicing & Electronics Technology
- Specialized Associate Degree In Electronics Technology

### Professional Equipment Is Included

Depending on the program you select, you'll perfect your skills using this advanced equipment, included in the price of tuition:

- IBM-Compatible Personal Computer
- Digital Multimeter
- Digital Logic Probe
- Elenco Oscilloscope
- Portable Cellular Telephone

(\* Source: U.S. Bureau of Labor Statistics)



### Exclusive Extras That Enhance Your Training

Peoples College introduces some training firsts to make your learning experience more complete:

- Accelerated Learning System — a scientifically proven study system that helps you learn faster and easier than ever before.
- Video Tutor Training Tapes — give you a permanent, visual record of informative lectures and close-up demonstrations.
- Experience Labs — professionally designed experiments that give you hands-on "bench" experience.
- Industry Certification Training Guide — provided with four of our programs. Prepares you for examinations you may take for your professional license or certification.

### Easy Payment Plans — No Finance Charges

To help you get started on your education, Peoples College has reduced tuition rates and offers low monthly payment plans with no finance fees. So don't delay, call or write for more information today!

### For COLOR CATALOG Mail Coupon or Call TOLL FREE 1-800-765-7247

Programs offered only in United States, Canada, Puerto Rico and Virgin Islands. No Obligation. No sales person will call.

Our programs are accredited by the Accrediting Commission of the National Home Study Council

YES! I would like to know more about your training programs. Send a catalog to:

Name \_\_\_\_\_

Address \_\_\_\_\_

City \_\_\_\_\_

State \_\_\_\_\_ Zip \_\_\_\_\_

Phone # \_\_\_\_\_

**PEOPLES COLLEGE**  
OF INDEPENDENT STUDIES

233 Academy Drive • P.O. Box 421768  
Kissimmee, FL 34742-1768

Member, D.L. Peoples Group E1091

CIRCLE 15 ON FREE INFORMATION CARD

# ELECTRONICS LIBRARY

## RS-232 MADE EASY: 2nd Edition

by Martin D. Seyer

Written in layman's terms and requiring no previous knowledge of the subject, this easy-to-follow guidebook helps readers to understand serial communications and to make connections between computers and printers, terminals, port boards, data switches, terminal servers, buffers, modems, and other computers. Clear charts illustrate how to connect more than 1,000 devices. Highlights



of the second edition include descriptions of the functions of each lead of the RS-232 interface; diagrams of more than 3600 cable designs; appendices that thoroughly explain the RS-232 and RS-449 stan-

dards; and charts outlining pin assignments, connections, port genders, and flow control information for more than 1000 devices and options. The book provides useful answers for some of the most frequently asked questions about interfacing, garnered from polling vendor support hotlines.

*RS-232 Made Easy: 2nd Edition costs \$29.95 and is published by Prentice-Hall, Englewood Cliffs, NJ 07632.*

**CIRCLE 99 ON FREE INFORMATION CARD**

## UNDERSTANDING PC SPECIFICATIONS

by R.A. Penfold

IBM PC's and compatibles are by far the most popular choice of computers for business, home-office, and personal use, due to their competitive prices, their expandability, and the enormous range of applications programs and hardware additions that are available to back them up. Unfortunately, all those options can lead to confusion, particularly for first-time purchasers. PC's range in complexity from simple systems with limited capabilities to sophisticated systems that can run even the most complex applications. This book is intended to help the uninitiated to determine the specific PC system that will best suit their needs, and to avoid the common pitfalls of wasting money on a system that goes beyond their requirements or skimping and not having their needs met.

The book offers detailed coverage of the differences between types of PC's (AT, XT, 80386, etc.); math coprocessors; input devices (mice, keyboards, and digitizers); memory, including both expanded (EMS) and extended RAM; RAM disks and disk caches; hard-disk drives; and display adapters, including

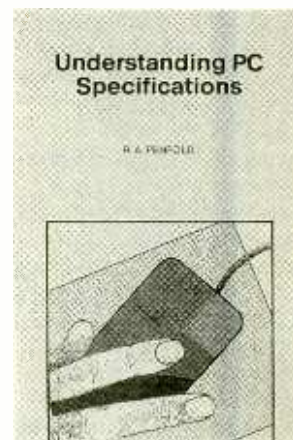

CGA, Hercules, Super VGA, and more.

*Understanding PC Specifications (order #BP282) is available for \$9.75, including shipping and handling, from Electronics Technology Today Inc., P.O. Box 240, Massapequa Park, NY 11762-0240.*

**CIRCLE 97 ON FREE INFORMATION CARD**

## LIGHT THE NIGHT: How to Design, Install and Service Low-Voltage Outdoor Lighting

from Intermatic, Inc.

Many homeowners like the idea of using low-voltage outdoor lighting to illuminate their yards, decks, and patios, yet are intimidated by the thought of doing the project themselves. This 20-page guide, written especially with the homeowner in mind, is designed to answer many of the commonly asked questions about installation and use of low-voltage outdoor lighting.

The guide is divided into six sections. The first two of these sections explain the basics of low-voltage lighting and lighting techniques, followed by a section describing the various



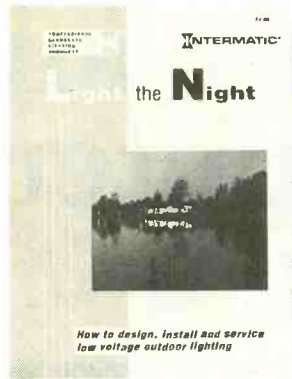

products available in Intermatic's Professional Landscape Lighting line. Section four provides more detailed information, covering everything from the type of lamps needed to the gauge of low-voltage cable and the size of the transformer required. The last two sections of the guide provide step-by-step installation instructions, helpful troubleshooting hints, and useful tips for keeping the lights in good working condition.

*Light the Night* is available for \$1.75 (check or money order) from *Light the Night, Intermatic Professional Landscape Lighting Products Division, Intermatic Plaza, Spring Grove, IL 60081-9698.*

**CIRCLE 85 ON FREE INFORMATION CARD**

### TECHNI-TOOL CATALOG #41

from Techni-Tool, Inc.

More than 18,000 items from over 850 manufacturers are described in this 248-page catalog. The items featured include everything from electro-mechanical and assembly devices to electronic, telecommunications and field-service tool kits. Also included



are full lines of items of aerospace production, computer maintenance, and surface-mount technology. The catalog

also features a complete line of ESD, static control, and clean-room items.

*Catalog #41 is free upon request from Techni-Tool, Inc., 5 Apollo Road, P.O. Box 368, Plymouth Meeting, PA 19462; Tel: 215-941-2400; Fax: 215-828-5623.*

**CIRCLE 86 ON FREE INFORMATION CARD**

### SUCCESSFUL NUGGET HUNTING: Volume I: Where to Find Gold

### Nuggets in Australia, Southern California & Southwestern Arizona

by Pieter Heydelaar

Written by a world-renowned treasure hunter and prospector, this book is a metal-detecting handbook and field guide that includes maps, travel tips, and histories of gold-producing areas in Australia and the Southwestern United States. The book opens with a detailed explanation of how to use a

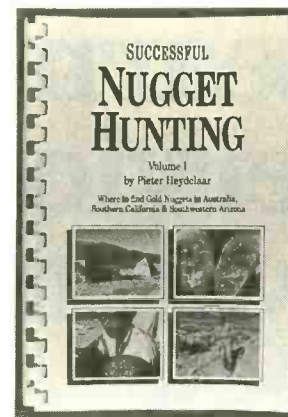

# STRIKE GOLD!



## Introducing the Techmaster™ series of ruggedized digital multimeters.

Stake your claim to what may be the most incredible digital multimeter value ever!

The new Techmaster 8000 series from A.W. Sperry offers exceptional features like drop-proof construction, water resistance, easy-to-read extra large LCDs, Bar Graphs, True RMS, 20A AC/DC range, temperature, 5-year limited warranty and lots more.

All of this at prices from \$119.95 to \$189.95.

And that's not all! Purchase any 8000 series digital multimeter and become a Techmaster Gold Card member. You'll be entitled to generous rebates on other A.W. Sperry products, 48-hour priority service, extended warranty options, and many other benefits.

Call or write today for a free brochure.

The Techmaster 8000 series. Quality and value no other multimeters can measure up to.



## A.W. SPERRY The Professional's Choice

245 Marcus Boulevard, Hauppauge, NY 11788 • Call: 1-800-645-5398 or 516-231-7050 • Fax: 516-434-3128

**CIRCLE 9 ON FREE INFORMATION CARD**  
www.americanradiohistory.com

# Learn to troubleshoot and service today's computer systems as you build a 386sx/20 MHz mini tower computer!

*Train the NRI way—and learn to service today's computers as you build your own 386sx computer system, now with 1 meg RAM, 40 meg IDE hard drive, and exciting new diagnostic hardware and software!*

Jobs for computer service technicians will almost double in the next 10 years according to Department of Labor statistics, making computer service one of the top growth fields in the nation.

Now you can cash in on this exciting opportunity—either as a full-time industry technician or in a money-making computer service business of your own—once you've mastered electronics and computers the NRI way.

NRI's practical combination of "reason-why" theory and hands-on building skills starts you with the fundamentals of electronics, then guides you through more sophisticated circuitry all the way up to the latest advances in computer technology.

**Train with and keep a powerful 386sx/20 MHz computer system plus popular Microsoft® Works software!**

Only NRI gives you hands-on training with the finest example of state-of-the-art technology: the powerful new West Coast 386sx/20 MHz mini tower computer. As you assemble this 1 meg RAM, 32-bit CPU computer from the keyboard up, you actually see for yourself how each section of your computer works.

You assemble and test your computer's "intelligent" keyboard, install the power supply and 1.2 meg, high-density floppy disk drive, then interface the high-resolution monitor.

Your hands-on training continues as you install a powerful new 40 meg IDE hard disk drive—now included in your course to dramatically increase the data storage capacity of your computer while giving you lightning-quick data access.



**NEW!**  
**386sx/20 MHz**  
**Mini Tower**  
**Computer**



Plus you now go on to work with today's most popular integrated software package, Microsoft Works, learning to use its word processing, spreadsheet, database, and communications utilities for your own personal and professional applications. But that's not all.

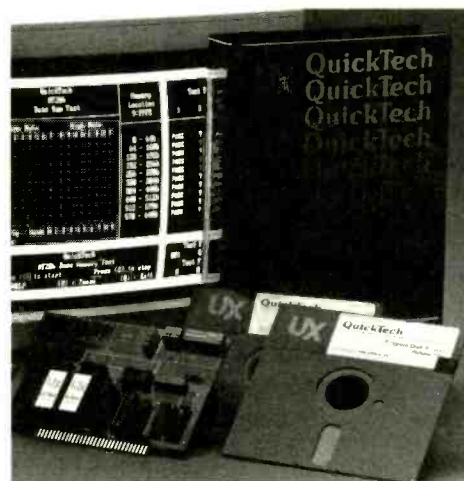

*Only NRI gives you hands-on training with the remarkable R.A.C.E.R. plug-in diagnostic card and QuickTech diagnostic software from Ultra-X—professional, state-of-the-art diagnostic tools that make computer troubleshooting fast and accurate.*

**Your NRI computer training includes all this:** • NRI's unique *Discovery Lab*® for circuit design and testing • Hand-held digital multimeter with "talk-you-through" instructions on audio cassette • Digital logic probe that lets you visually examine computer circuits • The new West Coast 386sx/20 MHz computer system, featuring a high-speed 80386sx CPU, 1 meg RAM, 101-key "intelligent" keyboard, 1.2 meg high-density floppy drive, and high-resolution monitor • 40 meg IDE hard drive • MS-DOS, GW-BASIC, and Microsoft Works software • R.A.C.E.R. plug-in diagnostic card and QuickTech menu-driven diagnostic software • Reference manuals with guidelines and schematics

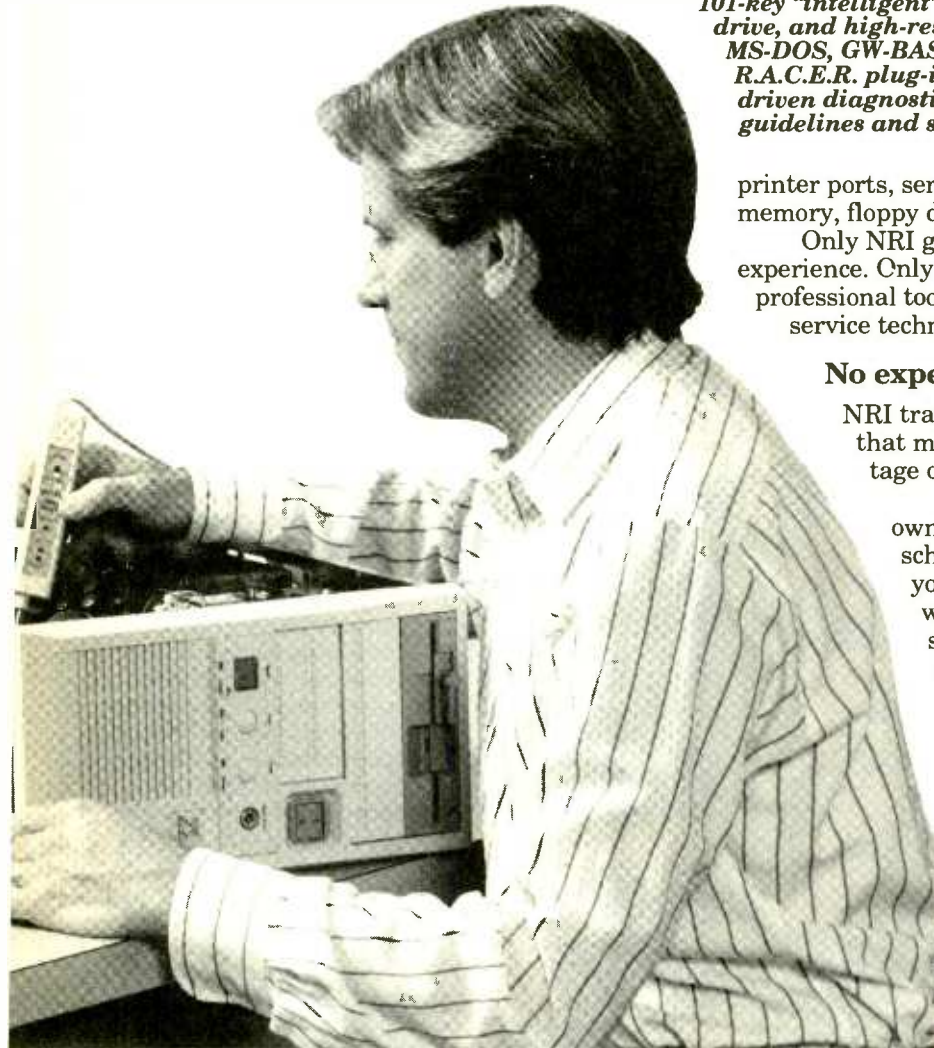

printer ports, serial communications ports, video display memory, floppy drives, and hard disk drives.

Only NRI gives you such confidence-building, real-world experience. Only NRI gives you both the knowledge and the professional tools to succeed as today's in-demand computer service technician.

**No experience needed ... NRI builds it in**

NRI training gives you practical, hands-on experience that makes you uniquely prepared to take advantage of today's opportunities in computer service.

You learn at your own convenience in your own home. No classroom pressures, no night school, no need to quit your present job until you're ready to make your move. NRI starts you with the basics, building on that foundation step by step until you have the knowledge and skills you need for success.

And all throughout your training you've got the full support of your personal NRI instructor and the entire NRI technical staff, always ready to answer your questions and help you achieve your training goals.

**FREE catalog tells more. Send today!**

Send today for NRI's big, free catalog that describes every aspect of NRI's innovative computer training, as well as hands-on training in other growing high-tech career fields.

If the coupon is missing, write to:  
NRI School of Electronics, McGraw-Hill Continuing Education Center, 4401 Connecticut Avenue, NW, Washington, DC 20008.

**NOW! Training now includes Ultra-X diagnostic hardware and software for quick, accurate troubleshooting!**

Now you train with and keep the latest in diagnostic hardware and software: the extraordinary R.A.C.E.R. plug-in diagnostic card and QuickTech diagnostic software, both from Ultra-X. Using these state-of-the-art tools, you learn to quickly identify and service virtually any computer problem on XT, AT 80286/80386, and compatible machines.

You discover how to use the R.A.C.E.R. diagnostic card to identify individual defective RAM chips, locate interfacing problems, and pinpoint defective support chips. Plus you learn to use your QuickTech diagnostic software to test the system RAM and such peripheral adapters as parallel



IBM is a registered trademark of International Business Machines Corp. R.A.C.E.R. and QuickTech are registered trademarks of Ultra-X, Inc.

**SEND TODAY FOR FREE CATALOG**

**NRI Schools** McGraw-Hill Continuing Education Center  
4401 Connecticut Avenue, NW  
Washington, DC 20008

Check one FREE catalog only

MICROCOMPUTER SERVICING

- TV/Video/Audio Servicing
- Telecommunications
- Industrial Electronics
- Security Electronics
- Electronic Music Technology
- Basic Electronics
- Automotive Servicing

- Computer Programming
- PC Software Engineering Using C
- Desktop Publishing
- Word Processing Home Business
- Paralegal
- Building Construction
- Bookkeeping & Accounting

For career courses approved under GI Bill  
 check for details.

Name \_\_\_\_\_ (please print) Age \_\_\_\_\_

Address \_\_\_\_\_

City/State/Zip \_\_\_\_\_ Accredited Member, National Home Study Council 18-101

metal detector, including the newest tips and techniques; discussions about prospecting for meteorites; advice on weights and measures, including how to do specific-gravity tests; and even a section on treatment of snake bites. The next two sections are devoted to prospecting in Australia and the Southwest, respectively. The book includes color and black-and-white photographs of metal-detecting equipment, gold finds, prospecting sites, and local wildlife. Clearly drawn maps are accompanied by brief descriptions of the area and directions for how to get there.

*Successful Nugget Hunting: Volume I* is available for \$11.95 (plus \$2.00 for shipping and handling) from Fisher Research Laboratory, Dept. PE, 200 West Willmott Road, Los Banos, CA 93635.

**CIRCLE 87 ON FREE INFORMATION CARD**

## MICROWAVE OVEN REPAIR

### Second Edition

by Homer L. Davidson

Over the past decade or so, microwave ovens have become standard kitchen appliances. Like any other major household appliance, they are subject to occasional malfunctions caused by improper maintenance or parts wearing out. For those who would rather not shell out big bucks on repair bills for problems that they could fix themselves—and even those who want to start their own part-time microwave oven repair business—this fix-it manual pro-



vides step-by-step instructions for solving almost any microwave-oven problem. The book offers complete coverage of the latest microwave oven models

and their features, along with practical information on microwave circuitry, including more than 100 circuit diagrams. Along with detailed maintenance and troubleshooting techniques, the book describes the latest test procedures used by major appliance manufacturers and offers specific solutions to more than 200 common microwave-oven malfunctions. The clear directions, accompanied by hundreds of detailed working illustrations and photographs, provide the guidance needed to allow even inexperienced do-it-yourselfers to perform leakage tests, fix a defective switch, replace a magnetron, or install a new fan motor.

*Microwave Oven Repair: Second Edition* costs \$19.95 and is published by TAB Books Inc., Blue Ridge Summit, PA 17294-0850; Tel: 1-800-233-1128.

**CIRCLE 98 ON FREE INFORMATION CARD**

## THE GRAY BOOK: Designing in Black & White on Your Computer

by Michael Gosney, John Odam, and Jim Schmal

Even though it's now possible to create four-color printing with personal computers, the majority of desktop designers still depend on the classic black-on-white combination. That's because black-and-white designs are less expensive and easier to produce, and work more effectively in some applications. This book explores the creative possibilities of designing in black, white, and shades of gray. Aimed at desktop publishers, it shows how to use basic design principles and your imagination to create interesting monotone pages. The first two chapters concentrate on how to use black and white to create contrast and reverse designs. Subsequent chapters explore the use of solid and graduated gray tones, 3-D designs, and special lighting effects to enhance printed material. The book also discusses the use of scanners, explaining how to achieve different effects from the same scanned image. Almost half of the book is devoted to an "idea gallery" that show-

cases stimulating graphics created in black, white, and gray. The illustrations are meant to provide inspiration and insight for those who want to create their own monotone designs. A handy appendix includes listings of manufacturers and sources for software (paint programs, clip art, utilities, and page-layout programs) for Macintosh, MS-DOS, and Amiga computers; hardware, including graphic tablets, monitors, scanners and digitizers, printers, large format output services, and film recorders; and references such as magazines, books, and bulletin-board services.

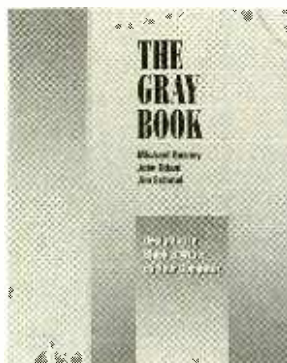

*The Gray Book* costs \$22.95 and is published by Ventana Press, P.O. Box 2468, Chapel Hill, NC 27515; Tel: 919-942-0220; Fax: 919-942-1140.

**CIRCLE 88 ON FREE INFORMATION CARD**

## USING CARBON COPY PLUS

by Walter R. Bruce III

Carbon Copy Plus is a computer-to-computer communications program that allows users to run programs on a remote computer, via the telephone lines, using your own PC as the controller. Besides remote-control capability, the program offers terminal emulation, an automated dialing directory, error-checking protocols, and a powerful script language. It also lets you transfer and receive computer files, access on-line information services, sign on to powerful mainframe computers, and to "talk" with another computer by typing in messages on your keyboard. This book provides a practical introduction to the techniques and functions of

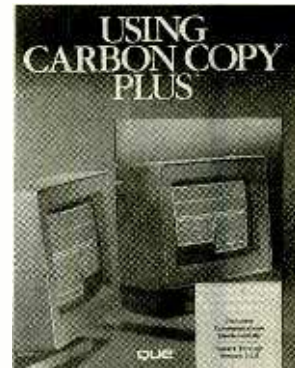

Carbon Copy Plus. It describes timesaving ways to "connect" your computer hardware via telephone, and explains how to run programs on other PC's from your computer. The book's communications primer explains common PC telecommunications terms, and quick-start tutorials depict how to navigate through the program's menu screens and terminal emulator screens. In addition to those fundamentals, the book shows how to connect to a remote host PC, run an application, transfer files, and manage incoming and outgoing information. Advanced lessons cover software configuration, setting general parameters, and creating script and batch files. The text is supported by reference tables, highlighted tips and cautions, and screen illustrations.

*Using Carbon Copy Plus* costs \$24.95 and is published by Que, 11711 North College Avenue, Suite 140, Carmel, IN 46032; Tel: 1-317-573-2500.

**CIRCLE 89 ON FREE INFORMATION CARD**

## ELECTRONIC COMMUNICATIONS

by John J. Dulin, Victor F. Veley, and John Gilbert

Designed to help you prepare for your FCC General Radiotelephone Operator License or CET examination, this introductory book covers both the theoretical and the practical aspects of modern electronic communications. It also provides a thorough understanding of the history and continuing evolution of this rapidly expanding field. The book's easy-to-follow format presents a wealth of information in a logical sequence, avoiding the frustrations caused by confusing cross-references. Extensive ap-

pendices include information on AM/FM station elements; licensing; and FCC designations, tolerances, and standards. The book is both a professional reference for those who are already working in the field, and a study guide for the aspiring technician. It provides a complete introduction to AC circuits, solid-state devices, amplifiers, receivers, radar, tube devices, filters, power supplies, oscillators, transmitters, digital systems, and microwave transmissions.

*Electronic Communications* costs \$24.95 and is published by TAB Books Inc., Blue Ridge Summit, PA 17294-0850; Tel. 1-800-233-1128.

**CIRCLE 98 ON FREE INFORMATION CARD**

## SATELLITE TELEVISION SOURCEBOOK '91

by Ken Reitz

Written by *Monitoring Times* magazine's Satellite Television Editor, this book combines a thorough explanation of how satellite television works with the practical information users require to make smart equipment purchases and get the most out of their systems. The book lists names, addresses, and phone numbers of suppliers, manufacturers, services, books, and publications on the subject of satellite TV. A chapter called "Wandering the Clark Belt" explains how to find interesting programming—including movies, sports, news, teletext, SCPC FM audio, and programming backhauls, or "feeds"—

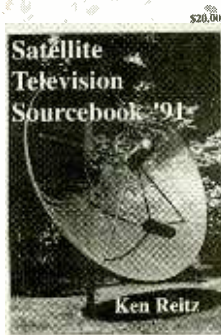

and includes a detailed listings guide. The book also describes installation procedures, along with special techniques to get the best reception of video, audio, and data from home

satellite-television systems. While concentrating on C- and Ku-band domestic satellites, the book also provides information on weather, amateur, and international satellites. The book is a valuable reference tool for consumers who are thinking of buying, or already own, a satellite-television system.

*The Satellite Television Sourcebook '91* costs \$20.00 (including information updates) and is published by Xenolith Press, Route 5, Box 156A, Louisa, VA 23093.

**CIRCLE 90 ON FREE INFORMATION CARD**

## JENSEN 1991 SUPPLEMENT S

from Jensen Tools

Updating Jensen's 1991 catalog, this 96-page supplement features several new products, along with a full selection of tool kits and cases, wire-wrapping



tools, wire strippers/crimpers, hand tools, soldering and desoldering equipment, lighting and optical devices, power tools and accessories, work holders, computer and test equipment, vacuums and cleaners, measuring devices, and static-control equipment. The new products include fixed-tip span wrenches; the Tektronix 2252 100-MHz, four-channel analog scope; an RCL meter, a hand-held DMM, and several frequency counters and counter/timers from Philips; screwdrivers for computer repair; and portable two-way radios from Motorola.

*The 1991 Supplement S is free upon request from Jensen Tools, Inc., 7815 South 46th Street, Phoenix, AZ 85044-5399; Tel: 602-968-6231.*

**CIRCLE 91 ON FREE INFORMATION CARD**

# Which symbol represents a variable inductor?

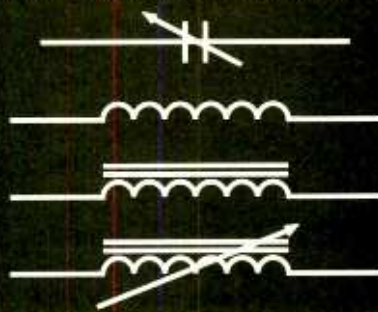

**What is the principal disadvantage of neon lights?**

**What are out-of-phase signals?**

## Heath Video Courses speed your learning curve!

Learn basic electronics at home at your own pace with four, 60-minute video tapes. Know the variable inductor symbol. Recognize a PN junction. Understand oscillator fundamentals. Clearly SEE what most basic electronic books can only describe.

**DC ELECTRONICS.** Covers electron movement to troubleshooting and repairing a simple electronic circuit. **EV-3101-A.**

**AC ELECTRONICS.** Follow-up to DC Electronics. Covers the principles of AC, voltage and electrical measurement. Includes motors, generators and test instrument meter movements. **EV-3102-A.**

**SEMICONDUCTORS.** Complete the DC/AC videos and you're ready to learn how semiconductor devices are made, plus the principles of discrete devices, integrated circuits & optoelectronic devices. **EV-3103-A.**

**ELECTRONIC CIRCUITS.** Complete the basic course with amplifier configurations, biasing, coupling, audio amplifiers, closed-loop vs. open-loop operation and more. **EV-3104-A.**

An activity-filled workbook and explanation of how to solve each problem comes with each tape so you learn three ways — video, workbook and hands-on!

**Order today!**

Call Toll free,  
24-hours a day.  
1-800-253-0570.

We accept VISA, MasterCard, American Express and Heath Revolving Charge card. Use Order Code 601-059.

**VIDEO TAPES**  
**\$44.95 EACH**

# Heath®

Benton Harbor, MI

**Call for a FREE catalog 1-800-44HEATH.**

Price does not include shipping and handling ED-238-R2 or applicable sales tax.

**CIRCLE 5 ON FREE INFORMATION CARD**

# NEW PRODUCTS

Edited by: Teri Scaduto

## AUDIO-COMPONENT KITS

Three do-it-yourself assembly kits from *Rockford Corporation* were developed for industrial/vocational students and kit-building hobbyists. The *Boomer Kit* (pictured) contains the necessary parts for building a 10-watt-per-channel amplifier, the *Tweeter Kit* has the parts for two 6½-inch 8-ohm satellite speakers, the *Woofers Kit* is for a 10-inch 8-ohm subwoofer.

Also included with each kit is a 72-page workbook that contains photographs, illustrations, a glossary, and quizzes, that is intended to simplify the construction process and enhance learning. The assembled kits



can be used in conjunction with a personal cassette player or personal CD player to create a complete stereo system. The kit builder can choose between three distinctive-looking models—*Boomer* (pictured), *Woofers*, and *Tweeter*—or can select optional finishing from Perfect Interface, Rockford's accessory division.

The *Boomer* costs \$59.95 and the *Woofers* and *Tweeter* audio-assembly kits each cost \$49.95. For further information on the kits, contact Rockford Corporation, Educational Services, 613 South River, Tempe, AZ 85282; Tel: 602-967-3565, ext. 3010.

**CIRCLE 101 ON FREE INFORMATION CARD**

## MODULAR WIRE TESTER

A simple four-, six-, and eight-wire modular tester from *Wilco Communications* tests all types of data-wire circuits, including



twisted-pair ethernet. The *RTP-9000* can also be used to test telephone-wire circuits. The compact, portable unit fits in a shirt pocket and is easy to use.

The model RTP-9000 modular wire tester, including battery, costs \$149.95. For more information, contact Wilco Communications, 473 Macara Ave., Suite #702, Sunnyvale, CA 94086; Tel: 408-746-3993.

**CIRCLE 102 ON FREE INFORMATION CARD**

## WRITE-ON TAPE SYSTEM

Providing a simple, effective method of labeling wire and cable, the *3M Write-On Tape System*, available from *Jensen Tools*, creates durable, self-laminated labels for proper system documentation and permanent future identification. The system includes a tape dispenser, pressure-sensitive tape, and a marking pen. As the tape is dispensed, a label area appears in the dispenser window and

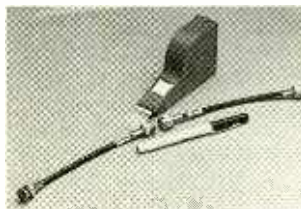

provides a smooth, flat writing surface. The tape is resistant to dirt, oil, and heat, and each roll contains 250 labels. The extra-fine-point permanent marking pen contains quick-drying water- and ultra-violet-resistant black ink. Tape refills and replacement pens are available.

The Write-On Tape System costs \$17.95. For additional information, contact Jensen Tools, Inc., 7815 South 46th Street, Phoenix, AZ 85044; Tel: 602-968-6231.

**CIRCLE 103 ON FREE INFORMATION CARD**

## NOTEBOOK PC

Featuring one of the most powerful batteries on the portable-computer market, *Philips' Magnavox Metalis/286 Notebook PC* runs for 3½ to four hours per charge, with full recharge capability in less than four hours. The user can also exchange a discharged battery for a fresh one without shutting down and rebooting the system. In addition, manual and automatic Standby/Resume modes allow the computer to be "put to sleep" for long periods of time with minimal battery drain.

The *Metalis/286* has a 20-MB hard drive and an internal 1.44-MB 3½-inch floppy-disk drive,



which allows easy data interchange with a desktop PC. Its 1 MB of RAM is expandable to 8 MB for advanced applications. *GeoWorks Ensemble*, included with the *Metalis/286*, includes a wordprocessor, a drawing program, a file/disk manager, an address book/automatic phone dialer (which requires the op-

tional modem), an appointment book and personal calendar, a communications program, assorted desk tools, and access to a telecommunications service called America On-Line. Other features include a complete assortment of standard I/O ports, a password security system, and MS-DOS 4.01 with full documentation.

The notebook PC is equipped with a bright backlit VGA LCD screen that provides exceptional display performance, and a full-size keyboard with full-stroke key switches. Also included is a mouse pen, a pointing device that allows users to enjoy the benefits of a mouse, but requires only about three inches of space to operate.

The Magnavox Metalis/286 has a suggested retail price of \$2699. For further information, contact Philips Consumer Electronics Corporation, One Philips Drive, P.O. Box 14810, Knoxville, TN 37914-1810.

**CIRCLE 104 ON FREE INFORMATION CARD**

## PHOTO/CONTACT TACHOMETER

Designed for inspecting and measuring the speed of moving gears, fans, pumps, and other equipment used in general maintenance, production, quality control, or laboratories, *Extech's Stroboscope/Tachometer* freezes motion and measures speed with or without



contact. The two-in-one instrument checks and analyzes motion by aiming and synchronizing its flash rate with a rotating object. It can measure between 100 and 10,000 flashes per second and has duty cycles from 5 to 30 minutes. Micro-processor circuitry provides accurate measurements to  $\pm 1$  digit and one-second sampling time. RPM's are displayed on a

built-in, four-digit LED readout. The Stroboscope/Tachometer features an automatic range selector located on its top panel. The 2.2-pound instrument can be mounted on a tripod for hands-free operation. It operates on 115/230 VAC and comes with a six-foot power cord.

The Stroboscope/Tachometer has a suggested list price of \$199.00; spare xenon lamps cost \$29. For more information, contact Extech Instruments Corporation, 150 Bear Hill Road, Waltham, MA 02154; Tel: 617-890-7740; Fax: 617-890-7864.

**CIRCLE 105 ON FREE INFORMATION CARD**

## PRINTER-SHARING SWITCH

*Solectek's Laser Access* auto switch allows two to four computers to automatically share a printer or other peripheral. The bi-directional switch can also be



used to enable one computer to use up to four peripherals, including printers, plotters, and modems. Both serial and parallel models are available, in two and four-port versions. Parallel models require no power. Laser Access is HP LaserJet compatible, and can be used in conjunction with line extenders and buffers for maximum workstation/peripheral flexibility. The fully automatic switch allows computers to access the printer on a "first-come, first-served" sequence by following normal printing procedures; no special commands are needed. The device also eliminates damaging "spikes" often experienced with manual switches, and offers automatic "form feed" to separate print jobs.

Suggested retail prices are \$169.95 for the four-port parallel (LA41P) and the four-port serial (LA41S) models and \$119.95 for the two-port parallel (LA21P) and two-port serial (LA21S) models. For further information,

## SUPER LONG PLAY TAPE RECORDERS

12 Hour Model —  
USES 120 TAPE  
\$119.00\*

Modified Panasonic Slimline, high quality AC-DC provide 6 continuous hours of quality recording & playback on each side of cassette for 12 hours total. Includes • Voice level control • Digital counter, etc. TDK - 120 Cassette Furnished.



## PHONE RECORDING ADAPTER

Records calls automatically. All Solid state connects to your telephone jack and tape recorder. Starts recording when phone is lifted. Stops when you hang up.

\$28.50\*  
FCC APPROVED

## VOX VOICE ACTIVATED CONTROL SWITCH

Solid state. Self contained. Adjustable sensitivity. Voices or other sounds automatically activate and control recorder. Uses either recorder or remote mike.

\$28.50\*

\* Add for ship & handling. Phone Adapter & Vox \$2.00 each. Recorders \$5.00 each. Calif. Res. add tax. Mail order. VISA available. Dealer Inquiries invited. Free data.

**AMC SALES INC.** Dept. B 3335 Luber Street  
Box 928, Downey, CA 90241  
Phones (213) 869-8513 1-800-526-2488  
FAX (213) 923-1478  
Mon-Fri 8-5 PAC TIME

**CIRCLE 7 ON FREE INFORMATION CARD**

## Be an FCC LICENSED ELECTRONIC TECHNICIAN!



Learn at home in spare time. No previous experience needed!

No costly school. No commuting to class. The Original Home-Study course prepares you for the "FCC Commercial Radiotelephone License." This valuable license is your professional "ticket" to thousands of exciting jobs in Communications, Radio-TV, Microwave, Maritime, Radar, Avionics and more...even start your own business! You don't need a college degree to qualify, but you do need an FCC License.

**No Need to Quit Your Job or Go To School** This proven course is easy, fast and low cost! **GUARANTEED PASS**—You get your FCC License or money refunded. **Send for FREE facts now. MAIL COUPON TODAY!**

### COMMAND PRODUCTIONS

FCC LICENSE TRAINING, Dept. 100  
P.O. Box 2824, San Francisco, CA 94126  
Please rush FREE details immediately!

NAME \_\_\_\_\_  
ADDRESS \_\_\_\_\_  
CITY \_\_\_\_\_ STATE \_\_\_\_\_ ZIP \_\_\_\_\_

contact Solectek Corporation, 6370 Nancy Ridge Drive, San Diego, CA 92121; Tel: 800-437-1518.

**CIRCLE 106 ON FREE INFORMATION CARD**

## POSTSCRIPT-COMPATIBLE LASER PRINTER

Designed for small businesses and entrepreneurial users who are interested in true desktop-publishing applications, The *LaserPrinter 4 StarScript* from *Star Micronics* is a low-priced,



four-page-per-minute laser printer. Because it is PostScript-compatible, the printer is supported by thousands of software packages, including Harvard Graphics, WordPerfect, WordStar, Pagemaker, and Ventura, allowing users to produce computer-generated graphics and desktop-published documents. The printer is fully compatible with the HP LaserJet IIP, and accepts HP font cartridges, toner cartridges, and lower paper cassettes.

Users can rotate and scale graphic images, construct geometric figures of virtually any size or shape, and print text in different sizes and positions. The printer's controller is configured around an Intel microprocessor that allows high-speed throughput of complex graphics. Two megabytes of RAM is standard, and a 4-MB upgrade is available. Fourteen bit-mapped fonts and 35 resident outline fonts from ten typeface families are resident in the *LaserPrinter 4 StarScript*. A wide range of interfaces allow easy connection to most PC's, including Apple Macintoshes and IBM-PC's and compatibles.

The *LaserPrinter 4 StarScript* has a suggested retail price of \$1995. For further information, contact *Star Micronics America, Inc.*, 420 Lexington Ave., Suite 2702, New York, NY 10170; Tel:

800-447-4700; Fax: 212-286-9036.

**CIRCLE 107 ON FREE INFORMATION CARD**

## PC MEMORY KEYS

A combination of IBM-compatible software and hardware from *MFJ Enterprises*, the *MFJ-1268 PC Memory Keyer*, turns your computer into a powerful memory keyer. The device hooks between your computer and a radio and provides a total of 100 function keys that can be set to send any messages or characters. For example, you can set a macro to send a second macro at any point, or set a macro to pause a preset period so that you can key in characters. Many useful messages come preset in the macros; those can be changed if desired. Other features include incrementing serial numbering, speeds from 5-40 words per minute, variable

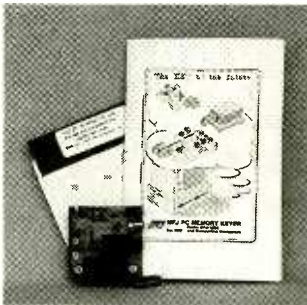

speaker tone, and weight adjustment. The *MFJ-1268* also offers instant access to on-line help, common CW abbreviations, Q-signals, and official ARRL NTS Traffic codes. In addition, the device comes with a full-featured CD Tutor with test administrator that lets you give a code test on screen or printed out on paper.

The *MFJ-1268 PC Memory Keyer* has a suggested retail price of \$49.95. For additional information, contact *MFJ Enterprises, Inc.*, P.O. Box 494, Mississippi State, MS 39762; Tel: 601-323-5869 (800-647-1800 for orders); Fax: 601-323-6551.

**CIRCLE 108 ON FREE INFORMATION CARD**

## DESKTOP FACSIMILE MACHINE

*Tandy's TandyFax 1020* personal fax machine is a compact, lightweight unit intended for use

in home offices and small business. The device prints the company logo and ID number on the top of each transmitted page so that the receiving party can easily identify the source. Other features include an automatic reception mode for unattended receipt of documents; a copy-resolution switch

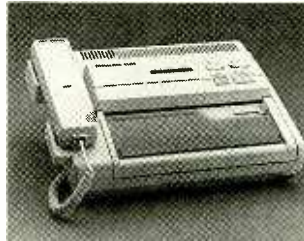

to adjust copy detail, including a 16-shade half-tone setting for photographs; 20-number memory for quick dialing of important numbers; a built-in, hearing-aid-compatible handset; and automatic redial for one-button speed-dialing of the last number called. To save the user money on phone bills, the *TandyFax 1020* skips blank portions of a document when sending to a fax with a similar feature. For ease of use, the unit has straight-forward controls and copying capability. For record keeping, it produces a journal of the documents sent and received, and a report for checking memory numbers and fax settings.

The *TandyFax 1020* has a suggested retail price of \$499.95 and is available at *Radio Shack* stores and *Radio Shack Computer Centers* nationwide. For more information, contact *Tandy Corporation*, 700 One Tandy Center, Fort Worth, TX 76102.

**CIRCLE 109 ON FREE INFORMATION CARD**

## SOLDERING POWER SUPPLY

A compact power supply from *M.M. Newman Corporation*, the *Antex PSU-24* comes with its



own temperature-controlled soldering iron, or can be used with most popular 50-watt-or-less 24-volt soldering irons. The *PSU-24* operates on 115 VAC. It is equipped with a built-in removable sponge tray and spring holder. The included model TCS positive-feedback, temperature-controlled soldering iron has zero-voltage switching. The iron heats up to 665°F in 60 seconds, provides rapid recovery times, has a molded plastic handle with the heating element under the tip for optimum thermal efficiency, and accepts a wide assortment of slide-on tips. Also supplied with the unit are three bezels to accommodate most makes of soldering irons. The power supply measures just 3 x 4 1/4 x 7 3/4 inches.

The *PSU-24* power supply with soldering iron has a list price of \$129.95; it is also available without the soldering iron for \$69.95. For additional information, contact *M.M. Newman Corporation*, 24 Tioga Way, P.O. Box 615, Marblehead, MA 01945; Tel: 617-631-7100; Fax: 617-631-8887.

**CIRCLE 110 ON FREE INFORMATION CARD**

## CLAMP-ON AMP/VOLT/OHMMETERS

Two multi-sensing, digital, AC clamp-on amp/volt/ohmmeters from *Amprobe Instrument* allow the user to select true rms sensing, average sensing, or peak sensing. That allows the user to measure AC current in the true-rms mode for circuits with non-linear loads (such as computers), average sensing for linear, undistorted loads, and peak sensing to measure motor in-rush. The multi-sensing capability also allows the user to make comparative evaluations of systems on which they suspect the presence of harmonic distortion. That type of analysis is a vital function for accurate measurement on electrical systems that serve computers or other non-linear loads. Models *ACD-2000* and *ACD-2001* each offer a peak hold feature to measure surges greater than or equal to 0.08 seconds, auto-ranging, a 2.5-second sampling rate, and 2% accuracy ± 2 least significant digits (40-400 Hz). Each instrument measures AC





volts, peak AC amps, and ohms from 0.1–199.9/999. The model ACD-2000 measures continuous AC amps from 0.1–199.9/999 and the model ACD-2001 from 0.1–199.9/300. All necessary fuses, voltage leads, and ohmmeter leads are included, along with a carrying case and operating instructions.

The models ACD-2000 and ACD-2001 clamp-on amp/volt/ohmmeters cost \$289.85 and \$269.85, respectively. For more information, contact Amprobe Instrument, 630 Merrick Road, Lynbrook, NY 11563; Tel: 516-593-5600; Fax: 516-593-5682.

**CIRCLE 111 ON FREE INFORMATION CARD**

### PARALLEL PORT TO A/D CONVERTER

B & B Electronics' Parallel Port to Analog/Digital Converter (model ADIO) allows you to connect your IBM computer (or clone) to the outside world. The device connects to your PC-compatible's parallel port and lets you measure eight different analog voltages in the range of 0–5 volts. Those voltages are



then converted to an 8-bit word that can be input into your computer. The converter can be used to measure power-supply voltages, the voltage on a potentiometer, voltage outputs

from lab experiments, and other voltages. It comes with complete instructions and sample programs written in BASIC, Pascal, and C. Those programs can be used to input and display analog voltages. You can incorporate parts of those programs into your own program to make it easier to interface to the model ADIO. In addition, by studying those programs you can learn how to write your own code in any language to do a similar job.

The ADIO Parallel port to Analog/Digital Converter costs \$99.95. A power supply (model 232PS) costs \$14.95. For more information, contact B & B Electronics Mfg. Co., 4000 Baker Road, P.O. Box 1040, Ottawa, IL 61350; Tel: 815-434-0846. **CIRCLE 112 ON FREE INFORMATION CARD**

### ESD-CONTROL SOLDERING STATION

According to Weller, their HYC3000 soldering station helps control problems of electrostatic discharge (ESD). The electronically controlled soldering station is equipped with a 42-watt, high-performance iron.



It also comes with a high-output, high-tip-mass soldering pencil that features the patented EM Series tips. The unit's dial is calibrated in 10°F steps. The soldering station, which meets all MIL specifications, is especially well-suited for multilayered boards and difficult applications that require large outputs from a small tool.

The HYC3000 soldering station has a suggested list price of \$236.51; quantity discounts are available. For additional information, contact Weller HYC3000, P.O. Box 728, Apex, NC 27502.

**CIRCLE 113 ON FREE INFORMATION CARD**

### PCB and SCHEMATIC C.A.D.

EASY-PC

**\$195**

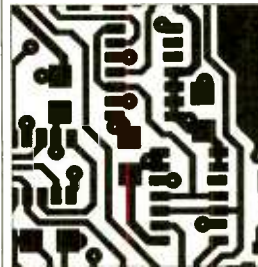
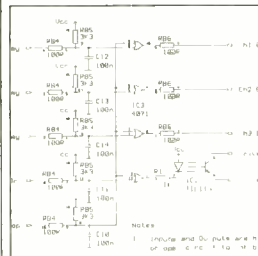

- Runs on PC/XT/AT/386/486 with Herc .CGA, EGA or VGA.
- Design Single sided, Double sided and Multilayer boards.
- Provides Surface Mount support.
- Exceptionally fast operation.
- Standard output includes Dot Matrix / Laser / Inkjet Printer, Pen Plotter, Photo-plotter and N.C. Drill.
- Award winning EASY-PC is in use in over 9000 installations in 50 Countries World-wide.
- Very easy to learn and use.
- Not Copy Protected.
- Dealer/Distributor enquiries welcome.

Options - 1000 Piece Symbol library \$75.00  
Gerber Import facility \$195.00

For full details write, call, fax or use inquiry #

### Number One Systems Ltd. 1

REF.: PEUSA, HARDING WAY, SOMERSHAM ROAD, ST. IVES, HUNTINGDON, CAMBS, ENGLAND, PE17 4WR

Telephone  
USA: 011 44 480 61778 (7 lines) **BRITISH DESIGN AWARDS 1989** AMERICAN EXPRESS, MASTERCARD and VISA WELCOME.  
Intnl: + 44 480 61778  
FAX: 011 44 480 494042

**CIRCLE 12 ON FREE INFORMATION CARD**

# FREE CATALOG

Call (800) 992-9943

Over 35,000  
Electronic Components

Call Today for Your  
FREE SUBSCRIPTION

If You Order Today,  
WE SHIP TODAY!!



**MOUSER  
ELECTRONICS**

(800) 992-9943

Stocking Locations Across America.

**CIRCLE 6 ON FREE INFORMATION CARD**

# AMAZING SCIENTIFIC & ELECTRONIC PRODUCTS

## LASERS AND SCIENTIFIC DEVICES

VRL2K	3mw Vis Red Laser Diode System Kit	\$159.50
LLIS1K	Laser Beam "Bounce" Listener Kit	\$199.50
LHC2K	Visible Simulated 3 Color Laser Kit	\$44.50
LC7	40 Watt Burning Cutting Laser Plans	\$20.00
RUB4	Hi Powered Pulsed Drilling Laser Plans	\$20.00
LGU40	1 to 2mw HeNe Vis Red Laser Gun Assembled	\$199.00
LLS1	Laser Lite Show - 3 Methods Plans	\$20.00
SD5K	See in the Dark Kit	\$299.50
EML1K	Electromagnetic Coil Gun Kit	\$69.50
MCP1	Hi Velocity Coil Gun Plans	\$15.00
LEV1	Levitating Device Plans	\$10.00
EH1	Electronic Hypnotism Techniques Plans	\$10.00

## HIGH VOLTAGE AND PLASMA DISPLAY DEVICES

HVM7K	75,000 Volt DC Variable Output Lab Source Kit	\$149.50
IOG3K	Ion Ray Gun Kit, project energy without wires	\$69.50
NIG9K	12V/115 VAC Hi Out Neg Ion Generator Kit	\$34.50
EMA1K	Telekinetic Enhancer/Electric Man Assembled	\$99.50
LG5K	Lightning Display Globe Kit	\$54.50
BTC1K	Worlds Smallest Tesla Coil Kit	\$49.50
BTC3K	250KV Table Top Tesla Coil Kit	\$249.50
BTC5	1.5 Million Volts Tesla Coil Plans	\$20.00
JL3	Jacobs Ladder - 3 Models Plans	\$15.00
GRA1	Anti Gravity Generator Plans	\$10.00
PFS20	Plasma Fire Saber Assembled	\$69.50
DPL20	Dancing Plasma to Music and Sounds Assembled	\$79.50

## SECURITY AND PROTECTION DEVICES

ITM10	100,000 Volt Intimidator up to 20" Assembled	\$129.50
IPG70	Invisible Pain Field Blast Wave Gen Assembled	\$74.50
PSP4K	Phasor Sonic Blast Wave Pistol Kit	\$59.50
LIST10	Infinity Xmt, Listen in Via Phone Assembled	\$199.50
TAT30	Automatic Tel Recording Device Assembled	\$24.50
VWPM7K	3 Mi. FM Auto Tel Transmitter Kit	\$49.50
FMV1K	3 Mi. FM Voice Transmitter Kit	\$39.50
HOD1K	Homing/Tracking Beeper Transmitter Kit	\$49.50

EASY ORDERING PROCEDURE TOLL FREE 1-800-221-1705  
or 24 HRS ON 1-603-673-4730 or FAX IT TO 1-603-672-5406  
VISA, MC, CHECK, MD IN US FUNDS. INCLUDE 10% SHIPPING. DRDRS  
\$100.00 & UP ONLY ADD \$10.00. CATALOG \$1.00 OR FREE WITH ORDER.

**INFORMATION UNLIMITED**  
P.O. BOX 716, DEPT. PE, AMHERST, NH 03031

## DIGITAL MULTIMETERS

Two 3½-digit, 0.8% accuracy digital multimeters from *Beckman Industrial* offer frequency, capacitance, and logic functions along with extra-large displays. The handheld models *DM25XL* and *DM27XL* each provide 11 functions and 37 ranges. The *DM27XL* also per-

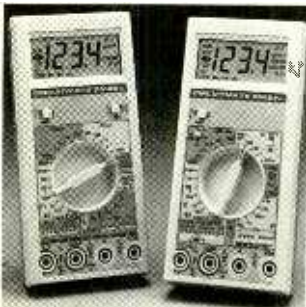

forms go/no-go tests on LED's and includes a frequency counter with the ability to measure frequency to 20 MHz.

Both meters have seven resistance ranges to 2000 megohms, five capacitance ranges to 20 µF, AC and DC

current measurement to 10 amps, five VAC and five VDC ranges, and the ability to test diodes and measure transistor gain. The input impedance of the meters is 10 megohms. The LCD readout features ¾-inch digits with annunciators for all available ranges. Having so many functions in one instrument saves time for the user, and the annunciators lessen the chance of using the wrong range. Other features include an audible continuity beeper, auto-off to conserve batteries, and transistor hFE measurements. Both DMM's come with a built-in, 20-MHz TTL logic probe that detects 20-ns pulses (2.4 volts Hi and 0.7 volts Lo); test leads; a 9-volt battery; and an operator's manual.

The *DM25XL* and *DM27XL* digital multimeters have suggested list prices of \$109 and \$129, respectively. For more information, contact Beckman Industrial Corporation, 3883 Ruffin Road, San Diego, CA 92123-1898; Tel: 619-495-3200.

**CIRCLE 115 ON FREE INFORMATION CARD**

## DIGITAL MEGOHMMETER

A battery-operated digital megohmmeter, *model AMB-4D*, from *Amprobe Instrument*, offers the ability to automatically perform dielectric absorption ratios. That ratio is used to test insulation in a plant or on equipment to prevent possible equipment damage or hazardous electrical shock. The *AMB-4D* also features a response time of less than five seconds and a sampling rate of no less than two times per second. It offers manual or automatic operation, and provides audible and visual indicators in the auto mode. The instrument is powered by six "AA" batteries; a low-battery indicator is provided.

The *AMB-4D* digital megohmmeter has a suggested list price of \$279.85. For additional information, contact Amprobe



Instrument, Division of Core Industries, Inc., 630 Merrick Road, P.O. Box 329, Lynbrook, NY 11563; Tel: 516-593-5600; Fax: 516-593-5682.

**CIRCLE 71 ON FREE INFORMATION CARD**

## "NOTEBOOK" PORTABLE COMPUTER

Weighing less than six pounds (including battery), the *Tandy 1500 HD* portable PC is easy to carry around. The "notebook" PC is equipped with both a 3½-inch, 1.44MB floppy-disk drive and an internal 20MB hard-disk drive with 23-millisecond access speed. For instant "out-of-the-box" computing, MS-DOS 3.3 and Tandy's DeskMate personal-productivity software are installed on the hard drive. The 1500 HD has a high-definition, blue-on-white liquid-crystal display with 640 x 200 CGA color resolution. The screen measures approximately 7½ x 5

inches and is backlit for improved contrast. The laptop has an NEC V-20 microprocessor, a 10-MHz clock speed, and zero wait-state memory. It has a full 640KB of memory, expandable to 1.64MB; to configure additional memory, a LIM 4.0 expanded-memory driver is also supplied. The rechargeable NiCd battery provides more than 3½ hours of computing time. An AC adapter/charger is



also included. The 84-key keypad features the Tandy Key-Switch that allow the user to interchange the CTRL key cap and function with the CAPS LOCK key cap and function. By switching those two keys, the 1500 HD's keyboard layout resembles that of a standard typewriter. Other features include an internal modem slot, one 25-pin parallel-printer port, and one 9-pin RS-232C serial-communications port for attaching a mouse or a portable fax machine. Options include a 1MB user-installable memory upgrade, a 2400-bps internal modem, a spare battery, and a choice of carrying cases.

The 1500 HD portable computer is available for a suggested retail price of \$1,999.00 at more than 7,000 Radio Shack Computer Centers, Radio Shack Stores, and dealers nationwide. For more information, contact Tandy Corporation, 1800 One Tandy Center, Fort Worth, TX 76102. ■

**CIRCLE 72 ON FREE INFORMATION CARD**



"It's so humiliating Doctor... I can build a VCR, but I don't know how to set the timer."

# Why take chances in today's job market?

Graduate as a fully trained electronics professional.

To get ahead and stay ahead in today's economy, you need the electronics training CIE has been providing its 150,000-plus successful graduates with for nearly 60 years.

### Meet the Electronics Specialists's.

When you pick an electronics school, you're getting ready to invest time and money. And your whole future depends on the education you receive in return. That's why it makes so much sense to go with number one... with the specialists... with CIE!

### There's no such thing as a bargain education.

If you talk to some of our graduates, and we recommend you do, chances are you'd find a lot of them shopped around for their training. Not for the lowest priced, but for the best training available. They pretty much knew what was available when they picked CIE as number one.

### Because we're specialists we have to stay ahead.

At CIE we have a position of leadership to maintain. Here are just a few of the ways we hang onto it...

### Programmed Learning.

That's exactly what happens with CIE's Auto-Programmed Lessons®. Each lesson uses famous "programmed learning" methods to teach you important electronics principles. You explore them, master them completely, before you start to apply them. You thoroughly understand each step before you go on to the next. You learn at your own pace.

And, beyond theory, some courses come fully equipped with electronics equipment to actually let you perform hundreds of hands-on experiments.

### Experienced specialists work closely with you.

Even though you study at home, CIE's faculty and staff stand ready to assist via CIE's toll free number. And, each time you return a completed exam you can

be sure it will be reviewed, graded and returned with the appropriate instructional help, you get it fast and in writing from the faculty technical specialist best qualified to answer your question in terms you can understand.

### Pick the pace that's right for you.

CIE understands people need to learn at their own pace. There's no pressure to keep up...no slow learners hold you back. If you're a beginner, you start with the basics. If you already know some electronics, you move ahead to your own level.



### "Same Day" grading cycle.

When we receive your lesson, we grade it and mail it back the same day. You find out quickly how well you're doing!

### State-of-the-art laboratory equipment.

Some courses feature the CIE Microprocessor

Training Laboratory. An integral part of computers, microprocessor technology is used in many phases of business, including service and manufacturing industries. The MTL gives you the opportunity to program it and interface it with LED displays, memory devices and switches. You'll gain all the experience

needed to work with state-of-the-art equipment of today and tomorrow.

### New Courses!

CIE now offers two new career courses: Automotive Electronics and Computer Operation and Programming.

### CIE offers you an Associate Degree.

One of the best credentials you can have in electronics — or any other career field — is a college degree. That's why CIE offers an Associate in Applied Science in Electronics Engineering Technology. And all CIE career courses earn credit toward your degrees.

### Which CIE training fits you?

Beginner? Intermediate? Advanced? CIE home study courses are designed for ambitious people at all entry levels. People who have: No previous electronics knowledge, but do have an interest in it; Some basic knowledge or experience in electronics; In-depth working experience or prior training in electronics.

At CIE you start where you fit and feel comfortable where you start, then go on from there to your Diploma, Associate Degree and career!

### Today is the day. Send now.

Fill in and return the postage-paid card attached. If some ambitious person has already removed it, cut out and mail the coupon below. You'll get a FREE CIE school catalog, plus complete information on independent home study. Mail in the coupon below or, if you prefer, call toll-free 1-800-321-2155 (in Ohio, 1-800-523-9109).

**YES!** I want to get started. Send me my CIE school catalog including details about the Associate Degree program. (For your convenience, CIE will have a representative contact you — there is no obligation.) AH18

Print Name \_\_\_\_\_

Address \_\_\_\_\_ Apt. \_\_\_\_\_

City \_\_\_\_\_ State \_\_\_\_\_ Zip \_\_\_\_\_

Age \_\_\_\_\_ Area Code/Phone No. (\_\_\_\_\_) \_\_\_\_\_

Check box for G.I. Bulletin on Educational Benefits  Veteran  Active Duty

**CIE** CLEVELAND INSTITUTE OF ELECTRONICS, INC.  
1776 East 17th Street • Cleveland, Ohio 44114 • (216) 781-9400



A school of thousands.  
A class of one.  
Since 1934.

# THINK TANK

By John J. Yacono

## Supercharging a 555

Few will dispute that the 555 timer is one of the most popular IC's on the market today. It really boggles the mind to try to imagine all the ways it can be used. Despite all the cookbooks written in its honor, there are a few functions of the 555 that are seldom explained in any depth. Oddly one of those functions (namely, voltage-controlled oscillator operation) is built into the chip—but it even has a pin dedicated to that purpose—but it usually gets swept under the rug early in the text. To set

can be ignored at this time because it's turned off. So the capacitor's charging rate is determined only by  $R_A$ ,  $R_B$ ,  $C$ , and  $V_{CC}$ .

The chip's internal resistors ( $R_{11}$ – $R_{13}$ ) divide the supply voltage,  $V_{CC}$ , into  $\frac{1}{3}V_{CC}$  and  $\frac{2}{3}V_{CC}$ . Those voltages are called the "trigger" and "threshold" reference voltages, respectively. The voltage across (or stored in) capacitor  $C$  is monitored by comparators  $C1$  and  $C2$  via the threshold and trigger inputs. Comparator  $C1$  compares the capacitor voltage to the threshold voltage and  $C2$  compares the capacitor voltage to the trigger voltage. When the capacitor voltage reaches the threshold-reference voltage, comparator  $C1$  momentarily goes high, toggling the flip-flop. The flip-flop output causes the output terminal (pin 3) to go low and the internal FET to discharge the capacitor via  $R_B$ . The rate of discharge is thus determined by  $R_B$ , capacitor  $C$ , and  $V_{CC}$ .

When the capacitor voltage drops to the trigger-voltage level, it triggers comparator  $C2$ , which toggles the flip-flop. The FET then turns off, the output goes high, and the capacitor begins to charge again. That completes one cycle.

There are a few interesting facts about this method of oscillation. For example, the timing is independent of the power-supply voltage. That's because even though the charge rate will increase if you raise the supply voltage, the threshold-reference voltage would also increase, so it takes the capacitor just as long to reach the higher threshold-voltage level at

the higher charging rate. Furthermore, although the capacitor dissipates that higher voltage slower, the trigger voltage is also higher, so the capacitor doesn't have to discharge as low.

The time it takes for the capacitor to charge from  $\frac{1}{3}V_{CC}$  to  $\frac{2}{3}V_{CC}$ —the length of time that the output remains high—can be calculated using:

$$t_h = 0.693(R_A + R_B)C$$

The time it takes for the capacitor to discharge from  $\frac{2}{3}V_{CC}$  to  $\frac{1}{3}V_{CC}$ —the length of time that the output is low—is given by:

$$t_l = 0.693(R_B)C$$

Now let's throw a monkey wrench into the works by applying a voltage ( $V_{CON}$ ) to the control-voltage terminal (pin 5). That pin is connected directly the threshold-reference input of  $C1$ , and it allows you to program in your own threshold-reference voltage. The control voltage also indirectly sets the trigger-reference voltage, which is always equal to half the threshold-reference voltage (take a close look at the resistor divider network inside the chip to see why that's true). However, altering the trigger-reference voltage does not affect the discharge time ( $t_l$ ) of the capacitor for the same reason a different supply voltage doesn't affect it (go back a couple of paragraphs if you forgot why). It does change the charging time ( $t_h$ ), however, which can be computed using the following formula:

$$t_h = (R_A + R_B)C(-0.693 + \ln[1 + 1/(1 - V_{CON}/V_{CC})])$$

There are a few neat

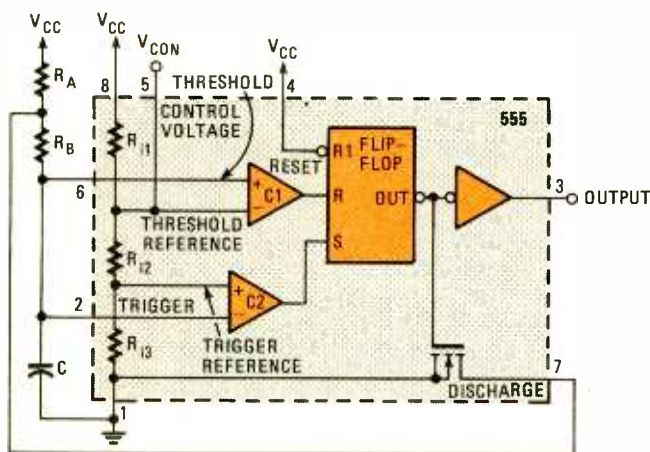

Fig. 1. Shown here are the basic building blocks of the 555 timer IC accompanied by a few external timing components.

things right, we'll explore voltage-controlled oscillator (or VCO) operation in this article.

But, first let me digress a little and give a simple explanation of how the 555 functions as an oscillator. A 555 connected as an astable oscillator is shown in Fig. 1. For now just ignore the control-voltage terminal (pin 5). When power is first applied to the circuit, capacitor  $C$  starts to charge via  $R_A$  and  $R_B$ . The chip's output (at pin 3) is initially high. The 555's internal FET

tricks that you can do by controlling the 555 in that way: The first is that by changing the control voltage, you can perform pulse-width modulation. You can also modulate the frequency and simultaneously modulate the duty cycle. (Unfortunately, you can't change the frequency without changing the duty cycle with this method.) Further, by swinging the control voltage up and down, you can even sweep a range of frequencies.

Now let's take a look at what some of you clever readers have done with 555's on their own. The first circuit is valuable if you use 555's a lot.

### A TEST FIXTURE

When I was building a 40,00-volt induction coil, a 555 oscillator timer used in the electronic-interrupter circuit kept burning up. Because of the current levels involved and the destruction of other components that occurred when the 555 would burn out, I could not use a logic probe as they are usually powered by the circuit under test.

That being the case, I built a 555 oscillator/timer tester (see Fig. 2). I placed it

in a plastic enclosure and mounted the SPST slide switch, LED1, and the 8-pin IC socket on the cover. To test the 555 in question, you place the IC in the socket and throw the switch. If the LED blinks fully on and off, the IC is okay. If the LED blinks dimly then turns fully on, the 555 is beginning to fail because it's having trouble turning off. If the LED just glows brightly, the IC is completely bad.

The operation of the circuit is very simple. When power is applied to the 555, it should go through normal oscillations, so its output should turn completely high and low, turning the LED fully on and off, respectively. Anything else will cause the LED to glow dimly during one part of the cycle. The unit is a simple, easy-to-use circuit that can be an important tool for the workbench.

—Kent Ponton,  
Manteno, IL

*Way to go, I like the circuit. Although it is unlikely, it is possible that the 555 being tested is so shot that the LED doesn't glow at all. Of course that could also be caused by a lack of power to the test fixture, so an LED power-on indicator*

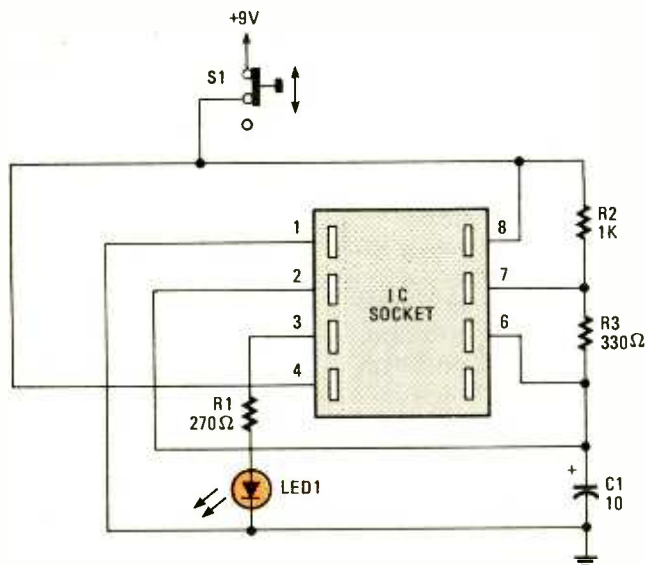

Fig. 2. This test fixture for 555's is a great time saver. Just pop in the suspect IC and watch the LED indicator.

## Earn Your B.S. Degree in ELECTRONICS or COMPUTERS



### By Studying at Home

Grantham College of Engineering, now in our 41st year, is highly experienced in "distance education"—teaching by correspondence—through printed materials, computer materials, fax, and phone.

No commuting to class. Study at your own pace, while continuing on your present job. Learn from easy-to-understand but complete and thorough lesson materials, with additional help from our instructors.

Our Computer B.S. Degree Program includes courses in BASIC, PASCAL and C languages — as well as Assembly Language, MS DOS, CADD, Robotics, and much more.

Our Electronics B.S. Degree Program includes courses in Solid-State Circuit Analysis and Design, Control Systems, Analog/Digital Communications, Microwave Engr, and much more.

An important part of being prepared to *move up* is holding the right college degree, and the absolutely necessary part is knowing your field. Grantham can help you both ways—to learn more and to earn your degree in the process.

Write or phone for our free catalog. Toll free, 1-800-955-2527, or see mailing address below.

Accredited by  
the Accrediting Commission of the  
National Home Study Council

**GRANTHAM**  
**College of Engineering**  
Grantham College Road  
Slidell, LA 70460

# LEARN VCR

## CLEANING/MAINTENANCE/REPAIR

EARN UP TO \$1000 A WEEK, WORKING PART TIME FROM YOUR OWN HOME!



Secrets Revealed!  
NO Special Tools or Equipment Needed.

EARN UP TO \$60 AN HOUR AND MORE!

### THE MONEY MAKING OPPORTUNITY OF THE 1990'S

IF you are able to work with common small hand tools, and are familiar with basic electronics (i.e. able to use voltmeter, understand DC electronics) . . .

IF you possess average mechanical ability, and have a VCR on which to practice and learn. . . then we can teach YOU VCR maintenance and repair!

**FACT:** up to 90% of ALL VCR malfunctions are due to simple MECHANICAL or ELECTRO-MECHANICAL breakdowns!

**FACT:** over 77 million VCRs in use today nationwide! Average VCR needs service or repair every 12 to 18 months!

Viejo's 400 PAGE TRAINING MANUAL (over 500 photos and illustrations) and AWARD-WINNING VIDEO TRAINING TAPE reveals the SECRETS of VCR maintenance and repair—"real world" information that is NOT available elsewhere!

Also includes all the info you'll need regarding the BUSINESS-SIDE of running a successful service operation!

**FREE INFORMATION**  
CALL TOLL-FREE 1-800-537-0589  
Or write to: Viejo Publications Inc.  
5329 Fountain Ave.  
Los Angeles, CA 90029 Dept. PE

CIRCLE 13 ON FREE INFORMATION CARD

# ATTENTION! ELECTRONICS TECHNICIANS



EARN YOUR B.S.E.E. DEGREE

### THROUGH HOME STUDY

Our New and Highly Effective Advanced-Placement Program for experienced Electronic Technicians grants credit for previous Schooling and Professional Experience, and can greatly reduce the time required to complete Program and reach graduation. No residence schooling required for qualified Electronic Technicians. Through this Special Program you can pull all of the loose ends of your electronics background together and earn your B.S.E.E. Degree. Upgrade your status and pay to the Engineering Level. Advance Rapidly! Many finish in 12 months or less. Students and graduates in all 50 States and throughout the World. Established Over 40 Years! Write for free Descriptive Literature.

## COOK'S INSTITUTE OF ELECTRONICS ENGINEERING

4251 CYPRESS DRIVE  
JACKSON, MISSISSIPPI 39212

CIRCLE 11 ON FREE INFORMATION CARD

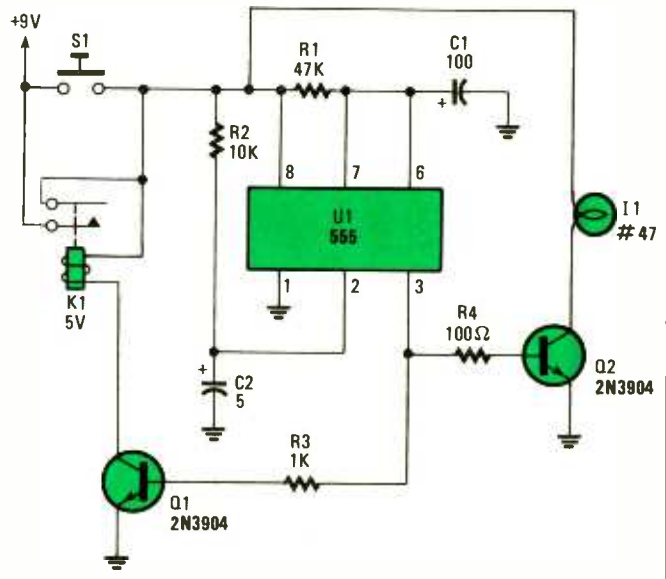

Fig. 3. If you've banged one of your big toes on the dresser enough times to form it into a ping-pong ball shape, then this circuit can at least save your other big toe from the same fate.

would be a nice but simple feature to add.

### A TIMED NIGHT LIGHT

I needed a wall-mounted, battery-powered certain night light to illuminate certain areas in my home. I only needed the light to be on for a brief period of time and since I wanted to use battery power, the current drain had to be kept to the bare minimum. That meant the circuit should draw no current until triggered.

Of course the first thing to come to mind was a 555 wired in a one-shot mode (see Fig. 3). Pressing S1 energizes the circuit. The 555 is triggered by the low that the initially uncharged capacitor C2 presents to pin 2. The capacitor is wired to charge through R2 because the timer will not turn off if the voltage at pin 2 remains low. When the 555 is triggered in that fashion, its output (pin 3) goes high for a length of time determined by R1 and C1. That biases Q2, which turns on I1, and also biases Q1, which energizes the relay. The relay keeps the circuit energized after the push-button, S1, is released until the one-shot times-out, at

which point the circuit shuts down.

Standard components are used throughout the circuit. Although the transistors are shown as 2N3904's, any NPN switching transistors will do. I used a Gordos 5-volt reed relay for K1. I housed the circuit in an 8-ounce opaque dish-shaped food container by mounting the circuit, a 9-volt battery, and I1 on the inside of the snap-on lid. Switch S1 was mounted so that it protruded through the dish portion of the container. The entire assembly was mounted to the wall through a hole in the lid.

The circuit has many more applications including switching high-voltage loads. Lamp I1 could be replaced by an optoisolator to control 117-volt AC loads. Relay K1 could be replaced by a small multi-pole unit capable of controlling several separate devices. For all that, do I get a book?

—J. dePrisco, Hazleton, PA  
You certainly do. For those readers interested in the idea of controlling 117-volt AC power with optoisolators, look back at last month's Think Tank column.

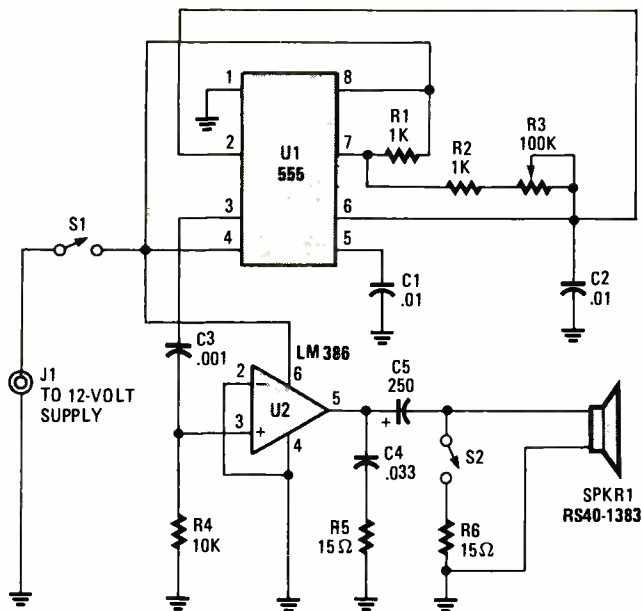

Fig. 4. This is a perfect circuit for the ultrasonic experimenter. However, be cautious and kind when using it; it can cause great pain to pets with sensitive hearing.

### ULTRASONIC-FREQUENCY GENERATOR

I have been an electronics hobbyist most of my life and I find your magazine to be a valuable source of information for designing and building circuits. I had a lot of fun with this circuit and thought your readers might enjoy it also. It's an ultrasonic-frequency generator built around a 555 oscillator/timer IC (see Fig. 4). The 555 functions as

a simple oscillator. Its operating frequency is determined by the values of R1-R3 and C2. Resistor R3 can be used to vary the frequency from 3 to 100 kHz.

The output of the oscillator (pin 3) is fed to U2, an LM386 low-voltage audio-power amplifier, which is used to drive a piezo transducer.

—Mack Hays, Birmingham, AL

Real nice. I hope Radio Shack continues to carry

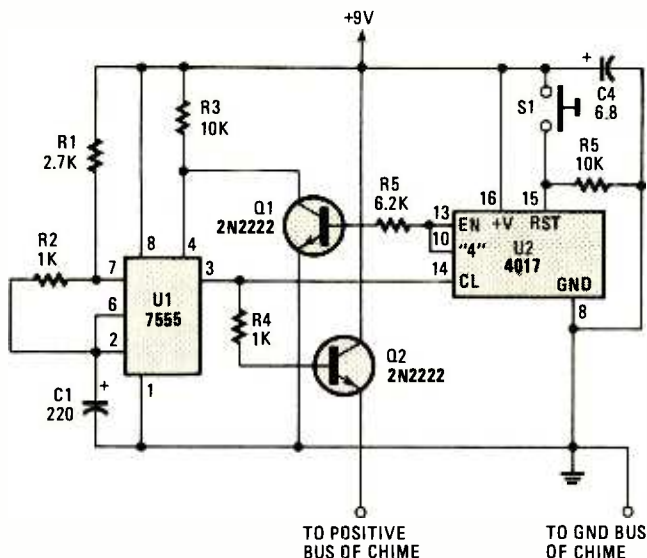

Fig. 5. This add-on to a circuit that appeared in this magazine awhile ago uses the 4017 decade counter in a manner described in this column back in May 1991.

that transducer. It could form the basis of a lot of interesting projects.

### WHOOPIING IT UP

In August of 1987, on page 94, *Think Tank* carried an interesting door-annunciator circuit that emits a nice and compelling "Whoop!" but I thought it should sound-off four "Whoops!" before quitting. So, I came up with an addition to that fantastic circuit (see Fig. 5).

If S1 is depressed, the 7555 (a special relative of the 555, although a regular 555 should do) clocks a 4017 decade counter/divider. It also turns on Q2 for a period of time determined by R2 and C1. That transistor should be used to apply power to the annunciator circuit (which means the old annunciator circuit will no longer need C1 or S1). After U1 goes through four

cycles, pin 10 of U2 goes high and transistor Q1 conducts, bringing the reset input (pin 4) of U1 low, which shuts-down the whole circuit.

—Sid Buck, Key Largo, FL

I'm glad you like the column; and don't worry, there's plenty more where this came from. Those of you that are interested in knowing precisely how the 4017 is used in this circuit should check out the discussion that appeared in the *Think Tank* column in the May 1991 issue of this magazine.

Well friends, as the sun slowly sinks into the west, we come to the end of another month. Happy trails to you and until we meet again, please send your comments, requests, and fruitful efforts to *Think Tank*, **Popular Electronics**, 500-B Bi-County Blvd., Farmingdale, NY 11735. ■

## Protel Easytrax 2™

### Outstanding value in Printed Circuit Board/CAD for your Macintosh and PC

Protel Easytrax 2 is a new, low-cost design package for PC and Macintosh users that includes everything required to produce professional quality Printed Circuit Board artwork.

Our easy-to-learn menu-driven design system breaks the 'expert barrier'—you'll be designing in minutes, not hours. Our comprehensive tutorials guide you through the program's extensive features that take the tedium out of board layout.

- Comprehensive library of Through-hole devices
- Gerber photoplotting and N/C drill tapes
- On-the-fly library components creation
- Intelligent Pad to Pad autorouting
- Switchable Metric/Imperial grid
  - Auto-panning
  - PostScript™ printing
- Powerful user-definable Macros
- Independent print/plot program
- Multi-layer boards of up to 32 X 32 inches.

At Protel, we offer free technical support, 24-hour BBS, and 30-day money back guarantee. Prices start at

**\$450**

**Free Evaluation Package**  
**Toll Free: 800-544-4186**

**Protel Technology, Inc.**  
50 Airport Parkway, San Jose, CA 95110  
Tel: 408-437-7771 Fax: 408-437-4913



CIRCLE 8 ON FREE INFORMATION CARD

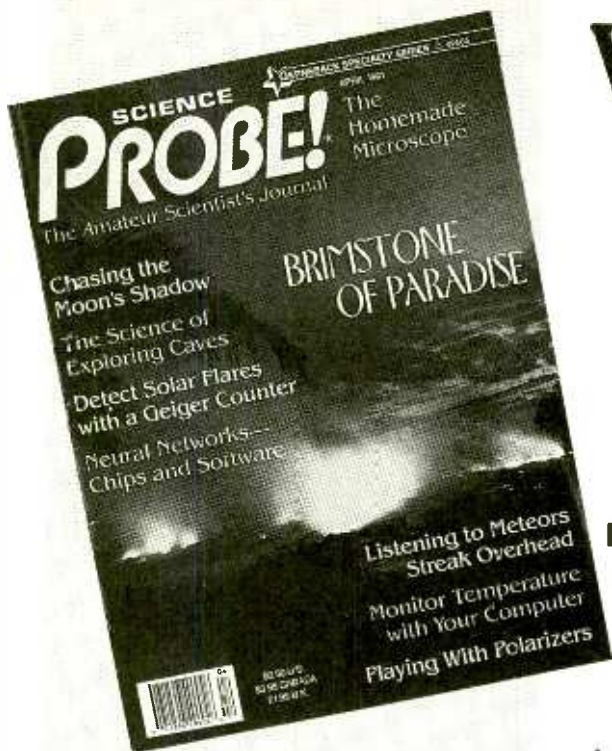

Welcome to . . .

# SCIENCE PROBE!®

The Amateur Scientist's Journal

Embark on an irresistible new journey into the realm of mystery, challenge, and exploration! The perfect magazine for the budding scientist, the serious amateur, the professional who would like to relax, and those who simply want to gaze at the stars.

**Science PROBE!** — the *only* magazine devoted entirely to Amateur Scientists! If you are fascinated by science in all its many forms . . . if you can't stay away from a microscope, telescope, calipers, or test tube — we invite you to share the wonders in every issue of **Science PROBE!** You will join a community of Amateur and Student Scientists who enthusiastically seek scientific knowledge or follow scientific pursuits for their own sakes and not merely as a profession.

Obtain your next issue of **Science PROBE!** by visiting a quality Newsstand, Convenience Store, or Supermarket or by reserving your personal copy through the mail by completing the coupon below.

From your very first issue of **Science PROBE!** you will be involved in a world of scientific facts, experiments, and studies pursued by amateur scientists who are university students, investors, academicians, engineers, or office workers, salesmen, farmers—whose *quest* is to probe into the mysteries of science and reveal them to all.

Plan to become a **Science PROBE!** reader!

Articles to appear in upcoming issues of **Science PROBE!** are:

**How an Amateur Mapped the Milky Way**  
**Make your own Seismometer**  
**Operate a Solar-powered Weather Station**  
**Grow Crystals Automatically**  
**Experiment with a Saltwater Aquarium**  
**How to Keep a Science Notebook**

If you're fascinated by science in all its many forms, if you are compelled to experiment and explore, then **Science PROBE!** is your kind of magazine!

**Science PROBE!**  
 500-B Bi-County Boulevard  
 Farmingdale, NY 11735

Please forward my copy of **Science PROBE!** as soon as it comes off the press. I am enclosing \$3.50-U.S.A. (\$4.23-Canada-includes G.S.T.) plus \$1.00 for shipping and handling. Better still, please enroll me as a subscriber and send the next four (4) quarterly issues of **Science Probe**. I am enclosing \$9.95-U.S.A. (Canada: \$16.00—includes G.S.T.)

Next Issue Only       Next Four Issues (1 Year)

Offers valid in the U.S.A. and Canada only. No foreign orders.

Name \_\_\_\_\_

Address \_\_\_\_\_

City \_\_\_\_\_ State \_\_\_\_\_ ZIP \_\_\_\_\_

All Orders payable in U.S.A. Funds only.

7PK14

**ON SALE AT QUALITY NEWSSTANDS, CONVENIENCE STORES AND SUPERMARKETS**  
**GET YOUR COPY TODAY—\$3.50-U.S.A.—\$3.95-Canada**



The one thing about typical laboratory power supplies is that you can never have too many of them, especially if you do a lot of experimenting. That's because you can't always power everything from one supply, and fixed-output units leave you high and dry when you need a variable voltage source. On top of that, the output of many home-brew variable supplies tend to drift up and down slightly, which is no good at all when you're trying to figure out the optimum reference voltage for some point in a circuit.

With a minimum amount of sweat and wallet shrinkage, we'll show you how to build a power supply with two

BY JOHN YACONO AND MARC SPIWAK

Popular  
Electronics®

OCTOBER 1991



# Build a Precision Dual Power Supply

*Here's how you can build an inexpensive, adjustable, dual-output power supply that's packed with features—invest a little bit more and you can control the output voltage to the nearest 1/100 of a volt!*

variable outputs—one positive, and one negative—that might make you shelve the rest. What's more is that, with the addition of two precision potentiometers, at added expense of course, the supply outputs can be set to the nearest rock-steady 1/100-volt.

**Adjustable Voltage Regulators.** The adjustable voltage regulators readily available today are a veritable boon to any hobbyist building a power supply. Unlike fixed regulators, adjustable units can be programmed to output any voltage within their operating range. (The minimum and maximum of the device varies from model to model and manufacturer to manufacturer.) Furthermore, the devices come in positive and negative "flavors" to suit any reasonable application.

Our power supply uses an LM317 positive adjustable regulator and an LM337 negative adjustable regulator. They can operate from around 1.25 to 33 volts. We buy these versatile little jew-

els in place of fixed regulators simply because they can provide any voltage required. As long as there are one or two of the units around, there's nothing to slow down building any project that may spring to mind.

Furthermore, as regulators go, they provide excellent ripple rejection. They also have a short-circuit shut-off feature: If you short the regulators' output, it shuts down and automatically turns back on when the short is removed. To add to their value, they are easy to use. In Fig. 1A, a positive adjustable regulator is shown with its two programming resistors in place. A negative adjustable regulator is shown in Fig. 1B. For the sake of discussion, we'll talk about positive regulators, but keep in mind that the exact same rules apply for negative regulators; the only difference is that the input and output voltages for negative regulators are (you guessed it) negative.

Resistor R1 is usually chosen to be around 240 ohms to provide optimal

performance, but I have often used 220-ohm resistors without the least bit of trouble. While the value of R1 is pretty standard, the value of R2 determines the output voltage of the regulator according to:

$$V_{OUT} = 1.25(1 + R2/R1) + R2 \times I_{adj}$$

where  $I_{adj}$  (the adjustment current as it's called) is usually between 40 to 50  $\mu$ A. That current is so small that you can often disregard it and use this abbreviated equation:

$$V_{OUT} = 1.25(1 + R2/R1)$$

Since you usually know the voltage you want, let's rearrange the equation to find R2 based on  $V_{OUT}$ :

$$R2 = R1(V_{OUT}/1.25 - 1)$$

There are just a couple of restrictions you should bear in mind while taking advantage of these devices. First, the supply to the regulator should be filtered to supply at least 3-volts rms more than the desired  $V_{OUT}$ . Second, if sub-

OCTOBER 1991

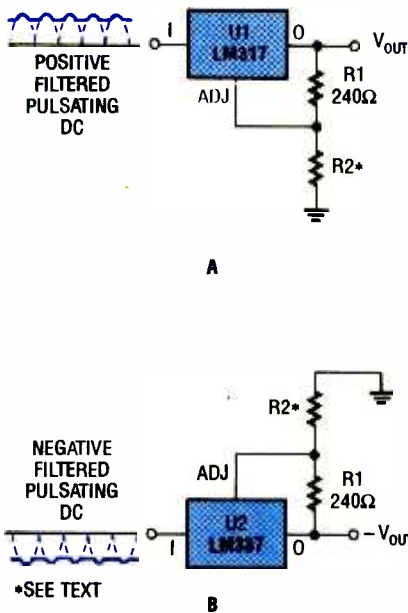

Fig. 1. Adjustable regulators are easy to use. Whether you need a positive (A) or a negative (B) output voltage, you just have to add two resistors and a filtered source of pulsating DC.

### PARTS LIST FOR THE LINE TAMER POWER SUPPLY

#### SEMICONDUCTORS

U1—LM317 positive adjustable-voltage regulator, integrated circuit  
 U2—LM337 negative adjustable-voltage regulator, integrated circuit  
 BR1—2-amp 50-PIV, full-wave bridge rectifier

#### RESISTORS

(All fixed resistors are 1/4-watt, 5% units.)

R1—33,000-ohm  
 R2—5000-ohm, dual potentiometer  
 R3, R5—100-ohm, precision, 10-turn potentiometer  
 R4, R6—220-ohm  
 R7—5000-ohm potentiometer

#### ADDITIONAL PARTS AND MATERIALS

C1, C2—1000-μF, 50-WVDC electrolytic  
 C3, C4—.02-μF, ceramic disc  
 F1—1/10-amp fast-blow fuse  
 NE1—NE-2H neon indicator  
 PL1—3-terminal molded AC plug with line cord  
 S1—SPST toggle switch  
 S2, S3—SPDT toggle switch  
 T1—25.2-volt, center-tapped, 2-amp power transformer  
 Perfboard, enclosure, rubber grommets, alligator clips, heat sinks, fuse holder, wire, solder, etc.

stantial current (more than 1/4-amp) is to be drawn from the regulator, use a heat sink. You should also use a heat sink if the input voltage is to be more than 6-volts greater than the output voltage.

One last thing to be aware of is the fact that adjustable regulators have different pinouts than constant-voltage models. In a similar vein, positive and negative adjustable regulators don't have the same pinouts as one another. That's enough theory for now, let's get to the real circuit.

**The Crux and the Frills.** The transformer's primary in the power supply (see Fig. 2) is connected to the AC line via S1 and F1. The value of F1 has been selected to prevent the secondary (yes, we said the secondary) from producing too much current.

If you choose to use a transformer with a different current rating than the 2-amp unit specified in the Parts List, then you will have to compute the value of the fuse to suit your needs. Most transformers are rated by their primary voltage, secondary voltage, and secondary current. You will need to know the maximum current to permit in the primary that will not damage the secondary. Here is a simple equation that you can use to determine that maximum:

$$I_p = I_s(V_s/V_p)$$

where  $I_p$  is the primary current,  $I_s$  is the

secondary current,  $V_p$  is the primary voltage, and  $V_s$  is the secondary voltage.

You may wish to select a slightly lower fuse capacity for added safety. However, since some of the power produced by the primary is lost in the transformer's iron core, not all of it reaches the secondary. Opinions may vary, but that provides a margin of safety that has proven itself sufficient over the years.

To turn AC into full-wave pulsating DC, most single-sided power supplies have either a center-tapped transformer and two diodes or a regular transformer and a bridge rectifier. Dual supplies usually contain a center-tapped transformer and two bridges. That's the first big difference between our supply and the rest. You'll note that the circuit does have a center-tapped transformer, but only one bridge rectifier. With the mode switch in the "dual" position, that is all the circuitry needs to produce both a positive and a negative voltage simultaneously.

A question you may be asking at this point is does the circuit provide full-wave rectification to both the positive and negative regulators of the supply? The answer is yes. To prove it to yourself, follow the current through the bridge when the top terminal of the secondary is positive and the bottom is negative with respect to the center tap. Then follow the current flow when the polar-

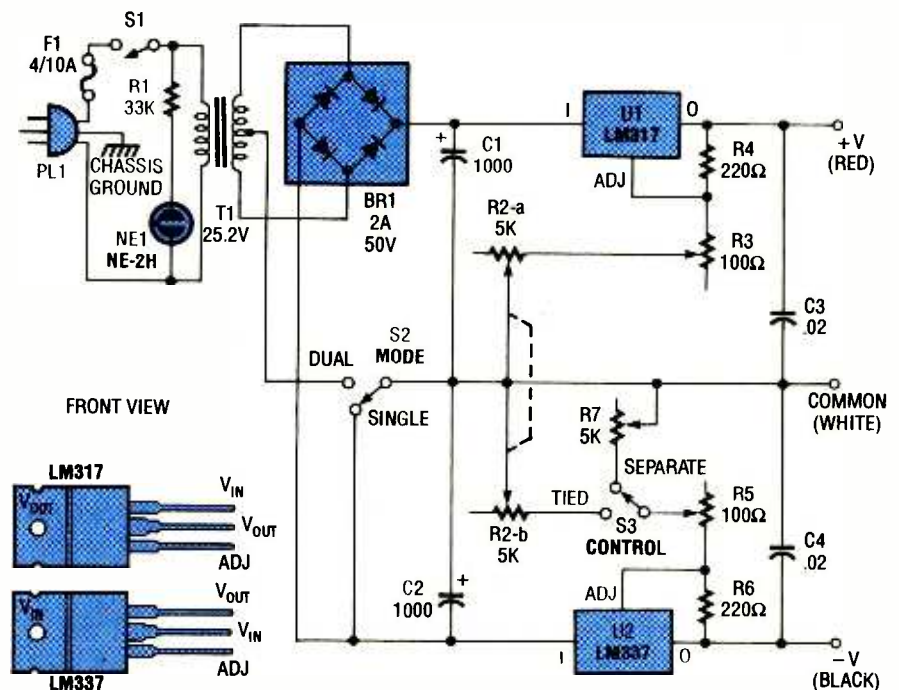

Fig. 2. The adjustable supply uses an unusual combination of bridge rectifier and center-tapped transformer to simultaneously provide positive and negative output voltages.

ity of the secondary reverses. Keep in mind that, no matter what the secondary's polarity is, the center tap is always at zero potential.

By using this scheme, each regulator receives half of the full secondary voltage in dual mode. When S2 is in the "single" position, the negative supply is shut down and the positive regulator receives the full secondary voltage. That turns the unit into a formidable single-ended power supply capable of driving 1.5-amps at about 17 volts. The voltage output increases to over 30 volts for lighter loads.

Regardless of whether the unit is operating in dual or single mode, the positive-supply voltage is determined by potentiometers R2-a and R3. They act as coarse and fine voltage-adjustment controls, respectively. Potentiometer R3 is a multi-turn device that allows you to easily set the output voltage to the nearest 1/100th of a volt. The extra precision is great at times when you need a precise reference voltage. If this feature is not important for your applications or seems too expensive to add, you can simply leave out R3.

The adjustable negative regulator is controlled in the same way, but S3 lets you choose between two coarse voltage controls: R2-b and R7. Potentiometer R2-b is ganged with R2-a (they form a stereo potentiometer), so if S3 is set to the "tied" position, the positive and negative supplies are adjusted simultaneously. That is useful when you need balanced supplies, such as for op-amps. In that mode, you can use the high-precision potentiometers to precisely adjust the balance. If the high precision feature is too much, you can leave out R5.

With S3 in the separate position, R7 acts as the negative-voltage control and R2 adjusts only the positive supply. This is useful for when the positive and negative voltages are not supposed to match. Of course R5 still acts as a fine-adjustment control.

Capacitors C1 and C2 filter the pulsating DC into a more manageable form for the adjustable regulators. The two capacitors at the outputs (C3 and C4) help eliminate any destructive transients presented to the two power leads.

**Construction.** Building the power supply is quite simple because very few components are required. We chose to mount the parts on a piece of perforboard using point-to-point wiring to in-

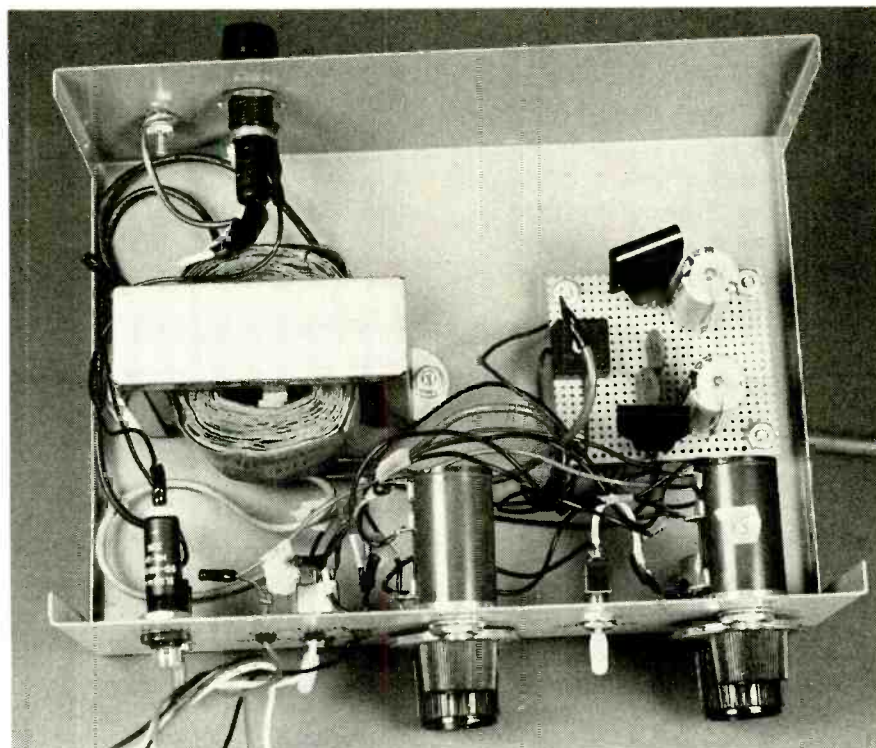

Here's what the inside of our unit looks like. If you work neatly, you'll end up with a very reliable unit.

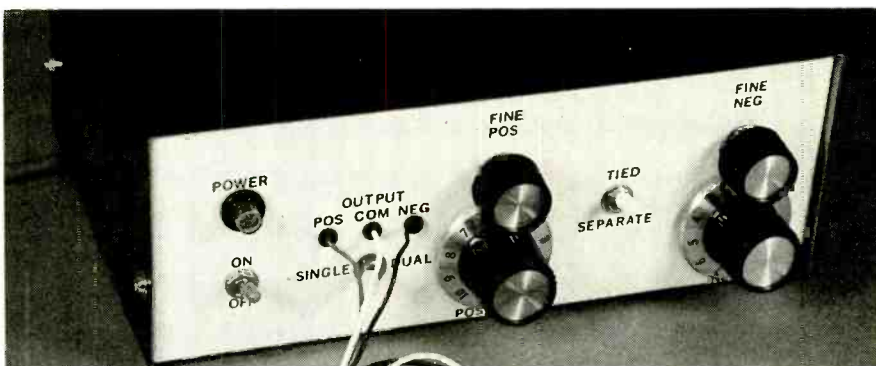

The front panel is neatly and logically laid out, so the controls are where you might expect them to be.

terconnect the various components. Because all of our controls can be mounted from the inside of the cabinet, we were able to fully assemble the board and all controls before installing them in the cabinet.

The size of the cabinet was chosen mainly for the size of the transformer—the circuit board itself is actually quite small. Also, the multitude of controls requires a lot of space on the front panel. Once you choose a cabinet, don't start drilling holes right away. First you should carefully lay out the drill points according to the controls you use. Also, try to position the controls in somewhat logical locations. You can copy our design if you like.

Although most power supplies have binding-post outputs, you always end up having to connect a lead to them

anyway. So for the sake of convenience, we decided to have alligator-clip-equipped leads coming directly out of the cabinet—a red one for the positive output, a white one for the common, and a black one for the negative output. Because of the unique shut-down feature of the voltage regulators, shorting is not a concern with this project.

A neatly drilled cabinet deserves neat labeling. Dry-transfer (rub-on) lettering looks good, and is pretty durable if you burnish it down when finished. Clear lacquer makes it permanent. Four rubber feet complete the job. It's the small details that lead to a good-looking, high-performance, easy-to-use lab supply. And one that will have a home on your workbench for years to come.

# How Wireless

**T**he wireless operators aboard ships within several hundred miles of Brant Rock, Massachusetts must have been astonished on Christmas Eve in 1906. Instead of the crackling of telegraph signals, they heard a voice and then music coming through their receivers for the first time ever. The ships had been alerted earlier by a telegraph message from Reginald Fessenden's Brant Rock station that a special transmission would be coming. But who could have imagined this?

Quickly, others aboard the ships crowded in to hear for themselves this first true broadcast of what would become known as "radio." The quality of the transmission was not outstanding by today's standards, but no one complained. They knew they were witnessing an amazing breakthrough in technology. They very likely could not imagine, however, the impact this new technology would have on the lives of countless people.

**Proudly Canadian.** Reginald Aubrey Fessenden was born on October 6, 1866 in East Bolton, a town in what is now Quebec. While he would live much of his adult life in the United States and eventually would become a U.S. citizen, Reginald Fessenden always proudly considered himself Canadian.

Consistently a serious and highly accomplished student, young Reginald excelled in mathematics and the classical languages. He entered Bishop's College in Lennoxville, Quebec at the age of 15. Fessenden's mathematical abilities were so advanced that he was given credit for the first year's courses merely by passing the final examinations. He was awarded a senior mastership in mathematics and taught low level college mathematics while he was studying more advanced topics. Reginald regularly read the magazines *Scientific American* and *Nature*. He was interested in the new "science" of electricity and in becoming an inventor.

In 1884, when he was not yet eighteen, Fessenden had completed most of the requirements for a college degree. Financial and health considerations, together with the desire to begin carving out a career, caused him to accept an offer to be the principal (and only teacher) at the Whitney In-

*When Reginald Fessenden demonstrated radiotelephony in would have any practical uses.*



# Got its Voice

*1906, few thought it ever*



stitute in Bermuda before completing the remaining degree requirements.

While Fessenden taught at the Whitney Institute, his fascination with electricity and the desire to be an inventor kept growing. After two years, it was clear to Reginald that he needed a career with brighter prospects for an adequate income and wanted a career that would allow him to pursue his electrical and inventing interests.

Fessenden knew electricity held the promise for producing a number of inventions for which the public would provide the market. Thomas A. Edison and others already had proven that point. But, if he was going to become a successful inventor of electrical devices, Reginald was aware that he had to learn much more about both electricity and inventing. He, therefore, headed for New York City in 1886, apparently with the brash idea of learning the science of electricity and the art of inventing from none other than Thomas A. Edison.

Fessenden was aware that he had to learn more about electricity before he would have any chance of being hired by Edison. So upon arriving in New York, he tried earning enough to sustain himself through jobs as a writer while studying electricity in his free hours.

After a few months of frustration and disillusionment as a writer, Fessenden decided he might as well seek employment with Edison immediately. At the Edison Company's New York office, Fessenden was told that Edison was spending most of his time at the Company's Lamp Works in Harrison, New Jersey.

When he arrived at the Lamp Works, Fessenden submitted his business card together with a piece of paper on which he had been told to state his business. These were taken to Edison in his laboratory. Reportedly, the paper came back with "What do you know about electricity?" written by Edison.

Fessenden knew that he possessed a solid mathematical background, but that his knowledge of electricity obviously was not up to Edison's standards. Not wishing to overstate his qualifications, Reginald replied "Do not know anything about electricity, but can learn pretty quick." The piece of paper soon returned with Edison's comment, "Have enough men now who do not know anything about electricity."

**Fessenden Keeps Trying.** Disappointed, but not discouraged, Fes-

senden went back to New York City and continued his attempt to support himself as a writer. Every week, however, he visited the Edison Machine Works in New York to see if there were any openings. Persistence paid off and Fessenden was eventually hired as an assistant tester for the Edison Company's underground electrical mains-laying project in the city.

Fessenden worked diligently at his job and studied electrical theory during his lunch breaks. His hard work and ingenuity in developing more efficient ways for the crews to do their jobs did not go unnoticed. Very quickly, Reginald was promoted; first to tester, then to chief tester, and finally to inspecting engineer for a section of the work. He had earned the attention and respect of his supervisors.

After the project was completed at the end of 1886, Reginald Fessenden was offered his choice of a job with the Edison Company in Schenectady or at its Llewellyn Park Laboratory in West Orange, New Jersey as one of Edison's assistants. Needless to say, Fessenden chose to work with Edison.

Fessenden very quickly impressed Edison by developing an inexpensive and fireproof insulating material for the wire windings of dynamos. Reginald then developed a glass-blowing machine that greatly reduced the cost of making incandescent lamps. He also worked with Edison on the development of talking movies.

When seeking a solution to a problem, Fessenden followed the same approach used by Edison: he first tried to read everything in print that was known about the subject, and then go to the laboratory and try all the possible (and some seemingly impossible) combinations of materials and techniques. Merely finding a solution was not enough; Like Edison, Fessenden would not rest until the *best* solution was found.

In time, Heinrich Hertz's experiments with electromagnetic waves attracted Fessenden's interest. Reginald carefully read all of Hertz's writings on these intriguing waves. He obtained Edison's permission to conduct experiments on high-frequency electromagnetic oscillations, but financial problems caused Edison to close the Llewellyn Park Laboratory in 1890 before the experiments could begin.

### From Edison to Westinghouse.

Reginald Fessenden had received a number of offers for higher paying jobs

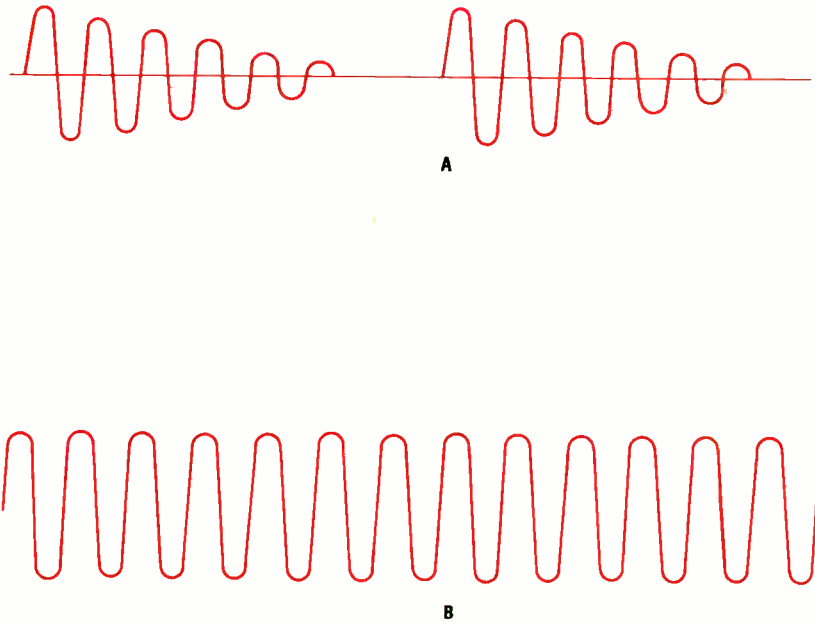

Fig. 1. Pulses of damped oscillations (A) generated by spark gap transmitters differed significantly from the continuous oscillations (B) Fessenden sought.

over the years, but he had turned them down for the privilege of continuing his work in the environment of scientific investigation and invention provided by Edison. But, now that the opportunity to work with Edison no longer existed and he planned to get married soon, Reginald had to think in terms of both pursuing his scientific interests and earning a more substantial income. A job in Newark offered by the United States Company, a branch of Westinghouse, provided the needed salary and the opportunity to design both AC and DC electrical equipment.

One of Fessenden's first major accomplishments in his new job was the discovery of a new insulating material. It substantially reduced the number of dynamos returned to the company for repair. Probably more important to his later career, however, was Fessenden's discovery of a new silicon iron alloy. The metal produced very low eddy current and hysteresis losses when used in AC motors and generators.

Interestingly enough, Fessenden also developed a technique for using the same alloy in making the glass-to-metal seals needed for the lead-in wires of incandescent lamps. This breakthrough allowed Westinghouse to produce lamps that did not infringe upon Edison's patents. The lamps later enabled George Westinghouse to meet his contract for lighting the 1893 Columbia Exposition in Chicago. Providing the lights for the exposition enhanced the image

of the Westinghouse Company and earned Fessenden the lasting gratitude of George Westinghouse.

### Back to the College Scene.

Alternating current was beginning to come into wider use. Fessenden kept abreast of the then-developing AC theory, as well as the work of Hertz, both on the job and in his spare time. He took a job with the Stanley Company of Pittsfield, Massachusetts late in 1891 where he could apply his knowledge to the design of AC motors and transformers.

Unfortunately, the Stanley Company soon fell on hard times due to the economic panic of 1892. When offered the chair of Purdue University's electrical-engineering program, he readily accepted. The prospect of coupling teaching with his own research interests was very appealing.

The following year, Fessenden received an offer to teach electrical engineering at the Western University of Pennsylvania (now the University of Pittsburgh). George Westinghouse had recommended Fessenden for the position and offered to provide financial and other material support for Reginald's research. Fessenden eagerly accepted the offer.

University life appealed to Reginald Fessenden. He enjoyed teaching students and having them help him with his electrical research very much. While at Pittsburgh, Fessenden developed a

micro-photography technique for recording and storing printed documents. This technique has evolved into the microfilm and microfiche methods used today. He also made some important contributions to the development of equipment for using the then recently discovered X-rays to check the uniformity of steel used in Navy ships.

**An Idea Begins.** Fessenden maintained his interest in AC electronics, particularly because it held promise for long distance communication via electromagnetic waves. Telegraphy was thought by most at the time to be the only way electromagnetic waves could be used for wireless communications. Reginald Fessenden, however, was already beginning to think about a grander form of communications system: wireless telephony.

A thorough study of the "coherer," the most commonly used wireless telegraphy detector of the day, was carried out by students under Fessenden's direction to determine its suitability as a detector of wireless telephony signals. The coherer consisted of a thin glass tube filled with metal filings. The tube had an electrode at each end. When connected to an antenna and no wireless signal was received, the coherer acted as an open circuit. When the antenna delivered a strong signal, however, the coherer became a short circuit. The coherer was not very sensitive and required tapping between each telegraphic dot or dash to restore its detecting ability.

Fessenden soon realized that the coherer could not be made into a suitable detector for wireless telephony. What was needed was a more sensitive detector that operated continuously, not intermittently. Also, the desired detector needed to provide an output that was proportional to the received signal. These things the coherer could never do. Fessenden knew that he, himself, would have to develop the needed detector.

Other serious problems stood in the way of the development of wireless telephony. The spark transmitters in use at that time produced pulses of damped oscillations. The pulsed oscillations used occurred at audio frequencies in what we now call the low radio-frequency range. So the keyed signal received was a single audio tone. Since a tone of one frequency could be sent, Fessenden was convinced that the transmission of voice and music also

might be possible. However, he knew that the amplitude modulation necessary for wireless telephony could only be achieved if the transmitter produced undamped, continuous radio-frequency oscillations. The difference between the pulses of damped oscillations produced by a spark transmitter and the undamped, continuous oscillations Fessenden wanted are shown in Fig. 1.

It was apparent to Fessenden that spark-transmitters would not be suitable for another reason: the noise that resulted from the spark discharge would drown out the desired audio-frequency modulation.

Elihu Thomson had devised and patented an oscillating arc discharge in 1892, which produced distorted, but continuous, oscillations. Others attempted to refine the oscillating arc, but the technique could not produce oscillations of great enough frequency to be useful for wireless transmissions.

### **An Alternator is the Answer.**

Reginald Fessenden began to think that the ideal source of the continuous sinusoidal oscillations he needed would be an alternator or AC generator. However, it would have to be capable of producing a high-frequency output. Such an alternator would require a very large number of poles and would have to operate at an extremely high rotational speed to produce the power at the frequency Fessenden wanted. The frequency would have to be at least 100,000 cycles per second.

It was not at all clear at the time how, or even if, such an alternator could be constructed. John Ambrose Fleming (who would one day develop the diode-valve detector) maintained that such an alternator could not be built and would not produce useful radiation anyway.

Many others firmly believed that the thought of any kind of wireless telephony system was pure fantasy. Even if such a system could be developed, people argued, who would want it? There would be no means for automatically making a permanent record of the message on paper as there was with the telegraphy systems then in use. Undiscouraged, he began making plans for both the improved detector and the alternator he sought.

Although Fessenden had some knowledge of the design of AC rotating machines operating at power-line frequencies, the design of a high-frequency

alternator would require more expertise than he, alone, could provide. He would have to get some outside help.

It was natural that Fessenden first approached Westinghouse to design his alternator. The Westinghouse Company declined, perhaps because they already were heavily involved in the design and manufacture of the alternators to be used at the Niagara Falls power plant.

The only logical choice remaining was the newly formed General Electric Company with the brilliant Charles Proteus Steinmetz as its expert on the design of alternating-current machines.



*Thomas A. Edison helped Reginald Fessenden learn about both the "science" of electricity and the art of inventing.*

Steinmetz was eager to tackle the problem, but designing and building the device would take several years.

In the spring of 1900, Fessenden decided to leave his university position in Pittsburgh. He had acquired some acclaim in wireless telegraphy and was offered a job with the U. S. Weather Bureau. His assignment was at Cobb Island, Maryland where he was to develop a wireless telegraph system that would enable remote stations to report and exchange weather conditions and forecasts.

The Weather Bureau had no interest in any farfetched schemes involving wireless telephony. Fessenden, therefore, had to confine his telephony research to his spare time and keep it unknown to his Weather-Bureau supervisor.

**The First Wireless Telephony Transmission.** While his plans for a high-frequency alternator were still very much in the beginning stages, Fessenden had formulated another plan for producing wireless telephony. He realized that if a spark transmitter produced pulses at a frequency higher than the audio to be transmitted, it might be possible to use it for crude, but acceptable, wireless telephony.

Utilizing the skills of a Pittsburgh craftsman whose abilities he respected very highly, Fessenden had an "interrupter" made to accomplish this feat. The interrupter was to act as a rotary mechanical switching device to increase the spark rate of the transmitter to about 10,000 pulses per second. While this was not out of the audible frequency range, it was above the voice frequencies Fessenden intended to send.

Toward the end of 1900, Fessenden set up his interrupter-equipped transmitter with a carbon microphone in the antenna circuit at Rock Point, Maryland. Another antenna, this one connected to a receiver equipped with a continuous-acting but low sensitivity detector Fessenden had developed, was set up about a mile away with Fessenden's assistant listening for Reginald's voice.

Fessenden succeeded in transmitting very noisy, but intelligible speech with this arrangement. The experiment earned Fessenden credit for the first successful wireless transmission of speech. As Fessenden's Weather-Bureau superiors would have taken a dim view of these activities, no account of this experimental success was reported until several years later.

Many improvements would be needed before this approach could produce wireless telephony of acceptable quality. The interrupter did not provide the switching rate hoped for and the oscillations still were too highly damped. At a minimum, the switching rate would have to be doubled and the amount of damping of the oscillations would have to be greatly reduced. Fessenden clearly knew, however, that even if these changes could be made, a spark generator would never produce the continuous waves he needed. A high-frequency alternator was still the device of choice.

**The Needed Detector.** The next major success toward achieving a practical wireless telephony system came in 1902 at Roanoke Island, North Carolina. Fessenden had been sent there by the



*Even though Reginald Fessenden has done so much to advance electronics, how many school children would know him from this photograph?*

Weather Bureau to set up a wireless telegraphy station. Still pursuing his own research on the side, he succeeded in developing a detector that possessed the qualities he was seeking: the "liquid barretter," as he called it, provided continuous reception and an output proportional to the received signal. In addition, it was significantly more sensitive and reliable than the coherer or any other detector then available.

The liquid barretter design evolved, literally by accident, from a "hot-wire barretter" Fessenden had developed while still in Pittsburgh and had used in his 1900 Rock Point wireless-telephony experiment. The hot-wire device consisted of a short length of very thin, silver-coated platinum wire bent in a "U" shaped loop and enclosed in an evacuated glass envelope (see Fig. 2). The

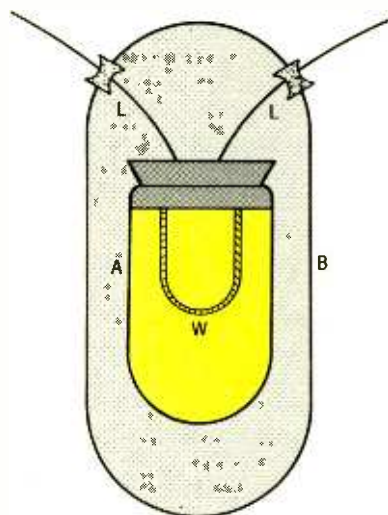

*Fig. 2. Fessenden's hot-wire barretter provided continuous detection but was not very sensitive. The device was made up of lead-in wires (L), a wire loop (W), an evacuated inner envelope (A) and a silvered outer bulb (B).*

glass envelope was enclosed in a silvered glass bulb to shield the wire from external radiation. The middle of the wire loop had its silver coating removed by nitric-acid etching.

A wireless signal passing through the hot-wire barretter caused its resistance to change. That produced an audible response in a telephone earpiece connected between the barretter and ground, in series with a battery and a resistor.

The hot-wire barretter detector was about as insensitive as the coherer, but it was continuous in operation and did provide a response that was approximately proportional to the intensity of the signal received. Fessenden was awarded a patent on the hot-wire barretter in 1902.

Good fortune struck in early 1902 when a wire filament being prepared for a hot-wire barretter was inadvertently left too long in the etching acid. A meter connected to the wire to monitor the etching process responded very strongly to electromagnetic waves being produced in the laboratory. The acid had completely dissolved the wire, leaving only a stub of the platinum making contact with the acid. Thus was born the "liquid barretter."

Basically, the liquid-barretter detector in operational form consisted of a short length of fine platinum wire and a small pool of 20% nitric acid solution. The tip of the wire barely penetrated the surface of the acid solution. The basic features of the liquid barretter are shown in Fig. 3.

The liquid barretter was not without its drawbacks, however. The need to have the wire tip make shallow contact with the acid solution made operation difficult on a ship rolling in a stormy sea. Nonetheless, Fessenden's liquid barretter was the standard to which other detectors were compared for many years until de Forest's triode audion detector, which after considerable refinement, became the standard.

A patent on the liquid barretter was issued to Fessenden in May of 1903. Many infringements of his liquid barretter patent occurred, however. One of the most serious violations was perpetrated by Lee de Forest. A Federal Court ultimately affirmed Fessenden's rights and ordered Lee de Forest to stop the infringement. However, this did not occur until de Forest already had sold a number of the devices to the U.S. Navy and others as a sensitive detector for wireless telegraphy reception.



Fessenden succeeded in developing a much improved wireless telegraphy system for the Weather Bureau. So much better in fact, his supervisor ordered him to share the patent rights. When Fessenden refused, the result was predictable. Reginald Fessenden's employment by the Weather Bureau was terminated in August of 1902.

A few months later, two wealthy men from Pittsburgh, named Given and Walker, offered to supply the financial backing that would enable Fessenden to further develop and market his wireless telegraphy and telephony systems. The three men formed the National Electric Signaling Company (NESCO). That provided Fessenden with the opportunity he had been seeking.

**The Heterodyne Principle.** The liquid barretter worked well for detecting either wireless telephony or spark-generated wireless telegraphy signals. Fessenden, however, knew that it had a serious drawback for use in a wireless-telegraphy system using undamped waves. The barretter would produce only a click in the telephone earpiece if the keyed signal consisted of continuous oscillations (or waves) rather than the pulses of damped oscillations occurring at an audio frequency. Fessenden understood well that undamped, continuous waves (CW) would be desirable for both wireless telegraphy and telephony, because they can be selectively tuned via resonant circuits.

After studying the problem, Fessenden arrived at a solution that eventually would be recognized as a milestone in wireless technology. He realized that if the continuous-wave telegraphy signal to be detected was combined ("mixed") with continuous waves of a slightly different frequency generated at the receiver, an audible note or tone would be produced.

Using his knowledge of languages, he coined the word "heterodyne" to describe the phenomenon. The word has its foundation in the Greek *heteros*, which means "different," and *dynamis*, which means "power."

The result of heterodyning, or mixing, two signals of frequencies  $f_1$  and  $f_2$  is the production of two additional signals of frequencies  $f_1 + f_2$  and  $f_1 - f_2$ , respectively. The new frequencies are called "beat" frequencies. (Other signals also are produced, but the two resultant frequencies mentioned are the important ones.)

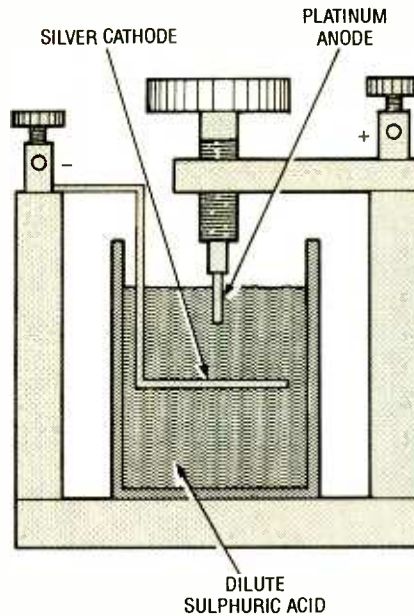

Fig. 3. The liquid barretter provided both the continuous detection and the sensitivity Fessenden wanted.

This idea of Fessenden's to heterodyne two signals truly was insightful. The principle still is commonly used in the superheterodyne receivers of today. At the time, however, detection of the damped oscillation pulses from the spark transmitters did not need the heterodyne principle. A stable source of sinusoidal high-frequency waves would still have to be developed before CW telegraphy would be feasible.

Fessenden, however, was able to demonstrate the fundamental merits of the heterodyne principle by using an arc, which was both noisy and lacking

in frequency stability, as his source of local oscillations at the receiver. The combination of the receiver's telephone earpiece and the human ear provided the necessary mixing of the signals to provide an audible tone. However, the poor quality of the arc-generated oscillations seriously degraded the audio output of the heterodyne receiver.

**The First Alternator is Tried.** A high-frequency alternator designed by Steinmetz was delivered in 1903. It produced one kilowatt of power, but at a frequency of only 10 kHz. The signal generated had neither the audio quality nor the range Fessenden sought. He wanted an output of 25 kilowatts at a frequency of 150 kHz! These requirements could not be met quickly or easily. Charles Proteus Steinmetz then turned over the job of redesigning the alternator to Ernst Alexanderson, a young engineer at GE who had already shown considerable talent.

Alexanderson took on the task enthusiastically. Studying both Fessenden's requirements and some of his design suggestions, Alexanderson discarded many traditional alternator-design approaches, which seemed unworkable at the frequency specified. The first goal would be to achieve the output frequency Fessenden wanted. Achieving Fessenden's desired output power would have to come later.

**Two-way, Trans-Atlantic Wireless Telegraphy.** Demonstrating the advantages of improved wireless telegraphy with the intent of marketing it commercially was an important goal of the NESCO organization. What more convincing demonstration could they provide than two-way, trans-Atlantic telegraph communications? That being so, the work of Fessenden and his NESCO staff continued while they waited for the alternator to be built.

A rotary spark-gap transmitter and Fessenden's improved receiving system were set up at Brant Rock, Massachusetts. An identical station also was built at Machrihanish, Scotland. A 400-foot high antenna of Fessenden's own design was erected at each station. Tests of the system were begun near the end of 1905. The Brant Rock station was first heard at Machrihanish on January 2, 1906.

On January 10, after Brant Rock finished its transmissions, the Ma-

(Continued on page 106)

#### Books and Articles

*The Continuous Wave: Technology and American Radio*; By Hugh G. J. Aitken, Princeton University Press, 1985.

*History of Radio to 1926*; By Gleason L. Archer, The American Historical Society, 1938.

*Fessenden - Builder of Tomorrows*; By Helen M. Fessenden, Coward-McCann, Inc., 1940.

"Wireless Telephony," By Reginald A. Fessenden, *Proceedings of the American Institute of Electrical Engineers*, Vol. XXVII, No. 7, July, 1908.

*Old Wires and New Waves*; By Alvin F. Harlow, D. Appleton Century Co., 1936.

*Early Radio Wave Detectors*; By Vivian J. Phillips, London, The Institution of Electrical Engineers, 1980.

*Radio's First Voice*; By Ormond Raby, Macmillan of Canada Ltd., 1970.

Multimeters are wonderful instruments, but they have their limitations.

Learn what not to expect from them in this informative article.

If you are actively engaged in electronics, either professionally or as a hobby, then it is a good bet that you will at some time use a voltmeter for making measurements in a circuit. It is very easy to take the meter reading as absolute truth, especially when the instrument is high priced. After all, the meter is an "authority figure" of sorts, and it couldn't lie to you... could it? You bet it could! Real meters often read something other than the voltage in the circuit and convert that into a hopefully equivalent voltage reading. There are certain situations that can affect the accuracy of this conversion process and thereby lead you astray. Understanding the conditions that produce such inaccuracies can prevent you from unknowingly taking erroneous readings.

In this article, we will look at common multimeters (*i.e.*, those meters that contain an AC/DC voltmeter, ohmmeter, and current meter all in one package). There are three different forms of multimeter on the market: analog volt-ohm-milliammeters (VOMs), electronic analog multimeters, and digital multimeters (DMMs). We will concentrate mainly on the performance of VOMs and DMMs because they are the most common forms currently on the market, and the most dissimilar to each other.

**How Meters Work.** An analog VOM contains an electro-mechanical DC meter movement. The basic meter has a full-scale current range, such as 0 to 100  $\mu$ A, or 0 to 1 mA. A resistor connected in parallel with the meter movement increases the full-scale current range. A "multiplier resistor" in series with the basic meter movement makes the current meter into a voltmeter. If a rectifier is used with the meter, then it will read alternating current instead of direct current. That's all there is to an analog meter.

A digital multimeter is completely dif-

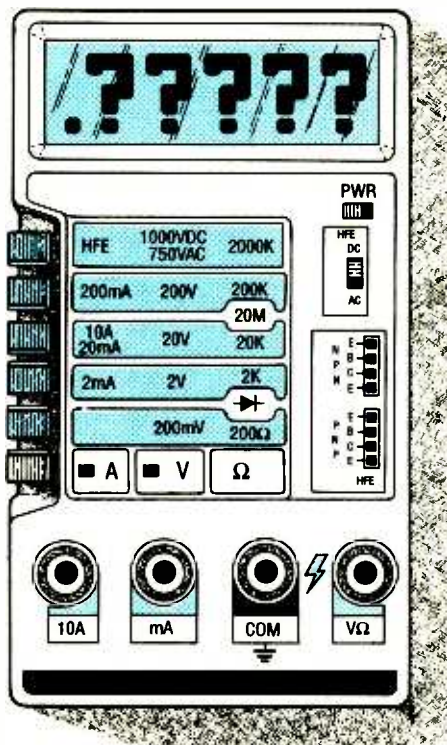

# Does Your Meter Lie To You?

BY JOSEPH J. CARR

ferent. In this type of instrument, an integrating analog-to-digital (A/D) converter is used to measure the applied voltage by comparing it to an internal precision reference voltage. So while an analog meter senses current, a DMM is sensitive to voltage. In order to measure current, a tiny resistance is placed in series with the load and the DMM measures the voltage drop across this standardized resistance and converts it to a current measurement.

There are two basic designs for the integrating A/D converter: a single-slope integrator and a dual-slope integrator. Of these, the latter is considered the better for most applications.

An example of a single-slope integrator is shown in Fig. 1. The principal components of this circuit are an input amplifier, a Miller integrator, a comparator, a main gate, and a binary counter. The input amplifier may or may not be used in any given single-slope integrator. It is optional, and is merely used to scale the input signal to a level that optimizes the operation of the integrator circuit—too-small a signal would take a long time to charge the integrator capacitor. For the sake of discussion, we will assume that the input amplifier has a gain of unity, so the input

to the integrator is the unknown input voltage  $V_x$ .

The Miller integrator uses an operational amplifier and a resistor-capacitor combination to produce an output voltage ( $V_1$ ) that is proportional to the integral (*i.e.*, time-average) of the applied input signal. That signal is then sent to the comparator.

A comparator is sometimes called an amplifier with too much gain. Indeed, we can make a comparator using an operational amplifier with an open feedback loop. An amplifier operating in this manner can have a gain of 50,000 to over 1,000,000 depending on the quality of the unit. Obviously, a few millivolts of input signal will saturate the output of such an amplifier. That is how a comparator operates: it produces an output level that indicates when the two input voltages are equal (*i.e.*, output zero) or which of the two is highest. In the limited case shown here, one input of the comparator is grounded (at zero volts potential), so the output will be zero when  $V_1$  is zero and high when  $V_1$  is more than a few millivolts higher than ground. When the output of the comparator is high, the gate is enabled and can pass pulses from the clock to the counter provided that the

"start-logic" pulse (the function of which will become obvious in a moment) is also high.

The counter will have either binary or BCD formats (the BCD format is used in voltmeter digital converters) and thus can be connected to a digital-display device such as an LCD panel. An overflow indicator is used to denote when the input voltage is overrange.

The start logic generates a pulse that closes switch S1 briefly in order to discharge capacitor C1 so that no accumulated charge will foul the results. Switch S1 is then opened, allowing C1 to begin charging at a rate that is determined by the input voltage  $V_x$ . As soon as the integrator output voltage is more than a few millivolts higher than ground, the output of the comparator will snap high, enabling the gate.

The start logic then transmits a pulse to the gate that completely enables it, so the gate allows a clock pulse to flow into the counter. The start pulse stays on for a period T and prevents the integrator from continuing to charge until the counter overflows. The count (or data) at the end of the timing period is proportional to the applied voltage, so at the end of the count the display is enabled to show the count.

One major problem with the single-slope integrator is that it is sensitive to noise riding on the input signal. A noisy signal will usually produce an erroneous result.

The dual-slope integrator of Fig. 2 solves the noise problem. The principal difference between the two converters is that the dual-slope converter makes the conversion in two steps. During the first step, the integrator is charged from the unknown input signal  $V_x$ . The output voltage of the integrator continues to rise as long as the input switch S1 is connected to the input amplifier. The binary/BCD counter is allowed to overflow, and this overflow signal tells the control logic circuits to switch S1 to position B, the output of a precision reference-voltage source. The polarity of this voltage is such that it will cause the integrator to discharge at a fixed rate.

The counter state at the instant the switch is changed is 0000 and begins incrementing from there. The counter will continue to increment until the reference source completely discharges the integrator capacitor. At that instant, the output of the comparator will drop low again, thereby stopping the flow of clock pulses to the counter. The state of the counter output at that instant is pro-

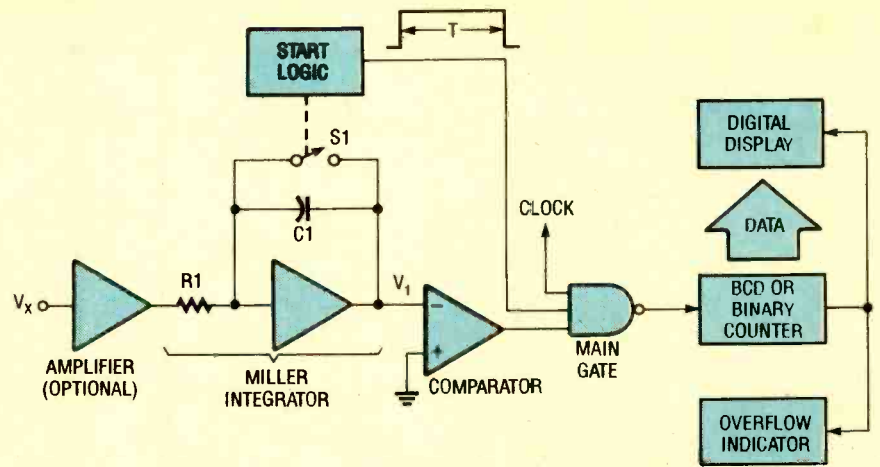

Fig. 1. A meter with a single-slope integrator design, like that shown here can be accurate, but not in situations where a lot of noise is present.

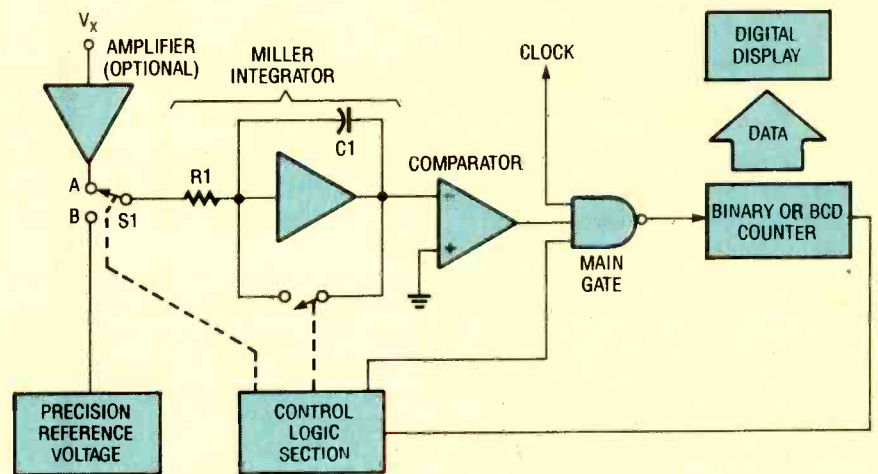

Fig. 2. A dual-slope integrator based meter can integrate-out noise to give more accurate readings than a single-slope device.

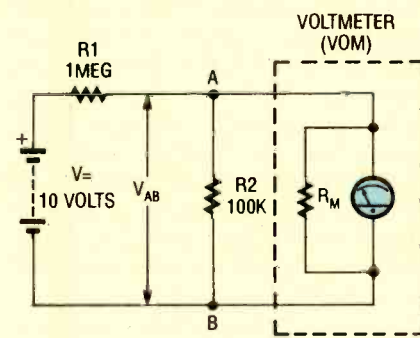

Fig. 3. A meter's internal resistance loads the circuit under test down, which can cause significant errors in measurement.

portional to the input voltage,  $V_x$ .

Since the counter state occurred as the result of a constant integrator-output discharge slope, it will not contain noise errors. The noise errors are integrated out of the data by the action of the integrator. Now let's take a look at some problems that can occur with VOM's and DMM's.

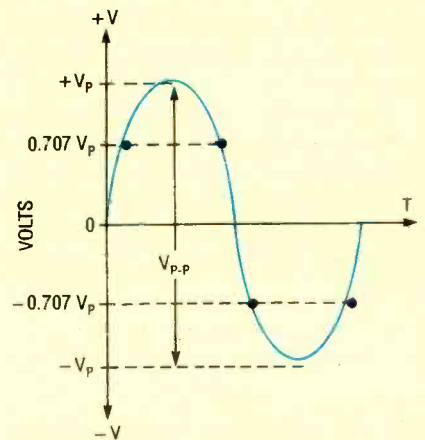

Fig. 4. What voltage should be read off this sine wave: rms, peak, or peak-to-peak?

**A Built-in VOM Defect.** A VOM can fool you in some circuits, especially when the circuit impedances are high. The problem is related to the sensitivity of the instrument. The sensitivity of the VOM is based on the impedance of the

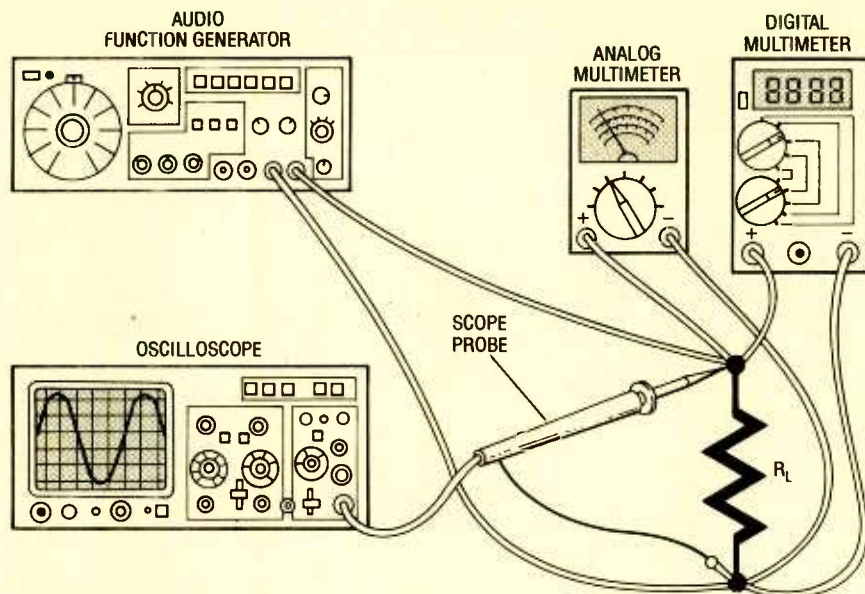

Fig. 5. In this experimental set-up, a VOM, a DMM, and an oscilloscope are wired in parallel across a load and a signal generator is used as a signal source.

instrument (i.e., the resistance across the input terminals of the device). It is specified in units of ohms-per-volt ( $\Omega/V$ ). Common VOM's have a sensitivity of 20,000  $\Omega/V$  while high priced models can have sensitivities as high as 100,000  $\Omega/V$ .

But what does sensitivity mean in terms of meter resistance? If a meter with a sensitivity of 20,000  $\Omega/V$  is set to the 0-10-volts scale, then the resistance of the meter ( $R_m$ ) is:

$$20,000 \Omega/V \times 10 \text{ volts} \\ = 200,000 \text{ ohms}$$

If the meter resistance is small compared to circuit resistances, then problems will occur.

Consider Fig. 3. In that circuit, a pair of resistors ( $R_1$  and  $R_2$ ) are connected in series across a 10-volt source,  $V$ . This little circuit is a model for a lot of circuits or circuit fragments in actual practical circuits. The "output voltage,"  $V_{AB}$ , is found from:

$$V_{AB} = V \times R_2 / (R_1 + R_2) \\ = 10 \times 100,000 / (1,000,000 + 100,000) \\ = 0.909$$

But if a 20,000  $\Omega/V$  meter is used to measure this voltage (say, on the 1.5 VDC scale), it places its own resistance ( $R_m$ ) in parallel with  $R_2$ . The value of the meter resistance is:

$$20,000 \Omega/V \times 1.5 \text{ volts} \\ = 30,000 \text{ ohms}$$

The parallel combination of  $R_2$  and  $R_m$  is effectively 23 kilohms, so the meter reads the voltage across 23 kilohms, not

100 kilohms. When this value is used in place of  $R_2$  in the equation above, the value of  $V_{AB}$  is 0.225 volts. That's a 75% error!

A typical DMM overcomes the circuit loading problem suffered by VOM's because the input impedance of a DMM is typically at least 1 megohm, with many of them reaching 10 to 100 megohms.

**DMM Defects.** The DMM may overcome circuit loading, but it is not error free. If a DC DMM is used to measure smooth, clean, noise-free DC levels, then it will function perfectly. However, if the DC being measured is noisy, then errors can occur. As mentioned before, dual-slope DMM's are a lot less sensitive to noise than cheaper single-slope meters, however even they can render an erroneous reading on a noisy signal.

A VOM does not suffer this problem in many cases because the inertia of the meter movement tends to integrate (i.e., time-average) out the reading, ignoring all but the most serious forms of noise.

If you work on high power radio-frequency devices, such as radio transmitters, then you may want to select the VOM over the DMM for another reason. It seems that many DMM's are sensitive to RF radiation, while VOM's are not. In other words, the RF will bias the reading on a DMM, but not a VOM.

**AC Voltmeters.** An AC voltmeter reads AC volts, but there are three common ways of measuring an AC voltage:

you can determine its rms voltage, peak voltage, or peak-to-peak voltage. To make things more interesting, a meter circuit designed to measure the rms voltage of a sine wave will not be able to accurately measure the rms voltage of any other waveform.

To explain this, let's look at a simple, undistorted sine wave (see Fig. 4). The voltage starts at zero on each cycle, and then climbs to a peak value ( $+V_p$ ). It passes the peak, and then falls back to zero. The current then reverses direction, so the voltage now goes negative. It then falls to a negative "peak" ( $-V_p$ ).

The peak values are merely the highest voltages on each half cycle. The peak-to-peak voltage is the voltage difference between the positive peak and the negative peak. For a perfect sine wave (i.e., one that is symmetrical about zero volts and undistorted) the peak-to-peak voltage is twice the peak voltage ( $V_{pp} = 2V_p$ ). That relationship is easy to see from Fig. 4.

But there is also the rms, or root-mean-square voltage. That voltage can be defined mathematically, but a practical definition of the rms voltage is the DC voltage level that would produce the same amount of heat in a resistor as the applied sine wave. In other words, if an AC voltage is said to be 115 volts rms, then it will produce the same amount of heat when applied to a resistor as 115 volts DC.

The rms value of an undistorted sine wave (and only for a sine wave) is:

$$V_p / \sqrt{2}$$

In other words, you can find the rms-voltage value for any pure sine wave by multiplying the peak value by 0.707.

Some people refer to the rms voltage as the "average" voltage, and that's okay when strict rigor is not needed, but it is not quite correct. You will also see some textbooks that say the average voltage of a sine wave is 0.636 times the peak voltage. This is true only for one-half of the sine wave, i.e., as in a rectified situation. The actual average value of a perfect sine wave is zero! After all, the voltage goes as much positive as it goes negative, so one can almost intuitively guess that the average over one complete cycle is zero.

Unfortunately, not all sine waves are so ideal. If there is noise on the signal, it will cause some meters to read differently than if the signal was not noisy. Also, if there is a DC component to the signal, which would force the sine wave

(Continued on page 102)

# Build a Light-Beam

## Communicator

*Here is a circuit that allows you to communicate over short distances using an ordinary flashlight!*

BY JERRY PENNER

Everyone is familiar with IR information transmission, after all there is hardly an electronics leisure-time device (TV's, VCR's, stereos, and even some boom boxes, to name a few) that does not come with an IR remote control. But did you know that IR is not the only form of light radiation that can be used to convey intelligence?

Light emitted by an ordinary flashlight lamp can be used to move voice and other audio over short distances. And that's just what our experimental *Solar Cell Communicator* (a receiver and transmitter pair) is designed to do. The circuit was not designed to fill any particular need, nor generate any useful amount of data, power, or "chicken sandwiches." It's pure fun, and was designed for its high "HTN" (Hey, That's Neat!) value.

Of course, the range of such a device will be inherently limited, but with a little imagination, the circuit can be altered to transmit over greater distances, or can be used for listening to various light and heat sources.

**Theory of Operation.** The whole idea behind the two circuits presented here is to send intelligent data from the trans-

mitter to the receiver using light. Actually, the transmitter and receiver circuits are nearly identical, save for the input and output devices. The transmitter is nothing more than an amplified microphone circuit that's used to drive an incandescent lamp instead of a speaker. The receiver is similar to an amplifier circuit that has a solar cell input and a speaker or headphone output.

The transmitter circuit picks up sound, amplifies it and then uses that audio signal to vary the voltage across the lamp at a rate equal to the frequency of input. The solar cell, which feeds an op-amp in the receiver, picks up the varying light and converts it back into a voltage, which is then applied to a speaker to reproduce the audio.

**The Transmitter.** A schematic diagram for the transmitter section of the Solar Cell Communicator is shown in Fig. 1. The circuit is essentially a microphone-fed audio amplifier—consisting of R2, R3, R4, and U1 (which is configured for inverting operation)—whose output is fed to the base of a general-purpose transistor. (The microphone in this case is a headphone speaker, but for simplicity and clarity, we'll continue

to refer to it as a microphone.) The transistor, in turn, responds to the incoming audio by increasing and decreasing the intensity of the light emitted by lamp I1.

The microphone takes sound waves presented to it and converts them into a varying (with respect to the intensity of the sound) electrical signal. That input signal is capacitively coupled via C1 to the inverting input of U1. Capacitor C1 (a 33- $\mu$ F unit) and R1 (a 100-ohm unit) limit the low-end frequency to about 60 Hz. Because U1 (a 741 general-purpose op-amp) is powered from a single-ended power supply, its output will always be at half the supplied voltage with no input signal applied, therefore lamp I1 remains at half brightness. With I1 at half brightness, the receiver circuit has a zero output, thereby greatly reducing distortion in its output.

When a signal is applied to the amplifier, its output varies in amplitude, following the input signal. That signal causes Q1's level of conductance to vary and the light intensity emitted by I1 to increase and decrease accordingly. The 6-volt flashlight lamp used for I1 will last a reasonably long time, because the average voltage across the lamp is

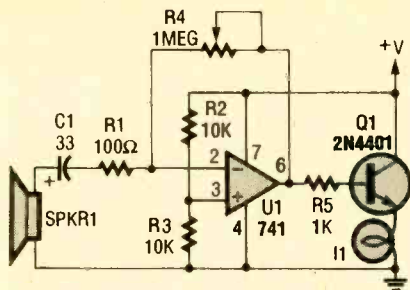

Fig. 1. The transmitter section of the Solar Cell Communicator is essentially a microphone-fed audio amplifier whose output is used to vary the intensity of the light emitted by an ordinary flashlight lamp.

### PARTS LIST FOR THE TRANSMITTER

- U1—741 general-purpose op-amp, integrated circuit
  - Q1—2N4401 general-purpose silicon NPN transistor
  - R1—100-ohm, ¼-watt, 5% resistor
  - R2, R3—10,000-ohm, ¼-watt, 5% resistor
  - R4—1-megohm logarithmic-taper potentiometer
  - R5—1000-ohm, ¼-watt, 5% resistor
  - C1—33-μF, 20-WVDC, electrolytic capacitor
  - I1—6-volt, 200-mW, incandescent lamp
  - SPKR1—Headphone speaker or microphone (see text)
- Printed-circuit materials, enclosure, 6-volt DC source, 8-pin IC socket, switch, lamp holder, wire, etc.

3 volts; well within the voltage rating of the bulb.

The author used a 30-ohm headphone speaker as the input device in his prototype, but any speaker with an impedance of up to 100 ohms may be used.

**Receiver Theory.** The receiver in Fig. 2 is just as simple as the transmitter and a lot more fun to play with. The solar cell picks up any light striking it and converts it to a DC voltage. Components C1 and R1 limit the lower input frequency as well as blocking DC from the solar cell. Components U1, R2, R3, R4, and C2 make up the amplifier stage. Speaker SPKR1 can be a headphone speaker or dynamic microphone.

A single solar cell delivers up to 0.5 volt in direct bright sunlight; the output current is based on the size and efficiency of the cell. The prototype uses a 200 mA unit. The actual current output of those devices is also based on the load across it. The cell in the prototype

generates 200mA under full light if short circuited.

Since the circuit will never need more than a few milliamps to produce a usable signal, it would be more beneficial to use several cells in series to increase the magnitude of the voltage variations. Increasing the voltage swings for a given light input would also increase the sensitivity and night range of the circuit.

**Circuit Construction.** Since the transmitter and receiver circuits are so simple and parts placement is not critical, the circuits may be assembled using the technique that you are most comfortable with. But to reduce the likelihood of errors and make construction as simple as possible, printed-circuit patterns for the transmitter and receiver circuits are provided in Figs. 3 and 4, respectively.

The transmitter's and receiver's parts-placement diagrams are shown in Figs. 5 and 6, respectively. Once the two circuit boards have been completely assembled, and your work checked, it's

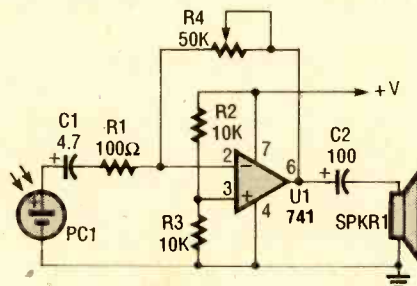

Fig. 2. The receiver portion of the communicator is just as simple as the transmitter: A solar cell picks up light emitted by the transmitter and converts it into a varying DC voltage.

### PARTS LIST FOR THE RECEIVER

- U1—741 general-purpose op-amp, integrated circuit
  - R1—100-ohm, ¼-watt, 5% resistor
  - R2, R3—10,000-ohm, ¼-watt, 5% resistor
  - R4—50,000-ohm logarithmic-taper potentiometer
  - C1—4.7-μF, 20-WVDC, electrolytic capacitor
  - C2—100-μF, 20-WVDC, electrolytic capacitor
  - PC1—0.5-volt, 200-mA photocell
  - SPKR1—Headphone speaker (see text)
- Printed-circuit materials, enclosure, 6-volt DC source, 8-pin IC socket, switch, lamp holder, wire hardware, etc.

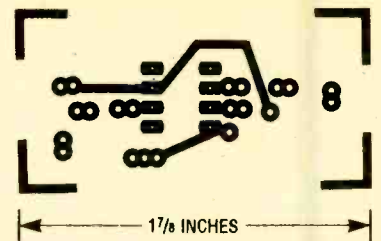

Fig. 3. Here's the printed-circuit pattern for the transmitter section of the communicator.

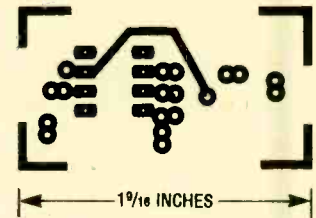

Fig. 4. There is very little difference between the printed-circuit patterns for transmitter (see Fig. 3) and receiver (shown here).

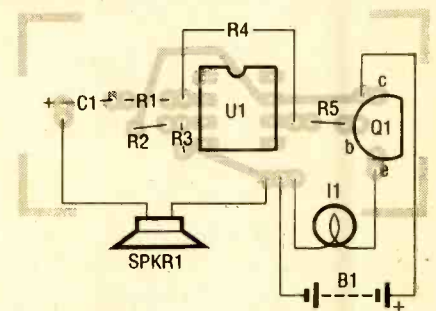

Fig. 5. Assemble the transmitter's printed-circuit board using this parts placement diagram as a guide.

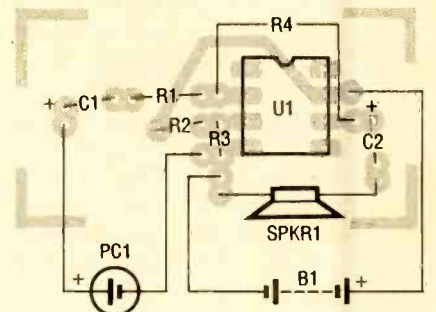

Fig. 6. Be careful when assembling the receiver circuit: some solar cells are extremely fragile, and are easily damaged by heat and other stress.

time to start thinking about housings for the two circuits. The transmitter can be built into an old flashlight (as the author did), which would also provide a means by which to focus the beam and extend the range.

(Continued on page 102)

# GIZMO®

A CHRONICLE OF CONSUMER ELECTRONICS

VOLUME 4,  
NUMBER 10

## Camcorder Heaven

**CANON L1 Hi8 CAMCORDER.** From: Canon U.S.A., Inc, One Canon Plaza, Lake Success, NY 11042. Price: \$2999.

Those of us who write about consumer electronics usually fall into one of two broad categories. Half of us, it seems, get jaded and constantly gripe that there's nothing new and exciting to write about. The other half of us gush about every new thing that comes down the pike ... after all, it's how we make a living.

We, of course, like to think that we fall into neither category. Actually, it's probably more accurate to say we fall into both. We love to see manufacturers come up with new gizmos, although we sometimes protest that some new products aren't really *new*—changing this year's color doesn't do much for us.

We've seen our share of camcorders over the years, and we've liked some of the advances we've seen: higher zoom ratios, titling, features to help get smooth scene changes, better backlight compensation, and so on. It's been a while, however, since we've been truly *excited* by a new camcorder. That is, until we got our hands on Canon's L1.

The L1 is a remarkable camcorder. Its most important claim to fame is that it features interchangeable lens capability—it's the world's first in that respect, but you can bet it won't be the last. The VL mount system that the camcorder uses was developed jointly by Canon, Hitachi, Matsushita, and Sony. Those other manufacturers are sure to introduce their own interchangeable-lens camcorders in the future, and you can also expect the VL mount to be licensed to others as well.

Because of the cooperation between manufacturers, every camcorder that features the VL mount will be able to use any VL lens—even if it's from a different manufacturer. That's a newsworthy item for consumer-electronics writers, and it's great news for consumers. Every VL lens



CIRCLE 50 ON FREE INFORMATION CARD

will let the camcorder retain its full focus, iris, and zoom control. And the VL system is not limited to Hi8 camcorders—standard 8mm. VHS, VHS-C, and even Beta camcorders can use the system as well. We expect, however, that it will take a while before anything other than top-of-the-line camcorders offer it.

The lens that is supplied with the L1 is impressive in its own right. It's a 15× (8–120-mm) zoom lens with  $f/1.4$  ( $f/2.1$  at its telephoto end). Lens buffs will be interested to know that the zoom lens is composed of 15 optical elements in 12 groups, and it features an 8-blade iris for precision exposure control.

Like all VL lenses, the 15× zoom lens contains its own microprocessor for iris, zoom, and focus control. A control microprocessor in the camera communicates with the lens microprocessor through four serial interface lines. Two additional contacts provide power for the lens.

One of the more interesting capabilities of the interface is that an optional adapter is available that will allow you to use any Canon EOS EF-Series lens (meant for EOS 35-mm auto-focus cameras) on the camcorder. EOS lenses also contain built-

in motors for focusing and iris control—however, zooming is manual. The adapter doesn't come cheap—it's \$350. Because of the difference in size between a frame of 35-mm film and the L1's CCD image sensor, the EOS lens delivers an image much larger than you might expect. The adapter, in effect, increases the focal length by a factor of 5.4. So the 28–80 zoom lens supplied with, for example, the EOS Rebel acts like a 151–432-mm lens. Similarly, a 200-mm lens would act like one with a focal length of 1080-mm! The only disadvantage of the setup is that EOS lenses were built for still cameras that don't record sound, so they're considerably noisier than video lenses.

Another feature that separates the L1 from the rest of the field is its uncommon shape and dual-action grips. The side grip lets you hold the camcorder much as you would any other: The right hand goes through a strap and surrounds the grip, with the thumb over the record/pause button, and the index and second fingers over the telephoto/wide-angle control. A second body grip allows you to hold the camcorder much as you would a 35-mm

(Continued on page 6)

TURN PAGE FOR CONTENTS

# This month in GIZMO

Canon L1 Interchangeable-Lens Camcorder.....	pg. 1
V-Tech Video Painter.....	pg. 2
AView Technology DesktopTV Converter Board.....	pg. 3
SNK Home Entertainment Neo-Geo 24-Bit Video Game.....	pg. 4
Reference Recordings A Video Standard Test Disc.....	pg. 5
Fidelity Electronics Swiss Lady Biological Watch.....	pg. 6
New Math Blaster Plus!.....	pg. 9
Two-Way Radios.....	pg. 9
Cordless Phone.....	pg. 10
Pillow Talker.....	pg. 10
Turbo Camcharger.....	pg. 10
Utility Pac.....	pg. 10
CD Wallet.....	pg. 11
Personal Pay Phones.....	pg. 11
"Super Computer".....	pg. 11
Surf Watch.....	pg. 11
Bodyguard Remote Protector.....	pg. 12
PRO-35 Handheld Scanner.....	pg. 12
Rabbit Wireless VCR Transmitter.....	pg. 12
STATX Cleanser.....	pg. 12

Gizmo is published by Gernsback Publications, Inc., 500-B Bi-County Blvd., Farmingdale, NY 11735. Senior Writers: Chris F. O'Brian, Teri Scaduto. Contributors to this issue: Carolyn Kerwin, Toni Vames, Steve Vames. ©Copyright 1991 by Gernsback Publications, Inc. Gizmo is a registered trademark. All rights reserved.



CIRCLE 51 ON FREE INFORMATION CARD

## Painting by Pixels

**VIDEO PAINTER.** Manufactured by: Video Technology Industries, Inc. (V-Tech), 380 West Palatine Road, Wheeling, IL 60090-5831. Price: \$99.

If there's one child's toy that has withstood the test of time, it's the coloring book. Along with a box of Crayolas (the 64-pack with built-in sharpener, if you're really lucky), a coloring book provides hours of diversion—even if you aren't proficient enough with a crayon to stay within the lines. The coloring book has long been a favorite with parents too, since it is inexpensive, and keeps the child quietly occupied in a creative endeavor for long periods of time at home, in the car, or at a friend's house.

Of course, the electronics wizards are never content to leave well enough alone. (It's a good thing, too, or we here at GIZMO would have no gizmos to review!) V-Tech's Video Painter is an electronic update of the plain old coloring book that turns your TV into a drawing pad, with several additional features added for good measure. The device vaguely resembles an "Etch-a-Sketch," with a drawing pad in the center of a flat, rectangular unit, but it also has a 12-color palette and several "function keys" arrayed across the top, a row of buttons running down the right side, and two "mark" buttons on either side of the bottom of the screen.

A row of seven boxes runs across the top of the drawing pad and correspond with the menus that appear on your television set. On the left side is a handle for carrying the unit around. A crayon-like drawing tool clips to the right side of the unit, and

video output and DC input jacks are on its back. (It also runs on six "D"-size—but not rechargeable—batteries.) The Video Painter must be connected to a TV or monitor via the video input jack. An RF modulator is available from V-Tech at an extra cost. Artistic creations are displayed not on the Video Painter, but on the television screen. It can also be hooked up to your VCR, so that you can record the finished product—or even the entire artistic process—for posterity.

When you turn the Video Painter on, it immediately goes into a demo mode, colorfully illustrating all of its capabilities. Those include drawing original pictures; adding words: "painting" an area in your choice of twelve colors and seven texture patterns, or coloring the picture by hand; enlarging, reducing, copying, or moving parts of the picture; using backgrounds and characters from the built-in picture library; and animating some of those characters. In addition, Video Painter offers the "Tangram" puzzle game, in which various geometric shapes must be placed in the proper spots to fill in pre-drawn shapes.

We were raring to go after watching the demo—and quickly learned that it's not as easy as it looks to draw professional-looking pictures. Pressing the drawing pad or any function key with the tip of the pen interrupts the demo so that you can start drawing. Pressing the drawing tool function key brings up a menu with seven options across the top of the TV screen. All of the function keys and on-screen menus are "labeled" by icons only—no words to confuse younger children. You can draw freehand using either a fine (pencil) or bold (crayon) line; use the pre-programmed thick or thin straight lines, square, or circle; or opt for lettering using

(Continued on page 7)



# Computer Video Redefined

**DESKTOPTV CONVERTER BOARD MODEL VG1.** From: AView Technology, Inc., 2 St. Clair Ave. West, Suite 1600, Toronto, Ontario, Canada M4V 1L5. Price: \$395.

We've always been a little frustrated with our computer monitors. Oh, they've worked just fine, and kept improving over the years. But none of them could display "plain vanilla" composite video. Our first monitor was a monochrome composite-video model—back in the pre-IBM-PC days of the CP/M operating system. (OK, we *could* use it to display composite video—assuming we didn't mind people with amber-colored faces!) We then graduated to a TTL computer monitor. We got the better resolution we needed to read a full screen of text, but we couldn't use it for anything else.

When we got our first RGB monitor to use with a CGA (color/graphics adapter) our frustration grew. Here we had a high-quality color monitor that we could use only for our computer work—even though we had plenty of other applications that required a good color monitor. Now, of course, our monitor of choice supports the VGA standard. It's by far, the most capable monitor we've ever used. But, it *still* can't display video.

There are some monitors out there that can display standard video along with computer video. But they're few and far between—and very expensive. So our monitor is restricted for use only with our computer. That's a little frustrating because we use our computer only about 50% of the time we're in our office. The rest of the time it sits idle—or at least it did until we installed *AView Technology's DesktopTV* in our computer.

Now we can watch our favorite TV shows, thanks to DesktopTV, a plug-in board that turns a PC into a TV. The board contains a 119-channel tuner that can receive VHF, UHF, and cable stations.

DesktopTV can be installed in any full-length slot in an IBM-PC or compatible computer. Two versions are available. The first, *model VG1*, is designed for use with VGA graphics adapters and monitors that support a horizontal frequency of 31.5 kHz. The second, *model MF1*, is designed for EGA and VGA graphics adapters, and multi-frequency monitors that support a horizontal frequency of 15.7 kHz.

For us, installing the card was quite easy. But then we've installed quite a number of other boards in our PC. The instructions are reasonably well written, so even users who have never installed a card before should have only a minimum of difficulty. After you open your comput-

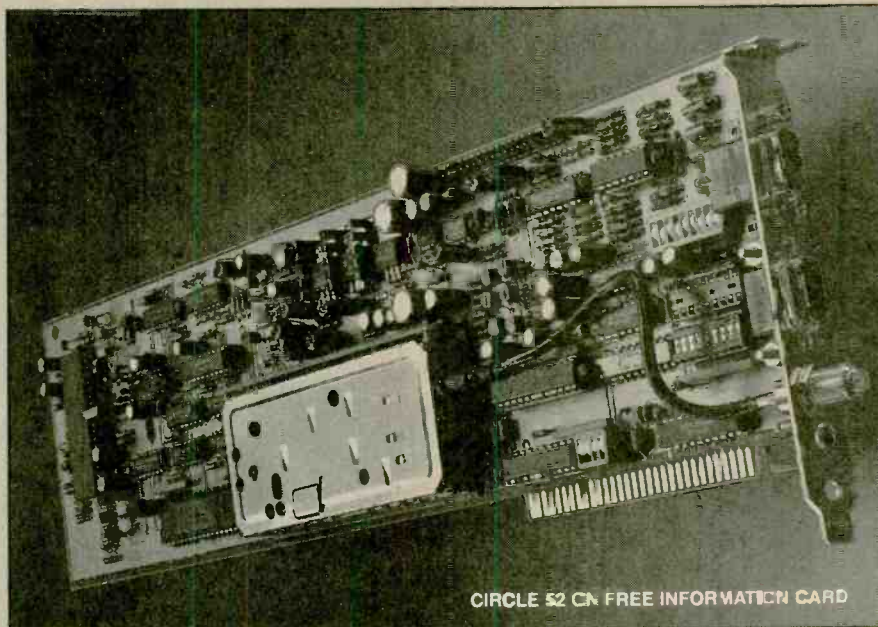

CIRCLE 52 ON FREE INFORMATION CARD

er case, you just have to insert the card into an empty slot and, using the short cable supplied, connect the output of your VGA card to the input of the DesktopTV, and the input of your monitor to the output of the DesktopTV.

There are only a couple of things to watch out for. First, because of the on-board tuner, the card is thicker than most others we've seen. You have to be careful that you don't short out any other boards. Second, both the input and output connectors are 15-pin female connectors. Since the rear of the card isn't labeled, it's easy to hook things up backward unless you have the manual in front of you. You won't do any damage if you hook it up that way, but we would have preferred if the input was, for example, a 15-pin male connector. That way, the hookup would have been obvious.

Once the card is in the computer, the only other connections are to an RF signal source (your antenna, cable, VCR, etc.) and to a speaker. (A small Covox Sound Master speaker is supplied, and can be plugged into a miniature phone jack on the rear of the card.)

When you're finished with the hardware installation, you're ready to run the software. The DesktopTV package includes both 3-1/2 and 5-1/4-inch disks, so you won't have any problems with incompatibility. If all goes well, software installation is simple. In the worst case, you'll get a message that the computer can't talk to the Desktop board. The problem can be one of two things. Either there is a conflict between the DesktopTV and another card installed in your computer, or you have the board set to the wrong address. (A set of 4 DIP switches lets you select one of 7 possible addresses.)

Our card had been inadvertently set to a different address when it was installed. Rather than opening the computer again to

find the right address, we simply used the setup menu to try each of the seven possibilities until we hit on the right one. Of course, it was the seventh one we tried.

Setting the I/O bus address is a reasonably simple concept, but one that many computer users don't understand. Unfortunately, instead of taking pains to clear up that potential trouble spot, the manual makes it a little more difficult, relegating the addresses and corresponding switch settings to an appendix. Worse yet, a table that shows the switch settings and addresses is "backward;" the table in the appendix shows switches 1 through 4 running from right to left, but on the board, they run left to right.

Two versions of the software are supplied. One is a TSR (terminate-and-stay-resident) program, which, once run, stays in memory. It is called up with the touch of one or more "hot keys." You can call up the TV from any application, and return to the application where you left off by hitting the Escape key—you can still monitor the TV audio however. If you prefer not to run DesktopTV as a TSR, you can run it instead as a stand-alone program from the DOS command line.

A second version of the program is also included for installation under Microsoft Windows 3.0. The main advantage of Windows installation is that, depending on what application you're running, you might be able to still get work done as you're watching TV. For example, a database program could be sorting itself while you're watching the latest updates from CNN.

We like DesktopTV because it's an honest-to-goodness gizmo. It's not something that everyone needs, but it is something that a lot of people will want. The first application that comes to mind is a home office. Space is at a premium in most home

(Continued on page 8)

## Adult Entertainment?

NEO-GEO 24-BIT VIDEO GAME SYSTEM. From: SNK Home Entertainment Inc., 22301 South Western Ave., Suite 107, Torrance, CA 90501. Price: \$649 (with two controllers and one game) or \$449 (with one controller and one game).

There's no doubt that video games have become one of the most popular pastimes of America's youth. According to the Electronic Industries Association, total factory sales of video-game software rose from an estimated \$360 million in 1987 to a projected \$2.5 billion this year. While Nintendo still holds the largest share of the video-game market, several other companies have been making inroads—particularly since the introduction of 16-bit games from NEC and Sega. When Nintendo countered with Super NES, a 16-bit version of the Nintendo Entertainment System, the contenders fought back by slashing prices. As we go to press, Sega's Genesis is retailing for \$149, NEC's TurboGrafx for \$99, and Super NES for \$199.95.

As the battle for the juvenile video-game market is fought, and the 16-bit marketing wars—and subsequent price wars—have been capturing everyone's attention, a company called *SNK Home Entertainment* has decided to stay out of the fray and cast its lot in a different direction. Figuring that the kids already have more than enough video games to keep them occupied, they've targeted their 24-bit game, *Neo-Geo*, at the 20-35-year-old-market instead.

Several factors set Neo-Geo apart from the rest of the video games on the market. First, of course, is that a 24-bit system provides superior graphics and sound. The system uses two processors: a 16-bit Motorola 68000 and an 8-bit Zilog Z80A. The system can have as many as 380 sprites on the screen at once, compared to Super NES's 128, Sega's 80, and NEC's 64 sprites. (A sprite is a group of pixels that the game designer can define and then move as a group, which creates character movement on screen. The Neo-Geo sprites can be as small as 1 × 2 pixels or as large as 16 × 512 pixels.) The system can also display 4096 colors simultaneously (double the capacity of Super Nes). Neo-Geo provides 15 sound channels (Sega has 10, Nintendo 8, and NEC, 6), with seven dedicated to real-voice speech. Stereo sound is available via a stereo-headphone jack located on the front of the base unit, along with a volume-control slide switch.

Another major difference is that Neo-Geo has an optional, credit-card-sized memory card that allows arcade players to



save up to 27 games played on Neo-Geo arcade games and then pick up where they left off when they get home, by plugging the card into their home system. The hardware and software of the home system and arcade system are identical. The home hardware looks a bit sleeker than most. And you won't see Neo-Geo commercials aired during Saturday morning cartoons—SNK's advertising dollars are going to print ads in magazines like *Playboy*, *Premier*, and *Omnii*, whose readers are young, upscale, mostly male, adults.

The picture and the sound are both noticeably better than those of the other brands of video game. The graphics feature the main character in the foreground and up to three independent background screen planes. (SNK calls the graphics "four-dimensional;" your guess as to what that means is as good as our's—we were unable to get a definition of that term from the company.) While the sound is the best that we've ever heard from a home video game (especially when we turned our surround speakers on), we can't understand why stereo sound is available only through headphones. We're sure that many (if not most) of those young, upscale guys who SNK expects to buy Neo-Geo already own stereo TV's and VCR's. Similarly, we're surprised that with seven channels dedicated to the human voice—which results in quite authentic vocals—SNK wasn't a bit more careful about the speech that they recorded. Particularly in "Baseball Stars Professional," where the narrator is a girl who looks American but speaks with a Japanese accent (and bows, Japanese style), the dubbing strongly resembles that done in all those sci-fi B-movies of the 1960's—with the lips continuing to move several seconds after the speech has stopped.

"Baseball Stars Professional" is one of

three games that we got to try out. It allows the user to choose between playing in a dome or a stadium and select two of twenty teams to play the game. The teams have names like "American Dreams" and "Ghastly Monsters" with players' names to match (Babe, Hank, Willie, etc., and Mummy, Cyclops, etc., respectively). There are even two all-women teams. When your team is at bat, you can move the batter closer to or farther from the plate and can control the swing of the bat, from a bunt to a home-run swing, using the joystick and the buttons on the controller simultaneously. Similarly, when pitching you can throw a curve ball, fast ball, and even put a spin on it.

The main picture shows the infield with home plate in the foreground. Insets show runners on base (runners can steal bases, and the pitcher can pick off a runner); the score; balls, strikes, and outs; and other stats. The players move smoothly and realistically, and the picture is clear enough that you can see "blades of grass" on the infield.

The sound is also amazingly lifelike. When the ball is hit, it ranges from that satisfying crack of the bat when a home run is hit to a softer tapping sound for a bunt. You can clearly hear the thud of a pitched ball hitting the catcher's glove, the swish of a missed pitch, and the sound of a runner sliding. Throughout the game, an announcer comments on the play. That's where, once again, some carelessness was evident.

Regardless of whether you're playing in a domed stadium or an open ballpark, the announcer comments on the weather and notes "The sun is really shining bright down on the field now." When a home run is hit, the announcer describes the batter by saying "He's really egging the crowd

(Continued on page 8)

# A Standard to Follow

**A VIDEO STANDARD.** From: Reference Recordings, Box 77225X, San Francisco, CA 94107. Price: \$69.98.

We all watch a lot of video—even those of us who claim not to. Sales of large-screen direct-view and projection sets are growing steadily, and videodisc players—the ultimate picture source for the home theater—are showing healthy gains. But with all the time we spend watching, and all the money we spend to be able to watch, how much do we really know about video?

After watching *A Video Standard*, a video demonstration and calibration disc from *Reference Recordings*, we're slightly embarrassed to admit that we knew less than we thought we did.

The 12-inch laserdisc, produced by Joe Kane, tries to "bring science to the art" of properly adjusting your video monitor. The instructions supplied with TV sets (or simply assumed by the viewer) are that the brightness, sharpness, hue, and tint controls should be adjusted "until the picture looks good." That's not what our NTSC standard calls for, though! If we want to see and hear what a producer intended us

to see and hear, then we have to pay attention to how we adjust our sets. Teaching us how to do that is the main focus of *A Video Standard*.

The disc also tries to tell us the story of our current NTSC system—how it was developed, what its built-in limitations are, and how we—and equipment manufacturers—often make it worse for ourselves. For example, because of daytime television, the TV set had to compete with direct sunlight to meet "consumer demand." But, according to Kane, "the consumer was never told that picture resolution would suffer with increased light output. The manufacturers just accommodated the demands by modifying the structure of the picture tube and increasing the blue drive to get more light output." The color of the gray scale was "significantly changed... destroying color fidelity."

What are we to do about it? Well, the first step is to learn the basics about our color-TV system from a chapter in the 40-page manual that accompanies the disc. And then we learn the principles of monitor calibration, the first of which is that "the ability of a monitor to properly reproduce a gray scale is one of the most important parameters in obtaining a good color picture."

We are then taken through the procedure for setting the monitor's black level correctly using a PLUGE (picture line-up

generation equipment) pattern. The PLUGE pattern, one of many test patterns on the disc, is a single frame of video. According to Reference Recordings, the patterns on the disc are equivalent to what you would obtain from about \$10,000 worth of video and audio laboratory equipment. (Although some laboratory equipment—and access to controls that may not be accessible on consumer equipment—is required to complete some of the tests.)

We're not going to argue with the \$10,000-worth claim, however. For determining a monitor's resolution and frequency response, a multiburst pattern, a classic Indian Head chart, and an SMPTE Resolution Chart are included. For color tests, several color-bar patterns are provided—along with a special blue filter that is necessary to properly use the bars (unless the monitor provides a "blue-only" capability).

Full-field color displays (to determine color noise), a cross-hatch pattern (to set convergence and to properly center the picture on the monitor), and checkerboard and circle patterns (to check geometry errors) are among the more than eighty separate test patterns provided on *A Video Standard*. And those are just the video test signals. A full complement of audio test signals are also provided. A particularly useful section of the disc lets you properly test and set your Dolby Surround Sound decoder. All of the audio test signals are contained on both the disc's digital and CX-encoded analog soundtracks.

The manual that accompanies the disc is essential for getting the most out of the disc. We would have preferred to see some of the information in the booklet contained on the disc as well, however. For example, one chapter of the videodisc demonstrates what happens when you transfer film to video, and gives examples of how the result looks different depending on whether you transfer from a print made from the film negative or the negative itself. The manual explains what to look for as you compare the two. Interesting stuff. But why didn't they put that information in the soundtrack instead of music?

We calibrated our system as best we could—and were limited by our monitor in many cases. We were unwilling to take all the steps that, according to Kane, are necessary for the ultimate setup. We can't, for example, place our monitor a distance of 2.5 to 5 times the picture height from the rear (neutral-colored) wall and sit a distance of 4 to 6 times the picture height from the screen. Our room simply isn't large enough, and we prefer to sit closer regardless of what the experts say!

We might not be willing—or able—to do everything in our power to get the most out of our NTSC television system. But thanks to the education we received from *A Video Standard*, at least we'll recognize what we, the producers, and the equipment manufacturers are doing wrong! ■

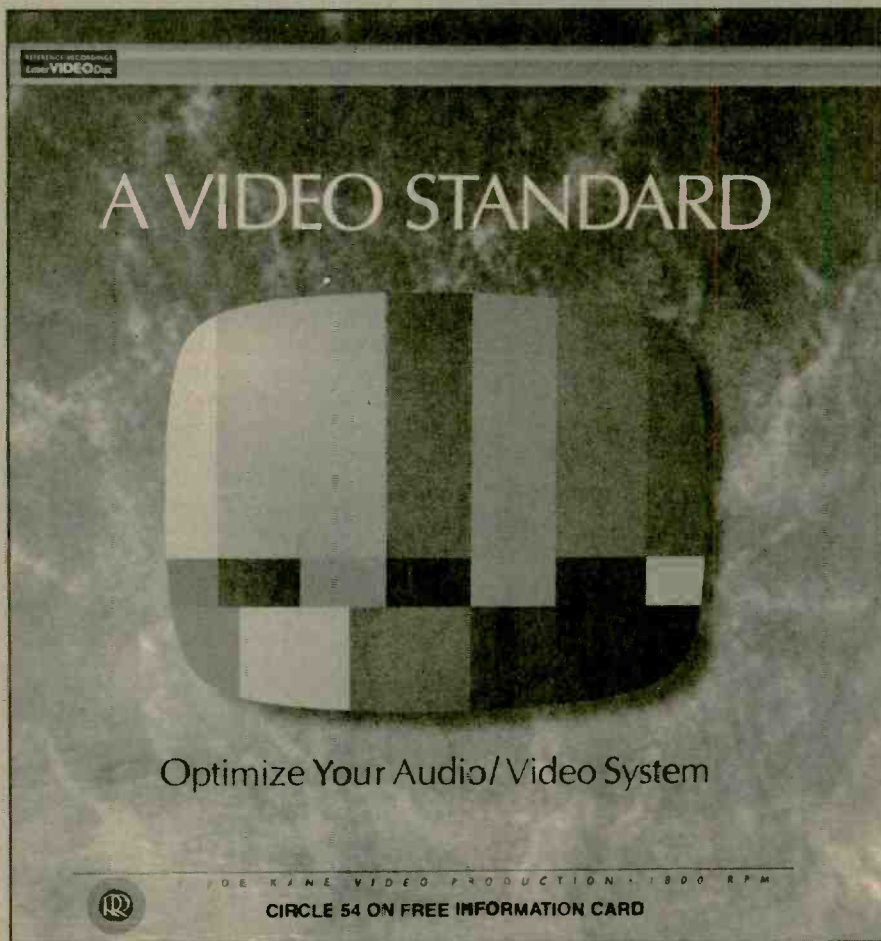

REFERENCE RECORDINGS  
Kane VIDEO Disc

# A VIDEO STANDARD

Optimize Your Audio/Video System

DE KANE VIDEO PRODUCTION • 1800 RPM

CIRCLE 54 ON FREE INFORMATION CARD

## Boy? Girl? Boy? Girl?

**SWISS LADY BIOLOGICAL WATCH.**  
Distributed by: Fidelity Electronics International, 13900 N.W. 58th Court, Miami, FL 33014. Price: \$69.95.

For as long as women have been having babies, parents have had preferences as to their unborn child's gender. In some societies, men have been allowed to divorce their wives for failing to produce a male heir (although, in reality, it is the man who determines the sex of the child). In modern America, the stakes aren't so high. But when the average family consists of mom, dad, and two kids—and the ideal family consists of mom, dad, son, and daughter—a couple who's planning a small family and already has a couple of boys is likely to want a girl the third time around. Well, they have a fifty-fifty chance, right?

Actually, there are ways to increase the odds of having a child of the gender of choice. One that we recently heard of is a medical procedure that involves extracting sperm from the father, separating out the male from the female (which can be done because the two types behave differently) as much as possible, and using artificial insemination with the desired sperm. That increases the odds to about 75%, at a cost of about \$5000. And then there's the *Swiss*

*Lady Watch*, from Fidelity Electronics. It combines the ages-old "rhythm method" with some modern know-how and gadgetry, and packages it in the form of a wrist watch. According to Fidelity, and Dr. Joyce Brothers, their spokesperson for the Swiss Lady at the Consumer Electronics Show last summer, tests performed on more than 2000 couples in Germany demonstrated a 90% success rate in gender selection.

A quick backgrounder for those readers whose health classes were less-than-specific on human reproduction: There are only about 72 hours each month—during ovulation—in which a woman is fertile. Because sperm can live in the body for a while, that makes a total of five days (or six, to play it safe) a month that a woman is likely to get pregnant. Ovulation occurs at basically the same time within the menstrual cycle each month. It's possible to keep track of ovulation by counting the days on the calendar, or by maintaining a record of a woman's body temperature, which rises slightly during ovulation. The calendar approach (or "rhythm method") is a frequently used but rarely effective method of birth control, and couples who have been trying to conceive are often instructed by their doctors to try the temperature method.

The Swiss Lady Watch is basically an update of the calendar method—but it also takes into account the different behavior patterns of male and female sperm. It seems that the males are stronger and fast-

er swimmers—meaning that if all other factors were equal, there would be a lot more boy babies than girls. But what the female sperm lack in vigor they make up for in endurance—they live much longer than male sperm. That means that if a couple makes love a day or two *before* ovulation, there's a much higher chance that it will be a female sperm—the only ones still swimming—that will impregnate the egg. On the other hand, *after* ovulation (when all other factors are equal) speed and strength are crucial.

We've all heard of the biological clock—but where does a biological watch enter the picture? The Swiss Lady is both a standard watch and a reproductive calendar watch. Just inside the numbers that represent hours and minutes is a circular band of information that represents ovarian time. The woman sets the fourth hand of the watch on the first day of her menstrual cycle (the watch works for women with 27- to 30-day cycles); each day the hand moves around the ovarian time band. If the hand is in the green field, the woman is infertile. Pink indicates the days that a girl is likely to be conceived, and blue is for conceiving a boy.

We just happen to have some close friends who fit the description above—both couples have 19-month old boys, and one also has a three-year-old boy—who are planning "to try for girls" in the next few months. So we decided to do our own—decidedly unscientific—test of the Swiss Lady Watch. We'll let you know the results next year! ■

## CAMCORDER HEAVEN

(Continued from page 1)

camera. The left hand supports the base of the camera or the lens, and the right hand holds the grip. The body grip has its own set of controls: The pause/record button is located where you would expect the shutter button to be on a still camera, while the telephoto/wide control is on back of the body for convenient thumb access.

The viewfinder is one of the best we've seen in a camcorder. It swivels 180 degrees so that it's comfortable to use in almost any position you're likely to want to shoot, but it doesn't swivel downward for over-the-head shots. The viewfinder's diopter, which allows you to match the viewfinder to your eyesight, has such a wide range that Canon calls it a "sports finder." You can easily adjust the viewfinder so that you can hold the camcorder at arm's length and still see the view in sharp focus. While that can make shooting more comfortable in many situations, it's especially useful when shooting sporting events because, with the viewfinder away from your eye, you can keep an eye on surrounding events. It works like a charm! We took the LI to a baseball game on one of our trial



CIRCLE 55 ON FREE INFORMATION CARD

runs. We caught some pretty good action, including Rickey Henderson, the all-time stolen-base leader, getting caught trying to steal second base! Even though the stadium featured a Sony Jumbotron video display, they didn't show the replay—a silly policy, if you ask us. We, however, had captured the play in all its glory, and got to see it again, and again, and again...

The L1's wireless remote control allows you to use many of the camera's features from a distance of up to 16 feet. The remote sensor is mounted on the front of the swivelling viewfinder, so that you can use the remote from either in front of or behind the camcorder. The controller works within an angle of 30 degrees on either side, and 15 degrees above and below the sensor.

The viewfinder keeps you informed of the L1's status while you shoot. An LCD on the top rear of the camcorder also displays important information.

The audio capabilities of the L1 actually match the video capabilities. Hi-f stereo sound is recorded in AFM (audio-frequency modulation) using the supplied removable microphone. The microphone features two modes of operation. In its stereo mode, a dial on the microphone's side adjusts the width of the stereo sound field. In its zoom mode, the dial adjusts the sensitivity of the microphone.

Although the recording level can be set to automatic, manual level control is also possible. The LCD on the top rear of the L1 contains a record-level meter. A headphone jack is provided so that you can monitor the recorded sound—it's especially valuable when using the zoom feature. For noisy environments (such as airports), a 20-dB attenuator can be switched in for more natural, undistorted sound recording.

Don't let its advanced features scare you off, the L1 is easy enough for even first-time videographers. Even though it features more than 30 controls and another eight behind doors, the camcorder can be set to full automatic control. You won't want to leave it in auto mode for long, though. Whether it's to select peak metering (which forces the camera to set proper exposure for the brightest object in the scene) or to use the exposure controller (which lets you change the exposure  $\pm 1$  stop in increments of  $\frac{1}{4}$  stop so that, for example, you can properly expose a dark subject in front of a bright background). Manual exposure control is, of course, also possible.

The shutter speed can be set manually for special effects. High shutter speeds are necessary to capture fast action without blurring. Seven high-speed shutter settings, from  $\frac{1}{600}$  to  $\frac{1}{60,000}$  of a second, are available. The standard high-shutter speed is  $\frac{1}{60}$  of a second.

The main reason that we turned off the full-auto switch was to try some of the L1's digital functions. Close-up, overlap, freeze, art freeze, and gain-up are offered.

The close-up feature effectively doubles the power of the zoom lens. Since it's done digitally, not optically, you do lose effective resolution. But it's a fun and sometimes very useful effect. We got, for example, some dramatic shots of a sparrow feeding its fledglings in a nest that had fallen to the ground in a storm. Not wanting to disturb the proceedings, we stayed as far away as we could, and zoomed to maximum. We got some pretty good shots, but we wanted to get closer. At the press of a button, we were so close that we could almost identify the insects the mother fed her offspring in the nest!

The overlap function lets you change scenes very smoothly—fading from your last shot to the new one. If you're satisfied with your present camcorder's fade control, you won't be once you try the L1's overlap. The thing we like best about it is that, although it's easy to set in motion, if you want to use the overlap function properly, you have to really *think* about what you're shooting. So you end up with better videos in the long run because you're more aware of scene transitions.

The digital freeze function freezes the image, as you might expect. Each time the digital-effect "on" button is pressed, the image that appears in the viewfinder is recorded as a still image. If you hold the "on" button down, the recorded image freezes for about 2 seconds, and is then replaced by a new image. "Art freeze" is similar to digital freeze except that it adds an "artistic" effect (posterization) to make images stand out.

The "gain-up" mode lets you slow the shutter speed  $\frac{1}{30}$ ,  $\frac{1}{15}$ ,  $\frac{1}{8}$ , and  $\frac{1}{4}$  second for shooting in the dimmest of situations. (The sensitivity increases to 0.5 lux!) The slow shutter speeds can also be used in brightly lit situations for some interesting blurring effects.

The L1 also offers self-timing and interval-timing capability. In self-timer mode, the L1 can be set to stand by for 10 seconds and then record continuously. Alternately, it will stand by and then record for 30 seconds before returning to pause mode. The interval timer can be set to do time-lapse photography. Three intervals—10, 20, and 60 seconds—can be selected. And the digital-overlap feature can be used for interval recording.

The L1 also features a clock that can be set to automatically start recording at any time within the 24-hour period. To be honest, we haven't really figured out a good use for the timer. Perhaps, since it can be used in conjunction with the "line in/out" modes, you can use it with the video outputs of a VCR to record programs that you can then take with you on vacation, or wherever else you bring the L1.

A built-in titler lets you create a 2-line by 16-character description of your scene. The date and time can be inserted with the touch of a button—a far better solution than drawing out the title cards.

With a suggested retail price of about \$3000, the L1 obviously isn't for everyone. It's copious features also make it a camcorder that many users wouldn't be willing to use. But if you already understand the basics of good videography and are looking to step up to a full-featured camcorder, or if you shoot videos semi-professionally, then the L1 is the camcorder to get. And because of the VL interchangeable-lens system and the plethora of accessories available, it's hard to imagine ever outgrowing the L1. Don't be surprised if you see some professionals using the L1, either. Without question, it's the video product of 1991. ■

## PAINTING BY PIXELS

(Continued from page 2)

the "A-B-C" function key. We first tried freehand drawing, by pressing the "crayon" function key and then one of the "mark" buttons. That sequence makes the menu disappear from the top of the screen (an area at the bottom of the screen is always reserved to indicate the color and function that you are currently using). A crayon-like cursor then appears on the screen, corresponding to the point on the drawing pad where you place your drawing pen. Once the pen is in the right position, holding down the mark button allows your marks to show up on the television screen. We found it most convenient to use the "mark lock" button for continuous drawing.

After a couple of false starts, we got accustomed to the mode-selection and drawing methods. We became adept at switching between functions none too soon—we quickly needed to change right to the "erase" mode to correct mistakes. Within about a half hour we were easily doodling away—and that's just what we came up with: doodles.

Granted, we're not professional artists. (Nor is any ten-year-old who is likely to use the Video Painter.) We can, however, render some lifelike images with pencil and paper. Our best efforts on the Video Painter, though, were decidedly childish. It's difficult to get a smooth line, particularly at first. Practice does help, and we have seen someone—an artist, no doubt!—copy pictures from a regular coloring book onto the Video Painter with terrific results. Still, our electronic drawings were, at best, primitively charming. They looked as if they belonged hanging on a refrigerator.

Once all the outlines were drawn in, we got to the easier part: coloring them in. While you have the option of coloring the old-fashioned way—using the crayon function key and stroking in the color—we preferred to simply paint our pictures. Colors are chosen by pressing one of the

twelve hues that appear on the color palette. The color can be changed with the press of a button at any time during any function. Pressing the function key marked with a paintbrush calls up a menu that consists of a solid square and six patterns (hearts, diamonds, stars, waves, bricks, and a random design). From that menu, you can choose to paint a solid color or give an object "texture" by using a pattern. For instance, you can "paint" a house in red bricks, or an ocean in blue waves. When the cursor (which resembles a paintbrush in the paint mode) appears on the screen, you simply move it into the boundaries of the area you wish to color and hold down the "mark" button until the area is filled.

As long as each area is completely enclosed, it will be colored in completely. There's no more going out of the lines. If there's a gap in your outline, however, the color bleeds out into surrounding areas. It's easy enough to push the "undo" button to erase the last color painted, go back and fix the line, and then paint it again. The "undo" function works only on the last thing you've done, but there are other ways to fix up a drawing.

It is possible to clean up your less-than-perfect renderings, for example, by using the "zoom" function. That allows you to select a portion of your drawing to be blown up so that you can see every pixel. You can then change the drawing, pixel by pixel, until you have it right. It's also possible to move part of your drawing to another part of the screen, duplicate it on the screen, or make it larger or smaller. We used the copy function, for example to place a copy of a patch of blue sky over a cloud that didn't look quite right.

If your artistic skills are non-existent, you can still use the Video Painter's built-in picture library. More than 50 pre-drawn, full-color pictures are stored in six categories: figures and animals, fantasy creatures, vehicles, stamps (a general category that includes a birthday cake, hand and foot prints, an explosion, musical notes, and a pointing hand), geometric shapes, and background scenes (a medieval castle, a sea shore, and a city street). The images of vehicles, people, animals, and fantasy creatures can be animated—but the "animation" is quite limited. You can mix and match the backgrounds and characters, add characters to your own backgrounds, or put your own characters into the Video Painter's scenery. And although all those pictures come in full color, you can change the colors to suit your fancy. For a real "coloring book" experience, you could even paint the entire scene white and start filling in the lines from scratch.

Although the old-fashioned coloring book has the Video Painter beat when it comes to price and simplicity (even though today's kids seem to master electronic devices at increasingly early ages, and V-Tech claims it's for "kids of all ages,"

children under the age of 8 or 9 might have difficulty with the Video Painter's controls), the Video Painter gains points in a few areas. Kids of all ages do seem to remain enthralled with any toy that involves the television set and/or VCR, and catch on quickly to the mechanics of using such devices. With the Video Painter, it's impossible for kids to "go out of the lines" and onto the carpet (or linoleum, or walls), and you don't have to worry about losing the crayons when you're at someone else's house. (The Video Painter is portable and easy to hook up.) Finally, that mass of "refrigerator art" can be relegated to videocassette tapes. In fact, a creative kid might want to tack a few drawings on to the end of the tape of her birthday party before sending it to Grandma. ■

## COMPUTER VIDEO

(Continued from page 3)

offices, and even more so on a desktop. Yet how do you keep track of those late break-ing stories or sports scores?

Business users could also use DesktopTV for video training presentations and eliminate the need for getting a separate video screen. Both home offices and businesses could benefit from using DesktopTV in security and surveillance—what better way to find out who's at the front door than simply pressing a hot key and viewing the output of a camera on your computer's monitor?

We found DesktopTV to perform surprisingly well, especially because we know how electrically "noisy" the inside of our computer is. However, the tuner apparently is well shielded. As long as the antenna cable leading to the card is also well shielded, interference won't be a problem. When using a VCR, videodisc player, or cable-TV as signal sources, we didn't have any problems. When using a standard antenna, we noticed interference on the low end of the VHF band (channels 2-4). We assume that computer-generated interference was entering via the lead-in cable.

We normally sit much closer to our computer monitors than we ever would to a TV. If you sit too close to a TV, the individual lines that make up the picture become readily apparent—and annoying. Computer monitors don't have the same problem because they use a non-interlaced display. The result? A clean, smooth picture that you can get right up to and still not see the lines! No, the picture doesn't have any better resolution, but it can sometimes seem that way.

Our only "complaints" are not with what the board does, but rather what it doesn't do. We would have preferred to see a direct video input instead of an RF input only. That wouldn't have required any ex-

tra circuitry, only a little more space on the back panel. We also would like to see stereo capability. But if there's any feature that would make DesktopTV really extraordinary, it would be the ability to change the size of the screen and keep it running in real time so that you could both watch and listen to the TV as you worked on other applications. Oh well. Multitasking on a PC isn't all it's cracked up to be. Nevertheless, DesktopTV is a fun and potentially very useful PC add-on. We'll never look at our VGA monitor the same way again. ■

## ADULT ENTERTAINMENT?

(Continued from page 4)

on as *he* rounds the bases"—even when one of the all-female teams is up at bat. The announcer also tends to say things like "Both teams were hot last inning. The next inning will be a real challenge"—in the *middle* of an inning. And "The top of the order is coming up to bat"—when they're not. Because there's no such thing as an error in "Baseball Stars Professional," a lot more hits are credited than in a real game—and every single one of them (even when you miss an easy pop fly) is accompanied by "That was a well-hit ball. That should be in there for a single!" (When you really bungle the fielding, that commentary is followed by "That could easily roll for a double.") And to think we complained about Phil Rizzuto's Yankees commentary!

This could be considered nit-picking, but similar carelessness was shown in the spelling of the players' names. For instance, besides Arthur, Lancelot, and Merlin the "Battle Knights" included "Ceaser" and "Sir Jhon."

Despite those annoying slip ups, the game action is both realistic and satisfying. The same can be said for "Top Player's Golf." We couldn't help groaning in frustration when we heard a ball land in a sand trap or splash into a stream, and smiling at the sound ("plunk") as it dropped into the hole.

We also tried a game called "Nam-1975," to which, we'll admit, we had an aversion (for political reasons) before even trying it. We tried hard to be fair judges, but—all politics aside—this game based on the Vietnam War is in poor taste—and definitely not for children. When the protagonist is shot, you can hear the impact of the bullet just before he grunts and his body either crumples and falls or is blown away. When you progress through the game, the weapons get worse. Napalm (or was it the flame throwers?) cause the very realistic death by burning of our hero. We know that there's an audience for both violent death scenes and return-to-Vietnam plots (Sylvester Stallone made

a fortune off that audience!), but we're not among its members.

There are 15 games currently available, and eight new titles are scheduled to be released before 1992. We would have liked to try a few others for this review, but were unable to get samples.

We were also unable to get our hands on a Memory Card, which is not included with either the standard or deluxe versions. As far as we can tell from the manual, the card can retain data (scores, games stage, etc.) from multiple games played either at home or in an arcade, and

then output the data into another Neo-Geo game. It lets you pick up from the middle of a game where you'd left off, or keep a record of the scores from several games.

Despite the superior audio and graphic quality exhibited by Neo-Geo, we question the demand for an adult-oriented video game. We fall into the targeted age and income group, and we haven't set foot in an arcade since we were teenagers, and rarely play video games unless we're reviewing them. As far as we can tell from an informal poll of friends and acquaintances who also fall into the target group, very

few people have both the time required for video games and the money required for buying Neo-Geo. Neo-Geo might have half-again as many bits and twice as many colors as Super NES—but it also has a price tag that's more than twice the size—triple, if you get two control units! (And then there are the high-priced games and the Memory Card.) If—and it's a big "if"—SNK can find large number of young adults with cash and time to spare (i.e., no demanding careers, mortgages, or young children) they can probably sell quite a few Neo-Geo games. ■

For more information on any product in this section, circle the appropriate number on the Free Information Card.

## ELECTRONICS WISH LIST

### Two-Way Radios

Many people have an image of two-way radios as kid's toys (we had a "Star Trek Walkie Talkie" when we were growing up). *Motorola* (1301 East Algonquin Road, Schaumburg, IL 60196-1078) is trying to change that image, by targeting its *Spirit Pro Series* of portable FM two-way radios at businesses and individuals who have never considered using radio communications. The lightweight, palm-sized portables are rugged, easy to use, and can be used for various applications. The *Spirit I* is a 1-watt, 1-channel VHF radio with a two-mile range. *Spirit II* is another one-channel radio, available in either VHF or UHF frequencies, that provides the ability to screen out unwanted conversations. *Spirit III* is a two-channel, VHF or UHF radio that allows for the addition of audio accessories. VHF radios are better suited for outdoor use and use in wooden buildings, while UHF radios are recommended for use in concrete and steel structures. The user can choose between open squelch, which permits communications between all radios on the same channel, and coded squelch, which screens out unwanted conversations by limiting communications to those radios with the same squelch code. Price: Spirit I, \$225; Spirit II, \$245; Spirit III, \$429.

CIRCLE 56 ON FREE INFORMATION CARD



Motorola Two-Way Radios

### Fun with Math

If kids spent as much time on their homework as they did playing video games, maybe there would be no need for products like *New Math Blaster Plus!* from Davidson & Associates Inc. (3135 Kashiwa St., Torrance, CA 90505). The math software program for Apple Macintosh computers uses state-of-the-art sound, animation, and graphics, and a problem-solving game to bring mathematics to life for children ages 6 to 12. The kids are taught about addition, subtraction, multiplication, division, fractions, decimals, and percents while helping the Blasternaut and his trusted robot, Spot, to save the universe from the "trash aliens" and to recycle garbage. Activities and lessons help children develop critical thinking and problem-solving skills by applying rules, making decisions, seeing cause and effect, predicting outcomes, looking for patterns, and taking risks. The software features 750 math facts and six levels of difficulty, a record-keeping system to track students' progress, certificates of excellence that motivate students by recognizing their achievements, and a test maker to determine the appropriate starting subject or level. A built-in editor allows parents and teachers to create and add their own math problems. Price: \$59.95 (two-disk teacher's edition is \$69.95; five-disk lab pack is \$179.95).

CIRCLE 57 ON FREE INFORMATION CARD



Davidson New Math Blaster Plus!

# ELECTRONICS WISH LIST

For more information on any product in this section, circle the appropriate number on the Free Information Card.

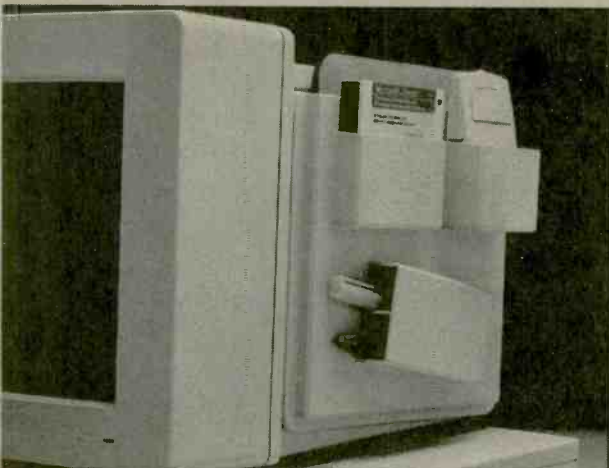

Basic Needs Utility Pac

## PC Utility Pac

We're all for anything that promises to bring some order to the chaos of our GIZMO offices—the *Utility Pac* from *Basic Needs* (2342 Meyers Avenue, Escondido, CA 92029), for instance. It's made of high-impact plastic and attaches to any flat surface, although it's specifically intended to go on the side of a computer monitor. The *Utility Pac* stores a mouse, mouse pads, diskettes, paper, and pens within easy reach, but off the desk top. Price: \$16.95.

CIRCLE 58 ON FREE INFORMATION CARD



Arkon Turbo Camcharger

## Camcorder-Battery Recharger

Designed to accommodate 9.6-volt Ni-Cd camcorder batteries, *Arkon Resources, Inc.*'s (1167 Clark Street, Suite 101, Arcadia, CA 91006) two models of *Turbo Camcharger TC200-9* offer the convenience of AC/DC capability for recharging at home or on the road. (It is available in both a DC-only version and DC with AC power adapter.) The *Camcharger* features electronic reconditioning circuitry to control the discharge/recharge process and eliminate the "memory build-up" problem that can plague Ni-Cd batteries. The device provides a deep-cycle charge each time, with full overcharge protection. Price: \$99.95 (DC only); \$119.95 (with AC adapter).

CIRCLE 59 ON FREE INFORMATION CARD



Sanyo Cordless Phone

## Cordless Telephone

The convenience of cordless phones is often offset by noisy reception, but *Sanyo* (21350 Lassen Street, Chatsworth, CA 91311-2329) has addressed that problem with "Super Comander II" noise-reduction technology. The audio signal sent from the base is compressed. When the voice signal is expanded by the handset, any noise picked up during the transmission stays compressed outside audible levels, resulting in an 86-dB signal-to-noise ratio. Other features include 10-number speed-dialing memory, 256 digital security codes to prevent access from other cordless phones, 10-channel manual scan, and stand-alone handset design. The handset has a seven-day battery stand-by feature that allows it to function apart from the base for up to a week before requiring recharging. The base includes a speaker phone for use when the handset is elsewhere. Price: \$129.99.

CIRCLE 60 ON FREE INFORMATION CARD

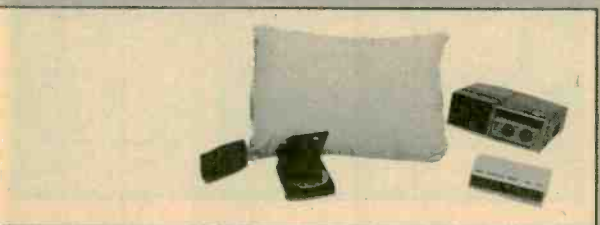

Technology Sales Pillow Talker

## Pillow Talk

Does your spouse keep you up past your bedtime by watching television or listening to the radio? Perhaps your significant other is a little more considerate—but you still end up sleeping in a bed full of cordless headphones or personal stereos. *Technology Sales, Inc.* (500 North Plum Grove Road, Palatine, IL 60067) offers a restful alternative, in the form of pillows with "tiny-but-powerful" speakers built in. *Pillow Talker*, stuffed with non-allergenic, polyester/cotton fill, are available in standard, queen, and king sizes. Each is equipped with a two-foot cord with a jack sized to fit all mini-headphone jacks, and comes with an adapter plug for standard headphone jacks. The *Pillow Talker* can be plugged into a bedside clock radio, cassette player, TV, stereo, or CD player, so that a person can listen to favorite music or television shows without disturbing others. Price: \$19.95 (standard); \$24.95 (queen); \$29.95 (king).

CIRCLE 61 ON FREE INFORMATION CARD



For more information on any product in this section, circle the appropriate number on the Free Information Card.

# ELECTRONICS WISH LIST

## Surf's Up!

Water-resistant to 1000 meters, a sporty watch from *Casio, Inc.* (570 Mt. Pleasant Ave., P.O. Box 7000, Dover, NJ 07801) features hour, minute, second, AM/PM, year, month, date, and day indicators along with a "surfing timer" with  $\frac{1}{1000}$ -second stopwatch to time those rides. For those who prefer calmer waters, or who are not coordinated well enough to push little buttons while balancing on a surf board, the *SUF-100IV* can also be used to time laps in a pool. The stopwatch feature has a 59-minute working range and net time, lap time, and first- and second-place times. Other functions include a countdown alarm, a daily alarm, hourly time signals, and 12-/24-hour formats. Price: \$49.95.

CIRCLE 62 ON FREE INFORMATION CARD

## Children's "Computer"

A pop-up screen, fold-in handle, QWERTY keyboard, enter key, and gray case give the *Super Computer* educational learning device the look of a real laptop computer. The device, from *Integ, Inc.* (2674 North First Street, San Jose, CA 95134), offers 22 activities at six skill levels in a choice of up to five languages. Kids interact with the Super Computer through digital voice technology, two-player compete buttons, and type-in functions as they explore such subjects as science, object recognition, history, geography, math, and spelling. Studying is fun with quizzes, games, jumbles, anagrams, trivia and exercises to enhance learning. Four optional conversion cartridges allow the Super Computer to function in German, French, Spanish, and Italian, as well as its standard English. Price: \$129.95; \$24.95 for each language conversion cartridge.

CIRCLE 63 ON FREE INFORMATION CARD

## Personal Pay Phones

It has been predicted that by the end of the decade, there will be far more privately owned pay phones than those owned by local phone companies. Because of federal deregulation, private pay phones can be used to prevent customer and employee abuse of business phones. *Telco Intercontinental Corporation's* (9812 Whithorn Drive, Houston, TX 77095) models 674 for local calls and 696 for local and long-distance calls allow the owner to keep 100% of the pay-phone revenues. The devices resemble regular desk-top telephones, require no electricity, and plug into standard phone jacks. They convert to conventional phones with a "coin-free" key. The *Lock-Up Banker* accessory allows the phones to be wall-mounted and expands the coin box from \$50 to \$250 capacity. Both phone models allow the owner to charge for or offer free calls to such numbers as 411, "O," and 800 numbers; to restrict numbers such as 900 and overseas calls; and to use an owner's key to allow coinless calls. The model 674 also times incoming and outgoing calls, and can limit the length from 1 to 16 minutes. The model 696 lets the owner earn extra income from 1+ calls and credit-card calls and has copyrighted programming capabilities. The pay phones are intended for use in restaurants and bars, health clubs, laundromats, employee lounges, vending-machine areas, waiting rooms, gas and service stations, professional offices, and beauty salons—but we can think of a few families with teenagers who also might be interested! Price: Model 674, \$299; Model 696, \$499; Lock-Up Banker, \$89.

CIRCLE 64 ON FREE INFORMATION CARD

## Compact Disc Wallet

Is your car littered with dozens of plastic CD cases? Have you been looking for a convenient way to carry extra discs for your portable CD player? A handy accessory from *Case Logic* (6930 Winchester Circle, Boulder, CO 80301) addresses both of those problems. The *Compact Disc Wallet* (model CDW-12) is designed to hold up to 12 discs without their jewel boxes. It provides protection for portable CD collections without taking up much room. The Compact Disc Wallet is made of durable nylon with foam padding, transparent-plastic pockets to hold the discs securely, a zippered closure to keep the CD's clean and dust-free, and an index card for listing the CD's. Price: \$12.95.

CIRCLE 65 ON FREE INFORMATION CARD



Casio Surf Watch



CGN "Super Computer"



Telco Personal Pay Phones

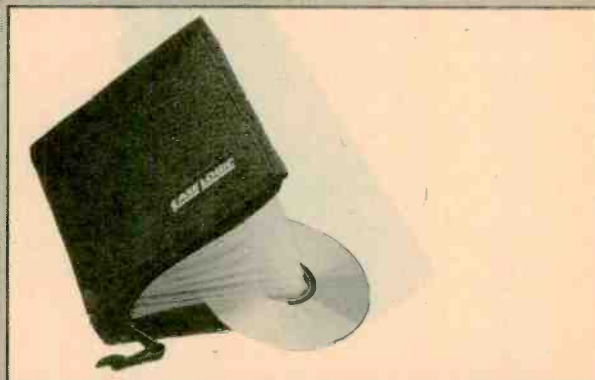

Case Logic CD Wallet

# ELECTRONICS WISH LIST

For more information on any product in this section, circle the appropriate number on the Free Information Card.



Gemini Rabbit Wireless VCR Transmitter



RTW STATX Cleanser



Melconi Bodyguard Remote Protector

## Wireless VCR Multiplier

If you want to send video and stereo-audio signals from the VCR in your family room to one or more TV sets in other rooms of the house—or even outside in the yard or garage—*Gemini Industries, Inc.'s* (215 Entin Road, Clifton, NJ 07014) *Rabbit VC5000* can transmit signals through walls, concrete, metal beams, and other structural materials from up to 120 feet away. The made-in-America device's crystal-controlled design and phase-locked loop circuitry ensure clear pictures with no fine tuning required. The Rabbit can also be set up with a camcorder or other video camera for use as an in-home babysitter or security system, and can be used for wireless videotape dubbing. Other applications of the system—which consists of a transmitter, a receiver, power adapters, and all necessary cables—tie-in with satellite receivers, TV/cable tuners, and PC's. Price: \$99.95 (additional receivers cost \$45.95).

CIRCLE 66 ON FREE INFORMATION CARD

## Dust-Repelling Cleaner

If there's anything that consumers can do on their own to prolong the life of their electronic gear, it's to keep the stuff clean and static-free. That's a simple, one-step process using *STATX*, the dual-action, dust-repellent and anti-static formula from *RTW Corporation* (1110 Lake Cook Road, Suite 150, Buffalo Grove, IL 60089). Originally developed for the aerospace industry, the consumer product is designed for use on computers, copiers, fax machines, home-entertainment components, microwave ovens, and household appliances. According to RTW, a light application on all exterior surfaces every few weeks will keep electronic equipment clean and protected from static-electric build-up. When the citrus-scented cleanser is applied with a light sweeping spray and then wiped with a soft cloth, it evaporates quickly without leaving any streaks or residue. *STATX* comes in a six-ounce, ozone safe spray can. It left our audio/video gear and computers gleaming. (We can finally read what we're typing!) Price: \$7.99.

CIRCLE 67 ON FREE INFORMATION CARD

## Remote Protection

One of the most abused pieces of electronic equipment in any home is the remote control. We expect that ours is typical: It gets dropped, lost behind sofa cushions and sat on, kicked, tossed across the room (and missed)—and that's in the course of one evening's TV viewing. It's not surprising that there are so many replacement remote controls on the market—often at high prices. *Melconi*, an Italian manufacturer represented in the U.S. by *Wittenberg Distributors, Inc.* (600 Erie Place, P.O. Box 957, Syracuse, NY 13201-0957) has designed the *Bodyguard*, a protective sleeve that slips over a TV or VCR remote control to cushion and safeguard it from falls and other mishaps. It is made of a black, high-resiliency rubber with extra cushioning around the edges and cutaways to expose the control buttons and infrared beam. The *Bodyguard* is molded in an assortment of sizes and shapes to fit various designs of video remote controls. Price: \$14.95.

CIRCLE 68 ON FREE INFORMATION CARD

## 100-Channel Handheld Scanner

The *Realistic PRO-35* direct-entry programmable scanner with 100-channel coverage offers scanner enthusiasts direct access to more than 20,000 frequencies, including police and fire departments, amateur radio, transportation services, and aircraft frequencies. The handheld unit from *Radio Shack (division of Tandy Corporation, 700 One Tandy Center, Fort Worth, TX 76102)* has 10 memory banks for easy identification of stored channels. The search mode makes it easy to locate new or unpublicized frequencies, and the monitor band lets the user quickly store channels found during the search. The *PRO-35* also has a weather band key for instant reception of local weather frequencies. Other features include a selectable two-second scan delay, channel lock-out, automatic shift to a preset priority channel whenever it is active, and memory backup that retains channels for up to an hour without the battery. A detachable, flexible antenna; a BNC antenna jack; an earphone jack; a belt clip; a rechargeable NiCd battery pack; and an AC adapter/charger come with the scanner. Price: \$229.95.

CIRCLE 69 ON FREE INFORMATION CARD

# A Buyer's Guide to DMM's

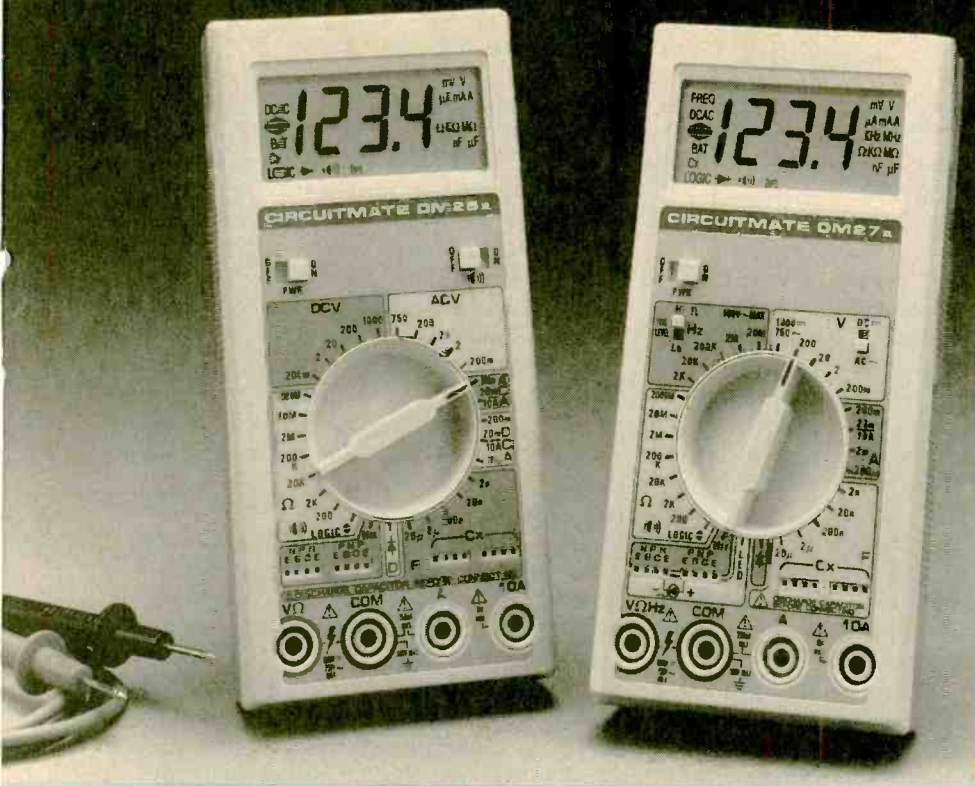

*Picking a digital multimeter that fits your needs from the literally hundreds available can be a formidable task. This buyer's guide makes that task a little easier.*

**W**ether you're a beginning electronics hobbyist, a veteran tinkerer, or an engineer, technician, or other electronics professional, when it's time to take an electronic measurement, the first thing most of us reach for is our trusty digital multimeter (DMM). That's not surprising considering how familiar, useful, and relatively inexpensive DMM's are.

In case you haven't looked lately, modern units are a far cry from the meters of just a few years ago. For one thing, today's DMM's truly are *multi* meters, featuring such things as built-in frequency counters, logic probes, capacitor testers, digital thermometers, and more. What's more, many meters offer features such as peak hold, data hold, memory, and more that make them easier to use and more versatile.

In the pages that follow, we present a Buyer's Guide to DMM's. In it, we list most of the DMM's currently on the market,

their capabilities, their features, and their prices. But before we get into that, let's look at what a basic DMM's function is, and what special features are available that can make a DMM more versatile, more accurate, and/or easier to use.

**Volts, AMPS, and OHMS.** A DMM's primary function is to measure voltage, current, and resistance and to display the results of that measurement directly on a display, usually an LCD. With some exceptions, all DMM's measure resistance and AC and DC voltage and current. One of those exceptions is low-priced meters, which may delete the AC functions and/or the current functions. Another exception is a probe or pen-type meter; most of those tiny meters, which are used for troubleshooting in tight quarters, only measure voltage and resistance.

When comparing between meters, be sure to take into account the number of ranges as well as the maximum measurement and the display type. For similar 3½-digit DMM's, a meter that breaks up its measurement capability into more ranges generally offers higher resolution for certain measurements.

You'll also notice that some, typically expensive meters are "true rms (root-mean-square) reading." A bit of explanation is in order: AC waveforms are typically thought of as sinusoidal, how-

ever other waveforms such as ramps, triangular waves, etc., are possible and, in fact, are common. Most meters are average sensing or responding; such meters can analyze and give an accurate rms measurement of sinusoidal AC waveforms, but cannot do that with other types. True-rms reading meters, on the other hand, can analyze and accurately measure and display the rms value of all types of AC waveforms.

**DMM Features.** As with just about anything else, with meters as you move up in price, you move up in features and performance. An expensive, professional-quality meter's primary selling point is extremely high precision. Perhaps even more important, however, is that those meters are built to stand up to the more rugged industrial environment. Many are drop resistant and are sealed to keep out water and other contaminants. Also, many of the high-end meters offer features, or feature implementations, that cannot be found on lower priced units.

However, once you go beyond the bare-bones lowest priced models, even modestly priced meters quickly begin to add functions, features, and all sorts of "bells and whistles." Some meters are virtually handheld test benches, incorporating capacitance meters, frequency counters, logic probes, and more. All of that can make a DMM more useful or versatile, but

keep in mind that a meter packed to the teeth with buttons and switches can be confusing to use, at least until you get to know it.

As you look through the guide, you'll see lots of features whose purposes are self-explanatory. However, if you are unfamiliar with DMM's, the purpose of some of those features may need some explanation. Let's discuss those now.

**Data hold** is a feature found on almost all pen- or probe-type DMM's, and on many other meters. When that feature is activated, the meter holds the results of a measurement on the display until it's either updated, cleared, or a preset period of time has elapsed. This feature is useful for measurement in tight quarters, and can be a life saver when working in high-voltage circuits where precise probe placement is critical for safety. Manufacturers implement this feature differently—some do it automatically, others require the push of a button—and some have different names for it such as Touch Hold and Probe Hold (not to be confused with a *probe holder*, which is simply a clip that holds one of the probes and allows you turn a standard DMM into a probe-type meter).

A **Relative** mode is used to measure the difference between two readings. It is useful for such things as sorting resistors, checking tolerances, etc. It is also used to zero out probe leads.

In the **Min/Max** mode, a meter keeps track of the minimum and maximum measurements at a specific point over

a period of time. This is useful for troubleshooting some transient or intermittent problems. Some meters notify the operator to new min/max readings with an audible alert. Similarly, a **peak hold** function keeps track only of the highest value measured, updating the display each time a new high value is detected.

With most meters, the user selects the measurement range by a rotary or pushbutton switch. On **Autorangeing** meters, the meter analyzes the input and selects the appropriate range. Of course, the measurement function must still be manually selected. Most autorangeing meters provide the user with a method of overriding the autorange selection or a way to manually select the range.

If you are forever draining batteries because you forget to turn things off, you may want a meter that features **auto power off**. Such meters turn off power automatically after a preset period of inactivity.

When digital multimeters were first introduced they met with some resistance (no pun intended). One of the chief complaints about them was that they could not be used for peaking and nulling adjustments. Some multimeters now overcome that limitation by including an **analog bargraph** display. The bargraph, located either above or below the digital display, shows trends and changes in much the same way as an analog pointer.

Normally, in performing resistance

measurements the meter uses a voltage that is high enough to bias a semiconductor junction. That makes the meter unsuitable for in-circuit resistance tests. However, some meters offer a **low power resistance** mode. In that mode, a lower voltage, one that is too low to bias a junction, is used; that allows the meter to make in-circuit resistance measurements.

Finally, some meters offer a **conductance** function. Used for making high-resistances measurement, it is useful when testing for leakage, and in other applications.

**Using This Guide.** It is impossible to summarize what makes a meter special or unique in just a few words. Indeed, many of the meters mentioned in the following pages deserve a page or two of their own. However, space makes that obviously impossible.

Instead, you should use this guide as a starting point, narrowing down your selection to a few meters that meet your features/price criteria. The next step is to get hold of the manufacturers literature on those units; to make that easier, we've included a manufacturers and exclusive distributors directory elsewhere in this article. Finally, pay a call to your local retailer and personally inspect and handle the meters you are interested in. Doing that will help ensure that you will select the digital multimeter that's the most perfect match to you and your needs.

And now, let's look at the meters!

## UNDER \$50

**COMPANY:** Kelvin Electronics  
**MODEL:** 100  
**DESCRIPTION:** Low-cost meter that's ideal for hobbyist use.  
**DIGITS:** 3½  
**DC VOLTAGE RANGE:** 1000 volts, 4 ranges  
**AC VOLTAGE RANGE:** 500 volts, 2 ranges  
**CURRENT RANGE:** 10 amps, 4 ranges DC only  
**RESISTANCE RANGE:** 2 megohms, 5 ranges  
**SPECIAL FEATURES:** Diode test, battery test  
**DIMENSIONS/WEIGHT:** N.A.  
**PRICE:** \$19.95

**COMPANY:** Alfa Electronics  
**MODEL:** 308  
**DESCRIPTION:** Pocket-sized meter with a large display.  
**DIGITS:** 3½  
**DC VOLTAGE RANGE:** 1000 volts, 4 ranges  
**AC VOLTAGE RANGE:** 500

volts, 2 ranges  
**CURRENT RANGE:** 10 amps, 4 ranges DC only  
**RESISTANCE RANGE:** 2 megohms, 5 ranges  
**SPECIAL FEATURES:** Diode test, battery test  
**DIMENSIONS/WEIGHT:** 5 × 2.8 × 1.3 inches/N.A.  
**PRICE:** \$24.95

**COMPANY:** Radio Shack  
**MODEL:** Micronta 22-171  
**DESCRIPTION:** An autorangeing, pocket-sized DMM with carrying case.  
**DIGITS:** 3½  
**DC VOLTAGE RANGE:** 200 mV–400 volts  
**AC VOLTAGE RANGE:** 2–400 volts  
**CURRENT RANGE:** N.A.  
**RESISTANCE RANGE:** 2–2000k ohms  
**SPECIAL FEATURES:** Audible continuity test, diode test, carrying case  
**DIMENSIONS/WEIGHT:** 4.25 ×

2.13 × 0.31 inches/N.A.  
**PRICE:** \$24.95



**COMPANY:** Radio Shack  
**MODEL:** Micronta 22-169  
**DESCRIPTION:** A pocket-sized autorangeing DMM with push-button operation.

**DIGITS:** 3½  
**DC VOLTAGE RANGE:** 400 volts, 5 ranges  
**AC VOLTAGE RANGE:** 400 volts, 5 ranges  
**CURRENT RANGE:** N.A.  
**RESISTANCE RANGE:** 2 megohms, 5 ranges  
**SPECIAL FEATURES:** audible continuity test, auto/manual ranging, hard-cover case  
**DIMENSIONS/WEIGHT:** 4¼ × 2¾ × ¾ inches/2.8 ounces  
**PRICE:** \$27.95

**COMPANY:** Beckman Industrial  
**MODEL:** DM78  
**DESCRIPTION:** This credit-card sized meter is easy to carry in a shirt pocket for measurements at any moment. It comes with a vinyl carrying case and attached test probes.  
**DIGITS:** 3½  
**DC VOLTAGE RANGE:** 450 volts, 5 ranges  
**AC VOLTAGE RANGE:** 250 volts, 4 ranges

**CURRENT RANGE:** N.A.  
**RESISTANCE RANGE:** 20 megohms, 4 ranges  
**SPECIAL FEATURES:** Continuity test, diode test  
**DIMENSIONS/WEIGHT:** 108 × 54 × 11 mm/99 grams  
**PRICE:** \$29.95

**COMPANY:** Kelvin Electronics  
**MODEL:** 150  
**DESCRIPTION:** Low-cost meter that's ideal for hobbyist use. An upgrade of the 100, this meter adds an audible continuity test and a transistor gain test.  
**DIGITS:** 3½  
**DC VOLTAGE RANGE:** 1000 volts, 5 ranges  
**AC VOLTAGE RANGE:** 750 volts, 2 ranges  
**CURRENT RANGE:** 10 amps, 4 ranges DC only  
**RESISTANCE RANGE:** 200 megohms, 7 ranges  
**SPECIAL FEATURES:** Diode test, audible continuity test, battery test, transistor gain test  
**DIMENSIONS/WEIGHT:** N.A.  
**PRICE:** \$29.95

**COMPANY:** Fordham Radio  
**MODEL:** Scope DVM-630  
**DESCRIPTION:** A small general-purpose DMM for hobbyists, students, etc.  
**DIGITS:** 3½  
**DC VOLTAGE RANGE:** 1000 volts, 5 ranges  
**AC VOLTAGE RANGE:** 750 volts, 2 ranges  
**CURRENT RANGE:** 2 amps, 5 ranges DC only  
**RESISTANCE RANGE:** 2 megohms, 5 ranges  
**SPECIAL FEATURES:** Diode test, battery test  
**DIMENSIONS/WEIGHT:** 5 × 2.6 × 0.9 inches/N.A.  
**PRICE:** \$32.50

**COMPANY:** Triplet Corporation  
**MODEL:** 2030  
**DESCRIPTION:** A pocket-calculator sized, autoranging DMM.  
**DIGITS:** 3½  
**DC VOLTAGE RANGE:** 2000 mV, 3 ranges  
**AC VOLTAGE RANGE:** 2000 mV, 3 ranges  
**CURRENT RANGE:** N.A.  
**RESISTANCE RANGE:** 2000k ohms, 4 ranges  
**SPECIAL FEATURES:** Auto/manual ranging, audible continuity test, built-in probes, hard-cover carrying case  
**DIMENSIONS/WEIGHT:** 2.2 × 4.25 × 0.39 inches/80 grams  
**PRICE:** \$33.00

**COMPANY:** A.W. Sperry Instruments, Inc.  
**MODEL:** DM-4100A  
**DESCRIPTION:** A full-featured multimeter that's rugged enough for professional use, yet inexpensive and simple to use, making it ideal for the hobbyist.  
**DIGITS:** 3½

**DC VOLTAGE RANGE:** 1000 volts, 4 ranges  
**AC VOLTAGE RANGE:** 200-500 volts, 2 ranges  
**CURRENT RANGE:** 10 amps, 4 ranges DC only  
**RESISTANCE RANGE:** 2 megohms, 5 ranges  
**SPECIAL FEATURES:** Diode test, battery test,  
**DIMENSIONS/WEIGHT:** 5.0 × 2.8 × 1.4 inches/7 ounces  
**PRICE:** \$34.95

**COMPANY:** Philips ECG  
**MODEL:** DM-26  
**DESCRIPTION:** A basic full-function, general-purpose DMM.  
**DIGITS:** 3½  
**DC VOLTAGE RANGE:** 1000 volts, 5 ranges  
**AC VOLTAGE RANGE:** 750 volts, 2 ranges  
**CURRENT RANGE:** 10 A, 4 ranges DC only  
**RESISTANCE RANGE:** 20 megohms, 6 ranges  
**SPECIAL FEATURES:** Diode test, low-power resistance function  
**DIMENSIONS/WEIGHT:** 5 × 2.8 × 1.3 inches/7 ounces  
**PRICE:** \$34.95

**COMPANY:** A.W. Sperry Instruments, Inc.  
**MODEL:** DM-1A  
**DESCRIPTION:** An economy-priced, pocket-calculator sized DMM loaded with advanced features.



**DIGITS:** 3½  
**DC VOLTAGE RANGE:** 500 volts, 5 ranges  
**AC VOLTAGE RANGE:** 500 volts, 4 ranges  
**CURRENT RANGE:** N.A.  
**RESISTANCE RANGE:** 20 megohms, 6 ranges  
**SPECIAL FEATURES:** Auto-ranging, data hold, diode test, audible continuity test, data hold, auto polarity, built-in test probes, carrying case  
**DIMENSIONS/WEIGHT:** 4.4 × 2 × 0.4 inches/3.5 ounces

**PRICE:** \$36.95  
**COMPANY:** Radio Shack  
**MODEL:** Micronta 22-188  
**DESCRIPTION:** A hobbyist-priced, autoranging DMM.  
**DIGITS:** 3½  
**DC VOLTAGE RANGE:** 1000 volts, 5 ranges  
**AC VOLTAGE RANGE:** 750 volts, 4 ranges  
**CURRENT RANGE:** 200 mA, 1 range DC only  
**RESISTANCE RANGE:** 2000k ohms, 5 ranges  
**SPECIAL FEATURES:** diode test  
**DIMENSIONS/WEIGHT:** 5 × 3 × 1.25 inches/5.5 ounces  
**PRICE:** \$36.95

**COMPANY:** Mercer Electronics  
**MODEL:** 9345  
**DESCRIPTION:** An autoranging, shirt-pocket sized DMM.  
**DIGITS:** 3½  
**DC VOLTAGE RANGE:** 500 volts, 5 ranges  
**AC VOLTAGE RANGE:** 500 volts, 4 ranges  
**CURRENT RANGE:** N.A.  
**RESISTANCE RANGE:** 20 megohms, 6 ranges  
**SPECIAL FEATURES:** Diode test, audible continuity test, autoranging, hard-cover case  
**DIMENSIONS/WEIGHT:** 4.25 × 2.13 × .31 inches/2.1 ounces  
**PRICE:** \$38.80

**COMPANY:** American Reliance, Inc.  
**MODEL:** AR-140/AR-140K  
**DESCRIPTION:** A low-cost DMM made with the student/hobbyist in mind. Also available in kit form as the AR-140K.  
**DIGITS:** 3½  
**DC VOLTAGE RANGE:** 1000 volts, 5 ranges  
**AC VOLTAGE RANGE:** 750 volts, 2 ranges  
**CURRENT RANGE:** 10 amps, 6 ranges DC only  
**RESISTANCE RANGE:** 20 megohms, 6 ranges  
**SPECIAL FEATURES:** Diode test  
**DIMENSIONS/WEIGHT:** 5.9 × 3.2 × 1.2 inches/7.1 ounces  
**PRICE:** AR-140: \$39.95; AR-140K: \$49.95

**COMPANY:** Component Specialties, Inc.  
**MODEL:** Emco DMR-26  
**DESCRIPTION:** An economy-priced meter designed for the hobbyist or student.  
**DIGITS:** 3½  
**DC VOLTAGE RANGE:** 200 volts, 2 ranges  
**AC VOLTAGE RANGE:** 500 volts, 1 range  
**CURRENT RANGE:** 10 amps, 1 range DC only  
**RESISTANCE RANGE:** 2000k ohms, 2 ranges  
**SPECIAL FEATURES:** diode test, drop proof

**DIMENSIONS/WEIGHT:** 5¼ × 2¾ × 1¼ inches/N.A.  
**PRICE:** \$39.95

**COMPANY:** Jameco Electronics  
**MODEL:** Metex M3800  
**DESCRIPTION:** A full-featured DMM at a hobbyist price.  
**DIGITS:** 3½  
**DC VOLTAGE RANGE:** 1000 volts, 5 ranges  
**AC VOLTAGE RANGE:** 700 volts, 5 ranges  
**CURRENT RANGE:** 20 amps, 7 ranges AC/DC  
**RESISTANCE RANGE:** 20 megohms, 6 ranges  
**SPECIAL FEATURES:** Diode test, audible continuity test, transistor gain test, carrying case  
**DIMENSIONS/WEIGHT:** 6.75 × 3.5 × 1.25 inches/1.4 pounds  
**PRICE:** \$39.95

**COMPANY:** Kelvin Electronics  
**MODEL:** 200  
**DESCRIPTION:** This low-priced, full featured meter is an upgrade of the 150; it adds an AC amps function and a capacitance test.  
**DIGITS:** 3½  
**DC VOLTAGE RANGE:** 1000 volts, 5 ranges  
**AC VOLTAGE RANGE:** 750 volts, 5 ranges  
**CURRENT RANGE:** 10 amps, 5 ranges AC/DC  
**RESISTANCE RANGE:** 200 megohms, 7 ranges  
**SPECIAL FEATURES:** Diode test, audible continuity test, capacitor test (20 μF, 5 ranges), transistor-gain test  
**DIMENSIONS/WEIGHT:** N.A.  
**PRICE:** \$39.95

**COMPANY:** Philips ECG  
**MODEL:** DM-27  
**DESCRIPTION:** A basic full-function, general-purpose DMM. An upgrade of the DM-26, this meter adds an audible continuity test.  
**DIGITS:** 3½  
**DC VOLTAGE RANGE:** 1000 volts, 5 ranges  
**AC VOLTAGE RANGE:** 750 volts, 2 ranges  
**CURRENT RANGE:** 10 A, 4 ranges DC only  
**RESISTANCE RANGE:** 20 megohms, 6 ranges  
**SPECIAL FEATURES:** Diode test, low-power resistance function, audible continuity test  
**DIMENSIONS/WEIGHT:** 5 × 2.8 × 1.3 inches/7 ounces  
**PRICE:** \$39.95

**COMPANY:** Radio Shack  
**MODEL:** Micronta 22-165  
**DESCRIPTION:** An autoranging pen-type meter.  
**DIGITS:** 3½  
**DC VOLTAGE RANGE:** 200 mV-400 volts  
**AC VOLTAGE RANGE:** 2-400 volts  
**CURRENT RANGE:** N.A.  
**RESISTANCE RANGE:** 2-

2000k ohms  
**SPECIAL FEATURES:** audible continuity test, data hold, auto power off  
**DIMENSIONS/WEIGHT:** 6.36 × 1.15 × 0.89 inches/2 ounces  
**PRICE:** \$39.95

**COMPANY:** Philips ECG  
**MODEL:** DM-25  
**DESCRIPTION:** A lightweight, pocket-sized, pushbutton-type meter.  
**DIGITS:** 3½  
**DC VOLTAGE RANGE:** 1000 volts, 4 ranges  
**AC VOLTAGE RANGE:** 750 volts, 2 ranges  
**CURRENT RANGE:** 2000 mA, 4 ranges DC only

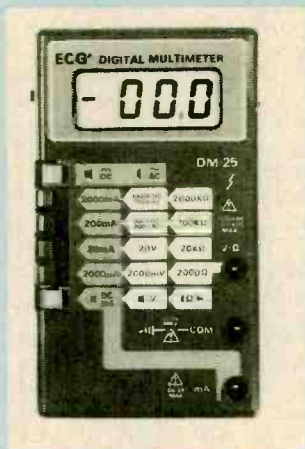

**RESISTANCE RANGE:** 2000k ohms, 4 ranges  
**SPECIAL FEATURES:** carrying case  
**DIMENSIONS/WEIGHT:** 5 × 3 × 1½ inches/6.88 ounces  
**PRICE:** \$41.95

**COMPANY:** B&K Precision  
**MODEL:** 2703  
**DESCRIPTION:** A general purpose DMM in a compact case.  
**DIGITS:** 3½  
**DC VOLTAGE RANGE:** 1000 volts, 5 ranges  
**AC VOLTAGE RANGE:** 750 volts, 2 ranges  
**CURRENT RANGE:** 10 amps, 4 ranges DC only  
**RESISTANCE RANGE:** 20 megohms, 6 ranges  
**SPECIAL FEATURES:** Diode test, audible continuity test  
**DIMENSIONS/WEIGHT:** 5 × 2¾ × 1¾ inches/9 ounces  
**PRICE:** \$44.00

**COMPANY:** Amprobe Instrument  
**MODEL:** AM-12  
**DESCRIPTION:** A general purpose DMM with all essential functions.  
**DIGITS:** 3½  
**DC VOLTAGE RANGE:** 1000 volts, 4 ranges  
**AC VOLTAGE RANGE:** 750 volts, 2 ranges

**CURRENT RANGE:** 10 amps, 4 ranges AC/5 ranges DC  
**RESISTANCE RANGE:** 2000k ohms, 5 ranges  
**SPECIAL FEATURES:** N.A.  
**DIMENSIONS/WEIGHT:** 5½ × 3 × 1 inches/5 ounces  
**PRICE:** \$44.85

**COMPANY:** Alfa Electronics  
**MODEL:** 5325  
**DESCRIPTION:** This pocket-sized meter has a capacitance function.  
**DIGITS:** 3½  
**DC VOLTAGE RANGE:** 1000 volts, 5 ranges  
**AC VOLTAGE RANGE:** 750 volts, 5 ranges  
**CURRENT RANGE:** 10 amps, 5 ranges AC/DC  
**RESISTANCE RANGE:** 20 megohms, 6 ranges  
**SPECIAL FEATURES:** Diode test, audible continuity test, capacitance test (20 µF, 5 ranges), transistor gain test  
**DIMENSIONS/WEIGHT:** 5 × 2.8 × 1.3 inches/N.A.  
**PRICE:** \$44.95

**COMPANY:** Beckman Industrial  
**MODEL:** DM10  
**DESCRIPTION:** A no-frills unit that provides digital convenience at an analog-meter price.  
**DIGITS:** 3½  
**DC VOLTAGE RANGE:** 1000 volts, 5 ranges  
**AC VOLTAGE RANGE:** 500 volts, 2 ranges  
**CURRENT RANGE:** 200 mA, 4 ranges DC only  
**RESISTANCE RANGE:** 2 megohms, 5 ranges  
**SPECIAL FEATURES:** Diode test  
**DIMENSIONS/WEIGHT:** 24 × 70 × 120 cm/175 grams  
**PRICE:** \$44.95

**COMPANY:** Elenco Electronics, Inc.  
**MODEL:** M-2600  
**DESCRIPTION:** An economy priced meter that offers a diode test function in addition to the standard DMM functions.  
**DIGITS:** 3½  
**DC VOLTAGE RANGE:** 1000 volts, 4 ranges  
**AC VOLTAGE RANGE:** 750 volts, 2 ranges  
**CURRENT RANGE:** 10 amps, 5 ranges DC only  
**RESISTANCE RANGE:** 20 megohms, 6 ranges  
**SPECIAL FEATURES:** Diode test  
**DIMENSIONS/WEIGHT:** N.A.  
**PRICE:** \$44.95

**COMPANY:** Triplett Corporation  
**MODEL:** 2200  
**DESCRIPTION:** A general purpose DMM with a transistor test function.  
**DIGITS:** 3½  
**DC VOLTAGE RANGE:** 1000 volts, 5 ranges

**AC VOLTAGE RANGE:** 750 volts, 2 ranges  
**CURRENT RANGE:** 2 amps, 5 ranges DC only  
**RESISTANCE RANGE:** 2 megohms, 5 ranges  
**SPECIAL FEATURES:** Diode test, transistor gain test  
**DIMENSIONS/WEIGHT:** 126 × 70 × 24 mm/125 grams  
**PRICE:** \$45.00

**COMPANY:** Component Specialties, Inc  
**MODEL:** Emco DMR-30T  
**DESCRIPTION:** An economy-priced meter with a transistor test and a high-visibility yellow case.  
**DIGITS:** 3½  
**DC VOLTAGE RANGE:** 1000 volts, 5 ranges  
**AC VOLTAGE RANGE:** 500 volts, 2 ranges  
**CURRENT RANGE:** 10 amps, 4 ranges DC only  
**RESISTANCE RANGE:** 2 megohms, 5 ranges  
**SPECIAL FEATURES:** diode test, transistor gain test  
**DIMENSIONS/WEIGHT:** 5¼ × 2¾ × 1½ inches/N.A.  
**PRICE:** \$45.50

**COMPANY:** Extech Instruments  
**MODEL:** 381625  
**DESCRIPTION:** Pen-type autoranging DMM with built in CMOS/TTL logic probe.  
**DIGITS:** 3½  
**DC VOLTAGE RANGE:** 500 volts, 5 ranges



**AC VOLTAGE RANGE:** 500 volts, 4 ranges  
**CURRENT RANGE:** 200 mA, 1 range AC/DC  
**RESISTANCE RANGE:** 20 megohms, 6 ranges  
**SPECIAL FEATURES:** CMOS/TTL logic probe, data hold, diode test, audible continuity test, autoranging  
**DIMENSIONS/WEIGHT:** 7.3 × 0.9 × 1.2 inches/2.4 ounces  
**PRICE:** \$49.00

**COMPANY:** Beckman Industrial  
**MODEL:** DM71  
**DESCRIPTION:** This pen-type autoranging multimeter is designed for easy one-hand operation in tight quarters.  
**DIGITS:** 3½  
**DC VOLTAGE RANGE:** 450 volts, 5 ranges  
**AC VOLTAGE RANGE:** 250 volts, 4 ranges  
**CURRENT RANGE:** RESISTANCE RANGE: 20 megohms, 6 ranges

**SPECIAL FEATURES:** Auto-ranging, data hold, diode test, continuity test  
**DIMENSIONS/WEIGHT:** 165 × 28 × 19 mm/75 grams  
**PRICE:** \$49.95

**COMPANY:** Philips ECG  
**MODEL:** DM-51  
**DESCRIPTION:** This general purpose DMM features transistor gain and battery test functions.  
**DIGITS:** 3½  
**DC VOLTAGE RANGE:** 1000 volts, 5 ranges  
**AC VOLTAGE RANGE:** 750 volts, 2 ranges  
**CURRENT RANGE:** 10 A, 5 ranges DC only  
**RESISTANCE RANGE:** 200 megohms, 7 ranges  
**SPECIAL FEATURES:** Diode test, low-power resistance function, audible continuity test, battery test, transistor gain test, carrying case  
**DIMENSIONS/WEIGHT:** 5 × 2.8 × 1.3 inches/7 ounces  
**PRICE:** \$49.95

## \$50-\$100

**COMPANY:** Mercer Electronics  
**MODEL:** 9370  
**DESCRIPTION:** A pocket-sized DMM with full function and range capability.  
**DIGITS:** 3½  
**DC VOLTAGE RANGE:** 1000 volts, 5 ranges  
**AC VOLTAGE RANGE:** 750 volts, 2 ranges  
**CURRENT RANGE:** 2 amps, 5 ranges DC only  
**RESISTANCE RANGE:** 20 megohms, 6 ranges  
**SPECIAL FEATURES:** Diode test, audible continuity test  
**DIMENSIONS/WEIGHT:** 4.96 × 2.76 × .94 inches/6 ounces  
**PRICE:** \$52.50

**COMPANY:** Triplett Corporation  
**MODEL:** 3525-B  
**DESCRIPTION:** An autoranging pen-type DMM for measurements in tight quarters.  
**DIGITS:** 3½  
**DC VOLTAGE RANGE:** 500 volts, 5 ranges  
**AC VOLTAGE RANGE:** 500 volts, 4 ranges  
**CURRENT RANGE:** N.A.



**RESISTANCE RANGE:** 20 megohms, 6 ranges  
**SPECIAL FEATURES:** Audible continuity test, data hold, autoranging, carrying case  
**DIMENSIONS/WEIGHT:** 1½ × ¾ × 6¾ inches/4 ounces  
**PRICE:** \$55.00

**COMPANY:** A.W. Sperry Instruments, Inc.

**MODEL:** DM-6593A

**DESCRIPTION:** A probe-style multimeter that's ideal for use in hard-to-reach areas.

**DIGITS:** 3½

**DC VOLTAGE RANGE:** 500 volts, 5 ranges

**AC VOLTAGE RANGE:** 500 volts, 4 ranges

**CURRENT RANGE:** N.A.

**RESISTANCE RANGE:** 20 megohms, 6 ranges

**SPECIAL FEATURES:** auto-ranging, interchangeable probe tips, audible continuity test, data hold, carrying case

**DIMENSIONS/WEIGHT:** 6.3 × 1.2 × 0.8 inches/2.29 ounces

**PRICE:** \$59.95

**COMPANY:** American Reliance, Inc.

**MODEL:** AR-120

**DESCRIPTION:** A low-cost basic DMM with 0.5% basic DC accuracy and plenty of features.

**DIGITS:** 3½

**DC VOLTAGE RANGE:** 1000 volts, 5 ranges

**AC VOLTAGE RANGE:** 750 volts, 5 ranges

**CURRENT RANGE:** 10 amps, 5 ranges AC/DC

**RESISTANCE RANGE:** 20 megohms, 6 ranges

**SPECIAL FEATURES:** Audible continuity test, diode test

**DIMENSIONS/WEIGHT:** 5.9 × 3.2 × 1.2 inches/7.1 ounces

**PRICE:** \$59.95

**COMPANY:** American Reliance, Inc.

**MODEL:** AR-100/AR-102

**DESCRIPTION:** Pen-type auto-ranging multimeter with built-in logic probe.

**DIGITS:** 3½

**DC VOLTAGE RANGE:** 500 volts, 5 ranges

**AC VOLTAGE RANGE:** 500 volts, 4 ranges

**CURRENT RANGE:** N.A.

**RESISTANCE RANGE:** 20 megohms, 6 ranges

**SPECIAL FEATURES:** Auto-ranging, diode test, interchangeable probe tips, built in TTL/CMOS logic probe (AR-100: 10 MHz; AR-102 40 MHz), data hold

**DIMENSIONS/WEIGHT:** 7.4 × 1.2 × 0.8 inches/2.4 ounces

**PRICE:** AR-100: \$59.95; AR-102: \$69.95

**COMPANY:** Beckman Industrial

**MODEL:** DM15B

**DESCRIPTION:** An upgrade of the DM10, this meter adds an AC-current function and an audible continuity test.

**DIGITS:** 3½

**DC VOLTAGE RANGE:** 1000 volts, 5 ranges

**AC VOLTAGE RANGE:** 750 volts, 5 ranges

**CURRENT RANGE:** 2 amps DC/AC, 5 ranges

**RESISTANCE RANGE:** 20 megohms, 6 ranges

**SPECIAL FEATURES:** Diode test, audible continuity test

**DIMENSIONS/WEIGHT:** 24 × 70 × 120 cm/175 grams

**PRICE:** \$59.95

**COMPANY:** Elenco Electronics, Inc.

**MODEL:** M-2650

**DESCRIPTION:** This economy priced meter is an upgrade of the M-2600; it offers transistor test and battery test functions and expanded measurement functions and ranges.

**DIGITS:** 3½

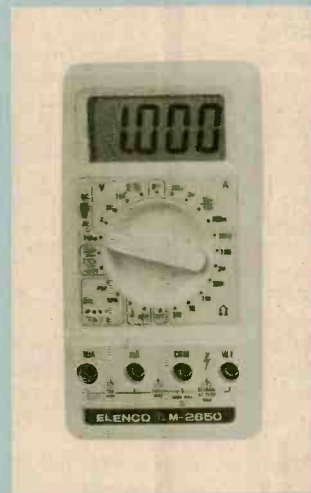

**DC VOLTAGE RANGE:** 1000 volts, 4 ranges

**AC VOLTAGE RANGE:** 750 volts, 5 ranges

**CURRENT RANGE:** 10 amps, 5 ranges AC/DC

**RESISTANCE RANGE:** 200 megohms, 7 ranges

**SPECIAL FEATURES:** Diode test, transistor gain test, battery test function, audible continuity test

**DIMENSIONS/WEIGHT:** N.A.

**PRICE:** \$59.95

**COMPANY:** Fordham Radio

**MODEL:** Scope DVM-636

**DESCRIPTION:** A general-purpose, pushbutton-operated DMM that includes capacitance and transistor functions.

**DIGITS:** 3½

**DC VOLTAGE RANGE:** 1000 volts, 5 ranges

**AC VOLTAGE RANGE:** 750 volts, 5 ranges

**CURRENT RANGE:** 10 amps, 5 ranges AC/DC

**RESISTANCE RANGE:** 20 megohms, 6 ranges high-power/5 ranges low-power

**SPECIAL FEATURES:** Diode test, transistor gain test, capacitance function (20 µF, 5 ranges), low-power resistance function

**DIMENSIONS/WEIGHT:** N.A.

**PRICE:** \$59.95

**COMPANY:** Global Specialties

**MODEL:** 735

**DESCRIPTION:** This full-featured, autoranging DMM includes a low-power resistance function and a memory mode.

**DIGITS:** 3½

**DC VOLTAGE RANGE:** 1000 volts, 5 ranges

**AC VOLTAGE RANGE:** 750 volts, 4 ranges

**CURRENT RANGE:** 10 amps, 2 ranges AC/DC

**RESISTANCE RANGE:** 2 megohms, 5 ranges high power/4 ranges low power

**SPECIAL FEATURES:** Diode test, audible continuity test, auto/manual ranging, memory mode, data hold, low-power ohms function

**DIMENSIONS/WEIGHT:** N.A.

**PRICE:** \$59.95

**COMPANY:** Heath Company

**MODEL:** 2311

**DESCRIPTION:** A general-purpose DMM with capacitance and transistor test functions.

**DIGITS:** 3½

**DC VOLTAGE RANGE:** 1000 volts, 5 ranges

**AC VOLTAGE RANGE:** 750 volts, 5 ranges

**CURRENT RANGE:** 10 amps, 5 ranges AC/DC

**RESISTANCE RANGE:** 20 megohms, 6 ranges

**SPECIAL FEATURES:** Diode test, audible continuity test, transistor gain test, capacitance test (20µF, 5 ranges)

**DIMENSIONS/WEIGHT:** N.A.

**PRICE:** \$59.95

**COMPANY:** Jameco Electronics

**MODEL:** Metex M3610

**DESCRIPTION:** A full-featured DMM with a large, 0.7-inch display.

**DIGITS:** 3½

**DC VOLTAGE RANGE:** 1000 volts, 5 ranges

**AC VOLTAGE RANGE:** 750 volts, 5 ranges

**CURRENT RANGE:** 20 amps, 6 ranges AC/DC

**RESISTANCE RANGE:** 20 megohms, 6 ranges

**SPECIAL FEATURES:** Diode test, audible continuity test, transistor gain test, carrying case

**DIMENSIONS/WEIGHT:** 7 × 3.5 × 1.5 inches/1.7 pounds

**PRICE:** \$59.95

**COMPANY:** Philips ECG

**MODEL:** DM-74

**DESCRIPTION:** A general purpose, autoranging DMM.

**DIGITS:** 3½

**DC VOLTAGE RANGE:** 1000 volts, 5 ranges

**AC VOLTAGE RANGE:** 750 volts, 4 ranges

**CURRENT RANGE:** 10 A, 2 ranges AC/DC

**RESISTANCE RANGE:** 2 megohms, 5 ranges high power, 4 ranges low power

**SPECIAL FEATURES:** Auto/manual ranging, extended ranges (in manual mode), low-power resistance function, memory/null (nulls out lead resistance), audible continuity test

**DIMENSIONS/WEIGHT:** 6 × 3 × 1.4 inches/8.1 ounces

**PRICE:** \$59.95

**COMPANY:** Radio Shack

**MODEL:** Micronta 22-184

**DESCRIPTION:** An autoranging DMM.

**DIGITS:** 3½

**DC VOLTAGE RANGE:** 1000 volts, 5 ranges

**AC VOLTAGE RANGE:** 750 volts, 4 ranges

**CURRENT RANGE:** 10 amps, 2 ranges AC/DC

**RESISTANCE RANGE:** 2000k ohms, 4 ranges

**SPECIAL FEATURES:** Diode test, audible continuity test, auto/manual ranging

**DIMENSIONS/WEIGHT:** 6½ × 3½ × 1¼ inches/7.97 ounces

**PRICE:** \$59.95

**COMPANY:** Radio Shack

**MODEL:** Micronta 22-185

**DESCRIPTION:** A 3½-digit meter for field or bench use.

**DIGITS:** 3½

**DC VOLTAGE RANGE:** 1000 volts, 5 ranges

**AC VOLTAGE RANGE:** 750 volts, 5 ranges

**RESISTANCE RANGE:** 20 megohms, 6 ranges

**SPECIAL FEATURES:** Diode test, audible continuity test, transistor gain test, carrying case

**DIMENSIONS/WEIGHT:** 7 × 3.5 × 1.5 inches/1.7 pounds

**PRICE:** \$59.95



volts, 4 ranges

**CURRENT RANGE:** 10 amps, 4 ranges AC/DC

**RESISTANCE RANGE:** 30 megohms, 6 ranges

**SPECIAL FEATURES:** diode test, audible continuity test

**DIMENSIONS/WEIGHT:** 6¾ × 3½ × 1¼ inches/11.6 ounces

**PRICE:** \$59.95

**COMPANY:** John Fluke Mfg. Co., Inc.

**MODEL:** 70

**DESCRIPTION:** Fluke's lowest priced model offers features such

as an analog bargraph display and auto/manual ranging.  
**DIGITS:** 4 (3200 count)  
**DC VOLTAGE RANGE:** 1000 volts, 5 ranges  
**AC VOLTAGE RANGE:** 750 volts, 4 ranges  
**CURRENT RANGE:** N.A.  
**RESISTANCE RANGE:** 32 megohms, 6 ranges  
**SPECIAL FEATURES:** Auto/manual ranging, diode test, audible continuity test, "Touch Hold", auto power off, analog bargraph display  
**DIMENSIONS/WEIGHT:** 6.55 × 2.95 × 1.12 inches/12 ounces  
**PRICE:** \$60.00

**COMPANY:** Component Specialties, Inc  
**MODEL:** Emco DMR-35  
**DESCRIPTION:** An economy-priced general-purpose meter.  
**DIGITS:** 3½  
**DC VOLTAGE RANGE:** 1000 volts, 5 ranges  
**AC VOLTAGE RANGE:** 500 volts, 2 ranges  
**CURRENT RANGE:** 10 amps, 5 ranges DC only  
**RESISTANCE RANGE:** 10 megohms, 6 ranges  
**SPECIAL FEATURES:** Diode test, audible continuity test, carrying case  
**DIMENSIONS/WEIGHT:** 6¾ × 3¾ × 1½ inches/N.A.  
**PRICE:** \$62.95

**COMPANY:** B&K Precision  
**MODEL:** 2802B  
**DESCRIPTION:** An autoranging pen-type DMM.  
**DIGITS:** 3½  
**DC VOLTAGE RANGE:** 500 volts, 5 ranges  
**AC VOLTAGE RANGE:** 500 volts, 4 ranges  
**CURRENT RANGE:** N.A.  
**RESISTANCE RANGE:** 20 megohms, 6 ranges  
**SPECIAL FEATURES:** Diode test, audible continuity test, data hold, autoranging  
**DIMENSIONS/WEIGHT:** 7 × 1¼ × ¾ inches/2.32 ounces  
**PRICE:** \$64.00

**COMPANY:** Amprobe Instrument  
**MODEL:** AM-14  
**DESCRIPTION:** A general purpose DMM that includes a temperature function.  
**DIGITS:** 3½  
**DC VOLTAGE RANGE:** 1000 volts, 5 ranges  
**AC VOLTAGE RANGE:** 750 volts, 5 ranges  
**CURRENT RANGE:** 10 amps, 5 ranges AC/DC  
**RESISTANCE RANGE:** 20 megohms, 7 ranges  
**SPECIAL FEATURES:** Diode test, audible continuity test, temperature function (-40 to +148.8°C/-40 to +300°F)  
**DIMENSIONS/WEIGHT:** 6 × 3¼ × ¾ inches/9.5 ounces

**PRICE:** \$64.85  
**COMPANY:** A.W. Sperry Instruments, Inc.  
**MODEL:** DM-4200A  
**DESCRIPTION:** A full-featured multimeter that's rugged enough for professional use, yet inexpensive and simple to use, making it ideal for the hobbyist. An upgrade of the DM-4100A, this meter adds extended ranges, an AC current test function, an audible continuity test, and a transistor test.  
**DIGITS:** 3½  
**DC VOLTAGE RANGE:** 1000 volts, 5 ranges  
**AC VOLTAGE RANGE:** 750 volts, 5 ranges  
**CURRENT RANGE:** 10 amps, 5 ranges AC/DC  
**RESISTANCE RANGE:** 200 megohms, 7 ranges  
**SPECIAL FEATURES:** Diode test, battery test, audible continuity test, transistor test  
**DIMENSIONS/WEIGHT:** 5.0 × 2.8 × 1.4 inches/7 ounces  
**PRICE:** \$64.95

**COMPANY:** B&K Precision  
**MODEL:** 2704  
**DESCRIPTION:** A general purpose DMM in a compact case. This upgrade of the 2703 adds AC amps, capacitance, and transistor gain functions.  
**DIGITS:** 3½  
**DC VOLTAGE RANGE:** 1000 volts, 5 ranges  
**AC VOLTAGE RANGE:** 750 volts, 5 ranges  
**CURRENT RANGE:** 10 amps, 5 ranges AC/DC  
**RESISTANCE RANGE:** 20 megohms, 6 ranges  
**SPECIAL FEATURES:** Diode test, audible continuity test, capacitance function (20 µF, 5 ranges), transistor gain test  
**DIMENSIONS/WEIGHT:** 5 × 2¾ × 1¾ inches/9 ounces  
**PRICE:** \$65.00

**COMPANY:** Elenco Electronics, Inc.  
**MODEL:** M-2690  
**DESCRIPTION:** An easy-to-use autoranging meter.  
**DIGITS:** 3½  
**DC VOLTAGE RANGE:** 1000 volts, 4 ranges  
**AC VOLTAGE RANGE:** 750 volts, 4 ranges  
**CURRENT RANGE:** 20 amps, 2 ranges AC/DC  
**RESISTANCE RANGE:** 20 megohms, 6 ranges  
**SPECIAL FEATURES:** Autoranging, diode test, audible continuity test  
**DIMENSIONS/WEIGHT:** N.A.  
**PRICE:** \$55.00

**COMPANY:** Mercer Electronics  
**MODEL:** 9370  
**DESCRIPTION:** A full-functioned, autoranging DMM with memory and a low-power resis-

tance mode.  
**DIGITS:** 3½  
**DC VOLTAGE RANGE:** 1000 volts, 5 ranges  
**AC VOLTAGE RANGE:** 750 volts, 4 ranges  
**CURRENT RANGE:** 10 amps, 2 ranges AC/DC  
**RESISTANCE RANGE:** 2000k ohms, 4 ranges low power/5 ranges high-power  
**SPECIAL FEATURES:** Diode test, audible and visual continuity test, memory mode, auto/manual ranging, low-power resistance mode  
**DIMENSIONS/WEIGHT:** 5.9 × 2.95 × 1.34 inches/8.1 ounces  
**PRICE:** \$66.15

**COMPANY:** B&K Precision  
**MODEL:** 2701  
**DESCRIPTION:** An autoranging meter with probe holder and data hold function.  
**DIGITS:** 3½  
**DC VOLTAGE RANGE:** 1000 volts, 5 ranges  
**AC VOLTAGE RANGE:** 750 volts, 4 ranges  
**CURRENT RANGE:** 200 mA, 2 ranges AC/DC  
**RESISTANCE RANGE:** 2 megohms, 5 ranges  
**SPECIAL FEATURES:** Diode test, audible continuity test, data hold, auto/manual ranging, probe holder, low-power ohms function, carrying case  
**DIMENSIONS/WEIGHT:** 6.9 × 2.3 × 1 inches/9 ounces  
**PRICE:** \$69.00

**COMPANY:** Brunelle Instruments, Inc.  
**MODEL:** 4080  
**DESCRIPTION:** An autoranging DMM with memory, low-power resistance, and audible and visible continuity functions.



**DIGITS:** 3½  
**DC VOLTAGE RANGE:** 1000 volts, 5 ranges  
**AC VOLTAGE RANGE:** 750 volts, 4 ranges  
**CURRENT RANGE:** 10 amps, 3 ranges AC/DC  
**RESISTANCE RANGE:** 2000k ohms, 5 ranges  
**SPECIAL FEATURES:** Diode test, auto/manual ranging, audi-

ble and visible continuity test, memory mode, low-power resistance function, data hold  
**DIMENSIONS/WEIGHT:** 6 × 3 × 1.34 inches/8.1 ounces  
**PRICE:** \$69.00

**COMPANY:** Alfa Electronics  
**MODEL:** 5365  
**DESCRIPTION:** This pocket-sized meter has a capacitance function, a frequency counter, and a logic probe.  
**DIGITS:** 3½  
**DC VOLTAGE RANGE:** 1000 volts, 5 ranges  
**AC VOLTAGE RANGE:** 750 volts, 5 ranges  
**CURRENT RANGE:** 10 amps, 5 ranges AC/DC  
**RESISTANCE RANGE:** 200 megohms, 7 ranges  
**SPECIAL FEATURES:** Diode test, audible continuity test, capacitance test (20 µF, 5 ranges), frequency counter (1 Hz-200 kHz), 20-MHz logic probe, transistor gain test  
**DIMENSIONS/WEIGHT:** 5 × 2.8 × 1.3 inches/N.A.  
**PRICE:** \$69.95

**COMPANY:** Beckman Industrial  
**MODEL:** DM73  
**DESCRIPTION:** This pen type autoranging multimeter is designed for easy one-hand operation in tight quarters. An upgrade



of the DM71, it offers higher precision for more demanding applications.  
**DIGITS:** 3½  
**DC VOLTAGE RANGE:** 500 volts, 5 ranges  
**AC VOLTAGE RANGE:** 250 volts, 4 ranges  
**CURRENT RANGE:** N.A.  
**RESISTANCE RANGE:** 2 megohms, 4 ranges  
**SPECIAL FEATURES:** Autoranging, data hold, continuity test  
**DIMENSIONS/WEIGHT:** 133 × 29 × 17 mm/70 grams  
**PRICE:** \$69.95

**COMPANY:** Fordham Radio  
**MODEL:** Scope DVM-638  
**DESCRIPTION:** This upgrade of the DVM-636 adds audible and visible continuity tests, a logic probe, and a conductance function.  
**DIGITS:** 3½  
**DC VOLTAGE RANGE:** 1000 volts, 5 ranges  
**AC VOLTAGE RANGE:** 750 volts, 5 ranges  
**CURRENT RANGE:** 10 amps, 4



ranges AC/DC

**RESISTANCE RANGE:** 20 megohms, 6 ranges high-power/5 ranges low-power

**SPECIAL FEATURES:** Diode test, transistor gain test, capacitance function (20  $\mu$ F, 5 ranges), low-power resistance function, logic probe, 20-nS conductance range, audible and visible continuity test

**DIMENSIONS/WEIGHT:** N.A.  
**PRICE:** \$69.95

**COMPANY:** Kelvin Electronics  
**MODEL:** 400

**DESCRIPTION:** This feature-packed meter includes a frequency counter and a logic probe.

**DIGITS:** 3 $\frac{1}{2}$

**DC VOLTAGE RANGE:** 1000 volts, 5 ranges

**AC VOLTAGE RANGE:** 750 volts, 5 ranges

**CURRENT RANGE:** 10 amps, 5 ranges AC/DC

**RESISTANCE RANGE:** 200 megohms, 7 ranges

**SPECIAL FEATURES:** Diode test, audible continuity test, capacitor test (20  $\mu$ F, 5 ranges), transistor gain test, frequency counter (20 MHz, 6 ranges), logic probe, LED test

**DIMENSIONS/WEIGHT:** N.A.  
**PRICE:** \$69.95

**COMPANY:** Philips ECG  
**MODEL:** DM-53

**DESCRIPTION:** An upgrade of the DM-51, this general purpose DMM features a capacitance test function.

**DIGITS:** 3 $\frac{1}{2}$

**DC VOLTAGE RANGE:** 1000 volts, 5 ranges

**AC VOLTAGE RANGE:** 750 volts, 5 ranges

**CURRENT RANGE:** 10 A, 5 ranges AC/DC

**RESISTANCE RANGE:** 20 megohms, 6 ranges

**SPECIAL FEATURES:** Diode test, low-power resistance function, audible continuity test, transistor gain test, capacitance test (20  $\mu$ F, 5 ranges), carrying case

**DIMENSIONS/WEIGHT:** 5 x 2.8 x 1.3 inches/7 ounces  
**PRICE:** \$69.95

**COMPANY:** Radio Shack  
**MODEL:** Micronta 22-167

**DESCRIPTION:** A full-featured, 3 $\frac{3}{4}$ -digit, auto/manual ranging DMM with a bargraph display.

**DIGITS:** 3 $\frac{3}{4}$

**DC VOLTAGE RANGE:** 1000 volts, 5 ranges

**AC VOLTAGE RANGE:** 750 volts, 4 ranges

**CURRENT RANGE:** 10 amps, 5 ranges AC/DC

**RESISTANCE RANGE:** 30 megohms, 6 ranges

**SPECIAL FEATURES:** diode test, audible continuity test, auto/manual ranging, analog bargraph display, data hold, auto

power off, protective holster

**DIMENSIONS/WEIGHT:** 6 $\frac{1}{2}$  x 3 $\frac{1}{16}$  x 1 $\frac{3}{8}$  inches/20 ounces  
**PRICE:** \$69.95

**COMPANY:** Radio Shack  
**MODEL:** Micronta 22-186

**DESCRIPTION:** A full-featured, 3 $\frac{3}{4}$ -digit, auto/manual ranging DMM with a bargraph display.

**DIGITS:** 3 $\frac{3}{4}$

**DC VOLTAGE RANGE:** 1000 volts, 5 ranges

**AC VOLTAGE RANGE:** 750 volts, 4 ranges

**CURRENT RANGE:** 10 amps, 2 ranges AC/DC

**RESISTANCE RANGE:** 30 megohms, 5 ranges

**SPECIAL FEATURES:** diode test, audible continuity test, auto/manual ranging, analog bargraph display, data hold

**DIMENSIONS/WEIGHT:** 6 $\frac{7}{16}$  x 3 $\frac{1}{8}$  x 1 $\frac{3}{8}$  inches/13 ounces  
**PRICE:** \$69.95

**COMPANY:** Brunelle Instruments, Inc.

**MODEL:** 4060

**DESCRIPTION:** Pushbutton-operated, 7-function, 35-range DMM.

**DIGITS:** 3 $\frac{1}{2}$

**DC VOLTAGE RANGE:** 1000 volts, 5 ranges

**AC VOLTAGE RANGE:** 750 volts, 5 ranges

**CURRENT RANGE:** 10 amps, 6 ranges AC/DC

**RESISTANCE RANGE:** 20 megohms, 6 ranges

**SPECIAL FEATURES:** Diode test, transistor gain test, low-power ohms function,

**DIMENSIONS/WEIGHT:** 180 x 86 x 42 mm/315 grams  
**PRICE:** \$73.00

**COMPANY:** Philips ECG  
**MODEL:** DM-300

**DESCRIPTION:** A professional quality, general purpose DMM.

**DIGITS:** 3 $\frac{1}{2}$

**DC VOLTAGE RANGE:** 1000 volts, 5 ranges

**AC VOLTAGE RANGE:** 750 volts, 5 ranges

**CURRENT RANGE:** 20 A, 6 ranges AC/DC

**RESISTANCE RANGE:** 20 megohms, 6 ranges

**SPECIAL FEATURES:** Diode test, audible continuity test, transistor gain test, low-power resistance functions

**DIMENSIONS/WEIGHT:** 6.8 x 3.5 x 1.7 inches/12 ounces  
**PRICE:** \$73.50

**COMPANY:** A.W. Sperry Instruments, Inc.

**MODEL:** DM-6510

**DESCRIPTION:** This autoranging (voltage and resistance ranges only) DMM offers many features normally found only in more expensive units. Noteworthy is an expanded resolution feature that extends the measurement capability of each man-

ual range by 50%.

**DIGITS:** 3 $\frac{1}{2}$

**DC VOLTAGE RANGE:** 1000 volts, 5 ranges

**AC VOLTAGE RANGE:** 750 volts, 4 ranges

**CURRENT RANGE:** 10 amps, 2 ranges AC/DC

**RESISTANCE RANGE:** 2 megohms, 5 ranges (4 ranges low-power mode)

**SPECIAL FEATURES:** audible continuity test, auto/manual ranging, extended resolution feature, low-power resistance mode, memory function

**DIMENSIONS/WEIGHT:** 5.9 x 3 x 1.3 inches/8.1 ounces  
**PRICE:** \$74.95

**COMPANY:** Jameco Electronics  
**MODEL:** Metex M3650

**DESCRIPTION:** This upgrade of the M3610 adds frequency and capacitance functions.

**DIGITS:** 3 $\frac{1}{2}$

**DC VOLTAGE RANGE:** 1000 volts, 5 ranges

**AC VOLTAGE RANGE:** 750 volts, 5 ranges

**CURRENT RANGE:** 20 amps, 4 ranges DC/3 ranges AC

**RESISTANCE RANGE:** 20 megohms, 6 ranges

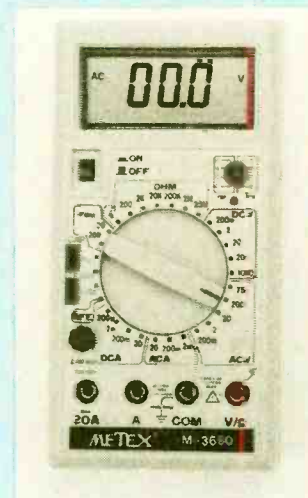

**SPECIAL FEATURES:** Diode test, audible continuity test, transistor gain test, capacitance function (20  $\mu$ F, 3 ranges), frequency counter (200 kHz, 2 ranges), carrying case  
**DIMENSIONS/WEIGHT:** 7 x 3.5 x 1.5 inches/1.7 pounds  
**PRICE:** \$74.95

**COMPANY:** Philips ECG

**MODEL:** DM-78

**DESCRIPTION:** A heavy-duty, water-resistant meter suitable for industrial applications.

**DIGITS:** 3 $\frac{1}{2}$

**DC VOLTAGE RANGE:** 1000 volts, 5 ranges

**AC VOLTAGE RANGE:** 750 volts, 4 ranges

**CURRENT RANGE:** 20 A, 5 ranges AC/DC

**RESISTANCE RANGE:** 20 megohms, 6 ranges high power, 5 ranges low power

**SPECIAL FEATURES:** Auto/manual ranging, extended ranges (in manual mode), low-power resistance function, memory function, probe holder, audible continuity test, diode test, data hold, analog bargraph display

**DIMENSIONS/WEIGHT:** 6.9 x 3.3 x 1.2 inches/12 ounces  
**PRICE:** \$74.95

**COMPANY:** Philips ECG

**MODEL:** DM-76

**DESCRIPTION:** This upgrade of the DM-74 adds data hold and a transistor gain test.

**DIGITS:** 3 $\frac{1}{2}$

**DC VOLTAGE RANGE:** 1000 volts, 5 ranges

**AC VOLTAGE RANGE:** 750 volts, 4 ranges

**CURRENT RANGE:** 10 A, 2 ranges AC/DC

**RESISTANCE RANGE:** 20 megohms, 6 ranges high power, 5 ranges low power

**SPECIAL FEATURES:** Auto/manual ranging, extended ranges (in manual mode), low-power resistance function, memory/null (nulls out lead resistance), audible continuity test, diode test, transistor gain test, data hold

**DIMENSIONS/WEIGHT:** 6 x 3 x 1.4 inches/8.1 ounces  
**PRICE:** \$74.95

**COMPANY:** Elenco Electronics, Inc.

**MODEL:** M-2660

**DESCRIPTION:** A full-featured meter that also offers a capacitor test function.

**DIGITS:** 3 $\frac{1}{2}$

**DC VOLTAGE RANGE:** 1000 volts, 4 ranges

**AC VOLTAGE RANGE:** 750 volts, 5 ranges

**CURRENT RANGE:** 10 amps, 5 ranges AC/DC

**RESISTANCE RANGE:** 20 megohms, 6 ranges

**SPECIAL FEATURES:** Diode test, transistor gain test, capacitance test (20  $\mu$ F, 5 ranges), audible continuity test

**DIMENSIONS/WEIGHT:** N.A.  
**PRICE:** \$75.00

**COMPANY:** Mercer Electronics  
**MODEL:** 9301

**DESCRIPTION:** A general-purpose DMM with all of the basic measurement functions.

**DIGITS:** 3 $\frac{1}{2}$

**DC VOLTAGE RANGE:** 1000 volts, 5 ranges

**AC VOLTAGE RANGE:** 750 volts, 5 ranges

**CURRENT RANGE:** 10 amps, 5 ranges AC/DC

**RESISTANCE RANGE:** 20 megohms, 6 ranges  
**SPECIAL FEATURES:** Diode test, audible continuity test  
**DIMENSIONS/WEIGHT:** 6.69 × 3.43 × 1.65 inches/12.1 ounces  
**PRICE:** \$77.70

**COMPANY:** B&K Precision  
**MODEL:** 2905  
**DESCRIPTION:** A general purpose DMM.  
**DIGITS:** 3½  
**DC VOLTAGE RANGE:** 1000 volts, 5 ranges  
**AC VOLTAGE RANGE:** 750 volts, 5 ranges  
**CURRENT RANGE:** 10 amps, 4 ranges DC/3 ranges AC  
**RESISTANCE RANGE:** 20 megohms, 6 ranges  
**SPECIAL FEATURES:** Diode test, audible continuity test, capacitance test function (20 µF, 5 ranges), transistor gain test, drop-resistant case (to 4 ft.)  
**DIMENSIONS/WEIGHT:** 7.5 × 3.6 × 1.4 inches/13 ounces  
**PRICE:** \$79.00

**COMPANY:** Extech Instruments  
**MODEL:** 380501  
**DESCRIPTION:** A compact, autoranging DMM.  
**DIGITS:** 3½  
**DC VOLTAGE RANGE:** 1000 volts, 5 ranges  
**AC VOLTAGE RANGE:** 750 volts, 4 ranges  
**CURRENT RANGE:** 20 amps, 3 ranges AC/DC  
**RESISTANCE RANGE:** 20 megohms, 6 ranges  
**SPECIAL FEATURES:** Diode test, audible continuity test, autoranging, data hold, carrying case  
**DIMENSIONS/WEIGHT:** 5.5 × 3 × 1.5 inches/10 ounces  
**PRICE:** \$79.00

**COMPANY:** A.W. Sperry Instruments, Inc.  
**MODEL:** DM-4300A  
**DESCRIPTION:** A full-featured multimeter that's rugged enough for professional use, yet inexpensive and simple to use, making it ideal for the hobbyist. An upgrade of the DM-4200A, this meter adds a capacitance test function.  
**DIGITS:** 3½  
**DC VOLTAGE RANGE:** 1000 volts, 5 ranges  
**AC VOLTAGE RANGE:** 750 volts, 5 ranges  
**CURRENT RANGE:** 10 amps, 5 ranges AC/DC  
**RESISTANCE RANGE:** 20 megohms, 6 ranges  
**SPECIAL FEATURES:** diode test, audible continuity test, capacitance test function (20 µF, 5 ranges), transistor test  
**DIMENSIONS/WEIGHT:** 5.0 × 2.8 × 1.4 inches/7 ounces  
**PRICE:** \$79.95

**COMPANY:** Alfa Electronics  
**MODEL:** 175A  
**DESCRIPTION:** A general pur-

pose meter with a capacitance function, a frequency counter, and a logic probe.  
**DIGITS:** 3½  
**DC VOLTAGE RANGE:** 1000 volts, 5 ranges  
**AC VOLTAGE RANGE:** 750 volts, 5 ranges  
**CURRENT RANGE:** 10 amps, 5 ranges AC/DC  
**RESISTANCE RANGE:** 200 megohms, 7 ranges  
**SPECIAL FEATURES:** Diode test, audible continuity test, capacitance test (20 µF, 5 ranges), frequency counter (1 Hz–20 MHz), 20-MHz logic probe, transistor gain test, LED test  
**DIMENSIONS/WEIGHT:** 6.3 × 3.3 × 1.5 inches/N.A.  
**PRICE:** \$79.95

**COMPANY:** Beckman Industrial  
**MODEL:** DM23  
**DESCRIPTION:** Beckman's base multi-function DMM, this meter adds an audible continuity test, a diode test, and a transistor gain measurement to the normal complement of meter functions.  
**DIGITS:** 3½  
**DC VOLTAGE RANGE:** 1000 volts, 5 ranges  
**AC VOLTAGE RANGE:** 750 volts, 5 ranges  
**CURRENT RANGE:** 10 amps DC/AC, 4 ranges DC, 3 ranges AC  
**RESISTANCE RANGE:** 20 megohms, 6 ranges  
**SPECIAL FEATURES:** Diode test, audible continuity test, transistor gain function  
**DIMENSIONS/WEIGHT:** 160 × 76 × 36 mm/311 grams  
**PRICE:** \$79.95

**COMPANY:** Brunelle Instruments, Inc.  
**MODEL:** 4040  
**DESCRIPTION:** This small, low-cost DMM offers a full complement of useful features including capacitance and frequency measurement functions.  
**DIGITS:** 3½  
**DC VOLTAGE RANGE:** 1000 volts, 5 ranges  
**AC VOLTAGE RANGE:** 750 volts, 5 ranges  
**CURRENT RANGE:** 10 amps, 5 ranges AC/DC  
**RESISTANCE RANGE:** 20 megohms, 6 ranges  
**SPECIAL FEATURES:** Capacitance measurement function (20 µF, 5 ranges), frequency measurement function (2 Hz–200 kHz, 3 ranges), 20-MHz logic probe, diode test, audible continuity test  
**DIMENSIONS/WEIGHT:** 135 × 72 × 31 mm/220 grams  
**PRICE:** \$79.95

**COMPANY:** Fieldpiece Instruments, Inc.  
**MODEL:** H221  
**DESCRIPTION:** A pen-type multimeter designed for field use.

**DIGITS:** 3½  
**DC VOLTAGE RANGE:** 1000 volts, 4 ranges  
**AC VOLTAGE RANGE:** 750 volts, 3 ranges  
**CURRENT RANGE:** N.A.  
**RESISTANCE RANGE:** 2000 ohms, 2 ranges  
**SPECIAL FEATURES:** Diode test, audible continuity test, drop-and contaminant-resistant case, auto off, data hold  
**DIMENSIONS/WEIGHT:** 7.2 × 1.9 × 1 inches/N.A.  
**PRICE:** \$79.00

**COMPANY:** Philips ECG  
**MODEL:** DM-55L  
**DESCRIPTION:** An upgrade of the DM-53, this meters features a frequency counter and a logic probe.  
**DIGITS:** 3½  
**DC VOLTAGE RANGE:** 1000 volts, 5 ranges  
**AC VOLTAGE RANGE:** 750 volts, 5 ranges  
**CURRENT RANGE:** 10 A, 5 ranges AC/DC  
**RESISTANCE RANGE:** 2000 megohms, 7 ranges  
**SPECIAL FEATURES:** Diode test, low-power resistance function, audible continuity test, transistor gain test, frequency counter (200 kHz, 3 ranges), TTL logic probe, carrying case  
**DIMENSIONS/WEIGHT:** 5 × 2.8 × 1.3 inches/7 ounces  
**PRICE:** \$79.95

**COMPANY:** Radio Shack  
**MODEL:** Micronta 22-194  
**DESCRIPTION:** A full-function

ranges AC/DC  
**RESISTANCE RANGE:** 20 megohms, 6 ranges  
**SPECIAL FEATURES:** Diode test, audible continuity test, transistor gain test, capacitance test (20 µF, 4 ranges)  
**DIMENSIONS/WEIGHT:** 6¾ × 3½ × 1½ inches/5.82 ounces  
**PRICE:** \$79.95

**COMPANY:** Component Specialties, Inc  
**MODEL:** Emco DMR-2012  
**DESCRIPTION:** A general-purpose meter that includes transistor and capacitor test functions.  
**DIGITS:** 3½  
**DC VOLTAGE RANGE:** 1000 volts, 5 ranges  
**AC VOLTAGE RANGE:** 750 volts, 5 ranges  
**CURRENT RANGE:** 20 amps, 5 ranges AC/DC  
**RESISTANCE RANGE:** 20 megohms, 6 ranges  
**SPECIAL FEATURES:** diode test, audible continuity test, transistor gain test, capacitor test (20 µF, 5 ranges), carrying case  
**DIMENSIONS/WEIGHT:** 6¼ × 2¾ × 1¼ inches/N.A.  
**PRICE:** \$81.50

**COMPANY:** A.W. Sperry Instruments, Inc.  
**MODEL:** DM-3010  
**DESCRIPTION:** A pushbutton operated DMM designed for easy, one-handed use.  
**DIGITS:** 3½  
**DC VOLTAGE RANGE:** 1000 volts, 5 ranges  
**AC VOLTAGE RANGE:** 750 volts, 5 ranges  
**CURRENT RANGE:** 10 amps, 6 ranges AC/DC  
**RESISTANCE RANGE:** 20 megohms, 6 ranges  
**SPECIAL FEATURES:** Auto zero, auto polarity, low-power resistance function  
**DIMENSIONS/WEIGHT:** 6¾ × 3½ × 1½/10 ounces  
**PRICE:** \$84.95

**COMPANY:** A.W. Sperry Instruments, Inc.  
**MODEL:** DM-6910  
**DESCRIPTION:** This autoranging (voltage and resistance ranges only) DMM offers many features normally found only in more expensive units. Noteworthy is an expanded resolution feature that extends the measurement capability of each manual range by 50%. An upgrade of the 6510, this meter adds transistor test, diode test, and data hold functions.  
**DIGITS:** 3½  
**DC VOLTAGE RANGE:** 1000 volts, 5 ranges  
**AC VOLTAGE RANGE:** 750 volts, 4 ranges  
**CURRENT RANGE:** 10 amps, 2 ranges AC/DC  
**RESISTANCE RANGE:** 20



DMM with transistor gain and capacitance measurement features.  
**DIGITS:** 3½  
**DC VOLTAGE RANGE:** 1000 volts, 5 ranges  
**AC VOLTAGE RANGE:** 750 volts, 5 ranges  
**CURRENT RANGE:** 10 amps, 4



**DIMENSIONS/WEIGHT:** 5 × 2¾ × 1¼ inches/N.A.  
**PRICE:** \$84.95

**COMPANY:** Philips ECG  
**MODEL:** DM-310  
**DESCRIPTION:** A professional quality, general purpose DMM with a low valued resistance range (20-ohm full scale) w/zero adjust and 0.1% basic DC accuracy.

**DIGITS:** 3½  
**DC VOLTAGE RANGE:** 1000 volts, 5 ranges  
**AC VOLTAGE RANGE:** 750 volts, 5 ranges  
**CURRENT RANGE:** 20 A, 6 ranges AC/DC  
**RESISTANCE RANGE:** 20 megohms, 7 ranges  
**SPECIAL FEATURES:** Diode test, audible continuity test, low-value resistance range, low-power resistance function  
**DIMENSIONS/WEIGHT:** 6.8 × 3.5 × 1.7 inches/12 ounces  
**PRICE:** \$85.70

**COMPANY:** Component Specialties, Inc  
**MODEL:** Emco DMR-2208  
**DESCRIPTION:** A general-purpose meter that includes a built-in frequency counter and a capacitor test function.

**DIGITS:** 3½  
**DC VOLTAGE RANGE:** 1000 volts, 5 ranges  
**AC VOLTAGE RANGE:** 750 volts, 5 ranges  
**CURRENT RANGE:** 10 amps, 4 ranges AC/DC  
**RESISTANCE RANGE:** 20 megohms, 6 ranges  
**SPECIAL FEATURES:** diode test, audible continuity test, carrying case capacitor test (20 µF, 5 ranges), frequency counter (200 kHz, 3 ranges)  
**DIMENSIONS/WEIGHT:** 5¼ × 2¼ × 1¼ inches/N.A.  
**PRICE:** \$87.95

**COMPANY:** Extech Instruments  
**MODEL:** 380165  
**DESCRIPTION:** This "Mini



Rangemaster" features a built-in logic probe, as well as a frequency counter and a capacitor test function.

**DIGITS:** 3½  
**DC VOLTAGE RANGE:** 1000 volts, 5 ranges  
**AC VOLTAGE RANGE:** 750 volts, 5 ranges  
**CURRENT RANGE:** 10 amps, 5 ranges AC/DC  
**RESISTANCE RANGE:** 2000 megohms, 7 ranges  
**SPECIAL FEATURES:** Frequency counter (200 kHz, 3 ranges), capacitance test (20 µF, 5 ranges), transistor gain test, logic probe, diode test, audible continuity test  
**DIMENSIONS/WEIGHT:** 2.8 × 5.1 × 1.3 inches/N.A.  
**PRICE:** \$89.00

**COMPANY:** A.W. Sperry Instruments, Inc.  
**MODEL:** DM-8010  
**DESCRIPTION:** A full-featured, general-purpose DMM with a basic DC accuracy of 0.25%.  
**DIGITS:** 3½  
**DC VOLTAGE RANGE:** 1000 volts, 5 ranges  
**AC VOLTAGE RANGE:** 750 volts, 5 ranges  
**CURRENT RANGE:** 10 amps, 6 ranges AC/DC  
**RESISTANCE RANGE:** 20 megohms, 7 ranges  
**SPECIAL FEATURES:** instant continuity buzzer, auto zero, auto polarity, diode test, low-power resistance test  
**DIMENSIONS/WEIGHT:** 6.7 × 3.43 × 1.65 inches/10 ounces  
**PRICE:** \$89.95

**COMPANY:** American Reliance, Inc.  
**MODEL:** AR-160H  
**DESCRIPTION:** This feature packed DMM also measures capacitance and transistor gain.  
**DIGITS:** 3½  
**DC VOLTAGE RANGE:** 1000 volts, 5 ranges  
**AC VOLTAGE RANGE:** 750 volts, 5 ranges  
**CURRENT RANGE:** 10 amps, 6 ranges AC/DC  
**RESISTANCE RANGE:** 20 megohms, 6 ranges  
**SPECIAL FEATURES:** Diode test, audible continuity test, transistor gain test, capacitance test (1 pF to 19.99 µF, 5 ranges)  
**DIMENSIONS/WEIGHT:** 6.8 × 3.4 × 1.4 inches/10.6 ounces  
**PRICE:** \$89.95

**COMPANY:** Beckman Industrial  
**MODEL:** DM25xl  
**DESCRIPTION:** This multi-function DMM is an upgrade of the DM23; it adds a capacitance test function, a logic test function, and an extended resistance measurement range to that meter.  
**DIGITS:** 3½  
**DC VOLTAGE RANGE:** 1000 volts, 5 ranges  
**AC VOLTAGE RANGE:** 750 volts, 5 ranges  
**CURRENT RANGE:** 10 amps

DC/AC, 4 ranges DC, 3 ranges AC  
**RESISTANCE RANGE:** 2000 megohms, 7 ranges  
**SPECIAL FEATURES:** Diode test, audible continuity test, transistor gain function, capacitance test function (20 µF, 5 ranges, 3% ±10 digit accuracy), logic test, auto off  
**DIMENSIONS/WEIGHT:** 168 × 81 × 35 mm/311 grams  
**PRICE:** \$89.95

**COMPANY:** Elenco Electronics, Inc.  
**MODEL:** M-2670  
**DESCRIPTION:** An upgrade of the 2660, this meter adds a frequency counter and a logic probe.  
**DIGITS:** 3½  
**DC VOLTAGE RANGE:** 1000 volts, 4 ranges  
**AC VOLTAGE RANGE:** 750 volts, 5 ranges

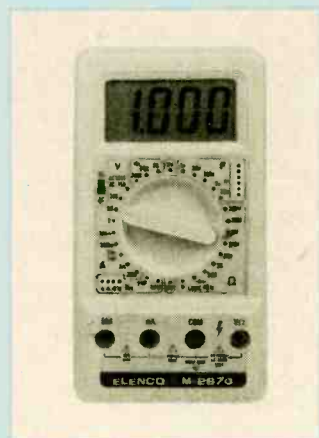

**CURRENT RANGE:** 10 amps, 5 ranges AC/DC  
**RESISTANCE RANGE:** 200 megohms, 7 ranges  
**SPECIAL FEATURES:** Diode test, transistor gain test, capacitance test (20 µF, 5 ranges), audible continuity test, frequency counter (200 kHz, 3 ranges), logic probe function  
**DIMENSIONS/WEIGHT:** N.A.  
**PRICE:** \$89.95

**COMPANY:** Heath Company  
**MODEL:** 2380  
**DESCRIPTION:** A shock and water resistant autoranging DMM with an analog bargraph display.  
**DIGITS:** 3½  
**DC VOLTAGE RANGE:** 1000 volts, 5 ranges  
**AC VOLTAGE RANGE:** 750 volts, 5 ranges  
**CURRENT RANGE:** 20 amps, 5 ranges AC/DC  
**RESISTANCE RANGE:** 20 megohms, 6 ranges  
**SPECIAL FEATURES:** Diode test, audible continuity test, auto/manual ranging, display hold, low-power resistance function,

megohms, 6 ranges (5 ranges low-power mode)  
**SPECIAL FEATURES:** Audible continuity test, auto/manual ranging, extended resolution feature, low-power resistance mode, diode test, transistor gain test, data hold, memory function  
**DIMENSIONS/WEIGHT:** 5.9 × 3 × 1.3 inches/8.1 ounces  
**PRICE:** \$84.95

**COMPANY:** Beckman Industrial  
**MODEL:** DM20L  
**DESCRIPTION:** An upgrade of the DM15B, this meter adds a transistor gain function, a logic test, and higher resistance ranges yet still retails at a reasonable price.  
**DIGITS:** 3½  
**DC VOLTAGE RANGE:** 1000 volts, 5 ranges  
**AC VOLTAGE RANGE:** 750 volts, 5 ranges  
**CURRENT RANGE:** 2 amps, 5 ranges AC/DC  
**RESISTANCE RANGE:** 2000 megohms, 8 ranges  
**SPECIAL FEATURES:** Diode test, audible continuity test, transistor gain function, logic test  
**DIMENSIONS/WEIGHT:** 24 × 70 × 120 cm/ 175 grams  
**PRICE:** \$84.95

**COMPANY:** Component Specialties, Inc  
**MODEL:** SPECO FD-95AR  
**DESCRIPTION:** An autoranging DMM with memory.  
**DIGITS:** 3½  
**DC VOLTAGE RANGE:** 1000 volts, 4 ranges  
**AC VOLTAGE RANGE:** 500 volts, 4 ranges  
**CURRENT RANGE:** 10 amps, 3 ranges AC/DC  
**RESISTANCE RANGE:** 2000k ohms, 5 ranges  
**SPECIAL FEATURES:** Auto and manual ranging, range hold, zero adjust, memory mode, carrying case, audible continuity test, low-power resistance mode

shock-proof and waterproof case, analog bargraph display  
**DIMENSIONS/WEIGHT:** N.A.  
**PRICE:** \$89.95

**COMPANY:** Triplett Corporation  
**MODEL:** 3360  
**DESCRIPTION:** A full featured, auto/manual ranging DMM.  
**DIGITS:** 3½  
**DC VOLTAGE RANGE:** 1000 volts, 5 ranges  
**AC VOLTAGE RANGE:** 750 volts, 4 ranges  
**CURRENT RANGE:** 10 amps, 4 ranges AC/DC  
**RESISTANCE RANGE:** 20 megohms, 6 ranges  
**SPECIAL FEATURES:** Audible continuity test, data hold, diode test, auto/manual ranging  
**DIMENSIONS/WEIGHT:** 5½ × 2¾ × 1 inches/8 ounces  
**PRICE:** \$91.00

**COMPANY:** Philips ECG  
**MODEL:** DM-305  
**DESCRIPTION:** A heavy-duty, professional quality, general purpose DMM.  
**DIGITS:** 3½  
**DC VOLTAGE RANGE:** 1000 volts, 5 ranges  
**AC VOLTAGE RANGE:** 750 volts, 5 ranges  
**CURRENT RANGE:** 20 A, 5 ranges AC/DC  
**RESISTANCE RANGE:** 20 megohms, 6 ranges  
**SPECIAL FEATURES:** Diode test, audible continuity test, water resistant, probe holder  
**DIMENSIONS/WEIGHT:** 6.9 × 3.3 × 1.2 inches/12 ounces  
**PRICE:** \$92.95

**COMPANY:** B&K Precision  
**MODEL:** 2906  
**DESCRIPTION:** This upgrade of the 2905 features a TTL/CMOS logic probe and a temperature measurement function.  
**DIGITS:** 3½  
**DC VOLTAGE RANGE:** 1000 volts, 5 ranges  
**AC VOLTAGE RANGE:** 750 volts, 5 ranges  
**CURRENT RANGE:** 10 amps, 4 ranges DC/3 ranges AC  
**RESISTANCE RANGE:** 20 megohms, 6 ranges  
**SPECIAL FEATURES:** Diode test, audible continuity test, TTL/CMOS logic probe, transistor gain test, temperature measurement (-20 to +1000°C/-4 to +1832°F), drop-resistant case (to 4 ft.)  
**DIMENSIONS/WEIGHT:** 7.5 × 3.6 × 1.4 inches/13 ounces  
**PRICE:** \$99.00

**COMPANY:** B&K Precision  
**MODEL:** 2911  
**DESCRIPTION:** An auto/manual ranging DMM with an analog bargraph display.  
**DIGITS:** 3¾  
**DC VOLTAGE RANGE:** 1000 volts, 5 ranges  
**AC VOLTAGE RANGE:** 750

volts, 5 ranges  
**CURRENT RANGE:** 10 amps, 1 range AC/DC  
**RESISTANCE RANGE:** 40 megohms, 6 ranges  
**SPECIAL FEATURES:** Diode test, audible continuity test, auto/manual ranging, analog bargraph display  
**DIMENSIONS/WEIGHT:** 6.8 × 3.2 × 1.3 inches/13 ounces  
**PRICE:** \$99.00

**COMPANY:** B&K Precision  
**MODEL:** 2820  
**DESCRIPTION:** A ruggedized DMM for use in industrial and other demanding applications.  
**DIGITS:** 3½  
**DC VOLTAGE RANGE:** 1000 volts, 5 ranges  
**AC VOLTAGE RANGE:** 750 volts, 5 ranges  
**CURRENT RANGE:** 20 amps, 5 ranges AC/DC  
**RESISTANCE RANGE:** 20 megohms, 6 ranges  
**SPECIAL FEATURES:** Diode test, audible continuity test, auto power off, probe holder, water- and shock-resistant case  
**DIMENSIONS/WEIGHT:** 6¾ × 3¾ × 1¼ inches/12 ounces  
**PRICE:** \$99.00

**COMPANY:** B&K Precision  
**MODEL:** 377  
**DESCRIPTION:** This lower-priced version of the 388-HD "portable test bench" offers many of the benefits of that popular DMM.



**DIGITS:** 3½  
**DC VOLTAGE RANGE:** 1000 volts, 5 ranges  
**AC VOLTAGE RANGE:** 750 volts, 5 ranges  
**CURRENT RANGE:** 10 amps, 5 ranges AC/DC  
**RESISTANCE RANGE:** 2000 megohms, 7 ranges  
**SPECIAL FEATURES:** Diode test, audible continuity test, capacitor test (20 µF, 5 ranges), transistor gain test, frequency counter (20 Hz-20 kHz), logic probe (TTL)  
**DIMENSIONS/WEIGHT:** 5 × 2¾ × 1¾ inches/9 ounces  
**PRICE:** \$99.00

**COMPANY:** Extech Instruments

**MODEL:** 380166  
**DESCRIPTION:** This "Mini Rangemaster" model features a temperature measurement function, a frequency counter, and a capacitor test function.  
**DIGITS:** 3½  
**DC VOLTAGE RANGE:** 1000 volts, 5 ranges  
**AC VOLTAGE RANGE:** 750 volts, 5 ranges  
**CURRENT RANGE:** 10 amps, 5 ranges AC/DC  
**RESISTANCE RANGE:** 2000 megohms, 7 ranges  
**SPECIAL FEATURES:** Frequency counter (20 kHz, 3 ranges), capacitance test (20 µF, 5 ranges), transistor gain test, temperature measurement function (1400°F/750°C, 1 range), diode test, audible continuity test, beaded wire temperature probe  
**DIMENSIONS/WEIGHT:** 2.8 × 5.1 × 1.3 inches/N.A.  
**PRICE:** \$99.00

**COMPANY:** John Fluke Mfg. Co., Inc.  
**MODEL:** 73  
**DESCRIPTION:** This upgrade of the model 70 adds an AC/DC current function.  
**DIGITS:** 4 (3200 count)  
**DC VOLTAGE RANGE:** 1000 volts, 5 ranges  
**AC VOLTAGE RANGE:** 750 volts, 4 ranges  
**CURRENT RANGE:** 10 amps, 1 range AC/DC  
**RESISTANCE RANGE:** 32 megohms, 6 ranges  
**SPECIAL FEATURES:** Auto/manual ranging, diode test, audible continuity test, "Touch Hold", auto power off, analog bargraph display  
**DIMENSIONS/WEIGHT:** 6.55 × 2.95 × 1.12 inches/12 ounces  
**PRICE:** \$99.00

**COMPANY:** Omega Engineering, Inc.  
**MODEL:** HHM55  
**DESCRIPTION:** Economical multi-function DMM that measures temperature, frequency, and transistor gain. It is available in two colors; gray and yellow.  
**DIGITS:** 3½  
**DC VOLTAGE RANGE:** 1000 volts, 5 ranges  
**AC VOLTAGE RANGE:** 750 volts, 5 ranges  
**CURRENT RANGE:** 10 amps, 5 ranges AC/DC  
**RESISTANCE RANGE:** 20 megohms, 6 ranges  
**SPECIAL FEATURES:** Temperature measurement (-58°F-+1999°F, -50-+1300°C), frequency measurement (to 200 kHz), transistor gain measurement, diode test, audible continuity test  
**DIMENSIONS/WEIGHT:** 6.5 × 3.1 × 1.3 inches/8.5 ounces  
**PRICE:** \$99

**COMPANY:** American Reliance,

Inc.  
**MODEL:** AR-690LP  
**DESCRIPTION:** A feature-packed meter that includes a built-in TTL logic probe.  
**DIGITS:** 3½  
**DC VOLTAGE RANGE:** 1000 volts, 5 ranges  
**AC VOLTAGE RANGE:** 750 volts, 5 ranges  
**CURRENT RANGE:** 10 amps, 6 ranges AC/DC  
**RESISTANCE RANGE:** 20 megohms, 6 ranges  
**SPECIAL FEATURES:** Diode test, audible continuity test, conductance function, peak hold, built-in 25-MHz TTL logic probe with audible indicator  
**DIMENSIONS/WEIGHT:** 6.9 × 3.4 × 1.2 inches/10.6 ounces  
**PRICE:** \$99.95

**COMPANY:** Elenco Electronics, Inc.  
**MODEL:** M-2680  
**DESCRIPTION:** An upgrade of the 2670, this meter adds a temperature measurement function.  
**DIGITS:** 3½  
**DC VOLTAGE RANGE:** 1000 volts, 4 ranges  
**AC VOLTAGE RANGE:** 750 volts, 5 ranges  
**CURRENT RANGE:** 10 amps, 5 ranges AC/DC  
**RESISTANCE RANGE:** 200 megohms, 7 ranges  
**SPECIAL FEATURES:** Diode test, transistor gain test, capacitance test (20 µF, 5 ranges), audible continuity test, frequency counter (20 kHz, 3 ranges), temperature measurement function (-20-+750°C; 0-1400°F, 1 range)  
**DIMENSIONS/WEIGHT:** N.A.  
**PRICE:** \$99.95

**COMPANY:** Fieldpiece Instruments, Inc.  
**MODEL:** H223  
**DESCRIPTION:** This upgrade of the HS21 adds a dangerous voltage beeper and a capacitance function  
**DIGITS:** 3½  
**DC VOLTAGE RANGE:** 1000 volts, 4 ranges  
**AC VOLTAGE RANGE:** 750 volts, 3 ranges  
**CURRENT RANGE:** N.A.  
**RESISTANCE RANGE:** 2000 ohms, 2 ranges  
**SPECIAL FEATURES:** Diode test, audible continuity test, drop- and contaminant-resistant case, auto off, data hold, capacitance function (200 µF, 1 range), dangerous-voltage alert  
**DIMENSIONS/WEIGHT:** 7.2 × 1.9 × 1 inches/N.A.  
**PRICE:** \$99.00

**COMPANY:** Fieldpiece Instruments, Inc.  
**MODEL:** HB71  
**DESCRIPTION:** A heavy-duty meter designed for field-service technicians.

## DMM MANUFACTURERS AND DISTRIBUTORS

A.W. Sperry Instruments, Inc.  
245 Marcus Blvd.  
Hauppauge, NY 11788  
Tel: 516-231-7050  
Fax: 516-434-3128

**CIRCLE 116 ON FREE INFORMATION CARD**

AEMC Corporation  
99 Chauncy St.  
Boston, MA 02111  
Tel: 617-451-0227  
Fax: 617-423-2952

**CIRCLE 117 ON FREE INFORMATION CARD**

Alfa Electronics  
P.O. Box 8089  
Princeton, NJ 08543-8089  
Tel: 800-526-ALFA, 609-275-0220

**CIRCLE 118 ON FREE INFORMATION CARD**

American Reliance, Inc.  
9952 E. Baldwin Place  
El Monte, CA 91731  
Tel: 818-575-5110  
Fax: 818-575-0801

**CIRCLE 121 ON FREE INFORMATION CARD**

Amprobe Instrument  
630 Merrick Rd., P.O. Box 329  
Lynbrook, NY 11563  
Tel: 516-593-5600  
Fax: 516-593-5682

**CIRCLE 122 ON FREE INFORMATION CARD**

B&K Precision  
6470 W. Cortland St.  
Chicago, IL 60635  
Tel: 312-889-9087

**CIRCLE 123 ON FREE INFORMATION CARD**

Beckman Industrial  
3883 Ruffin Rd.  
San Diego, CA 92123-1898  
Tel: 619-495-3200  
Fax: 619-268-0172

**CIRCLE 124 ON FREE INFORMATION CARD**

Brunelle Instruments, Inc.  
P.O. Box 1223  
Newport, VT 05855  
Tel: 800-567-3506  
Fax: 819-569-1408

**CIRCLE 125 ON FREE INFORMATION CARD**

Component Specialties, Inc  
1172 Route 109, P.O. Box 624  
Lindenhurst, NY 11757  
Tel: 516-957-8700  
Fax: 516-957-9142

**CIRCLE 126 ON FREE INFORMATION CARD**

Daetron  
7270 Tobram Rd., Unit 22  
Mississauga, Ontario,  
Canada, L4T 3X2  
Tel: 416-676-1600

**CIRCLE 127 ON FREE INFORMATION CARD**

Elenco Electronics, Inc.  
150 West Carpenter Ave.  
Wheeling, IL 60090  
Tel: 708-541-3800  
Fax: 708-520-0085

**CIRCLE 128 ON FREE INFORMATION CARD**

Extech Instruments  
335 Bear Hill Rd.  
Waltham, MA 02154  
Tel: 617-890-7440  
Fax: 617-890-7864

**CIRCLE 129 ON FREE INFORMATION CARD**

Fieldpiece Instruments, Inc.  
8322B Artesia Blvd.  
Buena Park, CA 90621  
Tel: 714-992-1239

**CIRCLE 130 ON FREE INFORMATION CARD**

Fordham Radio  
260 Motor Parkway  
Hauppauge, NY 11788-5134  
Tel: 516-435-8080  
Fax: 516-435-8079

**CIRCLE 131 ON FREE INFORMATION CARD**

Global Specialties  
70 Fulton Terrace  
New Haven, CT 06512  
Tel: 203-624-3103  
Fax: 203-468-0600

**CIRCLE 132 ON FREE INFORMATION CARD**

Heath Company  
Benton Harbor, MI 49022  
Tel: 800-253-0570

**CIRCLE 133 ON FREE INFORMATION CARD**

Jameco Electronics  
1355 Shoreway Rd.  
Belmont, CA 94002  
Tel: 415-592-8097  
Fax: 415-592-2503

**CIRCLE 134 ON FREE INFORMATION CARD**

John Fluke Mfg. Co.  
P.O. Box 9090  
Everett, WA 98206  
Tel: 206-347-6100  
Fax: 206-356-5116

**CIRCLE 135 ON FREE INFORMATION CARD**

Kelvin Electronics  
7 Fairchild Ave.  
Plainview, NY 11803  
Tel: 516-349-7620  
Fax: 516-349-7830

**CIRCLE 136 ON FREE INFORMATION CARD**

Kyoritsu Instrument  
Works, Ltd.  
62 N. Coleman Rd.  
Centereach, NY 11720  
Tel: 516-736-0601  
Fax: 516-732-4650

**CIRCLE 137 ON FREE INFORMATION CARD**

Mercer Electronics  
859 Dundee Ave.  
Elgin, IL 60120-3090  
Tel: 708-697-2265  
Fax: 708-697-2272

**CIRCLE 138 ON FREE INFORMATION CARD**

Omega Engineering, Inc.  
One Omega Drive, Box 4047  
Stamford, CT 06907  
Tel: 203-359-1660  
Fax: 203-359-7700

**CIRCLE 139 ON FREE INFORMATION CARD**

Philips ECG  
1025 Westminister Dr.  
Williamsport, PA 17701  
Tel: 717-323-4691

**CIRCLE 140 ON FREE INFORMATION CARD**

Radio Shack  
One Tandy Center  
Fort Worth, TX 76102  
Tel: 817-323-4691

**CIRCLE 141 ON FREE INFORMATION CARD**

Simpson Electric Company  
853 Dundee Ave.  
Elgin, IL 60120-3090  
Tel: 708-697-2260  
Fax: 708-697-2272

**CIRCLE 142 ON FREE INFORMATION CARD**

Tegam, Inc.  
7230 North Ridge Rd.  
Madison, OH 44057  
Tel: 216-428-7505  
Fax: 216-428-1068

**CIRCLE 143 ON FREE INFORMATION CARD**

Triplet Corporation  
One Triplett Drive  
Bluffton, OH 45817  
Tel: 419-358-5015  
Fax: 419-358-7956

**CIRCLE 144 ON FREE INFORMATION CARD**

**DIGITS:** 3½  
**DC VOLTAGE RANGE:** 1500 volts, 5 ranges  
**AC VOLTAGE RANGE:** 1000 volts, 5 ranges  
**CURRENT RANGE:** 20 amps, 4 ranges AC/DC  
**RESISTANCE RANGE:** 20 megohms, 6 ranges  
**SPECIAL FEATURES:** Diode test, audible continuity test, drop-and contaminant-resistant case, auto off  
**DIMENSIONS/WEIGHT:** 6.9 × 2.8 × 1.5 inches/N.A.  
**PRICE:** \$99.00

**COMPANY:** Heath Company  
**MODEL:** 2372  
**DESCRIPTION:** This upgrade of the 2311 adds a frequency coun-



ter and a logic probe function  
**DIGITS:** 3½  
**DC VOLTAGE RANGE:** 1000 volts, 5 ranges  
**AC VOLTAGE RANGE:** 750

volts, 5 ranges  
**CURRENT RANGE:** 10 amps, 5 ranges AC/DC  
**RESISTANCE RANGE:** 20 megohms, 7 ranges  
**SPECIAL FEATURES:** Diode test, audible continuity test, transistor gain test, capacitance test (20µF, 5 ranges), frequency counter (20 MHz, 5 ranges), logic probe, led test  
**DIMENSIONS/WEIGHT:** N.A.  
**PRICE:** \$99.95

**COMPANY:** Jameco Electronics  
**MODEL:** Metex M4650  
**DESCRIPTION:** This upgrade of the M4650 adds a 4½-digit display and a data-hold feature.  
**DIGITS:** 3½  
**DC VOLTAGE RANGE:** 1000

volts, 5 ranges  
**AC VOLTAGE RANGE:** 750 volts, 5 ranges  
**CURRENT RANGE:** 20 amps, 4 ranges DC/3 ranges AC  
**RESISTANCE RANGE:** 20 megohms, 6 ranges  
**SPECIAL FEATURES:** Diode test, audible continuity test, transistor gain test, capacitance function (20 µF, 3 ranges), frequency counter (200 kHz, 2 ranges), data hold, carrying case  
**DIMENSIONS/WEIGHT:** 7 × 3.5 × 1.5 inches/1.7 pounds  
**PRICE:** \$99.95

**COMPANY:** Radio Shack  
**MODEL:** Micronta 22-164  
**DESCRIPTION:** An autoranging DMM with a built-in speech syn-



thesizer for audible readouts.  
**DIGITS:** 3½  
**DC VOLTAGE RANGE:** 1000 volts, 5 ranges  
**AC VOLTAGE RANGE:** 750 volts, 4 ranges  
**CURRENT RANGE:** 300 mA, 1 range AC/DC  
**RESISTANCE RANGE:** 30 megohms, 6 ranges  
**SPECIAL FEATURES:** Diode test, audible continuity test, auto-ranging, built-in speech synthesizer for audible readings (voice button on special probe)  
**DIMENSIONS/WEIGHT:** 6¼ × 3½ × 1¼ inches/8 ounces  
**PRICE:** \$99.95

**\$100—\$150**

**COMPANY:** Component Specialties, Inc  
**MODEL:** SPEC0 FD-100TC  
**DESCRIPTION:** This versatile multimeter offers capacitor and transistor tests.  
**DIGITS:** 3½  
**DC VOLTAGE RANGE:** 1000 volts, 5 ranges  
**AC VOLTAGE RANGE:** 700 volts, 5 ranges  
**CURRENT RANGE:** 20 amps, 5 ranges DC/4 ranges AC  
**RESISTANCE RANGE:** 20 megohms, 6 ranges  
**SPECIAL FEATURES:** Audible continuity test with LED indicator, diode test, capacitance test (20 µF, 5 ranges), transistor test, carrying case  
**DIMENSIONS/WEIGHT:** 6¼ × 3¾ × 1½ inches/N.A.  
**PRICE:** \$103.95

**COMPANY:** Component Specialties, Inc  
**MODEL:** Emco DMR-3600B  
**DESCRIPTION:** A good general-purpose meter with capacitor and transistor test functions and an analog bargraph display  
**DIGITS:** 3½  
**DC VOLTAGE RANGE:** 1000 volts, 5 ranges  
**AC VOLTAGE RANGE:** 750 volts, 5 ranges  
**CURRENT RANGE:** 20 amps, 5 ranges AC/DC  
**RESISTANCE RANGE:** 20 megohms, 6 ranges

**SPECIAL FEATURES:** Analog bargraph display, transistor test function, capacitor test function (20 µF, 5 ranges), diode test, audible continuity test, carrying case  
**DIMENSIONS/WEIGHT:** N.A.  
**PRICE:** \$103.95

**COMPANY:** Extech Instruments  
**MODEL:** 380168  
**DESCRIPTION:** This "Range-master II" is built into an industrial-size case and features a large (0.7-inch) display. In addition to standard functions, it measures frequency, capacitance, and more.  
**DIGITS:** 3½  
**DC VOLTAGE RANGE:** 1000 volts, 5 ranges  
**AC VOLTAGE RANGE:** 750 volts, 5 ranges  
**CURRENT RANGE:** 20 amps, 5 ranges AC/DC  
**RESISTANCE RANGE:** 20 megohms, 6 ranges  
**SPECIAL FEATURES:** Frequency counter (200kHz, 3 ranges), capacitance test (20 µF, 4 ranges), transistor gain test, diode test, audible continuity test  
**DIMENSIONS/WEIGHT:** 3 × 6.4 × 1.3 inches/N.A.  
**PRICE:** \$109.00

**COMPANY:** Omega Engineering, Inc.  
**MODEL:** HHM57  
**DESCRIPTION:** A full-featured DMM that also offers temperature, transistor gain, and capacitance measurement functions.  
**DIGITS:** 3½  
**DC VOLTAGE RANGE:** 1000 volts, 5 ranges  
**AC VOLTAGE RANGE:** 750 volts, 5 ranges  
**CURRENT RANGE:** 10 amps, 5 ranges AC/DC  
**RESISTANCE RANGE:** 2000 megohms, 7 ranges



**SPECIAL FEATURES:** Temperature measurement (1400°F, 2 ranges; 750°C, 2 ranges), capacitance measurement (20 µF, 5 ranges), transistor gain test, diode test, audible continuity test, type K beaded wire probe, carrying case  
**DIMENSIONS/WEIGHT:** N.A.  
**PRICE:** \$109.00

**COMPANY:** Amprobe Instrument  
**MODEL:** AM-4B  
**DESCRIPTION:** An industrial-quality meter that includes low-current and low-resistance ranges.  
**DIGITS:** 3½  
**DC VOLTAGE RANGE:** 1500 volts, 5 ranges  
**AC VOLTAGE RANGE:** 1000 volts, 5 ranges  
**CURRENT RANGE:** 10 amps, 6 ranges AC/DC  
**RESISTANCE RANGE:** 2 megohms, 7 ranges  
**SPECIAL FEATURES:** Diode test, audible continuity test,  
**DIMENSIONS/WEIGHT:** 6⅞ × 3½ × 1⅞ inches/12.36 ounces  
**PRICE:** \$109.85

**COMPANY:** Beckman Industrial  
**MODEL:** DM27xl  
**DESCRIPTION:** This multi-function DMM is an upgrade of the DM25xl; it adds a frequency measurement function and an LED test.



**DIGITS:** 3½  
**DC VOLTAGE RANGE:** 1000 volts, 5 ranges  
**AC VOLTAGE RANGE:** 750 volts, 5 ranges  
**CURRENT RANGE:** 10 amps DC/AC, 5 ranges  
**RESISTANCE RANGE:** 2000 megohms, 7 ranges  
**SPECIAL FEATURES:** Diode test, audible continuity test, transistor gain function, capacitance test function (20 µF, 5 ranges, 3% ± 10 digit accuracy), frequency measurement (10 Hz–20 MHz), logic test, LED test, auto off  
**DIMENSIONS/WEIGHT:** 168 × 81 × 35 mm/311 grams  
**PRICE:** \$109.95

**COMPANY:** Fieldpiece Instruments, Inc.  
**MODEL:** HB73  
**DESCRIPTION:** This upgrade of the HB71 adds a capacitance function  
**DIGITS:** 3½  
**DC VOLTAGE RANGE:** 1500 volts, 5 ranges  
**AC VOLTAGE RANGE:** 1000 volts, 5 ranges  
**CURRENT RANGE:** 20 amps, 4

ranges AC/DC  
**RESISTANCE RANGE:** 20 megohms, 6 ranges  
**SPECIAL FEATURES:** Diode test, audible continuity test, drop- and contaminant-resistant case,

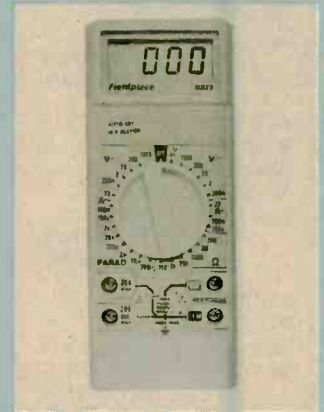

capacitance function (200 µF, 5 ranges), auto off  
**DIMENSIONS/WEIGHT:** 6.9 × 2.8 × 1.5 inches/N.A.  
**PRICE:** \$109.00

**COMPANY:** Component Specialties, Inc  
**MODEL:** Emco DMR-2208  
**DESCRIPTION:** A full-featured meter that includes transistor, capacitor, and frequency test function and a built-in TTL logic probe.  
**DIGITS:** 3½  
**DC VOLTAGE RANGE:** 1000 volts, 5 ranges  
**AC VOLTAGE RANGE:** 750 volts, 5 ranges  
**CURRENT RANGE:** 20 amps, 5 ranges AC/DC  
**RESISTANCE RANGE:** 20 megohms, 6 ranges  
**SPECIAL FEATURES:** Diode test, audible continuity test, transistor test, capacitor test (20 µF, 5 ranges), frequency counter (200 kHz, 3 ranges), TTL logic probe, carrying case  
**DIMENSIONS/WEIGHT:** 7½ × 3½ × 1½ inches/N.A.  
**PRICE:** \$111.75

**COMPANY:** Extech Instruments  
**MODEL:** 380196  
**DESCRIPTION:** An autoranging, multi-featured DMM in a weather-proof case.  
**DIGITS:** 3½  
**DC VOLTAGE RANGE:** 1000 volts, 5 ranges  
**AC VOLTAGE RANGE:** 750 volts, 4 ranges  
**CURRENT RANGE:** 20 amps, 5 ranges AC/DC  
**RESISTANCE RANGE:** 20 megohms, 6 ranges  
**SPECIAL FEATURES:** Analog bargraph display, diode test, audible continuity test, auto/manual ranging, data hold, memory off-set, weatherproof case, probe holder, auto power off

**DIMENSIONS/WEIGHT:** 6.8 × 3.3 × 1.2 inches/12.6 ounces  
**PRICE:** \$119.00

**COMPANY:** A.W. Sperry Instruments, Inc.

**MODEL:** DM-8100

**DESCRIPTION:** A member of the "Techmaster" series, this drop-proof, water-resistant, professional-quality meter is designed to operate even under adverse conditions.

**DIGITS:** 3½

**DC VOLTAGE RANGE:** 1000 volts, 5 ranges

**AC VOLTAGE RANGE:** 750 volts, 4 ranges

**CURRENT RANGE:** 20 amps, 4 ranges AC/DC

**RESISTANCE RANGE:** 20 megohms, 6 ranges

**SPECIAL FEATURES:** Auto-ranging, audible continuity test, logic indicator, data hold, range hold, relative readings, low-power resistance, diode test, auto power off

**DIMENSIONS/WEIGHT:** 7.5 × 3.4 × 1.5 inches/12.9 ounces

**PRICE:** \$119.95

**COMPANY:** Fieldpiece Instruments, Inc.

**MODEL:** H225

**DESCRIPTION:** This upgrade of the HS23 adds a logic probe.

**DIGITS:** 3½

**DC VOLTAGE RANGE:** 1000 volts, 4 ranges

**AC VOLTAGE RANGE:** 750 volts, 3 ranges

**CURRENT RANGE:** N.A.

**RESISTANCE RANGE:** 2000 ohms, 2 ranges

**SPECIAL FEATURES:** Diode test, audible continuity test, drop-and contaminant-resistant case, auto off, data hold, capacitance function (200 µF 1 range), dangerous-voltage alert, logic probe

**DIMENSIONS/WEIGHT:** 7.2 × 1.9 × 1 inches/N.A.

**PRICE:** \$119.00

**COMPANY:** Kycritsu Instrument Works, Ltd.

**MODEL:** 1007

**DESCRIPTION:** A rugged, 3½-digit autoranging DMM that offers good accuracy and plenty of features at an economical price.

**DIGITS:** 3½

**DC VOLTAGE RANGE:** 1000 volts, 5 ranges

**AC VOLTAGE RANGE:** 750 volts, 4 ranges

**CURRENT RANGE:** 12 amps, 2 ranges AC/DC

**RESISTANCE RANGE:** 20 megohms, 6 ranges

**SPECIAL FEATURES:** Auto-ranging, audible continuity test, diode test, data hold, range hold, low-power resistance range

**DIMENSIONS/WEIGHT:** 163 × 78 × 30 mm/300 grams

**PRICE:** \$119.95

**COMPANY:** B&K Precision

**MODEL:** 388-HD

**DESCRIPTION:** A professional-quality DMM with a full complement of useful functions and features.

**DIGITS:** 3½

**DC VOLTAGE RANGE:** 1000 volts, 5 ranges

**AC VOLTAGE RANGE:** 750 volts, 5 ranges

**CURRENT RANGE:** 20 amps, 5 ranges AC/DC

**RESISTANCE RANGE:** 2000 megohms, 7 ranges

**SPECIAL FEATURES:** Diode test, audible continuity test, capacitor test (20 µF, 5 ranges), transistor gain test, frequency counter (20 Hz–20 kHz), logic probe (TTL), drop resistant (to 4 ft.)

**DIMENSIONS/WEIGHT:** 7½ × 3½ × 1¼ inches/13 ounces

**PRICE:** \$129.00

**COMPANY:** Beckman Industrial

**MODEL:** 223F

**DESCRIPTION:** This professional-quality, autoranging DMM features an audible readout that changes pitch with changes in input levels.

**DIGITS:** 3½



**DC VOLTAGE RANGE:** 1000 volts, 5 ranges

**AC VOLTAGE RANGE:** 750 volts, 5 ranges

**CURRENT RANGE:** 10 amps, 5 ranges AC/DC

**RESISTANCE RANGE:** 20 megohms, 5 ranges

**SPECIAL FEATURES:** Auto-ranging, Diode test, continuity test, logic-pulse detector, audible readout

**DIMENSIONS/WEIGHT:** 173 × 71 × 32 mm/326 grams

**PRICE:** \$129.00

**COMPANY:** Brunelle Instruments, Inc.

**MODEL:** 4070

**DESCRIPTION:** A pushbutton-operated 4½-digit DMM.

**DIGITS:** 4½

**DC VOLTAGE RANGE:** 1000 volts, 5 ranges

**AC VOLTAGE RANGE:** 750 volts, 5 ranges

**CURRENT RANGE:** 10 amps, 5 ranges AC/DC

**RESISTANCE RANGE:** 20 megohms, 6 ranges

**SPECIAL FEATURES:** Diode test, transistor gain test, audible and visible continuity test

**DIMENSIONS/WEIGHT:** N.A.

**PRICE:** \$129.00

**COMPANY:** Philips ECG

**MODEL:** DM-410

**DESCRIPTION:** A 4½-digit DMM with .05% basic DC accuracy.

**DIGITS:** 4½

**DC VOLTAGE RANGE:** 1000 volts, 5 ranges

**AC VOLTAGE RANGE:** 750 volts, 5 ranges

**CURRENT RANGE:** 10 A, 4 ranges AC/DC

**RESISTANCE RANGE:** 20 megohms, 6 ranges

**SPECIAL FEATURES:** Diode test, audible and visible continuity test, 200-ohm range with zero adjust

**DIMENSIONS/WEIGHT:** 6.8 × 3.5 × 1.7 inches/12.5 ounces

**PRICE:** \$129.00

**COMPANY:** A.W. Sperry Instruments, Inc.

**MODEL:** DM-840C

**DESCRIPTION:** A member of the "Techmaster" series, this drop-proof, water-resistant, professional-quality meter is designed to operate even under adverse conditions.

**DIGITS:** 3¾

**DC VOLTAGE RANGE:** 1000 volts, 5 ranges

**AC VOLTAGE RANGE:** 750 volts, 4 ranges

**CURRENT RANGE:** 20 amps, 4 ranges AC/DC

**RESISTANCE RANGE:** 400 megohms, 7 ranges

**SPECIAL FEATURES:** Diode test, audible continuity test, logic indicator, data hold, auto power off, frequency/duty-cycle test (0 to 4000 kHz, 4 ranges), peak hold, low-power resistance test

**DIMENSIONS/WEIGHT:** 7.5 × 3.4 × 1.5 inches/12.9 ounces

**PRICE:** \$129.95

**COMPANY:** Alfa Electronics

**MODEL:** 2360

**DESCRIPTION:** A general purpose meter with a capacitance function, an inductance function, a frequency counter, a temperature function, and a logic probe.

**DIGITS:** 3¾

**DC VOLTAGE RANGE:** 1000 volts, 5 ranges

**AC VOLTAGE RANGE:** 750 volts, 5 ranges

**CURRENT RANGE:** 10 amps, 4 ranges AC/DC

**RESISTANCE RANGE:** 40 megohms, 6 ranges

**SPECIAL FEATURES:** Diode test, audible continuity test, capacitance test (40 µF, 5 ranges), frequency counter (1 Hz–4 MHz), 20-MHz logic probe, temperature function (302°F/150°C, 1 range), peak hold, carrying case

**DIMENSIONS/WEIGHT:** 7.4 × 3.5 × 1.5 inches/13.2 ounces

**PRICE:** \$129.95

**COMPANY:** American Reliance, Inc.

**MODEL:** AR-3000

**DESCRIPTION:** A programmable, autoranging 3¾-digit DMM with an analog bargraph display, a dBm function for audio/communications applications, and 0.5% basic DCV accuracy.

**DIGITS:** 3¾

**DC VOLTAGE RANGE:** 1000 volts, 5 ranges

**AC VOLTAGE RANGE:** 750 volts, 4 ranges

**CURRENT RANGE:** 20 amps, 3 ranges AC/DC

**RESISTANCE RANGE:** 40 megohms, 6 ranges

**SPECIAL FEATURES:** dBm function, diode test, audible continuity test, analog bargraph display, logic probe function, relative measurement mode, data hold, min/max function, auto power off, auto and manual ranging, range hold

**DIMENSIONS/WEIGHT:** 6.4 × 3.25 × 1.4 inches/12.5 ounces

**PRICE:** \$129.95

**COMPANY:** Beckman Industrial

**MODEL:** 300A

**DESCRIPTION:** A no-frills, professional-quality DMM that offers good precision and reliability at an affordable price.

**DIGITS:** 3½

**DC VOLTAGE RANGE:** 1500 volts, 5 ranges

**AC VOLTAGE RANGE:** 1000 volts, 5 ranges

**CURRENT RANGE:** 2 amps AC/DC, 5 ranges

**RESISTANCE RANGE:** 20 megohms, 6 ranges

**SPECIAL FEATURES:** Diode test, continuity test

**DIMENSIONS/WEIGHT:** 17.4 × 9.3 × 4.6 cm/N.A.

**PRICE:** \$135.00

**COMPANY:** Exttech Instruments

**MODEL:** 380198

**DESCRIPTION:** An autoranging, multi-featured DMM. This "deluxe" model is an upgrade of the 380196 and adds capacitance and frequency measurement functions.

**DIGITS:** 3½

**DC VOLTAGE RANGE:** 1000 volts, 5 ranges

**AC VOLTAGE RANGE:** 750 volts, 4 ranges

**CURRENT RANGE:** 20 amps, 5 ranges AC/DC

**RESISTANCE RANGE:** 20 megohms, 6 ranges

**SPECIAL FEATURES:** Analog

bargraph display, diode test, audible continuity test, auto/manual ranging, data hold, memory offset, capacitance function (20  $\mu$ F, 5 ranges), frequency counter (20 kHz, 2 ranges), probe holder, auto power off  
**DIMENSIONS/WEIGHT:** 6.8 x 3.3 x 1.2 inches/12.6 ounces  
**PRICE:** \$139.00

**COMPANY:** John Fluke Mfg. Co., Inc.

**MODEL:** 75/21

**DESCRIPTION:** This upgrade of the model 73 adds two additional current ranges. Available in industrial yellow as the model 21.  
**DIGITS:** 4 (3200 count)

**DC VOLTAGE RANGE:** 1000 volts, 5 ranges

**AC VOLTAGE RANGE:** 750 volts, 4 ranges

**CURRENT RANGE:** 10 amps, 3 ranges AC/DC

**RESISTANCE RANGE:** 32 megohms, 6 ranges

**SPECIAL FEATURES:** Auto/manual ranging, diode test, audible continuity test, "Touch Hold", auto power off, analog bargraph display

**DIMENSIONS/WEIGHT:** 6.55 x 2.95 x 1.12 inches/12 ounces  
**PRICE:** \$139.00

**COMPANY:** A.W. Sperry Instruments, Inc.

**MODEL:** DM-8500

**DESCRIPTION:** A member of the "Techmaster" series, this drop-proof, water-resistant, professional-quality meter is designed to operate under even adverse conditions. An upgrade of the DM-8400, this meter adds a capacitance function but deletes the DM-8400's duty-cycle function.

**DIGITS:** 3 $\frac{3}{4}$

**DC VOLTAGE RANGE:** 1000 volts, 5 ranges

**AC VOLTAGE RANGE:** 750 volts, 5 ranges

**CURRENT RANGE:** 20 amps, 3 ranges AC/DC

**RESISTANCE RANGE:** 40 megohms, 6 ranges

**SPECIAL FEATURES:** Audible continuity test, diode test, logic indicator, transistor gain test, peak hold, auto power off, capacitance test (40  $\mu$ F, 5 ranges), frequency test (4000 kHz, 4 ranges)

**DIMENSIONS/WEIGHT:** 7.5 x 3.4 x 1.5 inches/12.9 ounces  
**PRICE:** \$139.95

**COMPANY:** A.W. Sperry Instruments, Inc.

**MODEL:** DM-8200

**DESCRIPTION:** A member of the "Techmaster" series, this drop-proof, water-resistant, professional-quality meter is designed to operate even under adverse conditions. An upgrade of the DM-8100, this meter adds an analog bargraph display

**DIGITS:** 3 $\frac{1}{2}$

**DC VOLTAGE RANGE:** 1000 volts, 5 ranges

**AC VOLTAGE RANGE:** 750 volts, 4 ranges

**CURRENT RANGE:** 20 amps, 4 ranges AC/DC

**RESISTANCE RANGE:** 20 megohms, 6 ranges

**SPECIAL FEATURES:** Diode test, audible continuity test, logic indicator, data hold, range hold, relative readings, low-power resistance, auto power off, analog bargraph display, autoranging

**DIMENSIONS/WEIGHT:** 7.5 x 3.4 x 1.5 inches/12.9 ounces  
**PRICE:** \$139.95

**COMPANY:** Fieldpiece Instruments, Inc.

**MODEL:** HB75

**DESCRIPTION:** This upgrade of the HB73 adds a logic probe and an analog, variable-pitch output

**DIGITS:** 3 $\frac{1}{2}$

**DC VOLTAGE RANGE:** 1500 volts, 5 ranges

**AC VOLTAGE RANGE:** 1000 volts, 5 ranges

**CURRENT RANGE:** 20 amps, 3 ranges AC/DC

**RESISTANCE RANGE:** 20 megohms, 6 ranges

**SPECIAL FEATURES:** Diode test, audible continuity test, drop and contaminant-resistant case, capacitance function (200  $\mu$ F, 5 ranges), logic probe, variable-pitch analog output, auto off

**DIMENSIONS/WEIGHT:** 6.9 x 2.8 x 1.5 inches/N.A.  
**PRICE:** \$139.00

**COMPANY:** Global Specialties

**MODEL:** Protometer 4000

**DESCRIPTION:** A 3 $\frac{3}{4}$  DMM capable of performing 35 measurement functions.

**DIGITS:** 3 $\frac{3}{4}$



**DC VOLTAGE RANGE:** 1000 volts, 5 ranges

**AC VOLTAGE RANGE:** 750 volts, 5 ranges

**CURRENT RANGE:** 20 amps, 4 ranges AC/DC

**RESISTANCE RANGE:** 40

megohms, 6 ranges

**SPECIAL FEATURES:** Measures capacitance (4 nF to 40  $\mu$ F over 5 ranges); measures frequency (0-4 MHz, autoranging); diode/LED test; transistor gain test; logic probe function; peak hold; high-voltage warning; audible continuity test; impact resistant case

**DIMENSIONS/WEIGHT:** 3.5 x 1.5 x 7.6 inches/1 lb.

**PRICE:** \$139.95

**COMPANY:** Mercer Electronics  
**MODEL:** 9401

**DESCRIPTION:** A 4 $\frac{1}{2}$ -digit DMM with a data hold function and audible and visual continuity indicators.

**DIGITS:** 4 $\frac{1}{2}$

**DC VOLTAGE RANGE:** 1000 volts, 5 ranges

**AC VOLTAGE RANGE:** 750 volts, 5 ranges

**CURRENT RANGE:** 10 amps, 4 ranges AC/DC

**RESISTANCE RANGE:** 20 megohms, 6 ranges

**SPECIAL FEATURES:** Diode test, audible and visual continuity test, data hold

**DIMENSIONS/WEIGHT:** 6.69 x 3.43 x 1.65 inches/12.1 ounces  
**PRICE:** \$141.75

**COMPANY:** AEMC Corporation

**MODEL:** 9100

**DESCRIPTION:** This meter is built into a sturdy rubber housing to protect the unit from damage due to accidental drops

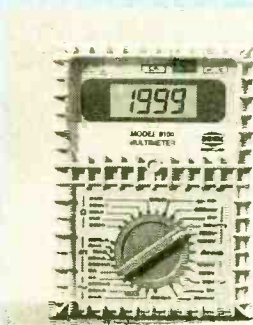

**DIGITS:** 3 $\frac{1}{2}$

**DC VOLTAGE RANGE:** 1000 volts, 5 ranges

**AC VOLTAGE RANGE:** 1000 volts, 5 ranges

**CURRENT RANGE:** 20 amps, 6 ranges AC/DC

**RESISTANCE RANGE:** 20 megohms, 6 ranges

**SPECIAL FEATURES:** Diode test, rubber housing

**DIMENSIONS/WEIGHT:** 5.7 x 4.1 x 1.7 inches/12.7 ounces

**PRICE:** \$149.00

**COMPANY:** B&K Precision

**MODEL:** 2912

**DESCRIPTION:** This upgrade of the 2911 offers twice as many measurement ranges and adds

several useful functions.

**DIGITS:** 3 $\frac{3}{4}$

**DC VOLTAGE RANGE:** 1000 volts, 5 ranges

**AC VOLTAGE RANGE:** 750 volts, 5 ranges

**CURRENT RANGE:** 10 amps, 5 ranges AC/DC

**RESISTANCE RANGE:** 40 megohms, 6 ranges

**SPECIAL FEATURES:** Diode test, audible continuity test, auto/manual ranging, analog bargraph display, frequency counter (400 kHz, 4 ranges), capacitance test (40 mF, 8 ranges), data hold, peak hold, min/max memory

**DIMENSIONS/WEIGHT:** 6.8 x 3.2 x 1.3 inches/13 ounces

**PRICE:** \$149.00

**COMPANY:** Beckman Industrial  
**MODEL:** RMS225

**DESCRIPTION:** A top-of-the-line, full-function, autoranging DMM designed with the professional user in mind.

**DIGITS:** 4 digits

**DC VOLTAGE RANGE:** 1000 volts, 4 ranges

**AC VOLTAGE RANGE:** 750 volts, 3 ranges

**CURRENT RANGE:** 10 amps AC/DC, 3 ranges

**RESISTANCE RANGE:** 40 megohms, 6 ranges

**SPECIAL FEATURES:** True rms reading, automatic min/max mode, relative measurement mode, probe hold, analog bargraph display, self-resetting fuse, audible overload alert, automatic power down, diode test, protective holster

**DIMENSIONS/WEIGHT:** 7.6 x 3.2 x 1.5 inches (with holster)/11.57 ounces

**PRICE:** \$149.00

**COMPANY:** Tegam, Inc.

**MODEL:** 130A

**DESCRIPTION:** An industrial-quality meter with a dust-, splash-, and drop-proof case.

**DIGITS:** 3 $\frac{1}{2}$

**DC VOLTAGE RANGE:** 1000 volts, 5 ranges

**AC VOLTAGE RANGE:** 750 volts, 5 ranges

**CURRENT RANGE:** 10 amps, 5 ranges AC/DC

**RESISTANCE RANGE:** 20 megohms, 5 ranges

**SPECIAL FEATURES:** Diode test; splash-, dust- and drop-resistant case

**DIMENSIONS/WEIGHT:** 7 x 3.1 x 1.6 inches/1 pound

**PRICE:** \$149.00

**COMPANY:** A.W. Sperry Instruments, Inc.

**MODEL:** DM-8600

**DESCRIPTION:** A member of the "Techmaster" series, this drop-proof, water-resistant, professional-quality meter is designed to operate under even adverse conditions. An upgrade of the DM-8500, this meter re-



places the capacitance function with a temperature measurement function.

**DIGITS:** 3¾  
**DC VOLTAGE RANGE:** 1000 volts, 5 ranges  
**AC VOLTAGE RANGE:** 750 volts, 5 ranges  
**CURRENT RANGE:** 20 amps, 5 ranges AC/DC

**RESISTANCE RANGE:** 40 megohms, 6 ranges  
**SPECIAL FEATURES:** Audible continuity test, diode test, logic indicator, peak hold, auto power off, temperature measurement test (-40°-400°C/1300°F; -58°-400°F/2372°F), frequency measurement (4000 kHz, 4 ranges)  
**DIMENSIONS/WEIGHT:** 7.5 × 3.4 × 1.5 inches/12.9 ounces  
**PRICE:** \$149.95

**COMPANY:** American Reliance, Inc.

**MODEL:** AR-170NL  
**DESCRIPTION:** This true rms reading DMM features audio level (in dBm) and system noise measurement functions making it especially useful for audio or communications applications. Basic DCV accuracy is 0.1%.

**DIGITS:** 3½  
**DC VOLTAGE RANGE:** 1000 volts, 6 ranges  
**AC VOLTAGE RANGE:** 750 volts, 6 ranges  
**CURRENT RANGE:** 10 amps, 7 ranges AC/DC  
**RESISTANCE RANGE:** 20 megohms, 7 ranges  
**SPECIAL FEATURES:** Diode test, audible continuity test, true rms reading, audio level function (-70 to +60 dBm), system-noise function with 3-kHz flat weighting filter  
**DIMENSIONS/WEIGHT:** 6.8 × 3.4 × 1.4 inches/11.7 ounces  
**PRICE:** \$149.95

**COMPANY:** American Reliance, Inc.

**MODEL:** AR-3010  
**DESCRIPTION:** A programmable, autoranging 3¾-digit DMM with an analog bargraph display and a dBm function for audio/communications applications. An upgrade of the AR-3000, this meter offers better accuracy (0.25% basic DCV accuracy) and adds a level comparator ("range alert") function.

**DIGITS:** 3¾  
**DC VOLTAGE RANGE:** 1000 volts, 5 ranges  
**AC VOLTAGE RANGE:** 750 volts, 4 ranges  
**CURRENT RANGE:** 20 amps, 3 ranges AC/DC  
**RESISTANCE RANGE:** 40 megohms, 6 ranges  
**SPECIAL FEATURES:** dBm function, diode test, audible continuity test, analog bargraph display, logic probe function, relative

measurement mode, data hold, min/max function, auto power off, auto and manual ranging, range hold, range alert  
**DIMENSIONS/WEIGHT:** 6.4 × 3.25 × 1.4 inches/12.5 ounces  
**PRICE:** \$149.95

## \$150-\$200

**COMPANY:** B&K Precision  
**MODEL:** 2940  
**DESCRIPTION:** This 4½-digit DMM includes a built-in frequency counter.

**DIGITS:** 4½  
**DC VOLTAGE RANGE:** 1000 volts, 5 ranges



**AC VOLTAGE RANGE:** 750 volts, 5 ranges  
**CURRENT RANGE:** 10 amps, 6 ranges AC/DC  
**RESISTANCE RANGE:** 20 megohms, 6 ranges  
**SPECIAL FEATURES:** Diode test, audible continuity test, frequency counter (20 Hz-200 kHz), data hold, drop resistant case (to 4 ft.)  
**DIMENSIONS/WEIGHT:** 7.5 × 3.6 × 1.4 inches/13 ounces  
**PRICE:** \$160.00

**COMPANY:** Beckman Industrial

**MODEL:** 310B  
**DESCRIPTION:** A no-frills, professional-quality DMM that offers good precision and reliability at an affordable price. An upgrade of the 300A, this model adds a 10-amp current range and a beeper for the continuity test function.

**DIGITS:** 3½  
**DC VOLTAGE RANGE:** 1500 volts, 5 ranges  
**AC VOLTAGE RANGE:** 1000 volts, 5 ranges  
**CURRENT RANGE:** 10 amps, 6 ranges AC/DC  
**RESISTANCE RANGE:** 20 megohms, 6 ranges  
**SPECIAL FEATURES:** Diode test, audible continuity test  
**DIMENSIONS/WEIGHT:** 17.4 × 9.3 × 4.6 cm/N.A.  
**PRICE:** \$165.00

**COMPANY:** John Fluke Mfg Co., Inc.

**MODEL:** 77/23  
**DESCRIPTION:** This upgrade of the model 75 offers improved basic DC accuracy and includes

Fluke's Holster/Flex stand. It is available in industrial yellow as the model 23.

**DIGITS:** 4 (3200 count)  
**DC VOLTAGE RANGE:** 1000 volts, 5 ranges  
**AC VOLTAGE RANGE:** 750 volts, 4 ranges  
**CURRENT RANGE:** 10 amps, 3 ranges AC/DC  
**RESISTANCE RANGE:** 32 megohms, 6 ranges  
**SPECIAL FEATURES:** Auto/manual ranging, diode test, audible continuity test, "Touch Hold", auto power off, analog bargraph display, Holster/Flex stand  
**DIMENSIONS/WEIGHT:** 6.55 × 2.95 × 1.12 inches/12 ounces  
**PRICE:** \$165.00

**COMPANY:** Beckman Industrial  
**MODEL:** HD153

**DESCRIPTION:** This heavy-duty meter is designed for dependability under demanding industrial conditions with all sensitive circuits shock mounted. Among its advanced features are autoranging and an audible readout that changes pitch as the meter's input levels increase or decrease.

**DIGITS:** 3½  
**DC VOLTAGE RANGE:** 1500 volts, 5 ranges  
**AC VOLTAGE RANGE:** 1000 volts, 5 ranges  
**CURRENT RANGE:** 10 amps AC/DC, 5 ranges  
**RESISTANCE RANGE:** 20 megohms, 5 ranges  
**SPECIAL FEATURES:** Autoranging, diode test, continuity test, logic-pulse detector, audible readout, sealed "environment-proof" case  
**DIMENSIONS/WEIGHT:** 173 × 71 × 32 mm/326 grams.  
**PRICE:** \$169.00

**COMPANY:** A.W. Sperry Instruments, Inc.

**MODEL:** DM-E300  
**DESCRIPTION:** A member of the "Techmaster" series, this drop-proof, water-resistant, professional-quality meter is designed to operate even under

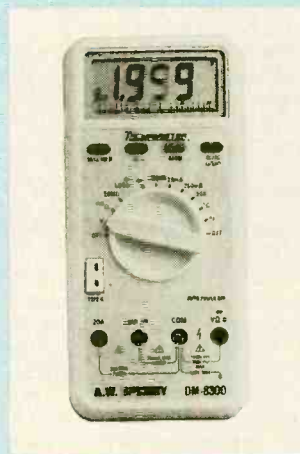

adverse conditions. An upgrade of the DM-8200, this meter adds a temperature measurement function

**DIGITS:** 3½  
**DC VOLTAGE RANGE:** 1000 volts, 5 ranges  
**AC VOLTAGE RANGE:** 750 volts, 4 ranges  
**CURRENT RANGE:** 20 amps, 4 ranges AC/DC  
**RESISTANCE RANGE:** 20 megohms, 5 ranges  
**SPECIAL FEATURES:** Diode test, audible continuity test, logic indicator, data hold, range hold, relative readings, low-power resistance, auto power off, analog bargraph display, autoranging, temperature measurement function (-58°F-200°F/2372°F; -50°C-200°C/1300°C)  
**DIMENSIONS/WEIGHT:** 7.5 × 3.4 × 1.5 inches/12.9 ounces  
**PRICE:** \$169.95

**COMPANY:** Fieldpiece Instruments, Inc.

**MODEL:** HB77  
**DESCRIPTION:** This upgrade of the HB75 is true-rms reading.

**DIGITS:** 3½  
**DC VOLTAGE RANGE:** 1500 volts, 5 ranges  
**AC VOLTAGE RANGE:** 1000 volts, 5 ranges  
**CURRENT RANGE:** 20 amps, 3 ranges AC/DC  
**RESISTANCE RANGE:** 20 megohms, 6 ranges  
**SPECIAL FEATURES:** Diode test, audible continuity test, drop- and contaminant-resistant case, capacitance function (200 µF, 5 ranges), logic probe, variable-pitch analog output, true-rms reading, auto off  
**DIMENSIONS/WEIGHT:** 6.9 × 2.8 × 1.5 inches/N.A.  
**PRICE:** \$179.00

**COMPANY:** Beckman Industrial  
**MODEL:** HD100

**DESCRIPTION:** This heavy-duty meter is designed for dependability under demanding industrial conditions. The case is fire retardant and waterproof.

**DIGITS:** 3½  
**DC VOLTAGE RANGE:** 1500 volts, 5 ranges  
**AC VOLTAGE RANGE:** 1000 volts, 5 ranges  
**CURRENT RANGE:** 2 amps, 5 ranges AC/DC  
**RESISTANCE RANGE:** 20 megohms, 6 ranges  
**SPECIAL FEATURES:** Diode test, continuity test  
**DIMENSIONS/WEIGHT:** 17.4 × 9.3 × 4.6 cm/N.A.  
**PRICE:** \$185.00

**COMPANY:** John Fluke Mfg. Co., Inc.

**MODEL:** 79/29  
**DESCRIPTION:** The top meter in Fluke's 70 series, this meter includes capacitance and frequency functions, a low-ohms range,



and a smoothing function that displays a running average of last 8 readings.

**DIGITS:** 4 (4000 count)  
**DC VOLTAGE RANGE:** 1000 volts, 6 ranges  
**AC VOLTAGE RANGE:** 750 volts, 5 ranges  
**CURRENT RANGE:** 10 amps, 4 ranges AC/DC  
**RESISTANCE RANGE:** 40 megohms, 7 ranges  
**SPECIAL FEATURES:** Auto/manual ranging, diode test, audible continuity test, "Touch Hold," auto power off, analog bargraph display, Holster/Flex stand, capacitance function (9999  $\mu$ F, 6 ranges), frequency counter (>20 kHz, 5 ranges), low-ohms range, smoothing function  
**DIMENSIONS/WEIGHT:** 6.55 x 2.95 x 1.12 inches/12 ounces  
**PRICE:** \$185.00

**COMPANY:** A.W. Sperry Instruments, Inc.

**MODEL:** DM-8700  
**DESCRIPTION:** A member of the "Techmaster" series, this drop-proof, water-resistant, professional-quality meter is designed to operate under even adverse conditions. An upgrade of the DM-8600, this meter features a 4½-digit display and is true rms reading.

**DIGITS:** 4½  
**DC VOLTAGE RANGE:** 1000 volts, 5 ranges  
**AC VOLTAGE RANGE:** 750 volts, 5 ranges  
**CURRENT RANGE:** 20 amps, 5 ranges AC/DC  
**RESISTANCE RANGE:** 20 megohms, 6 ranges  
**SPECIAL FEATURES:** Audible continuity test, diode test, logic indicator, data hold, auto power off, frequency measurement test (4000 kHz, 4 ranges), duty-cycle test  
**DIMENSIONS/WEIGHT:** 7.5 x 3.4 x 1.5 inches/12.9 ounces  
**PRICE:** \$189.95

**COMPANY:** A.W. Sperry Instruments, Inc.

**MODEL:** DM-7010  
**DESCRIPTION:** A 4½-digit multimeter with 0.05% basic DCV

accuracy, a built in frequency counter, and a conductance function.

**DIGITS:** 4½  
**DC VOLTAGE RANGE:** 1000 volts, 5 ranges  
**AC VOLTAGE RANGE:** 750 volts, 5 ranges  
**CURRENT RANGE:** 10 amps, 6 ranges AC/DC  
**RESISTANCE RANGE:** 20 megohms, 6 ranges  
**SPECIAL FEATURES:** Diode test, audible continuity test, frequency counter (200 kHz, 2 ranges), 200 nS conductance range,  
**DIMENSIONS/WEIGHT:** 6.9 x 3.4 x 1.3 inches/10.2 ounces  
**PRICE:** \$190.00

**COMPANY:** B&K Precision  
**MODEL:** 2907

**DESCRIPTION:** This true-rms reading DMM is an upgrade of the 2906.

**DIGITS:** 3½  
**DC VOLTAGE RANGE:** 1000 volts, 5 ranges  
**AC VOLTAGE RANGE:** 750 volts, 5 ranges  
**CURRENT RANGE:** 10 amps, 3 ranges AC/DC  
**RESISTANCE RANGE:** 20 megohms, 6 ranges  
**SPECIAL FEATURES:** Diode test, audible continuity test, TTL/CMOS logic probe, transistor gain test, true rms reading, capacitance measurement (20 $\mu$ F, 5 ranges), peak hold, drop-resistant case (to 4 ft.)  
**DIMENSIONS/WEIGHT:** 7.5 x 3.6 x 1.4 inches/13 ounces  
**PRICE:** \$195.00

**COMPANY:** Beckman Industrial  
**MODEL:** 800

**DESCRIPTION:** A professional-quality DMM that offers good precision and reliability. This 4½ digit model offers frequency measurement and data-hold functions.

**DIGITS:** 4½  
**DC VOLTAGE RANGE:** 1000 volts, 5 ranges  
**AC VOLTAGE RANGE:** 750 volts, 5 ranges  
**CURRENT RANGE:** 10 amps, 6 ranges AC/DC  
**RESISTANCE RANGE:** 20 megohms, 6 ranges  
**SPECIAL FEATURES:** Diode test, audible continuity test, frequency test function (200 kHz, 2 ranges), data hold  
**DIMENSIONS/WEIGHT:** 174 x 90 x 36 mm/370 grams  
**PRICE:** \$199.00

**COMPANY:** Beckman Industrial  
**MODEL:** 320B

**DESCRIPTION:** A no-frills, professional-quality DMM that offers good precision and reliability at an affordable price. An upgrade of the 310B, this model offers improved precision.

**DIGITS:** 3½  
**DC VOLTAGE RANGE:** 1500

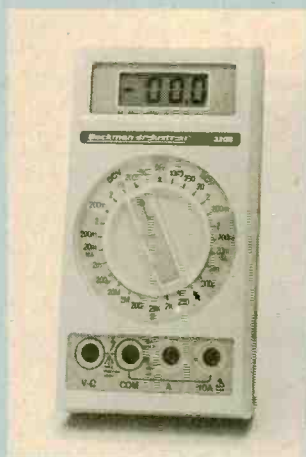

volts, 5 ranges  
**AC VOLTAGE RANGE:** 1000 volts, 5 ranges  
**CURRENT RANGE:** 10 amps, 6 ranges AC/DC  
**RESISTANCE RANGE:** 20 megohms, 6 ranges  
**SPECIAL FEATURES:** Diode test, audible continuity test  
**DIMENSIONS/WEIGHT:** 17.4 x 9.3 x 4.6 cm/N.A.  
**PRICE:** \$199.00

**COMPANY:** John Fluke Mfg. Co., Inc.

**MODEL:** 83

**DESCRIPTION:** The base meter in the 80 series, this unit offers a full compliment of useful features.

**DIGITS:** 3¾  
**DC VOLTAGE RANGE:** 1000 volts, 5 ranges  
**AC VOLTAGE RANGE:** 1000 volts, 5 ranges  
**CURRENT RANGE:** 10 amps, 6 ranges AC/DC  
**RESISTANCE RANGE:** 40 megohms, 7 ranges  
**SPECIAL FEATURES:** Auto/manual ranging, diode test, audible continuity test, "Touch Hold," auto power off, analog bargraph display with zoom mode, capacitance function (5  $\mu$ F, 4 ranges), frequency counter (>200 kHz, 5 ranges), duty cycle function, min/max mode, conductance function, relative mode, holster/flex stand  
**DIMENSIONS/WEIGHT:** 7.35 x 3.41 x 1.25 inches/12.5 ounces  
**PRICE:** \$199.00

**COMPANY:** Simpson Electric Company

**MODEL:** 487

**DESCRIPTION:** An industrial-quality DMM with a 3¾-digit display, auto/manual ranging, and a shock-proof case.

**DIGITS:** 3¾  
**DC VOLTAGE RANGE:** 1000 volts, 5 ranges  
**AC VOLTAGE RANGE:** 750 volts, 5 ranges  
**CURRENT RANGE:** 10 amps, 6 ranges AC/DC  
**RESISTANCE RANGE:** 30

megohms, 6 ranges

**SPECIAL FEATURES:** Diode test, audible continuity test, analog bargraph display, auto/manual ranging, data hold, peak hold, neck strap  
**DIMENSIONS/WEIGHT:** 7.3 x 3.9 x 1.9 inches/1.11 pounds  
**PRICE:** \$199.00

**COMPANY:** American Reliance, Inc.

**MODEL:** AR-270NL

**DESCRIPTION:** This 4½ digit, true rms reading DMM features audio level and system noise functions.

**DIGITS:** 3½  
**DC VOLTAGE RANGE:** 1000 volts, 5 ranges  
**AC VOLTAGE RANGE:** 750 volts, 5 ranges  
**CURRENT RANGE:** 10 amps, 6 ranges AC/DC  
**RESISTANCE RANGE:** 20 megohms, 6 ranges  
**SPECIAL FEATURES:** Diode test, audible continuity test, true rms reading, audio level function (-60 to +60 dBm), system noise function with built in 3-kHz flat weighting filter.  
**DIMENSIONS/WEIGHT:** 6.8 x 3.4 x 1.4 inches/11.1 ounces  
**PRICE:** \$199.95

**COMPANY:** American Reliance, Inc.

**MODEL:** AR-3100

**DESCRIPTION:** A programmable, autoranging 3¾-digit DMM with an analog bargraph display, a dBm function for audio/communications, and 0.25% basic DCV accuracy. An upgrade of the AR-3010, this meter is drop proof (to 10 feet) and adds 3 additional ranges to the current function.

**DIGITS:** 3¾  
**DC VOLTAGE RANGE:** 1000 volts, 5 ranges  
**AC VOLTAGE RANGE:** 750 volts, 4 ranges  
**CURRENT RANGE:** 20 amps, 6 ranges AC/DC  
**RESISTANCE RANGE:** 40 megohms, 6 ranges  
**SPECIAL FEATURES:** dBm function, diode test, audible continuity test, analog bargraph display, logic probe function, relative measurement mode, data hold, min/max function, auto power off, auto/manual ranging, range hold, range alert  
**DIMENSIONS/WEIGHT:** 6.4 x 3.25 x 1.4 inches/12.5 ounces  
**PRICE:** \$199.95

**COMPANY:** Simpson Electric Company

**MODEL:** 470

**DESCRIPTION:** A professional quality DMM.

**DIGITS:** 3½  
**DC VOLTAGE RANGE:** 1000 volts, 5 ranges  
**AC VOLTAGE RANGE:** 750 volts, 5 ranges  
**CURRENT RANGE:** 10 amps, 5



ranges AC/DC  
**RESISTANCE RANGE:** 20 megohms, 5 ranges  
**SPECIAL FEATURES:** Diode test, audible continuity test  
**DIMENSIONS/WEIGHT:** 7.1 x 3.4 x 1.8 inches/1 pound  
**PRICE:** \$200.00

### OVER \$200

**COMPANY:** Beckman Industrial  
**MODEL:** 850  
**DESCRIPTION:** A professional-quality DMM that offers good precision and reliability. This 4½-digit model offers frequency measurement and data-hold functions. An upgrade of the 800, this meter adds true rms sensing  
**DIGITS:** 4½  
**DC VOLTAGE RANGE:** 1000 volts, 5 ranges  
**AC VOLTAGE RANGE:** 750 volts, 5 ranges  
**CURRENT RANGE:** 10 amps, 6 ranges AC/DC  
**RESISTANCE RANGE:** 20 megohms, 6 ranges  
**SPECIAL FEATURES:** Diode test, audible continuity test, frequency test function (200 kHz, 2 ranges), data hold, true rms sensing  
**DIMENSIONS/WEIGHT:** 174 x 90 x 36 mm/370 grams  
**PRICE:** \$209.00

**COMPANY:** Beckman Industrial  
**MODEL:** HD110/HD110T  
**DESCRIPTION:** This heavy-duty meter is designed for dependability under demanding industrial conditions. The case is fire retardant and waterproof. This meter adds a 10-amp range to the HD100; a temperature measurement function is also added in the HD110T  
**DIGITS:** 3½  
**DC VOLTAGE RANGE:** 1500 volts, 5 ranges  
**AC VOLTAGE RANGE:** 1000 volts, 5 ranges  
**CURRENT RANGE:** 10 amps, 5 ranges AC/DC  
**RESISTANCE RANGE:** 20 megohms, 6 ranges  
**SPECIAL FEATURES:** Diode test, continuity test, temperature measurement from -20 to

+1260°C (type K thermocouple input) model HD110T only  
**DIMENSIONS/WEIGHT:** 17.4 x 9.3 x 4.6 cm/ N.A.  
**PRICE:** \$209.00 (HD110)/\$239.00 (HD110T)

**COMPANY:** AEMC Corporation  
**MODEL:** 9000  
**DESCRIPTION:** This meter is built into a sturdy rubber housing to protect the unit from damage due to accidental drops. An upgrade of the 910C, it offers higher accuracy, an audible continuity test, and two low-impedance voltage ranges.  
**DIGITS:** 3½  
**DC VOLTAGE RANGE:** 1000 volts, 5 ranges  
**AC VOLTAGE RANGE:** 750 volts, 5 ranges  
**CURRENT RANGE:** 15 amps, 5 ranges AC/DC  
**RESISTANCE RANGE:** 20 megohms, 6 ranges  
**SPECIAL FEATURES:** Diode test, rubber housing, audible continuity test (all resistance ranges), two low-impedance voltage ranges (2 and 300 volts)  
**DIMENSIONS/WEIGHT:** 5.67 x 4.1 x 1.65 inches/1 pound  
**PRICE:** \$229.00

**COMPANY:** Beckman Industrial  
**MODEL:** 330B  
**DESCRIPTION:** A professional-quality DMM that offers good precision and reliability at an affordable price. An upgrade of the 320B, this model is true rms sensing.  
**DIGITS:** 3½  
**DC VOLTAGE RANGE:** 1500 volts, 5 ranges  
**AC VOLTAGE RANGE:** 1000 volts, 5 ranges  
**CURRENT RANGE:** 10 amps, 6 ranges AC/DC  
**RESISTANCE RANGE:** 20 megohms, 6 ranges  
**SPECIAL FEATURES:** Diode test, audible continuity test, true rms sensing  
**DIMENSIONS/WEIGHT:** 17.4 x 9.3 x 4.6 cm/N.A.  
**PRICE:** \$229.00

**COMPANY:** American Reliance, Inc.  
**MODEL:** AR-3200

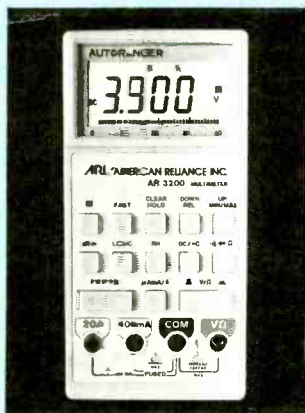

**DESCRIPTION:** A programmable, autoranging 3¾-digit DMM with an analog bargraph display, a dBm function for audio/communications, and 0.25% basic DCV accuracy. An upgrade of the AR-3100, this meter is water and contaminant proof  
**DIGITS:** 3¾  
**DC VOLTAGE RANGE:** 1000 volts, 5 ranges  
**AC VOLTAGE RANGE:** 750 volts, 4 ranges  
**CURRENT RANGE:** 20 amps, 3 ranges AC/DC  
**RESISTANCE RANGE:** 40 megohms, 6 ranges  
**SPECIAL FEATURES:** dBm function, diode test, audible continuity test, analog bargraph display, logic probe function, relative measurement mode, data hold, min/max function, auto power off, auto and manual ranging, range hold, range alert  
**DIMENSIONS/WEIGHT:** 6.4 x 3.25 x 1.4 inches/12.5 ounces  
**PRICE:** \$229.95

**COMPANY:** Daetron  
**MODEL:** MM100  
**DESCRIPTION:** This unusual multimeter is capable of displaying up to four readings simultaneously on a 16-character x 2-line dot matrix LCD.  
**DIGITS:** 4½ (up to 2 readings)/3½ (up to 4 readings)  
**DC VOLTAGE RANGE:** 500 volts, 5 ranges  
**AC VOLTAGE RANGE:** 500 volts, 4 ranges  
**CURRENT RANGE:** 2 amps, 2 ranges DC only  
**RESISTANCE RANGE:** 20 megohms, 5 ranges  
**SPECIAL FEATURES:** Multiple-reading display, audible continuity test, analog bargraph display, manual or autoranging, hold function, relative mode, audible-response keypad  
**DIMENSIONS/WEIGHT:** 276 x 250 x 60 mm/N.A.  
**PRICE:** \$229.95

**COMPANY:** John Fluke Mfg. Co., Inc.  
**MODEL:** 85  
**DESCRIPTION:** This upgrade of the 83 offers higher accuracy.  
**DIGITS:** 3¾  
**DC VOLTAGE RANGE:** 1000 volts, 5 ranges  
**AC VOLTAGE RANGE:** 1000 volts, 5 ranges  
**CURRENT RANGE:** 10 amps, 6 ranges AC/DC  
**RESISTANCE RANGE:** 40 megohms, 7 ranges  
**SPECIAL FEATURES:** Auto/manual ranging, diode test, audible continuity test, "Touch Hold," auto power off, analog bargraph display with zoom mode, capacitance function (5 µF, 4 ranges), frequency counter (>200 kHz, 5 ranges), duty cycle function, min/max mode, conductance func-



tion, relative mode, holster/flux stand  
**DIMENSIONS/WEIGHT:** 7.35 x 3.41 x 1.25 inches/12.5 ounces  
**PRICE:** \$239.00

**COMPANY:** Simpson Electric Company  
**MODEL:** 488  
**DESCRIPTION:** A true-rms reading version of the 487.  
**DIGITS:** 3¾  
**DC VOLTAGE RANGE:** 1000 volts, 5 ranges  
**AC VOLTAGE RANGE:** 750 volts, 5 ranges  
**CURRENT RANGE:** 10 amps, 6 ranges AC/DC  
**RESISTANCE RANGE:** 30 megohms, 6 ranges  
**SPECIAL FEATURES:** Diode test, audible continuity test, analog bargraph display, auto/manual ranging, data hold, peak hold, true-rms reading, neck strap  
**DIMENSIONS/WEIGHT:** 7.3 x 3.9 x 1.9 inches/1.11 pounds  
**PRICE:** \$239.00

**COMPANY:** Tegam, Inc.  
**MODEL:** 132C/132F  
**DESCRIPTION:** This industrial-quality meter is true-rms reading and has a temperature measurement function  
**DIGITS:** 3½  
**DC VOLTAGE RANGE:** 1000 volts, 5 ranges  
**AC VOLTAGE RANGE:** 750 volts, 5 ranges  
**CURRENT RANGE:** 2000 mA, 4 ranges AC/DC  
**RESISTANCE RANGE:** 20 megohms, 5 ranges  
**SPECIAL FEATURES:** Diode test, true-rms reading, temperature function (132F: 0-2000°F, 1 range; 132C: -20-1370°C, 1 range), drop-proof case  
**DIMENSIONS/WEIGHT:** 7 x 3.1 x 1.6 inches/1 pound  
**PRICE:** \$239.00

**COMPANY:** American Reliance, Inc.  
**MODEL:** AR-150W  
**DESCRIPTION:** This drop-proof unit is a dual DMM/wattmeter and will measure true AC power up to 5500 watts



**DIGITS:** 3½  
**DC VOLTAGE RANGE:** 1000 volts, 5 ranges  
**AC VOLTAGE RANGE:** 750 volts, 5 ranges  
**CURRENT RANGE:** 10 amps, 6 ranges AC/DC  
**RESISTANCE RANGE:** 20 megohms, 6 ranges  
**SPECIAL FEATURES:** Diode test, audible continuity test, power measurement (to 5500 watts, 2 ranges)  
**DIMENSIONS/WEIGHT:** 6.8 × 3.4 × 1.4 inches/10.6 ounces  
**PRICE:** \$249.95

**COMPANY:** B&K Precision  
**MODEL:** 2945  
**DESCRIPTION:** This 4½-digit, true-rms reading DMM is an upgrade of the 2940.  
**DIGITS:** 4½  
**DC VOLTAGE RANGE:** 1000 volts, 5 ranges  
**AC VOLTAGE RANGE:** 750 volts, 5 ranges  
**CURRENT RANGE:** 10 amps, 5 ranges AC/DC  
**RESISTANCE RANGE:** 20 megohms, 6 ranges



**SPECIAL FEATURES:** Diode test, audible continuity test, frequency counter (20 Hz–200 kHz), data hold, true-rms reading (–20 to +1000°C/–4 to

+1832°F), drop-resistant case (to 4 ft.)  
**DIMENSIONS/WEIGHT:** 7.5 × 3.6 × 1.4 inches/13 ounces  
**PRICE:** \$259.00

**COMPANY:** Beckman Industrial  
**MODEL:** 4410B  
**DESCRIPTION:** A professional-quality DMM that offers good precision and reliability at an affordable price. This 4½ digit model is true rms sensing.  
**DIGITS:** 4½  
**DC VOLTAGE RANGE:** 1500 volts, 5 ranges  
**AC VOLTAGE RANGE:** 1000 volts, 5 ranges  
**CURRENT RANGE:** 10 amps, 6 ranges AC/DC  
**RESISTANCE RANGE:** 20 megohms, 5 ranges  
**SPECIAL FEATURES:** Diode test, audible continuity test, true rms sensing  
**DIMENSIONS/WEIGHT:** 17.4 × 9.3 × 4.6 cm/N.A.  
**PRICE:** \$259.00

**COMPANY:** Daetron  
**MODEL:** MM200  
**DESCRIPTION:** This unusual multimeter is capable of displaying up to four readings simultaneously on a 16-character × 2-line dot matrix LCD. An upgrade of the MM100, this meter adds a frequency counter.  
**DIGITS:** 4½ (up to 2 readings)/3½ (up to 4 readings)  
**DC VOLTAGE RANGE:** 500 volts, 5 ranges  
**AC VOLTAGE RANGE:** 500 volts, 4 ranges  
**CURRENT RANGE:** 0.2 amp, 1 range DC only  
**RESISTANCE RANGE:** 20 megohms, 5 ranges  
**SPECIAL FEATURES:** Multiple-reading display, audible continuity test, analog bargraph display, manual or autoranging, hold function, relative mode, audible-response keypad, frequency counter (10 Hz–10 MHz, 9 ranges)  
**DIMENSIONS/WEIGHT:** 276 × 250 × 60 mm/N.A.  
**PRICE:** \$259.95

**COMPANY:** Beckman Industrial  
**MODEL:** HD130B  
**DESCRIPTION:** This heavy-duty meter is designed for dependability under demanding industrial conditions. The case is fire retardant and waterproof. This meter adds true rms reading and improved accuracy to the HD110  
**DIGITS:** 3½  
**DC VOLTAGE RANGE:** 1500 volts, 5 ranges  
**AC VOLTAGE RANGE:** 1000 volts, 5 ranges  
**CURRENT RANGE:** 10 amps, 5 ranges AC/DC  
**RESISTANCE RANGE:** 20 megohms, 6 ranges  
**SPECIAL FEATURES:** Diode test, continuity test, true rms

reading  
**DIMENSIONS/WEIGHT:** 17.4 × 9.3 × 4.6 cm/ N.A.  
**PRICE:** \$279.00

**COMPANY:** John Fluke Mfg. Co., Inc.  
**MODEL:** 87  
**DESCRIPTION:** This top-of-the-line, 80-series meter is true rms reading and offers a 4½-digit display.  
**DIGITS:** 4½  
**DC VOLTAGE RANGE:** 1000 volts, 5 ranges  
**AC VOLTAGE RANGE:** 1000 volts, 5 ranges  
**CURRENT RANGE:** 10 amps, 6 ranges AC/DC  
**RESISTANCE RANGE:** 40 megohms, 7 ranges

**SPECIAL FEATURES:** Auto/manual ranging, diode test, audible continuity test, "Touch Hold," auto power off, full-time high-resolution analog pointer, capacitance function (5 µF, 4 ranges), frequency counter (>200 kHz, 5 ranges), duty cycle function, min/max mode, conductance function, relative mode, true rms reading, holster/flex stand  
**DIMENSIONS/WEIGHT:** 7.35 × 3.41 × 1.25 inches/12.5 ounces  
**PRICE:** \$289.00

**COMPANY:** Tegam, Inc.  
**MODEL:** 135A  
**DESCRIPTION:** This industrial-quality meter features a 4½ digit display and .05% basic DCV accuracy.  
**DIGITS:** 3½  
**DC VOLTAGE RANGE:** 1000 volts, 4 ranges  
**AC VOLTAGE RANGE:** 750 volts, 4 ranges  
**CURRENT RANGE:** 10 amps, 2 ranges AC/DC  
**RESISTANCE RANGE:** 20 megohms, 5 ranges  
**SPECIAL FEATURES:** Diode test, drop-proof case  
**DIMENSIONS/WEIGHT:** 7 × 3.1 × 1.6 inches/1 pound  
**PRICE:** \$299.00

**COMPANY:** Simpson Electric Company  
**MODEL:** 474  
**DESCRIPTION:** This upgrade of the 470 features a 4½ digit display.  
**DIGITS:** 4½  
**DC VOLTAGE RANGE:** 1000 volts, 5 ranges  
**AC VOLTAGE RANGE:** 750 volts, 5 ranges  
**CURRENT RANGE:** 10 amps, 5 ranges AC/DC  
**RESISTANCE RANGE:** 20 megohms, 5 ranges  
**SPECIAL FEATURES:** Diode test, audible continuity test  
**DIMENSIONS/WEIGHT:** 7.1 × 3.4 × 1.8 inches/1 pound  
**PRICE:** \$300.00

**COMPANY:** Beckman Industrial  
**MODEL:** HD140B

**DESCRIPTION:** This heavy-duty meter is designed for dependability under demanding industrial conditions. The case is fire retardant and waterproof.  
**DIGITS:** 4½  
**DC VOLTAGE RANGE:** 1500 volts, 5 ranges  
**AC VOLTAGE RANGE:** 1000 volts, 5 ranges  
**CURRENT RANGE:** 10 amps, 5 ranges AC/DC  
**RESISTANCE RANGE:** 20 megohms, 5 ranges  
**SPECIAL FEATURES:** Diode test, continuity test, true rms reading, waterproof and fire-retardant case

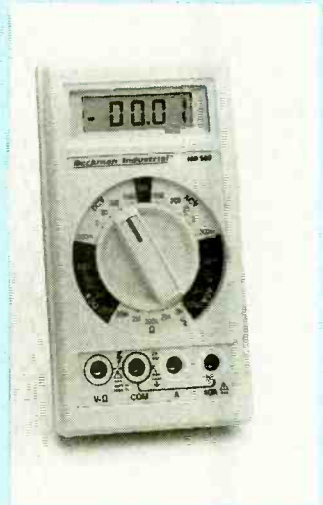

**DIMENSIONS/WEIGHT:** 17.4 × 9.3 × 4.6 cm/ N.A.  
**PRICE:** \$309.00

**COMPANY:** Triplett Corporation  
**MODEL:** 3360  
**DESCRIPTION:** A true-rms reading, extended range, precision DMM with user-selectable display, frequency counter, temperature function, and dBm mode.  
**DIGITS:** 3½ or 4½ (user selectable)  
**DC VOLTAGE RANGE:** 1000 volts, 5 ranges  
**AC VOLTAGE RANGE:** 750 volts, 5 ranges  
**CURRENT RANGE:** 10 amps, 2 ranges AC/DC  
**RESISTANCE RANGE:** 25 megohms, 6 ranges  
**SPECIAL FEATURES:** Audible continuity test, data hold, diode test, auto/manual ranging, peak hold, relative mode, frequency counter (10–99.999 kHz), temperature function (–50–+1200°C/–58–2192°F), dBm mode, selectable 3.5/4.5-digit display, true rms reading, user selectable 3½- or 4½-digit display  
**DIMENSIONS/WEIGHT:** 7 × 3½ × 1¼ inches/360 grams  
**PRICE:** \$399.00

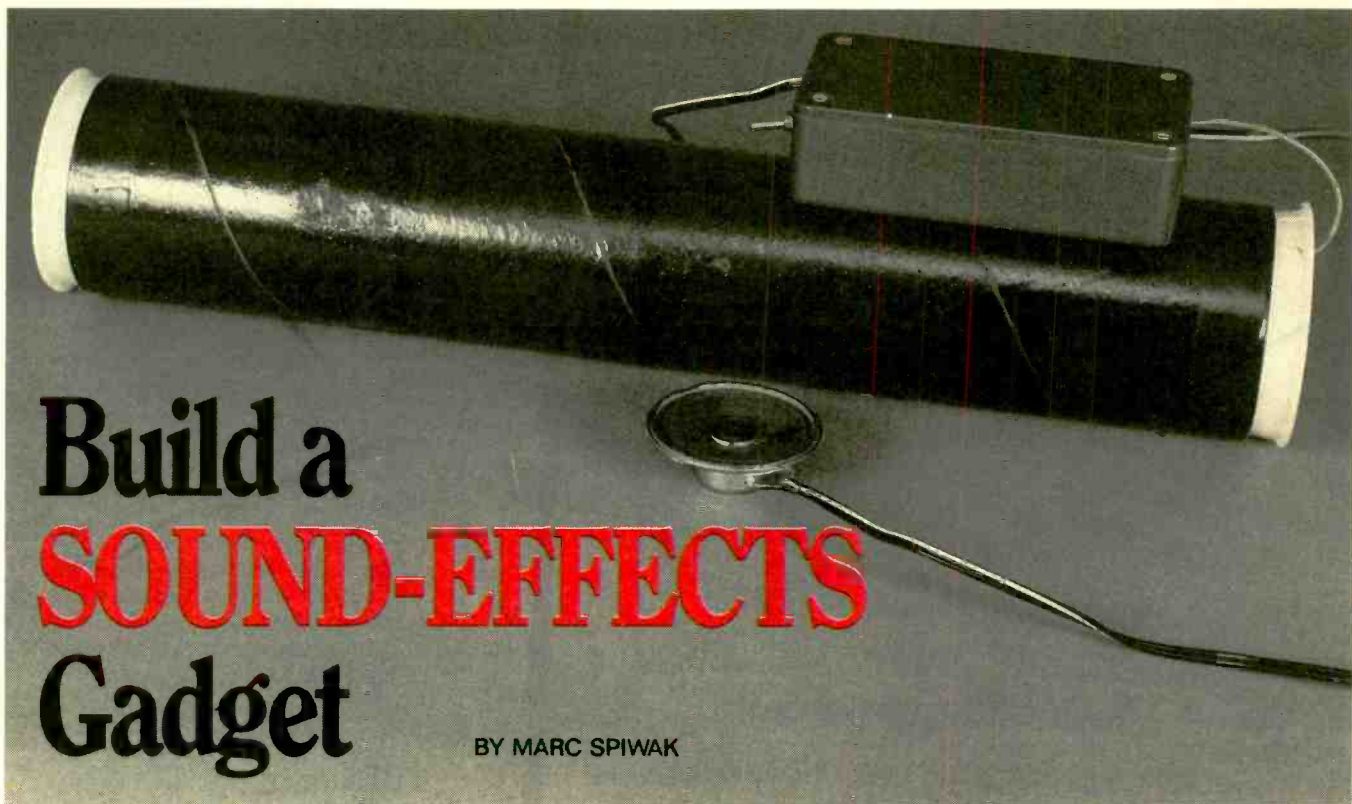

# Build a SOUND-EFFECTS Gadget

BY MARC SPIWAK

*This unusual gadget will make your voice sound almost android-like, for a Halloween effect that both big and little kids will enjoy!*

**S**ometimes someone shows you a gadget that makes you feel as though you must also have one of them. But, quite often, you can't find one in a store, so your only alternative is to build your own from scratch. That's just what led to the creation of the *Sound-Effects Gadget* described in this article. A friend of mine had what was left of an unusual children's toy; you could talk into one end, and a strange voice would come out of the other. I thought that the gadget was really neat, and I felt that the readers of **Popular Electronics** would think so too.

The electronic portion of the device is fairly straightforward; consisting of an electret microphone feeding its output into an amplifier circuit (which is powered from a 9-volt battery) with a speaker connected to the output.

However, further examination of the strange contraption showed that the sound effects were actually produced by a spring that was loosely strung between two diaphragms mounted inside a cardboard tube. The microphone was attached to an outer diaphragm on one end of the tube (see Fig. 1). Speaking into one side of the tube caused the diaphragm to vibrate, which, in turn, caused the spring to vi-

brate as well. Those vibrations are picked up by the microphone, along with speech, to produce a weird-sounding output.

To tell the truth, the spring inside the tube produces some unusual sound effects on its own. But only when the amplified signal from the electret microphone is heard in conjunction with the sound from the tube itself, does the device produce the completely bizarre sound, which is just perfect for some Halloween Fun.

**About The Project.** In order to reproduce the device, two things were needed. As you've probably guessed, they are an amplifier to boost the received signal to an audible level, and a tube with a spring in it. The amplifier part was easy; it doesn't take much to build a circuit that can amplify the signal from an electret microphone.

Figure 2 shows the amplifier portion of the circuit, which is built around a TBA820M audio-amplifier IC, and powered from a 9-volt battery. The spring tube was a little more difficult to fabricate. That's because the spring must be extremely loose and wobbly—almost like a miniature Slinky. You may have some difficulty locating such a

spring. The one used for the Sound-Effects Gadget was purchased from the neighborhood hardware store. The spring, selected from an Ajax spring display in the hardware store, was labelled 93X. If you do manage to find an Ajax spring display in a store near you, the springs may be numbered differently. So make sure that you get the "slinkiest," most-wobbly spring you can find. (If you were to build this project on a larger scale, you might just be able to use a real slinky—but I'm not sure what you would use for the diaphragms.)

Actually, the spring (number 93X) was wound quite tightly, but it was the type that you can flatten between your fingers and it would pop right back into its original cylindrical form when released. It would have to be stretched a bit to make it wobbly and long enough for the project. But before I could do that, I had to pay for it. Since the spring cost only 75 cents, I took the chance.

After stretching the spring from its original length of about one and a half inches to about ten inches, it would snap back to a length of about five or six inches. Then, when it was stretched to a length of about seven inches, it would vibrate back and forth quite easily, even from blowing on it.

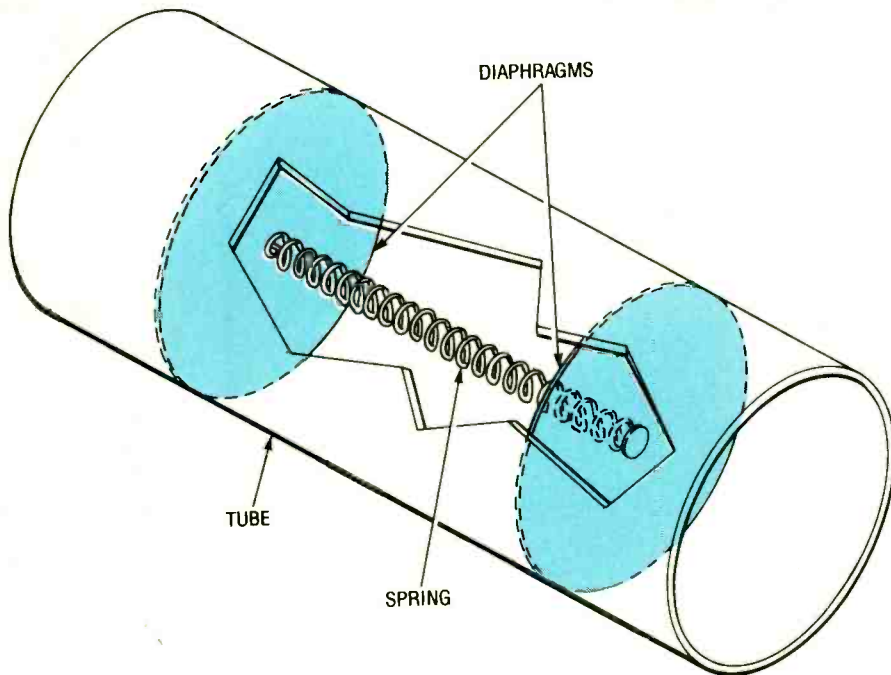

Fig. 1. The sound effects are produced by a very loose spring strung between two diaphragms inside a cardboard tube.

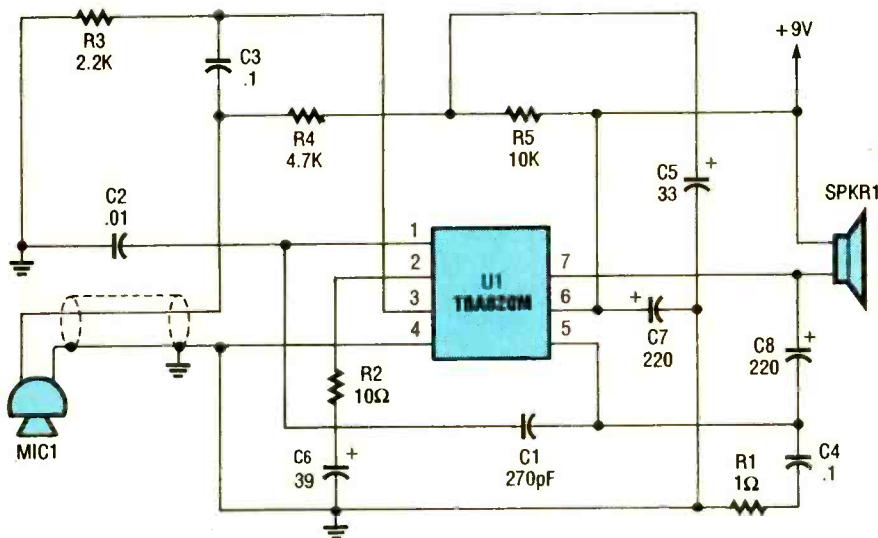

Fig. 2. The circuit is centered around a TBA820M integrated audio amplifier, and can be powered from a 9-volt battery.

If you look back at Fig. 1, you'll see that the spring is strung between two diaphragm-like panels inside the tube. As the diaphragm vibrates, the spring vibrates in unison with the sound-pressure waves of your voice. Because the microphone must then pick up both the sound of your voice and the vibration of the spring, it must be mounted on a third diaphragm to create a small chamber. After a bit of thinking, I decided to use wax-paper cups, as they had the right properties (you know how it sounds when you snap your finger against the bottom of an empty wax-paper cup!). In addition, they are read-

ily and inexpensively available. You actually need two wax-paper cups of one size (8-ounce cups in my case), and one that is slightly larger. That way, the larger one can be fitted into one of the smaller ones, to create a chamber for the microphone. The larger cup does not have to be wax-paper, though, since it does not have to vibrate. The size of the cups required will pretty much be determined by the tube's diameter.

The cardboard tube that was used for the prototype is the type used to mail posters, calendars, and similar items. The tube must be bigger and

## PARTS LIST FOR THE SOUND-EFFECTS GADGET

### RESISTORS

(All resistors are 1/4-watt, 5% units.)

- R1—1-ohm
- R2—10-ohm
- R3—2200-ohm
- R4—4700-ohm
- R5—10,000-ohm

### CAPACITORS

- C1—270-pF, ceramic disc
- C2—0.01- $\mu$ F, ceramic disc
- C3, C4—0.1- $\mu$ F, ceramic disc
- C5—33- $\mu$ F, 10-WVDC, electrolytic
- C6—39- $\mu$ F, 10-WVDC, electrolytic
- C7, C8—220- $\mu$ F, 10-WVDC, electrolytic

### ADDITIONAL PARTS AND MATERIALS

- U1—TBA820M audio amplifier, integrated circuit (SGS)
- MIC1—Electret Microphone
- SPKR1—8-ohm speaker
- Perfboard materials, shielded wire, speaker wire, 9-volt transistor-radio battery, battery connector, SPST switch (optional, see text) cardboard tube, wax-paper cups, a spring, thumb tacks, wire, solder, hardware, etc.

sturdier than the kind you get in a roll of paper towels. The tube used in the prototype is about 2 3/4 inches in diameter. The tube was cut to about 14 inches. However, the length to which the tube is cut depends on the spring that you use; the spring must be slung (stretched) loosely between its two supports. Once the tube is cut to the proper length, it can be spray painted (of course, whether to paint or not is up to you).

The last problem was figuring out how to connect the spring to the cups without destroying the bottom of the cups while, at the same time, allowing the bottoms of the cups to vibrate. Two thumbtacks and a pair of needle-nose pliers were used to tackle the problem. The tip of each tack was bent into a tiny hook that was small enough to pass through a tiny hole in the cup bottoms, but large enough to attach the spring. One hooked tack in the bottom of each cup holds the spring in place inside the tube (see Fig. 3).

**Construction.** The values selected for the capacitors and resistors in this project are extremely flexible. For example, the circuit calls for 220-, 39-, and 33- $\mu$ F electrolytics, but it has been successfully tested using 100's for the 220's, and 39  $\mu$ F for the other two. Also, you can use slightly different values for the

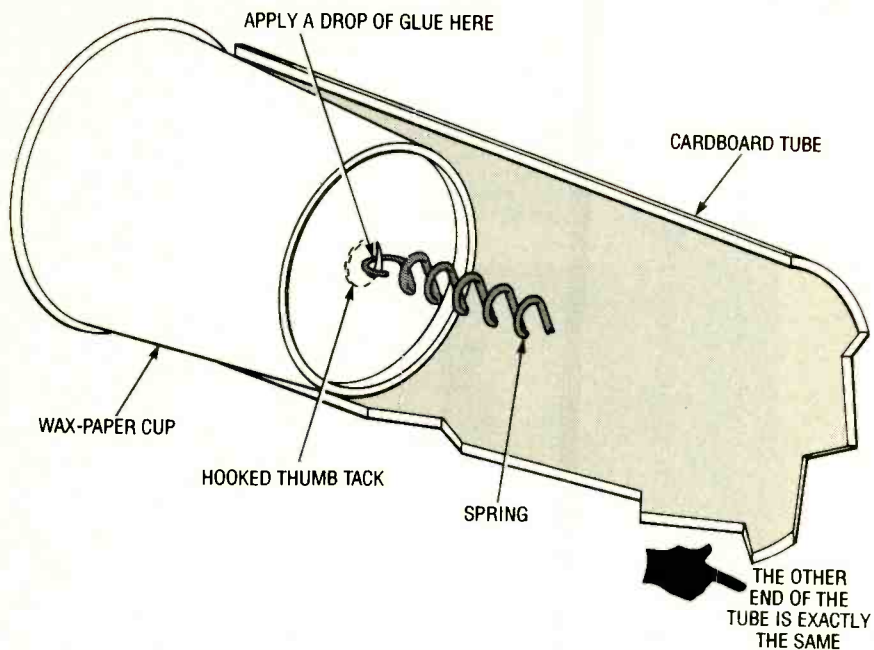

Fig. 3. A thumb tack with a hook on the tip holds the spring in place.

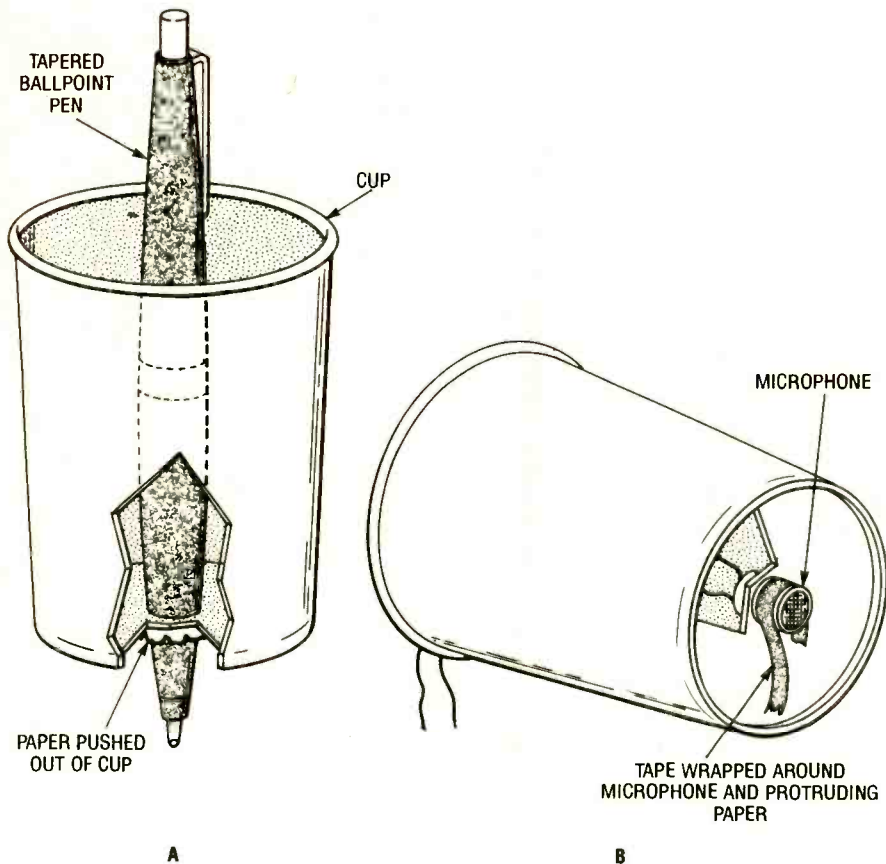

Fig. 4. Enlarge the hole in small increments, testing the fit of the microphone as you go (A). Wrap a narrow piece of tape around the microphone to hold it in place (B).

resistors, and the circuit will still work. Of course, variations in component values may alter the sound somewhat, but that doesn't really matter with this project. The point is that you can use practically any component values that you happen to have in your junkbox and still get

the thing to work. In fact, you can also design an amplifier circuit of your own if you happen to already have a different amplifier IC lying around. Just make sure that it is suitable for use with an electret microphone.

The components were assembled on

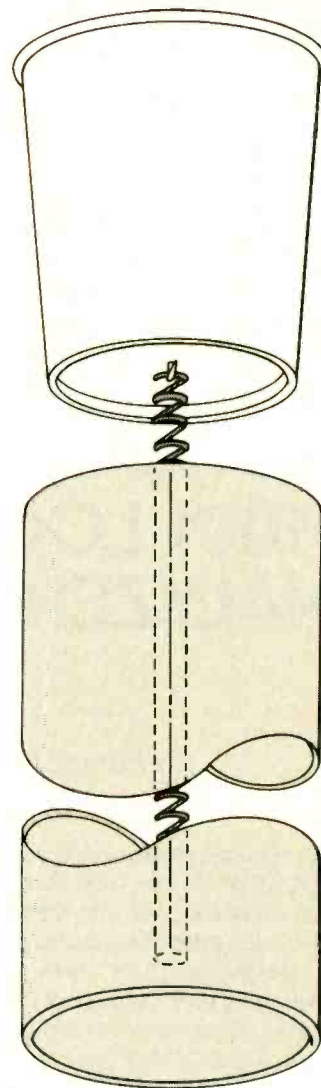

Fig. 5. Hold one of the cups in the upright position and hang the spring from the hook and lower it into the tube as shown. Then grab the dangling end of the spring and hook it onto the other cup.

a piece of perfboard, measuring about  $1\frac{3}{4} \times 3$  inches. You can probably use a much smaller piece of perfboard, but it is easier if you leave yourself some extra room to work with—but not too much, otherwise, you won't be able to use the component leads to interconnect the components. By bending the lead of one component over to where it must connect to another, you can then solder the connection, and cut off the extra component lead. But save the leads, just in case another component's lead isn't long enough by itself. It's actually faster to bend the component leads in that manner than to make a printed-circuit board for the project.

The microphone must be connected to the board by a piece of shielded cable, about 5 inches in length. That  
(Continued on page 105)



## THE HEATHKIT IC1001 LOGIC ANALYZER

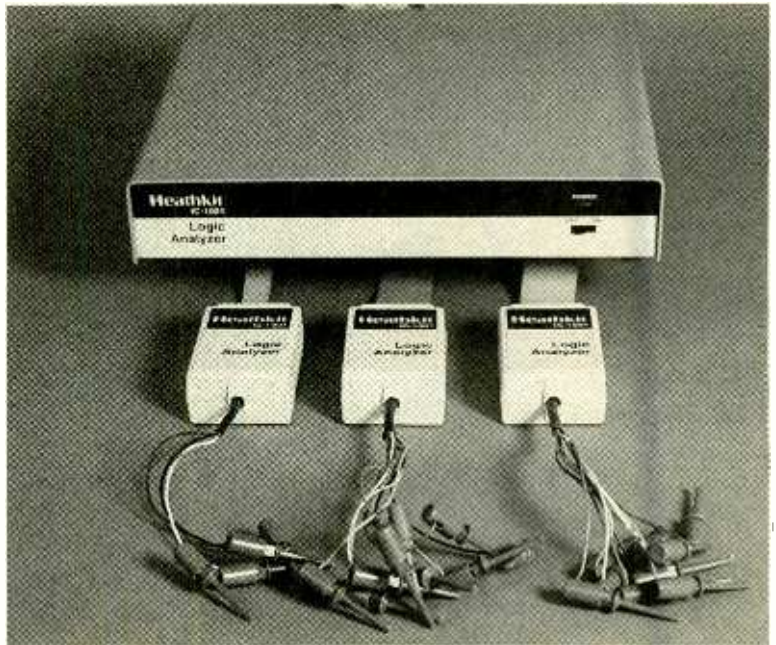

CIRCLE 119 ON FREE INFORMATION CARD

*A champagne-level logic analyzer for people with beer pockets.*

**E**lectronics hobbyists are a diverse group of people. Men, women, and children, with very different backgrounds, often find themselves drawn into the world of electronics. However, most electronics hobbyists share the common desire of some day owning an elaborate test bench chock full of high-tech test instruments. Unfortunately, another common desire of most hobbyists is to have a large bank account. That's unfortunate because some test equipment, special-purpose instruments in particular, can cost thousands of dollars. Furthermore, it's not always a lack of funds that prevents the purchase of a piece of equipment—sometimes the limited usefulness of an instrument makes it difficult to justify its expense.

A logic analyzer is both expensive and fits into that "hard-to-justify" category. Sadly, there's no substitute for a logic analyzer. It's not analogous to using a heavy piece of metal instead of a hammer.

**The Catches.** To all you hobbyists out there, now hear this: the Heathkit IC1001 Logic Analyzer (Heath Company, Benton Harbor, MI 49022, 800-253-0570) is available at the unheard-of price of \$259.95. There are only two catches: first, you must have an ANSI-protocol terminal, or PC-compatible computer with 128K RAM minimum, CGA, a 5¼-

inch disk drive, and an RS-232 card. Second, the analyzer is available only as a kit.

These two points really shouldn't dissuade you. Even if you have to buy a PC, you'll still save a lot of money; A complete 640K PC setup can be had for under \$500 these days.

Furthermore, building the unit should not be too much of a drawback for most of you. The skills necessary to assemble the kit should be second nature to anyone who has a use for the device. To make things very easy, the owner's manual includes complete technical explanations and schematics of the circuitry—it even includes pinout diagrams of the IC's that are used for the project.

Of utmost importance in building this kit is careful soldering. That's because there are so many IC's on the main-circuit board in the unit and that's where solder shorts are most likely to occur. So you have to be honest with yourself regarding your own soldering know-how, and stay away from this project if you've never been much of a solderer. Otherwise you might be able to get a friend who's good at soldering to do it for you.

**The Features.** Before you start thinking that the logic analyzer must be limited in its capabilities, think again. The IC1001 is powerful enough to be used

for applications ranging from hobbyist-to engineering level. It can check a 16-bit wide bus or 16 separate logic test points running at speeds as high as 10 MHz, which is pretty extensive.

The IC1001 consists of a main board, three pods, and a supplied wall adapter, which is used as a power source. All connections to the main unit are made via jacks on the back panel.

The pod assemblies contain micro clips that connect the unit to the logic test points of a circuit. Two pods are used for the 16 data inputs—one for the high byte and one for the low byte—and one pod handles the clock input and two clock-qualifier inputs.

The unit communicates with a computer or terminal through an RS-232 output. It also has two external trigger outputs to activate some other piece of test equipment that you might wish to use, such as an oscilloscope.

Whether used with a terminal or a PC running the supplied software, the IC1001 is fully keyboard operated. From the keyboard, you can tell the device how and when to acquire data in an amazing number of ways. You also have the ability to display various information and timing diagrams on-screen.

Running the analyzer from a PC instead of a terminal, allows it to use the computer as its "smarts" to provide more involved displays of the acquired



**TABLE 1—ANALYZER FEATURES**

Data Width	16 bits.
Data Depth	2046 words.
Clock Input	Rising or falling edge.
Clock Qualifiers	Two, each selectable to logic high or logic low.
Input Selections	Logic 0, logic 1, or X (don't care).
Logic Compatibility	TTL or CMOS operating at 5 volts.
Input Impedance	Greater than 1 megohm paralleled by 10 pF (all inputs).
Display Size	
With Terminal	24 words at a time plus a status line.
With PC-compatible computer	Variable to full depth (timing mode).
Display Base Format	Hex or octal.
Displays	Address relative to trigger word, state, timing, hex/octal equivalent, and ASCII equivalent. (Additional information is displayed in the PC mode.)
Logic Sense	Positive or negative.
Trigger Modes	Single trigger or repeating* (selectable time delay).
Operating Modes	Delay and non-delay.
Delay Range	2 to 50,000 qualified clocks (in delay mode).
Trigger Word Positions	Selectable within acquired data (in non-delay mode).
Data Positioning	Go to first, go to last, set address, word forward, word back, page forward, page back, and pattern search. (Additional positioning functions are available in the PC mode.)
Clock Period	100 nanoseconds minimum.
Clock Pulse Width (coincident with qualifiers)	40 nanoseconds minimum either level.
Data Set-up Time	Less than 5 nanoseconds typical.
Data Hold Time	Less than 5 nanoseconds typical.
Channel-to-Channel Skew	Less than 5 nanoseconds typical.
Baud Rates	300, 500, 1200, 2400, 4800, 9600, and 19,200 (jumper selectable or automatically determined). Fixed at 9600 or 19,200 when the Analyzer is used with a PC.
Serial Protocol	RS-232, XON/XOFF handshaking (input only). ANSI escape sequences. 32-character type-ahead buffer.
Oscilloscope Triggers	Two. One occurs at the detection of the trigger word, the other at the trigger word plus the selected delay. Both have jumper-selectable polarity.
Power Source	Wall cube (supplied).
Additional Features	On-screen help, prompting, status, and error reporting.  Checksum capability, with bit selection for easy comparisons of acquired data.  When the Analyzer is used with a terminal, Control-D initiates a binary dump of all acquired data (after a selectable delay).  When the Analyzer is used with a PC, Control-D provides disk functions.
Dimensions (overall)	1¾"H × 9¼"W × 8½"D (4.4 × 23.5 × 20.3cm).
Weight	2.9 lbs. (1.31 kg).

\*When the Analyzer is used with a terminal.

data. That permits it to be extremely versatile, yet inexpensive. It also gives you the ability to save the data to disk.

The IC1001 actually has so many features that we wouldn't be able to go over the details of all of them in this article. So there's a summary of all of its features in Table 1. Now let's discuss some of the steps that were confusing during the assembly and operation of the unit.

**Building the Kit.** This Heathkit, like all others, is about the best quality you'll find anywhere regarding both the parts that go into it and the performance that the finished unit delivers. The assembly/operating manual is very easy

to understand and everything is explained well—especially when one considers the technical complexity of the unit.

There are a few things worth mentioning that we ran across during the assembly. For one, there's no mention of the need for a crimping tool, although you may be able to use a pair of pliers instead. That's used for the assembly of the RS-232 interface cable.

Also the kit does not come with a DB-9 connector or wire to connect the analyzer to your computer. What you should do is order the Heath RS-232 interface cable (part number HCA-85 with a DB-9 at both ends) when you order the kit. The kit does include a

DB-25 connector in case the ordered cable has to be modified for use with your computer. Otherwise you can build your own cable completely from scratch as per the very general instructions provided in the manual.

Another pretty minor problem was that the 7805 voltage regulator included with the kit was marked only with Heathkit's part number, although no other part matched the description and the assembly instructions listed both numbers. Last, instruction number 3 on page 26 says to secure socket S105 with two hex studs; it should read S104 instead.

**Operating the Unit.** With the unit completed and the right cable connecting it to your computer, you're ready to begin. The first problem we encountered was that there's supposed to be a READ.ME file on the supplied floppy disk, but it wasn't there. However, a printed version of that helpful file can be found in Appendix D of the owner's manual.

The manual said to press the space bar upon power-up in the auto-baud detection mode, but that's true only when using a terminal; when using a PC, you should press the space bar at the software copyright notice. They also don't tell you to remove the write-protect tab from the floppy disk. That is necessary because of the exchange of data to and from the disk that may be required.

Once the software is running, you should have no trouble operating the unit. Basically, if you're familiar with menu-driven software in general, it's very easy to use. The command options appear on the last line.

One really neat feature in the PC mode is that the software allows you to zoom in and out of timing diagrams to see more or less data on the screen. The demo mode (which the unit automatically goes into if it hasn't collected data) is helpful for learning how to control the display, allowing you to manipulate the various forms of data without having to connect the unit to a logic circuit. All-in-all, we would say that the IC1001 is a powerful tool for troubleshooting and debugging all kinds of digital-logic circuits with excellent performance and a price that can't be beat.

For more information on the Heathkit IC1001 Logic Analyzer, contact the manufacturer directly, or circle no. 119 on the Free Information Card. ■

# PRODUCT TEST REPORTS

By Len Feldman

## Yamaha TX-930 AM/ FM Stereo Tuner

The TX-930 AM/FM Stereo Tuner from Yamaha (6722 Orangethorpe Ave., Buena Park, CA 90620), considered to be their flagship model, replaces and improves upon that company's TX-900U tuner. The TX-930 features a rotary tuning control that provides the "feel" and speed of analog tuning, as well as the accuracy of digital tuning. Any combination of AM or FM stations can be stored in the tuner's 24 preset locations. For those stored stations, a dual-mode display shows the se-

lected regardless of multipath interference or off-frequency broadcasts such as sometimes occur with cable FM services.

The TX-930 offers two methods of tuning: phase-locked loop (PLL) synthesized and voltage-servo tuning. Using a computer "servo-lock" system, the unit automatically selects the tuning method that yields the better reception for the particular situation and location.

Other features of the TX-930 include a 2-position (wide or narrow) IF-mode selector, a 24-segment signal-strength meter, an RF attenuator, and a high-gain loop AM antenna. While the TX-930 does not normally include a remote control, a 9-key remote is available and is compatible with other Yamaha RS-system remote components. The sample we tested was not supplied with this optional remote control. The TX-930 is available in black or titanium finishes.

### CONTROLS

To the right of the on/off button at the left end of the panel are eight preset buttons. A single button below the last of those serves as a "shift" key to (what else) shift the presets selected through successive groups of eight (1-8, 9-16, or 17-24). A wide, well illuminated display area to the right of the preset buttons shows a variety of operating data such as preset-station indication, frequency, IF mode, signal strength, fine-tuning mode (if selected), FM stereo, auto stereo, stereo blend (if acti-

ated), antenna selection (A or B), and automatic or manual tuning.

Below the display are thirteen small pushbuttons. The first of these chooses AM or FM operation. Next come a memory button that is used when storing preset information, a pair of station-display buttons for entering and recalling alpha-numeric station identification, an auto stereo/mono button, a blend button (for reducing noise at the expense of separation during weak-signal stereo reception), an IF-mode button, an RF-attenuator button, an antenna-selector button, the auto/manual tuning button, and a lock button that's used to lock in the frequency of a broadcast for drift-free reception.

The rear panel of the TX-930 is equipped with two 75-ohm coaxial connectors for hooking up two separate FM antennas. If you use 300-ohm twin-lead as your transmission line from an FM antenna, a 75/300-ohm transformer is supplied with the TX-930 package. Also on the rear panel are two spring-loaded terminals for use with the supplied AM loop antenna. The only other items on the rear panel, other than the power cord, are the left and right output jacks.

### TEST RESULTS

We first measured the tuner's FM performance. Essentially, the frequency response was perfectly flat from 20 Hz to 15 kHz. At the highest FM-broadcast frequency of 15 kHz, response was down less than 0.5 dB.



The Yamaha TX-930 AM/FM stereo tuner.

lected station in terms of its frequency or as the station's call letters (up to four letters can be programmed). The preset tuning memory will also store the station's fine-tuning frequency, IF-mode setting, RF attenuator status, auto stereo or mono setting, antenna-selector setting, and blend setting; all of those variables can be user selected and will be discussed as we examine the tuner's features.

First of all, the tuner offers a digital fine-tuning adjustment that permits offset tuning in .01-MHz increments. That allows the user to tweak the tuner's frequency setting so that the best signal can be ob-

## TEST RESULTS—YAMAHA TX-930 AM/FM STEREO TUNER

Specification	Manufacturer's Claim	PE Measured
Frequency response (20 Hz–15kHz)	+/- 0.5 dB	+0, -0.5 dB
Usable sensitivity, mono 50 dB quieting	15 dBf	N/A
Mono	15.1 dBf	20 dBf
Stereo	37.7 dBf	41 dBf
S/N ratio		
Mono	96 dB	88 dB*
Stereo	90 dB	84 dB*
Distortion, 1 kHz		
Mono	0.02%	0.04%
Stereo	0.03%	0.062%
Stereo separation, 1 kHz	60 dB	54 dB
Image rejection	90 dB	Confirmed
IF rejection	110 dB	>100 dB**
Spurious rejection	110 dB	>100 dB**
Alt. channel selectivity	85 dB	Confirmed
Capture ratio	1.2 dB	Confirmed
AM usable sensitivity	100 $\mu$ V/m	85 $\mu$ V/m
AM tuner selectivity	32 dB	33 dB
AM tuner S/N ratio	52 dB	50 dB
AM tuner distortion, 400 Hz	0.3%	0.5%
Audio output level		
FM, 100% mod., 1 kHz	500 mV	480 mV
AM, 30% mod. 400 Hz	150 mV	Confirmed
Power requirements	120V, 50/60 Hz, 10W	Confirmed
Dimensions (W x H x D, inches)	17 $\frac{1}{2}$ x 3 x 12 $\frac{1}{2}$	Confirmed
Weight	7 lbs. 8 oz.	Confirmed
Price:	\$399.00	

\* See text

\*\* Limits of test-equipment measurement capability

In the mono mode, 50-dB quieting was reached for a signal strength of 20 dBf, while the maximum mono signal-to-noise ratio at strong signal levels was 88 dB, one of the best S/N's we have measured. Yamaha claims a signal-to-noise ratio of 96 dB, and, in fact, this tuner may come close to that, since we know that our signal generator itself is not capable of delivering a signal with such a high S/N. Stereo S/N reached a high 75 dB at 65 dBf, but continued to increase with stronger signal inputs, reaching 84 dB at 80 dBf. The test results were essentially the same regardless of whether we used the narrow or wide IF modes to make the measurements.

For many of the remaining specifications, we needed to look at the tuner's performance in both of the IF modes since the mode selected influenced the test results. For example,

examining the distortion-plus-noise performance in the wide-IF mode showed that the mono THD-plus-noise at mid-frequencies was a very low .04%, decreasing further to .034% at 100 Hz, and increasing to a still negligible 0.12% at 6 kHz. Stereo THD-plus-noise was .062% at 1 kHz, .091% at 100 Hz, and 0.1% at 6 kHz. When the IF mode was changed to narrow, distortion increased, but not by as much as we might have expected. Under those operating conditions, THD-plus-noise measured .085% at 1 kHz, .05% at 100 Hz, and 0.14% at 6 kHz for mono reception and .09% at 1 kHz, 0.11% at 100 Hz, and 0.16% at 6 kHz for stereo reception.

Distortion was also influenced by the setting of the IF mode. Using a 1-kHz modulating signal, the wide-IF mode yielded lower distortion figures than the narrow mode for both

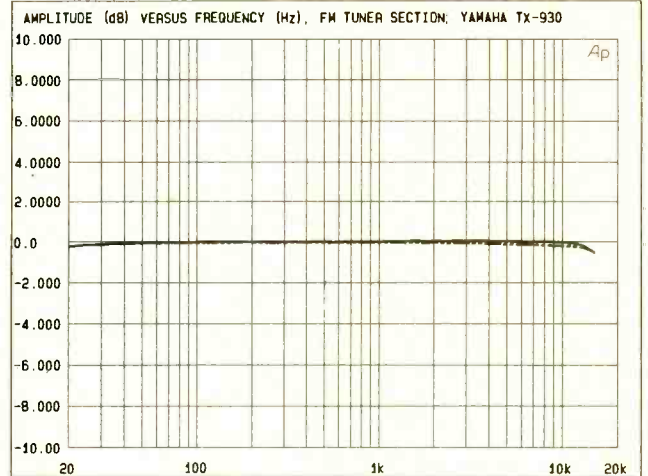

The tuner's frequency response was essentially flat from 20 Hz to 15 kHz.

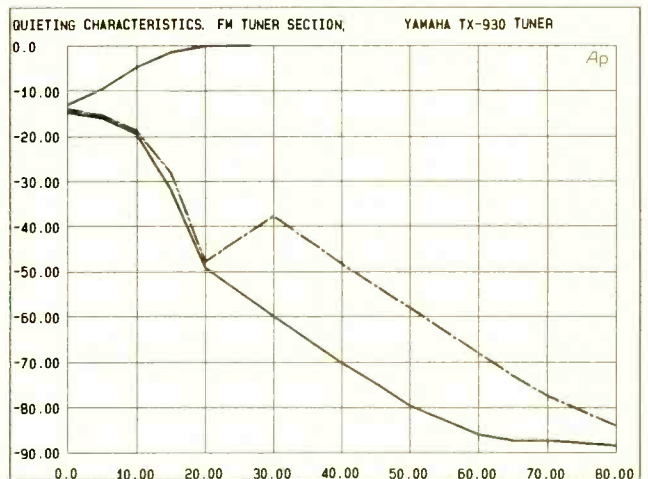

This plot shows the quieting characteristics in mono (lower solid line) and stereo (dashed line) as a function of signal strength at the antenna input. The upper solid line is the audio output reference level.

mono and stereo reception.

Another characteristic of FM performance that is significantly affected by the IF mode is stereo FM separation. With a strong input signal and the wide-IF mode, separation at 1 kHz was an outstanding 55 dB, and remained at an impressively high level of 53 dB at 100 Hz and 48 dB at 10 kHz. Next, looking at the action of the blend circuit, separation decreased in order to cancel background noise so that only about 10 dB of separation remained at 1 kHz, and virtually no separation at 10 kHz. This is typical of the action of blend controls.

Separation suffered somewhat when the narrow-IF mode was used. Without using the blend feature, separation was reduced to around 33 to 34 dB across the audio band; activating the blend control reduced the separation as before.

Another way of examining separation at a particular frequency is to do a spectrum analysis of the left and right outputs of the tuner while the left channel only is modulated with a 5 kHz signal. When that test was done, the fundamental 5-kHz output reached 0 dB, or the reference level, while from the

(Continued on page 101)

# CIRCUIT CIRCUS

By Charles D. Rakes

## Indicators for All Occasions

This month the Circus is going to spotlight the LED, offering as many circuit applications as space will allow. Probably the most common task performed by the LED is to indicate a circuit condition or function. In battery-powered equipment, using LED's as indicators requires little more than placing a current-limiting resistor in series with the LED and connecting that combination across the power source. However, in non-battery-operated equipment, such an arrangement may not be practical.

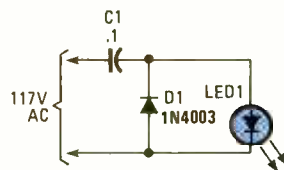

Fig. 1. This simple pilot light can be used to indicate the presence of 117 volts in AC-operated equipment.

### AC PILOT LIGHT

Figure 1 shows a simple pilot light that can be used with AC operated equipment. In that circuit, capacitor C1, which can have a value of from 0.1  $\mu\text{F}$  to 0.4  $\mu\text{F}$  sets the current

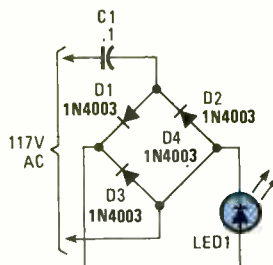

Fig. 2. This AC pilot-light circuit differs from the previous one in that current is delivered to the LED through a full-wave rectifier.

level for the LED. The greater the capacitor's value, the brighter the LED will glow. But don't go overboard, increasing the value of the capacitor also increases the LED's current, which could result in LED burnout.

With a 0.1- $\mu\text{F}$  capacitor, the LED's current is limited to about 2 mA; with a 0.4- $\mu\text{F}$  unit, the current is limited to about 10 mA. Diode D1 (a 1N4003 1-amp, 200-PIV rectifier) half-wave rectifies the AC, providing a DC voltage for the LED.

### DC PILOT LIGHT

Figure 2 shows another AC pilot light circuit; this

where DC voltage levels can vary between 6 and 20 volts, and yet keep the LED lit with little change in output brilliance. In that circuit, a 2N3906 general-purpose PNP transistor is connected in a constant-current circuit, while R1 is used to limit the current through the LED to about 6 mA. Decreasing R1's value would cause the current through the LED to increase, causing the LED's glow to intensify; the opposite would be true if the value of R1 is increased.

### POLARITY INDICATOR

In our next circuit, see Fig. 4, two LED's are wired in

### PARTS LIST FOR THE AC PILOT LIGHT

D1—1N4003, 1-amp 200-PIV silicon rectifier diode  
LED1—Light-emitting diode  
C1—0.1-0.4- $\mu\text{F}$ , 600-WVDC, ceramic-disc capacitor  
Perfboard materials, wire, solder, hardware, etc.

one differs from the previous one in that current is full-wave rectified before it is applied to the LED. Since the full-wave rectifier supplies current pulses twice as often, the value of the capacitor can be cut to about half, and yet deliver the same amount of current as the half-wave circuit shown in Fig. 1.

### TRANSISTOR-DRIVEN PILOT LIGHT

Our next circuit, see Fig. 3, can be used in circuits

parallel but are polarized oppositely to produce a circuit that is capable of indicating whether the applied voltage is positive or negative DC, or if it is AC. That circuit can be used to check battery or power-supply polarity, or any other source that's capable of supplying 3 to 15 volts at least 15 mA. Although the circuit may seem too simple to be of any value, it is sure to prove its worth when you have to troubleshoot circuits that operate from

### PARTS LIST FOR THE DC PILOT LIGHT

D1-D4—1N4003 1-amp, 200-PIV silicon rectifier diode  
LED1—Light-emitting diode  
C1—0.1-0.2- $\mu\text{F}$ , 600-WVDC, ceramic-disc capacitor  
Perfboard materials, wire, solder, hardware, etc.

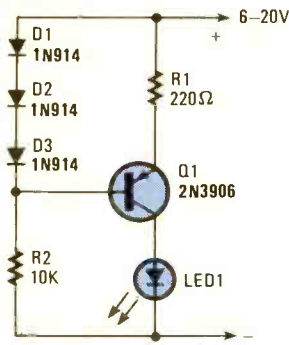

Fig. 3. With only a slight change in output brilliance, this pilot circuit can be used as an indicator for DC sources that vary in voltage from 6 to 20-volts.

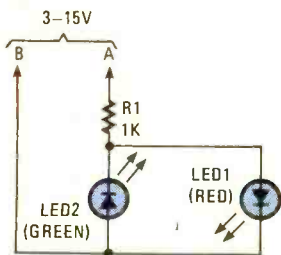

Fig. 4. This circuit, which contains two oppositely-polarized LED's wired in parallel, is capable of indicating whether positive or negative DC, or AC voltage is present.

dual-polarity power supplies.

When probe A is connected to a positive source and probe B is connected to a negative source (or ground), the LED1 will light. Reversing the polarity will cause the green LED2 to light. But, if the probes are connected to an AC source, the two LED's will light alternately.

### EXPANDED-RANGE POLARITY INDICATOR

An expanded-range polarity indicator is shown in Fig. 5. That version of the polarity indicator can be used to indicate the polarity of voltages of over 100 volts.

In that circuit, the two transistors act as switches. When a positive DC source of one volt or more is con-

nected to the input, transistor Q1 turns on, lighting LED1. However, when the input of the circuit is connected to a negative

Q2 to turn on and off alternately. That, in turn, causes LED1 and LED2 to alternately light; however, the switching speed is so fast

### PARTS LIST FOR THE TRANSISTOR-DRIVEN PILOT LIGHT

#### SEMICONDUCTORS

Q1—2N3906 general-purpose PNP silicon transistor  
D1—D3—1N914 small-signal silicon diode  
LED1—Light-emitting diode

#### ADDITIONAL PARTS AND MATERIALS

R1—220-ohm ¼-watt, 5% resistor  
R2—10,000-ohm, ¼-watt, 5% resistor  
Perfboard materials, wire, solder, hardware, etc.

### PARTS LIST FOR THE POLARITY INDICATOR

LED1—Light-emitting diode (red)  
LED2—Light-emitting diode (green)

R1—1000-ohm, ¼-watt, 5% resistor  
Perfboard materials, wire, solder, hardware, etc.

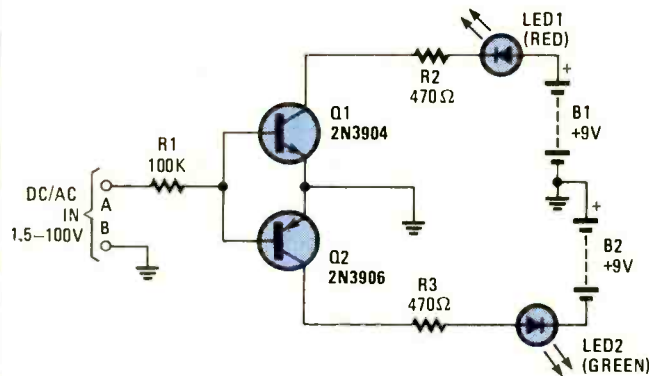

Fig. 5. The expanded-range polarity indicator can be used with voltages of over 100 volts.

### PARTS LIST FOR THE EXPANDED-RANGE POLARITY INDICATOR

#### SEMICONDUCTORS

Q1—2N3904 general-purpose NPN silicon transistor  
Q2—2N3906 general-purpose PNP silicon transistor  
LED1—Light-emitting diode (red)  
LED2—Light-emitting diode (green)

#### ADDITIONAL PARTS AND MATERIALS

R1—100,000-ohm, ¼-watt, 5% resistor  
R2, R3—470-ohm, ¼-watt, 5% resistor  
B1, B2—9-volt transistor radio battery  
Perfboard materials, wire, solder, hardware, etc.

voltage, Q2 turns on, causing LED2 to light. Applying an AC voltage to the input of the circuit causes Q1 and

that both LED's will appear to be lit at the same time.

Resistor R1 limits the input current to about 1 mA at

100 volts, and to less than 100  $\mu$ A at 10 volts. Two 9-volt transistor-radio batteries are used to power the circuit. A power switch is not needed because the circuit draws current only when either transistor turns on.

### VOLTAGE-LEVEL INDICATOR

Our next circuit uses three LED's to form a simple voltage-level indicator. The circuit, shown in Fig. 6, can be used to monitor a 5-volt power source for over- or under-voltage conditions. In that circuit, the transistor (Q1) is configured as an emitter follower through which current is supplied to the anodes of the three LED's (LED1—LED3). The cathode terminal of each LED is tied to a different voltage level, which is set by the diode string that is formed by D1—D3.

In that circuit, LED1 lights when the input voltage (which is applied to the base of transistor Q1) is about 3.5 volts; LED2 lights at about 4.5 volts, and LED3 glows when the voltage reaches about 5.5 volts. The voltage range of the circuit can be increased above 5.5 volts by adding more diodes in series with D1—D3.

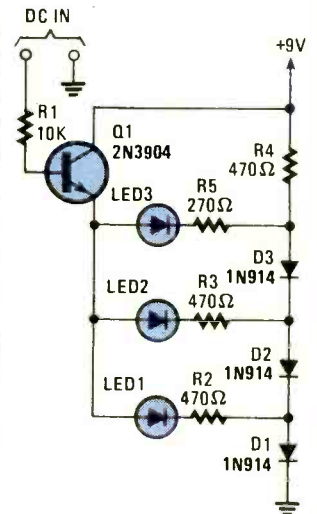

Fig. 6. The circuit shown here can be used to monitor a 5-volt power source for over- or under-voltage conditions.

## PARTS LIST FOR THE VOLTAGE-LEVEL INDICATOR

### SEMICONDUCTORS

Q1—2N3904 general-purpose NPN silicon transistor  
 D1-D3—1N914 general-purpose small-signal silicon diode  
 LED1—LED3—Light-emitting diode

### RESISTORS

(All resistors are 1/4-watt, 5% units.)

R1—10,000-ohm  
 R2-R4—470-ohm  
 R5—270-ohm

### ADDITIONAL PARTS AND MATERIALS

Perfboard materials, wire, solder, hardware, etc.

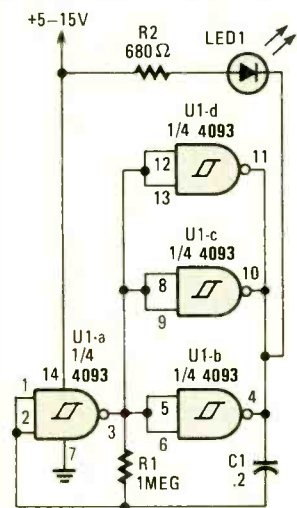

Fig. 7. This circuit, built around a 4093 quad 2-input NAND Schmitt trigger that is configured as an oscillator/driver, switches the LED on and off at a rate of 1 Hz.

## PARTS LIST FOR THE OSCILLATOR-DRIVEN INDICATOR

U1—4093 quad 2-input NAND Schmitt trigger, integrated circuit  
 LED1—Light-emitting diode  
 R1—1-megohm, 1/4-watt, 5% resistor  
 R2—680-ohm, 1/4-watt, 5% resistor  
 C1—0.2-μF, 50-WVDC, ceramic-disc capacitor  
 Perfboard materials, wire, solder, hardware, etc.

## OSCILLATOR-DRIVEN INDICATOR

Our next circuit, see Fig. 7, is a little different from the average panel indicator. In that circuit, an oscillator—built around a 4093 quad 2-input NAND Schmitt trigger—is used to switch the LED on and off at a rate of 1 Hz. The oscillator portion

of the circuit is formed by two gates, U1-a and U1-b. The two remaining gates (U1-c and U1-d) are connected in parallel with U1-b (the output gate) to share the LED's drive current.

The values of R1 and C1 set the oscillator's operating frequency, which, by extension, also determines the LED's flash rate. To lower the rate of flash, increase the value of either or both R1 and C1; do the opposite to increase the rate. Power for the circuit can be supplied by any 5- to 15-volt DC source; at 15 volts, the circuit draws a maximum current of 22 mA.

The circuit need not be limited to pilot-light applications; it can be used as

an indicator for a critical or urgent circuit condition. Just like any other indicator, all that's required is for power to be applied to the flasher circuit for activation.

## VISUAL CW DECODER

The majority of the radio amateurs who are into CW communications do so by

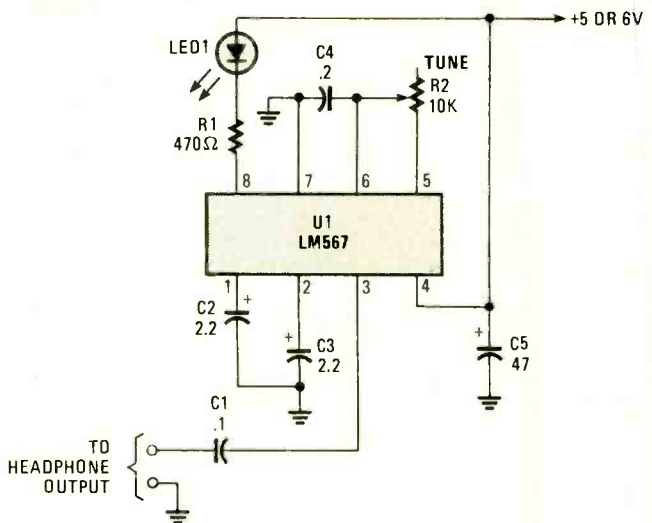

Fig. 8. By connecting this circuit to the headphone jack of a general-coverage communications receiver, hearing-impaired hams can continue to enjoy their hobby.

## PARTS LIST FOR THE VISUAL CW DECODER

### CAPACITORS

C1—0.1-μF, 50-WVDC, ceramic-disc capacitor  
 C2, C3—2.2-μF, 25-WVDC, electrolytic capacitor  
 C4—0.2-μF, 50-WVDC, ceramic-disc capacitor  
 C5—47-μF, 16-WVDC, electrolytic capacitor

### ADDITIONAL PARTS AND MATERIALS

U1—LM567 tone decoder, integrated circuit  
 LED1—Light-emitting diode  
 R1—470-ohm, 1/4-watt, 5% resistor  
 R2—10,000-ohm potentiometer  
 Perfboard materials, wire, solder, hardware, etc.

ear (the exceptions are those who use computers or computerized code readers). But for hams who are hearing impaired or for those in the process of losing their hearing, CW is no longer a viable option. But with the aid of the circuit shown in Fig. 8, it's possible to receive and decode CW by sight rather than sound, providing a means by which the hearing impaired can continue a fun hobby. Even if your hearing is not gone or fading, using the circuit can be fun and challenging...and no one will need to yell "turn down that dit-dah racket."

In the visual CW decoder, U1 is configured as a tunable audio-tone decoder. The output of U1 at pin 8

supplies current to "fire" the LED. The input to the circuit is designed to be connected to the headphone jack of a general-coverage communications receiver. Then, with receiver peaked for a CW output tone centered around 750 Hz and adjusting R2 (a 10k potentiometer) to the CW output tone, the LED will flash the CW message.

## 'TIL NEXT WE MEET

Well it looks like we have reached the end of the space allotted to us for this month. But be sure to join us on the next go-round, when we'll present another batch of circuits to entertain and educate you in the ways of electronics. Until then, may the flow be with you. ■

# ANTIQUE RADIO

By Marc Ellis

## The Making of a Collector

In last month's column, we began restoration work on a 1929-era RCA theremin that hadn't been fired up since the 1950's. As discussed in earlier columns, the musician who played this progenitor of the modern electronic music synthesizer did not touch the instrument in any way. He or she controlled pitch and volume by changing the position of his/her hands in relation to two antenna-like electrodes protruding from the instrument's case.

Last month was devoted to a preliminary checkout of the theremin's power

supply, speaker, and operating circuits. Almost everything was found to be in good working order, except for a critical coil in the volume-control circuit. The windings of that large coil had apparently become loose at some time in the past, then subjected to a crude field repair that didn't exactly look factory-approved. And, in fact, the volume-control circuit did turn out to be inoperable.

I'd hoped to get to the bottom of the coil problem in time to present a working theremin this month. However, a week of business travel for my regular job killed a couple of the weekends I normally devote to writing this column. And the Memorial Day holiday (which is our family's traditional time to shape up the yard for summer) killed another one.

Since my business trip took me to the San Francisco area, I was able to make a pilgrimage to the *Exploratorium*, S.F.'s serious-but-playful museum of "Science, Art, and Human Perception." The exhibits in the *Exploratorium* are innovative, offbeat, and definitely meant to be poked, prodded, explored, and tweaked by the inquisitive public. I'd heard that the museum had an original working theremin on exhibit, and thought it would be fun to see it in operation—and maybe get a look at a properly configured volume-control coil.

When Dave Nelson of the *Exploratorium's* electronics staff heard about my mission he said "I've got good news and bad news!" The good news turned out to be that the museum did

indeed have a working theremin. The bad news was that the original electronics had long ago been discarded and replaced by a transistorized circuit. The cabinet, with its volume and pitch antennae, was original—but that was about all.

Although I don't think the sounds generated by the replacement circuitry come close to duplicating the eerie effects possible with the original 1929 hookup, it was still interesting to see a working instrument in operation. And it was even more interesting to observe the intensity and involvement of the museum patrons as they attempted to coax musical effects out of Leon Theremin's engaging invention!

Next time you're in San Francisco, I'd highly recommend a visit to the *Exploratorium*. But here's fair warning. Don't go unless you have several hours to spare; you'll hate to tear yourself away!

### HOW ARE RADIO COLLECTORS MADE?

Since the topic I'd planned for this month didn't work out, I thought we might use the space to discuss a question that certainly occurs to me from time to time: What on Earth would make a person want to collect old radios? Most of us aren't born with that urge. For many people, and I think I was one of them, the desire builds up slowly as a result of certain life experiences.

We may not even know we've become collectors until an interesting old set crosses our path. We like its "vibes," acquire it, and soon begin looking for more.



Dave Nelson of the *Exploratorium's* electronics staff puts the museum's theremin through its paces.

Eventually, finding and collecting radio relics becomes a major preoccupation, and we begin haunting flea markets, garage sales, antique shops, used-furniture establishments and thrift stores.

For some (as with me) the urge may decrease after several years of serious acquisition. We realize that there's no way to capture a sample of every model ever made and are content to rest on our laurels. Then we can happily limit our activities to acquiring only the occasional very special find.

The factors that turn one on to radio collecting aren't difficult to understand on an individual basis. But I believe there can be many different ones operating within a given individual. I also think it can be useful to look inward and try to sort out the reasons why you collect.

Some may feel that this sounds a bit like psychotherapy and be concerned that they might "cure" themselves of deriving any further enjoyment from the antique-radio hobby. If you're worried about that, then stop reading here and hang onto your hangups! For the rest of you, the doctor is now "in." Why should you go on being driven by forces you don't understand?

### **FULFILLMENT OF PERSONAL NEEDS**

If you are old enough to remember your collectibles when they were new, you may be attracted to them through past personal experience. Maybe you were very young when such sets were on the market and desperately wanted one—but the adults in your family weren't interested or couldn't spare the cash. However, you now have the means to acquire the radios, and doing so helps you

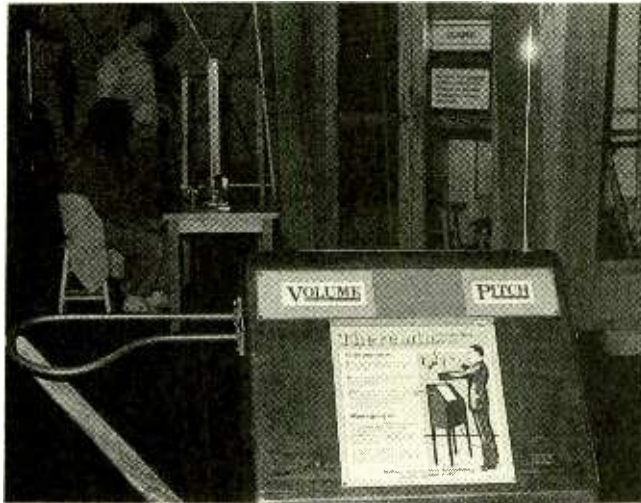

*Like all Exploratorium exhibits, the theremin bears a large poster explaining its operation and significance.*

satisfy the desire you've been carrying around all these years.

Or maybe you were given the set you wanted (or were old enough to purchase it for yourself). You threw that radio out many years ago when it became hopelessly obsolete. But now you wish you had it back. Buying sets similar to the one that once gave you so much pleasure allows you to re-experience some of that long-ago enjoyment.

Then again, perhaps you were young during the era when other people were throwing out those neat old radios. The sets really interested you, so you fished them out of back-alley trash cans and (much to your parents' chagrin) dragged them home to your basement workshop.

You didn't have the knowledge or resources to make those sets play again—particularly the fascinating old battery radios with their complicated controls and expensive power requirements. But you wanted to relate to the sets in some way, so you did the next best thing; you dismantled them in the hopes that you could use the hardware and components to build smaller, more affordable projects.

Now that you're an adult, you've acquired enough electronics knowledge to repair such radios and enough discretionary income to finance the projects. Acquiring and fixing the old sets helps you relieve some of the frustration you still feel at not having been able to operate the radios you found in the back alleys so many years ago. It also helps with some of the guilt you may still feel at having taken them apart.

Perhaps you don't have any guilt or frustration to overcome—but you're into electronics and do enjoy problem solving and troubleshooting. Repairing a complicated vintage radio can be a challenging exercise in logic, yet the circuitry is a lot more accessible than that of the modern semiconductor equipment with its densely packed circuit boards. Besides, you like the looks of those old sets!

### **TRAVELING BACK IN TIME**

Antique radios possess—almost more than any other type of collectible—a unique ability to transport us back to the time when they were built. The 1920's battery sets, with their engraved panels and multiple

controls, hark back to the era when tuning in radio stations was part scientific achievement, part magic, and part sport. The late 1920's (pre-depression) table models and consoles evoke images of the comfortable, if a little overdecorated, upper-middle-class living rooms in which they were installed.

The modest sets of the depression era evolved a special look of their own, as their designers attempted to graft some of the opulence of the late 1920's sets onto the scaled-down cabinets. In the 1940's, cabinet designs became simpler and, partly due to the development of new and more versatile plastic materials, began to take on a streamlined look. The sets looked up-to-date and action oriented—reflecting the frantic activity and rapid economic growth of the war and postwar years.

But though these radios were housed in furniture cabinets that reflected their eras, their real significance lay in their role as communications media. When we look at them, we think of the information and entertainment that once poured through their earphones, horns, or speakers.

That old battery three-dialer might have delivered the news of Coolidge's presidential nomination. That little wood-cabinet table model, with its lyre-shaped speaker grille, probably once resonated to Roosevelt's compelling voice as he spoke to the nation during a fireside chat. And you can almost hear the opening music of *The Hit Parade* coming out of that stylish-looking sloping-front console.

So those old sets can really deliver powerful images to a person who is imaginative and historically minded. Not only does their  
*(Continued on page 91)*



# FUN SOFTWARE

By Fred Blechman

## New Homes for Joysticks and Mice

Two popular controllers for games are mice and joysticks. With the growing use of pointing devices for "point and click" menu selections, or dragging things around the screen, more and more programs and simulations are moving away from the keyboard as the primary means of control. Can you imagine trying to control any of the modern flight simulators with only the keyboard? Similarly, a mouse offers many advantages over the keyboard for many game programs that require a lot of cursor movement. This month, we'll look at some hardware that can make using a joystick or mouse a

handed, you'd probably prefer the right side—but is there room?

Actually, the best place for a joystick is in your lap, just like in a real fighter plane (except for a few, like the F-16 Falcon, that use the right console.) Also, the joystick in an aircraft is used with the right hand. Even though I'm a "lefty," I've always flown a real plane's joystick with my right hand, so I'm most comfortable using a computer joystick with my right hand.

Although its main purpose is not for joystick use, the CTS-Pillow Model KB-101 EXT allows you to place a 101-key size keyboard and either a joystick, mousepad or trackball comfortably in your lap. The "CTS" refers to Carpal Tunnel Syndrome, a skeleto-muscular problem that develops from repetitive motion with a bent wrist—such as using a keyboard at desk level. The "EXT" is the wide-model pillow.

The CTS-Pillow consists of a 24-inch by 8-inch flat plastic shelf with an all-around rubber bumper, mounted on a mushy pillow that fits comfortably on your lap. An adjustable padded palmrest is also included.

You put both the keyboard and the joystick on the shelf portion, drop it onto your lap, and you have accomplished three things at once. You eliminate the danger of Carpal Tunnel Syndrome since your wrists are now lowered to a natural position; you have the joystick in your lap where it should be; and with the keyboard alongside, you can easily access keyboard commands (like

wheels, brakes, flaps and so forth) while controlling a simulator without the distraction of reaching up for the keyboard.

Recently, at a computer show, Byte-Size Stores, the national distributor, let me use the CTS-Pillow with a CH Products FlightStick to control the fabulous new Chuck Yeager's Air Combat simulator from Electronic Arts, which we reviewed last month. I was able to shoot down three enemy bombers with my "invincible" fighter much more quickly and easily than using the keyboard and joystick at desktop level.

Of course, the keyboard can be used on your lap for all other programs as well, so the CTS-Pillow is not just for entertainment. When the keyboard is in your lap, you no longer need to lean forward to your keyboard, tilting your head back to see the display and possibly being too close to the radiation from your computer and monitor. You can lean back comfortably, reducing wrist, back, neck, shoulder and leg strain.

*(Byte-Size Stores, 136 W. Olive Ave., Monrovia, CA 91016; Tel: 818-303-5006. \$45.*

**CIRCLE 76 ON FREE INFORMATION CARD**

### CORDLESS MOUSE

As for a mouse, have you ever been bothered by the mouse's tail—the long cord that goes to the computer serial port—getting tangled up in all the other cables? Have you wished you could operate your computer with the mouse a few feet away, without a dangling cord? Well, now you can,



*The CTS-Pillow Model KB-101 EXT allows you to place a 101-key keyboard and either a joystick, mousepad, or trackball comfortably in your lap.*

bit easier, and then we'll get into some more fun software.

### CTS-PILLOW

In the case of the joystick, a question that often arises is "where do you put it?" Usually, it's put on your desk alongside the keyboard. But then you have to decide on which side. If you're right-

with the Auva Cordless Mouse.

This two-part device consists of a receiver/stand and a transmitter/mouse. The two-button mouse is ergonomically designed for either left- or right-handed users, and is shaped to naturally fit in your palm. It uses a small infrared transmitter powered by a rechargeable battery to send click signals to the receiver, which is also a recharging stand.

When not in use, you put the mouse into the stand and the battery recharges, stealing a tiny bit of power from the serial port. True, it only charges when the computer is on, but the mouse will run about 8 hours without recharging. Furthermore, a spare rechargeable battery is in the stand; if your mouse battery poops out, just swap with the one that's in the stand. This takes all of about 15 seconds, since the batteries are in special molded holders that just snap in and out.

A 40-page manual describes the included software disk and its various programs. A comprehensive mouse driver allows you to control various parameters such as sensitivity and ballistic acceleration. I simply used my regular Microsoft-compatible mouse driver with its default settings and it worked perfectly. A test program is included, as well as a rather sophisticated pop-up menu system that makes most non-mouse programs recognize this mouse (and probably other Microsoft-compatible mice as well). Also included, if you need it for operating on otherwise smooth surfaces, is a mouse pad.

The Auva Cordless Mouse has a usable angle of 45-degrees each side of center, and a usable distance of about six feet. It also "sees" about 30-degrees



*The Auva cordless mouse can be used at distances of 5 feet or more away from the computer, and without worrying about "mouse-tail" tangle.*

above and below the receiver. I had no trouble at all using it remotely about five feet from the receiver, and at various odd-ball left-right-above-below positions in relation to the receiver. It operated perfectly with full room lighting.

Included with the mouse is the complete 2-disk Tele-Paint Version 3.0 and printed manual for drawing, painting, and printing. This is a surprisingly powerful and easy-to-learn program, and will provide up to 256 colors in VGA resolution with the proper equipment. It also works with CGA or Hercules monochrome displays, and prints out on typical IBM/Epson-compatible dot-matrix and HP LaserJet-compatible printers.

*(Byte-Size Stores, 136 W. Olive Ave., Monrovia, CA 91016; Tel: 818-303-5006. \$99.*

**CIRCLE 77 ON FREE INFORMATION CARD**

## STUNT DRIVER

If you have any illusions about being a racing- or stunt-car driver, try Spectrum HoloByte's Stunt Driver first. This unique game lets you race a 1966 Shelby Mustang, or any of ten other cars, against up to three competitors on daring tracks filled with loops, corkscrews, banked curves, oily surfaces, drawbridges, and jumps.

If the five pre-designed tracks are not enough of a challenge for you, a race-

course construction set lets you build and save custom tracks. Furthermore, a configuration editor allows you to manipulate variables such as traction, skid control, gravity, and more.

Trust me, this one is tough even at the trainee level—and the other two levels (rookie and expert) will take plenty of practice. Instant replay lets you see your mistakes (and horrible crashes!) with full VCR-like controls of forward, rewind, pause, etc. You can use keyboard, joystick, or mouse control; I found a joystick was best for me.

Each opponent has an individual personality and characteristics—including dirty tricks, like cutting you off or bumping you off the road! If you and a friend with another computer are close enough for a direct cable connection, or you both have Hayes-compatible modems with a baud rate of 1200 or more, you can compete in real time.

Just to make things more realistic, the damage each car sustains in a race accumulates and can reach a level where the car is out of the race unless the car is pulled into pit stops for repairs.

The game also features multiple views, including a helicopter that follows your car, and a view panning

the entire track from above. A zoom lens can focus the camera in and out anytime during an outside view.

Stunt driver features good 3-D polygon graphics and realistic car dynamics such as precise skidding, acceleration, cruise control, and gear ratios. Coupled with true-to-life sound, the game's realism gives you a taste of real stunt driving.

*(Spectrum HoloByte, 2061 Challenger Drive, Alameda, CA 94501; Tel: 415-522-3584. IBM PC 80286 8-MHz or compatible with 640K RAM and CGA, EGA, VGA, MCGA, or Tandy 1000 graphics. Supports AdLib, SoundBlaster and Tandy sound. \$49.95.*

**CIRCLE 78 ON FREE INFORMATION CARD**

## AMAZING PREVIEW DISK

There are many shareware and public-domain distributors, but TechStaff Corporation has come up with a unique idea. Their Amazing Preview Disk is a menu-driven database catalog that describes, in some detail, 240 of the software programs available in their 300+ disk library. The unique idea is that this is not just a database catalog, but actually displays screen "snapshots" from most of the programs.

Among the listings are 44 disks with 169 games categorized as arcade, pinball, shoot-em up, war, 2-player, adventure, board, card, simulations, sports, or TV types.

The game disks are only \$2 each, plus \$3 shipping and handling per order, and most disks have several games; one has ten! The Amazing Preview Disk itself is available in 360K 5.25-inch or 720K 3.5-inch format for only \$2 postpaid. A CGA or better monitor is needed to see some of the screen snapshots, but not to run the catalog itself.



*Go hot-rodding around your computer with Stunt Driver from Spectrum HoloByte.*

(TechStaff Corporation,  
P.O. Box 823, Dept. F, Water-  
town, MA 02272; Tel:  
617-924-0306.

**CIRCLE 79 ON FREE  
INFORMATION CARD**

### WINDOWS GAMES

With Windows 3.0 the biggest rage in the IBM PC world, it's no surprise that games should start to appear that work under the Windows environment. I recently came across a company, named Nuclear Computing, that handles only Microsoft Windows-3.0-compatible shareware and public-domain programs. They offer more than 250 program disks for \$3.50 each, plus \$4 shipping per order. In the Fun & Games section of their catalog, 56 disks are listed, with descriptions of each. Call or write them for their catalog—it's free!

(Nuclear Computing,  
P.O. Box 15757, North Hol-  
lywood, CA 91615; Tel:  
819-764-5374.

**CIRCLE 80 ON FREE  
INFORMATION CARD**

### NEW FUN SOFTWARE

Here are some recently announced programs that you can order from your regular software supplier. Suggested prices, where announced, are shown in parentheses.

MicroProse has announced F-117A Nighthawk Stealth Fighter 2.0 for Fall 1991 release (IBM, \$69.95). This will have all the features of the original F-19 Stealth Fighter, plus more missions, more worlds, more and better weapons, more glorious explosions, and improved 3D graphics for greater realism.

Two other MicroProse action simulations, Knights of the Sky (IBM, \$59.95) and Lightspeed (IBM, \$59.95) are now available. Knights has dazzling and smooth animation, a detailed campaign map, great manual,

accurate flight equations, and allows head-to-head dogfighting with another computer using modems or direct wiring. Lightspeed is a role-playing adventure in the future when Earth has become uninhabitable. You command a starship with truly devastating weaponry and must find a new home for Mankind amidst star clusters populated by strange alien races.

U.S. Gold has four new releases. Rotox (IBM, Amiga, \$39.95) is an off-world arcade game that features an entirely new 360-degree rotating environment. You are a devastating computer-assisted fighting machine facing deadly machines and hostile life forms. Vaxine (IBM, Amiga, \$39.95) is a rapid-fire arcade game that injects miniaturized players in a tiny craft into the body of the country's President to combat a marauding strain of virus now threatening to overwhelm his life-support organs. It's in the same vein as the hit movie *Fantastic Voyage*, with 256-color graphics, digitized sound, and three arsenals of firepower to blast the enemy cells. World Class Soccer (IBM, Amiga, \$44.95) simulates the 1990 World Cup competition by putting you in control of the actual 24 teams and players. Gold of the Aztecs (IBM, Amiga, \$49.95) has Bret Conrad, retired Special Forces Vietnam veteran, parachuting into the dense jungles of the Yucatan Peninsula to search for the legendary tomb of Quetzalcoatl.

Lucasfilm Games has just introduced *Indiana Jones and the Fate of Atlantis* (the first *Indiana Jones* adventure designed for the personal computer instead of the movies) and *The Secret of Monkey Island II*, another adventure with the Evil Ghost Pirate LeChuck to haunt players. ■

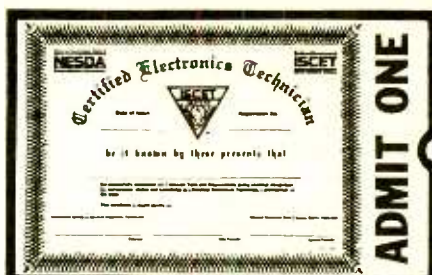

## Your Ticket To SUCCESS

Over 28,000 technicians have gained admittance worldwide as certified professionals. Let your ticket start opening doors for you.

ISCET offers Journeyman certification in Consumer Electronics, Industrial, Medical, Communications, Radar, Computer and Video. For more information, contact the International Society of Certified Electronics Technicians, 2708 West Berry Street, Fort Worth, TX 76109; (817) 921-9101.

Name \_\_\_\_\_

Address \_\_\_\_\_

City \_\_\_\_\_

State \_\_\_\_\_ Zip \_\_\_\_\_

Send material about ISCET and becoming certified.

Send one "Study Guide for the Associate Level CET Test." Enclosed is \$10 (inc. postage).

## LEARN Advanced VCR REPAIR TECHNIQUES



Now, in a **complete** multimedia package consisting of a 200-page training manual and a 1-hour 22-minute video training tape, you can learn **secrets** of Advanced VCR Repair. (Also includes Color Bar Test Tape.)

Includes many examples of VCR make/model specific troubleshooting tips... Learn how to quickly isolate most "tough" VCR malfunctions, whether electrical or mechanical.

Complete coverage of Theory of Operation — Read manual, view 1-hour 22-minute video!

### FREE INFORMATION PACKAGE!

Call 1/800-537-0589

Viejo Publications, Inc.  
5329 Fountain Ave., Dept. PEA  
Los Angeles, CA 90029

**CIRCLE 14 ON FREE INFORMATION CARD**

# COMPUTER BITS

By Jeff Holtzman

## Tools for Writing

**W**ord processing remains the single most popular application for personal computers. Ironically though, word processors remain among the most backward tools available. Sure, they greatly ease the process of editing and formatting text. But what about the process of creating text? Are there tools that aid the conceptual processes, not just the mechanical ones?

Sure there are—and some word processors even have them built in. For example, an outliner can be an immense help in brainstorming your ideas and

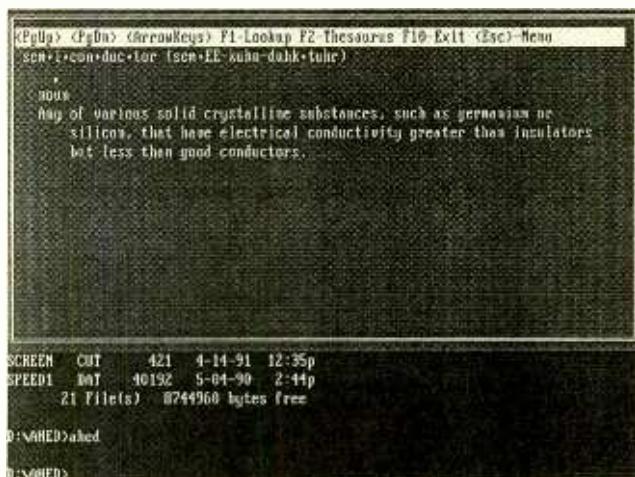

*The American Heritage Electronic Dictionary (AHED) gives you etymologies, shows how to hyphenate and pronounce words, and provides a list of synonyms.*

later reorganizing them coherently. (See the March, 1991 issue of this column for a discussion of outlining and the premier outliner for PCs, GrandView.) Some word processors (Word for Windows, for example) have built-in outliners that work fairly well, although I've yet to see one as powerful as GrandView. There are other more specialized tools designed to help brainstorming and to

cure writer's block; I hope to cover some of these next time.

This time, however, I'll look at several reference tools: a combination dictionary/thesaurus (the American Heritage Electronic Dictionary) and an unusual, highly original database (word-base?) called Inside Information.

### FULL SPEED "AHED"

The American Heritage Electronic Dictionary (AHED) is simply the best dictionary available for PC's. A pretty bold claim, no? The AHED is best because it's the only true dictionary. Most PC-based "dictionaries" are not dictionaries at all, but word lists, occasionally with definitions. A true dictionary is much more comprehensive. Like the pretenders, it shows you how to spell words and it defines them. Unlike those impostors, however, the AHED also gives you etymologies (word histories showing the parts of a word, where it comes from, and how it has evolved), and it shows you how to hyphenate and pronounce words.

Even better, it gives you multiple ways of accessing the information in its database. For example, you can search for words using standard DOS wildcards (b?t finds bat, bet, bit, but; b\*t finds Babbitt, baby-sat, baby-sit, baccarat, back out, backbit, backrest, backswept, back seat...). You can also search using "Boolean" keywords (and, or, not).

Another search technique is more subtle. The AHED has about two dozen special search symbols that

you can use to restrict searches in various ways. For example, you can search for entries in various categories ranging from accounting to TV. The electronics category, for instance, yielded the following: chip, echolocation, modulate, module, pickup, scan, scramble, tune. Other search symbols allow you to restrict your search by parts of speech, idioms, grammatical notes, etymologies, symbols, synonyms, and more.

Unfortunately, you cannot combine search techniques. For example, you cannot search for SEMI\* AND \*TRON. Another limitation is that a given search will locate only the first 120 items, and the program doesn't even warn you that it may have stopped prematurely. On the other hand, the dictionary and thesaurus functions are well integrated, so that within a definition, you can move the cursor to a word and press F1 to look it up or F2 to get a list of synonyms.

The AHED requires about three megabytes of space, and runs as a TSR (terminate-and-stay-resident) under your word processor. The version that I tested required about 140K of memory, but a newer version under development should decrease that amount drastically. Supported word processors include WordPerfect 5.1, Word 5.0, WordStar 6.0, Xy-Write 3.0, and others. The program runs just fine in a DOS window under the 386 Enhanced mode of Windows 3.0. A Macintosh version is also available.

The AHED is not as com-

plete, for example, as the unabridged Oxford English Dictionary (OED), which occupies several hundred megabytes on a hard-to-use CD-ROM. But, at only three megabytes and with a much better user interface, the AHED is a winner.

### INSIDE INFORMATION

Most people think that a thesaurus simply links related words based on similar meanings. In reality, however, Roget's original thesaurus (1852) had a much more ambitious goal: to elaborate a comprehensive scheme for classifying all human knowledge. Roget defined eight major classes, subdivided each class into numerous subclasses, further subdivided those, and so on for a total of four levels.

Items at the lowest level are numbered sequentially from 1 (Existence) to 1040 (Religious Institutions). (The numbers may vary depending on which edition you use.) Numbered items consist of groups of related words sorted by part of speech (noun, verb, adjective). A separate index lists words alphabetically and provides pointers to different senses of a word. You use the thesaurus by looking up a word in the index and then referring to the appropriate numbered section(s). Then you scan the words in those sections, and choose the one closest to the one you need. That's as far as most people go.

### VENDORS

Inside Information (\$119)  
Microlytics, Inc.  
Two Tobey Village Office Park  
Pittsford, NY 14534-9972  
Tel. 800-828-6293, 716-248-9150

American Heritage Electronic  
Dictionary (\$89.95)  
Houghton Mifflin  
One Memorial Drive  
Cambridge, MA 02142  
Tel. 800-633-4514, 617-252-3000

TABLE 1—CLASSIFICATION SCHEMES

Roget	Inside Information
Abstract relations	Nature
Space	Science & Technology
Physics	Domestic Life
Matter	Institutions
Sensation	Arts & Entertainment
Intellect	Language
Volition	The Human Condition
Affections	

However, by understanding the structure of Roget's classification scheme, and how the "synonyms" you find fit into it, you can connect concepts that seem to be totally unrelated—and that's the essence of creating new ideas.

There are several problems, however. Most people want quick answers, and don't want to study some abstract classification scheme. In addition, using a printed Roget's is cumbersome because you must constantly flip back and forth between index and entries.

Inside Information solves those problems and, in the process, provides two powerful methods of browsing through a wordbase, corresponding to both views of a Roget type thesaurus (by hierarchical category and by index).

In the outline view, Inside Information displays a window showing the highest level of categories (see Table 1 for a comparison with Roget's). The highest levels break down into 20 subcategories, and so on for a total of four levels. Each time you choose a more detailed view, a new window overlaps the preceding windows, but allows that window's title to show. In that way, you can always see where you are in the hierarchy. Browsing

the hierarchy is fun, and may teach you a few things in the process.

In the "reverse dictionary" view, you can search the wordbase for words or phrases; the program retrieves a list of articles with text matching your search string. The search string can contain Booleans, but not wildcards. Convenience features include a bookmark function that allows you to record as many as 30 entries and return quickly to a useful one. The program also provides a "bread-crumbs" function that keeps track of the last 30 entries that you examined, and allows you to return to any one by highlighting it and pressing return. Both of those features are available only in the outline (category) view. You can also copy and print entries.

The program runs as a TSR, and can occupy as little as 4K of memory if you enable a swapping function that works with expanded or extended memory (or a hard disk). The Inside Information wordbase occupies about 3.5 megabytes. Negative features include a slightly awkward user interface, and slow performance under Windows. In addition, the program does not support hypertext linking: You can't jump from the middle

of one article to another by a lookup; you can only move through the hierarchy or depend on search results. I also found it impossible to use my screen-capture utility (Pizazz Plus) with Inside Information.

### CONCLUSIONS

There are lots of dictionaries and thesauri available for PC's. The two discussed here are the most powerful and versatile yet released. They have their faults, and they're by no means complete. But, as PC hardware continues its relentless march toward greater speed and capacity, these products will evolve to match. One day soon, we're going to have tools that combine the thoroughness of paper products with the speed and ease-of-use of the computer. ■

### ANTIQUE RADIO

(Continued from page 86)

appearance evoke the era in which they were manufactured, but they seem almost ready to vibrate once again to the voices and music of the past.

But even those who aren't particularly into history can enjoy looking at antique radios, because many are so beautifully designed and constructed. They're interesting on their own terms—even divorced from the eras in which they were manufactured. In contrast to much of the merchandise sold in today's "throw-away" society, the old sets were made to last, be admired, and be repairable.

That's all the room for this month. If you have any questions, comments, etc., you can write to me c/o *Antique Radio, Popular Electronics*, 500-B Bi-Country Blvd., Farmingdale, NY 11735. ■

# HAM RADIO

By Joseph J. Carr, K4IPV

## Less Power To You

**H**ow much RF power do you run? How much power are you allowed to run? 100 watts? 2000-watts PEP? 1500 watts output? The FCC rules, Part 97.313(a), requires that you use the minimum power required to make and maintain communications. It's a well-known fact that lowering RF-power levels greatly reduces interference to your neighbors and your own entertainment equipment. Consumer equipment that is overloaded by a 2000-watt bandbuster is unaffected when lower RF-power levels, say 50 to 200 watts, are used.

Not quite a year ago, FCC field-engineering personnel pulled surprise station inspections on 209 randomly selected amateur-radio operators around



*It is improper to tune on the air any more than is absolutely necessary. The proper way to tune up is into a dummy load (artificial antenna), such as this one, and then switch to the real antenna for touch-up and operation.*

the country. The operators were asked to tune up normally so that a base-line measurement of field strength could be established. They then asked the operator to tune up at a lower-power level. An interesting outcome of the study was that 75 percent of the

stations experienced essentially no degradation of performance (as measured by being able to work the other guy) when RF power was reduced 50 percent.

Why would this be true? One of the reasons is that perceived signal strength is a logarithmic phenomenon, which is why it is measured in decibels (dB). The primary measure of signal strength on receivers is the S-unit. On most receivers, each S-unit represents a 6-dB change in signal strength. For example, an S7 signal is 6-dB greater than an S6 signal, and 6-dB weaker than an S8 signal. Further, for most people, one "S-unit" (i.e., 6 dB) is just about the smallest change that can be perceived by the human ear.

Now how much of a change in power is represented by the 6-dB S-unit? Going from 500 watts to 1000 watts (or the other way, for that matter), represents a 3-dB change (the equivalent of half an S-unit). Thus, a 6-dB change represents a 4:1 power change; e.g., going from 500 watts to 2000 watts. So, if you are already running 500 watts, you'll gain only a single S-unit by purchasing or building a 2000-watt power amplifier!

It's hardly worth the small change in perceived received signal strength. Besides, one also greatly increases the possibility of friction with the neighbors. One old-time FCC official once told me that the FCC generally doesn't like to allow commercial broadcasters to increase power less than five fold because of the limited

effect of smaller increases.

In the old days, it was common for citizen's banders to "soup up" their 5-watt rigs to 7- to 10-watt levels. Of course, only a few of them were smart enough to also boost the modulator power, so many of the souped-up rigs actually were less able to communicate because of the lower percentages of modulation.

Because the FCC actually paid attention to CB'ers (who were licensed), those characters made themselves illegal, reduced the reliability of their rigs, and in the bargain only fooled themselves into thinking they were "getting out" any better. Souping up a rig from 5 to 7 watts gains about 1.5 dB, or 1/4 S-unit, which is the smallest change that a person can hear.

It is possible that the FCC will issue a new rule, strengthening the requirement to reduce output power. However, that rule will probably have little or no effect on our operating...after all, how does one prove that power isn't being kept minimal?

Operating at lower power is relatively easy on modern rigs. The two principal modes of operation on modern HF transceivers are single sideband (SSB) and CW. The RF-output power when operating in SSB is controlled by the microphone's level setting; in CW that's handled by the carrier control. Those controls are often concentric to each other, or, in some cases, are even the same control. Both of them are basically drive controls that

adjust the RF-drive power to the final amplifier.

By the way, if the current reports in the media about the harmful effects of low-frequency electromagnetic radiation prove to be true, then it is prudent to lower RF-power levels to the minimum level necessary just for health reasons. Those reports are as yet not well verified by scientists, but research is on-going.

### A FRIENDLY WARNING

The Amateur Radio Service (ARS) is regulated by the Federal Communications Commission in Washington, DC (although our licenses arrive from an outpost in Gettysburg, PA). The Personal Radio Bureau is the pertinent office at the FCC's headquarters in Washington, while assorted Field Engineering Offices around the country provide local service. For the most part, the FCC leaves hams alone, paying attention to only those transgressors who come to their attention through public complaints, or through the occasional foray through the bands by the several FCC monitoring stations.

Much of the policing of the amateur bands over the years has been the domain of the American Radio Relay League's Official Observer Corps. The Observer Corps looks for transgressors with harmonics, out-of-band operation, and other technical violations, and then lets the operator know. No sanctions, just a collegial notice of a problem. If you get one of those notices, and you are smart, you'll act promptly to repair whatever defect is causing the violation.

### SOME OTHER MATTERS

One of the great annoyances on the ham bands is the large number of people who tune up on



*The legal limit is the lowest amount of power needed to establish communications. An RF wattmeter in the shack will help you to know what RF power is being sent to the antenna.*

the air at full power. A better, and legal way is to connect the output of the rig to a 50-ohm dummy load, and tune up the rig and its tuner into the dummy load. Then switch the output of the rig or tuner to the actual antenna and quickly adjust the controls—at the lowest power level that will give a usable deflection on the meters—for optimum settings.

Most antennas will not change very much over time, so it is possible to make a chart of antenna-tuner settings as a function of frequency. When the settings are found, it is possible to preset the tuner off the air to very nearly the final setting.

Another thing that the FCC requires is that harmonic radiation be considerably reduced. Most rigs will do -40 dB or better. But placing a lowpass filter in the antenna line or using a narrow-bandpass antenna tuner will help reduce the numbers even further and, thereby, prevent a large amount of TV (television interference). Proper antenna tuners can be bought or built.

For those who want to build a tuner, I have a BASIC software program called "MATCHER" (\$15) that will help you design your own. Contact me at P.O. 1099, Falls Church, VA, 22041 if you're interested. The dis-

kette is protected by my copyright, but is not copy protected. That means that you can make non-commercial (i.e., don't sell or place it on a computer bulletin board) copies for your own use or to share with other hams. I don't care if you pass it around, but if you sell it, then I want my cut. Unfortunately, the listing is too long to publish in this column.

### AN FCC "WAR STORY"

Many years ago (around the late 1950's), a friend of mine was an FCC field engineer somewhere in rural Virginia or Kentucky. He traveled throughout a large region visiting mostly broadcasting stations. There was a town on his route that paid most of its bills by operating a "Yankee trap" on the highway.

According to my friend, the town was so notorious that AAA and other travel groups marked it in red on their trip tickets. Anyway, they got my friend one Monday morning, and he got a \$25 speeding ticket. Now the story gets interesting. In those days, two-way mobile-radio transmitters had to have "transmitter-verification cards" mounted on them. My FCC friend noticed that the police radio lacked the requisite card. Further, the transmitter  
*(Continued on page 100)*

Make the most of your general coverage transceiver with Monitoring Times!

Every month Monitoring Times brings everything you need to make the most of your general coverage transceiver: the latest information on international broadcasting schedules, frequency listings, international DX reports, propagation charts, and tips on how to hear the rare stations. Monitoring Times also keeps you up to date on government, military, police and fire networks, as well as tips on monitoring everything from air-to-ground and ship-to-shore signals to radioteletype, facsimile and space communications.

**ORDER YOUR SUBSCRIPTION TODAY** before another issue goes by. In the U.S., 1 year, \$19.50; foreign and Canada, 1 year, \$26. For a sample issue, send \$2 (foreign, send 5 IRCs). For MC/VISA orders (\$15 minimum), call 1-704-837-9200.

### MONITORING TIMES

Your authoritative source, every month.

P.O. Box 98  
Brasstown, N.C. 28902

# DX LISTENING

By Don Jensen

## Learning About the Hobby

Shortwave listening got a tremendous boost during the Persian Gulf war. Many thousands of Americans who had never before given much thought to international broadcasting suddenly became intrigued with the prospect of tuning in radio signals from half a world away where their sons and daughters, brothers and sisters, husbands and wives were serving with the fighting forces. The result was a tremendous surge in SW receiver sales.

Some of the receivers were purchased at PX's by

the popularly priced SW radios—Sony's ICF-2010 and ICF-7600 models, and Panasonic's RF-B65, for example—were very difficult to find in the stores.

Even a major chain like Radio Shack was hard pressed to keep up with the demand for receivers like its \$200 "flagship" set, the DX-440. What that shortwave boom did was to bring many newcomers into the listening hobby.

That is underscored in some of the mail that I've been receiving from readers who've discovered **Popular Electronics** on their newsstands and want more information about this fascinating pastime that we call SWL'ing!

A typical letter comes from Cliff Rodrigues of Islington, Ontario, Canada, who says "I have recently taken up a hobby in SW-radio listening. Could you kindly give me any information that you think is vital for a budding DX listener? Any schedule information and tips will be very gratefully looked forward to."

Cliff has hit upon a key element in SWL'ing, "schedule information and tips." Keeping up with when and where to tune for foreign SW stations is essential. One good answer is a first rate reference, such as the annual *Passport To World Band Radio*, which presents the entire shortwave spectrum in computer-generated graphic form. It shows which shortwave stations operate when and where, the languages they use, their transmitter powers, and much more. The data is cross-referenced in such a way as to

easily come up with the needed information, whether one starts out with a frequency, country, or language-used reference point.

The venerable European-based annual *World Radio TV Handbook* also contains a broad collection of station data and schedules.

The 1991 edition of *Passport To World Band Radio* retails for \$16.95. The 1992 edition should be out just about when you read this column. The 1991 *World Radio TV Handbook* sells for \$19.95. Both are sold by, or can be ordered through, electronics-equipment dealers and the major bookstore chains in the U.S. and Canada.

The annual publications are essential for baseline information, and remain remarkably current even months after they come off the presses. But shortwave is a changing medium. So, to really keep on top of the frequency and schedule alterations, seasonal shifts in channels, moves sometimes made in response to interference from other broadcasters, or world political events, serious SWLs may want to join a listeners club.

There are a number of SW clubs, and some of them very good ones indeed, both here and abroad, from South America to Australia, and from

\*Credits: Pete Grenier, NV; Steve Batson, WV; David Edger, VA; Jerry Klinck, NY; Karl Forth, IL; Brian Alexander, PA; Richard D'Angelo, PA; Bob Karcheski, MA; William Flynn, OR; North American Shortwave Association, 45 Wildflower Road, Levittown, PA 19057



You will find shortwave listeners and their listening clubs all over the world. This sticker identifies a small hobby organization that was located in the South American city of Cochabamba, Bolivia.

the GI's themselves, so that they could keep up with the rest of the world's events beyond their own little patch of sand in the months before Desert Shield became Desert Storm. Still others back home were attracted by world-band radio's ability to present a wide range of global viewpoints, be they friendly or hostile.

That sales pressure boosted normal receiver sales to many times what electronic dealers had experienced in previous years. For months, some of



the Soviet Union to South Africa. However, in the interest of space, let me focus attention on just two, the largest of their kind in North America—the North American Shortwave Association (45 Wildflower Road, Levittown, PA 19057) and the Ontario DX Association (P.O. Box 161, Station A, Willowdale, Ontario, Canada, M2N 5S8).

Both are non-profit, volunteer-run organizations, each with more than 1200 members. Their main link with members is their monthly 60 to 80-page news magazines, the *Journal of the North American Shortwave Association* and *DX Ontario*, respectively.

The Canadian organization's membership has about a 3:1 ratio of Ontario residents to those living outside that province. NASWA has a majority of U.S. members. Both clubs, however, accept memberships worldwide. Annual fees—depending on the club, member location, and whether first-class or airmail delivery is required—range between \$23 and \$34.

The bulletins are somewhat similar in content, format and appearance, and are packed with information to help SW listeners, whether they are beginners or veteran listeners. The bulletins regularly include up-to-date schedule changes, tips on rare stations being heard, how-to-do-it and self-help information, equipment and new publication reviews, best-bet program guides, and much, much more.

Regular readers of this column will have noted that I often reprint information from both of those excellent club bulletins. Two dollars, including postage and handling, sent to either or both of those organizations will get you a sample copy. Then you can decide for

yourself if you wish to join. Tell them you read about their clubs in **Popular Electronics**.

### OTHER HOBBY REFERENCES

Another reader, Stephen Mahan, Myrtle Beach, SC, has written with a question about other hobby references. "After reading several of your columns in **Popular Electronics**," Stephen says, "I'm curious about this international pastime, DX listening. Would you recommend a book or books that could get me started? I would prefer reference material with practical application."

There are a number of useful books for the beginning SWL, Stephen. You might want to consider one of these: *So You Bought a Shortwave Radio! A Get Acquainted Guide to the Wide World of Shortwave*, by Gerry L. Dexter (\$6.95 plus \$2 shipping), which is available from various dealers as well as from the publisher (Tiare Publications, P.O. Box 493, Lake Geneva, WI 53147).

*Complete SWL's Handbook, 3rd Edition*, by Bennett, Helms and Hardy (\$16.95 plus \$1 shipping) is available from various dealers, including Universal Radio Inc. (1280 Aida Drive, Reynoldsburg, OH 43068).

*The World is Yours*, by Samuel Alcorn (price not available) is available from various dealers, including Electronic Equipment Bank (323 Mill St. NE, Vienna, VA 22180).

*Bob Grove's Scanner and Shortwave Answer Book*, (\$12.95 plus \$1.50 shipping) is available from various dealers, including the publisher, Grove Enterprises (P.O. Box 98, Brasstown, NC 28902).

Not all our new readers are new to the listening hobby, though, as this letter from Phil J. Wanat, North-

field Falls, VT, illustrates:

"I was a shortwave monitor in 1967–69 and had the call letters WPE1ENK, issued by the old *Popular Electronics*. I had given up the hobby for a long time and now am back again. I would like to be re-registered and still keep the same call I had back then. What is the procedure and the fee?"

Welcome back to DX'ing, Phil. Your question also has been raised by others who were *Popular Electronics* shortwave monitors more than 20 years ago. Yes, in the 1950's and 60's, *Popular Electronics* did register SWL's and issue calls such as yours, Phil, WPE1ENK, and my own, WPE9EZ. But about 1970, the magazine ended its sponsorship, turning over the program to former DX columnist Hank Bennett, who continued it on his own as the *WDX Monitoring*

*Service*. Many of those with the older WPE calls converted to "new" WDX-type calls. My WPE9EZ became WDX9EZ, for example.

After all these years, Bennett's WDX Monitoring Service still issues WDX monitor registration call letters for a nominal fee. Anyone interested in obtaining a new WDX call, or converting their old WPE registration, should send a self-addressed stamped envelope to P.O. Box 3333, Cherry Hill, NJ 08034, for details.

### DOWN THE DIAL

What are others hearing on shortwave? Here are some of the stations, times and frequencies. What are you hearing? Why not tell the rest of us? Your letters are always welcome. Send them to *DX Listening*, **Popular Electronics**, 500-B Bi-  
(Continued on page 101)

## Shortwave Listening Guidebook

by Harry Helms

The world is talking on shortwave radio, and here's the book that tells you how to listen in! In direct, nontechnical language, Harry explains how to get the most from your shortwave radio. Its 320 heavily illustrated pages are filled with practical advice on:

- antennas
- when and where to tune
- selecting the right radio for you
- accessories
- reception techniques



Learn how to hear the BBC, Radio Moscow, ham radio operators, ships at sea, even Air Force One! Includes hundreds of frequencies for stations around the world and the times you can hear them.

Only \$16.95 plus \$3.00 shipping (CA residents please include sales tax).

**HighText**  
Publications, Inc.  
7128 Miramar Road  
Suite 15L, San Diego, CA 92121

# SCANNER SCENE

By Marc Saxon

## Who Cares? We Do!

**H**ave you ever scanned the "nobody-cares" frequencies? I call them that because low-power handheld transceivers are mass marketed for general-communications purposes by the public, and nobody seems to really care if anybody takes out the necessary licenses to operate them legally. Sure, FCC license forms are packed in with the sets, and the instruction manuals clearly point out that a license is



*The 2-watt, 2-channel Courier Minicom VHF FM transceiver can open up a new world of monitoring experiences, picking up often unusual—and sometimes illegal—two-way communications.*

required, but most people don't bother. The FCC hasn't taken any steps to chase down illegal operators.

These sets are used by many businesses, from security services to building contractors. They're used in factories and warehouses, on farms, and for a wide range of industrial purposes. But it does seem that most are used by hikers, campers, hunters, and for all sorts of legal and illegal uses limited only by the imagination of their owners. That seems to include being put to use by burglars, prostitutes, drug dealers, and other assorted people who the FCC didn't have in mind for two-way radio use.

The three major frequencies that are commonly used in these handheld transceivers are 151.625, 154.57, and 154.60 MHz—frequencies allocated to the Business Radio Service. Sometimes they are simply called Frequencies A, B, and C by those who manufacture, sell, and use the handhelds. By putting those frequencies into your scanner, you should be opening up your horizons to a world of new monitoring experiences, some highly spirited and entertaining. If you're close to a fast-food emporium, you might even find their drive-up window communications using one of these channels.

Other, although not as popular, frequencies that also turn up unusual (and often apparently un-

licensed) two-way communications include: 151.49, 456.80, 457.525, 457.55, 457.575, 457.60, 458.025, 458.075, 458.125, 458.175, 467.75, 467.775, 467.80, 467.825, 467.85, 467.875, 467.90, 467.925, and 469.50 MHz.

### FREQUENCY FINDS

Steve Taylor (Jackson's Gap, AL) was nice enough to furnish us with frequencies used in his state. Those include the Alabama Forestry Commission on 159.315 and 159.42 MHz, and also Alabama State Troopers on 154.92 MHz (base) and 155.445 MHz (cars).

From Ken Fowler, of Fairfax, VA, we learn that his city's police use 453.975 for Dispatch; 460.075 for Detectives, Fire Marshals, and Youth Services; 460.05 for Surveillance; and 453.55 for Mutual Aid. Ken also advises that he is hoping to start a BBS that will feature discussions on scanner use in the Washington, DC Metro area. Those who are interested can contact Ken Fowler directly at 3511 Perry Street, Fairfax, VA 22030-2933.

### SCANNERS IN THE NEWS

In the Chicago suburbs, a couple of burglars had managed to avoid arrest by monitoring police communications. They were suspected of hundreds of household burglaries that netted them a half-million dollars in loot.

When the police dis-

# SELECT 5 BOOKS for only \$4.95 (values to \$117.75)

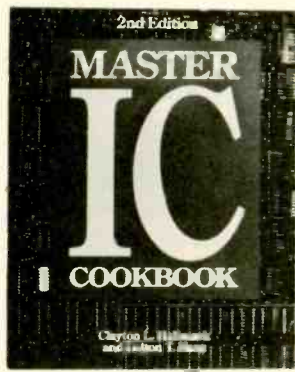
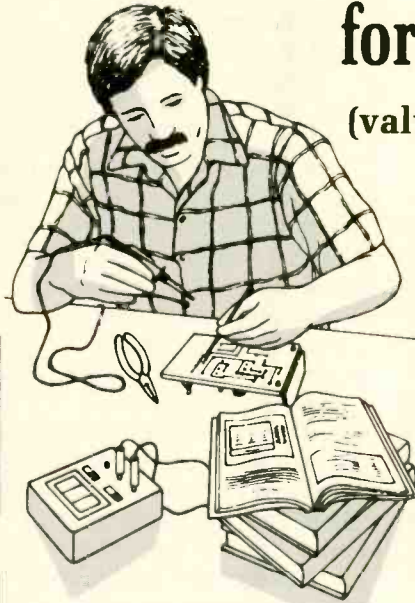

3550 \$34.95  
Counts as 2



2980P \$19.95



2800P \$16.95

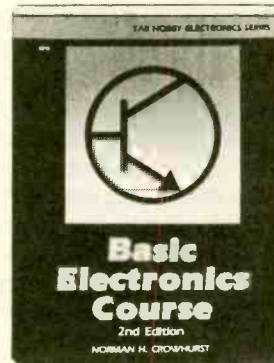

2613P \$17.95



2883P \$18.95



2867P \$18.95



3475 \$27.95  
Counts as 2

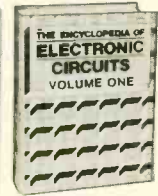

1938 \$60.00  
Counts as 3



3627 \$29.95  
Counts as 2



3329 \$29.95  
Counts as 2

Your most complete source for electronics books for over 25 years.



3260P \$14.95



295CP \$13.95



3414 \$39.95  
Counts as 2

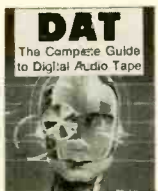

3670 \$23.95



3343 \$29.95  
Counts as 2



2865P \$14.95



1367P \$24.95

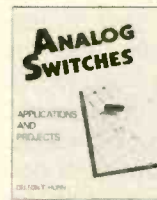

3445 \$21.95

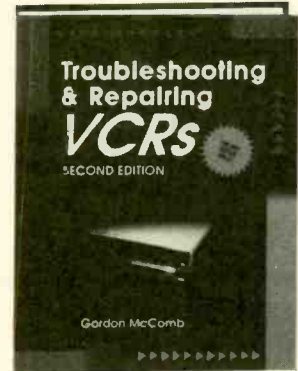

3777 \$32.95  
Counts as 2



3226P \$14.95

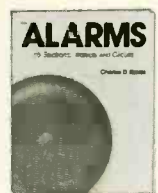

2986P \$14.95

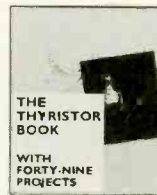

3307 \$26.95  
Counts as 2



2995 \$25.95



3454 \$23.95



3457 \$29.95  
Counts as 2



2790P \$14.95



3258P \$18.95



3265 \$22.95

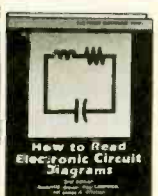

2940P \$14.95

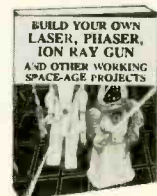

1604P \$17.95



3274 \$25.95  
Counts as 2



3345 \$39.95  
Counts as 2



3358 \$28.95  
Counts as 2



3628 \$26.95  
Counts as 2

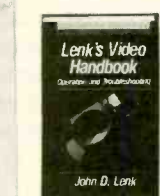

10018 \$39.95  
Counts as 2



3632 \$18.95



3267P \$16.95

**Membership Benefits • Big Savings.** In addition to this introductory offer, you keep saving substantially with members' prices of up to 50% off the publishers' prices. • **Bonus Books.** Starting immediately, you will be eligible for our Bonus Book Plan, with savings of up to 80% off publishers' prices. • **Club News Bulletins.** 15 times per year you will receive the Book Club News, describing all the current selections—mains, alternates, extras—plus bonus offers and special sales, with scores of titles to choose from. • **Automatic Order.** If you want the Main Selection, do nothing and it will be sent to you automatically. If you prefer another selection, or no book at all, simply indicate your choice on the reply form provided. You will have at least 10 days to decide. As a member, you agree to purchase at least 3 books within the next 12 months and may resign at any time thereafter. • **Ironclad No-Risk Guarantee.** If not satisfied with your books, return them within 10 days without obligation! • **Exceptional Quality.** All books are quality publishers' editions especially selected by our Editorial Board.

FE1091

© 1991 ELECTRONICS BOOK CLUBSM  
A shipping/handling charge and sales tax will be added to all orders.

If card is missing, use this address to join:  
ELECTRONICS BOOK CLUB, Blue Ridge Summit, PA 17294-0810

All books are hardcover unless number is followed by a "P" for paperback. (Publishers' Prices Shown)

covered that the secret of the burglars' success was based upon their ability to listen in on police communications, they devised a way of short circuiting the crooks' advantage. The police decided to temporarily abandon the frequencies they normally used for their stakeouts and surveillances, using instead some short-range 49-MHz transceivers.

Monitoring the police frequencies gave the burglars the impression that the coast was clear. They broke into a house and dragged off a safe filled with \$50,000 worth of jewels, cash, bonds, and rare coins. The police got their men!

In another bizarre incident, police in Prince William County, VA heard a distress call come over one of their agency's frequencies. The caller identified himself as a police officer needing assistance as a result of a chase. That was followed by several hours' worth of microphone clicks on the frequency, which the agency interpreted as continuing calls for help from a fellow officer injured so severely that he couldn't speak. An intensive ten-hour search ensued, involving helicopters and personnel from more than a dozen area police agencies.

When the search was over, a 39-year-old man was under arrest for sending out the false distress call from his parked van. The police learned that he was under suspicion for transmitting dozens of other fake distress calls from throughout Ohio and Kentucky.

To make it all worse, the suspect was a high-school physical-education teacher (from Ohio) who is a licensed ham operator, and the advisor to his school's ham-radio club. Go figure!

### INSIDE INFORMATION.

A letter from Rubin Scott, of Lumberton, NC, tells

about a problem he's having. He likes to monitor his city police on 453.20 MHz and the fire dispatcher on 154.235 MHz. The problem is that the stations come in poorly, and the sound level is very low. Rubin adds that he uses an indoor antenna.

Without knowing any further details, the first thing I'd try is an outside antenna. Although an inside antenna is often sufficient for general local monitoring, it's still an approach that will produce reduced results when compared to any antenna mounted outside a structure. Poor reception and low sound level are often heard complaints from scanner owners, and my first guess is that they're using an indoor antenna, like the dinky telescoping whip that mounts on the desktop scanner itself.

L.W.F., Jr., has passed his Tech Class ham ticket and is waiting for his license to come through. While waiting, he has purchased a two-meter band (144-to-148-MHz) transceiver, and erected a two-meter ground-plane antenna. He tried his scanner on this antenna, and it did a good job receiving from 118 to 174 MHz. The question is: Do we think the scanner and the two-meter transceiver can share that one antenna simultaneously?

If only one piece of equipment at a time will be connected to the antenna (such as via a rotary coaxial switch), then it should work OK. But I hope you aren't thinking about feeding both units off the antenna with a "T" connector, or anything like that, because that could lead to various types of unhappiness.

We await your questions, frequency information, and comments. Write to us at: *Scanner Scene*, **Popular Electronics**, 500-B Bi-Country Boulevard, Farmingdale, NY 11735. ■

## HAM RADIO

*(Continued from page 93)*

was a wideband-FM unit that was no longer legal.

Checking with headquarters, he found out that neither the town nor the county had a license. So accompanied by a U.S. Marshall, he confiscated the four mobile rigs, the base station at the police station, the mayor's home, and the police-chiefs home, plus the radar transmitter. It seems that a huckster had come through town a few months before and sold them a truck full of outdated radio and radar gear, and told them that because of their public service status, they did not need a license.

Of course, while in the court house he also paid the speeding ticket. I can't verify this story. It has been told for about a quarter century around this area, however.

to pay for the First Amendment...although I wonder if that's really true. But every now and then, we hear of some real degenerate who deserves criminal action.

The FCC caused the arrest last year of one fellow who intentionally interfered with emergency communications. Whenever we find one of these guys, it is wise and prudent to turn them in immediately.

One reader wrote about a neighbor of his who held a newly minted Novice Class license. Besides putting up an antenna over the reader's property without permission, the neighbor refused to investigate whether his rig was causing interference to the reader's TV and portable telephone. In retaliation, the ham claimed that the portable telephone's transmitter interfered with his own 80-meter CW operations.

On two occasions, the



*A view of the author's ham-radio station. The dummy load on top of the antenna tuners, although open for modification, is normally shielded. The RF wattmeter in the foreground is usually placed between the rig and the power amplifier. The output of the rig can be switched from the dummy load to the real antenna with a coaxial switch.*

## DEGENERATES IN OUR RANKS?

Most of us have heard stories about vulgar, profane individuals on the bands these days. Others of us have even heard them (I have). I suppose those idiots are the price that we have

ham allegedly cut the telephone lines to his neighbor's home! *Hams like him, we don't need.* I suspect that he violated several local, state, and federal laws or regulations...and should be turned in. ■

## AM/FM TUNER

(Continued from page 81)

opposite channel, 5 kHz is some 55 dB lower in amplitude. In addition to the actual 5-kHz crosstalk in the unmodulated right-channel output, there were other cross-talk products, such as second-harmonic distortion (at 10 kHz), some residual 19-kHz pilot signal, and a 38-kHz subcarrier product along with sidebands at 33 kHz and 43 kHz (arising from the 38-kHz subcarrier frequency  $\pm$  the 5-kHz modulating frequency used in the test).

This test was repeated using the narrow-IF mode and the results showed reduced actual separation (only about 40 dB at 5 kHz) and higher amplitudes of distortion and other crosstalk products at the output of the unmodulated channel. Other measurements made for the FM section confirmed an alternate selectivity ratio of 85 dB when the narrow-IF mode was used, and a capture ratio of exactly 1.2 dB, which is what is claimed by Yamaha.

While the performance of the FM section of this tuner was exemplary, such was not the case with the AM section. Like so many other manufacturers of "high fidelity" AM/FM tuners, Yamaha seems to have chosen to treat the AM section as pretty much of an afterthought, providing only minimal fidelity for that form of radio reception. That is unfortunate, especially when you consider the fact that many AM broadcast stations have adopted the new NRSC (National Radio Systems Committee) recommendations for improved quality of AM-radio transmission. The overall frequency response of the AM tuner section was down 6 dB at 60 Hz and also at 2.7 kHz.

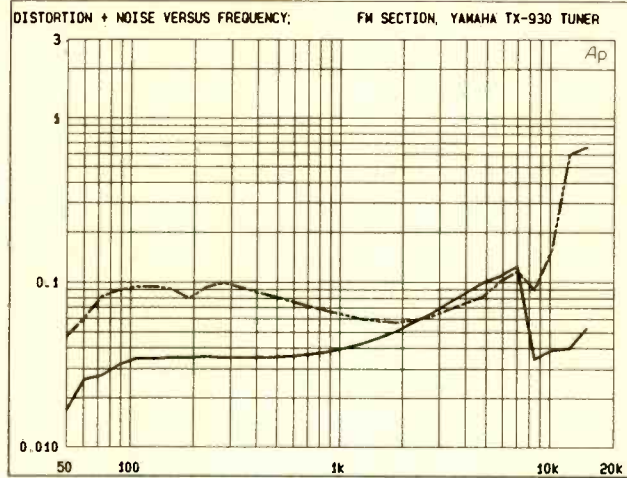

The THD figures were quite low when the receiver was in the wide-IF mode. The solid line is mono; the dashed line is stereo.

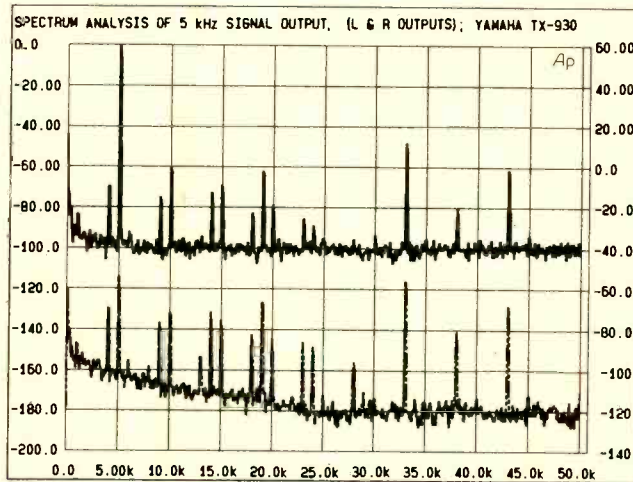

Spectrum analysis of left (solid line) and right (dashed line) outputs when a 5-kHz signal is input only to the left channel. Use the right-hand scale to read the crosstalk and distortion levels.

## HANDS-ON TESTS

FM reception using the Yamaha TX-930 was superb. Even with a simple indoor dipole antenna, we were able to pick up every major FM station in our area in stereo. Using a multi-element outdoor antenna, we logged some 52 stations—47 of them in acceptable stereo. Some of the weaker stations in this experiment were only 200-kHz removed from stronger, nearby stations, but using the narrow-IF mode in those instances, we were able to separate the two adjacent signals. Furthermore, while bench measurements showed that the use of the narrow-IF mode increased distortion,

the slight increase was not audible in our listening tests, and the improvement in selectivity was certainly worth the slight increase in distortion.

Physically, the Yamaha TX-930 is extremely attractive with its slim design (it measures only 3 inches high) and its comprehensive set of displays. The presence of a rotary tuning knob is a welcome addition, as far as we are concerned. Even though tuning is digital (and there is, of course, no "dial pointer" or dial scale), being able to spin a tuning knob to get from one frequency to another seems more natural than having to keep

one's finger pressed against a pushbutton. The presets are easy to program and, although entering station call letters takes a bit of time, it is a noteworthy feature for those who have trouble associating frequencies with specific FM stations.

In the course of using this tuner over a period of several days we detected no drift whatsoever, even when the lock feature was not used. Once you tune in to a given station, the tuner remains tuned to that frequency till you select another one. We can recall a time when tuners of this quality cost twice as much (or more) as Yamaha's modest suggested price of \$399.00.

For more information on the Yamaha TX-930 AM/FM stereo tuner, contact the manufacturer directly, or circle no. 120 on the Free Information Card. ■

## DX LISTENING

(Continued from page 95)

County Blvd., Farmingdale, NY 11735.

The schedules are listed in Coordinated Universal Time (UTC), which is equal to EST + 5 hours, CST + 6 hours, MST + 7 hours, and PST + 8 hours.

**NAMBIA**—3,290 kHz. The *Nambian Broadcasting Corp.* is a nice DX catch here at around 0330 UTC. It was noted here with English ID and western music.

**NORWAY**—9,655 kHz. *Radio Denmark* is being relayed by shortwave transmitters in Norway these days. Look for this one, in Danish, at around 0030 UTC.

**SOLOMON ISLANDS**—5,020 kHz. The *Solomon Islands Broadcasting Corp.* has been reported here in English until its 1200 UTC sign off. ■

## DOES YOUR METER LIE

(Continued from page 40)

to oscillate above and below the DC potential rather than zero, then all bets are off. These circumstances will create havoc with some types of meter, as we will see from a little experiment below.

**Meter-Reading Experiment.** Two different multimeters, one an analog VOM and the other a 3½-digit DMM, were connected in parallel across a load resistor ( $R_L$  in Fig. 5). Also connected across the load resistor was the vertical-input probe from an oscilloscope. First, the two meters were set to their respective 10-volt DC scales (0 to 10 volts on the VOM and 20 VDC on the DMM). Next, an audio function generator was connected so that its output was placed across the load resistor. The sinewave output of the function generator was adjusted to show 6 volts peak-to-peak on the calibrated oscilloscope when a 60-Hz sinewave was applied; this value corresponds to a peak value of:

$$6/2 = 3 \text{ volts}$$

If the sinewave was reasonably pure, then the rms value would be:

$$0.707 \times 3 \text{ volts} = 2.12 \text{ volts}$$

For this sinewave the analog meter read 2.0 volts, while the DMM measured 2.09 volts (close enough to be considered "accurate"). There was little difference between the readings at 60 Hz. The error widened a little bit at 1000 Hz, as the VOM reading dropped to 1.8 volts and the DMM was essentially unchanged as it bounced back and forth between 2.08 and 2.09 volts. In other words, the VOM appears to have a narrower range of audio frequencies over which it operates, a situation that is not unusual unless the meter is designed as an audio voltmeter as well (some are, mine was not).

The function generator was next set to produce a squarewave also of 6 volts peak-to-peak and symmetrical about zero volts. One would expect the rms value to be one-half the peak value, or 3 volts. The VOM read 3.2 volts at 1000 Hz, while the digital meter read 3.43 volts. At 60 Hz, the analog meter read 2.8 volts and the DMM read 3.12.

A 1000-Hz triangle waveform, also at 6 volts peak-to-peak and symmetric, yielded a reading of 1.65 volts on the VOM, and 1.7 volts on the DMM. At 60 Hz, the readings were 1.4 volts on the

VOM and 1.54 volts on the DMM. These readings are a lot closer together, reflecting the different composition of the waveform.

Results with non-symmetrical waveforms—a TTL squarewave, a sawtooth, and a sinewave with a considerable DC component—were also examined.

The TTL squarewave is not symmetrical because it is intended to operate with TTL digital devices. In this case, the base line is zero volts, and the peak voltage was +4.1 volts. The 60-Hz TTL signal snapped back and forth between 0 and +4.1 volts. The average value, therefore, was  $+4.1/2$ , or +2.05 volts. The analog meter read, surprisingly enough, 4 volts, while the digital meter read 1.96 volts. In other words, the VOM measured the peak voltage, while the DMM measured the average voltage.

The sawtooth wave was provided by a digital sawtooth-generator circuit created by connecting a digital-to-analog converter (DAC-0806) to the output of a binary counter that was driven by a clock. The sawtooth was a 400-Hz 4-volt peak waveform. The analog meter read 9.2 volts, while the DMM read 2.25 volts.

Finally, a 60-Hz sinewave signal that had a DC component was examined. Initially, the output level of the generator without the DC component was cranked up all the way. The reading on the analog VOM was 2.8 volts, and it bobbed between 2.08 and 2.09 volts on the DMM, very nearly identical readings. But when a +5-volt DC component was added, the VOM read +10 volts and the DMM read 3.12 volts. Similarly, when the DC offset was switched to -5 volts, the VOM read -10 volts and the DMM read 2.81 (with no polarity sign showing!).

Understanding the effects of different signals on the reading produced by a meter will make it easier to use the meter in situations where the input signal is other than a fixed DC level, or a pure, noise-free sinewave. ■

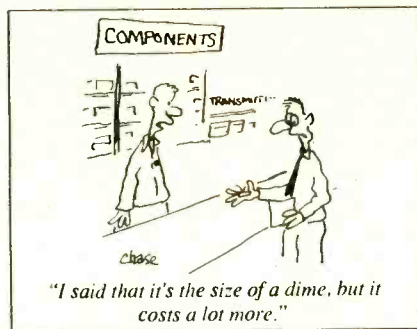

## LIGHT BEAM

(Continued from page 42)

The receiver needs no special consideration except for the solar cell; if an unmounted cell is being used, be very careful with it. Some are more fragile than eggshells and are easily damaged. Soldering to the backplane and front collector on an unmounted cell may also prove to be more difficult than imaginable, since excess heat can damage the cell.

**Limitations.** The transmitter and receiver have a frequency response of from 500 Hz to over 10 kHz. The high end can be cut off by using a higher current lamp. Such a lamp is slower to brighten and dim, and so will not reproduce all that is fed into it.

Since the receiver is designed to turn light variations into sound, simply pointing the receiver at a household lamp should produce a 120-Hz hum in the receiver's speaker. Although the frequency response cuts off at about 500 Hz, incandescent and fluorescent bulbs produce massive amounts of flicker, of which the tiniest bit will be picked up by the receiver. That also limits communications to nighttime or dark rooms, because the 120 Hz hum of room lights may override the transmitter signal.

Also, since sunlight is a DC source, it will raise the solar-cell bias to a point that gives a clipped output, or none at all. Solar cells are more sensitive to ultraviolet light than infrared, so television remotes won't activate the receiver, but suntanning lamps will.

**Conclusion.** Now that you have your Solar Cell Communicator, start pointing the receiver at whatever generates light. Clock-radio displays, neon signs, incandescent and fluorescent lamps, the television, the fireplace, jet engines, automobile headlights, and whatever else you desire. No two sounds you hear will be the same.

The prototype has an effective range of about four inches without the benefit of lenses, focusing mirrors, or multiple cells. But the range can be easily increased by running the transmitter on 12 volts, swapping the 2N4401 transistor for a high-power Darlington, and using an automobile headlamp.

The circuit may not do anything important, but to the untrained (and sometimes trained) observer, you'll look like you're doing some very important work instead of having fun. ■

# ELECTRONICS MARKET PLACE

## FOR SALE

**CABLE descrambler liquidation.** Major makes and models available. Industry pricing! (Example: Hamlin Combo's, \$44 each... Minimum 10 orders). Call **WEST COAST ELECTRONICS**, 1 (800) 628-9656.

**CABLE descramblers** (Jerrold) from \$40.00. Tocom VIP test chip. Fully activates unit. Also Zenith test board. Fully activates Z-Tacs. \$50.00. Call **(213) 867-0081**.

**PRINTED circuit boards** — etched, drilled, tin plated. Single sided \$1.25/sq. inch. Free shipping. **CHELCO ELECTRONICS**, 61 Water Street, Mayville, NY 14757. (716) 753-3200.

## CB RADIO OWNERS!

We specialize in a wide variety of technical information, parts and services for CB radios. 10-Meter and FM conversion kits, repair books, plans, high-performance accessories. Thousands of satisfied customers since 1976! Catalog \$2.

**CBC INTERNATIONAL**  
P.O. BOX 31500PE, PHOENIX, AZ 85046

**DESCRAMBLERS**, cable TV converters, lowest prices, guaranteed, best quality, special Sacramento units. **CNC CONCEPTS INC.**, Box 34503, Minneapolis, MN 55434. 1 (800) 535-1843.

**SAM'S** photofacts. #11 thru 2520 while stock lasts. \$6.00 per set. Discounts for volume purchases. 1 (800) 274-2081 MC/Visa.

**ELECTRONIC** parts since 1954. Send stamp for regular flyer. **BIGELOW ELECTRONICS**, Box 125, Bluffton, OH 45817.

**CABLE TV descramblers.** Absolutely the lowest prices! All major brands. Money back guarantee. Call us last! **ADVANCE ELECTRONICS**, 2140 Shattuck #2082, Berkeley, CA 94704. 1 (800) 659-3018.

## FREE CATALOG

**FAMOUS "FIRESTIK" BRAND CB ANTENNAS AND ACCESSORIES. QUALITY PRODUCTS FOR THE SERIOUS CB'er. SINCE 1962**

**FIRESTIK ANTENNA COMPANY**  
2614 EAST ADAMS  
PHOENIX, ARIZONA 85034

10 disks of EE PD-shareware for PC 5 1/4" disk, \$10.00. Bonus-disk library case with order. SHP \$3.00. **AGBSOFT**, Rm 2708, 1350 Sixth Ave., New York, NY 10019.

**THE** most advanced hi-tech security, surveillance and spy equipment available anywhere. All affordable send \$10.00 for complete catalog, (refunded on first purchase over \$100.00) to: **COMCON SYSTEMS**, 501 Boston Post Rd., Dept 153, Orange, CT 06477.

**HUGE** 92 page communications catalog of shortwave, amateur and scanner equipment. Antennas, books and accessories too. Send \$1.00 to: **UNIVERSAL RADIO**, 1280 Aida Dr., Dept. PE, Reynoldsburg, OH 43068.

**PHOTOCOPIER** theory and repair manual. Secrets revealed. \$19.95 **LOTUS PUBLISHING**, Dept. O, Box 1689, Guelph, Ont. N1H 6Z9.

**IBM** amateur license software. Select codeless, general, advanced or extra on 3.5 or 5.25 disk. Entire question pool, sample tests, help, problems worked, graphics and mouse supported. \$9.95 **GHZ ENGINEERING**, 78-6997 Mamalahoia #K, Honolulu, HI 96725.

**CRIBSHEET** laminated, of commonly used electronic formulas and symbols, \$3.00 to: **HUMEX**, 16365 Rhyolite Circle, Reno, NV 89511.



## Quality Microwave TV Antennas

**WIRELESS CABLE - IFTS - MMDS - Amateur TV**  
Ultra High Gain 50db(+) • Tuneable 1.9 to 2.7 Ghz.  
• 36-Channel System Complete \$149.95  
• 12-Channel System Complete \$114.95  
• Call or write (SASE) for "FREE" Catalog

**PHILLIPS-TECH ELECTRONICS**  
P.O. Box 8533 • Scottsdale, AZ 85252  
(602) 947-7700 (\$3.00 Credit all phone orders)  
MasterCard • Visa • COD's • Quantity Pricing

LIFETIME WARRANTY

## SATELLITE TV

**FREE** catalog — Lowest prices world wide **SKYVISION**, 2008 Collegeway, Fergus Falls, MN 56537. 1 (800) 334-6455. (See full page ad in the Market Center)

**CABLE** converters all major brands Info & orders 1 (800) 782-0552. **FREEWAY INC.** s.m.p., PO Box 5036, Burnsville, MN 55337.

## CABLE TV "BOXES"

**Converters-Descramblers Remote Controls-Accessories**

- ★ Guaranteed Best Prices ★
- ★ 1 Year Warranty - C.O.D.'s ★
- ★ Immediate Shipping ★
- ★ FREE CATALOG ★

Call or Write  
**NAS/TRANS-WORLD CABLE CO.**  
3958 North Lake Blvd. • Suite 255  
Lake Park, Florida 33403  
1-800-442-9333  
1-800-848-3997

## PLANS & KITS

**HOBBY/broadcasting/ham/CB/surveillance** transmitters, amplifiers, cable TV, science, bugs, other great projects! Catalog \$1.00 **PANAXIS**, Box 130-H10, Paradise, CA 95967.

**BUILD** — five-digit, ohms, capacitance, frequency, pulse, multimeter. Board, and instructions \$9.95. **BAGNALL ELECTRONICS**, 179 May, Fairfield, CT 06430.

## X-Y Scanner Kit for your Laser

- ◆ 2 Lissajous Oscillators
- ◆ 2 Audio Inputs 2 Galvo's
- ◆ Computer interface
- ◆ Fun to build and use !!

99<sup>00</sup> 4lbs 900/20

**Silicon Valley Surplus** 1273 Indstl-prkwy W. bldg 460  
415-582-6602 Hayward Ca. 94544-7025  
CALL OR SEND FOR OUR FREE KIT CATALOG

**DAZER** personal protectors! Lasers! AM/FM/infrared transmitters! Detectors! More! Kits/assembly. Catalog \$2.00. **QUANTUM RESEARCH**, 16645-113 Avenue, Edmonton, Alberta T5M 2X2.

**SURVEILLANCE** — Audio/video/intra-red/laser. Law enforcement, industrial, private. 500 item catalog \$7.00. **SECURITY SYSTEMS**, 3017F Hudson, New Orleans, LA 70131.

**REMOTE** car starter plan. 30 pgs. Universal. Simple. Works! \$12.75 **SCHLITZER**, 414 Alva, Grand Prairie, TX 75051.

**SMD** How to use surface mount technology. Build ultra miniature projects! Plans included free, infra red control, and an interesting light display. Send \$15.00 to **CHARLIE'S VIDEO**, Dept SMT, PO 7782, La Sierra, CA 92503.

**FREE** cable and satellite descrambler plans. Send self addressed stamped envelope. **MJH INDUSTRY**, Box 531, Bronx, NY 10461-0208.

**VIDEOCIPHER II**/scanner/cable/satellite modifications books. Catalog — \$3.00. **TELECODE**, PO Box 6426-PE, Yuma, AZ 85366-6426.

**DESCRAMBLER** kits. Complete cable kit \$44.95. Complete satellite kit \$49.95. Add \$5.00 shipping. Free brochure. No New York sales. **SUMMIT PE**, Box 489, Bronx, NY 10465.

## CABLE TV DESCRAMBLERS ★ CONVERTERS ★ and ACCESSORIES.

**SAVE MONEY.  
DON'T RENT!**

**PANASONIC,  
PIONEER, JERROLD, OAK,  
SCIENTIFIC ATLANTA  
AND MORE. LOWEST PRICES.  
FREE CATALOG.**

**(800) 234-1006  
CABLE READY COMPANY**

**SURVEILLANCE** schematic book. Real equipment you can build! \$9.95, **VHS**, 815 Louisa Drive, Santa Rosa, CA 95404.

**UNIDEN BC200/205XLT.** Restore locked-out frequencies. Simple! Plans \$5.00 S.A.S.E. **BOB STEELE**, PO Box 392, Medford, MA 02155.

**CHRISTMAS** star. Design for an 8 point sequencing star. Schematics, PCB layout and part sources included. \$10.00, **CONTINUOUS CONCEPTS**, PO Box 60414, San Diego, CA 92166. CA residents add 7% tax.

**GERNSBACK** — 1932, two tubes, plug-in coils, DX, shortwave radio. Free plan. **BOB RYAN**, PO Box 3039, Anaheim, CA 92803.

**SURVEILLANCE** transmitter kits tune from 65 to 305 MHz. Mains powered duplex, telephone, room, combination telephone/room. Catalog with **Popular Communications, Popular Electronics** and **Radio-Electronics** book reviews of "Electronic Eavesdropping Equipment Design," \$2.00. **SHEFFIELD ELECTRONICS**, 7223A Stony Island Ave., Chicago, IL 60649-2806.



## TUBES - 2000 TYPES DISCOUNT PRICES!

Early, hard-to-find, and modern tubes. Also transformers, capacitors and parts for tube equipment. Send \$2.00 for 28 page wholesale catalog.

**ANTIQUE ELECTRONIC SUPPLY**  
6221 S. Maple Ave. • Tempe, AZ 85283 • 602-820-5411

**CABLE DESCRAMBLERS  
OAK M358 COMBO \$39.95**

Jerrold, Zenith, Hamlin, Sci. Atlanta, Pioneer & MORE! OUR PRICES ARE BELOW WHOLESALE!  
**CABLE PLUS**  
14417 Chase St. #481-B Panorama City, CA 91402  
1-800-822-9955 • Other Info. 1-818-785-4500  
NO CALIF. SALES — DEALERS WANTED

**LIGHTING** — portable lighting system, perfect for stage lighting, exhibits or special events. Plans/application notes \$5.50. **ACS**, 6220 Shallowford Rd. #152, Chattanooga, TN 37421.

**TURN** your C-64 into a motion controller and sensor! Schematic & plans send \$9.00 to: **UNITED ELECTRONICS, INC.**, 39 Ora St., Pittsfield, MA 01201.

**SATELLITE TV** descrambler. Build your own. Easy to follow instructions, parts list, circuit board and wiring diagram. Send: \$9.95. **ABG ENTERPRISES**, 27081C, Halifax, NS, Canada, B3H-4M8.

**AUTOMOTIVE electrical system monitor IC** controlled with case. Complete kit \$6.95. Assembled \$9.95. S&H \$3.00. NY residents add tax. **VRELECTRONICS CORP.**, PO Box 313, Flushing, NY 11365. (718) 357-9091.

**BIG PROFITS** **ELECTRONIC ASSEMBLY BUSINESS**

Start home, spare time. Investment knowledge or experience unnecessary. **BIG DEMAND** assembling electronic devices. Sales handled by professionals. Unusual business opportunity.

**FREE: Complete illustrated literature**  
BARTA PE-00 Box 248  
Walnut Creek, Calif. 94597

**BUSINESS OPPORTUNITIES**

**YOUR own radio station!** Licensed/unlicensed. AM, FM, TV, cable. Information \$1.00 **BROADCASTING**, Box 130-H10, Paradise, CA 95967.

**EASY work!** Excellent pay! Assemble products at home. Call for information (504) 641-8003 Ext. 5730.

**MAKE \$50.00/hr** working evenings or weekends in your own electronics business. Send for free facts. **MJPI INDUSTRY**, Box 531, Bronx, NY 10461.

**MAKE \$75,000.00 to \$250,000.00 yearly or more** fixing IBM color monitors. No investment, start doing it from your home (a telephone required). Information, USA, Canada \$2.00 cash for brochure, other countries \$10.00 US funds. **RANDALL DISPLAY**, Box 2168-H, Van Nuys, CA 91404, USA. Fax (818) 990-7803.

**HOME assembly work** available! Guaranteed easy money! Free details! **HOMEWORK-P**, Box 520, Danville, NH 03819.

**UNLIMITED income** operating your own business. Opportunity is knocking. Free information: **JUPITER ENTERPRISES**, PO Box 541782 Dept. R, Dallas, TX 75354-1782.

**\$ DISTRIBUTORS** needed \$. New mini satellite antenna. Tremendous demand. 100% profit. No experience necessary. Serious inquiries only. 1 (800) 762-7952 Ex 774 24 hours.

**HUGE profits** best home businesses. Free details 20 cent stamps. **RCF**, Box 177-P, Mastic, NY 11950.

**MONEY! Money! Money!** Booklet outlines 30 methods to make and save money through credit cards, taxes, coupons, etc. \$7.95 **D.D.B. ENTERPRISES**, PO Box 59287, Pittsburgh, PA 15210.

**Great money in VCR repair!**

Home study. Learn high-profit repairs without investing in high-tech instruments.  
**FREE BOOKLET: 800-223-4542.**

Name \_\_\_\_\_  
Address \_\_\_\_\_  
City \_\_\_\_\_ State \_\_\_\_\_ Zip \_\_\_\_\_

The School of VCR Repair, 2245 Perimeter Park, Dept. VL341 Atlanta, Georgia 30341





**ANNOUNCING:**  
AN END  
TO  
HIGH MONTHLY  
CABLE FEES!



All Jerrold, Oak, Hamlin, Zenith, Scientific Atlanta, Magnavox and all specialized cable equipment available for shipment within 24 hours. For fast service MC/VISA or C.O.D. telephone orders accepted. 60 Day Guarantee (Quantity Discounts). Send self-addressed Stamped envelope.

**1-800-232-5017**

 **C.O.D. ORDERS ACCEPTED** 

**CABLE-TRONICS, INC.**  
1304 E. Algonquin Road Suite 501  
Algonquin, Illinois 60102

**BEST BY MAIL**  
Rates: Write National, Box 5, Sarasota, FL 34230

**HEALTH & BEAUTY**

**SHOCKING REPORT REVEALS** lies your gynecologist tells about vaginal infections/health! \$9.69. **MEDIFAX**, Box 53(PE), Franklin, VT 05457.

**LOSE WEIGHT WHILE Sleeping!** Revolutionary! No Dieting/Exercise! Free Hawaiian Vacation For Trying. 1-800-937-3096X121.

**HAIR LOSS? INFORMATION** about new treatments. Peter Proctor, MD 1-800-926-1752.

**FINANCIAL**

**CASH LOANS UNSECURED** to \$10,000. No Credit Check. 1-800-388-8878, Dealer Inquiries Welcome.

**1% INTEREST LOANS;** No Limit! No Refusal Guarantee! Write: JEF, Box 2342(PE), Ada, OK 74820.

**MONEYMAKING OPPORTUNITIES**

**\$48,900 INCOME and HAWAII!!!** Free Report: 480(PE), Hawi, Hawaii, 96719.

**OF INTEREST TO ALL**

**VCR REPAIR - TECHNICIANS' SECRETS REVEALED.** Do it yourself, literally save hundreds. Complete easy to follow manual. Includes 800 numbers of all major manufacturers for ordering parts direct. Schematics/Diagrams. More. \$9.95 to: **ACME VCR REPAIR**, 2104 Renwick Lane, Antioch, CA 94509.

**SAVE YOUR BATTERY.** Order New Headlight Reminder. Easy to install. \$3. DC Distributors, 31 1/2 Cedar St., New Castle, AL 35119.

★★★★PRESENTING★★★★  
**CABLE TV DESCRAMBLERS**  
★★★★STARRING★★★★  
**JERROLD, HAMLIN, OAK**  
AND OTHER FAMOUS MANUFACTURERS

- FINEST WARRANTY PROGRAM AVAILABLE
- LOWEST RETAIL/WHOLESALE PRICES IN U.S.
- ORDERS SHIPPED FROM STOCK WITHIN 24 HRS.
- ALL MAJOR CREDIT CARDS ACCEPTED

FOR FREE CATALOG ONLY **1-800-345-8927**  
FOR ALL INFORMATION **1-818-709-9937**

**PACIFIC CABLE CO., INC.**  
7325 1/2 Reseda Blvd., Dept. 2007  
Reseda, CA 91335

**T.V. FILTERS**

T.V. notch filters, phone recording equipment, brochure \$1.00. **MICRO Thinc.**, Box 63/6025, Margate, FL 33063. (305) 752-9202.

**WANTED**

**INVENTORS!** Confused? Need help? Call **IMPAC** for free information package. USA/Canada: 1 (800) 225-5800. (24 hours!).

**ANTIQUE RADIO CLASSIFIED**  
**Free Sample!**  
Antique Radio's  
Largest Circulation Monthly.  
Articles, Ads & Classifieds.  
6-Month Trial: \$15. 1-Yr: \$27(\$40-1st Class).  
A.R.C., P.O. Box 802-L8, Carlisle, MA 01741



**INVENTIONS/new products/ideas** wanted: Call **TLCI** for free information/Inventors Newsletter 1 (800) 468-7200 24 hours/day — USA/Canada.

**WANTED:** McIntosh and Marantz tube type Hi-Fi and old JBL, Altec, Tannoy, Electro-Voice Patrician and Western Electric speakers. **JOHN**, 1 (800) 356-4434.

**WANTED** Eprom erasure and copier or help in finding a kit (618) 271-1727.

**EDUCATION/INSTRUCTION**

**VCR repair.** Save money — make big profits! Learn how from *How to Keep Your VCR Alive*. "This detailed, step-by-step manual enables anyone with no previous knowledge or experience to fix most VCR problems easily, quickly, and inexpensively with a few simple tools." — Small Press Review. Highly recommended by *Popular Electronics*, *Modern Electronics*, *Popular Communications*, *Electronic Servicing*, *Videomaker*, *Library Journal*, and many other electronics and video magazines. "Far better than Viejo at 1/7 the cost." 400+ page book, with 724 illustrations, plus professional head-cleaning tool, \$24.95. Check B. Daltons and Waldenbooks. Or write **WORTHINGTON PUBLISHING**, PO Box 16691H, Tampa, FL 33687-6691. Or call 1 (800) 233-8277 toll-free for Visa or MC. Money-back satisfaction guarantee!

**LEARN color television in 2hrs** VHS-tape workbook **NTSC** \$37.00 + \$3.50 **guaranteed**. **WILLIAMSON LABS**, 6613 Lynndale Dr., Raleigh, NC 27612. (919) 848-8955.

**LEARN electronics & digital.** Teach yourself with the Crash Course in Electronics Technology (\$21.95 plus \$2.50 S&H) and Crash Course in Digital Technology (\$19.95 plus \$2.50 S&H). Programmed self study texts. Good introduction, refresher or update. Both \$37.75 plus \$4.00 S&H. Send check or money order to **TSI**, 6050 NW 68th Street, Parkland, FL 33067.

**FREE CATALOG!**  
**1-800-648-7938**  
**JERROLD HAMLIN OAK ETC**  
**CABLE TV**  
**DESCRAMBLERS**

- Special Dealer Prices!
- Compare our Low Retail Prices!
- Guaranteed Prices & Warranties!
- Orders Shipped Immediately!

**REPUBLIC CABLE PRODUCTS, INC.**  
4080 Paradise Rd. #15, Dept. PE1091  
Las Vegas, NV 89109  
For all other information (702) 362-9026



**CONVENTIONS**

**THE Greater Louisville Hamfest and Computer Convention.** Saturday, September 28, and Sunday September 29, 1991. New and used equipment, forums and testing. For additional information write Post Office Box 34444-P, Louisville, KY 40232-4444 or call (502) 964-1132.

**CABLE EQUIPMENT**

**CABLE TV secrets** — the outlaw publication the cable companies tried to ban. HBO, Movie Channel, Showtime, descramblers, converters, etc. Suppliers list included. \$9.95. **CABLE FACTS**, Box 711-H, Pataskala, OH 43062.



## SOUND EFFECTS GADGET

(Continued from page 77)

allows you to install the microphone in the tube and mount the board to the outside of the tube. The speaker must be attached to the circuit by a 3-foot (or longer) length of speaker wire. That is done to help prevent the microphone from picking up vibrations from the speaker; otherwise the resulting feedback would produce a constant hum that won't stop until power is removed from the circuit.

Although a switch is not included in the schematic diagram (Fig. 2) because a 9-volt battery is easy enough to connect and disconnect, one can be included in the circuit between the battery and the circuit. But be advised that if you want to install the board and the battery in a case of their own, where they'll be out of sight, then you'll need the switch.

Once the board is assembled, check your work for proper wiring and soldering, and then connect the battery and test the circuit. You should hear the sound of your voice coming from the speaker when you talk into the microphone. Actually, you only have to talk near the microphone and it will pick it up—electret microphones are extremely sensitive. If you have a problem, it's likely that you've made a mistake in assembling the board or left out a connection, rather than a defective component. Upon initial power-up of the prototype, it didn't work. It turned out that a connection was missed; as soon as the connection was made, the unit worked.

After you're sure that the amplifier board is working properly, it is time to prepare the tube, the spring, the cups, and the tacks. First cut the tube to length. It's a good idea to wrap tape around the ends of the tube to prevent it from unraveling. Now you can paint the tube if you wish. Next, take the larger cup, and make sure that it is fitted inside one of the smaller cups. There should be a space of at least an inch between the two bottoms. Cut off the portion of the larger cup that sticks out of the smaller one.

Separate the two cups and, with a sharp object, pierce the bottom of the larger cup from the inside out, but only make the hole large enough to fit the end of a tapered object, such as a pushbutton pen. Make sure that the tapered object is smaller than the diame-

ter of the microphone at one end and larger than it at the other. Enlarge the hole in small increments, testing the fit of the microphone as you go (see Fig. 4A). Then, when the microphone can be snugly fit into the hole, push it in and wrap a narrow piece of tape around it and the paper that was pushed out of the hole to hold the microphone in place (see Fig. 4B).

Test fit the two smaller cups in the ends of the tube, and approximate the distance between the bottoms of the two cups. Bend the tips of the thumb tacks to form hooks and insert them in the bottoms of the smaller cups (as shown in Fig. 3). Then stretch the spring so that it's just slightly shorter than the distance between the bottoms of the cups. Now, holding one of the cups in an upright position, hang the spring from the hook and lower it into the tube as shown in Fig. 5. Grab the free end of the spring with your fingers, a tweezer, or long-nose pliers, and pull it far enough out of the tube to hook to the other cup, and slowly slide that cup into the tube.

The spring should now be slightly stretched between the two cups, yet loose enough so that it can easily vibrate. The tube can now be tested on its own, by merely talking into one of the cups. It should add an unusual echo and rattle to your voice. You may have to experiment by stretching the spring to different lengths; if you accidentally make it too long, cut off the extra length and make a new loop in the end using pliers.

After the tube is working to your satisfaction, you should stretch each cup out of the tube and put a small drop of glue where the spring is hooked onto the tacks. That way, the spring won't snap off the hooks if you give the tube a sudden knock. Now insert the cup with the microphone attached to it into one end of the tube. Apply power to the amplifier circuit, and speak into the end of the tube that's opposite the microphone. The sound should be quite unusual.

Now you can mount the board and the battery inside a small project case or cardboard box, and attach it to the outside of the tube. Otherwise, a simple rubber band can be used to hold the circuit board and battery to the tube. As for the speaker, it can be mounted inside some kind of case if you like. Just make sure that it's acoustically transparent so that it does not muffle the sound.

## FUN WITH ELECTRONICS



- ◀  **160—COIL DESIGN & CONSTRUCTION MANUAL** .... \$5.95. How to make RF, IF, audio and power coils; chokes and transformers. Practically every possible type is discussed.

- PCP113—THE PC MUSIC HANDBOOK** .... \$13.95. Learn the basics of computer music systems. For the professional musician, gifted amateur or just plain curious.



- ◀  **BP297—LOUDSPEAKERS FOR MUSICIANS** .... \$6.25. Loudspeaker design from the musician's point of view! All you need to know, and you should be able to design your own after reading this.

- BP277—HIGH POWER AUDIO AMPLIFIER CONSTRUCTION** .... \$6.25. Here's background and practical design information on high power audio amplifiers capable of 300 ± 400 watts r.m.s. You'll find MOSFET and bipolar output transistors in inverting and non-inverting circuits.



- ◀  **BP302—A CONCISE USER'S GUIDE TO LOTUS 1-2-3 RELEASE 3.1** .... \$6.25. If you are a PC user and want to upgrade to Lotus 1-2-3 release 3.1, this book can teach you how to do that in the shortest and most effective way.

- BP298—A CONCISE INTRODUCTION TO THE MACINTOSH SYSTEM AND FINDER** .... \$6.25. This introduction for those new to the Mac, this book also serves as a quick refresher for experienced owners that have not used the machine in some time.



MAIL TO: **Electronic Technology Today, Inc.**  
P.O. Box 240  
Massapequa Park, NY 11762-0240

### SHIPPING CHARGES IN USA AND CANADA

\$0.01 to \$5.00	... \$1.50	\$30.01 to \$40.00	... \$5.50
\$5.01 to \$10.00	... \$2.50	\$40.01 to \$50.00	... \$6.50
\$10.01 to \$20.00	... \$3.50	\$50.01 and above	... \$8.00
\$20.01 to \$30.00	... \$4.50		

**SORRY, No orders accepted outside of USA and Canada**

Total price of merchandise	..... \$	_____
Shipping (see chart)	..... \$	_____
Subtotal	..... \$	_____
Sales Tax (NYS only)	..... \$	_____
Total Enclosed	..... \$	_____

Name \_\_\_\_\_  
Address \_\_\_\_\_  
City \_\_\_\_\_ State \_\_\_\_\_ Zip \_\_\_\_\_

OCTOBER 1991

# ADVERTISING INDEX

POPULAR ELECTRONICS magazine does not assume any responsibility for errors that may appear in the index below.

Free Information No.	Page		Page
7	AMC Sales	15	—
9	AW Sperry	7	5
—	Amazing Concepts	18	—
—	Antique Electronic Supply	103	—
—	Antique Radio Classified	104	—
—	Barta	104	6
—	CBC International	103	—
—	CIE	21	—
—	Cable Plus	104	12
—	Cable Ready Company	103	8
—	Cable-Tronics	104	—
—	Command Productions	15	15
11	Cook's Institute	24	—
—	Elec. Industry Association	CV3	—
—	Electronic Tech. Today	CV2, 105	—
—	Electronics Book Club	99	—
—	Electronics Engineers B.C.	3	—
—	Firestik II	103	13, 14
	Grantham College	23	
	Heathkit	13	
	HighText Publications, Inc.	95	
	ISCET	89	
	Monitoring Times	93	
	Mouser	17	
	NAS/TransWorld	103	
	NRI Schools	8	
	Number One Systems Ltd.	17	
	Protel Technology	25	
	Pacific Cable	104	
	People's College	5	
	Phillips Tech	103	
	R.E. Video Offer	CV4	
	Republic Cable	104	
	Silicon Valley Surplus	103	
	The School Of VCR Repair	104	
	Viejo Publications	24, 89	

## ADVERTISING SALES OFFICE

Gernsback Publications, Inc.  
500-B Bi-County Blvd.  
Farmingdale, NY 11735  
1-(516) 293-3000  
President: Larry Steckler  
Assistant to the President: Christina Estrada

For Advertising ONLY  
516-293-3000  
Fax 1-516-293-3115

Larry Steckler  
publisher  
Arlene Fishman  
advertising director  
Denise Haven  
advertising assistant  
Kelly McQuade  
credit manager

Customer Service/Order Form  
1-800-435-0715  
1-800-892-0753  
7:30 AM - 8:30 PM EST

### SALES OFFICES

#### EAST/SOUTHEAST

Stanley Levitan, Eastern Sales Manager  
1 Overlook Ave.  
Great Neck, NY 11021  
1-516-487-9357, 1-516-293-3000  
Fax 1-516-487-8402

#### MIDWEST/Texas/Arkansas/Okla.

Ralph Bergen, Midwest Sales Manager  
540 Frontage Road—Suite 204  
Northfield, IL 60093  
1-708-446-1444  
Fax 1-708-559-0562

#### PACIFIC COAST/Mountain States

Marvin Green, Pacific Sales Manager  
5430 Van Nuys Blvd. Suite 316  
Van Nuys, CA 91401  
1-818-986-2001  
Fax 1-818-986-2009

## WIRELESS VOICE

(Continued from page 35)

chrihanish station started sending. Its signal was weak, but the Machrihanish station was heard at Brant Rock. For the first time in history, two-way wireless telegraphy had spanned the Atlantic Ocean!

The exchange of messages between the two stations continued fairly regularly for several weeks, depending on the condition of the ionosphere. The onset of summer made regular communications impossible at the frequencies used. Trans-Atlantic communication was not resumed until October 1906. The communication capabilities of the Fessenden system were demonstrated for several months to a number of scientific, commercial, and military observers until the antenna at the Machrihanish station was destroyed by a fierce storm.

Other exciting developments were also occurring at Brant Rock during the late summer of 1906. The Alexanderson-designed alternator was delivered and tests were begun. Again, neither the frequency produced nor the output power met specifications. Fessenden would have to redesign the alternator

himself. The alternator was rebuilt in NESCO's shop incorporating Fessenden's numerous modifications. Finally, in the fall of 1906, approximately 500 watts of output power at a frequency of 75 kHz was obtained.

Successful wireless telephony was established between Brant Rock and Plymouth, a distance of 11 miles. Communications also took place between Brant Rock and a small fishing boat located in the ocean 12 miles away. Fessenden, however, had a much grander demonstration in mind.

**The First Broadcast.** Numerous ships at sea were using the Fessenden liquid-barretter receiving system, some legally and many illegally as far as patent rights were concerned. That provided Fessenden with a golden opportunity for his demonstration. The ships were notified by telegraph from Brant Rock to listen for a special transmission on Christmas Eve in that year of 1906, but no hint was given concerning what the transmission might be.

At the appointed hour, the radio operators on the ships were amazed to hear Reginald Fessenden's voice. Next came phonograph music followed by a violin solo performed by Fessenden. A

reading of the Christmas story from the Bible and an announcement that a similar transmission was planned for New Year's Eve concluded the first wireless broadcast in history.

The listeners were encouraged to send in reception reports to Brant Rock. Reports of the Christmas Eve broadcast were received from ships as far away as Norfolk, Virginia. The New Year's Eve transmission was received in the West Indies.

Amazing as Fessenden's wireless telephony demonstrations were, the world did not beat a path to his door. Telegraphy was more reliable for long-distance commercial and military message-handling purposes. No need existed for wireless telephony in 1906.

Commercial broadcasting to homes would not be recognized as economically practical until after World War I. Then, relatively easy-to-operate and reliable receivers could be produced at a price the public could afford. In addition, means for generating large amounts of power at higher, more effective frequencies were available. "Radio" broadcasting as we know it today, nevertheless, can trace its beginnings to that 1906 Fessenden broadcast from Brant Rock, Massachusetts. ■

# The Importance Of Setting Standards.



Without standardization in electronics, television wouldn't be seen, radio wouldn't be heard, computers wouldn't share information.

Fortunately the Electronic Industries Association (EIA) has been setting electronics standards since 1924 for everything from early tube radios to today's cellular telephones and stereo TV's.

Standards create *markets and jobs*. Today EIA, an internationally accredited standards making body, is helping to make HDTV a reality by working with the federal government and other industry organizations, to develop a timely, uniquely American transmission standard. For home automation,

EIA also is close to completing a standard which will permit all home electronic products to communicate with each other.

Our more than 1,000 member companies are manufacturers representing every facet of the American electronics industry—from defense to consumer products.

EIA is proud of the contributions it has made through its standards making process toward the growth and vitality of the U.S. electronics industries.

Setting the standard for more than 66 years.



**ELECTRONIC INDUSTRIES ASSOCIATION**

1722 Eye Street, N.W., Suite 300, Washington, D.C. 20006

# Countersurveillance

**Never before has so much professional information on the art of detecting and eliminating electronic snooping devices—and how to defend against experienced information thieves—been placed in one VHS video. If you are a Fortune 500 CEO, an executive in any hi-tech industry, or a novice seeking entry into an honorable, rewarding field of work in countersurveillance, you must view this video presentation again and again.**

*Wake up!* You may be the victim of stolen words—precious ideas that would have made you very wealthy! Yes, professionals, even rank amateurs, may be listening to your most private conversations.

*Wake up!* If you are not the victim, then you are surrounded by countless victims who need your help if you know how to discover telephone taps, locate bugs, or “sweep” a room clean.

There is a thriving professional service steeped in high-tech techniques that you can become a part of! But first, you must know and understand Countersurveillance Technology. Your very first insight into this highly rewarding field is made possible by a video VHS presentation that you cannot view on broadcast television, satellite, or cable. It presents an informative program prepared by professionals in the field who know their industry, its techniques, kinks and loopholes. Men who can tell you more in 45 minutes in a straightforward, exclusive talk than was ever attempted before.

## Foiling Information Thieves

Discover the targets professional snoopers seek out! The prey are stock brokers, arbitrage firms, manufacturers, high-tech companies, any competitive industry, or even small businesses in the same community. The valuable information they filch may be marketing strategies, customer lists, product formulas, manufacturing techniques, even advertising plans. Information thieves eavesdrop on court decisions, bidding information, financial data. The list is unlimited in the mind of man—especially if he is a thief!

You know that the Russians secretly installed countless microphones in the concrete work of the American Embassy building in Moscow. They converted



**CALL  
TOLL  
FREE**

**1-800-522-6260**

**HAVE YOUR  
VISA or MC CARD  
AVAILABLE**

what was to be an embassy and private residence into the most sophisticated recording studio the world had ever known. The building had to be torn down in order to remove all the bugs.

## Stolen Information

The open taps from where the information pours out may be from FAX's, computer communications, telephone calls, and everyday business meetings and lunchtime encounters. Businessmen need counselling on how to eliminate this information drain. Basic telephone use coupled with the user's understanding that someone may be listening or recording vital data and information greatly reduces the opportunity for others to purloin meaningful information.

The professional discussions seen on the TV screen in your home reveals how to detect and disable wiretaps, midget radio-frequency transmitters, and other bugs, plus when to use disinformation to confuse the unwanted listener, and the technique of voice scrambling telephone communications. In fact, do you know how to look for a bug, where to look for a bug, and what to do when you find it?

Bugs of a very small size are easy to build and they can be placed quickly in a matter of seconds, in any object or room. Today you may have used a telephone handset that was bugged. It probably contained three bugs. One was a phony bug to fool you into believing you found a bug and secured the telephone. The second bug placates the investigator when he finds the real thing! And the third bug is found only by the professional, who continued to search just in case there were more bugs.

The professional is not without his tools. Special equipment has been designed so that the professional can sweep a room so that he can detect voice-activated (VOX) and remote-activated bugs. Some of this equipment can be operated by novices, others require a trained countersurveillance professional.

The professionals viewed on your television screen reveal information on the latest technological advances like laser-beam snoopers that are installed hundreds of feet away from the room they snoop on. The professionals disclose that computers yield information too easily.

This advertisement was not written by a countersurveillance professional, but by a beginner whose only experience came from viewing the video tape in the privacy of his home. After you review the video carefully and understand its contents, you have taken the first important step in either acquiring professional help with your surveillance problems, or you may very well consider a career as a countersurveillance professional.

## The Dollars You Save

To obtain the information contained in the video VHS cassette, you would attend a professional seminar costing \$350-750 and possibly pay hundreds of dollars more if you had to travel to a distant city to attend. Now, for only \$49.95 (plus \$4.00 P&H) you can view *Countersurveillance Techniques* at home and take refresher views often. To obtain your copy, complete the coupon below or call toll free.

<b>RADIO-ELECTRONICS VIDEO OFFER</b>		<b>PE</b>
500-B Bi-County Blvd. Farmingdale, NY 11735		
Please rush my copy of the Countersurveillance Techniques Video VHS Cassette for \$49.95 plus \$4.00 for postage and handling.		
No. of Cassettes ordered _____	Amount of payment \$ _____	
Bill my <input type="checkbox"/> VISA <input type="checkbox"/> MasterCard	Card No. _____	
Expire Date _____ / _____	Signature _____	
Name _____	Address _____	
City _____ State _____	ZIP _____	
All payments in U.S.A. funds. Canadians add \$4.00 per VHS cassette. No foreign orders. New York State residents add applicable sales tax.		