

Protect Your Air Conditioner From Power Line Problems

48784

# Popular Electronics

AUGUST 1991

## DESIGN YOUR OWN ROBOT

Using nature as a model, researchers can create complex, behavior-based, mobile robots. Using the same principles, you can build your own simple yet fascinating demonstration robot



## BUILD THE MAGIC-FILM SPEAKER

Learn about the properties of piezoelectric film, and how it can be used to create a most unusual speaker

## ELECTRONIC LIMBS

New advances in electronics make modern artificial limbs work nearly as well as the real things

## WIRE ANTENNAS FOR HAMS AND SWL's

Though these simple designs have been around since the dawn of radio, their low cost and easy construction make them practical today

A  
**GERNSBACK**  
PUBLICATION



\$2.95 U.S.  
\$3.75 CANADA

3 NEW  
FactCards  
IN THIS ISSUE

#BXBDCCCH CAR-RT SORT \*\* CR24  
#60506DHM997GA006# FEB92 15  
ROBERT DAHM RESP  
997 GRAND AVE D69  
AURORA, IL 60506

# Electronics Paperback Books

GREAT PAPERBACKS AT SPECIAL PRICES

**BP248—TEST EQUIPMENT CONSTRUCTION** ..... \$5.95. Details construction of simple, inexpensive, but extremely useful test equipment. AF Gen, Test Bench Ampl, Audio Millivoltmeter, Transistor Tester and six more.



**BP267—HOW TO USE OSCILLOSCOPES AND OTHER TEST EQUIPMENT** ..... \$6.95. Mastering the oscilloscope is not really too difficult. This book explains all the standard controls and functions. Other equipment is also described.



**BP265—MORE ADVANCED USES OF THE MULTIMETER** ..... \$5.95. Use these techniques to test and analyze the performance of a variety of components. Also see how to build add-ons to extend multimeter capabilities.



**BP256—INTRO TO LOUDSPEAKERS AND ENCLOSURE DESIGN** ..... \$5.95. We explore the variety of enclosure and speaker designs in use today so the reader can understand the principles involved.

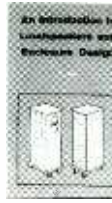

**BP263—A CONCISE INTRO TO dBASE** ..... \$6.95. The dBASE series of programs are probably the best known database programs for microcomputers. This book is designed to help you get started working with them.

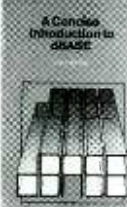

**BP260—CONCISE INTRO TO OS/2** ..... \$5.95. If you are a multitasking PC user and want to get the most out of your computer, then you must learn its OS/2 operating system. This book shows you just how to do that, quickly and easily.



**BP249—MORE ADVANCED TEST EQUIPMENT CONSTRUCTION** ..... \$6.95. Eleven more test equipment construction projects. They include a digital voltmeter, capacitance meter, current tracer and more.



Digital Audio Projects

**BP245—DIGITAL AUDIO PROJECTS** ..... \$5.95. Practical circuits to build and experiment with. Includes A/D converter, input amplifier, digital delay line, compander, echo effect and more.



**BP247—MORE ADVANCED MIDI PROJECTS** ..... \$5.95. Circuits included are a MIDI indicator, THRU box, merge unit, code generator, pedal, programmer, channelizer, and analyzer.



**BP257—INTRO TO AMATEUR RADIO** ..... \$6.95. Amateur is a unique and fascinating hobby. This book gives the newcomer a comprehensive and easy to understand guide to the subject.



**PCP102—INTRODUCING DIGITAL AUDIO** ..... \$9.95. Covers all kinds of digital recording methods—CD, DAT and Sampling. Bridges the gap between the technician and the enthusiast. Principles and methods are explained.

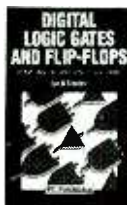

**PCP107—DIGITAL LOGIC GATES AND FLIP-FLOPS** ..... \$10.00. Thorough treatment of gates and flip-flops for enthusiasts, student and technicians. Only a basic knowledge of electronics is needed.

**BP251—COMPUTER HOBBYISTS HANDBOOK** ..... \$8.95. A wrapup of everything the computer hobbyist needs to know in one easy to use volume. Provides a range of useful reference material in a single source.

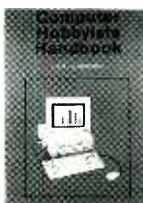

**PCP108—COMPUTERS AND MUSIC** ..... \$9.95. Explains the basics of computers and music with no previous knowledge of computers needed. Covers types of music software and explains how to set up your own computer music studio.

- BP195—INTRODUCTION TO SATELLITE TV** ..... \$9.95. A definitive introduction to the subject written for the professional engineer, electronics enthusiast, or others who want to know more before they buy. 8 x 10 in.
- BP190—ADVANCED ELECTRONIC SECURITY PROJECTS** ..... \$5.95. Includes a passive infra-red detector, a fiber-optic loop alarm, computer-based alarms and an unusual form of ultrasonic intruder detector.
- BP235—POWER SELECTOR GUIDE** ..... \$10.00. Complete guide to semiconductor power devices. More than 1000 power handling devices are included. They are tabulated in alpha-numeric sequence, by technical specs. Includes power diodes, Thyristors, Triacs, Power Transistors and FET's.
- BP234—TRANSISTOR SELECTOR GUIDE** ..... \$10.00. Companion volume to BP235. Book covers more than 1400 JEDEC, JIS, and brand-specific devices. Also contains listing by case type, and electronic parameters. Includes Darlingtons transistors, high-voltage devices, high-current devices, high power devices.
- BP99—MINI-MATRIX BOARD PROJECTS** ..... \$5.50. Here are 20 useful circuits that can be built on a mini-matrix board that is just 24 holes by ten copper-foil strips.
- BP82—ELECTRONIC PROJECTS USING SOLAR CELLS** ..... \$5.50. Circuits with applications around the home that are powered by the energy of the sun. Everything from radio receivers, to a bicycle speedometer, to timers, audio projects and more.
- BP117—PRACTICAL ELECTRONIC BUILDING BLOCKS—Book 1** ..... \$5.75. Oscillators, Timers, Noise Generators, Rectifiers, Comparators, Triggers and more.
- BP184—INTRO TO 68000 ASSEMBLY LANGUAGE** ..... \$6.95. The 68000 is a great new breed of microprocessor. Programming in assembly language increases the running speed of your programs. Here's what you need to know.
- BP179—ELECTRONIC CIRCUITS FOR THE COMPUTER CONTROL OF ROBOTS** ..... \$7.50. Data and circuits for interfacing the computer to the robot's motors and sensors.

- BP239—GETTING THE MOST FROM YOUR MULTIMETER** ..... \$5.95. Covers basics of analog and digital meters. Methods of component testing includes transistors, thyristors, resistors, capacitors and other active and passive devices.
- BP97—IC PROJECTS FOR BEGINNERS** ..... \$5.50. Power supplies, radio and audio circuits, oscillators, timers, switches, and more. If you can use a soldering iron you can build these devices.
- BP37—50 PROJECTS USING RELAYS, SCR'S & TRIACS** ..... \$5.50. Build priority indicators, light modulators, warning devices, light dimmers and more.
- RADIO—100 RADIO HOOKUPS** ..... \$3.00. Reprint of 1924 booklet presents radio circuits of the era including regenerative, neutrodyne, reflex & more.
- BP42—SIMPLE LED CIRCUITS** ..... \$5.50. A large selection of simple applications for this simple electronic component.
- BP127—HOW TO DESIGN ELECTRONIC PROJECTS** ..... \$5.75. Helps the reader to put projects together from standard circuit blocks with a minimum of trial and error.
- BP122—AUDIO AMPLIFIER CONSTRUCTION** ..... \$5.75. Construction details for preamps and power amplifiers up through a 100-watt DC-coupled FED amplifier.
- BP92—CRYSTAL SET CONSTRUCTION** ..... \$5.50. Everything you need to know about building crystal radio receivers.
- BP45—PROJECTS IN OPTOELECTRONICS** ..... \$5.50. Includes infra-red detectors, transmitters, modulated light transmission and photographic applications.

**BP185—ELECTRONIC SYNTHESIZER CONSTRUCTION** ..... \$5.95. Use this book to learn how to build a reasonably low cost, yet worthwhile monophonic synthesizer and learn a lot about electronic music synthesis in the process

CHECK OFF  
THE BOOKS YOU WANT

**ELECTRONIC TECHNOLOGY TODAY INC.**  
P.O. Box 240, Massapequa Park, NY 11762-0240

Name \_\_\_\_\_  
Address \_\_\_\_\_  
City \_\_\_\_\_ State \_\_\_\_\_ Zip \_\_\_\_\_

P-891

**SHIPPING CHARGES IN  
USA AND CANADA**

\$0.01 to \$5.00 ..... \$1.50  
\$5.01 to \$10.00 ..... \$2.50  
\$10.01 to 20.00 ..... \$3.50  
\$20.01 to 30.00 ..... \$4.50  
\$30.01 to 40.00 ..... \$5.50  
\$40.01 to 50.00 ..... \$6.50  
\$50.01 and above ... \$8.00

**SORRY No orders accepted  
outside of USA & Canada**

Number of books ordered

Total price of merchandise ..... \$ \_\_\_\_\_  
Sales Tax (New York State Residents only) ..... \$ \_\_\_\_\_  
Shipping (see chart) ..... \$ \_\_\_\_\_

**All payments must  
be in U.S. funds**

Total Enclosed \$ \_\_\_\_\_

# Popular Electronics<sup>®</sup>

THE MAGAZINE FOR THE ELECTRONICS ACTIVIST!

## CONSTRUCTION ARTICLES

<b>DESIGN YOUR OWN ROBOT</b> .....	Jonathan Connell	25
<i>Learn how complex robots are designed and built, then build a simple yet fascinating demonstration robot of your own</i>		
<b>BUILD THE COMPRESSOR-MATE</b> .....	James V. Jordan and John Yacono	35
<i>Extend the life of your air conditioner, refrigerator, or other compressor-based appliance with this project</i>		
<b>BUILD THE MAGIC FILM SPEAKER</b> .....	Marc Spiwak	56
<i>Have fun experimenting with this very unusual speaker</i>		

## FEATURE ARTICLES

<b>WIRE ANTENNAS FOR HAMS AND SWL'S</b> .....	Joseph J. Carr	49
<i>These antennas, although developed long ago, are still useful today</i>		
<b>ELECTRONIC LIMBS</b> .....	Martin Knight	53
<i>A revolutionary bioelectric-sensor system brings feeling and near-normal movement to artificial limbs</i>		
<b>ALL ABOUT OSCILLATORS</b> .....	Ron C. Johnson	59
<i>These simple sinewave generators can come in handy when working with audio and other circuits</i>		

## PRODUCT REVIEWS

<b>GIZMO</b> .....		37
<i>Including: Sony Handycam Marine Pack, Pioneer LaserKaroke, Heath Reflex Wireless Security System, and much more</i>		
<b>HANDS-ON REPORT</b> .....		61
<i>PCBoards Printed-Circuit Board Design Software</i>		
<b>PRODUCT TEST REPORT</b> .....	Len Feldman	64
<i>Sony CCD-TR4 Camcorder</i>		

## COLUMNS

<b>THINK TANK</b> .....	John Yacono	20
<i>The bitgrabber revisited</i>		
<b>ANTIQUÉ RADIO</b> .....	Marc Ellis	66
<i>Reading the mail</i>		
<b>COMPUTER BITS</b> .....	Jeff Holtzman	68
<i>The 386 revolution</i>		
<b>FUN SOFTWARE</b> .....	Fred Blechman	70
<i>Curses, Red Baron</i>		
<b>CIRCUIT CIRCUS</b> .....	Charles D. Rakes	72
<i>More NE602-based circuits</i>		
<b>DX LISTENING</b> .....	Don Jensen	76
<i>Change comes to Albania</i>		
<b>HAM RADIO</b> .....	Joseph J. Carr	78
<i>Improving reception in the crowded VHF/UHF bands</i>		
<b>SCANNER SCENE</b> .....	Marc Saxon	80
<i>Top value in a mid-range scanner</i>		

## DEPARTMENTS

<b>EDITORIAL</b> .....	Carl Laron	2
<b>LETTERS</b> .....		4
<b>ELECTRONICS LIBRARY</b> .....		6
<b>NEW PRODUCTS</b> .....		12
<b>POPULAR ELECTRONICS MARKET CENTER</b> .....		48A
<b>ADVERTISER'S INDEX</b> .....		92

**Popular Electronics** (ISSN 1042-170X) Published monthly by Gernsback Publications, Inc., 500-B B-County Boulevard, Farmingdale, NY 11735. Second-Class postage paid at Farmingdale, NY and at additional mailing offices. One-year, twelve issues, subscription rate U.S. and possessions \$21.95, Canada \$29.94 (includes G.S.T. Canadian Goods and Services Tax Registration No. R125186280), all other countries \$29.45. Subscription orders payable in U.S. funds only. International Postal Money Order, or check drawn on a U.S. bank. U.S. single copy price \$2.95. © 1991 by Gernsback Publications, Inc. All rights reserved. **Hands-on Electronics** and **Gizmo** trademarks are registered in U.S. and Canada by Gernsback Publications, Inc. **Popular Electronics** trademark is registered in U.S. and Canada by Electronics Technology Today, Inc. and is licensed to Gernsback Publications. Printed in U.S.A.

Postmaster: Please send address changes to **Popular Electronics**, Subscription Dept., P.O. Box 338, Mount Morris, IL 61054-9932.

A stamped self-addressed envelope must accompany all submitted manuscripts and/or artwork or photographs if their return is desired should they be rejected. We disclaim any responsibility for the loss or damage of manuscripts and/or artwork or photographs while in our possession or otherwise.

As a service to readers, **Popular Electronics** publishes available plans or information relating to newsworthy products, techniques, and scientific and technological developments. Because of possible variances in the quality and condition of materials and workmanship used by readers, **Popular Electronics** disclaims any responsibility for the safe and proper functioning of reader-built projects based upon or from plans or information published in this magazine.

**Larry Steckler**

*EHF, CET*

*Editor-In-Chief and Publisher*

## EDITORIAL DEPARTMENT

**Carl Laron**

*Editor*

**Robert A. Young**

*Associate Editor*

**John J. Yacono**

*Associate Editor*

**Byron G. Wels, K2AVB**

*Associate Editor*

**Teri Scaduto**

*Assistant Editor*

**Kathy Terenzi**

*Editorial Assistant*

**Marc Spiwak**

*Editorial Associate*

**Fred Blechman**

**Joseph J. Carr, K4IPV**

**Marc Ellis**

**Len Feldman**

**Jeffrey K. Holtzman**

**Don Jensen**

**Charles D. Rakes**

**Marc Saxon**

*Contributing Editors*

## PRODUCTION DEPARTMENT

**Ruby M. Yee**

*Production Director*

**Karen S. Brown**

*Production Manager*

**Marcella Amoroso**

*Production Assistant*

**Janice Box**

*Editorial Production*

## ART DEPARTMENT

**Andre Duzant**

*Art Director*

**Injae Lee**

*Illustrator*

**Russell C. Truelson**

*Illustrator*

**Jacqueline P. Cheeseboro**

*Circulation Director*

**Michele Torillo**

*P-E Bookstore*

## BUSINESS AND EDITORIAL OFFICES

Gernsback Publications, Inc.

500-B Bi-County Blvd.

Farmingdale, NY 11735

1-516-293-3000

Fax: 1-516-293-3115

President: **Larry Steckler**

**Customer Service/Order Entry**

1-800-435-0715

In IL 1-800-892-0753

7:30 AM - 8:30 PM EST

Advertising Sales offices listed on page 92

Cover photography by Diversified Photo Services  
and Jonathan Connell

Composition by  
Mates Graphics

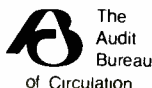

The publisher has no knowledge of any proprietary rights which will be violated by the making or using of any items disclosed in this issue.

# EDITORIAL

## INTRODUCING MARKET CENTER

Not too many years ago, being an electronics hobbyist was among this country's most popular pastimes. There were literally millions of basement workshops, and in towns large and small there was always a local merchant ready to supply the many tubes, capacitors, resistors, and what-have-you's that were greedily snatched up by a public that was fascinated by anything electronic.

As time went on, tubes gave way to transistors, which gave way to integrated circuits. Along the way, as such things usually go, some of the fascination began to fade, and with it many of those local parts suppliers.

Today, being an electronics hobbyist is truly a labor of love. Unless you are exceedingly fortunate, building a project or doing some electronics experimenting usually means turning to mail-order suppliers to obtain at least some of the parts. And even then, if the part you need is "exotic," finding it may entail searching through dozens of catalogs and making at least as many telephone calls, especially if you are not familiar with the relatively few companies still around that go out of their way to help the hobbyist.

It's not surprising, then, that of all the questions we get asked here at **Popular Electronics**, among the most popular is "Where can I find. . .?" This month we'll show you where to look. Starting on page 48A, you'll find the **Popular Electronics Market Center**, a special advertising section highlighting mail-order merchants who want to help you find what you need.

As you browse through the **Popular Electronics Market Center**, you'll find merchants dealing in all types of components, surplus gear, computer gear, audio and video gear, and much more. It's literally a one-stop supermarket for everything electronic; look for it every second month, and only in **Popular Electronics**.

P.S. When you call or write, tell 'em we sent you!

Carl Laron  
Editor

# SELECT 5 BOOKS

## for only \$4.95

(values to \$116.75)

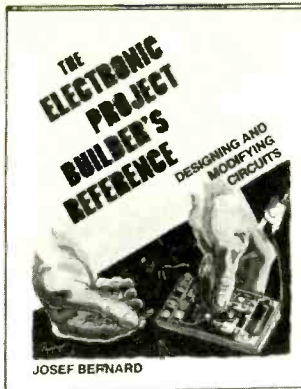

3260P \$14.95

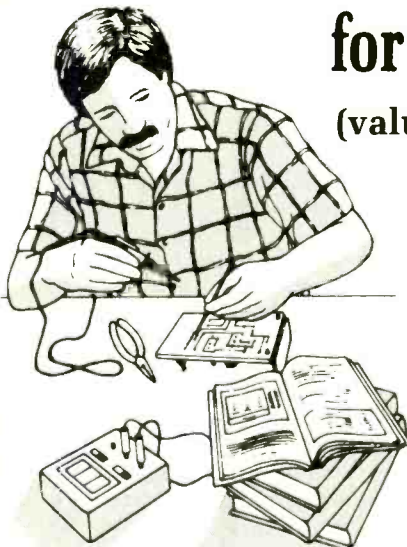

3329 \$29.95  
Counts as 2



2867P \$18.95

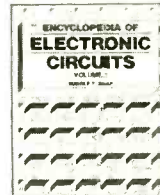

1938 \$60.00  
Counts as 3



2925P \$9.95

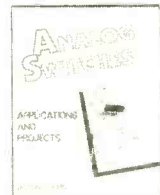

3445 \$21.95



2995 \$25.95

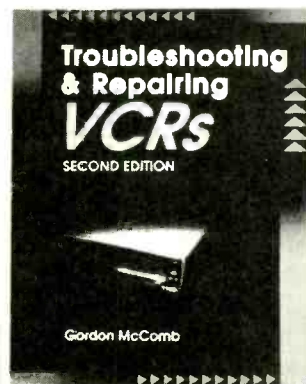

3777 \$32.95  
Counts as 2



1367P \$24.95  
Counts as 2



3275 \$22.95

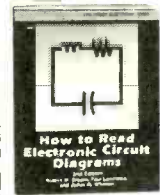

2880P \$14.95



2926 \$25.95



3343 \$29.95  
Counts as 2



3475 \$27.95  
Counts as 2

©1991 ELECTRONICS BOOK CLUB  
Blue Ridge Summit, PA 17294-0810



9290 \$36.00  
Counts as 2



3321P \$16.95



3457 \$29.95  
Counts as 2



3279 \$36.95  
Counts as 2

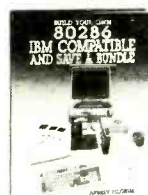

3031P \$17.95



2980P \$19.95



2790P \$14.95



3485 \$27.95  
Counts as 2



3540 \$26.95  
Counts as 2



2707P \$17.95

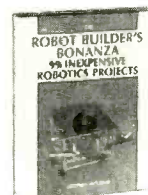

2800P \$16.95



2613P \$17.95

Your most complete source for electronics books for over 25 years.



3414 \$39.95  
Counts as 2

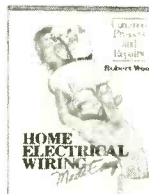

3072P \$16.95



2865P \$14.95

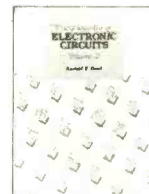

3138 \$60.00  
Counts as 3

**Membership Benefits • Big Savings.** In addition to this introductory offer, you keep saving substantially with members' prices of up to 50% off the publishers' prices. • **Bonus Books.** Starting immediately, you will be eligible for our Bonus Book Plan, with savings of up to 80% off publishers' prices. • **Club News Bulletins.** 15 times per year you will receive the Book Club News, describing all the current selections—mains, alternates, extras—plus bonus offers and special sales, with scores of titles to choose from. • **Automatic Order.** If you want the Main Selection, do nothing and it will be sent to you automatically. If you prefer another selection, or no book at all, simply indicate your choice on the reply form provided. You will have at least 10 days to decide. As a member, you agree to purchase at least 3 books within the next 12 months and may resign at any time thereafter. • **Ironclad No-Risk Guarantee.** If not satisfied with your books, return them within 10 days without obligation! • **Exceptional Quality.** All books are quality publishers' editions especially selected by our Editorial Board. (Publishers' Prices Shown)



## ELECTRONICS BOOK CLUB<sup>SM</sup>

Blue Ridge Summit, PA 17294-0810

Please accept my membership in the Electronics Book Club and send the 5 volumes listed below, billing me \$4.95. If not satisfied, I may return the books within ten days without obligation and have my membership cancelled. I agree to purchase at least 3 books at regular Club prices during the next 12 months and may resign any time thereafter. A shipping/handling charge and sales tax will be added to all orders.

--	--	--	--

Name \_\_\_\_\_  
 Address \_\_\_\_\_  
 City \_\_\_\_\_  
 State \_\_\_\_\_ Zip \_\_\_\_\_ Phone \_\_\_\_\_  
 Signature \_\_\_\_\_

Valid for new members only. Foreign applicants will receive special ordering instructions. Canada must remit in U.S. currency. This order subject to acceptance by the Electronics Book Club. PE891

All books are hardcover unless number is followed by a "P" for paperback.

## ATTACKING THE SONIC DEFENDER

The article, "The Sonic Defender" (**Popular Electronics**, May 1991), by Phil Salas does a grave disservice to your readers, and the manner in which it was published was irresponsible. Furthermore, the editorial that accompanied the article is blatantly incorrect in describing the weapon as "purely defensive" and a "sound" solution to the problem. The attitudes conveyed are simplistic, and are certain to get innocent people hurt.

As a Martial Artist, I have worked with civilian and military police for more than ten years, and there are four points on which most all of those law-enforcement and self-defense experts agree:

1. The "perfect" weapon or fighting technique, offensive or defensive, does not exist. For example, many people (myself included) are virtually immune to chemical mace or CS tear gas products, yet thousands of people swear by the aerosol cans that they carry in their pockets or purses.

2. There is no such thing as a "purely defensive" weapon. Anything effective in defense *must* (and therefore, can) be effective in offense. Once hostilities begin, the best defense is a good offense.

3. It is rare for the person attacked to have greater fighting skills or devices than the attacker. A 25-year-old mugger may well have a dozen years of training in street fighting, but the victim probably has but a few hours, at most. To be effective, the potential victim should have experience comparable to the attacker; there are no shortcuts to self-defense.

4. A determined and competent attacker will always seek to disarm the victim and, if appropriate, use the victim's weapon(s) against the victim. A typical knife fighter *expects* to be cut—badly—maybe losing a finger, or worse. With such an outlook, a little noise-maker like the Sonic Defender will be of little use.

The fourth point is particularly alarming because the Sonic Defender is so non-directional that it can injure the victim, even if used properly. Furthermore,

many attacks, including sexual attacks, generally involve torso-to-torso contact. In such cases, 130 decibels of sound will injure both parties, and the injuries might be permanent. In the United States, on more than one occasion attackers have been awarded damages for injuries sustained in the attack through lawsuits brought against their victims.

It is well known that noises (whistles, sirens, etc.) are effective in deterring crime, and the longer the noise can be continued, the better. But the Sonic Defender's locking switch is a nice, but wasted, feature. The unit can be smashed (and therefore turned off) instantly by a hand or a foot. In the process, the much-touted wrist strap becomes a trap, immobilizing the victim's hand and wrist.

Moreover, the Sonic Defender may well be considered a deadly weapon, and therefore be illegal to carry openly or concealed. Most states define a "deadly weapon" or a "dangerous instrument" as that which is readily capable of causing serious injury or death. Although the judicial system will have to rule on the Sonic Defender, loss of hearing would certainly seem to fall in the category of serious injury. Furthermore, use of a deadly weapon (as legally defined or construed) is generally justified legally only when life itself is threatened. Permanently deafening a purse snatcher could land the purse owner in jail.

In short, no one thing is effective in guaranteeing personal safety. If a victim attempts to use a weapon defensively, it is likely to be used offensively against the victim by a more skilled attacker. While the legal implications of the Sonic Defender are unclear, and its effectiveness limited, possession and use of this device are questionable.

The bottom line of my complaint is that a construction article was presented to the general public, with a minimal and incomplete disclaimer, and

with the intent that some readers will actually buy or build the device. Nowhere are there real assurances that they will be qualified to use it, or worse, will even be aware of its shortcomings. While I'm sure that your intentions were good, these issues are not simple, and do not fit in a paragraph or two. If

**Popular Electronics** is not the forum for a discussion of such matters, then it would be in the best interests of society for the magazine to confine itself to the multitudes of other projects and subjects that it can adequately address.

There is no panacea for defense or offense—the only effective means of defending oneself is to have a broad spectrum of techniques at one's disposal, and to train diligently in the use of those techniques. There are some very simple, easily mastered self-defense strategies, and others that are complex. If an individual wants to become skilled in self-defense, a competent training program should be sought out. If a product or device is offered for self-defense purposes, the provider has the responsibility to inform and/or train the user in the moral and legal aspects of using that product. Most major suppliers of martial-arts and/or law-enforcement weapons do that.

For further reading about the moral and legal implications of defending oneself, I highly recommend attorney Carl Brown's *American Law and the Trained Fighter* (1983, Ohara Publications Inc., Burbank, CA).  
M.H.F.  
San Jose, CA

*The Sonic Defender is intended to be used as a deterrent. It is definitely not, nor was it portrayed to be, the perfect defense. I will always be hopeful that no Popular Electronics readers will ever have cause to use it or any other device in any type of defensive situation.*

*The Sonic Defender does have a directional output. The user is not subjected to more*

*than about +100 dB when pointing the device away from himself. And while anyone within about three feet of the front end of the unit will experience a sound pressure at about the threshold of pain, permanent hearing loss should not occur unless there is prolonged exposure.*

*The Sonic Defender is expected to startle an attacker, possibly giving the victim the ability to run away while attracting attention. As M.H.F. stated, loud noises are well-known crime deterrents. The Sonic Defender is quite an attention getter.*

*Finally, I would prefer my wife to have a Sonic Defender with a wrist strap than a whistle on a cord around her neck, as many women wear. Also, I would prefer that my wife concentrate on running from an assailant and let the Sonic Defender scream for her, instead of trying to run as she blew a whistle or screamed.*

*I agree that there is no right answer in a defensive situation. I designed the Sonic Defender for my wife because she is a college student and often has to walk alone across virtually deserted parking lots. The Sonic Defender, while by no means the perfect answer, is far better than a police whistle.*  
Phil Salas

## ALL ABOUT RMS VOLTAGE

In his article "All About Meters" (**Popular Electronics**, May 1991) Stephen J. Bigelow states, "Since the voltage will still pulsate over time, the meter will indicate the average (or rms) value." That statement implies that the average voltage and the rms voltage are one and the same. That is not true for sinusoidal voltages, to which it is assumed the article is referring.

For a sinusoidal voltage waveform, the average voltage is zero volts. Think about it: The voltage spends as much time above zero as it does below,

# LETTERS

yielding an average of zero. Perhaps the author was thinking about the average voltage of the magnitude of the sine wave. If that is the case, he would still be wrong. The average of the magnitude of a sinusoidal waveform is  $0.637 \times V_p$ , where  $V_p$  is the peak voltage. The rms voltage, as he correctly states, is  $0.707 \times V_p$ . These clearly are not equal quantities. The derivation of these formulas can be found in most books explaining the origin of rms voltage.  
 R.W.F.  
 Albany, NY

*You are absolutely right! Average and rms magnitudes are indeed two completely different factors. While the two values were not intended to be equated, that is certainly how they were presented. The section to which you refer (which appeared under the subheading "AC Modifications") should have read something like this:*

*"Since the voltage will still pulsate over time, the meter will indicate the average AC value. Average voltages are slightly less than rms values, so the meter scale will have to be calibrated to read in rms."*

*I sincerely apologize for this confusion and regret any inconvenience that it may have caused.*  
 Stephen J. Bigelow

#### **MORE ON SIGNALS FROM SPACE**

I applaud L. George Lawrence for his exquisite and comprehensive coverage of the biological forces that truly exist in our universe in his article "Are We Receiving Biological Signals from Outer Space?" (**Popular Electronics**, April 1991), and the evidence that he has presented in the several biograms depicted. However, while his sensory analysis of egg cells, plant cells, and animal cells appear to be correct, within the environs in which he has placed them, he has totally failed to envision these biological transducers within two very different and important areas of concern.

Initially, I must say that my observations of the same data differ from his conclusions. His deductions were made in a desert-like atmosphere. My

observations were made for the past three years in a cold, clear climate in northern Maine, chosen for a similar reason: the absence of earth-bound radio emissions of whatever frequency. What Mr. Lawrence has failed to enter into the equation is the diurnal change in the Earth's magnetic field and the totally aberrant behavior of that field during periods of high magnetic activity created by the unpredictable activity of the sun. I have produced biograms sim-

ilar to his. However, on those occasions I correlated those observations with the degree of Earth's field disturbances with the Naval Observatory and found that my biograms were smeared or distorted by the effects of the solar winds.

I would suggest to Mr. Lawrence that before he instigates any further research into the biosensing field, he consider the effects of the Earth's magnetic field. The results obtained by doing so may indeed en-

lighten or disturb him. His research, while adequate for his purposes does not encompass the entire scenario. I would like to add that his image-acquisition device would be better served by using an FM mode rather than AM. As he states, the frequencies involved are quite low, with which I agree. However terrestrial and man-made interference does exist in the spectrum to which he refers.  
 R.G.H.  
 North Edgecomb, ME

## Major Manufacturer Service and Repair Documentation

SAMS, the leading source for service and repair documentation and manufacturers' schematics, offers you comprehensive coverage of a wide range of products.

- TVs (PHOTOFACT®)
- VCRs
- Computers
- Citizen Band Radios
- Scanners
- Automobile Radios
- Tape Recorders
- Transistor Radios
- Modular Hi-Fi
- Videodisc Players
- Disc Drives
- Monitors

*Overnight Delivery Available*

**See your local Electronics Distributor  
 or call SAMS at 1-800-428-7267 and ask  
 for Operator RE-1.**



**HOWARD W. SAMS & COMPANY**  
 2647 Waterfront Parkway East Drive, Suite 300  
 Indianapolis, Indiana 46214-2012

CIRCLE 5 ON FREE INFORMATION CARD

# ELECTRONIC LIBRARY

## Build Your Own Test Equipment

by Homer L. Davidson

With so much test equipment on the market, you might wonder why anyone would want to build their own. Homer L. Davidson gives four common-sense reasons: to save money, to learn how test instruments work, to create instruments that are not commercially available, and to locate defective circuits. He presents plans for 32 test instruments, some of which can be built in an evening and others that might take a couple of days to build—and all of which have actually been con-

## BUILD YOUR OWN TEST EQUIPMENT

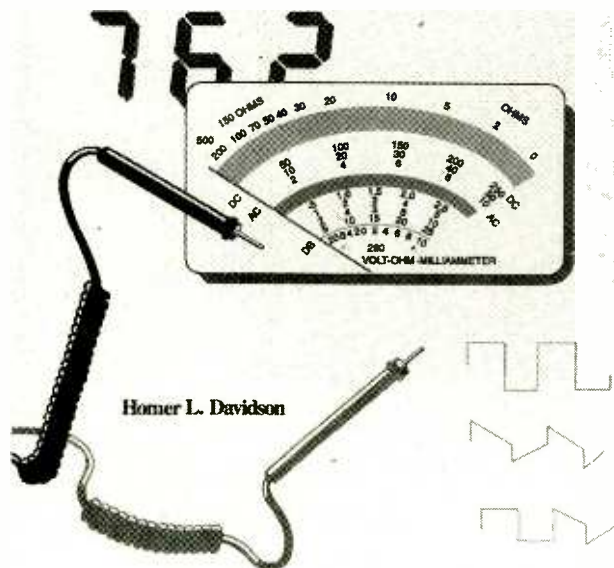

structed, tested, and placed in service. Along with complete parts lists instructions on how to build, wire, and solder each unit, the book contains information about testing and servicing possible problems. The book also explains how to etch

printed-circuit boards and select cabinets for the finished projects. Divided into five sections, the book covers five different types of test equipment, sorted by who might use them: the novice, beginner, homeowner, student, and electronic technician. Beginner projects include simple testers for diodes/LED's, fuses, power-line polarity, and microwave ovens. For the novice, projects include a white-noise generator, stereo balance tester, diode/SCR/Triac continuity tester, and CB indicator. Experienced electronic-project builders might want to tackle the sine/square/triangle wave generator, audio-amp checker, or audio handheld signal tracer, and technicians can build their own DC motor tester, TV troubleshooter, deluxe sine/square-wave function generator, or infrared remote-control checker.

*Build Your Own Test Equipment costs \$17.95 and is published by TAB Books Inc., Blue Ridge Summit, PA 17294-0850; Tel: 1-800-233-1128.*

**CIRCLE 98 ON FREE INFORMATION CARD**

## UNIVERSAL COMMUNICATIONS CATALOG

from Universal Radio Inc.

Combining Universal Radio's earlier shortwave, amateur, and scanner catalogs, this 92-page catalog is filled with equipment for the radio hobbyist. It includes an array of communications receivers, commercial receivers, portable receivers, shortwave antennas, RTTY and fax equipment, computer interfaces, HF transceivers, FM handheld transceivers, amplifiers, books, and accessories. The catalog packs in a lot of information, featuring detailed operational descriptions and specifications

for each item along with clearly written "introductions" to shortwave, amateur radio, facsimile, and radioteletype that offer a wealth of practical information for beginners.

*Universal Communications Catalog 91-02 is available for \$2.00 from Universal Radio Inc., 1280 Aida Drive, Reynoldsburg, OH 43068; Tel: 800-431-3939.*

**CIRCLE 80 ON FREE INFORMATION CARD**

## INSIDE AUTOSKETCH: 2nd Edition

by Frank Lenk

AutoSketch is an easy-to-use computer-aided drafting program that bridges the gap between the simplicity of paint programs and the power of highly technical CAD programs. This book shows readers how to unleash the program's full potential and increase the speed and performance of their drafting tasks. It uses practical examples and hands-on exercises to demonstrate the use of all AutoSketch commands.

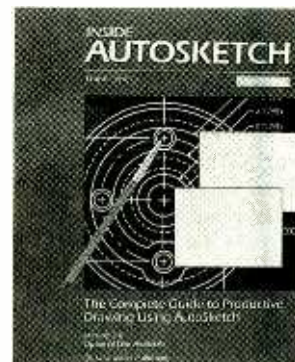

Readers are shown how to begin producing computer-assisted drawings for mechanical parts, schematics, and architectural designs. The book also provides tips and techniques for more sophisticated drawings. It explains how to create and manage AutoSketch



# Now! Experience the electronics behind the MIDI revolution as you build your own computer-controlled music center

Only NRI's innovative, at-home training in Electronic Music Technology gives you hands-on experience with the equipment that's revolutionizing the music industry—Atari ST Series computer with built-in MIDI ports, Casio HT-3000 synthesizer with advanced MIDI operations, and ingenious MIDI software that links computer keyboard to synthesizer keyboard—all yours to train with and keep!

This year, over \$1.5 billion worth of digital electronic music instruments, from keyboards to drum machines, will be sold in the U.S. alone. Enthusiasts everywhere—professional musicians and recording technicians, even people who have never touched a musical instrument before—are discovering the excitement of today's electronic music technology.

At the heart of this excitement is MIDI (Musical Instrument Digital Interface), an innovation that's transformed musical instruments into the ultimate computer peripherals...and opened up a whole new world of opportunity for the person who knows how to use, program, and service this extraordinary new digital equipment.

Now NRI's breakthrough Electronic Music Technology course puts you at the forefront of this booming new technology with exclusive training built around a MIDI-equipped computer, MIDI synthesizer, and MIDI software you keep.

## Dynamic new technology opens up new career opportunities

The opportunities are unlimited for the person who's trained to take advantage of today's electronic music phenomenon. Now you can prepare for a high-paying career as a sound engineer, recording engineer, or road technician... even start your own business selling and servicing today's high-tech musical instruments. Or simply unleash your own musical creativity with the breakthrough training and equipment only NRI gives you.

## Only NRI gives you hands-on training with today's MIDI technology

The Atari ST Series computer included in your course becomes the heart of your own

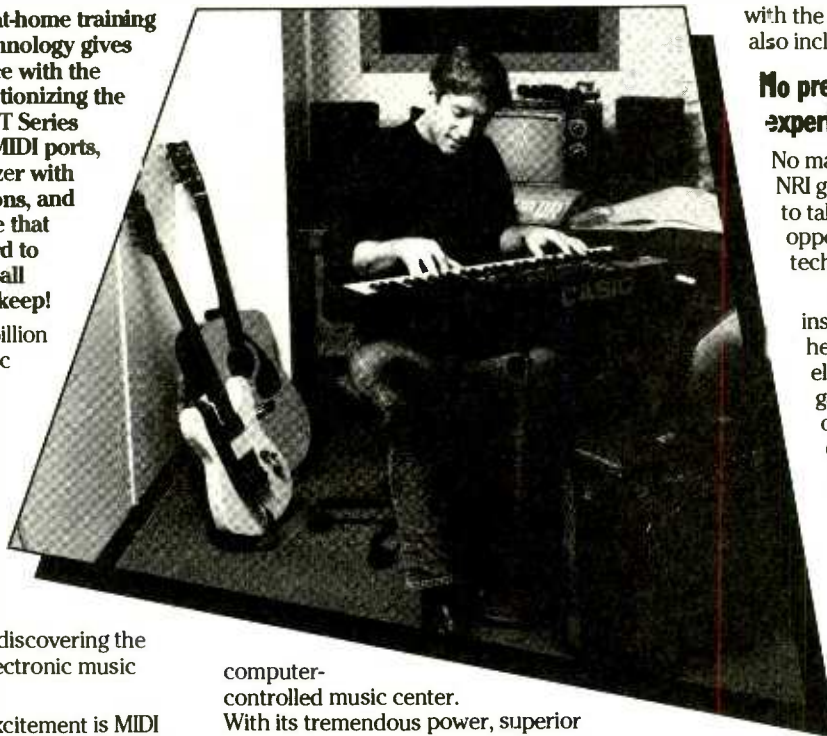

computer-controlled music center. With its tremendous power, superior graphics capabilities, and built-in MIDI interface, the 16/32-bit Atari ST has almost overnight become the computer of choice for today's most knowledgeable electronic musicians.

Your Casio HT-3000 synthesizer features a five-octave, MIDI-compatible digital keyboard with built-in monitor speakers, advanced tone editing and writing, pattern memory, keyboard split, tone and rhythm banks, chord memory, and dozens more state-of-the-art capabilities.

Plus you get ingeniously designed MIDI software that opens up amazing new creative and technical possibilities... you actually build your own 4-input audio mixer/amplifier...and you test the electronic circuits at the core of today's new equipment



*NRI training includes an Atari ST computer, Casio synthesizer, exclusive MIDI software, and much more—all yours to train with and keep! (TV not supplied)*

with the hand-held digital multimeter also included in your course.

## No previous electronics or music experience necessary

No matter what your background, NRI gives you the skills you need to take advantage of today's opportunities in electronic music technology.

With your experienced NRI instructor always available to help, you master the basics of electronic theory step by step, gaining the full understanding of electronics that's now so essential for technicians and musicians alike.

You move on to analyze sound generation techniques, digital logic, microprocessor fundamentals, and sampling and recording techniques... ultimately getting first-hand experience with today's explosive new technology as you

explore MIDI, waveshaping, patching, sequencing, mixing, special effects, and much more.

Plus, even if you've never been involved with music before, NRI gives you enough basic training in music theory and musical notation to appreciate the creative potential and far-reaching applications of today's electronic music equipment.

## Send today for FREE catalog

If the coupon is missing, write to NRI Schools, McGraw-Hill Continuing Education Center, 4401 Connecticut Avenue, NW, Washington, DC 20008.

### **NRI Schools**

McGraw-Hill Continuing Education Center  
4401 Connecticut Avenue, NW, Washington, DC 20008



**Check One FREE Catalog Only**

- Electronic Music Technology
- Microcomputer Servicing
- TV/Video/Audio Servicing
- Security Electronics
- Basic Electronics
- Computer Programming
- Desktop Publishing and Design
- Fiction/Nonfiction Writing
- Bookkeeping & Accounting

For Career courses approved under GI bill  check for details.

Name \_\_\_\_\_ Age \_\_\_\_\_

Address \_\_\_\_\_

City/State/Zip \_\_\_\_\_

Accredited Member, National Home Study Council

18-081

parts and files, produce industry-standard dimensional drawings, and import and export drawings to and from AutoCAD and other programs. The book begins with non-technical drawings—sketches that laymen might need to do—and in the process explores the basics of the program. The second section takes an in-depth look at some of the higher level features—reference grids, macros, drawing layers, group object manipulation, and printing or plotting—used to complete moderately complex technical drawings. Part three deals with full-blown technical drawing applications, and covers topics such as pattern fill, dimensioning, object arrays, and the transfer of drawing files to other software. The second edition of this book explores the new features added with the release of AutoSketch Version 3, which is easier for beginners to master, yet can handle a remarkable range of drafting jobs.

*Inside AutoSketch, Second Edition costs \$24.95 (an optional disk costs \$14.95) and is published by New Riders Publishing, 1025 East Powell, #202, Gresham, OR 97030.*

**CIRCLE 81 ON FREE INFORMATION CARD**

## SHORTWAVE LISTENING GUIDEBOOK

by Harry L. Helms

Despite the availability of up-to-the-minute news through satellite television and fiber-optic telephone communications, shortwave radio continues to be a popular hobby. Listening to shortwave broadcasts from foreign countries is like having a front-row seat to world events—often without all those layers of censorship imposed by various governments and military groups. Although shortwave radios are easy to use and don't require any special licenses or fancy antenna systems, some practical advice is needed to find the broadcasts that most interest you. This book tells you when, where, and how to hear shortwave broadcasts from around the globe. In non-technical language, it explains how to select the shortwave radio that meets your needs, why and how reception conditions vary at



different times of the day and seasons of the year, how to correctly operate a shortwave radio, and how to obtain program schedules and other materials from overseas stations. It also provides profiles of major international broadcasting stations and reveals the frequencies used by the U.S. armed forces, Air Force One, and ship-to-shore stations. Other relevant topics discussed include "pirate" and clandestine radio broadcasters, antennas, ham radio, and the hobby aspects of shortwave listening. Several tables provide quick reference material, and numerous photos and diagrams help clarify important concepts.

*Shortwave Listening Guidebook costs \$16.95, and is published by HighText Publications, Inc., 7128 Miramar Road, Suite 15, San Diego, CA 92121*

**CIRCLE 82 ON FREE INFORMATION CARD**

## BEGINNER'S GUIDE TO READING SCHEMATICS: 2nd Edition

by Robert J. Traister and Anna L. Lisk

Newcomers to electronics often view learning to read schematic diagrams and using them to analyze circuits as a complex and difficult task. This book sets out to prove that view is mistaken by showing that learning to interpret the symbols, interconnections, and component designations can be quite simple. The book clearly illustrates which symbols stand for capacitors, transformers, resistors, inductors, conductors, switches, cables, batteries, vacuum tubes, and more. It also explains how

those symbols work together, how to read combinations of symbols, and how to draw schematics. The second edition includes new, updated drawings that reflect the latest in electronic circuitry, as well as an index of symbols.

*Beginner's Guide to Reading Schematics, Second Edition costs \$10.95 and is published by TAB Books Inc., Blue Ridge Summit, PA 17294-0850; Tel. 1-800-233-1128.*

**CIRCLE 83 ON FREE INFORMATION CARD**

## 1991 REST-OF-THE-STORY ELECTRONICS CATALOG

from Home Automation Laboratories (HAL)

This 52-page catalog is filled with gadgets for do-it-yourself home automation—simple devices that don't require a degree in electronic engineering, but that you can hook up if you can use a screwdriver. Each product is described fully, including what it does and how it works. The brochure contains motion-sensing systems, video-doorphones,



remote-control devices, security systems, automated plant-watering systems, computer-controlled systems, telephone-control systems, light dimmers, and more. New to the 1991 edition are a "shoebox" 286 computer, wireless doorbell chimes, a computerized receptionist, advanced house sitters, illuminated house numbers, a temperature-monitoring system, and the X-10 two-way PC tool-kit.

*The 1991 HAL Catalog is free upon request from Home Automation Laboratories, 5500 Highlands Pkwy., Suite 450, Atlanta, GA 30082; Tel:*

404-319-6000; Fax: 404-438-2835.

**CIRCLE 84 ON FREE INFORMATION CARD**

## ELECTRONICS CATALOG #566

from Mouser Electronics

Up-to-date product data and pricing on more than 35,000 electronic components from more than 80 manufacturers are offered in this comprehensive buying guide. To help consumers locate particular products quickly and easily, product index tabs have been added and a quick index appears on the front cover. A "New Products" section—which is representative of the general merchandise offered in the rest of the catalog—includes a wide selection of cable assemblies, switches, tools, connectors, meters, jacks and plugs, components, breadboards, cabinets and cases, displays, security devices, and test equipment.

*The Electronics Catalog #566 is free upon request from Mouser Electronics, 2401 Highway 287 North, Mansfield, TX 76063; Tel: 800-992-9943.*

**CIRCLE 85 ON FREE INFORMATION CARD**

## LENK'S AUDIO HANDBOOK: Operation and Troubleshooting

by John D. Lenk

Thoroughly examining up-to-date methods for maintaining and troubleshooting today's consumer audio products, this book provides highly practical advice for audio technicians, field-service engineers, and serious audiophiles. It is intended to fill the gap between complex theoretical works on audio circuitry and often-scanty service literature. With step-by-step and circuit-by-circuit directions, this comprehensive reference provides enough information to enable readers to build audio circuits from scratch. Because no previous design experience is required to apply the design data and techniques presented, the practical experimenter can use the book as a hands-on tool. Detailed coverage is given to such products as CD players, AM/FM tuners, turntables,

graphic equalizers, surround-sound systems, cassette players, and laser-optic devices. In addition, the book explains the audio components of camcorders, stereo TV's, and VCR's. For each product, the book provides a complete description (including the specifications); reports on the operating procedures, controls, and indicators; explains troubleshooting and adjustment techniques; and provides circuit diagrams that indicate input/output, adjustment and test points, signal paths, power connections, and more.

*Lenk's Audio Handbook: Operation and Troubleshooting* costs \$39.95 in hardcover and is published by McGraw-Hill Book Company, 11 West 19th Street, New York, NY 10011; Tel: 1-800-2-MCGRAW.

**CIRCLE 96 ON FREE INFORMATION CARD**

### 1991 SUPPLEMENT R from Jensen Tools Inc.

Although it's called a supplement, this 100-plus page

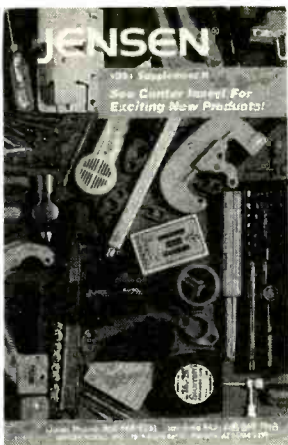

booklet is a full catalog in its own right. It features a wide assortment of tools commonly used by electronics hobbyists and professionals, including screwdrivers, nutdrivers, vacuums and cleaners, drills and accessories, flashlights, oscilloscopes, soldering equipment, test equipment, wire crimpers and strippers, and wire-wrapping tools. Also featured are tool kits, cases, and service kits. Of special interest, and highlighted in this issue is a

15-page insert of new products that includes production equipment, test equipment, logic analysis test kits, and plant-maintenance tools and equipment.

*The 1991 Supplement R is free upon request from Jensen Tools Inc., 7815 South 46th Street, Phoenix, AZ 85044-5399; Tel: 602-968-6231; Fax: 800-366-9662.*

**CIRCLE 86 ON FREE INFORMATION CARD**

### SOFTWARE ENGINEERING TOOLS CATALOG #4

from BSOFT Software Inc.

This catalog offers low-cost, stand-alone engineering programs designed for engineers, technicians, and hobbyists for use on IBM PC's and compatibles. Featured are programs for drawing schematics, simulating logic-control circuits, FFT analysis, and circuit analysis. CAD (computer-aided design) programs for performing structural analysis, designing electronic circuits, and PC-board layout are offered, as well as comput-

er-aided-mathematics and waveform-viewer software. The catalog contains descriptions

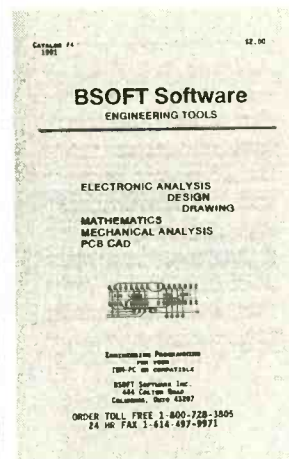

and ordering information on all the software.

*The Software Engineering Tools Catalog #4 is free upon request from BSOFT Software Inc., 444 Colton Road, Columbus, OH 43207-3902; Tel: 614-491-0832; Fax: 614-497-9971.*

**CIRCLE 87 ON FREE INFORMATION CARD**

# Ready, Willing and Able.

## 324 PanaVise Electronic Work Center ▶

This economical package makes work areas more efficient and manageable. Parts, tools, solder, soldering iron holder and PC board are exactly where you want them! Features famous PanaVise "tilt, turn and rotate" control. Solder spool holder self-centers the feed, and the soldering iron holder keeps the iron at an easy-to-reach angle. Rugged, sturdy and tough, it also accepts all regular PanaVise interchangeable heads.



### ◀ 301 Standard PanaVise

Here's the world's best small vise and the perfect introduction to PanaVise quality and convenience. One control knob locks work firmly into position! Also accepts all regular PanaVise interchangeable heads.

### ▲ 396 Wide Opening Head PanaVise

Combine our 300 Standard Base (which accepts all PanaVise interchangeable heads) with our 366 Wide Opening Head to create a versatile work-holding tool. Ribbed neoprene jaw pads hold circuit boards or other objects securely; reverse them for deep "v" grooves that can hold delicate cylindrical objects.



1485 Southern Way  
Sparks, Nevada 89431  
Tel: (702) 353-2900  
Fax: (702) 353-2929

**CIRCLE 8 ON FREE INFORMATION CARD**

# NEW PRODUCTS

## Modular-Cable Tester

You can precisely identify the exact point of two connections at each end of a modular cord assembly using the *PA1529 Patch Check* continuity tester from *Paladin*. The hand-held instrument identifies open, shorted, and cross-connected telecommunications circuits on a clear LED readout that you can hold in the palm of your hand. Designed for testing telephone (RJ11) and computer data-link (RJ45) wiring, the *Patch Check* also verifies the correct wiring configuration of



unshielded twisted pair in the 10BASE-T baseband medium. By simply pressing a button, you can review a sequential comparison of the wire position and the continuity of the modular plugs at each end of the cable.

The *PA1529 Patch Check* has a list price of \$49.95. For further information, contact *Paladin Corporation*, 3543 Old Conejo Road, Newbury Park, CA 91320; Tel: 805-499-0318.

**CIRCLE 101 ON FREE INFORMATION CARD**

## HANDHELD MULTIMETERS

At the high end of *John Fluke Mfg. Company's 70 Series II*, line of multimeters are the models 79 and 29. The handheld meters can check capacitance from 10 pF to 9,999  $\mu$ F, a useful range for testing large electrolytics and eliminating the need for a dedicated capacitance meter. An innovative frequency function can simultaneously display frequency—from 1 Hz to 20 kHz—on the digital display and AC voltage on the analog bar graph. That allows users to see how much potentially hazardous voltage is present when making frequency measurements. A 63-segment bar graph updates as fast as the eye can follow and simulates the function of an analog needle for watching trends, peaking, and nulling. The models 79 and 29 feature "Smoothing," which displays the running average of eight readings to provide stable readings even with uneven signals. The two meters also have a proprietary Lo-ohms function that provides 0.01 ohm resolution with high noise rejection to sense very small resistance changes.

Standard features on each unit in the 70 Series II family include automatic "Touch Hold," which captures and holds stable measurements, allowing technicians to take readings in hard-to-reach places while keeping their eyes on the circuit. An exclusive algorithm holds consecutive stable readings without manually resetting the meter.



Other standard features include autoranging, range hold, and optional manual ranging. The use of a single "time-activated" pushbutton and a rotary switch make the meters easy to operate and more reliable due to their low moving-parts counts. A holster with *Flex-Stand* allows the meters to hang from a door or pipe, stand at virtually any viewing angle, or clip on a belt or a tool kit.

The models 79 and 29 handheld multimeters each cost \$185. For further information, contact *John Fluke Mfg. Co., Inc.*, P.O. Box 9090, Everett, WA 98206-9090; Tel: 206-347-6100.

**CIRCLE 102 ON FREE INFORMATION CARD**

## VGA PACKAGE

Targeted at 8088, 286, 386, and 486 PC compatibles, *JDR Microdevices' Super High Resolution VGA Package* contains all the hardware and software needed to improve the graphic resolution of most systems. For existing software that



cannot take advantage of the enhanced resolution, the package is also compatible with VGA, EGA, CGA, HDC, and MDA modes.

The bundle consists of a *Re-lysis 9514 VGA monitor*, a *Modular Circuit Technology 1024 x 768 VGA card* with 512 KB installed, and software drivers for *Windows 3.0* and other popular software packages. The monitor was designed to reduce eye strain and provide high-definition video. Its 14-inch, non-glare screen features a 0.28mm dot pitch for improved clarity, and it has a 1:1 aspect

ratio in 1024 × 768 and 640 × 480 modes. The VGA card can be used in 8-bit mode on 8088-based machines, and can also be used in 16-bit, high-performance mode in machines with a 16-bit bus. The card's RAM is expandable to 1MB. In 1-MB configuration, the card-and-monitor combination will simultaneously display 256 colors at 1024 × 768 resolution.

The Super High Resolution VGA Package costs \$599. For more information, contact JDR Microdevices, 2233 Branham Lane, San Jose, CA 95124; Tel: 408-559-1200; Fax: 408-559-0250.

**CIRCLE 103 ON FREE INFORMATION CARD**

## STEREO MIXER

Incorporating a special sound-effects generator and inputs for a variety of audio and video equipment, the *SM509 ATUS* stereo mixer from *Audio-Technica* also features a five-band graphic equalizer and an electronic echo circuit. Unique circuitry adds six sound effects—snare, bomb, video gun, laser, phone, and UFO—to the mixed output. For added flexibility, the speed and volume of the sound effects can be continuously altered. The mixer provides inputs for microphones, CD players, turntables, tape decks, and video equipment. Four separate stereo inputs can be selected and mixed in a smooth, well-controlled manner, with a master volume control for the output. The *SM509* can mix combinations of two turntables, four stereo line-level devices, and two microphones. Dual VU meters with easy-to-read LED's provide continuous visual indication of the output levels. The mixer also features a separate microphone input with provisions for "voice-over," which automatically attenuates all other channels up to 12 dB. A pitch transposer alters the sound of the announcer's voice at the push of a button.



The *ATUS SM509* stereo mixer has a suggested retail price of \$399.95. For more information, contact Audio-Technica U.S., Inc., 1221 Commerce Drive, Stow, OH 44224; Tel: 216-686-2600.

**CIRCLE 104 ON FREE INFORMATION CARD**

## CLAMP-ON AMP/VOLT/OHMMETER

Featuring high-energy protection to 600 volts, *Amprobe's* updated *RS-3* amp/volt/ohmmeter is fused to protect both the user and the instrument against accidental misapplication. The *RS-3* retains its familiar, comfortable shape and standard features including locking, all-weather test leads; a magnified rotary scale for ease of application and reading; a pointer lock to capture readings in hard-to-see places; and full-capacity, locking transformer jaws for accurate readings and long instrument life.

The model *RS-3* amp/volt/ohmmeter has a list price of \$74.85. For further information, contact Amprobe Instrument, 630 Merrick Road, P.O. Box 329, Lynbrook, NY 11563; Tel: 516-593-5600; Fax: 516-593-5682.

**CIRCLE 117 ON FREE INFORMATION CARD**



## VHS VIDEOTAPE CLEANERS

Your videotapes will clean themselves as they play if they're equipped with *Ambico's V-0751 Automatic VHS Tape Cleaners*. The cleaner is a specially treated "micro-brush" that is held in place by the provided "cleaning clip." It attaches just

# Safety, Security, Convenience, Entertainment and Energy Management

## Home Automation from Heath, the catalog that has it all...

Enter the world of Home Automation. Remote lighting and appliance controls. Security alarms and lighting. Automated thermostats. Video monitoring systems. Whole-house security systems. They're all yours in the Heath Home Automation Catalog. To receive your FREE copy, call today toll-free.

**1-800-44-HEATH**  
(1-800-444-3284)

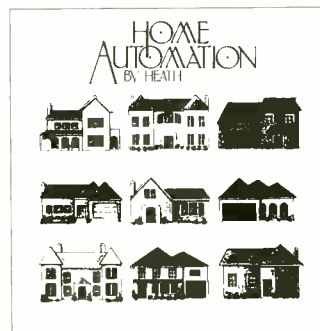

## Heath Company

Marketing Dept. 107-080  
Benton Harbor, MI 49022

CL-807R1

**CIRCLE 14 ON FREE INFORMATION CARD**



inside the cassette door and cleans the videotape while the VCR is in the play mode. The V-0751 package includes 100 micro-brushes, each of which will clean several tapes; three cleaning clips, which can be moved easily from tape to tape; and a "flap holder" to keep the cassette door open while inserting the cleaning clip.

The V-0751 VHS cleaning kit has a suggested retail price of \$7.95. For additional information, contact Ambico Inc., 50 Maple Street, Norwood, NJ 07648; Tel: 201-767-4100.

**CIRCLE 105 ON FREE INFORMATION CARD**

## BANDPASS FILTER

With the ability to separate closely spaced radio signals, the model APS-204 bandpass filter from *Optoelectronics* passes desired frequencies and eliminates interfering frequencies. It has a constant 4-MHz bandwidth and continuous tuning over the six octaves from 20 MHz to 1000 MHz. The APS-204 is particularly useful in



dense urban areas, military operations, and other situations where many radio transmitters must operate in close proximity, causing overloading and interfering with nearby receivers. It works as an active pre-selector, isolating desired signals and passing them on to the protected receiver, while rejecting all others. Unlike the clumsy, passive discrete units that it is intended to replace, the APS-204 is an active filter with no insertion loss whatsoever that measures only 4 x 1 1/2 x 7 inches. Its bandpass width is uniquely fixed at 4 MHz, regardless of the center frequency

to which it is tuned, by way of a four-pole, high-Q, resonant-cavity filter. The antenna output to be filtered is routed to and from the 4-MHz-wide resonant cavity by a patent-pending double-heterodyne technique that makes the APS-204 totally insensitive to drift. The unit runs on 12 VDC for mobile convenience.

The model APS-204 bandpass filter costs \$995. For more information, contact Optoelectronics Inc., 5821 NE 14th Avenue, Ft. Lauderdale, FL 33334; Tel: 800-327-5912 or 305-771-2050; Fax: 305-771-2052.

**CIRCLE 106 ON FREE INFORMATION CARD**

## TEMPERATURE-CONTROLLED SOLDERING IRON

Field-service, assembly, and repair personnel will find *M.M. Newman's Antex Model TCS* soldering iron easy to use in situations where adjustability is important but a separate soldering station is not convenient. The soldering iron features in-handle, positive-feedback temperature control from 390°F to 850°F with ±1% stability during typical use. Easily adjustable using a small screwdriver, the 50-watt iron heats up to 650°F within a minute and provides rapid recovery time. Designed for soldering sensitive electronic components, the model TCS

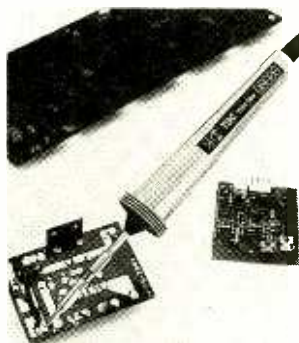

has zero voltage switching and the heating element is located under the tip for optimum thermal efficiency. It comes in a 110 VAC version and one for use with 24-volt power supplies, and a wide selection of slide-on tips is available.

The Model TCS temperature-controlled soldering iron has a list price of \$84.95. For additional information, contact M.M.

Newman Corporation, 24 Tioga Way, P.O. Box 615, Marblehead, MA 01945; Tel: 617-631-7100; Fax: 617-631-8887.

**CIRCLE 107 ON FREE INFORMATION CARD**

## OSCILLOSCOPE PROBE SET

Most dual-beam oscilloscopes can use algebraic addition to display the sum or difference of two signals, which requires that both channels be accurately matched over the frequency range. That means that the probes must also be accurately matched. The M12DF differential probe set from *Test Probes, Inc.* allows precise matching of oscilloscope channels for accurate measurement of two signals. The differential probes are designed to measure across points in a circuit where one



point is not directly referenced to ground. The M12DF set consists of a pair of 250-MHz adjustable passive probes, one of which has fine attenuation adjustment at DC and low frequencies. Although safety grounding (usually through the oscilloscope) is still required, the probe signal grounds can be left unconnected, eliminating unwanted signals that might upset the measurement. The M12DF set features probe resistance adjustable to 0.1%, coarse and fine controls for the adjustment of high-frequency response, 1.4-ns rise time, a compensating range of 10–60 pF, and an attenuation ratio of 10 to 1.

The M12DF differential probe set costs \$340. For further information, contact Test Probes, Inc., 9178 Brown Deer Road, San Diego, CA 92121; Tel: 800-368-5719.

**CIRCLE 108 ON FREE INFORMATION CARD**

## SMT VACUUM/TWEEZER TOOL

To ensure the safe handling of surface-mount parts, *ESP's VAC*

*Tweezer* presents no danger to leads or risk of board scratching. The vacuum tool features see-through silicone pads that aid in the exact picking or placement of very small to large SMT

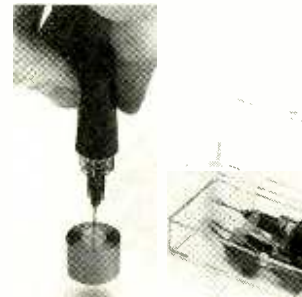

components. The vacuum created by squeezing and releasing the bulb is powerful enough to accurately pick up and replace parts weighing up to 80 grams. Five pads are included, ranging in size from 0.140 to 0.400 inches.

The VAC Tweezer kit costs \$12.50. For more information, contact ESP Solder Plus, 14 Blackstone Valley Place, Lincoln, RI 02865-1145; Tel: 401-333-3800 or 800-338-4353; Fax: 401-333-4954.

**CIRCLE 109 ON FREE INFORMATION CARD**

## CRAMOLIN DEOXIDIZER PEN

*Cramolin DeOxidizer*, a fast-acting solution that improves conductivity on connectors and contacts, is now available from *Caig* in economical, convenient, pen-style applicators. The non-flammable, non-corrosive, non-toxic, and ozone-safe solution works by dissolving resistive oxides from metal surfaces. It provides long-lasting protection from future oxidation, and is



effective on all metal surfaces. The pen applicator makes it easy to precisely apply the DeOxidizer, and is particularly well-suited for use on edge connectors, batteries, interconnecting cables, plugs,

# Why take chances in today's job market?

Graduate as a fully trained electronics professional.

To get ahead and stay ahead in today's economy, you need the electronics training CIE has been providing its 150,000-plus successful graduates with for nearly 60 years.

**Meet the Electronics Specialists.**

When you pick an electronics school, you're getting ready to invest time and money. And your whole future depends on the education you receive in return. That's why it makes so much sense to go with number one... with the specialists... with CIE!

**There's no such thing as a bargain education.**

If you talk to some of our graduates, and we recommend you do, chances are you'd find a lot of them shopped around for their training. Not for the lowest priced, but for the best training available. They pretty much knew what was available when they picked CIE as number one.

**Because we're specialists we have to stay ahead.**

At CIE we have a position of leadership to maintain. Here are just a few of the ways we hang onto it...

**Programmed Learning.**

That's exactly what happens with CIE's Auto-Programmed Lessons®. Each lesson uses famous "programmed learning" methods to teach you important electronics principles. You explore them, master them completely, before you start to apply them. You thoroughly understand each step before you go on to the next. You learn at your own pace.

And, beyond theory, some courses come fully equipped with electronics equipment to actually let you perform hundreds of hands-on experiments.

**Experienced specialists work closely with you.**

Even though you study at home, CIE's faculty and staff stand ready to assist via CIE's toll free number. And, each time you return a completed exam you can

be sure it will be reviewed, graded and returned with the appropriate instructional help, you get it fast and in writing from the faculty technical specialist best qualified to answer your question in terms you can understand.

**Pick the pace that's right for you.**

CIE understands people need to learn at their own pace. There's no pressure to keep up...no slow learners hold you back. If you're a beginner, you start with the basics. If you already know some electronics, you move ahead to your own level.

**"Same Day" grading cycle.**

When we receive your lesson, we grade it and mail it back the same day. You find out quickly how well you're doing!

**State-of-the-art laboratory equipment.**

Some courses feature the CIE Microprocessor

Training Laboratory. An integral part of computers, microprocessor technology is used in many phases of business, including service and manufacturing industries. The MTL gives you the opportunity to program it and interface it with LED displays, memory devices and switches. You'll gain all the experience

needed to work with state-of-the-art equipment of today and tomorrow.

**New Courses!**

CIE now offers two new career courses: Automotive Electronics and Computer Operation and Programming.

**CIE offers you an Associate Degree.**

One of the best credentials you can have in electronics — or any other career field — is a college degree. That's why CIE offers an Associate in Applied Science in Electronics Engineering Technology. And all CIE career courses earn credit toward your degree.

**Which CIE training fits you?**

Beginner? Intermediate? Advanced? CIE home study courses are designed for ambitious people at all entry levels. People who have: No previous electronics knowledge, but do have an interest in it. Some basic knowledge or experience in electronics; In-depth working experience or prior training in electronics.

At CIE you start where you fit and feel comfortable where you start, then go on from there to your Diploma, Associate Degree and career!

**Today is the day. Send now.**

Fill in and return the postage-paid card attached. If some ambitious person has already removed it, cut out and mail the coupon below. You'll get a FREE CIE school catalog, plus complete information on independent home study. Mail in the coupon below or, if you prefer, call toll-free 1-800-321-2155 (in Ohio, 1-800-623-9109).



AH14

**YES!** I want to get started. Send me my CIE school catalog including details about the Associate Degree program. (For your convenience, CIE will have a representative contact you — there is no obligation.)

Print Name \_\_\_\_\_

Address \_\_\_\_\_ Apt. \_\_\_\_\_

City \_\_\_\_\_ State \_\_\_\_\_ Zip \_\_\_\_\_

Age \_\_\_\_\_ Area Code/Phone No. (\_\_\_\_\_) \_\_\_\_\_

Check box for G.I. Bulletin on Educational Benefits  Veteran  Active Duty



A school of thousands.  
A class of one.  
Since 1934.

## SPECIAL FROM ETT

□ **PCP107—DIGITAL LOGIC GATES AND FLIP-FLOPS ... \$10.00.** Establishes a firm foundation for the user who wants to design and troubleshoot digital circuitry and wants to know more than a few rules of thumb. No background beyond a basic knowledge of electronics is assumed.



□ **PCP108—COMPUTERS AND MUSIC ... \$9.95.** Helps you learn the basics of computing, running applications programs, wiring a MIDI system and using the system to good effect. In fact, just about everything you need to know about hardware and programs.

□ **PCP109—EVERYDAY ELECTRONICS DATA BOOK ... \$10.00.** Presents the essential theory of electronic circuits and also deals with a wide range of practical electronic applications. Info is presented in the form of a basic electronics recipe book.



□ **PCP110—ELECTRONIC POWER SUPPLY HANDBOOK ... \$10.95.** All types of power supplies are covered, starting with cells and batteries, on to rectified supplies and linear stabilizers, to modern switch-mode systems, IC switch-mode regulators, DC-DC converters and inverters.

□ **BP285—BEGINNERS GUIDE TO MODERN ELECTRONIC COMPONENTS ... \$6.50.** Basic functions of resistors, capacitors, inductors, diodes (including Zeners and Varicaps), transistors, Thyristors, optoelectronic devices, op-amps, logic IC's, speakers and microphones, and meters are all described. Sort of a beginners bible of electronics.



MAIL TO: **Electronic Technology Today, Inc.**  
P.O. Box 240  
Massapequa Park, NY 11762-0240

### SHIPPING CHARGES IN USA AND CANADA

\$0.01 to \$5.00 ...	\$1.50	\$30.01 to 40.00 ...	\$5.50
\$5.01 to \$10.00 ...	\$2.50	\$40.01 to 50.00 ...	\$6.50
\$10.01 to 20.00 ...	\$3.50	\$50.01 and above ...	\$8.00
\$20.01 to 30.00 ...	\$4.50		

**SORRY, No orders accepted outside of USA and Canada**

Total price of merchandise ..... \$ \_\_\_\_\_  
Shipping (see chart) ..... \$ \_\_\_\_\_  
Subtotal ..... \$ \_\_\_\_\_  
Sales Tax (NYS only) ..... \$ \_\_\_\_\_  
Total Enclosed ..... \$ \_\_\_\_\_

Name \_\_\_\_\_  
Address \_\_\_\_\_  
City \_\_\_\_\_ State \_\_\_\_\_ Zip \_\_\_\_\_

sockets, and relays. The pen includes two chisel-head tips and one round-head tip that are easily interchangeable.

The Cramolin DeOxidizer Pen costs \$9.95. For more information, contact Caig Laboratories, Inc., P.O. Box J, Escondido, CA 92033-3679; Tel: 619-743-7143; Fax: 619-743-2460.

**CIRCLE 110 ON FREE INFORMATION CARD**



## RECEIVER PRE-AMPLIFIER

Designed to improve the performance of test equipment, VHF/UHF communications receivers,



and shortwave receivers, *ACE Communications' GW-2 GaAs FET, low-noise, wideband amplifier* allows flat response over its entire 100-kHz-1.3-GHz frequency range. Amplifier gain is continuously variable from -3 dB to +20 dB. For increased versatility, BNC connectors and an internal battery are used; the amplifier can even operate on hand-held receivers. The compact unit measures just 3 x 2 x 1 1/2 inches.

The GW-2 adjustable-gain preamplifier has a suggested retail price of \$89.00. For more information, contact ACE Communications Monitor Division, 10707 East 106th Street, Indianapolis, IN 46256; Tel: 317-842-7115; Fax: 317-849-8794.

**CIRCLE 112 ON FREE INFORMATION CARD**

## MINIATURE SOLDERING IRON

The 18-watt *Antex model B/3U* miniature soldering iron is as powerful as a conventional 30-

watt iron, according to *M.M. Newman Corporation*. It accommodates a broad selection of slide-on tips to handle all types of field-service repairs. The model G/3U heats up to 725°F in 45 seconds, recovers instantly after soldering each joint, and cools down enough to fit back into a field-service kit in two minutes. The iron has a plastic handle that stays cool to the touch, a six-foot cord, and a three-prong molded plug. The selection of interchangeable tips includes needle points, chisels, spades, pyramids, cones, and a hot knife.

The Antex model G/3U miniature soldering iron, including one standard tip, has a list price of \$19.95. Additional tips are priced starting at \$1.48 each. For further information, contact M.M. Newman Corporation, 24 Tioga Way, P.O. Box 615, Marblehead, MA 01945; Tel: 617-631-7100; Fax: 617-631-8887.

**CIRCLE 113 ON FREE INFORMATION CARD**

## TWO-CHANNEL FM WIRELESS INTERCOM

For enhanced communications in the home or office, *Midland International's model 72-015 FM wireless intercom* provides two separate channels. That allows the user to privately converse with two different locations (using three units) or to place conference calls on a single channel to all locations. The 72-015 also features a lock function that can provide full-





time monitoring of a specific location, such as a baby's room. The call button can be used to transmit a high-level audio tone to let the receiving party know that the operator wants to send a message. The unit plugs directly into an AC outlet for power, and a built-in noise-filter circuit virtually eliminates AC-line noise. Powerful FM range allows units placed up to 500 yards apart to be clearly heard. Other features include fully-automatic squelch for reduced background noise, a condenser-type omnidirectional microphone for wide-range sound pick up, and a large speaker on top of the unit.

The model 72-015 two-channel FM wireless intercom has a suggested retail price of \$27.95. For additional information, contact Midland International Corporation, Consumer Communications Division, 1690 North Topping, Kansas City, MO 64120; Tel: 816-241-8500.

**CIRCLE 114 ON FREE INFORMATION CARD**

### 10-BAND GRAPHIC EQUALIZER

ADC's *Soundshaper 200* is a slim-line graphic equalizer with a fluorescent spectrum-analyzer display that allows the listener to view the results of changes made to the music as its 15-dB sliders are moved up or down across ten different frequency bands. The unit's spectrum-analyzer sensitivity control ensures accurate analysis of the music spectrum by keeping the display centered, and a peak-hold button allows easy level analysis. With the *Soundshaper 200* the listener can adjust the sound of the stereo system to room acoustics, cure harshness or dullness of the sound, and improve TV and VCR sound through its video-audio inputs. Using the EQ-record button, users can customize cassettes for car use by improving their sound to overcome road and engine noise. For optimum performance, a precision 18-dB/octave switchable infrasonic (subsonic) filter provides cleaner bass by removing low-

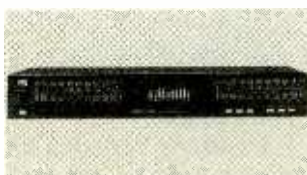

**CIRCLE 116 ON FREE INFORMATION CARD**

frequency rumble. Total harmonic distortion is less than 0.003%.

The *Soundshaper 200* has a suggested retail price of \$149.95. For more information, contact ADC, 707 East Evelyn Avenue, Sunnyvale, CA 94086.

**CIRCLE 115 ON FREE INFORMATION CARD**

### PASSIVE-INFRARED MOTION DETECTORS

Designed to work with the X-10 *Powerhouse* brand of home-automation products, the SP554 wireless, passive-infrared motion detector is self-supervised, so it can alert the homeowner to a problem (for instance, a low battery). As many as 16 motion detectors can be quickly and easily installed. The system automatically selects, at random, a unique internal code for each detector, so there are no code switches for the user to set. If the motion detector senses movement when the system is armed, the *Powerhouse* siren sounds and all household lights connected to X-10 lamp modules and wall-switch modules flash on and off. The SP554 has two modes of operation: In the first it will trip after detecting any

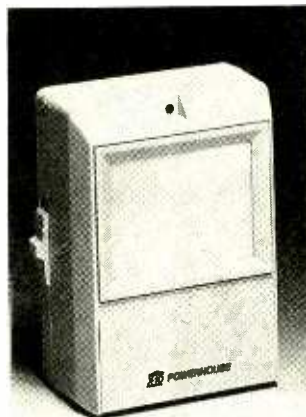

motion, and in the second mode it will trip only if two movements are detected in a short period of time or if continuous movement is detected.

The SP554 passive-infrared motion detector costs \$59.00. For additional information, contact X-10 (USA) Inc., 185A Legrand Avenue, Northvale, NJ 07647; Tel: 201-784-9700; Fax: 201-784-9464.

## AMAZING SCIENTIFIC & ELECTRONIC PRODUCTS

### LASERS AND SCIENTIFIC DEVICES

VRL2K	3mw Vis Red Laser Diode System Kit	\$159.50
LLI51K	Laser Beam "Bounce" Listener Kit	\$199.50
LHC2K	Visible Simulated 3 Color Laser Kit	\$44.50
LC7	40 Watt Burning Cutting Laser Plans	\$20.00
RUB4	Hi Powered Pulsed Drilling Laser Plans	\$20.00
LGU40	1 to 2mw HeNe Vis Red Laser Gun Assembled	\$199.00
LLS1	Laser Lite Show - 3 Methods Plans	\$20.00
SD5K	See in the Dark Kit	\$299.50
EML1K	Electromagnetic Coil Gun Kit	\$69.50
MCP1	Hi Velocity Coil Gun Plans	\$15.00
LEV1	Levitating Device Plans	\$10.00
EH1	Electronic Hypnotism Techniques Plans	\$10.00

### HIGH VOLTAGE AND PLASMA DISPLAY DEVICES

HVM7K	75,000 Volt DC Variable Output Lab Source Kit	\$149.50
IDG3K	Ion Ray Gun Kit, project energy without wires	\$69.50
NIG9K	12V/15 VAC Hi Dut Neg Ion Generator Kit	\$34.50
EMA1K	Telekinetic Enhancer/Electric Man Assembled	\$99.50
LG5K	Lightning Display Globe Kit	\$54.50
BTC1K	Worlds Smallest Tesla Coil Kit	\$49.50
BTC3K	250KV Table Top Tesla Coil Kit	\$249.50
BTC5	1 5 Million Volts Tesla Coil Plans	\$20.00
JL3	Jacobs Ladder - 3 Models Plans	\$15.00
GRA1	Anti Gravity Generator Plans	\$10.00
PFS20	Plasma Fire Saber Assembled	\$69.50
DPL20	Dancing Plasma to Music and Sounds Assembled	\$79.50

### SECURITY AND PROTECTION DEVICES

ITM10	100,000 Volt Intimidator up to 20' Assembled	\$129.50
IPG70	Invisible Pain Field Blast Wave Gen Assembled	\$74.50
PSP4K	Phasor Sonic Blast Wave Pistol Kit	\$59.50
LIS10	Infinity Xmr, Listen in Via Phone Assembled	\$199.50
TAT30	Automatic Tel Recording Device Assembled	\$24.50
VWPM7K	3 Mi. FM Auto Tel Transmitter Kit	\$49.50
FMV1K	3 Mi. FM Voice Transmitter Kit	\$39.50
HDD1K	Homing/Tracking Beeper Transmitter Kit	\$49.50

EASY ORDERING PROCEDURE TOLL FREE 1-800-221-1705

or 24 HRS ON 1-803-673-4730 or FAX IT TO 1-603-672-5406

VISA, MC, CHECK, MO IN US FUNDS. INCLUDE 10% SHIPPING. ORDERS \$100.00 & UP ONLY ADD \$10.00. CATALOG \$1.00 OR FREE WITH ORDER.

**INFORMATION UNLIMITED**  
P.O. BOX 716, DEPT. PE, AMHERST, NH 03031

# FREE CATALOG

Call (800) 992-9943

Over 35,000  
Electronic Components

Call Today for Your  
FREE SUBSCRIPTION

If You Order Today,  
WE SHIP TODAY!!



**MOUSER  
ELECTRONICS**

(800) 992-9943

Stocking Locations Across America.

**CIRCLE 13 ON FREE INFORMATION CARD**

# THINK TANK

By John J. Yacono

## The Bitgrabber Revisited

**B**ack in the December 1990 issue of **Popular Electronics**, there was a project (which I designed) that generated a good deal of mail—luckily all of it was good. Many people came out with additions and modifications to the circuit, and since it is a very simple project, I thought I'd present some of the mail here.

The project was called the *Bitgrabber*, and it was a very simple (read that "beginner's") computer project. In fact, even if you've never built a computer-oriented circuit, you needn't hesitate to try assembling the Bitgrabber; as long as you wire it correctly, it will work. (In fact, one of this month's contributors reduced the project to a one-IC circuit!)

What the Bitgrabber does

is monitor the parallel-printer connector of an IBM compatible and waits to see a particular character coming out from there. The character it looks for is set by the user through some switches. When the user-set character matches the computer-generated character, the output of the Bitgrabber goes low.

The Bitgrabber is as useful as it is simple. It can be used to troubleshoot parallel-printer cables and interfaces, or even serial cables. By using optocouplers, you can even use it to turn appliances in your house on and off at the command of your home computer.

### HOW IT WORKS

Inside a computer, characters are represented

by 8-bit binary numbers. The number that represents each character can be taken off an ASCII or IBM character chart, which is contained in most computer books. When a computer sends a character to a parallel printer, it sends all of the character's eight bits at once (*i.e.*, in parallel). They exit the computer through pins 2–9 on a DB-25 connector.

The Bitgrabber circuit is shown in Fig. 1. The eight switches, S1-a–S1-h, are used to tell the Bitgrabber the pattern of the bits it is to look for. When the bit pattern from the computer matches the pattern of the switches, the Bitgrabber's output goes low. That's all there is to it. If you want a more in-depth explanation of the parallel-printer port or the operation of the Bitgrabber, see the December 1990 issue of **Popular Electronics**.

The Bitgrabber is really a springboard; a project that leaves it up to the builder to make it really useful. That's what many of you have done. Let's take a look at some of the ideas that you've sent in (all of them will of course be rewarded with a *Think Thank II* book), and permit me to throw in a few curves of my own.

### THE ONE-CHIP BITGRABBER

I have been an avid reader of **Popular Electronics** for a number of years and although I normally get a chance to read the magazine when it arrives, I just got around to reviewing the December 1990 issue.

The Bitgrabber article starting on page 33 is a

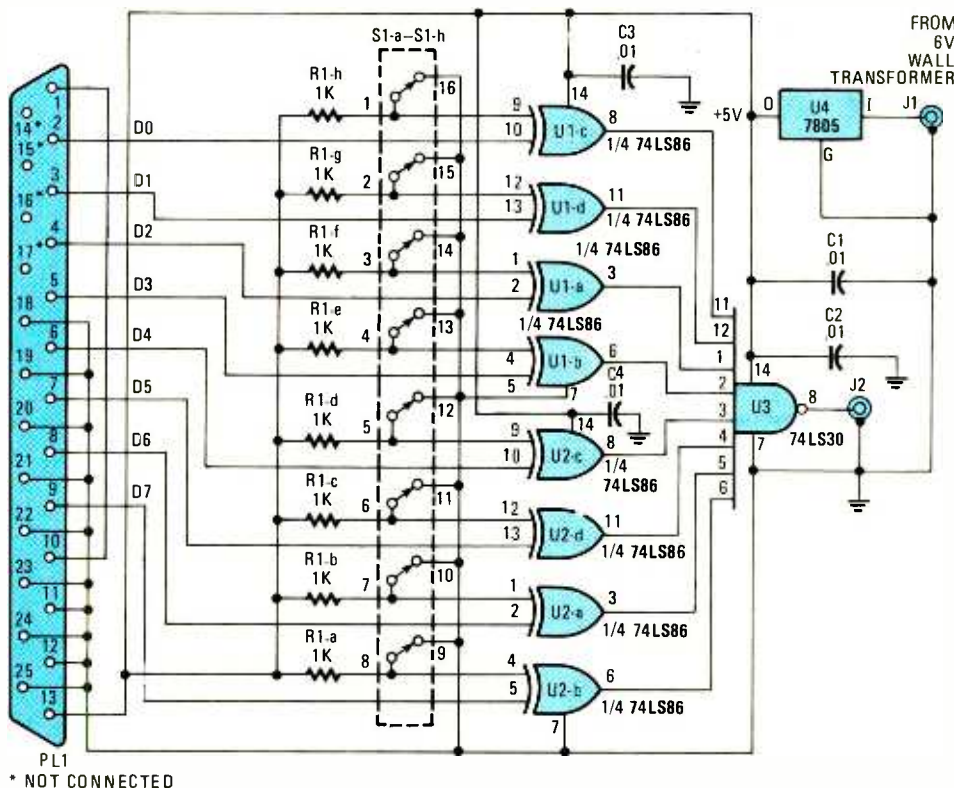

\* NOT CONNECTED

Fig. 1. The Bitgrabber in its earliest incarnation. It's a springboard that many ideas have sprung from.

# Earn Your B.S. Degree in ELECTRONICS or COMPUTERS



## By Studying at Home

Grantham College of Engineering, now in our 41st year, is highly experienced in "distance education"—teaching by correspondence—through printed materials, computer materials, fax, and phone.

No commuting to class. Study at your own pace, while continuing on your present job. Learn from easy-to-understand but complete and thorough lesson materials, with additional help from our instructors.

Our Computer B.S. Degree Program includes courses in BASIC, PASCAL and C languages — as well as Assembly Language, MS DOS, CADD, Robotics, and much more.

Our Electronics B.S. Degree Program includes courses in Solid-State Circuit Analysis and Design, Control Systems, Analog/Digital Communications, Microwave Engr, and much more.

An important part of being prepared to *move up* is holding the right college degree, and the absolutely necessary part is knowing your field. Grantham can help you both ways—to learn more and to earn your degree in the process.

Write or phone for our free catalog. Toll free, 1-800-955-2527, or see mailing address below.

Accredited by  
the Accrediting Commission of the  
National Home Study Council

**GRANTHAM**  
**College of Engineering**  
Grantham College Road  
Slidell, LA 70460

AUGUST 1991

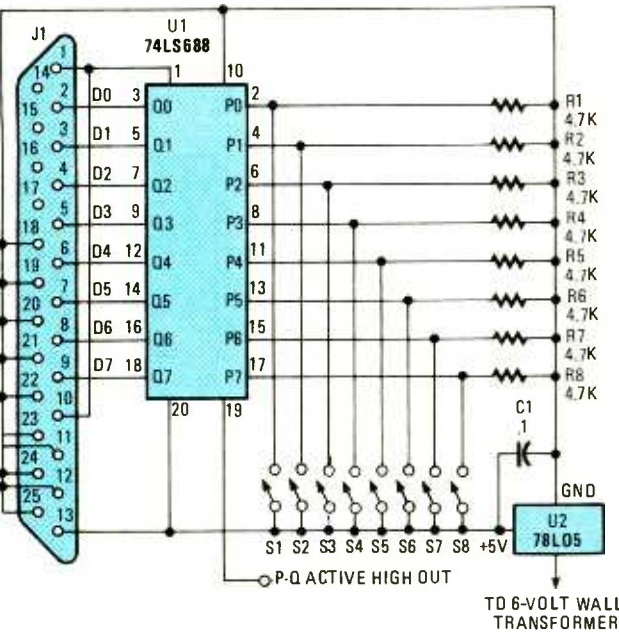

Fig. 2. One chip can replace all three of the chips in the old Bitgrabber. The trouble is getting the chip.

very interesting article and could be used as a basic building block for numerous computer projects. However, after a detailed inspection of the circuit I would like to suggest a simpler approach.

The IC used in my circuit (see Fig. 2) is a 74LS688 8-bit magnitude comparator. Amazingly enough, the functional blocks that make up the 74LS688 almost duplicates the circuit shown in your article. The chip is especially designed to accomplish exactly what the three chips in the Bitgrabber do. By placing the data from the comput-

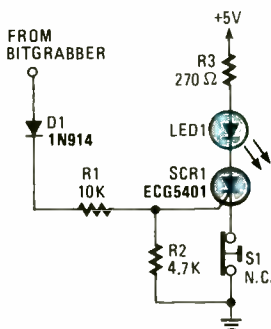

Fig. 3. A simple latching indicator can be made for the revised Bitgrabber (back in Fig. 2) with just a few components.

er on the Q inputs and the user-selected data from the switches (S1–S8) on the P inputs, you'll get an active-high output on pin 19, if and only if, the two sets of data match.

The greatest advantage to using this IC in the circuit is that it reduces the number of components. An added advantage, from my viewpoint, is that the output is an active high, which generally makes it easier to interface with other circuits. Also since the chip provides a chip-enable input (pin 1), it allows handshaking to be tested also.

The additional circuit (shown in Fig. 3) can easily be added to latch onto the circuit's output. It eliminates having to repeatedly output a match to activate a slow test instrument (such as a multimeter). It is a very simple circuit that can be found in about all reference books on SCR's. I hope both circuits will be useful to someone. Keep up the good work with the magazine.

—Bobby D. Smith, Lake Charles, LA  
Very, very well done!

# SPECIAL FROM ETT

**PCP101—PRACTICAL DIGITAL ELECTRONICS HANDBOOK ... \$9.95.** Introduces digital circuits, logic gates, bistables and timers, as well as microprocessors, memory and input/output devices. Special section on digital test gear projects.



**PCP102—INTRODUCING DIGITAL AUDIO ... \$9.95** Shows what is involved in the digital part of audio signals, particularly in the newest devices such as CD, DAT and sampling. Bridges the gap of understanding for the technician and enthusiast.

**PCP103—PRACTICAL MIDI HANDBOOK ... \$9.95.** Covers all MIDI based equipment you can use—keyboards, drum machines, sequencers, effects units, mixers, drum pads and guitars. Also a section on computer music that covers software and more.

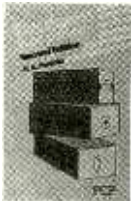

**PCP104—ELECTRONICS BUILD & LEARN, Second Edition ... \$9.95.** You start by assembling a circuit demonstrator that is then used to build and investigate a variety of useful circuits including oscillators, multi-vibrators, bistables and logic circuits

**PCP105—MAKE MONEY FROM HOME RECORDING ... \$10.00.** Now that you've spent all that money on all that recording gear, wouldn't it be nice to get some of it back? Well here's the book that can show you how.



**PCP106—SYNTHESIZERS FOR MUSICIANS ... \$10.00.** All current popular forms of synthesis explained; LA, additive, phase distortion, FM and sampling. Get the sounds you want from your synth. Written especially for musicians.

MAIL TO: **Electronic Technology Today, Inc.**  
P.O. Box 240  
Massapequa Park, NY 11762-0240

### SHIPPING CHARGES IN USA AND CANADA

\$0.01 to \$5.00 ... \$1.50	\$30.01 to 40.00 ... \$5.50
\$5.01 to \$10.00 ... \$2.50	\$40.01 to 50.00 ... \$6.50
\$10.01 to 20.00 ... \$3.50	\$50.01 and above ... \$8.00
\$20.01 to 30.00 ... \$4.50	

**SORRY, No orders accepted outside of USA and Canada**

Total price of merchandise .....	\$ _____
Shipping (see chart) .....	\$ _____
Subtotal .....	\$ _____
Sales Tax (NYS only) .....	\$ _____
Total Enclosed .....	\$ _____

Name \_\_\_\_\_  
Address \_\_\_\_\_  
City \_\_\_\_\_ State \_\_\_\_\_ Zip \_\_\_\_\_

Those of you interested in building 1-chip Bitgrabbers will be happy to know that there is a whole family of 8-bit magnitude comparators. They include the active-low 74520, 74521, 74522, and 74689, and the active-high 74518, and 74519. (By the way, the 74688 is actually an active-low chip.)

So with all those chips out there, why did I use a more fragmented approach? Simple, it was hard for me to get those chips (even here in New York), so I designed the unit out of more commonly available stuff. A project won't be popular if people can't get the parts to build it.

By the way, I really prefer active-low outputs on TTL circuits. The reasons for that are pretty strong. First of all, active-low outputs can operate optocouplers. Optocouplers can operate DC loads, rectified AC, and full-wave AC loads. All you need is an optocoupler with the right output (transistor, SCR, or Triac driver, respectively).

Also by using an active-low output, you can interface the circuit with CMOS circuitry operating with a higher supply voltage. That's one reason why most outputs on TTL devices are active low.

By the way, the enable-input feature you mentioned is an excellent improvement. Some output ports actually hold one or two of the eight data lines high when idle. Your circuit removes the chance of falsely detecting that idle data.

## BITGRABBER ADDITION

Here's a simple addition to the Bitgrabber circuit from your December 1990 issue (see Fig. 4). In order to increase the usability of the circuit, an LED-driving circuit is added to the output. The

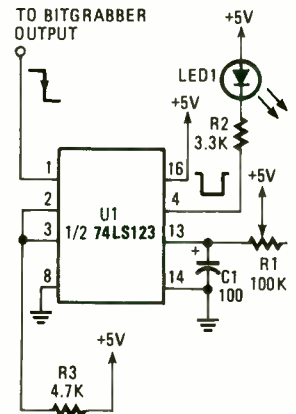

Fig. 4. A monostable can be added to the Bitgrabber for easy visual detection of pulses. The duration of the output pulse can be adjusted using R1.

circuit eliminates the need for hooking up a scope to the Bitgrabber's output and thus allows quick, portable use of the device.

In the circuit, the Bitgrabber's output drives half of a 74LS123 monostable multi-vibrator, which produces an output pulse with a duration long enough to illuminate LED1. The circuit is triggered by the falling edge of the Bitgrabber's output. The pulse width can be adjusted by varying R1. The values shown for R1 and C1 allow a maximum pulse duration of up to 4.5 seconds. When the desired character is detected, the LED will light for the duration of the pulse from the 74LS123.

If that character is detected again while the LED is still illuminated, the monostable is retriggered, prolonging the width of its output pulse. Thus, it is difficult to determine the exact number of occurrences of a particular character if the character is detected often (i.e., more frequently than the pulse width will allow). The circuit is, therefore, only useful for detecting an occurrence of a specific character.

—Brian Delsey, Hamilton, Ontario

You deserve a book for such a nice pulse stretcher.

### RELAY DRIVER

I enjoy experimenting with transistors and other devices that allow you to control a high voltage with a low one. I built this circuit (see Fig. 5) awhile ago and forgot about it. I found it today and connected it to the Bitgrabber. The relay remains pulled in as long as the base of Q1 is held high. Diode D1 protects the circuit from the inductive kick-back produced by the coil of K1. Resistor R1 reduces the current flow out of the Bitgrabber and into the base of Q1. Hope this gets me a *Think Tank* book.

—Jon Caywood, Lynnwood, WA

*Short and sweet. The reader should note that the printer port will have to output the selected character a couple of times to allow the relay (a pretty slow device) to deactivate.*

*Your interest in power control is well deserved; most of electronics is dedicated to that subject in one form or another.*

### MY OWN CURVE

At this point I'd like to throw in a twist of my own. By using SPDT center-off switches in place of the plain SPST units originally specified, you can set the

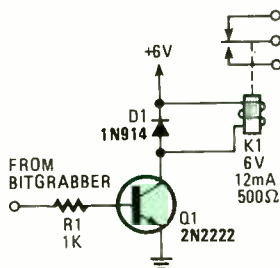

Fig. 5. A simple interface circuit can be made so that the Bitgrabber can operate powerful devices. Power control is one of the most important topics in electronics and its study accounts for most of the components we have today.

switches to a "don't-care" state, as well as to high and low. That will allow the unit to ignore the value of one or more of a character's bits if that bit is inconsequential.

Take a look at Fig. 6 to see how that is accomplished. In the figure, we only show the operation of one switch since they all function identically. As shown, the switch can be set in one of three positions: the "low" position, which ties an input of the xor gate to ground; the "high" position, which allows the gate input to float high via a pull-up resistor; or the "don't care" position, which ties the gate input to its corre-

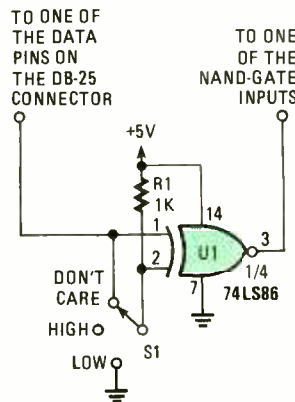

Fig. 6. The capability of the Bitgrabber can be greatly enhanced by using SPDT center-off switches. They allow the user to specify a "don't care" state for times when the value of a bit or two is unimportant.

sponding printer-port input, ensuring a match regardless of the port line's value. There is only one hitch to the modification: don't expect a Bitgrabber modified in this way to fit into a small case.

In the future, if you improve upon a project that you've seen in this magazine, let me know. If I get enough letters on a particular project, we can explore the possibilities together. Write to *Think Tank*, Popular Electronics, 500-B Bi-County Blvd., Farmingdale, NY 11735.

## Protel Easytrax 2™

### Outstanding value in Printed Circuit Board/CAD for your Macintosh and PC

Protel Easytrax 2 is a new, low-cost design package for PC and Macintosh users that includes everything required to produce professional quality Printed Circuit Board artwork.

Our easy-to-learn menu-driven design system breaks the 'expert barrier'—you'll be designing in minutes, not hours. Our comprehensive tutorials guide you through the program's extensive features that take the tedium out of board layout.

- Comprehensive library of Through-hole devices
- Gerber photoplotting and N/C drill tapes
- On-the-fly library components creation
- Intelligent Pad to Pad autorouting
- Switchable Metric/Imperial grid
- Auto-panning
- PostScript™ printing
- Powerful user-definable Macros
- Independent print/plot program
- Multi-layer boards of up to 32 X 32 inches.

At Protel, we offer free technical support, 24-hour BBS, and 30-day money back guarantee. Prices start at

**\$450**

**Free Evaluation Package  
Toll Free: 800-544-4186**

**Protel Technology, Inc.**

50 Airport Parkway, San Jose, CA 95110

Tel: 408-437-7771 Fax: 408-437-4913



CIRCLE 7 ON FREE INFORMATION CARD

## Enter A World Of Excitement with a Subscription to Popular Electronics™

### Get the latest electronic technology and information monthly!

Now you can subscribe to the magazine that plugs you into the exciting world of electronics. With every issue of Popular Electronics you'll find a wide variety of electronics projects you can build and enjoy.

Popular Electronics brings you informative new product and literature listings, feature articles on test equipment and tools—all designed to keep you tuned in to the latest developments in electronics. So if you love to build fascinating electronics, just fill out the subscription form below to subscribe to Popular Electronics... It's a power-house of fun for the electronics enthusiast.

#### EXCITING MONTHLY FEATURES LIKE:

- CONSTRUCTION—Building projects from crystal sets to electronic roulette
- FEATURES—Educational training on digital electronics, Ohm's Law, Antennas, Communications, Antique Radio, Simplified Theory
- HANDS-ON-REPORTS—User test comments on new and unusual consumer products
- SPECIAL COLUMNS—Think Tank, Circuit Circus, Computer Bits, DX Listening, Antique Radio, Amateur, Scanner, Scene

#### PLUS: ALL OUR GREAT DEPARTMENTS!

You'll get 12 exciting and informative issues of Popular Electronics for only \$18.95. That's a savings of \$16.45 off the regular single copy price. Subscribe to Popular Electronics today! Just fill out the subscription order form below.



FOR FASTER SERVICE CALL TODAY  
**1-800-435-0715**  
(7:30AM-8:30PM)  
EASTERN STANDARD TIME

## Popular Electronics SUBSCRIPTION ORDER FORM

P.O. Box 338, Mt. Morris IL, 61054

APEHI

**YES!** I want to subscribe to Popular Electronics for 1 Full year (12 Issues) for only \$18.95. That's a savings of \$16.45 off the newstand price.

Payment Enclosed  Bill me later

Please charge my:  Visa  Mastercard

Acct. # \_\_\_\_\_

Signature \_\_\_\_\_

Exp. Date \_\_\_\_\_

#### PLEASE PRINT BELOW:

NAME \_\_\_\_\_

ADDRESS \_\_\_\_\_

CITY \_\_\_\_\_

STATE \_\_\_\_\_

ZIP \_\_\_\_\_

Allow 6 to 8 weeks for delivery of first issue. U.S. Funds only. Includes add'l 3.00 postage. 10¢ extra 1-month add'l 5¢ for postage.

AUGUST 1991

# TAB Books is Your Key to State-of-the-Art Electronics



**POWER SUPPLIES** by *Ivory M. Gouvier*  
Brings you up to date on today's most advanced power supply circuits. Find out how new high-frequency devices are reducing production costs and dramatically improving power supply efficiency, reliability, compactness, and volume. 176 pp., 98 illus. #3540H \$26.95



**BUILD YOUR OWN 80486 PC AND SAVE A BUNDLE** by *Aubrey Pilgrim*  
Pilgrim makes the going easy by providing you with a comprehensive list of sources for low-cost components and equipment. The book details hundreds of business and personal applications that 486 systems can perform. 224 pp., 125 illus. #3628H, \$26.95

## SECRETS OF RF CIRCUIT DESIGN

by *Joseph J. Carr*  
Design and build your own radio frequency amplifiers, preselectors, signal generators, inductor coils, antennas, microwave circuits, and other devices. Experiments help you explore such problems as electromagnetic interference and 10 BASIC programs help you plan, design, and construct an antenna. 416 pp., 175 illus. #3710H \$32.95

## TROUBLESHOOTING AND REPAIRING VCR'S—2ND ED.

by *Gordon McComb*  
"Those many maintenance and repair functions which can be done are covered using exact detail and many hints."—*Midwest Book Review*  
You get step-by-step, illustrated instructions for diagnosing and servicing all types of VCRs, including VHS, Beta, and 8mm. 352 pp., 200 illus. #3777H \$32.95

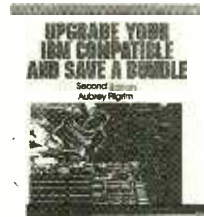

**UPGRADE YOUR IBM® COMPATIBLE AND SAVE A BUNDLE—2ND ED.** by *Aubrey Pilgrim*  
Get nontechnical instructions for upgrading any model IBM® or compatible for Windows 3.0. Replace motherboards with 80286, 80386, and 80486 boards; add new floppy disk drives and hard disks; replace old BIOS chips; install chips and memory boards; plug in internal modems and VGA, fax, and network boards. 272 pp., illus. #3828H \$29.95



**PROGRAMMABLE CONTROLLERS: Hardware, Software, and Applications** by *George L. Batten, Jr., Ph.D.*  
This timely guide gives you details on • PLC use • types of hardware • software and high and low level programming languages • interfacing PLCs with peripherals • and creating networks of PLCs. 304 pp., 187 illus. #3147H \$38.95

## INVENTING: Creating and Selling Your Ideas

by *Philip B. Knapp, Ph.D.*  
Profit from your brainstorm. This guide takes you through the entire inventing process: conceptualization, prototypes, patents, obtaining capital backing, and marketing your inventions. 270 pp. #3184P, \$15.95

## COPYRIGHTS, PATENTS, AND TRADEMARKS: Protect Your Rights Worldwide

by *Hoyt L. Barber*  
Make your patent, trademark, or copyright process hassle-free using the ready-to-use forms, applications, and important addresses found in this guide. 272 pp., 44 illus. #30060P, \$15.95

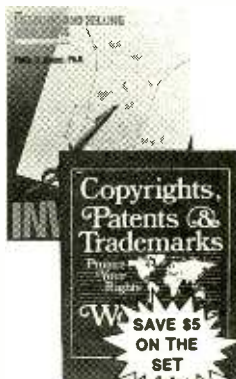

## CIARCIA'S CIRCUIT CELLAR—VOL. 7

by *Steve Ciarcia*  
Ciarcia shows you how to construct easy-to-build, cost-effective, and fun projects, including • infrared remote controllers • circuit cellar multiprocessor • gray scale video digitizer supercomputer • the smart spooler, and more! 256 pp., 100 illus. #10010P \$19.95

## THE COMPLETE SHORTWAVE LISTENER'S HANDBOOK—3RD ED.

by *Hank Benret, Harry L. Helms, and David T. Hardy*  
This "bible of shortwave" offers you the latest in equipment, innovations, and operating practices. You get a wealth of useful information, including a frequency listing for major and minor stations worldwide, SWL terminology, abbreviations, signals, equipment jargon, and more. 304 pp., 96 illus. #2655P \$17.95

## MICROWAVE OVEN REPAIR—2ND ED.

by *Homer L. Davidson*  
Save yourself countless dollars in repair bills with this easy-to-use fix-it manual. Clear, step-by-step instructions and hundreds of detailed working illustrations and photographs give you specific solutions for more than 200 common microwave oven malfunctions. 368 pp., 383 illus. #3457H \$29.95

## ELECTRONIC SIGNALS AND SYSTEMS: Television, Stereo, Satellite TV, and Automotive

by *Stan Prentiss*  
Prentiss exposes you to the composition and use of a wide variety of test instruments, transmission media, satellite systems, stereo broadcast and reception facilities, antennas, and television equipment. 328 pp., 189 illus. #3557H \$29.95

## OLD TIME RADIOS! Restoration and Repair

by *Joseph J. Carr*  
Troubleshoot and repair all kinds of antique and classic radios. This how-to guide gives you detailed instructions and schematics plus vacuum tube pinout diagrams. Includes a complete classic radio troubleshooting course. 256 pp., 247 illus. #3342H \$25.95

## To Order Call Toll Free: 1-800-822-8158

(In PA, AK, and Canada call 1-717-794-2191) or mail coupon to:

TAB Books, Blue Ridge Summit, PA 17294-0840

Fax orders: 1-717-794-2080

Please send me the book(s) below:

Book # \_\_\_\_\_ Price \_\_\_\_\_ Book # \_\_\_\_\_ Price \_\_\_\_\_

Book # \_\_\_\_\_ Price \_\_\_\_\_ Book # \_\_\_\_\_ Price \_\_\_\_\_

Please add applicable state and local sales tax  
(in Canada add \$5.00 shipping and handling) \_\_\_\_\_

TOTAL \_\_\_\_\_

Check or money order enclosed made payable to TAB Books.

Charge my  VISA  MasterCard  American Express

Acct. No. \_\_\_\_\_ Exp. \_\_\_\_\_

Signature \_\_\_\_\_

Name \_\_\_\_\_

Address \_\_\_\_\_

City/State/Zip \_\_\_\_\_

**Satisfaction Guaranteed**—If you are not completely satisfied, return the book(s) for a complete refund. PE81

# DESIGN your own ROBOT

*Learn the fundamentals of brain activity and how to simulate animal behavior by building your own robot.*

BY JONATHAN CONNELL

**T**he human brain is very complex. It contains billions of neurons and has trillions of connections between them. Although, many areas have a uniform structure, there are several-hundred architecturally distinct regions. That makes simulating a human brain very difficult.

By contrast, there are many insects and marine animals that have far fewer neurons. Some of them have been studied in detail and scientists have a good idea of how the various components of their brains are connected together. There is also a rich collection of experimental data detailing what sort of behaviors are present in each animal and how various groups of neurons interact to perform the necessary computations. So, at least for now, it's more feasible for us to build robotic models of such simple creatures rather than humans. Also, since man evolved from simpler organisms, the knowledge gained from such an endeavor should ultimately lead us to a better understanding of our own minds.

In this article, we'll investigate the nature and capabilities of elementary, animal-like reflex systems. We'll also show you how to construct an inexpensive mobile robot based on simple animal behavior.

**Behavior.** Before designing our own creature, we need to investigate some of the principles of natural control systems like the nervous system. Let's start by breaking an organism's overall behavior into a collection of separate reflexes. This allows us to study and develop an understanding of each reflex as though it was isolated from the others. Once each reflex is understood they can all be put together in a model that coordinates their activity. This coordination is necessary to prevent potential conflicts between reflexes.

Each reflex can be modeled as a set of "if-then" rules—if a particular circumstance exists, then perform a specific action. A simple way to model the coordination of the animal's actions is to give each rule a different priority. Experimental robotics research has shown that such systems, if cleverly designed, are powerful enough to accomplish sophisticated tasks.

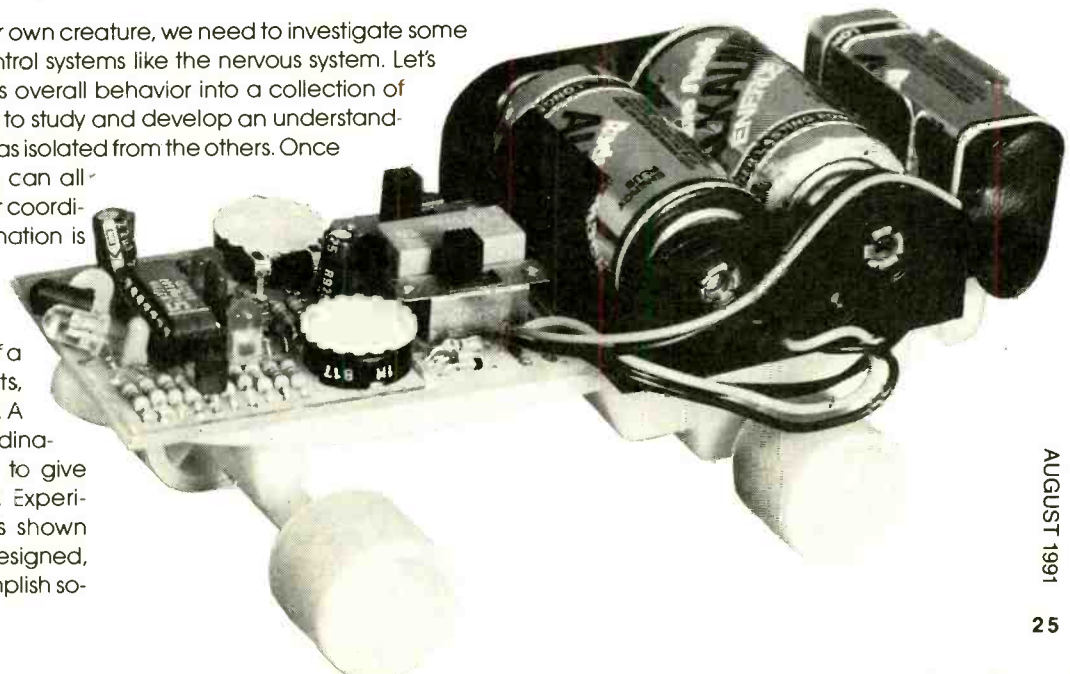
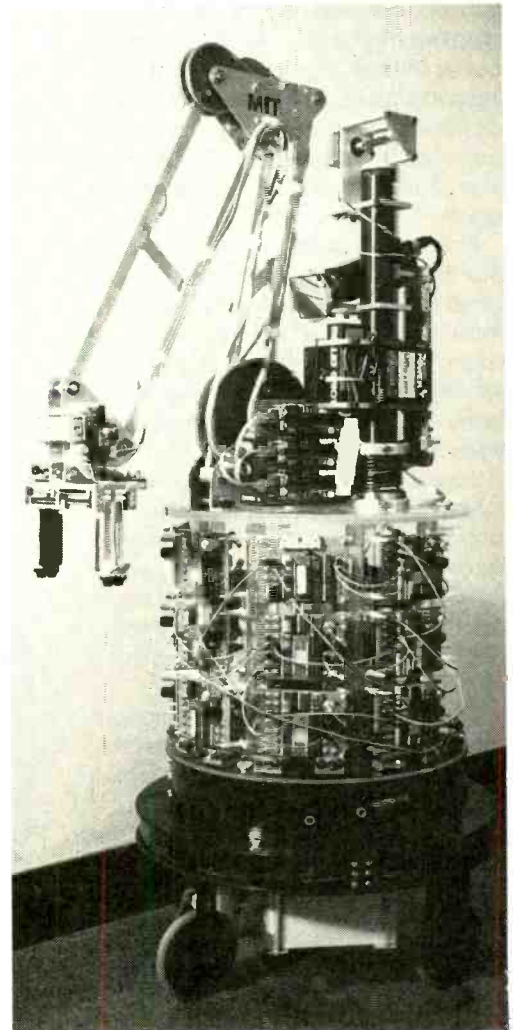

The functioning of a rule-based system is best illustrated by an example. Consider the coastal snail. This creature spends its life at the edge of the ocean, eating algae off rocks. The best place for this kind of snail is in a crack right above the waterline. There it can find a rich concentration of food and the creature is in no danger of being dried out by the sun or gulped-up by a passing bird. Unfortunately, the snails are occasionally swept away by a wave, so to avoid starvation they must have some way of seeking out this optimal region again.

Ethological studies have revealed that the snail has two primitive drives: to climb upward and to avoid light. We will refer to these reflexes as "up" and "dark." However, neither of these instincts completely controls the snail's behavior. In fact, there are some situations in which they play no part. For instance, if there is no difference in light intensity between directions, the dark behavior is quiescent and the snail crawls straight upward. Similarly, when the snail is on a more or less flat surface, the up drive is inactive and the snail's direction of travel is determined solely by the illumination gradient.

Overall, however, dark is the stronger reflex. If a very bright light source is present, the snail will crawl away from it even if this means going downward.

Surprisingly enough, if one turns the snail upside down, instead of avoiding light, it will now head toward bright areas. We can say that this is due to a third reflex, "bright," which provides the animal with an urge to seek out light. Since the bright reflex ends up controlling the motion of the animal, it must override the output of the dark module. Yet this new behavior only becomes active, or "potentiated," when the animal is inverted. When the snail is right-side up, the creature acts out one of the lower level behaviors.

There is one further twist to all this. It has been observed that the light-seeking behavior occurs only underwater. If the animal is in air, it will invariably seek out dark areas, even if it is upside down. We can model this by adding another behavior, called "crack," to the creature's repertoire. When the snail is out of the water, this behavior takes precedent over all the other drives and causes the creature to seek out dark places.

As shown in Fig. 1, we can draw the interaction of the reflexes (or "behavioral modules") as boxes. We can

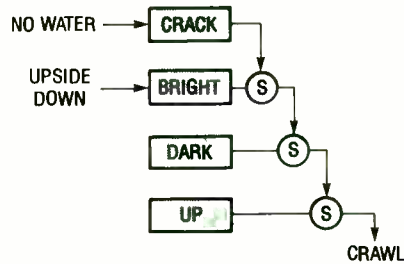

Fig. 1. The overall activity of a sea snail can be broken down into four natural tendencies or behaviors. In some situations, one tendency suppresses another. For example, bright behavior suppresses dark behavior.

indicate the priority of the behavioral modules through the use of circles with an "S" (which stands for suppressor node) in it. In the case of conflicting motion commands, the behavioral module which injects its signal into the side always wins and gets control of the snail's body. The dominant behavior

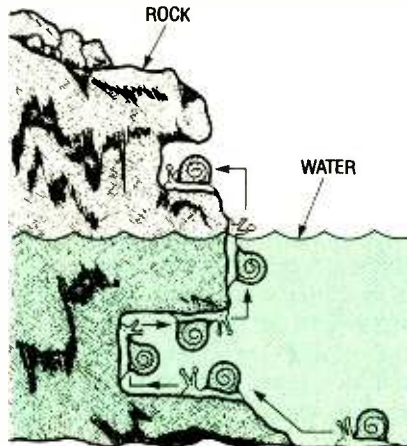

Fig. 2. The priorities placed on a snail's behavior cause it to climb up out of the water, seek a dark crack in the landscape and stay there.

suppresses the weaker behavior.

This collection of four behaviors allows the snail to find the best foraging area, even if it has to negotiate major obstacles along the way. Imagine, as shown in Fig. 2, that the snail starts on the ocean floor, a short distance offshore. Since the rocks are slightly darker



Fig. 3. Our robot will have three basic behaviors that will cause it to explore its world, avoid obstacles, and seek out objects.

than the surrounding sand, it crawls along the bottom towards them. Then, when it reaches an outcropping, it starts climbing the face. However, every time it comes across a notch in the rock, it is drawn inward by the darkness. Upon reaching the end of the crack, the snail starts climbing the rear wall and eventually reaches the ceiling. Here, it becomes inverted and thus moves outward toward light again.

Having successfully overcome this impediment, the snail continues climbing toward the surface. When it reaches the edge of the water, it ascends still further until it comes across another crack. As before, the dark-seeking behavior will take over and directs the snail into any crack encountered. However, since it is now above water, the snail does not head upward or turn around when it reaches the back, but instead stays deep in the crack to search for food.

**The Robot's Behavior.** Using behavior-based control systems we can now design our own synthetic creatures. The one to be described here is called "Muramator," which is Latin for "wall lover." As its name suggests, the robot follows the edges of walls and furniture. To design such a robot, we start by breaking its desired "behavior" down into separate parts.

The most primitive behavior we'll call "explore." This module should constantly urge the robot to go forward. While that causes the robot to move around its environment, it also causes the robot to get stuck easily. To prevent this, we'll add another behavior, "avoid," which overrides the output of the explore circuitry. Avoid's job is to steer the robot away from any obstacles that might be encountered.

With just these two behaviors a robot is capable of wandering around its environment for long periods of time. However, it tends to bounce around like a drunken pool ball. To make the robot more responsive to its world, let's add a third behavior, "seek." This module can search for objects and guide the robot toward them.

A dynamic balance between seek and avoid will keep the robot running roughly parallel to the edges of objects. Like an ancient mariner, the robot will attempt to keep the shoreline of its world in sight at all times.

The whole algorithm (shown in Fig. 3) has been successfully used by several larger robots. Our abstract specifica-



tions now need to be translated into real rules. To do this we need to know the actual perceptual and motion capabilities of our robot. To keep construction simple, for the body we have chosen a commercially available toy vehicle that is able to stop, go forward, or turn in place toward the left. No other actions are possible.

There are 3 different bodies (all available at Radio Shack) that will work with the Muramator circuit. The preferred body is a wire-controlled skate board. This configuration is called the "Whirligig" or WG model. Another option is to

### PARTS LIST FOR THE MURAMATOR

#### SEMICONDUCTORS

U1—LM339 quad comparator integrated circuit  
 D1—1N4001 rectifying diode (not used in the WG model)  
 D2—D11—1N914 small-signal diode  
 Q1, Q2—MPS2907 PNP transistor  
 Q3—TIL414 IR phototransistor  
 LED1—SEP8703-1 infrared emitting diode  
 LED2, LED3—Light-emitting diode

#### RESISTORS

(All fixed resistors are 5%, 1/4-watt units.)

R1—R3—1-megohm  
 R4—470,000-ohm  
 R5—R7—220,000-ohm  
 R8, R9—100,000-ohm  
 R10—R14—47,000-ohm  
 R15, R16—10,000-ohm  
 R17—R20—1000-ohm  
 R21—330-ohm  
 R22—R23—1-megohm potentiometer

#### CAPACITORS

C1—4.7- $\mu$ F, 35-WVDC, electrolytic  
 C2—0.1- $\mu$ F ceramic disc  
 C3, C4—.01- $\mu$ F metalized film  
 C5—470-pF metalized film  
 C6—22- $\mu$ F, 35-WVDC, electrolytic

#### ADDITIONAL PARTS AND MATERIALS.

K1—12-volt DPDT relay  
 S1—DPDT subminiature slide switch  
 S2—SPDT subminiature slide switch  
 B1—9-volt transistor-radio battery  
 B2, B3—1.5-volt C-cell battery  
 Printed-circuit board, wire-controlled skate board (Radio Shack No. 60-2298 or equivalent), 14-pin IC socket, 9-volt battery holder, 9-volt battery clip, 2 C-cell battery holder, wire, solder, etc.

A drilled and etched printed-circuit board with instructions is available for \$25 (post paid) from Johuco Ltd., Box 390, Vernon, CT 06066. CT residents must add appropriate sales tax.

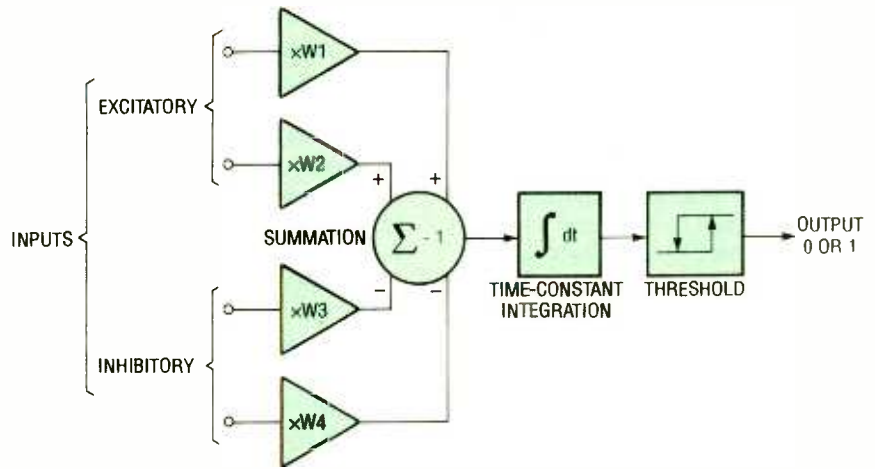

Fig. 4. A neuron receives input from other neurons and ascribes a certain amount of importance (weight) to each. Some weights are negative some positive. It then sums the overall value of the inputs, integrates them, and if the integrated value reaches a certain level the neuron outputs a one.

build the robot around a wire-controlled dinosaur (Radio Shack No. 60-2284), referred to as the "Dizzy Lizzy" (or DL) model. The DL model has a more appealing appearance, but the WG model has crisper performance. Still another option is the "Piro-jette" (or PJ) model, which uses a wire-controlled Stealth Fighter (Radio Shack No. 60-2305). However, the wings of that model have a tendency to get stuck on obstacles.

Since the Whirligig is the technically best model, we'll be covering that one here. You can get further information on using the other bodies from the kit supplier mentioned in the Parts List. Unfortunately, your choice of model might be constrained by which toys your local store has in stock, although they may be able to order the model you want. In any event, most Radio Shack stores stock most of the toys during the holiday season.

For sensing, we'll use a single infrared proximity detector. That device works by emitting a beam of light then looking for a bright reflection. The sensor is able to "see" objects in an almond-shaped region about 3-inches wide by 12-inches long.

The implementation of the first behavior, explore, is trivial: we just run the robot's motor. The next behavior, avoid, is also fairly simple. If the obstacle detector senses anything, we run the robot's motor in reverse. This causes the creature to turn away from the stimulus.

However, for this to work, the obstacle sensor must be oriented properly: On one hand, it is important that the robot have some forward vision to avoid ramming into objects directly in its path.

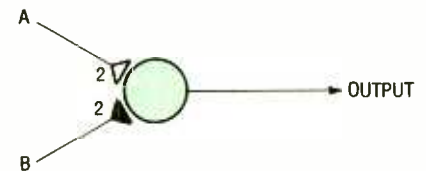

Fig. 5. This symbol of a neuron shows one excitatory input (A), one inhibitory input (B), the synapse (the circle), and the output. Both inputs have a weight of 2 as indicated.

However, if the sensor points straight forward, the robot is likely to side-swipe obstacles. Therefore, we compromise and aim the sensor about 30° to the right of the robot's midline. That naturally makes the robot more sensitive to obstacles on the right; a sensible choice since our robot avoids things by turning left.

The last behavior, seek, is more difficult to instill in the robot. Unfortunately, we can't directly determine where the wall is and how to steer the robot toward it. The robot only looks in one direction, and anytime it sees something, it is programmed to turn until the sensor reading disappears. However, if the proximity detector is active a large percentage of the time, we can assume that the robot is still near obstacles. Open spaces, on the other hand, are characterized by the absence of any sensor readings.

That forms the basis for our seeking strategy: When the robot has not seen anything for awhile, it spins around in an attempt to locate the edge of the world again. Notice that if the new seek behavior is omitted, the creature will not turn back toward the wall, but in-

stead it would zoom off into space. Since the robot avoids things by turning left, it has a good chance of finding things if it turns right instead. Yet, because our creature can only turn to the left, we must make a right turn the long way around. Thus, we generate a carefully timed burst of movement to yield approximately 270 degrees of rotation.

However, the creature is basically blind during a programmed turn, and may rotate all the way past the wall when seeking it. To fix this, as soon as the robot senses an object nearby, the seek circuit will be reset (*i.e.*, it will start measuring the amount of time it spends near objects again). That not only causes the robot to stop turning, it also synchronizes the unit so that it correctly measures the time since the last obstacle sighting.

**Neurons.** We have seen that it is not necessary to give a robot an explicit plan to perform action; instead, general rules suffice. This greatly reduces the complexity of the "nervous system" required. Typically, a set of ordered reflexes is adequate for simple navigation, but what mechanisms make these reflexes possible? In animals the answer is, of course, neurons. So, as a guide to implementing our "creature" electronically, let us see how real neurons work.

Neurons communicate via electrical/chemical impulses. To transmit a signal, one neuron releases a puff of a specific chemical across a gap (called a "synapse") toward the next neuron. The next neuron absorbs the chemical into one of its inputs (which consist of tree-like structures called "dendrites"). This substance briefly opens a number of ion channels in the receiving neuron's cell membrane, and the resulting flow of charge carriers causes it to act like a miniature battery.

The combined charges are funnelled back to the body of the cell (known as the "soma"). If enough dendrites are activated, the neuron gradually becomes more and more electrically charged. When there is enough accumulated potential, the neuron spontaneously generates its own series of impulses which travel down an output fiber (the "axon"). Eventually this signal impinges on the inputs of succeeding neurons and a similar series of events takes place.

**A Neuron Model.** Our model of a neuron takes into account all of these

phenomena. As shown in Fig. 4, there are a number of inputs (like dendrites) that converge on a single "summation" node, which is similar to a neuron's soma. The summation node adds all the inputs and passes them to an integrator. The integrated signal is passed to a threshold unit that evaluates the signal to determine whether any output should be produced.

Our model also incorporates some other salient features of real neurons not yet mentioned. For instance, all the inputs are not treated the same. Each input is amplified by its own gain or "weight factor," which is represented by the amplifier symbols shown. In this way, inputs with a large weight factor will influence the neuron more than inputs with a small weight factor. This reflects the anatomical fact that certain synapses in animals are more transmissive than others.

In addition, we also show inputs with negative weights (the lower two inputs). These correspond to "inhibitory connections" often observed between actual neurons. They can suppress the action of neurons.

Another characteristic of neurons that our model contains can be called "leakage." You can think of a neuron as a tub being filled with water. There are a number of hoses of different sizes feeding into the tub (the excitatory inputs) as well as a number of drain spouts (the inhibitory inputs). After the tub (neuron) has filled up, it fires. However, once "full," the neuron would fire at the slightest input so the tub has built-in leakage to gradually drain the remaining water.

To reproduce this effect, the summation node contains a "-1" term. This is essentially an inhibitory input that is always on. When none of the other inputs are active, the sum is now negative so the integrated excitation always decreases toward zero. However, we never let the value of the integral go

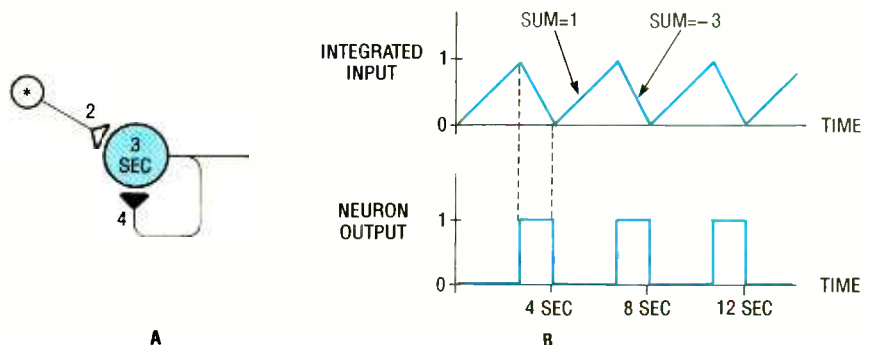

Fig. 6. The simple two-neuron system shown in A, can perform the operation of an oscillator. Its internal integration signal and final output are shown in B.

### Supplementary Reading.

*Vehicles*, Valentino Braitenburg, MIT Press, 1986.

*Minimalist Mobile Robotics*, Jonathan Connell, Academic Press, 1990.

*Mind Children*, Hans Moravec, Harvard University Press, 1988.

*The Study of Instinct*, N. Tinbergen, Oxford University Press, 1951.

negative; we restrict the integrated excitation to be between 0 and 1 at all times. This reflects the fact that we can not fill a tub above its rim or drain it below its bottom.

Interestingly, while real neurons also have limits to the voltages that they can produce, the voltage can drop below the usual "rest voltage." In animals, it is possible, and sometimes computationally useful, to discharge a cell below this neutral level. Such a condition makes it harder for later inputs to trigger the neuron.

The final twist to our neural model is the nature of the threshold circuit. We use a device known as a "Schmitt trigger" instead of a simple comparator. This device has two thresholds, a high one for rising signals and a lower one for falling signals. In our neuron model, the output switches on when the value of the integrated excitation reaches 1. The neuron will continue to output a 1 until the integrated output descends to 0 again.

This is much like the thermostat in a typical house. If you set the temperature to 70°F the furnace will not turn on until it gets as cold as 68°F or so. Then it will proceed to warm the house until the temperature slightly exceeds 70°F, say up to 72°, before shutting off. Although this feature is not totally accurate from a neurological point of view, it's a convenient feature to have.

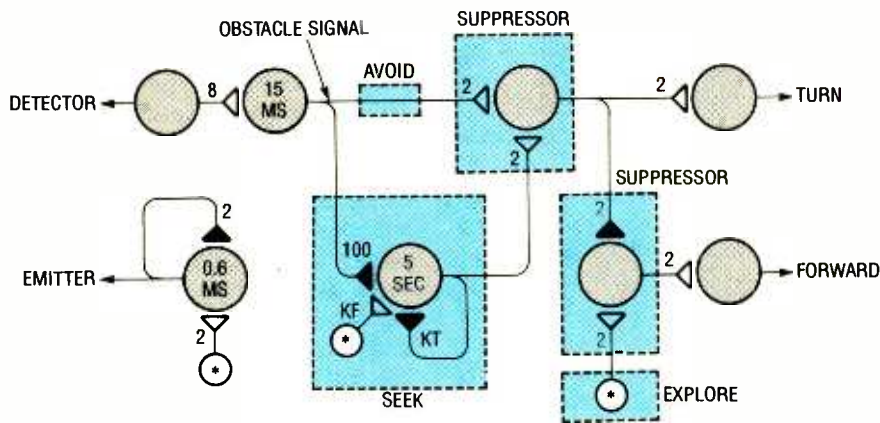

Fig. 7. The robot's 4-behavior activity can be emulated using 11 neurons. Can you find the two oscillators here? (Hint: look for feedback loops).

**Neuron Examples.** To see how such simulated neurons are used, consider the symbol shown in Fig. 5. Here, we depict the body of the neuron as a circle with an arrow coming out of it to represent the output. Input terminals are shaped like the bell of a trumpet and have their associated weight written next to them. White terminals are excitatory, whereas black ones are inhibitory. Since the structural details do not matter, we show all the inputs impinging directly on the cell body.

This neuron will only generate an output if input A is active and B is not. First, suppose neither A nor B is active. The input sum is:

$$0 \times 2 - 0 \times 3 - 1 = -1$$

(the last term comes from the leakage property of the model). This negative result causes the accumulated value inside the neuron (if any) to decay until the output switches to zero. Now sup-

pose A comes on. The new sum is:

$$1 \times 2 - 0 \times 2 - 1 = +1$$

If we set the time constant of the neuron to be very short, the output will almost immediately switch to one. Finally, imagine that B comes on as well. The computed sum for this case is:

$$1 \times 2 - 1 \times 2 - 1 = -1$$

which forces the neuron to turn off.

A more complicated example is the oscillator shown in Fig. 6A. The central part of this configuration is similar to an AND-NOT gate. Here, the neuron itself supplies the inhibitory input, while another neuron provides excitation. The asterisk inside this auxiliary neuron indicates that it is of a special type that is always on. Assume that the central neuron's internal potential starts off at zero and that its output is off. The initial input sum is:

$$1 \times 2 - 0 \times 4 - 1 = +1$$

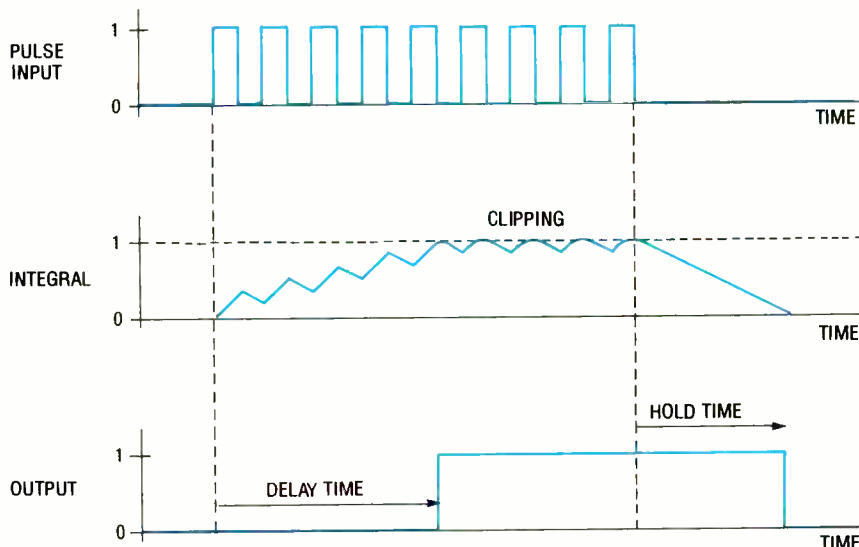

Fig. 8. Each detection of an infrared pulse (the top graph), causes the neuron to charge (middle graph). When the neuron reaches the threshold value, its output goes high and remains high till the neuron completely discharges (as shown by the bottom graph).

Thus, the integrated input starts climbing slowly as shown in the upper plot of Fig. 6B. The value written inside the neuron tells how long it takes for the neuron to fully charge with an input sum of 1. As can be seen, it takes 3 seconds for the integrated value to reach one.

Once the integral has reached the prescribed threshold level, the output of the neuron comes on. That is shown in the lower plot of Fig. 6B. However, this changes the overall sum sent to the integrator. It is now:

$$1 \times 2 - 1 \times 4 - 1 = -3$$

so the neuron's internal charge starts to decay. Yet, because of our special threshold stage, the neuron's output value remains at one until the integrator output again reaches 0. This happens one second after the output comes on. Once the output turns off, the whole cycle repeats.

As can be seen, the resulting output is a pulse train with a period of 4 seconds. The frequency of a cycle, as well as the width of the on and off portions, can be changed by adjusting the input weights because higher sums (whether positive or negative), alter the output in less time.

**The Neural Network.** The total collection of behaviors required for Muramator can be emulated by a network of 11 neurons as shown in Fig. 7. For motor control, the robot's brain has one neuron that drives the robot forward and another that causes it to turn. That makes the explore behavior easy to implement: a continuously active neuron provides input to the "forward" neuron. The activity of the avoid behavior is also simple: it just activates the "turn" neuron when the robot "sees" something. That is particularly easy since the appropriate obstacle-detection signal is directly available at the output of the neuron labeled "15 ms" (to be described later).

Notice that neither explore nor avoid is directly connected to the motor neurons. Instead, each sends its command via a single intermediate neuron. When designing large networks it is good practice to insert an "interneuron," such as this, to serve as an interface point where higher level signals can be injected. In this case, avoid indirectly suppresses the default forward drive by inhibiting the interneuron that would carry out the explore behavior. That blocks the forward behavior and allows the more important avoid module to substitute its own instructions. Tech-

nically, the avoid circuit should really have two interneurons: one to generate the turn command and one to suppress the forward command. This arrangement would let us cascade suppressor nodes so that the most important behavior could suppress all the others with a single connection.

The third behavior, seek, is composed of two additional neurons. Neglecting the weight-100 input, we can see that the remaining structure is identical to the basic oscillator presented earlier. The output of this unit feeds directly into the avoid interneuron and thus causes the robot to turn. There is no interneuron involved in this pathway because there are no higher level behaviors that might need to suppress seek. An important feature of this module is that the weights of both the excitatory and inhibitory connections (KF and KT) of the oscillator can be varied. Adjusting the KT weight makes the output of the oscillator remain high longer and thus

causes the robot to turn through a greater angle. Adjusting KF controls the interval between turns and thus determines the distance that the robot travels before spinning around to look for the wall again.

However, the creature is basically blind during one of these programmed turns, and may rotate all the way past the wall when seeking it! This is the reason for the inhibitory connection with a weight of 100. As soon as the robot senses an object nearby, the oscillator is turned off. This not only causes the robot to stop turning, it also synchronizes the unit so that it correctly measures the time since the last obstacle sighting.

The remaining four neurons form the proximity-detection subsystem. The neuron in the lower-left corner of the diagram is directly connected to the infrared emitter and generates the outgoing signal. That neuron functions as a simple oscillator and produces a symmetric square wave. It is necessary to

modulate the infrared beam so the detector can differentiate it from ambient infrared sources such as sunlight.

Once the beam bounces off some target, the two neurons in the upper-left corner of the diagram are responsible for processing the returned signal. The first neuron in the chain represents the detector. It is "on" when infrared radiation is detected. Since it receives a series of pulses when the robot is near an object, the output of this neuron resembles the top plot of Fig. 8.

The next neuron smooths out this waveform. When the detector neuron is on, the input to the second neuron is:

$$1 \times 8 - 1 = +7$$

so the internal potential of this neuron increases. Between pulses the input sum is simply  $-1$  and thus the potential slowly decays. The charging of the neuron is shown in the middle plot in Fig. 8. As can be seen, it takes several pulses to charge the neuron up to a high

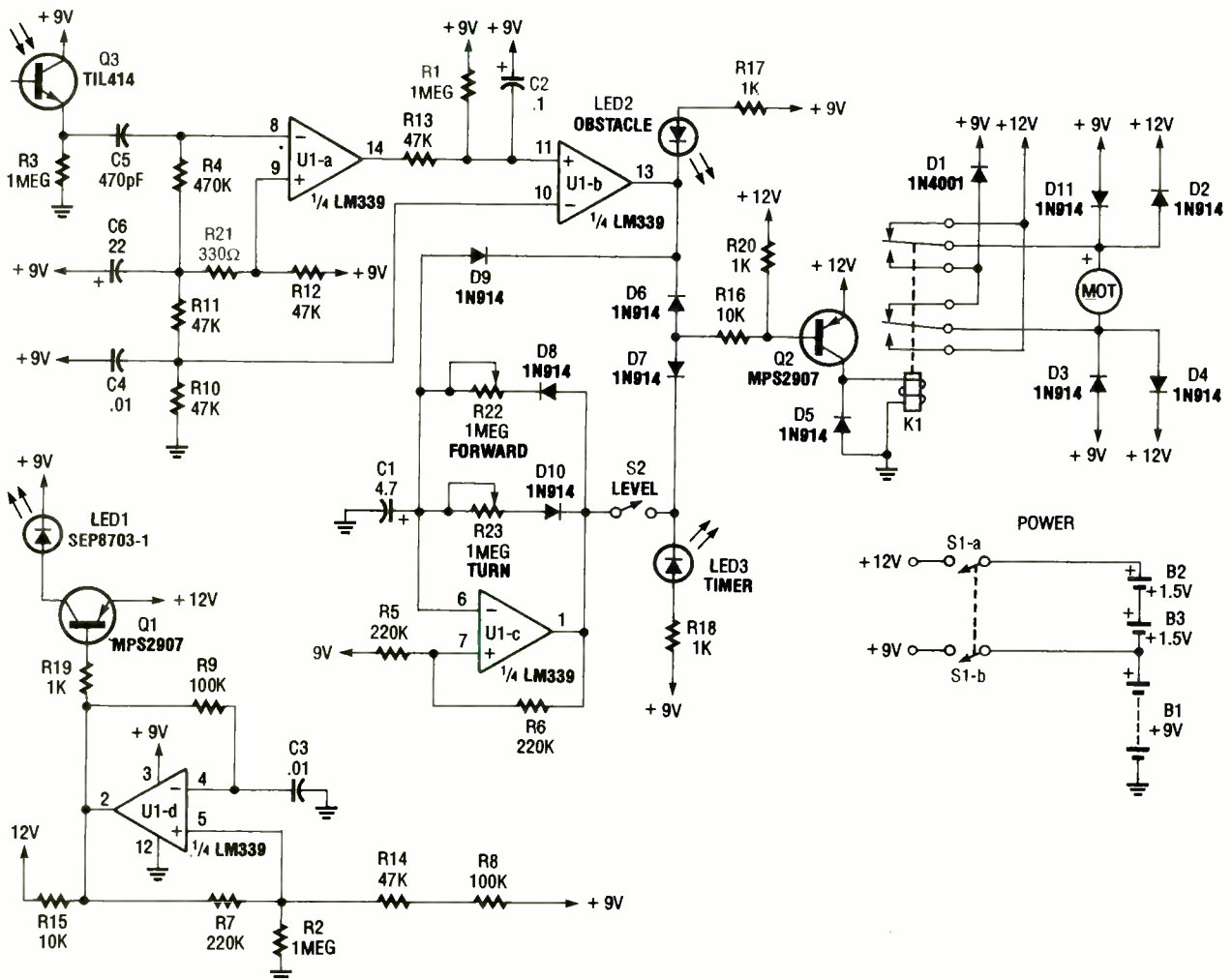

Fig. 9. All eleven of the robot's neurons are emulated by this circuit. Some neurons are based on comparators, while others are implemented with simple diodes.

enough level to generate an output, which is shown in the bottom plot.

This is useful for rejecting noise pulses. Similarly, the slow decay constant allows the system to “fly-wheel” through signal dropouts: the output of the neuron will remain on for several cycles after the stimulus vanishes. This same phenomenon can also be used to artificially increase the size of the avoidance turns the creature makes.

**Circuitry.** The final step is to compile all of this into circuitry. The actual schematic for the creature is shown in Fig. 9. In terms of actual circuitry, the 11 neurons in our model are implemented in a number of different ways. Some are modelled with voltage comparators, some with diode logic, and some with electro-mechanical devices. Keep this in mind as we describe the electronics for each of the creature’s component behaviors.

Let us start with the explore behavior module. The explore reflex is incorporated directly into the relay circuitry (right side of diagram). Normally the robot’s motor is connected so it runs forward. However, whenever the relay is energized by Q2, the voltage applied to the motor is reversed and the creature turns instead. An extra diode, D1, can be inserted to slow the creature down, if necessary. The diodes around the motor (D2–D4, and D11) and across the relay’s coil (D5) serve no behavioral function, they just clamp inductive spikes to the power-supply rails.

Thus, the explore neuron, the first suppressor, and the turn and forward neurons are all emulated in this piece of circuitry. The transistor for the relay can be considered the equivalent of the second suppressor node in the neural diagram, and diodes D6 and D7 act as the two excitatory connections to this interneuron.

The circuitry for the LED oscillator (see the lower-left corner of Fig. 9) corresponds directly to the neural model. Here, the feedback from a comparator’s output to its positive input provides the “hysteresis” needed by our dual-threshold neural model, while the resistor and capacitor on the negative input form the required integrator. The 10k resistor to +12 volts mimics the action of the necessary always-on neuron. This arrangement generates a squarewave that is amplified by another MPS2907 transistor to drive the IR LED. That unit radiates infrared energy (much like a TV remote control) into the

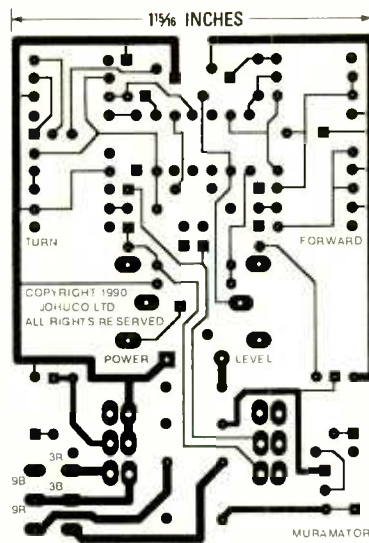

Fig. 10. This foil pattern is for the component side of the Muramator circuit board. The labels for the potentiometers and switches will help you use those controls.

environment, which then bounces off nearby objects.

The next behavior, avoid, switches the relay on using the signal from the infrared proximity detector. The circuitry for the detector is shown in the upper-left side of the diagram. The reflected IR signal biases a TIL414 phototransistor, which applies a small voltage across a 1-megohm resistor, R3. That signal is AC-coupled via a 470-pF capacitor into a simple threshold-detector formed by one section of the LM339 quad comparator. This is the “detector” neuron from the neural-network diagram. The capacitors on the voltage divider con-

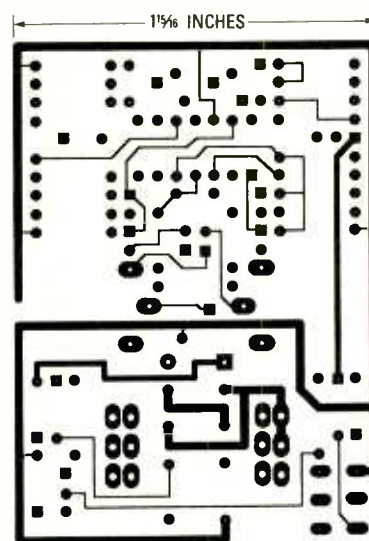

Fig. 11. This foil pattern for the solder side of the robot must be properly registered with the component-side pattern. Remember to connect all vias when the board is finished.

ected to the positive input of the comparator help stabilize the reference voltage against transients caused by switching the IR LED on and off, and operating the motor.

An inverted version of the obstacle-detection signal then enters a low-pass filter formed by R13 and C2. Since the LM339 has open-collector outputs, the decay rate of the voltage across C2 is governed solely by R1. It takes several pulses to discharge C2 sufficiently enough to generate an output. This is useful for rejecting noise pulses. As you’ll see, the slow decay constant allows the obstacle-detection signal to remain on for a period of time after the stimulus vanishes. By substituting a larger value for C2, you can increase the size of the avoidance turns the “creature” makes.

The RC-filtered voltage enters U1-b, which also acts as a simple comparator. The threshold level for this unit is obtained from the same voltage divider used for the first stage. This comparator combined with the previously described low-pass filter corresponds to the second detection neuron. The total result of all this processing is a clean digital signal indicating when an obstacle is present. It is connected to a red LED that indicates when the robot is “seeing” something.

The last of the creature’s behaviors, seek, is built from an oscillator similar to the one used to generate the IR beam. The oscillator has an active-low output: when pin 1 of U1-c is at zero volts, the robot should turn. Note that the oscillator’s output is connected back to the integrating capacitor (C1) through two diodes. These diodes steer current through the potentiometers so that the top potentiometer controls the capacitor’s charging time and the lower potentiometer controls the discharge rate.

Notice also that in the seek circuitry there is a diode (D9) descending from the obstacle-detection indicator, LED2. Since D9 has negligible resistance, it can “instantly” discharge capacitor C2 when the creature detects an obstacle. This connection models the weight-100 input in our neural design and is used to properly synchronize the oscillator as mentioned earlier.

The design also must have an arbiter that can combine the commands from each of the basic behaviors. To this end, both the seek oscillator and the avoid circuitry are connected to the relay’s driver transistor through diodes D6 and D7. This arrangement is used to model

the top "suppressor" neuron back in Fig. 7, as we mentioned earlier. Because both the obstacle detector and central oscillator have active-low outputs, these diodes form a logical OR gate. If the creature either sees something (LED2 turns on) or the turn timer kicks in (LED3 turns on), the relay will be activated and the creature will turn in place. The switch labelled "level" was installed to selectively disable the seek oscillator. That lets you investigate how the creature acts without this behavior. Of course the robot won't do anything at all unless its built, so let's get to that now.

**Circuit Construction.** Because of the complexity of the wiring, it is recommended that you use a printed-circuit board to wire the components together. For those of you that wish to make your own boards, the foil pattern for the component side of the board is shown in Fig. 10, and the foil-pattern for the other side is shown in Fig. 11. Since the board is double-sided, if you chose to make your own, you must solder tiny pieces of bus wire into the via holes and solder component leads to the pads on both sides of the board where applicable. Keep that in mind when soldering all components.

If you do not want to etch the circuit yourself, a drilled and etched plated-through printed-circuit board with instructions is available from the kit supplier mentioned in the Parts List.

With the board all ready to go, start by installing the 14-pin DIP socket at the location for U1 as shown in the parts-placement diagram of Fig. 12. Be sure to mount it and all the other components on the top side of the board (the side with the writing on it). Note that one end of the socket has a small notch. It should go toward the square pad on the printed-circuit board. Now flip the board over and solder its pins to the pads.

Now, guided by the parts-placement diagram, install the fixed resistors. Take each of the trimmer potentiometers and flatten the crinkles in its leads (if any) by squeezing the lead with needle-nose pliers. Now bend the two side leads of each potentiometer sharply downward away from the plastic adjustment dial. Next, gently bend the center lead of the potentiometer in the same direction. The bend should be made about halfway out from the body. Insert the potentiometers in the positions shown and solder them from

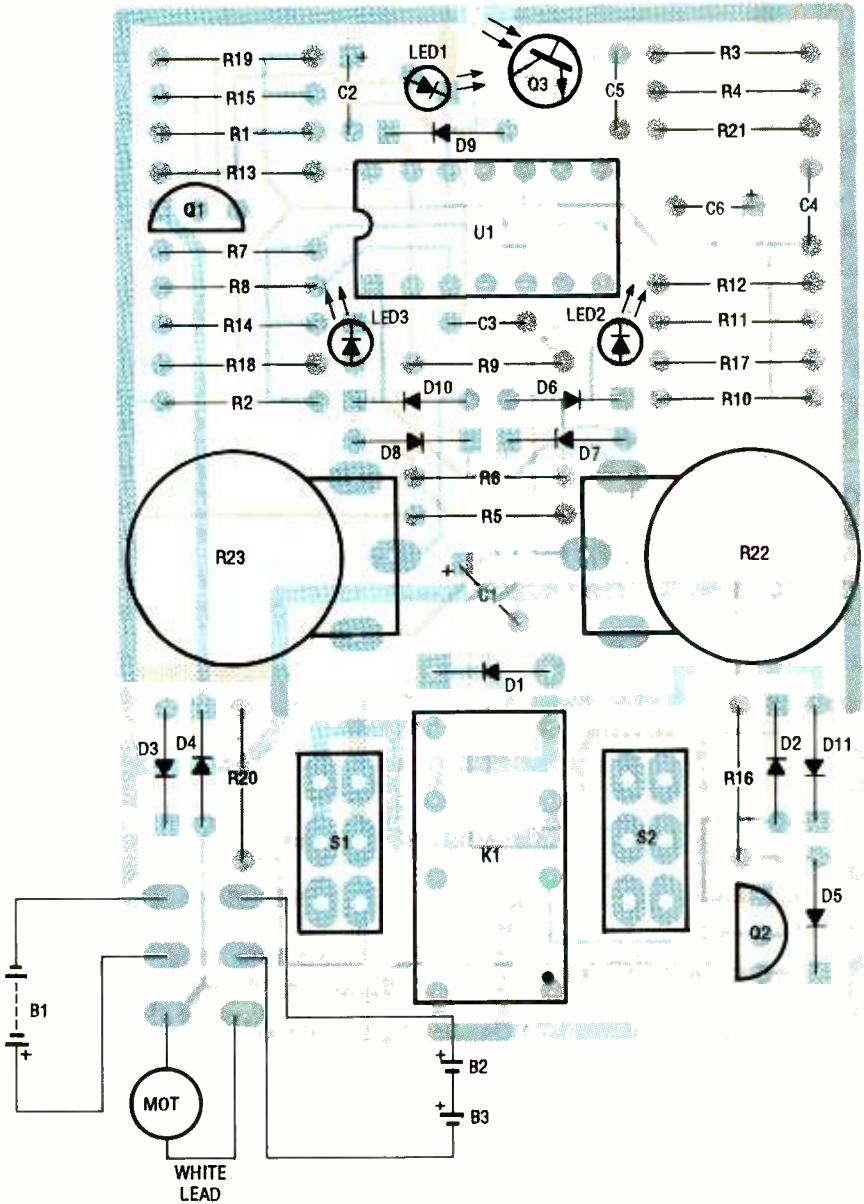

Fig. 12. Stuffing the board should be easy with this parts-placement diagram. Note that the pads for LED1 and Q3 are tilted at 30°.

the top of the board. Then turn the board over and apply more solder from the back side to completely fill the holes.

Next install, solder, and trim the ten 1N914 diodes and D1 in the places shown. Of course it is important to orient the diodes as illustrated.

The 0.01- $\mu$ F and 470-pF capacitors can be installed with any orientation. However, C1, C2, and C6 are polarized so be sure to insert the positive lead of each capacitor into the square pad for the component. Once all the capacitors are installed, bend, solder, and trim their leads.

The orientation of the transistors is important. Insert them positioned as shown in the parts-placement di-

agram. Sometimes the transistors come in a metal case rather than plastic. For this type, insert the device so that the lead closest to the tab on the case goes into the square pad.

Next install and solder the DPDT relay. The two plain LED's go near the corners of the 14-pin socket and should be installed next with the proper orientation.

Now, install the switches on the top side of the board. Do not push them completely down to the board, instead leave a tiny air gap under each switch to prevent the case from shorting out any of the copper traces nearby.

Cut a 3/8-inch by 3/4-inch wide piece of black electrical tape and wrap it around the body of the TIL414 phototransistor. It should be used to cover

only the sides of the component leaving the rounded end exposed. Install and bend the leads of the IR devices so that the body of each one lies along the surface of the board. Note that the orientation of the holes will place them at a 30° angle with the centerline of the board.

Next insert the LM339 integrated circuit into the socket with pin 1 oriented near the square solder pad used for the socket.

Take a 9-volt battery snap-on connector and cut its wires down to 4 inches. Strip and tin the ends and solder the wires into the lower-left corner of the board. The red wire should go into the hole marked "9R" and the black wire should go in the hole marked "9B."

If the C-cell holder you get has no leads of its own, you will have to add them. You can use a 3-inch section of the toy's wire-control cable for that. Strip and tin both ends of the two wires you use and attach them to the terminals on the holder.

If your battery holder has leads, then

trim them to 3 inches, and strip and tin the ends. Whether initially present or not, attach the lead from the positive terminal to the pad marked "3R," and connect the negative lead to the pad labelled "3B."

**Checking the Circuit Board.** Now that all the components have been installed, double check to ensure that everything is in the right place and oriented in the correct direction. Look for the dark bands on the diodes, the flattened rims of the LED's, the markings on the capacitors, the notched end of the chip, and the flat sides of the transistors.

Now turn the board over and check all the solder joints. Except for 2 holes in the lower-left corner of the board, all holes should have something soldered into them. Check to make sure that all the leads are securely soldered in place. Also make sure you have used enough solder on each joint—you should not be able to see the edge of the hole underneath.

Also check the bottom of the board for solder bridges. There is only one place on the board where adjacent pads should be connected: beneath two terminals of the power switch. If any other two pins have a blob of solder between them, remove it by heating the bridge then tapping the board against the table. If you find any other suspicious-looking connections, heat them up to see if they are actually mistakes.

**Electrical Tests.** Now it is time to test the basic operation of the board so install the batteries. Start with the power switch down (away from the potentiometers), and the level switch up. In a dark room, you should see a dim orange glow inside the IR emitter. If you don't, check the orientation of the IR LED and the transistor at the top of the board.

Now put your hand in front of the IR components. The obstacle LED should come on and go off again when you move your hand away. If it doesn't, check to be sure the LM339 is inserted properly and that C2 is connected with the correct polarity. If the LED lights at the wrong time, check its orientation. You should also hear the relay click every time the LED changes state. If not, check the orientation of Q2 and D5; those are located in the lower-right corner of the board.

Next, adjust both potentiometers so that they are in the middle of their ranges (arrows point toward the left and right edges of the board) and then move the Level switch down. The timer LED should now blink periodically and the relay should click. If the light doesn't blink, check that the LM339 chip is inserted properly. If there are no clicks, check the orientation of the diodes near the center of the board. Next, test whether rotating the turn potentiometer adjusts how long the light stays on. Also test to find out whether adjusting the forward knob controls how long it is between blinks. If these controls seem reversed, check the orientation of the timer LED.

Finally, test the synchronization. When the timer LED is on, move your hand into the detector's field of view. The timer indicator should immediately go out and stay off until you move your hand away and the obstacle indication disappears. If not, check the orientation of the diodes near the center of the board and look for possible cracks in them.

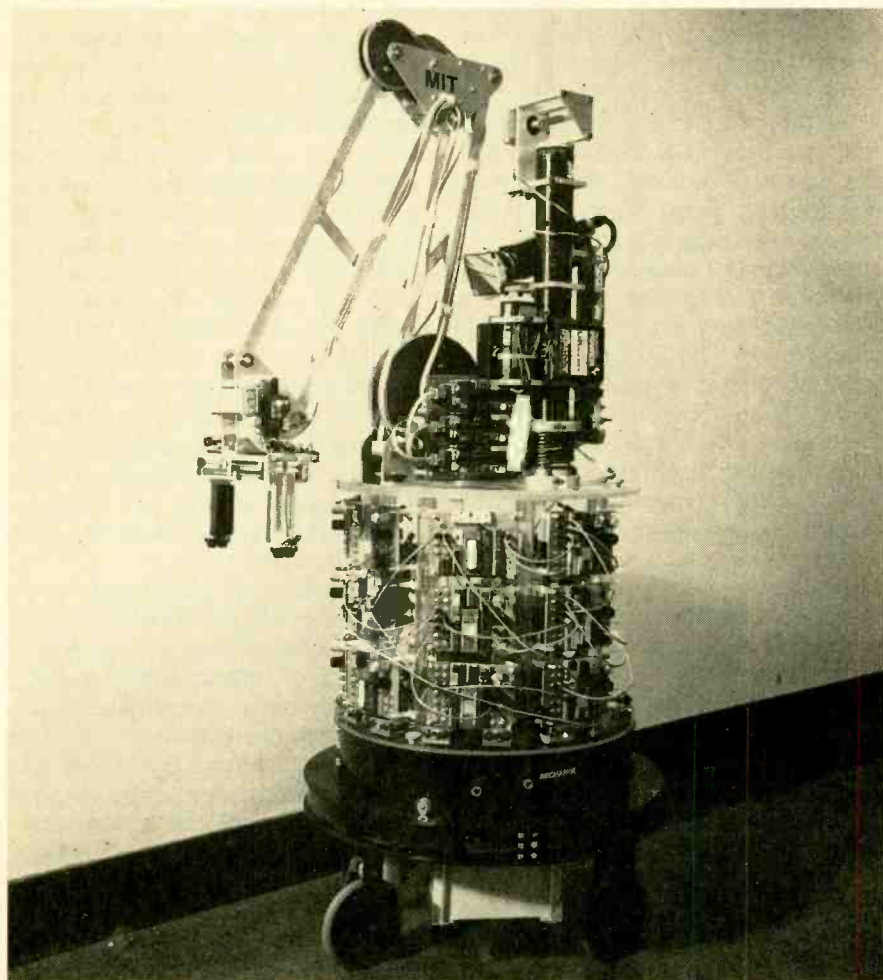

*This robot was designed and built by the author using the principles discussed in this article. Named Herbert and seen on PBS's "Discover" program, its function is to collect empty beverage cans.*

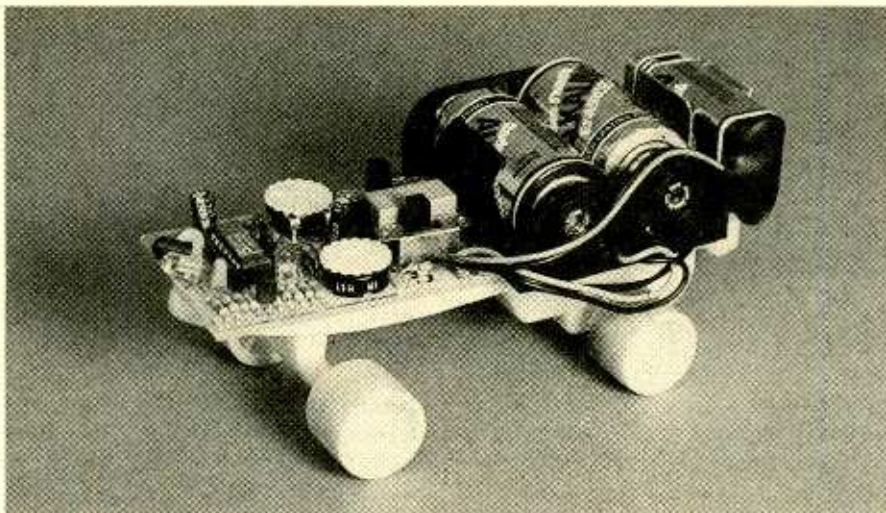

Meet Muramator, the simple 11 neuron robot described in the article. The version shown here is built on the Radio Shack Skateboard chassis.

**Final Assembly and Calibration.** The circuitry as well as the appropriate batteries now need to be mounted on the robot's body. Start by removing the human figure from the top of the skateboard. It is held on by two screws through its feet. To get to the screws, turn the vehicle over then remove the 3 screws that hold the rear wheel assembly onto the board. After removing the figure, reassemble the vehicle being careful to keep the white plastic gears firmly seated in their slots.

Next cut the wire-control cable at about 6-inches from where it exits the back of the board. Strip and tin the ends and solder them into the circuit board. The one with the white streak should go to the hole near the center of the board while the other wire should go to the hole in the corner. Now use double-sided foam tape to mount the U-shaped metal battery clip to the rear of the board.

Affix the C-cell holder to the skateboard directly in front of the 9V battery clip using double-sided foam tape. As the last step, use an elastic band to secure the circuit board to the vehicle. The rubberband is only a temporary restraint; once you are sure that everything works properly, you can use a piece of double-sided foam tape instead.

Once the electronics are mounted on the robot, it is necessary to calibrate the "creature." Carefully align the two IR components so that they point exactly parallel to each other and about 30° off the centerline of the robot body. Then turn the robot on and place it on the floor. Check to see that the robot runs forward when it is in an open space. If the obstacle-detection in-

dicator is always on when you put the robot on the floor, tilt the IR components slightly upwards until the light goes off. Next, hold the robot and move it to within 8-inches of an obstacle. Verify that the obstacle LED lights up and that the robot's motor runs in reverse.

**Experiments.** If you now let the "beast" loose. It should try to avoid things in its path. Muramator works best on wood or smooth tiled floors—it has a hard time plowing through carpeting. If the "creature" seems to lurch a lot or has trouble turning, shift the batteries around to change its balance.

You might try designing an experimental obstacle course for the vehicle to see what it can and cannot do. For instance, with the seek switch off if the robot encounters an obstacle that juts out, such as a convex corner, it will swerve away from it, but never come back toward it. That happens because the robot has no memory of which direction it was travelling so it cannot get back on track. You might also want to try changing the direction of the IR components, or purposely mis-align them, to see how these parameters alter the creature's behavior.

Switch in the second layer of control by sliding the Level switch on. Start with both potentiometers midway through their ranges. If you keep Muramator in a large open area, the timer LED should flash at regular intervals. When this light is on, the robot should perform some sort of spin. Once the circuitry appears to be working properly, adjust the Forward potentiometer until the robot goes about 8 inches between turns. Then adjust the Turn potentiometer so that the robot makes about 3/4 of a revo-

lution (270°) every time it turns. Muramator will now not only avoid objects, but turn around if it hasn't seen anything in a while. Together, these reflexes cause it to follow along walls and to circle any post-like object it sees.

Changing the values of the two potentiometers can produce noticeably different results. Note that if the turn timer is set for too long an interval, the robot will only regain the wall after a number of turns. If the obstacle had been a post rather than a corner, the robot might not have found it again at all. On the other hand, consider the scenario in which the travel distance is set too long; the robot may wander way off into the middle of the room when it encounters a corner. The first travel leg after an avoid turn is often longer than the succeeding ones. Thus, even though the robot heads back in the right direction, it will be too far away to see the wall again. Yet this can be a useful feature in a world with more than one robot because corners then become a natural meeting place for the "creatures."

Another interesting test involves two identical vehicles. If you set the travel distances very short with the turn angle at 180°, and send the two robots head-to-head, they will veer off from each other and then turn around for another pass. Robot jousting! It helps if you cover both opponents with commercially available Scotchlite retro-reflective tape. This increases the sighting distance for other robots to about 18 inches. To achieve the maximum range, make sure each robot's infrared beam is pointing level with respect to the floor. This is just one example of how robots can interact with each other. With a larger number of individuals, there maybe other interesting possibilities as well.

We have now progressed from a vague concept to an actual working robot. This transformation was made by applying the methodology of breaking an activity into component behaviors. We codified these behaviors as simple situation-action rules and finally cast the rules into circuitry based on a simple neural model. These same steps can be applied to other creatures with other behaviors. You might try designing some yourself, at least on paper. Incrementally extending this line of research to larger, more complex creatures is a promising path for developing a deeper understanding of how the human mind itself works. ■



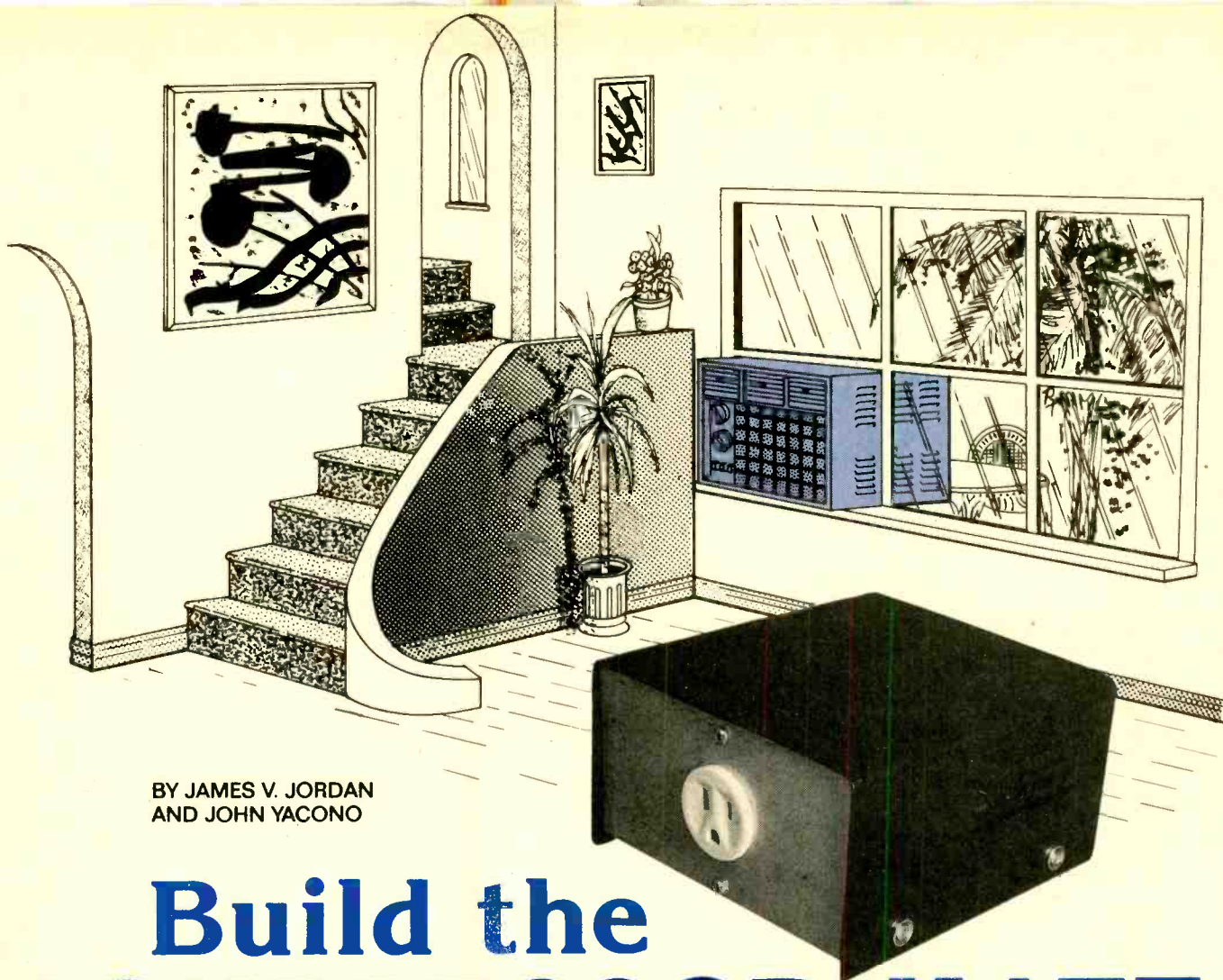

BY JAMES V. JORDAN  
AND JOHN YACONO

# Build the COMPRESSOR-MATE

*Although the compressors found in refrigerators, freezers, and air conditioners are heavy-duty devices, their life can be shortened by frequent power outages—unless you have a Compressor-Mate.*

It's a great mystery how my development, which has an underground power-distribution system, can have as many power failures as it does (at least two a month). Mystery or not, it's an unpleasant reality that I and my electronic hardware must endure. I shudder to think of what people who live in really windy areas with pole-mounted distribution networks must put up with.

While everyone is aware of what a nuisance power outages are—what with having to re-program the VCR, all the clocks in the house, and a stubborn microwave that refuses to work unless informed of the time—many people don't know that frequent outages can really cost them. If your local power is as unreliable as mine, the compressors in

your home appliances are probably taking a silent beating.

If a compressor is running at the time of a brown-out or intermittent power failure, it inevitably stalls and the overload-protection circuit cycles on and off a few times. As any refrigeration specialist will tell you, starting a compressor over and over under the load of compressed gas puts a lot of wear and tear on the equipment.

Since compressors form the heart of any appliance they're in, they don't come cheap. Depending on the age and cost of a machine, an owner is sometimes better off buying a new appliance instead of replacing a compressor.

To protect your present (and future) investments, you can build a solid-state

timer—the *Compressor-Mate*—that will keep the compressors that you own from destructively cycling on and off. The project consists of a solid-state, voltage-monitoring circuit with a five-minute delay timer controlling an electromechanical, 30-amp power relay. The relay, in turn, controls power to the appliance being protected.

When power fails and comes back on, the *Compressor-Mate* waits about five minutes before it restores power to the appliance. That gives the unit time to cool down and permits system pressures to equalize for unloaded restarting.

Beyond that, the project can be adapted to control AC or DC loads in the 24- to 240-volt range, so it can be used in a variety of other applications. It

requires a minimum of inexpensive, readily available parts. An avid hobbyist could build one in a single evening, and even a beginner should have no trouble putting one together.

**The How's and Why's.** The Compressor-Mate's schematic diagram is shown in Fig. 1. Although it can control a DC device, for the sake of discussion let's first talk about how it operates when it controls an AC device.

The circuit can be broken down into two main sections: an AC portion, consisting of PL1, K1, and SO1; and a DC portion, made of the rest of the components. Oddly enough, the coil of K1 (which is in an AC leg of the circuit) is in series with the DC circuit via the bridge formed by D1-D4. That's important because whatever current flows through K1 must flow through the DC circuit.

When power is first applied to the circuit, perhaps after a power failure, the DC circuit draws very little current (for reasons that will become obvious later). In fact, the current is so small that K1 is not activated. So when power is first supplied, K1 is inactive and SO1 receives no power. However, after about five minutes, the DC circuit draws lots of current, enough to engage the relay. So let's look at that portion of the circuit.

The bridge provides pulsating DC to a filter made up of capacitor C1 and resistor R1. The filter smooths out the pulsating DC and absorbs AC-line voltage transients to protect the other DC components. Zener diode D5, resistors R2 and R3, and capacitor C3 form a filtered-DC power supply. Resistor R2 limits current flow through D5 to a safe level. That allows the diode to provide 9 volts to another filter comprised of C3 and R3.

The power supply supports a timing circuit. At the heart of the timer is U1, a programmable 16-stage binary counter with an integral oscillator circuit. Its extremely low power requirements ensure that little current will flow through the circuit, preventing the relay from engaging.

The counter is a multi-faceted device that can be programmed to act in a variety of ways. For example, its internal oscillator can be replaced by sending the pulses of an external oscillator to pin 3. Whether you use the internal or an external oscillator, the pulses are sent to an internal programmable counter/divider. Depending on the logic levels presented to pins 12 and 13, the counter divides the pulses by 256,

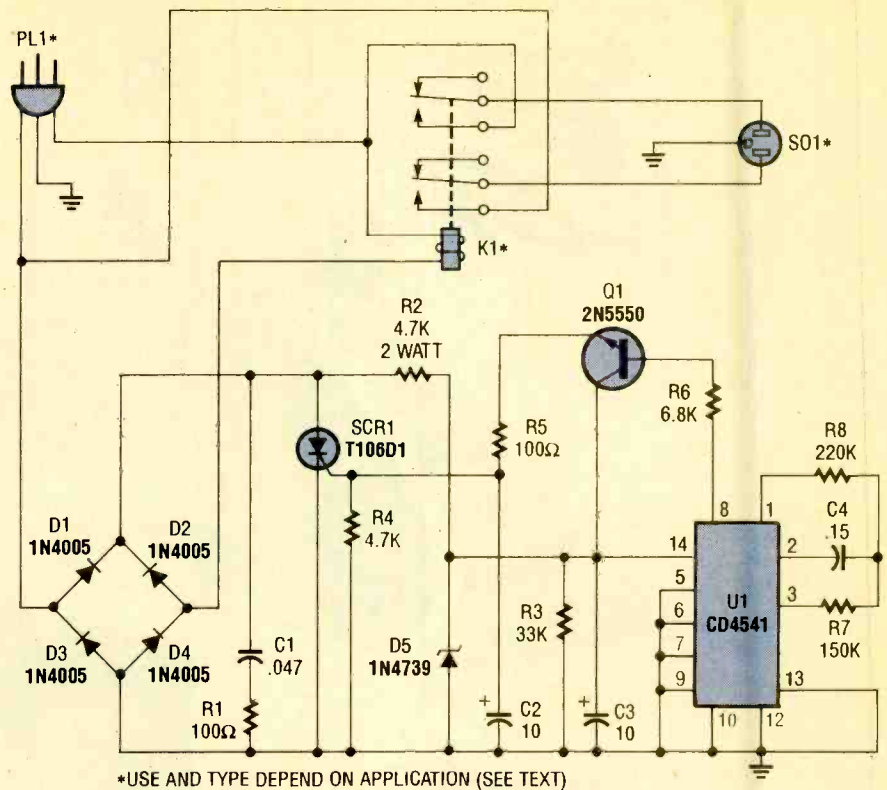

Fig. 1. The Compressor-Mate is unusual because it contains AC and DC elements in series. Another unusual feature is the DC portion of the circuit, which shorts itself out.

1024, 8192, or 65,536. Because pins 12 and 13 are tied low, the counter divides by 8192.

The internal oscillator was used. It requires R7, R8, and C4 to set the frequency. The values specified for those components set the frequency to around 26 Hz. That might seem pretty slow, but the 4541 can operate with an oscillator frequency of from close to DC to 100 kHz. The oscillator (running at 26 Hz) combined with the counter (dividing by 8192) set the timing interval at about 315 seconds, or 5 minutes and 15 seconds.

The timer has an array of other features that the circuit takes advantage of. For example, tying pin 5 to ground, as shown in the schematic, causes the timer to start timing on receipt of power. If that pin were tied high, the chip would wait for a low-to-high transition on pin 6 before operating.

If a low is placed on pin 9, as is shown in Fig. 1, the output of U1 at pin 8 goes low for the duration of a timing interval. However, if pin 9 of U1 was held high, the output would be high during a timing interval. Pin 10, which is connected to ground in the circuit, allows you to select between one-shot (if set to logic low) and astable (with a logic high) modes.

To summarize, the timer is set up as a

one-shot, power-activated, logic-low output timer with a period of 5 minutes, 15 seconds. So, when power is first applied to the circuit, the timer begins a timing interval and holds the output of U1 at pin 8 low for about five minutes. The low power drain of the timer prevents K1 from latching.

When the interval is over, pin 8 goes high and provides sufficient base bias to Q1 via R6 to cause it to conduct. The transistor then provides sufficient current to the gate of SCR1 through R5 to cause it to conduct. Capacitor C2 and resistor R4 prevent false triggering of SCR1. (Note that the diode bridge ensures that the SCR is always forward biased.)

The voltage drop across the SCR is so small it effectively shorts the DC portion of the circuit and draws more than enough current to cause K1 to latch. The relay, in turn, provides power to SO1, turning on anything connected to it. Since the SCR is always forward biased, the relay remains on. If power is removed and reapplied, another timing interval begins, permitting the device connected to SO1 five minutes to settle down before receiving power.

As was mentioned, the device is suitable for DC applications. You will need to select K1, PL1, and SO1 to suit your  
*(Continued on page 87)*

# GIZMO®

A CHRONICLE OF CONSUMER ELECTRONICS

VOLUME 4,  
NUMBER 8

## The Undersea World of Gizmo

**MPK-TR Handycam Marine Pack.** From: Sony Corporation of America, 9 West 57th Street, New York, NY 10019. Price: Marine Pack: \$1200, Carrying Case: \$300; Light: \$550; wide-angle lens: \$29.

Television shows that capture the interest and imagination of entire families are few and far between. But each time an "Undersea World of Jacques Cousteau" special came on, there were no arguments in our house over what to watch. We were all glad to vicariously travel to whatever exotic locale the *Calypso* was headed. For an hour, we'd be transported to a world that—despite the fact that it covers three-quarters of the Earth's surface—was otherwise hidden from our view. Thanks to the careful planning, meticulous research, daring dives, and the remarkable underwater photography of the Cousteau family and the crew of the *Calypso*, we could cavort with shy but friendly octopi, discover sunken treasure on the wrecks of ancient galleons, and be (safely) terrorized by great white sharks.

On the few occasions that we vacationed in the Caribbean, we'd try to get a taste of underwater adventure on snorkeling expeditions that were often the high point of the trips. Yet when we got home and watched our vacation videos, those highlights were always omitted.

That wasn't the case with our last trip. This time, we brought along Sony's *MPK-TR Handycam Marine Pack*, a special waterproof housing that allows the use of the ultra-compact CCD-TR4, CCD-TR5, or CCD-TR7 Handycam camcorder at up to 130 feet below the water's surface. We used the Marine Pack with the CCD-TR4, one of the smallest and lightest camcorders on the market. (For more information on the CCD-TR4, see "Product Test: Reports" elsewhere in this issue.)

The Marine Pack, however, is no light-



weight. The bright-yellow plastic housing measures  $11\frac{1}{8} \times 11\frac{1}{8} \times 10\frac{1}{8}$  inches and weighs in at 12 pounds, 2 ounces, without the optional underwater video light (5 pounds, 8 ounces). That might not sound like much—and, in fact, it's less than half the weight of Sony's previous model—but if you have to *schlep* it around airports, rental car agencies, hotel lobbies, and charter boats, it can cause some aching arms. Luckily, a carrying case is available that provides protection against damage during traveling, and has wheels for easy transport. The case itself (*LCH-M20*) is the size of a large suitcase, weighs almost 18 pounds, and is the same bright yellow as the Marine Pack—it attracts quite a bit of attention in airports. (One porter kept referring to it as the "yellow submarine.") On the plus side, it's easy to spot in the baggage-claim area!

We've become accustomed to traveling with a compact camcorder and a few accessories; taking along the Marine Pack required some adjustments to our usual routine. Similarly, actually taking underwater video footage requires some advanced preparations, so that when you get in the water you can just point and shoot. Because both water and salt air can damage video cameras, some precautions are necessary to keep the camcorder safe and dry before, during, and after its insertion in the Marine Pack.

The Marine Pack consists of two sections, the front body and the rear body, joined together around the middle by two O-rings and three buckles. The O-rings ensure the waterproof function of the pack, so it's vital that they are free of scratches, cracks, dust, sand, or hair and are not

(Continued on page 8)

TURN PAGE FOR CONTENTS

# This month in GIZMO®

Sony MPK-TR Handycam Marine Pack .....	pg. 1
Saitek Sunwatch.....	pg. 2
Pioneer LaserKaraoke CLD-V710 Combi-Player .....	pg. 3
Maxis Software SimEarth .....	pg. 4
Taliq Corportion Varilite Vision Panels .....	pg. 5
Heath Company Reflex SS6100 Wireless Home-Protection System.....	pg. 6
Audio/Video Connectors .....	pg. 9
Electronic Encyclopedia .....	pg. 9
Integrated Music System .....	pg. 9
TurboExpress Video Game.....	pg. 9
Car Security System .....	pg. 10
Laserdisc Player .....	pg. 10
Remote-Cam.....	pg. 10
TI Calculator .....	pg. 10
Digital Signal Processor.....	pg. 11
Remote-Controlled Equalizer ..	pg. 11
System Link Universal Remote.	pg. 11
Ultra-Compact Camcorder .....	pg. 11
Blood-Pressure Watch .....	pg. 12
CD'vider CD Organizers .....	pg. 12
Radiation Tested.....	pg. 12
TV Relay Device.....	pg. 12

Gizmo is published by Gernsback Publications, Inc., 500-B Bi-County Blvd., Farmingdale, NY 11735. Senior Writers: Chris F. O'Brian, Teri Scaduto. Contributors to this issue: Steve Vames. Copyright 1991 by Gernsback Publications, Inc. Gizmo is a registered trademark. All rights reserved.

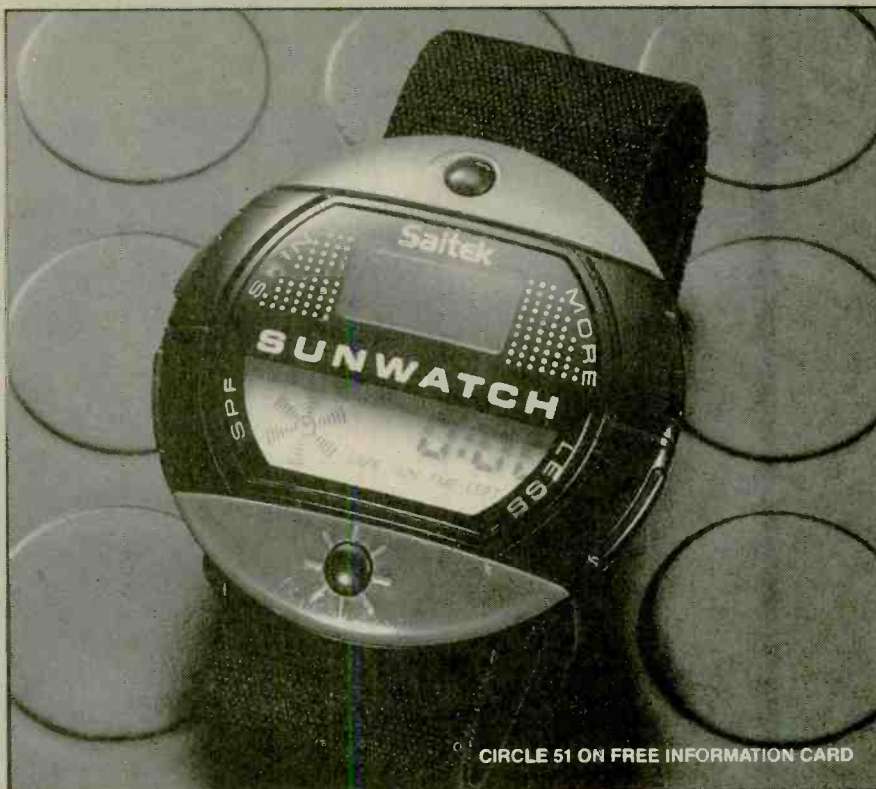

CIRCLE 51 ON FREE INFORMATION CARD

## Watch Your Back!

**SUNWATCH.** From: Saitek Industries Ltd., 2291 West 205th Street, Suite 101, Torrance, CA 90501. Price: \$59.95.

We grew up on Long Island, back in the 1960's when summer evenings meant backyard barbecues of burgers (with no fear of cholesterol or carcinogens from charcoal) and hot dogs (with not a care as to what they put in them) and summer days meant beaches, baseball, swimming, boating—out in the sun from morning till dusk. By the Fourth of July, even the most fair-skinned kids were tanned, and everyone thought that was a sign of a healthy, active life. As teenagers, a deep tan became a goal in itself, and we'd use whatever means were at hand (reflectors, for instance) to accelerate the process. We might have laughed at Zonker, the *Doonesbury* character who raised sunbathing to an art form—but we understood his motivation!

Things sure have changed since the 60's! Now, when we barbecue it's more likely to be chicken and vegetables than beef—forget the hot dogs! And even though, deep down, we still believe that a good tan makes a person look healthier, sexier, and even thinner, one look at the headlines is enough send us running for shade. New EPA estimates suggest that an additional 200,000 Americans could die from skin cancer over the next half century

due to the additional ultraviolet rays admitted by the ozone layer—which, according to the latest reports, is thinning twice as quickly as previously believed. Besides the increased cancer risk, too much sun causes advanced aging of the skin—which definitely doesn't look healthy or sexy. And we've had more than one vacation ruined by a bad sunburn, despite the liberal use of sunscreens.

Kids who are growing up in the 1990's are no less likely to be on the ball field or at the beach (except, of course, those who are hooked on Nintendo), so they really do need some sun protection. And many adults already got more than their share of ultraviolet rays during their formative years. Staying out of the sun often is not feasible—certainly not for children, and not for health-conscious folks who make every effort to keep their hearts healthy by hitting the (outdoor) jogging track, tennis court, or swimming pool.

So how can you protect yourself and your family from harmful ultraviolet rays, short of cloistering yourselves indoors? "Common sense," comes to mind. "We'll cover up as soon as we feel as if we're burning." Unfortunately, it's difficult to "feel" when you've had enough sun, especially on a cloudy or breezy day, or if you tend to get so involved in an activity that you forget to "listen to" your skin. And kids are notoriously short on that sort of common sense!

A less arbitrary judge of how much sun is enough is offered by Saitek. The Sunwatch watch boasts a special sun sensor

(Continued on page 7)

# Karaoke Plus

**LASERKARAOKE CLD-V710.** From: Pioneer Laser Entertainment, Inc., 2265 East 220th Street, Long Beach, CA 90810. Price: \$950.

This year, karaoke is expected to be the hot new consumer-electronics item in the United States. Karaoke players run the gamut from handheld cassette-tape players to laser-disc players with built-in amplifiers and speakers. What they have in common is the ability to remove the lead vocals from prerecorded songs so that the consumer can grab a microphone and take the spotlight. A popular pastime in Japan for more than a decade, karaoke is quickly catching on in the States. We admit, we like it—a lot—and so does everyone to whom we've introduced it. There's no denying that some basic human urge is fulfilled by singing—and it's particularly satisfying when your voice is enhanced by professional back-up musicians and a host of features like echo and key control. Karaoke is a terrific ice-breaker at parties, somehow bringing out the hani in even the shyest guests.

Unfortunately, there's only so much time that a person, or family, can spend belting out tunes in front of their entertainment centers. Value-conscious consumers are likely to take that into consideration when purchasing trendy new items—and will probably give some thought to other former "must-have" items, such as the exercise bike and pasta maker that are now gathering mold in the basement.

We have another reason for thinking twice before purchasing trendy new items: Until someone starts making modular entertainment centers to accommodate our ever expanding array of audio/video components, each new addition requires a major overhaul of the entire setup (except the television, which fits only in one spot), and quite often an old component gets bumped in favor of a new item. Accordingly, we greatly appreciate components with

more than one function (such as combi-players) and, despite our desire to possess the latest and greatest in consumer electronics, are loathe to give precious space to any "latest craze" items, whose shelf-life might be only as long as our attention spans.

Smart shoppers can put those fears to rest when looking at *Pioneer Laser Electronics LaserKaraoke CLD-V710*. Besides special LaserKaraoke discs, the unit plays 3- or 5-inch compact discs, 8- or 12-inch laserdiscs, 5-inch CDV's (CD with video), and 8- or 12-inch CD-Video laserdiscs. The karaoke function is an attractive bonus for those who are already considering the purchase of a standard combi-player. And those who are looking for a karaoke machine can still get plenty of use out of the CLD-V710 even when they don't feel like singing. At about 16½ × 15½ × 5 inches, it takes up only slightly more vertical space than a standard combiplayer.

The CLD-V710 offers a full array of karaoke functions designed to make the player easier to use and the vocalist's voice easier to listen to. A row of buttons numbered 1–20 stretching across the front panel (and corresponding buttons on the remote control) let you select a track instantly. Separate microphone systems allow you to independently adjust the levels for two optional microphones. In the vocal-assist mode, you can listen to the accompaniment and the original lead vocals through a set of headphones (not included). That's particularly handy for those songs whose chorus you know, but whose melody line escapes you—and, much to our surprise, we found that to be the case with quite a few familiar tunes that we thought we knew. While you're learning the song, the "once more" button is another helpful device. It backtracks the disc in 5 second increments so that you can repeatedly practice a difficult passage (serious instrumentalists should find that particularly attractive). If you're still having trouble, the "key-control" buttons (which are conveniently placed on the microphone as well as on the unit's front panel—as are the "once more" buttons) allow you

to change the pitch of the instrumental portion within an eight-step range, to match your voice. When you've perfected your sound, the "vocal-partner" mode replaces the original vocals with your voice, and the real karaoke fun begins.

Pioneer's LaserKaraoke song library contains about 500 titles from four decades of hit songs, including rock, country, rhythm and blues, pop, standards, Christmas songs, and nursery rhymes. Each four-song disc has a suggested retail price of \$20 and features instrumental music, back-up vocals, music-video-style full-motion video, and on-screen lyrics. None of the songs are performed by the original artists, but they are professionally done (and at a party, most people won't care anyway). Although the video portions of the karaoke discs tend to have some relevance to the lyrics and spirit of the song, they'll seem amateurish to anyone who was raised on MTV—and some are downright funny. For instance, Steppenwolf's "Born to be Wild"—the "theme song" from *Easy Rider*—replaces the 1960's hippie/druggie bikers Dennis Hopper and Peter Fonda with a 1990's yuppie photojournalist who travels with his camcorder from continent to continent on his motorcycle. Oh well, the disc producers know that the video is just background for the real star—the karaoke singer.

Actually, for first-time performers, having video accompaniment takes off some of the pressure—at least you're not alone "on stage." The voice-enhancement features are also reassuring; they make it possible for just about anyone to sound good as they sing along. (Even if the embarrassed singer stops, the "real" singers pick up the slack.) The digital-stereo key-control allows you to shift the key of the music by a maximum of four half-tones, without changing the tempo of the song (which, unfortunately, is how key-changing is accomplished on most inexpensive karaoke machines). The vocal-assist function produces multiplexed vocals that you can hear via your headphones to help keep you on key while being inaudible to your audience (the orchestral sounds are routed through the speakers). All of Pioneer's LaserKaraoke discs have multiplexed sound; a multiplex balance control lets you adjust the volume of the lead vocal on those discs without disturbing the instrumental track. The CLD-V710 also has a feature called "Magic Voice" that produces a number of special effects for your voice, including adjustable echo. You can even sing a duet without a live partner by pressing the "vocal partner" button, which allows each verse of the lead vocals to be heard only until you begin to sing. The lyrics appear on the screen in white letters that are highlighted as each word is to be sung—the modern version of following the bouncing ball.

Because the CLD-V710 is a combi-  
(Continued on page 5)



CIRCLE 52 ON FREE INFORMATION CARD

## Playing God via Computer

**SimEarth—THE LIVING PLANET.** Published by: Maxis. Distributed by: Broderbund Software, 17 Paul Drive, San Rafael, CA 94903. Price: \$69.95.

It's often hard to reconcile our love of nature with our passion for electronic technology. Silicon Valley—and each of its sister cities around the globe—creates a river of toxic wastes as it produces its electronic wonders.

Of course, many electronics companies are also working to clean up their images. For example, we've toured the facilities of Sanyo Electric Company in Japan, and have seen how they are promoting ecological responsibility with such ambitious ventures as their Genesis project, which would ring the planet with photovoltaic arrays to provide all of the world's electricity needs—albeit at the expense of 4% of the Earth's desert area, which would house the solar-cell arrays. New rechargeable-battery technologies, such as nickel-metal hydride, promise the convenience we all want with a reduction of the toxic metals and compounds that are generated by standard throw-away batteries and nickel-cadmium cells alike.

Of course, most of us don't think about the consequences of our everyday activities. What harm can throwing a battery in the garbage do? The way most people look at it, we've been throwing batteries away for years, and haven't noticed any ill effects.

That's one of the main problems with our society. We're so wrapped up in instant gratification, that we begin to ignore some of the subtle and long-term effects of our actions. Take, for example, the destruction of the tropical rain forest. It's taken us years to notice that the songbird population that is disappearing from North American backyards is directly related to the vanishing South American rain forests. Unfortunately, it will take people years longer to appreciate that every time they buy furniture made of rosewood, mahogany, teak, or other tropical woods, they're hastening the disappearance.

It's becoming clearer and clearer—to us, at least—that every action we take does have some impact on the planet. One scientist, James Lovelock, took that a little further and said that every action we take produces a reaction from the planet, or the planetary organism, which Lovelock called Gaia, after the Greek goddess of the Earth. The Gaia theory explains why the temperature of Earth has remained essentially constant for some 3.6 billion years—at a temperature that is favorable to life—despite a 25% rise in the output of heat from the sun over the same period of time.

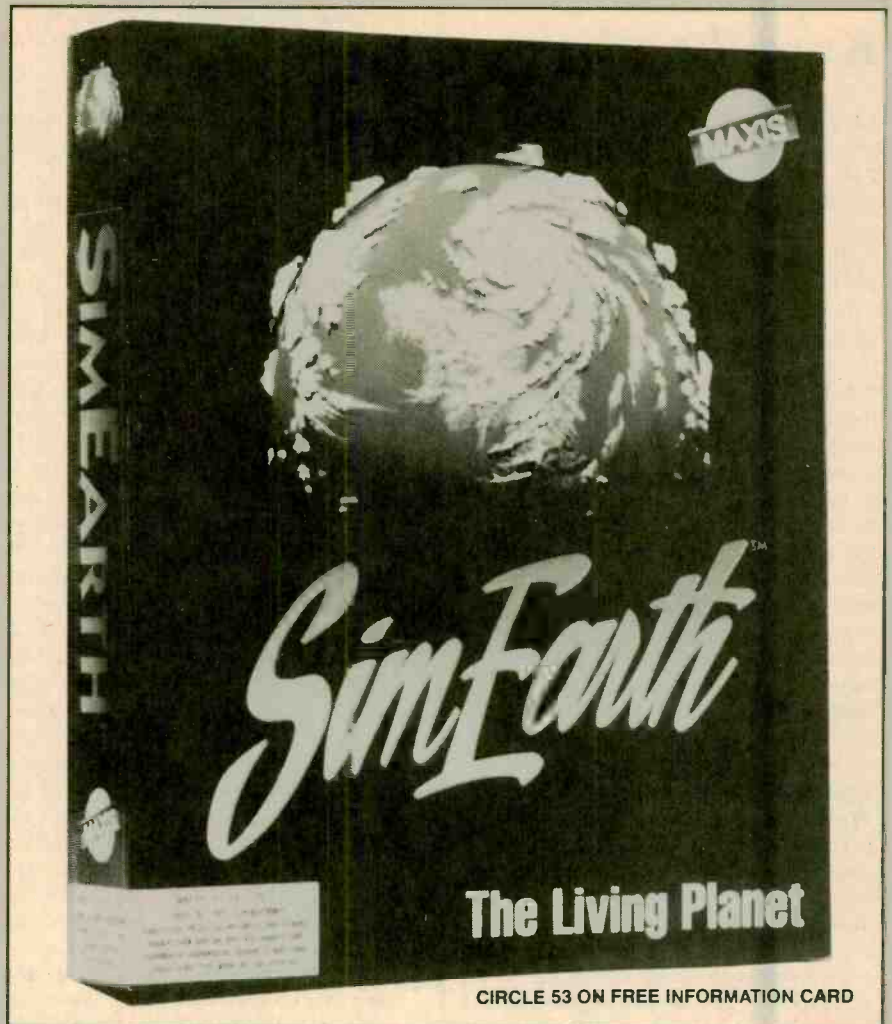

CIRCLE 53 ON FREE INFORMATION CARD

It also explains how the concentration of oxygen in our atmosphere has remained at about 21% for the last 200-million years, despite dramatic changes in the planet.

According to the Gaia theory, the world as we know it is a single, self-regulating organism, not a combination of separate systems of geology, biology, and climate. Humans are simply part of the Gaian organism. It's difficult to do justice to the theory in such a short space, especially when we're really trying to talk about software. However, we'd recommend Lovelock's books, *Gaia, A New Look at Life on Earth*, published by Oxford University Press, or his updated *The Ages of Gaia*, from Norton.

*SimEarth—The Living Planet* is centered around the Gaia theory (in fact, Lovelock served as technical consultant). In this computer simulation of the planet from Maxis, everything is interrelated. Climate, animals, plant life, geology, and the like all affect each other.

To start the game (which is available for Macintosh and IBM-compatible computers), you select a new planet from a menu of eight choices, which range from modern-day Earth, to a random planet. You can also select a time scale; each of the four choices simulate a different aspect of plan-

etary development. For example, the Geologic time scale looks at the last 4½ billion years and takes into account continental drift and the makeup of the atmosphere, while the Technology time scale concentrates on the last 100 years and looks primarily at the impact of technology and the changing climate.

Once you choose whether you want to play God (and create life and let it evolve) or to play savior (and solve the problems of modern-day technology), you're ready to really get started. You can look at the planet through a number of different windows. There's the Map window, which gives you a view of the entire planet, and lets you see, for example, where cities are, what kind of life is found where, where it rains, and where it's hot and dry. The Globe window lets you see the same information, but on a rotating globe instead of a flat map.

Where you really get to exercise your power, however, is in the Edit window. It's there that (assuming you have enough "energy," which accumulates or is depleted according to your actions) you can plant forests, create an earthquake, or send a meteor crashing onto the planet. If you plant a forest in the arctic, it won't last too

(Continued on page 8)

# Now You See It, Now You Don't

**VARILITE VISION PANELS.** From: Taliq Corporation, 1277 Reamwood Avenue, Sunnyvale, CA 94089. Price: \$90 per square foot.

We don't care for elaborate window treatments. In fact, if we lived in a secluded area, we'd opt to leave all our windows bare. That's a matter of personal design preference (probably stemming, in part, that with all the clutter around this place we'd like our windows, at least, to be unobscured). Yet studies have shown that natural light transmitted through windows to an indoor environment increases worker productivity, and that deprivation of natural light "reduces psychological warmth and cheerfulness"—so there is something to be said for letting the sun shine in. Unfortunately, the flip side to all that glass is lack of privacy and poor energy performance.

In days gone by, buildings were protected from excess solar-heat gain by using small windows, spaced few and far between. Double-pane glass provided better insulation and allowed the use of more, and larger, windows. More recent options include tinted glass and reflective glass. Both of those treatments are of limited value, since they block both useful daylight and heat (tinted glass through absorption and reflective glass, as you might suspect, through reflection). Both reduce the natural light enough that artificial lights are required, even during daylight hours. Reflective glass has the additional problems of "second-hand" reflected heat, which has been proven (in court, as you might have guessed) to raise the cooling costs in adjacent office buildings, and glare, which has been linked to traffic accidents on nearby roads.

With the recognition that light and heat are two separate—and separable—components of sunlight has come the development of new technologies designed to take advantage of the beneficial properties of sunlight while blocking the transmission of heat. Low-emissivity (low-e) glazing can transmit more than 50% of the sun's visible light, while blocking more than 90% of the sun's invisible heat. Today, a number of different glazing methods—combinations of single or double pane, clear or tinted, reflective, and low-e—are available. The architect's choice will be affected by climate, aesthetics, window orientation, and nearby buildings. Those options mean that a lot more glass can now be used—efficiently—than in the past.

All that remains is the lack-of-privacy problem. Not many of us live or work in wooded seclusion, or on lots large enough that our neighbors are out of sight. Does

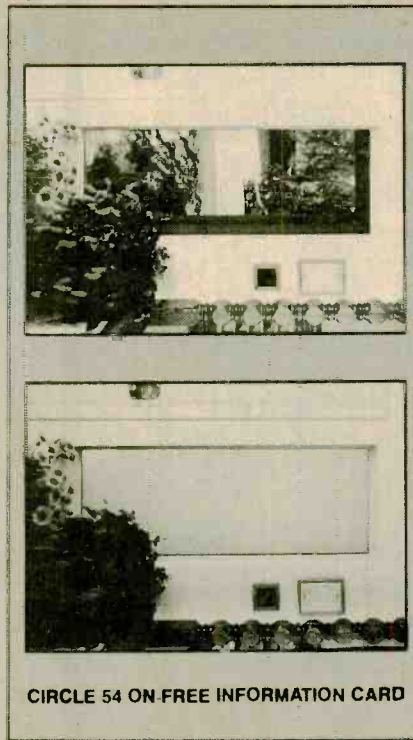

that mean still more windows that require shades, curtains, and/or blinds? Perhaps not.

Taliq Corporation has put liquid-crystal technology to work in window-size glass, called *Varilite Vision Panels*, that can change from transparent to translucent, and back again, at the flick of a switch—a high-tech, two-way version of the old one-way mirror window. Vision panels were originally developed for interior use in corporate conference rooms, offices, and presentation facilities where the ability to see through glass walls or interior windows is normally desired, but where privacy is required at certain times. Other indoor uses include the viewing windows in medical facilities such as intensive care units and nurseries, and in private homes between kitchen and dining areas or bedrooms and bathrooms. Now Vision Panels are available to be installed alone or as part of an insulating glass unit, as fixed glass or in window frames, for use in exterior walls.

The ability to change from transparent (clear) to translucent (similar to frosted) is accomplished by using a thin film coated with liquid-crystal (LC) droplets composed of molecules in a regular crystalline configuration. The film is bonded with polyvinyl butyral (PVB) interlayers and laminated between panels of heat-treated flat glass. When an electric current is sent through the panel, the liquid crystals arrayed along the curved inner surfaces of each droplet align to transmit light, and the Vision Panel instantly becomes clear like a normal window. When the power is switched off, the liquid crystals realign randomly, scattering light, and the Vision Panel turns a milky gray/white, allowing light to pass through but rendering normal

viewing impossible. The Vision Panels are powered by a module installed in the wall above or beside the glass. At room temperature, approximately 1 watt of electricity is required to make one square foot of glass transparent.

We propped our 11½ × 8-inch sample in front of a small window. With the power off, the view is totally obscured, from either side of the window. We found ourselves looking at a surface that resembled a cross between a frosted-glass window and a blank TV screen. As soon as we turned on the power, the view returned. We found it a bit disconcerting at first to "turn on" and "turn off" our view of the outside world as if it was a television show. It is, however, much easier than closing the draperies or shades, and there is no loss of natural light when the Varilite panel is off. Instead, the light is softly diffused, so that the natural-light level is maintained, but with no glare.

The Vision Panels alone don't provide the insulation or solar control performance of low-e glass. They can be used as part of an insulating glass unit in which the outer pane is a solar-control product, however, to achieve energy-efficiency, privacy, and no glare. Glazers can install a Vision Panel, but an electrician is required to complete the electrical connections.

While the \$90-square-foot price might be considered prohibitive in residential applications, that price is expected to decrease as Varilite Vision Panels gain in popularity. If that's the case, we'll be using plenty of Vision Panel windows in our retirement dream house. ■

## KARAOKE PLUS

(Continued from page 3)

player, you're not limited to only those 500 songs available on karaoke discs. You can use the "one-touch karaoke" key to remove virtually all of the lead vocals from most standard compact discs and music videos. If the vocals are recorded so that they appear equally in each channel, that common audio will be filtered out—the same way that most "vocal eliminators" work. Discs that are recorded differently—most later Beatles albums, for example—can't be filtered. Of course even when it does work, no lyrics appear on the screen (and, for CD's, no video at all!), but chances are you already know most of the words to your favorite songs.

Because standard CD's and video discs don't use multiplexed sound, you can't use vocal assist or the multiplex balance control, but you can listen to them with the vocals a few times if you need to refresh your memory. On the plus side, the video on professional music videos is far superior to the hokey "mood-setting" images shown on the LaserKaraoke discs. And it's nice to be able to sing along to "non-

(Continued on page 8)

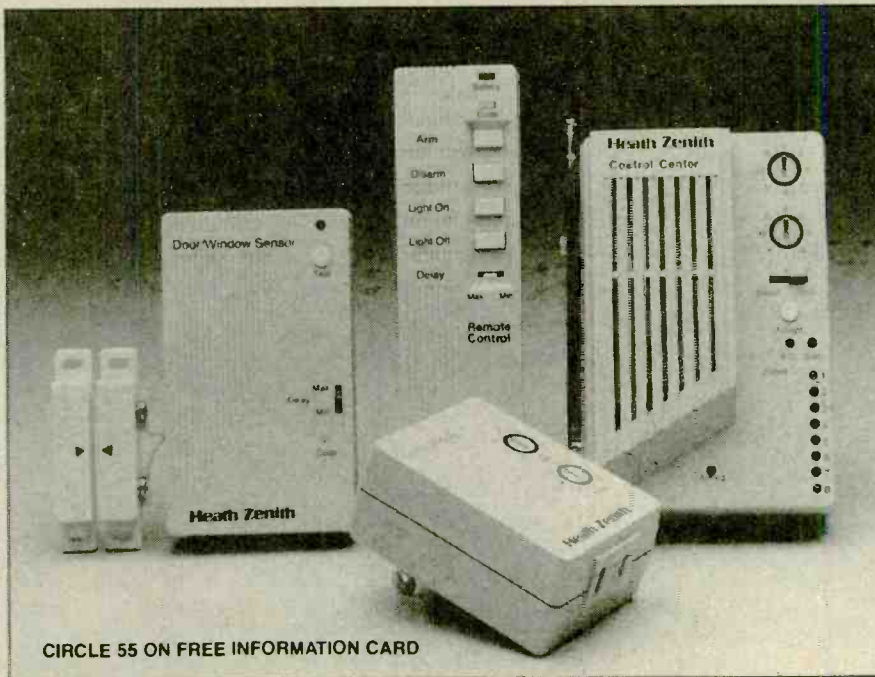

CIRCLE 55 ON FREE INFORMATION CARD

## Better Safe than Sorry

**REFLEX SS-6100 WIRELESS SUPERVISED HOME PROTECTION SYSTEM.**  
**From: Heath Company, Hilltop Road, St Joseph, MI 49805. Price: \$99.95**

It's no secret that people don't feel safe in the streets these days. (Just look at how effective George Bush's Willie Horton ads were in his presidential campaign!) What's even worse than feeling at risk on city streets is feeling unsafe in one's own home. Sad to say, burglaries and other residential crimes are far from uncommon.

We're not alarmists. Some areas of the country, and some neighborhoods, are quite dangerous. But in most areas, the chance of being a crime victim is not as great as media coverage (and campaigning politicians) make it sound.

We're not stupid, either. We know that whether you're taking a stroll around a major city or are relaxing at home, certain behaviors make you a prime target for a crime. Walking down a dark alley in a deserted, unfamiliar neighborhood, for instance, is asking for trouble—as is wandering around looking uneasy, distracted, or lost, or flashing a wad of money. At home—or when you're away from home—there are also sure tip-offs that you're an easy mark. Letting mail and newspapers pile up while you're on vacation, positioning your brand-new stereo system so that it's easily visible from the street, and leaving windows and doors open are all welcome signs to would-be burglars. Just as a confident, alert posture is intimidating to muggers and purse snatchers, there are certain things that can

make your house less appealing to thieves. A simple timer on your lights to make your empty home look lived-in can offer protection. But perhaps the most valuable safeguard for your property is a burglar alarm.

Most people don't install a burglar alarm until *after* they've been burglarized. We understand the reasons why. First, there's the tendency to think "Well, it won't happen to *me*." Second, there's procrastination. Third, there's the belief that all alarm systems are complex, expensive, and difficult to install.

Not all alarms are, however. *Heath Company* teamed up with wireless technology to make it possible for all but the *klutziest* of us to install a complete alarm system with their *Reflex SS-6100 Wireless Supervised Home Protection System*. The system installs with (if you're lucky) only a screwdriver. (If you're not so lucky, you'll also need a small drill.)

The system comes in a single box, and contains a control center, a remote control, a door/window sensor, and a lamp module.

The control center is quite small—about  $4\frac{3}{4} \times 3\frac{3}{4} \times 2$  inches—and is meant to plug directly into a wall outlet. Two piezoelectric transducers emit a loud, piercing alarm when a break-in occurs, and a series of LED's indicates what "zone" was breached. The control center "supervises" all of the system's sensors, checking periodically that all batteries are good. When you arm the system, it checks that you didn't accidentally leave any doors or windows open.

The remote control is a thin pocket-sized device that measures about  $5\frac{1}{2} \times 1\frac{3}{4} \times 1$  inches. You need it to arm and disarm the system. It can also be used to set off a "panic" alarm, or to turn on a light, even before you enter your home.

The door/window sensor is a small transmitter to which a magnetic-sensitive switch is connected. When the sensor detects that the magnetic switch has been tripped, it transmits a signal to the control center, which sounds the alarm.

The lamp module is designed to flash a lamp connected to it when a break-in occurs. It not only startles a burglar, but also alerts neighbors (or you, when you return home) that a break-in has occurred.

Setting the system up is easy—about a ten-minute job, not counting installing the sensor. First you have to put 9-volt batteries in the remote control, the door/window sensor, and the control center (for power-fail backup). You then plug the control center into a standard wall outlet—the outlet's center screw is used to hold the control center in. (It's not really necessary, but it would make it a little more difficult for a burglar to rip it out of the wall.)

You then "install" the remote control by hitting the small, recessed "Code" button, which identifies the remote. Up to eight different remote controls can be supported by the system, so each family member can have one.

The door/window sensor is installed in much the same way: With the control center in the install mode, simply press the sensor's "Test" button (or activate the magnetic switch). The first sensor you install is automatically on zone 1. If you expand the system by adding extra sensors (a total of 16 can be supported), they will be installed on successive zones.

The lamp module is installed as you would any X-10-type lamp module (it is, after all, X-10 compatible): The lamp is plugged into the module, and the module is plugged into the wall outlet.

The control center should be mounted where it will be able to communicate with the sensors and remote control, each of which has a range of about 150 feet. It also has to be mounted somewhere where it's convenient—when you arm the system, you have to be able to see its eight zone LED's. (Unfortunately, most outlets, except kitchen-countertop ones, are rather close to the ground.) The other consideration is that you want the control center to be near where you would expect a break-in, because it's the center that emits the beeping alarm.

Using the alarm system is reasonably straightforward. You can arm the system to sound off instantaneously or with a delay of about one minute. That gives you enough time to leisurely leave the house, or to come home and disarm the alarm without causing an uproar. Even if the system is set for the delay mode, you can still set individual sensors to instantly set off an alarm. That means you can set things up so that your normal entrance and exit doors are on a delay, but a burglar entering through a window would set off the alarm instantly.

For a small apartment, you might be



able to get by with just the basic system. Although only one sensor module is included, you can wire as many magnetic switches in series as you like, so the single module can protect all of your doors and windows. Extra modules, however, are available from Heath.

The first upgrade we'd suggest, however, is the "power siren." The control center does emit a loud, annoying alarm, but we're not sure if it would scare off a determined (or experienced) burglar. Since most burglaries are committed by inexperienced teenagers and not "professionals," the standard alarm will probably do the trick in most instances. The \$39.95 power siren, with its 105-dB alarm (that's four times louder than the control center's) would, however, be more likely to attract the attention that would send even a career burglar running. Other useful accessories that are available include a motion sensor (\$59.97), a three-module expansion pack (\$79.97), extra remotes (\$24.97), and extra lamp modules (\$12.99).

Even though the add-ons won't turn the SS-6100 into a full, professional alarm system, we did like some of the system's professional features—especially the module supervision that keeps tabs on battery condition. If you'd like to feel a little more secure for a small investment, and you're an avowed "do-it-yourselfer," the Reflex system is tough to beat. ■

## WATCH YOUR BACK

*(Continued from page 2)*

designed to measure the ultraviolet B (UVB) rays that can cause long-term skin damage. When you input your skin type and the sun protection factor (SPF) of your suntan lotion, and point the sensor toward the sun, the Sunwatch calculates the amount of time that you can safely spend in the sun without getting burned. When your safe-sun time has run out, a warning buzzer sounds.

The Sunwatch is a sporty, trendy-looking timepiece, slightly larger than a standard watch; its face is about 2 inches in diameter. Ours was bright yellow and black, but it also comes in Day-glo pink and black, Day-glo green and black, and basic black. It's not something a kid would be embarrassed to be seen wearing. A small button on the top of the watch's face is used to enter the sun mode; another button on the bottom is used to set or display the time. Four buttons along the perimeter are labeled "skin," "SPF," "more," and "less." The display, an LCD, is easy to read in the sun, but somewhat more difficult indoors. Above the display is the UVB sensor. An elastic wristband fits adult- or child-sized wrists, or you can wear the Sunwatch clipped to your belt or your sun visor.

Setting the Sunwatch properly is not difficult, though you'd probably want to decide on the skin-type and SPF settings for your children. The time is set by holding down the time button and pressing more or less until you reach the correct setting. Your skin type and the SPF are selected in the same manner, using the buttons on the side of the watch to select the numbers that correspond to your skin type and SPF. The instructions include a chart titled "Estimating Your Skin Number." The settings range from 1 (always burns, never tans) to 19 (naturally dark, seldom burns, already tanned). The SPF numbers range from 1 (dark tanning oil, we suppose) to 39 (although we have seen sunscreens with SPF's of 45). The instructions strongly suggest that you be conservative in choosing both settings, and we agree—particularly if you are still getting accustomed to using the Sunwatch.

The Sunwatch has several "advanced" operations to offer as well. For instance, if you go indoors for a while, the Sunwatch will remember how long you've already spent in the sun and will take that into account. It also remembers the amount of sun exposure you had the previous day. If you're spending several consecutive days in the sun, Sunwatch automatically adjusts for increased safe exposure time. It tells you how strong the sun is, on a scale of 1-50, and displays as a percentage how close you are to reaching your safe sun limit.

Getting to those advanced readings requires nimble fingers, since you must hold down both the sun button and the time button on the face of the watch as you press the more or less button to change modes—impossible to do if you're wearing the watch on your wrist. Interpreting the advanced-mode data is also a bit tricky, since each reading consists of a number on the right side of the LCD and is indicated by an icon on the left. For instance, you know you're in the sun-strength mode when the icon is a sunburst. The other symbols are not as obvious—a percent sign for safe-sun limit, "mem" for yesterday's exposure, and nothing at all for today's sun exposure.

The standard sun-mode display, however, is easy to read at a glance. The time remaining is shown in digital-clock style (00:00), with a row of seven little asterisks (representing suns) below it, and a smiley face to the left. As the time dwindles away, the seven suns begin disappearing one at a time, and the smile on the face turns into a frown.

We first used the Sunwatch on a Caribbean island in early spring. We were conservative in estimating skin type, selecting a number 5—right on the border of "always burns, never tans" and "burns easily, tans poorly"—and said that our suntan lotion had an SPF of 4. We were surprised to see that in a tropical climate at 11:00 AM

(the Sunwatch takes the time of day into account in its calculations), the UVB was rated at 29 on a scale of 1 to 50, and we were allotted about an hour and a half of safe sun time. We left the beach, feeling more than a little scorched, a few minutes before our time ran out. Yet, after showering off (as true sun-tanning aficionados know, a shower "brings out" the tan), we found that we had turned slightly pink, but not uncomfortably so, and we probably could have stayed out for those extra minutes.

The second day of our trip was devoted to testing Sony's Marine Pack (reviewed elsewhere in this issue)—on an all-day snorkeling expedition. That's when we discovered the Sunwatch's primary drawback—it isn't waterproof. (It is "splash-proof.") We were extremely careful out on the boat, slathering on the number-15 sunscreen even though we tried not to leave the protective cover of the boat's canopy. But we couldn't take the Sunwatch in the water with us. It seems that our sunscreen wasn't waterproof either, and with the reflection of the water added to the strength of the sun, we got burned to a crisp.

Of course, we disregarded the cardinal rule (one that is emphasized in the manual): The Sunwatch is not meant to replace common sense. Perhaps one of us should have stayed on the boat to watch the Sunwatch—but that wouldn't have been much fun. Ideally, we should have been able to clip the watch to the back of a bathing suit, so that it would get the same exposure as our backs did, and so that we could hear the alarm when our safe sun time was up. But we don't live in an ideal world, and we had to stay out of the sun for the rest of our trip.

Back in New York, however, a stretch of record-breaking high temperatures had us out again, tackling the yard work we'd neglected last autumn. According to the Sunwatch, the sun's strength at mid-afternoon in New York was a 24—just 5 increments less than in midday in the tropics. Perhaps the difference between 25 and 29 is far greater than it sounds, because even setting the skin-type and SPF to the minimum (respecting our crisped backs from the snorkling trip), the Sunwatch allowed us about 3½ hours of safe sun time. We were dubious, but we stayed out for the allotted time anyway—and once again we came out just slightly pink.

The Sunwatch isn't intended to keep you pale-faced. Once you begin to tan, you can gradually increase your skin-type number to the maximum for your range, to get the deepest tan that's safely possible. If the Sunwatch continues to predict safe-sun times as accurately as it did for our first few exposures—with the exception of its incompatibility with water—getting some color with minimum skin damage should be possible. In the meantime, we might not threaten Zonker's championship tan, but at least we'll feel somewhat safer in the sun. ■

## UNDERSEA WORLD

(Continued from page 1)

twisted or pinched between the front and back bodies. They must also be well greased. If the camcorder is inserted under high-temperature, high-humidity conditions, moisture condensation can occur inside the pack, and might cause the glass to fog or even damage the camcorder.

The best bet is to mount the camcorder inside the Marine Pack in the air-conditioned safety of a hotel room. Before installation, the camcorder's battery pack must be charged and mounted, and the correct lens attached. (We used an optional wide-conversion lens, model VF-77.) The camcorder screws onto the shelf-like "pedestal" that has microphone and remote control cords, which connect to the camcorder's mic and remote jacks. All of the camcorder's functions must be preset (white balance, power, shutter speed, zoom position, and focus), and a cassette inserted. Then the pedestal slides into position in the front body of the Marine pack and is screwed in place, and the camcorder is set to standby. Before closing the Marine Pack, its proper operation and the condition of the O-rings must be checked. Once the pack is securely buckled, the "sports finder" view window should be attached to the top.

Unfortunately, our press sample was missing the sports finder, and we had to try to peer through a small window on the back of the Marine Pack to see through the camcorder's viewfinder—which was next to impossible when underwater. Fortunately, Sony did supply us with the wide-angle lens (which made it easier to guess what we were focusing on), and nature provided a reef full of interesting subject matter.

Because the Marine Pack is somewhat heavy, as we were getting in the water we felt a momentary twinge of anxiety that it would drag us down. But once we were in the water, the unit seemed weightless—it's actually bouyant—and quite easy to handle. We held the camera directly in front of us. Holding onto the two grips while kicking our flippers to propel ourselves, we didn't miss having our hands free. After all the prep work, we were able to simply point and shoot—and the results were amazing. We are enthusiastic but inexperienced skin divers—using the HandyCam Marine Pack for the first time and, lacking the sports finder, with virtually no way to frame our shots—and yet we captured on videotape a beautiful panorama of tropical fish, underwater plants flowing in the current, and coral reefs. The underwater microphone picks up the distinctive, muffled sounds of lapping waves, breathing (or bubbling), and boat engines, and lends another realistic dimension to the video.

Our short island stay precluded any scuba-diving expeditions—which require quite a bit of training—so we can only imagine what the results might have been at depths of up to 130 feet, using the *HVL-80D* underwater video light. (We stayed so close to the surface that no light was needed.) The serious diver, who has already invested time and money in training and equipment, would probably be most interested in using the Marine Pack—and would get the most interesting videos. And we would imagine that the scuba/skin-diving charter boats, whose reservations desks are set up in many hotel lobbies, would see a boost in business if they had TV monitors showing underwater footage of their expeditions.

We might not be ready for the *Calypto* yet, but the HandyCam Marine Pack has opened up a whole new world of videography to us. If you're a dedicated undersea adventurer who enjoys making videos on land, and you haven't tried the HandyCam Marine Pack, you should find out what you're missing. ■

## PLAYING GOD

(Continued from page 4)

long. Earthquakes can give rise to mountains. If a meteor hits the planet, you'll cause tidal waves or create giant dust clouds.

The events or life that you create can behave in a variety of ways, depending on how the Atmosphere, Geosphere, Biosphere, and Civilization models are set. Model-Control panels let you vary the settings. You shouldn't expect cut-and-dried reactions however. For example, in the Atmosphere control panel, you have control over such variables as solar input, cloud formation, air-sea thermal transfer, and the greenhouse effect. If you turn up the greenhouse effect without changing any of the other variables, you can expect the planet to get warmer. But other events can change that. If a few meteors hit the planet's surface, for example, they'll raise a lot of sun-blocking dust, and thus cool the planet. Similarly, in the Civilization model control panel, you can be reasonably sure that if you don't spend enough energy on medicine, plagues will seriously threaten your population. If you don't spend energy on science, your advancement will be slow.

A Report window lets you see how you're doing. You get a picture of whether the civilization is happy. (The civilization isn't necessarily human—it's possible to have other life forms evolve intelligence.) You get feedback on the concentration of the atmosphere, a description of rainfall, and just about anything else you want to know. For constant feedback on the overall picture, you can leave the Gaia window open. Gaia is represented as a planet with a

face—with a happy expression if everything is going well, and an exasperated look if your SimEarthlings are a polluting bunch.

SimEarth isn't as much as a game as it is an educational toy. You can't really "lose" in SimEarth. In the worst case, you end up with a barren planet. But then it's ripe and ready for new life to come out of the primeval soup, and to start the process over. You can't really "win" either. If you play your moves right, you may provide the right kind of planet in which the dominant civilization develops interplanetary travel and turns the planet into a sort of wildlife preserve.

What SimEarth seems to try to do most of all is to teach. The manual, for example, takes pains to explain about Earth science, and the basic concepts of climate, geology, and life. And the simulation, of course, vividly illustrates how seemingly isolated events can have profound ecological consequences.

Many of the premises of SimEarth are, however, open to debate—most of all the Gaia theory itself. Of course, we should try to appreciate SimEarth for what it is: a computer simulation game. Even though we're not big fans of computer games, we had fun with SimEarth. More important, it teaches several lessons that are relevant to our global survival—particularly that seemingly unrelated events are, indeed, related. ■

## KARAOKE PLUS

(Continued from page 5)

hits"—which are rarely available on the top-40-dominated karaoke song selections.

When used as a standard combi-player, the CLD-V710 provides several convenience features that are now becoming common—including several search modes, user-programmable track selection, program and track repeat, and elapsed and remaining time displays. No adapters are required for the various sized discs that it accepts, and the unit automatically senses the type of disc and goes into the proper mode of play. It's particularly easy to program the tracks of a CD to play in a certain order, thanks to on-screen programming. Similar to what you may be used to on your VCR, the CLD-V710 displays the numbers of the tracks in order, and the total time of the songs selected.

While we had the most fun with its karaoke functions, we spent much more time using the CLD-V710 as a CD player, and we watched quite a few laserdisc movies, as well. Judging by the versatility and space criteria mentioned earlier (especially considering that it took up less space than a CD player and a laserdisc player), the LaserKaraoke player certainly earned its prominent position in our entertainment center. ■

For more information on any product in this section, circle the appropriate number on the Free Information Card.

# ELECTRONICS WISH LIST

## Affordable Music System

When you're looking for a sound system for the kitchen or a bedroom, chances are you're not willing to make as large an investment as you did on your primary audio components—yet most of today's bookshelf units are priced in the \$500-plus range. *Sharp Electronics Corporation* (Sharp Plaza, Mahwah, NJ 07430-2135) has come up with an integrated music system that offers the convenience features to which we've become accustomed without breaking the bank. The *CMS-R300CD* features a top-loading, five-disc rotary CD changer that allows the listener to change up to four discs as the fifth plays. It also includes a digital tuner with 30 station presets, a double cassette deck, and a high-speed dubbing mechanism that offers a variety of taping capabilities. A four-band graphic equalizer with enhanced bass response (X-BASS) and a full-range speaker system keep sound quality up to par. The 16-key remote control operates the volume control and recalls up to 32 of the listener's favorite tracks with its random-access programming capabilities. Price: \$399.

CIRCLE 56 ON FREE INFORMATION CARD

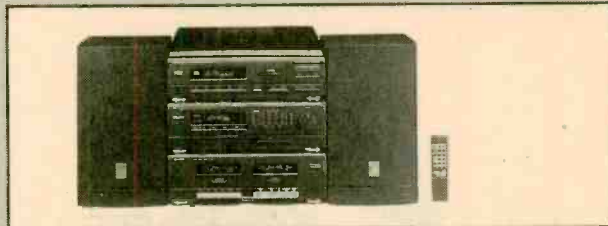

Sharp Integrated Music System

## Handheld Video Game

Now that 16-bit quality has become *de rigeur* for home video-game systems, we knew that similar-quality handhelds couldn't be far behind. *NEC Technologies'* (1255 Michael Drive, Wood Dale, IL 60191) *TurboExpress* portable video game not only offers "TV-quality" screen images—with an optional snap-on TV-tuner with video-in port, it doubles as a miniature color television or a camcorder monitor. TurboExpress uses active matrix, backlit, liquid-crystal technology. The 238 × 312-pixel display is capable of simultaneously displaying up to 512 colors. As the first handheld video game that is fully software-compatible with a home system, TurboExpress doesn't require long waits for one's favorite games to become available in a portable format, or double software investments: It accepts all of the dozens of games available on TurboChip cards for the TurboGraphx-16. The portable unit weighs about one pound, measures 4.3 × 7.3 × 1.8 inches, and runs on six "AA" batteries. Stereo sound is available through a headphone jack. Price: TurboExpress, \$350; TV-tuner attachment, \$100.

CIRCLE 57 ON FREE INFORMATION CARD



NEC TurboExpress Video Game

## Electronic Encyclopedia

We have no space in our crowded offices for a full set of encyclopedias—which means that we spend a lot of time in our library's reference section. Now you can get a 20,000-entry encyclopedia that takes up about the same amount of space as a remote control. *Selectronics, Inc.* (Two Tobey Village Office Park, Pittsford, NY 14534) is offering the pocket-sized *Random House Electronic Encyclopedia*, with 10 megabytes of easy-to-access information. The electronic reference tool searches out any word in the entire text in less than two seconds. An extensive cross-referencing system and detailed Table of Contents, which displays subjects and categories, encourages browsing and simplifies the identification of relevant entries. Other features include a chronological "Time Chart" of historical data, a "Notepad" that lets the user jot notes in the "margins," and a "Bookmark" that flags passages for later perusal. The Electronic Encyclopedia features a "QWERTY"-style keypad and an easy-to-read LCD screen, and it weighs less than 12 ounces. It will accept ROM-based cartridges including dictionaries, other reference materials, business organizers, and language translators. Price: \$350.

CIRCLE 58 ON FREE INFORMATION CARD



Selectronics Electronic Encyclopedia

## Connections Selection

You can have the biggest, fanciest, most elaborate assortment of audio/video components but, if you can't get them all hooked up and plugged in, they're not going to do you much good. To keep you from being foiled by small details, *Memtek Products* (Division of Memorex, P.O. Box 901021, Fort Worth, TX, 76101) has introduced a comprehensive line of accessories. The *Great Connections* lineup includes a wide array of cables, connectors, and adaptors, along with a selection of coil cords, wall plates, and modular extension cords. Prices: \$1.99 to \$24.99.

CIRCLE 59 ON FREE INFORMATION CARD



Memtek Great Connections

# ELECTRONICS WISH LIST

For more information on any product in this section, circle the appropriate number on the Free Information Card.



Black Widow Car Security System

## Arachnophobia

Dubbed "the vehicle security system that thieves hate like poison," the *Black Widow Series-1* from *Black Widow Security* (12753 Moore Street, Cerritos, CA 90701) is, nevertheless, based not on venomous eight-legged creatures but on electronics. Easy to use and to install, it includes two 100-foot-range remote transmitters with more than 20,000 code combinations and an activated panic feature, entry violation memory, visual/audible indicators, a 60-second re-arm timer, 5- or 30-second exit delay, and a manual override switch. Options include power door locks, a starter disabler, and battery backup. Price: \$189.

CIRCLE 60 ON FREE INFORMATION CARD

## Laserdisc Player

We're strong advocates of putting the same controls on the front panel and the remote control of each audio or video component, and *Mitsubishi Electronics America, Inc.* (Consumer Electronics Group, Audio Video Division, 5757 Plaza Drive, Cypress, CA) has taken that concept seriously. Its full-featured combination laserdisc player, model *M-V8000*, has a jog/shuttle dial on both the front panel and the remote. Each jog dial offers precise visual search capabilities by allowing the user to advance or reverse frames at half-, normal-, or double speed. They are encircled by shuttle rings that advance or reverse play at two, five, and ten times the normal speed. The 18-bit, eight-times-oversampling *M-V8000* uses digital timebase correction to reduce jitter by clocking the video signal into memory and then releasing it at a steady rate. Digital frame memory stores frames of information and allows still, pause, and visual search functions to be used with extended-play laserdiscs. For convenience, the player has a full range of chapter/track search capabilities, plays both sides of two-sided discs without manually reversing the disc, and comes with a manual designed to be easy to follow. Price: \$1499.

CIRCLE 61 ON FREE INFORMATION CARD

Mitsubishi Laserdisc Player

## Remote Camcorder System

There are some places where camcorders are impractical, forbidden, or inconvenient. A couple of examples: Some churches frown on amateur filmmakers (often obtrusively—which is the reason for all that frowning) recording wedding ceremonies, and it can be downright dangerous to try for close ups of wild animals in their natural habitats. The *Rader Remote-Cam* (*Rader Video Products*, 1039 North Main, Fremont, NE 68025), which lets you place an S-VHS camcorder anywhere that a person is not allowed to be, is designed for just those sorts of situations. From as far away as 200 feet, you can zoom, pan, tilt, focus, and pause the recorder, as well as operate the standby control. All of those functions can be monitored at the control box via a 3-inch color monitor. The Remote-Cam system comes with a modified camera, pan tilt, remote control unit, cable, an adjustable camera stand, batteries, AC adapters, and carrying case. Price: \$2950.

CIRCLE 62 ON FREE INFORMATION CARD

Rader Remote-Cam

## Printer/Display Calculator

Designed to meet the varied needs of small businesses and home offices, the *T1-5035 II* calculator from *Texas Instruments* (Consumer Relations, P.O. Box 53, Lubbock, TX 79408) runs on batteries or AC line current, and provides both a 12-digit, two-color serial printer and an easy-to-read, 12-digit vacuum-fluorescent display. The compact calculator takes up little desk space, and can be tucked into a briefcase when on-the-road needs arise. The full-size keyboard has well-spaced, contoured keys; a two-key rollover feature that protects against errors when two keys are pressed simultaneously; and eight-level keyboard buffering to increase speed and accuracy. An independent add register keeps addition and subtraction calculations separate from multiplication and division calculations. Other features include selectable decimal-point placement, a four-key memory to allow two calculations to be run at the same time, a non-add key for labeling the tape with dates or other reference information, and a right-shift key for making corrections without clearing the whole entry. Price: \$85.

CIRCLE 63 ON FREE INFORMATION CARD

Texas Instruments Calculator

For more information on any product in this section, circle the appropriate number on the Free Information Card.

# ELECTRONICS WISH LIST

## Preprogrammed Universal Remote

When Thomson Consumer Electronics Inc. (Distributor and Special Products, Deptford, NJ 08096-2088) decided to enter the universal-remote field, their market research indicated that a significant number of universal remotes are purchased as replacements for lost or broken originals. So they decided to introduce a preprogrammed unit, rather than one that relies on the original remote control for setup. The result is the *RCA System Link*, which operates virtually all brands of televisions, VCR's, and cable boxes, as well as many audio components. To set up the System Link, the user locates the brand of the component in the instruction manual, presses a button to indicate what type of component it is, presses the two-digit code, and then presses the ID button. The same procedure is followed for other components. Price: \$69.95.

CIRCLE 64 ON FREE INFORMATION CARD

## Digital Signal Processor

The hottest item in car audio these days is a digital-signal processor (DSP), which emulates the acoustics of the particular environment in which the original music was played—or where you'd most like to hear it. For instance, you can simulate the sound dimensions of a concert hall or a jazz club. *Clarion Corporation of America's* (661 West Redondo Beach Blvd., Gardena, CA 90247) *DSP959* combines different features to yield clear, lifelike sound. Eight preprogrammed memories, each derived from actual listening environments, are available. The original signal is converted from analog to digital (if necessary), and then it passes through a built-in digital equalizer. The final step is "sound shaping," which processes the music to make it sound like it was being played in the environment selected. The listener can use the preprogrammed factory setting, or can manipulate the sound field by altering the nine equalization bands or by manipulating each effect individually to create new versions, which can be stored in memory. Those effects include initial delay, room-size delay, liveliness delay, reverb time, and the effect level that balances the sound of the rear speakers. A sound balance feature lets the driver adjust the sound depending on the number of people in the car and where they are sitting, so that any position in the vehicle becomes the focal point. A pink-noise generator allows the system to be set up and balanced during installation and checked easily anytime thereafter. Price: \$799.95.

CIRCLE 65 ON FREE INFORMATION CARD

## Palm-Sized Camcorder

For sophisticated travel videography as well as home use, the *R-86 Super* ultra-compact camcorder from *Ricoh Corporation* (Consumer Products Group, 180 Passaic Avenue, Fairfield, NJ 07004) features true stereo recording capability, fade-to-black, and an 8:1 zoom ratio. The 8mm camcorder can record in mono, or stereo can be recorded either from the built-in, unidirectional, switchable (normal/wind), stereo microphone or from two external microphones plugged into the camcorder's stereo input jacks. The 8x zoom lens has manual override, as do the automatic focus, back light, and white balance controls. Rather than the white fade found in most camcorders, the *R-86 Super* fades to or from black for more professional-looking results. Other features include in-camera insert editing, digital tiling in up to eight colors, and six programmable shutter speeds. Price: \$1599.

CIRCLE 66 ON FREE INFORMATION CARD

## Remote-Controlled Equalizer

To add a greater degree of sophistication to *Fisher's* (21350 Lassen Street, Chatsworth, CA 91311-2329) Studio Standard line of audio components, the company recommends adding the *EQ-916* electronic equalizer, which puts 21 functions at the user's finger tips, including control of seven frequencies with twin full-logic and spectrum analyzer displays. Five preset programs and five user-programmable settings make it fast and easy to adjust EQ settings to fit a wide variety of music. An EQ Record button allows the user to make equalized tape recordings. The *EQ-916* also features a tape monitor, display-dimmer and peak-hold buttons, and a Flat switch to bypass equalizer control. Price: \$199.95.

CIRCLE 67 ON FREE INFORMATION CARD



RCA System Link Universal Remote

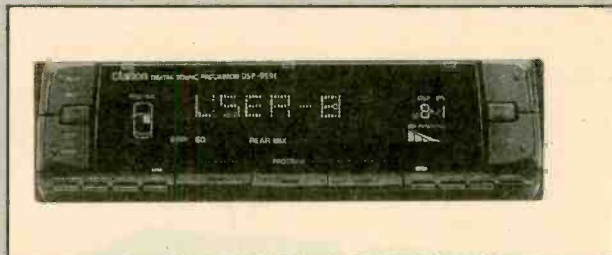

Clarion Digital Signal Processor



Ricoh Ultra-Compact Camcorder

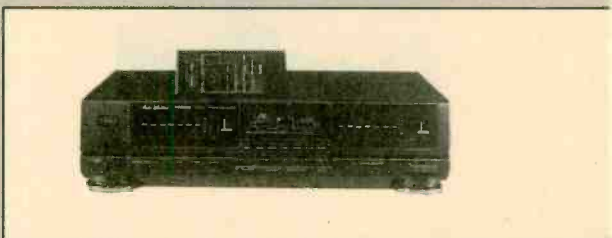

Fisher Remote-Controlled Equalizer

# ELECTRONICS WISH LIST

For more information on any product in this section, circle the appropriate number on the Free Information Card.



Casio Blood-Pressure Watch

## Sphygmomanometer Watch

Now you can see just how much time you spend trapped in traffic, or waiting for that late train, and at the same time you can watch your blood pressure go up from the stress. Casio, Inc.'s (570 Mt. Pleasant Avenue, P.O. Box 7000, Dover, NJ 07801) model BP-100 wristwatch has a built-in sphygmomanometer (instrument for measuring blood pressure). Blood-pressure measurements are completed within 30 seconds after a person places two fingers over the sensor on the watch. An EKG indicator sweeps across the graphic display while measurements are being made, and a heart symbol flashes in time with the user's pulse. Once measurements are complete, a tone sounds and diastolic and systolic blood pressure, as well as pulse rate, appear on the watch's display. Those three measurements are automatically stored in memory along with the month, date, day, hour, and minute of the reading. Up to 30 sets of such data can be stored in the BP-100's memory. The latest 21 sets are used to create bar graphs of diastolic and systolic blood pressure. Extremely high readings flash on the display to warn the user. Target values can be set, and users can train themselves to attain lower blood-pressure and pulse rate measurements. The watch itself has an AM/PM indicator and a calendar, and is water resistant up to 50 meters. Price: \$159.95.

CIRCLE 68 ON FREE INFORMATION CARD

## TV-Relay Device

You don't have to buy a second VCR to watch a rented movie in your bedroom when your first VCR is in the family room. Vidi-View is a wireless TV-relay device from Vidicraft (8770 SW Nimbus Avenue, Beaverton, OR 97005) that lets you view cable or VCR programming anywhere in the house without adding extra wiring. It even allows one family member to watch a ball game on cable while another watches a video. Vidi-View includes a transmitter and a receiver unit and hookup adapters. It uses ultra-high frequencies in the 900-MHz UHF-band range—recently approved by the FCC for in-home use—to transmit pictures and sound. The transmitter attaches to the video and audio outputs of the source TV, VCR, or camcorder. The receiver attaches to the antenna or video inputs of the receiving TV. Transmitted signals can pass through walls, metal beams, and other structural materials. Vidi-View will transmit a picture and sound signal up to a 120 foot radius. Price: \$149 (extra receiver, \$69.95).

CIRCLE 69 ON FREE INFORMATION CARD

## Compact-Disc Organizer

Our quickly growing CD collection quickly outgrows all our attempts to keep it organized, and it's become increasingly difficult to locate the discs we want to hear. According to Chapman Design Associates (7411 Lowell Canyon Blvd., Suite 7, N. Hollywood, CA 91605), we're not the only ones with that complaint. That company offers a solution in the form of their CD'vider CD library organizing system. The CD'vider is a durable set of precision die-cut vinyl index cards—similar to the dividers used in index-card files—that is available in two versions. Both Categorical and Alphabetical sets each contain 12 dividers. The Categories set includes 11 of the most popular music categories (jazz, pop, classical, etc.) and one blank. Price: \$12.95.

CIRCLE 70 ON FREE INFORMATION CARD

## Low-Frequency Radiation Tester

Every time we turn around, they've come up with something else in our everyday lives that causes cancer. Case in point: Low-frequency radiation has been the subject of dozens of news reports and articles as a "probable human carcinogen." You can't shield yourself from low frequency radiation, but it is possible to determine the sources and avoid them. The Red-Alert meter from Certified Products Corporation (2816 East 51st Street, Tulsa, OK 74105-1704) tests and indicates the level of low-frequency radiation generated by such things as high-tension electrical transmission lines, computer VDT's, electric blankets, and other appliances. For construction or remodeling work, the Red-Alert also locates hidden or buried electric lines before you begin grading the land, digging a hole, or tearing out walls. Price: \$69.95 (plus \$2.95 shipping and handling).

CIRCLE 71 ON FREE INFORMATION CARD



CD'vider CD Organizers

# WIRE ANTENNAS FOR



## HAMS and SWL's

*There are some antennas that, although developed long ago, are still useful today. We'll present some of those designs and provide you with some sources for such hardware.*

BY JOSEPH J. CARR

**A**mong my many hobby interests is a devotion to antique radio receivers, antique transmitters, and the old books and magazines that taught people to build them. It is difficult for me to pass up either a reprint or original Hugo Gernsback magazine from the era when radio was an expensive novelty. Some of those old publications reveal a number of good wire-antenna designs that are still useful today. Indeed, some of them are still in common daily use, while others are less well known. This article is no mere trip down nostalgia lane, but rather a technical look at some antennas that you might want to consider for yourself.

**Tee Antennas.** The Tee antenna (shown in Fig. 1) is especially suited to shortwave listeners, although ham operators have used them. The Tee antenna is a length of wire 40 to 100-feet long that is fed at the center by another wire, called the downlead. The antenna element can be bare, but the downlead should be insulated 12-, 14-, or 16-

gauge wire. The antenna element should be made of 14-gauge Copperweld wire. That type of wire has a steel core coated with copper. Because of the skin effect, RF only flows on the surface, so the steel core does not add losses to the circuit. If Copperweld is not available, then at least use hard-drawn stranded copper wire. If regular soft-drawn wire is used, then it will soon fatigue and the antenna will fall down.

The downlead can be brought to the receiver by way of a small hole cut into the wall of the house, or through the window. At the antenna end, it is wrapped five to seven times around the antenna element wire, and then soldered. The purpose of the solder is not strength, but rather to prevent corrosion of the joint in weather. Wrapping the wire provides added strength.

**Random-Length Long-Wire Antennas.** The term long wire is used for a wide variety of different antennas. The only rigorously correct usage of the term is for antennas that are more than

two wavelengths long. However, it is common to use the term long wire for antennas that are actually random-length wire antennas (see Fig. 2). If the antenna element is, say, 100-feet long, then it is a long wire at frequencies of 20-MHz and up, and a random-length antenna for lower frequencies.

The random-length long-wire antenna of Fig. 2 is a 40- to 150-foot long run of 14-gauge or larger wire (again, Copperweld is preferred). In the case shown, the end closest to the house is supported by a mast installed on the roof while the far end has a stand-alone support. However, both ends could be attached to buildings, trees, or other structures. The downlead of the random-length antenna must be insulated, but need not be Copperweld wire. Ordinary 14-gauge stranded wire will suffice.

If the random-length antenna is used for transmitting, then a good ground must be provided. In fact, a "good ground" is also useful for receive-only installations, but for hams it is a must. A

"good ground" means a short run of heavy wire to one or more 8-foot ground rods. Alternatively, if only a few bands are used, then a system of resonant quarter-wave radials can be provided. Technically speaking, they can be left on the surface, but that's not safe even if there is no chance of a family member crossing over the area (even trespassers can sue you!). For the sake of safety, bury the radials a few inches under the earth.

Also required for good transmission, and useful for SWL's as well, is an antenna tuner. A standard L-section coupler, or some other low-to-high impedance-transforming coupler will do.

A variation on that theme is to add the device shown in Fig. 3. The wire antenna and downlead are similar to the ones in Fig. 2. However, at the feed end you have the ability to select direct coupling to the rig, capacitive coupling for antennas that are too long for the operating frequency, and an inductor for frequencies that require a longer antenna. The minimum and maximum values for the inductor and the capacitor are shown in Fig. 3. Use the lower values for antennas that are predominantly in the high end of the MF spectrum, and the larger ones for lower frequencies.

**Doublet Antennas.** A doublet antenna is one that is fed in the center. Unlike the Tee antenna, the doublet is broken in the middle and each half is fed by one side of a two-conductor transmission line. If the doublet is a half-wavelength long, then each half is a quarter wavelength. The overall length of such an antenna is found from:

$$L = 468/f$$

Where L is the length in feet, and f is the frequency in megahertz. Each quarter-wavelength element is one-half that length.

Keep in mind that, although equations for antenna length look absolute, they are only approximations. The actual length is determined by the immediate locale, and what's in it that'll alter the antenna characteristics (houses, trees, etc). For proper operation, the antenna will have to be tuned, which we'll discuss later.

Figure 4 shows the basic form of the half-wave doublet. That type of antenna is usually called the dipole, and today is most often fed with 75-ohm coaxial cable. But in older designs, two other types of feedline were often used.

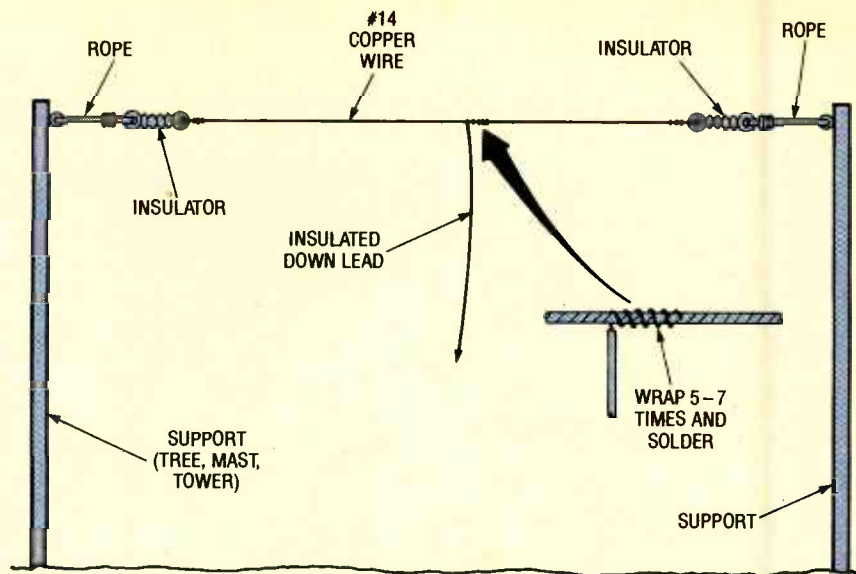

Fig. 1. The Tee antenna is a length of wire 40 to 100-feet long that is fed at the center by another wire, called the downlead.

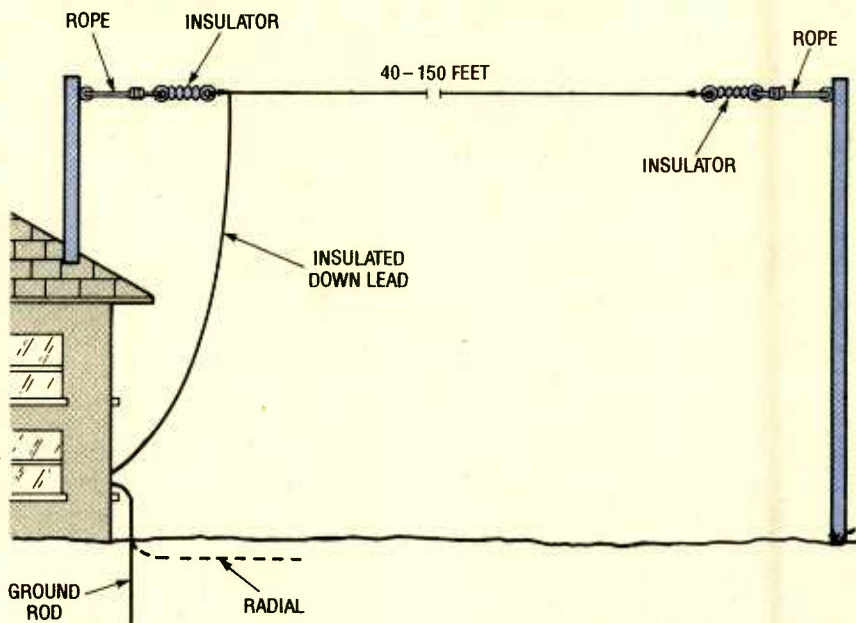

Fig. 2. It is common to use the term long wire for antennas that are actually random-length wire antennas. If the antenna element is, say, 100-feet long, then it is a long wire at frequencies of 20 MHz and up, and a random-length antenna for lower frequencies.

Shown in Fig. 4 is a form of line called twisted pair. The two insulated conductors are twisted together. You can either buy twisted-pair wire, or make it using a hand drill and two lengths of regular stranded hook-up wire. Use about eight twists per foot. The other form of two-wire transmission line is ordinary lamp cord (called zip cord). You can buy either 14- or 16-gauge zip cord at most hardware or electrical supply stores.

Figure 5 shows the folded dipole form of doublet antenna. Again, the overall length of the antenna is a half wavelength. The folded dipole consists of

two half-wavelength radiators that are closely coupled to each other. The two radiators are insulated from each other at all points except the very ends, where they are shorted together. The feedpoint is at the middle of one of the radiators. That form of antenna has a feedpoint impedance of around 280 ohms, so it is a good match for 300-ohm twin-lead (TV-antenna wire).

The radiator element of the folded dipole can be made using 300-ohm twinlead if only used for receiving, or low-power transmitting, but if higher power-levels are contemplated you



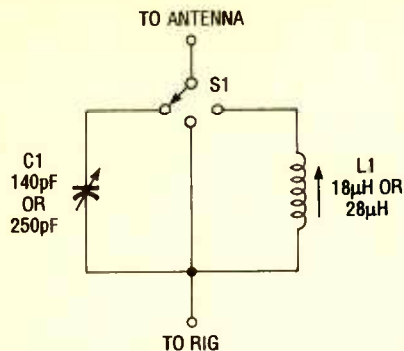

Fig. 3. This little device when placed between the antenna and rig gives you the ability to select direct coupling to the rig, capacitive coupling for antennas that are too long for the operating frequency, and an inductor for frequencies that require a longer antenna.

should use 14-gauge stranded wire spaced 4- to 8-inches apart. The ideal spacers are the ceramic types once found in abundance in radio stores, but lucite, PVC, or even treated (water-proofed) wooden dowels can be used. The detail in Fig. 5 shows how to connect the spreaders to the antenna wires, and how to use safety wires to keep them in place.

Another means of feeding the folded dipole is to replace the center insulator with a 4:1 balun transformer. These low-cost devices will transform the 300-ohm balanced impedance of the folded dipole down to 75-ohms unbalanced so that ordinary coaxial cable can be used.

Still another form of doublet antenna

is the three-wire folded dipole of Fig. 6. That form of antenna is similar to the standard two-wire folded dipole, but it uses three parallel conductors instead of two. The conductors are kept insulated from each other except at the far ends, where they are connected together. The impedance of the three-wire folded dipole is controllable by varying the ratio of the conductor diameters and their relative spacing. For our purposes, however, a simplified arrangement is used in which all three conductors have the same diameter, and they are all spaced from each other by 4.5 to 5 inches. That arrangement will yield a feedpoint impedance of about 600 ohms, so it is a good match to a 600-ohm parallel feedline.

### Those Winsome Windoms.

The windom antenna is a half-wavelength wire antenna that is fed off center. Because the mid-point of the half-wavelength antenna is the low point (about 70 ohms), the off-center feedpoint is at a higher impedance. Figure 7 shows the classic windom antenna used in the 1930's. The single-conductor downlead feed point is  $0.36L$ , where  $L$  is the length of the antenna as given by the equation provided earlier. The windom antenna is usually fed through an antenna coupler so that its impedance can be matched to the lower impedance of the transmitter or receiver.

Figure 8 shows a modified windom design in which the single-wire downlead is replaced with either 300-ohm twin-lead transmission line, or a 4:1 balun transformer that is in turn fed with 75-ohm coaxial cable. The antenna does not provide an ideal impedance match, and one can expect (as with both windoms) some "RF in the shack" when more than moderate power levels are used. However, the VSWR is not terribly high and can be overcome using a standard coax-to-coax "line flattener" form of antenna tuner.

An actual kit for a modified form of windom antenna called the Carolina Windom is shown at the beginning of this article. Designed and produced by The Radio Works (Box 6159, Portsmouth, VA 23703; Tel. 1-804-484-0140), the Carolina Windom kit is available in both 80-10 meter and 40-10 meter versions. According to the literature that came with the antenna, the Carolina Windom offers a low VSWR on 75/80 meters, but must be matched with an antenna tuner on higher frequencies. One of the keys to the Carolina Windom antenna

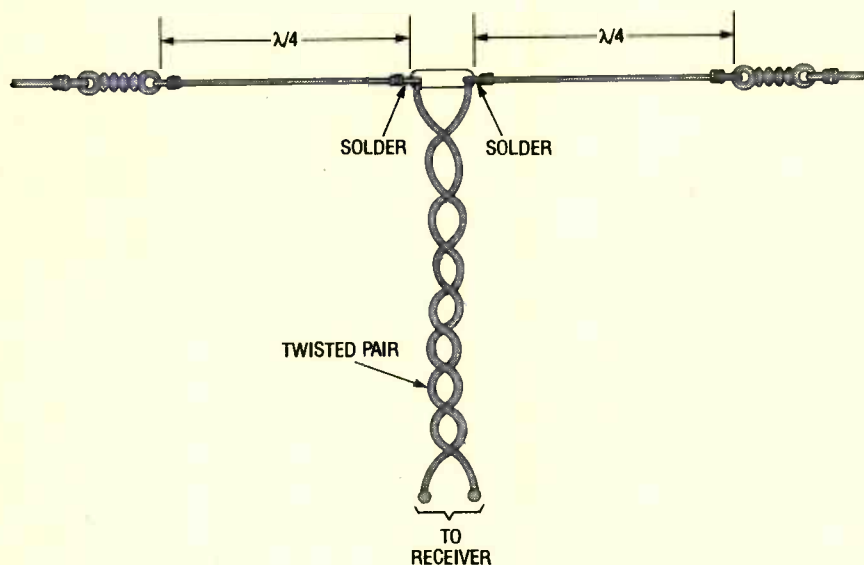

Fig. 4. This half-wave doublet (or dipole), is most often today fed with 75-ohm coaxial cable. But in older designs two other types of feedline were often used.

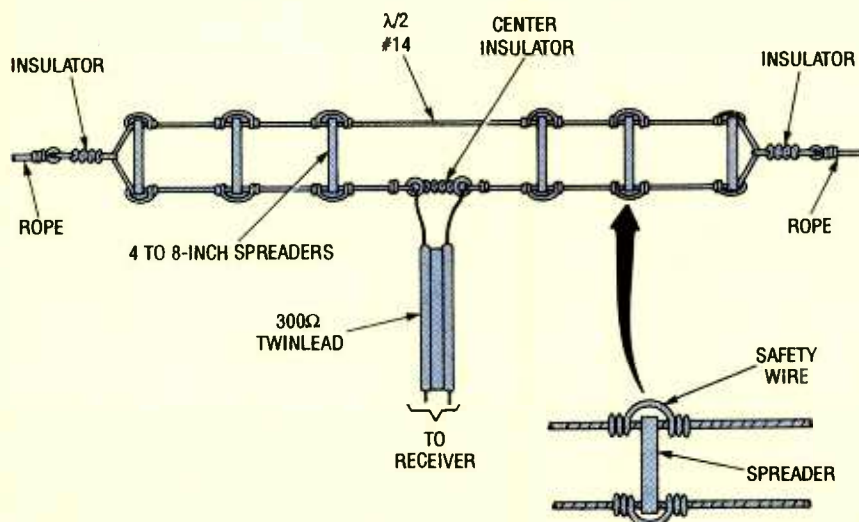

Fig. 5. This is a folded dipole form of doublet antenna. It consists of two half-wavelength radiators that are closely coupled to each other.

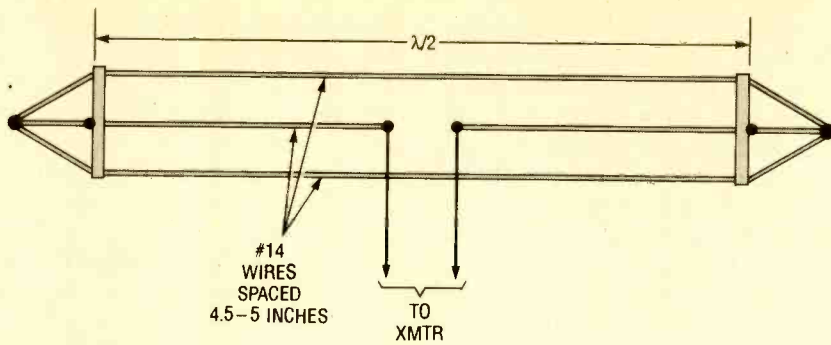

Fig. 6. Another form of doublet antenna is the three-wire folded dipole. It is similar to the standard two-wire folded dipole, but it uses three parallel conductors instead of two.

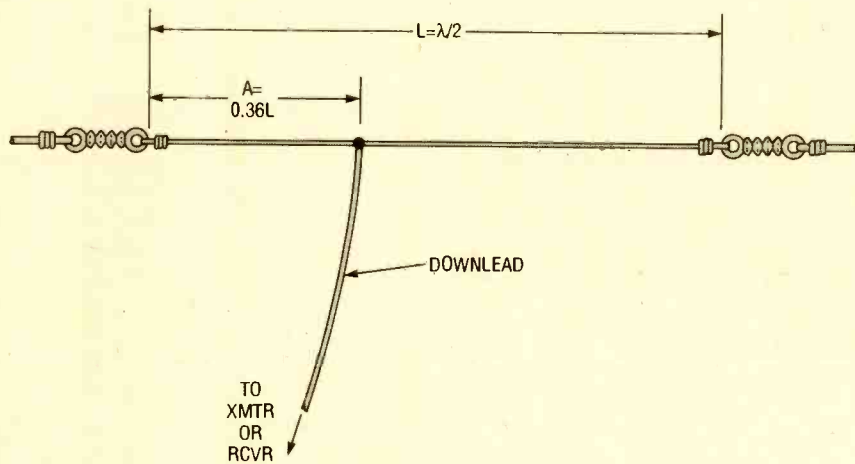

Fig. 7. The classic windom antenna is a half-wavelength wire antenna that is fed off center. The design dates from the 1930's.

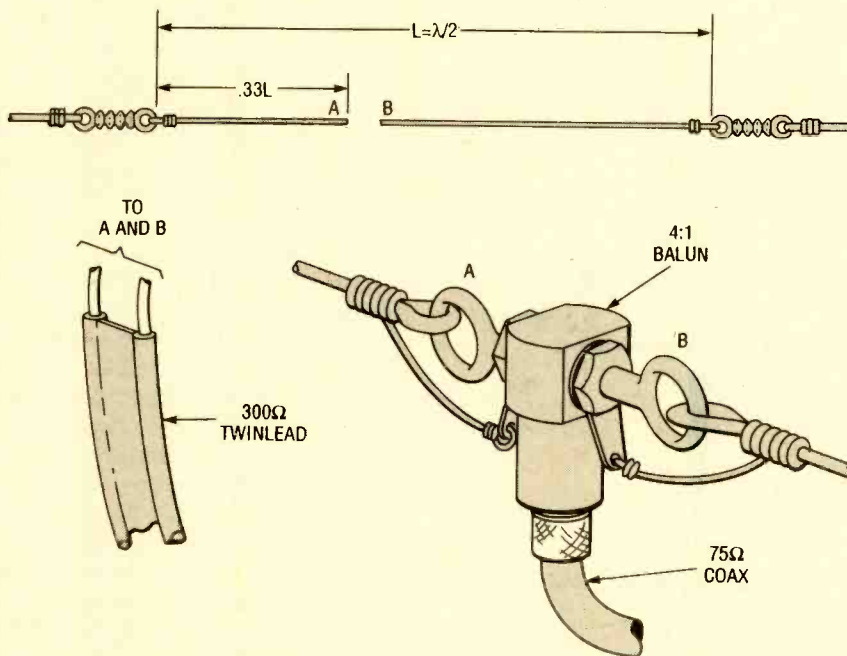

Fig. 8. This is just a modified windom design in which the single-wire downlead is replaced with either 300-ohm twin-lead transmission line, or a 4:1 balun transformer and 75-ohm coax.

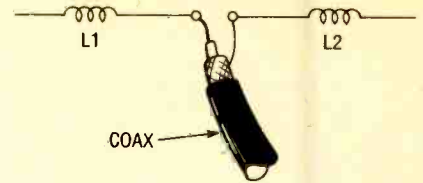

Fig. 9. People with space limitations can use a shortened dipole such as this one. It is very similar to a regular dipole, except that the overall length is less than half a wavelength.



People with space limitations can use shortened dipoles with coils such as these in the two poles.

is the vertical radiator segment between the feedpoint and the matching transformer. That section of the antenna is approximately a half-wavelength on 15-meters.

**Shortened Dipole.** Some shortwave enthusiasts cannot easily erect a half-wavelength antenna because of space limitations. Those people can use a shortened dipole such as in Fig. 9. Those antennas are very similar to the regular dipole, except that the overall length is less than half a wavelength. The difference is made up by inserting an inductor in each element. Although the placement and value of the inductor is determined through a complex process, some companies offer preset coils that will suffice for most readers. Follow the instructions that come packed with the coils for proper installation.

**Testing and Tuning Antennas.** Antennas should be tuned to resonance for best reception and transmission. Thus, both the ham and the SWL need some means for finding the resonant point. The ham can always use a  
(Continued on page 84)

# Electronic Limbs

BY MARTIN KNIGHT

*A revolutionary bioelectric-sensor system and light-weight controls bring feeling sensation and near-normal motion and usefulness to artificial limbs.*

In 1986, Chuck Tiemann was working as a lineman for a rural electric company. Being a lineman is a hazardous occupation, shunned by all but the stout of heart. One day a mishap occurred that sent 7,200 volts of electricity through Chuck's body. The burn damage to Chuck's body resulted in the loss of his right leg below the knee and his left arm below the elbow.

In his own words, "I went through a lot of emotional changes after the amputations. When you lose a limb, much less two, you feel ugly and mutilated. I wondered how I could ever again live in a two-arm, two-leg society.

"Even before I had my artificial limbs, I went back to work at Kay County Rural Electric. I even climbed a pole. I think I had to prove that Chuck Tiemann wasn't handicapped."

Within five weeks after the amputation, he was fitted with a prosthetic leg by John Sabolich of the Sabolich Prosthetic & Research Center in Oklahoma. Chuck worked hard at perfecting his gait by watching videotapes provided by the research center and practicing at home in front of a full-length mirror. His wife, Terri, would help by checking his posture. "I wanted to walk as naturally as possible," he recalls.

Chuck applied the same *I-am-going-to-do-this* attitude to mastering his *myoelectric* arm and hand, which he received nine months after his prosthetic leg and foot.

Wanting to do all that he's capable of doing, Chuck has dubbed himself a "...guinea pig for the latest in prosthetic



devices. Whenever someone has something new that might make life easier for amputees, I try it. I feel like whether it's good or bad, whatever I do today is going to affect what's available in the future. If somebody didn't do it, amputees would still have hooks and wooden legs."

In 1990, Chuck Tiemann ran and finished the grueling Bay-to-Breakers race in San Francisco—a seven-and-one-half-mile uphill run that would challenge even the most able-bodied runner. His prosthetic leg included the new Sabolich "Sense-of-Feel-System." "My time wasn't as good as I had hoped," he says, "but I finished the race and I know I'll better my time next year."

**About the Sabolich Leg.** The Sabolich Sense-of-Feel System is the first prosthetic system developed to restore a sense of feel to lower-limb amputees that approximates the *natural* feeling lost because of amputation. In the Sabolich leg for example (as shown in Fig. 1), this is accomplished using pressure transducers incorporated in the sole of the artificial foot. The sensors respond *proportionally* to pressure on different areas on the sole of the foot. The more pressure exerted on the artificial foot, the greater the magnitude of the signal.

The analog electrical signals produced in this fashion are sent to a battery-powered electronic interface (see Fig. 1). The electronic interface contains the circuit elements necessary to interpret and convert the signals from the transducers to digital signals that mimic the signals that the nerves in a human foot would normally generate and transmit.

Those signals are then sent to a socket on the artificial leg where the residual limb enters the leg. The signals are transferred to nerve endings in the remaining limb by electrodes in the socket. The nerves naturally transmit the signals up to the brain where the sensation of feeling is experienced.

As many as eight different sensors can be incorporated in the sole of the prosthetic foot. The location of the electrodes for the transducers helps the patient determine which part of the foot (which sensor) is experiencing pressure. For example, the pressure transducers on the ball of the foot pick up various levels of pressure generated from walking. The resulting signals are sent to the skin on a forward section of the amputee's residual limb (toward the knee).

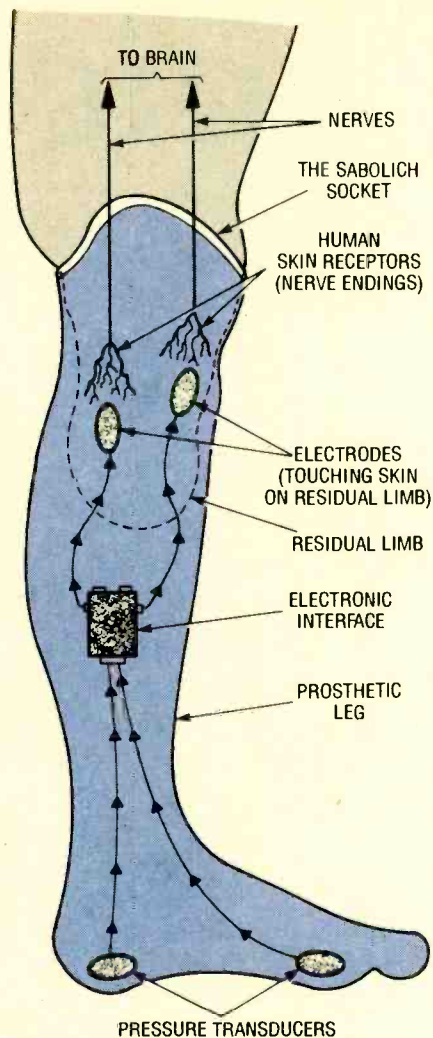

Fig. 1. This diagram shows pressure transducers at the heel and ball of the foot. Analog pressure signals from the transducers are received at the electronic interface where they are converted to digital-like, electrical signals which are detected by human skin receptors.

That's where the nerves and muscles at the ball of a real foot would send their signals to communicate with the upper leg, and from there to the brain.

Since the socket (called the Sabolich Socket in this application) is the electrical interface between the amputee and the artificial limb, it is one of the most important components in the system. The newly designed socket in the system is highly muscle and nerve contoured, making it most conducive to the muscle and nerve re-education process. Muscles and nerves have been inhibited from functioning properly in conventional sockets of the past as there is no feedback provided by the artificial limb.

When fitted with the Sabolich leg, amputees are able to feel sensations

generated by the artificial foot. In effect, the brain learns to "communicate" with the floor via the artificial foot. After only several minutes of wearing the artificial limb, the amputee's brain begins to interpret the sensations in the residual limb as being generated by the foot, approximating the brain's reaction to sensations it formerly received directly from the natural foot.

And advances on the system are being made all the time; At the beginning of 1991, the Sabolich electronic interface was reduced to half the approximate size of a pocket pager or beeper, making the electronics package capable of fitting into very small prosthetic devices. As of this writing, the cost of the system is \$1,400.

**Benefits Derived.** The Sabolich System provides patients improved balance for walking or running since sensory information is transmitted from the prosthetic foot. If the amputee is on a slanting surface, for example, or steps on a rock, he will know it because of the information being received from the artificial foot. Consequently, the amputee can immediately correct his stride to compensate, just as would be done with a natural foot.

The feedback also helps a new amputee learn to use the artificial leg quicker and with a good gait pattern. A therapist can turn up the intensity of a specific electrode to increase its effect so that the amputee is reminded of which movements are correct and which to avoid, in effect creating a sensory biofeedback gait-training system rather than having the amputee rely on an audible beep or flashing light system as with conventional biofeedback units. A therapist can also place electrodes directly over particular muscles that need to be trained and stimulated, encouraging appropriate muscles to contract, strengthening them and further encouraging correct gait patterns.

The sensory information also helps to reduce the stress and impact of faulty steps, thus preventing trauma to the knee and hip joints and spinal column. Furthermore, patients can feel their foot in such non-ambulatory activities as pushing an automobile clutch, brake, or bicycle pedals.

**The Extra Benefits.** Early tests suggest that using the Sabolich System may result in a significant lowering of "phantom pain," in which amputees experience feelings of pain in their

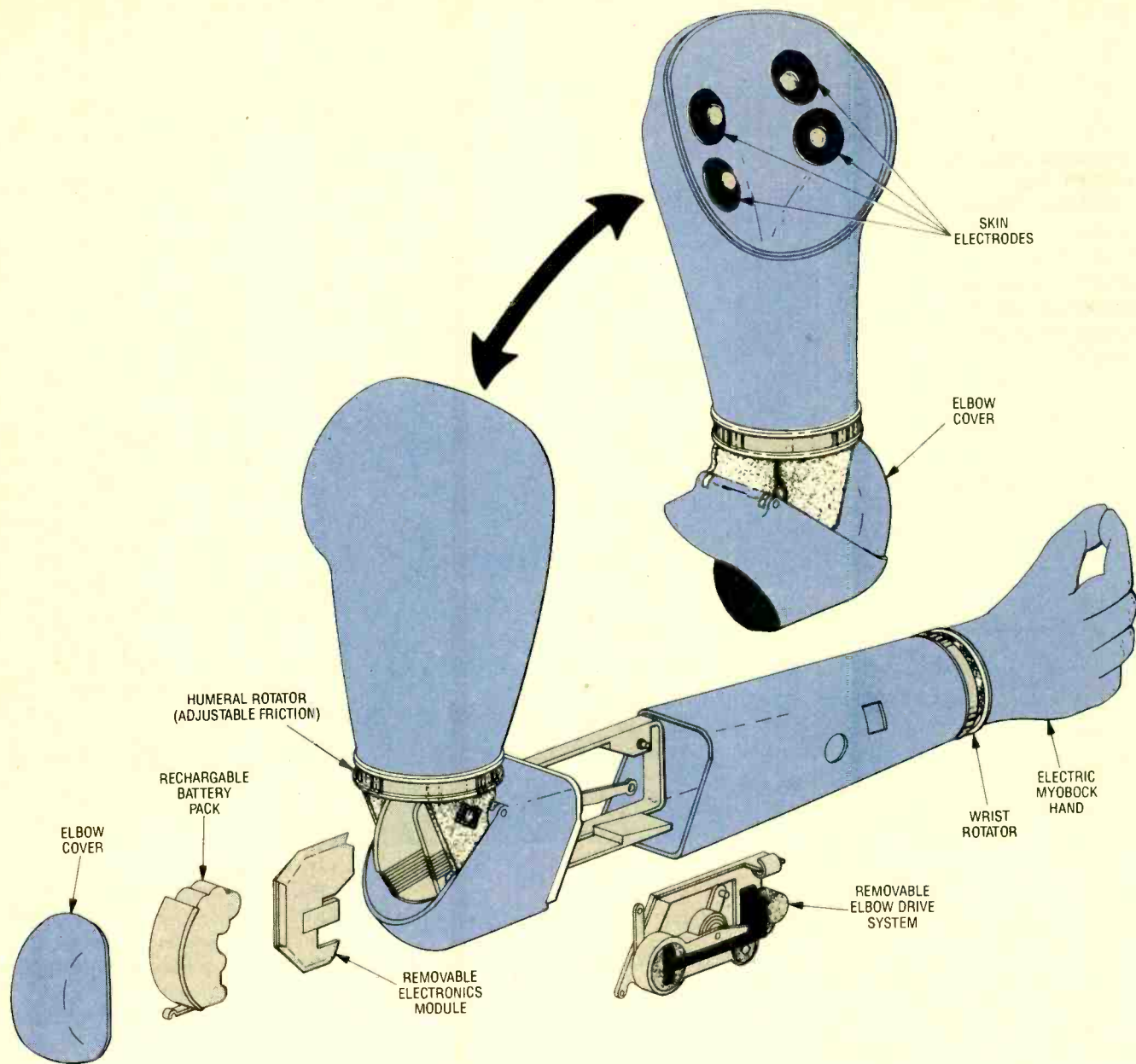

Fig. 2. Although this diagram of the Utah Artificial Arm shows a hand "terminal device," the arm can also support other terminal devices such as a prosthetic hook for use around the shop.

missing limbs. The sensation can range from severe aching to a sense of cramping. Apparently, the new system tricks the brain into "feeling" the foot in a more natural and positive way, reducing the tendency of the brain to generate phantom-pain sensations.

This is linked to a phenomena called "cerebral projection," in which the brain projects the missing foot back in the patient's mind. The Sabolich System increases the sensation of having the missing limb, so some patients report the ability to feel their toes and mid-foot bending under the pressure of walking on an artificial foot.

Aside from use by amputees, the Sabolich Sense-of-Feel System holds promise for a wide scope of head-injured and paraplegic patients since they, much like amputees, could benefit from again feeling the bottom of their paralytic feet.

Similarly, millions of diabetics, who often have little or no sensation on the soles of their feet, could benefit from the increased balance and sensation provided by the system. They would be warned of too much pressure being placed on the foot, pressure which can cause severe damage, ulceration, or amputation.

**The Utah Arm.** Wriggle your arm about your body flexing your elbow, wrist, and altering your grip. You'll realize with overwhelming conviction that the well coordinated human musculoskeletal behavior is not one of simple command/response between the higher decision centers and actuating muscles. As you would expect from performing this simple experiment, the myoelectric Utah Arm that Chuck was fitted with is undoubtedly an engineering marvel.

The Utah Arm and Hand for above-elbow amputees allows sensitive con-

(Continued on page 86)

# The "Magic-Film" Speaker

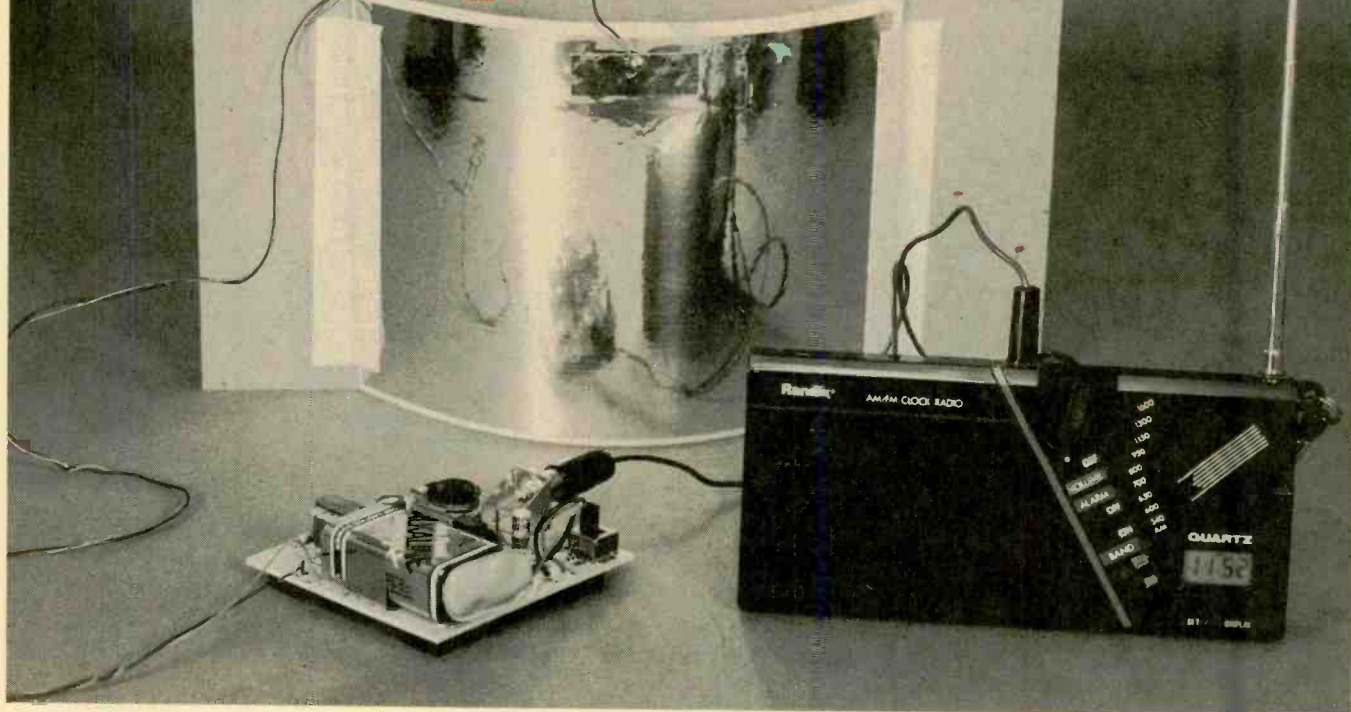

A speaker is a speaker is a speaker—or is it? Most of you are probably familiar with an ordinary audio speaker. You know, the kind that you find in any radio, stereo, or TV. And while there are certainly differences in the quality of different speakers or, more specifically, the quality of the sound that they can reproduce, most speakers are basically very similar in their construction. However, that's not so with the *Magic Film Speaker* that we'll describe in this article. That speaker, which you can build, uses piezoelectric film to reproduce sound. To be a little more precise, what you build is a circuit that allows you to use piezoelectric film as a speaker.

The piezoelectric-film speaker circuit is designed by Heathkit, and sold in kit form (as item number SK-120). The ordering information for the kit can be found in the Parts List. However, because some of you may want to build the circuit from scratch, we have provided complete construction details, as well as a source for the piezoelectric film (see the Parts List).

In order to understand how the de-

## *Have fun experimenting with this unusual speaker*

BY MARC SPIWAK

vice works, you will first have to understand what piezoelectric film is and how it works. Before we discuss the piezoelectric film, however, let's first talk about how an ordinary speaker works.

**Speakers in General.** A common everyday speaker is usually a shallow conical disc, or diaphragm, that vibrates back and forth within its housing in tune with the audio signal that is presented to it. (An audio signal is basically a complex AC signal.) The vibrations reproduce sound by sending sound-pressure waves through the air that vary along with the audio signal. The sound waves reach your eardrum (which is connected to your brain), which translates the waves into sounds that you have come to understand. Now let's see how the speaker diaphragm is made to move back and forth.

We all know how an electromagnet works, and that magnets can be made to attract or repel one another. If you were to make an electromagnet using some insulated wire and a nail, you'd find that when current is passed through the wire in one direction, one end of the nail would attract one pole of a magnet while the other end would repel it. If you reverse the current flow, the opposite would be true.

Figure 1 shows a cut-away view of the average speaker. There you can see what is called the *moving coil*; a hollow cylindrical coil that surrounds, but is not attached to, a fixed magnet. The moving coil is attached to the diaphragm, and is allowed to move back and forth around the fixed magnet. When it moves it takes the diaphragm with it.

When an audio or AC signal is passed through the moving coil, it tries to repel and attract the fixed magnet—just like the electromagnet made from the wire and nail. But since the fixed magnet is stationary, the diaphragm is forced to move back and forth in time with the oscillations of the audio signal. As the diaphragm oscillates, it creates the

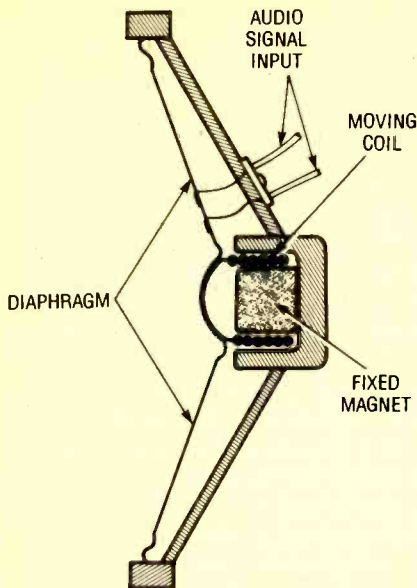

Fig. 1. Here is a cut-away side view of the average speaker.

pressure (or sound) waves that are detected by the ear. Now let's see what piezoelectric film is, and how we can make it behave like a speaker.

**Piezoelectric Film.** A piezoelectric material has the ability to turn a mechanical force into electricity, and it can also produce a mechanical force when subjected to electricity. Sometimes the material is a rigid ceramic or crystal-like substance, as is the case with a quartz crystal. But in this project, we are going to use a piezoelectric substance made from a flexible plastic film.

Piezoelectric film contains *dipoles* that are produced in the material's crystalline structure. A dipole is a molecule that has opposite polarity on either end (see Fig. 2). The film is metallized on either side so that a voltage can be placed across the film. The voltage causes the dipoles to align, and the material to change in shape as shown in Fig. 3 (as it gets thinner, it gets longer and wider). When an audio or AC signal is placed across the film, the film changes shape in accordance with the signal. As the voltage polarity reverses, the film bends in the opposite direction. And, as you might have guessed, the film can produce sound waves much like a regular speaker.

The only problem is that piezoelectric film requires a high voltage to produce the desired effect, therefore a common 1-volt peak-to-peak audio signal will not do the job. What we need is a "high-voltage" audio amplifier to make the film act like a speaker. With that in mind,

let's take a look at the circuit that is used to drive the film speaker.

**Circuitry.** The schematic diagram for the amplifier is shown in Fig. 4. An audio signal is input at J1, an RCA jack. A voltage divider, consisting of R1 and R2, provides a load for the signal source; R2 (a 2000-ohm potentiometer) also serves as a volume control. The signal is amplified by U1, an LM386 low-power audio amplifier. Power is supplied by the 9-volt battery, B1, while capacitor C1 is used to filter the supply line. The amplifier gain is set to about 60 by R3 and C3. Resistor R4 and capacitor C4 cause low frequencies to be amplified more than high ones to improve the speaker's sound.

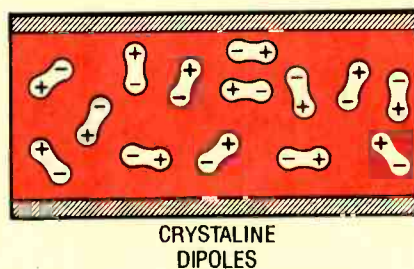

Fig. 2. Piezoelectric film contains dipoles, a molecule that has a natural opposite polarity on either end.

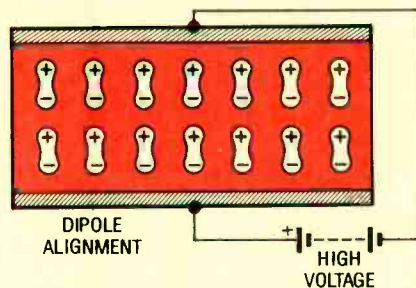

Fig. 3. A voltage causes the dipoles to align, and the material to change its shape.

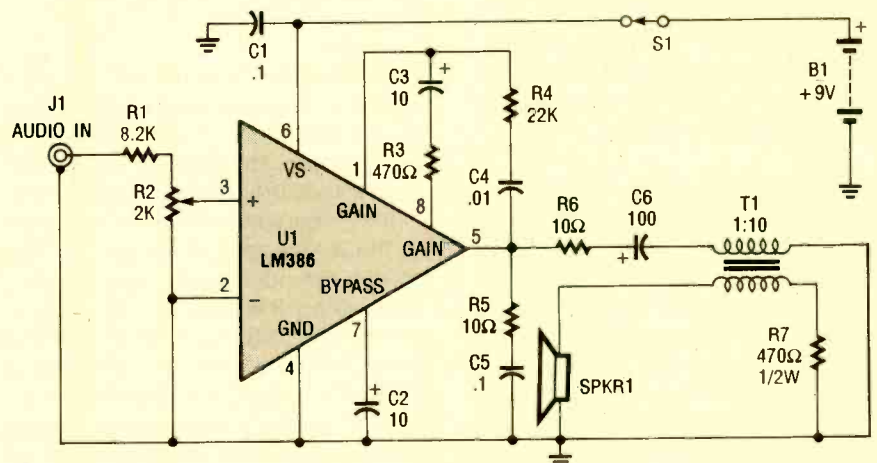

Fig. 4. Shown here is the schematic diagram for the amplifier portion of the project. An audio signal is fed to the circuit via J1 and is highly amplified to operate the film speaker.

## PARTS LIST FOR THE MAGIC FILM SPEAKER

### RESISTORS

(All fixed resistors are 1/4-watt, 5% units, unless otherwise noted.)

- R1—8200-ohm
- R2—2000-ohm, potentiometer
- R3—470-ohm
- R4—22,000-ohm
- R5, R6—10-ohm
- R7—470-ohm, 1/2-watt

### CAPACITORS

- C1, C5—0.1- $\mu$ F, ceramic-disc
- C2, C3—10- $\mu$ F, 35-WVDC, electrolytic
- C4—.01- $\mu$ F, ceramic-disc
- C6—100- $\mu$ F, 25-WVDC, electrolytic

### ADDITIONAL PARTS AND MATERIALS

- U1—LM386 low-power audio amplifier, integrated circuit
- T1—1:10 step-up audio transformer
- S1—SPST switch
- B1—9-volt transistor-radio battery
- J1—Phono jack
- SPKR1—Piezoelectric film, see text
- Printed-circuit materials, 8-pin IC socket, speaker-lead wire, 9-volt battery holder and connector, foam-rubber feet, etc.

**Note:** The Magical Film Speaker (kit SK-120) is available for \$21.95 from Heathkit, Heath Company, Benton Harbor, MI 49022; Tel. 800-253-0570. The kit includes everything in the Parts List, except the 9-volt battery.

Piezoelectric film is available from Atochem North America, 3 Parkway, Philadelphia, PA 19102. Contact them directly for pricing and other information

Components R5, C2, and C5 stabilize the amplifier, while R6 and the primary of T1 act as a load for U1. DC voltage is blocked from the primary of T1 by C6.

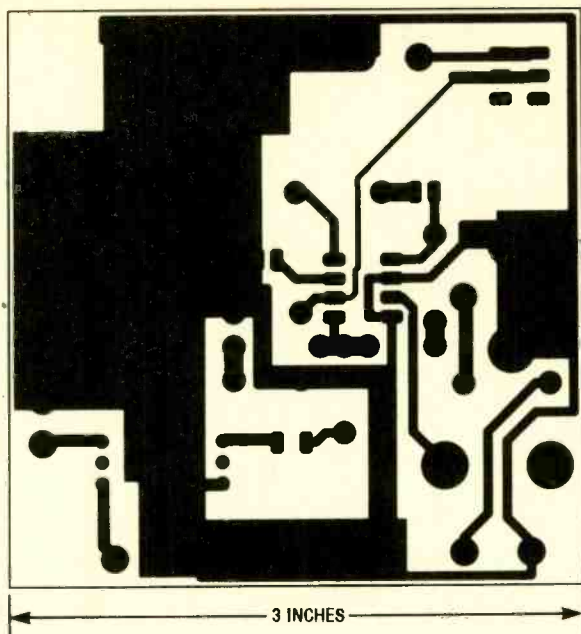

Fig. 5. You can make your own printed-circuit board from this foil pattern.

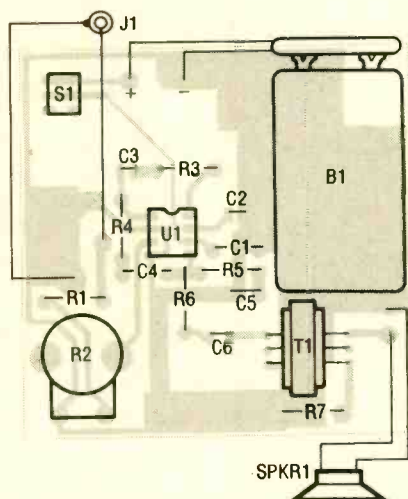

Fig. 6. Solder the components to the board using this parts-placement diagram as a guide.

allowing only audio to be coupled to T1. Transformer T1 steps up the audio signal by a factor of ten to drive the piezoelectric-film speaker. Resistor R7 limits current in case the output is accidentally shorted to ground.

**Construction.** It's a good idea to use a printed-circuit board for this project. You can make your own from the foil pattern provided in Fig. 5, or use the board that comes with the kit. You could also probably get away with using a piece of perfboard. If you use a printed-circuit board, solder the parts to the board as shown in the parts-placement diagram in Fig. 6.

Be sure to observe proper component polarity—especially with the inte-

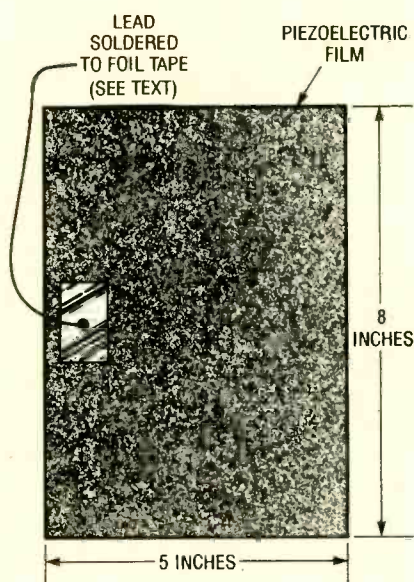

Fig. 7. Solder a lead to a piece of copper-foil tape and then stick the tape on the piezoelectric film.

grated circuit, U1. Make sure that your soldering is done carefully, and be sure to check the board for any solder shorts, opens, cold-soldered leads, and heavy flux buildups when you're done.

The 9-volt battery holder is mounted to the board using a couple of small screws, although some double-sided tape will do. The leads from the battery holder are soldered to plus (+) and minus (-) points on the board; positive (red) to + and negative (black) to -. The PC board is designed to directly accept a particular RCA jack for J1 that is included in the kit. If you use a different RCA jack, simply solder the con-

nections as shown in Fig. 6. Then you have to use an adapter cable to supply an input signal to J1, depending on the source that you're using.

The speaker is made from a piece of piezoelectric film that measures 5 by 8 inches. When making electrical contact with the piezoelectric film, you *cannot* just solder a lead directly to the film, because the solder will melt right through it. You have to use some copper-foil tape with a conductive adhesive backing; that tape is normally used to repair PC-board traces. Solder a lead to a piece of copper-foil tape and then stick the tape on the piezoelectric film, as shown in Fig. 7. Do the same on the opposite side of the film in the same position. The speaker leads—any length of stranded insulated wire—are soldered to the points indicated in Fig. 6, with the lead on the exposed surface of the film going to the upper speaker pad.

The film needs something to help it hold its shape. The kit comes with a thin piece of styrofoam, and the film already has an adhesive backing on one side. If you're building the project from scratch, try using the bottom of a styrofoam meat-packing tray—the thinner the better. Or try attaching the film to a sheet of glass or some other unusual surface—a balloon, for instance. To adhere the film to the styrofoam pad, try using a "roll of adhesive" sold in art-supply stores—it's like tape without the tape—just glue on a paper backing. Whatever kind of adhesive you use, be sure apply only a thin layer and try not to trap any dirt or air bubbles between the film and the backing.

Finish up by placing foam-rubber feet on the bottom of the board. The feet will provide a steady base for the project.

**Operation.** Because the unit has a volume control, almost any audio-signal source will work; an earphone jack, an output from a tape deck or CD player, etc. With the power off, and the volume control set at mid-point, connect an audio signal to J1. Turn on the power and you should hear the audio. You will notice that by bending the speaker film, the volume will vary. Try doing something unusual like mounting the speaker in a picture frame. You could also mount it curved on a piece of cardboard to achieve maximum volume. Then plug it in to your TV's earphone jack for a unique novelty item. ■



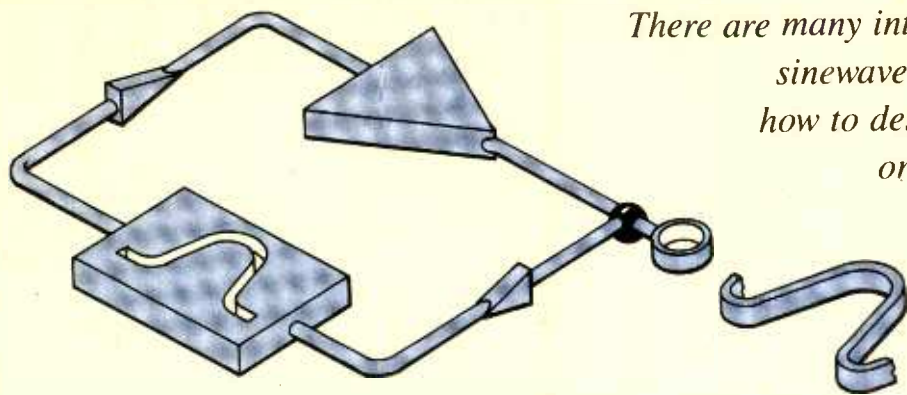

*There are many interesting projects that require sinewave oscillators. If you only know how to design square-wave generators, or need a refresher in sinewave generation then this is the article for you.*

BY  
RON C. JOHNSON

# All About OSCILLATORS

If you've been involved in electronics as a hobbyist for a while, or even if you're just getting started, no doubt you have seen or heard about various uses for sinewave oscillators. Sound generators, signal sources, radios, televisions, and tape decks use such oscillator circuits to generate signals used in their operation.

So you've encountered sinewave oscillator circuits, but might wonder about how they work? What makes them create an alternating voltage at their output with only DC going in?

That's what we'll be looking at here: the ingredients, if you will, that go into making a circuit oscillate. We'll also take a look at some basic (and some familiar) circuits and how they meet the requirements needed for oscillation.

**Sinewave Oscillators.** Figure 1 shows the block diagram of the most basic sinewave oscillator. The type of design produces a sinewave at a particular frequency. The top section is an amplifier and the bottom is a frequency-dependent attenuation and phase-shift network. The amplifier is like any other amplifier; its gain produces a copy of the input at the output but with a larger amplitude.

Note that we show the output of the amplifier connected to the attenuator/phase-shift network and the output of the network is connected back to the input of the amplifier. You might be wondering why the output of the amplifier fed back to its own input. That's a good question. Part of the answer is that in order to create an AC signal the am-

plifier needs a signal to amplify. But that is only a partial answer because, although the resonant feedback network is designed to give maximum output at the chosen frequency, it can't create that signal out of nothing. The amplifier has to supply a signal so the network can do its part. But where is the signal being generated? What came first, the chicken or the egg?

Well, in this case, neither. Obviously, a signal must be generated somewhere to start the whole process. In an actual oscillator that can happen in a couple of ways. One common way is that when the power is switched on, a small voltage spike occurs somewhere in the amplifier. You can think of a spike as a short burst of a range of frequencies or harmonics. Anyway, the amplifier adds gain to the glitch and sends it to the feedback network. The resonant circuit filters out all the harmonics except the ones near its resonant frequency, which it sends to the amplifier. The amplifier in turn amplifies that signal and sends it to the feedback network, and so on. And

that's how oscillation starts. However, that explanation is only partially true; we'll clear up the problems with it a little later.

**Let's Look at the Amplifier.** In order for a circuit to oscillate, it must have two important characteristics: The overall gain of the circuit must be 1, and the total "phase shift" through the circuit (which we'll discuss later) must be zero.

First, the gain. Why a gain of one? Let's assume the oscillator is operating normally—outputting a sinewave at some frequency—but the overall gain of the circuit is made greater than one. Each time the signal is fed back around the loop its amplitude would increase by the gain until the maximum output voltage swing of the amplifier was exceeded. At that point, the sinewave would begin to clip causing distortion.

Now let's assume that the loop gain is reduced to less than one. Each time the signal was fed back through the loop, it would decrease until there was no signal left. So, for stable, undistorted operation, the gain of the loop must be one.

But what determines the overall loop gain? If the amplifier has voltage gain, which we call  $A_v$ , and the feedback network has attenuation, which is  $B$ . The overall loop gain,  $A_L$ , can be expressed as:

$$A_L = A_v \times B = 1$$

So we should find out how much attenuation is inherent in a particular feedback loop and set the gain of the amp to offset it so that the overall loop gain is one.

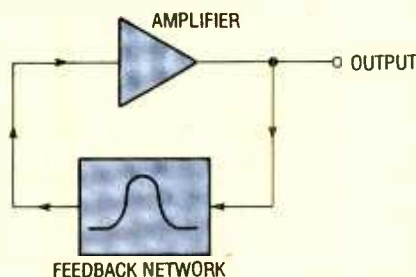

Fig. 1. A sinewave oscillator can be broken down into two key sections: an amplifier and a frequency sensitive feedback network.

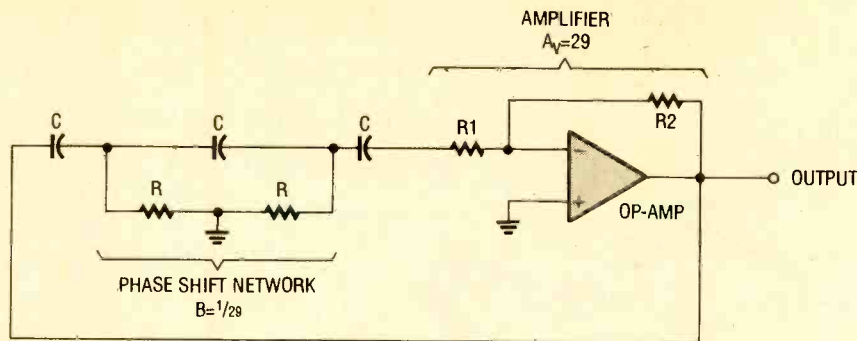

Fig. 2. A phase-shift oscillator relies on the fact that the feedback network will permit only a signal of the desired frequency to have a 360° phase shift around the loop.

Before we leave the topic of total loop gain, one more aspect should be considered: When we talked about how the oscillator gets started, we said that a small signal created by switch-on transients was amplified, fed back, and amplified some more, increasing in amplitude until the desired output signal was obtained. How could that happen with an overall loop gain of one? Sorry, but the answer is that it couldn't.

In practical cases, the overall loop gain at start-up must exceed one in order for the oscillator to operate. In some cases that is accomplished by a portion of the circuit that only operates when the circuit is first turned on. In other cases, the operation of circuit itself limits the gain once the output nears clipping. To do that, the loop gain must be only slightly higher than one.

**Phase Shift.** Now let's look at the other requirement for oscillation: the total phase shift must be zero. We say "total" phase shift because the amplifier may provide a phase shift. Some amplifiers invert the input signal. That is equivalent to a phase shift of 180°; inverting the signal twice creates a phase shift of 360°, which would put the output back in phase with the input signal.

We need to know the amplifier's phase shift to design the feedback network. We have already said that the job of the attenuator and frequency network is to dictate the frequency at which the oscillator operates. Usually it is some form of resonant or tuned circuit that has a phase-shift of its own. If the phase shift of the network doesn't compliment the phase shift of the amplifier—to make the overall shift 0° or 360°—the waves produced by them will destructively interfere. The circuit will either oscillate at the wrong frequency or fail to oscillate altogether. With that

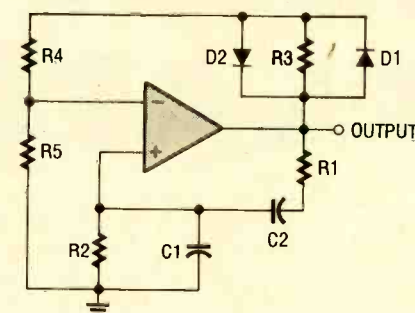

Fig. 3. A Wien-bridge oscillator uses two feedback loops, a negative loop to limit the gain, and a positive loop to set the frequency.

under our belts, let's look at a couple of practical circuits.

**The Phase-Shift Oscillator.** The circuit in Fig. 2 is called a phase-shift oscillator. In this particular circuit, an op-amp and two resistors (R1 and R2) form the amplifier. The feedback circuit consists of three capacitors (all with the same value, C) and three resistors (all with the value R) that set the frequency of oscillation. As the signal is fed through the network, a phase shift of 180° occurs. Hence, the name "phase-shift oscillator." The other important aspect of the feedback network is that it gives an attenuation, B, of 1/29.

Since a feedback network has an inherent phase shift of 180°, and we have said that we need the signal in phase (360°), we use an inverting amplifier to add another 180° phase shift. That takes care of the phase-shift requirement for oscillation.

We have to now set the gain. If the feedback network has an attenuation of 1/29, the gain of the amp must be 29 in order to achieve an overall loop gain of one:

$$A_L = A_v \times B = 29 \times 1/29 = 1$$

The gain of the amplifier,  $A_v$ , is deter-

mined by the ratio of the resistors R1 and R2 as follows:

$$A_v = R1/R2$$

if  $A_v = 29$  and  $R1 = 10,000$  ohms:

$$R2 = 10,000 \times 29 = 290,000 \text{ ohms}$$

To make sure the circuit will start oscillating we can choose the next higher resistor value of 330k, which will give us an amplifier gain of 33 and an overall loop gain of 1.14. That should be enough to ensure start up of the oscillator. Losses in the circuit components will offset the extra gain, so once the circuit starts oscillating it shouldn't go into clipping.

We can determine the frequency of oscillation using the following formula:

$$f = 1/(2\pi\sqrt{6}RC)$$

According to that equation, if we used .01- $\mu$ F capacitors and 10k resistors the frequency is 1.59 kHz.

The circuit is actually quite simple and easy to set up using practically any op-amp. The drawback to the circuit is that it isn't very stable. Temperature vari-

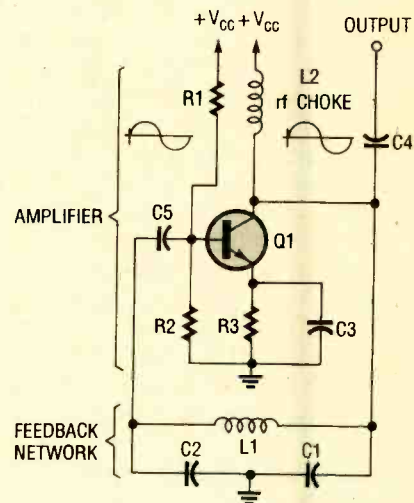

Fig. 4. This basic Colpitts oscillator is built from discrete components, but contains an amplifier and feedback network like the other oscillator circuits.

ations in the components can cause the frequency to drift so it isn't used very often.

Next we'll look at a circuit that uses a slightly different technique to achieve the same results.

**The Wien Bridge Oscillator.** The Wien Bridge uses two feedback loops. One supplies positive feedback through a bandpass filter that has zero phase shift and an attenuation of 1/3 at

(Continued on page 84)



# PCBoards PC-PATTERN DESIGN SOFTWARE

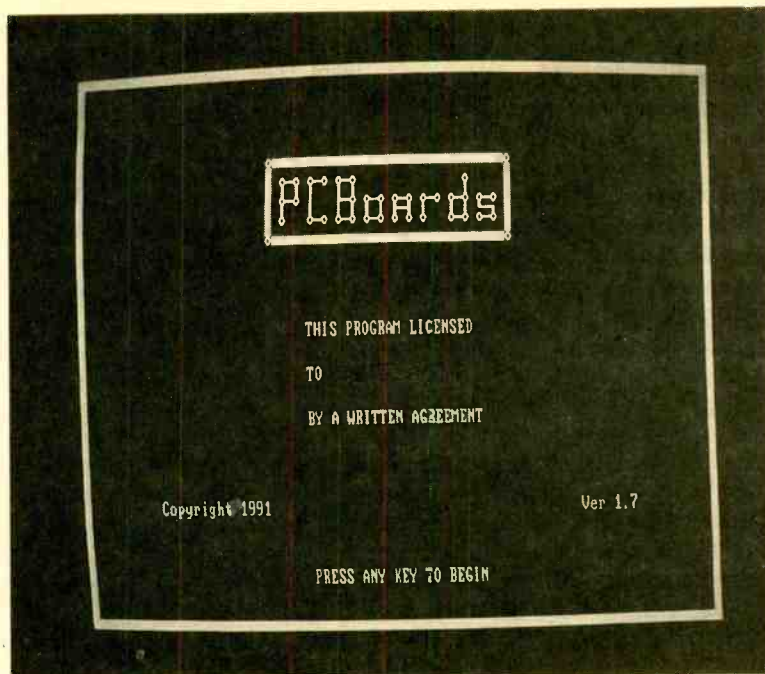

CIRCLE 119 ON FREE INFORMATION CARD

*Anyone can make professional-looking printed-circuit patterns and save precious time and money.*

Computers have found their way into just about every facet of our existence. They have even become essential to many of us in our daily lives. Computers control many of the things we now take for granted and countless feats could not be achieved without them. To find examples all one has to do is look around: communications, transportation, even household appliances are computerized. They speed through many previously tedious tasks, and can even change those chores into creative enjoyable outlets for us.

Working on my computer became an enjoyable task even for me, second only to building electronic devices. Eventually I learned I could combine the two interests by using my computer to help me design the printed-circuit foil patterns used for my projects. Producing accurate printed-circuit boards is the most demanding part of any electronic construction project and double-sided boards more than double the chore. But as I mentioned, there is an affordable and easy-to-run computer program to tackle the job. The program is so easy to run, that within 30 minutes you will be well on your way to making all your PC patterns this way.

**PCBoards: The Program.** The program is called PCBoards by Ralph A. Lindstrom (from PCBoards, 2110 14th Avenue South, Birmingham, Alabama 35205; Tel. 205-933-1122). PCBoards runs on any IBM PC or compatible system with a minimum 384k of memory and CGA. It even runs on a single disk-drive system, but requires DOS version 3.0 or higher. The foil patterns it generates can be printed out using an IBM graphics-compatible dot-matrix printer, which works well. However, for absolutely superb results, you can use an HP Laser Jet II or a compatible laser printer.

The program starts with a "viewport" or "window" on the screen (see photos). The window is filled with a grid of dots representing  $\frac{1}{20}$ -inch increments on a circuit board. The viewport on the monitor is only a small portion of the total allowed workspace of 6.05 x 13-inches.

Inside the viewport is a small green box that is used as a cursor. The cursor can be moved around via the arrow keys. If you try to move off the edge of the viewport, the viewport is redrawn to reveal the portions of the board hidden from view. When you first begin to draw a pattern, the cursor and traces start

out green, indicating you are operating on the bottom or solder side of the board. When working on the top or component layer, the cursor and traces appear red. The areas where traces overlap are shown in yellow.

Across the bottom of the screen are some helpful status indicators. At the lower left is an "absolute counter." The absolute counter displays the x-y coordinates of the cursor at all times. The coordinates are always relative to the upper left corner of the board (not necessarily the viewport).

Just to the right of the absolute counter is an arrow that is a further indication of the board layer you are working on. When working on the solder side of the board the arrow points down. Pressing the minus key flips the arrow to point up and changes the current layer to the top or component side of the board. The plus key will return you to the lower side.

At the lower-right of the screen is a "relative counter." That counter also tracks the cursor position, but relative to the last time it was zeroed by using the insert key.

At the bottom middle of the display, is the "selection block." That indicator tells you which command you are currently

executing or just displays the PCBoards' logo if no choice has been made. The selection block is changed by selecting an option from the menu, so let's look at the menu options.

**The Command Menu.** The menu is filled with commands for designing boards and performing some file-management operations. To bring up the menu you must position the cursor at an unoccupied point and press F2. You can select a command from the menu by typing the capital letter that appears in that command on the menu, or you can use the up and down arrow keys to position a highlight bar over the desired command. Once the highlight bar is in position, the command can be executed by just hitting the enter key, or by pressing the F1 key (which causes an asterisk to appear next to the command) and pressing the insert key. Pressing the insert key returns you from the menu, but you also could leave the menu by pressing the Escape key.

Once you are familiar with the program you can execute a command simply by typing the capital letter that appears in that command without calling up the menu. This feature saves considerable time.

**The Command Options.** Taking the

command options in order, the first command on the menus is the "pad" command. That command positions component pads on both layers of the workspace at once. Move the cursor to the desired spot and press the F1 key to place, or F2 to remove a pad.

The next command is "via." A via is a small square pad used for plated-through holes on both layers of a workspace. Vias are also typically used to designate pin one of dual in-line packages (DIP's). Using this command places a via at the cursor position.

The DIP command places the pads for a DIP socket on the board. However, before carrying out the DIP command, the size and orientation of the pins should be selected. To do this press the insert key after pointing to the DIP command on the menu. That calls up a dialog box that allows you to adjust the size and orientation. While at the dialog box, pressing the F1 key steps you through the sizes of DIP's from 6 to 40 pins. The program will automatically adjust the spacing of the pins. Striking F2 changes the orientation of the DIP to the desired direction.

The DIP's number one pin will be placed at the cursor location by then pressing the F1 key. The rest of the DIP will be placed according to the orientation you selected. Removing a DIP is

accomplished by locating the cursor over each pin and pressing F2, which removes one pin at a time.

If you execute the DIP command without using the dialog box, then a default 6-pin socket with south orientation (the socket below pin 1) will be generated.

Placing down pads for a single in-line package (SIP) is akin to choosing a DIP. The SIP command performs this task. The size and orientation need to be designated before carrying out the command. The insert key calls up the dialog box just as it did for the DIP command. The F1 key walks you through the sizes up to 40 pins. The F2 key allows you to select one of the four possible orientations.

The "thin" command creates 20-mil wide traces to connect pads, DIP's, etc. Horizontal and vertical traces are allowed, but not angles. With the 1/20-inch spacing allowed, that would rarely cause a problem. Traces can be placed between pads, but you must print in the 2x mode, to yield enough clearance for the trace.

To create a thin trace you would press the F2 key to call the menu up, select the thin command, and press insert to remove the menu. Then you use the arrow keys to move the cursor to the starting point and press the F1 key. The cursor block will change from a box to a solid block, indicating a route is in progress. Move cursor to the ending point and again press the F1 key. The trace is then drawn connected to any pads along the route you followed. Placing the cursor over a thin trace and pressing F2 removes the trace up to the adjacent junctions.

The "thick" command expands thin traces to 50 mils wide. You must have a thin trace already in place to execute this command. As with the other commands, the F1 key invokes the order, and the F2 key revokes it.

By using the "fill" command you can place down 50 mil square blocks. Pressing the F1 key places the solid block on the appropriate layer, and the F2 key removes them. If you press the F1 key while the cursor is on an already filled block (you can just press the F1 key twice) the entire layer in the viewport will be filled. The fill stops when it reaches either a thick trace or another fill. Pads, thin traces, and text will all be bypassed. This command is convenient for making larger pads.

The ability to copy part of the current pattern, or load a previously saved one

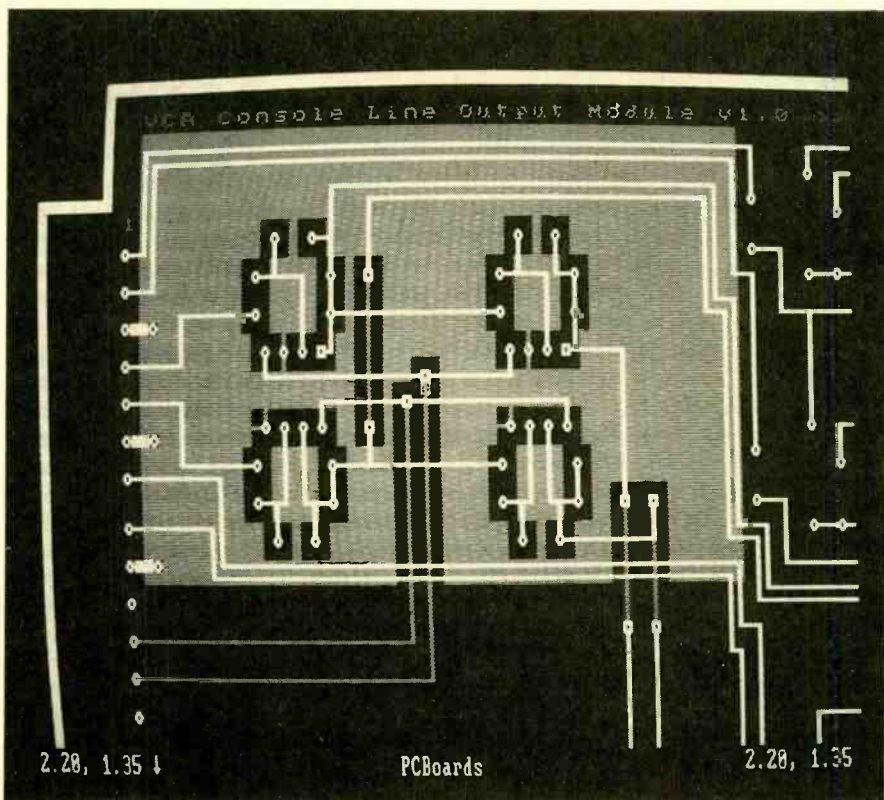

The viewport (or window) shows you only a portion of the PC board you are working on. The cursor position, layer, current operation, and other information are also displayed.

is accomplished by using the "Block" command. When you select block from the main menu, another menu will appear with a list of different block operations. "Load block" is used to import portions of circuits or entire patterns that have been saved to disk. "Mark block" allows you to mark the corners of the area you wish to manipulate. The other options on the block menu (place, erase, save, and quit) are self explanatory. The Block command can save considerable time when working with frequently used patterns.

The "text" command permits you to put text down. When working on the component or top layer, text will appear properly, but on the lower layer text appears as a mirror image. Pressing the insert key allows you to change the text's direction, and return to the workspace.

Invoking "load" calls up a dialog box requesting a file name. You can type in the name of a previously stored file and hit enter to load the pattern stored in the file.

The dialog box for the save command asks for you to assign a file name if you have not done so already. Saves should be performed often to prevent losses in case of a mistake or some other disaster.

The "zoom" command allows you to view the entire 6.05 x 13-inch workspace at once. Zoom is useful for finding your way around large patterns. Statistics for the pattern are displayed in this mode as well.

Executing the "clear" command will wipe out both sides of the work area. You must be sure you have previously saved any important art work. With the viewport cleared, you will be returned to the top-left corner of the workspace.

Suspending work temporarily to run another application is possible with the "shell" option, but this feature must only be used with DOS version 3.0 or higher. To return to the memory-resident PCBoards program, just type in "exit." To use shell while running PCBoards from a floppy disk, you must have a copy of COMMAND.COM on the disk with PCBoards.

Using the "quit" option causes the program to prompt you for confirmation. If you answer "yes," it will return you to DOS. That's to give you a chance to make sure you have saved any changes or important art work before quitting.

**Using the Program.** To help you

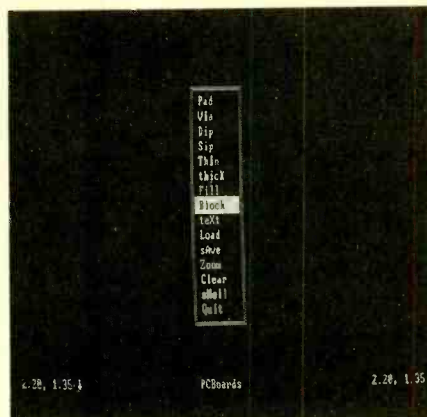

*There is one main menu, shown here. It contains all the commands you'll need to run the software, although there are some dialog boxes as well.*

along, there is a 14 page manual in on the program disk, that can be printed by typing "A:COPY MANUAL.TXT PRN" at the DOS prompt. PCBoards also has instant on-line help. To get help on the subject needed, press "?" then the letter of the command you need assistance with. To get an index of available help topics, just press "?" twice. The program also beeps you to notify you if you attempt to perform any illegal function that cannot be carried out.

There is also a telephone number for technical assistance. I did have to use it one time, but the problem was my quirky Tandy monitor. The author of the program suggested this fix: By hitting <Alt-F>, you can change the foreground colors. By pressing <Alt-B>, you toggle through background colors. I not only learned how to intensify overlapping areas, but how to easily use colors that are not listed in the program's manual.

You may run PCBoards with a mouse. This feature of course greatly simplifies the pattern-making task, but it is not required. For those of you that have never used a mouse, try one before you say you don't need one. Over half of my software runs better with one, including this program.

Of course maneuvering the mouse, moves the cursor. Pressing the left mouse button is the same as hitting F1. Pressing the right mouse button is the same as hitting F2. Hitting both mouse buttons simultaneously corresponds to pressing the insert key. Being able to substitute the arrow keys, F1, F2, and insert key by a mouse, significantly simplifies the running of PCBoards. I've found by typing the menu commands' capital letters with my free hand, and

the mouse with the other, I can breeze through making printed-circuit patterns.

Before you print a pattern, you will need to place a thin or thick trace all the way around your layout. That prevents the outermost pads from being printed incorrectly.

When printing layouts with PCBoards, you have the choice of printing patterns the original size, double size, draft, or final artwork. For best results when using a dot-matrix printer, choose double size and final artwork. The printer will make three passes and the quality increases even more when the pattern is reduced by a copy machine. The printer driver will also prompt you for separate upper or lower board layouts. The grid work that you see on the screen will disappear when printing, so don't worry about that. If using a laser printer, it is possible to print directly to transparency sheets.

By entering "DRILL" followed by a PCBoards filename at the DOS prompt, the program will create an X-Y drilling list and print it for use in mass manufacturing of PC boards.

After trying several other printed-circuit board design programs, PCBoards has become my favorite. The program is easy to run, inexpensive, and delivers high-quality printing for either dot-matrix or laser printers. Professionals as well as non-professionals will find this program an effective aid in the production of printed-circuit boards. With a computer at the ready and PCBoards loaded up, I can easily attack the previously dreaded task of printed-circuit pattern creation.

**Ordering Info.** A PCBoards Demo disk is offered with two complimentary demo programs, PCRoute, and SuperCAD. PCRoute is a powerful autorouter layout program for PCBoards. SuperCAD is a computer-aided design program that flatters both PCBoards and PCRoute. The cost for the 3 Demo disks is \$10 and shipping is free for all pre-paid orders. The \$10 may be credited towards the purchase of PCBoards. PCBoards Demo is a full working program minus the save function. No artwork can be saved, but the demo has 3 sample patterns.

As for PCBoards itself, the program sells for \$99 and shipping is free for all pre-paid orders. For more information on PCBoards, contact the company directly, or circle No. 119 on the Free Information Card.

# PRODUCT TEST REPORTS

By Len Feldman

## Sony CCD-TR4 Camcorder

**B**illed as the world's "smallest" camcorder, Sony's CCD-TR4 is one of three new camcorders that serve to expand their 8mm TR-series of small, hand-held camcorders. The CCD-TR4 measures only 4 $\frac{3}{8}$  inches wide by 4 $\frac{1}{8}$  inches high by 6 $\frac{5}{8}$  inches deep and weighs a mere 1 pound, 9 ounces (without tape and battery). Despite its small size, it offers many of the features found in Sony's earlier, and highly successful CCD-TR5 model.

This unit is equipped with a 6-times variable-speed power-zoom lens (f7-42mm) with macro-focusing. With a 5-lux minimum-illumination rating, the

superimposer lets you add titles or other graphic elements in any one of eight colors. Like other Sony "Handycam" units, the CCD-TR4 features a flying erase head for clean transitions between scenes.

The CCD-TR4 incorporates a new "Quick Recording" mechanism that significantly reduces the interval between the time the record button is pressed and the time the unit actually begins recording. During recording, a linear time counter displays the tape position through the viewfinder in hours, minutes, and seconds. The current time and date can be superimposed on a video recording at the touch of a button. Edit search and record-review functions permit playback while the unit is still in the camera mode.

Once a video recording is completed, the CCD-TR4 can be connected to a TV set for playback or to any videocassette recorder for editing and dubbing, using its switchable audio/video input/output terminals. An RF-modulator supplied with the unit permits direct connection to the antenna terminals of a TV set (using channel 3 or 4) if your TV set is not equipped with direct audio and video input jacks.

The CCD-TR4 is available in standard black color (as was the sample we tested) or in white. Accessories supplied with the unit include a carrying strap, a nickel-cadmium battery, and a battery charger that also serves to power a slim DC

power source that can be affixed to the camcorder instead of the bulkier battery where a source of AC is available. A handy lens cover is attached to the front of the camcorder.

### CONTROLS

Along the left side of the camcorder body are a superimpose switch, a button for selecting color of superimposed title or graphics, and a memory button for memorizing the superimposed scene for subsequent recall. Date and time setting buttons are also found on this surface, as is the macro-lens button, up front. Shutter speed and manual focus buttons are found along the cylindrical surface housing the lens itself. A spring-loaded battery-release button is located near the rear of the camcorder. The rear surface of the unit is equipped with a counter-reset button and an edit switch, and houses the battery or the alternate DC power supply. To the right of the battery is the start/stop switch, which is augmented by a standby/lock knob that prevents accidental starting or stopping of the recording process.

The 8mm-cassette housing is found on the right side of the camcorder body. Also found along this side surface are an external-microphone input (neatly covered by a tiny plug button when not in use) as well as the audio and video input/output jacks, which are similarly protected when they are

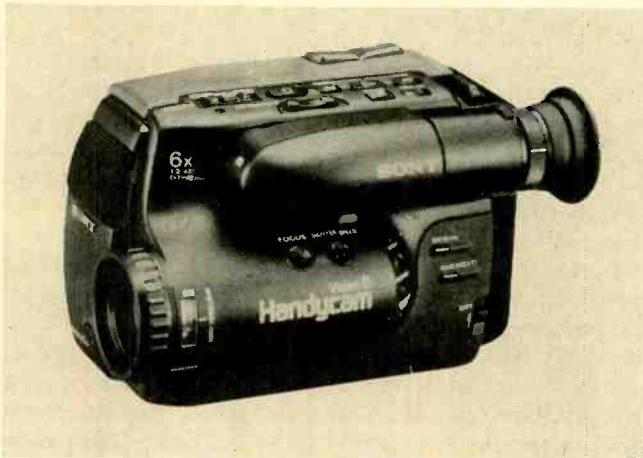

The Sony CCD-TR4 8mm camcorder.

CCD-TR4 performs well in low light situations. The camcorder features a  $\frac{1}{3}$ -inch CCD image sensor with 270,000 pixels and a four-speed variable shutter with a top speed of  $\frac{1}{40000}$ th of a second. Automatic features include through-the-lens auto-focusing, auto-iris adjustment, and automatic white balance. A one-page

not used. Only one pair of jacks is provided; the choice of whether they are to be used as inputs or outputs is made by means of a tiny switch. When using the jacks to connect the RF converter, a third tiny terminal provides the required DC power for the RF converter. Up front, near the zoom lens, is a terminal for connection of a remote control, while nearby is a pushbutton labeled back-light that is used to compensate for situations in which bright lighting occurs behind the subject being taped.

The top surface of this small unit is equipped with the usual power zoom rocker switch as well as those controls normally associated with the VCR section of the camcorder: the fast-forward, fast-rewind, play, stop, record, pause, edit-search, and power switch. The power switch is a three-position unit that turns the camera on and off and also selects either camera or VCR mode.

## TEST RESULTS

As usual, the camcorder was turned over to the Advanced Product Evaluation Laboratories (APEL) for testing. APEL determined that the minimum illumination required by this camcorder to produce a full-scale video signal was actually lower than claimed by Sony, measuring 4.3 lux. White balance (the amount of chrominance or color that appears on a neutral object when the balance control is set for optimum) was an acceptably low 5 IRE, while color contamination measured a bit higher than we would have liked at 10 IRE. During normal use, this degree of color contamination is not likely to be noticed by most users.

Phase accuracy and chroma (or color saturation)



*As shown in this vectorscope photo, the phase accuracy and chroma (or color saturation) were close to perfect.*

were close to perfect, as illustrated in the vectorscope photo. The white spot in the photo is virtually in the center of the red target area and its distance from the center of the display indicates that color saturation levels were just about perfect. Thanks to the use of a solid-state CCD image sensor, there was no evidence of streaking, lag, or image retention such as one found with earlier camcorders that used vacuum-tube sensing devices.

Horizontal picture resolution measured directly from the camera was an excellent 330 lines. That, by the way, is about the limit of resolution that can be attained from a live

broadcast using the NTSC system of TV transmission used in the U.S. However, when measured via the complete record/play cycle, resolution decreased to a still acceptable 260 lines. That reading is at the upper end of what we expect from a standard 8mm-format camcorder. The chroma AM signal-to-noise ratio when measured directly from the camera output, was a high 44.0 dB, but decreased to 36.5 dB when measured via the complete record/play cycle. Conversely, luminance (or brightness) signal-to-noise ratio was actually a bit better when measured via the record/play cycle than it was when measured directly from the camera output. The two results were 40.8 dB from the camera and 41.8 dB for the entire record/play cycle.

APEL reports that the built-in microphone delivered a maximum audio-output signal level of 0.56 volts, while the sensitivity for the external-microphone input was 5 millivolts. The audio signal-to-noise ratio was an adequate 63.2 dB.

## HANDS-ON TESTS

After testing was complete, the Sony CCD-TR4 was returned to me for further evaluation. I found that the camcorder was a joy to use! Having owned both full-size and compact camcorders since these devices were introduced in the mid-1980's, I can attest to the fact that this tiny unit offers many of the features found in much larger, heavier camcorders. Yet, even after hours of continuous use, I found that my arm did not get tired. Picture quality was as good as any we have seen for a standard 8mm-format camcorder. About the only types of camcorders that would be able to improve upon that quality would be more expensive Super VHS or Hi8 units.

Sony has managed to cram quite a few controls into this small unit, so it may take you a while to get used to its compact configuration, especially if your fingers are on the large side. Still, for the ease and comfort that the CCD-TR4 affords, it will be worth the effort. The Sony CCD-TR4 carries a suggested retail price of \$1100.

Introduced along with the CCD-TR4 were two other small units, the CCD-TR6 (with a suggested price of \$1200.00) and the CCD-TR7 (carrying a suggested price of \$1400.00). The CCD-TR6 adds an 8x power zoom (as opposed to the 6x zoom of the CCD-TR4) while the CCD-TR7, with a 410,000 pixel CCD, is said to produce more detailed images. It is also the first camcorder of its size to offer AFM hi-fi stereo recording.

For more information on the Sony CCD-TR4 8mm camcorder, contact Sony (Sony Drive, Park Ridge, NJ 07656) directly, or circle no. 120 on the Free Information Card. ■

### TEST RESULTS—SONY CCD-TR4 CAMCORDER

#### Video Section

Specification	PE Measured
Minimum illumination	4.3 lux
White balance	5 IRE
Color contamination	10 IRE
Phase accuracy and color saturation	(See text)
Resolution	
camera mode	330 lines
Rec./play output	260 lines
Video signal-to-noise ratio	
Camera (chroma AM/luminance)	44.0/40.8 dB
Rec./play (chroma AM/luminance)	36.5/41.8 dB

#### Audio Section

Microphone maximum output	0.56 volts
External microphone sensitivity	5.0 mV
Signal-to-noise ratio	63.2 dB

#### Additional Data

Minimum focus distance	38 inches
Macro setting	1/8 inch
Power requirements	6.5 watts
Weight (w/battery & cassette)	2 1/2 lbs.
Dimensions (H x W x D, inches)	4 1/16 x 4 1/4 x 6 3/4
Suggested retail price:	\$1100.00

# ANTIQUE RADIO

By Marc Ellis

## Reading The Mail

**T**his month, I'll have to take a short break from the story we've begun to develop on the RCA Theremin. It's going to be necessary to send the column in about a week early because my family and I will be on vacation when it would normally be due. As a result, I haven't had enough time to do the necessary background work to continue with the Theremin theme.

That might be a blessing in disguise. Quite a few reader letters have accumulated since the last time

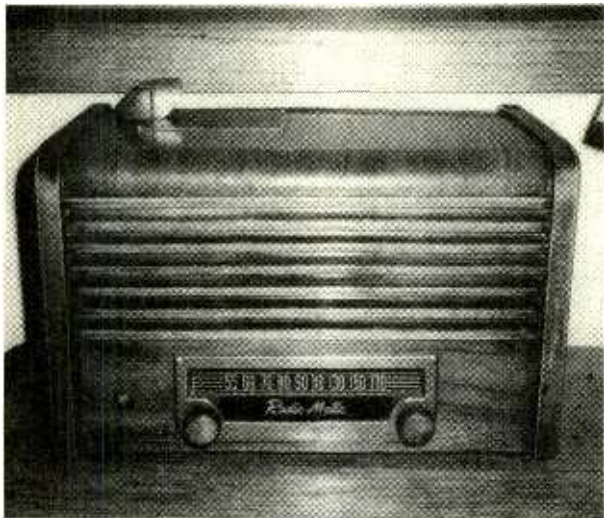

*B.W. Brown would like the model number and other data for this nice-looking coin radio manufactured by General Electric for Radiomatic of America, Inc.*

we were able to devote some attention to the mail, and it's about time that as many as possible be recognized in this space. As a matter of fact, some of the letters date back to last November. They didn't get the attention they deserved then because incoming correspondence relating to the Theremin contest was at its height. So, without further ado, let's get busy and dive into the mailbag!

### WANTED: INFORMATION AND SCHEMATICS

Reader John Engelbrecht's mom has some RCA radios from the 1920's and '30's, as well as some old radio tubes. John would like to determine the value of those items, and hopes to make contact with a knowledgeable person or group in his area. Contact him at 13907 Drake Drive, Rockville, MD 20853. B.W. Brown (whose letter is postmarked Valley Springs, SD, but who neglected to include his address) sent along a shot of a nice coin-operated hotel radio that he's working on. The set is marked "Manufactured by General Electric for Radiomatic of America, Inc." He'd like the model number and any background information he can get. If you can help, send the information to me and I'll run it in the column at the first opportunity.

Jim Moody (10 Bobwhite Dr., Enon, OH 45323) has a wood-cabinet, table-top radio-phonograph combination marked "Aircastle Model 5044." The phonograph is a three-speed manual, and the radio is AM only. He'd like to know the name of the set's actual manufacturer—if Aircastle is not it—and the date of manufacture. Jim tells me he's an old-time reader of **Popular Electronics** and bears the **Popular Electronics**-issued short-wave radio listener call letters WPE8BAX! Are there any other old WPE'ers in the audience?

Steven E. Sebaugh (1124 Sioux Ave., Jackson, MO 63755-2752) has a 1925 Brunswick-Radiola containing an RCA dual-dial



*This photo is a little dark, but Steve Sebaugh hopes for an identification of his two-dial RCA superhet (see text).*

Superheterodyne. The lighting on the photo he sent in leaves a little to be desired, but the shot should be suitable for identification. He'd like to get the model number, schematic, and replacement UV199 tubes.

Lawrence A. Weide (5270 E. Nassau Circle, Englewood, CO 80110) obtained a beautiful R.E. Thompson Mfg. Co. (Model S-70) Neutrodyne set from an office friend. The battery compartment of this nicely preserved three-dial set contained scorecards for a 1926 Word Series game between St. Louis and the New York Yankees! Larry's very detailed questions on the care, feeding, and operation of 3-dialers would probably require several *Antique Radio* columns to answer. I'll try to develop some material on this topic in the near future. In the meantime, if someone can help, he'd like to obtain a schematic and any other available information.

Dave Winters (343 K St., #104, Davis, CA 95616) has a Zenith Model 5-S-319 table model in mint condition. He'd like to know its age and approximate value. Gary Shults (2



Oregon Way, Henderson, NV 89105) would like to get servicing information and a schematic for a Gloritone Model 26 cathedral set. Tony Bender (7456 Annin St., Holland, OH 43528) has Sylvania Model 630 and Triplett Model 66 tube testers. The Triplett is missing its test chart and the Sylvania lacks test data for older tubes.

## MYSTERY SETS

John R. Stout (2635 Southcrest Dr., Haughton, LA 71037) sent some shots of a mystery set—apparently built from a kit—found by his daughter while helping to tear down an old garage. The hole in the front panel was possibly once occupied by a filament voltmeter. I count nine tubes (and there may be empty sockets for others) in this unusual apparatus—yet there seem to be only two panel-adjusted tuned circuits.

I'm wondering if this could be a primitive superheterodyne; the four dark, cylindrical units at the center rear of the breadboard could be IF transformers, and the four tubes associated with them could be IF amplifiers. All the tubes are 01-A's, says John. He'd like to restore the set and donate it to a museum, but first he needs to identify it! Anyone recognize this baby?

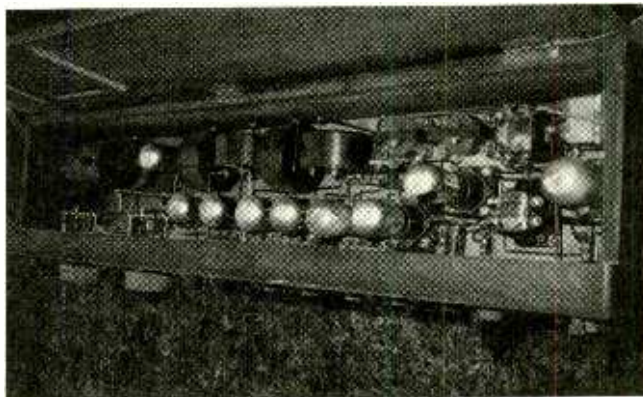

*The interior view of the Stout mystery set features a staggeringly long row of 01A's. The large number of tubes suggests that the radio might be an early superhet (see text).*

Another mystery battery set is in the possession of George Paschal (Von Haerel and Associates, 639 West Broadway, Glendale, CA 91204). This once-hand-some table model has a built-in speaker and uses four UV-199 tubes. Its design resembles that of the mid-1920's RCA radios. However, the front panel bears only the designations "Quadrodyne" and "No. 220." George would like to get any information he can about this set, and I'm including his very clear front view of the radio to assist in identification.

## HELP FOR NEWCOMERS

Fifteen-year-old Matthew Ettus (61-55 98 St., Rego Park, NY 11374) is just getting started in radio restoration. He needs help with his first project, an

Emerson table model similar to one that appeared in my article "A Beginner's Guide to Vintage Radio" (**Popular Electronics**, November, 1988), but a bit larger. Matthew can't find the model number for the set (it may have been on the back—which is missing), but the numbers E-1665 and 7XD-113 appear on the tuning dial.

Can someone help Matt identify the set and find a schematic? He could also use some hints on restoring or replacing the plastic dial window, which is too yellowed to see through. (Actually, if someone with that expertise turns up, please also share it with me. I'd like to include the information in a future column.) Finally, Matt is interested in locating an antique-radio club in his area.

John Quinn (6140 Tyrn-bury Drive, Lisle, IL 60532) is also just getting started in the antique-radio hobby. He has a good electronics background, but needs basic information on the history, dating, and restoration of old sets. In addition, John could use some advice on his realignment of a Silvertone table model.

Steve Burns is a first-time antique *auto* restorer, and the 1948 Plymouth he's working on came with two radios—one installed and one for parts. Both of the radios are marked Mopar

Model 802 (Philco Model C4608-122), yet they appear to have different internal arrangements. Steve would like to discuss this, and other specialized auto-radio repair problems with a knowledgeable person. He'd also like to get schematics and service information for the sets.

## PARTS AND REPAIRS

Does anyone know where Marc Halpert (245 Fairfax Dr., Stratford, CT 06497) can find a 3KP4 picture tube? He needs it as a replacement for his Pilot TV Model 37. John A. Swett (8116 Olmway, Olmsted Falls, OH 44138) is looking for 15-volt Sonora or Arcturus radio tubes for his restored 1928 Sonora set. And while we're talking about tubes, Herschel A. Wells (742 Berclair Rd., Memphis, TN 38122) needs WD-11's for his RCA Radiola III receiver.

Steve Russell (Box 396, Kalispell, MT 59903) wants a knob for his 1946-vintage Hoffman Model A 401 radio/phonograph. Steve would also like to get an idea of the value of that set in restored condition. Al La Soya (P.O. Box 417, Channelview, TX 77530) sent along a shot of a neat-looking tube tester made by Westmore, Inc. of Fanwood, NJ (no model number given). He needs a line-test switch for it, and also some advice on rehabilitating a Sencore tester requiring specialized factory parts.

Leslie Van Luven (60 Rochelle St., Rochester, NY 14612) overwhelmed me with a number of very broad questions on antique-radio repair (mostly relating to the correction of various types of cosmetic problems). As in the case of Larry Weide's questions, the answers would require a series of special columns to

*(Continued on page 82)*



*Here's a front view of John Stout's mystery monster, which is shown artistically posed on a couple of concrete blocks. The empty round cutout might have once held a filament voltmeter.*

# COMPUTER BITS

By Jeff Holtzman

## The 386 Revolution

In the good old days, there were three well-defined classes of IBM-compatible personal computers: PC, XT, and AT. The PC sported an 8088 microprocessor, five expansion slots, and could address 640K of memory. The XT added three slots and a hard disk drive to the basic PC. The AT substituted an 80286 microprocessor, a better hard disk, and the ability to access 16 megabytes of memory.

Those basic categories made sense in the good old days. Then Intel introduced the 80386 microprocessor and ini-

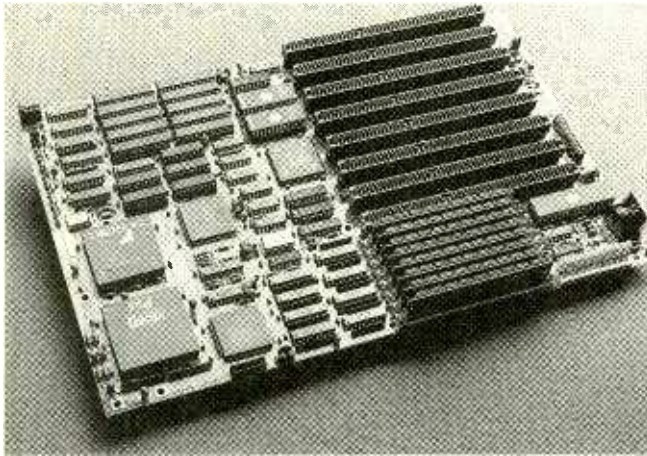

*The Pioneer 486 is a powerful XT-size board with 0–256K of cache memory, as much as 32MB of main memory, and eight expansion slots.*

ated the next tidal wave in the personal-computer revolution. (In case you aren't on top of the differences between the various microprocessors, see the May 1990 *Computer Bits* column, which gives a quick review.)

Initially, the 386 just functioned as a faster AT. But gradually, through the introduction of faster 386-based machines and software that could take advantage of the 386's distinctive charac-

teristics, that neat division of the market (which included the PC, XT, AT, and early versions of the 386) disappeared, to be replaced by a spectrum running from the 386SX to 33-MHz 486 machines, with 50-MHz units on the way. However, the market has now segmented in a way parallel to the old division.

Note that there is no mention of the 8088 or the 80286. That's because those machines no longer count. If you have one of the older machines, use it, but don't expect to be able to run the really neat new software that's coming out. If you're getting ready to purchase a new computer, don't even think about buying anything other than some sort of 386.

In the old divisions, most machines used Hercules monochrome-graphics adapters (or clones thereof). However, VGA is the new standard. If you can't afford color, at least get a monochrome VGA monitor. BOCA and other companies now sell VGA video adapters for \$100, and I've seen mono VGA monitors going for about \$150. That's not much more than a Hercules setup, and VGA is much nicer than Hercules. If you've got a few extra bucks to spare, or if you think there's serious computing in your future, super VGA (800 × 600) is the minimum acceptable resolution for running Windows. Super VGA can be had for under \$500 complete.

As for how much hard-disk space you'll need, remember that graphics software eats up disk space. A 40-megabyte

drive is the bare minimum; 80 megabytes will give you room to grow. You'll need more semiconductor memory (RAM) as well. Four megabytes will get you going with Windows, and shouldn't set you back more than \$200. Eight megabytes is much more comfortable.

Think 386 prices are high? By way of comparison, I bought a real IBM XT in the winter of 1986 with 256K of memory, a 20-megabyte hard disk, and no video system for about \$1900. I added my own Hercules system for about \$250. For about the same amount of money, I can now get a 16-MHz 386SX with a 1024 × 768 Super VGA system and 100MB hard disk, or a 25-MHz 386DX system with mono VGA from a reputable mail-order dealer.

### BUY OR UPGRADE?

But what if you've got a perfectly good system that you just can't junk? If it's anything less than an AT, give it to your kids, younger siblings, or church. You can try to sell it, but good luck. Or you might consider keeping it around as a second machine, something for your spouse to use, or connect your modem to it and use it for uploading and downloading while you work (or play) on the main machine.

If it's an AT with a reasonably fast hard disk and decent video, you can upgrade it by buying a new 386 motherboard. However, if you have to upgrade more than one component, you're probably better off buying a whole new system. Whether buying new or up-

**TABLE 1—COMPUTER CONSIDERATIONS**

Feature	Description
CPU Type	386SX minimum; 386DX on a reasonable budget; 486 as long-term investment.
Speed	You can never get enough; 25-MHz should be the minimum
On-board RAM	The amount and placement of RAM varies widely. It's better on the motherboard than on a special expansion card. Even on the motherboard, location is important; RAM on some boards interferes with expansion cards. Behind the keyboard connector is best.
Type of RAM	The three choices are DIP (chips), SIMM's and SIPP's, DIP's are on the way out; SIMM's are more popular, hence cheaper, than SIPP's. Don't buy 256K SIMM's or SIPP's. If your board will accept them, buy 4MB units.
Wait States	Wait states allow use of cheaper memory but slow a board down.
Memory Speed	Check your board to be sure, but generally 25-MHz boards require 80 ns chips for 1 wait state, 70 ns chips for 0 wait states, and 33-MHz boards require 70 ns for 1 and 60 ns for 0.
Memory Architecture	Some boards perform better when memory is added in certain multiples. For example, Jameco's JE3533 will run with 1 or 4 MB, but it really needs 2, 8, or 16 MB to run most efficiently.
Size	AT or mini. Mini size fits in XT type case; most have mounting holes for AT case as well.
Math Coprocessor	Should have a socket for 80387 or Weitek 3167.
Cache	Special high-speed RAM that provides faster access to main RAM. Cached boards cost more but provide better performance. During the past year, non-cached boards have become more and more scarce. 64K or 128K of cache is acceptable for most applications.
System Logic	Many vendors use integrated chip sets (made by Chips & Technologies), but some use custom chip sets or discrete logic. Discrete component boards tend to have lots of IC's, hence more potential for blowing up.
Expansion Slots	Most boards have eight slots, but may require use of one for a memory board. Some older XT type expansion boards have a "skirt" that precludes use in a 16-bit slot, so an 8-bit slot with low profile components is required.

grading, don't get anything less than a 25-MHz 386. And be prepared: No matter what you buy, two years from now, it will be out of date; five years from now, it will be barely usable; and ten years from now, it will be a museum piece.

**UPGRADING**

I found myself in the position of running a buggy first-generation 16-MHz 386. Although the major system components (hard disk and video) were more than adequate, the motherboard had only 3MB of special

(hence, expensive) RAM chips, and I experienced random system crashes under Windows. So it was time to go motherboard shopping.

I spoke with all major motherboard manufacturers and several distributors; several were kind enough to loan me a sample board for several months each for testing. I conducted my tests in late 1990 and early 1991. In each case, I installed a board in my main machine and ran it for several weeks with the following hard-

ware: Hayes 2400-bps internal modem, generic serial/parallel port card, Video Seven VRAM VGA card, Hercules Graphics Station Card, LANtastic Ethernet network interface card, Always Technology SCSI adapter driving a Micropolis 1674-7 SCSI drive, and an interface card for an Irwin Magnetics tape-backup unit. That hardware represents a heavier load than the average user is likely to place on their own motherboard, and as such should be a good indicator of the board's compatibility.

I also tested each board with numerous software applications, including Windows 3.0 and several major applications (Word for Windows, PageMaker, ToolBook, CrossTalk for Windows, etc.), in addition to numerous DOS applications and utilities. Unless otherwise noted, all boards

passed all compatibility tests.

I tested 25-MHz 386 boards from Hauppauge Computer Works, JDR Microdevices, and Mylex Corporation, a 33-MHz 386 board from Jameco Electronics, and a 25-MHz 486 board from Pioneer Computing. I'll talk about my experiences with each of those boards next time. In the meantime, if you're hot to buy, Table 1 shows the various factors that you should consider. ■



"Systems crash"

**LEARN VCR**  
**CLEANING/MAINTENANCE/REPAIR**  
 EARN UP TO \$1000 A WEEK, WORKING  
 PART TIME FROM YOUR OWN HOME!

Secrets Revealed!  
 NO Special Tools or Equipment Needed.  
 EARN UP TO \$60 AN HOUR AND MORE!

**THE MONEY MAKING OPPORTUNITY OF THE 1990'S**

IF you are able to work with common small hand tools, and are familiar with basic electronics (i.e. able to use voltmeter, understand DC electronics) . . .

IF you possess average mechanical ability, and have a VCR on which to practice and learn . . . then we can teach **YOU** VCR maintenance and repair!

**FACT:** up to 90% of ALL VCR malfunctions are due to simple MECHANICAL or ELECTRO-MECHANICAL breakdowns!

**FACT:** over 77 million VCRs in use today nationwide! Average VCR needs service or repair every 12 to 18 months!

Viejo's **400 PAGE TRAINING MANUAL** (over 500 photos and illustrations) and **AWARD-WINNING VIDEO TRAINING TAPE** reveals the **SECRETS** of VCR maintenance and repair—"real world" information that is **NOT** available elsewhere!

Also includes all the info you'll need regarding the **BUSINESS-SIDE** of running a successful service operation!

**FREE INFORMATION**  
 CALL TOLL-FREE 1-800-537-0589  
 Or write to: Viejo Publications Inc.  
 5329 Fountain Ave.  
 Los Angeles, CA 90029 Dept. PE

CIRCLE 10 ON FREE INFORMATION CARD

# FUN SOFTWARE

By Fred Blechman

## Curses, Red Baron!

I was leading an echelon formation with two other Spads off my left wing. I cleared my Vickers machine guns, getting ready for the oncoming Fokker D.VII's, now only specks on the horizon. Struggling to gain altitude to be above the Huns when we finally tangled, I thought about our mission instructions: "Your flight of THREE will fly SPAD 7 fighters against FOUR German VETERAN pilots led by ERNST UDET flying FOKKER D.VII fighters. Your flight will start over ALLIED TERRITORY at the SAME ALTITUDE as the enemy. The sun is at NO ONE'S BACK.

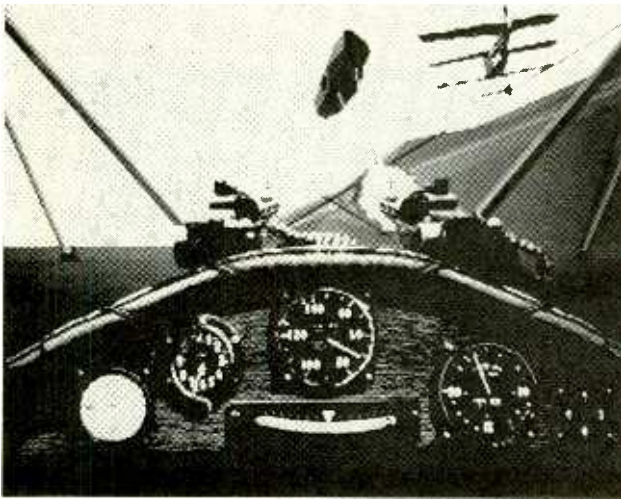

*Would-be Snoopys can take on famous World War I aces, including Baron Von Richthofen—the infamous Red Baron—in Dynamix's Red Baron, distributed by Sierra On-Line.*

The winds are LIGHT. The sky is PARTLY CLOUDY."

Fortunately, this was not taking place in the skies over France during World War I, but was one of the many, many scenarios available in Red Baron, the spectacular World War I air combat simulation from Dynamix, and sold through Sierra On-Line. In fact, any of the items capitalized in the mission instructions

above could be changed to various other options.

Red Baron has captured the look and the feel of the most exciting aerial dogfighting in history. It takes you back in time to the war that birthed aerial combat, and it does so with uncanny accuracy.

From the comfort of your IBM PC, you'll be able to "fly" more than 100 missions as a pilot of either the Royal Flying Corps or the German Air Service. You'll have your choice of 17 different aircraft—including the Sopwith Camel, Spad, SE-5, Nieuport, Albatross, Pfalz, Fokker D.VII, Fokker Triplane, and others—and engage in close-range dogfights. You'll be able to fly with or against 8 German or 11 Allied aces. You can go balloon busting, attack a Zeppelin, strafe and bomb supply dumps—even at night, navigating by the stars.

Red Baron's historical accuracy even goes to the extent of modeling the flying styles of the individual aces, including the paint schemes of some of their aircraft. An over-230-page glossy spiral-bound manual, loaded with photos from the Smithsonian Institution and other archives, goes into considerable detail about World War I, its planes and their aces, and the furious campaigns as air power became an integrated element of war. Six large, detailed maps add more facts, and allow you to navigate visually around the war zone as you seek your targets.

When all is said and done, the real measure of a game or simulation is its playability. Red Baron is

easy to get up and running, and plays smoothly with the right equipment. You'll need to have VGA graphics and at least a 10-MHz clock speed for proper operation. I'd strongly recommend using a hard-disk drive, and you'll need a high-density drive (1.2 or 1.44 megabytes) to load the program from the non-copy-protected disks provided. No code disk or password is required, and you only go through a few simple menus to get airborne. The program defaults are well chosen, but you can change anything and everything of any importance—missions, planes, weather, adversaries, etc.

Aircraft control can be accomplished with a joystick, mouse, trackball, or keyboard. As a former Navy fighter pilot, I strongly favor the joystick, but keyboard control is also good. You can specify novice, intermediate, or expert and the plane handles accordingly. For example, in the expert mode you'll need to use stick and rudder properly to keep from losing altitude in a turn, or dropping into a spin from a stall; the novice mode is far more forgiving. Control variations also emulate the characteristics of the selected aircraft.

The instrument panel is refreshingly spartan and easy to interpret, so you can put your attention on finding and blasting the enemy. You have both internal and external views, with zoom and panning under some conditions. It's fascinating to watch yourself from a distance, milling around the sky with various computer-controlled oppo-

nents trying to get you in their gun sights. Mono-planes, biplanes, triplanes, and old stick-and-rag pusher planes are shown with surprising accuracy considering the need to rapidly refresh the screen for animation.

If you have any of the supported sound boards, such as Roland, Ad Lib, or SoundBlaster, you'll get excellent sound. When you're being shot at you can hear the bullets ping as they bounce off your engine or metal frame, and you might even see parts of your plane getting shot away. Crashes, capture, imprisonment, and death offer their distinctive melodies as digitized photos appear on screen.

Due to the relatively slow speeds and high maneuverability of World War I aircraft, their melees provided the most intimate and exciting dogfighting in history. The Red Baron computer simulation, coupled with the outstanding manual, can give you a taste of that history. Grab your helmet, white scarf, flying gloves, and goggles—notice, no parachute!—climb into your PC, and keep your eye peeled for the Red Baron, Manfred von Richthofen.

*(Distributed by Sierra On-Line, P.O. Box 485, Coarsegold, CA 93614, Tel. 800-326-6654. Retail Price: IBM PC/Compatibles, \$59.95. 10 MHz, VGA, and high density floppy drives required. Hard-disk drive and joystick recommended.)*

**CIRCLE 121 ON FREE INFORMATION CARD**

## **GEOWORKS KLONDIKE**

I'm not a card player. Until Windows 3.0 came out for the IBM PC with their Solitaire program included, I never played Solitaire either with cards or on a computer. If you have Win-

dows 3.0, you have probably discovered Solitaire and perhaps, like me, became obsessed with winning and watching the spectacular display of cascading cards on your display as your reward.

I have no complaints with Windows' Solitaire. It plays well and easily, and it's not too hard to win. But now there's another solitaire game, played by essentially the same rules, but tougher to win. It's called Klondike, and is included as an extra with GeoWorks Ensemble for the IBM PC.

GeoWorks produced a GUI (Graphical User Interface) for both the Commodore and Apple lines of computers in past years, and recently released their jazzed-up IBM PC version. Frankly, I like it considerably better than Windows 3.0. Running it on my 12-MHz 80286 AT with VGA and a hard drive, I found GeoWorks faster to use and easier to understand. The Ensemble package comes with some terrific applications, such as a word processor, a drawing program, a desktop publisher, a flat-file database, a communications program with an on-line service—and Klondike. Oddly, although the screen display calls this game "Solitaire," it is referred to in the documentation as "Klondike."

It is inevitable that GeoWorks' Klondike will be compared with Windows' Solitaire. I have found a number of differences. For one thing, Klondike looks better on the screen, since the cards have a sculptured look with a VGA (and perhaps an EGA) monitor. For another thing, there are Beginner, Intermediate, and Advanced modes, and many other options, when played in the Professional level of GeoWorks. You can select single or three-card

draw, different scoring and display methods, and other options (some of which are also available in Windows' Solitaire). A less-optional version is available in the Appliances level of GeoWorks.

The Beginner mode lets you get some hints as you play, and allows more freedom of movement of the cards—although you can't cheat. The hints are in the form of highlighting possible moves when you click on a selected card. The Intermediate mode highlights a target card only when a chosen card is moved near it. The Advanced mode gives you no clues at all, and restricts the movement of cards to full groups instead of partial groups.

The cards seem to be dealt in the same manner regardless of the mode, and you can switch between modes during a game. A score is kept at the lower left corner of the screen, while elapsed time is shown in the lower right corner. When you win a game, a single deck of cards fans across the screen, and your next game changes the card backs to a design with a large golden trophy and the words "You Won!"

*(Part of GeoWorks Ensemble, GeoWorks, 2150 Shattuck Ave., Berkeley, CA 94704. Suggested retail price for Ensemble is \$199.99)*

**CIRCLE 122 ON FREE INFORMATION CARD**

## **NEW FUN SOFTWARE**

Here are some recently announced programs you can order from your regular software supplier. The versions and suggested retail prices are shown in parentheses.

Virgin Mastertronic is now shipping the long-awaited IBM version of Overlord (formerly announced as

Quasar, and shipping in Europe as Supremacy). The game offers strategy, simulation, and serious science-fiction fun (IBM, Amiga, Atari ST, \$49.99).

Sierra On-Line has released a new version of King's Quest I, Quest for the Crown with new graphics, animation, and sound. King's Quest claims to be the most popular computer adventure series of all time (IBM, \$59.95).

Accolade, "the industry leader in computer driving simulations," now offers Road & Car #1, the first in a planned series of add-on disks combining both cars and scenery for Test Drive III: The Passion (IBM, \$24.95). Jack Nicklaus Presents the Great Courses of the U.S. Open is number four in a series of add-on disks for the Jack Nicklaus Unlimited and Championship Golf games (IBM, Amiga, Macintosh, Apple IIGS, \$21.95; Commodore 64/128, \$14.95). Two new adventure games also are now available from Accolade: Conspiracy: The Deadlock Files has over 350 256-color digitized images of New York City; HoverForce is a futuristic 3-D hovercraft adventure with vector graphic vehicle simulation (IBM, \$54.95 each). Incidentally, Accolade now has exclusive distribution rights in North America for U.S. Gold products.

Electronic Arts (over 15 million games sold!) has been busy with its own and affiliated-label products. Under the Electronic Arts label: F-29 Retaliator futuristic flight simulation (IBM, Amiga, Atari ST, \$49.95); Nightbreed interactive movie scenario (IBM, \$25.95; Amiga, Atari ST, \$39.95); The Untouchables interactive movie scenario (Commodore 64, Amiga, Atari ST, \$39.95); Lost Patrol lets you lead your men

*(Continued on page 83)*

# CIRCUIT CIRCUS

By Charles D. Rakes

## More NE602-Based Circuits

This time around we're going to continue from where we left off last month and explore a few more circuits built around the NE602 double-balanced mixer. In case you missed the last installment of *Circuit Circus*, here's a brief description of the NE602. The chip's 8-pin package contains a voltage regulator, an on-board oscillator, an input-differential amplifier, and a "Gilbert-cell" mixer. The oscillator can operate at frequencies up to 200 MHz, while the mixer circuit offers about 18 dB of gain with a noise figure of less than 5 dB. Its current requirement is normally less than 3 mA, making it a good choice for use in portable equipment.

### PARTS LIST FOR THE VLF CW-SSB-AM RECEIVER

#### SEMICONDUCTORS

U1—NE602 double-balanced mixer, integrated circuit  
U2—LM386 low-power audio amplifier, integrated circuit  
Q1—2N3904 general-purpose NPN silicon transistor

#### RESISTORS

(All fixed resistors are 1/2-watt, 5% units.)

R1, R2—100,000-ohm  
R3, R4—1000-ohm  
R5—10-ohm  
R6—10,000-ohm potentiometer

#### CAPACITORS

C1—C3—.01- $\mu$ F, ceramic-disc  
C4—.05- $\mu$ F, ceramic-disc  
C5, C6, C13—0.1- $\mu$ F, ceramic-disc  
C7, C8—680-pF, ceramic-disc  
C9—330-pF, ceramic-disc  
C10—.0015- $\mu$ F, mylar  
C11—365-pF, variable broadcast (see text)  
C12—220- $\mu$ F, 16-WVDC, electrolytic  
C14—100- $\mu$ F, 16-WVDC, electrolytic

#### ADDITIONAL PARTS AND MATERIALS

L1, L2—1.8-mH choke (Mouser Electronics, part 43LH218)  
T1—10,000-ohm to 2000-ohm audio transformer (Mouser Electronics, part 42KL002)  
SPKR1—4 or 8-ohm speaker  
Perfboard materials, enclosure, 9-volt power source, IC sockets, knob, wire, solder, hardware, etc.

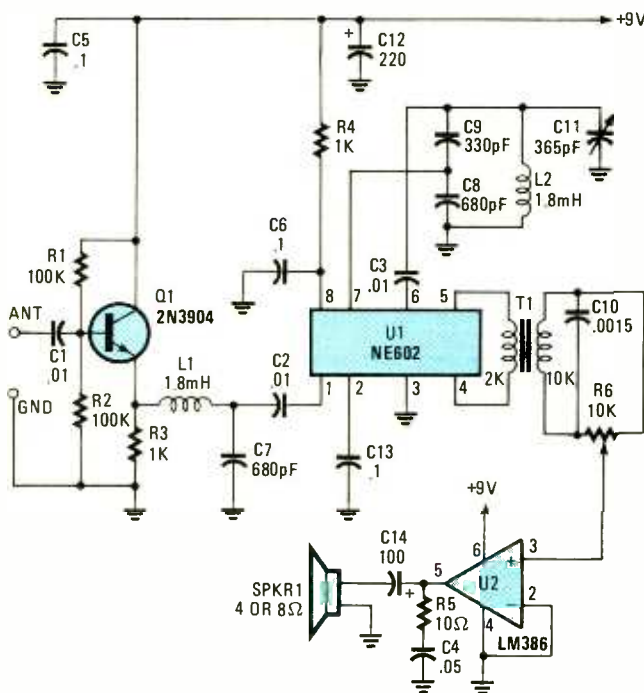

Fig. 1. The VLF CW-SSB-AM receiver—built around the NE602—can be used to tune a number of beacons and several mysterious RF signals that appear between 150 kHz and 250 kHz.

Once again, if you cannot locate the NE602 locally, it can be purchased

by mail from D.C. Electronics, PO Box 3203, Scottsdale, AZ 85271-3203; Tel. 1-800-423-0070. Contact them directly for pricing and shipping information, etc.

### VLF CW-SSB-AM RECEIVER

Our first circuit—a VLF CW-SSB-AM receiver, see Fig. 1—can be used to receive a number of beacons and several mysterious RF signals that appear between 150 kHz and 250 kHz. The circuit, built around the NE602 (U1), has at its input a 2N3904 general-purpose transistor set up in an emitter-follower configuration. That transistor functions as a buffer between the antenna and input of U1. Inductor L1 and capaci-

tor C7 form a simple low-pass filter that is used to attenuate RF signals above the 250-kHz level and to keep strong AM-broadcast signals from getting into U1's input circuit. Components L2, C8, C9, and C11 comprise a tuned circuit, which sets the operating frequency of U1's internal oscillator. Capacitor C11, a 365-pF broadcast-variable capacitor (which can be salvaged from an old broadcast receiver or purchased new), is used to tune the oscillator from about 150 kHz to 250 kHz.

The signal picked up by the antenna (not shown) is fed through the buffer (Q1) to the input of U1 at pin 1. Within U1, the incoming RF signal is mixed with the local-oscillator signal. The

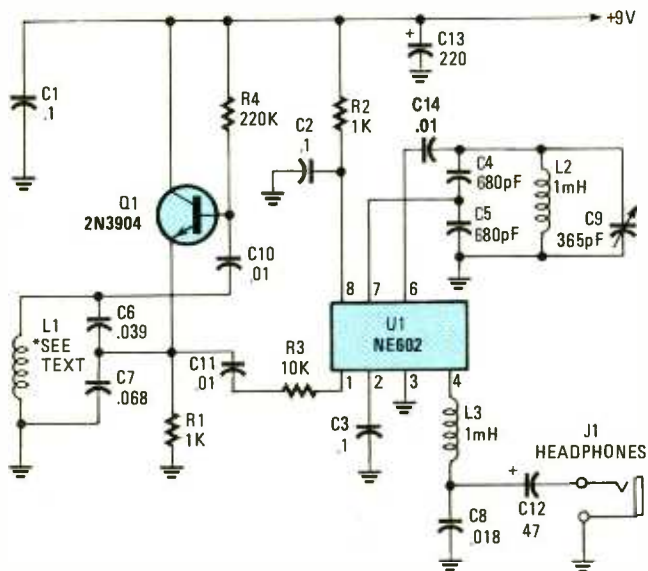

Fig. 2. In this metal-detector circuit, transistor Q1 (a 2N3904 general-purpose transistor) is configured as a Colpitts oscillator. When sense-loop L1 is brought near metal, the loop's inductance changes, shifting the oscillator's operating frequency.

resulting balanced-audio output of U1 at pins 4 and 5 is fed to the primary winding of an audio transformer, T1. The transformer's secondary is connected to the input of an LM386 low-power audio amplifier (U2) through volume-control potentiometer R6. The output of U2 is then used to drive SPKR1.

This type of receiver is commonly referred to as a DC receiver (direct-conversion receiver). The RF input is converted directly to audio by mixing the incoming RF signal with the signal produced by the local oscillator, which is tuned to about the same frequency. The DC receiver is one of the simplest and most sensitive receivers you can build.

The antenna for the VLF receiver should be as high and as long as possible for the best reception of long-wave signals, although a short antenna will work well enough to pull in a few of the stronger signals. In any case, you may find that experimenting with an antenna system can be just as much fun as building the receiver itself.

### METAL DETECTOR

Our next entry, see Fig. 2, places the NE602 at the center of a simple yet sensitive metal detector. Transistor Q1, a 2N3904 general-purpose NPN transistor, is connected as a Colpitts oscillator, operating at a frequency of about 250 kHz. The oscillator's inductor, L1, serves as the metal sensor. When the loop is brought near a metal object, the loop's inductance changes, causing a shift in oscillator frequency, which is transmitted to pin 1 of U1.

Integrated circuit U1's internal oscillator is also operating at a frequency of about 250 kHz. When the two oscillators are operating at, or about the same frequency, U1's mixer output at pin 4, is an audio tone that equals the difference frequency of the two oscillators. If the loop oscillator is operating at 250 kHz and the local oscillator is operating at 250.5 kHz, the audio tone would be the difference of the two, or 500 Hz.

The audio tone passes through a low-pass filter, made up of L3 and C8,

# ATTENTION! ELECTRONICS TECHNICIANS

EARN YOUR B.S.E.E. DEGREE



THROUGH HOME STUDY

Our New and Highly Effective Advanced-Placement Program for experienced Electronic Technicians grants credit for previous Schooling and Professional Experience, and can greatly reduce the time required to complete Program and reach graduation. No residence schooling required for qualified Electronic Technicians. Through this Special Program you can pull all of the loose ends of your electronics background together and earn your B.S.E.E. Degree. Upgrade your status and pay to the Engineering Level. Advance Rapidly! Many finish in 12 months or less. Students and graduates in all 50 States and throughout the World. Established Over 40 Years! Write for free Descriptive Literature

**COOK'S INSTITUTE**  
OF ELECTRONICS ENGINEERING

4251 CYPRESS DRIVE  
JACKSON, MISSISSIPPI 39212

CIRCLE 11 ON FREE INFORMATION CARD

### DIGITAL VIDEO STABILIZER ELIMINATES ALL VIDEO COPY PROTECTIONS



While watching rental movies, you will notice annoying periodic color darkening, color shift, unwanted lines, flashing or jagged edges. This is caused by the copy protection jamming signals embedded in the video tape, such as Macrovision copy protection. Digital Video Stabilizer: RXII completely eliminates all copy protections and jamming signals and brings you crystal clear pictures.

**WARNING :**  
SCO Electronics and RXII dealers do not encourage people to use the Digital Video Stabilizer to duplicate rental movies or copyrighted video tapes. RXII is intended to stabilize and restore crystal clear picture quality for private home use only.

- FEATURES:**
- Easy to use and a snap to install
  - State-of-the-art integrated circuit technology
  - 100% automatic - no need for any troublesome adjustments
  - Compatible to all types of VCRs and TVs
  - The best and most exciting Video Stabilizer in the market
  - Light weight (8 ounces) and Compact (1x3.5x5")
  - Beautiful deluxe gift box
  - Uses a standard 9 Volt battery which will last 1-2 years.

(Dealers Welcome)

To Order: \$49.95 ea + \$4 for FAST UPS SHIPPING  
1-800-445-9285 OR 516-568-9850  
Visa, M/C, COD M-F: 9-6 (battery not included)  
SCO ELECTRONICS INC.  
Dept. CPBE 581 W. Merrick Rd. Valley Stream NY 11580  
Unconditional 30 days Money Back Guarantee

CIRCLE 12 ON FREE INFORMATION CARD

## PARTS LIST FOR THE METAL DETECTOR

### RESISTORS

All resistors are 1/4-watt, 5% units.)

R1, R2—1000-ohm  
R3—10,000-ohm  
R4—220,000-ohm

### CAPACITORS

C1—C3—0.1- $\mu$ F, ceramic-disc  
C4, C5—680-pF, ceramic-disc  
C6—.039- $\mu$ F, mylar  
C7—.068- $\mu$ F, mylar  
C8—.018- $\mu$ F, mylar  
C9—365-pF, broadcast variable (see text)  
C10, C11, C14—.01- $\mu$ F, ceramic disc  
C12—47- $\mu$ F, 16-WVDC, electrolytic  
C13—220- $\mu$ F, 16-WVDC, electrolytic

### ADDITIONAL PARTS AND MATERIALS

U1—NE602 double-balanced mixer, integrated circuit  
Q1—2N3904 general-purpose NPN silicon transistor  
L1—See text  
L2, L3—1-mH choke (Mouser Electronics Part 43LH210)  
J1—Headphone jack  
Perfboard materials, enclosure, 9-volt power source, #20 enamel-coated copper wire, IC socket, wire, solder, hardware, etc.

and then travels on to the headphone jack (J1) through coupling capacitor C12. When the sense loop is passed over a metal object, the Colpitts oscillator's frequency is shifted, causing the audio tone to

change, thereby indicating that metal has been detected.

Inductor L1 is a home-made coil, made from 5 turns of #20 enamel-coated copper wire wound on a 9-inch diameter wood

## PARTS LIST FOR THE ULTRASONIC MOTION DETECTOR

### SEMICONDUCTORS

U1—NE602 double-balanced mixer, integrated circuit  
Q1—Q5—2N3904 general-purpose, NPN silicon transistor  
D1, D2—1N914 general-purpose, small-signal silicon diode

### RESISTORS

(All resistors are 1/4-watt, 5% units.)

R1—220,000-ohm  
R2—4700-ohm  
R3, R7, R11—1000-ohm  
R4—2200-ohm  
R5, R6, R10, R13—100,000-ohm  
R8—270-ohm  
R9—470-ohm  
R12—10,000-ohm

### CAPACITORS

C1—C3—.01- $\mu$ F, ceramic-disc  
C4, C5, C16—0.1- $\mu$ F, ceramic-disc  
C6, C7—.0033- $\mu$ F, ceramic-disc  
C8—680-pF, ceramic-disc  
C9—220-pF, ceramic-disc  
C10, C11—4.7- $\mu$ F, 16-WVDC, electrolytic  
C12—10- $\mu$ F, 16-WVDC, electrolytic  
C13—47- $\mu$ F, 16-WVDC, electrolytic  
C14, C15—220- $\mu$ F, 16-WVDC, electrolytic

### INDUCTORS

L1—1.8-mH choke (Mouser Electronics, part 43LH218)  
L2—27-mH choke (Mouser Electronics, part 43LH327)  
L3—33-mH choke (Mouser Electronics, part 43LH333)

### ADDITIONAL PARTS AND MATERIALS

SPKR1, SPKR2—2-inch Piezo tweeter speaker)  
BZ1—Piezo buzzer  
Perfboard materials, enclosure, 9-volt power source, IC socket, wire, solder, hardware, etc.

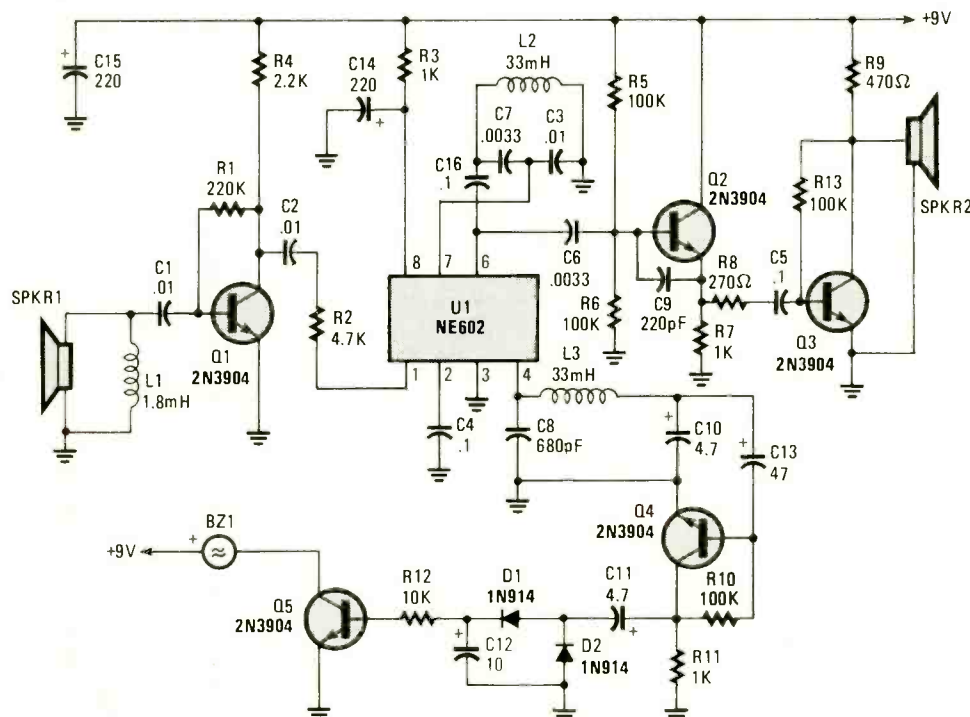

Fig. 3. The ultrasonic motion detector uses two speakers; one to emit a signal, and the other to detect the reflected signal. If motion—which causes a slight shift in the emitted signal frequency—is detected, the difference between the emitted and reflected signal is used to sound a buzzer.

or plastic form. After winding the coil, tape the windings in place and attach a non-metallic handle to the search loop. The coil should be connected to the circuit via shielded mike or mini-coaxial cable.

To obtain the best operating stability, the metal-detector circuit should be neatly assembled (keeping the component leads as short as possible) and housed in a metal cabinet. Transistor Q1 and its associated components should be located away from U1 and its support components, so that the two oscillators won't lock together when the circuit is tuned for a very low-frequency, audio-output tone. A standard 9-volt transistor-radio battery will do for the power source.

(Continued on page 88)



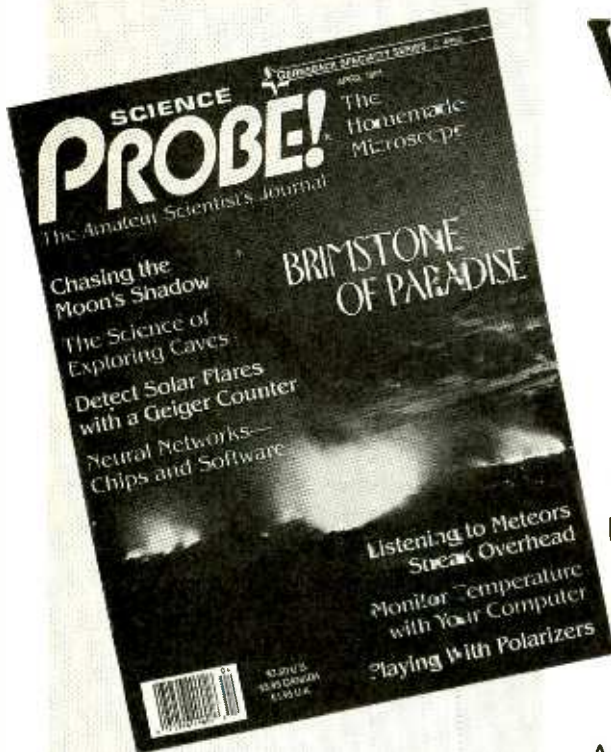

Welcome to . . .

# SCIENCE PROBE!

The Amateur Scientist's Journal

Embark on an irresistible new journey into the realm of mystery, challenge, and exploration! The perfect magazine for the budding scientist, the serious amateur, the professional who would like to relax, and those who simply want to gaze at the stars.

**Science PROBE!** — the *only* magazine devoted entirely to Amateur Scientists! If you are fascinated by science in all its many forms . . . if you can't stay away from a microscope, telescope, calipers, or test tube — we invite you to share the wonders in every issue of **Science PROBE!** You will join a community of Amateur and Student Scientists who enthusiastically seek scientific knowledge or follow scientific pursuits for their own sakes and not merely as a profession.

Obtain your next issue of **Science PROBE!** by visiting a quality Newsstand, Convenience Store, or Supermarket or by reserving your personal copy through the mail by completing the coupon below.

From your very first issue of **Science PROBE!** you will be involved in a world of scientific facts, experiments, and studies pursued by amateur scientists who are university students, investors, academicians, engineers, or office workers, salesmen, farmers—whose *quest* is to probe into the mysteries of science and reveal them to all.

Plan to become a **Science PROBE!** reader!

Articles to appear in upcoming issues of **Science PROBE!** are:

- How an Amateur Mapped the Milky Way
- Make your own Seismometer
- Operate a Solar-powered Weather Station
- Grow Crystals Automatically
- Experiment with a Saltwater Aquarium
- How to Keep a Science Notebook

If you're fascinated by science in all its many forms, if you are compelled to experiment and explore, then **Science PROBE!** is your kind of magazine!

**Science PROBE!**  
500-B Bi-County Boulevard  
Farmingdale, NY 11735

Please forward my copy of **Science PROBE!** as soon as it comes off the press. I am enclosing \$3.50-U.S.A. (\$4.23-Canada-includes G.S.T.) plus \$1.00 for shipping and handling. Better still, please enroll me as a subscriber and send the next four (4) quarterly issues of **Science Probe.** I am enclosing \$9.95-U.S.A. (Canada: \$16.00—includes G.S.T.)

Next Issue Only       Next Four Issues (1 Year)

Offers valid in the U.S.A. and Canada only. No foreign orders.

Name \_\_\_\_\_

Address \_\_\_\_\_

City \_\_\_\_\_ State \_\_\_\_\_ ZIP \_\_\_\_\_

All Orders payable in U.S.A. Funds only.

7PH18

ON SALE AT QUALITY NEWSSTANDS, CONVENIENCE STORES AND SUPERMARKETS  
GET YOUR COPY TODAY—\$3.50-U.S.A.—\$3.95-Canada

# DX LISTENING

By Don Jensen

## Change Comes To Albania

Finally, after more than four decades, the winds of change have come to Albania. That mountainous Balkan country of 3.5 million, sandwiched between Greece and Yugoslavia, was the last of the diehard communist regimes of eastern Europe.

Events change rapidly, sometimes too rapidly to be reflected in this monthly magazine column, but as this is being written, and since last December, Albania has been in the throes of what amounts to a popular uprising of the sort

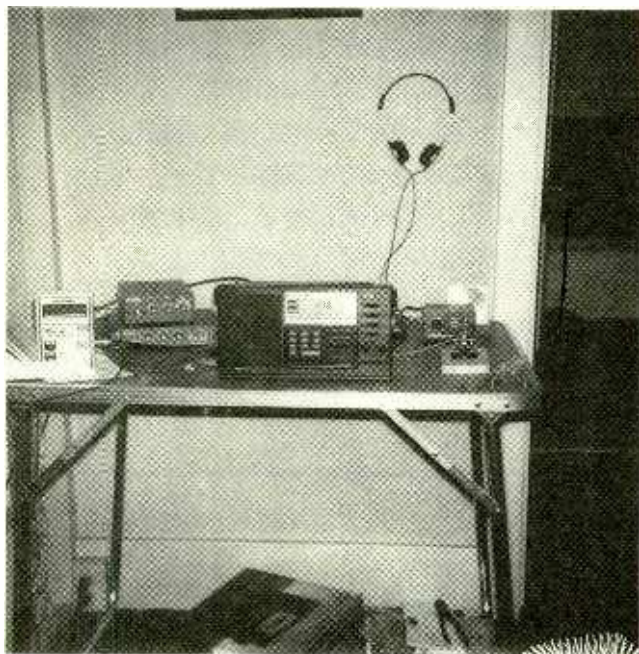

"My modest listening spot" is the description of California SWL, Paul Simes. This simple but neat setup, centered on a Sangean ATS-803A portable SW receiver, establishes that one can enjoy shortwave listening without spending a fortune.

that has swept through its neighboring countries during the past several years.

Last year, American tourists finally were allowed to travel in Albania. Hardy travelers have found it a bit like journeying back in time. Tourist facilities definitely are limited. The standard of liv-

ing is low and there are few automobiles. But, on the other hand, the beaches are clean and attractive, and there is little crime.

While tourists were banned from Albania for years, that was not so for SWLs, who have kept in tune with *Radio Tirana* on shortwave. Long after harshly critical, politicized diatribes disappeared from other eastern European SW broadcasters, the Albanian station continued its verbal attacks on the West.

DX listeners have long considered Radio Tirana's deadly serious propaganda the worst on shortwave. Still many continued to tune in, if only for the novelty. Radio Tirana's programming has been changing, it's true, but you'll still hear some unusual things, like regular sports broadcasts that focus exclusively on the scores of obscure Albanian soccer teams. However, the programs of exotic Albanian popular and folk music are real listening treats.

Radio Tirana's daily English half hour is easy to hear in North America. It is aired at 0230 and 0330 UTC on 9,760 kHz, and at 0630 UTC on 7,205 and 9,500 kHz.

### FEEDBACK

What do you have to say? I'm looking for your letter, with your comments about SWL'ing, your questions about the listening hobby, information about the stations that you are hearing, or those that you want to hear but haven't yet. This section of *DX Listening* is reserved for you each month. Write to *DX Listening*, **Popular Electronics**, 500-B Bi-County Blvd., Farmingdale, NY 11735.

Paul Simes, Fairfax, CA, has a brief message for other SWLs. Keep things short and simple! He doesn't need many words to get his point across either.

"Enclosed is a photo of my modest listening spot," he writes. "It includes a Sangean ATS-803A receiver, a Heathkit active antenna (which is used as preselector and preamplifier), and an Eavesdropper trapped-dipole antenna. I find it works for a modest price," Paul continues. "I didn't get in the picture myself, though. I'm not photogenic. Who needs pictures of an old 'geezer' anyway?"

To which I respond, in kind: Thanks for the pictures, Paul. Good point! SWL'ing doesn't take a zillion bucks, and it doesn't require an elaborate setup to have fun listening!

Falokh Bhatthana writes from Glen Ellyn, IL: "I am of Indian origin. When I was in India, I was a serious DX listener, especially to stations like the *British Broadcasting Corporation* and the *Voice of America*. Ever since I have been in the United States, I have lost touch with shortwave. Can we hear *All India Radio* over here? What are the frequencies that I can tune for Indian music and the latest news in the local Indian languages?"

*All India Radio's* English-language, overseas-shortwave service indeed can

\*Credits: Richard D'Angelo; Edward Cichorek, NJ; Brian Alexander, PA; Jerry Johnston, KY; Rufus Jordan, PA; John Prath, FL; Richard Folland, MI; North American SW Association, 45 Wildflower Road, Levittown, PA 19057.

be heard in the U. S., although the programming is not beamed directly to North America. Still the European transmissions offer opportunities for American listeners. Try listening from 1845 to 1945 UTC on 7,412, 9,665, or 11,620 kHz; and from 2045 to 230 UTC on the same frequencies, plus 9,910 kHz, and from 1845 to 2230 UTC on 11,810 kHz.

It's also possible, especially at dawn during midwinter in North America, to hear the much lower powered home-service shortwave stations, with programming in both English and Indian languages.

Among those domestic SW outlets is *AIR Hyderabad* on 4,800 kHz, along with similar stations at Bombay, Calcutta, and Bhopal. Because those stations operate with only a fraction of the power of the international station, occasional reception may be possible, but difficult.

A welcomed letter from Bob Comeau of New Germany, Nova Scotia, Canada, who first wrote several years ago for some assistance when he was trying to interest local school officials in supporting the addition of shortwave listening to the curriculum.

Bob writes of the success of the program in the school where he teaches. "Last year we applied for and received a grant, which purchased a Kenwood R-5000 receiver and some reference books that will be used in the curriculum this year. The science teacher, Greg Selig, my partner in this project, set up a two-week session on SWL'ing in his science class, involving the radio spectrum, propagation, etc. I am teaching the ham-radio course.

"Students have designed a QSL card for our ham station, VE1NGH, which went on the air for the first time

during Education Week last April, giving prospective hams in our course the incentive to go for their own licenses. This year, things are a little tougher. The course is going slow but sure. However, with the economy as it is, budget cuts have made it necessary for us to do our own fund raising. But we're not giving up after going this far."

Wonderful, Bob! Keep up the good work! And for other school teachers out there, I can recommend *Shortwave Goes to School: A Teacher's Guide to Using Shortwave Radio in the Classroom* by Miles Mustoe, which is available for \$24.95, plus \$2 postage from Tiare Publications, PO Box 493, Lake Geneva, WI 53147.

"Hi Don," writes Jay Hawthorne, Claresholm, Alberta, Canada. "I'm pleased with *DX Listening*. I do have a complaint to register, however. I wish shortwave stations would slow down the announcements of their identifications and locations, and give them more often. I often miss them because of fading."

A valid comment, Jay. An old joke among DX'ers is that static always seems to get worse on the hour and half hour, just when stations give their ID's. What many SWL's do to help solve the problem is to tape record their loggings, and then play back the tape. A repeat listen often lets you pick out the tough ID.

### FEEDBACK

Here are this month's listening targets. Give them a try. As usual, all times are listed in Coordinated Universal Time (UTC), using the 24-hour time system. To convert your local time to UTC, subtract four hours for Eastern Daylight Time, five hours for CDT, six hours for MDT, or seven hours for PDT.

**ARGENTINA**—11,710 kHz. *RAE* in Buenos Aires can be logged on this 25-meter band frequency, broadcasting in English following a multilingual ID at 0100 UTC.

**CONGO**—4,765 kHz. *Radio TV Congolaise* has been noted on this 60-meter band frequency, signing on at 0355 UTC with the station's interval signal, identification in French, and continuing with West African highlife music.

**PHILIPPINES**—15,450 kHz. The *Far East Broadcasting Corp.* is a longtime shortwave voice from this Asian island nation. It has been logged from 0130 UTC with identification, news, and a religious program.

**SOUTH AFRICA**—3,215 kHz. One of the several South African home-service shortwave voices is *Radio Oranje*. It has been logged at around 0300 UTC with light popular music and an-

nouncements, and ads in the Dutch-based Afrikaans language, with some English as well.

**USA**—7,510 kHz. *KTBN, Trinity Broadcasting Network*, is the identification of the religious shortwave broadcaster that last December bought out the former *KUSW* in Salt Lake City, UT. Between about 0200 and 0400 UTC, it operates on this frequency, and on 15,590 kHz after 1600 UTC.

**USSR**—4,795 kHz. While most SWL's are familiar with *Radio Moscow*, less well known is the so-called voice of Soviet public opinion, *Radio Peace and Progress*. This station has been logged with English news and commentary at 2200 UTC.

**VIETNAM**—12,184 kHz. *Hanoi's Voice of Vietnam* broadcasts here in English at 2345 UTC. ■

**Be an FCC LICENSED ELECTRONIC TECHNICIAN!**

Earn up to \$30 an hour and more!

Learn at home in spare time. No previous experience needed!

No costly school. No commuting to class. The Original Home-Study course prepares you for the "FCC Commercial Radiotelephone License." This valuable license is your professional "ticket" to thousands of exciting jobs in Communications, Radio-TV, Microwave, Maritime, Radar, Avionics and more...even start your own business! You don't need a college degree to qualify, but you do need an FCC License.

**No Need to Quit Your Job or Go To School** This proven course is easy, fast and low cost! **GUARANTEED PASS**—You get your FCC License or money refunded. **Send for FREE facts now. MAIL COUPON TODAY!**

### COMMAND PRODUCTIONS

FCC LICENSE TRAINING, Dept. 100  
P.O. Box 2824, San Francisco, CA 94126  
Please rush FREE details immediately!

NAME \_\_\_\_\_  
ADDRESS \_\_\_\_\_  
CITY \_\_\_\_\_ STATE \_\_\_\_\_ ZIP \_\_\_\_\_

# HAM RADIO

By Joseph J. Carr, K4IPV

## Improving Reception In Crowded VHF/UHF Bands

When I first got into ham radio many years ago, the VHF and UHF bands from 50 MHz (6 meters) and up were darn near dead. You could tune for an hour or more and not hear another station on "two," at least in some areas.

In those days, we used a motley collection of homebrew equipment (a 2-meter downconverter ahead of a 14- to 19-MHz general-coverage shortwave receiver, for example), Heath "Benton Harbor Lunch Boxes" (a low-power rig with a squawking super-

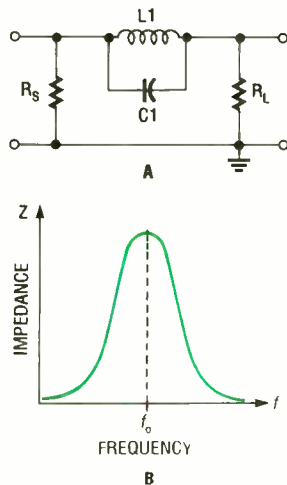

Fig. 1. A parallel-resonant wave trap (A), which has a very high impedance at its resonant frequency, will block the offending signal when placed in series with the signal line. Its impedance curve is shown in B.

regenerative receiver), and Gonset Communicator II/III rigs. The latter were the cream of the crop for many of us. They used a moderately low-power transmitter based on the 2E26 tube (little brother to the 6146B) and a real super-heterodyne receiver. Tuning the transmitter was aided

by a "magic eye" tube on the Communicator II (closing the eye was peaking the RF), or by a small relative RF-output meter on the Communicator III.

Regardless of the rig, we could tune for a long while and not hear any other station, especially out west where amateur stations were fewer and further between than in the east. Even in Virginia, I can recall when two or three contacts was a good night on two-meters.

Another limitation on VHF/UHF operation was that it was essentially line of sight. In other words, signals propagated only a little ways beyond the horizon—however that is defined given the heights of the antennas of the two stations. Operation was what we now call *simplex* (improperly, by the way), with stations either receiving and sending on the same frequency, or on inverted frequencies (*i.e.*, I might use  $f_1$  for transmitting, and  $f_2$  for receiving, while you would use  $f_2$  for transmitting and  $f_1$  for receiving). The latter mode was used because we tended to have tunable receivers, but crystal-controlled transmitters.

But that changed radically. About 25-years ago, Ken Sessions and a bunch of other W6-land amateurs started the repeater revolution. In repeater systems, all users, whether mobiles, portables, or fixed stations, use the same pair of frequencies; call them  $f_1$  for transmitting and  $f_2$  for receiving. A repeater station would have exactly the opposite arrangement:  $f_1$  for receiving and  $f_2$  for transmitting.

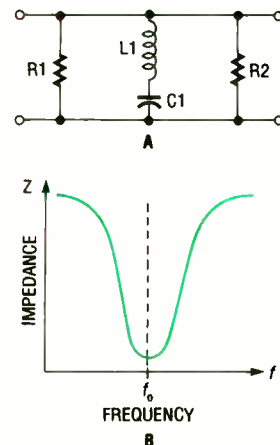

Fig. 2. A series-resonant wave trap (A), which has a low impedance at its resonant frequency, will snuff the offending signal when shunted across the line. Its impedance curve is shown in the illustration in B.

In that arrangement, an automatic (or semi-automatic, since there was a control operator) repeater would pick up weak signals from all users, and re-transmit them on a frequency that they could all hear. In that way, a repeater that was properly sited (a high antenna located on a hill or tall building) would allow hams to communicate over a much larger range than would normally be possible with simplex operation.

Today, there are not only 2-meter repeaters, but they are also on the other VHF/UHF bands as well. Repeaters are operated by amateur-radio clubs, as well as many hundreds of individuals, all across the country. It is almost impossible to drive somewhere without being within range of some ham-band VHF/UHF repeater.

All of that VHF/UHF operation is heartening, and it helps us to maintain our

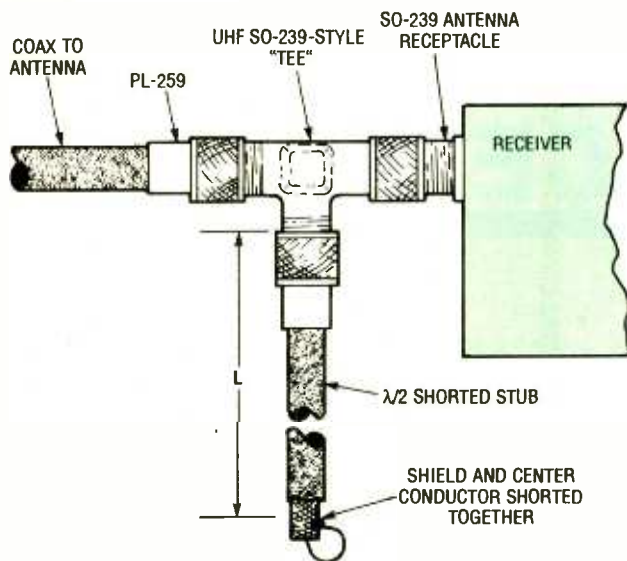

Fig. 3. With a half-wavelength shorted stub, like this one made from coaxial cable, connected at the antenna input of the receiver, the load impedance will be "reflected" every half wavelength along the line. When the line is exactly an electrical half wavelength, the input impedance looking into the line is the same as the load impedance.

bands in a hostile "grab-em" environment (and believe me, dear ham, commercial interests covet our bands). But there is a little problem with all of that activity: interference. The most obvious interference is co-channel mush; i.e., when another station attempts to use the same frequency or frequency pair and it results in what the CB'ers call being *stepped on*. There is little we can do about that, save coexist.

Another form of interference is intermodulation. That's when two signals are mixed together in a non-linear circuit, resulting in a complex output-frequency spectrum that contains the sum and differences of the original frequencies, plus the sum and differences of all of their significant harmonics. The general formula is:

$$f_{out} = mf1 \pm nf2$$

where  $f1$  and  $f2$  are the two interfering frequencies,  $f_{out}$  is the output frequency spectrum, and  $m$  and  $n$  are integers (1, 2, 3, and so on). In other words, equation 1

tells us that there can be an immense number of possibilities.

For example, suppose you are not too far from an FM-broadcast station on 105.1 MHz. Further, suppose that there is a local repeater on 146.94, and a landmobile transmitter on 462.24 MHz. The third harmonic of the FM station is  $mf1 = 3 \times 105.1 = 315.3$  MHz. The harmonic can be generated in your receiver front-end because of overload, even when the original signal is clean. When the third harmonic is mixed with the 462.24-MHz

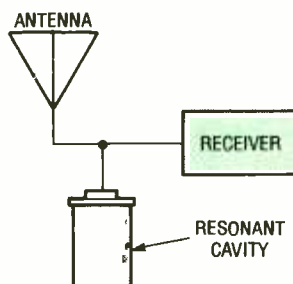

Fig. 4. In UHF systems, a cavity resonator—which acts very much like a shorted, half-wavelength stub—can be used to eliminate an offending signal.

signal, the difference frequency is  $462.24 \text{ MHz} - 315.3 \text{ MHz} =$  (you guessed it!)  $146.94$ . In other words, you would hear one or both signals on the two-meter repeater frequency.

In some urban and suburban areas, that situation is further complicated by dozens, scores, and even hundreds of transmitters in relatively small areas.

### WHAT TO DO?

How can you keep that situation under control? Well, one thing is to buy a good receiver with a wide dynamic range (providing freedom from overload) and a tuned (selective) front-end. After that's done, however, some people will still suffer intermodulation problems. There are still some neat tricks for them, all of which involve eliminating one or both of the offending frequencies from the receiver.

One solution that is useful on six-meters (the FM-broadcast band) and on two-meters, if done right, is the wave trap. Figure 1 shows a parallel-tuned wave trap, while Fig. 2 shows a series-tuned wave trap. A parallel tuned circuit has a very high impedance at its resonant frequency, so it will block the offending signal when placed in series with the signal line. On the other hand, the series resonant circuit has a low impedance at its resonant frequency, so will snuff the offending signal when shunted across the line. Keep the following rules in mind: a parallel trap is in series with the signal line and a series trap is in parallel with the signal line.

Another option is to use a half-wavelength, shorted, transmission-line stub (like that shown in Fig. 3) across the antenna line at the an-

*(Continued on page 85)*

Make the most of your general coverage transceiver with **Monitoring Times!**

Every month Monitoring Times brings everything you need to make the most of your general coverage transceiver: the latest information on international broadcasting schedules, frequency listings, international DX reports, propagation charts, and tips on how to hear the rare stations. Monitoring Times also keeps you up to date on government, military, police and fire networks, as well as tips on monitoring everything from air-to-ground and ship-to-shore signals to radioteletype, facsimile and space communications.

**ORDER YOUR SUBSCRIPTION TODAY** before another issue goes by. In the U.S., 1 year, \$18; foreign and Canada, 1 year, \$26. For a sample issue, send \$2 (foreign, send 5 IRCs). For MC/VISA orders (\$15 minimum), call 1-704-837-9200.

### MONITORING TIMES

Your authoritative source, every month.

P.O. Box 98  
Brasstown, N.C. 28902

# SCANNER SCENE

By Marc Saxon

## Top Value in a Mid-Range Scanner

Somewhere between the inexpensive, no-frills scanners and the exotic delights that run in the \$400 price range is a category of scanners commonly considered to be "mid-range." That might sound more like a specification for a stereo loudspeaker, but it actually refers to scanners whose prices are in the \$200 ballpark.

At \$199.95, that's exactly where we find the *Radio Shack Realistic PRO-2024*. Mid-range scanners fill the bill for the large number of monitors who want more

nels. It's fully keyboard programmable, has dual-speed operation and a monitor bank that allows you to store up to six channels found during search operations, and it offers search-scan priority channel, individual channel lockouts, and memory backup.

So, at half the cost, you are getting most of the important features of a scanner costing twice as much. The most obvious differences are the PRO-2024's 60-channel memory (instead of 400 channels), and the fact that it doesn't cover the 800-MHz band. However, you might not feel that either or both of those features are worth the additional \$200! Besides, if you decide you want to add 800-MHz coverage, you can always get a converter for less than \$100.

When you go shopping for a scanner, keep these mid-range units in mind as being thoroughly suited to many applications, at less than maximum cost. These Realistic scanners are available through the 7,000-store Radio Shack chain.

### FROM THE MAIL

David Sudduth is a fan of the Realistic PRO-34, and writes that he'd be surprised to see a scanner that would beat it. David, who hails from Gladstone, MO, asks if the PRO-34 is the handheld with the most bands and frequency coverage. He also would like to know the frequency range that military aircraft use to communicate.

The PRO-34 is an excellent scanner, but I think that you'd certainly want to include the Bearcat BC-200/205XLT in any considerations of superior handhelds. However, neither of these two top handhelds offer the largest frequency coverage. That honor probably belongs to the AOR AR1000, which has 1,000 memory channels and covers from 8 MHz in the HF band to 1300 MHz (except a gap from 600 to 805 MHz in the UHF-TV band).

The military-aircraft band about which Dave asks is 225 to 400 MHz, and the AR1000 is the only generally available handheld scanner that can receive that band.

From Cedar Rapids, IA, we got a note from Walter J. Kibler, who wants to know the frequency used by the detectives in his home town. We don't have the detective frequency specified in our records, but a check on 460.175, 460.25, 460.30, and 460.40 MHz will turn up the detectives on one or more of those channels.

Larry McClure, of Hillsboro, OR, writes to say that while he was searching through the VHF spectrum, his scanner stopped on 147.35 MHz and treated him to listening in on a contact between two ham operators, one of whom was quite far out in the Pacific on a tanker. In fact, in the 90 minutes that Larry monitored 147.35 MHz, the maritime mobile operator worked at least ten more

than a sow's ear, but aren't sufficiently involved and/or well-financed to spring for the silk purse.

You really get a lot for your money in a mid-range scanner. The PRO-2024 covers 30 to 54, 118 to 136, 138 to 174, and 380 to 512 MHz in 60 memory chan-



*If you really don't need the 800-MHz band, and can get by with "only" 60 memory channels, the Realistic PRO-2024 will provide all the other features found on top-of-the-line scanners—at about half the price.*

shore-based ham operators. Larry suggests that the 2-meter ham band (144 to 148 MHz) is usually overlooked by scanner listeners, but offers plenty of interesting fare.

Taking a handheld scanner to sports events adds excitement, and that's why Jeff Pluymers, of Battle Creek, MI, wrote to ask if we can find out the frequencies used at NASCAR auto races. NASCAR uses 464.50 and 464.775; individual drivers, however, usually have their own communications systems. Jeff specifically mentioned Dale Earnhardt and Richard Petty in his letter. Dale uses 464.0125 and 469.0125 MHz, while Richard uses 464.80 and 469.80 MHz.

Take Morrie Renosa, of Los Angeles, out to the ball game. He would like to know what frequency to monitor while attending Dodgers' games. We would recommend 151.745 and 154.57 MHz, while giving a listen on 151.625 MHz will tune you in on the press box.

#### HANDY HINT

W.N.P., of Kansas City, KS, wrote to pass along a hint that you might find useful. He observes that, even after entering every possible frequency of interest he could think of into his 400-channel Realistic PRO-2006, he found that he still had plenty of empty channel space going begging for some useful purpose.

That's when he recalled that his scanner can receive FM broadcast frequencies (88 to 108 MHz). He then took one 40-channel memory bank and dedicated it to FM broadcast reception. As it turns out, the set is a pretty decent FM receiver, featuring push-button frequency selection and digital readout. He programmed the channels with all of his favorite

FM frequencies in range, remembering to program the scanner for wide-FM (WFM) mode.

When he's interested in scanning the action bands, he simply removes that bank of channels from the scanning sequence. When he wants to hear FM, it takes only the push of one button to return that bank to the scanning sequence. The scanning will immediately lock up on the first FM carrier, and, using the "manual" button the individual stations can be stepped through, one at a time. Or, he can go directly to a desired station by punching up its channel number. He adds that the loudspeaker in the scanner doesn't have the greatest sound quality, so a larger size external speaker will sound better for FM broadcast listening.

We can add a few thoughts to this fine idea. It will also work with a PRO-2004 and a PRO-2005, and perhaps other scanners as well. If you decide to go to an external speaker, however, *do not* opt for one intended for high-fidelity audio reproduction. While your FM broadcasts will sound terrific, regular two-way scanner communications won't sound as good as when copied via a less elegant speaker that was specifically intended for communications use (such as the one built into the scanner).

As always, we would like to hear from our readers. You are welcome to send us a photo of your monitoring station, newspaper clippings relating to scanners and VHF/UHF communications, or any thoughts, questions, frequencies, ideas, and operating hints. Write to me at: **Scanner Scene, Popular Electronics**, 500-B Bi-County Boulevard, Farmingdale, NY 11735. ■

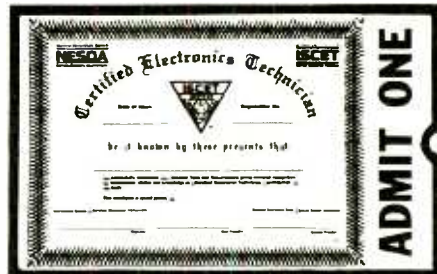

## Your Ticket To SUCCESS

Over 28,000 technicians have gained admittance worldwide as certified professionals. Let your ticket start opening doors for you.

ISCET offers Journeyman certification in Consumer Electronics, Industrial, Medical, Communications, Radar, Computer and Video. For more information, contact the International Society of Certified Electronics Technicians, 2708 West Berry Street, Fort Worth, TX 76109; (817) 921-9101.

Name \_\_\_\_\_

Address \_\_\_\_\_

City \_\_\_\_\_

State \_\_\_\_\_ Zip \_\_\_\_\_

\_\_\_\_\_  
Send material about ISCET and becoming certified.

\_\_\_\_\_  
Send one "Study Guide for the Associate Level CET Test." Enclosed is \$10 (inc. postage).

### SUPER LONG PLAY TAPE RECORDERS

**12 Hour Model —  
USES 120 TAPE  
\$119.00\***

Modified Panasonic Slimline, high quality AC-DC provide 6 continuous hours of quality recording & playback on each side of cassette for 12 hours total. Includes • Voice level control • Digital counter, etc TDK - 120 Cassette furnished.



---

**PHONE RECORDING ADAPTER**

Records calls automatically. All Solid state connects to your telephone jack and tape recorder. Starts recording when phone is lifted. Stops when you hang up. **\$28.50\*** FCC APPROVED

---

**VOX VOICE ACTIVATED CONTROL SWITCH**

Solid state Self contained Adjustable sensitivity. Voices or other sounds automatically activate and control recorder. Uses either re- corder or remote mike **\$28.50\***

\* Add for ship & handling Phone Adapter & Vox \$2.00 each. Recordors \$5.00 each. Calif. Regs. and tax. Mail order. VISA/M.C. COD's OK. Money Back Guarantee. Quantity discounts available. Dealer inquiries invited. Free data.

**AMC SALES INC.** Dept. B 9325 Lubex Street  
Box 929, Downey, CA 90241  
Phones (714) 869-8519 1-800-726-2488  
FAX (714) 923-1478  
Mon-Fri 9-5 PAC TIME

CIRCLE 6 ON FREE INFORMATION CARD

## ANTIQUE RADIO

(Continued from page 67)

be put together some time in the future. However, Leslie has several old sets that need to be checked and restored, and is looking for a meticulous and reliable shop to do the work. In the same vein, Steven Biffoni (646 Argyle Rd., Apt. F2, Brooklyn, NY 11230) would like to find a repairperson for his 60's-era Zenith S-65234. Any recommendations?

### TIPS, HELPS, AND THANK-YOUS

William Eslick (Wichita, KS) writes that those who are looking for old tubes might want to contact David Headley, 651 S. Yale, Wichita, KS 67214. According to Bill, Headley has about 170,000 new and tested-used tubes in stock.

David Overton (Auston, TX), who mentions that he has answered several reader queries from previous "Mailbag" columns, wrote to put in a plug for Lindsay Publications. Dave says that Lindsay has several great books on old radios—and I'm in complete agreement, having reviewed the Lindsay electrical catalog in a previous column.

The Lindsay line is composed almost entirely of reprints, and they've been able to make available a lot of wonderful old material that might otherwise be lost. Write to Lindsay Publications, P.O. Box 583, Manteno, IL 60950-0583, for a free copy of their *Electrical Books* catalog.

Stan Lopes (1201-74 Monument Blvd., Concord, CA 94520) writes to call our attention to the monthly antique-radio publication *Radio Age*. Contact *Radio Age* at 636 Cambridge Rd., Augusta, GA 30909 for current rates and a free sample copy. Stan likes to

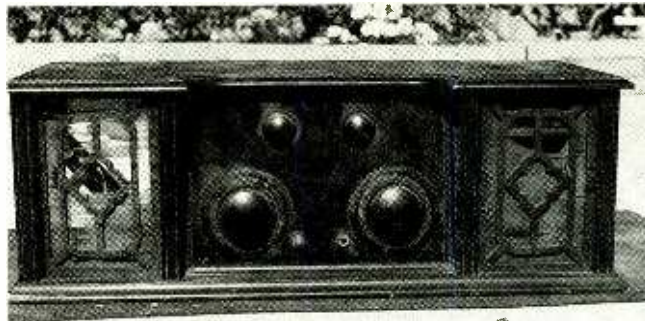

George Paschal's mystery radio uses four '99 tubes and resembles an RCA design. Its front panel is marked "Quadrodyne."

collect novelty radios (including transistor sets), and right now he is looking for certain models having a "Snow White and the Seven Dwarfs" theme.

John C. Tufts (10800 Tuckaway Dr., Thonotosassa, FL 33592) can probably help you if you are looking for an old schematic. He has a collection of over 2500, covering sets made between 1919 and 1945. He'd be glad to send a list to any interested party, but requests that you please enclose \$1.00 with your request to cover postage and handling.

Once you find what you want, John's price is \$1.25 per sheet for high-quality laser copies. (I presume postage would be extra, but he didn't say.) John would also be very happy

to swap for schematics, service data, and other old literature that he doesn't already have.

Reader Quoas-Manual Mimoso (Lisbon, Portugal) writes to thank us for helping him identify a console cabinet that had been modified to accept a *Howard* radio. The query, along with a picture of the cabinet, had run in the March, 1991 "Mailbag" column. Thanks to another reader who saw the picture and contacted him, Mr. Mimoso learned that the cabinet's original occupant had been an RCA Radiola 80 receiver.

While we're into thank-yous, I have a couple of my own: First of all, thanks to reader Richard Glasson (Columbus, IN) for sending me several issues of *Radio*

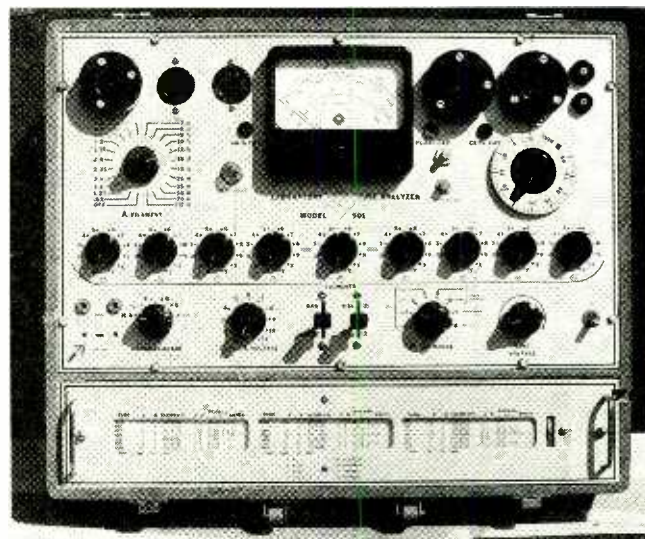

Al La Soya needs a line-test switch for this neat tube tester made by Westmore, Inc. (model unknown).

*World* magazine from 1924–1925. I'm sure that graphics and information from those books will be appearing in many future *Antique Radio* columns. And thanks also to Robert Nunnikoven (Suresnes, France) for the photocopied excerpts from a 1920's Dutch radio book. The Dutch ads for American products were particularly interesting to me, as were Bob's occasional handwritten translations.

### DON'T FORGET THE CONTEST!

As always, we'll be back here next month. At that time, hopefully, we'll examine the RCA Theremin now reposing in my basement and see what might need to be done in order to make it play again.

In the meantime, don't forget about our new contest! We want to know how you deal with your antique radios and related collectibles after acquisition. How do you catalog and display them? How do non-collecting members of your family relate to them? Have you used any clever tactics to gain the support of those family members who were negative?

Tell us all about it and try to include some photos to illustrate your points. All replies will be acknowledged in the column, and the eight judged to be most interesting will receive reprint copies of *100 Radio Hookups*, the same 1924 Gernsback publication sent to the winners of our Theremin contest. Once again, only those entries that are received before the Labor Day holiday will be considered, so if you haven't already entered, you better get busy now!

Send your contest entries to me c/o *Antique Radio*, **Popular Electronics**, 500-B Bi-County Blvd., Farmingdale, NY 11735. ■



## FUN SOFTWARE

(Continued from page 71)

through battlefield survival (IBM, Amiga, Atari ST, \$49.95); Hard Nova is a mercenary adventure in the Triangulum Galaxy with 256-color graphics and 3-D landscapes (IBM, \$49.95). Under the UBI SOFT label: B.A.T.—Bureau of Astral Troubleshooters has you as the one agent who can save Terrapolis (IBM, Amiga, Atari ST, \$49.95; Commodore 64, \$39.95). Under the Three-Sixty label: Battleset #3, The Med Conflict data disk for its renowned Harpoon Simulation (IBM, \$29.95); DAS BOOT German U-Boat simulation (IBM, Amiga, \$49.95). Under the SSI label: Typhoon of Steel World War II tactical game in three theaters (IBM, Amiga, \$59.95; Commodore 64/128, Apple II, \$49.95). Under the Cinemaware label: Air Strike USA combat flight simulator (IBM, Amiga, Atari ST, \$39.95); Dragonlord fantasy role playing game (IBM, Amiga, Atari ST, \$49.95). Under the Interstel label: D.R.A.G.O.N. Force man-to-man combat simulation (IBM, \$49.95).

MicroProse has a number of new releases. Under the Paragon label: TROIKA is a trilogy of arcade and strategy games (Rebel Planets, Metal Hearts, and Ivan's Time Machine) by Russian gamer Dima Pavlovsky (IBM, \$34.95); Megatraveller II science-fiction role playing (IBM, \$59.95); Twilight 2000 role-playing adventure in the aftermath of World War III (IBM, \$59.95). Under the MicroPlay label: Elite Plus space exploration with strategy, adventure, and arcade action (IBM, \$49.95); Universal Military Simulator II is a sophisticated wargame construction kit for historical and fictional military encounters (IBM \$59.95; Amiga, Macintosh, price not yet announced). ■

# WATCH <sup>FOR</sup> THIS ISSUE ON SALE JULY 2

## Radio Electronics®

TECHNOLOGY - VIDEO - STEREO - COMPUTERS - SERVICE

### BUILD THIS SPECTRUM ANALYZER!

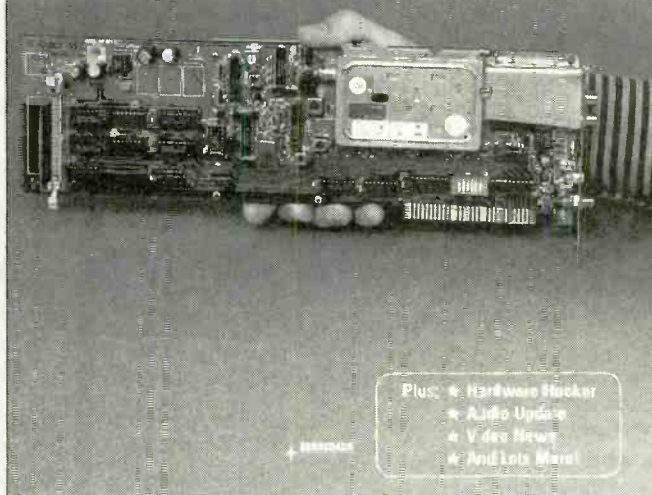

## OUR AUGUST ISSUE FEATURES:

### BUILD A SPECTRUM ANALYZER

*PC-based analyzer operates from 0.1 - 800 MHz and costs about \$300.*

### BUILD AN RS-232 TERMINAL/MONITOR

*Based on the MC78HC705 microcontroller, this device can act as either a dumb terminal or a sophisticated serial bus analyzer.*

### AN INTUITIVE LOOK AT ELECTRO- MAGNETIC THEORY

*On the one hundredth anniversary of Maxwell's A Treatise on Electricity and Magnetism, we present Part I: The Electric Field*

### BUILD AN EKG

*Part 2. Construction and operating details.*

**PLUS: Hardware Hacker  
Video News  
Drawing Board**

**Audio Update  
Computer Connections  
And Lots More!**

**Don't miss even one issue—Order Now!  
Call TOLL FREE 1-800-999-7139**

#5PE13

## WIRE ANTENNAS

(Continued from page 52)

VSWR meter or RF power meter to find the point of least reflected power (lowest VSWR). However, the SWL cannot use the transmitter method, so some other means must be found.

A useful tool that I've used (for both ham and SWL antennas) is the MFJ Enterprises, Inc. (Box 494, Mississippi State, MS, 39762; Tel. 601-323-5869) MFJ-204B antenna impedance bridge. Unlike other Z bridges that only hams can use, the MFJ-204B has an internal RF-signal generator that will supply the signal that both hams and SWL's need to find the antenna impedance.

This instrument can handle resistive impedances up to 500 ohms, and covers all HF bands up to 30 MHz. Although the MFJ-204B has a dial, I like the fact that it also has an output jack for a digital frequency counter. That little option makes it possible to very accurately locate the frequency. It also allows you to use the internal signal generator for other jobs. If for some reason you can't get right to the antenna feedpoint terminals, then use a half-wavelength section of transmission line to reflect the feedpoint impedance back to the instrument.

There are two ways to use the Z bridge. First, set the frequency selector to the desired resonant frequency, and then adjust the impedance knob for minimum deflection of the meter needle. The impedance where that null occurs is the antenna impedance that must be matched. Second, adjust the impedance and frequency to that which is desired, and then adjust the antenna length to minimize meter-needle deflection. One thing to keep in mind—despite what you might have heard to the contrary, the feedline length does not control the antenna resonance point. Only the length of the



*This Z bridge contains a built-in RF generator. That's very helpful to shortwave listeners as they have no broadcast equipment.*

antenna element will tune the antenna!

All radio antennas work better if the impedance of the antenna is matched to the impedance of the transmission line, and the line impedance is matched to the receiver or transmitter. Both hams and SWL's can use antenna-impedance matching networks for that job, although the ham versions seem a little easier to obtain. Fortunately, companies like MFJ make antenna tuners for both hams and SWL's. Their model MFJ-955 is intended for receiver use at frequencies that range from VLF to 30 MHz. Their differential-IT tuner is used for amateur operators using full legal-limit power levels.

Wire antennas date back to the very earliest days of radio (even Marconi used a random-length wire antenna). However, they are still viable designs for amateur radio operators and shortwave listeners today. ■

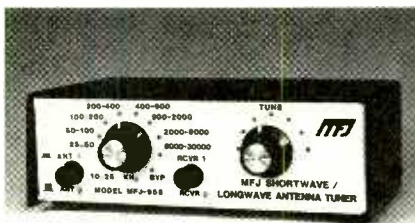

*This antenna tuner can work from VLF to 30 MHz. It can support two antennas and two transmitters for the well equipped shack.*

## OSCILLATORS

(Continued from page 60)

the resonant frequency. The other is a negative feedback loop that is used to limit the gain of the amplifier. Figure 3 shows the schematic diagram.

You'll notice that in the negative feedback loop, (connected to the inverting input of the op-amp), an extra resistor, R3, and two diodes, D1 and D2, are shown. The resistor increases the loop gain during start-up to greater than one. When the output signal reaches a level sufficient to forward bias the diodes (D1 on the positive excursion and D2 on the negative), R3 is shorted out reducing the loop gain to one. Of course, since the attenuation of the positive feedback network is  $\frac{1}{3}$ , the gain of the amplifier circuit is slightly greater than 3 on start-up and about 3 during normal operation.

The main difference between this circuit and the phase-shift oscillator is that the feedback network has a zero phase shift (or  $360^\circ$  phase shift) at the resonant frequency. Since the phase shift of the network meets the requirement for oscillation, the network is connected to the non-inverting input of the op-amp so it provides no phase shift of its own.

The network is made up of two identical resistors and two identical capacitors. One RC pair is arranged as a low-pass filter and the other pair forms a high-pass filter. Together they form a bandpass filter. Components R1 and C1 make up the low-pass filter because at higher frequencies C1 becomes a low

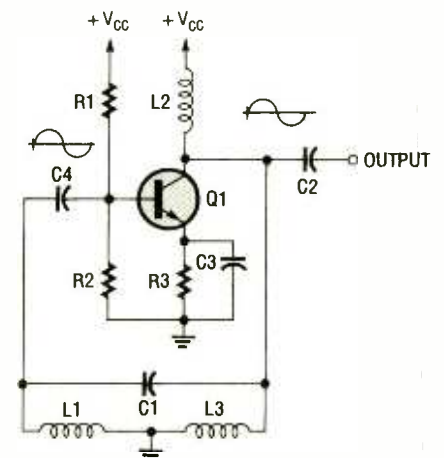

*Fig. 5. The only difference between this Hartley oscillator and the colpitts unit presented earlier is the tank circuit. note how the tank's capacitors were replaced with inductors and vice versa.*

impedance, shunting the signal to ground. Components R2 and C2 form the high-pass filter, blocking lower frequencies due to C2's high impedance at lower frequencies. The network is also called a lead-lag network because of the phase shifts on either side of the resonant frequency.

The frequency of oscillation and the gain of the op-amp can be determined using the following formulas:

$$f = 1/(2\pi R1C1),$$

and

$$A_v = (R4 + R5 + R3)/R5$$

for the "start-up" gain, and

$$A_v = (R4 + R5)/R5$$

for the operating gain. Again, the overall gain is expressed as:

$$A_L = A_v \times B = 3 \times \frac{1}{3} = 1$$

This circuit can also easily be constructed or breadboarded using almost any basic op-amp.

**Other Oscillators.** There are lots of other feedback-oscillator designs that have been widely used over the years. Due to space limitations, we will only touch on them here; their design will be left as an exercise for the more ambitious reader.

The Colpitts oscillator, shown in Fig. 4, uses a resonant tank circuit made up of an inductor (or sometimes one side of a transformer) and two capacitors. The circuit shown uses a common-emitter transistor amplifier that inverts the output. The grounding point between the two capacitors creates a 180° shift of the signal coming out of the tank making the overall phase shift 360°.

There are several variations on that design. The Hartley oscillator (see Fig. 5) uses two inductors (or a center-tapped inductor) and one capacitor for its tank circuit. The Clapp oscillator, which is not shown, is virtually identical to the Colpitts oscillator of Fig. 4, with one significant difference: a small capacitor is placed in series with the inductor (L1). That capacitor sets the oscillation frequency and reduces the effect of transistor-junction capacitance on the circuit. The list of possible oscillator circuits could go on, but the main requirements for each of them are the same: positive feedback and a gain of one.

I hope that this article has given you enough information for you to design your own oscillator circuits. Good luck with your endeavors, and may all your feedback be positive!

# Popular Electronics

## REPRINT BOOKSTORE

- |                                                                                                                            |                                                                                                                              |
|----------------------------------------------------------------------------------------------------------------------------|------------------------------------------------------------------------------------------------------------------------------|
| <input type="checkbox"/> <b>221</b> Popular Electronics (1991 back issues) <b>\$4.00</b><br>Write in issues desired _____  | <input type="checkbox"/> <b>107</b> Radio-Electronics (1987 back issues) <b>\$5.25</b><br>Write in issues desired _____      |
| <input type="checkbox"/> <b>220</b> Popular Electronics (1990 back issues) <b>\$4.50</b><br>Write in issues desired _____  | <input type="checkbox"/> <b>106</b> Radio-Electronics (1986 back issues) <b>\$5.50</b><br>Write in issues desired _____      |
| <input type="checkbox"/> <b>119</b> Popular Electronics (1989 back issues) <b>\$4.75</b><br>Write in issues desired _____  |                                                                                                                              |
| <input type="checkbox"/> <b>118</b> Hands-On Electronics (1988 back issues) <b>\$5.00</b><br>Write in issues desired _____ |                                                                                                                              |
| <input type="checkbox"/> <b>117</b> Hands-On Electronics (1987 back issues) <b>\$5.25</b><br>Write in issues desired _____ |                                                                                                                              |
| <input type="checkbox"/> <b>116</b> Hands-On Electronics (1986 back issues) <b>\$5.50</b><br>Write in issues desired _____ |                                                                                                                              |
| <input type="checkbox"/> <b>EH91</b> Experimenters Handbook (1991) <b>\$4.50</b>                                           |                                                                                                                              |
| <input type="checkbox"/> <b>EH90</b> Experimenters Handbook (1990) <b>\$5.00</b>                                           |                                                                                                                              |
| <input type="checkbox"/> <b>EH88</b> Experimenters Handbook (1988-89) <b>\$5.50</b>                                        |                                                                                                                              |
| <input type="checkbox"/> <b>EH87</b> Experimenters Handbook (1987) <b>\$6.00</b>                                           |                                                                                                                              |
| <input type="checkbox"/> <b>HH91</b> Popular Electronics Hobbyist Handbook (1991) <b>\$5.00</b>                            |                                                                                                                              |
| <input type="checkbox"/> <b>HH90</b> Popular Electronics Hobbyist Handbook (1990) <b>\$5.50</b>                            |                                                                                                                              |
| <input type="checkbox"/> <b>HH89</b> Popular Electronics Hobbyist Handbook (1989) <b>\$6.00</b>                            |                                                                                                                              |
| <input type="checkbox"/> <b>126</b> Radio-Electronics Annual 1986 <b>\$6.00</b>                                            |                                                                                                                              |
| <input type="checkbox"/> <b>211</b> Radio-Electronics (1991 back issues) <b>\$4.00</b><br>Write in issues desired _____    |                                                                                                                              |
| <input type="checkbox"/> <b>210</b> Radio-Electronics (1990 back issues) <b>\$4.50</b><br>Write in issues desired _____    |                                                                                                                              |
| <input type="checkbox"/> <b>109</b> Radio-Electronics (1989 back issues) <b>\$4.75</b><br>Write in issues desired _____    |                                                                                                                              |
| <input type="checkbox"/> <b>108</b> Radio-Electronics (1988 back issues) <b>\$5.00</b><br>Write in issues desired _____    |                                                                                                                              |
|                                                                                                                            | <b>REPRINTS</b>                                                                                                              |
|                                                                                                                            | <b>REPRINTS</b>                                                                                                              |
|                                                                                                                            | <input type="checkbox"/> <b>169</b> Think Tank (133 Circuits) <b>\$3.50</b>                                                  |
|                                                                                                                            | <input type="checkbox"/> <b>169A</b> Think Tank Vol. 2 <b>\$3.00</b>                                                         |
|                                                                                                                            | <input type="checkbox"/> <b>168</b> Fact Cards (#34-66) <b>\$4.00</b>                                                        |
|                                                                                                                            | <input type="checkbox"/> <b>168C</b> Fact Cards (#67-99) <b>\$3.50</b>                                                       |
|                                                                                                                            | <input type="checkbox"/> <b>168D</b> Fact Cards (#100-132) <b>\$3.50</b>                                                     |
|                                                                                                                            | <input type="checkbox"/> <b>167</b> Designing With IC's <b>\$4.00</b>                                                        |
|                                                                                                                            | <input type="checkbox"/> <b>166</b> Collected Works of Mohammed Ulyses Fips (62 pages, April Fools Collection) <b>\$5.00</b> |
|                                                                                                                            | <input type="checkbox"/> <b>165</b> How to Repair CD Disc Players <b>\$5.00</b>                                              |
|                                                                                                                            | <input type="checkbox"/> <b>164</b> Modern Electrics (April 1908) <b>\$3.00</b>                                              |
|                                                                                                                            | <input type="checkbox"/> <b>163</b> Receiving Satellite TV <b>\$5.00</b>                                                     |
|                                                                                                                            | <input type="checkbox"/> <b>162</b> Build Your Own Satellite TV Receiver <b>\$5.00</b>                                       |
|                                                                                                                            | <input type="checkbox"/> <b>161</b> Descrambling (Feb. 1984) <b>\$4.00</b>                                                   |
|                                                                                                                            | <input type="checkbox"/> <b>160</b> New Ideas - 42 Circuits <b>\$3.50</b>                                                    |
|                                                                                                                            | <input type="checkbox"/> <b>159</b> Low Frequency Receiving Techniques Building and using VLF Antennas <b>\$5.00</b>         |
|                                                                                                                            | <input type="checkbox"/> <b>158</b> Electro Importing Co. Catalog (Circa 1918) <b>\$5.95</b>                                 |
|                                                                                                                            | <input type="checkbox"/> <b>157</b> All About Kits <b>\$2.00</b>                                                             |
|                                                                                                                            | <input type="checkbox"/> <b>156</b> How To Make PC Boards <b>\$2.00</b>                                                      |
|                                                                                                                            | <input type="checkbox"/> <b>155</b> IBM Typewriter To Computer <b>\$2.00</b>                                                 |
|                                                                                                                            | <input type="checkbox"/> <b>154</b> How To Repair VCR's <b>\$3.50</b>                                                        |
|                                                                                                                            | <input type="checkbox"/> <b>150</b> Pay TV Decoder (1981) <b>\$3.00</b>                                                      |

To order any of the items indicated above, check off the ones you want. Complete the order form below, **include your payment**, check or money order (DO NOT SEND CASH), and mail to **Popular Electronics**, Reprint Department, P.O. Box 4079, Farmingdale, NY 11735. Please allow 4-6 weeks for delivery.

If you need a copy of an article that is in an issue we indicate is unavailable you can order it directly from us. We charge 50¢ per page. Indicate the issue (month & year), pages and article desired. Include payment in full, plus shipping and handling charge. Make checks payable to Gernsback Publications, Inc.

ARTICLE \_\_\_\_\_

PAGES _____	MONTH _____	YEAR _____
TOTAL PAGES _____	@ 50¢ each	TOTAL PRICE _____

MAIL TO: **Popular Electronics**  
Reprint Bookstore, P.O. Box 4079, Farmingdale NY 11735

**All payments must be in U.S. funds**

**SHIPPING CHARGES IN USA & CANADA**

\$0.01 to \$5.00 . . . . . \$1.50	\$30.01 to 40.00 . . . . . \$5.50
\$5.01 to \$10.00 . . . . . \$2.50	\$40.01 to 50.00 . . . . . \$6.50
\$10.01 to 20.00 . . . . . \$3.50	\$50.01 and above . . . . . \$8.00
\$20.01 to 30.00 . . . . . \$4.50	

**SORRY** — We only ship to USA & Canada

Total price of merchandise . . . . . \$ _____	
Sales Tax (New York State Residents only) . . . . . \$ _____	
Shipping Charge (see chart) . . . . . \$ _____	

Name \_\_\_\_\_ Total Enclosed . . . . . \$ \_\_\_\_\_

Address \_\_\_\_\_

City \_\_\_\_\_ State \_\_\_\_\_ Zip \_\_\_\_\_

**PE891**

## ELECTRONIC LIMBS

(Continued from page 55)

trol for both elbow and hand using only two muscles. Since the control of the limb is primarily provided through muscle contractions, it lends itself to more natural command and is easier to learn how to use. In Chuck's own words, "Within three months I was doing things many people never thought I'd be able to do. I was picking up everything from individual pieces of popcorn to five-gallon buckets of water, and I was tying my shoelaces."

The prosthesis will also be healthier for Chuck's remnant limb and shoulder as the muscles there will be actively exercised. The activity will minimize the muscular atrophy that occurs after amputation.

Several unique features make the Utah Artificial Arm superior in both function and appearance to older limbs (see Fig. 2). It is motor driven so it doesn't have the cumbersome cables common to prior designs. The power drive can actively lift three pounds. With the elbow locked (which occurs automatically if it is not flexed for about one second), the arm can hold 50 pounds. To unlock the elbow, the wearer simply must depress a switch, or contract a certain set of muscles.

Like a normal arm, the Utah Arm falls freely whenever muscles relax, and swings freely during walking. Also, the arm permits side-to-side motion

(humeral rotation) of the arm via an adjustable friction socket.

The wrist rotator allows pronation and supination of the hand, operated by the same muscle that controls gripping force. Four stainless-steel skin electrodes in the shoulder socket provide the neural signals necessary to manipulate the hand and wrist. The entire unit is powered by a rechargeable battery.

The makers of the arm (Motion Control, Inc. in Salt Lake City, Utah) are known for their advanced prosthetic products, particularly the Utah arm. The arm was developed by the University of Utah and was first available in 1980.

For Chuck, the effectiveness of the new arm matched that of the foot. He was now not only able to scuff under a fly ball, he was able to snag it!

**Is Chuck Alone?** In 1980 Holley Howard, a 21-year-old dance instructor, lost her leg in a boating accident. Today, at 32, she also wears the Sabolich Sense-of-Feel leg.

"After more than 30 surgeries, and a nine-year search for a functional prosthesis, I can finally say that I'm back," relates Holley. "I'm back enjoying life to the fullest. I don't limp anymore. I can do anything I want to. I love to dance and what a difference this makes in dancing. But, most of all, it's wonderful to simply have feeling again."

Holley is a very active member of her community. She has served as the volunteer chairman of the Children's Miracle Network Telethon that raised over

\$125,000 in 1989. She is also on the Board of Directors of the Junior League and an active volunteer for the American Cancer Society, the American Heart Association, and is Director of the East Texas Amputee Foundation.

**In Closing.** Of his continuing work at the Sabolich Prosthetic & Research Center, John Sabolich says, "Our mission is to research and develop the single most advanced prosthetic solutions to the needs of those who have been born without or have lost their natural limbs to disease or accident. We have at our center an incredible prosthetics team whose talent and technological expertise benefits our many patients, enabling them to capture or recapture whatever aspect of movement and functioning they may be lacking. It is a goal for us at the center, and an endeavor whose rewards are unmatched by anything else I've ever known. When you see the look in the face of a child who has never been able to run before but now can, or a man or woman who has forgotten what it's like to walk easily and comfortably and now does, that makes all the hard work and research even more rewarding." ■

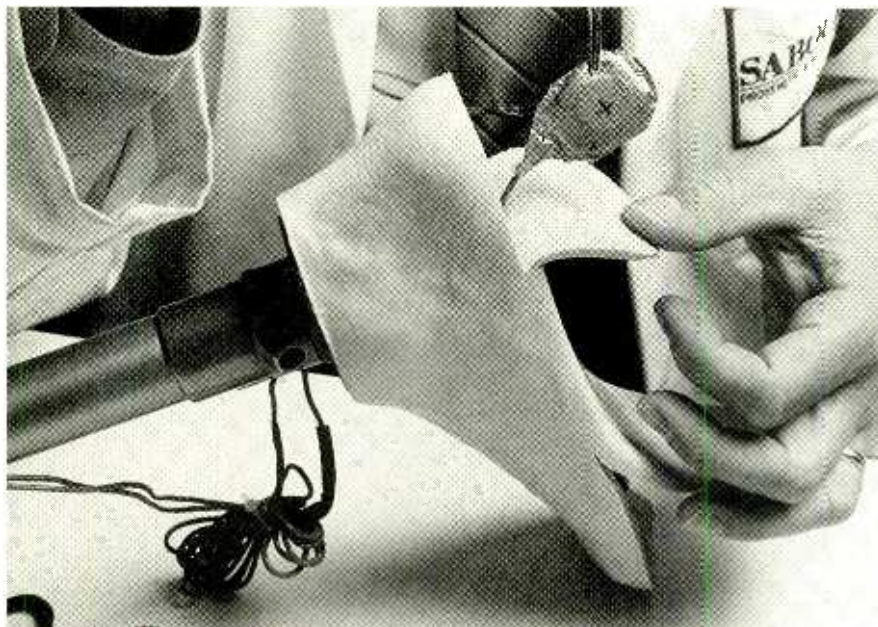

Here a pressure transducer is being implanted in the heel of a prosthetic foot. When stepped on, the transducer will send analog signals via wires to the electronic interface for processing, helping the wearer to walk normally.

**There's only  
one way to  
come out ahead  
of the pack.**

**QUIT**



**American Heart  
Association**

WE'RE FIGHTING FOR  
YOUR LIFE

## COMPRESSOR-MATE

(Continued from page 36)

application. Although not needed for DC use, the diodes will make the unit immune to polarity reversal.

**Assembly and Testing.** The DC portion of the circuit may be assembled on a piece of perfboard using point-to-point wiring, as in the prototype. Be mindful of the orientation of diodes D1 through D4 and especially that of D5. The same holds true for capacitors C2 and C3, as they are electrolytic units. Both Q1 and SCR1 are available in a variety of case styles and lead configurations, so check their pin configurations before wiring them into the circuit. The use of a socket for U1 is highly recommended, but **do not install U1 until called for during the test procedure.**

When all components have been installed (except U1), check the wiring

### PARTS LIST FOR THE COMPRESSOR-MATE

#### SEMICONDUCTORS

- U1—CD4541 programmable-timer, integrated circuit
- Q1—2N5550, or equivalent, NPN silicon transistor
- SCR1—T106D1 or similar, 4-amp, 400-PIV, sensitive-gate, silicon-controlled rectifier
- D1—D4—1N4005 1-amp, 600-PIV, rectifier diode
- D5—1N4739 9-volt, 400-mW, Zener diode

#### RESISTORS

(All resistors are 1/4-watt, 5% units unless otherwise noted.)

- R1, R5—100-ohm
- R2—4700-ohm, 2-watt
- R3—33,000-ohm
- R4—4700-ohm
- R6—6800-ohm
- R7—150,000-ohm
- R8—220,000-ohm

#### CAPACITORS

- C1—.047- $\mu$ F, 400-WVDC, Mylar
- C2—10- $\mu$ F, 15-WVDC, electrolytic
- C3—10- $\mu$ F, 25-WVDC, electrolytic
- C4—0.15- $\mu$ F, 100-WVDC, Mylar

#### ADDITIONAL PARTS AND MATERIALS

- K1—30-amp DPDT power relay with 117-volt coil
- PL1—3-terminal AC power plug with line cord
- SO1—3-terminal AC socket, chassis mount
- Perfboard, metal enclosure, wire, solder, hardware, etc.

carefully. If you are satisfied that the wiring is correct, strip the insulation from the ends of two leads and connect them to the AC points on the diode bridge. The wire should be thick enough to easily carry current for the relay.

Wire the relay's coil in series with one of the DC circuit's two leads. Connect the appropriate connectors (PL1 and SO1) to the remaining lead of the DC circuit and the relay. The wire that delivers power from PL1 to SO1 via the relay should be selected to withstand the current needed by the device that you're protecting.

It's a good idea to test the circuit before placing it in an enclosure. When testing the unit, be sure to place it on a non-conductive surface. Apply power to the unit; the power relay should not energize at this time. If it does, remove power and recheck the wiring before going any further. If the relay coil does not pull in the armature, but hums slightly, that is acceptable.

Remove power and take a piece of small diameter, insulated bus wire and jumper pins 8 and 14 of U1's empty socket. (Never do this with U1 in place, it will destroy the IC.) Now apply power to the circuit. The relay should pull in its armature and remain energized even if you remove the jumper wire (which you should do carefully if you are using the project to control line current).

Disconnect power to the project and carefully install U1 in its socket. Reconnect power to the project. In 315 seconds, the power relay should energize. After the relay energizes, momentarily interrupt the power. The relay should

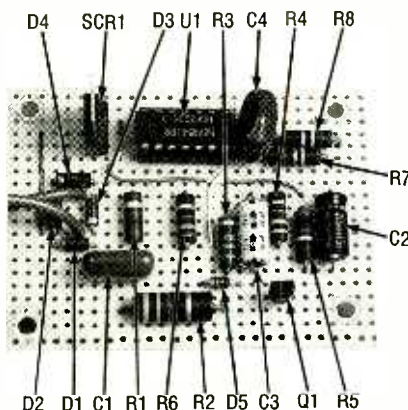

Here is the Compressor-Mate's circuit board—with all board-mounted components called out—prior to installation in its cabinet. When assembling the circuit, be sure to use a 2-watt or more resistor for R2.

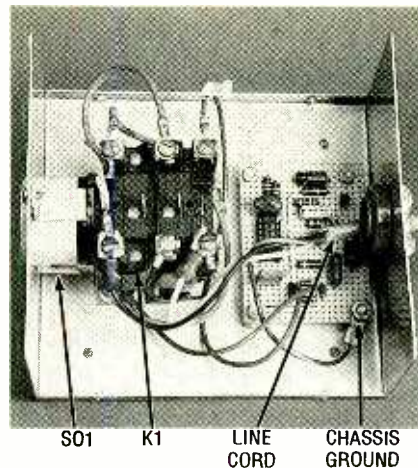

The wiring within the cabinet should be neat. It should also be heavy enough to handle the current required for its task. Note that the chassis is connected to the ground lead of the power cord via a mounting screw and nut.

de-energize and then re-energize again 315 seconds later.

Note that during the first five timing cycles R2 will become warm and may smell. That's no cause for concern unless the condition persists or if the resistor seems seriously overheated. If the tests go well, house the project in a grounded metal box with holes cut for the appropriate male and female power connectors. ■

When  
you give blood  
you give  
another  
birthday,  
another laugh,  
another hug,  
another  
chance.



American Red Cross

Please give blood.



## CIRCUIT CIRCUS

(Continued from page 74)

To use the circuit, position the search loop away from any metal object and adjust C9 for a low-frequency audio tone. It is much easier to detect metal objects at greater distances from the search loop if the output-tone's frequency is very low. That's because it is much easier to detect a two- or three-hertz change at 15 Hz than at 150 Hz. Therefore, it is wise to set C9 for the lowest possible output frequency for maximum sensitivity. When searching for buried objects, position the search loop parallel to the ground and about one inch above its surface. Then simply sweep over the desired area.

## ULTRASONIC MOTION DETECTOR

Our final entry for this

month, shown in Fig. 3, places the NE602 in the middle of an ultrasonic motion-detector circuit. The component values shown for L2, C3, and C7 set U1's internal oscillator to a frequency of about 20 kHz. Transistor Q2 is connected in an emitter-follower configuration and is used to isolate the local oscillator's tank circuit from loading effects of the speaker-driver circuit. It is also used to couple the 20-kHz oscillator signal to the input of Q3 (the speaker driver). Transistor Q3 increases the signal to a level suitable to drive a piezo tweeter, SPKR2.

A second piezo speaker, SPKR1, operating as a microphone, is connected across L1 (a 1.8-mH choke), which greatly attenuates any low-frequency sounds that might reach the speaker and interfere with the circuit's operation. That

high-pass filter passes the 20-kHz signal to the input of a grounded-emitter amplifier, Q2, and on to the input of U1 at pin 1.

A low-pass filter made up of L3, C8, and C10 allows frequencies below 50 Hz to pass to the input of Q4, another grounded-emitter amplifier. Diodes D1 and D2 convert the low-frequency signals to DC, which is then used to bias Q5 on, causing BZ1 to sound.

The operation of the motion detector is simple. The two piezo speakers are located side-by-side, with about 1-inch separation between edges and facing in the same direction. One speaker, SPKR2, operates as an output device, sending out a 20-kHz signal, while the other speaker, SPKR1, operating as a mike, picks up any reflected 20-kHz sound. As long as there's no movement, the frequency picked up by SPKR1 is the

same as the frequency leaving SPKR2.

But when an object moves in front of the speakers the 20-kHz sound is slightly shifted in frequency due to the Doppler effect. The difference in frequency is picked up by SPKR1, amplified by Q1, and fed to pin 1 of U1. If the reflected signal is 20,010 Hz and the transmitted signal is 20 kHz, the difference frequency is 10 Hz. The 10-Hz signal appears at pin 4 of U1 and then passes through the low-pass filter to the amplifier and sounder circuits.

The motion detector can detect a person passing in front of the speakers as far as 10 feet away; smaller objects must be closer. The rate of movement also makes a difference in the detection range of the circuit. A faster moving object will produce a greater output and will be detected at a greater range. ■

## HAM RADIO

(Continued from page 79)

tenna input terminal of the receiver. In any transmission line, the load impedance will be "reflected" every half wavelength along the line. When the line is exactly an electrical half wavelength, the input impedance looking into the

line is the same as the load impedance.

In the half-wavelength shorted stub, the load impedance is zero ohms because of the short circuit. That zero-ohm impedance is reflected every half wavelength, so appears across the input end of the line. Thus, because the physical length that creates an electrical half wave-

length is frequency dependent, the "short" appears only at the resonant half wavelength of:

$$L_{\text{inches}} = 5904 V / f_{\text{MHz}}$$

where  $L_{\text{inches}}$  is the length of the transmission line in inches,  $f_{\text{MHz}}$  is the offending frequency in MHz, and  $V$  is the velocity factor of the transmission line (use 0.66 for polyethylene line, and 0.80 for foam line). Always use the same type of line for the stub that you used for the transmission line.

In UHF systems, you can also use a tuned cavity (Fig. 4). They act very much like a shorted, half-wavelength stub at a single frequency, and can be tuned. A tuned cavity can be bought commercially by some repeater operators, but they are very expensive. They are also sometimes available on the surplus market and at hamfests. Older editions of *The Radio Amateur's Handbook*

and *The Radio Amateur's VHF Manual* (both ARRL publications) had instructions for building your own, so a little research might yield good results.

Another pricey, but otherwise attractive, solution is the new Model APS-204 bandpass filter (from Optoelectronics, 5821 N.E. 14th Avenue, Fort Lauderdale, FL, 33334; Tel. 305-771-2050). That high-Q, six-octave, tunable bandpass filter maintains a constant 4-MHz bandwidth over a range of 20 to 1,000 MHz. It's an active filter, so it produces no insertion loss—the normal bane of filter users. Don't bother asking about the APS-204 unless you can go the price: \$995. I suspect that repeater operators with a real problem will find it cheap, however, because many of the other solutions to severe problems cost a similar amount, or more. ■



The Optoelectronics APS-204 six-octave, tunable, bandpass filter maintains a constant 4-MHz bandwidth over a range of 20 to 1000 MHz.

# ELECTRONICS MARKET PLACE

## FOR SALE

**CABLE descrambler liquidation.** Major makes and models available. Industry pricing! (Example: Hamlin Combo's, \$44 each... Minimum 10 orders). Call **WEST COAST ELECTRONICS**, 1 (800) 628-9656.

**CABLE** descramblers (Jerrold) from \$40.00. Tocom VIP test chip. Fully activates unit. \$50.00. Call (213) **867-0081**.

**PRINTED** circuit boards — etched, drilled, tin plated. Single sided \$1.25/sq. inch. Free shipping. **CHELCO ELECTRONICS**, 61 Water Street, Mayville, NY 14757. (716) 753-3200.

**CONVERTERS** all major brands info + orders 1 (800) 782-0552 **FREEWAY INC.** (s.m.p.), PO Box 5036, Burnsville, MN 55337. No MN sales.

**LEARNING** electronics troubleshooting? Basic electronics simulations and problems program can help. PC/MSDOS \$32.95 **EES-PE7**, POB 1391, Lubbock, TX 79408.

## CLASSIFIED AD ORDER FORM

To run your own classified ad, put one word on each of the lines below and send this form along with your check to:

**Popular Electronics Classified Ads**, 500-B Bi-County Boulevard, Farmingdale, N.Y. 11735

**PLEASE INDICATE** in which category of classified advertising you wish your ad to appear. For special headings, there is a surcharge of **\$11.00**.

- ( ) Plans/Kits ( ) Business Opportunities ( ) For Sale  
 ( ) Education/Instruction ( ) Wanted ( ) Satellite Television  
 ( )

Special Category: \$11.00

### PLEASE PRINT EACH WORD SEPARATELY, IN BLOCK LETTERS.

(No refunds or credits for typesetting errors can be made unless you clearly print or type your copy.) Rates indicated are for standard style classified ads only. See below for additional charges for special ads. **Minimum: 15 words.**

1	2	3	4	5
6	7	8	9	10
11	12	13	14	15 (\$23.25)
16 (\$24.80)	17 (\$26.35)	18 (\$27.90)	19 (\$29.45)	20 (\$31.00)
21 (\$32.55)	22 (\$34.10)	23 (\$35.65)	24 (\$37.20)	25 (\$38.75)
26 (\$40.30)	27 (\$41.85)	28 (\$43.40)	29 (\$44.95)	30 (\$46.50)
31 (\$48.05)	32 (\$49.60)	33 (\$51.15)	34 (\$52.70)	35 (\$54.25)

We accept MasterCard and Visa for payment of orders. If you wish to use your credit card to pay for your ad fill in the following additional information (Sorry, no telephone orders can be accepted.):

Card Number \_\_\_\_\_ Expiration Date \_\_\_\_\_

PRINT NAME \_\_\_\_\_

SIGNATURE \_\_\_\_\_

**IF YOU USE A BOX NUMBER YOU MUST INCLUDE YOUR PERMANENT ADDRESS AND PHONE NUMBER FOR OUR FILES. ADS SUBMITTED WITHOUT THIS INFORMATION WILL NOT BE ACCEPTED.**

**CLASSIFIED COMMERCIAL RATE:** (for firms or individuals offering commercial products or services) \$1.55 per word prepaid (no charge for ZIP code)...**MINIMUM 15 WORDS.** 5% discount for same ad in 6 issues within one year; 10% discount for 12 issues within one year if prepaid. **NON-COMMERCIAL RATE:** (for individuals who want to buy or sell a personal item) \$1.25 per word, prepaid...no minimum. **ONLY FIRST WORD AND NAME** set in bold caps at no extra charge. Additional bold face (not available as all caps) **30¢ per word additional.** Entire ad in boldface, \$1.85 per word. **TINT SCREEN BEHIND ENTIRE AD:** \$1.90 per word. **TINT SCREEN BEHIND ENTIRE AD PLUS ALL BOLD FACE AD:** \$2.25 per word. **EXPANDED TYPE AD:** \$2.05 per word prepaid. Entire ad in boldface, \$2.45 per word. **TINT SCREEN BEHIND ENTIRE EXPANDED TYPE AD:** \$2.55 per word. **TINT SCREEN BEHIND ENTIRE EXPANDED TYPE AD PLUS ALL BOLD FACE AD:** \$2.95 per word. **DISPLAY ADS:** 1" x 2 1/4"—\$205.00; 2" x 2 1/4"—\$410.00; 3" x 2 1/4"—\$615.00. **General Information:** Frequency rates and prepayment discounts are available. **ALL COPY SUBJECT TO PUBLISHERS APPROVAL. ADVERTISEMENTS USING P.O. BOX ADDRESS WILL NOT BE ACCEPTED UNTIL ADVERTISER SUPPLIES PUBLISHER WITH PERMANENT ADDRESS AND PHONE NUMBER.** Copy to be in our hands on the 18th of the fourth month preceding the date of issue (i.e., Sept. issue copy must be received by May 18th). When normal closing date falls on Saturday, Sunday or Holiday, issue closes on preceding work day. Send for the classified brochure. Circle Number 49 on the Free Information Card.

## CALL DOCTOR DESCRAMBLER

...for symptoms relating to scrambled cable T.V. signals. We have **JERROLD • TOCOM • ZENITH • HAMLIN OAK • SCIENTIFIC ATLANTA.** Six month warranty! We ship C.O.D. Lowest retail/wholesale prices. **FREE CATALOG:** Global Cable Network 1032 Irving St. Ste 109 S.F., CA 94122 **NO CALIFORNIA SALES!!! OPEN SATURDAYS**



**1-800-327-8544**

**UNDERSTANDING Telecommunications** by Ronald R. Thomas (W8QYR). A single-source reference to the entire field of telecommunications. Available from **Tab Books**, Blue Ridge Summit, PA 17294-0850.

**DESCRAMBLERS**, cable TV converters, **lowest prices**, guaranteed, best quality, special Sacramento units, **CNC CONCEPTS INC.**, Box 34503, Minneapolis, MN 55434. 1 (800) 535-1843.

**CABLE** descramblers, all types, absolutely the lowest prices — call us last! Money back guarantee. No CA sales! **ADVANCED ELECTRONICS**, 1 (800) 659-3018.

## CB RADIO OWNERS!

We specialize in a wide variety of technical information, parts and services for CB radios. 10-Meter and FM conversion kits, repair books, plans, high-performance accessories. Thousands of satisfied customers since 1976! Catalog \$2

**CBC INTERNATIONAL**  
P.O. BOX 31500PE, PHOENIX, AZ 85046

**DRUG** raid seizures! Buy dirt cheap autos, houses, equipment — everything — guaranteed! Details: rush stamped envelope: **Dept. DRS**, Box 11384, Norfolk, VA 23517.

**FOR** sale: Panasonic professional monitors model CT-1330M, refurbished — 90 days warranty by **NIVIE ELETRONICS**, — \$190.00. (718) 230-9600.

## FREE CATALOG

**FAMOUS "FIRESTIK" BRAND CB ANTENNAS AND ACCESSORIES. QUALITY PRODUCTS FOR THE SERIOUS CB'er. SINCE 1962**  
**FIRESTIK ANTENNA COMPANY**  
2614 EAST ADAMS  
PHOENIX, ARIZONA 85034

AUGUST 1991

**Quality Microwave TV Antennas**

WIRELESS CABLE - IFTS - MMDS - Amateur TV  
Ultra High Gain 50db(+) • Tuneable 1.9 to 2.7 Ghz.

- 36-Channel System Complete \$149.95
- 12-Channel System Complete \$114.95
- Call or write (SASE) for "FREE" Catalog

**PHILLIPS-TECH ELECTRONICS**  
P.O. Box 8533 • Scottsdale, AZ 85252  
(602) 947-7700 (\$3.00 Credit all phone orders)  
MasterCard • Visa • COD's • Quantity Pricing

LIFETIME WARRANTY

**COMPLETE IBM computer system**, new, 640K memory with keyboard, monitor, two drives, \$495.00 one year warranty. Send \$5.00 for information. **THE DATA FACTORY**, 7433 Kaiser, Fontana, CA 92336.

**ASSORTED bulk software** at huge savings, 5 disk full \$10.00, 10 disk full \$18.00, 20 disk bonanza only \$25.00, 40 MB of VGA games on DC2000 mini tape for Colorado memory tape backup only \$89.00. We can furnish programs by bulk in any form. \$5.00 for info. **THE DATA FACTORY**, 7433 Kaiser, Fontana, CA 92336.

**STARCON VI VII stock Oak combo** with remote \$169.00 scientific Tocom 1 (800) 688-8736 **CABLE CITY**.

## PLANS & KITS

**HOBBY/broadcasting/ham/CB/surveillance transmitters**, amplifiers, cable TV, science, bugs, other great projects! Catalog \$1.00 **PANAXIS**, Box 130-HB, Paradise, CA 95967.

**BUILD** — five-digit, ohms, capacitance, frequency, pulse, multimeter. Board, and instructions \$9.95. **BAGNALL ELECTRONICS**, 179 May, Fairfield, CT 06430.

**SURVEILLANCE TELEPHONE**

Monitor room conversations \$175.00  
Monitor room & telephone conversations \$275.00  
Dialer tap, calls you when phone is used \$305.00

Available in the telephone or small plastic case

Range Unlimited - 6 month warranty - Phone Tap Catalog \$3.00  
LISTEN ELECTRONICS, 603 Elgin, Muskogee, OK 74401  
1-800-633-TAPS

**MINIATURE FM transmitters!** Tracking transmitters! Voice disguisers! Bug detectors! Phone devices! More! Available as kits or assembled and tested! Catalog \$2.00 (refundable): **XANDI ELECTRONICS**, Box 25647, Dept. 32G, Tempe, AZ 85285-5647.

**DAZER Personal protectors!** Lasers! AM/FM/infrared transmitters! Detectors! More! Kits/assembled. Catalog \$2.00. **QUANTUM RESEARCH**, 16645-113 Avenue, Edmonton, Alberta T5M 2X2.

**SURVEILLANCE** — Audio/video/infra-red/laser. Law enforcement, industrial, private. 500 item catalog \$7.00. **SECURITY SYSTEMS**, 3017F Hudson, New Orleans, LA 70131.

**RECEIVER plans, kits.** Simple to sophisticated. Thorough explanations included. All bands. Catalog and sample schematics \$3.00. **PREMIER ENTERPRISES**, 3850 Plymouth Blvd., Suite 104, Plymouth, MN 55446.



Get a handle on your soldering. Gets your hand closer to your work. Steadier, \$5.00 Postpaid, Check or M.O.  
**R.L. PRODUCTS**  
P.O. Box 743, Hayesville, N.C. 28904

**SAVE** your ni-cad's. Power pack charger automatically deep cycles and charges. Information \$1.00. Circuit board kit \$35.00. Complete kit \$70.00. California residents add 6%. \$5.00 shipping per order. **R. DANA NEGLE**, 8032 Levering Way, Sacramento, CA 95823.

## CABLE TV DESCRAMBLERS ★ CONVERTERS ★ and ACCESSORIES.

# SAVE MONEY. DON'T RENT!

PANASONIC,  
PIONEER, JERROLD, OAK,  
SCIENTIFIC ATLANTA  
AND MORE. LOWEST PRICES.  
FREE CATALOG.

**(800) 234-1006**  
**CABLE READY COMPANY**

**REMOTE car starter plan.** 30 pgs. Universal. Simple. Works! \$12.75 **SCHLITZER**, 414 Alva, Grand Prairie, TX 75051.

**SURVEILLANCE** — countermeasures! Guaranteed lowest prices! Huge Catalog \$5.00 (refundable). **PROTECTOR**, PO Box 520294-E, Salt Lake City, Utah 84152.

**SMD** How to use surface mount technology. Build ultra miniature projects! Plans included free, infra red control, and an interesting light display. Send \$15.00 to **CHARLIE'S VIDEO**, Dept SMT, PO 7782, La Sierra, CA 92503.

**ROBOTICS!** Engines! Inventions! Muscle wires contract with surprising strength when powered. Send business SASE for latest flyer. **MONDO-TRONICS**, 2476 Verna Ct. %PE, San Leandro, CA 94577.

**Motion Control System** \$159.00

Includes Computer, Monitor, Keyboard, Power supply, 4 Motors, and Software.  
Call or Send for **Free Robotics Catalog**

**Silicon Valley Surplus** 4222 E. 12th St. Serving you since 1983  
415 261-4506 Oakland Ca. 94601 8 am to 4 pm PST

**FREE** cable and satellite descrambler plans. Send self addressed stamped envelope. **MJH INDUSTRY**, Box 531, Bronx, NY 10461-0208.

**VIDEOCIPHER II** scanner/cable/satellite modifications books. Catalog — \$3.00. **TELECODE**, PO Box 6426-PE, Yuma, AZ 85366-6426.

**TELSA coil plans.** Create fork lightning 50,000V — 1,200,000V... Information \$1.00 **SCIENTIFIC**, Box 1054EG, Duvall, WA 98019.

## ANTIQUE RADIO CLASSIFIED

**Free Sample!**  
Antique Radio's  
Largest Circulation Monthly.  
Articles, Ads & Classifieds.  
6-Month Trial: \$15. 1-Yr: \$27 (\$40-1st Class).  
A.R.C., P.O. Box 802-L8, Carlisle, MA 01741

**Z-80 microcontroller development system.** Explore microprocessor system design, programming and interfacing. Contains on-board Eprom programmer. Instructional projects included. Kit: \$99.00. Include \$2.50 P&H. **THE MARTIAN OUTPOST**, Rt. 1, Box 75, Quemada, TX 78877. SASE free info.

**INFRARED** night viewer, laser gun, plans \$8.00 each. SASE. **TWINTech**, 32 Gorsey Sq., Scarborough, Ont., M1B 1A7.

**SURVEILLANCE transmitter kits!** Four models of each; telephone, room, combination telephone/room transmitters tune from 65 to 305 MHz. Catalog with **Popular Communications** and **Popular Electronics** book reviews of "Electronic Eavesdropping Equipment Design," \$2.00. **SHEFFIELD ELECTRONICS**, 7223A Stony Island Ave., Chicago, IL 60649-2806.

**CONTROL** your PC's speaker. Turn it off or on when desired. Plug in headphones for private listening or an external speaker for extra volume. Easy step-by-step instructions, \$5.00. **DAVIS COMPUTING**, Box 20043-E, Ft. Worth, TX 76102.

**CAPACITANCE meter.** 0.5%, 1% on 1pF, 6 ranges, for all precision caps. Plans \$10.00. **GARY NOVACK**, Rt. 2, Box 139, Highmore, SD 57345.

**EASY** to build electronic home protection unit! Digital display, TTL logic, time delay and more! Send \$5.00 for detailed instructions and schematic! **MURPHY**, PO Box 380872, Miami, FL 33238.

## BEST BY MAIL

Rates: Write National, Box 5, Sarasota, FL 34230

OF INTEREST TO ALL

**44 FREE IBMPC programs**, catalog inexpensive applications, \$1.50: **TexasSD**, Box 233-PE, LaFeria, TX 78559. **CIGARETTES 30 CENTS** Pack. Sources \$2.00. **IRWIN**, Box 2096(EF), Baytown, TX 77522-2096.

**BUSINESS OPPORTUNITIES**

**\$10,000.00 MONTHLY!** TAKING Photos at home. No Experience. Photopro, 21839 Avalon #199-E, Carson, CA 90745. Recorded details: (213)549-0997.

**PERSONAL-MISCELLANEOUS**

**ROMANTIC INTRODUCTIONS. CONFESSIONS.** Fantasies. Secrets. All Lifestyles. 1-900-FUN-1990. \$1.95 minute.

## WANTED

**INVENTORS!** Need help? Call **IMPAC** for free information kit. USA/Canada: 1 (800) 225-5800. (24 hours.)

**INVENTIONS/new products/ideas** wanted: Call **TLCI** for free information 1 (800) 468-7200 24 hours/day — USA/Canada.

**INFORMATION** of portable co alarm kits or assembly. 33 Arrow Street, Winnipeg, Manitoba, Canada R2R 0R6.

**TUBES - 2000 TYPES DISCOUNT PRICES!**

Early, hard-to-find, and modern tubes. Also transformers, capacitors and parts for tube equipment. Send \$2.00 for 28 page wholesale catalog.

**ANTIQUE ELECTRONIC SUPPLY**  
6221 S. Maple Ave. • Tempe, AZ 85283 • 602-820-5411.

**INVENTORS:** Make cash fast, your electronic and electromechanical concept ideas turned into schematics and prototypes super fast, rapid quotes, free information package. **MERLIN TECHNICAL COMPANY**, PO Box 44213, Boise, ID 83711-0213.

**ANTIQUE Telephones**, microphones, parts and related items wanted. Send SASE for working Antique Telephone Brochure. **RUSS PATE**, WB4VNN, 235 Sandpine Road, Indialantic, FL 32903. (407) 777-1759.

## T.V. FILTERS

**T.V. notch filters**, phone recording equipment, brochure \$1.00. **MICRO Thinc.**, Box 63/6025, Margate, FL 33063. (305) 752-9202.

## TEST EQUIPMENT

**SUPER** low prices on computers, motherboards, hard and floppy drives, and add-on cards. We have everything. Full line of test equipment at unbeatable prices. Free catalog. **APPLIED ELECTRONIC RESEARCH INC.**, Ft. Lauderdale, FL 33314. (305) 987-9785.



★★★★ PRESENTING ★★★★★  
**CABLE TV  
 DESCRAMBLERS**  
 ★★★★★ STARRING ★★★★★  
**JERROLD, HAMLIN, OAK**  
 AND OTHER FAMOUS MANUFACTURERS

- FINEST WARRANTY PROGRAM AVAILABLE
- LOWEST RETAIL / WHOLESALE PRICES IN U.S.
- ORDERS SHIPPED FROM STOCK WITHIN 24 HRS.
- ALL MAJOR CREDIT CARDS ACCEPTED

FOR FREE CATALOG ONLY 1-800-345-8927  
 FOR ALL INFORMATION 1-818-709-9937

**PACIFIC CABLE CO., INC.**  
 7325 1/2 Reseda Blvd., Dept. 2005  
 Reseda, CA 91335

### SATELLITE TV

FREE catalog — Do-it-yourself save 40—60%  
 Lowest prices world wide, systems, upgrades,  
 parts, all major brands factory fresh and warranted.  
**SKYVISION**, 2008 Collegeway, Fergus Falls, MN  
 56537. 1 (800) 334-6455.

LPTV transmitters. Attention Mexico and Latin  
 America, for communities outside U.S.A. and Canada,  
 low power TV transmitters, to serve towns and  
 little cities TV from satellite dishes call: (62) 150199  
 (Mexico), Write: **ELECTRONICA SONORA**, 252  
 Grand Ave., Nogales, AZ 85621.

**FREE CATALOG!**  
**1-800-648-7938**  
**JERROLD HAMLIN OAK ETC**  
**CABLE TV  
 DESCRAMBLERS**

- Special Dealer Prices!
- Compare our Low Retail Prices!
- Guaranteed Prices & Warranties!
- Orders Shipped Immediately!

**REPUBLIC CABLE PRODUCTS, INC.**  
 4080 Paradise Rd. #15, Dept. PE891  
 Las Vegas, NV 89109  
 For all other information (702) 362-9026

### CABLE EQUIPMENT

CABLE TV secrets — the outlaw publication the  
 cable companies tried to ban. HBO, Movie Channel,  
 Showtime, descramblers, converters, etc. Sup-  
 pliers list included. \$9.95. **CABLE FACTS**, Box 711-  
 H, Pataskala, OH 43062.

**CABLE DESCRAMBLERS  
 OAK M35B COMBO \$39.95**

Jerrold, Zenith, Hamlin, Sci. Atlanta, Pioneer  
 & MORE! OUR PRICES ARE BELOW WHOLESALE!

**CABLE + PLUS**  
 14417 Chase St. #481-B Panorama City, CA 91402  
 1-800-822-9955 • Other Info. 1-818-785-4500  
 NO CALIF. SALES — DEALERS WANTED

### BUSINESS OPPORTUNITIES

**YOUR own radio station!** Licensed/unlicensed.  
 AM, FM, TV, cable. Information \$1.00 **BROAD-  
 CASTING**, Box 130-H8, Paradise, CA 95967.

**EASY work!** Excellent pay! Assemble products at  
 home. Call for information (504) 641-8003 Ext.  
 5730.

**HOME assembly work available!** Guaranteed easy  
 money! Free details! **HOMEWORK-P**, Box 520,  
 Danville, NH 03819.

**UNLIMITED income** operating your own business.  
 Opportunity is knocking. Free information:  
**JUPITER ENTERPRISES**, PO Box 541782 Dept. R,  
 Dallas, TX 75354-1782.

**Great money in VCR repair!**  
 Home study. Learn high-profit repairs  
 without investing in high-tech instruments.  
**FREE BOOKLET: 800-223-4542.**

Name \_\_\_\_\_  
 Address \_\_\_\_\_  
 City \_\_\_\_\_ State \_\_\_\_\_ Zip \_\_\_\_\_

The School of VCR Repair, 2245 Perimeter  
 Park, Dept. VJ341 Atlanta, Georgia 30341



**MAKE \$50.00/hr** working evenings or weekends in  
 your own electronics business. Send for free facts.  
**MJPI INDUSTRY**, Box 531, Bronx, NY 10461.

**MAKE \$75,000.00 to \$250,000.00** yearly or more  
 fixing IBM color monitors. No investment, start  
 doing it from your home (a telephone required).  
 Information, USA, Canada \$2.00 cash for bro-  
 chure, other countries \$10.00 US funds. **RAN-  
 DALL DISPLAY**, Box 2168-H, Van Nuys, CA  
 91404, USA.

**MAKE \$\$\$!** Become an American electronics deal-  
 er! Profit opportunities since 1965. Call **WAYNE  
 MARKS**, 1 (800) 872-1373.

**BIG PROFITS** **ELECTRONIC  
 ASSEMBLY BUSINESS**

Start home spare time. Investment knowledge or  
 experience unnecessary. **BIG DEMAND** assem-  
 bling electronic devices. Sales handled by profes-  
 sionals. Unusual business opportunity.

**FREE:** Complete illustrated literature  
 BARTA PE 00 Box 248  
 Walnut Creek Calif. 94597

AC/DC VOLTAGE **KELVIN 200**  
 AC/DC CURRENT  
 RESISTANCE DIODE TEST \$39.95  
 LOW BATTERY Warning  
 ACCURACY +/- 0.5%  
 CONTINUITY TEST/BUZZER  
 TRANSISTOR CHECKER Stock No. 990091  
 CAPACITANCE CHECKER

**KELVIN Electronics** VISA MC  
 7 Fairchild Ave., Plainville, NY 11803  
 (516) 349-7620 1(800) 645-9212



### EDUCATION/INSTRUCTION

VCR repair. Save money — make big profits! Learn  
 how from *How to Keep Your VCR Alive*. "This de-  
 tailed, step-by-step manual enables anyone with no  
 previous knowledge or experience to fix most VCR  
 problems easily, quickly, and inexpensively with a  
 few simple tools." — *Small Press Review*. Highly  
 recommended by *Popular Electronics*, *Modern  
 Electronics*, *Popular Communications*, *Electronic  
 Servicing*, *Videomaker*, *Library Journal*, and many  
 other electronics and video magazines. "Far better  
 than Viejo at 1/7 the cost." 400+ page book, with  
 724 illustrations, plus professional head-cleaning  
 tool. Check B. Daltons and Waldenbooks. Or mail  
 \$24.95 to **WORTHINGTON PUBLISHING**, PO Box  
 16691H, Tampa, FL 33687-6691. Or call 1 (800)  
 233-8277 toll-free for Visa or MC. Money-back satis-  
 faction guarantee!

**LEARN IBM PC assembly language.** 80 programs.  
 Disk \$5.00, book \$18.00. **ZIPFAST**, Box 12238, Lex-  
 ington, KY 40581-2238.

**I'LL HAVE MINE  
 DESCRAMBLED**



If you find a better deal, We'll beat  
 it! **JERROLD • TOCOM • HAMLIN •  
 OAK • SCIENTIFIC ATLANTA •  
 ZENITH** • ask about our warranty  
 program C.O.D. Visa, M/C, AM.EX.  
 welcome. **FREE CATALOG •  
 FREE CALL •  
 OPEN SATURDAYS**  
**1 800 562-6884**  
 VIDEO TECH  
 3702 S. Virginia St. Ste. 160-304  
 Reno, NV 89602

**TALK radio fans.** Don't miss favorite shows. Rec-  
 ord on your VCR up to 8 hrs. Booklet tells how. Send  
 \$10.00 to: **BROOKSIDE INNOVATIONS**, Box 62,  
 Martinsville, NJ 08836.

**COLLEGE degrees** by home study. Bachelor's,  
 Master's, PhD's, etc. Fully accredited, credit given  
 for life experience. Free academic counseling. For  
 information, send \$2.00 to: **ADULT RESOURCES**,  
 Box 291703, Ft. Lauderdale, FL 33329.

**WHY PAY SKY  
 HIGH MONTHLY  
 FEES?**



If you find a better deal, We'll beat it!  
**JERROLD • TOCOM • HAMLIN • OAK •  
 SCIENTIFIC ATLANTA • ZENITH** •  
 ask about our warranty program C.O.D.  
 Visa, M/C, AM.EX. welcome. **FREE  
 CATALOG • FREE CALL • OPEN SAT-  
 URDAYS**

GT 1464 Garner Station Blvd #315 Raleigh,  
 NC 27603

**1 800 328-0198**

**ANNOUNCING:**  
 AN END  
 TO  
 HIGH MONTHLY  
 CABLE FEES!



All Jerrold, Oak, Hamlin, Zenith, Scientific At-  
 lanta, Magnavox and all specialized cable equip-  
 ment available for shipment within 24 hours. For  
 fast service MC/VISA or C.O.D. telephone or-  
 ders accepted. 60 Day Guarantee (Quantity Dis-  
 counts). Send self-addressed Stamped envel-  
 ope.

**VISA C.O.D. ORDERS  
 ACCEPTED**

**CABLE-TRONICS, INC.**  
 1304 E. Algonquin Road Suite 501  
 Algonquin, Illinois 60102

**CABLE TV  
 "BOXES"**

**Converters — Descramblers  
 Remote Controls — Accessories**

- Guaranteed Best Prices
- 1 Year Warranty — C.O.D.s
- Immediate Shipping
- FREE CATALOG

Call or Write  
**NAS/TRANSWORLD**  
 3958 Northlake Blvd., Suite 255  
 Lake Park, FL 33403  
 1-800-442-9333



## ADVERTISING INDEX

POPULAR ELECTRONICS magazine does not assume any responsibility for errors that may appear in the index below.

Free Information No.	Page	—	ISCET	81
6	AMC Sales	81	Kelvin	91
—	Amazing Concepts	19	Listen Electronics	90
—	Antique Electronic Supply	90	Monitoring Times	79
—	Antique Radio Classified	90	Mouser	19
—	Barta	91	NAS/TransWorld	91
—	CBC International	89	NPEC	92
—	CIF	17	NRI Schools	9
—	Cable Plus	91	Protel Technology	23
—	Cable Ready Company	90	Pacific Cable	91
—	Cable-Tronics	91	Panavise	11
—	Command Productions	77	P.E. Reprint Bookstore	85
11	Cook's Institute	73	Phillips Tech.	90
—	Electronic Tech. Today	18, 22	R-E Video	CV3
—	Electronic Tech. Today	CV2	RI Products	90
—	Electronics Book Club	3, 24	Republic Cable	91
—	Firestik II	89	SCO Electronics	73
—	GTV	91	Silicon Valley Surplus	90
—	Global Cable Network	89	The School of VCR Repair	91
—	Grantham College	21	Video Tech	91
14	Heathkit	13	Viejo Publications	69
5	Howard W. Sams & Co.	5	Windjammer	CV4

### ADVERTISING SALES OFFICE

Gernsback Publications, Inc.  
500-B Bi-County Blvd.  
Farmingdale, NY 11735  
1-(516) 293-3000  
President: **Larry Steckler**  
Assistant to the President: **Christina Estrada**

**For Advertising ONLY**  
516-293-3000  
Fax 1-516-293-3115

**Larry Steckler**  
publisher

**Arlene Fishman**  
advertising director

**Denise Haven**  
advertising assistant

**Kelly McQuade**  
credit manager

**Customer Service/Order Form**  
1-800-435-0715  
1-800-892-0753  
7:30 AM - 8:30 PM EST

#### SALES OFFICES

##### EAST/SOUTHEAST

**Stanley Levitan**, Eastern Sales Manager  
259-23 57th Avenue  
Little Neck, NY 11362  
1-718-428-6037, 1-516-293-3000  
Fax 1-718-225-8594

##### MIDWEST/Texas/Arkansas/Okla.

**Ralph Bergen**, Midwest Sales Manager  
540 Frontage Road—Suite 204  
Northfield, IL 60093  
1-708-446-1444  
Fax 1-708-559-0562

##### PACIFIC COAST/Mountain States

**Marvin Green**, Pacific Sales Manager  
5430 Van Nuys Blvd, Suite 316  
Van Nuys, CA 91401  
1-818-986-2001  
Fax 1-818-986-2009

# HANDS-ON TECHNICAL SEMINARS FOR PROFESSIONALS

**“Servicing the Video Laser Disc Player” - EIA / CEG**

**“Hot-Air Soldering Techniques” - Thomson Consumer Electronics**

**“Advanced Digital Circuitry - Digital TV” - Toshiba America, Inc.**

**“Troubleshooting Tough VCR Mechanical and Electronic Problems” -  
Tentel Corp. and Sencore, Inc.**

**“Microprocessor Controls - Troubleshooting Techniques Using the Mitsubishi  
Wide-Screen Simulator” - Mitsubishi Electronics America**

Courses **FREE** when registered at the National Professional Electronics Convention  
August 5-11, 1991; Nugget Resort, Reno NV.

**Full \$230 Registration (at door) includes:**

- |                                                                                                                                                                                                                       |                                                                                                                                                                                                                                                                                                            |
|-----------------------------------------------------------------------------------------------------------------------------------------------------------------------------------------------------------------------|------------------------------------------------------------------------------------------------------------------------------------------------------------------------------------------------------------------------------------------------------------------------------------------------------------|
| <ul style="list-style-type: none"> <li>• All Technical Training Seminars (limited seating)</li> <li>• All Management and Business Seminars</li> <li>• Continuing Education units for all seminars attended</li> </ul> | <ul style="list-style-type: none"> <li>• Two Day Trade Show</li> <li>• Head-to-head Meetings with Manufacturers' National Service Managers</li> <li>• All Sponsored Meals and Functions</li> <li>• NESDA / ISCET Association Meetings</li> <li>• Price discounts available for pre-registration</li> </ul> |
|-----------------------------------------------------------------------------------------------------------------------------------------------------------------------------------------------------------------------|------------------------------------------------------------------------------------------------------------------------------------------------------------------------------------------------------------------------------------------------------------------------------------------------------------|

Sponsored by the National Electronic Sales & Service Dealers Association  
and the International Society of Certified Electronics Technicians

### For more information, contact NPEC '91

2708 W. Berry St., Fort Worth, TX 76109-2356  
(817) 921-9061; fax (817) 921-3741

**Never before has so much professional information on the art of detecting and eliminating electronic snooping devices—and how to defend against experienced information thieves—been placed in one VHS video. If you are a Fortune 500 CEO, an executive in any hi-tech industry, or a novice seeking entry into an honorable, rewarding field of work in countersurveillance, you must view this video presentation again and again.**

*Wake up!* You may be the victim of stolen words—precious ideas that would have made you very wealthy! Yes, professionals, even rank amateurs, may be listening to your most private conversations.

*Wake up!* If you are not the victim, then you are surrounded by countless victims who need your help if you know how to discover telephone taps, locate bugs, or “sweep” a room clean.

There is a thriving professional service steeped in high-tech techniques that you can become a part of! But first, you must know and understand Countersurveillance Technology. Your very first insight into this highly rewarding field is made possible by a video VHS presentation that you cannot view on broadcast television, satellite, or cable. It presents an informative program prepared by professionals in the field who know their industry, its techniques, kinks and loopholes. Men who can tell you more in 45 minutes in a straightforward, exclusive talk than was ever attempted before.

### Foiling Information Thieves

Discover the targets professional snoopers seek out! The prey are stock brokers, arbitrage firms, manufacturers, high-tech companies, any competitive industry, or even small businesses in the same community. The valuable information they filch may be marketing strategies, customer lists, product formulas, manufacturing techniques, even advertising plans. Information thieves eavesdrop on court decisions, bidding information, financial data. The list is unlimited in the mind of man—especially if he is a thief!

You know that the Russians secretly installed countless microphones in the concrete work of the American Embassy building in Moscow. They converted



**HAVE YOUR  
VISA or MC CARD  
AVAILABLE**

what was to be an embassy and private residence into the most sophisticated recording studio the world had ever known. The building had to be torn down in order to remove all the bugs.

### Stolen Information

The open taps from where the information pours out may be from FAX's, computer communications, telephone calls, and everyday business meetings and lunchtime encounters. Businessmen need counselling on how to eliminate this information drain. Basic telephone use coupled with the user's understanding that someone may be listening or recording vital data and information greatly reduces the opportunity for others to purloin meaningful information.

The professional discussions seen on the TV screen in your home reveals how to detect and disable wiretaps, midget radio-frequency transmitters, and other bugs, plus when to use disinformation to confuse the unwanted listener, and the technique of voice scrambling telephone communications. In fact, do you know how to look for a bug, where to look for a bug, and what to do when you find it?

Bugs of a very small size are easy to build and they can be placed quickly in a matter of seconds, in any object or room. Today you may have used a telephone handset that was bugged. It probably contained three bugs. One was a phony bug to fool you into believing you found a bug and secured the telephone. The second bug placates the investigator when he finds the real thing! And the third bug is found only by the professional, who continued to search just in case there were more bugs.

The professional is not without his tools. Special equipment has been designed so that the professional can sweep a room so that he can detect voice-activated (VOX) and remote-activated bugs. Some of this equipment can be operated by novices, others require a trained countersurveillance professional.

The professionals viewed on your television screen reveal information on the latest technological advances like laser-beam snoopers that are installed hundreds of feet away from the room they snoop on. The professionals disclose that computers yield information too easily.

This advertisement was not written by a countersurveillance professional, but by a beginner whose only experience came from viewing the video tape in the privacy of his home. After you review the video carefully and understand its contents, you have taken the first important step in either acquiring professional help with your surveillance problems, or you may very well consider a career as a countersurveillance professional.

### The Dollars You Save

To obtain the information contained in the video VHS cassette, you would attend a professional seminar costing \$350-750 and possibly pay hundreds of dollars more if you had to travel to a distant city to attend. Now, for only \$49.95 (plus \$4.00 P&H) you can view *Countersurveillance Techniques* at home and take refresher views often. To obtain your copy, complete the coupon below or call toll free.

<b>RADIO-ELECTRONICS VIDEO OFFER</b>		<b>PE</b>
500-B Bi-County Blvd. Farmingdale, NY 11735		
Please rush my copy of the Countersurveillance Techniques Video VHS Cassette for \$49.95 plus \$4.00 for postage and handling.		
No. of Cassettes ordered _____	Amount of payment \$ _____	
Bill my <input type="checkbox"/> VISA <input type="checkbox"/> MasterCard	Card No. _____	
Expire Date _____ / _____	Signature _____	
Name _____	Address _____	
City _____	State _____	ZIP _____
All payments in U.S.A. funds. Canadians add \$4.00 per VHS cassette. No foreign orders. New York State residents add applicable sales tax.		

# East of the sun. West of the moon. Windjammer.



A place to live your fantasies.  
A place to free your soul.  
To cozy up to the Caribbean sun.  
To dance among a thousand stars  
to the rhythms of steel drums.  
To play on sparkling white and  
pink sand beaches.  
To discover the underwater  
paradise of the reefs.  
To find a new friend and share the  
intimacies of a sensuous night.  
To come alive and live.  
To remember for a lifetime.

6 days and 6 nights. From \$675.

Reservations toll free  
1-800-327-2600  
In Florida 305/373-2090.

**Windjammer  
Barefoot Cruises**

Post Office Box 120,  
Miami Beach, Florida 33119.



Cap'n Mike, rush me my free, full color 'Great Adventure' booklet and show  
me the way to Paradise for 6 days and 6 nights from \$675.  
Windjammer 'Barefoot' Cruises  
P.O. Box 120, Dept. 1642 Miami Beach, Fla. 33119

Name \_\_\_\_\_  
Address \_\_\_\_\_  
City \_\_\_\_\_  
State/Zip \_\_\_\_\_