

Popular Electronics

JUNE 1991

A New Decade In Consumer Electronics
Fuzzy logic, interactive video, DCC, and other new technologies promise consumers plenty of high-tech excitement for the 1990's

Experiments in Electrochemistry
Changing colors, beautiful streamers, and metallic gardens are just some of the wonders you'll find when you perform these fun experiments

Build The ProtoMax Prototyping Workstation
Designing, testing, and troubleshooting circuits is a snap when everything you need is at your fingertips

Build The Access III
A telephone-operated, remote power switch for your computer

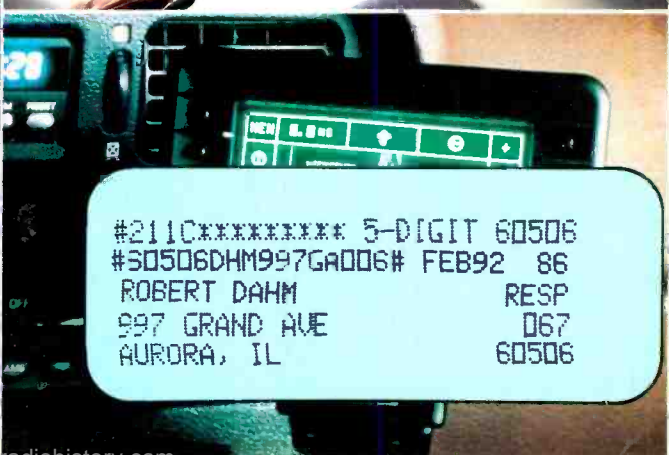

#211C***** 5-DIGIT 60506
#30506DHM997GAD06# FEB92 86
ROBERT DAHM RESP
997 GRAND AVE 067
AURORA, IL 60506



A GERNSBACK PUBLICATION

3 NEW
FactCards
IN THIS ISSUE

\$2.95 U.S.
\$3.75 CANADA



Electronics Paperback Books

GREAT PAPERBACKS AT SPECIAL PRICES

BP248—TEST EQUIPMENT CONSTRUCTION \$5.95. Details construction of simple, inexpensive, but extremely useful test equipment. AF Gen, Test Bench Ampl, Audio Millivoltmeter, Transistor Tester and six more.



BP263—A CONCISE INTRO TO dBASE \$6.95. The dBASE series of programs are probably the best known database programs for microcomputers. This book is designed to help you get started working with them.



BP267—HOW TO USE OSCILLOSCOPES AND OTHER TEST EQUIPMENT \$6.95. Mastering the oscilloscope is not really too difficult. This book explains all the standard controls and functions. Other equipment is also described.



BP265—MORE ADVANCED USES OF THE MULTIMETER \$5.95. Use these techniques to test and analyze the performance of a variety of components. Also see how to build add-ons to extend multi-meter capabilities.



BP256—INTRO TO LOUDSPEAKERS AND ENCLOSURE DESIGN \$5.95. We explore the variety of enclosure and speaker designs in use today, so the reader can understand the principles involved.

BP260—CONCISE INTRO TO OS/2 \$5.95. If you are a multitasking PC user and want to get the most out of your computer, then you must learn its OS/2 operating system. This book shows you just how to do that, quickly and easily.



BP249—MORE ADVANCED TEST EQUIPMENT CONSTRUCTION \$6.95. Eleven more test equipment construction projects. They include a digital voltmeter, capacitance meter, current tracer and more.



Digital Audio Projects



BP245—DIGITAL AUDIO PROJECTS \$5.95. Practical circuits to build and experiment with. Includes A/D converter, input amplifier, digital delay line, compander, echo effect and more.

BP247—MORE ADVANCED MIDI PROJECTS \$5.95. Circuits included are a MIDI indicator, THRU box, merge unit, code generator, pedal, programmer, channelizer, and analyzer.



BP257—INTRO TO AMATEUR RADIO \$6.95. Amateur is a unique and fascinating hobby. This book gives the newcomer a comprehensive and easy to understand guide to the subject.



PCP102—INTRODUCING DIGITAL AUDIO \$9.95. Covers all kinds of digital recording methods—CD, DAT and Sampling. Bridges the gap between the technician and the enthusiast. Principles and methods are explained.

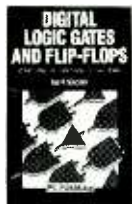

PCP107—DIGITAL LOGIC GATES AND FLIP FLOPS \$10.00. Thorough treatment of gates and flip-flops for enthusiasts, student and technicians. Only a basic knowledge of electronics is needed.

BP251—COMPUTER LOGIC GATES AND FLIP FLOPS \$8.95. A wrapup of everything the computer hobbyist needs to know in one easy to use volume. Provides a range of useful reference material in a single source.

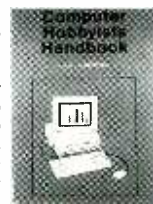

PCP108—COMPUTERS AND MUSIC \$9.95. Explains the basics of computers and music with no previous knowledge of computers needed. Covers types of music software and explains how to set up your own computer music studio.

- BP195—INTRODUCTION TO SATELLITE TV**..... \$9.95. A definitive introduction to the subject written for the professional engineer, electronics enthusiast, or others who want to know more before they buy. 8 x 10 in.
- BP190—ADVANCED ELECTRONIC SECURITY PROJECTS**.....\$5.95. Includes a passive infra-red detector, a fiber-optic loop alarm, computer-based alarms and an unusual form of ultrasonic intruder detector.
- BP235—POWER SELECTOR GUIDE**.....\$10.00. Complete guide to semiconductor power devices. More than 1000 power handling devices are included. They are tabulated in alpha-numeric sequence, by technical specs. Includes power diodes, Thyristors, Triacs, Power Transistors and FET's.
- BP234—TRANSISTOR SELECTOR GUIDE**.....\$10.00. Companion volume to BP235. Book covers more than 1400 JEDEC, JIS, and brand-specific devices. Also contains listing by case type, and electronic parameters. Includes Darlington transistors, high-voltage devices, high-current devices, high power devices.
- BP99—MINI-MATRIX BOARD PROJECTS**.....\$5.50. Here are 20 useful circuits that can be built on a mini-matrix board that is just 24 holes by ten copper-foil strips.
- BP82—ELECTRONIC PROJECTS USING SOLAR CELLS**.....\$5.50. Circuits with applications around the home that are powered by the energy of the sun. Everything from radio receivers, to a bicycle speedometer, to timers, audio projects and more.
- BP117—PRACTICAL ELECTRONIC BUILDING BLOCKS—Book 1**.....\$5.75. Oscillators, Timers, Noise Generators, Rectifiers, Comparators, Triggers and more.
- BP184—INTRO TO 68000 ASSEMBLY LANGUAGE**.....\$6.95. The 68000 is a great new breed of microprocessor. Programming in assembly language increases the running speed of your programs. Here's what you need to know.

BP179—ELECTRONIC CIRCUITS FOR THE COMPUTER CONTROL OF ROBOTS \$7.50. Data and circuits for interfacing the computer to the robot's motors and sensors

- BP239—GETTING THE MOST FROM YOUR MULTIMETER**..... \$5.95. Covers basics of analog and digital meters. Methods of component testing includes transistors, thyristors, resistors, capacitors and other active and passive devices
- BP97—IC PROJECTS FOR BEGINNERS**.....\$5.50. Power supplies, radio and audio circuits, oscillators, timers, switches, and more. If you can use a soldering iron you can build these devices.
- BP37—50 PROJECTS USING RELAYS, SCR'S & TRIACS**.....\$5.50. Build priority indicators, light modulators, warning devices, light dimmers and more.
- RADIO—100 RADIO HOOKUPS**.....\$3.00. Reprint of 1924 booklet presents radio circuits of the era including regenerative, neodyne, reflex & more.
- BP42—SIMPLE LED CIRCUITS**.....\$5.50. A large selection of simple applications for this simple electronic component.
- BP127—HOW TO DESIGN ELECTRONIC PROJECTS**.....\$5.75. Helps the reader to put projects together from standard circuit blocks with a minimum of trial and error.
- BP122—AUDIO AMPLIFIER CONSTRUCTION**.....\$5.75. Construction details for preamps and power amplifiers up through a 100-watt DC-coupled FED amplifier.
- BP92—CRYSTAL SET CONSTRUCTION**.....\$5.50. Everything you need to know about building crystal radio receivers.
- BP45—PROJECTS IN OPTOELECTRONICS**.....\$5.50. Includes infra-red detectors, transmitters, modulated light transmission and photographic applications.

BP185—ELECTRONIC SYNTHESIZER CONSTRUCTION \$5.95. Use this book to learn how to build a reasonably low cost, yet worthwhile monophonic synthesizer and learn a lot about electronic music synthesis in the process

CHECK OFF THE BOOKS YOU WANT

ELECTRONIC TECHNOLOGY TODAY INC.
P.O. Box 240, Massapequa Park, NY 11762-0240

Name _____
Address _____
City _____ State _____ Zip _____

SHIPPING CHARGES IN USA AND CANADA

\$0.01 to \$5.00	... \$1.25
\$5.01 to 10.00	... \$2.00
\$10.01 to \$20.00	... \$3.00
\$20.01 to \$30.00	... \$4.00
\$30.01 to \$40.00	... \$5.00
\$40.01 to \$50.00	... \$6.00
\$50.01 and above	... \$7.50

SORRY No orders accepted outside of USA & Canada

Number of books ordered

Total price of merchandise \$ _____
Sales Tax (New York State Residents only) \$ _____
Shipping (see chart) \$ _____

All payments must be in U.S. funds

Total Enclosed .. \$ _____

P-691

Popular Electronics®

THE MAGAZINE FOR THE ELECTRONICS ACTIVIST!

CONSTRUCTION ARTICLES

- BUILD THE PROTOMAX DESIGN STATION** Marc Spiwak and John Yacono 31
Designing electronics circuits can be much easier when you use this breadboarding system
- THE SCANNER COMPANION** Brian Pliier 39
Make using your scanner more enjoyable by eliminating the annoying hiss between messages
- A TELEPHONE-OPERATED POWER SWITCH FOR YOUR COMPUTER** Jim Stephens 53
This simple project can save you many a weekend trip to the office to retrieve data from, or to do work on, your office computer

FEATURE ARTICLES

- EXPERIMENTS IN ELECTROCHEMISTRY** Stanley Czarnik 27
Changing colors, beautiful streamers, and metallic gardens are among the wonders you'll discover in these fun-filled experiments.
- NEW DECADE IN CONSUMER ELECTRONICS** Teri Scaduto and Brian Fenton 34
The new technologies and products introduced this year will set the pace for consumer electronics for the rest of the decade
- DEALING WITH UNCERTAINTIES** James E. Tarchinski 56
Even small variations in parts values can lead to big headaches if you don't know how to deal with them
- THE DIGITAL ELECTRONICS COURSE** Robert A. Young 58
A look behind the face of multiplexed displays

PRODUCT REVIEWS

- GIZMO** 41
Including: Fidelity Chess Computer, Sony Audio/Video Switcher, Memorex Surround Sound Headphones, and much more!
- HANDS-ON REPORT** 61
AutoCommand Plus Remote-Control Car-Starter System
- PRODUCT TEST REPORT** Len Feldman 63
Nakamichi CDPlayer2 CD Changer

COLUMNS

- THINK TANK** John Yacono 18
Current-limiting resistors and more
- ANTIQUÉ RADIO** Marc Ellis 66
America's six decade love affair with the Theremin
- COMPUTER BITS** Jeff Holtzman 68
A closer look at hypertext
- FUN SOFTWARE** Fred Blechman 70
Seeing the stars
- CIRCUIT CIRCUS** Charles D. Rakes 72
Detector circuits
- DX LISTENING** Don Jensen 74
Tune in to Radio Bangladesh
- HAM RADIO** Joseph J. Carr 76
Slaying some SLJ's
- SCANNER SCENE** Marc Saxon 78
Handheld memories, and X-rated McDonalds' communications

DEPARTMENTS

- EDITORIAL** Carl Laron 2
- LETTERS** 3
- ELECTRONICS LIBRARY** 4
- NEW PRODUCTS** 12
- ADVERTISER'S INDEX** 94

Popular Electronics (ISSN 1042-170X) Published monthly by Gernsback Publications, Inc., 500-B Bi-County Boulevard, Farmingdale, NY 11735. Second-Class postage paid at Farmingdale, NY and at additional mailing offices. One-year, twelve issues, subscription rate U.S. and possessions \$21.95, Canada \$26.84 (includes G.S.T. Canadian Goods and Services Tax Registration No. R125166280), all other countries \$29.45. Subscription orders payable in U.S. funds only. International Postal Money Order, or check drawn on a U.S. bank. U.S. single copy price \$2.95. © 1991 by Gernsback Publications, Inc. All rights reserved. **Hands-on Electronics** and **Gizmo** trademarks are registered in U.S. and Canada by Gernsback Publications, Inc. **Popular Electronics** trademark is registered in U.S. and Canada by Electronics Technology Today, Inc. and is licensed to Gernsback Publications. Printed in U.S.A.

Postmaster: Please send address changes to **Popular Electronics**, Subscription Dept., P.O. Box 338, Mount Morris, IL 61054-9932.

A stamped self-addressed envelope must accompany all submitted manuscripts and/or artwork or photographs if their return is desired should they be rejected. We disclaim any responsibility for the loss or damage of manuscripts and/or artwork or photographs while in our possession or otherwise.

As a service to readers, **Popular Electronics** publishes available plans or information relating to newsworthy products, techniques, and scientific and technological developments. Because of possible variances in the quality and condition of materials and workmanship used by readers, **Popular Electronics** disclaims any responsibility for the sale and proper functioning of reader-built projects based upon or from plans or information published in this magazine.

Larry Steckler

*EHF, CET
Editor-In-Chief and Publisher*

EDITORIAL DEPARTMENT

Carl Laron

Editor

Robert A. Young

Associate Editor

John J. Yacono

Associate Editor

Byron G. Wels, K2AVB

Associate Editor

Teri Scaduto

Assistant Editor

Kathy Terenzi

Editorial Assistant

Marc Spiwak

Editorial Associate

Fred Blechman

Joseph J. Carr, K4IPV

Marc Ellis

Len Feldman

Jeffrey K. Holtzman

Don Jensen

Charles D. Rakes

Marc Saxon

Contributing Editors

PRODUCTION DEPARTMENT

Ruby M. Yee

Production Director

Karen S. Brown

Production Manager

Marcella Amoroso

Production Assistant

Janice Box

Editorial Production

ART DEPARTMENT

Andre Duzant

Art Director

Injae Lee

Illustrator

Russell C. Truelson

Illustrator

Jacqueline P. Cheeseboro

Circulation Director

Michele Torrillo

P-F Bookstore

BUSINESS AND EDITORIAL OFFICES

Gernsback Publications, Inc.

500-B Bi-County Blvd.

Farmingdale, NY 11735

1-516-293-3000

Fax: 1-516-293-3115

President: **Larry Steckler**

Customer Service/Order Entry

1-800-435-0715

In IL 1-800-892-0753

7:30 AM - 8:30 PM EST

Advertising Sales offices listed on page 92

Composition by
Mates Graphics



The publisher has no knowledge of any proprietary rights which will be violated by the making or using of any items disclosed in this issue.

A HAM'S HAM

Amateur-radio operators routinely volunteer their time and equipment in times of disaster, whether natural or man-made. Sometimes, though, you hear about the ham whose efforts to aid and comfort his fellow man reaches truly heroic proportions; this is one of those times.

Abu Mansour Marafie is a 53-year old Kuwaiti businessman who lives in the Selwa neighborhood of Kuwait City. He is also a ham. During the Iraqi occupation of his homeland, he routinely risked his life to send exiled Kuwaitis information about their families still trapped in their country.

In the first days of the occupation, there were many hams on the air. But as the Iraqis increased their terror campaign, the number dwindled until just Marafie remained.

Fellow hams from the U.S., Europe, the Middle East, and elsewhere would relay inquiries from Kuwaitis about their families. Marafie would contact those families by telephone and relay the information back. He continued on the air until the allied ground invasion began, at which point the Iraqis cut the local telephone lines.

Marafie ignored the obvious dangers to continue his radio link to the world. Iraqi troops were quartered nearby and made frequent patrols. Despite this, and despite the antennas that could be seen on his roof, the Iraqis did not confiscate his rig until December, and then only as part of a general sweep to confiscate all ham-radio equipment. However, they missed a broken Kenwood portable transceiver, which Marafie quickly repaired and put back on the air.

Marafie's skill as an amateur-radio operator, his courage in the face of circumstances that are all but unimaginable to us in the U.S., and his humanity in providing aid and comfort to his countrymen helps to remind all of us of the ideals on which the amateur-radio service is based. He is a shining example of what the best of amateur radio can be, even in the worst of times.

Carl Laron
Editor

LETTERS

SPEAKER DESIGN CORRECTIONS

I recently picked up the March, 1991 issue of **Popular Electronics**. I was particularly interested in the article "How to Design Your Own Speakers" by Richard Honeycutt. I am currently designing and building my own speaker system and was interested in the information on designing an appropriate crossover network. This is the finest article I've read on the subject to date.

However, I ran into a problem when I attempted to follow the author's sample calculations for C2, C3, L2, and L4. I could not obtain the same results as the author. All of the formulas for those contain a radical (square root). The other calculations that appeared in the article were readily confirmed.

Is the source of the error mine, or is there a mistake in the article.?

L.C.M.
Van Buren, AK

Thank you for your letter, and for your kind compliment. In comparing my calculations to yours, I found that you apparently included the π under the radical when you calculated the values for those components. When I work the equations as if the denominator contained $\sqrt{2\pi}$ instead of $\sqrt{2\pi}$ as stated in the article and correct, I get the same result as you for capacitor C2.

However, when I made the change in the other three equations, I got yet a different result. Checking further I found that you did indeed catch me in an error. Somehow, erroneous values found their way into my manuscript. When I called up the computer simulator that I used to verify performance of the circuit, it had the correct values. Those values are as

2x56.9 follows: C3 = 2.6 μ F, L2 = 0.81mH, and L3 = 5mH.

Incidentally, I'd like to call attention to the fact that there were two other errors in the article as it appeared in the magazine: The first was that Figs. 1 and 6 were interchanged.

The second error was that the term "dielectric absorption" was used in the last column on page 35. The term "dielectric hysteresis loss" would have been more correct.

Richard A. Honeycutt

SENTRY STROBE ALERT ERROR

I spotted an error in the article "The Sentry Strobe Alert System," which appeared in the February issue of **Popular**

Electronics. The correct formula to determine W/s is: $W/s = .5 (C \times V^2)$. The formula in the article doesn't have the voltage squared.

J.M.P.
Hillside, NJ

HAVES AND NEEDS

Now that I finally have my old reel-to-reel tape player back in working condition, I'm trying to locate a source for pre-recorded reel-to-reel tapes, particularly rock, jazz, and classical recordings. I'd be grateful to anyone who can point me toward either individual or retail sources. Thanks.

Tony Scaduto
c/o New York Newsday
2 Park Avenue
New York, NY 10016 ■



2-1/2" SANYO TWEETER

Paper cone with gold tone dust cap. 8 oz. magnet. 8 ohm. 1/2" ferro fluid voice coil. Power handling: 50W RMS. 70W max. Frequency response: 3K-20KHz.



#PD-271-020 \$1⁹⁵ \$1⁷⁵ 95c
(1-9) (10-59) (60-up)

SUPER HORN TWEETER

Original piezo tweeter made by Motorola. SPL=94 dB 2.83V/1M. Response: 4KHz-27KHz. Handles approximately 50 watts.



#PD-270-010 \$5³⁰ \$4⁵⁰ \$3⁹⁵
(1-9) (10-79) (80-up)

2" DOME MIDRANGE

Textile dome midrange made by Philips. 8 ohm. SPL=90 dB 1W/1M. 30W RMS. 40W max. Response: 550-5KHz.



#PD-280-210 \$27³⁰ \$25⁷⁰
(1-3) (4-up)

15" SUBWOOFER



Dual voice coil. 40 oz. magnet. 6 ohm imp. 100W RMS, 140W max. Response: 20-1.2KHz. Resonant frequency: 21Hz. SPL=93 dB 1W/1M.

PIONEER
#PD-290-190 \$54⁵⁰ \$49⁹⁰
(1-3) (4 up)

SUBWOOFER XOVER



200W RMS crossover designed specifically for use with dual voice coil subwoofers. 12 dB per octave roll-off at 150Hz.

#PD-260-220 \$28⁸⁰ \$24⁴⁰

10" POLY WOOFER

Medium duty. 60W RMS. 80W max. 14 oz magnet. Response 25-2.5KHz. fs=28Hz



#PD-290-096 \$18⁵⁰ \$16⁹⁰
(1-3) (4-up)

TITANIUM COMPOSITE TWEETER

The advantages of both hard and soft dome technologies. 8 ohm. Ferro fluid cooled voice coil. SPL=90 dB 1W/1M. 50W RMS. 70W max. 4" round Polydax #DTW100T125.



polydax
#PD-270-047 \$27⁵⁰ \$24⁸⁰
(1-9) (10 up)

SPEAKER BUILDING BOOK

Revised edition of David Weems' best selling book. Learn to build low cost speakers that rival the high priced models.



#PD-500-021 \$16⁹⁵

12" CAST FRAME WOOFER



EMINENCE

12" woofer made in the USA by Eminence. Paper cone and dust cap with treated cloth surround. 80 oz. magnet. 2-1/2" vented voice coil. 8 ohm. 170W RMS, 235W max. 40-4.5KHz response.

#PD-290-147 \$72⁸⁰ \$69⁵⁰
(1-3) (4 up)



340 E. First St., Dayton, Ohio 45402
Local: 1-513-222-0173
FAX: 513-222-4644

• 15 day money back guarantee • \$15.00 minimum order • We accept Mastercard, Visa, Discover, and C.O.D. orders. • 24 hour shipping • Shipping charge = UPS chart rate + \$1.00(\$3.00 minimum charge) • Hours 8:30 am-7:00 pm EST, Monday - Friday • Mail order customers, please call for shipping estimate on orders exceeding 5 lbs. Foreign customers please send \$5.00 U.S. funds for catalog postage.

CALL TOLL FREE
1-800-338-0531

FREE
CATALOG

CIRCLE 13 ON FREE INFORMATION CARD

ELECTRONICS LIBRARY

The Master IC Cookbook: Second Edition

by Clayton L. Hallmark
and Delton T. Horn

Designed to eliminate the time-consuming and tedious chore of poring through books, magazines, and applications notes in search of specifications for particular IC's, the revised edition of this one-stop reference contains up-to-date data on hundreds of different digital and linear integrated circuits. The book now contains sections on TTL and CMOS products, memories, op-amps, audio amplifiers, RF amplifiers, and other linear devices. It also provides information essential to selecting integrated circuits, in-

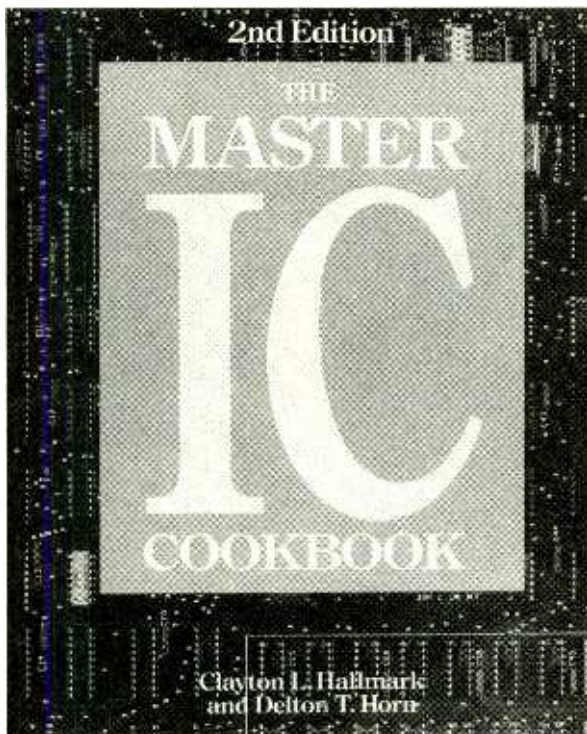

cluding pinouts, block diagrams, temperature ranges, truth tables, schematics, and voltage and current ratings. In each section, IC's are listed in numerical order; the index is arranged alphabetically. An appendix of symbols and definitions is also included. The book is a convenient reference for hobbyists and professionals.

The Master IC Cookbook (Second Edition) costs \$22.95 and is available from TAB Books Inc., Blue Ridge Summit, PA 17294-0850; Tel. 1-800-233-1128.

CIRCLE 98 ON FREE INFORMATION CARD

THE PIRATE RADIO DIRECTORY

edited by George Zeller

Pirate radio-broadcasting activity reached a modern-day high in 1990. According to the editor of *The Pirate Radio Directory*, 165 pirate radio stations were monitored on shortwave frequencies last year. Some of those made only one appearance, while others broadcast frequently—such as the 54 individual broadcasts by Hope Radio that were monitored. Pirate programming included everything from underground rock to political commentary, from humor to rebroadcasts of licensed AM and FM stations. The FCC traced and shut down approximately a dozen pirate stations. This book contains a detailed introduction to pirate radio. It takes the reader on a station-by-station tour, discussing formats, frequencies, times heard, phone numbers, addresses, and other information.

The Pirate Radio Directory is available for \$8.95 plus \$2.00 shipping and handling from Tiare Publications, P.O. Box 493, Lake Geneva, WI 53147; Tel: 414-248-4845.

CIRCLE 81 ON FREE INFORMATION CARD

DVORAK'S GUIDE TO DOS AND PC PERFORMANCE

by John C. Dvorak and Nick Anis

This comprehensive 950-page-book/dual-diskette package provides scores of new and original

ideas on how to use DOS to obtain peak PC performance. It includes in-depth coverage of DOS 5 as well as all the leading operating systems, so that readers can use the book as a stepping stone for learning other systems. The package also provides extensive coverage of text editors, including DOS EDLIN, EDIT, QEDIT, and the included program, VDE. It examines DOS batch files and explains how to stretch them to their limits using 12 powerful Dvorak utility pro-

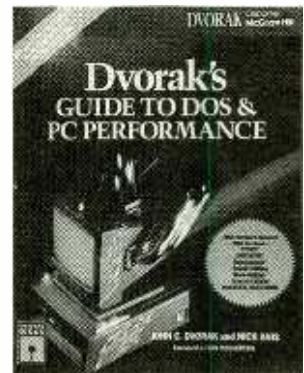

grams. Device drivers—DOS PRAM.SYS, DRIVER.SYS, RAMDRIVE.SYS, and SMARTDRIVE.SYS—are discussed in detail.

The two disks contain more than one megabyte of compressed software, including more than 70 programs. They contain shareware and special versions of commercial programs developed especially for this book. Included are programs such as XTree; DeskConnect, a special edition of Mace Utilities; Dvorak Utilities; DOSCACHE, and more. The book also offers special money-saving coupons for discounts on PC-related products and services.

*Dvorak's Guide to DOS and PC Performance costs \$49.95 (for the book and two diskettes) and is published by Dvorak*Osborne McGraw-Hill,*

2600 Tenth Street, Berkeley, CA 94710.

CIRCLE 83 ON FREE INFORMATION CARD

GREAT RADIO READS
from Tiare Publications

Radio hobbyists—whether they're into SWL, CB, ham, or scanning—will find books and other interesting items in this newly expanded catalog. Some of the new books being offered include *Coast Guard Radio*, *The Warship Directory*, and the *Radio Communications Software Directory*. The catalog offers books on surveillance, antennas, pirate and clandestine stations, the history of radio, and broadcasting. In ad-

GREAT RADIO READS

The New Tiare Catalog is filled with a wide variety of books and other items to help you get more out of your hobby. Available in paperback or hardcover, these books cover a wide variety of radio subjects and related items.

We've greatly expanded our offering in the areas of radio and other hobby-related items. Now available from Tiare include: *Coast Guard Radio*, *The Warship Directory*, and the *Radio Communications Software Directory*.

We hope you find something in this catalog that interests you. We appreciate the opportunity to serve you!



Tiare Publications
P.O. Box 493
Lake Geneva, WI 53171

dition, it includes software for the radio hobbyist and "Infocards" that contain frequently needed information.

Great Radio Reads is available for \$1.00 from Tiare Publications, P.O. Box 493, Lake Geneva, WI 53171; Tel: 415-248-4845.

CIRCLE 84 ON FREE INFORMATION CARD

COMPUTERS: 49 SCIENCE FAIR PROJECTS

by Robert L. Bonnet and G. Daniel Keen

This new entry in TAB's Science Fair Project Series of books designed to provide children aged 8 through 13 with solid ideas for school science-fair competitions reflects the widespread acceptance of computers in the field of education. By employing fundamental techniques of computer operation and BASIC programming, the project ideas in the book are intended to spark students' in-

terest in science and help them become familiar with computers. It shows students how to use a PC to explore a variety of scientific areas, including biology, physics, math, and meteorology. The projects are designed to challenge students to think logically and to apply scientific principles to games of chance, calculating odds, making mathematical conversions, calculating energy costs, forecasting weather, and sorting and filing data. Each project is

presented in the order that a science-fair project should be approached: subject overview, materials list, problem, hypothesis, procedure, record keeping, conclusion, and further research. Throughout the book, students are encouraged to take the experiments discussed even further by coming up with their own, more sophisticated applications.

Computers: 49 Science Fair Projects costs \$9.95 and is published by TAB Books Inc., Blue

Ridge Summit, PA 17294-0850; Tel. 1-800-233-1128.

CIRCLE 98 ON FREE INFORMATION CARD

COAXIAL PRODUCTS CATALOG #1991
from Pasternack Enterprises

This 58-page catalog features a complete line of amplifiers; molded breakouts; coaxial cable, switches, detectors, attenuators, terminations, and cable assemblies; tools for cut-

48 HOUR SHIPPING

ELENCO & HITACHI PRODUCTS
AT DISCOUNT PRICES

48 HOUR SHIPPING

Hitachi RSO Series
(Portable Real-time Digital Storage Oscilloscopes)

VC-6023 - 20MHz, 20MS/s	\$99/mo*
VC-6024 - 50MHz, 20MS/s	\$120/mo*
VC-6025 - 50MHz, 20MS/s	\$135/mo*
VC-6045 - 100MHz, 40MS/s	\$125/mo*
VC-6145 - 100MHz, 100MS/s	\$200/mo*

RSO's from Hitachi feature roll mode, averaging, save memory, smoothing, interpolation, pretriggering, cursor measurements. These scopes enable more accurate, simpler observation of complex waveforms. In addition to such functions as hardcopy via a plotter interface and waveform transfer via the RS-232C Interface. Enjoy the comfort of analog and the power to digital.

LEASING AVAILABLE
For all Hitachi Scopes - Call for details
* Based on 24 months except V-1150, VC-6045, VC-6145 (36 months)

Hitachi Portable Scopes
DC to 50MHz, 2-Channel, DC offset function, Alternate magnifier function

V-525 - CRT Readout, Cursor Meas.	\$1,025
V-523 - Delayed Sweep	\$995
V-522 - Basic Model	\$895
V-422 - 40MHz	\$795
V-223 - 20MHz delayed sweep	\$695
V-212 - 20MHz	\$425

HITACHI COMPACT SERIES SCOPES
This series provides many new functions such as CRT Readout, Cursor measurements (V-1085/1065/665), Frequency Crt (V-1085), Sweep/Time Autoring, Delayed sweep and Trigger Lock using a 6-inch CRT. You don't feel the compactness in terms of performance and operation.

V-660 - 60MHz, Dual Trace	\$1,195
V-665 - 60MHz, DT, w/cursor	\$1,345
V-1060 - 100MHz, Dual Trace	\$1,425
V-1085 - 100MHz, DT, w/cursor	\$1,050/mo*
V-1085 - 100MHz, DT, w/cursor	\$1,250/mo*
V-1100A - 100MHz, Quad Trace	\$125/mo*
V-1150 - 150MHz, Quad Trace	\$115/mo*

20MHz Elenco Oscilloscope
MO-1251 \$375

- Dual Trace Component Tester
- 6" CRT
- X-Y Operation
- TV Sync
- 2 P:1 Probes

FREE DMM
with purchase of
ANY SCOPE

SCOPE PROBES
P-1 65MHz, 1x, 10x \$19.95
P-2 100MHz, 1x, 10x \$23.95

Elenco 35MHz Dual Trace
Good to 50MHz \$495
MO-1252

- High Luminance 5" CRT
- 1mV Sensitivity
- 6kV Acceleration Voltage
- 10ns Rise Time
- X-Y Operation - 2 Axis
- Delayed Triggering Sweep
- Includes 2 P:1 Probes

All scopes include probes, schematics, operators manual and 3 year (2 yrs for Elenco scopes) world wide warranty on parts & labor. Many accessories available for all Hitachi scopes. Call or write for complete specifications on these and many other fine oscilloscopes.

B + K TEST EQUIPMENT
All Models Available
Call for special price

Digital Capacitance Meter
CM-1550B \$58.95

9 Ranges
1pf-20,000pf
5% basic accuracy,
Zero control w/ Case
Big 1" Display

Digital LCR Meter
LC-1801 \$125

Measures:
Coils 1uH-200H
Caps 1pf-200uF
Res. 01-20M

Multimeter with Capacitance and Transistor Tester
\$55 CM-1500B

Reads Volts, Ohms
Current, Capacitors,
Transistors and
Diodes w/ case

FLUKE MULTIMETERS
All Models Available
Call for special price

Quad Power Supply XP-580 \$59.95

2-20V @ 2A
12V @ 1A
5V @ 3A
-5V @ 5A

Fully regulated and short circuit protected

Triple Power Supply XP-620 Assembled \$65 Kit \$45

2 to 15V @ 1A,
-2 to -15V @ 1A
(or 4 to 30V @ 1A)
and 5V @ 3A

All the desired features for doing experiments.
Features short circuit protection, all supplies

AM/FM Transistor Radio Kit
with Training Course
Model AM/FM 108 \$26.95

14 Transistors + 5 Diodes
Makes a great school project

True RMS 4 1/2 Digit Multimeter M-7000 \$135

05% DC Accuracy
1% Resistance with Freq. Counter and Deluxe Case

Soldering Station Temperature Controlled SL-30 \$99

Digital Display
Temp Range: 300F-900F
Grounded Tip
Overheat Protect

Color Convergence Generator SG-200 \$69.95

Finest in the industry
10 rock steady patterns

Four-Function Frequency Counters F-100 120MHz \$179 F-1000 1.2GHz \$259

Frequency, Period, Totalize, Self Check with High Stabilized Crystal Oven Oscillator, 8 digit LED display

Digital Triple Power Supply XP-765 \$249

0-20V at 1A
0-20V at 1A
5V at 5A

Fully regulated, Short circuit protected with 2 limit control, 3 separate supplies
XP-860 with Analog Meters \$175

GF-8016 Function Generator with Freq. Counter \$249

Sine, Square, Triangle
Pulse, Ramp, 2 to 2MHz
Freq Counter .1 - 10MHz

Function Generator Blox #9600 \$28.95

Provides sine, triangle, square wave from 1Hz to 1MHz
AM or FM capability

XK-500 DIGITAL / ANALOG TRAINER
A complete mini-lab for building, testing, prototyping analog and digital circuits. Elenco's Digital / Analog Trainer is specially designed for school projects, with 5 built-in power supplies, includes a function generator, eff. continuously variable sine, triangle, square wave forms. All power supplies are regulated and protected against shorts.

POWER SUPPLIES
• Variable Power Supply
• +1.25 to 20VDC @ 5 Amp
• +1.25 to 18VDC @ 1 Amp
• +1.25 to 30VDC @ 2 Amp
• +1.25 to -15VDC @ 1 Amp
• +12 VDC @ 1 Amp
• -12VDC @ 1 Amp
• +5VDC @ 1 Amp
• -5VDC @ 1 Amp
• 30VAC Center Tapped @ 15VAC @ 1 Amp

ANALOG - SECTION
• Function Generator: Sine, Triangle, Square Wave forms
• Frequency adjustable in five ranges from 1 to 100kHz
• Fine frequency adjust
• Amplitude adjust
• DC offset
• Modulation FM AM

DIGITAL - SECTION
• Eight data switches
• Two 16 channel 8000 gates
• Eight LED readout TTL outputs
• Clock frequency: 1 to 100kHz
• Clock frequency: 1000 Hz to 10 MHz

BREADBOARDS
• 2 Breadboards, each contain 800 tie points (total 1,600)

\$139.95 Assembled
\$119.95 Kit

Learn to Build and Program Computers with this Kit
Includes: All Parts, Assembly and Lesson Manual
Model MM-8000 \$129.00

Starting from scratch you build a complete system. Our Micro-Assembler trainer teaches you to write in RAM, ROMs and run a 8085 microprocessor, which uses similar machine language as IBM PC.

Robotics Kit for above (MM8010) \$179.95

Wide Band Signal Generators SG-9000 \$129

RF Freq 100K-450MHz AM Modulation
CG-9500 w/ Digital Display & 150MHz built-in Counter \$249

WE WILL NOT BE UNDERSOLD!
UPS Shipping: 48 States 5% (\$3 Min \$10 Max) Shipping
IL Res.: 7% Tax FAX: 708-520-0085

C & S SALES INC.
1245 Rosewood, Deerfield, IL 60015
(800)292-7711 (708) 541-0710

15 Day Money Back Guarantee
2 Year Warranty (Print Subject to Change)

WRITE FOR FREE CATALOG

CIRCLE 11 ON FREE INFORMATION CARD

6

ting and stripping; waveguide adapters; patch cords; programmable and push-button attenuators; and twinaxial adapters and connectors. It also features several new cable as-

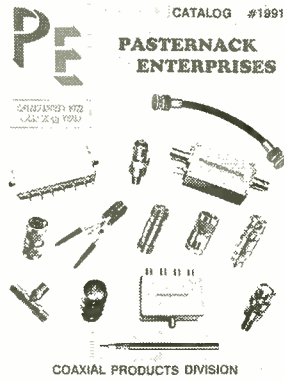

semblies that use 3.5mm, 7mm, HN, N, SMA, SMC, BNC, TNC, UHF, SC, SHV, and MHV connectors. Pricing information for more than 2500 standard items is included, as well as technical information.

The Coaxial Products Catalog #1991 is available from Pasterneck Enterprises, P.O. Box 16759, Irvine, CA 92713-6759; Tel: 714-261-1920; Fax: 714-261-7451.

CIRCLE 85 ON FREE INFORMATION CARD

INSIDE AUTOCAD: Sixth Edition

by D. Raker and H. Rice

This book serves a triple purpose: It provides a thorough introduction to drawing and drafting using AutoCAD, an easy-to-use tutorial designed to help readers unlock AutoCAD's power for their own design and drafting work, and a reference for readers to keep on hand for pointers after they've mastered AutoCAD. It is divided into three parts. The first demonstrates how to use the keyboard, mouse, and menus to "communicate" with AutoCAD; and takes readers step-by-step from setting up the program through building and editing two-dimensional drawings. Three-dimensional drawing is covered in part two, including how to use 3-D surface meshes and solids modeling, and how to pass a 3-D drawing to AutoShade for rendering. Part three shows readers how to customize AutoCAD into their own personal

drawing systems, and how to use AutoLISP to create new commands and to automate drawings. The book includes details on scaling, multiview plotting, dimensioning, and drawing file overlays. More than 300 drawings accompany the text. Three helpful appendices provide complete listings of all the AutoCAD commands included in the book; additional help in setting up AutoCAD, improving performance, and dealing with problems; and a quick-reference chart of system variables.

Inside AutoCAD (Sixth Edition) costs \$34.95 and is published by New Riders Publishing, 1025 East Powell, #202, Gresham, OR 97030.

CIRCLE 86 ON FREE INFORMATION CARD

USING PRODIGY

by Stephen Nelson

Although it is intended to be a user-friendly on-line information service, its broad scope makes Prodigy somewhat difficult for beginners to navigate. This book guides readers through each of Prodigy's on-line services. Beginning with the basic information needed to start using Prodigy—such as how to enroll as a member—the book goes on to offer a general "tour" of the more popular Prodigy

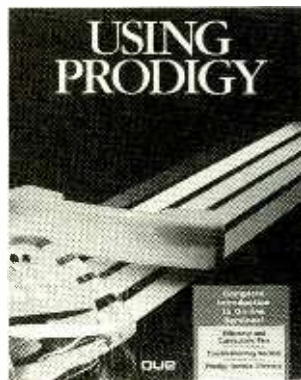

features. Those include shopping from home; news coverage, such as national and world events, sports, weather, and an on-line encyclopedia that covers more than 30,000 topics; money management, which offers tools for bill paying, record keeping, and making investments; and travel arrangements, such as on-line airline and hotel reservations. Those features are explored in

greater detail in Part II. The book also examines on-line game-playing; Prodigy's "Living" features, which concern food, health, lifestyles, entertainment, and information; and learning about computing with Prodigy's on-line tutorials, columns, and bulletin board. Detailed information on using both electronic mail and bulletin boards is provided, along with information on managing, fine-tuning, and troubleshooting the Prodigy system. Appendices explain how to install and start using Prodigy on both IBM-PC compatibles and the Apple Macintosh.

Using Prodigy costs \$19.95 and is published by Que Corporation, 11711 North College Avenue, Carmel, IN 46032.

CIRCLE 87 ON FREE INFORMATION CARD

THE SNEAKY SQUARE AND 113 OTHER MATH ACTIVITIES FOR KIDS

by Dr. Richard M. Sharp and Dr. Seymour Metzner

There has been a good deal of concern expressed lately about American students lagging behind those of other industrialized nations when it comes to mathematical skills. In today's high-tech society, good math and reasoning skills are essential, yet it's difficult to get children interested in the subject. This book aims to spark the mathematical curiosity of students by offering more than a hundred challenging activities that can be done at home or in the classroom. The series of illustrated games and puzzles presented in the book are designed to build the child's capacity for critical thinking, problem solving, and accurate estimation. Aimed at children aged 8 to 13, the book includes activities in speed calculation, number positioning, geometric puzzles, logical prediction, money problems, traps and conundrums, lattice problems and drawings, pattern reasoning, number combinations, and paradoxes. Each exercise is laid out in step-by-step fashion, and includes an indication of level of difficulty, an explanation of the solution, and a parts list. None requires more than a few minutes of advance preparation.

The Sneaky Square & 113

Other Math Activities for Kids costs \$8.95 and is published by TAB Books Inc., Blue Ridge Summit, PA 17294-0850; Tel: 1-800-233-1128.

CIRCLE 98 ON FREE INFORMATION CARD

THE ULTIMATE IN LOW COST TEST EQUIPMENT

from Mercer Electronics

This eight-page catalog describes Simpson Electric's Mercer line of high-quality, reasonably priced test equipment. The fully-illustrated brochure features handheld and pocket digital multimeters, multifunction frequency counters, 2-MHz sweep/function generators, logic probes, and handheld volt-ohm-milliameters. Special digital testers and the Mercer Digi-Clamp are also described. Besides ordering information, the catalog includes lists of specifications and accessories.

The Ultimate In Low Cost Test Equipment catalog is free upon request from Mercer Electronics, 859 Dundee Avenue, Elgin, IL 60120-3090; Tel: 708-697-2275; Fax: 708-697-2272.

CIRCLE 88 ON FREE INFORMATION CARD

LOTUS 1-2-3 STEP-BY-STEP

by Judd Robbins

Lotus 1-2-3 is a powerful and versatile spreadsheet program, but it can be difficult to learn to use it effectively. To help business people, students, scientists, and teachers quickly master the potential of Lotus, this book guides readers through basic to advanced applications. Step-by-step instructions show how to build powerful worksheets, and how to understand and use cell ranges. The book explains how to perform sophisticated calculations and how to improve published worksheets with the Always spreadsheet publishing program. Throughout the book, real-world examples, ample illustrations, and end-of-chapter quizzes and summaries support the lessons. Those lessons, which consist of hands-on exercises and interactive tutorials intended to help readers learn by doing, demonstrate how to format, build, update, and im-

Lotus 1-2-3 Step-by-Step

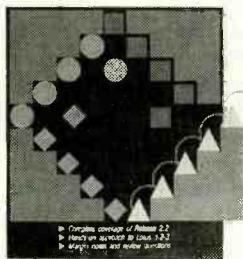

prove worksheets; how to link 1-2-3 for large applications; how to generate professional-quality graphs; how to automate functions with macros; and how to support investment and financial records with 1-2-3. The book provides complete coverage of Release 2.2. A complementary disk is available as an optional learning tool.

Lotus 1-2-3 Step-by-Step costs \$24.95 and is published by SAMS, Division of Macmillan, Inc., 11711 North College, Suite 141, Carmel, IN 46032.

CIRCLE 95 ON FREE INFORMATION CARD

THE TAB SERVICE MANUAL FOR CCTV AND MATV

by Robert L. Goodman

There is a great demand for technicians skilled in the installation and maintenance of standard signal reception and security television systems, due to the increase in office buildings, apartment complexes, and hospitals that depend on those systems. Written especially for technicians, this book provides a complete guide to installing, adjusting, and servicing closed-circuit TV (CCTV) and master antenna TV (MATV) systems. The first half of the book provides detailed coverage of CCTV, including video monitors and TV cameras, camera pick-up tubes and vidicons, video sequential switchers, remote-camera control systems, and camera-lens and light considerations. The second section explains MATV-system design and what types of test instruments are needed for MATV repairs and installation. It fully explains how to use the Sen-core FS74 signal analyzer to

troubleshoot and adjust various MATV systems. The book provides systems operational block diagrams and layouts, as well as numerous tips to help technicians optimize the performance of CCTV and MATV systems.

The TAB Service Manual for CCTV and MATV costs \$18.95 and is published by TAB Books Inc., Blue Ridge Summit, PA 17294-0850; Tel: 1-800-233-1128.

CIRCLE 98 ON FREE INFORMATION CARD

1991 CATALOG

from DC Electronics

A full range of products for electronics professionals, hobbyists, and students is offered in this 48-page catalog. It includes tools, transformers, IC's, cabinets and enclosures, books, kits, LED's, printed-circuit supplies, resistors, transistors, diodes and rectifiers, batteries and battery holders, breadboards, inductors, plugs, jacks, sockets, connectors, switches, panel meters, and more. Highlighted in this edition are a wireless FM-stereo broadcaster

IC and a discounted universal programmer. New items include TEC-200 image film for making PC boards and several build-it-yourself kits, including an electronic roulette wheel, a playable mini piano, a robotic arm, and a stereo hi-fi power amplifier.

The 1991 Catalog is available from DC Electronics, P.O. Box 3203, Scottsdale, AZ 85271-3203; Tel: 1-800-423-0070 (for orders) or 602-945-7736.

CIRCLE 89 ON FREE INFORMATION CARD

ELECTRONICS MATH: Third Edition

by Bill Deem

This textbook was written to provide a thorough, practical study of electronics math and its relation to real-world electronics. Greater emphasis is placed on subjects that are frequently and intensively used than is placed on abstract mathematics. The book is intended to be used as a course accompaniment and/or as a benchtop reference. Features new to the third edition include color high-

Ready, Willing and Able.

324 PanaVise Electronic Work Center ►

This economical package makes work areas more efficient and manageable. Parts, tools, solder, soldering iron holder and PC board are exactly where you want them! Features famous PanaVise "tilt, turn and rotate" control. Solder spool holder self-centers the feed, and the soldering iron holder keeps the iron at an easy-to-reach angle. Rugged, sturdy and tough, it also accepts all regular PanaVise interchangeable heads.



◀ 301 Standard PanaVise

Here's the world's best small vise and the perfect introduction to PanaVise quality and convenience. One control knob locks work firmly into position! Also accepts all regular PanaVise interchangeable heads.

▲ 396 Wide Opening Head PanaVise

Combine our 300 Standard Base (which accepts all PanaVise interchangeable heads) with our 366 Wide Opening Head to create a versatile work-holding tool. Ribbed neoprene jaw pads hold circuit boards or other objects securely; reverse them for deep "v" grooves that can hold delicate cylindrical objects.



PANA VISE®

1485 Southern Way
Sparks, Nevada 89431
Tel: (702) 353-2900
Fax: (702) 353-2929

CIRCLE 17 ON FREE INFORMATION CARD

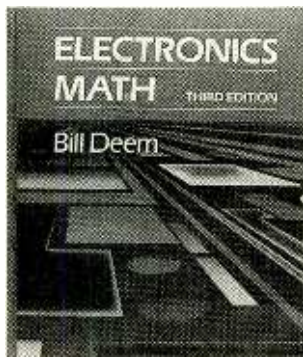

lighting of key concepts, sections, and topics; step-by-step calculator applications sections; a chapter on "Karnaugh Maps" that offers an alternative method of logic-circuit simplification; and expanded coverage of fractions and trigonometric functions. More than 300 examples reinforce key concepts, and more than 1300 practice problems within chapters, and more than 2600 end-of-chapter problems, are included to help readers reach a thorough understanding of the material. Every example, practice problem, self test, and end-of-chapter problem has been worked by three technical reviewers to ensure accuracy; answers appear at the end of the book.

Electronics Math: Third Edition is published by Prentice-Hall, Englewood Cliffs, NJ 07632.

CIRCLE 99 ON FREE INFORMATION CARD

ELECTRONIC DATA INTERCHANGE

by Paul Kimberley

The author of this book predicts that electronic data interchange (EDI) will be the catalyst that permanently changes the way that intercompany and interpersonal business will develop. This book explores the history of EDI, reviews the current status of the technology around the world, and provides an introduction to the services and technologies that will be offered in the future. It covers everything from basic principles of EDI to its costs and benefits, from state-of-the-art communications hardware to the relevant areas of international law. The book explains the use of EDI in international trade and reveals its impact on customs and trade

payment procedures. It offers a global look at the principle document standards now in use, focusing on ANSI X12 and EDIFACT. In-depth coverage of EDI software technology is provided, including translation file-transfer, EDI-server, enabling, and mailbox software. The book also gives specific details on how to select the right vendors and how to install and manage a full-scale EDI system. A comparative analysis of the major service providers, telecoms, and networkers is also provided.

Electronic Data Interchange costs \$34.95 and is published by McGraw-Hill Book Company, 11 West 19th Street, New York, NY 10011; Tel. 1-800-2-MCGRAW.

CIRCLE 96 ON FREE INFORMATION CARD

1991 D.A.T.A. DIGEST LIBRARY OF ALTERNATE SOURCES AND REPLACEMENTS

from D.A.T.A. Business Publishing

For purchasing agents, design engineers, and repair and maintenance technicians, this three-volume set can help simplify the identification of devices and their functions. The three books are *Integrated Circuits Alternate Sources*, which includes more than 77,000 IC's; *Discrete Semi-*



conductors Direct Alternate Sources, with more than 437,000 devices; and *Discrete Semiconductors Suggested Replacements*, which features more than 173,000 devices. Each volume contains full descriptive names, and includes specific device suggested replacements (different part numbers with the same or similar specifications), direct replacement information from alternate manufacturers, and an extensive manufacture directory

with complete addresses and phone numbers.

Each volume in the D.A.T.A. Digest Library of Alternate Sources and Replacements costs \$125 plus shipping and handling; the three-volume set costs \$295 plus shipping and handling. Those prices include a completely updated edition in six months at no extra charge. They are published by D.A.T.A. Business Publishing, 15 Inverness Way East, P.O. Box 6510, Englewood, CO 80155-6510; Tel: 800-447-4666; Fax: 303-799-4082.

CIRCLE 90 ON FREE INFORMATION CARD

ELECTRONIC, COMPUTER AND ELECTROMECHANICAL COMPONENTS CATALOG

from American Design Components

This 48-page catalog is filled with products for computer enthusiasts, electronics technicians, hobbyists, and students. Computer equipment includes entire systems, individual work stations, disk drives, cards, cables, modems, mice, scanners, joysticks and game controllers, power supplies, battery backups, surge suppressors, and even some special manufacturer's close-outs. Electromechanical products include tools, AC and DC gear motors, stepping motors, batteries, pumps and compressors, and heating and cooling devices. For the electronics professional or enthusiast, the catalog includes a variety of switches, power supplies, transformers, high-voltage devices, LED's, heat sinks, connectors, breadboarding equipment, semiconductors, and IC's. Also featured in the catalog are do-it-yourself kits, including robotics kits, as well as consumer-electronics products, including a wireless video transmitter.

The Electronic, Computer, and Electromechanical Components Catalog is free upon request from American Design Components, 815 Fairview Avenue, P.O. Box 520, Fairview, NJ 07022; Tel: 1-800-776-3700 or 201-941-7480.

CIRCLE 91 ON FREE INFORMATION CARD

ENCYCLOPEDIA OF ELECTRONIC CIRCUITS: Volume 3

by Rudolf Graf

This companion to Volumes 1 and 2 is not a revision, but a collection of more than a thousand all-new circuits. It includes schematics for the latest electronic circuits from industry leaders, including Motorola, Texas Instruments, Teledyne, and others. The tightly organized book is divided into more than 100 separate chapters and provides a meticulous index and extensive cross references. Some of the circuits described in its 800-plus pages are the latest available alarm and security circuits; smoke, moisture, and metal detectors; capacitance, current, voltage, and frequency meters; computer, fiber optic, and laser circuits; and amplifiers, receivers, and transmitters.

The Encyclopedia of Electronic Circuits Volume 3 costs \$29.95 in softcover or \$60.00 in hardcover and is published by TAB Books Inc., Blue Ridge Summit, PA 17294-0850; Tel. 1-800-233-1128.

CIRCLE 98 ON FREE INFORMATION CARD

QUEST FOR CLUES III

compiled by Shay Addams

Written for anyone who's ever been totally frustrated trying to work their way through adventure or role-playing computer games, this book is the third annual installment in a popular series. It provides complete walk-throughs, maps, and solutions to 40 best-selling games. A small sampling of the adventure and role-playing-game software titles included in its 198 pages includes *Arthur*, *Indiana Jones & The Last Crusade*, *Conquests of Camelot*, *Dragon Wars*, *Manhunter: San Francisco*, *Gold Rush*, *Transylvania III*, *Future Wars*, *Hero's Quest*, *Leisure Suit Larry III*, *Circuit's Edge*, and *Chamber of the Sci-Mutant Priestess*.

Quest for Clues III costs \$24.99 and is published by ORIGIN Systems, Inc., 110 Wild Basin Road, Suite 330, Austin, TX 78746; Tel: 512-328-0282; Fax: 512-328-3825.

CIRCLE 92 ON FREE INFORMATION CARD

SELECT 5 BOOKS for only \$4.95

(values to \$112.75)

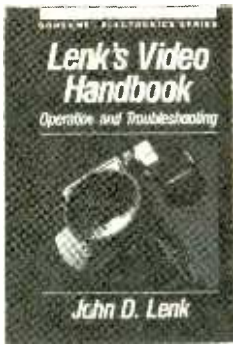
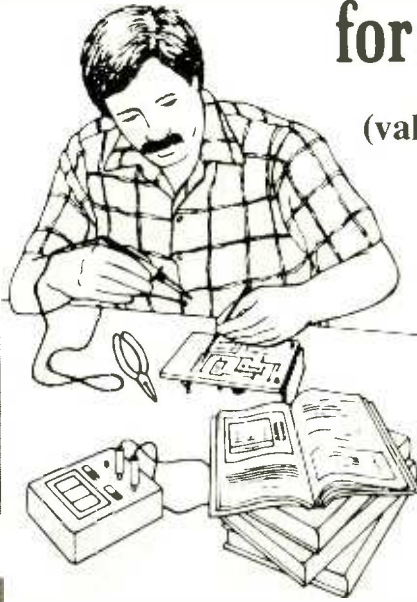

1001B \$39.95
Counts as 2

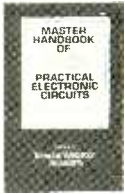

2980P \$19.95



2800P \$16.95

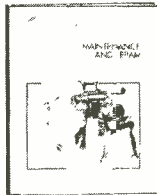

3157P \$16.95

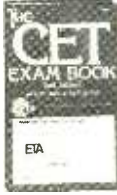

2950P \$13.95



3414 \$39.95
Counts as 2



3165 \$17.95



3342 \$25.95
Counts as 2



3285 \$25.95
Counts as 2



3265 \$27.95

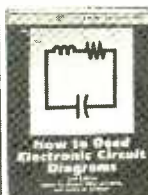

2880P \$14.95

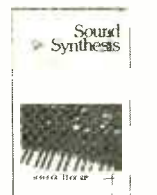

3276P \$14.95



3205 \$24.95



2882P \$17.95



2867P \$18.95



2826P \$16.95

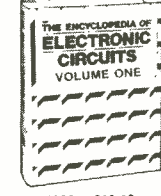

1938 \$60.00
Counts as 3



2707P \$17.95



3219 \$27.95
Counts as 2



3329 \$29.95
Counts as 2

Your most complete source for electronics books for over 25 years.



3103 \$27.95
Counts as 2



3241P \$16.95



2724P \$16.95



804P \$21.95
Counts as 2



3307 \$26.95
Counts as 2

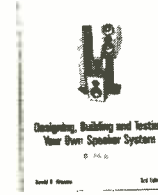

3374P \$16.95

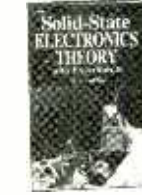

2926 \$25.95



3321P \$16.95



2613P \$17.95

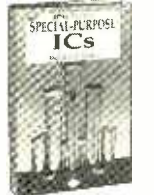

2625P \$16.95



2947P \$13.95

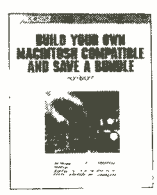

3656P \$17.95



3360 \$29.95
Counts as 2



2790P \$14.95



3258 \$27.95
Counts as 2

Membership Benefits • Big Savings. In addition to this introductory offer, you keep saving substantially with members' prices of up to 50% off the publishers' prices. • **Bonus Books.** Starting immediately, you will be eligible for our Bonus Book Plan, with savings of up to 80% off publishers' prices. • **Club News Bulletins.** 15 times per year you will receive the Book Club News, describing all the current selections—mains, alternates, extras—plus bonus offers and special sales, with scores of titles to choose from. • **Automatic Order.** If you want the Main Selection, do nothing and it will be sent to you automatically. If you prefer another selection, or no book at all, simply indicate your choice on the reply form provided. You will have at least 10 days to decide. As a member, you agree to purchase at least 3 books within the next 12 months and may resign at any time thereafter. • **Ironclad No-Risk Guarantee.** If not satisfied with your books, return them within 10 days without obligation! • **Exceptional Quality.** All books are quality publishers' editions especially selected by our Editorial Board. PE691



3355 \$26.95
Counts as 2



3031P \$17.95



2925P \$9.95



3072P \$16.95

©1991 ELECTRONICS BOOK CLUBSSM
A shipping/handling charge and sales tax will be added to all orders.

If card is missing, use this address to join:
ELECTRONICS BOOK CLUB, Blue Ridge Summit, PA 17294-0810

All books are hardcover unless number is followed by a "P" for paperback. (Publishers' Prices Shown)

NEW PRODUCTS

Frequency-Counter Computer Card

Optoelectronics' Model PC-10 Universal Frequency Counter/Timer comes in the form of a 9-inch drop-in card for personal and laptop computers. It uses Windows 3.0 as a control panel and display window, and it directly tunes radio receivers like the ICOM R7000, resulting in a uniquely configured self-tuning radio. The 10-Hz–2.4-GHz radio instrument measures, captures, and analyzes discrete and average frequency readings, pulse width, time interval, period, and the ratio between two frequencies. It provides a "reciprocal-counting" feature for 8-digit resolution of low-frequency readings.

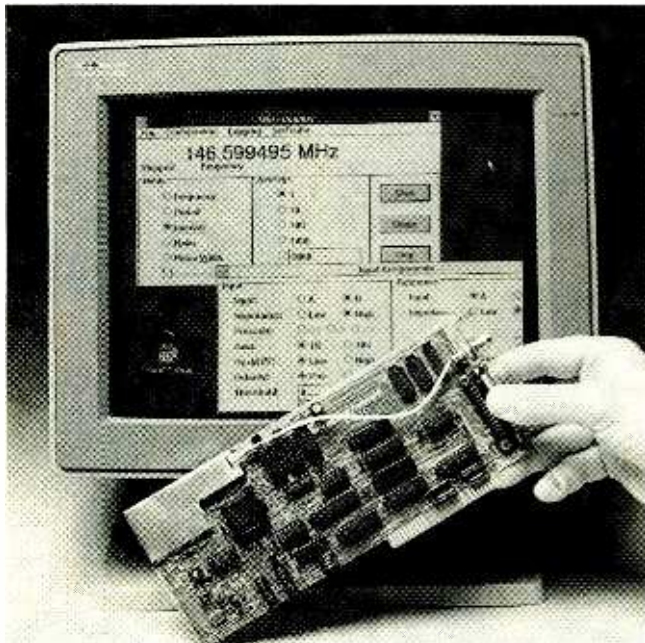

The heart of the PC-10 is a 200-MHz custom CMOS ASIC and three bipolar MMIC's that provide a blend of sensitive radio instrumentation and PC-based data manipulation and analysis. The PC-10 operates as a self-tuning radio. For surveillance applications where frequency scanning is too slow, it identifies the nearest signal source and tunes a companion receiver to it. User-controlled lock-out frequencies are written to a file to override local broadcasters and other anticipated noise sources.

The card is easy to install, set up, and use in any 8088- or higher-based IBM-compatible PC with Windows 3.0. Its "assignments" window controls both input and reference signal conditions such as gain, pre-scaler, input impedance, polarity, hysteresis, interval, and ratio (two amplifiers at once). It accepts any input signal of 10 mV or greater from sub-audio to 2.4 GHz, determines its frequency in terms of a ± 1 ppm temperature-compensated crystal oscillator, and then displays it with up to 10-digit resolution. For optimum balance between sample time and resolution, the input gate is continuously variable from 1 ms to 28 seconds. A unique software-calibration frequency takes a user-input reference signal and its frequency, determines the reference frequency, compares it to what the user says it is, and then writes the difference to an initialization file. Then, whenever the PC-10 takes a measurement, it automatically corrects the reading according to the calibration data.

The PC-10 Frequency Counter/Timer drop-in card costs \$335. For more information, contact Optoelectronics, Inc., 5821 NE 14th Avenue, Fort Lauderdale, FL 33334; Tel: 800-327-5912 or 305-771-2050; Fax: 305-771-2052.

CIRCLE 110 ON FREE INFORMATION CARD

EPROM ERASER

Dubbed "the world's smallest UV EPROM eraser," Logical Devices' Palm-Erase measures $4 \times 2 \times 2$ -inches and weighs only seven ounces. The hand-held device is well suited for field service and engineering applications where space is at a premium. The high-speed Palm-Erase can erase EPROM's in less than three minutes. It incorporates a small tray that can accommodate one 24-, 28-, 32-, or 40-pin EPROM at a time. The device is packaged in a gray-and-white plastic enclosure and



operates with the 110-VAC input power. The bulb intensity is $1.7 \mu\text{W}/\text{cm}^2$, and average bulb life-time is rated at 3000 hours.

The Palm-Erase UV EPROM eraser costs \$49.95. For additional information, contact Logical Devices, Inc., 1201 NW 65th Place, Ft. Lauderdale, FL 33309; Tel: 1-800-EE1-PROM; Fax: 305-974-8531.

CIRCLE 112 ON FREE INFORMATION CARD

STATIC-FREE SMT VACUUM PICK-UP PENCIL

Static-sensitive surface-mount technology components can be handled safely with OK Industries' VP-150 Series vacuum pick-up pencil. Because it is manufactured using static-dissipative materials, the VP-150 provides users with confidence that manually placed IC's will be handled without static discharge. The VP-150 also features two user-selectable vacuum-deactivation modes. A two-position switch allows for "continuous" vacuum operation, and vacuum deactivation is achieved by removing one's finger from the handpiece's bleed-hole. The vacuum can also be electrically deactivated via a foot pedal. The vacuum pick-up pencil can be used together with OK Industries' SMT-810 board holder with movable hand rest and SMT-815 component carousel. As a set, the combination provides a low-cost alternative to manual pick-and-place systems. It also offers the advantages of a hand rest for greater placement accuracy and speed, work area organization for improved efficiency, and protection from electrostatic discharges.



The VP-150 Series vacuum pick-up pencil has a suggested price of \$176.00. For further information, contact OK Industries, Inc., 4 Executive Plaza, Yonkers, NY 10701; Tel: 914-969-6800; Fax: 914-969-6650.

CIRCLE 113 ON FREE INFORMATION CARD

TRUE-RMS AC RECORDERS

Three true-RMS AC recorders from *Amprobe Instrument* allow the monitoring of voltages and currents with distorted waveforms—a function vital for the prevention of transformer destruction or loss of a neutral. *Model LAV3RMS* can sequentially record up to three true-RMS AC voltages on the same chart; *Model LAA3RMS*, up to three true-RMS AC currents; and *Model LAV21RMS*, one true-RMS AC current and one true-RMS AC voltage. All three units feature chart recording by the use of pressure-sensitive



paper, which eliminates the need for messy inks or ribbons; 50–400-Hz measuring range capability; accurate measurement of distorted waveforms with a crest factor of up to 3:1; and three user-selectable chart speeds (1-, 6-, and 12-inches per hour). The recorders are portable, weighing less than 8.6 pounds. Each comes with all the necessary power cords, voltage leads, transducers, instructions, and chart paper.

The Models LAV3RMS, LAA3RMS, and LAV21RMS cost \$489.85, \$527.85, and \$477.85, respectively. For further information, contact Amprobe Instrument, Division of Core Industries Inc., 630 Merrick Road, Lynbrook, NY 11563; Tel: 516-593-5600; Fax: 516-593-5682.

CIRCLE 117 ON FREE INFORMATION CARD

WIRELESS VIDEO TRANSMITTER

An FCC-approved 910-MHz wireless transmitter from *Ambico*, called the *V-7900 Video Air Link*, allows wireless broadcasts from any video source to any TV up to 100 feet away. It can be used to transmit signals from cable-TV tuners, VCR's, videodisc players, satellite dishes, camcorders, and security cameras through all walls and ceilings to any TV in



the house—with no messy wires. The Video Air Link can also be used for recording between two VCR's, which don't even have to be in the same room to make quality copies. The easy-to-set-up V-7900 comes with a compact transmitter, a receiver, cables, and a switch. Additional receivers are also available.

The Video Air Link (V-7900) has a suggested retail price of \$149.95; additional receivers (V-7901) cost \$69.95 each. For more information, contact *Ambico, Inc.*, 50 Maple Street, Norwood, NJ 07648; Tel: 201-767-4100.

CIRCLE 115 ON FREE INFORMATION CARD

SURGE SUPPRESSOR

A premium-grade surge suppressor from *Perma Power*, the *Model LS-812*, has a unique "failsafe" automatic-shutdown circuit that shuts off all power if

Courteous Service • Discount Prices • Fast Shipping

ALL ELECTRONICS

P.O. Box 567 • Van Nuys, CA 91408

FLASH ASSEMBLY

This NEW compact flash assembly comes from a U.S. manufacturer of cameras. Unit operates on 3 Vdc and measures 2 1/2" X 1 1/4". Ideal for use as a strobe, warning light or attention getter. Complete with instruction on how to wire.

CAT# FSH-1 \$3.75 each 10 for \$35.00

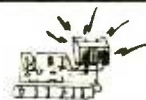

Special New Reduced Price PHOTOFLASH CAPACITOR

Rubicon CE photoflash capacitor. 0.79" dia. X 1.1" high. These are new capacitors that have been prepped with 1.4" black and red wire leads soldered to the terminals. 210 Mfd 330 Volt CAT# PPC-210 \$1.25 each • 10 for \$11.00 • 100 for \$100.00 Large quantities available. Call for pricing.



FLASHING L.E.D.

Diffused L.E.D. with built in flashing unit. PULSE RATE: 3 Hz @ 5 Volt/20 ma. Unit continually flashes when 5 Volts is applied. Operates between 4.5 Volts and 5.5 Volts. T 1 3/4 size. IDEAL AS AN INDICATOR.

RED CAT# LED-4
GREEN CAT# LED-4G
YELLOW CAT# LED-4Y
\$1.00 each • 10 for \$9.50 • 100 for \$90.00



HEAVY-DUTY NICKEL CADMIUM "C" BATTERY

Yuasa 1800C Special purchase of new, rechargeable nickel-cad batteries. 1.2 volts, 1800 mA.H. PRICE REDUCED ON 10 OR MORE.

CAT# HDNCB-C
10 pieces for \$42.50 (\$4.25 each)
100 pieces for \$375.00 (\$3.75 each)



POWER SUPPLIES

12 Vdc 5 AMP

ACDC Electronics # 12N5 or equiv. Input: 100-240 Vac (wired for 115 Vac) Output: 12 Vdc @ 5 amps. Open frame style. 7" X 4 3/4" X 3" high. Regulated. CAT# PS-125 \$37.50 each



24 Vdc 2.4 AMP

Power-One Inc. #HC-24-2.4 Input: 115/230 Vac (wired for 115 Vac). Output: 24 Vdc @ 2.4 amps. Open frame style. 5.62" X 4.87" X 2.50" CSA listed. CAT# PS-2424 \$30.00 each

SWITCHES

DIP P.C. PUSHBUTTON

ITT Shadow Digitast Series SE S.P.D.T. momentary pushbutton. Mounts in 14 pin DIP configuration. Designed for low current switching applications. Grey keycap is 0.68" X 0.67". CAT # PB-28 \$1.00 each 10 for \$9.50 • 100 for \$85.00



ROTARY BCD SWITCH

ECCO # 2310-02G - BCD 10 position rotary switch. DIP configuration fits in standard 8 pin I.C. socket. Right angle style. Screwdriver actuation. 0.42" cube. CAT# RDIP-2 \$1.75 each • 10 for \$16.00 • 100 for \$145.00



TOLL FREE ORDER LINES

1-800-826-5432

CHARGE ORDERS to Visa, MasterCard or Discover.

TERMS: Minimum order \$10.00. Shipping and handling for the 48 continental U.S.A. \$3.50 per order. All others including AK, HI, PR or Canada must pay full shipping. All orders delivered in CALIFORNIA must include state sales tax (6 %, 6 1/2 %, 7 %). Quantities Limited. NO C.O.D. Prices subject to change without notice.

Call or Write For Our
FREE 60 Page Catalog
(Outside The U.S.A. Send \$2.00 Postage)
ALL ELECTRONICS CORP.
P.O. Box 567 • Van Nuys, CA • 91408

CIRCLE 5 ON FREE INFORMATION CARD

Earn Your B.S. Degree in ELECTRONICS or COMPUTERS



By Studying at Home

Grantham College of Engineering, now in our 41st year, is highly experienced in "distance education"—teaching by correspondence—through printed materials, computer materials, fax, and phone.

No commuting to class. Study at your own pace, while continuing on your present job. Learn from easy-to-understand but complete and thorough lesson materials, with additional help from our instructors.

Our Computer B.S. Degree Program includes courses in the BASIC, PASCAL, and C languages — as well as Assembly Language, MS DOS, CADD, and more.

Our Electronics B.S. Degree Program includes courses in Solid-State Circuit Analysis and Design, Control Systems, Robotics, Analog/Digital Communications, and more.

An important part of being prepared to *move up* is holding the right college degree, and the absolutely necessary part is knowing your field. Grantham can help you both ways—to learn more and to earn your degree in the process.

Write or phone for our free catalog. Toll free, 1-800-955-2527, or see mailing address below.

Accredited by
the Accrediting Commission of the
National Home Study Council

GRANTHAM
College of Engineering
Grantham College Road
Slidell, LA 70460

the surge-suppressor circuit fails due to high voltage or repetitive surges. That automatic disconnection prevents any exposure to unprotected power, which is important since surge suppressors are often placed

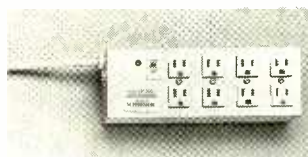

out of sight. The surge protector carries a lifetime warranty that provides equipment-repair coverage for the equipment under protection. The LS-812 provides two rows of four outlets, in a rugged metal case with a 12-foot power cord. The outlets are positioned wide enough apart to allow easy plug-in of AC adapters.

The LS-812 surge suppressor has a suggested retail price of \$99.95. For more information, contact Perma Power Electronics, Inc., 5601 West Howard Avenue, Chicago, IL 60648; Tel: 312-763-0763; Tel: 312-763-0763.

**CIRCLE 122 ON FREE
INFORMATION CARD**

RADAR DETECTOR

Cobra's Trapshooter Stealth D•R•O Model RD-3182 radar detector features highly sophisticated dielectric resonant oscillator (DRO) circuitry—originally developed for military applications against signal detection—that significantly reduces RF-signal leakage. The RD-3182 features an aerodynamic wedge-shaped design with wrap-around corner alarm lamps. It offers separate "X" and "K" tone alarms, variable volume control, a test/mute function, and a city/highway selector. In addition, the radar detector offers a signal-strength meter and a three-position dimmer switch. Accessories provided with the unit include an



adjustable visor-mounting bracket, hook-and-loop fasteners, and a six-foot coiled power cord. The radar detector's case is made of metal, not plastic, for added reliability and durability.

The Trapshooter Stealth RD-3182 has a suggested retail price of \$189.95. For additional information, contact Cobra Electronics Group/Dynascan Corporation, 6500 West Corland Street, Chicago, IL 60635; Tel: 312-889-8870.

**CIRCLE 123 ON FREE
INFORMATION CARD**

ELECTRICAL- INSULATION TESTER

Safety was a primary concern in the design of *Kyoritsu Electrical Instrument Works' Model 3001B* insulation checker, which indicates the presence of potentially dangerous live voltage with both audible and visual warnings. The 3001B also features fuse



protection and safety-recessed industry-standard banana terminals with shroud-covered banana jacks on the test leads. The test leads have one large, insulated alligator clip on one lead and one safety probe on the other.

The insulation checker has an easy-to-read digital display with three auto-ranging insulation-testing ranges in two high-voltage DC outputs. The ranges are 2/20/200 megohm autoranges in both 500 volts DC and 1000 volts DC outputs. When the output is selected using the front-panel switch, the instrument automatically selects the correct range. The model 3001B also measures low resistance in two (20/200 ohm) ranges. Standard features include a lock-down on/off button for continuous insulation testing and automatic discharge of circuit capacitance after insulation testing is complete. The instrument comes with eight "AA"

batteries and a carrying case with neck strap.

The model 3001B insulation checker has a suggested retail price of \$299.95. For further information, contact Kyoritsu Electrical Instruments Works, Ltd., 62 North Coleman Road, Centereach, NY 11720; Tel: 516-736-0601; Fax: 516-732-4650.

CIRCLE 124 ON FREE INFORMATION CARD

SOLDERING IRON WITH HEAVY-DUTY TIP

A 25-watt soldering iron from M.M. Newman Corporation, their *Antex Model XS*, is as powerful as a conventional 40-watt iron and handles bigger tips for working with large components and heavy-gauge wire. The Model XS has a plastic handle with an adjustable finger support that lets users get close to the work for optimum control. It features a 0.178-inch-diameter heating element shaft and accepts a variety of different heavy-duty, iron-plated, slide-on tips that provide greater thermal inertia for soldering compo-



nents. The heating element is located under the tip for improved thermal efficiency; the iron heats up to 750°–800°F tip temperatures in 45 seconds. The tips for the soldering iron, which come in a variety of shapes, are made from a special copper alloy to ensure maximum strength at high temperatures, as well as optimum heat conductivity for rapid heat up and recovery.

The Antex Model XS standard-size soldering iron has a list price of \$23.19, including one tip. For more information, contact M.M. Newman Corporation, 24 Tioga Way, P.O. Box 615, Marblehead, MA 01945; Tel: 617-631-7100; Fax: 617-631-8887.

CIRCLE 125 ON FREE INFORMATION CARD

PARALLEL-TO-SERIAL CONVERTER

To simplify the communication link between PC's and printers, Telebyte has introduced its *model 109* parallel-to-serial converter. Since the converter is bidirectional, it is used to connect a computer with parallel output to a serial device, or a computer with serial output to a parallel device. In addition, the model 109 contains a 64K data memory, which acts as a buffer, thereby releasing the sending device for other uses. It accommodates serial data rates of 300 to 38,400 BPS. The converter's operational parameters—including direction of conversion, baud rate, character length, parity, and handshake mode—are set via DIP switches that are



accessible from the side of the unit. The handshake mode allows X-ON/X-OFF or a DTR mode of operation. The converter is housed in a compact metal case, and power is supplied by a small wall-mounted transformer. The serial port uses a DB25 male connector, while the parallel port uses a Centronics 36-pin female connector.

The Model 109 parallel-to-serial converter costs \$99. For further information, contact Telebyte Technology Inc., 270 East Pulaski Road, Greenlawn, NY 11740; Tel: 516-423-3232 or 800-835-3298; Fax: 516-385-7060.

CIRCLE 126 ON FREE INFORMATION CARD

12-VOLT POWER PACK/CAR JUMPER

Combining a rechargeable, portable source of 12-volt power with a patented cordless charging system for vehicle batteries, *Innova Electronics' Power Pack with Jump Start* does double duty. In the event of a dead battery, the Jump Start mode requires only that the device be

FREE CATALOG with over 100 innovations to add comfort and convenience to your home.

Latest in electronics.

Heath Company's new Home Automation catalog features easy-to-install electronics that bring sophisticated technology into your home for as little as \$12.95. Simple. Easy to install. Affordable. Guaranteed.

Some bring you peace of mind.

Affordable protection for your home or car. Expandable security systems to meet your needs today and tomorrow. Advanced motion sensor lighting that reduces false triggering (often caused by blowing leaves or small pets) by up to 75%. You get protection where and when you need it, indoors and out.

Some save you time.

Watch the kids play outside, monitor the baby's room, or see who's at the front door just by looking at your television screen. (Who says you can't be two places at once?) Call home to turn on your slow-cooker or other appliances. From one center, control lights, fans, air conditioners — almost

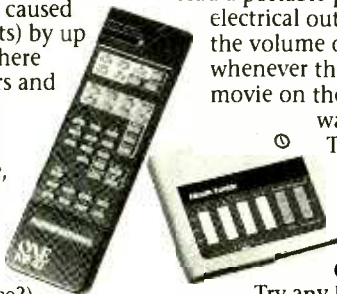

anything that plugs into an electrical outlet.

Some just make life easier.

Add a portable phone extension to any electrical outlet. Automatically lower the volume of your music system whenever the phone rings. Or play a movie on the living room VCR and watch it on your bedroom TV.

100% satisfaction ... the Heath guarantee for over 40 years.

Try any Heath product at no risk. If you aren't completely satisfied, simply return the item within 30 days for credit or full refund.

CIRCLE 12 ON FREE INFORMATION CARD

Call 1-800-44-HEATH for your FREE CATALOG.

Free call for a free catalog. Or, just mail the coupon below. Heath adds comfort and convenience ... and makes coming home even better.

Heath

Benton Harbor, Michigan

Please send me the NEW Home Automation catalog.

Name _____

Address _____

_____ Apt. _____

City _____

State _____ Zip _____

Mail to Heath Company, Dept. 107-060, Benton Harbor, MI 49022.

HA-101R1

plugged into the cigarette lighter. It provides 15 volts of current to "push" the energy (amperage) into a drained 12-volt battery, and, a few minutes later, the car can be started again. The Power Pack mode provides cordless, portable power for devices—including cellular phones, camcorder lights, por-



table stereos, or CB radios—that use 12-volt DC power. The Power Pack mode uses a 6.5-amp-hour, 12-volt, rechargeable battery. 12-volt power for accessories is supplied through the cigarette-lighter-style socket on the face of the unit. The Power Pack with Jump Start can be recharged through the cigarette-lighter socket on any vehicle with a 12-volt system. An optional AC outlet recharger is available.

The Power Pack with Jump Start has a suggested retail price of \$99.95. For additional information, contact Innova Electronics Corporation, 1590 Sunland Lane, Costa Mesa, CA 92626; Tel: 714-435-3535.

CIRCLE 127 ON FREE INFORMATION CARD

FREQUENCY-SYNTHESIZED WIDEBAND PORTABLE

Midland's Model 70-265C frequency-synthesized, wideband UHF, portable, two-way radio is programmable over a 32-MHz range from 480 to 512 MHz. The 48-channel includes an LCD readout and can be expanded to 99 channels with a simple plug-in module. It has a



built-in programmable priority-channel scan and tone-coded squelch. Output power is 4 watts, switchable to 1 watt. The rugged portable stands only about six inches high with a 600-mAh battery. Available options include a function keypad, DTMF signaling, and a weatherproof external speaker/microphone.

For pricing and other information on the Model 70-265A frequency-synthesized wideband two-way radio, contact Midland LMR, 1690 North Topping, Kansas City, MO 64120; Tel: 1-800-MIDLAND, Ext. 1690.

CIRCLE 128 ON FREE INFORMATION CARD

ANALOG MULTIMETER

Enclosed in a highly-visible yellow case made of resilient ABS plastic for increased drop protection, Simpson Electric's 260^R-8Xi analog multimeter is designed for use in harsh environments. The meter allows for direct trend indication; easy nulling and peaking; and quick, positive "yes/no" checks for



voltage and current. An audible continuity mode is also available for fast troubleshooting. A tri-color mirrored scale eliminates parallax errors, promising fast, consistent readings. The 260^R-8Xi also features high-current output on the lowest resistance range for locating potential problem areas. The multimeter has diode-protective meter movements in addition to standard and high-energy fusing. It features AC frequency response to 100 kHz. Accuracy +/-2% of full scale for DC voltage and +/-3% of full scale for AC voltage is provided by the "taut-band" self-shielding meter movement. The meter comes with batteries, test leads, insu-

lated alligator clips, and operator's manual. An optional "grab-and-go" padded nylon carrying case lets the unit be stored for quick field use by allowing the test leads to remain in the instrument's panel jacks.

The model 260^R-8Xi analog multimeter costs \$159.00. For further information, contact Simpson Electric Company, 853 Dundee Avenue, Elgin, IL 60120-3090; Tel: 708-697-2260; Fax: 708-697-2272.

CIRCLE 129 ON FREE INFORMATION CARD

ANTENNA STATIC DISCHARGER

The AS-1 precipitation/corona static device, designed by *The Truax Company*, is a static-discharge wick that will provide a path for electrons or static-charge dissipation on towers and antennas of all types. The device significantly reduces or eliminates corona noise and precipitation static, thereby reducing undesired electrical noise that causes receiver desensitization long before an operator notices any audible noise. Even in fair weather, the AS-1 can lower the noise floor. During precipitation static or corona-changing conditions, the AS-1 can improve the noise level up to 20–30 dB or more, depending on the frequency. The one-ounce discharger mounts easily to any antenna, boom or tower.

The AS-1 is essentially the same device that has been

used for years by the aircraft industry to minimize electrostatic interference to airborne and ground-station equipment. The AS-1 discharger, however, has been optimized for antennas to prevent any detuning of the antenna even if it is element mounted.

The AS-1 antenna static discharger costs \$12.95, plus \$1.00 shipping and handling. For further information, contact Static Busters, Inc., 3535 Shepardsville Road, Elizabethtown, NJ 42701; Tel: 502-769-2244.

CIRCLE 130 ON FREE INFORMATION CARD

DIGITAL MULTIMETER

Aimed at technicians, students, and hobbyists, the model 735 digital multimeter from *Global Specialties* provides easy-to-use, high-performance features. The handheld 3½-digit multimeter (DMM) has autoranging capability, a data-hold function, and a memory mode. The in-



strument measures DC and AC voltage, DC and AC current up to 10 amps, resistance, diode check, and continuity check. The data-hold function retains the last measurement value even after the test probes have been removed from the circuit. The memory mode lets the user make deviations and relative measurements by subtracting the latest measurement from the stored value.

The model 735 DMM costs \$59.95. For more information, contact Global Specialties, 70 Fulton Terrace, New Haven, CT 06512; Tel: 1-800-572-1028.

CIRCLE 131 ON FREE INFORMATION CARD



VIDEO EDITOR/COLOR PROCESSOR

Providing amateur video buffs with the ability to edit and adjust the color on home videos, *SIMA Products' Pro Ed/it 3* allows easy editing; the capability to add music and narration; complete video processing; and adjustments to color intensity, tint, and detail. Professional-quality picture and audio fades can be done automatically at each edit point. A video-enhance control boosts the video signal to restore washed-out colors, and a bypass button



provides instant comparison to the original picture. The Pro Ed/it 3 has two instantly switchable input sources and two outputs so that two copies of a tape can be made simultaneously. An automatic three-second fade button adjusts fade-ins and fade-outs so that changes are gradual and flowing throughout the editing process. A high-fidelity microphone for sound mixing is included, along with all necessary cables.

The Pro Ed/it 3 video editor/color processor has a suggested retail price of \$299.95. For additional information, contact SIMA Products Corporation, 8707 North Skokie Boulevard, Skokie, IL 60077; Tel: 1-800-345-7462.

CIRCLE 114 ON FREE INFORMATION CARD

APPLE ANTI-THEFT KIT

To prevent the "unauthorized borrowing" of Apple computers, *Curtis Manufacturing Company* has introduced the *Apple Security Kit*. The easy-to-use kit installs in minutes without tools, uses wound-steel security cables and a brass-and-steel padlock to secure the computer, keyboard, and peripherals to a desk or other immovable object. Several items in the kit have been designed specifically for Apple computers, including five special security brackets, a key-



board security loop, and ten security screws that can be removed only using the special allen wrench that comes with the kit. The Apple Security Kit can be used with Macintosh, Macintosh Plus, Macintosh SE, Macintosh II, and Apple IIGS systems.

The Apple Security Kit has a suggested retail price of \$29.95. For more information, contact Curtis Manufacturing Company, 30 Fitzgerald Drive, Jaffrey, NH 03452; Tel: 603-532-4123; Fax: 603-532-4116.

CIRCLE 116 ON FREE INFORMATION CARD

SWEEP/FUNCTION GENERATOR

Providing a full range of lab and service capabilities, *B&K-Precision's model 3022* 2-MHz

sweep/function generator with five-digit frequency counter measures sine, triangle, square wave, and ramp along with TTL and CMOS pulse-signal outputs. All have variable duty cycles. The instrument's operating modes include sweep, AM, FM, and voltage-controlled generator. It covers from 0.02 Hz to 2 MHz in seven ranges. The model 3022 has internal or external sweep capability with continuously adjustable sweep width to a maximum 1000:1 ratio. A sweep-ramp output lets it be synchronized with an oscilloscope for frequency response measurements.

Separate outputs are available for TTL/CMOS and other waveforms. For engineering applications, a variable DC offset simulates the presence of a DC signal on the generator output. That comes in handy for matching the DC voltage at the signal input point and for evaluating the effects of DC bias on AC circuits. The generator output can be amplitude or frequency modulated by an internal 400-Hz sinewave or an external source. For AM, the external



signal can extend to 1 MHz, while FM operation accepts input of any audio-range signal to 20 kHz. Both modulation ratio and FM deviation are fully adjustable.

The built-in five-digit frequency counter can be used to accurately display the output frequency of the generator or to read an external signal from 5 Hz to 10 MHz. The unit's external counter offers four user-selectable gating times for resolution to 0.1 Hz.

The model 3022 2-MHz sweep/function generator has a suggested price of \$450.00. For further information, contact B&K-Precision, Division of Maxtec International Corp., 6470 West Cortland Street, Chicago, IL 60635; Tel: 312-889-1448. ■

CIRCLE 118 ON FREE INFORMATION CARD

No Better Probe Ever at this Price!



Shown here
Model SP150 Switchable 1x-10x **\$49**

Risetime less than 1.5 nsec.

- **Universal**
Works with all oscilloscopes
- **Rugged**
Flexible cable lasts longer-
Replaceable ground lead
- **Economical**
Substantial savings compared to
OEM probes
- **10 Day Return Policy**
Guaranteed performance and quality

**TEST
PROBES, INC.**

TPI

9178 Brown Deer Road, San Diego, CA 92121
Toll Free 1-800-368-5719

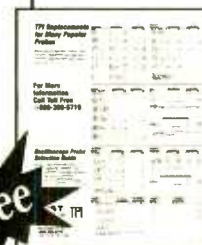

Free probe guide shows economical replacements for Tektronix, H-P, Philips and all others.

CIRCLE 19 ON FREE INFORMATION CARD

THINK TANK

By John J. Yacono

Current-Limiting Resistors and More

As its name implies, a current-limiting resistor restricts the amount of current flowing through a branch of a circuit. They are usually used to protect some current-sensitive device in series with them. Some of you who are new to electronics may not know how to calculate the value of current-limiting resistors to use in your projects. Even if you do, there are a couple of important considerations you should keep in mind that many hobbyists overlook. With that in mind, I'd like to present a couple of the basics for choosing the best

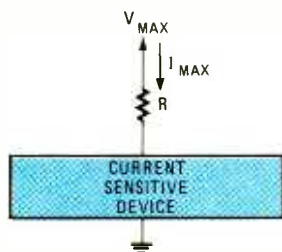

Fig. 1. Most current-limiting resistors are simply placed in series with the devices that they are supposed to protect.

value of current-limiting resistor for three common circumstances.

The most-common and simplest configuration for using one is shown in Fig. 1. In that circuit, there is a current-sensitive device (such as an LED) protected by a current limiting resistor, R. They are connected in series to some voltage source (a power supply or perhaps some other circuit) whose maximum output voltage is denoted V_{MAX} .

To figure out the best value for the resistor, R, we take the maximum voltage and divide it by the maximum current (I_{MAX}) that the

sensitive device can handle; you can usually find that value in the device's application notes or specifications. Effectively that limits the current flow to a safe value (I_{MAX}) even if the current-sensitive device acts like a dead short.

Although usually overlooked, you should also determine the wattage of the current-limiting resistor. Not checking the wattage needed is a ready invitation to disaster. The wattage (P) can be determined from:

$$P = I_{MAX}^2 R$$

When you calculate R and P, you'll probably get values that can't be found in the real world. If so, use a resistor whose resistance and wattage slightly exceed the values you've arrived at. That provides the circuit with a little extra protection.

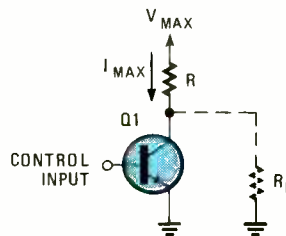

Fig. 2. A current-limiting resistor in a transistor-switch circuit protects the transistor, but it also limits the output voltage and current.

Another common circuit that requires a current-limiting resistor is a transistor-switch (see Fig. 2). In that circuit, when current is applied to the control input (in this case, the base of the transistor), Q1 turns on and current flows through R and Q1's collector and emitter to ground. Resistor R limits the current flow to a safe value exactly as it did in the

previous circuit. In fact you, can use the principles we've already described to determine its specifications.

However, there is one extra consideration to take into account: the load impedance, represented by the dashed resistor, R_L , in the circuit. It is drawn dashed because the load may be something other than a resistor; for instance it could be another transistor stage or an op-amp input. The load impedance is important because R limits the current and voltage available to drive the load. The maximum current through the load (I_L) will be:

$$I_L = V_{MAX} / (R + R_L)$$

If the value of load current is too small, you will have to lower the value of R and chose a transistor that can handle the additional collector-emitter current to replace Q1. Recalculate the wattage of the resistor too, just in case.

If the load is a voltage-sensitive device (such as a FET), then you'll need to determine the maximum voltage (V_L) the circuit will deliver to the load. Use this equation for that:

$$V_L = (V_{MAX} R_L) / (R + R_L)$$

The last use for current-

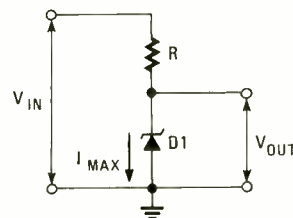

Fig. 3. Zener diodes make excellent regulators. However, the current-limiting resistors they require reduce the maximum output current as well as the voltage.

limiting resistors we'll discuss is to protect Zener diodes (see Fig. 3). In Fig. 3, we show a Zener diode acting as a voltage regulator. With the help of the resistor, it is used to reduce an input voltage (V_{IN}) to a desired output voltage (V_{OUT}). As you probably know, the Zener diode you chose determines the output voltage. The Zener diode can only pass so much current, and we'll denote the maximum current as I_{MAX} . The resistor value needed to protect the Zener can be determined by:

$$R = (V_{IN} - V_{OUT})/I_{MAX}$$

The load connected to V_{OUT} will be subject to the same current and voltage restrictions that we mentioned in our discussion on the transistor switch. In fact, you can use the same equations for V_L and I_L to determine the maximum values, provided that you do two things: substitute V_{IN} for V_{MAX} , and remember V_L will not rise above V_{OUT} no matter what the equation says.

And now onto the mail. As always, my co-conspirators in this month's column will receive a copy of Think Tank II. If you've contributed to this column before and already have a copy, let me know and we'll find something else to send you.

PHONE-RING DETECTOR

Most telecommunications products are capable of automatically answering the phone to perform their tasks. They normally let the phone ring a few times and then answer the call. You can add that feature to your own telephone-line connected projects with the simple circuit shown in Fig. 4. Optocoupler U1 isolates the circuit from the telephone line. Transistor Q1 acts as a buffer that allows C2 to charge each time it receives pulses (the ring signal) from U1.

The transistor also helps detect degraded ring signals. Op-amp U2 is used as a comparator that will go high when C2 is sufficiently charged (seven rings to be exact). The op-amp output can be used to trigger your own project, take the phone off hook, or whatever.

—Tony K.P. Wong, Robinson Heights, Hong Kong
I like how D1 helps protect the LED in U1 from overvoltage. Note that the timing constant of R6 and C2 is such that the circuit will not be fooled by dialing pulses.

TELEPHONE INTERCOM

The church that I attend needed an intercom with

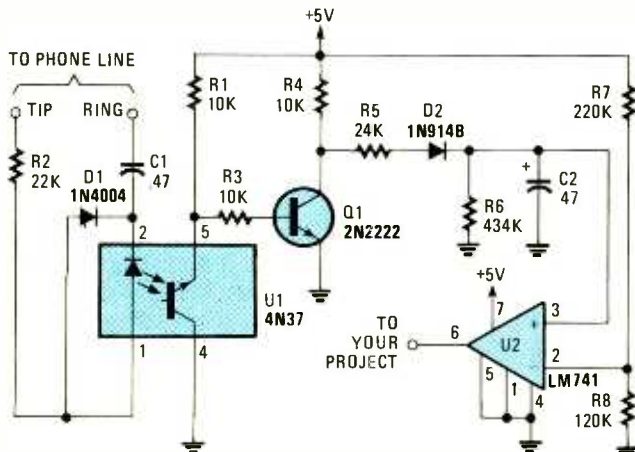

Fig. 4. This ring detector can be a great front end to a phone-answering project. You can alter the value of R6 and C2 to change the number of rings that activates the device.

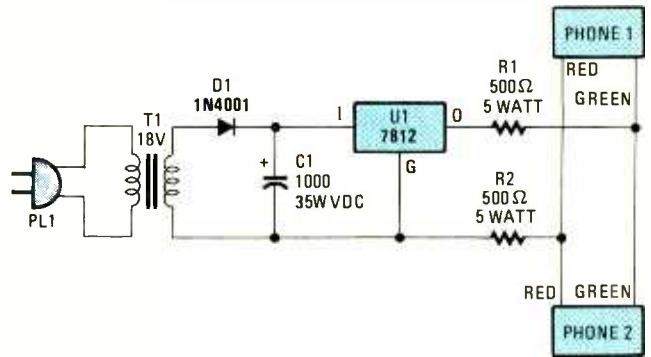

Fig. 5. If you've got a couple of old phones lying around, then this phone intercom might get your interest. You just need a very simple power supply or batteries and a couple of high-wattage resistors and you're all set.

two stations. There was no need for a ring signal. I wanted to make it simple, but with good quality sound.

Remembering that I'd seen a way to connect two telephones together, I came up with the circuit in Fig. 5. It uses two telephones and a power source that form an excel-

lent intercom. The red (ring) wires of the phones are tied together, the green (tip) wires are connected together, and the two sets of wires are connected to the power source via two 500-ohm, 5-watt resistors.

The resistors are the key to making the phone intercom work; they isolate the phones from the power

Protel Easytrax 2™

Outstanding value in Printed Circuit Board/CAD for your Macintosh and PC

Protel Easytrax 2 is a new, low-cost design package for PC and Macintosh users that includes everything required to produce professional quality Printed Circuit Board artwork.

Our easy-to-learn menu-driven design system breaks the 'expert barrier'-you'll be designing in minutes, not hours. Our comprehensive tutorials guide you through the program's extensive features that take the tedium out of board layout.

- Comprehensive library of Through-hole devices
- Gerber photoplotting and N/C drill tapes
- On-the-fly library components creation
- Intelligent Pad to Pad autorouting
- Switchable Metric/Imperial grid
- Auto-panning
- PostScript™ printing
- Powerful user-definable Macros
- Independent print/plot program
- Multi-layer boards of up to 32 X 32 inches.

At Protel, we offer free technical support, 24-hour BBS, and 30-day money back guarantee. Prices start at

Free Evaluation Package
Toll Free: 800-544-4186

\$450

Protel Technology, Inc.
50 Airport Parkway, San Jose, CA 95110
Tel: 408-437-7771 Fax: 408-437-4913



CIRCLE 7 ON FREE INFORMATION CARD

ATTENTION! ELECTRONICS TECHNICIANS



**EARN YOUR
B.S.E.E.
DEGREE
THROUGH HOME STUDY**

Our New and Highly Effective Advanced-Placement Program for experienced Electronic Technicians grants credit for previous Schooling and Professional Experience, and can greatly reduce the time required to complete Program and reach graduation. No residence schooling required for qualified Electronic Technicians. Through this Special Program you can pull all of the loose ends of your electronics background together and earn your B.S.E.E. Degree. Upgrade your status and pay to the Engineering Level. Advance Rapidly! Many finish in 12 months or less. Students and graduates in all 50 States and throughout the World. Established Over 40 Years! Write for free Descriptive Literature.

**COOK'S INSTITUTE
OF ELECTRONICS ENGINEERING**

 4251 CYPRESS DRIVE
JACKSON, MISSISSIPPI 39212

CIRCLE 16 ON FREE INFORMATION CARD

FREE CATALOG

Call (800) 992-9943

Over 35,000
Electronic Components

Call Today for Your
FREE SUBSCRIPTION

If You Order Today,
WE SHIP TODAY!!



**MOUSER
ELECTRONICS**

(800) 992-9943

Stocking Locations Across America.

CIRCLE 14 ON FREE INFORMATION CARD

supply, permitting AC audio signals on the phone line. Without the resistors the red and green wires would be clamped at the DC-source voltages.

The power-supply voltage is not critical—the intercom will work on 5- to 50-volts DC. However, if you use an AC power supply, a voltage regulator is a must. On my first try at this circuit, I did not use one and got an earful of hum.

A 12-volt car battery will work for a portable system. I think others will find this circuit easy to build and very useful.

—*Vincent Grabosky,
Ruffsdale, PA*

If I'm not mistaken, you could probably use one 1000-ohm resistor in place of the two 500-ohm units. Of course, you'll have to either use it between the ground and red lines or the positive supply rail and the green wires.

There may be some potential for using the same type of idea on a household telephone system to turn extensions into intercoms. You would probably need a 90-Hz oscillator to provide a ring signal to get someone's attention.

CHRISTMAS-LIGHT TESTER

How often have you been out in the cold trying to figure out which light in a string of Christmas lights has gone out? You could try replacing bulb after bulb till the string works, but that could take a very long time, and if two lights are faulty that method fails. That's why I'm submitting this Christmas-tree light tester circuit (see Fig. 6).

To build one, connect an old AC line cord to two diodes making sure that the diodes (which form a full-wave rectifier) are connected as shown in the schematic and their leads are insulated. The remain-

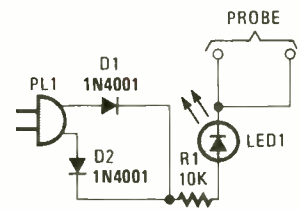

Fig. 6. This little project could help you keep the holiday spirit alive next winter. It will help you quickly trouble-shoot bad Christmas-tree lights so you can spend your time enjoying the festivities.

ing leads of the diodes should be tied together and connected to a 10,000-ohm resistor. The resistor should be connected to the anode of an LED. The cathode of the LED should be connected to a length of stranded wire. Insulate all the leads with heat-shrink tubing or electrical tape and house the whole assembly in a tubular enclosure with the LED visible from one end.

The wire will be connected to a probe made from a dead bulb. First remove the glass bulb from its base by giving it a pull. Now twist the wires on the bulb together a couple of turns, attach the stranded wire to the twist and solder the three wires together. Snip the assembled junction from the bulb and place the wires back in the base so they protrude the way they did before you removed them. Place a plastic rod (which will act as a handle) in the modified bulb base and epoxy it in place.

To use the tester, the lights and the tester should be plugged into an AC socket. Start the test by removing the bulb that is electrically in the middle of the circuit formed by the bulbs and insert the probe in its place. (Inspect the wiring carefully; the bulb that's physically in the middle of the string is not necessarily in the middle of the circuit.) The LED

Take any 3 PROFESSIONAL BOOKS for only \$4.95

when you join the **ELECTRONICS ENGINEERS & DESIGNERS BOOK CLUB**SM values to \$129.40

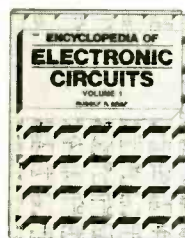

1938 \$60.00
Counts as 2

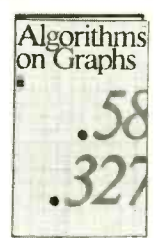

3429 \$29.95

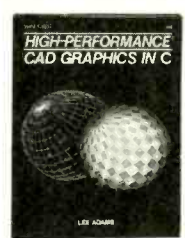

3059 \$34.95
Counts as 2



3199 \$52.00
Counts as 2

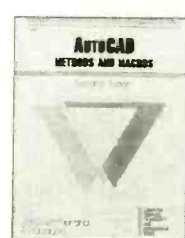

3544 \$34.95

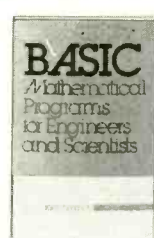

8225P \$19.95

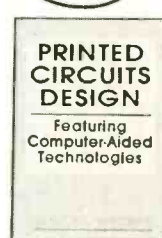

10016 \$39.95

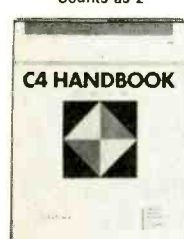

3098 \$44.50
Counts as 2

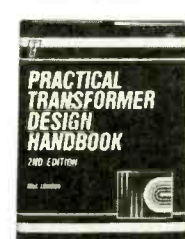

3212 \$34.95



9813 \$39.95

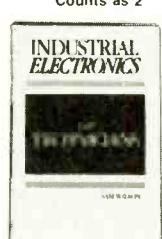

3321P \$16.95



3329 \$29.55

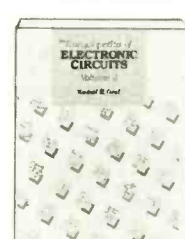

3138 \$60.00
Counts as 2



2672 \$49.50



3203 \$44.50
Counts as 2

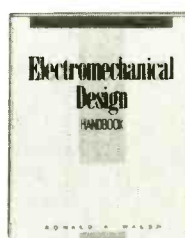

3102 \$49.50
Counts as 2

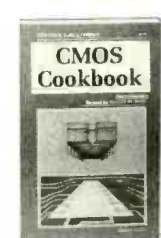

9244P \$18.95



3365 \$34.95
Counts as 2



2962P \$17.95



9243P \$12.95

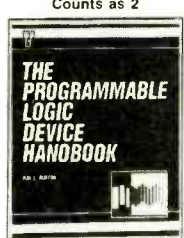

3140 \$49.95
Counts as 2



10010P \$19.95



3151 \$39.95
Counts as 2



3100 \$75.00
Counts as 3



3279 \$36.95
Counts as 2

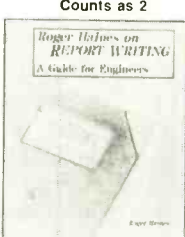

3313 \$22.95

How the Club Works

YOUR BENEFITS: You get 3 books for \$4.95 plus shipping and handling when you join. You keep on saving with discounts of up to 50% off as a member.

YOUR PROFESSIONAL BOOKSTORE BY MAIL: Every 3-4 weeks, you will receive the EE&D Book Club News describing the Main Selection and Alternates, as well as bonus offers and special sales, with scores of titles to choose from.

AUTOMATIC ORDER: If you want the Main Selection, do nothing and it will be sent to you automatically. If you prefer another selection, or no selection at all, simply indicate your choice on the reply form provided. You will have at least 10 days to decide. As a member, you agree to purchase at least 3 books within the next 2 years and may resign at any time thereafter.

BONUS BOOKS: Starting immediately, you will be eligible for our Bonus Book Plan, with savings of up to 80% off publishers' prices.

IRONCLAD NO-RISK GUARANTEE: If not satisfied with your books, return them within 10 days without obligation!

EXCEPTIONAL QUALITY: All books are quality publishers' editions especially selected by our Editorial Board. (Publishers' Prices Shown)

Your source for quality, affordable and timely authoritative engineering books.

EE & D **ELECTRONICS ENGINEERS & DESIGNERS BOOK CLUB**SM
Blue Ridge Summit, PA 17294-0860

YES! Please accept my membership in the *Electronics Engineers & Designers Book Club* and send the 3 volumes I have listed below, billing me \$4.95. If not satisfied, I may return the books within 10 days without obligation and have my membership cancelled. I agree to purchase at least 3 books at regular Club prices during the next 2 years, and may resign any time thereafter. A shipping/handling charge and sales tax will be added to all orders.

Name _____
Address _____
City _____
State _____ Zip _____ Phone _____
Signature _____

Valid for new members only. Foreign applicants will receive special ordering instructions. Canada must remit in U.S. funds. This order subject to acceptance by the *Electronics Engineers & Designers Book Club*. PP1F691

All books are hardcover unless number is followed by a "P" for paperback.
©1991 EEDBC, Blue Ridge Summit, PA 17294-0860

AMAZING SCIENTIFIC & ELECTRONIC PRODUCTS

LASERS AND SCIENTIFIC DEVICES

VRL2K	3mw Vis Red Laser Diode System Kit	\$159.50
LLIS1K	Laser Beam "Bounce" Listener Kit	\$199.50
LHC2K	Visible Simulated 3 Color Laser Kit	\$44.50
LC7	40 Watt Burning Cutting Laser Plans	\$20.00
RUB4	Hi Powered Pulsed Drilling Laser Plans	\$20.00
LGU40	1 to 2mw HeNe Vis Red Laser Gun Assembled	\$199.00
LLS1	Laser Life Show - 3 Methods Plans	\$20.00
SD5K	See in the Dark Kit	\$299.50
EML1K	Electromagnetic Coil Gun Kit	\$69.50
MCP1	Hi Velocity Coil Gun Plans	\$15.00
LEV1	Levitating Device Plans	\$10.00
EH1	Electronic Hypnotism Techniques Plans	\$10.00

HIGH VOLTAGE AND PLASMA DISPLAY DEVICES

HVM7K	75,000 Volt DC Variable Output Lab Source Kit	\$149.50
IOG3K	Ion Ray Gun Kit, project energy without wires	\$69.50
NIG9K	12V/115 VAC Hi Out Neg Ion Generator Kit	\$34.50
EMA1K	Telekinetic Enhancer/Electric Man Assembled	\$99.50
LG5K	Lightning Display Globe Kit	\$54.50
BTC1K	Worlds Smallest Tesla Coil Kit	\$49.50
BTC3K	250KV Table Top Tesla Coil Kit	\$249.50
BTC5	1.5 Million Volts Tesla Coil Plans	\$20.00
JL3	Jacobs Ladder - 3 Models Plans	\$15.00
GRA1	Anti Gravity Generator Plans	\$10.00
PFS20	Plasma Fire Saber Assembled	\$69.50
DPL20	Dancing Plasma to Music and Sounds Assembled	\$79.50

SECURITY AND PROTECTION DEVICES

ITM10	100,000 Volt Intimidator up to 20' Assembled	\$129.50
IPG70	Invisible Pain Field Blast Wave Gen Assembled	\$74.50
PSP4K	Phasor Sonic Blast Wave Pistol Kit	\$59.50
LIS110	Infinitely Xmtr, Listen in Via Phone Assembled	\$199.50
TAT30	Automatic Tel Recording Device Assembled	\$24.50
VWPM7K	3 Mi. FM Auto Tel Transmitter Kit	\$49.50
FMV1K	3 Mi. FM Voice Transmitter Kit	\$39.50
HDD1K	Homing/Tracking Beeper Transmitter Kit	\$49.50

EASY ORDERING PROCEDURE TOLL FREE 1-800-221-1705
or 24 HRS ON 1-603-673-4730 or FAX IT TO 1-603-672-5406
VISA, MC, CHECK, MG IN US FUNDS. INCLUDE 10% SHIPPING. ORDERS
\$100.00 & UP ONLY ADD \$10.00. CATALOG \$1.00 OR FREE WITH ORDER.

INFORMATION UNLIMITED
P.O. BOX 716, DEPT. PE, AMHERST, NH 03031



For you. For her. For
Life. Keep your heart
healthy.

**American Heart
Association**



will light if the socket is getting power from at least one side of the socket.

Now you need to determine which half of the circuit is not providing power. Remove one of the bulbs next in series to the socket you're testing (again, do not assume that bulbs physically next to each other are connected in series); if the LED remains on, then the fault is in the leg that contained the bulb you just now removed. Of course, if the LED goes out, the fault is in the other half of the circuit. By determining which side the fault is on, you have cut the possibilities in half.

Remove the probe, replace the bulbs, and put the probe in a socket half way along the faulty side. Determine which side of that socket is not getting power as you did with the first socket. If the fault lies somewhere between the last and current sockets tested, then test a socket about halfway between them. If the fault is on the other side, test a point halfway between the current socket and the end-most socket. Keep proceeding in that manner, testing points halfway between sockets you've tested, till the string lights up. Remove the probe and put a fresh bulb in its place.

If the LED doesn't light in a particular socket, then there are at least two bulbs out (one on either side of the socket being tested). Use the same method of dividing suspect legs of the circuit in half and test again; only keep in mind that the string will only light up when you find the last faulty bulb. Instead you'll know you've found a faulty bulb because the LED will light when connected to a socket on one side of it.

I would like to emphasize how much I appreciate *Think Tank*. I don't have time

for lengthy projects. Your projects are quite manageable and most of them are very ingenious thanks to your readers and your selection. Keep it up!

—PT. Chopping, Allison Park, PA

You've just helped me reduce the time and drudgery involved in a chore I've never liked. If anybody feels a little uncomfortable about connecting an LED to line voltage I think you could probably use the same technique with DC voltage provided you reduce the value of R1 (just like we discussed in the beginning of this month's column).

SOLDERING HINT

I use rubber bands to hold components to a printed-circuit board during soldering operations. It's easier than bending the leads the way I used to do, and I've found that bending the leads can cause unwanted shorts.

—Al Williams, Jasper, FL

See Al? That's all it took to win a book for you. Good going!

Well that brings us to the close of another month. As usual, all the submissions we use are rewarded with a copy of *Think Tank II*. So get the mailman hop'in by sending your circuits and ideas to *Think Tank*, **Popular Electronics**, 500-B Bi-County Blvd., Farmingdale, NY 11735. ■



"I know even super heroes have to sleep somewhere, but he's de-tuning my beam."

CIE Gives You The Training You Need to Succeed... At Your Own Pace...& In Your Own Home!

Discover Your Career Potential In The
Fast-Growing Field Of High-Tech Electronics!

If you're anxious to get ahead...and build a *real* career...you owe it to yourself to find out about the Cleveland Institute of Electronics!

CIE can help you discover your career potential in the fast growing field of high-tech electronics. A career that will challenge and excite you every day...reward you with a powerful feeling of personal accomplishment...and deliver a level of financial security you may have only dreamed of before!

As the leading school in home-study electronics, CIE has helped over 150,000 students in the U.S.A. and over 70 foreign countries get started in this exciting field. To find out how CIE could be helping you...read on...then send for a CIE catalog TODAY!

A Growing Need For Trained Professionals!

The career opportunities shown here are only a few of the challenging, high-paying careers you could enjoy as an electronics technician.

You could be the "brains" behind the scenes of an exciting TV broadcast...trouble-shoot life-saving medical equipment...design exotic new aeronautics systems...CIE's job-oriented programs offer you the quickest possible path to the career of your dreams! And CIE also features military and union re-training, to build on what you already know.

Dozens Of Fascinating Careers To Choose From!

Even if you aren't sure which career is best for you, CIE can get you started with core lessons applicable to *all* areas of electronics. As you advance, CIE makes job opportunities available to you through the bimonthly school paper, *The Electron*.



Data Communications



Automotive Electronics



Avionics



Computer-Assisted Manufacturing



Consumer Electronics



Military Electronics

Personal Training From A Renowned Faculty.

Unlike the impersonal approach of large classroom study, CIE offers you one-on-one instructional help 6 days a week, toll-free. Each CIE lesson is authored by an independent specialist, backed by CIE instructors who work directly with you to answer your questions and provide technical assistance when you need it.

Practical Training... At Your Own Pace.

Through CIE, you can train for your new career while you keep your present job. Each course allows a generous completion time, and there are no limitations on how fast you can study. Should you already have some electronics experience, CIE offers several courses which start at the intermediate level.

"State-Of-The-Art" Facilities & Equipment.

In 1969, CIE pioneered the first electronics laboratory course, and in 1984, the first Microprocessor Laboratory. Today, no other home study school can match CIE's state-of-the-art equipment. And all your laboratory equipment is included in your tuition cost. There is no extra charge—it's yours to use while you study at home and on the job after you complete your course!

Earn Your Degree To Become A Professional In Electronics!

Every CIE course you take earns you credit towards the completion of your Associate in Applied Science Degree, so you can work towards your degree in stages. And CIE is the only school that awards you for fast study, which can save you thousands of dollars in obtaining the same electronics education found in four-year Bachelor's Degree programs!

Send For Your Catalog Today!



CIE World Headquarters

Cleveland Institute of Electronics, Inc.
1776 East 17th St., Cleveland, Ohio 44114

YES! Please send me your independent study catalog (For your convenience, CIE will have a representative contact you—there is no obligation.)

Print Name _____

Address _____ Apt # _____

City/State/Zip _____

Age _____ Area Code/Phone No. _____

Check box for G.I. Bill bulletin on educational benefits: Veteran Active Duty

Mail This Coupon Today!

AH09

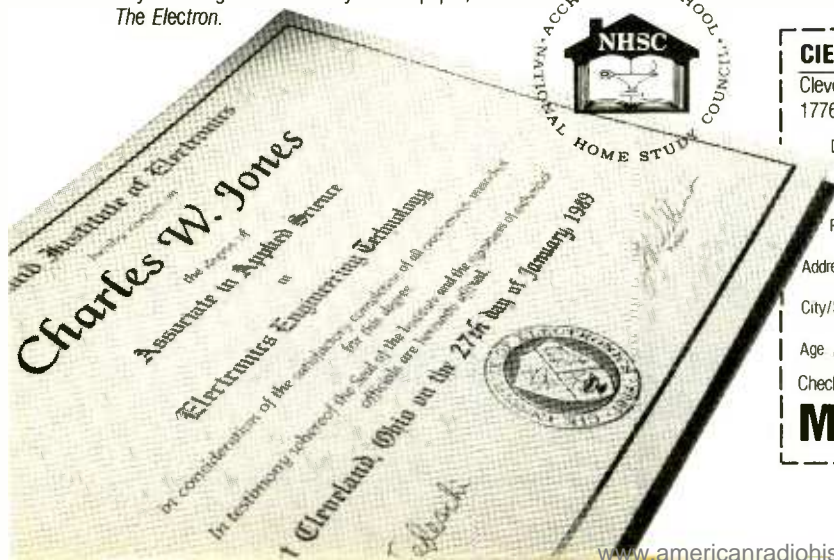

The Importance Of Setting Standards.



Without standardization in electronics, television wouldn't be seen, radio wouldn't be heard, computers wouldn't share information.

Fortunately the Electronic Industries Association (EIA) has been setting electronics standards since 1924 for everything from early tube radios to today's cellular telephones and stereo TV's.

Standards create *markets and jobs*. Today EIA, an internationally accredited standards making body, is helping to make HDTV a reality by working with the federal government and other industry organizations, to develop a timely, uniquely American transmission standard. For home automation,

EIA also is close to completing a standard which will permit all home electronic products to communicate with each other.

Our more than 1,000 member companies are manufacturers representing every facet of the American electronics industry—from defense to consumer products.

EIA is proud of the contributions it has made through its standards making process toward the growth and vitality of the U.S. electronics industries.

Setting the standard for more than 66 years.



ELECTRONIC INDUSTRIES ASSOCIATION

1722 Eye Street, N.W., Suite 300, Washington, D.C. 20006

In 1800, William Nicholson and Anthony Carlisle announced that they had achieved the chemical decomposition of ordinary water with an electric current supplied by the "galvanic apparatus" of Alessandro Volta. The work was published in Nicholson's *Journal of Natural Philosophy, Chemistry, and the Arts*, where it caught the attention of a poetic young experimenter by the name of Humphry Davy. Immediately, Davy began to wonder what other kinds of electrochemical changes might be possible with that marvelous new invention: the battery.

Davy's electrochemical investigations were interrupted in 1801 when he was appointed to a lectureship at the Royal Institution. Davy was a highly successful public speaker. His science lectures became as popular and as fashionable as the latest piece of literature. The stylish London audiences were thrilled to have the latest advances in physics and electrochemistry reproduced before their eyes.

In addition, the income helped sup-

Experiments In Electrochemistry

BY
STANLEY A. CZARNIK

port the Royal Institution and provided the money necessary for the pursuit of natural philosophy in a well-equipped workshop. And that's just what happened. Humphry Davy's large London laboratory became one of the finest in all of western Europe.

The Discovery of Potassium. Davy returned to his electrochemical studies in 1806. His thinking on the subject was already very far advanced. He was confident that with the new electrochemical techniques, it might someday be possible to identify and even manipulate the "true elements" of the physical world.

In 1807, Davy began a famous series of experiments involving the decomposition of potash (potassium carbonate). He placed a small amount of

Changing colors, beautiful streamers, and metallic gardens are just some of the wonders you'll discover in these fun experiments.

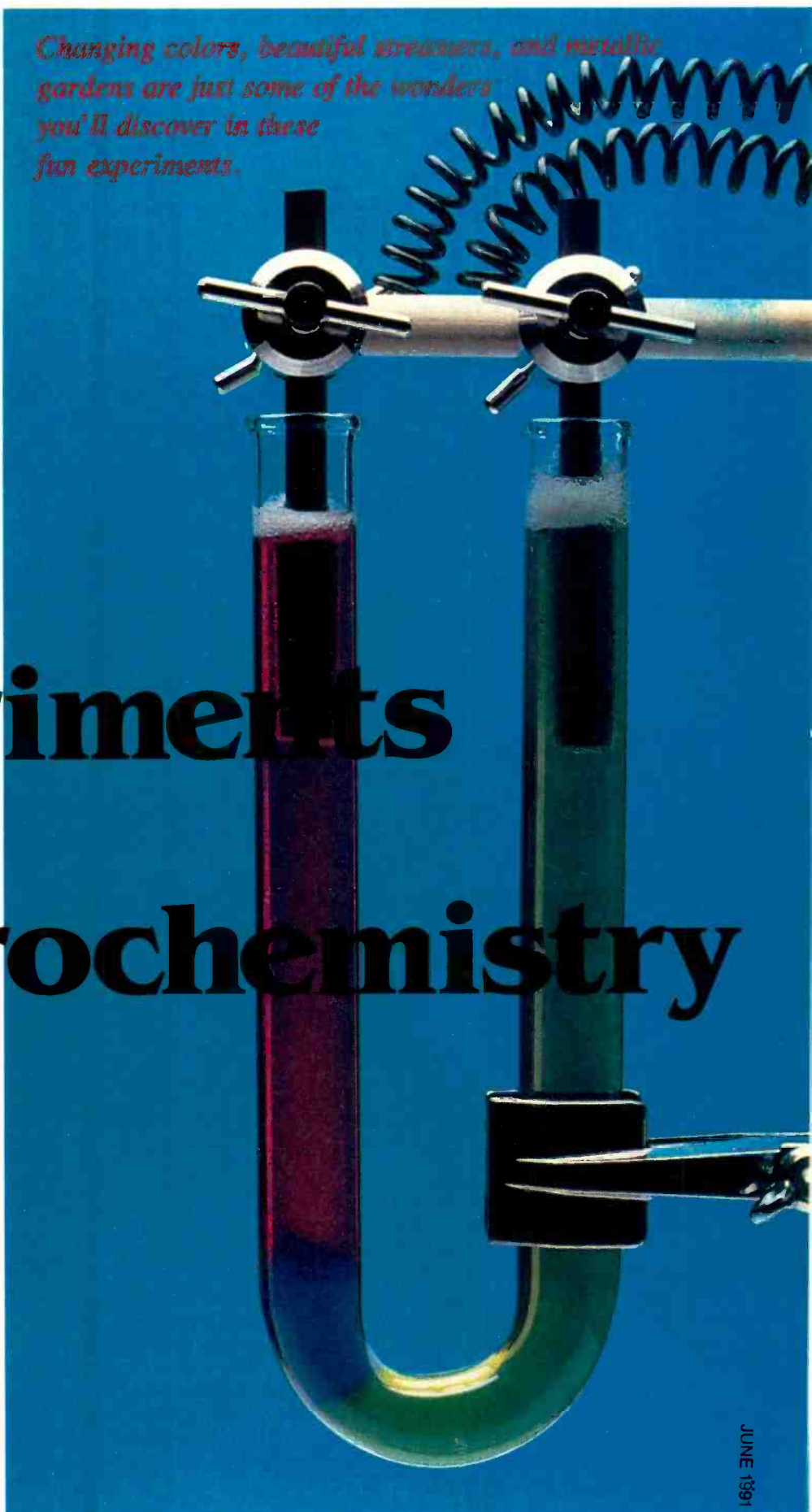

JUNE 1991

WARNING!! This article deals with and involves subject matter and the use of materials and substances that may be hazardous to health and life. Do not attempt to implement or use the information contained herein unless you are experienced and skilled with respect to such subject matter, materials and substances. Neither the publisher nor the author make any representations as for the completeness or the accuracy of the information contained herein and disclaim any liability for damages or injuries, whether caused by or arising from the lack of completeness, inaccuracies of the information, misinterpretations of the directions, misapplication of the information or otherwise.

potash into a platinum spoon and attached the spoon to the positive pole of a battery. A flame was placed beneath the spoon to melt the chemical. When a wire connected to the negative pole of the battery was touched to the hot potash, a ball of fire appeared over the point of contact.

Humphry Davy knew that something special was being collected at the negative wire. He also knew that a slightly different technique would be necessary in order to isolate the collected material.

So, he moistened the potash with a bit of water to make it conductive and repeated the experiment without the heat. This time, tiny metallic globs appeared at the end of the negative wire. Some of the pieces, once again, caught fire; but some remained and became covered with a white film.

Here, at last, in free form, was the material he had been looking for. He called it potassium, one of the "true elements" from which potash is made. The results of the experiments were reported to the Royal Society on November 19, 1806.

Leaves and Seeds. Davy's discovery of potassium, as well as sodium and a number of other alkali metals, has become a classic example of electrochemical decomposition. But there's more: A close reading of Davy's lecture "On Some Chemical Agencies of Electricity," delivered originally in 1806, reveals work with various organic materials like laurel leaves, mint plants, and strips of beef. He even experimented with seeds. In a somewhat cryptic footnote, he says: "Seeds, I find, when placed in pure water in the positive part of the circuit, germinate much more rapidly than under common circumstances; but in the negative

part of the circuit they do not germinate at all."

Clearly, Humphry Davy was fascinated by the physical transformations which so often occur in electrochemical circuits of all kinds. Indeed, he even imagined certain similarities between the effects of electrochemical change and the mystic visions of the alchemical philosophers. Maybe you will too.

Early Warning. There's no getting around it: the chemicals and reactions

PARTS AND MATERIALS LIST FOR EXPERIMENTS IN ELECTROCHEMISTRY

Copper sulfate
Hydrochloric acid, 20% solution (muriatic acid)
Potassium iodide
Red cabbage, shredded
Sodium bisulfate
Sodium chloride (table salt)
Tin chloride
Burette clamp
Carbon rods (2)
6-12-volt DC power supply
Glass vessels for mixing and storage
Hook-up wire
Ringstand
Two-way rod clamps (3)
U-tube, 6 inch (Hagenow catalog no. 42, or similar)
Wooden dowel-rod

Note: Chemicals, glassware, and laboratory equipment are available from the following suppliers:

Hagenow Laboratories, 1302 Washington Street, Manitowoc, WI 544220. The Hagenow catalog is \$1.50

Chem-Lab Supplies, 1060-C Ortega Way, Placentia, CA 92670. Tel. 714-630-7902. The Chem-Lab catalog is \$5.00

Analytical Scientific, Post Box 675, Helotes, TX 78023. Tel. 512-684-7373. The Analytical catalog is \$3.00.

discussed in this article are potentially dangerous. Every effort has been made to minimize the risks involved. But, the possibility of an accident still exists.

Please keep all of the following in mind while running your experiments:

- Do not allow any of these solutions or materials to come into contact with your hands, arms, fingers, face, or clothing. Take no chances whatsoever with poisonous or corrosive substances.
- Perform all experiments in a well-ven-

tilated room. The room should be free of any open fire or flame. Keep your face away from the apparatus and do not inhale any gas or chemical dust.

- Do not experiment with large quantities of any chemical solid or solution. For one thing, it's just not necessary. All of the effects discussed are perfectly visible in a small vessel containing only a small amount of conductive material.

- If at all possible, use regular laboratory glassware. Chemicals do not belong in pots, pans, plastic cups, and paper plates. They do belong in glass beakers, flasks, tubes, and graduates.

- Be very careful not to spill anything. Accidental spills can be very frightening and very hazardous. Work slowly and pay close attention to what you're doing. When transferring solutions from one vessel to another, use a good glass funnel whenever necessary.

- Do not, under any circumstances, work on a valuable surface. Run your experiments, for example, on a heavy slab of plywood that will never be used for anything else.

- Never store chemicals of any kind in unmarked containers. Keep a supply of gummed labels handy and put one on every beaker, bottle, or jar containing any type of experimental substance whatsoever.

Setting up your Lab. Electrochemical experimentation involves the use of some specialized hardware and glassware. You'll need some electrodes, a U-tube, and a dependable way of holding the whole system in a stable vertical position. A good many electrochemical effects require electrodes made of a material that will not react with the conductive solution (electrolyte). One such material is carbon. Carbon rods (you'll need at least two) may be obtained by cutting open a

FURTHER READING

On Some Chemical Agencies of Electricity, Humphry Davy., W. Blumer, 1807

Great Scientific Experiments, Rom Harre, Oxford University Press, 1983

"The Chemical Philosophy of Humphry Davy," Robert Siegfried, *Chymia*, Volume 5, pp. 193-201, 1959

Chemistry Magic, Kenneth Swezey, McGraw-Hill, 1956

"Humphry Davy," L.P. Williams, *Scientific American*, Volume 202, pp. 106-116, June 1960

couple of ordinary 1.5-volt dry cells. Do not use nickel-cadmium or lithium batteries; they do not contain carbon.

Good quality carbon rods are also available at many large building supply stores in the form of carbon-arc welding rods. Such rods are often covered with a thin layer of copper. The copper coating can usually be removed by slitting the material with a sharp knife and then, very gently, peeling it off. The carbon electrodes in the photographs are about a 1/4 inch in diameter and were cut to a length of about 3 inches each.

Next, you'll need a peculiar piece of laboratory glassware sometimes called a U-tube. A clear glass U-tube will ac-

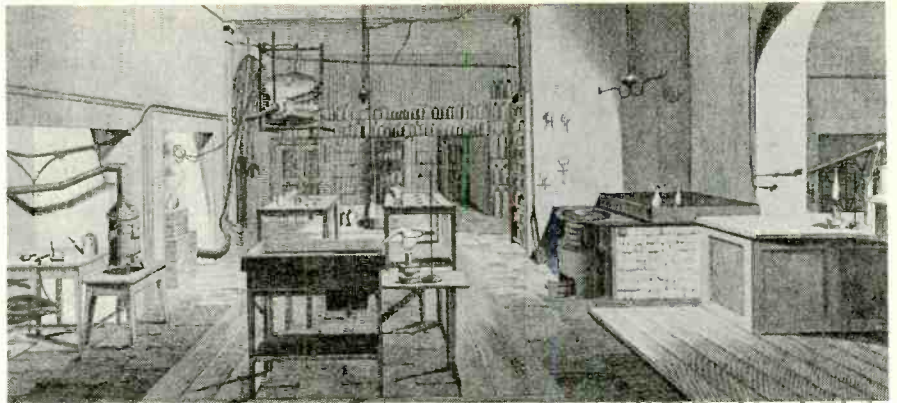

Humphry Davy's large laboratory at the Royal Institution in London was one of the finest in all of western Europe. It was here that Davy performed his famous electrochemical experiments in the early years of the 19th century. This engraving appeared originally in William Thomas Brande's Manual of Chemistry (1819).

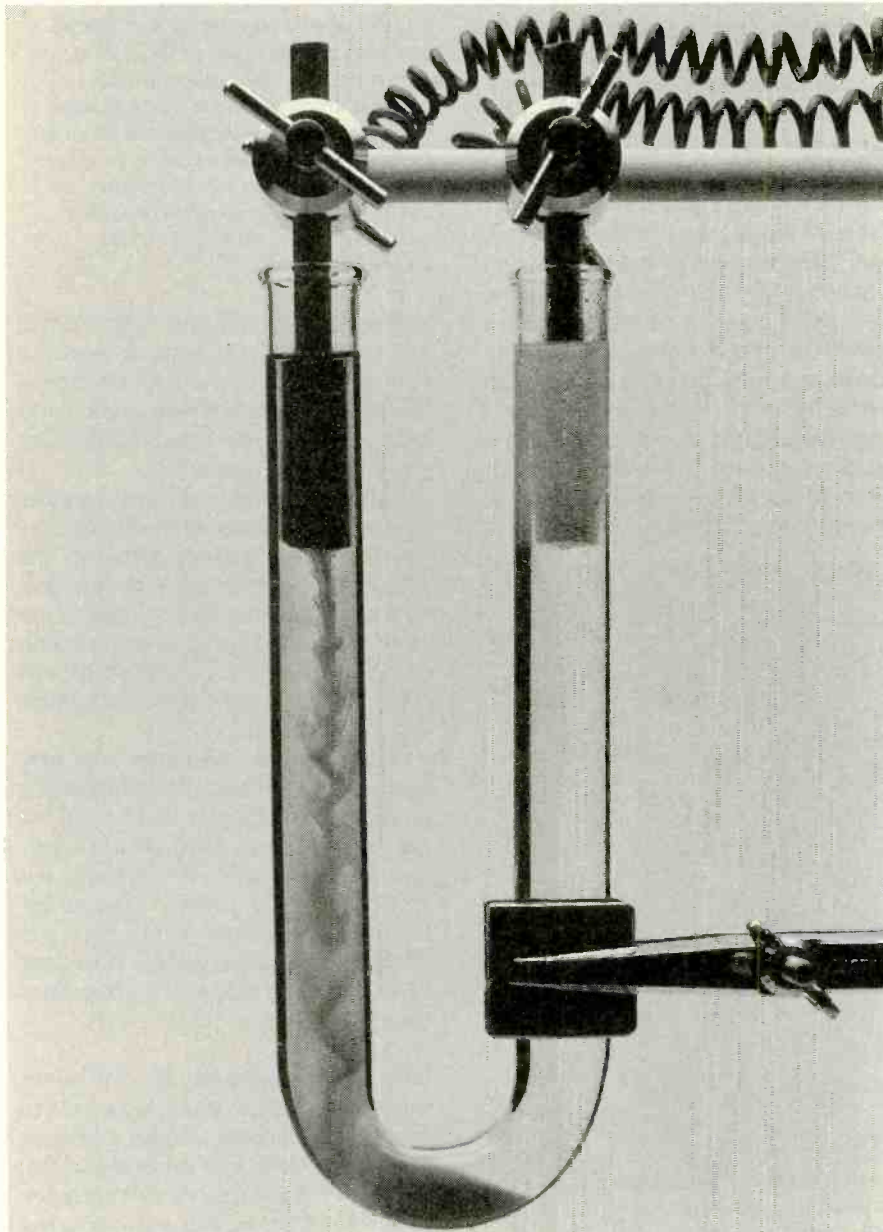

The electrochemical decomposition of potassium iodide in water releases iodine at the positive electrode. The iodine dissolves in the potassium-iodide solution and sinks down to the bottom of the tube.

commodate the carbon rods nicely and provide an unobstructed view of the electrochemical reactions. U-tubes come in a number of sizes. The examples in the photographs are about 6 inches long and hold about 1 1/2 fluid ounces (or about 50 ml).

U-tubes are available from many laboratory supply houses. If you can not locate one locally, they can be bought through the mail from Hagenow Laboratories, a science supply company in Wisconsin. The catalog number is 42 and the 6-inch length must be specified. See the Parts and Materials List for more information.

When you get your U-tubes, order several, if possible. U-tubes are difficult to clean and notoriously easy to break.

Finally, we must deal with the problem of holding the entire electrochemical system in a stable vertical position. That can be done by attaching the U-tube to a ring stand with a burette clamp and suspending the carbon electrodes over the U-tube from a non-conductive wooden dowel rod. The carbons are fastened to the wooden rod with a couple of two-way laboratory rod clamps. The power cables are then connected directly to the rod clamps. The wooden rod is attached to the ring stand with another two-way clamp.

That arrangement facilitates wiring and makes it easy to remove the electrodes for cleaning. If you do not wish to reproduce the electrode support structure that appears in the photographs, a similar mechanism can be made with a couple of large alligator clips. You can even use modified clothespins.

Complete the set-up by attaching the carbon rods to a variable 6-12-volt DC power supply with two long pieces of hook-up wire. And remember, polar-

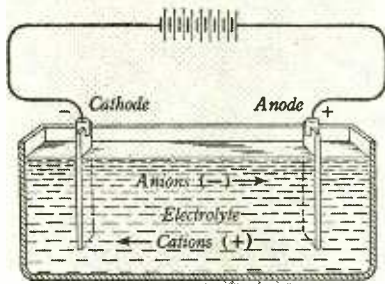

All simple electrolytic systems operate in the same way. A direct current of electricity is applied to a conductive solution. The conductive solution is usually called an electrolyte. All conductive solutions contain ions. The ions that carry a negative charge (anions) are attracted to the positive electrode (anode); the ions that carry a positive charge (cations) are attracted to the negative electrode (cathode).



Ordinary table salt (sodium chloride) dissolved in a cup of dilute red cabbage juice makes a conductive solution that will actually change color when subjected to the influence of a direct current of electricity. The solution around the negative electrode will turn green. The solution around the positive electrode will become a pinkish-red.

ity is important, so check to make sure you know which electrode is which before you start experimenting.

Chameleon Colors. One of the simplest, as well as one of the prettiest, electrochemical experiments you can perform involves the use of little more than tap water, table salt, and a bag of red cabbage. It's an experiment you'll want to perform again and again for your family and friends. Here's what to do:

Obtain some fresh red cabbage at the local supermarket. If possible, get the pre-shredded kind; it's a lot easier to work with. Place one large handful of cabbage in a heat-resistant container and add 7 or 8 ounces of plain water. Now, boil the mixture until the liquid becomes a deep purplish-red. Allow the vessel with its contents to cool. Pour the red cabbage extract (the liquid) into a labeled bottle and save it. You've made enough extract for several demonstrations.

When you're ready for the experiment, mix about 1 ounce of cabbage extract with about 1 ounce of clear water. Then add about ½ teaspoon of sodium chloride (ordinary table salt) and agitate the mixture to dissolve as much of the solid as possible. The liquid should now be a semi-transparent grayish-blue or bluish-purple.

Now, set up one of your U-tubes and fill it with the red-cabbage/sodium-chloride solution. Then, insert the two carbon electrodes. For a good visual effect, illuminate the tube from the rear with small desk lamp.

Finally, plug in your power supply and turn up the voltage until the electrodes begin to bubble. Keep your eyes on the tube. Almost immediately, the mixture around the negative electrode turns green, while the solution around the positive electrode becomes an iridescent pink. In a few minutes, the entire tube will become occupied by the two electrochemical colors.

What you see inside the tube occurs because the sodium chloride is chemically decomposed by the electric current. When the salt goes into solution, the crystal structure of the material is destroyed, and the sodium and chloride ions assume an independent existence. The chloride ions, which carry a negative charge, are attracted to the positive electrode (the anode). The sodium ions, which carry a positive charge, are attracted to the negative

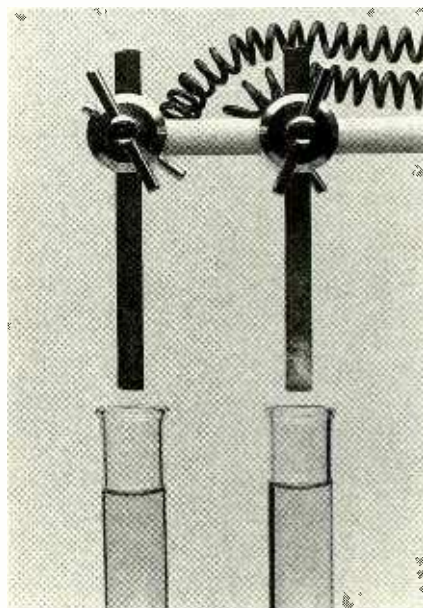

When a direct current is passed through an aqueous solution of copper sulfate, pure copper will appear on the negative electrode (the one on the right). Sodium bisulfate has been added to the solution to improve its conductivity.

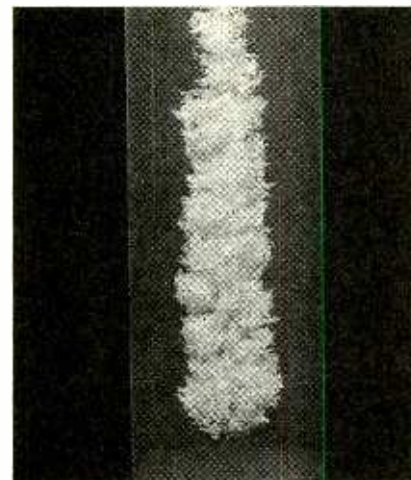

Early in the 19th century, Freiherr Theodor Von Grothus became interested in the delicate plant-like deposits that formed on wires connected to a battery and placed in an aqueous solution of certain metallic salts. He noticed a resemblance between such deposits and the crystalline growths known within the European alchemical tradition as arbors (trees). Here, a tiny tree of tin forms on the negative electrode in a conductive mixture of water, tin chloride, and hydrochloric acid.

electrode (the cathode). At that point, the sodium ions lose their electric charge and become sodium atoms. The sodium unites with the water in the tube to form a strongly alkaline substance, sodium hydroxide.

The red cabbage contains a natural indicator material called anthocyanin. The anthocyanin turns green in the presence of alkalis, and that accounts for the color of the solution around the cathode. At the anode, where chlorine gas develops, acidic substances (like hypochlorous acid) are formed, which turn the indicator red.

Note: **Sodium hydroxide is a very corrosive chemical and chlorine is a highly poisonous gas**, so perform the experiment in a well-ventilated room, and, when you're done, dispose of the solution properly. To finish up your experiment, dismantle your apparatus, clean the U-tube thoroughly with a test-tube brush, and wash the carbon electrodes.

Iodine Streamers. Similar electrochemical principles allow you to create long, flowing, sinuous streamers of iodine. Here's the experiment: Dissolve 2 or 3 teaspoons of potassium iodide in 1-1/2 ounce of water. Pour the solution into your U-tube and insert the electrodes.

(Continued on page 89)

Quite often when you're working on one project, you have to start working on a second project to help speed the completion of the first one. That's exactly the scenario that led to the creation of the ProtoMax prototyping station described in this article. While assembling and testing a bunch of power-supply filter boards, it seemed that a custom test fixture was needed to speed up the test procedures.

However, on second thought, it seemed more worthwhile to build a "generic" test fixture. It could contain everything needed to test the filters, in addition to many other components that could come in handy.

You've all seen the usual kind of prototyping board, containing a power supply and maybe some switches, but very little else. And even though an ordinary protoboard (for short) is helpful when testing a new circuit design, you always end up having to solder leads to a potentiometer, a switch, a jack, etc. And when you get down to it, you can never find the jumper leads that you had cut, stripped, and tinned the last time you used your breadboard. Well, no matter what devices you commonly use, you can permanently install them on the ProtoMax and have them always available.

With that in mind, let's take a closer look at the ProtoMax, and explore the ways that such a device can help save you a lot of time and aggravation. By the way, all of the components to be discussed have wire braids already attached to them, so they can simply be plugged into the prototyping board whenever needed.

An Overview of Features. Believe it or not, the most electrically "active" part of the ProtoMax is the AC-power section. It's located in the upper-left corner of the unit. It consists of an AC power cord, a circuit breaker, a toggle switch, and an AC socket, all connected in series (see Fig. 1). That section is used to provide safe, switchable current for either a test instrument or an AC adapter used to power a prototyped circuit. By the way, buying a universal AC adapter (like a wall-transformer type) will keep you from having to build a power supply for each circuit that you just want to try out.

An interesting section of the unit is the variable attenuator (located in the upper-middle section of the ProtoMax chassis). For what it does, it's very easy to

Build the

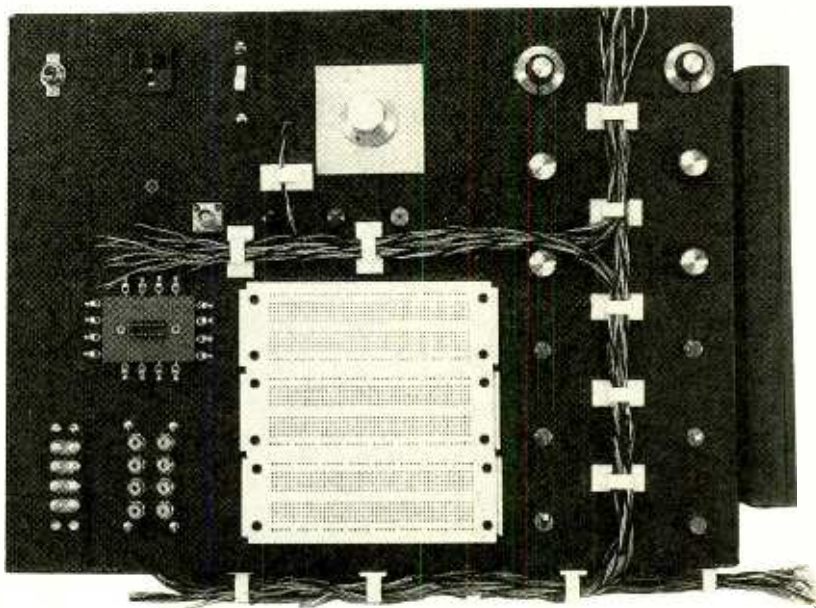

ProtoMax Design Station

BY JOHN YACONO
AND
MARC SPIWAK

Designing electronics circuits is much easier with this breadboarding system. It puts everything you need at your finger tips.

build. Its purpose is to allow the user to tap current off of a resistor network (see Fig. 2). The switch allows you to select one of several voltage dividers in the network. If the input and common leads were connected to a power supply (or some other signal source) the power available to the output lead is halved each time you switch to a lower position in the network.

If you decide to build one for yourself, keep in mind that the values of resis-

tance you use and the number of switch positions is up to you. In fact, the resistor labeled R_{min} can be omitted if you don't want a minimum value of resistance between the input and the output. Its usefulness depends on the limits of your imagination. I've used it to tap a desired voltage from power supplies while providing them with a continuous load (which is mandatory for transformerless supplies), and to attenuate signals to determine certain

circuit characteristics; output impedance, for example.

Off to the left of the protoboard is a curious device built around an IC socket. It can fill a variety of needs. It is a piece of printed-circuit board with traces that run between the socket and the terminals that surround it. The terminals can be used to grab onto wire or the tip of a test probe. (You know how difficult it is to hold a test probe on an IC pin while also doing other things!) It's also very easy to put an alligator clip on the terminals. Another neat benefit that may not be apparent is that the entire assembly can be detached from the main unit with the removal of two screws. That way the IC board can be used all by itself if it's more convenient that way.

One of the niftiest uses for the IC board is to test DIP headers in projects that require multiple copies of the same header. For those unfamiliar with DIP headers, they're just terminals arranged exactly like the pins on an IC. You can solder components to the terminals and plug them into an IC socket as a complete assembly. They're really great for designs that lend themselves to modular assembly. For example, if you have a series of display boards on a project, all requiring the same signal-conditioning circuit, noise filter, or pull-up resistors. If one of the displays fails, you simply have to swap DIP headers between display circuits to find the culprit.

When making-up a batch of headers, the builder need only hook the small board up to either the prototyped circuit on the protoboard or the actual circuit and test header after header.

It also provides you with a means of transferring support components from the protoboard to a header. Assuming your prototype is already working, you would start by plugging an empty header into the little board. Remove a component from the protoboard and replace its leads with wires on the board. Install the component into the header, and attach the leads you put in the protoboard to the appropriate terminals on the little board. Do that for each component to be moved to the header, test the system and you're done. Now all you have to do is make copies of that header. Not only have you prototyped a header, but you've made a test fixture for them as well!

One use for the socket (and perhaps an obvious one) is to permit you to try different pin-compatible IC's in the

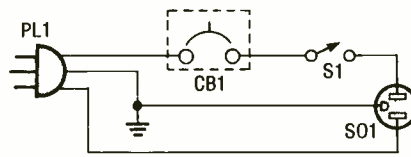

Fig. 1. The AC-power section consists of an AC power cord, a circuit breaker, a toggle switch, and an AC socket all connected in series.

PARTS LIST FOR THE PROTOMAX

- R_A, R_B —See text
 PL1—3-terminal molded AC power plug with line cord
 CB1—Circuit breaker
 S1—SPST switch
 S2—Rotary switch
 SO1—3-terminal 117-volt AC outlet
 Perfboard materials; enclosure; IC socket; assorted potentiometers, switches, connectors; wire; hardware; etc.
Note: The following items are available post paid from John Yacono, P.O. Box 4042, Farmingdale, NY 11735. An assortment of three control potentiometers (10k, 250k, and 2-megohm) for \$5.00; fifty 4-inch nylon wire ties for \$2.00; both of the above and 20 feet of industrial-grade Teflon-coated twisted pair for \$9.00. Send a SASE for a list of other available parts (list is included with all orders). All payments in U.S. funds only; NY residents add applicable sales tax.

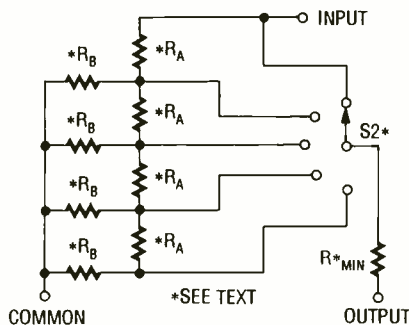

Fig. 2. A switchable attenuator is easy to build. The switch allows you to select one of several voltage dividers in the network.

same application. I was designing a circuit one time, only to find out (after burying an LM239 quad comparator under tons of wire) that a different IC (an LM339) was needed to provide enough source current. (My eloquence for profanity was elevated beyond all human stature that day)

Kidding aside, it can also be used as a mini break-out box for computer-in-

terface projects. The incoming signals can first be sent to one side of the board (going to the pins on one side of the IC socket). They will leave the little board and go to the protoboard from the other side. Bus wire can be used to connect and cross-connect pins on one side of the IC socket to the pins on the other side, allowing you to change connections (and thus hardware protocol) without touching the circuit on the protoboard. That provides you with the ability to organize your work clearly and keeps things from looking like a rat's nest. As a variation on the same idea, you can put a DIP switch in the socket and switch between different protocols.

Just below the header-prototyping area are a barrier strip and eight RCA phone jacks. The barrier strip allows you to connect external circuits that have either lugged or bare, stranded ends to circuits on the protoboard. The RCA jacks perform the same function for external devices sporting RCA plugs.

Eight jacks might seem excessive, but what if you need to set up some kind of audio/video A/B switch? If the circuit must condition one signal based upon another (handling the audio and video separately), you'll need two audio inputs and two composite-video inputs (for A/B operation), two modulating-signal inputs (one audio and the other video), and two outputs (again audio and video). There go the eight jacks! Now imagine even a simple surround-sound project and all its possibilities.

All the knobs and switches on the right side of ProtoMax allow the user to control all the various parameters in your prototyped circuit. The potentiometers include many of the standard values in use by most hobbyists: 10k, 50k, 250k, 500k, 1-megohm, and 2-megohm. They, like the RCA jacks, can be connected to a prototype circuit using the leads already soldered to them.

Various types of switches are used on the ProtoMax. However, there are no single-pole single-throw toggle switches—that would be a waste of the unit's surface area. Why install an SPST when a DPDT can do the same job...and then some? Among the switches are two center-off DPDT's (again because they are more versatile than normal DPDT's), one locking DPDT (for sensitive circuits you don't want to switch accidentally), and three momentary-contact switches of various configurations.

The last area of interest (besides the

breadboard itself, which is self explanatory) lies between the attenuator and the prototyping board. Located there is a row of inputs and outputs: one BNC connector, and a series of pin jacks. They can be used to provide power and allow the user to connect an oscilloscope or other instrumentation (signal generators, DMM's, etc.) to the prototype via the pre-tinned twisted pairs.

But enough about the features of our ProtoMax, let's talk about what features you should put in yours.

Build What You Need. To begin with, you must first determine what immediate needs you have. That's because, even though it's a good idea to have a ProtoMax, you probably won't build one project until you have a definite need for one. You may need anything: a speaker, a switch, whatever. Then try to remember what components might have come in handy in the past, had you had them around with leads attached. Last, consider the things that are likely to be needed, such as common jacks, connectors, power supplies, perhaps a voltmeter, and, of course, the breadboards. Then all you need is a cabinet that is suitably sized.

Keep in mind that the ProtoMax doesn't have to win any beauty contests. You can mount everything on a wooden board if you have to, just as long as any hazardous voltages are safely concealed. All that matters is that you effectively transform your "junkbox" parts into something that is very useful, and at your fingertips when you need it.

Construction. Since the ProtoMax is pretty much a "generic" test fixture, let's talk about building it from a generic point of view. We'll tell you how to build any kind of fixture from the ground up, and include examples of how the ProtoMax itself was assembled.

To start off, gather up everything that you think you would like to include in your unit. Then decide which things will be wired directly together, if any; you may want to have everything independently available. For example, you could hook up a power supply directly to a terminal strip, or just have leads coming from the supply ready to be hooked up to whatever you like, whenever you like. If a number of the devices in your unit are to be interconnected, it's a good idea to draw a schematic.

Now you must choose some sort of cabinet for the unit. Our ProtoMax was

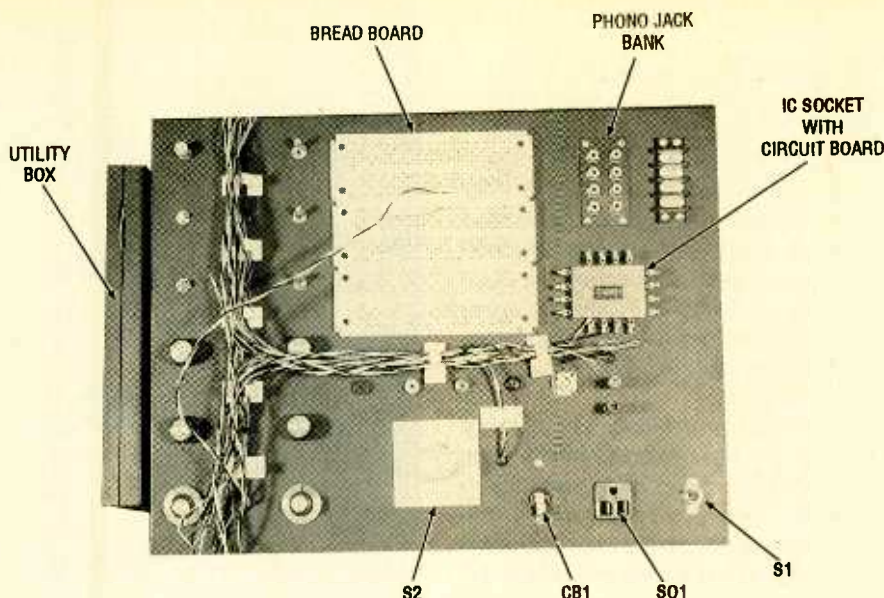

ProtoMax contains a step-variable attenuator, consisting of S2 (a multi-position rotary switch) and several series connected fixed resistors; there's also a bank of RCA phono jacks, a breadboard, several potentiometers and assorted switches, and an IC socket.

installed inside a large aluminum project box. Holes for the various attachments were made in different ways. Round holes were simply drilled out, while square holes were cut out with a nibbling tool and filed to a perfect fit.

Other types of cabinets are just fine; plastic, wood, etc. You can even mount everything on a piece of wood, although it's hard to mount panel-mount items on a board—but if you can find a way to mount everything, do it.

The next thing to do is plan how you are going to position everything on the front panel. While laying out your unit, it's best if you make a template for the front panel out of a piece of paper, with the components evenly spaced. If you use a ruler to do the job right, the final result will be neat in its appearance.

Like our ProtoMax, you should group similar items together. For example, all of the switches should be grouped together, output jacks together, etc. Another thing to keep in mind when positioning some items is whether you're right handed or left handed. Controls are easier, and safer to use when you don't have to reach across the board to get to them. Also, try to keep controls that are easily knocked out of whack (like potentiometers) further away from you than more stable ones. For the same reason, place toggle switches closer to the protoboard than pushbuttons.

If you must attach leads to, say, a potentiometer, and they must come through the panel to the front, prepare

a spot for an oversized hole to accept a rubber grommet. A grommet will prevent the rough edge of the cabinet's material from harming the wire's insulation. Note you can reduce the number of grommet holes you must drill if you use some kind of color scheme in your wiring. Also, don't forget to mark holes for mounting hardware as required.

After you have your template just how you want it, either transfer the markings to the front panel or tape the paper to the panel and drill right through it. (By the way, if the cabinet you use is metal, center-punching is recommended. Misaligned controls and connectors are easy to spot and, if you like symmetry, can make you wince each time you use the unit.)

After all of the holes are drilled, test fit all of the components before continuing. If all is well, now is the time to paint the cabinet if you are going to do so. It's not necessary, but it does add a nice touch to the project without adding too much extra work.

The ProtoMax was painted with a flat-black spray paint that dries with a pebble-grain texture. You can simulate that kind of test-equipment finish with any flat black spray paint, although it takes more time and paint. Start by applying a very light (barely complete) coat of spray paint to all surfaces from a distance of at least two feet. Use broad sweeping strokes, first left and right, and then up and down to fill in any unevenly covered areas. For this kind of finish

(Continued on page 81)

Not all the gambling in Las Vegas this past winter was taking place in the casinos. From January 9 to 13, at the Winter Consumer Electronics Show (WCES), more than 1550 exhibitors were taking chances on new products and technologies. Because the show was held under the dual specters of war and recession, some manufacturers were espousing "hold-tight" no-risk policies. But many more were taking risks.

It seemed only fitting that the first show of the new decade (that's right; technically speaking, since our modern calander begins with the year 1, the new decade began this year and not in 1990!) should herald the arrival of some truly innovative products and promising technologies, while offering a close-up look at the trend-setting items that are likely to represent this decade's consumer-electronics fads and "must-haves." The buzzwords at WCES 91 included "home theater," "karaoke," "fuzzy logic," and "digital compression." Interactive technology was displayed in games and in full audio/video systems. Home-office products made a strong showing, and several PC's made their CES debuts in January. Satellite TV is counting on new technology to put it back into orbit, after years stuck mired in a stagnant market. The once-scarce DAT players were in evidence—and were being challenged by yet another digital audio-tape format.

Whetting our Appetites. At every Consumer Electronics Show, we're treated to previews of products that haven't quite hit the market yet. Perhaps it's that old psychological trick of wanting what we can't have, but those unobtainable items usually seem to be among the best. That certainly was the case at WCES 91.

A true highlight of the show was Sharp's demonstration of high-definition television; it was without question the most impressive HDTV demonstration we've ever seen. Presented on their LCD-projection, 110-inch-screen system, the picture quality was breathtakingly flawless. With 3.6 million pixels, 1125 scan lines, and a 9:16 aspect ratio, it rivaled movie-theater quality. The HDTV system put to shame the images from the standard projection systems—which were actually very good in their own right—being demonstrated next to it. But don't bother running to your local high-end video shop just yet; the



BY TERI SCADUTO
and BRIAN C. FENTON

A New Consumer

HDTV projection-TV system is available only in Japan (where there's only about one hour a day of HDTV broadcasting), and currently costs the equivalent of about \$35,000.

Also in the Sharp booth—and also available only in Japan right now—was a "fuzzy logic" microwave that promises to bring that appliance from the popping-corn/reheating-leftovers realm to gourmet cooking. Fuzzy logic, a form of artificial intelligence, allows electronic devices to go beyond yes/no choices and to consider "maybe" as a possible answer. In the world of microwave cooking, that means being able to determine, based on information input by the user and the data from five sensors, how long and at what power level to cook various foods. A real bonus in the RE-F1 is a built-in, blender-like attachment that stirs, beats, or mashes foods as they cook—allowing the gourmet to make a hollandaise sauce (which requires constant stirring over low heat), and the rest of us to make pudding or mashed potatoes, effortlessly. Infrared sensors can gauge the texture of the

food and determine how much stirring needs to be done, and when everything's just right. The RE-F1 does convection cooking, grilling, and broiling as well. And it even does popcorn.

Sanyo was showing a car-stereo system with a twist—voice-activated control. Combining safety and convenience, the EX-S2 system lets the driver use pre-programmed vocal commands to select a radio station, or tape or CD recording without pushing a button or taking his eyes off the road. It recognizes a total of 20 words or phrases, but it must be "taught" by the person who is going to use it, and it will respond only to that person. If another person drives the car occasionally, he or she could opt to use the manual controls or to spend about a minute reprogramming the system (a very simple process). The system will carry a price tag of about \$750 when it reaches these shores from Japan.

Although electronic car navigation isn't a new concept, and systems have been demonstrated before, this year's news is that Blaupunkt's *TravelPilot* is fi-



Decade in Electronics

nally available, albeit only in select U.S. consumer markets (primarily in major metropolitan areas up and down the two coasts). TravelPilot is a CD-ROM-based car-navigation unit that uses a dead-reckoning/map-matching system developed by ETAK. It consists of a trunk-mountable CD-ROM drive, a 5-inch CRT screen surrounded by the control panel, a compass, wheel sensors that measure the relative rotation of the right and left wheels, and a disc containing maps of the driver's home region and of the national highways. By comparing the data from the compass and sensors with the digital maps, TravelPilot can logically determine where on the map the car must be. For a mere \$3400, drivers can peruse a general map of main roads and highways or zoom in for a detailed look at specific streets.

Satellite TV Returns? The satellite-TV industry is making a concerted effort to do what videogames have done; that is, make a remarkable comeback. Although satellite TV is steady for now,

those boom years of the mid 1980's haven't been forgotten. Small-dish systems may be the key to the re-emergence of satellite TV. SkyPix, the first fully operational digital DBS (direct-broadcast satellite) system, demonstrated their technology. It's scheduled to roll out to consumers this summer, and promises to let viewers choose between 40 to 50 major Hollywood movies at any time—a virtual on-demand programming schedule.

Digital signal compression is what makes SkyPix interesting, and what allows 80 channels of programming to be squeezed on 10 satellite transponders. The audio quality will rival that of compact discs, and the video quality will rival that of video discs. It won't come cheap, however. The SkyPix receiver/decoder will have a suggested retail price of about \$700. There will be some free channels on the system, but the good stuff, of course, will have to be bought. Both monthly packages and automatically billed pay-per-view programming will also be available.

The dish will be small—two or three

The new technologies and products introduced this year will likely shape the face of consumer electronics for the rest of this century.

feet in diameter depending on where you live. And although SkyPix will use medium-powered Ku-band satellites, it shouldn't suffer from weather-related problems like current Ku-band services because it uses digital signals. Whether it will be competitive enough to break cable television's monopoly is another story in itself.

Time Compression? If squeezing 10 TV channels into a single satellite transponder doesn't impress you, how about squeezing a full-length movie into a few seconds? That's just what Explore Technology, Inc. is doing with their patented "Instant Video" technology. The technology will work with various delivery systems—satellite, cable, fiber-optics, and telephone lines—but the speed of transmission will decrease with the lower-bandwidth delivery media.

We doubt if you'll be seeing Instant Video anytime soon. Explore Technology was showing off their technology to anyone who might be willing to put it to work. We hope some enter-



The guy in the next car might think you're talking to yourself, when you're actually giving verbal commands to Sanyo's EX-S2 voice-activated car-stereo system.



Do you have no sense of direction? Your car can get you where you want to go if it's equipped with Blaupunkt's TravelPilot navigation system.

prising businessmen take them up on their offer. Imagine having an Instant Video receiver that could receive a movie of your choice in seconds. No more trips to the video store in the rain, no out-of-stock movies, late charges, or poor selections. If telephone companies get the okay to distribute video services, they would seem to be able to benefit immensely from the technology. They're not the only ones, however. Any business that rents satellite-transponder time could cut costs dramatically.

Agoraphobic Heaven. Even without Instant Video, it's getting so that there's rarely a need to leave the house—at least not for work or entertainment. Home-office products are a fast-growing category. Polls have shown that 35% of all American households have some sort of home office, and 18% of those households have income-generating offices. Income-producing offices increased from 1989 to 1990 by 23%. Perhaps those figures influenced IBM's decision to exhibit at CES for the first time, highlighting their PS/1 home computer. IBM was only one of 30 com-

panies displaying computers aimed at the home market.

Home-office workers are also spending money on printers, telephone-answering devices, fax machines, two-line telephones, copiers, and electronic typewriters—and plenty of manufacturers are ready to meet their needs. Fax is a particularly hot market, with experts predicting minimum 20% unit growth this year. Upscale models include Toshiba's 4700, with automatic switching between the fax and the user's TAD, an automatic paper cutter, 256K memory for broadcasting or storing messages (so that you can retrieve them remotely), and a suggested retail price of \$1399; Canon's FaxPhone 23 series with special "de-curling" feature and FaxPhone 80 plain-paper fax, \$1395 and under \$2000, respectively; and Sharp's DA-7000, which combines ease-of-use with advanced answering-machine and fax features, including remote retrieval, and which will cost \$1995.

What if you spent your fax allowance a couple of years ago on a model lacking all those fancy features? Code-A-Phone's 7700 Personal Fax Answering Machine is an add-on device that can store, retrieve, and forward fax messages, even remotely. Its suggested retail price is a relatively inexpensive \$499. Command Communications' ASAP TF 333 is a line-sharing switch that automatically routes calls to fax, phone, TAD, voice-mail card, or modem.

What if your home office is a closet-sized niche with no space for all those



The small dish is only part of the appeal of SkyPix Direct Broadcast Satellite system. Eighty channels should offer something for everyone.



Time flies with Explore Technologies' Instant Video, which can compress a full-length movie into 15 seconds.



There's no need to restrict your singing to the shower if you have a Karaoke player like Pioneer's CLK-V9000.

gadgets? Canon's Navigator HD40 combines the functions of a phone, a facsimile machine with thermal printer, and a phone-answering device with a personal computer that comes complete with software targeted to the home or mobile office, a Bubble Jet printer, and a mouse—all for a suggested retail price of \$2495.

Technology Concepts, Inc. has come up with a way to cash in on the popularity of laser printers and everybody's distaste for that horrible thermal fax paper. Their Omnilink/Laser converts any HP- or Canon-compatible laser printer into a plain-paper Group III laser facsimile. You can send computerized faxes with it, and even use it as a 2400-baud modem.

All work and no play is frowned upon (but not by our bosses!)—so when you finally manage to get out of your home office, it helps to have a home theater waiting in the den. To get the full theater effect, the ideal system should have a large-screen TV, an AV receiver, surround sound, plenty of speakers, a laserdisc or combi-player, and a VCR. If the thought of coordinating all those components sounds to you like more

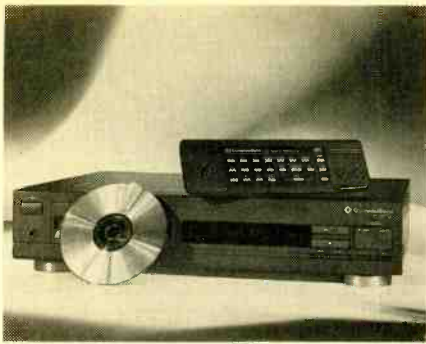

Multimedia mania—Commodore's CDTV is the first interactive audio/video product to actually hit the shelves.

work than the play warrants, you're certainly not alone. CEDIA, the Custom Electronic Design & Installation Association, says that custom installation is probably the fastest-growing segment of the consumer-electronics market, with an estimated \$350 million spent on custom-installed audio/video systems in 1990. At the Show, International Jensen, in conjunction with Square D Company, was demonstrating the ELAN Advanced Home Network, which is custom wiring for new construction with a unique selling point: Its cost can be tacked onto the mortgage, for low-interest, tax-deductible financing.

The home-theater experience can be achieved without remodeling or calling in the pros with systems like Hitachi's UTS-461, which includes a 46-inch Ultravision projection TV, a Dolby surround-sound four-channel audio/video amplifier, an MTS Hi-Fi VCR, a laserdisc/CD player, a pair of two-way tower speakers, two rear speakers, and a cabinet—all for a suggested retail price of \$5,999.95. What if you're happy with all the various components you already have, but are unsure how to get them to work together for the theater experience? If those components are Sony's, you can use that company's DST (Digital Signal Transfer) system. DST links all the components of an existing system and gives you access to them and their signals from anywhere in a house.

Back Talk. For those who prefer to take a more active approach to their home entertainment, several ways to "talk back" to your home electronics were displayed at WCES. By far the most popular was the karaoke machine. Karaoke ("empty orchestra" in Japanese) removes the vocals from popular recordings and allows you to take over as lead singer. You don't have to know the words and you don't even have to sing very well. Video accompaniment in-

cludes all song lyrics, and some machines let you change the key in which the song is sung, and even to correct for off-key vocals. Karaoke "bars" have been popular night spots in Japan for some time now, and are obviously catching on in the States—the week that this is being written, karaoke players were used during prime time on the popular sitcoms *Cheers* and *The Simpsons*. At the Consumer Electronics Show, attendees were urged to take the stage and "follow the bouncing ball" at dozens of exhibits. Pioneer's Laser Ka-

hooked up to the user's existing television and audio equipment, CD-I provides audio, visual, graphic, text, and interactive capabilities. The system has the capacity for more than 19 hours of audio and 7000 photographic-quality images, as well as full-motion video (but not all at the same time). CD-I players, which also are compatible with standard audio CD's, are targeted for market introduction this summer.

Attracting larger crowds at the show was CDTV, Commodore International's interactive CD-ROM system, based on



Our pick for the high-impact introduction at WCES is the Digital Compact Cassette. Judging by the crowd, we weren't the only ones impressed with DCC technology.

rooke CLK-V900, a self-contained unit with a CD/laserdisc combi-player, a two-way speaker system, a stereo amplifier, a cassette deck for recording your performance, two microphone inputs, and a microphone holder, represents the high end of the field at a suggested price of \$1600. Pioneer has available more than 450 MTV-like, 8-inch laser karaoke discs that sell for about \$20 apiece. Nikkodo USA showed a line of karaoke add-on products, priced from \$299 to \$1000, that complement the consumer's existing components. Citizen's CBM America division introduced the CD-8700, a high-quality CD player with some karaoke ability and a \$399 price tag.

Karaoke isn't the only way to get your two cents in. Interactive video has been talked about for years, and a couple of actual products were demonstrated at WCES: Compact-Disc Interactive (CD-I) and Commodore Dynamic Total Vision (CDTV).

CD-I was quietly previewed by Philips' American Interactive Media (AIM) and has the support of other industry giants including Sony and Matsushita. When



Covering all the bases when you take the DAT plunge, Sharp's RX-P1 is equally at home in your car, your house, or on the jogging path.

the (but not requiring the use of an external) Amiga computer. Two-thirds of Commodore's 4000-square-foot main-hall exhibit was devoted to demonstrating the CDTV player (which might explain the crowds). The CDTV player connects to the user's TV and stereo and can play standard CD's and CD+G's (compact disc plus graphics)—along with an impressive array of peripherals and software, including any MIDI-compatible equipment. An on-screen encyclopedia allows users to look up a topic and then see video or

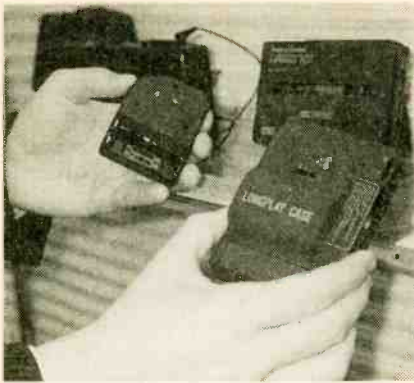

No more dead batteries at inopportune times with Memorex's personal stereo. Its "long-play case" packs its own spares.

hear audio supplements, and to pinpoint specific points for more detailed examinations. Other software included *The Silver Palate Cookbook*, interactive games, sports tutorials, and a worldwide country tour. Thirty titles will be in-

roduced at the same time as the CDTV player, (scheduled for early February), with about 50 more to follow in the spring, at prices ranging from \$39.95 to \$199.95. The CDTV player has a \$999 price tag.

Now that consumers have had a couple of decades to get accustomed to video add-ons in the form of VCR's and Nintendo-type games, and have fully accepted compact-disc technology, industry experts believe they are ready to embrace interactive systems. Although Commodore has beaten CD-I to the retail stores, its market dominance isn't predetermined. With the backing of the Japanese consumer-electronics industry, CD-I—although years behind schedule—is still a strong contender in the interactive-media format war.

Fighting the Format Wars. As if Dig-

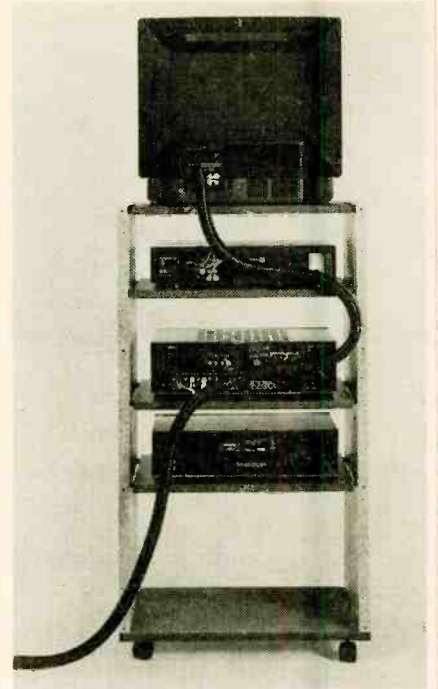

Put an end to the tangled mess behind your entertainment center with Get Organized wire-management system.

MANUFACTURERS ADDRESSES

Blaupunkt
2800 South 25th Ave,
Broadview, IL 60135

Canon U.S.A. Inc.
One Canon Plaza
Lake Success, NY 11042-1113

CBM America Corp. (Citizen)
2020 Santa Monica Blvd. #410
Santa Monica, CA 90404

CEDIA
10400 South Roberts Road
Palos Hills, IL 60465

Code-A-Phone Corp.
P.O. Box 5656
Portland, OR 97228

Command Communications Inc.
10800 East Bethany Dr. #300
Aurora, CO 80014

Commodore Business Machines Inc.
1200 Wilson Drive
West Chester, PA 19380

Explore Technology Inc.
7950 East Acoma Drive
Suite 211
Scottsdale, AZ 85260

Get Organized
328 Canham Road
Scotts Valley, CA 95066

Hitachi Home Electronics (America) Inc.
401 West Artesia Blvd.
Compton, CA 90220

IBM Corp.
11400 Burnett Road
Austin, TX 78758

International Jensen
25 Tri-State International Office Ctr.
Suite 400
Lincolnshire, IL 60069

Kenwood USA Corp.
2201 East Dominguez
P.O. Box 22745
Long Beach, CA 90801-5745

Memtek Products
P.O. Box 901021
Fort Worth, TX 76101

Nikkodo Co. Ltd.
4600 N. Santa Anita Ave.
El Monte, CA 91731

Philips Consumer Electronics
P.O. Box 555
Jefferson City, TN 37760

Pioneer Electronics (USA) Inc.
2265 East 220th Street
Long Beach, CA 90810

Sanyo Fisher (USA) Corp.
21350 Lassen Street
Chatsworth, CA 91311

Sharp Electronics Corp.
Sharp Plaza
Mahwah, NJ 07430-2135

Sony Corp. of America
Sony Drive
Park Ridge, NJ 07656

Tandy Corporation
1800 One Tandy Center
Fort Worth, TX 76102

Technics
Division of Matsushita
One Panasonic Way
Secaucus, NJ 07094

Technology Concepts Inc.
1159 Triton Drive
Foster City, CA 94404

Toshiba America Consumer Products Inc.
82 Totowa Road
Wayne, NJ 07470

ital Audio Tape (DAT) technology didn't have its hands full with protracted (but finally retracted) opposition from the Recording Industry Association of America, two competitive digital-audio technologies were unveiled at WCES: Digital Compact Cassettes (DCC) and recordable, or write-once, CD's.

Tandy and Philips unveiled prototypes of Digital Compact Cassettes and a DCC player—a cassette player/recorder that offers the sonic quality of DAT and CD players, with the added advantage of being playback-compatible with existing cassette tapes (640 million of which were sold in America last year). In other words, you'll be able to play back all of the cassettes you now own on a DCC player, as well as new digital compact cassettes. (The digital cassettes, however, aren't compatible with your existing equipment). With the support of recording companies including Polygram and EMI, and existing Tandy facilities in the U.S. geared up to manufacture DCC tapes, the lack-of-listening-material dilemma is eliminated.

The DCC tapes are similar in size to existing cassette tapes, but have a few important differences. First, they're "flat;" they don't get wider where the audio head enters the shell. (When the cassette format was invented by Philips in the early 1960's, the technology required to make small audio heads

(Continued on page 90)

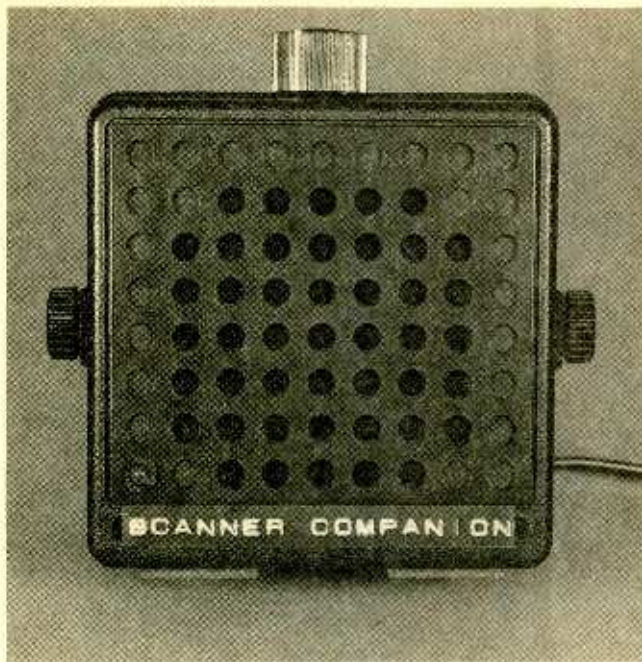

The Scanner Companion

This simple project can make using your scanner more enjoyable by eliminating the annoying hiss between messages.

If you like to listen to your scanner, but the constant hissing sound between messages bothers you, then the *Scanner Companion*, described in this article may be just what you've been looking for. The *Scanner Companion* is basically an amplified extension speaker with voice-deactivated muting. When no speech is present, the speaker is disconnected, thereby eliminating the hiss normally heard between messages. And for added convenience, there's also a volume control on the *Scanner Companion* to allow the scanner to be placed out of the way—maybe in another room—and still have control of its volume.

The unit can be built into an existing communications extension speaker. All it requires to operate is a single supply of between 6 and 12 volts DC. Best of all, no modifications to the scanner are necessary. It simply plugs into the ear-phone jack on the scanner itself.

How It Works. A schematic diagram of the *Scanner Companion*—which consists of two LM386 low-power audio amplifiers, an LM741 op-amp, a couple of transistors, and a few additional components—is shown in Fig. 1.

When the incoming signal is applied to the circuit, it travels along two paths: one path leads to an audio muting circuit (consisting of U1, U2, Q1, and a few other parts); the other path leads to the audio-amplifier section of the circuit. Let's look at the muting circuit first.

In the muting circuit, the audio signal is fed through coupling capacitor C1 to U1, which is configured (in the non-in-

verting mode) for a voltage gain of 20. After amplification, the signal is applied to a voltage-doubler circuit, consisting of C2, C3, D1, and D2, which changes the audio signal into a DC control voltage. That voltage is then used to turn on transistor Q1.

When power is applied to the circuit, C4 charges toward the supply voltage via R1. Capacitor C4, along with resistor R1 and op-amp U3, form a retriggerable monostable multivibrator. A voltage-divider network comprised of R2 and R4 sets the reference at pin 3 (the non-inverting input) of U3 at half the supply voltage. When a positive voltage is applied to the base of Q1, it turns on, allowing C4 to discharge. As C4 discharges, pin 2 (U3's inverting input) is pulled to rear ground potential. When the voltage at pin 2 of U3 goes lower than that at pin 3, the output of U3 is forced high.

Once discharged, C4 again slowly charges through R1. When the charge on C4 exceeds the voltage at pin 3 of U3, the op-amp's output again goes low (around 2 volts), resulting in a "squench tail" of approximately two seconds. Most of that voltage is dropped across D3 and LED1, allowing Q2 to fully turn off.

When speech is detected, the voltage produced at pin 6 of U3 is sufficient to overcome the 2-volt drop across D3 and LED1. That causes Q2 to turn fully on, thereby feeding clear and undistorted audio to the speaker. When activated, LED1 lights, showing that the unit is working. Once speech stops, there should be a two-second delay

before LED1 extinguishes, and the speaker is again muted; that slight delay is provided to prevent choppy audio and is similar to the squelch delay used on scanners.

The audio amplifier section of the circuit consists of a second LM386 low-power audio amplifier (U2), two capacitors, and an audio-taper potentiometer (R3). Audio is fed through C5 and R3 (the volume control) to the non-inverting input of U2, which provides a gain of 20. After amplification, the signal is fed to the speaker. But, as you already know, no audio will be heard unless transistor Q2 is turned on, connecting the minus terminal of the speaker to ground. The effect of this is that the speaker is inoperative unless a signal is being received, thereby eliminating the hissing sound that is normally heard between messages. Capacitor C7 is included to filter the supply.

Now that we know how the *Scanner Companion* works, it's time to build your own. Let's do that now.

Assembly There is nothing particularly critical about the construction of the *Scanner Companion*; so use the construction technique that you are most comfortable with. The author's prototype unit was built on a small piece of perfboard, measuring 1- x 2¼-inches, with the interconnections between components handled through point-to-point wiring.

Although the author did not socket the IC's in his prototype, it's a good idea for you to do so. Aside from making troubleshooting and repair a lot easier,

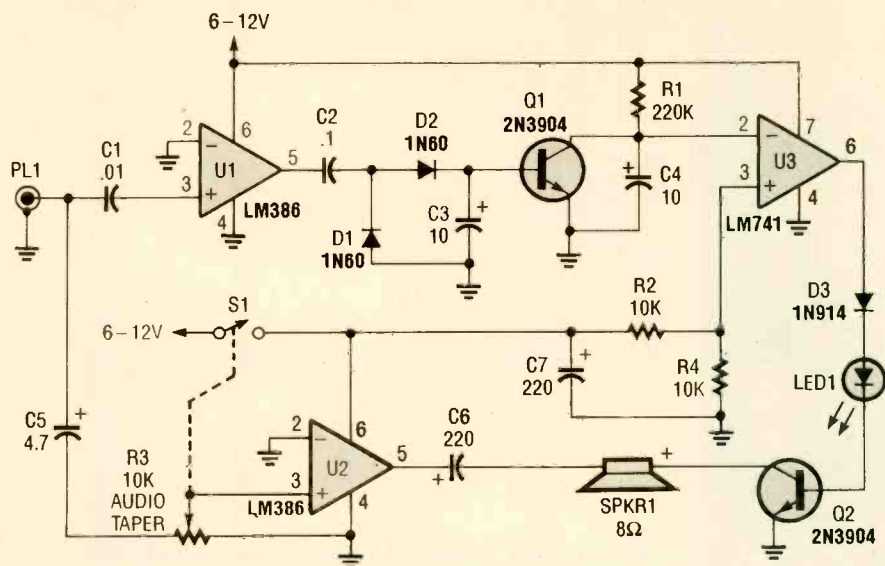

Fig. 1. The Scanner Companion consists of two LM386 low-power audio amplifiers, an LM741 op-amp, a couple of transistors, and a few additional components.

the use of sockets makes assembly a bit easier because you need not worry about overheating the IC terminals, thereby destroying the relatively expensive IC's.

You might also consider mounting the passive components and diodes in an IC socket, giving the circuit board a much neater appearance. In addition, that technique has the advantage of making replacement of those components a lot easier.

Note from the schematic diagram that S1 is piggy-backed to the volume control, R3; however, a separate switch and potentiometer can be used instead.

The author's unit was housed in a 4- x 4- x 2½-inch plastic, mini-CB, extension-speaker enclosure, which is avail-

able for \$6.95 from an after-market automotive parts supplier, J.C. Whitney & Co. (1917-19 Archer Ave., P.O. Box 8410, Chicago, IL 60680; Tel. 312-431-6102). That speaker, and most other speakers of that type, have sufficient room inside for the additional circuitry, and the speaker in the case can be used as the project speaker.

If you also choose to take that approach, you'll only have to drill one hole in the enclosure for the volume control, R3. The circuit board and battery holder can be mounted to the inside walls of the enclosure with double-sided tape, eliminating the need to drill additional holes for mounting, etc.

Using the Unit. To use the Scanner Companion, turn the unit on and insert

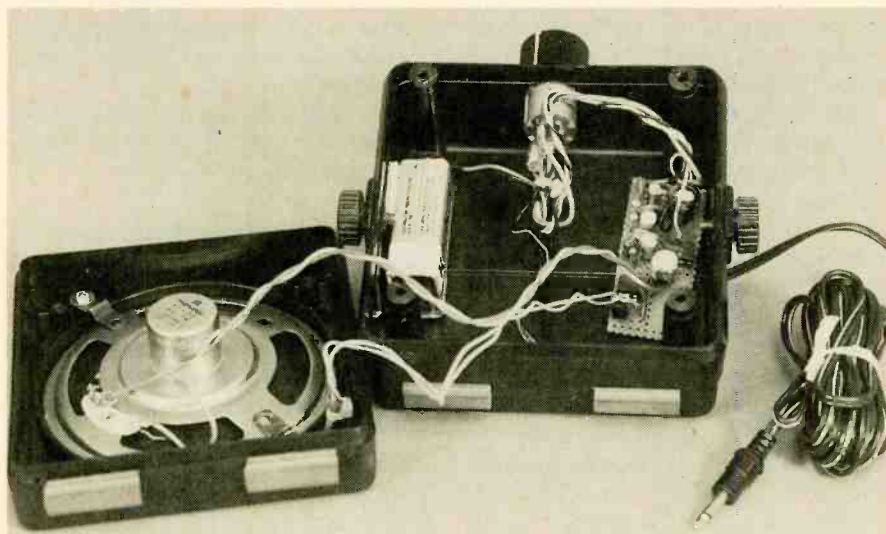

Here is an inside view of the author's prototype of the Scanner Companion. Note that even with the added circuitry and battery with holder, there is still plenty of room left within the speaker housing.

PARTS LIST FOR THE SCANNER COMPANION

SEMICONDUCTORS

- U1, U2—LM386 low-voltage, audio amplifier, integrated circuit
- U3—LM741 general-purpose op-amp, integrated circuit
- Q1, Q2—2N3904 general-purpose NPN silicon switching transistor
- D1, D2—1N60 small-signal germanium diode
- D3—1N914 general-purpose silicon diode
- LED1—Jumbo red light-emitting diode

RESISTORS

- (All fixed resistors are ¼-watt, 5% units unless otherwise noted)
- R1—220,000-ohm
- R2, R4—10,000-ohm
- R3—10,000-ohm, audio-taper potentiometer with SPST switch

CAPACITORS

- C1—0.01-μF, ceramic-disc
- C2—0.1-μF, ceramic-disc
- C3, C4—10-μF, 16-WVDC, electrolytic
- C5—4.7-μF, 16-WVDC, electrolytic
- C6, C7—220-μF, 16-WVDC, electrolytic

ADDITIONAL PARTS AND MATERIALS

- SPKR1—8-ohm, 4-inch speaker (see text)
- PL1—Phono plug to fit scanner earphone jack
- S1—Part of R3 (see text)
- Perfboard materials, enclosure (see text), 9-volt transistor-radio battery, battery holder and connector, LED bezel, speaker wire, hook-up wire, control knob, IC sockets, solder, hardware, etc.

PL1 into the earphone jack on the scanner to be used. Note that since C4 has discharged, LED1 will glow for the delay period when first turned on. With potentiometer R3 (the Scanner Companion's volume control) at the halfway point, turn on your scanner with the volume low, then squelch the scanner until noise is present. Then increase the setting of the volume control on the unit until LED1 glows and audio is heard through the Scanner Companion's speaker.

Adjust the squelch control on the scanner for silence. LED1 should glow for approximately two seconds and then extinguish, muting the sound from the speaker. If the LED doesn't extinguish, lower the volume on the scanner and try again. That's all there is to it! Set the volume of the Scanner Companion to a comfortable level and then relax and enjoy. ■

GIZMO®

A CHRONICLE OF CONSUMER ELECTRONICS

VOLUME 4,
NUMBER 6

It Walks, It Talks ... It Wins

CHESSTER PHANTOM MODEL 6100.
Manufactured by: Fidelity Electronics
International, 13900 N.W. 58th Court,
Miami, FL 33014. Price: \$599.

"I'm sorry, Frank, I think you missed it," says HAL, the deviously deranged computer in *2001: A Space Odyssey*, to his astronaut chess opponent, before going on to explain the few moves remaining before checkmate. When Frank wisely concedes, HAL politely replies, "Thank you for a very enjoyable game." When the movie premiered back in the 1960's, the idea that a computer could play such a "human" game was an intriguing concept, and conversing with your electronic opponent was difficult to imagine outside of science-fiction tales. In the '90's, however, we can play anything from checkers to "Indiana Jones & the Last Crusade" on our computers, usually accompanied by loud, but mindless, soundtracks, and hand-held computerized versions of old standards like backgammon and chess are widely available. But none of those games had sufficient personality to bring HAL to mind—until we met *Chesster*, the walking, talking chess set, that is.

Chesster (whose full name is *Chesster Phantom Model 6100*), from *Fidelity Electronics International*, is not just another software program or hand-held toy. Rather, it (we'll refrain from saying "he") is a full-sized, table-top chess set with real pieces. A 10¼-inch square beige-and-black board is centered on the 18½ × 22 × 3½-inch unit. On each side of the board is an area for captured pieces, called the Border Area, with icons marking the correct place to put them. At the front of the board (where the human player sits) is a control panel that features, from left to right, an LCD readout, an indicator to show whose move it is, a "shift" key, and eight other soft keys that each have two functions (switchable via the shift key).

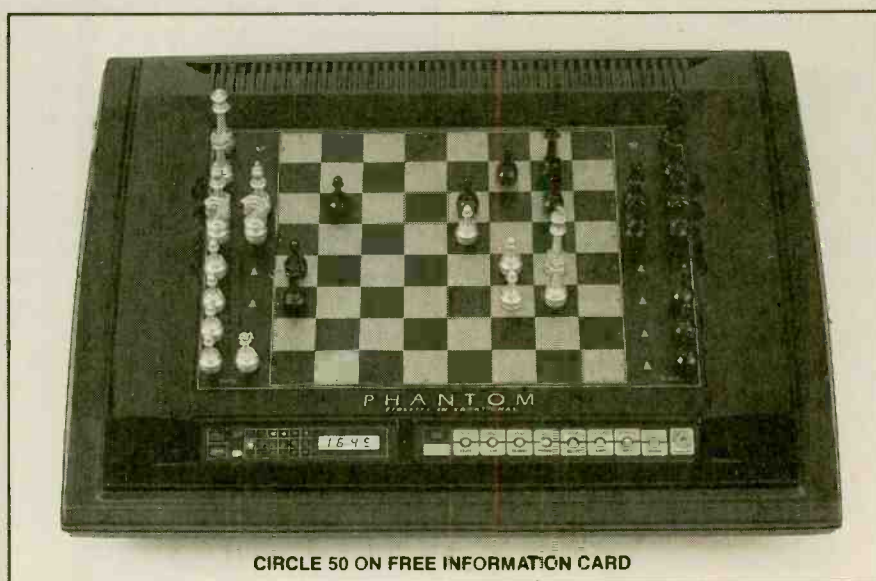

CIRCLE 50 ON FREE INFORMATION CARD

Stretching across the rear of the unit is a speaker, which gets a lot of use.

From that speaker, as soon as the game is turned on, comes the voice of Chesster: "Hi, I'm Chesster! How about a nice game of chess?" The voice is nowhere near as melifluous as HAL's—in fact it's rather nasal and tinny. But the fact remains that this chess set talks to you in complete—and completely understandable—sentences. Its vocabulary is impressive, and its personality is persistent. For instance, once the game is turned on, if you don't commence play after a minute or so, Chesster calls out, "Hey, you! Yes, you. Come over here. How about a nice game of chess. Press any key and I'll show you how to play."

Actually, it's more "tell" than "show." Chesster continues, "I'm glad you stopped by. Are the pieces set up? You can talk to me, you know. I have 'yes,' 'no,' and 'repeat' keys. Do you see them?" By pressing yes, you initiate a dialog in which Chesster teaches you how to play Phantom chess. It lets you know that you'll be playing white, that it's your move, and that to make a move you must press down first on the space the piece is on (the "from" space) and then on the space to which

you're moving it (the "to" space). Holding the piece on a slight angle, the edge of its base is used to press the center of a square. When the pressure registers, you'll hear a beep. (Each reviewer had difficulty moving the pieces the first time they tried. But they all got the hang of it pretty quickly, and had no subsequent trouble.) If the game is in "demo" mode, Chesster asks if you're new at the game. If you respond yes, it automatically switches to the "coach" mode, in which it tells you, each time you start to move a piece, how that piece can move. For example: "Pawns move forward, but they capture diagonally. The pawn can move forward two squares, but only on its first move."

Once you've made your move, it's Chesster's turn. Chesster actually moves his own pieces around the board—which is quite impressive, even for those who are used to game-playing machines. And, if he should capture one of your pieces, he moves that to its proper spot on the Border Area. (Chesster is a bit of a neat-freak; if you put a piece that you've captured on the wrong spot, or just a bit off the mark, Chesster will line it up perfectly for you. The exception is that it can't tell if the

(Continued on page 7)

TURN PAGE FOR CONTENTS

This month in GIZMO[®]

Fidelity Electronics Chesster Phantom Model 6100 Chess Set	pg. 1
Sony SB-V66S Audio/Video Switcher	pg. 2
Visonary Products In the Picture	pg. 3
Memorex VHS 100 Surround-Sound Headphones	pg. 4
Doc-Tech TennaTek Wireless Video-Multiplying System	pg. 5
ComputerEasy Dream House Professional Software	pg. 6
Mobile Audio Speakers	pg. 9
ShowerStar	pg. 9
Palmtop Portfolio Computer	pg. 10
Personal Paper Shredder	pg. 10
Surround-Sound TV	pg. 10
Cellular PagerPhone	pg. 11
Compact-Disc Player	pg. 11
Preassembled Stereo System	pg. 11
Clock Radio	pg. 12
High-Capacity Diskette	pg. 12
Keyboard Organizer	pg. 12
Power Amplifier	pg. 12

Gizmo is published by Gernsback Publications, Inc., 500-B Bi-County Blvd., Farmingdale, NY 11735. Senior Writers: Chris F. O'Brian, Teri Scaduto. Contributor to this issue: Steve Varnes. Copyright 1991 by Gernsback Publications, Inc. Gizmo is a registered trademark. All rights reserved.

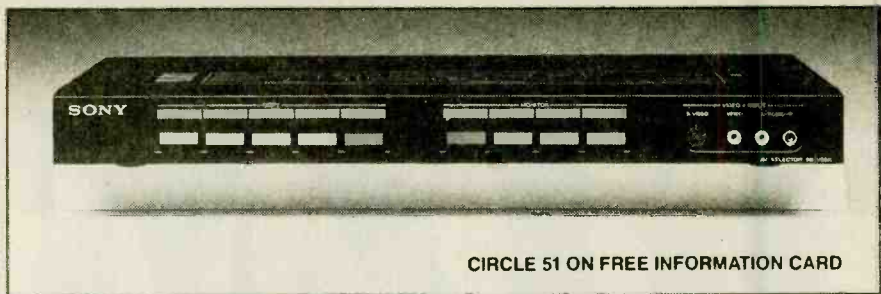

CIRCLE 51 ON FREE INFORMATION CARD

That's A Switch!

Sony SB-V66S AUDIO/VIDEO SWITCHER. Manufactured by: Sony Corporation of America, Sony Drive, Park Ridge, NJ 07656. Price: 129.95

Those of us who write about consumer electronics are often quick to complain that new technology and new features are slow to find their way into consumer products. Most of those complaints, however, probably start when writers sit down in front of their keyboards and are faced with the need to write about something interesting, and are confronted with yet the same old stuff.

As consumers, too, we've complained that we'd like to see more high-tech gadgetry in our products. But more and more, we're beginning to realize that maybe the omission of new, high-tech features is more the fault of our fellow consumers than of the manufacturers. Consider that most people—about 60%—*never use their VCR's to record!* Manufacturers certainly deserved some of the blame, when they seemed to deliberately make their first VCR's difficult to program for any "low-tech" consumer. These days, however, consumers who can't program their VCR's have only themselves to blame.

If the majority of consumers don't even use that basic function of their VCR's, how many would you guess use such features as audio dubbing, editing, etc. Since no one has ever collected such data, your guess is as good as ours. However, you can be sure that it's a small fraction of the people who own the capable equipment.

Both consumers and manufacturers share the blame there. Setting up the equipment can be difficult. Well, maybe not really difficult, but it certainly can be a hassle. Most people, after all, have their VCR's mounted in an entertainment center or a rack, with all of the necessary jacks in the back, facing a wall. (Although some manufacturers have begun, considerately, to include a set of input jacks on the front panel as well.) When hooking up equipment is required to take advantage of special functions—and such hookups entail moving a very heavy piece of furniture that's full of delicate components—we'll admit that we're likely to just forget about the whole thing.

Now we've come across a device that makes using some of the high-tech features of our equipment a little easier: Sony's SB-V66S audio/video selector, with its assortment of inputs, outputs, and switching capabilities, offers consumers a convenient way to make connections between assorted components. The switcher measures approximately 17 inches wide, 7½ inches deep, and 1¾ inches high. That size, and its black case with gold lettering will fit in with many video systems. A set of matching labels can be used to "personalize" the inputs to your particular system.

With four sets of video inputs and two sets of video outputs, Sony's switcher provides a number of different ways of hooking your electronics together. Each set of inputs includes left- and right-channel audio inputs, and composite- and S-video inputs. The rear panel holds three of the inputs; the fourth is on the front panel. Two of the inputs also have a corresponding set of outputs. That means you can "semi-permanently" connect to your television (via the SB-V66S's three rear-panel inputs) a VCR, an A/V receiver, and a laserdisc player, for example, and still be able to plug in a camcorder using the switcher's remaining input. Since the fourth input is located on the front panel, you don't have to risk a hernia moving the entertainment center when you want to connect the camcorder to your video system.

A third set of outputs, called "Monitor," is also provided. The monitor output—the output to which your TV or monitor is usually connected—can be switched, using the four monitor pushbuttons on the front panel, to select any of the four inputs for viewing. Four "Copy" buttons can be used to route signals. The four copy options are from input 1 to input 2, input 2 to input 1, input 3 to input 1, and input 4 to input 1. So, if your configuration is as described above, you can use your VCR to copy something from your camcorder, then with the press of a button, you can watch what you're taping or switch to your laserdisc player.

That setup isn't as versatile as a switching matrix where you could choose any input and send signals to any output, but it is quite easy to use—even for those who otherwise might never attempt to change connections between video components. It's also a simple procedure to use the

(Continued on page 7)

Ready, Aim, Aim, Aim...

IN THE PICTURE. Manufactured by: Visionary Products, 222 Third Street, Cambridge, MA 02142. Price: \$299.

Remember those old, low-budget horror movies in which a portrait in a haunted house had eyes that would follow the unsuspecting protagonist as he walked around the room? *Visionary Products* has taken that creepy concept and put it to positive use in a straightforward product for today's videographers. *In the Picture* allows an ordinary camcorder to automatically follow its subject around the room—or across the tennis court or on the dance floor.

There's nothing supernatural or sinister about the device, which is, in effect, an automatic cameraman. It consists of a transmitter that fits on your subject's belt and a receiver that mounts between your camcorder and a tripod. When both are turned on, *In the Picture* swivels to follow the subject's movements, and the camcorder that's perched on top of it follows right along. *In the Picture* can rotate a full 360 degrees, and can follow the transmitter within a 35 foot range—so the effective range is a circle with a 70-foot diameter. The panning motion is smooth and accurate.

In the Picture works by transmitting and receiving an ultrasonic signal. The transmitter weighs only five ounces, is powered by a 9-volt battery, and clips onto a belt in three places. Two extension transmitters

are connected to the main one by coiled wires: those are intended to clip equally spaced around the belt, so that the receiver can track the subject no matter what direction he turns. The power switch is recessed to avoid accidental shut off.

When the transmitter is switched on, it emits an ultrasonic signal, said by the manual to be "heard only by the tracking unit." However, holding the transmitter near our ears, we could clearly hear a high-pitched clicking sound (although it wasn't audible in normal use).

The receiver, or Tracking Unit, processes the transmitted signal and rotates the camcorder to keep the subject in the picture. It attaches easily between a (sturdy) tripod and any camcorder, using universal mounts. It requires 10 "AA" batteries, and weighs less than two pounds. A manual tilt control allows the user to make adjustments for the subject's height. The tracking unit consists of a box measuring approximately 4 x 3 x 5-inches with a tripod-mounting apparatus on its bottom. A piece that projects from the top of the box contains the tilt-adjustment knob and the mounting screw for the camcorder. Extending across the front of that piece, and reaching out to each side like a pair of outstretched arms, is a 21-inch rod with an ultrasonic receiver at each end. The power switch, a red tracking-indicator light, and a green power-indicator light are at the front of the box's top. The green light is also used for setting the panning speed when *In the Picture* is first turned on.

In the Picture has three panning speeds, or "Smart-Track Modes." As a rule of thumb, the faster the speed, the less smooth the panning. For capturing events

like family parties and barbecues on videotape, the manual recommends using the General Action mode. Fast Action is recommended for recording sporting events. Relatively sedentary events, like a college lecture or a dinner party, are best recorded using the Slow Action mode. The green light on the tracking unit illuminates with four long flashes when the unit is turned on. The Smart-Track modes are selected by turning on the transmitting unit during one of those four flashes. If it's turned on during the first flash, general action is selected; during the second flash, fast action; during the third flash, slow action. The fourth flash is for the self-test mode. If, during the fourth flash, you turn the transmitter on for at least one second and then turn it off, the tracking unit will go into the self-test mode, in which it continuously pans right and left. After the test cycle is complete, it will return to the general action mode. If you turn on the transmitter before turning on the tracker, or after the four flashes, the tracker will automatically go into the general action mode.

Before you start taping, it's necessary to frame your subject correctly, using the tilt adjustments handle on the tracker. The manual provides clear, illustrated advice for adjusting the framing for virtually any situation you might find yourself recording: adults indoors or outdoors, children indoor or outdoors, groups of both children and adults, scenery or close-up shots, and small rooms. Basically, it's simply a matter of setting up the tripod where there are the least possible number of potential obstacles, with the camcorder aimed at the subject's nose level. For groups of various heights, it should be set halfway between the nose level of the tallest and the shortest person. Of course, you should scan the scene through the camcorder's viewfinder to make sure that it's framed correctly. Also, for smoothest panning, the camcorder should be "pulled back" to its widest angle of view.

Once *In the Picture* is hooked up and swiveling a camcorder, the whole setup resembles a friendly robot (perhaps the one from *Lost in Space*) more than a haunted portrait, particularly with its "arms" spread as if in welcome. It is most definitely a friendly device to use. The setup is easy, and when it's done, you can pretty much forget about it as you get in the picture.

One of the main advantages of using *In the Picture* is that the cameraman can also be the star. Now, that family member who's always the voice behind the movie, but whose face is never captured on video, can get in on the action. At a child's birthday party, for instance, the guest of honor can wear the transmitter. Not only can both Mom and Dad be in the video, but they can be sure that their little darling will be in every frame.

(Continued on page 8)



Surrounded by Privacy

MEMOREX VHS 100 VIDEO HEADPHONE SYSTEM. Manufactured by: Memtek Products, P.O. Box 901021, Fort Worth, TX 76101. Price: \$99.95.

We've become spoiled. When we watch video, we want the best possible sound to accompany it. That means surround sound, which really does make you feel as if you're part of the on-screen action. But setting up, and listening to, a surround-sound "home theater" system can create problems—both personal and technological.

Although many of us with fancy audio/video setups have taken to calling the room in which they're kept "media" rooms, in most instances those spaces are still, in reality, family rooms. As the name implies, more than one person will be using the room, and the space must accommodate various activities and various tastes. Home theater is terrific for the person who's watching *Top Gun*, but not for the rest of the family, who might want to play a board game, or pay some bills with the help of the computer, listen to music, or just sit in a favorite chair with the newspaper. Even if the whole clan agrees on a movie to watch, not everyone has the same taste when it comes to the sound. In action thrillers, the surround track's explosions, gunshots, and music can get rather loud and draw complaints from viewers with more sensitive hearing.

The actual setup of a surround-sound system can be problematic, especially in a small room. Good result are hard to achieve in cramped quarters because there's not enough space to set up the speakers properly—and proper speaker placement is essential to good surround sound.

None of those drawbacks would make us consider giving up our surround sound (no way!). But we've been keeping our eyes peeled for some way to remedy them. We've finally found a way to keep the peace in media rooms across the country, in the form of the *Memorex VHS 100 Video Headphone System*, which solves at least some of those problems. As far as we know, it's the first product that allows private headphone listening to any surround-sound source.

At first glance, we thought the headphones provided surround-sound decoding; in reality, you must hook them up to your own decoder. What they do provide is surround-sound listening.

What makes the VHS 100 headphones different from standard headphones is that they contain two driver elements for each ear. The right and left front drivers have a frequency response rated from 20 Hz–18



CIRCLE 53 ON FREE INFORMATION CARD

kHz, while the each of the two rear drivers is rated from 80 Hz–12 kHz.

To accommodate the two drivers, and to improve the separation between the front and rear channels, the headphones have a slight oval shape. That permits the front drivers to be mounted slightly in front of the ear, and the rear drivers slightly behind. As it should, the placement sounds obvious when listening to surround sound. But, interestingly, when you're listening to standard stereo sources, you don't get the impression that the sound is in front of you. Presumably, what makes the front channel appear to be in front of you when listening to surround sound is the presence of a rear channel.

The headphones are reasonably light, about 6½ ounces, and are softly cushioned. That means that you can watch a full-length movie without discomfort. The headband adjustments feature notches, or detents, for sure fit.

Connecting the VHS 100 to your audio/video system should be reasonably straightforward. However, you can't expect to rely on the manual—there is none. The instructions printed on the packaging are among the worst we've ever seen. The front headphone jack plugs into the receiver or amplifier that you normally use for the front channel. The rear headphone jack connects to your surround amplifier. Don't worry if your surround amplifier doesn't have a headphone jack—most don't—the VHS 100 comes with a headphone adapter. To use it, you connect the speaker outputs of your surround amplifier to the inputs of the headphone adapter. Then your speakers are connected to the outputs of the headphone adapter. The rear channels of the headphones are connected

to the headphone jack on the headphone adapter. Since the headphone drivers are so close to the ear, it is important that your surround processor includes a good delay system for the rear channel to get the best results.

The headphones feature ¼-inch miniature stereo plugs, but ⅜-inch adapters are supplied. All connectors are gold plated to ensure maximum signal transfer. The headphone cord supplied is almost 18 feet long, which should be sufficient for most rooms.

The only possible source of trouble is that the front and rear headphone jacks can be separated by, at most, no more than two feet. (Although, since the headphone adapter is connected to the surround amplifier by speaker wire, we presume it's easy to move it close enough.)

Once the hookup was complete, we got to try out the VHS 100 headphones for real. The first show we watched was "Twin Peaks"—a terrific example of how surround sound can enhance a television show. The sound was dramatic, and we could listen to a loud soundtrack with full surround-sound effects, but without disturbing anyone else in the room. Switching from the headphones back to the regular speakers is simple—you just unplug the headphones—so if the rest of the family decides to watch with you, you won't have to miss any of the show's action. The headphones worked just as well with feature films, and were quite comfortable to wear.

As is usual when we review the first sample of a new product category, we have a few constructive criticisms. When the VHS 100's rear headphone connector is

(Continued on page 8)

Wireless Video...With Wires!

TENNA TEK WIRELESS VIDEO MULTIPLYING SYSTEM. Manufactured by: Doc-Tech International, P.O. Box 7944, Amarillo, TX 79114-7944. Price: \$79.99.

It was back in late 1985 that we first encountered wireless video transmitters, which broadcast on TV frequencies. They were quite popular with consumers, despite the fact that they were illegal. The Federal Communications Commission, or FCC, which is responsible for regulating electronic communications, allowed some license-free transmitters (wireless FM microphones, for example), but it did not have any provisions for video broadcasters. While that didn't stop some companies from introducing video broadcasters, the FCC caught up with all of the manufacturers or importers eventually.

There were a number of reasons that wireless video transmitters were popular with consumers. First, of course, they offered a less expensive alternative to buying a second VCR for watching movies on a second TV. Another reason is that camcorders as we know them today didn't exist. Two-piece camera/VCR combinations were the popular configuration—but only because lightweight compact camcorders weren't available. Lightweight battery-powered transmitters offered a way to get the heavy recorder unit off your shoulder—or even to use a standard VCR and video camera much as you would use a camcorder.

With the existence of a market for video broadcasters established, it was only a

matter of time before the FCC was petitioned to allow for such devices. Although the FCC usually moves slowly, they did open a band of frequencies for home video transmitters. And, although several companies have announced the availability of such video casters, none has been able to fulfill our request for an evaluation unit. The usual explanation is that they are awaiting final FCC approval.

Doc-Tech International's TennaTek wireless video-multiplying system was available immediately, however. But that's because it doesn't use RF (radio-frequency) waves to transmit video from the source to a receiver. Instead, it transmits the RF energy over your home's power lines, using carrier-current (sometimes called wired-wireless) technology.

The TennaTek consists of two main parts, the "multiplier" transmitter and the receiver. Also included are two short lengths of coaxial cable, a "Y" connector, and a matching transformer or balun. Installing the unit is reasonably straightforward. The RF output of your VCR or cable box is connected via a coaxial cable to the input of the transmitter, which is then plugged into a grounded wall outlet. You must use a Channel-3 output, however, as that is the only channel on which the system will operate. Since no local station broadcasts on Channel 3, we couldn't tell whether that would cause problems in areas where a local station does broadcast on that channel.

The receiver portion is hooked up in a similar manner. A coaxial cable is run from the TV to the receiver unit, and the unit is plugged into a grounded wall outlet. A six-position DIP switch, which Doc-Tech calls the "combination switcher," must be adjusted for the best picture. A card is included that lists the 52 unique combinations, so you don't have to figure them out for yourself. The different com-

binations are intended to compensate for the variation in wiring from one outlet to another.

Once everything is hooked up, all you have to do is turn on the VCR (or cable box) that you hooked up to the transmitter, and turn on the receiving TV. Theoretically, you'll be able to watch the video source. In practice, it doesn't always work out that way; there are a number of things that can go wrong. The manual that's supplied with the TennaTek warns of several possible problems. The first item in the manual (immediately following the unpacking instructions) is a disclaimer that states, in bold capital letters, "Doc-Tech International does not guarantee that the TennaTek VMS will operate satisfactorily under all conditions." It goes on to warn that the system performs best in homes with areas of 2200 square feet or less, and will also perform when both the transmitter and receiver are plugged into outlets that are on the same circuit.

Other possible problems could be due, according to the manual, to "poor construction of the wiring circuits and the wall outlets themselves, and ... static, noise, and interference, of undetermined origin, in the wiring circuit."

We were fairly confident that we wouldn't suffer from any major problems. Our test home was considerably smaller than 2200 square feet, and our initial test was setup in an area that had relatively new wiring, with both the transmitter and receiver on the same circuit—with the outlets quite close to each other. We had no other carrier-current devices (such as an X-10 control system) installed on our power lines. However, keep in mind that our experiences might be due to our particular setup; your setup might provide different results.

On our initial test, we found that adjusting the combination switcher improved the originally-very-poor signal to one that was slightly better than poor. Although we were confident that we had everything hooked up properly, we went back to the manual and checked the troubleshooting sections. Most of the suggested troubleshooting steps were fairly obvious, and didn't give us any hints on improving the operation. We did, however, find in a different section of the manual a note that neither the "multiplier" unit or the receiver should be plugged into any kind of extension or power strip. We had missed that the first time through the manual, so we had some hope that we had found our problem. We plugged the transmitter directly into a wall socket, and ... no improvement.

We then pulled out a separate sheet, supplied with the manual, that had a bold "How to improve your TV reception" printed across the top. That was for us! It suggested that a VHF signal booster be added between the output of the VCR and

(Continued on page 8)



CIRCLE 54 ON FREE INFORMATION CARD

DREAM HOUSE
professional

KITCHEN
BEDROOM
GARAGE

IBM PC, XT, AT and Compatibles
ComputerEasy

CIRCLE 55 ON FREE INFORMATION CARD

Drawing Castles in the Air

DREAM HOUSE PROFESSIONAL; Published by ComputerEasy, 414 East Southern, Tempe, AZ 85282. Price: \$79.95.

Here in the Northeast, the housing market has been in a slump for the past few years, and there's no upturn in sight. From what we've been reading in the papers, the situation isn't much better for homeowners in most other parts of the country, either. For many families who bought "starter" houses in the last few years, "trading up" to something that will fit their growing families is no longer possible. It's hard to shop for a new house when you're not likely to be able to sell—particularly at a price you can live with—the one in which you're currently living.

When you can't actually buy the house you want, there are still a couple of options available. You can try to be content with clipping magazine articles, collecting floor plans, and striving to create on paper the ideal house that you'll build or buy when the market picks up again. Or you can remodel. Around here, that's a popular option. On our street alone, we've seen two extensive remodels in the past year,

and two other neighbors are seriously considering it.

Whether you're trying to design your perfect house, or trying to figure out how to make the one you now own big enough for your family, *ComputerEasy's Dream House Professional (DHP)* software can help you visualize the plans. The program lets you use your IBM XT, AT, PS/2, or compatible computer to draw much neater floor plans than most of us could achieve using a pencil, a ruler, and graph paper. It lets you designate areas on the plan as livable space, storage, garage, or atrium areas, and calculates square footage accordingly. Icons for doors, sinks, stoves, and toilets can be placed in the appropriate spots on your sketch, as can labels for each room. And, when you're finished, you can print out the floor plan of your dream house or extension on most IBM and Epson dot-matrix, HP LaserJet, and compatible printers.

Dream House Professional can be used with a mouse, joystick, or keyboard. We preferred using the cursor (arrow) keys on our keyboard; although it was the slowest of the three methods, it offered the surest control and the best accuracy.

Learning to use the program is not difficult—but unless you're the type who will sit and read the entire manual without turning on your computer, we'd suggest

you turn to "Chapter 4: Tutorial With Sample Sketches" *before* trying to wade through "Chapter 3: Using Dream House Professional." If you want more details on anything in the tutorial, you can always flip back a few pages and look it up as you go, but trying to make sense of those details without a sample sketch in front of you can get quite confusing. You can also refer to the summary of commands, which is conveniently placed just to the right of the on-screen drawing board.

The drawing board is a blank rectangle that occupies the top left two-thirds of the screen. If you prefer, you can add a "grid" of evenly spaced dots that represent the scale of the drawing. DHP's default scale is two-feet-per-grid, but you can use any scale ranging from one to 24 feet per grid, in one-foot increments. You can also change the scale of the sketch in the middle of drawing it. The largest home you can draw in the one-foot scale is 43 by 37 feet; in the 24-foot scale you can draw a grandiose 1032-by-902 foot mansion.

Function keys F1 to F5 determine which type of area you will be drawing: livable space, garage, patio, storage, or atrium, respectively. You can change those names to suit your particular drawing (replacing garage with carport, or patio with deck, for example). The remaining function keys are used for calculating the area of each of those types of area.

Regardless of the type of area, drawing walls requires the same procedure. The entire outside perimeter of each area is drawn first; it is recommended that you begin with the livable space. You place the pointer at the position where you want the wall to start; press the "enter" key to start drawing; and use your keyboard, mouse, or joystick to move the pointer to the wall's end point. As you draw, the current length of the wall is shown at the lower right side of the screen, always in increments of the selected grid size. By pressing the shift button, you can move in smaller increments of tenths of a foot. When you reach the desired length, pressing "enter" again ends ("anchors") the wall, and its dimension appears next to it. You can position the dimension number using the pointer and hit enter to place it, or you can delete it by pressing the space bar. The remaining outside walls of the area are drawn in the same manner.

Before proceeding to draw a different type of area (adding a garage or a deck, for instance), or to insert interior walls, you must "close" the area on which you've been working. If all your walls match up perfectly, the close command works instantly and the message "Livable area closed" appears on the bottom of the screen. If you measured or drew a wall incorrectly, however, a pointer will appear along the wall that may need to be changed. You can select which wall to change by moving the pointer; DHP will

(Continued on page 8)

THAT'S A SWITCH

(Continued from page 2)

monitor function to verify that you're recording what you want to.

The switcher has the feel of quality; the switches' operation is smooth and sure. All of the connectors are gold-plated to reduce signal degradation, apparently successfully—we could not detect any deleterious effects of having the switcher in line.

Personally, we'd like to have a little more flexibility—but then we've never had trouble hooking up our VCR's! Adding flexibility at the cost of easy operation would defeat the purpose of the switcher. The SB-V66S, as it is, is very easy to use. As such, it gives people the opportunity to use more of the features of their audio-video systems than they otherwise would. And more consumers start using those features, maybe they'll start clambering for still other high-tech features—and we'll have more and more things about which to write in **GIZMO!** ■

WALKS, TALKS, WINS

(Continued from page 1)

knights face the wrong way, which drives us crazy.) Between the voice and the self-animation, playing chess on the Phantom really is like playing against another person—or several people.

Chesster offers a plethora of game-playing and game-level options, and you can make it as talkative or as silent as you like. By pressing first the option key and then certain spaces on the board (as specified in the manual), you can opt for anything from beginner level with full coach mode to its certified rating (by the U.S. Chess Federation) of 2100 with no words spoken other than "check," "checkmate," or "stalemate." Chesster can beat more than 95% of the chess-playing population.

You can also choose various preset time controls (for instance, you can have the computer play 60 moves in five minutes) or countdown levels, in which each player is allotted a certain amount of time, ranging from five minutes to three hours per side, in which to complete the game. In addition, you can set Chesster's ability to look ahead and analyze moves anywhere from one move to eight moves.

None of us here at **GIZMO** goes beyond the advanced beginner level of play, and we tended to stick with the lower levels of play. And even at that, for the first two weeks we had to play with the Phantom, we never won a game—without cheating that is. It's possible, when things are looking truly dire for your side, to switch sides with Chesster. It will object, "No way! I don't want your mess!" Although it has no choice but to go along, it will do so grudgingly, complaining, "This

game is giving me a headache." When we finally did win a game, Chesster's only comment was, "I resign. You win."—a far cry from the "I win! Don't you think I'm great?" that we'd become accustomed to hearing. We also managed to play to a draw, without cheating.

Chesster does help beginners. Besides explaining how each piece can move, Chesster will give you hints when you ask for them. It will tell you out loud what piece you should move, and display in the LCD window both the "to" and the "from" squares of the suggested move. Unfortunately, Chesster can't explain *why* the moves it suggests make sense. And, when it says first, "I give great advice," then recommends a move that leads to the immediate capture of one of your major pieces, followed by a comment like "Tell me you want to keep me"—and offers no reason for the play—it can lead to frustration for beginners. While the manual is written clearly and is well illustrated, we feel that it would have been appropriate to include a booklet explaining some basic chess strategies, opening moves, etc. A complete novice will have a hard time grasping the subtleties of chess simply by playing against Chesster.

Our skills noticeably improved, however, since by the third week we managed to win a few games when Chesster was in its "easy" mode. And we were surprised to hear Chesster say "You win!" in a normal tone of voice.

Strong intermediate players would be even more likely to find a good learning tool in Chesster. They could take full advantage of an array of features designed to strengthen one's game. Chesster allows you to set up "problem" boards so that you can find your way out of pre-arranged sticky situations. Using "mate level finders," you can set up problems and tell Chesster to search for a mate in a specified number of moves, from one to eight. At the end of a game, if you want to relive the thrill of victory or see where you went wrong, the "replay" option will let you re-examine the whole course of a game from beginning to end.

There are also a number of options that would not be considered legal in real play, but that serve to teach players at all levels. You can take back a move, or a string of moves, using the "take back" key (although Chesster will sometimes call you a cheater!). Those players who haven't learned to project the consequences of their actions will find themselves using the "take back" option frequently in the beginning. Along with the previously mentioned hints, if you press down on one of your pieces and simultaneously press the "hint" key, Chesster will actually demonstrate all possible moves available to that piece. If Chesster isn't moving quickly enough for you, you can force it to stop thinking and make a move by pressing the "move" key. And, if you're not happy

with a move that Chesster makes, by pressing first the "option" key and then "take back," you can force it to make another, different move.

All of those functions are selected using the soft keypad at the front of the game, with the shift key used to toggle between each key's two available functions. Each square on the chess board, when used with the "option" key, allows you to set game parameters. While Chesster is recommended by its manufacturer for visually impaired players—because of its "move-assist" option, in which it announces every move and key press in a clear voice—the soft keypad would present an obstacle for blind players. Discrete keys, or toggle switches, would have been more appropriate on a game that the company bills as easy for the visually impaired to play.

Also not available to the visually impaired—although not vital to game play—is the information displayed in the "rotating display." Whenever Chesster is thinking about its next move, you can ask to see displayed in the LCD window various data, simply by pressing down on certain squares on the chess board. You can find out the "score"—the computer's opinion of the current board position, based on numerical values for each captured piece; "search depth"—how far ahead the computer is looking as it ponders a move; nodes per second—how many chess positions the computer is considering each second; and up to four moves of "principle variation." Principle variation is the line of play that Chesster currently believes to be its best, and you can opt to see between one and four moves of the computer's principle variation.

Between the walking and the talking, playing with Chesster doesn't seem like playing with a machine. Chesster has his own distinct personality. Where HAL was sinister and manipulating, Chesster is simply, well, obnoxious. In fact, one **GIZMO** reviewer said that Chesster reminded her of the reason she gave up chess years ago—a younger brother who, upon surpassing her skill, tended to alternate smug hints with taunts. (Granted, many of Chesster's more annoying phrases appear to be aimed at attracting potential customers and helping retailers sell the game: "Take me home; you'll love me!", "I'm a great value!", and one we're sure is intended to be used in a sales demo. "Only a salesman would make a dumb move like that!") But Chesster also can get smug—for example, "I'll give you a hint: Give up!"—and he gloats whenever he wins. Perhaps his name is a play on the word "jester."

Of course, you can always turn off his voice. But that's where the real resemblance to HAL comes in. Not only does the process entail a few intermediate steps—you must first deactivate the "coach," "demo," and "move assist"

modes—but as you're doing it, Chesster (like HAL) is begging you not to—“Nooo! Please let me talk or I'll go crazy!” (At least it doesn't start singing “Daisy, Daisy, give me your answer do....”)

Whether it was due to his impassioned pleas, or simply the novelty of having a chess set that talks back, we tended to let Chesster keep putting his two cents in. Perhaps it was because his gloating smugness kept us (perversely) striving to better our games for the satisfaction of beating Chesster, but we found ourselves compulsively playing game after game. And, in doing so, almost missed this month's deadline. ■

READY, AIM, AIM, AIM

(Continued from page 3)

Anyone who has tried to follow an active toddler with a camcorder is sure to appreciate the range and smooth panning movement provided by In the Picture. We're sure that resourceful parents will be able to come up with a way to ensure that the tripod setup is somehow “baby-proofed” and that the child doesn't crawl behind the sofa and block the transmitter. In the Picture doesn't require a totally unobstructed path between the tracker and the transmitter. However, when the person wearing the transmitter leaves the room or is blocked by a large piece of furniture (or by other people), the tracker will pan back and forth (rather forlornly, we thought) searching for its target. If it can't find its subject, it simply points the camcorder straight ahead.

The slow-action mode would be ideal for filming a wedding processional and ceremony—if you could find an unobtrusive way to clip it to a wedding gown. (Actually, the receiver can “hear” the transmitter through light clothing, so it shouldn't be too difficult to hide.) The manual recommends using the slow mode for public speaking; you can also record your own speeches before presenting them in public, to see which part of your delivery might need to be more polished.

The fast speed can be used to track a subject who's running around a tennis court, stealing a base, or dribbling down a basketball court. It lets you capture your form on film so that you can analyze your mistakes, without having to talk a friend into standing on the sidelines trying to anticipate the direction in which you're about to move. Even in the fast-action mode, In the Picture scans smoothly and steadily. If your sport is pole-vaulting, however, you're out of luck. In the Picture can't track vertically moving subjects.

In our tests, that was the only way we could find—short of hiding behind a wall or desk—to stump the device. Granted,

none of us has won any 100-yard dashes lately, but In the Picture managed to keep up with our fastest efforts to thwart it. The device performs better in large, clear areas than it does in tight, crowded quarters: we assume that's because the sound it emits is reflected from the walls and other objects, making it more difficult for In the Picture to track the subject. For instance, when we walked behind a fence and a brick barbecue outdoors, In the Picture never wavered. Yet in our rather small and admittedly cluttered offices, walking behind a desk effectively blocked the transmission. (That problem can be alleviated by placing the camcorder as high up as possible, affording the clearest view even in small rooms.)

At first, many subjects felt a bit uncomfortable under In the Picture's relentless pursuit (sort of like that movie hero under the portrait's gaze, perhaps). Actually, it was less uncomfortable than being trailed by a persistent human videographer. That uneasy feeling quickly changed to a sense of friendly competitiveness—it's hard not to try to trick the tracker. But it doesn't take long before you get so used to In the Picture that you forget you're being videotaped—which rarely happens when someone is hounding you with a camcorder—and that can make for some truly memorable, candid performances. ■

SURROUNDED BY PRIVACY

(Continued from page 4)

plugged into the headphone jack, the rear speakers are automatically cut off. We would like to see an option that allowed you to listen to the rear channel in both the headphones and rear speakers, so that people with different opinions on how loud the surround channel should be could listen together in peace. However, since the headphone adapter doesn't offer any volume control—another feature we'd recommend—that wouldn't be of much use in this model. Also, although the headphones do surround the ear, the construction of the headphone shell does allow outside sounds to be heard—the effect can be like sitting in a theater next to some of those annoying people who whisper incessantly throughout the movie. We hope some of those features will be included in the next generation of surround-sound headphones.

Those slight disadvantages are a small price to pay for privacy and peace. Here in our GIZMO offices, we often find ourselves at odds as one staff member is testing a loud audio or video product while others are attempting either to try out a different item or to write about the results. The VHS 100 headphones let us all work together harmoniously—and we're convinced that they can have the same effect in many people's family rooms. ■

WIRELESS VIDEO

(Continued from page 5)

the input of the transmitter. Well, although we were beginning to feel rather skeptical, we figured that it couldn't hurt. After all, Radio Shack sells a variety of signal boosters, starting at \$12.95.

The signal booster helped quite a bit, as long as we didn't turn the gain on the unit up too high. We had color at all times, and could actually read the numbers on basketball jerseys—something we couldn't do with certainty before we added the amplifier. However, the picture we saw was still quite noisy, noisy enough to be considered unacceptable under most circumstances.

We can, however, come up with some circumstances where it could come in very handy. Because we live in a “fringe” area, the reception on portable TV's is usually unsatisfactory. When “real life” conflicts with a live sporting event that we just must see, we've often tried using the portable TV in our work shop as we tried to finish a project—and usually ended up missing the game. In such a case, we suppose that some picture is better than no picture at all. And that's just what the TennaTek video-multiplying system offers, a picture that is okay in an emergency, but unacceptable for normal use.

We can think of a few other situations in which the TennaTek would be suitable. It could be acceptable for use as a baby monitor—the picture is good enough that you should be able to see if a child has managed to climb out her crib, although you probably wouldn't be able to make out the pattern on her pajamas. And if you'd recorded Julia Child cooking a seven-course feast, you could use the TennaTek to rebroadcast the show to the kitchen to watch as you attempted to replicate her meal. But when it comes to using a video caster so that you can sit back and enjoy your favorite movie, we'd recommend bypassing this unit and waiting for an RF broadcaster. ■

CASTLES IN THE AIR

(Continued from page 6)

automatically redraw the sketch, adjusting the dimensions and closing the space. (When you add a garage or deck that abuts the house, you must draw the wall that borders the house, even though it appears as if you are drawing over an existing line, so that the space can be closed.)

Once an area is closed, you can find out the square footage in a few different ways. Simply pressing “A” is the easiest: the square footage of each type of living area will be displayed. Pressing “M” replaces the list of commands on the right side of the screen with the measurement calcula-

tion area. The F9 key will make DHP automatically calculate the measurements from your sketch. You can also use the keypad numbers to enter your own calculations; for example, you can type in "22 X 16" and "Enter" and DHP will supply the answer ("352").

Interior walls are drawn by pressing "1" and then proceeding as previously described. There is no need to "close" interior areas, and those walls will not affect the square footage. After the interior walls are drawn, you can use the icons supplied with Dream House Professional to add doors, sinks, toilets, circles, or bathtubs to your sketch. You can also label each room you've created, using large or small type. If things start looking a bit messy, pressing "R" will redraw and "freshen" the sketch.

If you discover a mistake made earlier, or decide you want to change something you've already done, you can keep hitting the "delete" key to erase the drawing, step by step, until you reach the error. Once you make the change, you can use the "insert" key repeatedly to redraw the corrected sketch.

We used DHP to draw the upstairs of an existing house after the addition of a full dormer. The whole house measures 30 x 24 feet, so we selected the 1-foot-per-grid scale. (In the 2-foot default scale, the drawing was minuscule.) It was easy to redesign the expanded living space to include an extra bedroom and bath and an expanded master suite with its own bath. Unfortunately, the icons are scaled only to DHP's default setting; at any other scale, the icons don't match, and they can't be re-scaled.

We also changed our "dream house on

the lake" from a much-erased-and-redrawn graph-paper sketch to a neat, professional-looking floor plan. It was a bit more difficult than the dormered upstairs we'd just finished. The kitchen/family room in our dream house is six-sided, to take in the view, and we had a bit of trouble making the angled walls line up precisely enough that the area could be closed. (DHP lets you draw walls at any angle.) We were happy to discover, after DHP calculated the size to be less than 3,000 square feet, that maybe we could afford to build it—someday.

Once we had the rooms drawn in, we found that we really wanted to start playing around with furniture arrangements. We would have appreciated icons for standard pieces of furniture, and for kitchen appliances—and we strongly feel that all the icons should be available in every possible scale.

The finished sketches can be saved to a file, cleared (deleted), or printed. Printing is accomplished by using "Shift" and "Print Screen"—which means that the whole screen is printed, not just the sketch. The manual suggests going into the measurement mode before printing. Then the unwanted part of the printout is at least relevant to the sketch.

The "professional" in Dream House Professional is something of a misnomer. Anyone who has taken even one semester of architectural drafting will recognize that the results are amateurish, albeit neat, due to several factors. First, the accuracy required in architectural drafting cannot be achieved with a program whose smallest unit of measure is 1/16 foot. Trying to convert a wall that measures 12 feet, 7/8 inches into 12 feet, x-tenths of a foot con-

vinced us to forgo total accuracy for the sake of expediency. (Our drafting teachers would be cringing.) Although the drawings produced by the software might give a contractor a good idea of what you wanted done, they certainly couldn't be used as working plans.

Second, nowhere in the manual does it tell you that an interior wall should be at least 6 inches deep. If you are aware of that, you can use two lines for each interior wall, but it is difficult to space them so closely using DHP. Similarly, outside walls should be one foot deep for a professional looking drawing (like the one shown on the software packaging). We suppose that, once you'd finished (closed) your livable-area sketch, you could draw another border around the edges to represent the outer wall's depth.

Third, no provision is made for drawing curved walls (like the one on the package cover), so you're out of luck if your dream house isn't all straight walls. Finally, no icons are included for windows (another feature that appears on the package illustration) or stairs, and no instructions for how to include them are provided.

We would imagine that a product like Dream House Professional would appeal much more to graph-paper sketchers than to trained draftsmen, so perhaps the amateurish quality won't be too much of a drawback. The printed results are quite an improvement over pencil-and-paper sketches—in fact, they look quite impressive, albeit small.

One thing is certain: It was much easier to draw both the remodeling and the new house using Dream House Professional than it will be to get financing for either project! ■

For more information on any product in this section, circle the appropriate number on the Free Information Card.

ELECTRONICS WISH LIST

Mobile Loudspeakers

Sanyo Mobile Audio's (21350 Lassen Street, Chatsworth, CA 91311-2329) top-of-the-line car loudspeaker is the HD152. It boasts an enclosed two-way bass-reflex design and, with a 75-watt maximum power-handling capability it gives strong audio support. A 5-inch woofer, a 2-inch tweeter, and 5.4-ounce strontium magnet combine to deliver the full impact of high and low frequencies. Specifications are 70-Hz to 20-kHz frequency response, 90-dB SPL, and 4-ohm impedance. The speakers are encased in rugged ABS resin enclosures with metal grilles. Price: \$99.99.

CIRCLE 56 ON FREE INFORMATION CARD



Sanyo Mobile Audio Speakers

Showerhead Light

While you're saving water by showering with a friend, you can also save on electricity (and create a "friendly" ambience) with O'Ryan Industries (9400 NE 130th Avenue, Vancouver, WA 98682) ShowerStar water-powered lighted showerhead that includes red, blue, green, and amber bulbs. The ShowerStar is powered by a built-in, miniature hydro-electric generator, so no electricity is required. It provides a measure of safety in poorly lit tubs or shower stalls, and is available in either chrome or brass. Price: \$39.99 (chrome) or \$59.99 (brass).

CIRCLE 57 ON FREE INFORMATION CARD



O'Ryan Industries ShowerStar

ELECTRONICS WISH LIST

For more information on any product in this section, circle the appropriate number on the Free Information Card.



Atari Palmtop Portfolio Computer

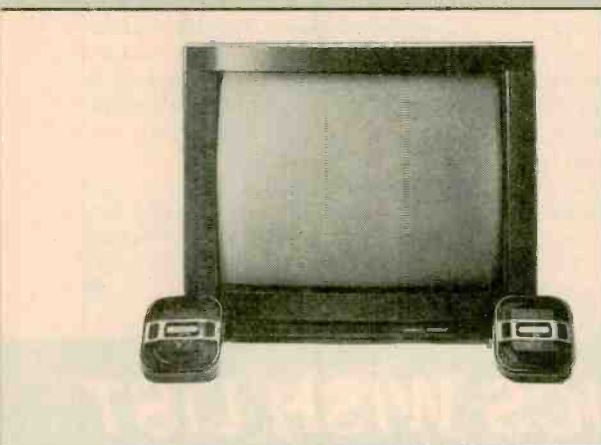

Goldstar Surround-Sound TV

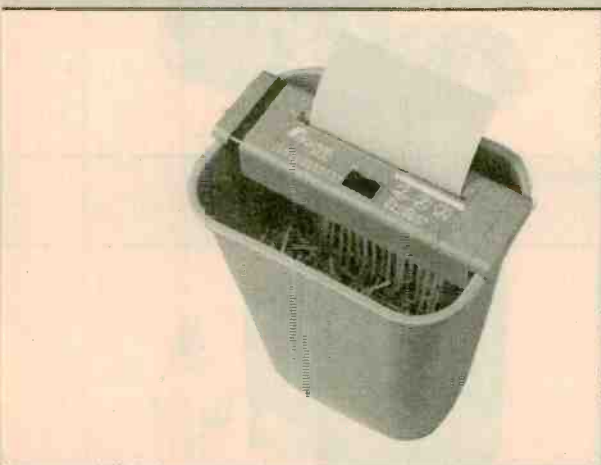

Fellowes Personal Paper Shredder

Palmtop Personal Computer

If a \$1000, 10-pound laptop (or a lighter but more expensive version) stretches your definitions of affordability and portability, Atari (1196 Borregas Avenue, Sunnyvale, CA 94088) is offering a more palatable solution in the form of its *Portfolio Palmtop PC Traveler*. The one-pound Portfolio has 128K RAM (expandable to 640K) and is sized to fit in a pocket, purse, or briefcase. Additional 32K, 64K, and 128K credit-card-sized memory cards are optionally available. The PC package includes built-in applications such as a Lotus 1-2-3 file-compatible spreadsheet, a basic text editor, an appointment calendar with reminder alarms, an address/phone directory, and a calculator (which will come in handy to tally the costs of all the optional add-ons!). Also included in the package is a PC-card drive, which connects the Portfolio to almost any personal computer through a controller card that slides into an empty expansion slot, essentially making the Portfolio part of the user's DOS-compatible desktop computer. With the PC-card drive, files from the credit-card-sized disks can be formatted, read, and written to directly from a desktop system. Files can also be downloaded onto the memory cards at high speeds. The Portfolio Traveler has a 63-key keyboard with an embedded calculator keypad and a supertwist LCD readout with 40-column by 8-line text mode and 240 x 64-pixel graphics mode. Three "AA" batteries provide power for six to eight weeks of typical use. Price: Portfolio PC, \$499; AC adapter, \$9.95; serial interface, \$79.95; parallel interface, \$49.95; 32K, 64K, and 128K memory cards, \$79.95, \$129.95, and \$199.95, respectively; DOS utilities card, \$89.95; leather carrying case, \$39.95.

CIRCLE 58 ON FREE INFORMATION CARD

Surround-Sound TV

To provide the theater experience at home, *Goldstar Electronics International Inc.* (1000 Sylvan Avenue, Englewood Cliffs, NJ 07632) is offering the *CMT-2702A*, a 27-inch color monitor/receiver that features a built-in Dolby Surround-Sound processor with rear-channel outputs and an MTS stereo-TV decoder with SAP and true dbx noise reduction. The system provides 10-watts-per-channel audio-output amplification feeding into four channels and a built-in, two-way, four-speaker system. Its horizontal resolution is better than 600 lines, and comb and SAW filters are included for improved image sharpness. Jacks are provided for S-VHS input and a variety of auxiliary audio/video inputs and outputs, as are external speaker terminals. The *CMT-2702A* also features a 181-channel random-access tuner with auto programming; a remote that's compatible with Goldstar's VCR's; an on-screen menu for channel, picture, and sound adjustments; favorite-channel scan; and a programmable on/off timer. What, no popcorn maker? Price: \$849.95

CIRCLE 59 ON FREE INFORMATION CARD

Personal Privacy

Even if your "sensitive" papers aren't as incriminating as those disposed of by Fawn Hall, you might not want any "dumpster divers" sneaking a look at your personnel records, confidential memos, pay-check stubs, or credit-card numbers. You can maintain your privacy at home or at the office (or in your home office) with the *model PS 30* compact paper shredder from *Fellowes Manufacturing Company* (1789 Norwood Avenue, Itasca, IL 60143). The shredder is designed to be kept next to your desk, perched atop a standard wastebasket. Weighing only 4½ pounds, the PS 30 is portable and can be carried in a briefcase for privacy protection on business trips (or vacations). Price: \$149.

CIRCLE 60 ON FREE INFORMATION CARD

For more information on any product in this section, circle the appropriate number on the Free Information Card.

ELECTRONICS WISH LIST

Pre-assembled Audio Rack System

Admit it: At least one of your close friends or relatives has trouble hooking up anything electronic that requires more than plugging in a power cord. *Soundesign Corporation* (Harborside Financial Center, 400 Plaza Two, Jersey City, NJ 07311-3962) took pity on those "all-thumbs" consumers, and came up with the model 63R63M factory-assembled audio rack system. The system features a cabinet that holds an AM/FM stereo receiver with three-band graphic equalizer, a dual cassette deck, a wireless remote control, and two cassette-storage compartments that accommodate 18 tapes each. Dynamic, two-way pedestal speakers match the cabinet. For adventurous sorts, the system includes front-panel jacks for stereo headphones and two microphones (not included). Otherwise, you can just take it out of the box and plug it in. (We can think of a few people who might not be able to handle even *that!*) Price: \$199.95

CIRCLE 61 ON FREE INFORMATION CARD



Soundesign Preassembled Stereo System

Remote-Operated CD Player

For those LP diehards who've decided—finally—to take the plunge and buy a CD player and some discs, but who don't want to be limited to listening to those expensive compact discs at home only, *Technics* (One Panasonic Way, Secaucus, NJ 07094) has introduced a CD player that's equally at home in the house, on the road, or on the jogging path. The ultra-slim *SL-XP300* weighs less than ¾-ounces (with batteries) and runs for up to 2½ hours on its two internal rechargeable batteries. It can also be powered via two "AA" alkaline batteries, the included AC adaptor/recharger, or an optional car adaptor. The *SL-XP300* comes with a credit-card-sized remote control, so that it offers the convenience you'd expect from a large, home component. The remote operates all the player's major functions and offers 10-key direct access to instantly select any desired track. The *SL-XP300* features 8-times oversampling, an 18-bit digital filter, a separate digital-to-analog converter for each channel, and the Extra Bass System for boosting low frequencies. The player also comes with headphones with a wired remote-control key, audio cables, and a carrying case. Price: \$249.95.

CIRCLE 62 ON FREE INFORMATION CARD



Technics Compact-Disc Player

Pager Phone

If keeping in touch, and in control, is vital to your job, *Universal Cellular, Inc.'s* (3365 Miraloma Avenue, Anaheim, CA 92806) *PagerPhone* can help. Combining cellular-phone technology and paging capabilities in one pocket-sized unit, the hand-held phone has a built-in alphanumeric pager that displays transmitted messages of up to 256 characters. When calls are received by the phone's pager, you can choose which calls are to be returned, and do so at your convenience. Because it does not have to be answered to receive a message, you don't have to pay for every incoming call. *PagerPhone's* exclusive *Universal Paging*, a nationwide roaming pager service, automatically forwards all incoming messages to the phone, anywhere in the country. Two hours of continuous talk time are provided by its 1200-milliamp-hour battery. Minimum standby time is 12 hours, but can be extended to 100 hours when the pager function is used to receive incoming calls. Other features include a highly sensitive, hidden antenna; two-touch speed recall of up to 90 names and numbers; a backlit display; a programmable alarm clock; durable slide-open case; and a menu for selecting functions. Not even Dick Tracy's watch did all that. Price: \$1895 (including pager activation).

CIRCLE 63 ON FREE INFORMATION CARD



Universal Cellular PagerPhone

ELECTRONICS WISH LIST

For more information on any product in this section, circle the appropriate number on the Free Information Card.



Fuji High-Capacity Diskette

More Byte for your Bucks

Extra-density 3.5-inch floppy disks from *Fuji Photo Film U.S.A. Inc.* (555 Taxter Road, Elmsford, NJ 10523) provide extra storage capacity for users who create large files on a regular basis. The *MF2ED* diskettes are compatible with the new 2.88MB disk drives, and store twice as much information as standard 3.5-inch double-sided high-density disks. The increased storage capacity is due to a barium-ferrite coating formula, which also guarantees accurate signal integrity and extends the life of the disk. The disks allow more data than ever to fit in your shirt pocket—which, conveniently, will contain a lot less money once you've purchased them. Price: \$137.90 per 10-pack.

CIRCLE 64 ON FREE INFORMATION CARD

Clock Radio

Any marriage counselor worth his fee will tell you never to go to bed angry at your spouse. But what if the fights start up again first thing in the morning—when the alarm rings? *Lloyd's Electronics'* (P.O. Box 2066, Aurora, IL 60507) *model CR105* is designed to put an end to marital discord (and occasional contusions) caused by "rollover:" when one person attempts to silence the alarm that's ringing on the opposite night stand. The result of "several years of intimate research," the *CR105* has a detachable speaker, to be placed on the second nightstand, that provides true stereo sound along with separate alarm and snooze features. The radio features an extra-large LED readout, so the person on the speaker-only side of the bed can still read the time: forward and reverse time and alarm settings; a power-failure indicator, and dual wide-range speakers. Price: \$49.95.

CIRCLE 65 ON FREE INFORMATION CARD



Lloyd's Electronics Clock Radio

Audio Power Amplifiers

The first audio power amplifiers to use a new semiconductor output device called the insulated gate bipolar transistor, or IGBT (pronounced IG-BIT) are available from *InConcert* (Division of Threshold Corporation, 7325 Roseville Road, Sacramento, CA 95842) and include the stereo *Forte Model 4*. In the amplifier's proprietary circuitry, IGBT's combine the high-input impedance and wide bandwidth of MOSFET's with the high-current capability of bipolar transistors. Driven by *Forte's* front-end amplifying circuits, the devices provide performance said to approach that of the parent company's renowned *STASIS* amplifier technology. A single-ended Class-A FET/bipolar cascode circuit serves as the front end, and the entire amplifier is DC coupled from input to output. That approach is said to preserve phase integrity and to contribute to the high-output damping factor across the audio band. The *Model 4's* power output is 50 watts per channel. Price: \$1795.

CIRCLE 66 ON FREE INFORMATION CARD



InConcert Power Amplifier

Keyboard Organizer

If your computer stand looks anything like ours do, you're in deep trouble. *Curtis Manufacturing Company* (30 Fitzgerald Drive, Jaffrey, NH 03452) has something to help less-than-neat computer users. The *Keyboard Organizer*, which will also delight the compulsively tidy, completely surrounds the keyboard (including IBM and Macintosh extended keyboards) and serves as a disk holder, keyboard cover, mouse garage, palm rest, and copy holder. As an organizer, it provides slots for holding eight diskettes, plus compartments for pens and pencils, paper clips, and a memo pad. Space has been left under the *Keyboard Organizer* for storing a standard-size mouse pad. A clear plastic cover protects the keyboard from dust and debris and easily converts into a copy holder. The padded, full-length palm rest provides wrist support. Price: \$39.95.

CIRCLE 67 ON FREE INFORMATION CARD



Curtis Keyboard Organizer

A Telephone-Operated

It seemed that every time I needed to work on my computer at home, the files I needed were usually on the hard drive at work. The problem was that the office computer was always off at night and during the weekends, so there was no way to download the information. I thought about leaving the office modem and console running overnight, but the wear and tear on the unit running for long periods of time seemed too much.

During one of my Saturday 30-minute drives to the office to work on the office computer, I realized that what was needed was a simple way to turn on the office modem and computer from a remote location. Then, using the right communications software, I could either remotely operate the office console from my home computer or simply download the needed files. Dubbed *Access III*, the simple circuit that follows allows you to do exactly that. The circuit is inexpensive, simple to build, and easy to operate.

About the Circuit. Figure 1 shows a schematic diagram of *Access III*. The circuit is basically a telephone-tone decoder that produces a binary code, which then can be used to remotely activate 117-volt AC devices individually using a tone code that's transmitted via the telephone line. Although the circuit shown will handle three power switches, only two would generally be required for most remote computer applications. However, some offices (or homes) might use an external hard-disk drive; the third switch could be used to apply power to that unit.

Access III is built around a SSI-202 telephone-tone decoder IC. The tones required by *Access III* are available at the speaker terminal of the average answering machine that has been set to the "call monitor" mode. *Access III* is connected to the answering machine speaker through a small coupling capacitor and a short length of shielded cable.

In order to activate the office com-

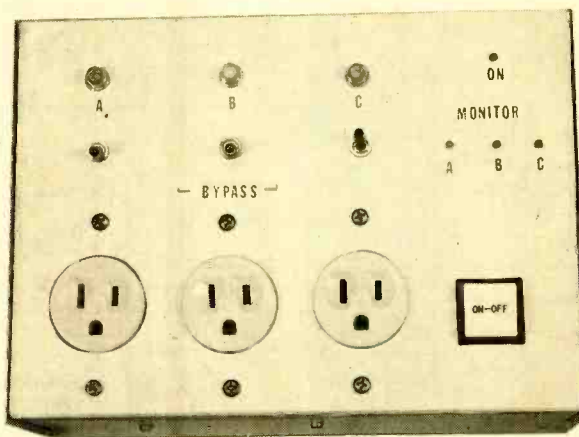

Power Switch for your Computer

*This simple project can
save you many a weekend
trip to the office to retrieve
data from, or do work on,
your office computer*

BY JIM STEPHENS

puter and modem from a remote location, the call is taken by the answering machine, which is set to answer the phone on the third or fifth ring. When the message recorder starts, you simply press the code that activates the modem followed by the code that activates the computer, and then hang up. The computer's boot-up disk must contain an auto-execute batch procedure that loads a communications program preset to automatically enter the answer mode.

The communications program must be instructed to avoid menus and go straight to the connect modem—a fairly simple task with a good program and a Hayes compatible modem. The

modem switches must be set to answer the phone on the first ring. A second call is then made by the communications program from the remote location to the now-ready office computer to establish the communications link.

The main player in that data link is the tone decoder, which accepts the DTFM tones (available from the speaker terminals of the answering machine), and converts (decodes) that signal, producing a binary output that's sent to U3 (a 74175 quad D flip-flop). Each time U1 receives a valid tone, a positive pulse is produced on the DAV (Data Available) line at 14. The DAV pulse is inverted and delayed by a pair of NAND gates, U2-a and U2-b.

That negative transition is used by U3 as the clock pulse to latch the data from U1. The output of U1 could be decoded into sixteen bits, but since all sixteen combinations are not needed, you will not have to go to that extra effort and expense. The \bar{Q} outputs of U3 are then sent to three optoisolators/couplers (U4-U6) that are used to activate three 4-amp Triacs (TR1-TR3). The Triacs control the power to the modem and computer console.

It should be noted here that the computer monitor of the remote (office) computer does not have to be activated. Actually, it is better that the computer monitor be left off; like home television sets, they can and do sometimes cause fires.

The decoder circuit produces a separate high output for the DTMF tones, 1, 2, 4, and 8. Actually, all numbers on the touch pad are recognized, since all other numbers and symbols on the keypad are simply combinations of those four lines. So, if the modem was connected to channel 1, sending a 1 DTMF tone would activate the modem. If the computer was connected to the channel 2 line, pressing 2 would turn off the modem and activate the computer.

That's undesirable; to get around that problem you have to press 1 first, wait a few seconds for the modem to initialize,

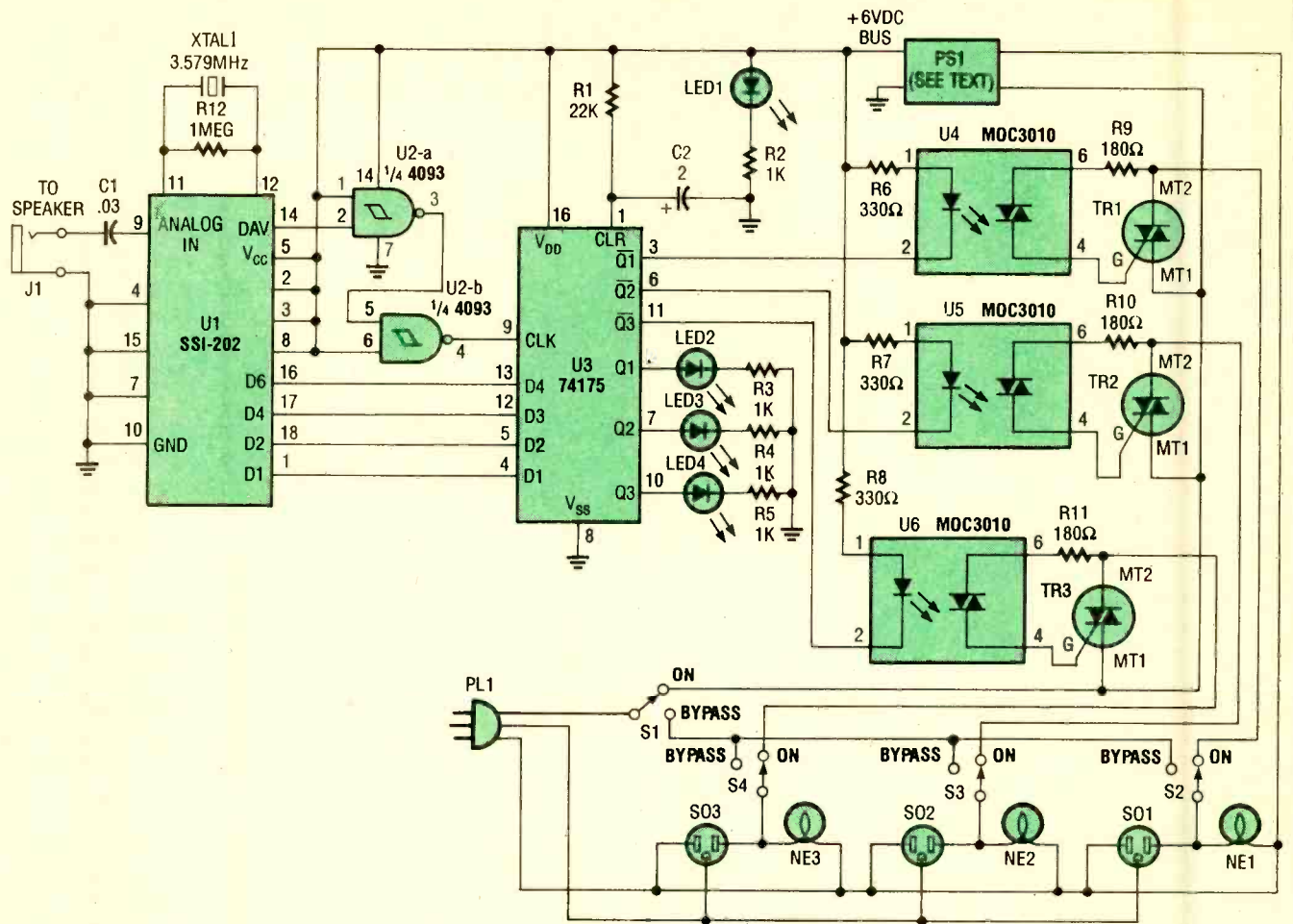

Fig. 1. Access III is essentially a telephone-tone decoder that produces a weighted binary output that is fed to D flip-flops, which are used to activate individual Triac circuits that apply power to the connected devices.

and then press 3 to leave the modem on and turn the computer on also. Pressing the 7 key would then activate the third channel, while leaving channel 1 and 2 on. All three channels should not be powered up all at once to minimize the surge on the line.

It is possible to decode several numbers that allow a code to be entered before the circuit can be activated. That would keep an unauthorized activation from occurring. That can get complicated and isn't really necessary because most remote-access programs include a password function that must be correctly entered before access is allowed.

False triggering due to noise on the line, or power-switch bounce could cause the latch to start with one or two of the channels already activated. So C1 and R2 have been added to the circuit to provide a delayed pulse at pin 1 of U3 when the decoder is first activated to prevent that condition.

Bypass switches (S2-S4) are included

in the circuit so that the equipment can be powered without having to disconnect power plugs from the circuit. In order for the bypass function to work, S1 must be placed in the bypass position. Then S2-S4 can be used to power up the desired device. Note that a neon lamp is connected in parallel with each socket. Those lamps indicate which socket has been activated. All switches can be neon lighted, but I chose separate neon indicators to save money on the switches.

Wiring the Circuit. Access III was built on two sections of perfboard; one section containing the decoder/latch portion of the project, and the other containing the optocoupler/Triac portion of the unit. Things were handled that way because the optocouplers and Triacs relate directly to the 117-volt lines and should be separated as much as possible from the low voltage components.

Caution: When working with a 117-

volt AC line, extra care is extremely important because house current can be dangerous to your health. If you are not experienced with high-current wiring, get help from someone more experienced.

Assemble the circuit guided by the schematic diagram in Fig. 1. The author used sockets for all of the IC's in the project; point-to-point wiring was used to interconnect the board-mounted components. Begin assembly by mounting the IC sockets to the board, and then wire the support components to the sockets. In the case of the optoisolator/coupler board, make sure that the connections between each Triacs' main terminals (MT1 and MT2), the receptacles, and the bypass switches use well-insulated, heavy, stranded, 12-gauge wiring, and all solder connections for those lines should be insulated with heat-shrink tubing.

The project should be housed in an all-metal case for safety. Note that the case should **not** be connected to the

ground wire of the 117-volt line. If your computer manual states that your computer should not be activated from a plug strip or surge protector, the power connections may be made at the computer switch terminals. You can check your manual for such requirements.

The power receptacles, SO1-SO3, should be standard, single-outlet, polarized, three-terminal, 15-amp AC types. Pay particular attention to the polarized wiring on the receptacles as it relates to the plug, PL1. The large holes on the receptacles go to the large prong on the plug. That keeps the system's common lead common. Since the output is capable of handling three devices, the power cord from the plug should be a heavy-duty, three-wire cord. Switch S1 must be connected in the line going to the small prong (the "hot" wire).

The Decoder Power Supply. Rather than build a complete power-supply circuit for the small amount of current needed by the decoder/latch circuit, the author opted to use a small 6-volt, 150-mA DC adapter. The adapter provides several times the power needed by the decoder/latch circuit. Use a VOM to make certain of the polarity of the wires before making the power connections to the decoder/latch board. A reversed connection to that section can damage the IC's.

Note that the ground lead from the adapter is shown as system ground. Only the low-voltage circuitry is grounded via that lead. The 12-volt circuit does not connect to the 117-volt AC ground in any way and should not be tied to the case.

In order to avoid yet another wire dangling from the case and another plug to plug in, the adapter was installed within the decoder case and wired directly to the main AC leads (which are wired to the Triacs and receptacles). That allows the decoder/latch circuit to be activated via S1. The small amount of heat produced by the adapter is no problem and is easily dissipated by the metal case.

Answering Machine Connection. Only two wires connect to the answering machine: One wire comes from the decoder's analog-in terminal and the other is the low-voltage ground. If the distance from the answering machine to the decoder is over two feet, that connection should be made through

PARTS LIST FOR THE ACCESS III

SEMICONDUCTORS

- U1—SSI-202 DTMF tone decoder, integrated circuit
- U2—4039B quad 2-input CMOS NAND gate, integrated circuit
- U3—74175 quad D flip-flop with clear, integrated circuit
- U4-U6—MOC3010 Triac-driver optoisolator/coupler, integrated circuit
- TR1-TR3—6-amp, 400-PIV Triac
- LED1—Miniature red LED
- LED2-LED4—Miniature green LED

RESISTORS

- (All fixed resistors are 1/4-watt, 5% units.)
- R1—22,000-ohm
 - R2-R5—1000-ohm
 - R6-R8—330-ohm
 - R9-R11—180-ohm
 - R12—1-megohm

ADDITIONAL PARTS AND MATERIALS

- C1—0.03- μ F, ceramic-disc capacitor
 - C2—2- μ F, 16-WVDC, electrolytic capacitor
 - J1—Phono jack
 - NE1-NE3—Neon lamp
 - SO1-SO3—117-volt 3-terminal AC socket
 - PL1—117-volt 3-terminal molded AC power plug with line cord
 - PS1—6-volt DC wall adapter
 - S1-S4—SPST switch
 - XTAL1—3.579-MHz colorburst crystal
- Perfboard materials, metal enclosure, wire, solder, hardware, etc.
- Note:** The SSI-202 DTFM tone decoder may be ordered for \$12.00, plus \$2.00 shipping and handling, from Syntronics, 2143 Guaranty Drive, Nashville, TN 37214; Tennessee residents please add 7 1/2% sales tax.

small-diameter, shielded, phono cable to minimize AC hum and RF pick-up, which could cause tone distortion and unreliable operation.

The answering machine case will need to be opened and a small phono jack installed that connects to the existing two speaker leads inside the case. Another phone jack in the decoder case accepts the other end of the cable.

There are other methods of automatic answering of the phone, but those get somewhat complicated and can be expensive if certified equipment is used to detect the ring and take the phone off-hook. I've seen several circuits of that type that use a neon bulb that activates a light sensitive diode and relay.

If you don't want to open up the office answering machine, it is possible to simply connect the tone through a small mike and op-amp. You could experiment on your own if an answering machine is not available, but the use of a certified answering machine as described simplifies the installation procedure and is a very reliable way of making that connection.

Turning the Computer and Modem Off.

The need to power down the modem and computer is just as important as turning it on. That's done by hanging up and calling the number back and pressing the 8 key on the telephone keypad. The tone produced by the 8 key places a high at the cathodes of the optoisolator/coupler internal LED's, thereby deactivating the optocouplers. That, in turn, removes the gate trigger from the Triacs, so that on the next transition of the AC waveform, the Triacs are deactivated. And that results in power being removed from the sockets and, by extension, the devices connected to the sockets.

That can be difficult since your decoder circuit is connected to the answering machine which no longer will get to answer the phone if your modem is answering on the first ring. You must instruct your modem by way of the Hayes "AT" software commands (while the computer is running) that you do not want it to automatically answer. The command for this is ATSO=O\$Od. There are several ways that this can be accomplished. Here's how I do it: I use Bitcom as my communications program, but others will work fine since many have the same file and switch capabilities.

The remote location's modem auto-answer switch is set to the "no auto-answer" position. The program must switch the modem over to automatic answer when it boots up. As stated previously, the autoexec.bat file at the start of the procedure begins by loading an automatic answer file that avoids the menus and goes directly to the connect mode with the automatic answer feature selected for the modem.

When you hang up the phone on your end of the communication link, the modem will use a hang-up string that resets the modem back to the switch settings. The modem will now not answer when the phone rings, and the answering machine will allow you to enter the power-down code. Press an 8

(Continued on page 82)

As the saying goes, the only two things in life that are certain are death and taxes. The field of electronics supports that adage. Electronics is filled with numerical uncertainties—values that may fall anywhere within a limited range.

Normally a circuit's lack of precision components have little effect on its operation. Indeed, most circuits are designed to tolerate variation. Even the most cautiously designed network, however, can be crippled if deviations from nominal specifications add up.

One of the largest sources of uncertainty is the variation between component values; no two are exactly the same. Of all the 1000-ohm resistors you've ever used, probably none of them were exactly 1000 ohms. They may have been so close that your meter registered 1000, but more sensitive equipment would have shown a deviation.

Variations between component values are not the only culprits. Other causes of uncertainty in electronics include uncalibrated meters, imperfectly regulated power supplies, induced electrical noise, and even environmental effects such as temperature and humidity.

Armed with even a limited knowledge of how to deal with uncertainties in calculations, you can identify potential problems and eliminate them. This awareness can also be a great asset when selecting component tolerances (e.g. you'll know when to use a 5% resistor and when to spend the extra few cents for its 1% counterpart).

This article presents a basic overview of how uncertainties should be dealt with for the four primary mathematical operations: addition, subtraction, multiplication, and division. While discussing the four basic operations, the article will demonstrate a generic methodology that can be used to determine how uncertainties should be handled in more complex operations. Before we get to all that, though, a short discussion of the notation used for uncertainties is in order.

Uncertainty Notation. As you're probably aware, numbers with uncertain values can be written as a series of three separate numbers: a target or nominal value, a maximum deviation above nominal, and a maximum deviation below nominal. Because the two deviations are generally the same

DEALING WITH UN

BY JAMES E. TARCHINSKI

in magnitude, only two numbers are usually listed.

For example, let's return to the hypothetical 1000-ohm resistor mentioned earlier. If it were a 5%-tolerance component (signified by a gold fourth color band), its value could be listed as 1000-ohm $\pm 5\%$. That indicates that the component's actual resistance can vary from 1000 ohms by up to 5% in either direction. Because 5% of 1000 is 50, the resistor may actually be anywhere from 950 to 1050 ohms.

Note that the deviation from nominal are usually given as either a percentage (1000 $\pm 5\%$), but can be specified as an absolute magnitude (1000 ± 50).

Addition and Subtraction. Assume two resistors are connected in series, the first a 5% component with a nominal value of 820 ohms and the second a 10%, 360-ohm element. The network's nominal resistance, from the top of the upper component to the bottom of the lower one, would then be 1180 ohms.

The highest possible total resistance would occur if both components were at the upper end of their tolerance bands. True resistance values would then be 861 and 396 ohms, respectively, and the total circuit resistance would therefore be 1257 ohms. Finally, the actual circuit's deviation from its designed value would be 77 ohms. Clearly, the total deviation of 77 ohms is the sum of the absolute deviations for the two individual components, 41 and 36 ohms.

Now let's apply the above procedure to the subtraction operation. Figure 1 shows a segment of a larger circuit, in

which the current through a resistor is dependent on the exact values of two independent current sources. By Kirchoff's current law, the current through the resistor (I_r) is the difference between I_1 and I_2 ; that is:

$$I_r = I_1 - I_2$$

We would expect I_r to have its largest value if I_1 and I_2 were at the upper and lower ends of their respective tolerance bands. Let's say they have a tolerances of ± 50 mA and ± 25 mA respectively. So:

$$I_1 = (750 \text{ mA} + 50 \text{ mA}) = 800 \text{ mA}$$

and

$$I_2 = (200 \text{ mA} - 25 \text{ mA}) = 175 \text{ mA}$$

the calculation of I_r yields a result of 625 mA. The actual current flowing through the resistor would therefore be 75 mA greater than the target rate of 600 mA. We conclude that the current through the resistor is 600 mA ± 75 mA.

From the results of these two thought experiments we can infer a standard rule: When adding or subtracting two numbers, the total nominal value is the

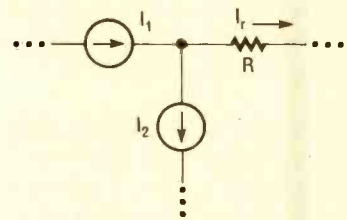

Fig. 1. The uncertainty of component values leads to uncertainties in the values of current through a circuit. The overall uncertainty can really add up.

The tolerance of components can lead to design errors. Learn how to determine when tight component tolerances are needed with this quick tutorial.

CERTAINTIES

sum or difference of the two original values; the uncertainty of the result is the sum of the absolute magnitudes of the two original uncertainties.

Multiplication and Division. With a general rule for addition and subtraction under our belts, we now turn our attention to the more complex operations of multiplication and division. Since multiplication and division have the same relationship to each other as addition and subtraction (they are algebraic inverses of one another), we might expect a single rule to cover both multiplication and division. That does turn out to be the case, so we will therefore only consider multiplication in detail.

Assume P is the power dissipated by a resistor in a direct-current (DC) circuit. The power is the product of the current (I) through the resistor and the voltage (V) across it. If $I = 16 \pm 2$ amps and $V = 20 \pm 5$ volts, the nominal value of P is 320 watts. The power will deviate furthest from this value when both the multiplier (V) and multiplicand (I) are at the upper limits of their ranges. In that case, P is 450 watts. The difference be-

tween the two 130, or 40.625% of the nominal value.

To obtain a minimum value for the component's power both V and I must be at the lower ends of their respective ranges. The calculation becomes:

$$P = 15 \times 14 = 210 \text{ watts}$$

which is 110 (34.375%) below nominal. Unlike addition, the multiplication operation produces asymmetric (read that unequal) positive and negative uncertainties. A mathematical purist would be forced to indicate separate positive and negative tolerances. Those of us who can afford to lose some accuracy, however, can make an approximation of the uncertainty of the final result.

Averaging the two deviations comes to mind as a good method. When that is done, in both the absolute and percentage forms, the averages are 120 and 37.5%. From that it is easy to see that an approximation for the final uncertainty is just the addition of the percentage uncertainties of the multiplier and multiplicand.

By performing a similar analysis for division it can be shown that the same result applies. Hence we can write a general rule for both operations: When the operation of multiplication or division is to be performed on two numbers, the uncertainty of the result is the sum of the percentage uncertainties of the two original numbers.

Example. Finally, to demonstrate the rules just derived, we'll calculate the total resistance of the series/parallel resistor network shown in Fig. 2. It is sug-

gested that you try this exercise on your own before reading the solution.

Assume the following component values:

$$\begin{aligned} R_1 &= 910 \pm 5\% \text{ ohms} \\ R_2 &= 560 \pm 1\% \text{ ohms} \\ R_3 &= 180 \pm 5\% \text{ ohms} \end{aligned}$$

Given those values, the parallel combination of R1 and R2 would yield a combined resistance of R_p where:

$$\begin{aligned} R_p &= R_1 \times R_2 / (R_1 + R_2) \\ &= (910 \pm 5\%) \times (560 \pm 1\%) \div \\ &\quad ((910 \pm 45.5) + (560 \pm 5.6)) \\ &= 509600 \pm 6\% / (1470 \pm 51.1) \\ &= 509600 \pm 6\% / (1470 \pm 3.476\%) \\ &= 346.7 \text{ ohms} \pm 9.476\% \\ &= 346.7 \pm 32.8 \text{ ohms} \end{aligned}$$

Of course, the last step in the calculation of R_t (the total equivalent resistance) is to add the resistance of R1 to the value of R_p just calculated:

$$\begin{aligned} R_t &= R_1 + R_p \\ R_t &= 180 \pm 5\% + 346.7 \pm 32.8 \\ R_t &= 180 \pm 9 + 346.7 \pm 32.8 \\ R_t &= 526.7 \pm 41.8 \text{ ohms} = 526.7 \text{ ohms} \\ &\quad \pm 7.94\% \end{aligned}$$

From this example we see how even rather small uncertainties can be amplified through repeated calculations. The tolerance of the total resistance network is nearly 8% even though the individual tolerances are 5% or less.

As mentioned in the introduction, normally this type of error "stack-up" will have a little effect on a circuit's operation. But armed with even the bounded knowledge presented here, you should be able to avoid any problems that may arise from uncertainty. ■

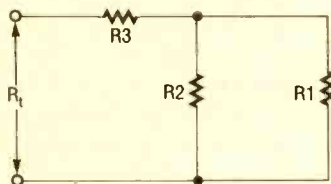

Fig. 2. This example resistor network should help clarify how tolerance values are affected by mathematical operations.

THE DIGITAL ELECTRONICS COURSE

MULTIPLEXED DISPLAYS

Multi-digit displays can add considerable cost to electronic equipment, but display multiplexing—a process by which the number of discrete components and IC drivers is reduced—can cut the cost to a minimum.

BY ROBERT A. YOUNG

The vast majority of seven-segment displays used commercially are housed in packages containing one or more individual digits (either common anode or common cathode), each configured for "direct drive." Direct drive means that each segment of each digit is provided with one terminal for connection to external driver circuitry. Such displays may be driven by a standard decoder/display driver (such as the 7447 and 7448 unit covered in a previous exercise).

However, when the number of digits in a display panel reaches four or more, the circuit becomes too complex, bulky, and expensive for direct drive—too many external connections and too many individual drivers are needed, which adds considerably to the cost.

To reduce the hardware needed to implement a four or more digit display a technique known as *multiplexing* is used. Multiplexing is accomplished using a special type of circuit known as (what else?) a multiplexer.

Multiplexer Basics. A multiplexer is actually a signal-selector circuit (like a multi-position switch) that allows what is best termed as a form of time sharing of

The Digital Microprocessor Course is reprinted here with the permission of the Electronic Industries Association/Consumer Electronic Group (EIA/CEG). The complete parts kit is available from EIA/CEG. For further information, contact EIA/CEG Product Services Department, 1722 Eye Street, NW, Suite 200, Washington, DC 20006; or call 202/457-4986.

current paths. Several signals are fed to the multiplexer and by using control inputs, the selected signal is made available at the output.

The concept of multiplexing can best be illustrated using a couple of single-pole double-throw switches, as shown in Fig. 1 (simplistic though it may be), where two input signals and two output devices share a single current path. For the sake of discussion, let's assume the A input signal is applied to switch S1 and switch S2 is connected to the A output device. After a period, the control sig-

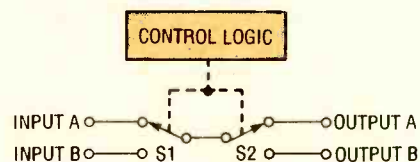

Fig. 1. To reduce the hardware needed to implement multi-digit displays, a technique known as multiplexing is used. A multiplexer is actually a signal selector circuit (or multi-position switch) that allows a form of time sharing of current paths.

nal causes both S1 and S2 to toggle to the B positions, passing the B input signal to the B output device. Display multiplexing requires slightly more complex circuitry to reduce the number of connections to the display, however the concept is pretty much the same.

Display Multiplexing. Multiplexed, multiple-digit displays require special decoder/drivers. Such drivers connect all like segments of each digit in parallel, forming a matrix of seven segment by N (N being the number of digits in the display).

The task of the multiplexed decoder/driver is to logically select the appropriate segments and digit of the display, illuminating each at the proper time. Only one digit is actually activated at a time, however, due to the rapid switching action—sequential strobing—of the multiplexed decoder/driver, all digits appear constantly on.

A block diagram of a generic multi-digit display with multiplexed seven-segment decoder/driver is shown in Fig. 2. The multiplexer consists of a decoder (which accepts a 4-bit BCD input), segment drivers (which either sink or source current to light the LED segments), digit-drivers (that, like their counterparts, the segment drivers, either sink or source current), and the control-logic circuit (that controls the multiplexer's switching). Note that the multiplexer provides only one set of segment drivers and

*Our gratitude is extended to the EIA/CEG for the creation of this course, especially to the consultants who brought it to fruition: Dr. William Mast, Appalachian State University; Mr. Joseph Sloop, Surry Community College; Dr. Elmer Poe, Eastern Kentucky University.

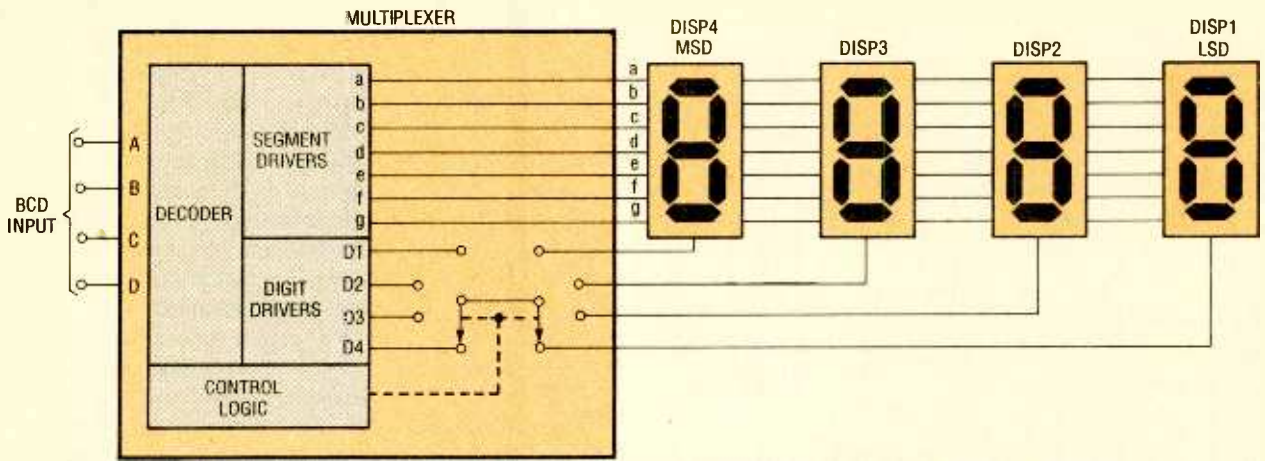

Fig. 2. This generic multiplexer consists of a decoder, segment drivers, digit-drivers, and a control-logic circuit.

that all like segments are tied together.

When a valid BCD input is received, it is decoded and fed to the driver circuits. Let's assume that 1111 (decimal 15) is applied to the BCD input of the multiplexer. Ignoring the decimal point, decimal 1 (the most-significant digit or MSD) is placed on the segment lines. The multiplexer activates DISP4 for a set period of time. And after that time has elapsed, the segment drivers output a signal to produce a decimal 5, while the control logic activates the second MSD (DISP3).

The control logic then returns to the first position again lighting the first digit with a 1, and then switches back to the second MSD, displaying a 5. The actual switching takes place so fast that eye does not detect any blinking. The multiplexer may also include circuitry for the positioning of a decimal point (which is not included in our example, but positioning is handled in pretty much the same manner as the digit drivers).

Timing is Key. In all multiplexing operations, timing is critical; if, for instance, data intended for the most-significant digit is on the segment outputs, but the least-significant digit (LSD) is activated, or the control logic is in the process of deactivating the LSD and activating the MSD, it's obvious that you'll get an incorrect readout.

Many multiplexing circuits come equipped with an internal clock generator, and require a minimum of external components to set the proper clock rate (often nothing more than a resistor or two, a couple of capacitors, and a crystal to stabilize the clock frequency). Such all-encompassing IC's have gained in popularity in recent years. In fact,

with the advent of large-scale integration (LSI), it is quite common to find complete systems of many types packaged in a single chip—Intersil's ICL7107 3½ digit, single-chip A/D converter, for example.

The ICL7107—a pinout diagram of which is shown in Fig. 3—contains seven-segment decoders, display drivers, a reference, and a clock circuit. That low-power, high-performance chip boasts a guaranteed zero reading for a 0-volt input, true polarity at zero for precise null deflection, a typical input current of 1 pA, direct-display drive capabilities (no external limiting components are required) low noise (less than 15 μ V peak-to-peak), and low power dissipation (typically less than 10 mW).

PARTS LIST FOR THE DEMONSTRATION CIRCUIT

RESISTORS

(All resistors are ¼-watt, 5% units, unless otherwise noted.)

- R1—24,000-ohm
- R2—47,000-ohm
- R3—100,000-ohm
- R4—1000-ohm trimmer potentiometer
- R5—1-megohm

CAPACITORS

- C1—0.1- μ F, ceramic-disc
- C2—0.47- μ F, ceramic-disc
- C3—0.22- μ F, ceramic-disc
- C4—100-pF, ceramic-disc
- C5—0.01- μ F, ceramic-disc

ADDITIONAL PARTS AND MATERIALS

- U1—ICL7107 3½-digit A/D converter, integrated circuit
- DISP1—Common-anode display, see text
- Breadboard materials, \pm 5-volt power supply, low-voltage variable power source, voltmeter, etc.

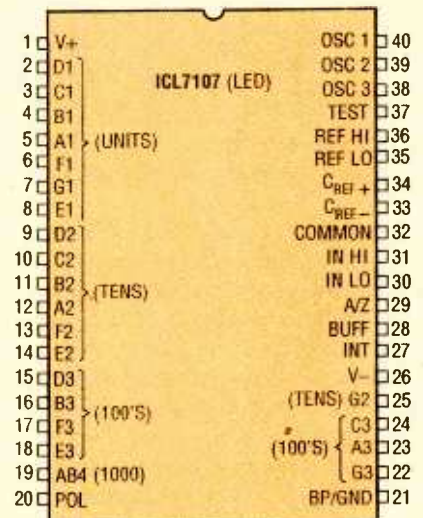

Fig. 3. The ICL7107 contains seven-segment decoders, display drivers, a reference, and a clock circuit.

Operational Characteristics. Each measurement cycle of the ICL7107 is broken down into three phases: auto zero (A-Z), signal integrate (INT), and de-integrate (DE). During the auto-zero phase three things happen: input high and low (pins 31 and 30, respectively) are internally disconnected from their external pins and shorted to analog common (pin 32); the reference capacitor (connected between pins 33 and 34) is charged to the reference voltage; and a feedback loop is closed around the system to charge the auto-zero capacitor to compensate for offset voltages in the ICL7107's internal buffer/amplifier, integrator, and comparator. Since the comparator is included in the loop, the auto-zero accuracy is limited only by the noise of the system. In any case, the offset referred to the input is less than 10 μ V.

Display Multiplexing Exercise.

Figure 4 shows a typical application of the ICL7107 3½-digit, single-chip A/D converter. That circuit is a simple voltmeter capable of readings of from 0–2 volts, and will serve to demonstrate the concept of multiplexing. Note that our demonstration circuit uses only two components (R3 and C4) to set the IC's internal oscillator, while C1 is used as a reference capacitor.

The display for our circuit consists of four common-anode display modules (we used whatever was on hand) with the anodes of each tied together and connected to the +5-volt bus. The individual segment of each module is then connected to the appropriate segment driver. (You will note that this circuit differs slightly from the description above. That's because our circuit is designed to use the cheaper direct-drive display modules, rather than a multiplexed display. However the basic concept is the same.)

When breadboarding the circuit shown in Fig. 4, it will be necessary to provide a negative (–) 5-volt power source in addition to the +5-volt source that has been used throughout this series. You'll also need a low-voltage power supply and an accurate voltmeter to adjust the circuit for the proper readout.

Breadboard the circuit that is shown in Fig. 4, and connect the voltmeter and power source across the input of the circuit. With a 0-volt input the circuit should give a 0-volt reading. If not, adjust potentiometer R4 until a 0-volt reading is obtained.

Now bring the power supply voltage up to 1-volt as indicated on your voltmeter readout. If the demonstration circuit gives the proper response, vary the power supply voltage while observing the readout of the demonstration circuit. If not, re-adjust R4 for the proper readout. The demonstration circuit's readout should vary accordingly; *i.e.*, count up or down.

Our demonstration circuit can be expanded to read voltage many times its basic 2-volt range by the addition of a resistor voltage-divider network and a range switch, providing a useful piece of test equipment. For those who wish to take the basic circuit a step further, select the resistors in the divider network to provide decade steps. In other words, since the basic range of the circuit is 2 volts, the next higher ranges should be 20 volts, 200 volts, 2000 volts, and so on. ■

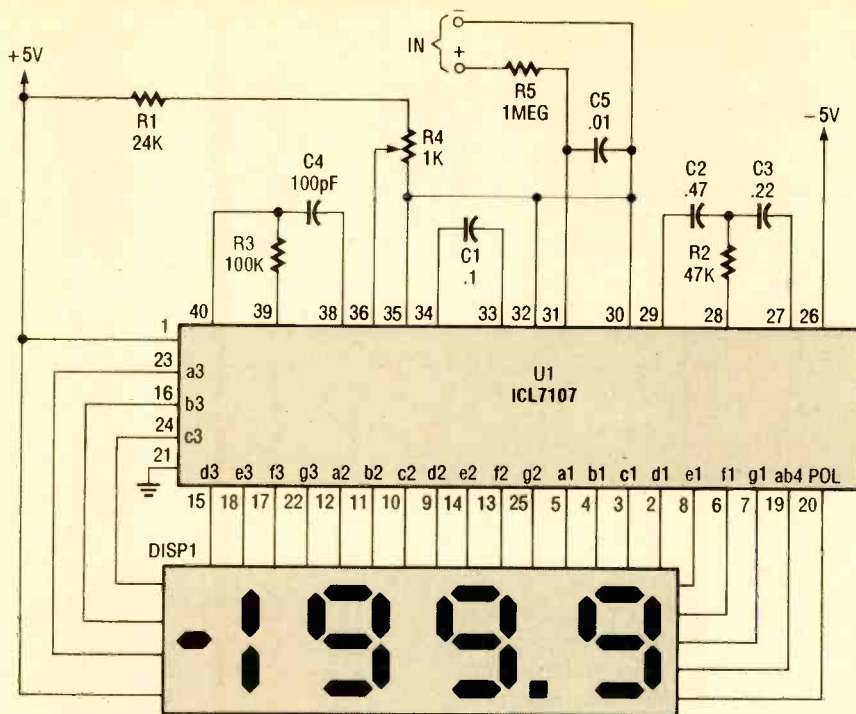

Fig. 4. The ICL7107 3-1/2-digit single chip A/D converter can be used as the basis of a simple voltmeter capable of readings of from 0–2 volts.

During the signal-integrate phase of operation, the auto-zero loop (initiated during the auto-zero phase) is opened, the internal short (to analog common) is removed, and the high and low inputs are reconnected to their respective pins. The converter then integrates the differential voltage—which can be within a wide common-mode range (within 1 volt of either supply)—between pins 30 and 31 for a fixed time. If, on the other hand, the input has no return with respect to the converter power supply, input low can be tied to analog common to establish the correct common-mode voltage after which the polarity of the integrated signal can be determined.

In the final phase, deintegrate (or reference integrate), input low is initially connected across analog common and input high is connected across the previously charged reference capacitor. Circuitry within the chip ensures that the reference capacitor is connected with the correct polarity to cause the integrator output to return to zero.

For critical applications the integrator swing can be reduced to less than the recommended 2-volt full-scale swing with little loss of accuracy. The integrator output can swing within 0.3 volt of either supply without loss of linearity.

The differential reference voltage can be generated anywhere within the power-supply voltage of the converter.

The main source of common-mode error is a roll-over voltage caused by the reference capacitor losing or gaining charge due to stray capacitance at its nodes. If there is a large common-mode voltage, the capacitor can gain charge (increase in voltage) when called upon to deintegrate a positive signal, but lose charge (decrease in voltage) when called upon to deintegrate a negative input signal. That difference in reference for a positive or negative signal voltage gives a roll-over error. However, by selecting—in comparison to the stray capacitance—a large reference capacitor, the roll-over error can be held to less than 0.5 of the count for the worst-case condition.

Analog common (pin 32) is included primarily to set the common-mode voltage for battery operation, or for any system in which the input signal is floating with respect to the power supply. Pin 32 sets a voltage that is about 2.8 volts more negative than the positive supply voltage, which is selected to give a minimum end-of-battery-life voltage of about 6 volts. However, pin 32 has some of the properties of a reference voltage. When the total supply voltage is large enough to cause the ICL7107's internal Zener diode to regulate, the common voltage will have a low-voltage coefficient, a low output impedance, and a temperature coefficient of less than 80ppm/°C.

**A
Hands-on
Electronics
REPORT**

AutoCommand Plus Remote Car Starter

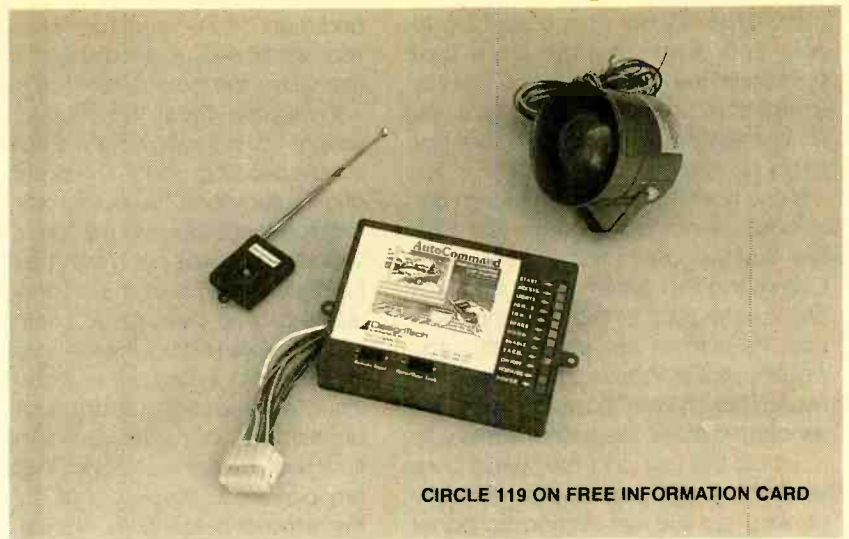

CIRCLE 119 ON FREE INFORMATION CARD

Start your car while in your home and have the motor and interior's climate ready for your quick getaway in any weather.

One cold day this past January, I walked into the kitchen on Monday morning, pressed a button on a mini-module attached to my keychain, and sat down to enjoy a hot breakfast. As I looked out the window at the 3 inches of new snow on the lawn, I saw my car standing in the driveway with plumes of white mist emanating from the tail pipe—the motor was running! As the car heated up, hot air from the defroster would clear the windshield glass and the car's interior would be comfortably warm.

You guessed it; That module on my keychain was a transmitter that triggered a device installed in my car to automatically start it. Not only is it a great gadget for winter warmups, in the summer, when the car's interior gets up to 160°F in the hot sun, I can start the motor and the air-conditioning system will make the passenger compartment's temperature comfortable.

The device that makes all this possible is called the AutoCommand Plus Remote-Control Car-Starter System. AutoCommand Plus allows anyone to start a car using a match-book size, keychain transmitter from up to 400 feet away, plus it gives the owner the ability to activate the air conditioner, heater, and defroster (although those must be left on when the car is shut down). AutoCommand Plus ends the winter ritual of scraping ice, defrosting windshields, and shivering in your cold

car while waiting for it to warm up. The benefits for those in the "Sun Belt," who swelter in a sun-baked car at start-up time, need no further explanation.

There are many features packed into the AutoCommand Plus system. For example, it will only start your car when it's in park, and only if the engine hood is closed. Also, it will attempt to start the engine for up to 8 seconds, but no longer, to avoid overheating the starter motor.

To prevent theft, when AutoCommand Plus is in control it will automatically shut off the engine when the brake pedal is pressed, the hood is opened, the accelerator (gas) pedal depressed, or the transmission is removed from park. Basically, after remote starting, your car cannot be driven without a key in the ignition.

Those protection measures are overridden when the ignition key is inserted and rotated to the run position. The engine will automatically be shut off after 10 minutes if no key is put into the ignition and placed in the run position. The engine will also be turned off should it stall or drop below 400 RPM.

For safety and convenience while walking to your car, AutoCommand Plus keeps your headlights on to let you know the car is running, if desired. In fact, it may be used in conjunction with most remote alarm systems. If the installer uses a remote alarm system, either a positive or negative output from

the alarm system can be used to trigger the AutoCommand Plus car starter. There's even a valet switch that lets you turn the AutoCommand off when you don't want anyone else using it.

There are a few restrictions: AutoCommand Plus can only be installed in cars equipped with fuel-injection, an automatic transmission, and a 12-volt negative-ground electrical system.

Some Technical Details. The AutoCommand Plus system's radio/control circuit is an RF system that uses a factory-set coded-audio technique. Of course, the system is FCC approved. The transmitter uses a standard 6-volt alkaline battery available at camera stores (or through DesignTech International, Inc.) that should be replaced once a year.

In the unlikely event that another nearby radio/control system has the same transmitter keying as your car-starting system, you can change the system's operating frequency by snipping selected colored wires in the transmitter and receiver. The installation manual also describes the procedure for changing the factory-set user code. To do so you just snip one of three different-colored wires in the receiver and a corresponding wire in the transmitter.

Easy Installation. You should begin by very carefully reading the AutoCom-

mand Plus manual from beginning to end and examining the parts that come with the AutoCommand Plus car starter kit as you read. This will give you an understanding of the work that has to be performed.

If you have little experience with automobile electrical systems, you may feel that the task of installing the AutoCommand Plus system is too formidable. You shouldn't let those feelings stop you. Its built-in self-diagnostic capability, makes installing the AutoCommand Plus System easy for even the amateur installer. The system constantly monitors the unit and the wiring connections. If all the wires are correctly hooked up, the self-diagnostic panel indicators will all light-up. If something is not connected correctly, the corresponding indicator will not go on. What could make installation easier and more goof-proof? If the unit ever fails to operate, just look at the lights on the self diagnostic readout panel to find out precisely what went wrong.

However, to help you in first wiring the unit, you should obtain a service manual from the car's manufacturer since it will point out the location of the electrical cables that you have to tap into. Your local library may have manufacturers' repair manuals; if so, you can either borrow them or just copy pertinent pages.

Since auto wires are color-coded, and the manuals contain both color and position information, you'll probably find each wire on your first try. When you find a wire you will have to tap into, attach a piece of masking tape to it

and mark it for easy identification later. That will speed-up electrical connection when the actual hook-up begins.

If you are 4-foot, 8-inches tall and weight 95 pounds, you will have no trouble working under the dashboard of an automobile. The author has much larger dimensions and my Ford Crown Victoria's size was not much help. Fortunately, removal of the steering-column's plastic decorative casing will expose about half of the wires you'll be tapping into. In any event, if you have trouble squeezing underneath the dashboard, consider removing the front seat. Bucket seats, even those that are powered, usually come out after the removal of four bolts. Any electrical connections can be separated at the snap-in connectors. Place an old blanket or canvas on the flooring to avoid accidental scratches from the sharp exposed metal, if any.

Your biggest problem may be finding a good site to mount the control unit. Remember that you will want to see the LED indicators in the unit during installation, or for troubleshooting purposes at a later time. For large cars, that is not a major problem. Cars with a console between the two front seats provide lots of unused space after removing a few screws and panels. Real small, tight cars can present problems to the neophyte installer, but they can be overcome.

Refer to the AutoCommand owner's manual to begin the hook-up. The preparatory work already described will make the job faster and fun to do.

The receiver for the AutoCommand Plus system goes under the hood. Fol-

low the instructions carefully, especially when placing the black antenna wire. Do not cut that wire, its exact length is critical. The operation of the receiver can be checked using the transmitter and a voltmeter. In some instances, the electrical noise from the engine may simulate an "off" signal to the receiver. Should that happen, instructions are provided to cure the problem. Note that if there is excessive electrical noise under your hood, your car may be in need of a tune-up.

Now begin hooking up the control unit under the dash. The author used Velcro strips and a long plastic tie to secure the control unit so that the control unit can be dropped quickly and the LED indicators can be examined to locate the fault in the event trouble should occur long after the installation is completed. Again, follow the manual carefully to install the unit and recheck your work.

Once the wiring is complete recheck your work carefully and then start the car using the precautions discussed in the manual. The engine should start and run. If so, the basic installation is complete.

Added Options. There are some built-in options the installer can take advantage of by connecting one wire per option. For example, if you connect one light-yellow wire from the unit to the car's low-beam headlamps, the headlamps will come on when the Auto command starts the engine. The light will go off when the car's engine stalls or times out (after ten minutes), or when the ignition key is inserted and rotated to the "run" position.

Connecting a dark-blue wire makes the car horn beep when the radio signal has been received. That's a plus when you can't find your car in a stadium parking lot after a game. If you don't need that feature, you instead can connect that wire to the door lock/unlock circuit, if your car has one, to permit you to remotely unlock your car door next time you must dash through the rain.

Still another hookup, an orange wire that goes to the brake circuit, will disable the AutoCommand Plus system and shut the motor off when the key is not in the ignition switch and the brake pedal is depressed. Anyone attempting to drive away in your car will be disappointed.

There is one additional feature you
(Continued on page 80)



A little perusal of the car's wiring manual and the AutoCommand's manual gives the installer a good idea of what he has to do.

PRODUCT TEST REPORTS

By Len Feldman

Nakamichi CDPlayer2 CD Changer

Although this remarkable CD player looks to all the world like a conventional single-disc player, thanks to Nakamichi's innovative MusicBank system, the CDPlayer2 is in fact a CD changer. But, aside from its brother unit, the CDPlayer3, it's like no other CD changer currently available.

What makes the CDPlayer2 different is an ingenious "1 + 6" stocking mechanism that lets you internally store up to six discs for fast, direct access at any time. You load, inspect, or retrieve and unload CD's using the same

of the CDPlayer2 is its large diameter disc stabilizer that is magnetically clamped into place on top of a CD before play begins. That stabilizer is said to suppress the effects of external vibrations and dampens disc resonances.

The Nakamichi CDPlayer2 also features a newly developed stereo system that insures excellent tracking. Tracking ability is also improved by locating the RF amplifier right at the optical transport instead of on the main circuit board, thereby shortening the signal path between the optical pickup and the processing circuitry.

Other features include a multi-regulated power supply; a full complement of disc and track search, access and programming features; delete play; 3-way random play; 3-way repeat play; 50-program memory; synchro recording for automated CD dubbing with most Nakamichi cassette decks; 3-inch disc compatibility in the single-play mode; a digital output; remote controllable, motor-driven variable output and headphone level; and a full-function wireless remote control.

THE CONTROLS

Nakamichi has maintained an elegant, non-intimidating look to the front panel of the CDPlayer2 by using several rocker-type, light-touch pushbutton switches. Touch the lower end of one of these switches and one function is performed; touch the upper part and a different function is activated.

The power on/off switch is at the extreme left end of the panel, adjacent to the disc-loading tray and drawer. To the right of the tray is the first of the dual function buttons. Touch the lower part of that control and the tray opens to accept a single disc. Touch it again and the tray smoothly closes. If the upper part of the button is depressed, the tray opens once more; but this time, upon closing, it stores the disc in the internal stocking area of the player and reopens for the insertion of one or more additional discs. A display

CIRCLE 120 ON FREE INFORMATION CARD

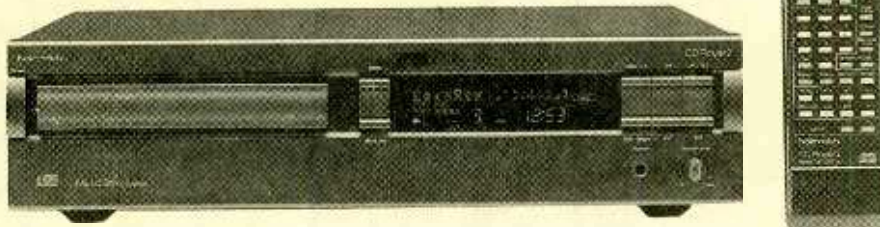

The Nakamichi CDPlayer2 CD Changer

single-disc tray. And even if six discs have been loaded and stored internally, you can still play a seventh disc without having to juggle the others. Further, you do not have to remove the single disc to play any of the stored discs.

We found the MusicBank System to be quieter and faster than conventional changer mechanisms. It requires no external cartridge for multi-disc operation.

Another unusual feature

The player also features digital de-emphasis. When de-emphasis is required, it is performed in the digital domain to avoid phase shifts and distortion. The unit uses 8-times oversampling digital filters, and the analog low-pass filters preceding the outputs are linear-phase-active, 3rd-order Bessel-type circuits that ensure a high degree of phase accuracy. The CDPlayer2 uses dual D/A 20-bit converters.

area to the right of this "load/store" button provides an assortment of status information, such as the number of discs stored; the number of the disc that's currently playing; and synchro recording, memory-programming, play, pause, time-editing, time- and track-data, time-counter mode, repeat-play, and random-play indicators.

To the right of the display are three more dual-function, rocker-type pushbuttons. The first of these sequentially choose discs 1 through 6 when the MusicBank storage feature is in use. Alternatively, it chooses single-disc operation. The second button is used for forward or reverse track skipping. The third dual function button is used for play/pause commands or for stopping the player. Beneath those three buttons, at the lower right of the panel, are a stereo-headphone jack and an output-level control that sets both the headphone and the variable line-output levels.

The supplied remote control has buttons that duplicate all of the front-panel functions except power on/off. In addition, there are two sets of number buttons that are used for programming and for disc selection. There are also a variety of buttons to take care of the special features of the player such as track delete, program clear, time editing, synchro recording, disc scanning (for playing the beginning of the first track of each disc stored in the MusicBank System), random play, and repeat play. The rear panel of the CDPlayer2 is equipped with pairs of fixed and variable stereo-output jacks, a coaxial digital-output jack, a switch for selecting analog or digital output, and jacks for system remote control and synchro

Specification	Manufacturer's Claim	PE Measured
Frequency response	5-20,000 Hz, ± 0.5 dB	Confirmed
Signal-to-noise ratio	105 dB	106.9 dB
Dynamic range	100 dB	108 dB
THD at 1 kHz	0.0035%	0.0022%
THD + noise	0.004%	0.004%
Channel separation	More than than 100 dB	101.5 dB
Output level		
Fixed	2.0 volts	2.06 volts
Variable (max.)	2.0 volts	2.06 volts
Headphones	60 mW (40 ohms)	62 mW (40 ohms)
Power requirement	120 V, 60 Hz, 27 watts	Confirmed
Dimensions (W x H x D, in.)	16 $\frac{1}{16}$ x 3 $\frac{1}{16}$ x 14 $\frac{3}{4}$	Confirmed
Weight	17 lbs. 10 oz.	Confirmed
Suggested Price:	\$799	

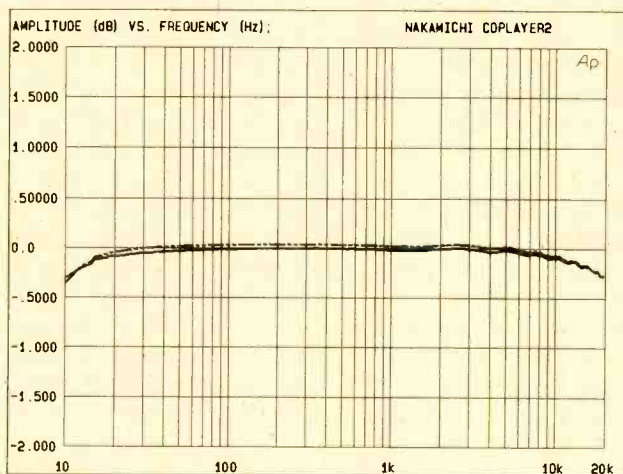

The frequency response of the Nakamichi CDPlayer2 from below 10 Hz to 20 kHz is shown here. The dashed line trace is the right-channel output; the solid line is the left channel.

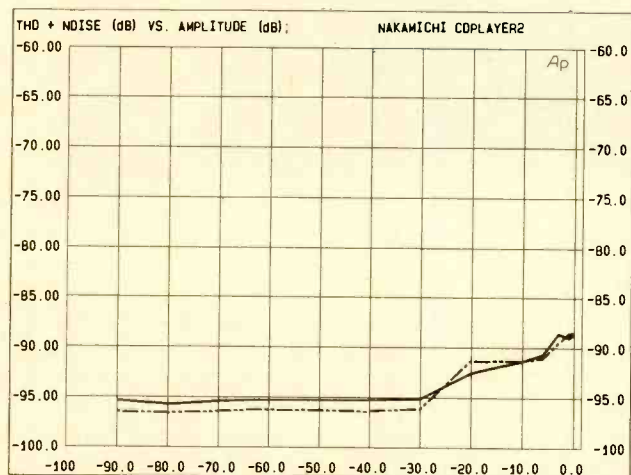

This plot shows how THD varied with changes in the recorded level of a 1-kHz test signal. For all levels below -30 dB (referred to the maximum recorded level), THD plus noise was -95 dB or better. In percentage terms, that works out to a THD of 0.002% or better.

recording when certain other Nakamichi audio components are used with this player.

THE TEST RESULTS

Frequency response of the Nakamichi CDPlayer2 was essentially flat from 20

Hz to 20 kHz, with a roll-off of no more than 0.3 dB at 20 Hz and 0.25 dB at 20 kHz. Ripple was virtually non-existent at the treble end of the spectrum, a good indication of the high quality and matching characteristics of the analog low-pass output filters. Output levels from both channels were virtually identical.

Throughout the low and mid-frequency region, and even for lower treble frequencies, harmonic distortion plus noise was around 0.004% or less, rising to a maximum of 0.004% near the top of the audio spectrum. Even that slight rise was not attributable to actual distortion but resulted from minute "beats" that occur at such high frequencies, but which are generally inaudible at such low levels.

We next looked at how THD varied with changes in recorded level; we used a 1-kHz signal on our CBS CD-1 test disc for these tests. For all levels below -30 dB (referred to maximum recorded level), THD plus noise was more than 95 dB below the maximum level. Quoted in percentage terms, that works out to be 0.002%, or less. As the maximum recorded levels are approached, the THD plus noise rises insignificantly to around -88.5 dB for both channels, corresponding closely with the 0.004% readings that were noted earlier.

In order to separate the actual distortion products from the small amount of accompanying noise, we ran a spectrum analysis of a full-level 1-kHz test signal using the THD mode of our Audio Precision digital signal-processing system. In that test, the fundamental 1-kHz tone was suppressed (to around -142 dB) leaving only the harmonic components of that signal. Residual noise was then

"averaged out" by acquiring the signal and analyzing it sixteen successive times. Since the noise is random, it tends to be canceled out by those successive readings, allowing us to zero in on the discrete, repeated harmonic components, which remain in the same place regardless of the number of sweeps. The tallest of those harmonic "spikes" were all about 100 dB below the maximum recorded level. If we calculate the composite distortion represented by those spikes we come up with an actual harmonic distortion figure (ignoring noise components) of only 0.0022%, or actually considerably less than the 0.0035% figure claimed by Nakamichi in their published specifications for this model. A measurement of SMPTE-IM distortion resulted in readings of only 0.0044%.

The A-weighted signal-to-noise ratio of the CDPlayer2 measured 106.9 dB for the left channel and 107.3 dB for the right channel, again exceeding Nakamichi's claims by a small margin. A spectrum analysis of the residual noise of this player revealed that the actual random noise is far lower than the overall S/N figure just quoted. The major contributions to the overall S/N readings are from the minute amounts of power-supply related components (at 60 Hz, 120 Hz, etc.), and even the greatest of those was well over 100 dB below maximum recorded level.

We next examined how stereo separation varied with frequency. At 1 kHz, separation was better than 100 dB, just as claimed by Nakamichi. As usual, separation tended to decrease somewhat at higher frequencies, but it still measured around 85 dB at 16 kHz. What's more, separation was very nearly

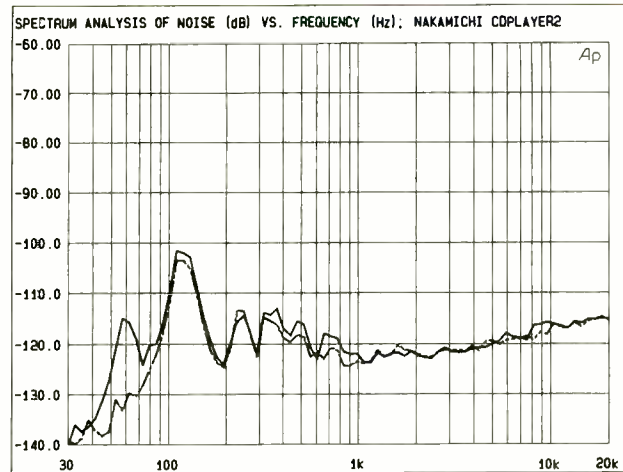

The A-weighted signal-to-noise ratio of the unit measured 106.9 dB for the left channel and 107.3 dB for the right. This spectrum analysis of the residual noise of this player shows that the actual random noise is far lower than that overall S/N figure.

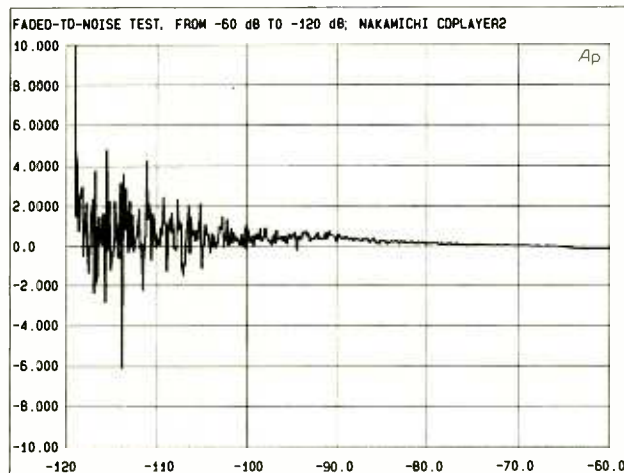

The fade-to-noise test provided further indication of the superb linearity of this player, and also provided the data needed for determining the dynamic range, which measured over 107 dB.

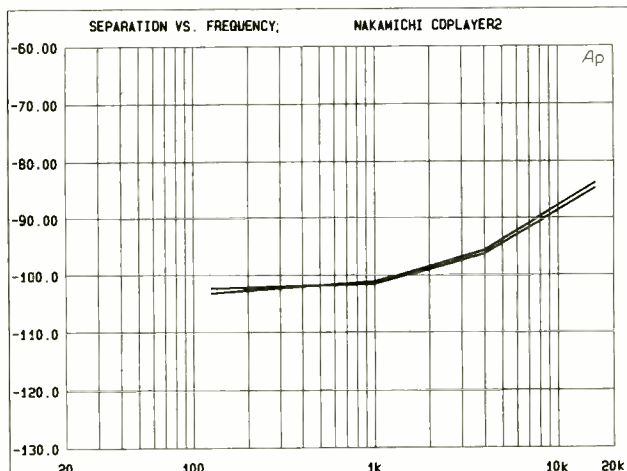

This plot shows how stereo separation varied with frequency. As shown, the separation was virtually identical for both channels—hence the overlap of the two curves.

identical whether measured from left channel to right channel, or in the op-

posite direction.

We also looked at the player's deviation from per-

fect linearity at various recorded levels. In one test, we plotted linearity errors from maximum recorded level (0 dB) down to -90 dB using undithered signals. At the lowest extreme of that plot, deviation from perfect linearity was no more than about +0.5 dB. That's about as good as we have ever measured for any CD player, regardless of price.

For the next test, we used dithered signals (signals containing deliberate amounts of noise that actually enable a CD player to extract lower-level information than would be possible otherwise) in the range from -70 dB to -100 dB below maximum recorded level. Even at -100 dB, deviation from perfect linearity was less than +1.0 dB.

Finally, using a test signal that gradually fades from a -60-dB level to a -120-dB level, we plotted deviation from perfect linearity again, as the signal fades into the residual noise level. Again, linearity was superb, hovering at or near the 0-dB deviation line to well below -100 dB. This test also enabled us to determine the dynamic range capability of the player, which turned out to be approximately 107 dB. Frequency accuracy of the internal master digital clock was also measured and was accurate to within 0.0033%.

HANDS-ON TESTS

The Nakamichi CDPlayer2 was able to play through a disc even when rather severe vibrations and shocks were applied externally to its case. It was also able to track our special "defects" disc at points where 1.5 millimeters of missing data was deliberately "built into" that test disc. The Music-Bank System handled discs extremely well, and with a speed that we have not

(Continued on page 80)

ANTIQUÉ RADIO

By Marc Ellis

The Theremin: America's Six-Decade Love Affair

Nineteen twenty-seven. It was the height of the roaring twenties. America was lusty and prosperous, busily shaking off Victorian inhibitions and reveling in the accomplishments of its new technologies. Cars were faster and more powerful, radio broadcasting was entering every home, jazz-age flappers danced in speakeasies, and Lindbergh flew the Atlantic.

That same year, a dapper young Russian scientist arrived in New York City to

demonstrate a novel musical instrument he'd invented a few years before. Lev Sergeivitch Termen, more commonly known as Leon Theremin (apparently a Gallicized version of the name, reflecting his French descent), had just completed a successful European tour and was ready to take America by storm.

Theremin's instrument was truly unique. For one thing, its sounds weren't produced by mechanical means as in traditional musical instruments; there was nothing to blow into, saw on, or strike. For another, the music was produced without touching the instrument in any way! The musician simply moved his or her hands in the air, varying their position relative to two antenna-like electrodes.

THE FIRST ELECTRONIC INSTRUMENT

Theremin's invention was, in fact, the first musical instrument to produce sounds by purely electronic means. Its circuits were similar to those that had been developed for radio transmitters and receivers; its sound was reproduced by a loudspeaker and its tones were rich and full—sometimes bearing an uncanny resemblance to the human voice, sometimes mimicking the notes of a violin or cello.

The inventor had originally named his apparatus the *aetherphon* and later referred to it as the *thereminvox*, but in popular usage, the name was eventually shortened to *theremin*. Prior to its appearance in New York City in 1927, the theremin had

already attracted the attention of the world music community. The first composition expressly for the instrument, "A Symphonic Mystery" by the composer A.F. Pashteschenko, had been premiered in 1924 by the Moscow Philharmonic. And audiences on the 1927 European tour had been wildly enthusiastic.

The New York demonstration concert created a sensation among the listening public and serious musicians alike. Theremin set up a laboratory and studio in the city to build new instruments and train performers, and soon theremin concerts—as well as theremin appearances with symphony orchestras—became commonplace.

Today, it may be a little difficult to understand the appeal of what was essentially a novelty instrument. Controlled as it was by making hand movements in the air, it was difficult to move from note to note without creating "sliding," or *glissando* sounds—limiting the theremin's facility and responsiveness.

But keep in mind that we're talking about an era when people were truly awed by technology. The radio and telephone were beginning to provide instant worldwide communication; auto, rail, and air transportation were shrinking distances between cities and countries; inexpensive electricity and labor-saving appliances were improving the quality of life for everyone. So why shouldn't the almost magical science of electronics be used to revolutionize music?

Theremin virtuosos such

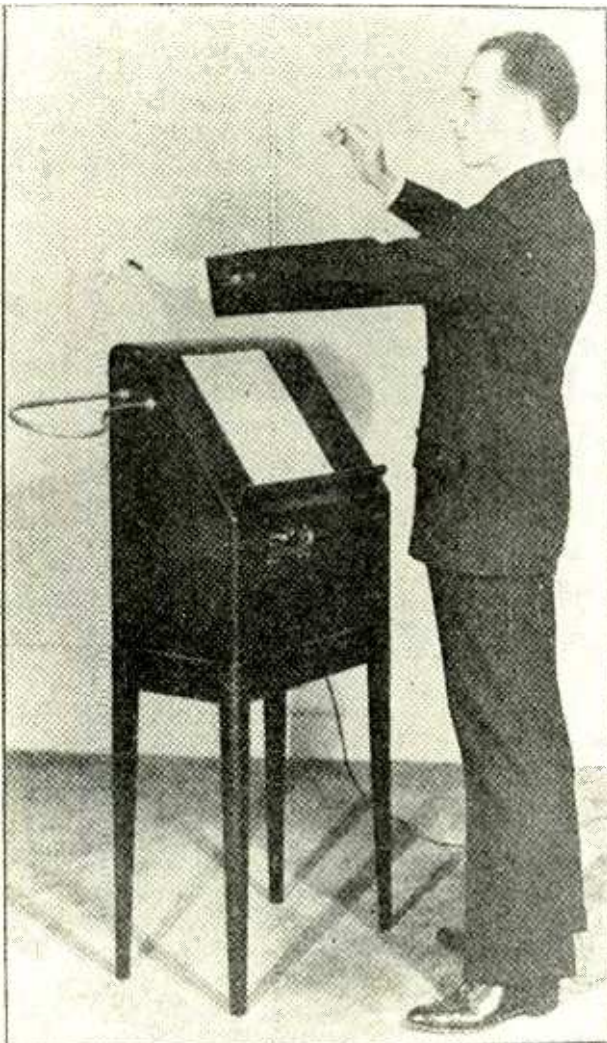

A dapper young Leon Theremin demonstrates his invention some time in 1929 or 1930.

as the legendary Clara Rockmore were indeed impressive to watch as they drew music from their instruments by making commanding gestures with their hands. The intense, rigid pose required to play the instrument without creating unwanted *glissandos* added to the supernatural effect, as did the eerie, almost vocal quality of the music. The thereminist seemed to be in control of some elemental life force.

RCA ENTERS THE PICTURE

In 1929, attracted by the mushrooming popularity of Theremin's magical invention, RCA purchased a license to manufacture the instrument and speedily produced about two hundred of them. The RCA theremins closely followed Theremin's design. They were well-made, elegant-looking units consisting of a sloping-front cabinet, which housed the electronics, mounted on four slender legs. Fitted with a narrow, flip-down shelf, the sloping cabinet front served as a convenient music holder. The instrument required a separate speaker, such as RCA's tapestry-front, floor-standing Model 106.

A short rod extended upward from the top of the cabinet at the performer's right. That was the pitch antenna. As the musician's hand approached that antenna, the pitch of the music became higher; as it was withdrawn, the pitch became lower. Volume was controlled by means of a horizontal looped antenna extending from the other side of the cabinet. Moving the hand closer to the loop reduced the volume; withdrawing the hand increased it.

RCA attempted to market the theremin to the home consumer, advertis-

ing it as an instrument that could be played, without study, by anyone who could hum or whistle. As an early RCA promotional brochure enthusiastically gushed ...

"... Thus, playing this almost incredible instrument resolves itself into nothing more complicated than waving one's hands in the air! The Theremin is the only musical instrument ever conceived which anyone can play without touching! It is the most intimate and personal of musical instruments, for it employs nothing mechanical, nothing, indeed, but the player's own mental conception of music, expressed in a few simple gestures of his hands. And it is the simplest and most universal of musical instruments, because no technical knowledge of music, no tedious practice, no long period of study is necessary in order to play it. Anyone who can hum or whistle a tune can play the Theremin ... and, as far as technique is concerned, anyone can begin to play it on the same footing with the finest cellist, or pianist, or other instrumentalist in the world!"

In reality, however, the theremin was an extremely difficult instrument to master. The player had no fingerboard, frets, or keys to serve as reference points. He or she had to somehow achieve correct hand positions in thin air, recognize the desired notes when they came out, and make lightning-quick corrections when they didn't. Then there was always the problem of getting from one note to another without those unwanted *glissandos*!

The RCA radio dealers who handled theremin sales weren't much help in arranging music lessons for customers. And, in any case, 1929 was a very bad year to launch an expensive new consumer item.

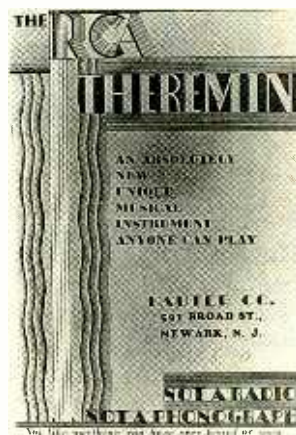

The cover of RCA's promotional brochure for the theremin stressed the novelty of the instrument and its ease of performance.

The theremin's price tag seems to have been about \$600.00—a bit steep for the depression-era pocket-book. Sales bottomed out and RCA discontinued the product.

Though few private individuals chose to purchase a theremin or to invest their time in learning to play one, the instrument was used intermittently on the concert stage throughout the 1930's and '40's. And experimentally-minded serious composers continued to write pieces for it. The theremin also occasionally appeared before the public in variety acts and music-hall performances.

THE THEREMIN IN HOLLYWOOD

The theremin had flopped as an instrument for the do-it-yourself home musician, but it was soon to make a grand re-entry into the popular consciousness. The mid-forties was the era of the psychologically-oriented movie thriller, and screen composer Miklos Rosza decided to try using the theremin as a source of chilling special-effects music.

In his autobiography, *A Double Life* (Wynwood Press, 1989), Rosza explains how he first wanted to use

the theremin to underscore a scene dealing with a premonition of death in the movie *Sundown*. The producers wouldn't agree, so he fell back on some effects from a musical saw.

Rosza finally got his chance to use a theremin in the now-classic film *Spellbound* (1945). Director Alfred Hitchcock wanted an eerie sound to suggest recurring attacks of paranoia, and agreed to give the Russian inventor's instrument a try. The results were electrifying, as most classic-movie buffs know. Be sure to rent a copy of that film if you'd like to experience the tasteful and powerful use of special effects to suggest terror and the theremin's unique ability to produce the required eerie sounds.

Rosza used the theremin with similarly chilling results in *The Lost Weekend*, which immediately followed *Spellbound*. Spurred on by his success with those two Oscar-winning films, the composer went on to use theremin effects in other psychological thrillers that he scored during this era, as well as in some of the gangster melodramas produced during the late 1940's.

The spine-tingling compositions for *Spellbound* and *The Lost Weekend* were played in the film studio by theremin virtuoso (and Beverly Hills foot doctor) Dr. Sam Hoffman. In a 1960 interview for *Electronics Illustrated* magazine, Dr. Hoffman estimated that he had played theremin music for more than thirty movie soundtracks as well as half a dozen record albums.

During the same interview, Dr. Hoffman explained that, when the full four-octave range of the instrument is used, only a 1/16-inch movement of the performer's fingertip is required

(Continued on page 94)

COMPUTER BITS

By Jeff Holtzman

A Closer Look At Hypertext

Last time, I gave you a brief introduction to hypertext (also known as hypermedia and multimedia). Vannevar Bush started things off in the 1940's with the concept of associative information access. Ted Nelson contributed the idea of non-linear reading and writing in the 1960's. Apple

intosh people have been doing since 1984. And Apple Computer Co. suddenly feels the MS-DOS puppy nipping at its heels. (Saber-tooth tiger might be better: powerful yet anachronistic.)

You can build hypertext systems without a GUI, but doing so with a GUI makes a better product. Anyway, the huge popularity of Win3 has created a great deal of interest in hypertext, both by consumers and by developers of hypertext authoring systems and end-user products (more about those will be covered next time).

hypertext is a base technology, like memory chips, hard disks, and video adapters. By themselves, memory chips are worthless; it's only when they're integrated into a system that they become useful.

The situation is similar with hypertext. You can't just saunter into your local computer store, sidle up to the counter, and say, "I'd like an order of hypertext, please, and hold the mayo." You can buy software tools to build something using hypertext, and you can buy products that are built on hypertext principles. So what is hypertext?

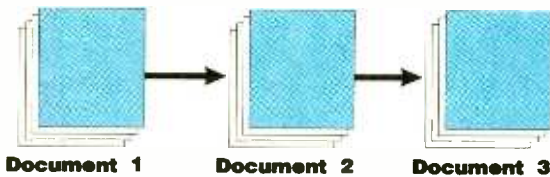

A

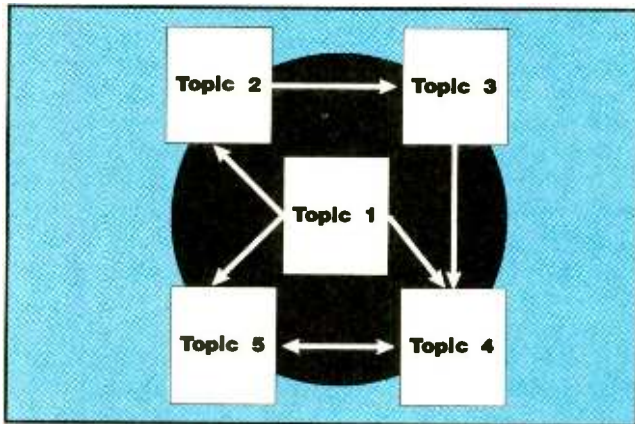

B

Hypertext is a way of organizing and presenting cross-linked information. Imagine that you're reading an article and it refers you to another article, which thereafter refers you to yet another article (A)—an interrelated network of topics of perhaps dozens of articles. Hypertext documents (B) allow a much richer set of interconnections than do traditional documents; instead of reading dozens of articles, you could move from topic to topic simply by clicking a mouse.

contributed HyperCard in 1987.

One part of the story that I neglected to mention is Windows 3.0. Whatever its faults, Win3 has legitimized the graphical user interface (GUI) for the PC world. Suddenly there is a huge flurry of interest in what the Mac-

WHAT IS HYPERTEXT?

Is hypertext a product, a technology, a concept—or maybe just another fad in a fad-prone industry? Whatever it is, what good is it? Before we start trying to answer those questions, a word about terminology. In some quarters, multimedia seems to be the preferred term; I think that's because it conjures up images of super-sexy high-tech presentations via computer, using high-quality video, sound, and other media.

Hypertext can be sexy, but that's not what's important. What is important is content, the message that must be communicated. Hypertext is a means of communications, not the message itself.

By way of analogy, film and television can be sexy, gripping, and compelling; but they're just media, they have no intrinsic content. Film and TV can be used to convey information that is worthwhile or worthless—that's up to the programmers. The same is true of hypertext. In that sense, hy-

DEFINITION.

Hypertext is a way of organizing and presenting information by computer. At a minimum, it provides cross-linked text; it may also include graphics, sound, animation, and motion video.

The trade press, and the industry in general, tend to focus on the presentation aspects, and to ignore the organizational ones. That's understandable, but unfortunate. It's understandable because it's easier to grasp the concept of flashy computer-based presentations than vague mumbo-jumbo about "associative information access" and "non-linear reading and writing." It's unfortunate because it's giving hypertext a bad name among thoughtful, if skeptical, people. So let's skip over the flashy parts for a moment, and try to see what lies beneath the surface.

ORGANIZATION.

Organization is extremely important. What were Bush

and Nelson getting at with terms like associative and non-linear? Imagine an encyclopedia. You start reading an article; it refers you to another article for more information. That article may, in turn, refer you to yet another article. Thus, in investigating a subject, you may end up reading half-a-dozen articles—or perhaps dozens of articles. What you've got then is an inter-related network of topics.

Suppose that that encyclopedia existed in electronic form on computer. Suppose that instead of opening half-a-dozen volumes, you could move from topic to topic simply by clicking a mouse. Suppose that the encyclopedia provided special maps showing the interrelations among those topics. Suppose that the computer provided a bread-crumbs function that would allow you (like Hansel and Gretel) to find your way back home. Let's further suppose that the presentations were beefed up with photographs, film clips, speeches, animation sequences, and the like.

Now you see why people get excited about hypertext. (By the way, there really is an encyclopedia like that: Compton's MultiMedia Encyclopedia. Doubtless, the CME is the most ambitious commercial hypertext product attempted to date, and for that it is admirable, but it also has a few problems as well; more on it later.)

Organization is extremely important. Traditional linear paper presentation has a familiar look and feel; we know how to navigate it, and we know how to correct our course when we get lost. With hypertext, where any given topic may branch off into many other topics, there is much greater potential for getting lost. Therefore, hypertext engi-

neers must design navigational aids into their systems. Some aids can be generic, but most must be specific to a particular subject.

For example, if a subject logically breaks down into two sub-parts, one of which breaks down into three sub-sub-parts, two of which ..., and so on. Obviously, the hypertext designer for that subject must build an appropriate road map.

WHAT GOOD IS IT?

Hypertext is a means of communication, probably the richest means yet invented by mankind, because it has the potential to subsume all other types of media. In that sense, hypertext can be used for all the things for which all other types of media are used; those include news (news-paper, radio), entertainment (film, radio), training (film, paper), education (paper, film), and so forth.

My preschoolers have a PC game called The Playroom that is built on hypertext principles, and is probably the single best implementation of hypertext principles that I've seen. You interact with The Playroom by clicking with a mouse on various objects in a graphically represented playroom. If you click on the bird, it chirps. If you click on the bed, a lullaby plays. Other objects link to other "rooms" with educational lessons for counting, telling time, learning letters. Kids love it, and they learn from it as well.

If you can figure out how to engender the same reaction in adults studying adult subjects, you can start your own company, get rich, and do something for society.

Next time, I'll talk about ways of getting involved; in particular, tools suitable for building hypertext applications. ■

AMAZING NEW Pocket Reference

480 pages of tables, maps, formulas, and conversions and it fits in your shirt pocket (3.2" x 5.4" x 0.6")!

\$9.95*



* Plus \$2.00 shipping & handling. Colorado residents add 56¢ tax.

Small sample of contents

Air Tool CFM vs PSI	Radio Alphabet
Battery Charging	TEN Radio Codes
Tire Manufacturer Codes	Telephone Area Codes
Lumber Sizes & Grades	Lost Credit Card Phones
Concrete & Mortar	Sound Intensities
Element Tables	Wind Chill Factors
Computer ASCII Codes	Frequency Spectrum
IBM® PC Error Codes	Geology Mineral Tables
IBM® Interrupts-I/O Map	Glues and Solvents
80286 Hard Disk Types	Bolt Torque Tables
Printer Control Codes	Wood Screw/Nail Sizes
Electric Wire Size vs Load	Math Formulas & Tables
NEMA Motor Frames	Plane/Solid Geometry
Wire & Sheet Gauges	Copper/Steel/PVC Pipe
Resistor/Capacitor Colors	Ropes, Cable and Chain
Pilot Lamps Specs	Tap-Die-Drill Sizes
Fuse & Battery Specs	Sand Paper & Abrasives
RF Coil Winding Data	Weld Electrode & Solder
Wire Size vs Turns/Inch	3200 Conversion Factors

Money Back Guarantee - If not completely satisfied, return book postage prepaid, in mint condition for a 100% refund!

Sequoia Publishing Inc.
Dept 921, P.O. Box 620820
Littleton, CO 80162

CIRCLE 9 ON FREE INFORMATION CARD

Be an FCC LICENSED ELECTRONIC TECHNICIAN!



**Earn up to
\$30 an hour
and more!**

Learn at home in spare time.
No previous experience needed!

No costly school. No commuting to class. The Original Home-Study course prepares you for the "FCC Commercial Radiotelephone License." This valuable license is your professional "ticket" to thousands of exciting jobs in Communications, Radio-TV, Microwave, Maritime, Radar, Avionics and more...even start your own business! You don't need a college degree to qualify, but you do need an FCC License.

No Need to Quit Your Job or Go To School
This proven course is easy, fast and low cost! **GUARANTEED PASS**—You get your FCC License or money refunded. **Send for FREE facts now. MAIL COUPON TODAY!**

COMMAND PRODUCTIONS

FCC LICENSE TRAINING, Dept. 100
P.O. Box 2824, San Francisco, CA 94126
Please rush FREE details immediately!

NAME _____
ADDRESS _____
CITY _____ STATE _____ ZIP _____

FUN SOFTWARE

By Fred Blechman

Seeing the Stars

If you've ever looked up at the sky on a dark, clear night, you have probably wondered about all those thousands and thousands of stars. Some—the ones that don't appear to blink at all—are planets. The stars themselves are like our own sun, and it is believed that most have planets around them much like our own solar system.

Many of these stars are arranged in recognizable relatively fixed formations called "constellations," used from ancient times for navigational purposes because of the predictability of each individual star's angular relationship (bearing and

sure to thrill amateur astronomers and would-be astronomers. But we won't stop there: For those of you that have installed Windows 3.0 and are looking for a break from productivity, we'll also cover a package from Microsoft that includes eight games that will only work in the Windows 3.0 environment. And we'll end up with information on some hot new fun software!

ASTRONOMY LAB

If you have even a remote interest in astronomy, this package will probably fascinate you; it did me. My closest contact with astronomy was over 40 years ago, when I had to learn celestial navigation in flight training to be a Naval Aviator. We had to learn certain constellations to recognize particular stars for navigational fixes, using a sextant and astronomical tables. Incidentally, after I got my wings in 1950, I flew only single-seat fighters and never had to take a star sighting!

Astronomy Lab, especially considering its low price, is an amazingly versatile and comprehensive program. It displays slow-motion "movies" that simulate a host of astronomical phenomena, displays and prints charts that illustrate many fundamental concepts of astronomy, and prints reports that contain mathematical predictions of the most important astronomical events. All movies, charts, and reports are customized for the exact user's location and time zone, with any date from 1000 AD to 3000 AD.

The database includes an incredible 1160 stars,

down to a magnitude of 5 (which is 2.5 times brighter than the limit for a naked eye, magnitude 6). "Messier" objects, nebulae, asteroids, and comets are not included in the database. The planets, sun, and moon are, of course, included, as well as Jupiter's four brightest moons.

Movies are available for solar eclipses, lunar eclipses, transits of Mercury and Venus, lunar occultations (blocking) of stars and planets, mutual planetary occultations, and even planetary occultations of stars. You can show a movie of planet orbits around the sun (top or side view), or the orbits of four of Jupiter's 12 moons as seen from Earth or from above Jupiter. It's all absolutely amazing.

A particularly useful and interesting display is the day/night movie that shows the sunlit regions of the Earth, using a Mercator Projection map of the world, at a designated date and time. You can have the frames advance in real time, hourly, weekly, or monthly. I just saw an ad in a magazine for an electro-mechanical world time indicator that has a similar color display operating only in real time. It sells for \$1350!

Another outstanding feature of Astronomy Lab is its built-in screen-dump module that works with an Epson- or PostScript-compatible printer. It scans the display, then prints in landscape mode (sideways) every dot on the screen, including all colored images, in black and white. This screen dump is so good it should be sold as a separate program.

I counted 12 different

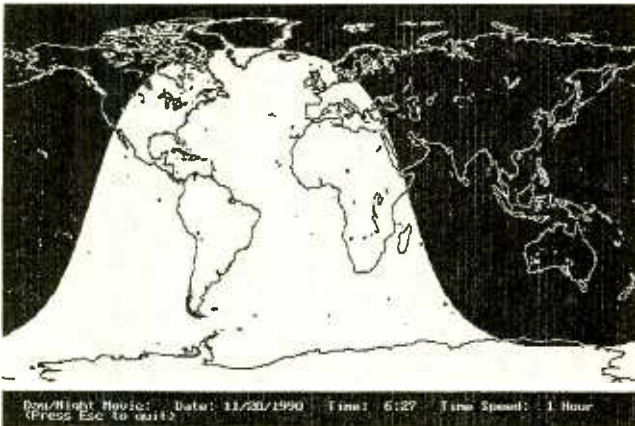

One of the "movies" available in Astronomy Lab shows the day/night progression across the Earth. The frames can be made to advance in real time, or hourly, weekly, or monthly.

elevation) from any point on Earth at a given time. All visible-to-the-eye stars and constellations are part of our galaxy, one of billions of similar galaxies, each with millions or billions of stars. It's enough to boggle the mind.

As you may have guessed from the forgoing, one of the software packages that we'll review this month is an astronomy-oriented software package that's

graphical charts and 12 reports available from within the program, including a calendar report that tells you, for every day at your specific location, the sunrise, sunset, moonrise, moonset, solar eclipses, lunar eclipses, moon phases, equinoxes, and solstices.

All of this is accomplished with a very friendly user interface of pull-down menus and dialogue boxes. A mouse is not supported by the software, but it's not needed. The program operates seamlessly and quickly from a hard drive, and I had no crashes.

The spiral-bound 153-page 8.5-inch by 11-inch soft-cover manual is itself an outstanding piece of work. It is heavily illustrated with printouts produced by the program itself, and the text is very detailed, yet easy to follow.

I'd like to write several thousand words about this program, but I don't have the space here. Both the software and the manual appear to be the work of a single man, Eric Bergman-Terrell. I don't know Eric, and he's not paying me to say this, but this is one of the most fascinating and well-implemented technical programs I have ever seen. It should sell for hundreds of dollars. When I called him to rave about how great I think Astronomy Lab is, Eric said, "It has been a labor of love."

(Personal MicroCosms, 8547 E. Arapahoe Road, Suite J-147, Greenwood Village, CO 80112, Tel. 303-753-3268. Requires IBM PC or compatible, DOS 3.0 or higher, 512K of available RAM, hard drive, or high-density floppy drive, EGA or VGA graphics. PC/AT or above recommended. 8087 math coprocessor supported if installed. Epson or PostScript compatible printer. \$59.95 plus \$2.95 shipping within the U.S.)

ENTERTAINMENT PACK FOR WINDOWS

This package was originally released with six high-resolution games; now the popular Soviet arcade game Tetris has been added. Some of these seven games offer a great diversion from serious work, and just running these programs for this review pulled me away from reality for many hours. Not very productive, but lots of fun.

Except for Tetris, these games were developed by Microsoft Windows programmers in their spare time, and became so popular at Microsoft that the company decided to market them as a package. Bear in mind they all require Windows 3.0.

If you have Windows 3.0, you have certainly by now discovered Solitaire and Reversi, two of the included games. If you like those, you'll love some of the Entertainment Pack games (though none offer as spectacular a display as when you win at Solitaire).

Tetris challenges your skill at interlocking various shapes. You can rotate and move them left or right as they drop from the top of the screen to form solid lines at the bottom. This tests your spatial relations and finger coordination. Oddly, the mouse is not used.

Taipei uses Oriental Mah-Jongg tile designs, but is not played like Mah-Jongg. You choose one of seven patterns (bridge, castle, cube, etc.) and the tiles are stacked in this pattern. The object is to remove matching tiles, with certain rules. This was a lot of fun, and I went through all seven patterns. When you successfully remove all tiles, you get a fortune-cookie-like prophecy on the screen.

MineSweeper tests logic skills. You need to clear a minefield before time runs

out. For a beginner, there are 10 mines located randomly within a 64-square grid. For the expert, there are 99 mines in a 480-square grid. Step on a mine (select a square with a mine) and you lose. All that happens then is that a "happy face" turns to a "sad face;" no explosion. I got sad-faced every time, and quickly lost interest. There was too much chance involved, and not enough logic.

TicTactics is like tic-tac-toe, but played with marbles in a grid. You have a choice of a conventional two-dimension 3 x 3 grid, or three-dimension 3 x 3 x 3 or 4 x 4 x 4 grids. The computer is merciless! I could win the 3 x 3, but struggled with the 3 x 3 x 3, and was hopelessly outclassed by the computer in the 4 x 4 x 4 grid. When there is a winner, the winning marbles flash. This game reminds me somewhat of the three-dimensional chess seen on the old Star Trek TV shows.

Pegged is a version of the traditional peg jumping game that looks deceptively simple. However, you can select any of seven starting patterns, and all but one (Cross) are tough—or maybe impossible! I lost interest in this quickly.

Two card games, Cruel and Golf (which has nothing to do with golf) are solitaire-like games. I found Cruel well named, and Golf boring—or maybe I just didn't understand the rules. I never won at Golf, but when you win at Cruel you get a simple message of congratulations on the screen. Yawn! I was hoping for something more like the Solitaire display.

IdleWild, also included, is not a game, but a selection of screen displays, and a screen blanker. You can display fireworks and a field of stars moving toward you at

Warp-10 (both best viewed in a darkened room), colored line patterns, and random screen blocks shuffling around. These are fun to watch, but only for a little while.

My vote goes to Taipei and TicTactics as the best in this package, with Tetris and Cruel worth some time.

(Microsoft Corporation, One Microsoft Way, Redmond, WA 98052, Tel. 206-882-8080. Requires IBM PC or compatible using 80286, 80386SX or higher processor; DOS 3.1 or higher; Microsoft Windows 3.0; a hard drive and either a 1.2MB 5.25-inch or a 720K 3.5-inch disk drive; EGA, VGA, 8514/A, or Hercules graphics and monitor (color recommended); and a Microsoft Mouse or compatible. No printer used. Suggested retail price is \$39.95.)

NEW FUN SOFTWARE

Here are some recently announced programs you can order from your regular software supplier. Suggested retail prices, where announced, are shown in parentheses.

MicroProse has five new releases. Spellcasting 101: Sorcerers Get All The Girls (IBM \$59.95), where the player is a would-be sorcerer who must escape from his home and evil stepfather to attend Sorcerer University. Midwinter (IBM \$49.95; Amiga and Atari ST \$39.95) combines elements of role-playing, strategy, and simulation games as the players fight for the survival of the human race in the wake of a new Ice Age. Covert Action (IBM) has the player participate in actual spy activities, such as disabling computerized defense systems, breaking complex codes, and trailing suspects around the globe. Knights Of The Sky (IBM) is an accurate
(Continued on page 83)

CIRCUIT CIRCUS

By Charles D. Rakes

Detector Circuits

Fellow experimenters, it's time to dig out your junkbox and join me at the Circus for a little circuit wizardry. I find that trying new circuit ideas is a good way to escape the troubles of the world and, at the same time, gain some knowledge in the process. And who knows, one of the circuits that we cover just might be what your next project needs.

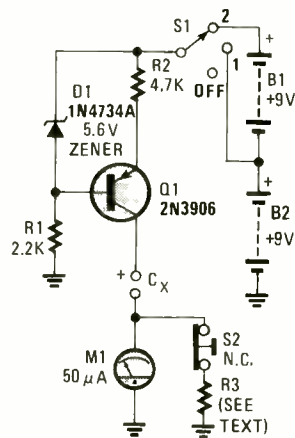

Fig. 1. The leak detector circuit is a simple circuit built around a 2N3906 general-purpose PNP transistor that's configured as a constant-current source, through which a 1-mA charging current is applied to the test capacitor.

This time around, we're going to look at a couple of detector circuits; the first of which is a simple electrolytic-capacitor leakage-test circuit. If you have ever put together an R/C timer circuit that, for some unknown reason, didn't perform as expected, it's very possible that the culprit was a leaky electrolytic timing capacitor.

Some leaky capacitors develop an internal resistance that varies with temperature and/or volt-

age changes. That internal leakage is like having a variable resistor in parallel with a timing capacitor. In extremely short timing periods, the effect of the leaky capacitor may be minimal, but as the timing period is extended, the leakage current can cause the timer circuit to vary greatly or even fail altogether. In any case, an unstable timing capacitor will turn a perfectly sound timer circuit into an erratic piece of junk.

LEAK DETECTOR.

Figure 1 is a schematic diagram of our electrolytic leak detector. In that circuit, a 2N3906 general-purpose PNP transistor (Q1) is connected in a constant-current circuit configuration through which a 1-mA charging current is applied to the test capacitor. A dual-range metering circuit is used to monitor the capacitor's charge and leakage current. Two 9-volt transistor batteries provide power for the circuit. A 5-volt Zener diode (D1) sets Q1's base at a constant 5-volt level, guaranteeing a

constant voltage drop across R2 (Q1's emitter resistor) and a constant current to the capacitor under test (which we'll refer to as C_x).

With S1 in position 1, the voltage applied to C_x is limited to about 4 volts; with S1 in position 2, the voltage across the capacitor rises to about 12 volts. Another battery can be added in series with B1 and B2 to increase the charging voltage to about 20 volts. With S2 in its normally closed position (as shown), the meter is connected in parallel with R3 (the meter's shunt resistor), giving the circuit a full-scale reading of 1 mA. When S2 is depressed (open), the metering range of the circuit is reduced to 50- μ A full scale.

MODIFYING THE CIRCUIT.

The circuits in Figs. 2 and 3 illustrate two methods of selecting a shunt resistor (R3 in Fig. 1) to extend M1's range from its basic 50- μ A range to 1 mA.

If you have an accurate voltmeter that can read 1 volt, use the circuit in Fig. 2

PARTS LIST FOR THE LEAK DETECTOR

RESISTORS

(All fixed resistors are 1/4-watt, 5% units.)

R1—2200-ohm

R2—4700-ohm

R3—See text

ADDITIONAL PARTS AND MATERIALS

Q1—2N3906 general-purpose NPN silicon transistor

D1—1N4734A 5.6-volt Zener diode

M1—50- μ A meter

B1, B2—9-volt transistor-radio battery

S1—SP3T switch

S2—Normally-closed pushbutton switch

Perfboard materials, enclosure, AC molded power plug with line cord, battery(s), battery holder and connector, wire, solder, hardware, etc.

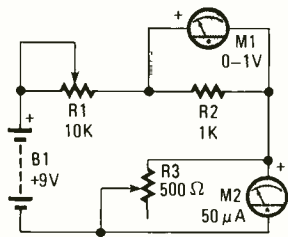

Fig. 2. Use this circuit to determine the value of R3 (in Fig. 1), if you are using a voltmeter.

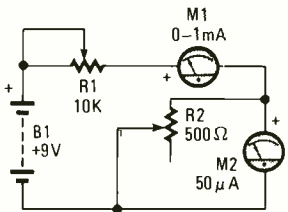

Fig. 3. If your most-accurate measuring instrument is a current meter that can monitor 1-mA, use this circuit to determine R3's value.

to select the value of R3. To use the Fig. 2 circuit, set R1 (the 10k potentiometer) to its maximum resistance and R3 (the 500-ohm potentiometer) to its minimum value. Connect a battery as shown and adjust R1 for a 1-volt reading on M1. Slowly increase the resistance of R3 until M2 (the current meter) reads full scale. Readjust R1 as you adjust R3 to keep a 1-volt reading on M1. When M1 reads 1 volt and M2 reads full scale, the potentiometer is set at the resistance value needed for R3. You can either use the potentiometer for the shunt resistor or select one of equal value from your resistor supply.

On the other hand, if your most-accurate measuring instrument is a current meter that can monitor 1 mA, use the circuit in Fig. 3. Follow the same procedure for the circuit in Fig. 3 as in Fig. 2 and adjust the R1 for a 1-milliamper reading.

To use leakage test circuit, start with S1 in the off position. Connect the capacitor under test to the C_x terminals, with the proper

polarization. Switch S1 to position 1 and the meter should (depending on the value of the capacitor) read full scale for a brief time and then drop back to a zero current reading. If the capacitor is shorted or extremely leaky, the meter will read up scale continuously.

If the meter does drop to zero, press S2 and the meter shouldn't move up scale on a good capacitor. If the capacitor's voltage rating is above 6 volts, switch S1 to position 2 and the results will be the same for a good capacitor. If the meter reading rises, the capacitor is not a good candidate for use in a timer circuit.

It's possible that a capacitor will fail the test and still be a good unit. If an electrolytic capacitor is idle for long periods without being charged, the leakage current can be high when a voltage is first applied; but if the voltage remains across the capacitor for an extended time, it can often be rejuvenated. The test circuit can be used to regenerate a sleeping capacitor and the results monitored on M1.

METAL DETECTOR.

A while ago we discussed a simple metal-detector circuit and, judging from the response, it was obvious that a number of you were very enthusiastic about the subject. So the next circuit that we'll discuss is one that is designed to do the same job, but in a different way.

One of the most sensitive and inexpensive metal detectors that you can build is a variation of the VLF TX/RX (very-low frequency, transmitter/receiver) detector, which is a two part apparatus. Such double-box detectors—which would not respond to anything smaller than a pound coffee can—were generally designed to

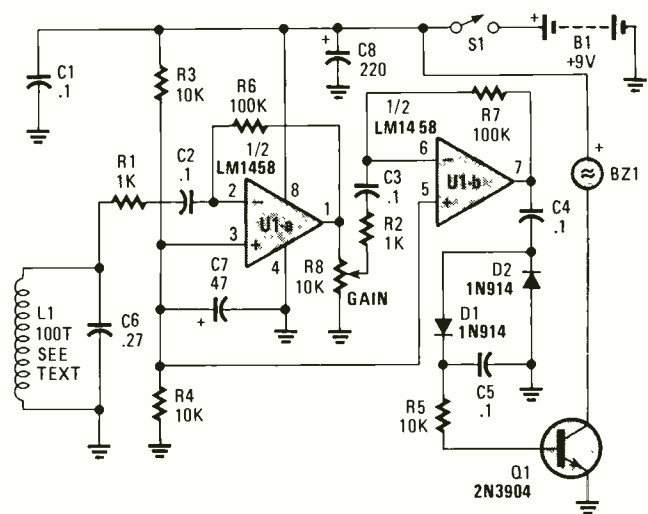

Fig. 4. The receiver portion of the metal detector is built around an LM1458 dual op-amp, a single 2N3904 general-purpose silicon transistor, and a 100-turn homebrew coil that's tuned to about 7 kHz via C6.

PARTS LIST FOR THE VLF RECEIVER

SEMICONDUCTORS

U1—LM1458 dual op-amp, integrated circuit
Q1—2N3904 general-purpose NPN silicon transistor
D1, D2—1N914 general-purpose small-signal silicon diode

RESISTORS

(All fixed resistors are 1/4-watt, 5% units.)
R1, R2—1000-ohm
R3, R5—10,000-ohm
R6, R7—100,000-ohm
R8—10,000-ohm potentiometer

CAPACITORS

C1—C5—0.1-μF, ceramic-disc
C6—0.27-μF, Mylar or similar
C7—47-μF, 16-WVDC, electrolytic
C8—220-μF, 16-WVDC, electrolytic

ADDITIONAL PARTS AND MATERIALS

B1—9-volt transistor-radio battery
BZ1—Piezo buzzer
S1—SPST switch
L1—Receiver loop, see text
Perfboard materials, enclosure, battery holder and connector, wire, solder, hardware, etc.

detect large metal objects buried deep, beneath the ground.

Our's is a mini-version that can detect coin-sized objects from a few inches away, or larger objects at a distance of over two feet. The sensing loops (coils) on both the transmitter and receiver portions of our detector are slightly over 4 inches in diameter and are separated by about 12

inches. The operation of the TX/RX metal detector is based on the directional properties of the magnetic field produced by the transmitter loop and the reception properties of the receiver loop.

In such circuits, the majority of the magnetic energy flows from the transmitter loop in an edgewise direction with almost no

(Continued on page 84)

DX LISTENING

By Don Jensen

Tune In To Radio Bangladesh

Bangladesh is neither one of the largest nor best known Asian countries tucked away in a corner next to India. Nor is *Radio Bangladesh* (the government's station) the region's most powerful or most-commonly heard short-wave broadcaster. But that makes it an especially interesting and somewhat challenging listening target for North American SWLs.

Bangladesh was part of India until the 1947 partition of the Asian subcontinent, when it became the eastern and smaller part of a divided Pakistan. Twenty-three years later, after India

Radio Bangladesh operates five shortwave transmitters; three with powers ranging from 7.5 to 100 kilowatts, for domestic broadcasting, and a pair of 250-kilowatt stations, enough power to be heard worldwide, for the shortwave foreign service.

The Indian colonial government established a regional medium-wave station at Dhaka just before the start of World War II. The operation's beginnings were simple and the facilities were limited. But by the time the subcontinent was partitioned into Pakistan and India, it was a healthy broadcasting operation that became a part of Radio Pakistan, the key radio outlet in the eastern region of the new nation.

From that, Radio Bangladesh emerged as one of Asia's finest broadcasting services when the country became independent on Dec. 16, 1971.

The Radio Bangladesh studios in the National Broadcasting House at Sher-e-Banglanagar in Dhaka produces programs for local audiences, which are transmitted on medium wave, shortwave, and FM frequencies. Foreign service programs for overseas listeners are broadcast in six languages—Bengali, Arabic, Hindi, Urdu, Nepalese, and English.

A half-hour English program is aired twice daily at 0800 and 1230 UTC on 11,705, 15,195, and 17,850 kHz, with 15,510 kHz carrying the later transmission only. In addition, there is a 45-minute program at 1815 UTC on 11,862 and 15,25 kHz. Those are intended for Europe; but U.S. and Canadian listeners may have

their best luck with the 1230 to 1300 UTC transmission.

Listeners reception reports should be sent to Masudul Hasan, the station's deputy director, at Radio Bangladesh, External Services, P.O. Box 2204, Dhaka, Bangladesh.

TIP SHARING

For SWLs who really want to keep on top of the quickly changing, short-wave-broadcasting scene, and perhaps share some of their own DX'ing tips with others, there's the Sunday morning SWL HAM NET. It's a popular gathering point for shortwave listeners who are also amateur-radio operators, as well as for those who aren't hams, but just like to listen in.

KW3F Bob Brown of Lansdale, PA, manages that network most weekends. SWL hams share their DX news and information via their own amateur-radio stations. Others may phone their logging tips to one of the "gateway" ham stations, which then relays it on the net frequency. The SWL Net frequency is 7,240 kHz, lower sideband. Listen in on Sunday mornings at about 1400 UTC during the summer months. The time moves to 1500 UTC in the fall when daylight savings time ends.

That ham-radio-info exchange often has hot DX news only days or even hours old. Unfortunately, it is

Credits: Tom Williamson, ONT; Wallace Triebel, WA; Harold Sellers, ONT; Edward Chichorek, NJ; Al Gastle, ONT; Ontario DX Association, P.O. Box 161 Station A, Willowdale, ONT, M2N 5S8, Canada; North American SW Association, 45 Wildflower Road, Levittown, PA 19057.



Jerry Klinck of West Seneca, NY, returned to shortwave DX'ing in 1989 after many years out of the listening hobby. "I'm having a ball," says Jerry. "I wish I'd come back to it years ago!" He now uses a Kenwood R-5000 receiver, which Jerry calls "a great rig!"

and Pakistan went to war, Bangladesh became independent. Radio Bangladesh, a year and a half ago, reached the half century mark, celebrating the anniversary of the first broadcasts from this part of South Asia in late 1939.

In those days, the broadcasting center was located at Dacca. Today the city, Bangladesh's capital, is spelled Dhaka, but it still remains the hub of the nation's radio operations.

primarily a network of eastern ham operators, so intelligible reception often is very tough west of the Mississippi.

MAKING CONTACT

One publication I've found interesting is "The DX'ers Directory," available from Universal Radio (1280 Aida Dr., Reynoldsburg, OH 43068; \$4.95 plus \$1 shipping). Fred Osterman has compiled a list of some 1800 DX'ers in 75 different countries. The list includes names, addresses, phone numbers, and specific listening interests. It is organized by geographical region—a real help in locating and contacting other SWL's in your area who have similar listening interests.

Fred would be happy to add your name and information to the next edition of The DX'ers Directory, if you wish. There's no charge for that, of course.

FEEDBACK

Here's where we read the mail, the letters with comments, and questions about shortwave listening and what you're hearing on the SW bands. Your letters are always welcome and should be sent to me, Don Jensen, *DX Listening*, **Popular Electronics**, 500-B Bi-County Blvd., Farmingdale, NY 11735.

"I'm an ex-Marine," writes Bill Kovaleski, "and I well remember the old *Armed Forces Radio Service*. When I was overseas, I always used to listen in to AFRTS on shortwave for the news from home and especially the sports broadcasts. I was really upset when, a couple of years ago, AFRTS, as it's now called, stopped broadcasting on shortwave. I know the military figured it could reach all troops with local FM transmitters, closed-circuit shipboard stations, and all the rest. But

with hundreds of thousands of our boys now isolated (at the time this was written) out in the desert, I think a shortwave AFRTS signal would make sense!"

A lot of SWL's agree with you, Bill. Interestingly, shortly after the Mideast military buildup began, Great Britain's equivalent of AFRTS, the *British Forces Broadcasting Service*, began broadcasting on shortwave, using BBC facilities, to its military personnel there.

Actually, it's still possible to hear AFRTS programs on shortwave, as many SWL's and not a few GI's in Saudi Arabia discovered. AFRTS operates a lower-sideband feeder, relaying programs for rebroadcast by local-radio services on several SW frequencies. For example, try 16,041.3 kHz at around 2000 UTC.

Wesley Thompkins, Waverly, IA, has a question about the *Voice of America*. "I remember a few years ago reading about a major upgrading of VOA shortwave stations around the world. How is it coming along?"

During the 1980's, there was a major program to improve VOA facilities. A lot was accomplished. Today, the only major relay-station projects actually still under construction are those in Thailand and Morocco. But with money considerably harder to come by in the 1990's, VOA officials ruefully note that there is too much over-age equipment still on line.

Nearly 100 of the VOA transmitters, worldwide, are more than 15 years old, with more than 65 of them having been in operation for more than a quarter century. And of those, 38 "museum pieces" range in age from 36 to 47 years! In fact, two relay transmitters at Munich, Germany, captured from the Nazis at the end of WWII, still are on the air for the VOA.

DOWN THE DIAL

Here are some listening tips for you to try. Why not send me yours?

CHILE—15,140 kHz. *Radio Nacional Chile*, one of the few shortwave stations operating from this "deep" South American country, has been logged on this frequency in Spanish at about 0250 UTC. Interference from 15,145 kHz can be a problem at times.

CHINA—11,875 kHz. *Radio Beijing* operates on many frequencies in many languages. You can hear English news here at 1300 UTC.

CUBA—9,570 kHz. *Radio Havana Cuba* has been heard operating on this frequency, in parallel with 11,750 kHz, with English programs at around 0400 UTC.

ITALY—11,800 kHz. *RAI* is heard here in English at 0100 UTC, much better than on 9,575 kHz, which operates simultaneously. The expressionless female an-

nouncer, whom some SWL's have dubbed "The Dead Lady," can be heard droning through a newscast.

PAPUA NEW GUINEA—3205 kHz. Under favorable reception conditions, you may hear the local broadcaster, *Radio Sanduan* at Vanimo at around 1100 UTC, broadcasting in the Pidgin language. Sanduan is Pidgin for "sundown," or west.

USSR—11,790 kHz. The foreign services of several of the Soviet republics continue to be heard with good signals in North America. *Radio Yerevan* in the Armenian S.S.R. is noted with a brief five minutes of English news at about 0352 UTC on this frequency.

USSR—17,665 kHz. Another of the Soviet outlets with English programming is *Radio Kiev*. It signs on at 0000 UTC with tuning signal and ID, "This is Radio Kiev from the capital of the Ukraine." News follows. ■

Make the most of your general coverage transceiver with *Monitoring Times!*

Every month *Monitoring Times* brings everything you need to make the most of your general coverage transceiver: the latest information on international broadcasting schedules, frequency listings, international DX reports, propagation charts, and tips on how to hear the rare stations. *Monitoring Times* also keeps you up to date on government, military, police and fire networks, as well as tips on monitoring everything from air-to-ground and ship-to-shore signals to radioteletype, facsimile and space communications.

ORDER YOUR SUBSCRIPTION TODAY before another issue goes by. In the U.S., 1 year, \$18; foreign and Canada, 1 year, \$26. For a sample issue, send \$2 (foreign, send 5 IRCs). For MC/VISA orders (\$15 minimum), call 1-704-837-9200.

MONITORING TIMES

Your authoritative source,
every month.

P.O. Box 98
Brasstown, N.C. 28902

HAM RADIO

By Joseph J. Carr, K4IPV

Slaying Some SLJ's

Do you know what an "SLJ" (pronounced "Slidge") is? Everyone has them, and everyone dreads them. Some people call them "chores," while others call them "honeydos" (honey do this, honey, do that). "SLJ" stands for "Silly Little Job" (it has other names, but you get the point). SLJ's

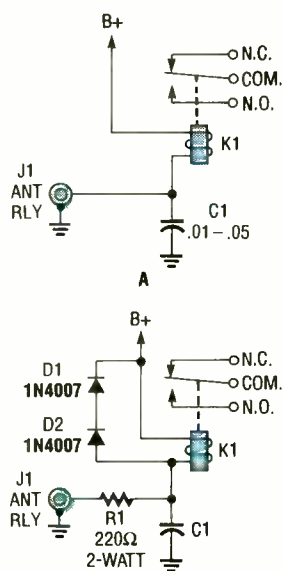

Fig. 1. Many transmit relays in HF linear amplifiers connect one end of the relay coil to the B+ source, and the other end to the ANT RLY jack (as shown in A). A popular cure for relay disorder is illustrated in B; simply break the line and insert a 220-ohm, 2-watt resistor in the line ahead of the capacitor. Also shown is a little "fix" (two series connected diodes wired in parallel with the relay coil) that's used for transceivers that have a transistor instead of a relay.

are some of those little repairs, enhancements, and improvements that we all need to make to our equipment from time to time.

This month in Ham Radio, we will look at some of the

more common problems associated with amateur-radio equipment (by no means all of them, but a couple)—especially those that translate into a Saturday morning or one-evening SLJ.

INTERMITTANT TRANSCEIVER PUSH-TO-TALK

Most hams that operate in the high-frequency (HF) portion of the spectrum use a transceiver (transmitter and receiver in one package) that covers all bands from 160 meters up to 10 meters (with a few also giving us 6 meters). In most cases, the transceiver's transmitter section has a 100- to 250-watt PEP output (SSB), with 100 watts being very common.

One of the most common complaints about such rigs is intermittent transmit or receive. If the complaint is intermittent transmit, find out (by using the rig) whether or not the intermittent operation is common to both CW and SSB. If it is *not* common, then it's possible that the trouble is a broken wire inside the microphone, microphone cable, or microphone connector (the last being most likely).

I keep two microphones handy: One is the mobile-style mike that came with the rig, while the other is a super desk microphone that I bought at a high premium (it's got designer styling, but it somehow lacks the aesthetic design integrity of my old "Chrome Lollipop" D-104).

If the trouble is common to CW and SSB, however, then the problem is most likely inside the rig. In most

transceivers, the job of toggling back and forth between transmit and receive functions is handled by an old-fashioned electromechanical relay. In such units, a set of switch contacts are mounted on a movable mechanical armature that is operated by an electromagnet.

If the rig is intermittent on transmit, or if the power jumps up and down (use an RF wattmeter to monitor output while "transmitting" into a dummy load) on successive keyings of the push-to-talk or transmit button, then suspect the relay. Alternatively, if the receiver sensitivity sometimes drops one *heckuva* lot on returning from transmitting, then also suspect the relay.

WHY HARP ON THE RELAY?

One service manager at a major mail-order retailer of ham gear told me that relay problems account for somewhere around 25 percent of all conditions found by his technicians, and that relays pose the second most frequent problem. (At the end of this article, I'll tell you what the number one condition found was.)

The relay is, quite frankly, a high failure rate item. It is designed to last for so many operations, and will inevitably fail someday. In some rigs, the relay is easily removed from a socket, but in others, it must be unsoldered. If you're unhappy at the prospect of desoldering a zillion-pin relay from a printed-circuit board, then let a pro do it.

Look in your repair manual to find out where the relay is located and how it is configured. Sometimes it's

possible to extend the life of relays by cleaning them with switch/contact and tuner cleaner. Your manual should give information on that operation.

If you use a high-power linear amplifier, it's possible that you'll shorten the life of the transceiver's relay by a considerable factor. Figure 1 can be used to illustrate how that might happen. Figure 1A shows the circuit used for many transmit relays in HF linear amplifiers. The relay coil is connected to a B+ source—which could be as little as 12 volts or as much as 250 volts. In many cases, B+ is about 120 volts DC. (Only occasionally have I seen an AC relay, and those were on older rigs.)

Look in the amplifier service manual or schematic to find out which is the case. The "cold" end of the relay's (K1) coil is connected to an ANT RLY jack (J1, usually an RCA phono jack) at the rear of the amplifier. The relay contacts inside of the transceiver short the center of the ANT RLY jack in order to turn on the amplifier.

The problem is the RF bypass capacitor connected between the center pin of J1 and ground. It is charged by the B+ voltage when not in use. When the relay contacts inside the transceiver short together in order to actuate the amplifier, the current stored in C1 is dumped through those contacts—pitting them and forcing an early death.

THE CURE

The circuit in Fig. 1B illustrates a popular cure for that relay disorder. All you need do is break the line between the bypass capacitor (C1) and insert a 220-ohm, 2-watt, carbon-composition or metallic-film resistor between the center pin of J1 and the capacitor. When the transceiver relay terminals short together, the

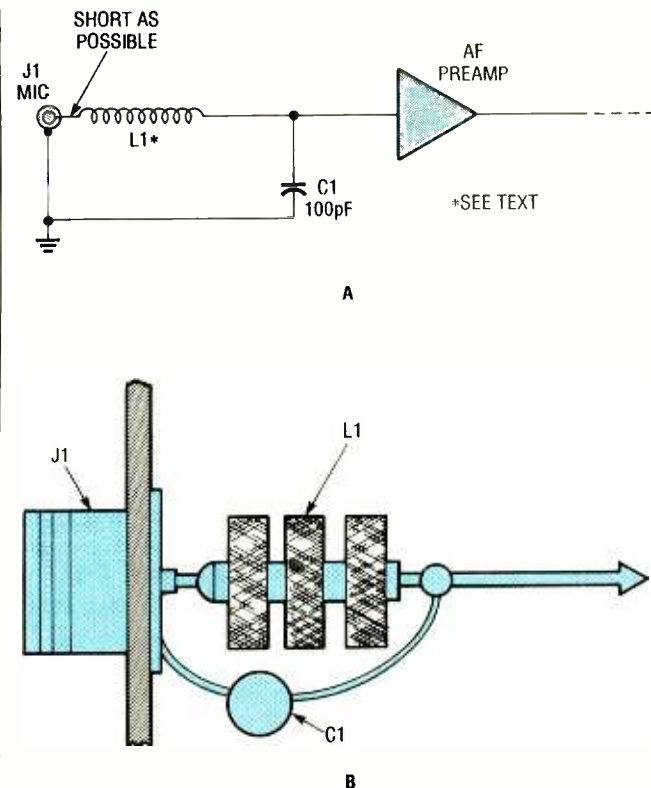

Fig. 2. A lowpass filter—consisting of L1 and C1—can be added to the microphone-input circuit to pass audio signals, while severely attenuating RF signals. Shown in B is the typical mechanical configuration of the lowpass filter; the coil should be mounted as close as physically possible to the microphone jack.

resistor acts to limit the current. Don't use a higher value resistor, or the time constant (set up by the resistor and capacitor) may interfere with the operation of the linear amplifier.

Figure 1B also shows a little "fix" that's used if your transceiver has a transistor instead of a relay. Some older linear amplifiers (and, I suspect, some newly produced older designs) use an internal relay that has no spike protection across the coil. Any inductor will produce a counter-electromotive force (CEMF) when the current in the inductor is interrupted. In other words, a high-voltage spike of opposite polarity to the supply voltage is generated when the coil is de-energized.

That inductive kickback can damage the control transistor in the transceiver that energizes the linear amplifier's relay. Connect

one or two diodes in parallel (with a reverse-bias orientation) with the relay coil. Figure 1B shows the orientation of the diodes used when the source voltage is positive (B+). If, on the other hand, the DC voltage to the relay is negative (B-), then the diodes should be reversed.

The diodes are reverse biased under normal conditions, but are forward biased for CEMF spikes; that results in the spikes being clipped to a safe level.

RF-TO-AUDIO FEEDBACK

You start getting complaints that your signal is very broad, and a bit distorted; in fact, it's downright sinful to stay on the air, you are told. Funny, the problem didn't exist until I bought that linear amplifier. The problem might be RF electromagnetic interference (EMI) getting into the rig,

causing feedback and biasing (through auto-rec-tification) of the audio preamplifier stages.

Fortunately, that problem is less likely today because microphone impedances are lower than in the past. However, the problem is not altogether gone. First, check the microphone's shielded cable. A gap of an inch or two between the end of the shield and the connector pin may suppress 60 Hz hum, but still allow a *heckuva* RF path into the rig!

If the microphone's shielded cable is OK, then you might want to experiment with the low-pass filter shown in Fig. 2A. By adding the filter to the microphone-input circuit, audio signals are allowed to pass, while RF signals are severely attenuated. The lowpass filter consists of a radio-frequency choke (L1) connected in series with the signal line and a bypass capacitor connected across the signal line.

The capacitor value can range from 100 pF to 0.001 μ F, but I prefer to use the smallest value that does the job (there's less chance of attenuating high, audio frequencies that way). Capacitor C1 should be a ceramic-disc or a mica capacitor, with the former being preferred. The value of L1 should range from 1 to 2.5 mH in HF rigs, and be about 100 μ H in VHF/UHF rigs. Figure 2B shows the typical mechanical configuration; note that the coil is mounted as close as physically possible to the microphone jack. That is to prevent RF from "spraying" into the rig's circuitry.

Now, about that "number one fault." Believe it or not, it is "no trouble found!" Many of those rigs were just packed and shipped off without even a basic attempt at troubleshooting. It really makes you wonder! ■

SCANNER SCENE

By Marc Saxon

Handheld Memories, and X-Rated McDonalds' Chatter

Not too many handheld scanners offer you the chance to hold 1000 memory channels in the palm of your hand. A notable exception is the *AOR AR 1000*, made by Ace Communications. Yes, my friends, it has 1000 channels and a tuning range that starts out at 8 MHz (in the HF band) and runs straight on through to 1300 MHz. The only coverage missing is 600 to 805 MHz, and that's just some UHF-TV channels. But the 800-MHz communications frequencies are all intact; they haven't been locked out at the factory.

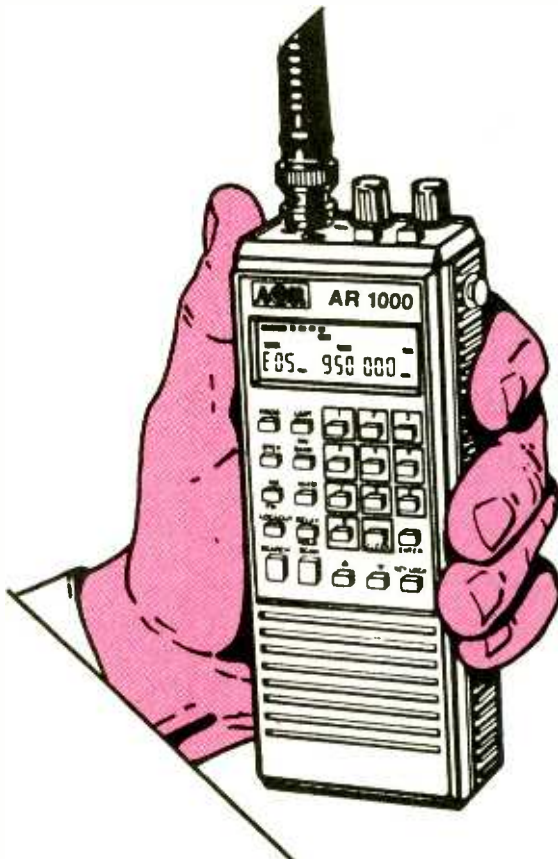

AOR packs a lot of punch into a small package with its AR 1000. The handheld boasts 1000 memory channels and a wide tuning range.

The AR 1000 scans at 20 channels-per-second, and can search at 40 channels-per-second. The memory is set up in ten banks, and there are ten search banks. The AR 1000 can search in selectable bands from 5 to 955 kHz. It receives NFM, WFM, and AM modes, in 5- and 12.5-kHz steps.

Among the scanner's features are a manual-tuning knob, a selectable priority channel, permanent memory backup, a 10-dB attenuator switch, and a cigarette-lighter charger.

The AR 1000 is designed to operate on four "AA" rechargeable batteries. Sensitivity is rated at 0.35 μ V in NFM, and 1 μ V in AM and WFM. The unit weighs 12 ounces.

This looks like a lot of scanner, and it's priced in the \$500 ballpark. For more information on the AOR AR 1000 handheld, contact Ace Communications Monitor Division, 10707 E. 106th St., Fishers, IN 46038.

SPEAKING OF HANDHELDS...

Ted Rybicki, of Staten Island, NY, wrote to tell us that he has a Bearcat 100XLT handheld and found that, even though the cellular bands were locked out at the factory, the calls still come through! Ted reports that he finds that to be the case if he searches 894 to 913 MHz, which is above the cellular allocation.

That is known as "image" reception, Ted, and works surprisingly well with some scanners. Owners of other Bearcat scanners (all mod-

els that receive the 800-MHz band) may well find that it works for them, too.

The reason it works is that the scanner appears quite willing to pick up phantom signals from other bands, based on twice the IF frequency, subtracted from the frequency to which the scanner is tuned. Bearcat scanners use an IF of 10.8 MHz, and if you apply the formula to the band Ted is tuning, it will be noted that it represents a portion of the band used by the cell sites.

Ted also reports that ever since this column suggested listening on 154.60 MHz for drive-up window communications at McDonalds, he's gotten a lot of enjoyment out of listening in on the one not far from his location.

MORE THAN A BIG MAC?

Ted's letter arrived in the same mail as one from an anonymous reader in Shawnee, KS. That reader sent us a newspaper clipping about McDonald's workers there being startled by strange voices and information suddenly emerging from their wireless headsets one night. The voices were describing ladies' lingerie and bikini bathing suits.

They quickly realized that the McDonalds receivers were picking up signals from a wireless microphone being used at a nearby bar that had just reopened. The place had been shut down by the police several months earlier because the live erotic-dancing shows

there violated zoning ordinances. Now it was open again, and they were having what they described as a "fashion show."

The manager of the McDonalds called the bar to explain the problem, and the announcer cooperated by switching to another channel. A few hours later, police arrived again to hand out citations in the bar charging violations of zoning and nudity ordinances.

It was a night that McDonalds' employees and scanner owners in Shawnee won't forget for a very long time!

BIG BADGE MAN

Several readers have written to ask about the FCC has field-engineering crews that perform various functions, including such things as broadcast-station inspections, interference, investigations, and catching pirate stations. Basically, those readers would like to scan in on any communications relating to these activities, and hope that we can point them in the right direction.

To the best of our knowledge, the single most-popular scanner frequency used nationwide by the FCC for its operational communications is 167.05 MHz. The field units, however, can operate on any communications frequency. You may hear them operating on the frequency of a station they are checking out, and conversing with that station.

SCRAMBLERS

Some VHF/UHF communications systems use voice scrambling in order to maintain the privacy of their traffic. We get quite a bit of mail here asking about where to purchase units that will turn those transmissions into something that makes sense.

Without attempting to get too deep into a technical rap here, suffice it to say that there are two basic types of voice scrambling that you're likely to encounter while scanning. The simplest, and most inexpensive for an agency to use, is an analog system using a type of speech inversion. To an outsider, that results in sounds like a duck quacking. Some police and conservation agencies use that system.

Federal agencies such as the FBI (and others) transmit some of their traffic in a digital scrambling system. That method is far more sophisticated and secure than analog methods. To the person listening on a scanner, such transmissions sound like a steady hissing noise. No technology has been devised to permit outsiders to descramble such transmissions. Moreover, there are many different scrambling codes, and these are changed regularly.

Analog scrambling, on the other hand, isn't too difficult to descramble. For a number of years, you could purchase inexpensive little descramblers for doing just that. Such units haven't been (legally) sold since the passage of the Electronic Communication Privacy Act of 1986. Used ones are worth their weight in gold!

If you search between 163 and 164 MHz, or 167 and 168 MHz, you're likely to hear occasional transmissions sent using digital scrambling. The most popular system appears to be Motorola's DVP.

Until next time, remember we are here to answer your questions, to pass along frequencies, and more. Our address is: **Scanner Scene, Popular Electronics**, 500-B Bi-County Boulevard, Farmingdale, NY 11735. ■

Save on cable rental fees!

CABLE TV DESCRAMBLERS WE'LL BEAT ANY PRICE!

CALL TOLL-FREE 1-800
284-8432

JERROLD-TOCOM-ZENITH
HAMLIN-OAK-PIONEER
SCIENTIFIC ATLANTIC

- 24 HOUR SHIPMENTS!
- MONEY BACK GUARANTEE!
- FREE CATALOG & INFO!
- QUANTITY DISCOUNTS!

MASTER CARD / AMEX / VISA / C.O.D.



Have make and model number of equipment used in your area ready

1-800-284-8432

CABLE WAREHOUSE

4700 N. HIATUS ROAD, SUNRISE, FLA. 33351
NO FLORIDA SALES

CIRCLE 15 ON FREE INFORMATION CARD

FCC LICENSE PREPARATION

- General Radiotelephone
- Radiotelegraph
- Amateur Radio Licenses

We offer the most up-to-date study materials available. Our formats include: texts, audio programs, and video programs.



WPT PUBLICATIONS
979 Young Street, Suite E
Woodburn, OR 97071
(503) 981-5159

CIRCLE 10 ON FREE INFORMATION CARD

Popular Electronics REPRINT BOOKSTORE

- | | |
|--|---|
| <input type="checkbox"/> 221 Popular Electronics (1991 back issues) \$4.00
Write in issues desired _____ | <input type="checkbox"/> 107 Radio-Electronics (1987 back issues) . \$5.25
Write in issues desired _____ |
| <input type="checkbox"/> 220 Popular Electronics (1990 back issues) \$4.50
Write in issues desired _____ | <input type="checkbox"/> 106 Radio-Electronics (1986 back issues) . \$5.50
Write in issues desired _____ |
| <input type="checkbox"/> 119 Popular Electronics (1989 back issues) \$4.75
Write in issues desired _____ | |
| <input type="checkbox"/> 118 Hands-On Electronics (1988 back issues)
Write in issues desired _____ \$5.00 | |
| <input type="checkbox"/> 117 Hands-On Electronics (1987 back issues)
Write in issues desired _____ \$5.25 | |
| <input type="checkbox"/> 116 Hands-On Electronics (1986 back issues)
Write in issues desired _____ \$5.50 | |
| <input type="checkbox"/> EH91 Experimenters Handbook (1991) . . . \$4.50 | |
| <input type="checkbox"/> EH90 Experimenters Handbook (1990) . . . \$5.00 | |
| <input type="checkbox"/> EH88 Experimenters Handbook (1988-89) \$5.50 | |
| <input type="checkbox"/> EH87 Experimenters Handbook (1987) . . . \$6.00 | |
| <input type="checkbox"/> HH91 Popular Electronics Hobbyist Handbook (1991) . . . \$5.00 | |
| <input type="checkbox"/> HH90 Popular Electronics Hobbyist Handbook (1990) . . . \$5.50 | |
| <input type="checkbox"/> HH89 Popular Electronics Hobbyist Handbook (1989) . . . \$6.00 | |
| <input type="checkbox"/> 126 Radio-Electronics Annual 1986 \$6.00 | |
| <input type="checkbox"/> 211 Radio-Electronics (1991 back issues) . \$4.00
Write in issues desired _____ | |
| <input type="checkbox"/> 210 Radio-Electronics (1990 back issues) . \$4.50
Write in issues desired _____ | |
| <input type="checkbox"/> 109 Radio-Electronics (1989 back issues) . \$4.75
Write in issues desired _____ | |
| <input type="checkbox"/> 108 Radio-Electronics (1988 back issues) . \$5.00
Write in issues desired _____ | |

REPRINTS REPRINTS

- | | |
|--|--|
| <input type="checkbox"/> 169 Think Tank (133 Circuits) \$3.50 | <input type="checkbox"/> 169A Think Tank Vol. 2 \$3.00 |
| <input type="checkbox"/> 168 Fact Cards (#34-66) \$4.00 | <input type="checkbox"/> 168C Fact Cards (#67-99) \$3.50 |
| <input type="checkbox"/> 168D Fact Cards (#100-132) \$3.50 | <input type="checkbox"/> 167 Designing With IC's \$4.00 |
| <input type="checkbox"/> 166 Collected Works of Mohammed Ulyses Fips (62 pages, April Fools Collection) . . . \$5.00 | <input type="checkbox"/> 165 How to Repair CD Disc Players . . . \$5.00 |
| <input type="checkbox"/> 164 Modern Electrics (April 1908) . . . \$3.00 | <input type="checkbox"/> 163 Receiving Satellite TV \$5.00 |
| <input type="checkbox"/> 162 Build Your Own Satellite TV Receiver \$5.00 | <input type="checkbox"/> 161 Descrambling (Feb. 1984) \$3.00 |
| <input type="checkbox"/> 160 New Ideas - 42 Circuits \$3.50 | <input type="checkbox"/> 159 Low Frequency Receiving Techniques Building and using VLF Antennas . . . \$5.00 |
| <input type="checkbox"/> 158 Electro Importing Co. Catalog (Circa 1918) \$5.95 | <input type="checkbox"/> 157 All About Kits \$2.00 |
| <input type="checkbox"/> 156 How To Make PC Boards \$2.00 | <input type="checkbox"/> 155 IBM Typewriter To Computer . . . \$2.00 |
| <input type="checkbox"/> 154 How To Repair VCR's \$3.50 | <input type="checkbox"/> 150 Pay TV Decoder (1981) \$3.00 |

To order any of the items indicated above, check off the ones you want. Complete the order form below, **include your payment**, check or money order (DO NOT SEND CASH), and mail to **Popular Electronics**, Reprint Department, P.O. Box 4079, Farmingdale, NY 11735. Please allow 4-6 weeks for delivery.

If you need a copy of an article that is in an issue we indicate is unavailable you can order it directly from us. We charge 50¢ per page. Indicate the issue (month & year), pages and article desired. Include payment in full, plus shipping and handling charge. Make checks payable to Gernsback Publications, Inc.

ARTICLE _____

PAGES _____ MONTH _____ YEAR _____

TOTAL PAGES _____ @ 50¢ each TOTAL PRICE _____

MAIL TO: Popular Electronics

Reprint Bookstore, P.O. Box 4079, Farmingdale NY 11735

All payments must be in U.S. funds

SHIPPING CHARGES IN USA & CANADA

\$0.01 to \$5.00 \$1.25	\$30.01 to 40.00 \$5.00
\$5.01 to \$10.00 \$2.00	\$40.01 to 50.00 \$6.00
\$10.01 to 20.00 \$3.00	\$50.01 and above . . . \$7.50
\$20.01 to 30.00 \$4.00	

SORRY — We only ship to USA & Canada

Total price of merchandise \$ _____
Sales Tax (New York State Residents only) \$ _____
Shipping Charge (see chart) \$ _____

Name _____ Total Enclosed \$ _____

Address _____

City _____ State _____ Zip _____

PE691

AUTOCOMMAND CAR STARTER (Continued from page 62)

can install and that is a temperature sensor that will turn on the motor for intervals throughout the night to prevent freezing in sub-zero weather. The sensor is attached to the upper radiator hose. When the temperature falls to 0°F the AutoCommand system will start the engine. When the sensor heats to a certain temperature it shuts the engine down until the sensor falls back to 0°F. At temperatures above 0°F, the sensor has no effect on the system and can be left installed year round.

Further Info. The system comes in two versions: the AutoCommand and the AutoCommand Plus (the latter was reviewed in this report). Both systems contain the car-starter control unit with all the features necessary to control and monitor the starting of your car. They include multiple built-in safety and security features and the control unit in both systems has the built-in LED diagnostic system.

However, the basic AutoCommand system does not contain the remote-control radio system; that version is intended for users who already have a remote-control radio transmitter/receiver system incorporated in their cars—such as a remotely armed and disarmed alarm system. For those installations, the user's remote radio transmitter system can be used to trigger AutoCommand to start your car when you disarm the alarm system. The AutoCommand Remote-Control Car Starter carries a suggested retail price of \$229.00.

AutoCommand Plus adds a remote-control radio transmitter and receiver system, which has an operating range of up to 400 feet. The AutoCommand Plus Remote-Control Car Starter sells for \$320.00 and it includes the remote car starter, miniature radio transmitter, radio receiver, and installation kit.

Both versions can be obtained directly from DesignTech International Inc., 7401 Fullerton Road, Building I, Springfield, Virginia, 22153; telephone 703/866-2000, FAX 703/866-2001, or purchases can be made from selected auto-parts distributors in North America. For more information on the AutoCommand Remote Car Starter, contact Design Tech International directly, or circle No. 119 on the Free Information Card. ■

PROTOMAX DESIGN STATION

(Continued from page 33)

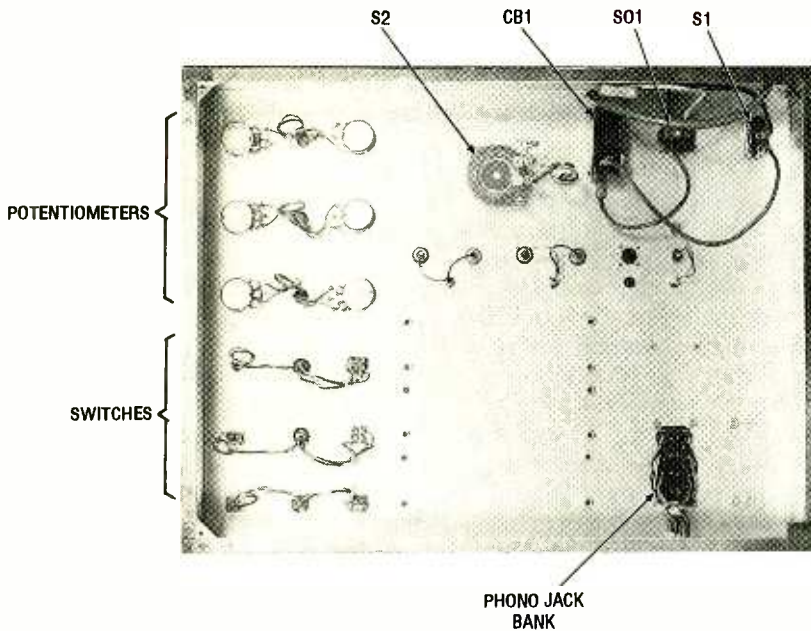

Here's an inside view of ProtoMax, prior to the installation of the multitude of inter-connecting wires. Insert a rubber grommet in any hole through which wires are to pass to prevent jagged edges around the hole from stripping the insulation from the wires. To prevent accidental disconnection of any of the connecting wires, be sure to use strain reliefs: Anything that will prevent pressure being exerted on the connection joints themselves is fine.

don't move too slowly. Repeat that procedure every 20 minutes until the cabinet is thoroughly coated.

Just remember though, no matter how you paint your cabinet, be sure to wait at least 24 hours for the paint to dry completely. It may seem dry after an hour or so, but the finish doesn't harden for some time after that.

When the paint is fully dry, mount all of the components in the proper holes and then turn the unit over for wiring. Be careful not to scratch the paint as you install the components. It is a good idea to place the project on a throw rug or an old piece of carpet to prevent marring the finish.

When wiring each component, you should solder a lead to each of their terminals. That way they'll be as versatile as possible. Make sure that the wire that you use can fit in the breadboard sockets after it has been tinned. You can use solid wire, but it has a tendency to break more easily than stranded wire. Try to come up with some sort of color scheme so that you can immediately tell which wire goes where. If you don't have enough different colors for easy identification, you

can mark some of the wires with pieces of heat-shrink tubing placed at various places along their length.

Use at least a foot of wire for each lead, so that it will be easy to test-wire your circuits later on. Twist all the wires common to one component together, and pass them through a grommeted hole. Also, it's a good idea to add some kind of strain-relief to the wire coming out of the front panel.

There are two methods of incorporating strain relief to the leads. In one, a self-locking wire-tie larger than the hole itself prevents the wires from tugging on the solder connections. In the other, a loop of wire is fastened behind the panel and performs the same job in places where a large grommet is used. Use whichever method you find to be the easiest.

Turning back to the other side of the unit, each group of wires should be uniformly cut, and the ends of the wires stripped and tinned. The wires can then be plugged right into the breadboard whenever the component they are connected to is needed.

Now let's go over a few of the finishing touches that were done to our Pro-

toMax. To begin with, adhesive-backed rubber feet were put on the underside of the enclosure at all four corners. That way, the unit will stay put on your workbench.

Also, a neat little metal utility box was attached to the side of the unit using Velcro tape. It is very handy for toting tools that you use all the time (but can never seem to find). Ours contains bus wire for protoboard wiring, an IC extractor, small wire strippers, test-instrument leads, and a full compliment of color-coded alligator clips (which, no matter how many you have, you never seem to have enough of).

As a final touch, adhesive-backed snap clips are used to hold the leads out of the way when not in use. Place them on the front of the unit in positions where they will do the most good. Notice the unused wires for the ProtoMax are a good distance from the protoboard and don't interfere with controls and such.

Now you are ready to tackle the "meanest" of test circuits without even breaking a sweat from running around looking for components. Everything will be all together whenever you need it and at your finger tips. ■

SUPER LONG PLAY TAPE RECORDERS

12 Hour Model — USES 120 TAPE
\$119.00*

Modified Panasonic Slimline high quality AC-DC provide 6 continuous hours of quality recording & playback on each side of cassette for 12 hours total. Includes • Voice level control • Digital counter, etc. TDK - 120 Cassette. Furnished.



PHONE RECORDING ADAPTER

Records calls automatically. All Solid state connects to your telephone Jack and tape recorder. Starts recording when phone is lifted. Stops when you hang up.
\$28.50* FCC APPROVED



VOX VOICE ACTIVATED CONTROL SWITCH

Solid state Self contained Adjustable sensitivity. Voices or other sounds automatically activate and control recorder. Uses either recorder or remote mike.
\$28.50*



* Add for ship. & handling Phone Adapter & Vox \$2.00 each
 Recorders \$5.00 each Cash Res. add tax Mail order VISA
 M/C, COD's OK Money Back Guarantee. Quantity discounts
 available Dealer Inquiries invited. Free data

AMC SALES INC. Dept. B 9235 Lubec Street
 Box 228 Desney CA 90241
 Phones (213) 664-2515 1 800 426 2488
 FAX (213) 925-1478
 Mon-Fri 9-5 PAC TIME

CIRCLE 6 ON FREE INFORMATION CARD

FUN WITH ELECTRONICS

Coil Design and Construction Manual



◀ **160—COIL DESIGN & CONSTRUCTION MANUAL** \$5.95. How to make RF, IF, audio and power coils; chokes and transformers. Practically every possible type is discussed.

◀ **BP87—50 SIMPLE LED CIRCUITS, BK 2** \$5.50. Fifty more uses for the simple LED. Combine this book with BP42 and you'll have a file of 100 useful LED applications.



◀ **BP45—PROJECTS IN OPTOELECTRONICS** \$5.50. Describes a number of projects including infrared transmitters, modulated light transmission and photographic projects.

◀ **BP33—ELECTRONIC CALCULATOR USERS HANDBOOK** \$5.75. Presents formulae, data, methods of calculation, conversion factors, etc., with the calculator user especially in mind, often illustrated with simple examples.



50 (FET) Field Effect Transistor Projects



◀ **BP39—50 FET TRANSISTOR PROJECTS** \$5.50. The projects described in this book include RF amplifiers and converters, test equipment and receiver aids, tuners, receivers, mixers and tone controls and a variety of other circuits.

◀ **#219—SOLID STATE NOVELTY PROJECTS** \$4.95. How to build a number of novelty projects including a musical instrument played by reflecting a light beam with your hand, water warbler for pot plants, musical tone generator, touch switch and more.



MAIL TO: **Electronic Technology Today Inc.**
P.O. Box 240
Massapequa Park, NY 11762-0240

SHIPPING CHARGES IN USA AND CANADA

\$0.01 to \$5.00	\$1.25	\$30.01 to \$40.00	\$5.00
\$5.01 to 10.00	\$2.00	\$40.01 to \$50.00	\$6.00
\$10.01 to \$20.00	\$3.00	\$50.01 and above	\$7.50
\$20.01 to \$30.00	\$4.00		

SORRY, No orders accepted outside of USA and Canada

Total price of merchandise \$ _____
Shipping (see chart) \$ _____
Subtotal \$ _____
Sales Tax (NYS only) \$ _____
Total Enclosed \$ _____

Name _____

Address _____

City _____ State _____ Zip _____

COMPUTER SWITCH

(Continued from page 55)

and hang up. Your computer equipment will now be off and the decoder circuit will still be on and awaiting your next call.

Remote Access Software. The average modem communication software will not allow remote access to the computer's operating system. Several commercial software packages are sold specifically for that purpose. Two popular ones are Carbon Copy and PCAnywhere. There are even good shareware packages available that allow remote access such as Tandem and Telereplica, which can be easily downloaded from many bulletin boards. In any event, your selection should include one that has the password, answer, and hang-up string function.

Some programs called "doors" will attach to your regular communications software and will allow regular communications to provide a secondary function to allow remote-access capability. The host computer (the one being accessed) can then be controlled, searched, and files down loaded or up loaded while using your favorite modem program. Again, whatever modem program you use should be capable of setting both the answer string and the hang-up string, which can be used to control the auto-answer feature of the modem.

Check Out and Troubleshooting. It is most likely that the circuit will work properly on the first try. But just in case it doesn't, here are a few things to look for

if the circuit does malfunction! Of course, such things as chips inserted backward and leads going to the wrong pins could be possible causes. Those possible trouble sources should be checked out before powering up the circuit. (I learned to do this after blowing several expensive IC's by thinking that I could always check for those types of problems if the circuit failed to work.)

Double check to be certain that S1 is in the on position. If so, check S2-S4 to make sure they are not in the "bypass" mode. Usually, the most common malfunction will be no activation of one or more of the Triacs when a tone is entered. A good logic probe can be used to show if the tone decoder (U1) is producing the DAV latch pulse at pin 14 each time a key is pressed. If not, press the 1 key on the keypad while the answering machine is recording a message and place the probe on pin 1 of U1. A high state should be produced each time the key is pressed.

Another probable cause of a malfunction is that the tone is not properly reaching U1. Try tuning up the volume slightly on the answering machine. If that doesn't help, try turning the volume down; the volume may be too high, distorting the signal. Then try a different capacitor value for C1. If U1 seems to be functioning properly, place your probe on pin 9 of U3 to verify that the DAV pulse fed through U2-a and U2-b is reaching the latch. If not, check the wiring on pins 3 and 4 of U2.

If each time the tone is released, LED's D2-D4 go out, check for a constant high at pin 1 (clear) of U3, which must have a high for the latch to hold the data. Otherwise, the latch just follows the clock.

The optoisolators/couplers (U4-U6) could be bad if data seems to be getting to them but they are not responding. If you are sure of your wiring and only one Triac seems to be malfunctioning, try switching them. Make sure the power is off before working on the Triac board.

Conclusion. Like the telephone, this can be a very useful device. It is not a toy and could be a very useful part of every serious communications system. The circuit will pay for itself the first time you don't have to drive to the office to get a file from the computer. But it also saves time, effort, and wear and tear on the computer and even more important, your nerves. ■

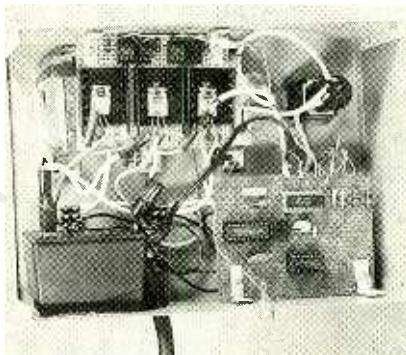

Access III was built on two sections perfboard; one section containing the decoder/latch portion of the project, and the other containing the optocoupler/Triac portion of the unit. Point-to-point wiring was used to interconnect the board-mounted components.

FUN SOFTWARE

(Continued from page 71)

rate representation of combat flying during World War I, including a two-player feature using modems or a data cable. Lightspeed (IBM), which uses 3-D graphics, requires the player to explore star clusters.

Virgin Mastertronic now offers The Computer Edition of Deluxe Scrabble Brand Crossword Game (IBM \$59.99) to replace the earlier version. The Official Scrabble Player's Dictionary is included, with four players, nine skill levels, and a wide range of timers supported. Super Off-Road (IBM \$39.99; Amiga, Atari ST, Commodore 64 to follow) includes features carried over from the arcade version of Ivan "Ironman" Stewart's Super Off-Road, and includes options for up to three players with sixteen

different racing tracks.

GAMETEK, creators of highly popular computer games such as Jeopardy and Wheel of Fortune, has just added Carl Lewis Go For The Gold (IBM \$29.95) designed for up to five players in ten Olympic decathlon events. They also recently released Harlem Globetrotters (IBM \$29.95) for up to three players.

Special mention should go to Bill Dedes for his inexpensive, clever, and colorful puzzles and games (some specially designed to use VGA graphics and colors) offered through the shareware marketplace. Request his illustrated catalog (no price stated, but \$1 would be fair) from Alive Software, P.O. Box 4004, Santa Clara, CA 95056. You can call his BBS at 408-982-9345, 1200 or 2400 baud, 8N1, for downloading the latest Alive shareware and information. ■

Phonvu Videophone in a Chip

STILL FRAME TV PICTURE TELEPHONE
TRANCEIVER KIT
Sends Slow Scan TV pictures over
The phone line in Twelve Seconds

**Captures any TV Camera, Camcorder
VCR, NTSC Video output and holds
the display and sends on command**

**Auto Mode allows hands free send
and receive. Displays on any TV**

IC Chip Replaces 150 SSI Dips

**50 Levels
of Grey Scale
Serves as:
TV FAX**

Camera 200 x 2425
High Res.
**50,000
Pixels**

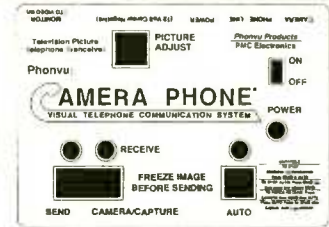
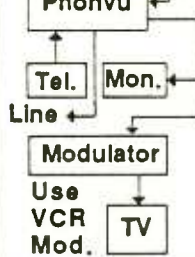

Videophone Chip and Schematic	48P DIP	\$59.95
A/D, DRAM, & CHIP SET		\$35.00
PC Board (BARE)		\$18.95
DISCRETE COMPONENTS		\$28.75
Cabinet (MOLDED)		\$12.75
Power Pack		\$ 8.75
KIT PRICE:		\$ 164.15
ASSEMBLED		TOTAL \$ 235.00

VISA/MC, PHONE & FAX Order (213) 827-1852
PMC Electronics Box 11148
Marina Del Rey, CA 90292

CIRCLE 18 ON FREE INFORMATION CARD

Popular Electronics

WE
**HAVE THE
RIGHT
ANSWER**

Advertisers who want to place their print ads in a quality publication ask the question: "Is your circulation audited?" We're very proud to answer "Yes."

We are a member of the Audit Bureau of Circulations because we share ABC's belief that circulation audits are an essential assurance of value.

ABC is the premier circulation auditing organization in the world, and has been since 1914. Each year, ABC auditors test and verify that our circulation figures are facts, not claims. An ABC audit is the sign of a sound investment for advertisers.

Not all publications are audited, but they should be. Because when advertisers ask "Is your circulation audited?" there's only one answer.

"Yes."



Audit Bureau of Circulations

CIRCUIT CIRCUS

(Continued from page 73)

radiation perpendicular to the loop. The receiver loop offers the same directional properties as the transmitter's loop, but since it is positioned perpendicular to the transmitter loop, almost no energy is detected. When a metal object is placed within the field of either loop, the loop's magnetic field is slightly distorted, allowing the receiver to detect a small part of the redirected energy.

The VLF receiver, see Fig. 4, is built around an LM1458 dual op-amp and a single 2N3904 general-purpose NPN silicon transistor. Coil L1, the pick-up device, is a homebrew inductor (100-turn loop) that is tuned to approximately 7 kHz by C6. Any 7-kHz signal picked up by the loop is fed to U1-a, which provides a gain of 100. The second op-amp is also configured for a gain of 100. The two op-amps produce a combined gain of 10,000, depending of the setting of R8. The output of U1-b at pin 7 is fed to a rectifier circuit that converts the 7-kHz signal into a positive DC voltage.

That DC voltage is then fed to the base of Q1 through R5, causing Q1 to turn on. With Q1 turned on, BZ1 sounds to indicate that metal has been detected. Power for the receiver is supplied by a single 9-volt transistor radio battery.

The transmitter portion of the circuit (see Fig. 5) is built around a single transistor that's configured as a Colpitts oscillator. The transmitter's sensing coil, L1 (another 100-turn loop), is tuned to about 7 kHz by capacitors C2-C4. Transmitter power is supplied by a 9-volt battery.

Assembling the circuit is a snap. The loops are wound

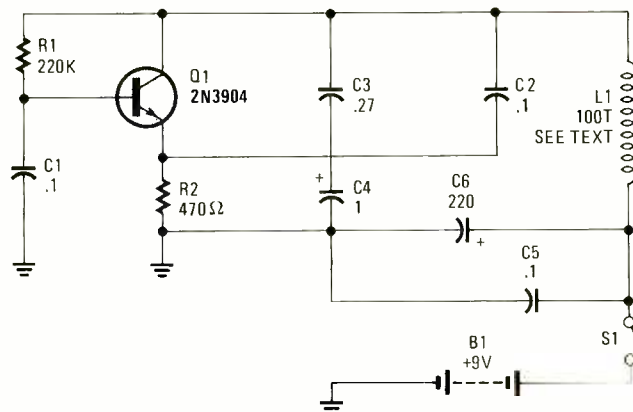

Fig. 5. The transmitter portion of the detector is built around a single transistor that's configured as a Colpitts oscillator, and another 100-turn coil (the transmitter's sensing loop), which is tuned to about 7 kHz by capacitors C2-C4.

PARTS LIST FOR THE VLF TRANSMITTER

CAPACITORS

C1, C2, C5—0.1- μ F, ceramic-disc or mylar

C3—0.27- μ F, Mylar or similar

C4—1.0- μ F, Mylar or similar

C6—220- μ F, 16-WVDC, electrolytic

ADDITIONAL PARTS AND MATERIALS

B1—9-volt transistor-radio battery

Q1—2N3904 general-purpose NPN silicon transistor

R1—220,000-ohm $\frac{1}{4}$ -watt, 5% resistor

R2—470-ohm, $\frac{1}{4}$ -watt, 5% resistor

L1—Transmitter loop, see text

S1—SPST switch

Perfboard materials, enclosure, battery holder and connector, wire, solder, hardware, etc.

on plastic end caps (that are made to fit on 4-inch plastic pipe) with an outside diameter of 4½ inches. The coil is made by jumble-winding 100 turns of number-26 enamel-covered copper wire around the center of each end cap. The ends of the coil are then taped in place. The loops are then mounted to opposite ends of a wood dowel (about 12 inches), and oriented perpendicular to each other.

The receiver and transmitter circuitry can be built on perfboard and mounted inside the end caps on which the loops are formed, or placed in separate plastic enclosures and positioned away from the dowel mounted loops.

Tuning up and checking out the detector is easy. Turn both units on; the buzzer (BZ1) should sound. Turn

the receiver's gain down until the sound just about ceases, and then slowly rock the transmitter's loop back and forth until a perfect null is obtained. Keep increasing the receiver's gain and re-positioning the transmitter for the deepest null. If everything is working correctly, the null (at full receiver gain) will be sharp. If not, the receiver and transmitter may not be tuned to the same frequency.

To tune the receiver to the transmitter's frequency, connect a DC voltmeter to the cathode of D1 and vary C6 for the maximum output voltage at the diode; 4 to 5 volts is normal.

The detector is most sensitive when the circuit is operating at maximum gain and off null just enough to produce a low-level output from BZ1. ■

PRODUCT REPORT

(Continued from page 65)

seen equalled by other CD changers, which use separate cartridges for disc loading. Perhaps more important than these physical qualities of the player is the quality of musical reproduction that the CDPlayer2 delivers. It is extremely clean and smooth, even during whisper-soft moments in a musical selection where some players tend to imbue sounds with a gritty or grainy characteristic.

About the only thing we would have liked to see on this model that was not present is the ability to access a given index point within a track, where such index points are included in a CD. Since it is possible to fast-search forward or backward, however, this is not a serious omission.

If you have been debating between a single-play CD player (for its supposedly superior sound) and a multiple disc machine (for its convenience) you need seek no further than the Nakamichi CDPlayer2. While this player's suggested retail price (\$799) is certainly justified, if that's a bit steep for your budget you might want to consider Nakamichi's other MusicBank CD Player, the CDPlayer3. That player has a suggested price of \$599.00, and the only difference between it and the more expensive model is the use of 18-bit D/A converters (as opposed to the 20-bit type used in the CDPlayer2) and the fact that it does not use the new high-stability servo system.

For more information on the CDPlayer2, contact Nakamichi (19701 S. Vermont Ave., Torrance, CA 90502) directly, or circle no. 120 on the Free Information Card. ■

5 sure steps to a fast start as a high-paid computer service technician

1. Choose training that's right for today's good jobs

Jobs for computer service technicians will almost double in the next 10 years, according to the latest Department of Labor projections. For you, that means unlimited opportunities for advancement, a new career, or even a computer service business of your own.

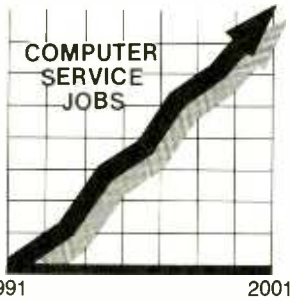

But to succeed in computer service today, you need training—complete, practical training that gives you the confidence to service any brand of computer. You need NRI training.

Only NRI—the leader in career-building, at-home electronics training for more than 75 years—gives you practical knowledge, hands-on skill, and real-world experience with a powerful AT-compatible computer you keep. Only NRI starts you with the basics, then builds your knowledge step by step until you have everything you need for a fast start as a high-paid computer service technician.



2. Go beyond "book learning" to get true hands-on experience

NRI knows you learn better by doing. So NRI training works overtime to give you that invaluable practical experience. You first read about the subject,

studying diagrams, schematics, and photos that make the subject even clearer. Then you do. You build, examine, remove, test, repair, replace. You discover for yourself the feel of the real thing, the confidence gained only with experience.

3. Get inside a powerful computer system

If you really want to get ahead in computer service, you have to get inside a state-of-the-art computer system. That's why NRI includes the powerful new West Coast 1010 ES computer as the centerpiece of your hands-on training.

As you build this fully IBM AT-compatible micro from the keyboard up, you actually see for yourself how each section of your computer works. You assemble and test your computer's "intelligent" keyboard, install the power supply and high-density floppy disk drive, then interface the high-resolution monitor. But that's not all.

You go on to install a powerful 20 megabyte hard disk drive—today's most-wanted computer peripheral—included in your course to dramatically increase the data storage capacity of your computer while giving you lightning-quick data access.



Plus, now you train with and keep the latest in diagnostic hardware and software: the R.A.C.E.R. plug-in diagnostic card and QuickTech diagnostic software, both from Ultra-X. Using these state-of-the-art diagnostic tools, you learn to quickly identify and service virtually any computer problem on IBM-compatible machines.

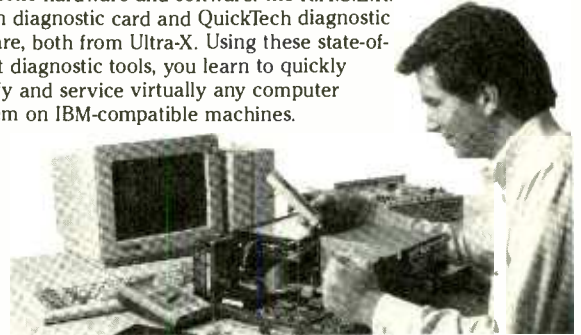

4. Make sure you've always got someone to turn to for help



Throughout your NRI training, you've got the full support of your personal NRI instructor and the entire NRI technical staff. Always ready to answer your questions and help you if you should hit a snag, your instructors will make you feel as if you're in a classroom of one, giving you as much time and personal attention as you need.

5. Step into a bright new future in computer service—start by sending for your FREE catalog today!

Discover for yourself how easy NRI makes it to succeed in computer service. Send today for NRI's big, 100-page, full-color catalog describing every aspect of NRI's one-of-a-kind computer training, as well as training in robotics, TV/video/audio servicing, electronic music technology, security electronics, and other growing high-tech career fields.



If the coupon is missing, write to: NRI School of Electronics, McGraw-Hill Continuing Education Center, 4401 Connecticut Avenue, NW, Washington, DC 20008. R.A.C.E.R. and QuickTech are registered trademarks of Ultra-X, INC.

NRI Schools

McGraw-Hill Continuing Education Center
4401 Connecticut Avenue, NW, Washington, DC 20008

CHECK ONE CATALOG ONLY

- | | |
|--|--|
| <input type="checkbox"/> Microcomputer Servicing | <input type="checkbox"/> Computer Programming |
| <input type="checkbox"/> TV/Video/Audio Servicing | <input type="checkbox"/> PC Systems Analysis |
| <input type="checkbox"/> Telecommunications | <input type="checkbox"/> PC Software Engineering Using C |
| <input type="checkbox"/> Industrial Electronics/Robotics | <input type="checkbox"/> Desktop Publishing & Design |
| <input type="checkbox"/> Basic Electronics | <input type="checkbox"/> Bookkeeping & Accounting |

Name _____
Address _____
City _____ State _____ Zip _____

Accredited Member, National Home Study Council

18-061

WATCH FOR THIS ISSUE ON SALE MAY 7



OUR JUNE ISSUE FEATURES:

BUILD A 16-CHANNEL 50-MHZ LOGIC ANALYZER

Full-featured stand-alone analyzer can interface to your PC through its serial port.

BUILD AN ELECTRONIC COMPASS

A hall-effect sensor shows you the way.

DIGITAL SIGNAL PROCESSING

A no-nonsense look at DSP, one of the new buzz words in consumer electronics.

V/F CONVERTERS

An in-depth description of voltage-to-frequency converters and a look at some common devices.

**PLUS: Hardware Hacker
Video News
Drawing Board**

**Audio Update
Computer Connections
And Lots More!**

**Don't miss even one issue—Order Now!
Call TOLL FREE 1-800-999-7139**

#5PE13

35mm Color



Prints and Slides from the same roll

Seattle FilmWorks has adapted Kodak's professional Motion Picture film for use in your 35mm camera. Now you can use the same film — with the same fine grain and rich color saturation — Hollywood's top studios demand. Its wide exposure latitude is perfect for everyday shots. You can capture special effects, too. Shoot it in bright or low light — at up to 1200 ASA. All for a surprisingly low processing cost. And Seattle FilmWorks lets you choose prints or slides, or both, from the same roll — without the high cost of slide film. Try this remarkable film today!

SEND ME 2 ROLLS FREE!

RUSH me two 20-exposure rolls of Kodak MP film, Eastman 5247® (200 ASA) and 5294® (640 ASA). Enclosed is \$2 for shipping and handling.

100% Satisfaction Guaranteed

©1987 SFW

NAME _____

ADDRESS _____

CITY _____

STATE _____ ZIP _____

Mail to: Seattle FilmWorks 24526
500 3rd Ave. W.
P.O. Box 34056
Seattle, WA 98124-1056

Kodak, 5247 and 5294 are trademarks of Eastman Kodak Co. Seattle FilmWorks is wholly separate from the manufacturer. Process at Seattle FilmWorks with limited availability from other labs.

ELECTROCHEMISTRY

(Continued from page 30)

When a current is applied to the solution, the iodide ions, which carry a negative charge, are attracted to the positive electrode. There, atoms of iodine are formed as the ions lose their electric charge. Immediately, the iodine sinks and dissolves in the potassium iodide solution, leaving the streamers as they fall. If the power is left on for a few minutes, the material will begin to accumulate at the bottom of the tube.

Note: **Iodine is very poisonous stuff. Please be extremely careful with it. Do not spill the solution, and throw it away as soon as you're through.**

Homemade Copper. Here's how to make your own copper metal in a matter of minutes. The copper can't really be used for anything; the quantity created is much too small. But still, it's genuine electrolytic copper.

Place 1 teaspoon of copper sulfate in 1½ ounces of water. Agitate the liquid until the solid has dissolved. Now, to improve the conductivity of the solution, add a ½ teaspoon of sodium bisulfate.

Pour the solution into a clean U-tube, insert your electrodes, and turn on the current. The copper ions, which carry a positive charge, are attracted to the cathode. And there, at the lower end of the negative electrode, you'll soon see a thin layer of reddish-brown copper.

Note: Copper sulfate is sometimes used to make insecticides and sodium bisulfate is sometimes used to clean drains. Both of these chemicals are **highly poisonous** and should be treated with a great deal of respect. Be very careful with the solution, and, when you're finished, dispose of it quickly.

Metallic Vegetation. Humphry Davy wasn't the only one running electrochemical experiments in the early years of the 19th century. Another observer of galvanic effects was a young German nobleman by the name of Freiherr Theodor Von Grothhus. Von Grothhus was living in Rome at the time.

Von Grothhus became interested in the delicate plant-like deposits that formed on wires connected to a battery and placed in an aqueous solution of certain metallic salts. He noticed a resemblance between such deposits and the crystalline growths known with in the European alchemical tradition as

arbors. Arbor, or *arbos*, is a Latin word meaning tree. Arbors appeared when one metallic material in a solution was displaced by another.

Von Grothhus found that the old alchemical arbors could be produced with electricity. Writing in 1807, he called all such growths *vegetation metallique* (metallic vegetation). But, do the formations really resemble vegetation? Let's find out:

Place about ⅓ teaspoon of tin chloride in 1½ ounces of water. That's not a lot of chemical; but, for our purposes, a little goes a long way. Now, very carefully, add ½ ounce of hydrochloric acid, 20% solution. Wait a few minutes for the undissolved solid to settle to the bottom of your mixing vessel. Note: Hydrochloric acid at 20% concentration is available at many hardware stores where it is also known as muriatic acid.

Please remember that hydrochloric acid is a corrosive and poisonous material. It's nasty stuff, and you must be extremely careful when working with it. Moreover, **the electrolysis creates a small amount of poisonous chlorine gas, so perform the experiment in a well-ventilated room. Hydrogen, a combustible gas, is also released, and that means keeping all open flames far away from your equipment.**

The arbor requires a special surface on which to grow. Obtain a 3- or 4-inch piece of stranded hook-up wire and remove all of the insulation. Twist the bare copper strands into a firm cable and straighten the piece with your fingers. Next, replace the negative carbon rod with your new stranded-wire electrode.

When the electrode is ready, pour the tin-chloride/acid mixture slowly and carefully into your U-tube. Note: If the solution is cloudy or milky to the point of being opaque, you've used too much tin chloride. Lower the electrodes into the tube and make sure the twisted wire is connected to the negative side of your power supply.

Next, turn on the current and watch the wire. Within seconds, the electrode becomes covered with a mass of bubbles. Then, tiny fern-like laminations of pure tin begin to appear on the surface. The arbor grows before your eyes and soon extends a dense collection of gleaming crystal branches down towards the bottom of the tube.

Von Grothhus was right. It really does look like something pulled from some weird electrochemical garden. ■

LEARN VCR
CLEANING/MAINTENANCE/REPAIR
EARN UP TO \$1000 A WEEK, WORKING
PART TIME FROM YOUR OWN HOME!



Secrets
Revealed!

NO Special
Tools or
Equipment
Needed.

EARN UP TO \$60
AN HOUR AND
MORE!

THE MONEY MAKING OPPORTUNITY OF THE 1990'S

IF you are able to work with common small hand tools, and are familiar with basic electronics (i.e. able to use voltmeter, understand DC electronics) . . . IF you possess average mechanical ability, and have a VCR on which to practice and learn. . . then we can teach **YOU** VCR maintenance and repair!

FACT: up to 90% of ALL VCR malfunctions are due to simple MECHANICAL or ELECTRO-MECHANICAL breakdowns!

FACT: over 77 million VCRs in use today nationwide! Average VCR needs service or repair every 12 to 18 months!

Viejo's **400 PAGE TRAINING MANUAL** (over 500 photos and illustrations) and **AWARD-WINNING VIDEO TRAINING TAPE** reveals the **SECRETS** of VCR maintenance and repair—"real world" information that is **NOT** available elsewhere!

Also includes all the info you'll need regarding the **BUSINESS-SIDE** of running a successful service operation!

FREE INFORMATION

CALL TOLL-FREE 1-800-537-0589

Or write to: Viejo Publications Inc

5329 Fountain Ave

Los Angeles, CA 90029 Dept. PE

CIRCLE 8 ON FREE INFORMATION CARD



"Plant a tree for
your tomorrow"

Join me and plant a tree for
your tomorrow. . . and for the
earth. For your free brochure,

write:
Trees for
America
The National
Arbor Day
Foundation,
Nebraska
City, NE
68410



John Denver for

**The National
Arbor Day Foundation**

JUNE 1991

ELECTRONICS PAPERBACKS

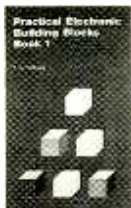

❑ **BP117—PRACTICAL ELECTRONIC BUILDING BLOCKS, BK-1** \$5.75. Circuits for a number of useful building blocks are presented. Combine these circuits to build the devices you need.

❑ **BP192—MORE ADVANCED POWER SUPPLY PROJECTS** \$5.95. Topics covered include switched-mode power supplies, precision regulators, dual tracking regulators and computer-controlled supplies.

More Advanced Power Supply Projects



❑ **BP190—MORE ADVANCED ELECTRONIC SECURITY PROJECTS** \$5.95. Projects include a passive infra-red detector, a fibre-optic loop alarm, computer-based alarms and an ultrasonic intruder detector.

❑ **BP113—30 SOLDERLESS BREADBOARD PROJECTS, BK-2** \$5.95. All projects are based on CMOS logic IC's. Many components are common to several projects. Each project includes a brief circuit description, component layout and parts list.



Electronic Music Projects



❑ **BP74—ELECTRONIC MUSIC PROJECTS** \$5.95. Provides a number of circuits for Fuzz Box, Waa-Waa Pedal, Sustain Unit, Reverberation and Phaser Units, Tremelo Generator and more.

❑ **BP255—INTERNATIONAL RADIO STATIONS GUIDE** \$7.95. Provides the casual listener, amateur radio DXer and the professional radio monitor with an essential reference work designed to guide him or her around than ever more complex radio bands.



MAIL TO: **Electronic Technology Today, Inc.**
P.O. Box 240
Massapequa Park, NY 11762-0240

SHIPPING CHARGES IN USA AND CANADA

\$0.01 to \$5.00	\$1.25	\$30.01 to \$40.00	\$5.00
\$5.01 to 10.00	\$2.00	\$40.01 to \$50.00	\$6.00
\$10.01 to \$20.00	\$3.00	\$50.01 and above	\$7.50
\$20.01 to \$30.00	\$4.00		

SORRY, No orders accepted outside of USA and Canada

Total price of merchandise	\$	_____
Shipping (see chart)	\$	_____
Subtotal	\$	_____
Sales Tax (NYS only)	\$	_____
Total Enclosed	\$	_____

Name _____
Address _____
City _____ State _____ Zip _____

CONSUMER ELECTRONICS

(Continued from page 38)

didn't exist. The cassette shell had to get wider to let the large head contact the tape.) The DCC shell is sealed. When inserted into a tape deck, a small door slides open to expose the tape and spools. The spools don't go all the way through the cassette, so the front of the cassette is completely available for labels.

Although the battle of the digital-audio formats was being presented by some as America (DCC) versus Japan (DAT), that strikes us as nonsense. Matsushita (a Japanese company) actually co-developed DCC with Philips (based in the Netherlands). The battle lines are more likely to be drawn between the "blue-collar" DCC and "audiophile" DAT markets. Tandy is planning to sell DCC players at an affordable (under-\$500) price, leaving DAT to the high-end marketplace—and hoping there is room for two formats in digital-audio cassettes.

Meanwhile, Kenwood displayed the first consumer prototype of a CD-WO—write-once—home recording system. The write-once discs (sometimes called WORM, or write-once, read many times, discs) can be played back on standard CD players. No availability or pricing information was available for the CD-WO system, although the discs themselves promise to be relatively expensive.

Several companies were showing new DAT products, including Sony's \$849 *DAT Walkman*. Sharp's *RX-P1*, a portable DAT player/recorder sold at about \$1100 as a kit that includes everything necessary to use the player in the car, at home, or as a personal stereo. Technics was showing a \$900 DAT unit for home use, and Sony also had their second-generation, \$1800 DAT player. With those kinds of prices, it's no wonder that DAT sales are slow.

In the camcorder arena, there were new introductions of both 8mm and VHS-C compact units from most of the major players in the field. But one new camcorder just might portend the continued strength of the 8mm format. (Of the 2.9-million unit market projected for this year, 8mm should account for about 38%, full-size units for about 50%, and VHS-C just 12%.) Philips, formerly standing strongly behind the VHS-C format, introduced two pocket-sized 8mm models (*CVM710* and *CVM720*) to be

sold under the Magnavox brand, although they say that they are not abandoning their VHS-C line.

Why Didn't We Think of That?

Occasionally at Consumer Electronics Shows we see items that might not feature any major technological breakthroughs, but that are so "commonsensical" that we don't know why somebody (like us) didn't think of them ages ago. One of those is a personal stereo previewed by Memorex that had an extra-battery pack on its back. When the first batteries wear out—as they seem to do at the halfway point of any flight—auxiliary batteries can be brought into play with the flick of a switch for uninterrupted listening.

Another device successfully tackles the tangled-wire dilemma that strikes in most multi-component homes. Get Organized's stereo-wire organizer combines a flexible tube that's slit up the side so that it neatly holds all the wires yet allows their ends to stick out where needed, and color-coded tabs that adhere to each wire and the port it plugs into. There's no mess, and no confusion, even when you have to dismantle your A/V system and then have to get it all back together again.

The Post-Show Game. It might seem strange to read about the January show in the June issue of **Popular Electronics**; unfortunately, the realities of publishing dictated that the deadline for articles in the May issue fell smack in the middle of the show! Yet this story should remain timely for a lot longer than the few months it took to hit the press. Not only did we see more innovative products at WCES 91 than at any other show in recent memory—most of which *still* aren't available as you read this—but the technologies revealed foreshadow consumer-electronics products that aren't even on the engineers' drawing boards yet. If this year is any indication, the 1990's promise to be an exciting decade in the world of consumer electronics. ■

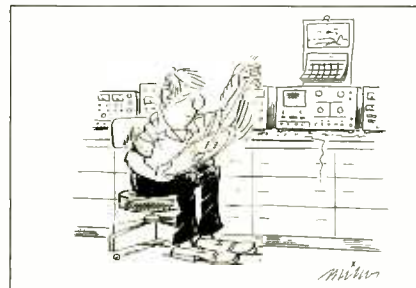

ELECTRONICS MARKET PLACE

FOR SALE

FREE cable and satellite descrambler plans. Send self addressed stamped envelope. **MJH INDUSTRY**, Box 531, Bronx, NY 10461-0208.

CABLE descrambler liquidation. Major makes and models available. Industry pricing! (Example: Hamlin Combo's, \$44 each.... Minimum 10 orders). Call **WEST COAST ELECTRONICS**, 1 (800) 628-9656.

PRINTED circuit boards etched & drilled. Free delivery. **K & F ELECTRONICS, INC.**, 33041 Groesbeck, Fraser, MI 48026. (313) 294-8720.

HUGE 88 page communications catalog of shortwave, amateur and scanner equipment. Antennas, books and accessories too. Send \$1.00 to: **UNIVERSAL RADIO**, 1280 Aida Drive, Dept. PE, Reynoldsburg, OH 43068.

CABLE descramblers (Jerold) from \$40.00. Tocom VIP test chip. Fully activates unit. \$50.00. Call (213) **867-0081**.

STOP unwanted use of long distance with simple telephone product. Free details. **PO BOX 504**, Plattsburgh, NY 12903.

PRINTED circuit boards — etched, drilled, tin plated. Single sided \$1.25/sq. inch. Free shipping. **CHELCO ELECTRONICS**, 61 Water Street, Mayville, NY 14757. (716) 753-3200.

CLASSIFIED AD ORDER FORM

To run your own classified ad, put one word on each of the lines below and send this form along with your check to:

Popular Electronics Classified Ads, 500-B Bi-County Boulevard, Farmingdale, N.Y. 11735

PLEASE INDICATE in which category of classified advertising you wish your ad to appear. For special headings, there is a surcharge of **\$11.00**.

() Plans/Kits () Business Opportunities () For Sale
 () Education/Instruction () Wanted () Satellite Television
 ()

Special Category: \$11.00

PLEASE PRINT EACH WORD SEPARATELY, IN BLOCK LETTERS.

(No refunds or credits for typesetting errors can be made unless you clearly print or type your copy.) Rates indicated are for standard style classified ads only. See below for additional charges for special ads. **Minimum: 15 words.**

1	2	3	4	5
6	7	8	9	10
11	12	13	14	15 (\$23.25)
16 (\$24.80)	17 (\$26.35)	18 (\$27.90)	19 (\$29.45)	20 (\$31.00)
21 (\$32.55)	22 (\$34.10)	23 (\$35.65)	24 (\$37.20)	25 (\$38.75)
26 (\$40.30)	27 (\$41.85)	28 (\$43.40)	29 (\$44.95)	30 (\$46.50)
31 (\$48.05)	32 (\$49.60)	33 (\$51.15)	34 (\$52.70)	35 (\$54.25)

We accept MasterCard and Visa for payment of orders. If you wish to use your credit card to pay for your ad fill in the following additional information (Sorry, no telephone orders can be accepted.):

Card Number

Expiration Date

PRINT NAME

SIGNATURE

IF YOU USE A BOX NUMBER YOU MUST INCLUDE YOUR PERMANENT ADDRESS AND PHONE NUMBER FOR OUR FILES. ADS SUBMITTED WITHOUT THIS INFORMATION WILL NOT BE ACCEPTED.

CLASSIFIED COMMERCIAL RATE: (for firms or individuals offering commercial products or services) \$1.55 per word prepaid (no charge for ZIP code)...**MINIMUM 15 WORDS.** 5% discount for same ad in 6 issues within one year; 10% discount for 12 issues within one year if prepaid. **NON-COMMERCIAL RATE:** (for individuals who want to buy or sell a personal item) \$1.25 per word, prepaid....no minimum. **ONLY FIRST WORD AND NAME** set in bold caps at no extra charge. Additional bold face (not available as all caps) **30¢ per word additional.** Entire ad in boldface, \$1.85 per word. **TINT SCREEN BEHIND ENTIRE AD:** \$1.90 per word. **TINT SCREEN BEHIND ENTIRE AD PLUS ALL BOLD FACE AD:** \$2.25 per word. **EXPANDED TYPE AD:** \$2.05 per word prepaid. Entire ad in boldface, \$2.45 per word. **TINT SCREEN BEHIND ENTIRE EXPANDED TYPE AD:** \$2.55 per word. **TINT SCREEN BEHIND ENTIRE EXPANDED TYPE AD PLUS ALL BOLD FACE AD:** \$2.95 per word. **DISPLAY ADS:** 1" x 2 1/4"—\$205.00; 2" x 2 1/4"—\$410.00; 3" x 2 1/4"—\$615.00. **General Information:** Frequency rates and prepayment discounts are available. **ALL COPY SUBJECT TO PUBLISHERS APPROVAL. ADVERTISEMENTS USING P.O. BOX ADDRESS WILL NOT BE ACCEPTED UNTIL ADVERTISER SUPPLIES PUBLISHER WITH PERMANENT ADDRESS AND PHONE NUMBER.** Copy to be in our hands on the 18th of the fourth month preceding the date of issue (i.e.; Sept. issue copy must be received by May 18th). When normal closing date falls on Saturday, Sunday or Holiday, issue closes on preceding work day. Send for the classified brochure. Circle Number 49 on the Free Information Card.

CALL DOCTOR DESCRAMBLER

...for symptoms relating to scrambled cable T.V. signals. We have **JEROLD • TOCOM • ZENITH • HAMLIN OAK • SCIENTIFIC ATLANTA.** Six month warranty! We ship C.O.D. Lowest retail/wholesale prices. **FREE CATALOG:** Global Cable Network 1032 Irving St. Ste 109 S.F., CA 94122 **NO CALIFORNIA SALES!!! OPEN SATURDAYS**

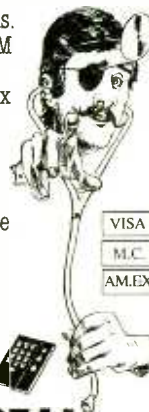

VISA
M.C.
AM.EX

1-800-327-8544

IBM PC video digitizer, connects through printer port. 640 by 480 resolution, 256 gray levels \$89.98. Demo disk \$3.00. **COLORBURST**, Box 3091, Nashua, NH 03061.

RADIO tubes, capacitors. Extensive listings. \$29 stamp. **DIERS**, 4276 North 50 Street #H5, Milwaukee, WI 53216-1313.

CONVERTERS all major brands info + orders 1 (800) 782-0552 **FREEWAY INC.** (s.m.p.), PO Box 5036, Burnsville, MN 55337. No MN sales.

Quality Microwave TV Antennas

WIRELESS CABLE • IFTS • MMDS • Amateur TV
 Ultra High Gain 50db(+) • Tuneable 1.9 to 2.7 Ghz

- 36-Channel System Complete \$149.95
- 12-Channel System Complete \$114.95
- Call or write (SASE) for "FREE" Catalog

PHILLIPS-TECH ELECTRONICS
 P.O. Box 8533 • Scottsdale, AZ 85252
 (602) 947-7700 (\$3.00 Credit all phone orders)
 LIFETIME WARRANTY MasterCard • Visa • COD's • Quantity Pricing

LEARNING electronics troubleshooting? Basic electronics simulations and problems program can help. **PC/MSDOS** \$32.95 **EES-PE5**, POB 1391, Lubbock, TX 79408.

SECRETS of data encryption standard \$7.00, secure microprocessors explained \$5.00, "smart cards" explained \$5.00. Details free. Sent first class. **BBB**, Box 637, Polk City, FL 33868.

CB RADIO OWNERS!

We specialize in a wide variety of technical information, parts and services for CB radios, 10-Meter and FM conversion kits, repair books, plans, high-performance accessories. Thousands of satisfied customers since 1976! Catalog \$2

CBC INTERNATIONAL
P.O. BOX 31500PE, PHOENIX, AZ 85046

HOBBYISTS! Students! Experimenters! Electronics grab box. Great values. Send \$19.95 to **J&D SALES**, 518 S. Cedar, Roswell, NM 88201. Postage included.

ALPHA/Theta brainwave stimulation software. Why pay \$300.00 or more for brainwave stimulation devices when you can experiment on your IBM or 100% compatible clone? Our program provides a low-cost alternative allowing selection of colors, patterns and frequencies in the Alpha-Theta ranges. Do these hypnotic pulses really offer a method of drugfree relaxation and mind exploration? Requires color monitor and EGA/VGA. **WARNING! EPILEPTICS MUST NOT USE!** 5 1/4" \$19.95, 3 1/2" \$21.95. **TEMPLEHOF**, Dept 113-P, PO Box 19300, Austin, TX 78760-9300.

FREE CATALOG

FAMOUS "FIRESTIK" BRAND CB ANTENNAS AND ACCESSORIES. QUALITY PRODUCTS FOR THE SERIOUS CB'er. SINCE 1962
FIRESTIK ANTENNA COMPANY
2614 EAST ADAMS
PHOENIX, ARIZONA 85034

WINDOWS software. Great game disk and catalog. Only \$5.00. **ONE-UP SYSTEMS**, Box 820, Pompano, FL 33061.

MAGNET wire for coils, transformers, electro-magnets available in gauges 18 to 38 solderable round copper with enamel insulation. For details send \$1.00 to: **SMW DISTRIBUTION**, PO Box 1015, Huntington, IN 46750.

COPPER clad laminate FR-4 SS, DS, 3/64, 1/16, 3/32. (Cut to size — no charge.) Free information. **DIGI-TEK**, Box 538, Rockwell, IA 50469.

SURVEILLANCE TELEPHONE

Monitor room conversations \$175.00
Monitor room & telephone conversations \$275.00
Dialer tap, calls you when phone is used. \$305.00



Range Unlimited - 6 month warranty - Phone Tap Catalog \$3.00
LISTEN ELECTRONICS, 603 Egin, Muskegoe, OK 74401
1-800-633-TAPS

PLANS & KITS

CATALOG: hobby/broadcasting/HAM/CB: Cable TV, transmitters, amplifiers, surveillance devices, computers, more! **PANAXIS**, Box 130-H6, Paradise, CA 95967.

BUILD — five-digit, ohms, capacitance, frequency, pulse, multimeter, Board, and instructions \$9.95. **BAGNALL ELECTRONICS**, 179 May, Fairfield, CT 06430.

KELVIN 200

AC/DC VOLTAGE
AC/DC CURRENT
RESISTANCE DIODE TEST \$39.95
LOW BATTERY Warning
ACCURACY +/- 0.5%
CONTINUITY TEST/BUZZER
TRANSISTOR CHECKER
CAPACITANCE CHECKER



Stock No 990091
KELVIN Electronics
7 Fairchild Ave. Plainview NY 11803
(516) 349-7620 1(800) 645-9212

SURVEILLANCE — Audio/video/infra-red/laser equipment. Industrial or private. 500 item catalog \$7.00. **SECURITY SYSTEMS**, 3017F Hudson, New Orleans, LA 70131.

SURVEILLANCE transmitter kits! Four models of each; telephone, room, combination telephone/room transmitters tune from 65 to 305 MHz. Catalog with **Popular Communication's** and **Popular Electronics** book reviews of "Electronic Eavesdropping Equipment Design," \$2.00. **SHEFFIELD ELECTRONICS**, 7223A Stony Island Ave., Chicago, IL 60649-2806.

MINIATURE FM transmitters! Tracking transmitters! Voice disguisers! Bug detectors! Phone devices! More! Available as kits or assembled and tested! Catalog \$2.00 (refundable); **XANDI ELECTRONICS**, Box 25647, Dept. 32E, Tempe, AZ 85285-5647.

DAZER II Personal protection device! Plans \$8.00. Lasers! Transmitters! Detectors! More! Kits or assembled! Catalog \$2.00. **QUANTUM RESEARCH**, 16645-113 Avenue, Edmonton, Alberta T5M 2X2.

Motion Control System --- \$59.00



Includes Computer, Monitor, Keyboard, Power supply, 4 Motors, and Software.

Call or Send for **Free Robotics Catalog**

Silicon Valley Surplus 415 261-4506
4222 E. 12th St. Oakland, Ca. 94601
Serving you since 1983
8 am to 4 pm PST

ALCOHOL fuel. Haven't you had enough of high gas prices? Save money, \$.17 per gallon. Great hobby, easy to produce. Free info. **PROSPECTS UNLIMITED**, 620 Dick Road, Suite 383, Depew, NY 14043.

RECEIVER plans, kits. Simple to sophisticated. Thorough explanations included. All bands. Catalog and sample schematics \$3.00. **PREMIER ENTERPRISES**, 3850 Plymouth Blvd., Suite 104, Plymouth, MN 55446.

REMOTE car starter plan (\$19.90), or complete devices. **SCHLITZER**, 414 Alva, Grand Prairie, TX 75051. (214) 642-0338.

CABLE TV DESCRAMBLERS ★ CONVERTERS ★ and ACCESSORIES.

SAVE MONEY. DON'T RENT!

**PANASONIC,
PIONEER, JERROLD, OAK,
SCIENTIFIC ATLANTA
AND MORE. LOWEST PRICES.
FREE CATALOG.**
(800) 234-1006
CABLE READY COMPANY

KITS, over 100 electronic kits, sound effects, visual effects. Write for free catalog: **JM ELECTRONICS**, PO Box 150454, Altamonte Springs, FL 32715-0454.

SURVEILLANCE — countermeasures! Guaranteed lowest prices! Huge Catalog \$5.00 (refundable). **PROTECTOR**, PO Box 520294-E, Salt Lake City, Utah 84152.

ANALOG to digital converter. PC compatible kit includes board, chips, software \$24.95. Plans \$2.00. **KIRK BACH**, PO Box 9131P, Dayton, OH 45409.

METAL detector, easy to build. Schematic, PCB layout and parts list, \$3.00. **KEY ELECTRONICS**, 22 West Ave. C, San Angelo, TX 76903.



TUBES - 2000 TYPES DISCOUNT PRICES!

Early, hard-to-find, and modern tubes. Also transformers, capacitors and parts for tube equipment. Send \$2.00 for 28 page wholesale catalog.

ANTIQUE ELECTRONIC SUPPLY
6221 S. Maple Ave. • Tempe, AZ 85283 • 602-820-5411

SMD How to use surface mount technology. Build ultra miniature projects! Plans included free, infra red control, and an interesting light display. Send \$15.00 to **CHARLIE'S VIDEO**, Dept SMT, PO 7782, La Sierra, CA 92503.

ROBOTICS! Engines! Inventions! Muscle wires contract with surprising strength when powered. Send business SASE for latest flyer. **MONDO-TRONICS**, 2476 Verna Ct. %PE, San Leandro, CA 94577.

SATELLITE TV descrambler. Build your own. Easy to follow instructions, parts list, circuit board and wiring diagram. Send \$9.95. **ABG ENTERPRISES**, 27081 P Halifax, NS, Canada B3H-4M8.

TRACKING transmitter. True miniature bug. Weighs approximately 1 oz. including battery. One mile range. Copy of discontinued government publication, includes parts list, schematics, data. \$5.00 **JBGIZMO**, Box 1084, Jones, OK 73049.

I'LL HAVE MINE DESCRAMBLED



If you find a better deal, We'll beat it! **JERROLD • TOCOM • HAMLIN • OAK • SCIENTIFIC ATLANTA • ZENITH** • ask about our warranty program C.O.D. Visa, M/C, AM.EX. welcome. **FREE CATALOG** •

FREE CALL •
OPEN SATURDAYS
1 800 562-6884

VIDEO TECH
3702 S. Virginia St. Ste. 160-304
Reno, NV 89502

"BUILD Your Own Macintosh And Save A Bundle." book 80 illustrations 224 pages \$17.95. With 68 minute audio tape \$24.95. Add \$3.00 shipping US/Canada. Ck/MC, Visa/MC. **BRANT ASSOCIATES**, Dept P, Box 68708, Portland, OR 97268.

EDUCATION/INSTRUCTION

MAGIC! Four illustrated lessons plus inside information shows you how. We provide almost 50 tricks including equipment for four professional effects. You get a binder to keep the materials in, and a one-year membership in the International Performing Magicians. Order now! \$29.95 for each course + \$3.50 postage and handling. (New York residents add applicable state and local sales tax). **THE MAGIC COURSE**, 500-B BiCounty Blvd., Farmingdale, NY 11735.

VCR repair. Save money — make big profits! Learn how from *How to Keep Your VCR Alive*. "This detailed, step-by-step manual enables anyone with no previous knowledge or experience to fix most VCR problems easily, quickly, and inexpensively with a few simple tools." — Small Press Review. Highly recommended by *Popular Electronics*, *Modern Electronics*, *Popular Communications*, *Electronic Servicing*, *Videomaker*, *Library Journal*, and many other electronics and video magazines. "Far better than Viejo at 1/7 the cost." 400+ page book, with 724 illustrations, plus professional head-cleaning tool, \$24.95. Check B. Daltons and Waldenbooks. Or write **WORTHINGTON PUBLISHING**, PO Box 16691H, Tampa, FL 33687-6691. Or call 1 (800) 233-8277 toll-free for Visa or MC. Money-back satisfaction guarantee!

SUPERNATURAL cloud — Earth rotation displacement nuclear warfare \$1.00. **NEIDER**, PO Box 5162, San Antonio, TX 78201.

MAKE your own PC boards. Comprehensive video shows best methods. \$19.95. Visa/MC or check. **JASE VIDEO**, 1 (800) 234-1966.

BEST BY MAIL
Rates: Write National, Box 5, Sarasota, FL 34230
OF INTEREST TO ALL

AMAZING, NEW BATTERY Checker for 1.5V, 9V batteries. Order today! \$3.00: T-Mac, P.O. Box 782371-(PE), Wichita, KS 67278-2371.

SOLAR POWERED PORTABLE Radio \$39.95. Kit \$29.95. **SUNMAN**, POB 7589, Chula Vista, CA 92012.

BUSINESS OPPORTUNITIES

JOB MARKET TOUGH? Consider Professional Retirement Counseling. Complete Details: New Careers, 3871 Piedmont Ave., Oakland, CA 94611.

\$2,750 WEEKLY! CALL 1-900-988-5152, Ext. #130. \$3.00 per minute.

WANTED

INVENTORS! Call **IMPAC** for free information package. USA/Canada: 1 (800) 225-5800. Performance profile provided.

NEED help with your electronic project, schematic or PCB artwork? Write to **TOP SECURITY**, PO Box 5275, Flint, MI 48505.

MASTERCARD AND VISA are now accepted for payment of your advertising. Simply complete the Classified Ad order form and we will bill you.

BIG PROFITS **ELECTRONIC ASSEMBLY BUSINESS**

Start home. spare time. Investment knowledge or experience unnecessary. **BIG DEMAND** assembling electronic devices. Sales handled by professionals. Unusual business opportunity

FREE: Complete illustrated literature
BARTA E-00 Box 248
Walnut Creek Calif 94597

BUSINESS OPPORTUNITIES

YOUR own radio station! AM, FM, TV, cable. Licensed/unlicensed. **BROADCASTING**, Box 130-H6, Paradise, CA 95967.

LET the government finance your small business. Grants/loans to \$500,000. Free recorded message: (707) 448-0270. (KJ8)

EASY work! Excellent pay! Assemble products at home. Call for information (504) 641-8003 Ext. 5730.

MAKE \$50.00/hr working evenings or weekends in your own electronics business. Send for free facts. **MJPI INDUSTRY**, Box 531, Bronx, NY 10461.

MAKE \$\$\$! Become an American electronics dealer! Profit opportunities since 1965. Call **WAYNE MARKS**, 1 (800) 872-1373.

★★★★ PRESENTING ★★★★★
CABLE TV DESCRAMBLERS
★★★★ STARRING ★★★★★
JERROLD, HAMLIN, OAK
AND OTHER FAMOUS MANUFACTURERS

- FINEST WARRANTY PROGRAM AVAILABLE
- LOWEST RETAIL / WHOLESALE PRICES IN U.S.
- ORDERS SHIPPED FROM STOCK WITHIN 24 HRS
- ALL MAJOR CREDIT CARDS ACCEPTED

FOR FREE CATALOG ONLY 1-800-345-8927
FOR ALL INFORMATION 1-818-709-9937

PACIFIC CABLE CO., INC.
7325 1/2 Reseda Blvd., Dept. 2003
Reseda, CA 91335

MAKE \$75,000.00 to \$250,000.00 yearly or more fixing IBM color monitors. No investment, start doing it from your home (a telephone required). Information, USA, Canada \$2.00 cash for brochure, other countries \$10.00 US funds. **RAN-DALL DISPLAY**, Box 2168-H, Van Nuys, CA 91404, USA.

TEST EQUIPMENT

SUPER low prices on computers, motherboards, hard and floppy drives, and add-on cards. We have everything. Full line of test equipment at unbeatable prices. Call for free catalog. **APPLIED ELECTRONIC RESEARCH**, Hollywood, FL (305) 987-9785, Fax (305) 987-5996.

CABLE DESCRAMBLERS OAK M358 COMBO \$39.95

Jerrold, Zenith, Hamlin, Sci. Atlanta, Pioneer & MORE! OUR PRICES ARE BELOW WHOLESALE!

CABLE+PLUS

14417 Chase St. #481-B Panorama City, CA 91402
1-800-822-9955 • Other info. 1-818-785-4500
NO CALIF. SALES — DEALERS WANTED

THIS IS A BOLDFACE EXPANDED-TYPE AD WITH A TINT SCREEN. See how it jumps out on the page. To order your ad in this format calculate the cost at \$2.70 per word.

FREE CATALOG!
1-800-648-7938
JERROLD HAMLIN OAK ETC
CABLE TV DESCRAMBLERS

- Special Dealer Prices!
- Compare our Low Retail Prices!
- Guaranteed Prices & Warranties!
- Orders Shipped Immediately!

REPUBLIC CABLE PRODUCTS, INC.
4080 Paradise Rd. #15, Dept. PE 601
Las Vegas, NV 89109
For all other information (702) 382-9026

SATELLITE TV

FREE catalog — Do-it-yourself save 40—60% **Lowest prices** world wide, systems, upgrades, parts, all major brands factory fresh and warranted. **SKYVISION**, 2008 Collegeway, Fergus Falls, MN 56537. 1 (800) 334-6455.

CABLE TV CONVERTERS
WHY PAY A HIGH MONTHLY FEE?

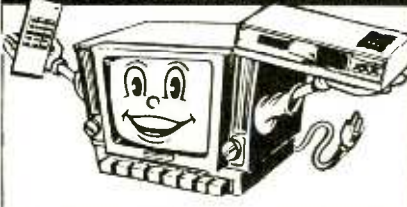

All Jerrold, Oak, Hamlin, Zenith, Scientific Atlanta, Magnavox and all specialized cable equipment available for shipment within 24 hours. For fast service MC / VISA or C.O.D. telephone orders accepted (800) 648-3030 60 Day Guarantee (Quantity Discounts) 8 A.M. to 5 P.M. C.S.T. **CLOSED WEEK-ENDS.** Send self-addressed Stamped envelope (60¢ postage) for Catalog.

MIDWEST ELECTRONICS INC.
P.O. Box 5000
Suite 311 (PE)
Carpentersville, IL 60110
No Illinois Orders Accepted

VIDEOCIPHER II manuals. **Volume 1** — Hardware. **Volume 2** — Software — either \$34.95. **Volume 3** — Projects/Software, **Volume 5** — Documentation or **Volume 6** — Experimentation \$44.95 each. **Volume 7** — 032/Hacking \$54.95. **Volume 4** — Repair \$99.95. VC Primer — \$9.95. **Scanner Hacker's Bible** — \$34.95. **Cable Hacker's Bible** — \$34.95. **Satellite Hacker's Bible** — \$54.95. Catalog — \$3.00. CODs (602) 782-2316. **TELECODE**, PO Box 6426-PE, Yuma, AZ 85366-6426.

LPTV transmitters. Attention Mexico and Latin America, for communities outside U.S.A. and Canada, low power TV transmitters, to serve towns and little cities TV from satellite dishes call: (62) 150199 (Mexico), Write: **ELECTRONICA SONORA**, 252 Grand Ave., Nogales, AZ 85621.

T.V. FILTERS

T.V. notch filters, phone recording equipment, brochure \$1.00. **MICRO THinc.**, Box 63/6025, Margate, FL 33063. (305) 752-9202.

CABLE EQUIPMENT

CABLE TV secrets — the outlaw publication the cable companies tried to ban. HBO, Movie Channel, Showtime, descramblers, converters, etc. Suppliers list included. \$9.95. **CABLE FACTS**, Box 711-H, Pataskala, OH 43062.

THIS IS AN EXPANDED TYPE AD. Notice how it stands out on this page. To get your ad set in this type style mark your classified ad order, "Expanded-type ad," and calculate your cost at \$1.85 per word.

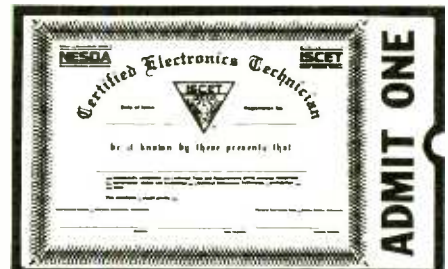

Your Ticket To SUCCESS

Over 28,000 technicians have gained admittance worldwide as certified professionals. **Let your ticket start opening doors for you.**

ISCET offers Journeyman certification in Consumer Electronics, Industrial, Medical, Communications, Radar, Computer and Video. For more information, contact the **International Society of Certified Electronics Technicians**, 2708 West Berry Street, Fort Worth, TX 76109; (817) 921-9101.

Name _____
Address _____
City _____
State _____ Zip _____

Send material about ISCET and becoming certified.

Send one "Study Guide for the Associate Level CET Test." Enclosed is \$10 (inc. postage).

JUNE 1991

ADVERTISING INDEX

POPULAR ELECTRONICS magazine does not assume any responsibility for errors that may appear in the index below.

Free Information No.	Page	—	ISCET	Page	
6	AMC Sales	69	—	Kelvin	92
5	All Electronics	13	—	Listen Electronics	92
—	Amazing Concepts	22	—	Midwest Electronics	93
—	Antique Electronic Supply	92	—	Monitoring Times	75
—	Barta	93	14	Mouser	20
—	CB City	92	—	NRI Schools	87
11	C&S Sales	5	18	PMC Electronics	83
—	CIE	25	7	Protel Technology	19
—	Cable Plus	93	—	Pacific Cable	93
—	Cable Ready Company	92	17	Panavise	7
15	Cable Warehouse	79	13	Parts Express	3
—	Command Productions	81	—	Phillips Tech.	91
16	Cook's Institute	20	—	P.E. Reprint Books	80
—	EE&D Book Club	21	—	R.E. Video Offer	CV3
—	Elec. Industry Association	26	—	Republic Cable	93
—	Electronic Tech. Today	82, 90	9	Sequoia Publishing	69
—	Electronic Tech. Today	CV2	—	Silicon Valley Surplus	92
—	Electronics Book Club	11	19	Test Probes	17
—	Firestik II	92	—	Video Tech	92
—	Global Cable Network	91	8	Viejo Publications	89
—	Grantham College	14	10	WPT Publications	79
12	Heathkit	15	—	Windjammer	CV4

ADVERTISING SALES OFFICE

Gernsback Publications, Inc.

500-B Bi-County Blvd.

Farmingdale, NY 11735

1-(516) 293-3000

President: Larry Steckler

Assistant to the President: Christina Estrada

For Advertising ONLY

516-293-3000

Fax 1-516-293-3115

Larry Steckler

publisher

Arline Fishman

advertising director

Denise Haven

advertising assistant

Kelly McQuade

credit manager

Customer Service/Order Form

1-800-435-0715

1-800-892-0753

7:30 AM - 8:30 PM EST

SALES OFFICES

EAST/SOUTHEAST

Stanley Levitan, Eastern Sales Manager

259-23 57th Avenue

Little Neck, NY 11362

1-718-428-6037, 1-516-293-3000

Fax 1-718-225-8594

MIDWEST/Texas/Arkansas/Okla.

Ralph Bergen, Midwest Sales Manager

540 Frontage Road—Suite 204

Northfield, IL 60093

1-708-446-1444

Fax 1-708-559-0562

PACIFIC COAST/Mountain States

Marvin Green, Pacific Sales Manager

5430 Van Nuys Blvd. Suite 316

Van Nuys, CA 91401

1-818-986-2001

Fax 1-818-986-2009

ANTIQUÉ RADIO

(Continued from page 67)

to "find" a new note. Quite a challenge for the player's coordination, spatial sense, and musicianship!

Another insight into the problems of the thereminist is given by electronic music expert Robert Moog in his liner notes for the Delos CD (D/CD 1014), *The Art of the Theremin*, featuring solos by premier theremin concert artist Clara Rockmore. "Ms. Rockmore," he reports, "uses a large, open-back speaker cabinet which she places behind and slightly above her head, pointing out toward her audience. With such an arrangement, she is able to hear the effect of her hand motions soon enough so that the audience is rarely, if ever, aware of the aural feedback corrections she intuitively applies."

EFFECTS ON MODERN MUSIC

Robert Moog, best-known for his pioneering work with music synthesizers, began producing modern versions of Theremin's instrument in 1954. According to *New Grove Dictionary of Musical Instruments* (Grove Dictionaries of Music, 1980), Moog manufactured five models between the mid-50's and the mid-60's. Two transistorized models are offered in Moog's newsletter *Moog Music* for Fall-Winter 1962: the "Melodia" (\$49.95 in kit form, \$75.00 assembled), an amateur instrument; and the "Troubadour" (\$160.00), a professional version.

It's pure speculation on my part, since I've never talked or corresponded with Moog. But it's easy to imagine that this man's accomplishments in the field of synthesized music were inspired and influenced by

his work with Theremin's instrument.

With the availability of modern equipment, contemporary music groups began to use the theremin. Rock bands were particularly attracted to its wide repertoire of unearthly noises. Among those were the '60's groups The Beach Boys and Lothar and the Hand People. Led Zepelin's guitarist Jimmy Page was a particularly avid theremin user, and you can see him play it in the movie *The Song Remains the Same*, which is still available at video stores. Watch for the songs "Dazed and Confused" and "Whole Lotta Love."

Electronics hobbyists, too, have long been fascinated by Leon Theremin's engaging invention. Theremin construction articles have been popular hobby magazine fare from the mid fifties, when Moog first be-

gan manufacturing the instrument, right through to the present. **Hands-On Electronics**, the predecessor of this magazine, ran the article *Build the Digital Theremin* as recently as September, 1987.

COMING ATTRACTIONS

I'm indebted to the more than 40 entrants to our recent "Theremin Contest" for the source material used to put together this column. Next month, we'll keep right on going with the theremin topic and deal with the operating theory of this fascinating musical instrument. Following that, we'll work over an actual RCA theremin (acquired through the courtesy of reader Tony du Bourg) that's been in storage since the 1950's. We'll examine its construction in detail and see what needs to be done to the instrument in order to make it play again. ■

Never before has so much professional information on the art of detecting and eliminating electronic snooping devices—and how to defend against experienced information thieves—been placed in one VHS video. If you are a Fortune 500 CEO, an executive in any hi-tech industry, or a novice seeking entry into an honorable, rewarding field of work in countersurveillance, you must view this video presentation again and again.

Wake up! You may be the victim of stolen words—precious ideas that would have made you very wealthy! Yes, professionals, even rank amateurs, may be listening to your most private conversations.

Wake up! If you are not the victim, then you are surrounded by countless victims who need your help if you know how to discover telephone taps, locate bugs, or “sweep” a room clean.

There is a thriving professional service steeped in high-tech techniques that you can become a part of! But first, you must know and understand Countersurveillance Technology. Your very first insight into this highly rewarding field is made possible by a video VHS presentation that you cannot view on broadcast television, satellite, or cable. It presents an informative program prepared by professionals in the field who know their industry, its techniques, kinks and loopholes. Men who can tell you more in 45 minutes in a straightforward, exclusive talk than was ever attempted before.

Foiling Information Thieves

Discover the targets professional snoopers seek out! The prey are stock brokers, arbitrage firms, manufacturers, high-tech companies, any competitive industry, or even small businesses in the same community. The valuable information they filch may be marketing strategies, customer lists, product formulas, manufacturing techniques, even advertising plans. Information thieves eavesdrop on court decisions, bidding information, financial data. The list is unlimited in the mind of man—especially if he is a thief!

You know that the Russians secretly installed countless microphones in the concrete work of the American Embassy building in Moscow. They converted



**HAVE YOUR
VISA or MC CARD
AVAILABLE**

what was to be an embassy and private residence into the most sophisticated recording studio the world had ever known. The building had to be torn down in order to remove all the bugs.

Stolen Information

The open taps from where the information pours out may be from FAX's, computer communications, telephone calls, and everyday business meetings and lunchtime encounters. Businessmen need counselling on how to eliminate this information drain. Basic telephone use coupled with the user's understanding that someone may be listening or recording vital data and information greatly reduces the opportunity for others to purloin meaningful information.

The professional discussions seen on the TV screen in your home reveals how to detect and disable wiretaps, midget radio-frequency transmitters, and other bugs, plus when to use disinformation to confuse the unwanted listener, and the technique of voice scrambling telephone communications. In fact, do you know how to look for a bug, where to look for a bug, and what to do when you find it?

Bugs of a very small size are easy to build and they can be placed quickly in a matter of seconds, in any object or room. Today you may have used a telephone handset that was bugged. It probably contained three bugs. One was a phony bug to fool you into believing you found a bug and secured the telephone. The second bug placates the investigator when he finds the real thing! And the third bug is found only by the professional, who continued to search just in case there were more bugs.

The professional is not without his tools. Special equipment has been designed so that the professional can sweep a room so that he can detect voice-activated (VOX) and remote-activated bugs. Some of this equipment can be operated by novices, others require a trained countersurveillance professional.

The professionals viewed on your television screen reveal information on the latest technological advances like laser-beam snoopers that are installed hundreds of feet away from the room they snoop on. The professionals disclose that computers yield information too easily.

This advertisement was not written by a countersurveillance professional, but by a beginner whose only experience came from viewing the video tape in the privacy of his home. After you review the video carefully and understand its contents, you have taken the first important step in either acquiring professional help with your surveillance problems, or you may very well consider a career as a countersurveillance professional.

The Dollars You Save

To obtain the information contained in the video VHS cassette, you would attend a professional seminar costing \$350-750 and possibly pay hundreds of dollars more if you had to travel to a distant city to attend. Now, for only \$49.95 (plus \$4.00 P&H) you can view *Countersurveillance Techniques* at home and take refresher views often. To obtain your copy, complete the coupon below or call toll free.

RADIO-ELECTRONICS VIDEO OFFER **PE**

500-B Bi-County Blvd.
Farmingdale, NY 11735

Please rush my copy of the Countersurveillance Techniques Video VHS Cassette for \$49.95 plus \$4.00 for postage and handling.

No. of Cassettes ordered _____
Amount of payment \$_____

Bill my VISA MasterCard
Card No. _____
Expire Date _____ / _____

Signature _____
Name _____
Address _____
City _____ State _____ ZIP _____

All payments in U.S.A. funds. Canadians add \$4.00 per VHS cassette. No foreign orders. New York State residents add applicable sales tax.

East of the sun. West of the moon. Windjammer.



A place to live your fantasies.
A place to free your soul.

To cozy up to the Caribbean sun.
To dance among a thousand stars
to the rhythms of steel drums.
To play on sparkling white and
pink sand beaches.
To discover the underwater
paradise of the reefs.
To find a new friend and share the
intimacies of a sensuous night.

To come alive and live.
To remember for a lifetime.

6 days and 6 nights. From \$675.

Reservations toll free
1-800-327-2600
In Florida 305/373-2090.

**Windjammer
'Barefoot' Cruises**

Post Office Box 120,
Miami Beach, Florida 33119.



"Cap'n Mike rush me my free full color 'Great Adventure' booklet and show
me the way to Paradise for 6 days and 6 nights from \$675."
Windjammer 'Barefoot' Cruises,
P.O. Box 120, Dept. 1642 Miami Beach, Fla. 33119.

Name _____
Address _____
City _____
State/Zip _____