

Simple VCR Repairs that YOU Can Do!

48784

Popular Electronics

MAY 1991

Build The Sonic Defender

An effective, non-lethal deterrent to those who wish you harm. It protects you and your property with a blast of high-intensity sound

Build The "Slot-Machine" Bank

See your pocket change pile up with this fascinating electronic bank

Weather-Alert Decoder

It keeps a "weather eye" peeled for National Weather Service emergency alerts

All About Meters

Learn how analog and digital meters work, and how to design circuits to measure voltage, current, and resistance

The Birth of the Vacuum Tube

Lee de Forest claimed that he got the idea for the audion from a gas flame; Fleming thought that story was just hot air!

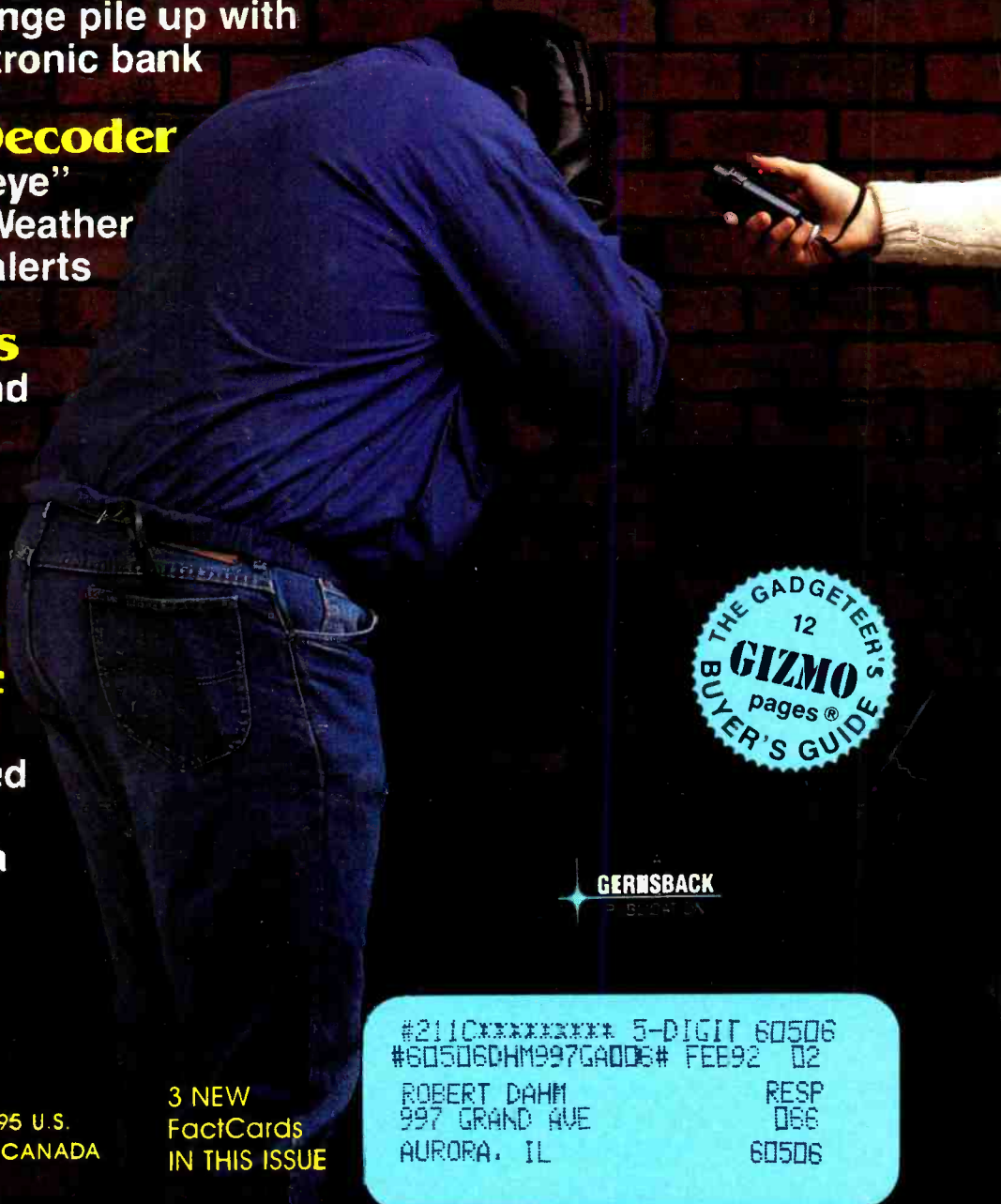

THE GADGETER'S
12
GIZMO
pages®
BUYER'S GUIDE

GERNSBACK



\$2.95 U.S.
\$3.75 CANADA

3 NEW
FactCards
IN THIS ISSUE

#2110***** 5-DIGIT 60506
#60506DHM997GADD6# FEB92 02
ROBERT DAHM RESP
997 GRAND AVE D66
AURORA, IL 60506

Electronics Paperback Books

GREAT PAPERBACKS AT SPECIAL PRICES

BP248—TEST EQUIPMENT CONSTRUCTION \$5.95. Details construction of simple, inexpensive, but extremely useful test equipment. AF Gen, Test Bench Ampl, Audio Millivoltmeter, Transistor Tester and six more.

Test Equipment Construction



How to Use Oscilloscopes and Other Test Equipment

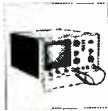

BP267—HOW TO USE OSCILLOSCOPES AND OTHER TEST EQUIPMENT \$6.95. Mastering the oscilloscope is not really too difficult. This book explains all the standard controls and functions. Other equipment is also described.

BP265—MORE ADVANCED USES OF THE MULTIMETER \$5.95. Use these techniques to test and analyze the performance of a variety of components. Also see how to build add-ons to extend multi-meter capabilities.

More Advanced Uses of the Multimeter



An Introduction to Loudspeakers and Enclosure Design

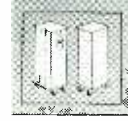

BP256—INTRO TO LOUDSPEAKERS AND ENCLOSURE DESIGN \$5.95. We explore the variety of enclosure and speaker designs in use today so the reader can understand the principles involved.

BP263—A CONCISE INTRO TO dBASE \$6.95. The dBASE series of programs are probably the best known database programs for micro-computers. This book is designed to help you get started working with them.

A Concise Introduction to dBASE



BP260—CONCISE INTRO TO OS/2 \$5.95. If you are a multitasking PC user and want to get the most out of your computer, then you must learn its OS/2 operating system. This book shows you just how to do that, quickly and easily.

A Concise Introduction to OS/2



BP249—MORE ADVANCED TEST EQUIPMENT CONSTRUCTION \$6.95. Eleven more test equipment construction projects. They include a digital voltmeter, capacitance meter, current tracer and more.

More Advanced Test Equipment Construction



Digital Audio Projects



BP245—DIGITAL AUDIO PROJECTS \$5.95. Practical circuits to build and experiment with. Includes A/D converter, input amplifier, digital delay line, compander, echo effect and more.

BP247—MORE ADVANCED MIDI PROJECTS \$5.95. Circuits included are a MIDI indicator, THRU box, merge unit, code generator, pedal, programmer, channelizer, and analyzer.



An Introduction to Amateur Radio



BP257—INTRO TO AMATEUR RADIO \$6.95. Amateur radio is a unique and fascinating hobby. This book gives the newcomer a comprehensive and easy to understand guide to the subject.

Introducing Digital Audio



PCP102—INTRODUCING DIGITAL AUDIO \$9.95. Covers all kinds of digital recording methods—CD, DAT and Sampling. Bridges the gap between the technician and the enthusiast. Principles and methods are explained.

DIGITAL LOGIC GATES AND FLIP-FLOPS



PCP107—DIGITAL LOGIC GATES AND FLIP FLOPS \$10.00. Thorough treatment of gates and flip-flops for enthusiasts, student and technicians. Only a basic knowledge of electronics is needed.

BP251—COMPUTER HOBBYISTS HANDBOOK \$8.95. A wrapup of everything the computer hobbyist needs to know in one easy to use volume. Provides a range of useful reference material in a single source.

Computer Hobbyists Handbook



COMPUTERS AND MUSIC



PCP108—COMPUTERS AND MUSIC \$9.95. Explains the basics of computers and music with no previous knowledge of computers needed. Covers types of music software and explains how to set up your own computer music studio.

- BP195—INTRODUCTION TO SATELLITE TV**..... \$9.95. A definitive introduction to the subject written for the professional engineer, electronics enthusiast, or others who want to know more before they buy. 8 x 10 in.
- BP190—ADVANCED ELECTRONIC SECURITY PROJECTS**.....\$5.95. Includes a passive infra-red detector, a fiber-optic loop alarm, computer-based alarms and an unusual form of ultrasonic intruder detector.
- BP235—POWER SELECTOR GUIDE**.....\$10.00. Complete guide to semiconductor power devices. More than 1000 power handling devices are included. They are tabulated in alpha-numeric sequence, by technical specs. Includes power diodes, Thyristors, Triacs, Power Transistors and FET's.
- BP234—TRANSISTOR SELECTOR GUIDE**.....\$10.00. Companion volume to BP235. Book covers more than 1400 JEDEC, JIS, and brand-specific devices. Also contains listing by case type, and electronic parameters. Includes Darlingtons transistors, high-voltage devices, high-current devices, high power devices.
- BP99—MINI-MATRIX BOARD PROJECTS**..... \$5.50. Here are 20 useful circuits that can be built on a mini-matrix board that is just 24 holes by ten copper-foil strips.
- BP82—ELECTRONIC PROJECTS USING SOLAR CELLS**.....\$5.50. Circuits with applications around the home that are powered by the energy of the sun. Everything from radio receivers, to a bicycle speedometer, to timers, audio projects and more.
- BP117—PRACTICAL ELECTRONIC BUILDING BLOCKS—Book 1**.....\$5.75. Oscillators, Timers, Noise Generators, Rectifiers, Comparators, Triggers and more.
- BP184—INTRO TO 68000 ASSEMBLY LANGUAGE**.....\$6.95. The 68000 is a great new breed of microprocessor. Programming in assembly language increases the running speed of your programs. Here's what you need to know.

BP179—ELECTRONIC CIRCUITS FOR THE COMPUTER CONTROL OF ROBOTS \$7.50. Data and circuits for interfacing the computer to the robot's motors and sensors

- BP239—GETTING THE MOST FROM YOUR MULTIMETER**..... \$5.95. Covers basics of analog and digital meters. Methods of component testing includes transistors, thyristors, resistors, capacitors and other active and passive devices.
- BP97—IC PROJECTS FOR BEGINNERS**.....\$5.50. Power supplies, radio and audio circuits, oscillators, timers, switches, and more. If you can use a soldering iron you can build these devices.
- BP37—50 PROJECTS USING RELAYS, SCR'S & TRIACS**.....\$5.50. Build priority indicators, light modulators, warning devices, light dimmers and more.
- RADIO—100 RADIO HOOKUPS**.....\$3.00. Reprint of 1924 booklet presents radio circuits of the era including regenerative, neutrodyne, reflex & more.
- BP42—SIMPLE LED CIRCUITS**.....\$5.50. A large selection of simple applications for this simple electronic component.
- BP127—HOW TO DESIGN ELECTRONIC PROJECTS**.....\$5.75. Helps the reader to put projects together from standard circuit blocks with a minimum of trial and error.
- BP122—AUDIO AMPLIFIER CONSTRUCTION**.....\$5.75. Construction details for preamps and power amplifiers up through a 100-watt DC-coupled FED amplifier.
- BP92—CRYSTAL SET CONSTRUCTION**.....\$5.50. Everything you need to know about building crystal radio receivers.
- BP45—PROJECTS IN OPTOELECTRONICS**.....\$5.50. Includes infra-red detectors, transmitters, modulated light transmission and photographic applications.

BP185—ELECTRONIC SYNTHESIZER CONSTRUCTION \$5.95. Use this book to learn how to build a reasonably low cost, yet worthwhile monophonic synthesizer and learn a lot about electronic music synthesis in the process

CHECK OFF THE BOOKS YOU WANT

ELECTRONIC TECHNOLOGY TODAY INC.
P.O. Box 240, Massapequa Park, NY 11762-0240

SHIPPING CHARGES IN USA AND CANADA

SORRY No orders accepted outside of USA & Canada

Number of books ordered

Name _____
Address _____
City _____ State _____ Zip _____

\$0.01 to \$5.00	... \$1.25
\$5.01 to 10.00	... \$2.00
\$10.01 to \$20.00	... \$3.00
\$20.01 to \$30.00	... \$4.00
\$30.01 to \$40.00	... \$5.00
\$40.01 to \$50.00	... \$6.00
\$50.01 and above	... \$7.50

Total price of merchandise \$ _____
Sales Tax (New York State Residents only) \$ _____
Shipping (see chart) \$ _____

All payments must be in U.S. funds

Total Enclosed .. \$ _____

P-591

Popular Electronics®

THE MAGAZINE FOR THE ELECTRONICS ACTIVIST!

CONSTRUCTION ARTICLES

THE SONIC DEFENDER	<i>Phil Salas</i>	25
<i>Protect yourself and your property with a blast of high-intensity sound</i>		
BUILD THE "SLOT MACHINE" ELECTRONIC BANK	<i>Marc Spiwak and John Yacono</i>	35
<i>Watch your pocket change add up with this fun-to-build, fun-to-use electronic bank</i>		
WEATHER ALERT DECODER	<i>Keith Rawlinson</i>	62
<i>You'll never miss another severe-storm warning with this weather-alert detection device</i>		

FEATURE ARTICLES

ALL ABOUT METERS	<i>Stephen J. Bigelow</i>	28
<i>With a little know-how, you can design and build your own metering circuits</i>		
THE BIRTH OF THE VACUUM TUBE	<i>James P. Ryback</i>	40
<i>A look at the device that made world-wide radio communications practical, and at the men who battled to control it</i>		
SIMPLE VCR REPAIRS THAT YOU CAN DO	<i>Sam Allen</i>	57
<i>This guide to basic VCR repairs can save you a bundle.</i>		

PRODUCT REVIEWS

GIZMO		45
<i>Including: SharpVision XV-100 Projection-TV System, Fosgate Surround Sound Processor, and more</i>		
HANDS-ON REPORT		65
<i>Laser PC4 Portable Computer</i>		
PRODUCT TEST REPORT	<i>Len Feldman</i>	67
<i>Toshiba M-441 VCR</i>		

COLUMNS

THINK TANK	<i>John Yacono</i>	20
<i>Multiplexing with counters</i>		
ANTIQUÉ RADIO	<i>Marc Ellis</i>	69
<i>Operating the Cunningham Special</i>		
COMPUTER BITS	<i>Jeff Holtzman</i>	72
<i>Hypertext: hype or text?</i>		
CIRCUIT CIRCUS	<i>Charles D. Rakes</i>	74
<i>Test instruments for your bench</i>		
HAM RADIO	<i>Joseph J. Carr</i>	78
<i>An audio-noise blander</i>		
DX LISTENING	<i>Don Jensen</i>	80
<i>Reader mail</i>		
SCANNER SCENE	<i>Marc Saxon</i>	82
<i>A high-tech turbo scanner</i>		

DEPARTMENTS

EDITORIAL	<i>Carl Laron</i>	2
LETTERS		3
ELECTRONICS LIBRARY		4
NEW PRODUCTS		12
ADVERTISER'S INDEX		92

Popular Electronics (ISSN 1042-170X) Published monthly by Gernsback Publications, Inc., 580-B Bi County Boulevard, Farmingdale, NY 11735. Second-Class postage paid at Farmingdale, NY and at additional mailing offices. One-year, twelve issues, subscription rate U.S. and possessions \$21.95, Canada \$26.94 (includes G.S.T., Canadian Goods and Services Tax Registration No. R125186280), all other countries \$29.45. Subscription orders payable in U.S. funds only. International Postal Money Order, or check drawn on a U.S. bank. U.S. single copy price \$2.95. © 1991 by Gernsback Publications, Inc. All rights reserved. **Hands-on Electronics** and **Gizmo** trademarks are registered in U.S. and Canada by Gernsback Publications, Inc. **Popular Electronics** trademark is registered in U.S. and Canada by Electronics Technology Today, Inc. and is licensed to Gernsback Publications. Printed in U.S.A.

Postmaster: Please send address changes to **Popular Electronics**, Subscription Dept., P.O. Box 338, Mount Morris, IL 61054-9932.

A stamped self-addressed envelope must accompany all submitted manuscripts and/or artwork or photographs if their return is desired should they be rejected. We disclaim any responsibility for the loss or damage of manuscripts and/or artwork or photographs while in our possession or otherwise.

As a service to readers, **Popular Electronics** publishes available plans or information relating to newsworthy products, techniques, and scientific and technological developments. Because of possible variances in the quality and condition of materials and workmanship used by readers, **Popular Electronics** disclaims any responsibility for the safe and proper functioning of reader-built projects based upon or from plans or information published in this magazine.

Larry Steckler

EHF, CET

Editor-In-Chief and Publisher

EDITORIAL DEPARTMENT

Carl Laron

Editor

Robert A. Young

Associate Editor

John J. Yacono

Associate Editor

Byron G. Wels, K2AVB

Associate Editor

Teri Scaduto

Assistant Editor

Kathy Terenzi

Editorial Assistant

Marc Spiwak

Editorial Associate

Fred Blechman

Joseph J. Carr, K4IPV

Marc Ellis

Len Feldman

Jeffrey K. Holtzman

Don Jensen

Charles D. Rakes

Marc Saxon

Contributing Editors

PRODUCTION DEPARTMENT

Ruby M. Yee

Production Director

Karen S. Brown

Production Manager

Marcella Amoroso

Production Assistant

Janice Box

Editorial Production

ART DEPARTMENT

Andre Duzant

Art Director

Injae Lee

Illustrator

Russell C. Truelson

Illustrator

Jacqueline P. Cheeseboro

Circulation Director

Michele Torrillo

P-E Bookstore

BUSINESS AND EDITORIAL OFFICES

Gernsback Publications, Inc.

500-B Bi-County Blvd.

Farmingdale, NY 11735

1-516-293-3000

Fax: 1-516-293-3115

President: **Larry Steckler**

Customer Service/Order Entry

1-800-435-0715

In IL 1-800-892-0753

7:30 AM - 8:30 PM EST

Advertising Sales offices listed on page 92

Cover photography by Diversified Photo Services

Composition by

Mates Graphics



The
Audit
Bureau
of Circulation



The publisher has no knowledge of any proprietary rights which will be violated by the making or using of any items disclosed in this issue.

EDITORIAL

A SERIOUS PROBLEM, AND A "SOUND" SOLUTION

Ask most people about what they think are the most serious problems facing society today, and crime is sure to be near the top. That's not surprising, considering that many of us have, or know someone who has been a victim of some type of criminal activity.

Crime knows no social, economic, or geographic boundaries. It can strike the richest and the poorest among us. It is common in cities, but far from unknown in rural areas. Crime can strike anyone at any time.

This month, **Popular Electronics** presents the Sonic Defender, a device that can help keep you from joining the ever-growing legion of crime victims. A purely defensive weapon, it uses blasts of painful, high-intensity sound to deter those with wrong-doing on their mind. Further, the sound is so loud that it is sure to attract the attention of others who may be in the vicinity.

The unit is compact enough to fit into a purse or jacket pocket. It also features a wrist strap that makes the unit easier to carry, and harder to wrest away from its owner.

We wish that there was no need for projects like the Sonic Defender. Unfortunately, crime is a very real part of modern life. We hope, however, that the Sonic Defender can help keep it from becoming a part of your life.

Carl Laron
Editor

CHEMICAL CAUTION

I want to warn other readers that one of the chemicals listed in **Table 1 of the article "Build a Lava Lamp" (Popular Electronics, March 1991)** is quite dangerous. Nitrobenzene is deadly through inhalation, skin contact, or ingestion, and the article does not make that evident.

S.D.

Powell River, BC, Canada
You are correct. However, the chemicals listed in that Table were only candidates for further investigation by the author and none, other than benzyl alcohol, was either pursued or used in the project. Based on the information we have received from you and other readers since publication, **we strongly caution and urge that the use of nitrobenzene be avoided.**—
Editor

3 × 3 ALARM ALTERATION

I was glad to see my article "3 × 3 Alarm" in the February issue of **Popular Electronics**. I have noticed one small error in the parts placement diagram on page 99. The outline of the SCR is reversed 180°. The flat side of the outline should be toward S1. The lead markings are correct, so the readers shouldn't have too much trouble with it.

Richard Hampton

LUCKY 13

I loved "The PortMaster Home-Automation System" (**Popular Electronics**, February 1991), but I noticed an error that a novice PC user might not "latch" onto. On page 61, it said to send an ASCII number 12 for a carriage return. It should read an ASCII number 13.

Here's a question for you: Do you have any device types recommended for either the Triacs (for AC control) or the D flip-flop?

Thanks for another great/simple project.

J.C.

Vancouver, BC, Canada

We're glad you liked the PortMaster so much. Even though it's easy to build, it's a

handy gadget to have. The point you've made is a valid one: A carriage return is character 13, not 12. Luckily, the mistake was made in discussing DOS's idiosyncrasies and shouldn't affect the operation of the unit or the software. Still and all, I like to be accurate. Thanks for your correction.

As far as recommending a Triac is concerned, it really depends on the current requirements of the AC device in question. Further, I can't recommend a particular flip-flop because any flip-flop configured to toggle will do.—*John J. Yacono*

SUPERB SUPER-SIMPLE FREQUENCY COUNTER

I am writing concerning my Super-Simple Frequency Counter, which I built from the instructions in the January 1991 issue of **Popular Electronics**, using the set of parts offered by SHF Microwave Components.

When assembly was completed, I plugged in the battery and turned it on—and immediately got a "0" on the meter, indicating that it was working. I then connected it to my frequency generator and my AC-powered frequency counter, which was showing about 8500 Hz. The Super-Simple Frequency Counter almost immediately displayed the exact same value as my AC-powered frequency counter. I checked its response over the whole range of my frequency counter, and it was right-on at all frequencies. I didn't even have to tweak the calibration pot!

Since I wanted to use the Super-Simple Frequency Counter as a portable device, I mounted it in a Radio Shack #270-627 Experimenter Box, which is a nice handy size and encloses all the components without crowding. It also costs only \$1.95 and has a nice aluminum front panel.

I am really delighted with the device, and am sure I will get a

LETTERS

lot of use out of it for many years. Many thanks to Steven Stronczek for a great design, and to **Popular Electronics** for publishing it. I hope you have some similar articles in store, featuring handy devices, for people with home electronics shops. I'll be looking for them.

W.P.H.

Richland, WA

SMART LABEL PRINTER

I use the Seiko Smart Label Printer that was featured in *Gizmo* (**Popular Electronics**, January 1991) as an integral part of the word-processing aspects of my medical practice.

A solution to the occasional (and infrequent) error status problems that the reviewer encountered is to run the Label TSR program and a session of your favorite word processor in a DeskView window. If the program crashes, you can simply close the window and be on your way.

That scheme also allows you to do your word processing as a separate window or session. The two programs can be "connected" either through DeskView's cut-and-paste facility or via an intermediate file. Keyboard macros can be used to automate and speed up the label creation process. Because of DeskView's multitasking nature, the label printer usually prints simultaneously with my HP DeskJet, decreasing the time one might have to wait to collate the envelope, label, and letter.

Adding the Seiko printer to my word-processing system has decreased the office's manpower needs by about 30 minutes per day, paying back the cost of the printer in well under three months.

C.C.H., M.D.

Hood River, OR

We, too, were generally impressed with Seiko's Smart Label Printer. The problems we encountered were caused by a

bad cable. Once it was replaced, everything worked like a charm.

Your suggestion undoubtedly works. But we don't think that it should be up to the user to find a graceful way to compensate for a program's shortcomings. It is, however, often necessary.—
Chris F. O'Brian

VAN DE GRAAFF INACCURACIES

"The Wimshurst Machine" (**Popular Electronics**, December 1990) contains some inaccuracies in its description of the operation of the Van de Graaff generator.

The Van de Graaff generator does not produce static electricity by friction. It works with induction, just as the Wimshurst machine does. Unlike the figure in the article, the combs of the Van de Graaff do not touch the belt. They are a few millimeters away. Friction does generate a small positive charge in the lower pulley and, by induction, produces a negative charge in the lower comb. Because the teeth of the comb are pointed, a corona discharge sprays electrons onto the moving belt. At the top, the electrons jump to the teeth of the upper comb and are deposited on the dome. Electrons repel each other and end up on the outer surface of the dome, leaving the inner surface neutral—*i.e.*, a Faraday cage. The limit to the charge on the dome is governed by corona leakage.

The source of electrons is the Earth itself. That is why the generator works best when the base is connected to a water pipe. A positive charge can be sprayed onto the belt if a positive supply of charges is attached to the lower comb through a battery or a power supply.

I hope this will help dispel some of the myths that have surrounded the explanation of the Van de Graaff generator.

G.R.M.

Meriden, CT

ELECTRONICS LIBRARY

Old Time Radios! Restoration and Repair

by Joseph J. Carr

Even those of you who enjoy reading his *Ham Radio* column in **Popular Electronics** might be unaware that Joe Carr's expertise extends to antique radios as well. In this book, he puts to use his years of experience in radio repair to teach old-time-radio enthusiasts how to restore and repair their finds. He provides a glimpse at the early history of radio receivers from the first 19th-century experiments to superheterodyne sets, before going into more detail about vacuum-tube radios. To give readers of all levels of experience a firm background upon which to base their repair work, a full chapter is devoted to explaining vacuum-tube technology. In addition to tube technology, the author explains transistor theory and practice

rebuild radios, and includes information on power-supply circuits, capacitors and other components, RF and IF amplifiers, and amplitude-modulation detectors. In addition, the specific types of test equipment used for radio repair are discussed. The book includes a complete radio troubleshooting course, a capacitor/resistor color-code chart to help readers identify parts, and vacuum-tube pinout diagrams that are often missing from schematics.

Old Time Radios! Restoration and Repair costs \$16.95 and is published by TAB Books Inc., Blue Ridge Summit, PA 17294-0850; Tel: 1-800-233-1128.

CIRCLE 98 ON FREE INFORMATION CARD

POWER UP!

from JDR Microdevices

Filled with products to help computer enthusiasts maximize the speed and efficiency of their equipment, this 100-page catalog features color-coded sections to help customers quickly locate products. New products highlighted in the catalog include JDR's Front Panel—a combination bus extender and instruction execution detector designed for hardware and software debugging—and the Breadboard-On-A-Card Series with Decode for faster and easier prototyping. Other new items include an accelerator card with a high-speed 28-MHz 68030 CPU, a 486 motherboard, Amiga products, and an expanded software line that features many software products for Windows. The catalog also includes technical information for computer enthusiasts, such as "Derick's High Tech Corner"—a column that provides PC-technology information and purchasing tips—and numerous "Tech Tips" that are scattered throughout.



Power Up! is free upon request from JDR Microdevices, 2233 Branham Lane, San Jose, CA 95124; Tel: 480-559-1200 or 800-538-5000; Fax: 408-559-0250.

CIRCLE 80 ON FREE INFORMATION CARD

AN INTRODUCTION TO AMATEUR COMMUNICATIONS SATELLITES

by Alan Pickard

Despite the large number of communications satellites currently orbiting the earth, and the large role they play in our information-based society, most people—even those who have and use satellite television systems—have no understanding of satellite technology. This book explains the complex technology behind amateur-communications satellites, including operating frequency, life expectancy, and orbital paths. It also shows how they can be tracked and their signals received with relatively inexpensive equipment that most hobbyists can afford. That equipment can be hooked up to home computers, such as IBM-PC compatibles, for the decoding of received signals. Several currently available systems are described, and software is discussed. The results of decoding signals that contain information such as telemetry data and

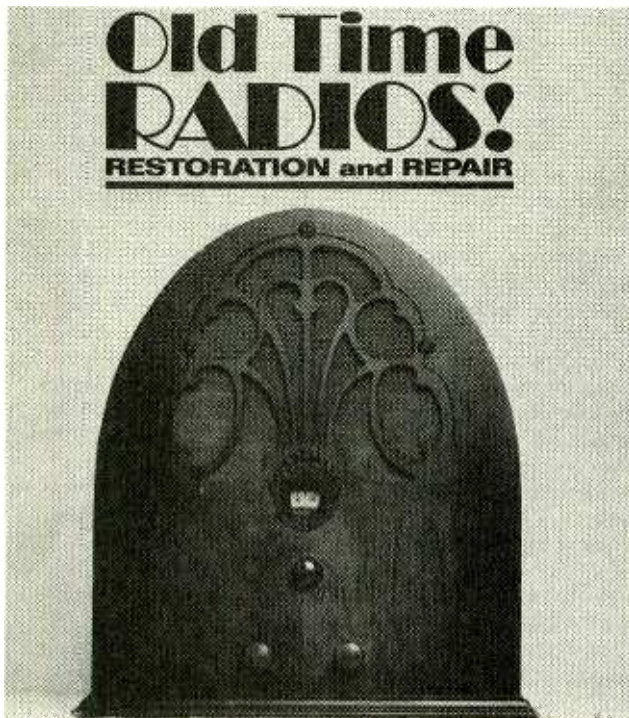

that can be used on many of the highly collectible "old-time" radios manufactured in the 1950's and 1960's. The book provides detailed instructions and schematics needed to repair and

weather pictures are demonstrated. Although individuals can't launch their own satellites, they can achieve fun and rewarding results from received signals, either in the form of telemetry data or picture information.

An introduction to Amateur Communications Satellites is available for \$7.95 (including shipping and handling) from Electronics Technology Today Inc., P.O. Box 240, Massapequa Park, NY 11762-0240.

CIRCLE 97 ON FREE INFORMATION CARD

Box 19100, Washington, DC 20036.

CIRCLE 81 ON FREE INFORMATION CARD

SELECTION AND USE OF PANDUIT ADHESIVE MOUNTS
from Panduit Electrical Corp.

This technical/application data sheet aids in the selection and use of Panduit's adhesive mounts for wire and cable.

Those mounts are available in nylon, PVC, aluminum, and

chrome-plated steel. The illustrated 8-page bulletin provides detailed information on types of adhesives, general guidelines for surface preparation, and short listings of applications and markets. A table includes complete listings of the company's mounts and provides dimensions, service temperature ranges, adhesive type, maximum static loads, and which cable ties (if any) are used with the mounts. An application chart helps users select the right type of adhesive for a

variety of surfaces, and gives their resistance to various chemicals and proper installation procedures.

Selection and Use of Panduit Adhesive Mounts (Technical/Application Data Sheet TADS-WA-14B) is free upon request from Panduit Electrical Corp., Product Manager, Wiring Accessories, 17301 Ridgeland Avenue, Tinley Park, IL 60477-0981; Tel: 1-800-777-3300, ext. 7346.

CIRCLE 82 ON FREE INFORMATION CARD

CONSUMERS SHOULD KNOW: ALL ABOUT AUTO ELECTRONIC PRODUCTS

from Electronic Industries Association/Consumer Electronics Group

Gone are the days when cars were simply equipped with AM radios. Today's vehicles are likely to have AM/FM stereo receivers with built-in cassette decks—and an increasing number of vehicles also have CD players, extra speakers, high-tech security systems, cellular mobile phones, and CB radios. This 48-page brochure poses and clearly answers the questions that auto-electronic consumers are most likely to ask. It explains what makes a good car stereo system, how to evaluate the relative performance of various systems, features to look for in each component, and what installation options are available. In the cellular-phones section, the booklet explains the basic technology, pricing (including leasing options), cellular services, what features to look for, and how cellular phones are used. CB radios and car-security systems receive similar treatments. Warranties, and retail practices are also discussed. Throughout the brochure, terms that might be unfamiliar or confusing to consumers are printed in italics, indicating that explanations are provided in the glossary.

Consumers Should Know: All About Auto Electronic Products is complimentary. To obtain a copy, send a No. 10-size self-addressed envelope with 37-cent postage to Electronic Industries Association, AEP, P.O.

ELENCO & HITACHI PRODUCTS AT DISCOUNT PRICES

NEW! RSOs (Real-Time & Storage Oscilloscopes) From HITACHI **NEW!** Compact Series Scopes

The RSO - Its the new solution View, Acquire, Test, Transfer and Document Your Waveform Data

4-Channel, 100MS/s Model	Introductory Price
100MS/s (25MS/s on 4 channels simultaneously), 100MHz, 4kw x 1ch, 2kw x 2ch, 1kw x 4ch. VC-6145	\$ 4,695.00

Compact Full Feature Models

40MS/s, 100MHz, 4kw x 1ch, 2kw x 2ch	VC-6045	\$ 3,049.00
20MS/s, 50MHz, 2kw x 2ch	VC-6025	\$ 2,295.00

Low Cost/High Value Models

20MS/s, 50MHz, 2kw x 2ch	VC-6024	\$ 2,049.00
20MS/s, 20MHz, 2kw x 2ch	VC-6023	\$ 1,749.00

RSOs from Hitachi feature such functions as roll mode, averaging, save memory, smoothing, interpolation, pretriggering, cursor measurements, plotter interface, and RS-232C interface. With the comfort of analog and the power of digital.

Hitachi Portable Scopes

V-212 DC to 50MHz, 2-Channel, DC offset function, Alternate magnifier function DC to 20MHz Dual Channel V-525 CRT Readout, Cursor Meas. \$1,025 V-523 Delayed Sweep \$995 V-522 Basic Model \$895

20MHz Elenco Oscilloscope \$375 MO-1251

- Dual Trace
- Component Tester
- 6" CRT
- X-Y Operation
- TV Sync
- 2-P1 Probes

FREE DMM with purchase of ANY SCOPE

SCOPE PROBES

P-1 65MHz, 1x, 10x	\$19.95
P-2 100MHz, 1x, 10x	\$23.95

Elenco 35MHz Dual Trace \$495 MO-1252

- High Luminance 6" CRT
- 1mV Sensitivity
- 9KV Acceleration Voltage
- 10ms Rise Time
- X-Y Operation = 2 Axis
- Delayed Triggering Sweep
- Includes 2 P-1 Probes

All scopes include probes, schematics, operators manual, and 3 year (2 yrs for Elenco scopes) world wide warranty on parts & labor. Many accessories available for all Hitachi scopes. Call or write for complete specifications on these and many other fine oscilloscopes.

WE NOW CARRY COMPLETE LINE OF FLUKE MULTIMETERS Models

71F	83
23F	85
25F	87
77F	8050A
77F	8060A
77F	8062A
77F	+ More

CALL FOR SPECIAL PRICING

True RMS 4 1/2 Digit Multimeter M-7000 \$135

05% DC Accuracy
1% Resistance with Freq. Counter and deluxe case

10 Function Multimeter CM-365 \$65

AC + DC Voltage & Amps
Resistance to 2000MΩ
Diode, Logic, & Trans test
Capacitance to 200uF

Digital Capacitance Meter CM-1550 \$58.95

9 Ranges
1p1-20,000uFd
.5% basic accy
Zero control
with case

Digital LCR Meter LC-1801 \$125

Measure
Coils 1uH-200H
Caps 1p1-200uF
Res. 01-200M

Function Generator Box \$9600 \$28.95

Provides sine, triangle, square wave from 1Hz to 1MHz AM or FM capability

Triple Power Supply XP-620 Assembled \$65 Kit \$45

2 to 15V at 1A,
2 to 15V at 1A
(or 4 to 30V at 1A)
and 5V at 3A

Contains all the desired features for doing experiments. Features short circuit protection, all supplies.

Wide Band Signal Generators SG-9000 \$129

RF Freq 100K-450MHz
AM Modulation of 1KHz
Variable RF output

SG-9500 w/ Digital Display and 150MHz built-in Counter \$249

Soldering Station SL-30 \$99

Temperature Controlled
Digital display
Temp range 300F-900F
Grounded tip
Overheat protected

Color Convergence Generator SG-200 \$69.95

Finest in the industry
10 rock steady patterns

10MHz Oscilloscope S-3000 \$275

10MHz DC or AC
Triggered Sweep
Enhanced Vert & Hor
Reads Volts & Freq

Temperature Probe M-1100C \$58.95

Semiconductor type
Range 50F-302F
Fits most digital meters

Autorangeing DMM M-5000 \$45

9 Functions
Memory and Data hold
1/2 % basic acc
3 1/2 digit LCD

AC Current Meter ST-1010 \$69.95

1000 Amps
Data & Peak hold
9 Functions
Deluxe Case

Decode Blox #9610 or #9620 \$18.95

#9610 Resistor Blox
47 ohm to 1M & 100K pot
#9620 Capacitor Blox
47p1 to 10MFD

Quad Power Supply XP-580 \$59.95

2-20V at 2A
12V at 1A
5V at 3A
5V at .5A

Fully regulated, short circuit protected
XP-575 without meters \$39.95

Digital Triple Power Supply XP-765 \$249

0-20V at 1A
0-20V at 1A
5V at 5A

Fully regulated, Short circuit protected with 2 limit control, 3 separate supplies
XP-860 with Analog Meters \$175

GF-8016 Function Generator with Freq. Counter \$249

Sine, Square, Triangle
Pulse, Ramp, 2 to 2MHz
Freq. Counter, 1 - 10MHz

GF-8015 without Freq. Meter \$179

LEARN TO BUILD AND PROGRAM COMPUTERS WITH THIS KIT!

INCLUDES: All Parts, Assembly and Lesson Manual

Model MM-8000 \$129.00

Starting from scratch you build a complete system. Our Micro-Master trainer teaches you to write into RAM, ROMs and run a 8085 microprocessor which uses similar machine language as IBM PC. You will write the initial instructions to tell the 8085 processor to get started and store these instructions in permanent memory in a 2816 EPROM. Teaches you all about input and output ports, computer timers. Build your own keyboard and learn how to scan keyboard and display. No previous computer knowledge required. Simple easy to understand instruction teaches you to write in machine language.

ROBOTICS KIT FOR ABOVE (MM-810) \$175.95

WE WILL NOT BE UNDERSOLD!
UPS Shipping: 48 States 3%
(\$10 Max) IL Res. 7% Tax

C & S SALES INC.
1245 Rosewood, Deerfield, IL 60015
(800) 292-7711 (708) 541-0710

15 Day Money Back Guarantee
2 Year Warranty (Price subject to change)

WRITE FOR FREE CATALOG

CIRCLE 9 ON FREE INFORMATION CARD

AOR Scanners.

Great Performance. Great Service. Great Value.

Free Freight
25-Day Money-Back Guarantee
Toll-Free Service and Support
No Credit Card Surcharge
One Year Warranty

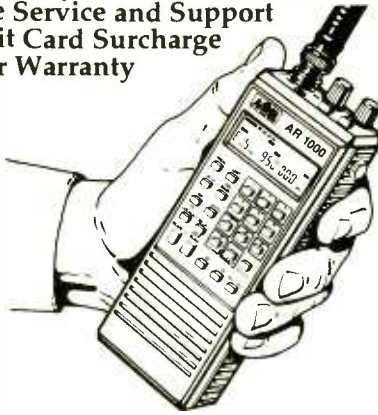

AR1000

\$499

1000 Channels. 8-600MHz, 805-1300MHz

Standard Features:

- Extremely compact size.
- Continuous coverage (except UHF TV 600-805)
- Antenna attenuator switch, 10db.
- Manual tuning knob.
- Earphone jack, 3.5mm.
- AM, FM and wide band FM tuning modes.
- Backlighted LCD display.
- 10 Scan Banks, 10 Search Banks.
- Selectable Priority Channel.
- Delay, Hold Features.
- Selectable Search Increments, 5-955KHz.
- Permanent memory backup.
- 4 AA Ni Cad batteries included.
- AC adaptor/charger.
- Carry Case.
- Cigarette Lighter Charger.
- Belt Clip.
- Earphone.

Options:

- External Speaker. Mobile Mount. MS190 \$19.50
- Extended Warranty. 2/3 yrs \$45/\$55

Specifications:

- Coverage: 8-600, 805,1300MHz
- Sensitivity: .35uV NFM, 1.0uV WFM, 1.0AM
- Speed: 20 ch/sec. scan. 40 ch/sec. search
- IF: 561.225, 58.075, 455KHz or 10.7MHz
- Increments: 5 to 955KHz selectable/ 5 or 12.5 steps.
- Audio: .4 Watts
- Power: Input 9 - 13.8 V. DC
- Antenna: BNC
- Display: LCD
- Dimensions: 6 7/8H x 1 3/4D x 2 1/2W. 12oz wt.

AR950

\$239

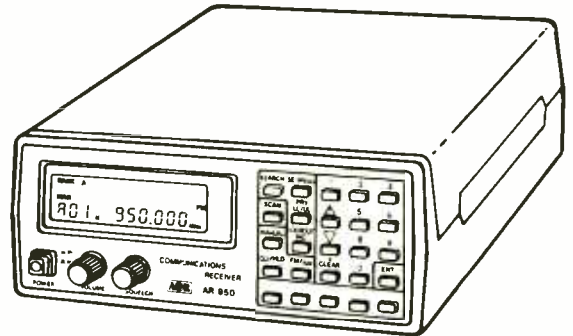

100 Channels. Low, Air, High, UHF & 800MHz.

Standard Features:

- Extremely compact size.
- Unrestricted 800MHz coverage.
- 100 channels permanent memory.
- Earphone Jack & Attenuator.
- Delay, Hold features.
- Channel 1 Priority.
- 5 Scan Banks, 5 Search Banks.
- Telescopic and Flexible Antennas w/ BNC connector.
- AC & DC Power cords w/ mtng hardware.
- One Year Limited Warranty.

Options:

- Base type antenna 25 to 1000MHz w 50' coax. AS300 \$59.95
- Mag Mnt Mobile Antenna. 15' coax. MA100 \$25.00
- Cigarette Lighter power adaptor. CP100 \$4.00
- External Speaker with mobile mount. MS100 \$19.50
- Extended Warranty. 2/3 yrs \$40/\$55

Specifications:

- Coverage: 27-54, 108-174, 406-512, 830-950MHz
- Sensitivity: .4uV Lo./Hi. .8uV Air. .5uV UHF. 1.0uV 800
- Scan Speed: 15 ch/sec.
- IF: 21.4MHz, 455KHz
- Increments: 10,12.5,25,30
- Audio: 1W
- Power: 12.8VDC, 200MA
- Antenna: BNC
- Display: LCD w/backlight
- Dimensions: 2 1/4H x 5 5/8W x 6 1/2D. 14oz wt.

We offer 100's of communications products.

AR3000

\$995

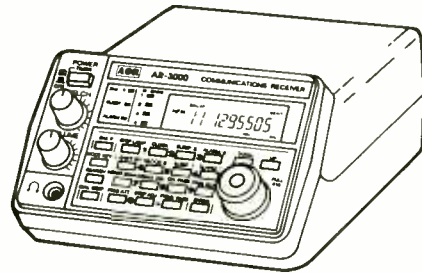

400 Channels. 100KHz to 2036MHz.

Standard Features:

- Extremely compact size.
- Continuous coverage
- Attenuation Programmable by Channel.
- Manual tuning knob.
- Tuning increments down to 50Hz.
- AM, FM, wide band FM, LSB, USB, CW modes.
- Backlighted LCD display.
- 4 Scan and Search Banks, Lockout in Search.
- 4 Priority Channels.
- RS232 control through DB25 connector.
- Delay, Hold Features.
- 15 band pass filters, GaAsFET RF amp.
- Sleep and Alarm Features.
- AC adaptor/charger. DC power cord.
- Telescopic Antenna.

Options:

- | | | |
|---------------------------------|-------|----------|
| Earphone. | EP200 | \$2.00 |
| External Speaker. Mobile Mount. | MS190 | \$19.50 |
| Extended Warranty. 2/3 yrs. | | \$65/75 |
| Mobile Mounting Bracket. | MM1 | \$14.90 |
| RS232 Control Package | SCS3 | \$295.00 |
- (software & cable) offers spectrum display and database.

Specifications:

- | | |
|--------------|---|
| Coverage: | 100KHz - 2036MHz |
| Sensitivity: | .35uV NFM, 1.0uV WFM,
1.0AM/SSB/CW |
| Speed: | 20 ch/sec. scan. 20ch/sec. search |
| IF: | 736.23, (352.23) (198.63) 45.0275, 455KHz |
| Increments: | 50Hz and greater |
| Selectivity: | 2.4Khz/-6db (SSB) 12KHz/-6db
(NFM/AM) |
| Audio: | 1.2 Watts at 4 ohms |
| Power: | Input 13.8 V. DC 500mA |
| Antenna: | BNC |
| Display: | LCD |
| Dimensions: | 3 1/7H x 5 2/5W x 7 7/8D Wt. 2lb 10oz. |

AR2500

\$499

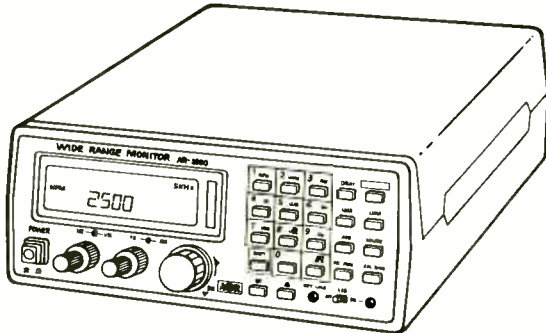

2016 Channels. 1 MHz to 1500 MHz

Standard Features

- Continuous coverage
- AM, FM, wide band FM, & BFO for SSB, CW.
- 64 Scan Banks.
- 16 Search Banks.
- RS232 port built in.
- Includes AC/DC pwr crd. Antenna, Mntng Brckt.
- One Year Limited Warranty.

Options:

- | | | |
|---------------------------------|-------|----------|
| Earphone. | EP200 | \$2.00 |
| External Speaker. Mobile Mount. | MS190 | \$19.50 |
| Extended Warranty. 2/3 yrs. | | \$65/75 |
| Mobile Mounting Bracket. | MM1 | \$14.90 |
| RS232 Control Package | SCS2 | \$295.00 |
- (software & cable) offers spectrum display and database.

Specifications:

- | | |
|--------------|---------------------------------------|
| Coverage: | 1 MHz - 1500MHz |
| Sensitivity: | .35uV NFM, 1.0uV WFM,
1.0AM/SSB/CW |
| Speed: | 38 ch/sec. scan. 38 ch/sec. search |
| IF: | 750.00, 45.0275, 5.5MHz 455KHz |
| Increments: | 5,12,5,25 KHz |
| Audio: | 1.2 Watts at 4 ohms |
| Power: | Input 13.8 V. DC 300mA |
| Antenna: | BNC |
| Display: | LCD, backlighted. |
| Dimensions: | 2 1/4H x 5 5/8W x 6 1/2D Wt. 1lb. |

To Order Call 1•800•445•7717

In All 50 States and Canada. 24 Hours a Day. Fax Orders: 1-800-448-1084, 24 Hours a Day.

ACE Communications Monitor Division 10707 E. 106th Street, Fishers, IN 46038

Int'l Voice# 317-842-7115. Int'l Fax# 317-849-8794.

Service and Support Lines: Mon-Fri 9a.m. to 9p.m., Saturday 10-4. EST

MasterCard, Visa, American Express, Checks, Approved P.O.'s. & C.O.D. (add 5.00)

Prices and specifications subject to change.

SUPER LONG PLAY TAPE RECORDERS

12 Hour Model —
USES 120 TAPE
\$119.00*

Modified Panasonic Slimline high quality AC-DC provide 6 continuous hours of quality recording & playback on each side of cassette for 12 hours total. Includes • Voice level control • Digital counter, etc. TDK - 120 Cassette Furnished.



PHONE RECORDING ADAPTER
Records calls automatically. All Solid state connects to your telephone jack and tape recorder. Starts recording when phone is lifted. Stops when you hang up. **\$28.50***
FCC APPROVED



VOX VOICE ACTIVATED CONTROL SWITCH
Solid state. Self contained. Adjustable sensitivity. Voices or other sounds automatically activate and control recorder. Uses either recorder or remote mike. **\$28.50***



*Add for ship & hdg. Phone Adapter & Vox \$1.50 ea. Recorders \$4.00 ea. Cal. Res. add tax. Mail order, VISA, M/C, COD's OK. Money Back Guarantee. Qty. disc avail. Dealer Inquiries invited. Free data ©
AMC SALES INC. Dept. B 9335 Lubec St.
Box 928, Downey, CA 90241
Phone (213) 869-8519
FAX (213) 923-1478

CIRCLE 6 ON FREE INFORMATION CARD

USING MACDRAW

by Marvin Bryan

One of the most popular programs available for the Macintosh computer, MacDraw is an object-based drawing program that can be used to create a wide variety of projects, including professional artwork and illustrations, invitations and announcements, brochures, newsletters, floor plans and other architectural renderings, charts, graphs, training materials, and presentations. This book is designed to help readers ranging from absolute beginners to professional artists and experienced MacDraw users to get the most out of the program. It offers information on MacDraw's basics and tools along with advanced concepts on designing, editing, and production. The book is filled with sample screens and practical examples that the reader can try out on a Macintosh computer for a hands-on learning experience. The book provides step-by-step instructions on how to handle perspective, how to create pictures and captions,

and how to measure visual elements to scale. Special tips show how to work with multiple design layers, colors, shadows, and typefaces. The book also offers detailed information on MacDraw's commercial applications.

Using MacDraw costs \$24.95 and is published by Que, 11711 North College Avenue, Suite 140, Carmel, IN 46032; Tel: 1-317-573-2500.

CIRCLE 94 ON FREE INFORMATION CARD

CATALOG OF PRODUCTS

from Beckman Industrial Corporation

Beckman's complete line of test instrumentation and industrial products is featured in this 40-page brochure. Included are digital multimeters, component testers, oscilloscopes, function generators, universal and frequency counters, communication testers, digital temperature meters and probes, digital calibrators/indicators, signal conditioners, digital panel indicators, precision bench ther-

mometers, data-acquisition and recording instruments, and digital controllers. Some of the products featured include full specifications while others can be supplemented with more detailed literature. The catalog is indexed by general product type on the contents page and by model numbers on the numerical index page to help readers easily locate particular products.

The Catalog of Products is free upon request from Beckman Industrial Corporation, 3883 Ruffin Road, San Diego, CA 92123-1898; Tel: 619-495-3200.

CIRCLE 83 ON FREE INFORMATION CARD

RADIO FREQUENCY TRANSMISSION SYSTEMS: Design and Operation

by Jerry C. Whitaker

Radio-frequency (RF) transmission systems are increasingly being used in a wide range of applications.

Written for technicians and engineers who work with the design, installation, operation, or maintenance of RF transmis-

power radiators. The book also offers helpful examples of both solid-state and vacuum-tube RF power amplifiers and presents full coverage of RF combiner systems.

The individual elements of RF transmission systems are described, and their interrelation is explained. Complex theory and math are included only when essential for understanding the basic concepts. Special emphasis is placed on television and radio hardware, because those applications provide examples that can be extended to other uses.

Radio Frequency Transmission Systems: Design and Operation costs \$49.50 in hard-cover and is published by McGraw-Hill Book Company, 11 West 19th Street, New York, NY 10011; Tel: 1-800-2-MCGRAW. CIRCLE 96 ON FREE INFORMATION CARD

WORDPERFECT PC TUTOR

by Marianne B. Fox, Lawrence C. Metzelaar, and Susan Hafer

The combined book/diskette self-instruction package provides an on-screen guide to learning WordPerfect 5.1. The user simply inserts the tutorial disk, types a command, and they are ready to begin the interactive learning process. The lesson files on the disk contain examples and exercises that are clearly explained in the text. The package is designed to quickly teach readers all the essential WordPerfect procedures, including how to format, create, and edit a document. The tutorial shows users how to operate their computers with confidence, load and start WordPerfect on their PC's, format page layouts, and design documents. Advanced word-processing skills are also featured. Beginners are advised to start with the first lesson and progress through the tutorials in order; more experienced WordPerfect Users can simply pick and choose those areas in which they need to brush up their skills.

WordPerfect PC Tutor book/diskette package costs \$39.95 and is published by Que Corporation, 11711 N. College Ave., Suite 140, Carmel, IN 46032. ■

CIRCLE 94 ON FREE INFORMATION CARD

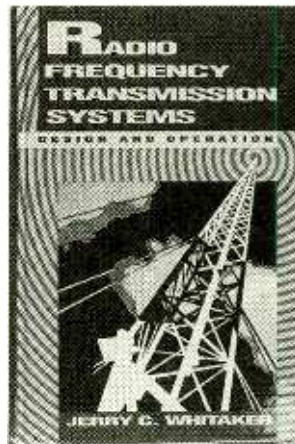

sion equipment, this book provides a complete hands-on guide that ranges from in-depth discussions of individual components to expert advice on keeping systems running smoothly. It provides detailed discussions of the latest developments in power devices, including solid-state power devices, the Klystron, the MSDC klystron, and the TWT. The use of high-power coaxial transmission lines and waveguides is examined, along with the design and operation of high-

CIE Gives You The Training You Need to Succeed... At Your Own Pace...& In Your Own Home!

Discover Your Career Potential In The
Fast-Growing Field Of High-Tech Electronics!

If you're anxious to get ahead...and build a real career...you owe it to yourself to find out about the Cleveland Institute of Electronics!

CIE can help you discover your career potential in the fast growing field of high-tech electronics. A career that will challenge and excite you every day...reward you with a powerful feeling of personal accomplishment...and deliver a level of financial security you may have only dreamed of before!

As the leading school in home-study electronics, CIE has helped over 150,000 students in the U.S.A. and over 70 foreign countries get started in this exciting field. To find out how CIE could be helping you...read on...then send for a CIE catalog TODAY!

A Growing Need For Trained Professionals!

The career opportunities shown here are only a few of the challenging, high-paying careers you could enjoy as an electronics technician.

You could be the "brains" behind the scenes of an exciting TV broadcast...trouble-shoot life-saving medical equipment...design exotic new aeronautics systems...CIE's job-oriented programs offer you the quickest possible path to the career of your dreams! And CIE also features military and union re-training, to build on what you already know.

Dozens Of Fascinating Careers To Choose From!

Even if you aren't sure which career is best for you, CIE can get you started with core lessons applicable to all areas of electronics. As you advance, CIE makes job opportunities available to you through the bimonthly school paper, *The Electron*.



Data Communications



Automotive Electronics



Avionics

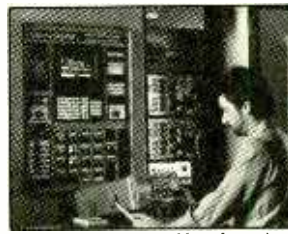

Computer-Assisted Manufacturing



Consumer Electronics



Military Electronics

Personal Training From A Renowned Faculty.

Unlike the impersonal approach of large classroom study, CIE offers you one-on-one instructional help 6 days a week, toll-free. Each CIE lesson is authored by an independent specialist, backed by CIE instructors who work directly with you to answer your questions and provide technical assistance when you need it.

Practical Training... At Your Own Pace.

Through CIE, you can train for your new career while you keep your present job. Each course allows a generous completion time, and there are no limitations on how fast you can study. Should you already have some electronics experience, CIE offers several courses which start at the intermediate level.

"State-Of-The-Art" Facilities & Equipment.

In 1969, CIE pioneered the first electronics laboratory course, and in 1984, the first Microprocessor Laboratory. Today, no other home study school can match CIE's state-of-the-art equipment. And all your laboratory equipment is included in your tuition cost. There is no extra charge—it's yours to use while you study at home and on the job after you complete your course!

Earn Your Degree To Become A Professional In Electronics!

Every CIE course you take earns you credit towards the completion of your Associate in Applied Science Degree, so you can work towards your degree in stages. And CIE is the only school that awards you for fast study, which can save you thousands of dollars in obtaining the same electronics education found in four-year Bachelor's Degree programs!

Send For Your Catalog Today!



CIE World Headquarters

Cleveland Institute of Electronics, Inc.
1776 East 17th St., Cleveland, Ohio 44114

YES! Please send me your independent study catalog (For your convenience, CIE will have a representative contact you—there is no obligation.)

Print Name _____

Address _____ Apt # _____

City/State/Zip _____

Age _____ Area Code/Phone No. _____

Check box for G.I. Bill bulletin on educational benefits: Veteran Active Duty

Mail This Coupon Today!

AH07

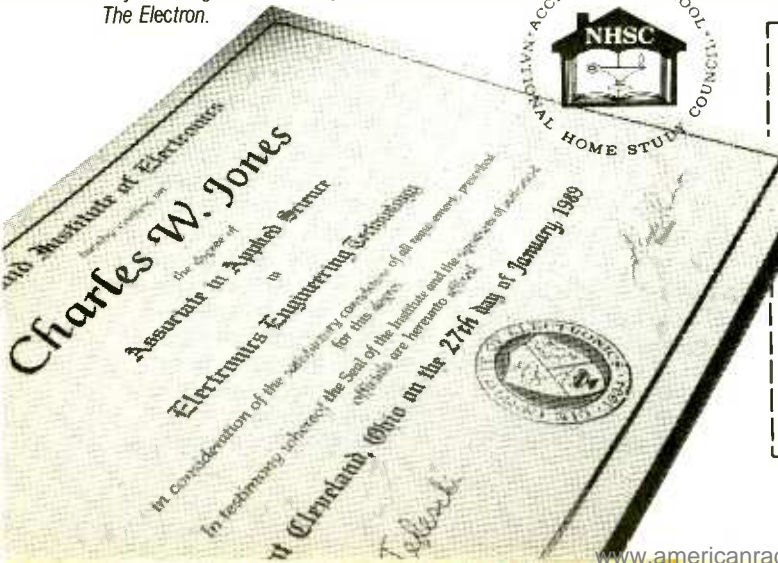

NEW PRODUCTS

80286 Notebook Computer

Weighing in at only 6.7 pounds (with battery), the *Tandy 2810 HD* laptop is a full-function AT-compatible unit. The notebook-style computer features a 16-MHz 80C286 microprocessor, VGA graphics, an internal 20MB hard-disk drive with a 23-ms access speed, a 1.44MB 3½-inch floppy drive, a battery life of up to 3½ hours, and an AC adapter/charger. With 1MB of standard memory, expandable to 5MB, the 2810 HD can run advanced business and other software applications, and an optional Intel 287 XLT coprocessor can be added for math-intensive applications. For immediate, out-of-the-box computing, MS-DOS 4.01, Tandy's DeskMate 3.5 personal productivity software, and a TEMM



memory manager are factory-installed on the hard drive.

The 2810 HD, with built-in ports for an external 101-key enhanced keyboard, and external VGA monitor, and other peripherals, is designed to double as a desktop system. For portable use, the 1.7 × 12.2 × 10-inch laptop has a full-size, fluorescent backlit, black-on-white LCD screen with 640 × 480 VGA graphics resolution and 16 or 32 gray scales for improved contrast. Its 84-key keyboard has true 101-key emulation and Tandy's Key-Switch feature, which allows the user to switch the

CONTROL and CAPS LOCK keys and their functions so that the keyboard layout resembles a standard typewriter.

The Tandy 2810 HD notebook-style computer is available at Radio Shack Computer Centers, Radio Shack Stores, and dealers nationwide at a suggested retail price of \$2499. For more information, contact Radio Shack, Division of Tandy Corporation, 700 One Tandy Center, Fort Worth, TX 76102.

**CIRCLE 102 ON FREE
INFORMATION CARD**

SOLDERING-IRON STAND

Featuring a metal base for added stability, the *Antex ST-5* from M.M. Newman Corporation is a heavy-duty soldering-iron stand. Using a coil-spring holder and bezel for holding the iron, the ST-5 prevents heat sinking and helps protect the user from burns. It comes with a choice of two different bezels that leave the soldering tip unsupported to eliminate contact with the spring holder. The stand also has a phenolic tray, and a half-inch-thick wiping sponge with a center hole for collecting dross. The ST-5 is compatible with all popular soldering irons and conforms to DOD-STD-2000-1B 4.11.3.3 requirements.

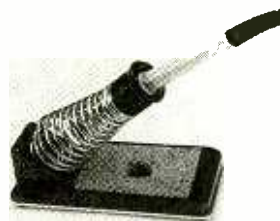

The Antex ST-5 soldering-iron stand has a list price of \$11.95. For additional information, contact M.M. Newman Corporation, 24 Tioga Way, P.O. Box 615, Marblehead, MA 01945; Tel: 617-631-7100; Fax: 617-631-8887.

**CIRCLE 103 ON FREE
INFORMATION CARD**

TRI-PORT ADAPTER CARD

Designed to eliminate PC-adaptor obsolescence as changes are made to local-area-network configurations, *Telebyte's Model 516 Tri-Port Adapter* is a 16-bit Ethernet PC adapter card that is compatible with either thick coax, thin coax, or unshielded twisted pair and maintains complete compliance for IEEE 803.2 10 Base 2, 10 Base 5, and 10 Base T. By using the Tri-Port Adapter, the LAN manager does not need to

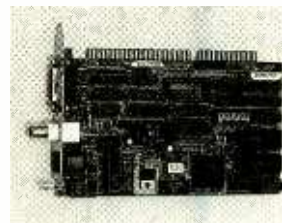

stock different adapter cards to meet the needs of a growing network, and changing adapter cards is no longer required.

Contained on a half card, the Tri-Port Adapter has three different types of connectors. An RJ-45 is used for 10 Base T networks using unshielded twisted pairs, while a BNC is used for thin coax. Thick coax can be accommodated using a transceiver attached to the standard DIX (DB-15) connector. The desired connector port is activated by jumper placement on the model 516, which performs at 10 MB per second regardless of the wiring media selected. Its use is compatible with the Novell NE-2000 adapter, and it features 16-bit architecture for use with PC/AT/386-type computers. The 516 also features complete software compatibility with Novell Netware Advanced, ELS, SFT, and 286/386 NETBIOS.

The Tri-Port Adapter includes a boot ROM socket and optional ROM to allow its use in a diskless workstation. A DIP switch is used to set the base addresses for the boot ROM and the workstation.

The model 516 Tri-Port Adapt-

er costs \$395 in single quantities, with quantity discounts available. For additional information, contact Telebyte Technology Inc., LAN Sales Department, 270 East Pulaski Road, Greenlawn, NY 11740; Tel: 800-835-3298 or 516-432-3232; Fax: 516-385-8184 or 516-385-7060.

CIRCLE 104 ON FREE INFORMATION CARD

BENCHTOP DIGITAL MULTIMETER

Especially well-suited for use where a large, easy-to-read display is needed, *B&K-Precision's Model 2831A* digital multimeter can be used for education; engineering-lab work; or for testing, analyzing, or repairing electronic equipment. The 3½-digit DMM has 0.1% DC-voltage ac-



curacy, AC voltage response to 40 kHz, and a 0.5-inch bright LCD readout. The instrument measures current to 20 amps, voltage to 1200 VDC or 1000 VAC, and resistance to 20 megohms. It also includes a diode-test function. For precise readings, the 2831A features resolution to 0.1 mV, 0.1 amp, and 0.1 ohm. An audible continuity-check feature sounds a tone for resistances under 10 ohms. All functions are overload protected, with high-energy fusing on current ranges.

The benchtop instrument comes with test leads, spare fuses, and a user's manual. For user convenience, it features a combination tilt handle/bail. Optional accessories include a test-probe assembly, a demodulator probe, a high-voltage probe, and temperature probes.

The model 2831A digital multimeter has a suggested list price of \$295. For further information, contact B&K-Precision, 6470 West Cortland Street, Chicago, IL 60635; Tel: 312-889-1448.

CIRCLE 105 ON FREE INFORMATION CARD

SATELLITE ANTENNA

For areas where antenna size is restricted, *Channel Master* is offering a 7½-foot quad mesh satellite antenna. The *Mirage VII Model 6375* is a four-piece antenna made with expanded and rolled Ku-mesh aluminum.



The four antenna petals are preassembled at the factory, for easy installation. Mesh panel inserts are preformed to the parabolic curve and then attached to 20 aluminum support ribs using self-tapping screws. A 22-gauge intermediate-circular support ring and the specially designed cradle brack-

ets provide strength and maintain dish accuracy. The model 6375 is packaged with a quad leg-feed support and cover, which accepts standard C-band and Ku-band feed assemblies. The one-inch-diameter feed-leg support allows cable to be routed through it for a neater appearance.

The standard-steel mount comes out of the box ready for installation on a 3½-inch O.D. ground pole. Four high-grade locking bolts eliminate slippage in high winds. Specially formulated paint protects the antenna and mount finish from scratches and corrosion, and the hardware is cadmium-dichromate plated.

The *Mirage VII Model 6375* satellite antenna—complete with a feed cover, hardware, and detailed installation instructions—has a suggested retail price of \$309. For further information, contact Channel Master, Division of Avnet, Inc., P.O. Box 1416, Industrial Park Drive, Smithfield, NC 27577; Tel: 919-934-9711.

CIRCLE 106 ON FREE INFORMATION CARD



2-1/2" SANYO TWEETER

Paper cone with gold tone dust cap. 8 oz. magnet. 8 ohm. 1/2" ferro fluid voice coil. Power handling: 50W RMS, 70W max. Frequency response: 3K-20KHz.



#PD-271-020 **\$1⁹⁵** **\$1⁷⁵** **\$9^{5c}**
(1-9) (10-59) (60-up)

SUPER HORN TWEETER

Original piezo tweeter made by Motorola. SPL=94 dB 2.83V/1M. Response: 4KHz-27KHz. Handles approximately 50 watts.



#PD-270-010 **\$5³⁰** **\$4⁵⁰** **\$3⁹⁵**
(1-9) (10-79) (80-up)

2" DOME MIDRANGE

Textile dome midrange made by Philips. 8 ohm. SPL=90 dB 1W/1M. 30W RMS, 40W max. Response: 550-5KHz.

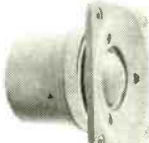

#PD-280-210 **\$27³⁰** **\$25⁷⁰**
(1-3) (4-up)

15" SUBWOOFER



Dual voice coil. 40 oz. magnet. 6 ohm imp. 100W RMS, 140W max. Response: 20-1.2KHz. Resonant frequency: 21Hz. SPL=93 dB 1W/1M.

PIONEER **\$54⁵⁰** **\$49⁸⁰**
#PD-290-190 (1-3) (4-up)

SUBWOOFER XOVER

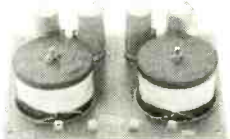

200W RMS crossover designed specifically for use with dual voice coil subwoofers. 12 dB per octave roll-off at 150Hz.

#PD-260-220 **\$28⁸⁰** **\$24⁴⁰**

10" POLY WOOFER

Medium duty. 60W RMS, 80W max. 14 oz. magnet. Response: 25-2.5KHz. fs=28Hz.



#PD-290-096 **\$18⁵⁰** **\$16⁹⁰**
(1-3) (4-up)

TITANIUM COMPOSITE TWEETER

The advantages of both hard and soft dome technologies. 8 ohm. Ferro fluid cooled voice coil. SPL=90 dB 1W/1M. 50W RMS, 70W max. 4" round. Polydax #DTW100T125.



#PD-270-047 **\$27⁵⁰** **\$24⁸⁰**
(1-9) (10-up)

SPEAKER BUILDING BOOK

Revised edition of David Weems' best selling book. Learn to build low cost speakers that rival the high priced models.



#PD-500-021 **\$16⁹⁵**

12" CAST FRAME WOOFER



EMINENCE

12" woofer made in the USA by Eminence. Paper cone and dust cap with treated cloth surround. 80 oz. magnet. 2-1/2" vented voice coil. 8 ohm. 170W RMS, 235W max. 40-4.5KHz response.

#PD-290-147 **\$72⁹⁰** **\$69⁵⁰**
(1-3) (4-up)



340 E. First St., Dayton, Ohio 45402
Local: 1-513-222-0173
FAX: 513-222-4644

* 15 day money back guarantee • \$15.00 minimum order • We accept Mastercard, Visa, Discover, and C.O.D. orders. • 24 hour shipping • Shipping charge = UPS chart rate + \$1.00 (\$3.00 minimum charge) • Hours 8:30 am-7:00 pm EST, Monday-Friday • Mail order customers, please call for shipping estimate on orders exceeding 5 lbs. Foreign customers please send \$5.00 U.S. funds for catalog postage.

CALL TOLL FREE
1-800-338-0531

CIRCLE 12 ON FREE INFORMATION CARD

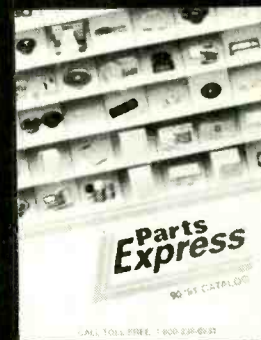

FREE CATALOG

Protel Easytrax 2™

Outstanding value in Printed Circuit Board/CAD for your Macintosh and PC

Protel Easytrax 2 is a new, low-cost design package for PC and Macintosh users that includes everything required to produce professional quality Printed Circuit Board artwork.

Our easy-to-learn menu-driven design system breaks the 'expert barrier'-you'll be designing in minutes, not hours. Our comprehensive tutorials guide you through the program's extensive features that take the tedium out of board layout.

- Comprehensive library of Through-hole devices
- Gerber photoplotting and N/C drill tapes
- On-the-fly library components creation
- Intelligent Pad to Pad autorouting
- Switchable Metric/Imperial grid
 - Auto-panning
 - PostScript™ printing
- Powerful user-definable Macros
- Independent print/plot program
- Multi-layer boards of up to 32 X 32 inches.

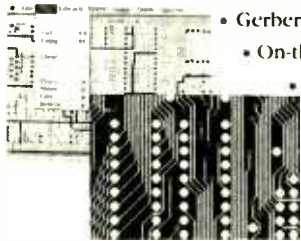

At Protel, we offer free technical support, 24-hour BBS, and 30-day money back guarantee. Prices start at

Free Evaluation Package
Toll Free: 800-544-4186

\$450

Protel Technology, Inc.

50 Airport Parkway, San Jose, CA 95110
Tel: 408-437-7771 Fax: 408-437-4913



CIRCLE 7 ON FREE INFORMATION CARD

WORKSTATION PLUS TOOL KIT

The tools in Jensen's JTK-49DBL "Workstation Plus" tool kit were selected for servicing personal computers, word processors, printers, modems, and terminals. They are packaged in a multi-functional case that features a versatile document file and three foam-lined outside pockets for better protection of delicate parts and accessories. Included in the kit are standard screwdrivers, nutdrivers, hex drivers, pliers, hemostats, a wire stripper, and soldering equipment. Also included are specialty tools such as Torx drivers, DIP insertion and extraction tools, contact in-

sertion/extraction tools, a pin vise, a key cap puller, and a phone-line tester. Optional items include a choice of pulser probes, a Fluke 77 digital multimeter, and a wire-tap breakout box.

The JTK-49DBL "Workstation Plus" tool kit costs \$245. For more information, contact Jensen Tools, Inc., 7815 South 46th Street, Phoenix, AZ 85044; Tel: 602-968-6231.

CIRCLE 108 ON FREE INFORMATION CARD

SINGLE-OUTLET SURGE PROTECTOR

Designed to protect personal computers, microwaves, TV's, VCR's, stereos, electronic phone systems, and other microprocessor-based devices, Intermatic's *Electra Guard EG3C* surge protector features an indicator light that shows the user that the surge suppressor is providing protection. The device being protected is plugged into the single-outlet unit, which then plugs directly into any standard grounded electrical outlet. The EG3C responds

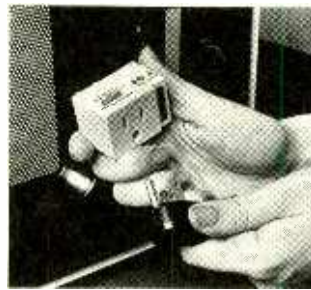

within one nanosecond to protect electronic equipment from hazardous overvoltages, surges, spikes, and transients. It provides protection on all three lines—hot, neutral, and ground. Special hybrid circuitry allows the EG3C to clamp voltages as low as 345 volts, and provides protection from surges up to 6,000 volts.

The *Electra Guard EG3C* single-outlet, wall-mounted surge suppressor has a suggested list price of \$9.95. For additional information, contact Intermatic Inc., Intermatic Plaza, Spring Grove, IL 60081-9698.

CIRCLE 109 ON FREE INFORMATION CARD

AUDIO NOTCH FILTER

jCom's MagicNotch is an automatic audio notch filter, for use by amateur radio operators and SWL's, that is designed to instantly remove heterodyne QRM from SSB reception. It effectively reduces interference caused by negligent operators tuning on or near the frequency,



CW signals, and other carriers. The *MagicNotch* filter also is useful in reducing the effects of computer-generated RFI, which is becoming a major source of heterodynes in the modern ham shack.

No tuning of the filter or modification of existing equipment is required. When interference of a constant frequency is detected by the control circuitry, the internal switched-capacitor active filter is automatically tuned to that frequency, effectively reducing the interference by up to 40 dB. The filter will continue to

track any variation in the frequency of the interference until it disappears. The width of the notch is very narrow, so there is no noticeable degradation in the quality of normal speech signals. The filter activates in less than one second, and a two-color LED turns red when an interfering signal is locked in. The filter operates on the audio output from the receiver as obtained from the external speaker output. The built-in 2-watt amplifier can drive any 8-ohm speaker.

The *MagicNotch* audio filter costs \$99.95 (plus \$5.00 shipping and handling). For further information, contact jCom, P.O. Box 194, Ben Lomond, CA 95005-0194; Tel: 408-336-3503.

CIRCLE 110 ON FREE INFORMATION CARD

VHF WEATHER MONITOR

Combining the entertainment value of AM and FM radio with 24-hour-a-day National Weather Bureau reports, *Midland International's Weather Max 74-105* features a built-in, full-tone,



alert-monitoring system. When the system is activated, a special tone will interrupt an AM or FM broadcast, advising listeners to switch to the weather band to hear an immediate emergency weather report. That convenience allows listeners to enjoy regular broadcasts without worrying about missing important weather developments. The *Weather Max 74-105* receives three National Weather Bureau channels in the 162-MHz FM band from up to 50 miles away. It is powered by a standard AC adapter and an external power jack, and will also operate with an optional DC cigarette-lighter power cord. A battery backup system (battery not included) comes in handy in the event of a power loss, and also makes the monitor completely portable. A

(Continued on page 18)

No other training—in school, on the job, anywhere—shows you how to troubleshoot and service computers like NRI

DIGITAL MULTIMETER

Professional test instrument for quick and easy measurements.

LESSONS

Clearcut, illustrated texts build your understanding of computers step by step.

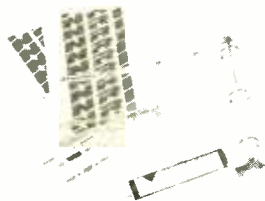

SOFTWARE

Including MS-DOS, GW BASIC, word processing, database and spreadsheet programs.

Only NRI walks you through the step-by-step assembly of a powerful AT-compatible computer system you keep—giving you the hands-on experience you need to work with, troubleshoot, and service all of today's most widely used computer systems. You get all it takes to start a money-making career, even a business of your own in computer service.

No doubt about it: The best way to learn to service computers is to actually build a state-of-the-art computer from the keyboard on up. As you put the machine together, performing key tests and demonstrations at each stage of assembly, you see for yourself how each part of it works, what can go wrong, and how you can fix it.

Only NRI—the leader in career-building, at-home electronics training for more than 75 years—gives you such practical, real-world computer servicing experience. Indeed, no other training—in school, on the job, *anywhere*—shows you how to troubleshoot and service computers like NRI.

You get in-demand computer servicing skills as you train with your own AT-compatible system—now with 20 meg hard drive

With NRI's exclusive hands-on training, you actually build and keep the powerful new AT-compatible West Coast 1010 ES computer, complete with 1 meg RAM and 20 meg hard disk drive.

You start by assembling and testing the 101-key "intelligent" keyboard, move on to test the circuitry on the main logic board, install the power supply and 1.2 meg 5 1/4" floppy disk drive, then interface your high-resolution monitor. But that's not all.

Only NRI gives you a top-rated micro with complete training built into the assembly process

Your NRI hands-on training continues as you install the powerful 20 megabyte hard disk drive—today's most wanted computer peripheral—included in your course to dramatically increase your computer's storage capacity while giving you lightning-quick data access.

Having fully assembled your West Coast 1010 ES, you take it through a complete series of diagnostic tests, mastering professional computer servicing techniques as you take command of the full power of your computer's high-speed 80286 microprocessor.

In no time at all, you have the confidence and the know-how to work with, troubleshoot, and service every computer on the market today. Indeed you have what it takes to step into a full-time, money-making career as an industry technician, even start a computer service business of your own.

No experience needed, NRI builds it in

You need no previous experience in computers or electronics to succeed with NRI. You start with the basics, following easy-to-read instructions and diagrams, quickly

HARD DISK

20 megabyte hard disk drive you install internally for greater data storage capacity and data access speed.

NEW! AT-COMPATIBLE COMPUTER

High-speed 80286 CPU (12 MHz clock, 0 wait states), 1 meg RAM, 1.2 meg, 5 1/4" high-density floppy disk drive.

MONITOR

High-resolution, non-glare, 12" TTL monochrome monitor with tilt and swivel base.

TECHNICAL MANUALS

With professional programs and complete specs on your computer.

DIGITAL LOGIC PROBE

Simplifies analyzing digital circuit operation.

DISCOVERY LAB

Complete breadboarding system to let you design and modify circuits, diagnose and repair faults.



moving from the fundamentals to sophisticated computer servicing techniques. Step by easy step, you get the kind of practical hands-on experience that makes you uniquely prepared to take advantage of every opportunity in today's top-growth field of computer service.

What's more—you learn at your own pace in your own home. No classroom pressures, no night school, no need to quit your present job until you're ready to make your move. And all throughout your training, you have the full support of your personal NRI instructor and the NRI technical staff always ready to answer your questions and give you help whenever you need it.

Your FREE NRI catalog tells more

Send today for your free full-color catalog describing every aspect of NRI's innovative computer training, as well as hands-on training in robotics, video/ audio servicing, electronic music technology, security electronics, telecommunications, and other growing high-tech career fields.

If the coupon is missing, write to NRI School of Electronics, McGraw-Hill Continuing Education Center, 4401 Connecticut Avenue, Washington, DC 20008.

AT is a registered trademark of International Business Machines Corporation

NRI

School of Electronics

For career courses approved under GI bill
 check for details

McGraw-Hill Continuing Education Center
4401 Connecticut Avenue, Washington, DC 20008

Check one FREE catalog only

<input type="checkbox"/> Computers and Microprocessors	<input type="checkbox"/> Security Electronics
<input type="checkbox"/> Robotics	<input type="checkbox"/> Electronic Music Technology
<input type="checkbox"/> TV/Video/Audio Servicing	<input type="checkbox"/> Basic Electronics
<input type="checkbox"/> Computer Programming	<input type="checkbox"/> Telecommunications

Name _____ (please print) Age _____

Address _____

City/State/Zip _____

Accredited Member, National Home Study Council 18-051

EKI

Your Name Here
 Certified Electronic
 Technician



You Can Increase Your Knowledge and Income

by becoming an EKI Certified Electronics Technician—whether you are starting or experienced.

If you are looking to:

- Obtain certification as an electronics technician
- Enhance your current knowledge
- Change your career or advancement
- Have more hands-on training in conjunction with your current study

Features:

- Excellent home-study program
- Immediate results
- A great value
- NO CONTRACT to sign
- Study at a pace that's right for you
- 2-week trial/evaluation is available to qualified applicants

**FREE
 FREE
 FREE**
 FULL COLOR
CATALOG

CALL TODAY:
1-800-453-1708

EKI 16631 NOYES AVE
 IRVINE CA 92714

CIRCLE 14 ON FREE INFORMATION CARD

NEW PRODUCTS

(Continued from page 14)

test function allows the user to test the alert monitor system. Other features include a large, top-firing speaker; a folding telescoping antenna; and an external antenna jack.

The Weather Max 74-105 has a suggested retail price of \$99.95. For more information, contact Midland International Corporation, Consumer Communications Division, 1690 North Topping, Kansas City, MO 64120; Tel: 816-241-8500.

CIRCLE 112 ON FREE INFORMATION CARD

SWITCHING POWER SUPPLIES

Intended for applications including microprocessor-based systems, datacommunications equipment, mass-storage equipment, and industrial equipment, *Power General's*

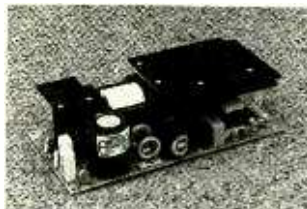

FLU4-100 Series is a family of highly reliable quad-output, 100-watt switching power supplies. Five models provide outputs of +5 VDC and combinations of -5, +/-12, +/-15, and +24 VDC. Three models include a fully isolated auxiliary output. The FLU4-100 units are each fabricated on a single 4 x 8-inch printed-circuit board.

The series features a universal input-voltage range of 85-265 VAC (100-370 VDC). Universal inputs allow equipment manufacturers with international markets to specify and stock one power supply; they also eliminate field-system failures caused by the incorrect wiring of the power-supply input. An on-board, input-line filter virtually eliminates noise due to conducted emissions and, in many cases, also eliminates the need for an external line filter.

Standard features include 0% minimum load on auxiliary outputs, indefinite short-circuit protection, soft start, over-voltage protection, and a 16-ms hold-up time. Other features in-

clude 5300-VDC input/output isolation and an on-board input-line fuse. Efficiency is 65% minimum, and the +5-VDC output is adjustable by $\pm 5\%$. Line regulation is 0.2% for the primary (+5-VDC) output and 0.5% for auxiliary outputs. Load regulation is specified at 1%; output ripple and noise is 1% maximum.

The FLU4-100 series of power-switching supplies cost \$159 each. For additional information, contact Power General, 152 Will Drive, Canton, MA 02021; Tel: 617-828-6216; Fax: 617-828-3215.

CIRCLE 113 ON FREE INFORMATION CARD

REPAIRABLE OSCILLOSCOPE PROBE

The modular configuration of *Test Probe Inc.'s 250-MHz x1-x10* oscilloscope probe makes it easy for the user to replace a failed tip, ground lead, probe head, cable, or BNC box. The parts screw together for a secure connection and quick repair. The oscilloscope probe, which comes in 1.2-, 2-, and 3-meter lengths, offers x1 and x10 switchable attenuation factors in one probe, with 250-MHz bandwidth for the x10 mode and 10-MHz bandwidth for the x1 mode. The probe also features a 1.4-ns risetime, compensation for high and low frequency to optimize pulse response, and a 10-60-pF compensation range that allows



it to be used with any scope that has a 1-megohm input resistance. It has a unique sawtooth center conductor to eliminate microphonics and resist failure from pulling and bending.

The 250-MHz x1-x10 oscilloscope probe costs \$72.00 in single quantity. For additional information, contact Test Probes Inc., 9178 Brown Deer Road, San Diego, CA 92121; Tel: 800-368-5719.

CIRCLE 114 ON FREE INFORMATION CARD

SYNTHESIZED FUNCTION GENERATOR

Designed to rival higher-priced competitors, *Global Specialties' Model 2003* synthesized function generator has a frequency range of DC to 1.6 MHz, with sine, square, triangle, and ramp outputs. Up to 16 preset frequencies can be programmed into memory and automatically sequenced in the "frequency hop" mode, which simplifies repetitive test applications such as amplifier performance

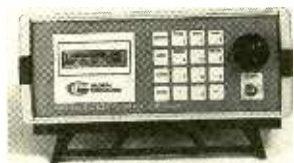

checks. Tone bursts can be generated using the external trigger/gate feature, while internal linear/log sweep is available across the entire frequency range. The function generator provides a 32-character, two-line LCD readout. For selecting functions and tuning frequen-

cies, it has a keyboard that provides direct access and mode selection, as well as a rotary encoder that allows analog-style tuning. The digitally controlled output is 20V peak-to-peak into an open circuit, 10V peak-to-peak in 50 ohm, with DC offset adjustment.

An optional RS-485 serial interface allows the user to set all functions from a personal computer. For use in automated testing applications, multiple function can operate on a single loop, each with its own address.

The 2003 synthesized function generator costs under \$500. For more information, contact Global Specialties, 70 Fulton Terrace, New Haven, CT 06512; Tel: 800-527-1028.

CIRCLE 115 ON FREE INFORMATION CARD

HIGH-POWER, LOW-BAND MOBILE RADIO

If you're waiting for a user-friendly scanner, then wait no more. This 45-channel, 60-watt, low-band mobile radio from *RELM Communications*, the model *RML60A*, offers sophisti-

cated features such as track tuning, area scan, and an instant priority button. The track-tuning feature enables the radio to cover the entire 30-50-MHz band in two versions: *RML60A* (30-43 MHz) and *RML60B* (37-50 MHz). The instant priority button allows the user to place the radio in its highest available power at the touch of a single button, regardless of the radio function in use. Area scan allows the radio's 45 channels to be conveniently grouped in up to four scan areas, so that the user can organize like channels for more efficient access and monitoring. The number of channels available per area is directly proportional to the number of areas programmed in the radio—either 45 channels in one scan area, 22 and 23 channels each in two areas, three areas of 15 channels each, or three areas with 11 channels and one with 12 when all four areas are programmed. The same priority channel can appear in all scan areas. In the scan mode, the user can monitor all channels programmed in the radio, or only

those selected to be included in the scan list. The *RML60* can scan at rates up to 40 channels per second.

Other features offered by this unit include a time-out timer, a busy-channel-lockout whine filter, cloning, and IBM-compatible

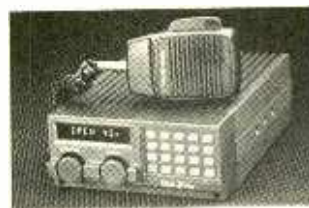

programming (when used in conjunction with an optional PC-Kit). Built-in signaling options CTCSS for all 37 standard EIA tones plus 13 additional tones, and both standard and inverted Digital Coded Squelch. The mobile radio measures just 2.6 x 6 x 8.5 inches.

For the *RML60's* suggested list price or more information, contact *RELM Communications, Inc.*, 7707 Records Street, Indianapolis, IN 46226; Tel: 317-545-4281.

CIRCLE 116 ON FREE INFORMATION CARD

Add comfort, convenience, fun to your home with these innovative electronics.

Hundreds of easy innovations.

Your home will do more for you with Heath products. Simple to install. Affordable. Guaranteed.

Play a tape on the living room VCR and watch it on your bedroom TV.

Turn on and adjust your TV, VCR, music system, lamps, fans and more with just one remote control.

Plug in an extra phone jack without messy cutting and drilling.

Get a complete home status report via phone from anywhere in the world. (If the electricity goes off, this electronic "house sitter" calls you.)

Automatically water your lawn at a fraction of the cost of a built-in system.

Call home and turn on your lights, appliances ... even a window air conditioner.

Affordable security for your home or car.

Protect your home or car with a professional-quality security system for as little as \$100.

Program lights to go on or off, so your home looks lived-in when you're away.

HOME
AUTOMATION
BY HEATH

Never again return to a dark house. Motion sensor lighting turns on your outdoor lights as soon as you approach.

100% satisfaction ... the Heath guarantee for over 40 years.

Try any Heath product at no risk. If you aren't completely satisfied, simply return the item within six months for credit or full refund.

CIRCLE 10 ON FREE INFORMATION CARD

Get your FREE CATALOG.

Heath's new Home Automation catalog features the latest in home control. For over 100 ways to make your home comfortable and convenient, call **1-800-44-HEATH** or send the coupon below.

Heath
Benton Harbor, Michigan

Please send me the NEW Home Automation catalog.

Name _____
Address _____
_____ Apt. _____
City _____
State _____ Zip _____

Mail to Heath Company, Dept. 107-050,
Benton Harbor, MI 49022

HA-100

THINK TANK

By John J. Yacone

Multiplexing With Counters

A new month is here and with it a batch of creative ideas from you readers. You've been most generous with your correspondence this time out, thank you. As always, the people submitting to this month's column will receive a copy of *Think Tank II*. If you've already received that fun and useful book, we'll find something else to send you.

I would also like to hear from those of you that have some ideas about what you would like to see in this column. As you know, I like tinkering with circuits myself, so if you have a question regarding a circuit that you've come across, or perhaps you need general information on a topic just ask it. I'm here to both help budding "circuiters" and present their circuits.

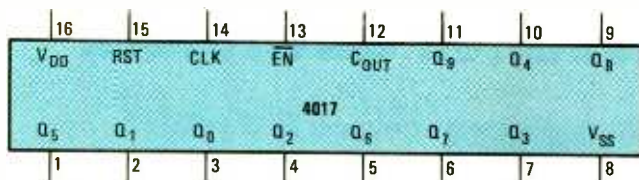

Fig. 1. The lowly looking 4017 decade counter can do much more than you may think. It can divide by 1-10, count, and even run a multiplexed display.

THE HUMBLE 4017

With that in mind, I'd like to discuss a very inexpensive chip and show you a number of interesting uses for it (including one that's not in the data books). It's the 4017 decade counter (shown in Fig. 1). At first glance, the application notes won't lead you to believe that it's a powerful contender for breadboard space. But after a short introduction, we'll see what it can do when you take the notes a step further.

Most of you readers are

probably familiar with integrated-circuit counters of one sort or other. The vast majority of them count in either binary or binary-coded decimal. What that means is their outputs represent a number in binary or binary-coded decimal; each time such a chip receives a pulse, it increments the value available from the outputs. That more or less restricts their use to simple counting—not exactly a vista of toe-curling applications.

On the other hand, the 4017 counts by ten. It has ten outputs assigned values 0 through 9. When first turned on, the 0 output (denoted Q_0) is high and the other nine outputs are low. When a clock pulse is received (via the CLK pin), the Q_0 output goes low and the Q_1 output goes high. On the next pulse, Q_1 goes low again and Q_2 goes high. Each time a pulse is received, a high will appear at the next highest output. It's as though the high gets pushed from one output to the next with each clock pulse.

When the high is at Q_9 (the last or highest output), the next pulse causes the high to jump back to Q_0 and the process starts again.

The most obvious use for such a chip, besides just counting from 0 to 9, is as a light-chaser controller. If LED's or lamps were turned on (or off) in sequence by a 4017, it would give a marquee appearance to the lights. However, the chip itself cannot supply enough current to power LED's or light bulbs (although it can sink enough current if you want nine LED's on and one

off). You should use transistors or relays under the control of the 4017 to supply power to your display.

But there are three other pins on the chip that make it much more useful and applicable to more interesting circuits: First, there's a clock-enable pin (denoted EN in Fig. 1). If that pin is held high, the counter ignores the clock pulses and refuses to advance. There's also a reset pin (the one labeled RST) and, as its name implies, if it is pulsed high, it puts the counter back to zero.

The last pin of interest is a carry output (C_{OUT}), which is high while the chip is counting from 0 to 4, and stays low as the count proceeds from 5 to 9. That output is useful for cascading 4017 chips (and little else as far as I can see). If you connect that output to the clock input of another 4017, the first 4017 will count in "ones" (0 through 9), and the additional chip will count in tens (10, 20, 30, etc.). Each chip you add on in that way will give the circuit the ability to count to the next power of ten.

But enough of counting, what else can one do? To help me answer that, take a look at the circuit in Fig. 2. That circuit will count from 0 to 4 and stop. To start the cycle again you have to depress S1. If you connect the clock-enable pin to a different output, the circuit will count until it sets that output high and then halt.

That kind of circuit is useful for turning on some number of devices one at a time. For example, let's say there's a long hall in your home or perhaps an office building that leads to an exit door and you don't

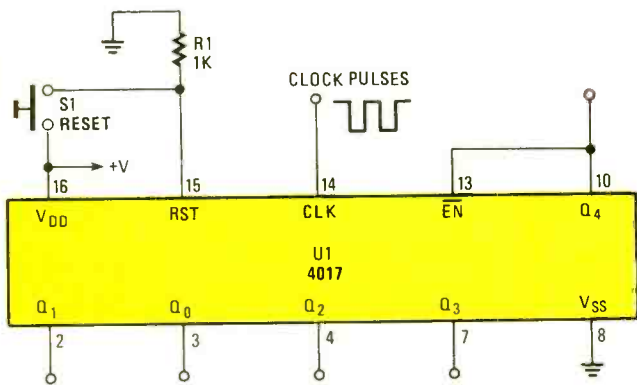

Fig. 2. By connecting pin 13 to the appropriate output, you can make a 4017 count to a one-digit number and halt.

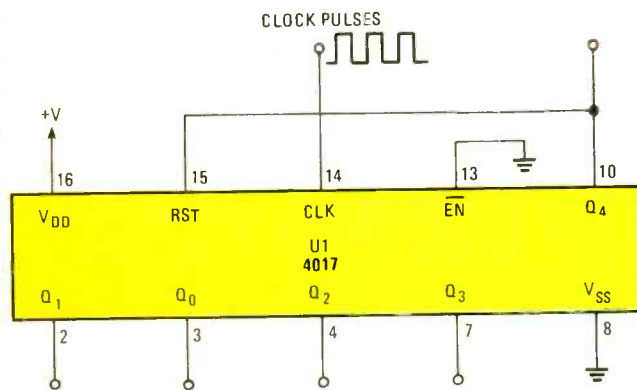

Fig. 3. By connecting pin 15 to the appropriate output, you can make a 4017 divide a series of clock pulses by a value from 1 to 10.

want to leave more than one light on at a time. You can use the circuit in Fig. 2 to sequence the hall lights on and off one at a time. To do that, you'll need a slow clock circuit to sequence the 4017's outputs at the desired rate. You'll also need some optoisolator/couplers to control the lights.

If you control the light at the exit with output Q_4 , the next light down the hall with Q_3 , and so on, and place S1 at the far end of the hall (away from the exit), someone heading for the exit just has to press S1. The light nearest him will come on, then the next light, and so on until the light nearest the exit is lit, and then the sequence will stop leaving the light at the exit on. Every time a light comes on, the one prior to it goes out.

Another useful circuit is

shown in Fig. 3. That circuit repeats a sequence over and over. The output you connect to the reset pin determines the number of steps in the sequence. The circuit shown has 4 steps. The first three steps last for the length of one clock cycle. The last step only lasts until the chip resets itself. That is a great circuit for performing digital frequency division.

Let's say you need to measure the clock frequency of a really fast computer circuit, but you've only got an old oscilloscope with too narrow a bandwidth. Send the computer pulses to the 4017 and connect the scope to Q_0 and the positive supply. Set the scope's input to AC coupling. Now connect the reset input to Q_1 . That divides the computer pulse frequency in half and the AC-coupling

Courteous Service • Discount Prices • Fast Shipping

ALL ELECTRONICS

P.O. Box 567 • Van Nuys, CA 91408

FLASH ASSEMBLY

This NEW compact flash assembly comes from a U.S. manufacturer of cameras.



Unit operates on 3 Vdc and measures 2 1/2" X 1 1/4". Ideal for use as a strobe, warning light or attention getter. Complete with instruction on how to wire.

CAT# FSH-1 \$3.75 each 10 for \$35.00

Special New Reduced Price PHOTOFLASH CAPACITOR

Rubicon CE photoflash capacitor. 0.79" dia. X 1.1" high. These are new capacitors that have been prepped with 1.4" black and red wire leads soldered to the terminals.



210 Mfd 330 Volt CAT# PPC-210
\$1.25 each • 10 for \$11.00 • 100 for \$100.00
Large quantities available. Call for pricing.

FLASHING L.E.D.

Diffused L.E.D. with built in flashing unit. PULSE RATE: 3 Hz @ 5 Volt/20 ma. Unit continually flashes when 5 Volts is applied. Operates between 4.5 Volts and 5.5 Volts. T 1 3/4 size. IDEAL AS AN INDICATOR.

RED CAT# LED-4

GREEN CAT# LED-4G

YELLOW CAT# LED-4Y

\$1.00 each • 10 for \$9.50 • 100 for \$90.00

HEAVY-DUTY NICKEL CADMIUM "C" BATTERY

Yuasa 1800C

Special purchase of new, rechargeable nickel-cad batteries. 1.2 volts, 1800 mA.H.

PRICE REDUCED ON 10 OR MORE.

CAT# HDNCB-C

10 pieces for \$42.50 (\$4.25 each)

100 pieces for \$375.00 (\$3.75 each)



POWER SUPPLIES

12 Vdc 5 AMP

ACDC Electronics # 12N5 or equiv.

Input: 100-240 Vac

(wired for 115 Vac)

Output: 12 Vdc @ 5 amps.

Open frame style.

7" X 4 3/4" X 3" high. Regulated.

CAT# PS-125 \$37.50 each



24 Vdc 2.4 AMP

Power-One Inc. #HC-24-2.4 Input: 115/230 Vac (wired for 115 Vac). Output: 24 Vdc @ 2.4 amps. Open frame style. 5.62" X 4.87" X 2.50" CSA listed.

CAT# PS-2424 \$30.00 each

SWITCHES

DIP P.C. PUSHBUTTON

ITT Schadow Digitast Series SE

S.P.D.T. momentary pushbutton.

Mounts in 14 pin DIP configuration.

Designed for low current switching

applications. Grey keycap is 0.68" X 0.67".

CAT # PB-28 \$1.00 each

10 for \$9.50 • 100 for \$85.00



ROTARY BCD SWITCH

EECO # 2310-02G - BCD 10 position

rotary switch. DIP configuration fits in

standard 8 pin I.C. socket. Right angle

style. Screwdriver actuation. 0.42" cube. CAT# RDIP-2

\$1.75 each • 10 for \$16.00 • 100 for \$145.00



TOLL FREE ORDER LINES

1-800-826-5432

CHARGE ORDERS to Visa, MasterCard or Discover

TERMS: Minimum order \$10.00. Shipping and handling for the 48 continental U.S.A. \$3.50 per order. All others including AK, HI, PR or Canada must pay full shipping. All orders delivered in CALIFORNIA must include state sales tax (6 %, 6 1/2 %, 7 %). Quantities Limited. NO C.O.D. Prices subject to change without notice.

Call or Write For Our

FREE 60 Page Catalog

(Outside The U.S.A. Send \$2.00 Postage)

ALL ELECTRONICS CORP.

P.O. Box 567 • Van Nuys, CA • 91408

CIRCLE 5 ON FREE INFORMATION CARD

circuit in the scope should be able to integrate the wave form into something more visible (although it may not be a square wave).

If that doesn't work try connecting the reset pin to one of the other outputs (it's best to try them in order). If the duration of the negative pulse produced by the 4017 is too brief that's easy to fix: you need to tie more of the 4017's outputs to the scope. Just make sure the subscripts of the outputs connected to the scope are all less than half of the subscript of the output you connect to the reset pin. To determine the frequency, just multiply the frequency of the wave on your scope by 1 plus the subscript of the output connected to the reset pin.

And now for a real neat application: sequencing up to 100 "multiplexed" devices with only two chips. If you haven't heard the term

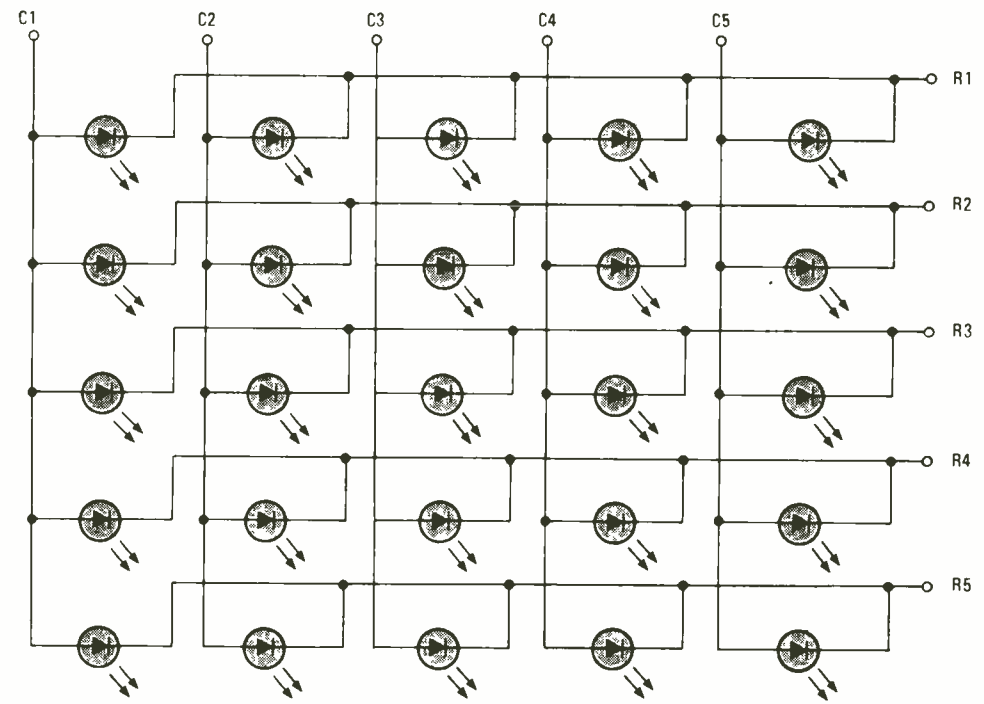

Fig. 4. This is a multiplexed display of LED's. A particular LED can be lit by connecting its row and column terminals to a power supply.

multiplexing don't worry: it's just a big word for a simple concept. Multiplexing is a way of wiring a number of devices together, but allows

FREE
Catalog

**All the tools
& test equip-
ment you need
for hobby or work!**

Electrical,
electronics,
computers,
communications, sound
systems -
all the tools,
meters and
other equip-
ment you
need to do a
professional
job!

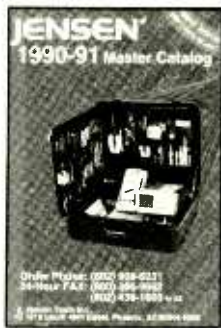

Top technicians and field service personnel prize their Jensen tool kits. Our new 232-page Master Catalog will show you why. You'll discover hard-to-find items, the latest high-tech developments, soldering stations, wire & cable accessories and many more quality products you want and need. **Send for your free copy today!**



JENSEN TOOLS INC.

7815 South 46th St.,
Phoenix, AZ 85044-5399
Phone: (602) 968-6231
FAX: (800) 366-9662

CIRCLE 8 ON FREE INFORMATION CARD

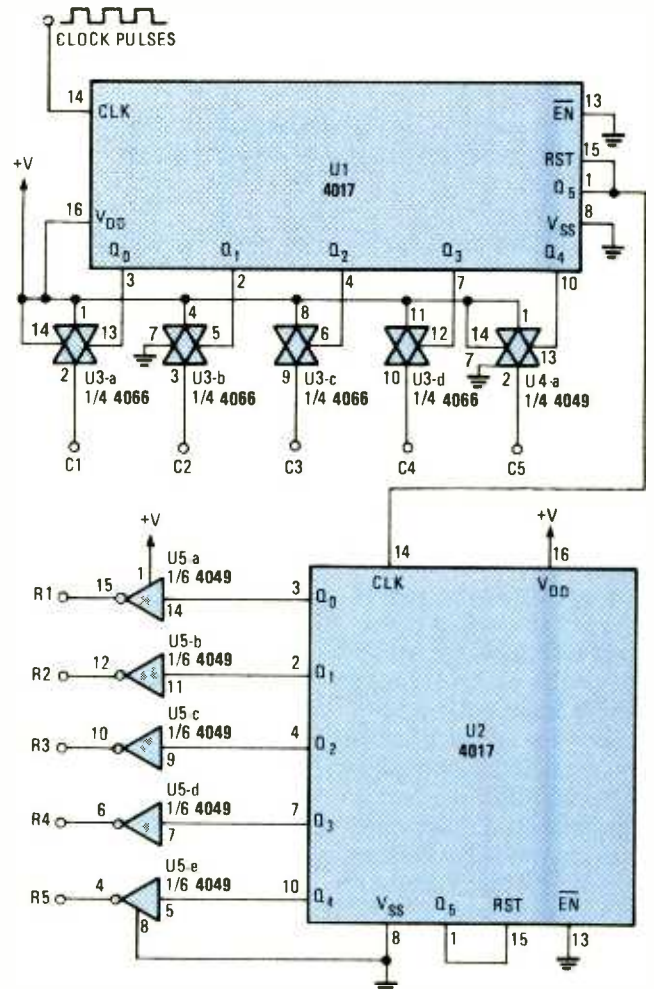

Fig. 5. Two dividing 4017's can be configured to count up to 100. The circuit shown here can count to 25.

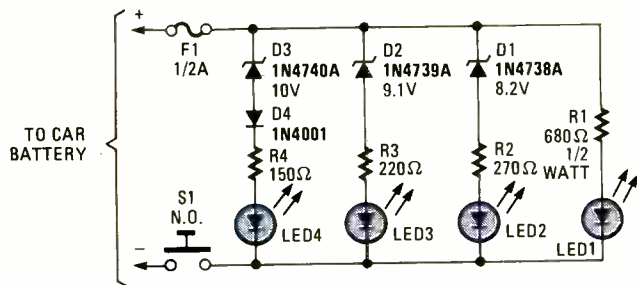

Fig. 6. This simple car-battery voltage checker can be built small enough to be installed in your car's dashboard.

them to work independently. It reduces the number of wires and components you need in a circuit, as you'll see. Take a look at the multiplexed LED's in Fig. 4. If we connect one of the column terminals (marked C_1-C_5) to a voltage supply, and one of the row terminals (marked R_1-R_5) to ground, then the LED in that row and column will light.

In that way, we can turn on any one LED from a group of 25 by just using 10 wires (5 row wires and 5 column wires). You could use that technique to control 100 LED's (or other devices) by using only 20 wires, etc. For the sake of brevity, the multiplex-control circuit (see Fig. 5) is shown set up to control only 25 devices. The two decade dividers in the circuit are both set up for divide-by-five operation using the same technique as the circuit in Fig. 3. However, U2 gets its clock pulses from the Q_5 output of U1, so U1 sequences Q_4 through Q_4 and then U2 gets its clock pulse.

Note that the outputs of U1 are used to control several bilateral switches. The switches act just like relays, although they have a little internal resistance. When an output goes high, its bilateral switch closes, connecting one of the column outputs to the power supply. For example, if Q_0 goes high, U3-a closes, connecting C_1 to $V+$.

The outputs of U2 are

connected to inverters. When a divider output goes high, the inverter connected to it grounds the corresponding row output. For example, if Q_0 goes high, the output of U5-a goes low grounding R_1 .

If you connect that circuit to the display circuit in Fig. 4 and supply it with clock pulses, it will turn on one LED at a time. First the LED connected to C_1 and R_1 is active. Integrated circuit U1 then activates C_2-C_5 in turn, while U2 leaves R_1 active. Then U2 receives a clock pulse from U1 so R_2 becomes active and U1 gets reset, so the LED in column 1, row 2 is now lit. Integrated circuit U1 will light each LED in that row, then the next row, and so on until all the LED's have been lit and the process starts over again. You can use more of the outputs on the two decade counters to control up to 100 LED's provided that you connect the reset pin to the proper output.

And now for the mail!

BATTERY-VOLTAGE INDICATOR

My circuit is a car-battery voltage indicator (see Fig. 6) that allows you to quickly check the relative health of a battery. The LED readout simplifies testing and the circuit lets you monitor the battery even under cranking conditions.

When placed across a battery's terminals and the normally open momentary
(Continued on page 86)

Earn Your B.S. Degree in ELECTRONICS or COMPUTERS



By Studying at Home

Grantham College of Engineering, now in our 41st year, is highly experienced in "distance education"—teaching by correspondence—through printed materials, computer materials, fax, and phone.

No commuting to class. Study at your own pace, while continuing on your present job. Learn from easy-to-understand but complete and thorough lesson materials, with additional help from our instructors.

Our Computer B.S. Degree Program includes courses in the BASIC, PASCAL, and C languages — as well as Assembly Language, MS DOS, CADD, and more.

Our Electronics B.S. Degree Program includes courses in Solid-State Circuit Analysis and Design, Control Systems, Robotics, Analog/Digital Communications, and more.

An important part of being prepared to *move up* is holding the right college degree, and the absolutely necessary part is knowing your field. Grantham can help you both ways—to learn more and to earn your degree in the process.

Write or phone for our free catalog. Toll free, 1-800-955-2527, or see mailing address below.

Accredited by
the Accrediting Commission of the
National Home Study Council

GRANTHAM
College of Engineering
Grantham College Road
Slidell, LA 70460

SELECT 5 BOOKS for only \$4.95

(values to \$127.70)

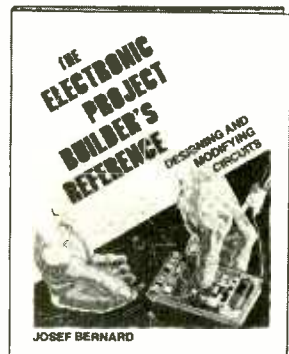
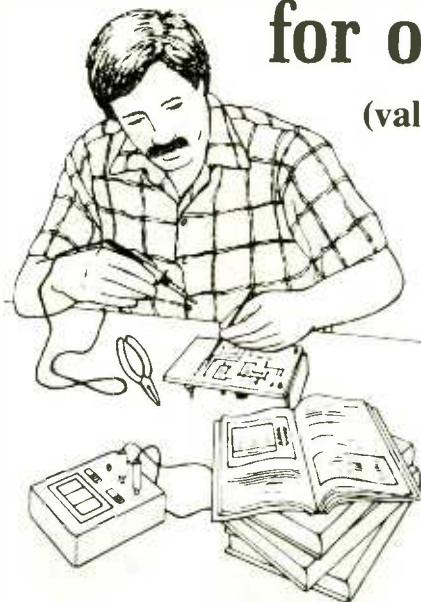

3260 \$22.95

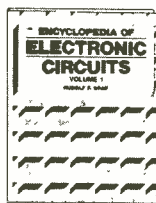

1938 \$60.00
Counts as 3



2867P \$18.95



10010P \$19.95



3321P \$16.95



3329 \$29.95
Counts as 2

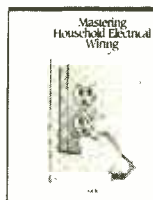

2987P \$16.95



3360 \$29.95
Counts as 2

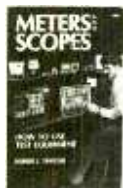

2826P \$16.95



3279 \$36.95
Counts as 2

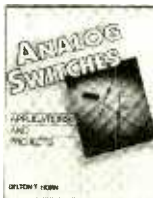

3445 \$21.95



2995 \$25.95

Your most complete source for electronics books for over 25 years.



3031P \$17.95

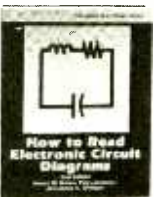

2880P \$14.95



3258 \$27.95
Counts as 2



3107P \$18.95



2865P \$14.95

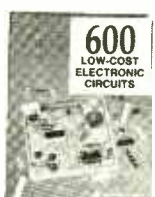

3219 \$27.95
Counts as 2

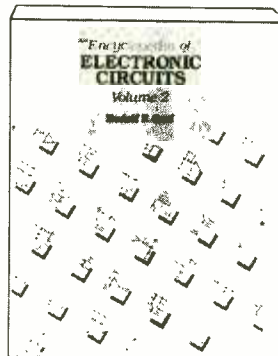

3138 \$60.00
Counts as 3



3267P \$16.95



3342 \$25.95
Counts as 2

Membership Benefits • Big Savings. In addition to this introductory offer, you keep saving substantially with members' prices of up to 50% off the publishers' prices. • **Bonus Books.** Starting immediately, you will be eligible for our Bonus Book Plan, with savings of up to 80% off publishers' prices. • **Club News Bulletins.** 15 times per year you will receive the Book Club News, describing all the current selections—mains, alternates, extras—plus bonus offers and special sales, with scores of titles to choose from. • **Automatic Order.** If you want the Main Selection, do nothing and it will be sent to you automatically. If you prefer another selection, or no book at all, simply indicate your choice on the reply form provided. You will have at least 10 days to decide. As a member, you agree to purchase at least 3 books within the next 12 months and may resign at any time thereafter. • **Ironclad No-Risk Guarantee.** If not satisfied with your books, return them within 10 days without obligation! • **Exceptional Quality.** All books are quality publishers' editions especially selected by our Editorial Board.

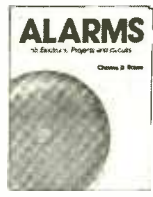

2996P \$13.95

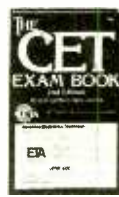

2950P \$13.95



3205 \$24.95



2707P \$17.95

ELECTRONICS BOOK CLUB

Blue Ridge Summit, PA 17294-0810

Please accept my membership in the Electronics Book Club and send the 5 volumes listed below, billing me \$4.95. If not satisfied, I may return the books within ten days without obligation and have my membership cancelled. I agree to purchase at least 3 books at regular Club prices during the next 12 months and may resign any time thereafter. A shipping/handling charge and sales tax will be added to all orders.

--	--	--	--	--

Name _____

Address _____

City _____

State _____ Zip _____ Phone _____



3270 \$32.95
Counts as 2



2926 \$25.95



2800P \$16.95



2613P \$17.95



1897P \$15.95



2883P \$17.95

Valid for new members only. Foreign applicants will receive special ordering instructions. Canada must remit in U.S. currency. This order subject to acceptance by the Electronics Book Club. PE591

(Publishers' Prices Shown)
©1991 ELECTRONICS BOOK CLUB

Lets face it, how often do we read about attacks on joggers or people walking at night; or attacks on women in parking lots, even during broad daylight? Such occurrences are all too common. The *Sonic Defender* can help you to ward off possible danger and in emergency situations, it can be a great attention-getting aid.

The *Sonic Defender* is a compact personal protection device that can help ward off any attacker, whether animal or human. The Defender is designed to generate a very high intensity sound to cause maximum discomfort to anyone that it's directed towards. It is small enough to comfortably fit in the smallest hand, and its wrist strap makes

it difficult to pull away from you. And even if your attacker does manage to wrest it from your hand, the locking action of its on/off switch causes it to continue sounding. In addition, the Sonic Defender easily fits within a vest pocket or purse for easy carrying in non-threatening situations.

Keep in mind, however, that **continued exposure to the business end of the Defender can cause permanent hearing loss.** The Sonic Defender generates a sound intensity of about 130 dB, which is loud enough to hurt the ears of anyone that it's pointed at. The unit's actual operating frequency is centered around 3 kHz with a very high warble rate. Significant time was spent

in finding the frequencies and warble rates that cause the most discomfort.

How it works. Figure 1 shows a schematic diagram of the Sonic Defender. The circuit consists of two oscillator circuits built around a 74HC00 quad NAND gate IC. Gates U1-a and U1-b, along with resistor R1, and capacitors C1 and C2 comprise a low-frequency, or warble rate, generator (oscillator), which operates at a frequency of about 10 Hz. The warble rate generator is used to

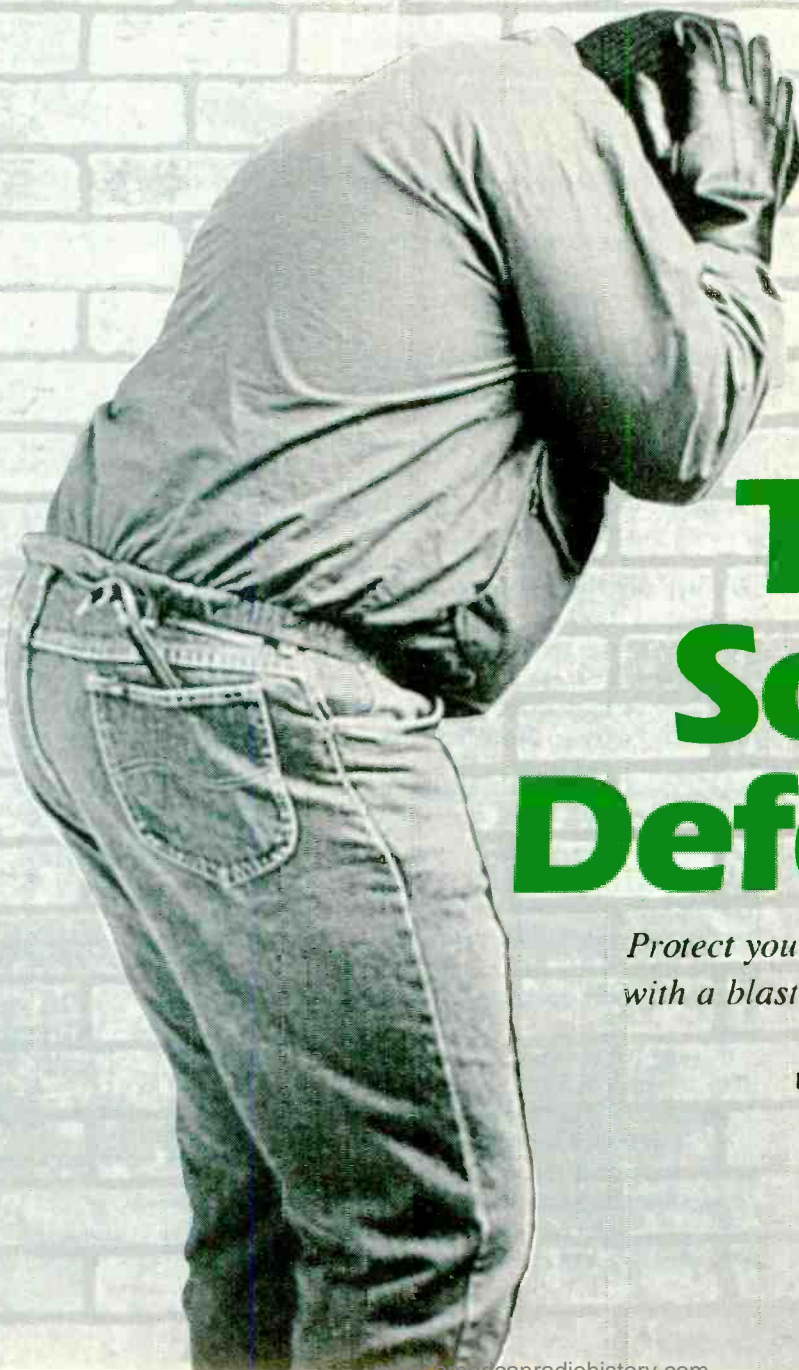

The Sonic Defender

*Protect yourself and your property
with a blast of high-intensity sound*

BY PHIL SALAS

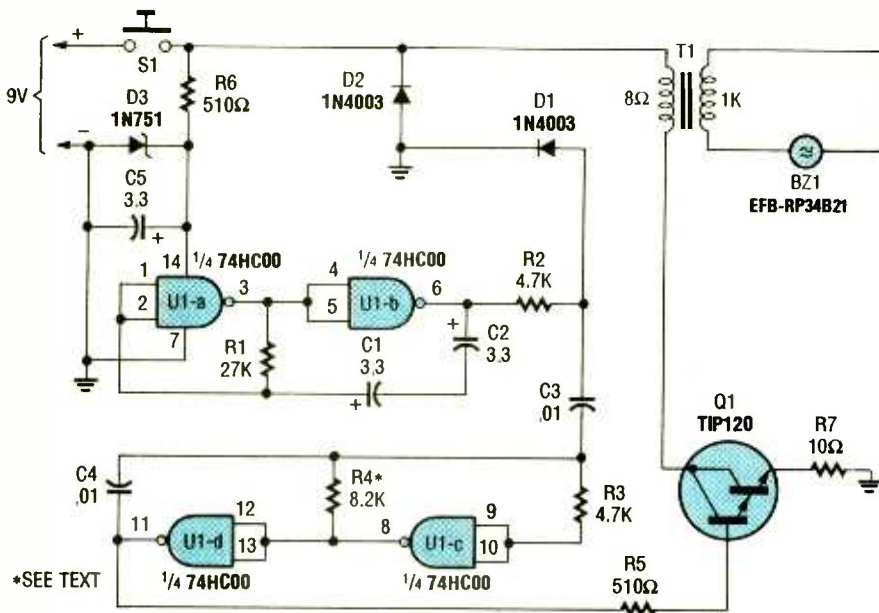

Fig. 1. The Sonic Defender consists of two oscillator circuits built around a 74HC00 quad NAND gate IC. One oscillator, built around U1-a and U1-b, comprises a low-frequency, or warble rate, generator; the other oscillator, formed from gates U1-c and U1-d, is used as a tone generator.

modulate the output frequency (around 3 kHz) of the tone generator, which consists of gates U1-c and U1-d, resistor R4, and capacitor C4.

The warble sound is produced when diode D1 is biased on and off through resistor R2 at the rate of the low-frequency generator. When D1 is biased on and off, capacitor C3 is alternately connected to and disconnected from ground through diode D1 at the warble rate, resulting in additional capacitance being switched into and out of the high-frequency generator. Whenever C3 is connected to ground, the frequency of the high-frequency generator is lowered, thereby giving the output of the tone oscillator a warble effect.

An effort was made to keep impedances low so that the generated frequencies would be very stable. That's why 3.3- μ F electrolytic capacitors were used for C1 and C2, instead of a single smaller value and a corresponding higher resistance for R1.

The output of U1-d switches a current-amplifying transistor, Q1, on and off, producing a pulsating DC voltage through the primary of T1. The pulsating voltage through T1's primary induces a higher voltage in its secondary, which is applied to transducer BZ1. Resistor R7 limits the average current through the transformer to less than 200 milliamps.

Resistor R6 and Zener diode D3 provide regulation for the dual-oscillator circuit, and keeps the oscillator fre-

quencies independent of battery voltage. Diode D2 was included in the circuit to prevent damage to the IC if the power supply is inadvertently connected with reversed polarity.

Construction. The author's prototype of the Sonic Defender was built into a sprinkler head. The one used here is made by Orbit and sells for around \$1 at local hardware stores. The sprinkler head is perfect in that it has just the right amount of room for the circuit and 9-volt battery, and it has an easily removable head so that battery replacement is easy. The pipe hole in the rear of the sprinkler head is perfect for attaching the wrist strap assembly.

To prepare the sprinkler head, first remove and discard the internal parts keeping just the body and screw on top. Drill a $\frac{5}{16}$ -inch hole exactly $\frac{1}{10}$ ths of an inch below the wide opening end. That's where the switch will mount. Take the transducer and clip off its mounting feet. Drill a hole in the sprinkler head cap to clear the "G" lead of the transducer. Mount the transducer to the sprinkler-head cap using a hot glue gun.

The wrist-strap assembly is made from a nylon $\frac{5}{8}$ -inch protector foot available from your hardware store. Drill a $\frac{1}{8}$ -inch hole in the middle of the protector foot and thread a piece of heavy-duty black shoe string through it. Adjust for the desired loop length and tie a knot in the string, and cut off the

PARTS LIST FOR THE SONIC DEFENDER

SEMICONDUCTORS

U1—74HC00, quad 2-input, NAND gate, integrated circuit
 Q1—TIP120 NPN Darlington transistor
 D1, D2—1N4003 1-amp, 200-PIV, silicon rectifier diode
 D3—1N751, 5.1-volt, 400-mW, Zener diode

RESISTORS

(All fixed resistors are $\frac{1}{4}$ -watt, 5% units, unless otherwise noted.)

R1—27,000-ohm
 R2, R3—4700-ohm
 R4—8200-ohm (see text)
 R5, R6—510-ohm
 R7—10-ohm, $\frac{1}{2}$ -watt

ADDITIONAL PARTS AND MATERIALS

C1, C2, C5—3.3- μ F, 16-WVDC radial-lead electrolytic capacitor
 C3, C4—0.01- μ F, 16-WVDC, monolithic capacitor
 S1—Low-profile, locking pushbutton switch (Digi-Key 501-PB)
 T1—8-ohm to 1000-ohm, audio transformer
 BZ1—EFB-RP34B21 (Matsushita) transducer
 Printed-circuit board materials, Orbit sprinkler head or equivalent, $\frac{5}{8}$ -inch nylon protector foot, heavy black shoestring, 9-volt alkaline battery, 9-volt battery connector, wire, solder, hardware, etc.

The following is available from Niche Technologies, Inc., P.O. Box 851264, Richardson, Texas 75085-1264: A complete kit of parts (including sprinkler head and printed-circuit board) for the Sonic Defender for \$19, plus \$2 shipping and handling; printed-circuit board only for \$3 postage paid; the EFB-RP34B21 Matsushita transducer \$5 each postage paid. A fully wired and tested unit is available for \$29 plus \$2 shipping and handling. Please send check or money order. Texas residents, please add 8 $\frac{1}{4}$ % state sales tax.

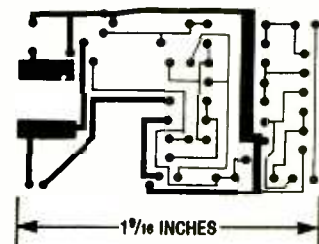
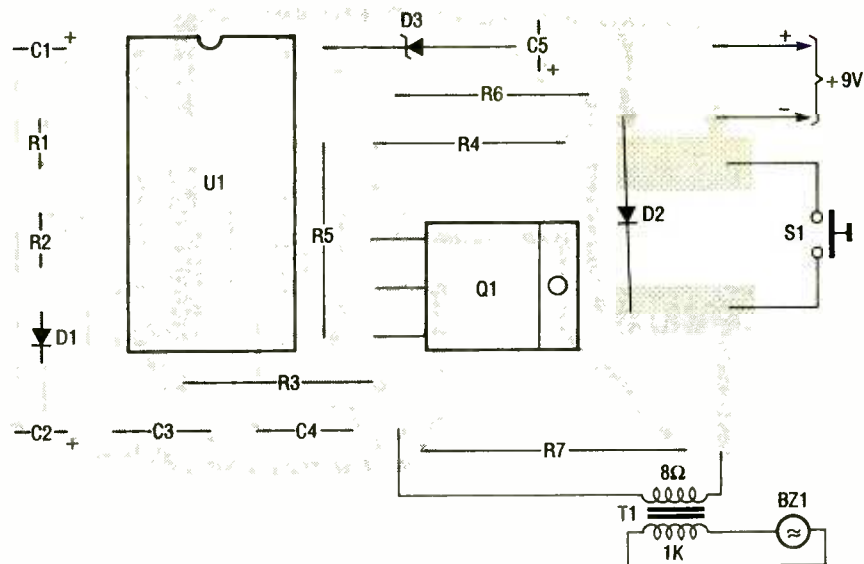

Fig. 2. The Sonic Defender was assembled on a tiny printed-circuit board, the template for which is shown here.



WARNING!! This article deals with and involves the construction of a device that may be hazardous to health and life. Do not attempt to implement or use the information contained herein to construct said device unless you are experienced and skilled with respect to the same. Neither the publisher nor the author make any representation as for the completeness or the accuracy of the information contained herein and disclaim any liability for damages or injuries, whether caused by or arising from the lack of completeness, inaccuracies of the information, misinterpretations of directions, misapplication of the information or otherwise.

Fig. 3. Assemble the printed-circuit board, using this parts-placement diagram as a guide. Note that because of the small size of the board, it will be necessary to mount several axial-lead components vertically.

Trial and Error. The final step in the assembling the Sonic Defender is to determine the best possible resistor value for R4. Start by first turning the printed-circuit assembly over so that the bottom (trace side) of the board is visible. Connect a 9-volt battery to the battery connector.

Point the transducer away from you and turn on the switch. Alternately press a 7.5k, an 8.2k, and an 9.1k resistor across the pads for R4. Turn off the unit, disconnect the battery, and permanently install the value that gives the highest sound intensity.

Once R4 is selected and installed, slide the completed printed-circuit assembly into the body of the sprinkler head until the switch pops through the hole. Secure the assembly with the switch nut. Reconnect the battery and slide it into the body. Use an alkaline battery since the Sonic Defender typically draws about 120 milliamps of current. The alkaline unit should provide about a half hour of continuous use. Do not use a Ni-Cd battery; they self discharge at 1-2% per day. Now carefully screw on the cap. Once that is done, you're finished!

Conclusion. The Sonic Defender is an easy-to-build device that can provide an extra measure of protection when you are threatened. With its convenient wrist strap, you can even wear it to bed! It will provide you with a non-violent means of warding off trouble, so you won't be reduced to the level of your attacker just to defend yourself. The next time someone tries to bother you, a blast from the Sonic Defender will send him packing.

excess. Now, apply some hot glue to the end of the protector foot, and press it into the pipe hole at the rear of the sprinkler head.

The original circuit was built on a 1.6-by 1-inch piece of perfboard, and later reconstructed on a printed-circuit board (which is recommended for ease of wiring); a template for the printed-circuit board is shown in Fig. 2. Assemble the printed-circuit board, using the parts-placement diagram shown in Fig. 3 as a guide. **DO NOT** use an IC socket for U1. Since T1 sits atop U1, the height of the socket will raise the transformer high enough so that the completed assembly will not fit in the sprinkler-head body. Use your hot-glue gun to attach the transformer to the IC. The transformer should be as close to the rear of the printed-circuit board as possible to maximize the space available for the battery.

Switch S1, a low-profile unit, mounts directly to the printed-circuit assembly, with its solder tabs simply soldered to the printed-circuit traces. A large alligator clip was used to hold the switch on the board while it was being soldered in place. After soldering the switch tabs to the board, apply some hot glue to give the switch more mechanical stability. The switch is used to mount the completed printed-circuit assembly to the inside wall of the sprinkler head.

When adding components to the printed-circuit board, do not permanently attach R4. Resistor R4 is nominally

8.2k, however, resistor values of 7.5k and 9.1k should also be tried in order to optimize the sound intensity. (The correct value will be determined in the next section.) Note the proper orientation of the semiconductors (U1, Q1, D1, D2, D3), and the electrolytic capacitors C1, C2, and C5. Transistor Q1 should have the leads bent at 90-degrees prior to mounting on the printed-circuit board.

After all components except R4 have been installed, attach 6-inch extension wires to the 1000-ohm winding of T1. Attach a 9-volt battery connector to the circuit board at the points and with the orientation indicated (the black wire to - and the red one to +). Finally, cut off the "F" lead on transducer BZ1. Then solder the extended transformer leads to the "G" and "M" leads on the transducer, and put a glob of hot glue on each transducer connection.

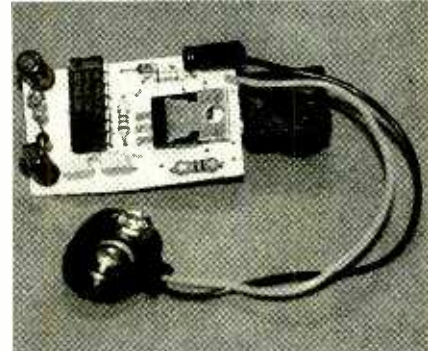

Here is the Sonic Defender's printed-circuit board prior to the mounting of T1. Once T1 is mounted, the integrated circuit will no longer be visible.

BY
STEPHEN J. BIGELOW

ALL ABOUT

Of all the tools and equipment on a hobbyist's workbench, perhaps the most useful and versatile is the multimeter. They are relatively inexpensive and simple to use, and yet they can provide essential readings of voltage, current, and resistance—measurements imperative to building even the most sophisticated circuits.

Because of their necessity, meters are readily available in a staggering variety of shapes, sizes, and features from an array of foreign and domestic (U.S.) manufacturers.

This article will explain the important concepts behind the operation of both analog and digital meters. It will also present the major design considerations for each family of meter (volt, amp, and ohm), so you can build them to suit your own particular needs.

Analog-Meter Concepts. Until the last decade, the vast majority of all available test instruments contained analog meter movements to display readings. The overall design of this analog movement has changed very little since 1881 when a French physicist by the name of Jacques Arsene d'Arsonval developed the mechanism. In his honor, the devices are collectively known as d'Arsonval movements.

The d'Arsonval movement is truly a marvel of engineering in its simplicity and great versatility. They are ideally suited for use in ammeters, voltmeters, ohmmeters, and bridge circuits. Analog movements based on d'Arsonval's design have been employed extensively in more exotic test instruments such as decibel, power, and frequency meters (just to name a few).

d'Arsonval Operation. The functioning of the d'Arsonval movement is remarkably straightforward. In its simplest form, a coil of fine wire is wrapped about a cylindrical iron core to form an electromagnet (Fig. 1). The electromagnet is then mounted on very-low-friction bearings between the poles of a permanent magnet. A tension spring, stops, and a pointing nee-



METERS

With a little knowledge you can build your own meter circuits. We provide you with what you need to know to design ammeters, voltmeters, and ohmmeters.

dle are added to complete the unit.

When a current is applied to the meter, some portion of it is made to flow through the electromagnet. The current flow generates a field in the electromagnet that opposes the field of the permanent magnet. The conflicting fields create a torque that causes the electromagnet to rotate on its bearings and tense the spring. Since the torque and the current are proportional, the greater the current, the greater the torque on the movement, and the more the needle deflects. As the current drops, the tensed spring will tend to move the needle back to its rest position. Thus the position of needle can be used to indicate the amount of current flowing in the meter.

The rest or zero position on d'Arsonval movements can usually be adjusted by turning a small set screw located on the front of their enclosure. Typically, meters are "zeroed" with all current disconnected. Never use a zero-calibration screw as an offset or trim adjustment. d'Arsonval movements are very delicate devices and can be damaged by careless calibration.

d'Arsonval movements are rated in terms of their full-scale current requirement (I_{FS}) and their internal resistance (R_{INT}). For example, a typical meter movement might have specifications of 1 mA and 43 ohms. Those parameters will become very important when we discuss analog meter design. Let's take a close look at the operation and design of the most common analog meter applications—measuring current, voltage, and resistance.

DC Ammeter Design. Ammeters measure the amount of current flowing through them. So in order for a meter to measure the current flowing through a branch in a circuit it must be inserted in that branch.

The simplest ammeter is the meter movement itself as shown in Fig. 2 (R_a and R_b are just two components in the circuit). Manufacturers already produce a variety of meters designed and calibrated to function over a broad range. As you can see from the meter's

specifications, it will deflect to its full scale at 1 mA and will add 43 ohms to the series circuit. As long as the circuit carries 1 mA or less, the meter will read properly without the need for support components. If current should rise above 1 mA, the needle will be forced (or "pegged") against the clockwise stop. Severe or repeated surges can easily wrench the electromagnet off its delicate bearings, damage the internal springs, or burn out the coil. Be sure to use caution when applying current to meter movements. It is often a good idea to place a fast-acting fuse in line with the meter leads to protect it from excessive current.

Notice that d'Arsonval movements are polarized—current can only be applied to the meter in one direction to ensure clockwise rotation. A reversal of current will "peg" the needle against its counterclockwise stop possibly damaging the movement as mentioned before.

But what if you want to measure more current than the movement alone can handle? Easy, simply add a "shunt resistor" (R_{SHUNT}) across the movement as shown in Fig. 3. The input current (I_{INPUT}) that is applied to the meter circuit will split into meter current and shunt-resistor current (I_{SHUNT}). Just how much current will flow through the resistor will depend upon its value and the value of the meter resistance (R_{INT}).

The shunt resistor serves two very important functions: it channels some current away from the movement to extend its useful range, and it reduces the overall resistance of the unit. Reducing the resistance minimizes the load the meter places on the circuit.

You can use the following formula to calculate the proper value for just about any shunt resistor:

$$R_{SHUNT} = R_{INT} I_{FS} / (R_{INPUT} I_{FS})$$

The amount of current flowing in the shunt itself can be determined with the following relationship:

$$I_{SHUNT} = I_{INPUT} - I_{FS}$$

The first step is to determine the amount of current that must flow

through R_{SHUNT} . If you want to build a meter to read 0–1 amp (full scale), but you have a meter on hand that carries only 1 mA (full scale), then I_{SHUNT} will be:

$$1 - .001 = 0.999 \text{ amps}$$

Using this value, we find the value of R_{SHUNT} to be:

$$43 \times .001 / 0.999 = .043 \text{ ohms}$$

If a .043-ohm shunt resistor is used, the movement will reach full scale when 1 amp flows through the meter. It is always a good idea to keep the overall resistance of the assembly as low as possible to minimize the loading effects of the meter on the circuit under test.

Another consideration is the power dissipated by the shunt resistor, which can be expressed as:

$$P_{shunt} = I_{SHUNT}^2 R_{SHUNT}$$

For our previous example, the .043-ohm shunt resistor will dissipate:

$$0.999^2 \times .043 = .043 \text{ W}$$

So a 1/8-watt resistor would do just fine. Now this is a very small value, but suppose our meter was to measure up to 100 amps. Then I_{SHUNT} would almost be 100 amps:

$$100 - .001 = 99.99 \text{ amps}$$

R_{SHUNT} would be:

$$43 \times .001 / 99.99 = .00043 \text{ ohms}$$

Power would then be:

$$(100)^2 \times .00043 = 4.3 \text{ watts!}$$

That would require at least a 5-watt resistor, which would be much larger and run much hotter than our previous 1/8-watt resistor. Always consider the power dissipation.

A multi-range ammeter can be created by simply making several appropriate shunt resistors available to the meter via a rotary switch. You can calculate the value of a shunt resistor for each range just as we did in the single-range example. Keep in mind that you do not have to stick to powers of 10 when you choose maximum currents. Feel free to pick any current range(s) that suits your particular needs.

If you do decide to build a multi-

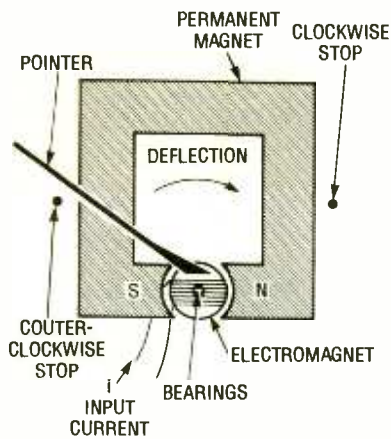

Fig. 1. This is a simple d'Arsonval movement. The deflection of the needle is proportional to the input current (i).

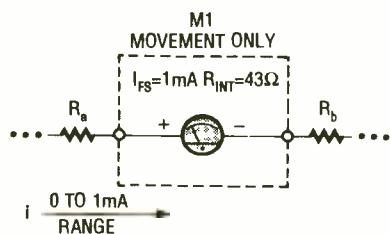

Fig. 2. A simple meter movement must be inserted in a series to a circuit to measure current flow.

range ammeter be sure that the switch you use is make-before-break, or that at least one meter lead is disconnected, any time you change ranges. That will prevent any surges of current through the movement in the brief instant that the switch may be moving between positions.

Don't worry if the values of resistance you calculate seem exotic; precision resistors down to 0.1 ohm are available. Also remember that resistors can be combined in series and parallel networks to obtain even lower values.

The 1-mA, 43-ohm meter movement used in our previous examples is just one of the many units that are currently on the market. Commercial DC-ammeter movements are available in ranges from 0–25 μ A all the way up to 0–15 amps. Their resistance can be as high as 3700 ohms, or as low as .003 ohm (depending on the scale).

DC Voltmeters. Voltmeters measure the potential difference between any two points in a network. For a voltmeter to function properly, it must be placed in parallel with the load creating the voltage drop.

It is easy to use a standard d'Arsonval movement in voltmeter applications.

This is done by re-arranging its circuit configuration. Since our meter is now measuring voltage, we must consider what voltage will cause a full scale deflection. For the meter used in our previous examples, according to ohm's Law it would take:

$$.001 \times 43 = .043 \text{ volt}$$

to cause full deflection. That means that if we were to use the movement alone, an input of 43 mV would deflect the meter fully. That value is commonly referred to as the meter's "voltage sensitivity" or VS.

Unfortunately, a voltmeter that only reads up to 43 mV is not very useful in most practical situations, but it is possible to extend the range of the meter by

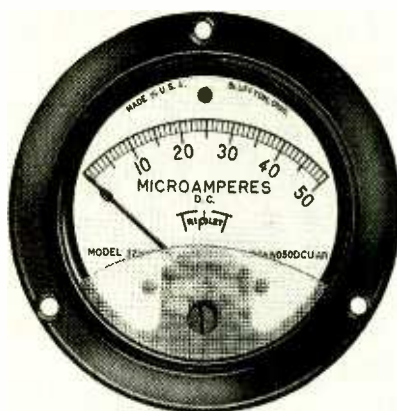

This is the front view of a typical d'Arsonval-type meter movement. Note the zero-adjust screw.

adding a current-limiting resistor in series with the movement. This limiting resistor serves two very important purposes. First, it dissipates enough energy to let the meter read within its rated range. Second, it adds resistance to the meter network, minimizing the loading of the circuit under test.

Effectively, the limiting resistor is chosen so that the current flowing through the movement is equal to I_{FS} when the maximum desired input voltage is applied. Remember that d'Arsonval movements are polarized; be sure to apply voltage with the proper polarity.

You can use the following formula to calculate the value of the limiting resistor:

$$R_{LIMIT} = (V_{MAX} - I_{FS} \times R_{INT}) / I_{FS} \text{ (eq. 1)}$$

Let's say we want to use our 1-mA, 43-ohm meter movement in a voltmeter design that will measure up to 20 volts. We know:

$$\begin{aligned} V_{MAX} &= 20 \text{ volts} \\ VS &= I_{FS} \times R_{INT} = .043 \text{ volt} \\ I_{FS} &= .001 \text{ amp} \end{aligned}$$

Using equation 1, we can determine the value of R_{LIMIT} :

$$(20 - .043) / .001 = 19957 \text{ ohms}$$

A 20,000-ohm resistor will work satisfactorily. Give it a try.

One word of caution: To achieve the best performance from the meter at lower voltage ranges, keep the limiting resistor as close as possible to the calculated value. That is because the meter circuit will be more sensitive down at lower ranges since the voltage across the meter will be closer to the voltage dropped across the limiting resistor. If R_{LIMIT} has poor tolerance, the reading will be less accurate. Higher ranges are less sensitive since the meter's voltage versus the applied voltage is so much smaller, so you can afford to be more lenient with the limiting resistor's tolerance.

Unlike the shunt resistors in our ammeter circuits, limiting resistors are almost always low-power ($1/8$ or $1/4$ -watt) devices. That is the general rule since only a small amount of current will ever

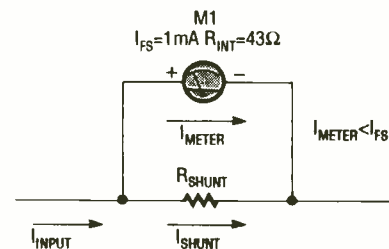

Fig. 3. An expanded-range ammeter is really a simple ammeter movement in parallel with a "shunt" resistor.

flow through them. For our voltmeter example, the power dissipated by the limiting resistor would be:

$$.001^2 \times 19957 = .01996 \text{ watt}$$

That's well within the range of a $1/8$ -watt resistor.

Multi-range voltmeters are equally easy to put together. Work out the appropriate resistor values by using equation 1 for each scale that will be needed. Use a simple rotary switch to select the desired resistor, and thus the scale. For 1-, 5-, and 10-volt ranges the limits can be calculated as follows:

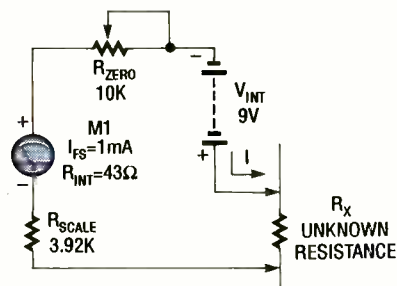

Fig. 4. A meter's internal voltage source is used to drive an ohmmeter circuit.

knowing the full-scale current of the movement and the maximum voltage rating of the particular scale:

$$R_{\text{INPUT}} = V_{\text{MAX}} / I_{\text{FS}}$$

For our example voltmeter, its input resistance would be:

$$20 / .001 = 20,000 \text{ ohms}$$

Just remember that the input resistance for a particular scale is the same regardless of the actual amount of voltage applied.

However, unlike a voltmeter or ammeter, resistance must be measured with the circuit power off. That is because ohmmeters supply their own current for ease of use; any additional current from the circuit under test may cause enough extra current to damage the meter. Even if damage does not occur, any reading would be worthless since the meter is calibrated to work from its internal voltage only.

We can use d'Arsonval movements to build our own ohmmeter as shown in Fig. 4. That type of ohmmeter is known as a "series ohmmeter" because of the series circuit it forms with the resistor. The design is also referred to as a "mid-range," or "general-purpose" ohmmeter. Although it is capable of measuring from 0 ohm to infinity, the non-linear response of the meter only allows accurate readings up to about 1/3 of the meter's scale (depending upon the chosen scale). Accurate measurements below 1 ohm would require the use of additional circuitry to

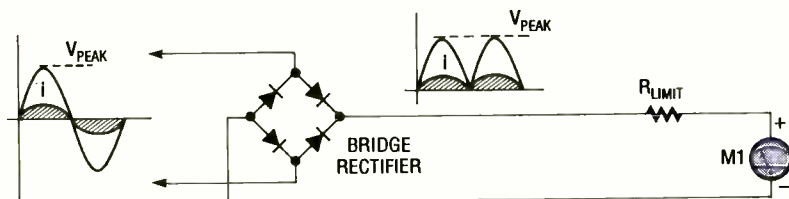

Fig. 5. A simple diode bridge can turn a DC voltmeter into an AC voltmeter. However, the voltage drop across the diodes must be taken into account when determining the value of the limiting resistor.

$$R1 = (1 - .043) / .001 = 957 \text{ ohms,}$$

$$R2 = (5 - .043) / .001 = 4957 \text{ ohms,}$$

$$R3 = (10 - .043) / .001 = 9957 \text{ ohms}$$

There is no limit to the number of ranges that you could add.

Ohms/Volt Ratings. Many voltmeters carry an ohms-per-volt rating. That rating can be used to determine both the meter's internal resistance and the current sensitivity (I_{FS}).

For a voltmeter with a given ohms/volt rating, the I_{FS} can be determined simply by taking the reciprocal of the rating:

$$I_{\text{FS}} = 1 / (\text{ohms-per-volt rating})$$

If you use a voltmeter marked at 20,000 ohms/volt, the full-scale current of the movement would be:

$$1 / 20,000 = 50 \mu\text{A}$$

Conversely, if you wish to determine a voltmeter's ohms-per-volt rating, just rearrange the formula to take the reciprocal of I_{FS} :

$$\text{ohms-per-volt rating} = 1 / I_{\text{FS}}$$

For our 1 mA meter, its rating would be:

$$1 / .001 = 1000 \text{ ohms/volt}$$

Try to keep the ohms-per-volt rating as high as possible to reduce loading on the circuit under test.

The internal resistance for each voltmeter scale can be easily calculated

Fig. 6. This is a block diagram of a basic digital meter. The input circuit is programmed by the switches which are not shown here.

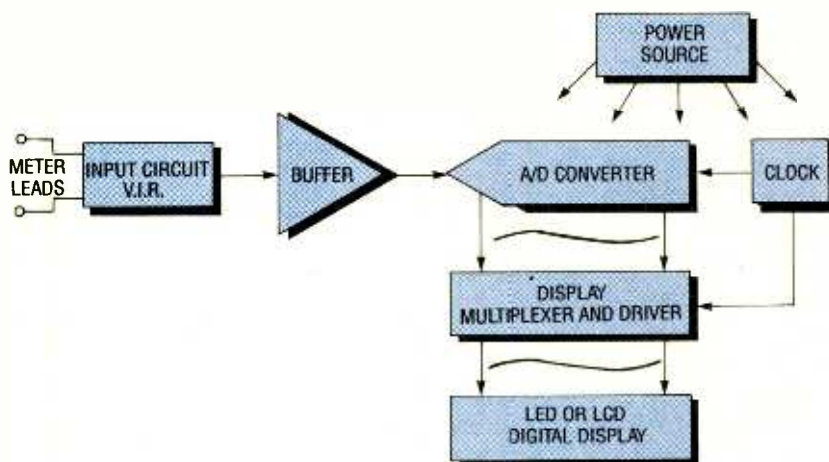

As you know from our discussion on ammeters, there are a number of types and ranges of meter movements available to suit a wide variety of applications. It is important to note also that there are many movements on the market already configured and marked as voltmeters. They can be handy if you can not find the resistor values to suit your needs, but it will limit you to a single scale.

Ohmmeters. Ohmmeters measure the resistance across two points in a circuit. In order to do that, an ohmmeter must be placed across the component(s) to be measured—just like a voltmeter.

compensate for errors caused by such factors as lead length and contact resistance. Measurements over 10 megohms would require higher excitation voltages to generate meaningful current in a circuit.

For our ohmmeter of Fig. 4, the choice of zero resistor (R_{ZERO}) is almost arbitrary. It can be as large or small as you like. Its purpose is to compensate for any variations in voltage or component values within the meter. A larger value of R_{ZERO} will give you a larger range of compensation, but will tend to drift more due to temperature and humidity. A smaller value will offer a smaller range of compensation, but it will be more sensitive. For our purposes, a

Meter Glossary

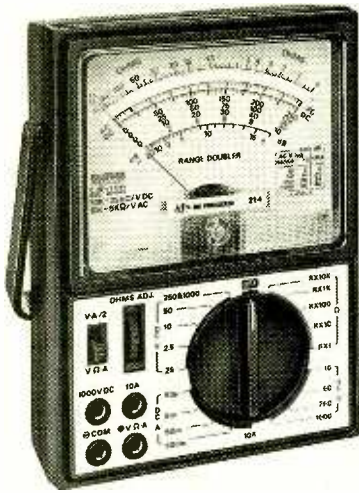

Here is an overall view of a typical analog VOM. It can perform the three basic measurements.

10,000-ohm rheostat will be used.

The meter scale is set with a fixed-value scale resistor, R_{SCALE} . The meter will be calibrated based solely on the values of R_{SCALE} , R_{ZERO} , and the internal battery V_{INT} . The value of R_{SCALE} can be calculated with the following formula:

$$R_{SCALE} = V_{INT} / I_{FS} - R_{INT} - R_{ZERO} / 2$$

For the ohmmeter circuit shown, the value of R_{SCALE} would be:

$$9.001 - 43 - 10000/2 = 9000 - 43 - 5000 = 3957 \text{ ohms}$$

A 3920-ohm, 1% 1/4-watt resistor can be used since the zero-adjust resistor can easily be adjusted to compensate for the inaccuracy of the scale-resistance value. As a general rule, though, try to keep your scale resistor close to the calculated value. Remember that the greater the difference between your calculated scale resistance and your actual scale resistance, the more you must adjust the zero-adjust resistor to compensate for that error. That means you will automatically lose a portion of your adjustment range just to compensate for a poorly selected resistor.

An ohmmeter must be recalibrated each time the scale is changed, or after periods of disuse. In order to calibrate our ohmmeter, first set the zero adjustment to the approximate center of its range, then short the test leads together. That establishes a current flow through the meter-test circuit itself, which will cause the meter to deflect. If R_{ZERO} is in the center of its range and R_{SCALE} is very close to its calculated value, the meter should deflect fully coun-

Accuracy—A percentage of error which states how closely a meter reads the actual value of an input signal. The smaller the percentage is, the more accurate the meter. Many commercial meters can measure to 0.5% accuracy.

d'Arsonval Movement—an electromechanical indicator using an electromagnet that is free to rotate within the magnetic field of a permanent magnet. The coil will rotate in direct proportion to the amount of current flowing through it.

High ohms—A resistance scale using a slightly higher voltage that will allow semiconductor junctions to be forward-biased when placed across the meter leads.

Low ohms—A resistance scale using a low battery voltage that will not forward-bias semiconductor junctions.

Multimeter—A versatile meter capable of measuring several ranges of either voltage, current, or resistance. Also known as a "Multitester" or "VOM (volt-ohm-milliammeter)."

Ohms/volt—A voltmeter rating that indicates the effective impedance (or current sensitivity) of the voltmeter scale. The rating is typically used to describe analog meters.

Rectifier-type AC meter—A conventional DC meter movement modified to read the RMS value of voltage through a bridge or full-wave diode rectifier.

Resolution—The smallest amount of change that a meter is capable of detecting. The rating is most often applied to digital meters.

RMS (Root Mean Square)—The effective value of an AC signal. It is commonly calculated as 70.7% of the peak value of the AC signal (assuming a pure sine wave).

Shunt—A low-value resistor used in ammeter circuits to extend the range of the meter movement in use. The shunt is used in parallel with the meter movement. ■

terclockwise to indicate zero resistance. If the needle swings too far clockwise, or not far enough, simply adjust R_{ZERO} until the needle rests on the fully clockwise marking. That will now represent zero ohms. Separate your test leads and the needle should fall to the fully counterclockwise marking. That represents infinite resistance (or an open circuit). Your ohmmeter is now calibrated for your chosen scale.

When you place an unknown resistance between the test leads, it will complete the meter circuit and cause the meter to deflect. The amount of the deflection will depend on the value of the unknown resistance.

AC Modifications. The meters we have discussed this far have been strictly DC instruments—current must move steadily in one direction in order for the

d'Arsonval movement to measure the proper magnitude of the signal. AC signals present special problems since the polarity of the signal varies over time. If an AC signal were placed on a conventional d'Arsonval movement, the needle would try to follow the changes in magnitude. For signals more than 15 Hz or 20 Hz, the needle would just tend to quiver without producing any useful reading. For AC signals to be measured accurately, they must first be converted to a corresponding DC level.

A simple bridge rectifier circuit can be used for AC to DC conversion for our voltmeter circuits. The full-wave bridge rectifier shown in Fig. 5 will allow current to flow through the meter in one direction only. However, since the voltage will still pulsate over time, the meter will indicate the average (or RMS) value. For a sinewave with a maximum voltage of V_{PEAK} , that is:

$$0.707 \times V_{PEAK}$$

and the value for the limiting resistor must be found from:

$$R_{LIMIT} = (V_{PEAK} - I_{FS} \times R_{INT} - 1.2) / I_{FS}$$

Already assembled AC-voltmeter movements that can measure up to 300 volts are commercially available.

Unfortunately, the solution is not so simple for AC ammeters. Introducing the voltage drops produced by the rectifier diodes can have very adverse effects on the circuit under test. Luckily, commercial AC-ammeter movements are available off-the-shelf that can measure up to 300 amps. Commercial VOM's (volt-ohm-milliammeters) are readily available from many different vendors. Prices for analog meters can range anywhere from \$20 to \$200.



This DMM can measure frequency, H_{fe} , and capacitance as well as resistance, ampereage, and voltage.

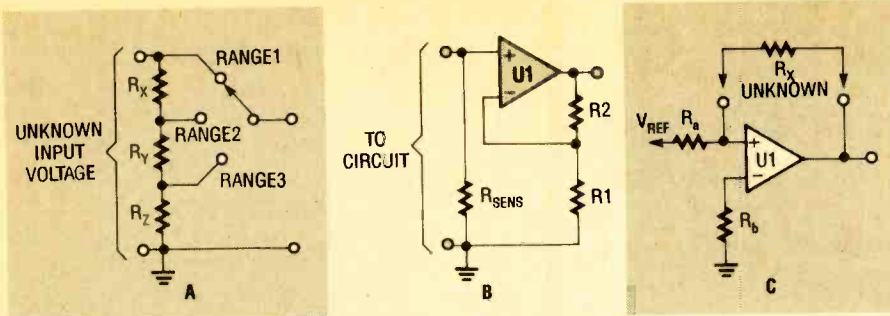

Fig. 7. These various input circuits can allow for a digital-meter circuit to detect voltage (A), current (B), and resistance (C).

Digital-Meter Concepts. Unlike the analog meters we have discussed, digital meters make extensive use of VLSI (Very Large Scale Integration) devices to accomplish the functions required to drive a multi-segment display. Although modern semiconductor technology has made single IC chips that perform many digital-meter functions possible, all DMM's (digital multimeters) contain the sections shown in Fig. 6.

The input-circuit section is informed by the switches and controls on the unit about the type of input that will be applied to it (i.e. voltage, current, or resistance). Figure 7 demonstrates just a few of the possible input circuits.

After some conditioning, the signal passes from there to the the A/D converter via a buffer. The buffer circuit provides some measure of isolation and further signal conditioning.

The A/D converter is the very heart of a DMM. It is responsible for converting the analog signal delivered from the outside world into an equivalent digital word that will be interpreted by the display driver. The operations of the A/D converter are regulated by a local clock signal that can be up to several kilohertz. Another local clock signal controls the operation of the display.

The display-driver section consists of code-converting circuitry and a display multiplexer. The code-converting circuit accepts raw digital information generated by the A/D converter, and generates the corresponding BCD (binary-coded decimal) numbers that will appear in the display. The multiplexer is synchronized to the code converter so that the appropriate display element is activated when the BCD code is generated. Multiplexing the display in this way is usually done at a very high rate so the display appears "flicker-free."

Lastly, there's the power source. Unlike the analog meters that we have cov-

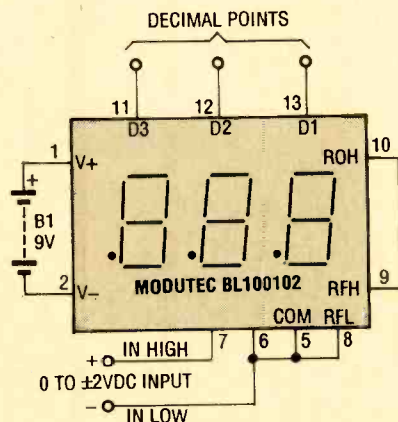

Fig. 8. A pre-packaged digital panel meter can be employed directly as a digital voltmeter.

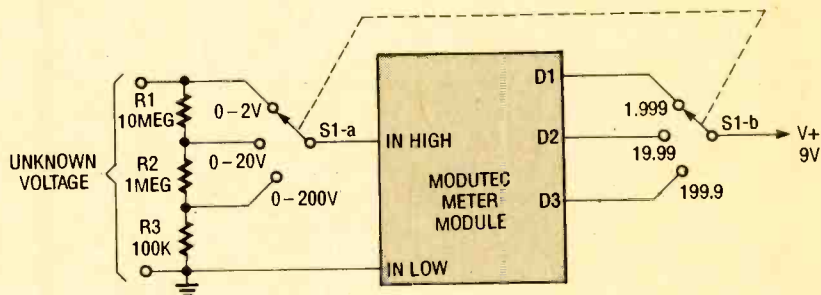

Fig. 9. A simple voltage divider can greatly extend the range of your digital voltmeter. Note the switch selects the proper decimal point for a reading.

ered, DMM's require some source of power to operate. Hand-held DMM's use a battery (often a typical 9-volt battery). More sophisticated benchtop DMM's usually have a built-in power supply.

Digital Meter Design. Many of the vital elements needed to build a digital meter are already available in the form of commercial panel meters. These compact and versatile assemblies are inexpensive and easy to use.

In our first voltmeter-design example, we will use the Modutec Series BL100 digital panel meter (available through various nationwide distributors such as

Newark Electronics, Chicago, IL) as a 0 to ± 2 -volt voltmeter (see Fig. 8). Since the DPM itself has a range of 0 to ± 2 volts DC, signals falling in that range can be connected directly to the meter without the aid of any voltage-dividing components. The meter can be operated conveniently from a single 9-volt battery. In this particular model, a low-battery indicator informs you when the battery power drops below 7.2 volts.

The BL100102 is referred to as a 3-1/2-digit meter. That means that the display consists of 3 full seven-segment digit displays and an indicator for a leading "4" called a "half" digit. Therefore, the meter can display numbers anywhere from a -1999 to +1999. If you use a 4-1/2-digit meter, then there will be 4 complete seven-segment numbers plus a leading 1, and so on.

The schematic of our digital voltmeter in Fig. 8 is very straightforward. Power is applied to the V+ and V- terminals (pins 1 and 2). The signal to be measured is connected to the IN HI and IN LOW pins. Notice that there are also a few other simple connections to be made. The IN LOW pin must be connected to the COM (common) pin as well as the RFL (reference low) pins of the module. That establishes the common reference point between our meter

and any circuit under test. Also note that the ROH pin is connected to the RFH pin. That simply allows a 1:1 scale so the meter will interpret and scale the signal properly. No other pins need to be connected.

If you want to extend the range of the voltmeter, you can add a voltage-dividing network such as the one in Fig. 9. With the selector in the 0-2-volt range, a 0 to ± 2 -volt signal would be connected directly to the input. In the 0-20-volt range, the 10-megohm resistor forms a 9:1 voltage divider with the 1-megohm and 100,000-ohm resistors. If 20 volts were applied to the network, almost 18 volts would be dropped across the 10-

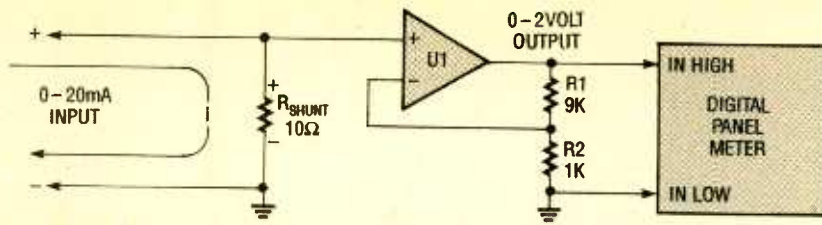

Fig. 10. An operational amplifier can be added to convert current into voltage for the digital panel meter. The shunt resistor determines the range.

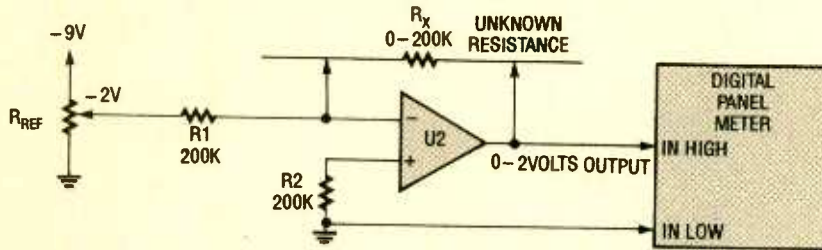

Fig. 11. An operational amplifier can be used to form a resistance sensor for a digital panel meter. The reference voltage sets the range of the meter reading.

megohm resistor, leaving about 2 volts at the input. In the 0-200-volt position, a voltage divider is formed between the 10-megohm and 1-megohm resistors, and the 100,000-ohm resistor resulting in a ratio of about 100:1. A 200-volt input will yield about 2 volts at the input to the module. You can alter the values of the divider resistors to achieve other voltage-division ratios.

A ganged selector switch can be used to select the appropriate decimal place for each scale as shown. The desired decimal point can be lit simply by connecting it to V+. In the 0-2V position, the left-most decimal point will be lit. The middle point will light in the 0-20V range, and the one on the right will light in the 0-200V position.

Ammeter. Remember that our meter module can only read DC voltage. In order for the meter to read current, the current signal must be converted into a related voltage signal. The circuit addition in Fig. 10 uses an operational am-

plifier configured as a non-inverting amplifier. The meter leads can be inserted into the circuit just like an analog ammeter. Current will flow through the shunt resistor and generate a voltage drop. The potential is amplified by the factor of:

$$R1/R2 + 1$$

The multiplication factor would then be:

$$9000/1000 + 1 = 10$$

and the resulting output voltage will be supplied to the digital module.

For the circuit of Fig. 10, a 10-ohm resistor will sense the current in the 0 to 20 mA range. In that range, R_{SHUNT} will develop a potential from 0 to 0.2 volts. At 20 mA, the 0.2-volt DC signal will be amplified by 10 to yield 2 volts to the module. In this case, 20 mA will cause a full-scale response. The middle decimal point may be used in this range (19.99 mA). As a general rule, try to keep the sense resistor as small as possible to reduce the load on the circuit under test.

For a 0 to 200 mA range, try a 1-ohm sense resistor in place of the 10-ohm resistor. At 200 mA, the potential across R_{SHUNT} will be:

$$0.2 \times 1 = 0.2 \text{ volts}$$

That will be amplified by 10 to provide 2 volts to the digital panel meter. At 200 mA, the DPM will be at full scale for a display of 199.9 mA, so you must use the right decimal point. Try some different scales, but be careful of excessive power dissipation in the shunt resistor.

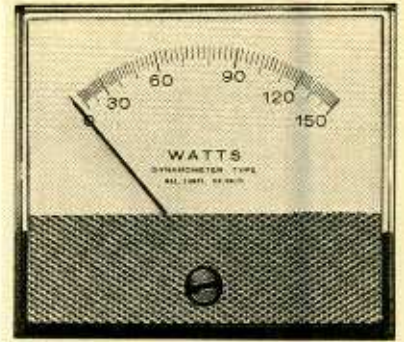

This specialized analog meter is based on a d'Arsonval movement modified to measure watts.

Digital Ohmmeter. Of course, the digital module can not measure resistance directly. Like current, resistance must be converted into an equivalent value of voltage in order to be displayed.

The circuit of Fig. 11 can be used to sense an unknown value of resistance by using an operational amplifier configured as an inverting amplifier. The input and output of the op-amp will have opposite polarity. The amplification factor is:

$$-R_x/R1$$

With infinite resistance (no connection), the output would be:

$$-(\infty/R1) \times -2$$

which means the reading is a positive over-range or 199.9 ohms. If R_x is 0 ohms the output would be:

$$-(0/R1) \times -2 = 0$$

The zero for the meter can be adjusted by altering the reference voltage via potentiometer R_{REF} . This particular circuit has a useful range from 0 to 200,000 ohms before reaching the top of the DPM's scale. When $R_x = 200,000$ ohms, the output will be:

$$-(-2) \times 200,000/200,000 = 2 \text{ volts}$$

which produces a display of 199.9k ohms. Use the right decimal place (D3) for this scale.

To change the scale, change R1 and R2 (they must be equal). For a 0-20,000-ohm scale, replace R1 and R2 with 20,000-ohm resistors and turn on the middle decimal point (D2). Any unknown resistance greater than 20,000 ohms will cause an over-range reading. For the very best circuit performance, try to keep the values of R1 and R2 as close together as possible.

(Continued on page 87)



Here's a typical digital panel meter with an LED display. It requires front-end circuitry and switches to be really useful.

An old-fashioned look combined with digital operation will make you want to trash your old pink piggy—this bank keeps track of what you save!

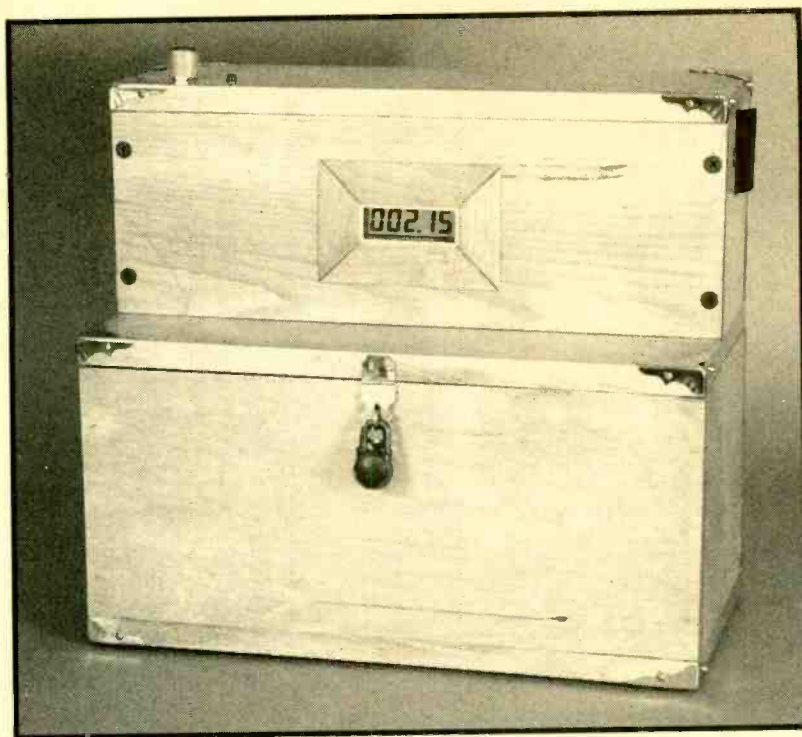

Build the "SLOT-MACHINE" Electronic Bank

BY MARC SPIWAK AND
JOHN YACONO

Did you ever stop to think that by merely saving your daily pocket change, you can gradually accumulate a small nest egg that can be used to fuel some of your hobby interests? It's true, a buck or so a day adds up to well over \$300 a year. The only problem is that finding out how much change is in a bottle or jar can be a pain in the neck. You could certainly go out and buy a bank that counts change, but for a true hobbyist, that's cheating (and for most of us, it's expensive). We now present a project—an old-fashioned "Slot-Machine" Bank—that's inexpensive, fun to build, and will also encourage you to squirrel away some money for your next project. It even makes a nice gift for children and adults alike.

You just feed nickels, dimes, or quarters into a slot on the side of the bank, the bank figures out what coin denomination has been inserted, and the total is updated and displayed on the front panel. Pennies will register as a dime, so they shouldn't be inserted; besides, they don't add up to much and

would waste a lot of space anyway. The circuit can count up to a thousand dollars, so you can build your bank just about as large as you please.

A little bit of high tech is what gives the bank its ability to actually "see" what coin has been inserted. Three infrared (IR) emitter/detector pairs are positioned in the coin chute so that a dime will block one of them, a nickel two, and a quarter all three. A circuit, made up of a handful of components, then decodes the information and sends it to the counter/display module. That is, of course, a simplified explanation of how the bank works, but we'll get to the details later on.

To operate the bank, all you have to do is push a button on the top of the bank to activate it; a green LED lets you know it's on. Then, after inserting a coin in the slot, a beeper counts off the number of cents in the coin as the display counts up in single increments. The only hitch is that you do have to wait for the bank to finish counting one coin before inserting another.

The bank could have been made so

that it's on all the time, but the current draw from the IR LED's would quickly drain the batteries. That's why the push-button is used to manually activate the unit; a timer circuit gives you approximately ten seconds to insert a coin before power shuts off. However, every coin inserted re-starts the ten-second delay so you don't have to keep pushing the button.

The Timer. Before we discuss the bank's circuitry, we should explain a little bit about the functioning of the special LS7210 programmable timer it contains. Unfortunately, the LS7210 is so versatile that we won't be able to discuss all its features, so we'll have to gloss over some of its abilities for the sake of brevity.

The timer is capable of operating in four different modes. You select a mode by placing the appropriate binary value on its two mode-select pins. We will use the one-shot (monostable) mode, which is chosen by tying the mode-select pins (pins 1 and 2) low.

The chip can work with an external or

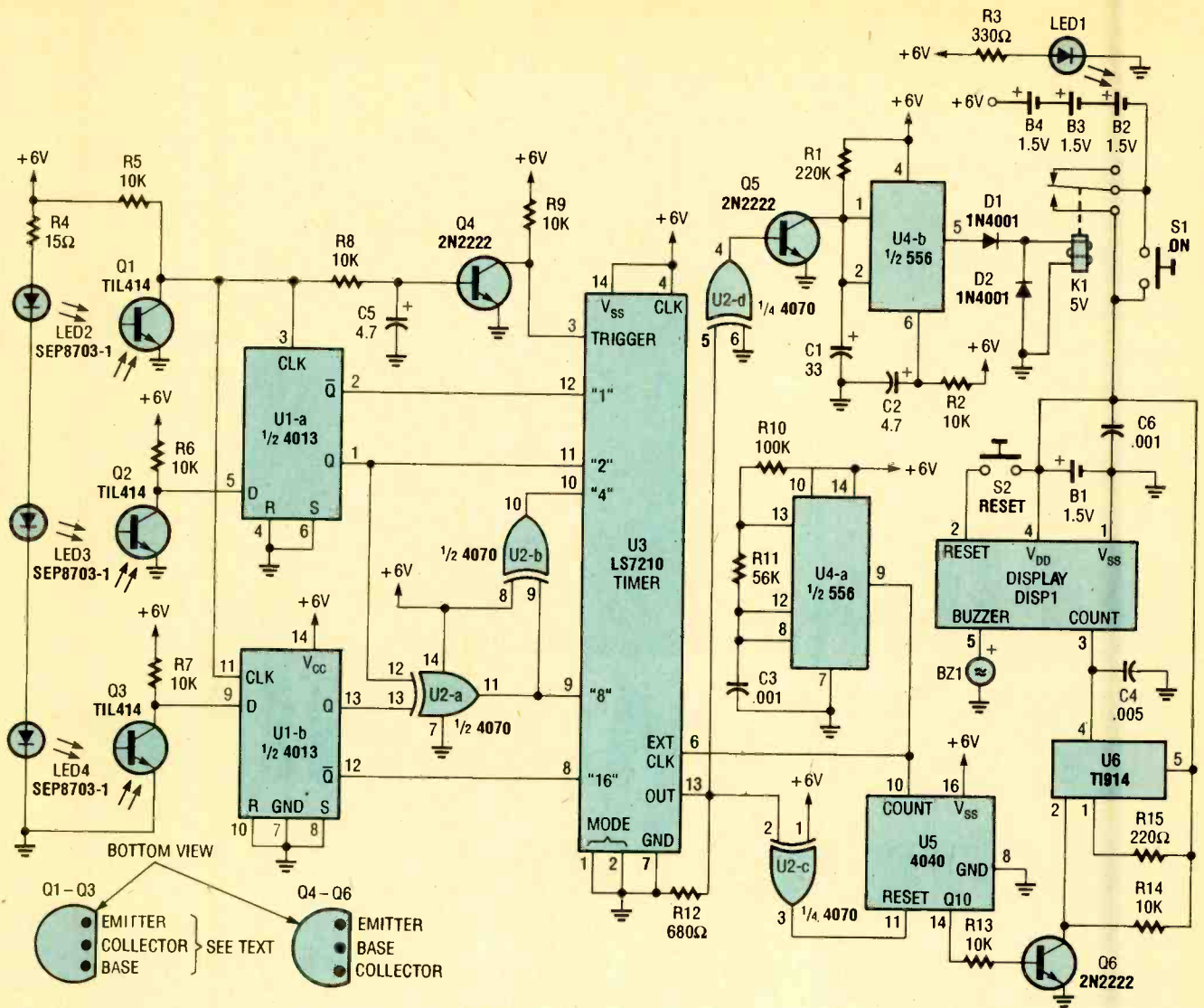

Fig. 1. This is the circuit for the "Slot-Machine" Bank. The phototransistors on the left determine what coin has been put in the slot and that is converted into pulses for the counter.

internal clock. As you'll see, we will need a clock that can oscillate between ground and +V to provide the proper logic-level signals needed to operate other parts of the circuit. The internally driven clock does not swing up and down that far, so we must use an external clock. The external-clock mode is selected by tying pin 4 high. The external oscillator can run continuously without affecting the timer's output; the timer will only become active when its trigger input (pin 3) is toggled.

The trigger input can be positive- or negative-going depending on the timer mode used. For monostable mode, only negative transitions trigger the timer; positive ones are ignored. When a negative transition is presented to the trigger input, the output (pin 13) goes high for one timing period.

The length of the timing period is determined by the frequency of the external oscillator and the logic levels at a series of pins (pins 8-12) called the "weighting-factor inputs." Those inputs accept the binary 1's complement of a number aptly called the "weighting factor." That number programs the timer to hold the output high until the clock has gone through a certain number of transitions. The number of clock pulses (P) counted by the timer is given by:

$$P = 1 + 1023W$$

where W is the weighting factor. In that sense, the timer is similar to a programmable counter, which is how it's used in the bank circuit.

If W is six when the monostable is triggered, the timer will count 6139 pulses

before going low again. If we send the pulses to a binary divider with a 2^{10} (1024) output, that output will go high 5 times. If W is 11, that same divider output pulses 10 times, and if W is 26, the divider yields 25 pulses. Each of those divisions has a remainder, so the divider must be reset to zero after each coin value is tallied to be useful for counting coins—but that's taken care of, as you'll soon see.

The Circuit. The "Slot-Machine" Bank uses some common components in an interesting fashion to provide some unusual features. One key component, that is not so common, is the counter/display module denoted DISP1 in the schematic diagram shown in Fig. 1; fortunately, it can be purchased from Radio Shack (see Parts List). It comes as a

PARTS LIST FOR THE "SLOT-MACHINE" BANK

SEMICONDUCTORS

- U1—4013 dual flip-flop, integrated circuit
- U2—4070 quad XOR-gate, integrated circuit
- U3—LS7210 programmable-timer, integrated circuit
- U4—556 dual oscillator/timer, integrated circuit
- U5—4040 12-stage binary-ripple counter/divider, integrated circuit
- U6—TI914, or similar, transistor-output optoisolator/coupler, integrated circuit
- Q1-Q3—TIL414 infrared phototransistor
- Q4-Q6—2N2222 general-purpose NPN silicon transistor
- DISP1—TL90063 LCD counter module (Radio Shack 277-302)
- D1, D2—1N4001, 1-amp, 50-PIV, rectifier diode
- LED1—Green light-emitting diode
- LED2-LED4—SEP8703-1, or similar, infrared-emitting diode

RESISTORS

- (All resistors are 1/4-watt 5% units.)
- R1—220,000-ohm
 - R2, R5-R9, R13, R14—10,000-ohm
 - R3—330-ohm
 - R4—15-ohm
 - R10—100,000-ohm
 - R11—56,000-ohm
 - R12—680-ohm
 - R15—220-ohm

CAPACITORS

- C1—33- μ F, 16-WVDC, electrolytic
- C2, C5—4.7- μ F, 16-WVDC, electrolytic
- C3—0.001- μ F ceramic-disc
- C4—0.005- μ F ceramic-disc
- C6—0.001- μ F monolithic

ADDITIONAL PARTS AND MATERIALS

- BZ1—Piezo-electric buzzer element
 - K1—Subminiature, 5-volt, relay
- Perfboard, fiber-optic cable, wire-wrap sockets, wire-wrap wire, solder, jumper wire, wood, etc.

Note: Fiber-optic cable is available from Circuit Specialist, Inc., PO Box 2047, Scottsdale, AZ 85271-3047 (Tel. 800-528-1417); and from Edmund Scientific, Co, 101 E. Gloucester Pike, Barrington, NJ 08007 (Tel. 609-573-6250 and 609 547-3488).

preassembled counter with a built in 5-digit display. The two least-significant digits are used to represent cents, so it can display up to \$999.99. When it counts, buzzer BZ1 beeps once for each cent, and can be reset to \$000.00 by depressing S2. The display unit is decoupled by C6 to prevent noise problems. Counter/display module DISP1 is powered by B1 and, since it must keep

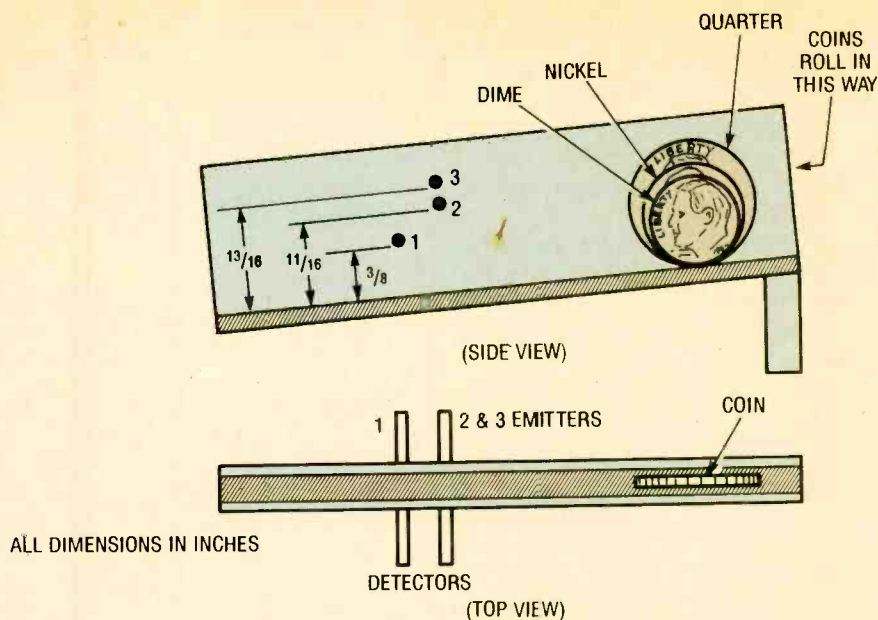

Fig. 2. There are three pairs of IR emitters and detectors: pair 1 forms a trigger/dime detector, pair 2 is for nickels, and pair 3 is for quarters.

track of the total, it remains on all the time. That is nothing to worry about, though, as it consumes only 3 μ A.

The rest of the circuit does not receive continuous power. There is a power-saver circuit built into the unit that turns the rest of the circuit off if left idle. Cells B2-B4, when connected to the counter's battery (B1), form a 6-volt supply that is used to power the remainder of the circuit.

When S1 is depressed, it momentarily connects the positive side of B1 to the negative side of B2. That activates monostable U4-b (half of a 556 dual oscillator/timer). As you may know, to trigger such a monostable, there must be a negative pulse at the trigger input (pin 6). If you just tie that pin to ground, the monostable can't time-out. Since C2 is initially uncharged, it imitates a low and is allowed to slowly charge via R2 to allow the monostable to time out. The monostable turns on relay K1, which connects the cells together until the monostable times out. As you'll see though, the monostable is reset each time you feed the circuit a coin. LED1 indicates that the circuit is fully powered and ready.

When a coin is inserted into the coin slot of the bank, it rolls down a channel, or chute (see Fig. 2). On one side of the channel are three infrared LED's (LED2-LED4), and on the other side of the channel, directly opposite them, are three infrared-detecting phototransistors (Q1-Q3, respectively). Since the presence of infrared light turns the phototransistors on, they normally ground their pull-up resistors. Their

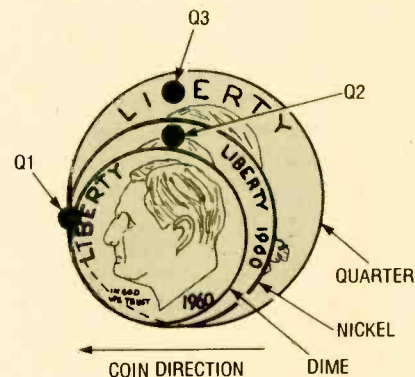

Fig. 3. Shown is the outline for the three coins detected by the circuit, and their relationship to the sensors. If your optics have trouble with cross-talk between Q2 and Q3, you can move Q3 further to the right.

collectors, thus, appear to be in the logic-0 state. If an LED is blocked by a coin in the channel, the collector of its corresponding phototransistor is pulled high by the pull-up resistor and generates a logic 1.

The coin's size (and thus its value) determines which LED's get blocked (see Fig. 3). All coins block light to Q1, which is used to provide a trigger signal. The trigger signal is used to indicate that the coin is in the proper position to block the other two LED's as appropriate. If the coin is a dime, only LED2 is blocked, causing the collector of Q1 to go high; neither LED3 nor LED4 is blocked, so the collectors of Q2 and Q3 are low. A nickel blocks LED2 and LED3, so Q1 and Q2 are high and Q3 is low. A quarter blocks LED2-LED4, making Q1-Q3 go high.

Regardless of the coin's value, the

trigger signal provided by Q1 causes the two D-type flip-flops, U1-a and U1-b, to capture the data from Q2 and Q3. The latched outputs of the flip-flops are used to help convert the phototransistor data into the weighting inputs required by the timer (U3).

As mentioned earlier, the weighting factor needed for each coin will be the value of the coin plus one. The binary 1's complement of the weighting factor will have to be supplied to pins 8-12 on the timer chip to program it. Pin 8 is the most-significant bit, while pin 12 is the least-significant bit.

As you can see from Table 1, pin 11 of U3 can simply be tied low, as it is zero regardless of the coin's value. Pin 12 is always equal to the value of Q2. Pin 8 of U3 is the inverse of Q3. Pin 9 is the XOR of the two transistor values, and pin 10 is its inverse. Those logical relationships are maintained by the flip-flops (U1-a and U1-b) and the XOR gates (U2-a and U2-b). Note that U2-b is set up as an inverter to provide pin 10 of U3 with the inverse of the signal applied to pin 9 of U3.

The timer receives its trigger signal from Q1 via inverting transistor Q4. Note that C5 delays the action of Q4, and thus the timer, so the flip-flops and the XOR gates have a chance to set their outputs. Once triggered, the timer output goes high and the IC begins to count a number of pulses from U4-a (the external clock) based on the weighting-factor value.

The timer-output pulse does two things: First, it causes U2-d (which is used as a buffer) to turn on Q5. That transistor discharges the timing capacitor for the power-saver's monostable, effectively resetting it. Second, the timer output is inverted and sent to the reset input of

TABLE 1—WEIGHT-FACTOR LOGIC

COIN	Detector		Weight (w)		Pin Input (w)				
	Q2	Q3	Decimal	Binary	8	9	10	11	12
5	1	0	6	0 0 1 1 0	1	1	0	0	1
10	0	0	11	0 1 0 1 1	1	0	1	0	0
25	1	1	26	1 1 0 1 0	0	0	1	0	1

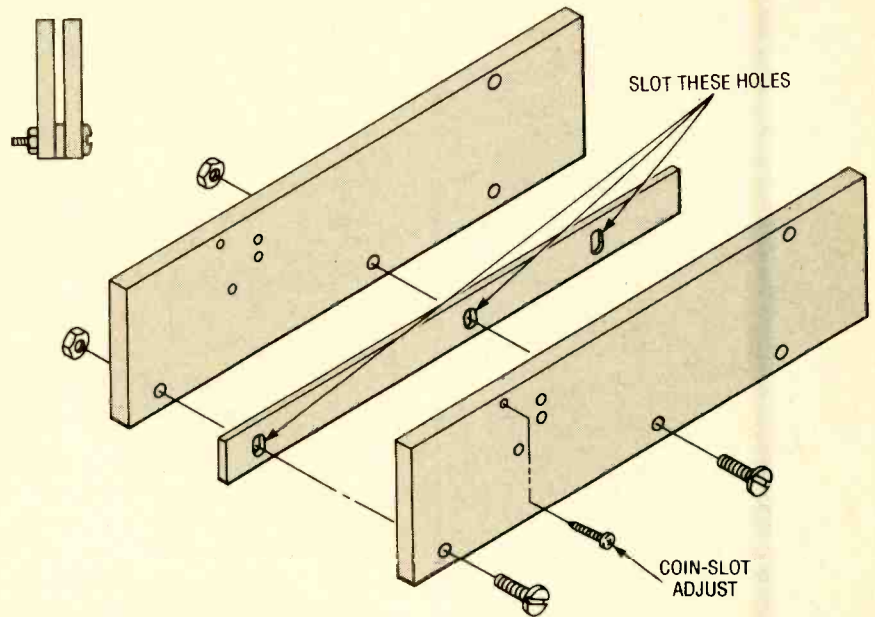

Fig. 5. The coin chute is made from two slats of wood with a narrow strip of wood in the middle, all held together with screws.

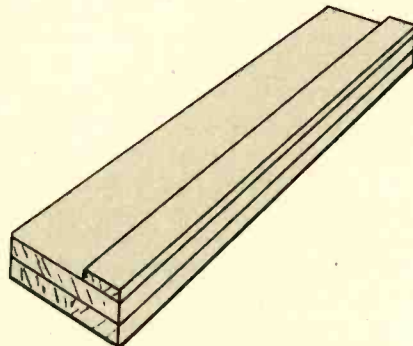

Fig. 6. Stack the wood on top of each other and tape them together to ensure that your drill holes will match up perfectly.

U5 (multi-stage divider) at pin 11. The resulting low at pin 11 of U5 enables it, and it starts to divide the pulses from the external timer. When the timer goes low again, the reset input goes high, clearing any remainder and disabling U5.

The divided output is inverted by Q6, which operates optoisolator U6. The optoisolator ties the count pin of DISP1 high for each pulse, causing the counter to advance once for each cent.

Construction. Since few components are used in the circuit, it is the easiest

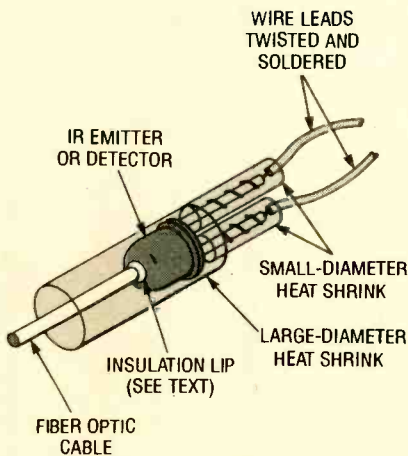

Fig. 4. Prepare the IR detectors and emitters as shown here. Note the lip faces the component.

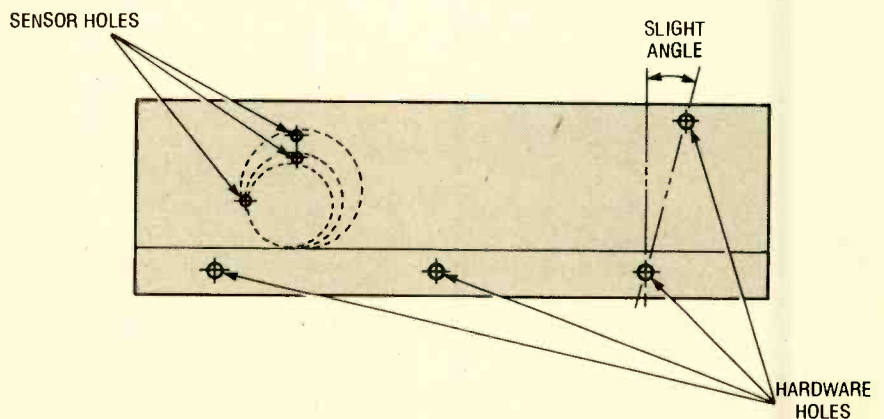

Fig. 7. Use this pattern as a drill guide for the coin chute. Be extra careful when drilling the sensor holes.

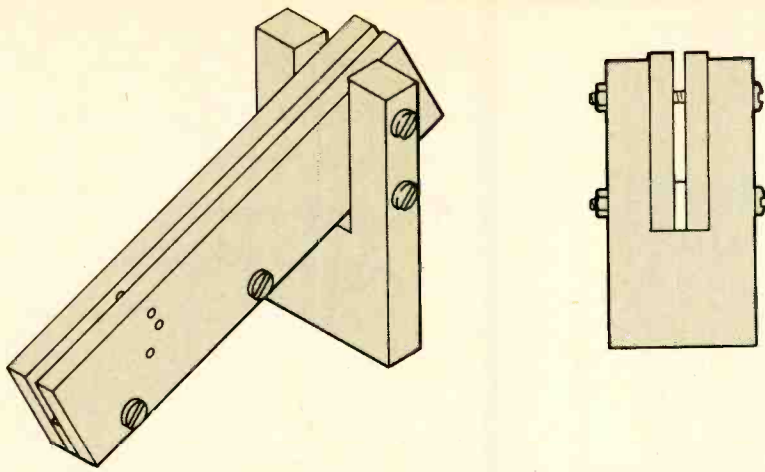

Fig. 8. Attach a U-shaped mounting bracket to the coin chute as shown. That makes installing the chute in the cabinet very easy.

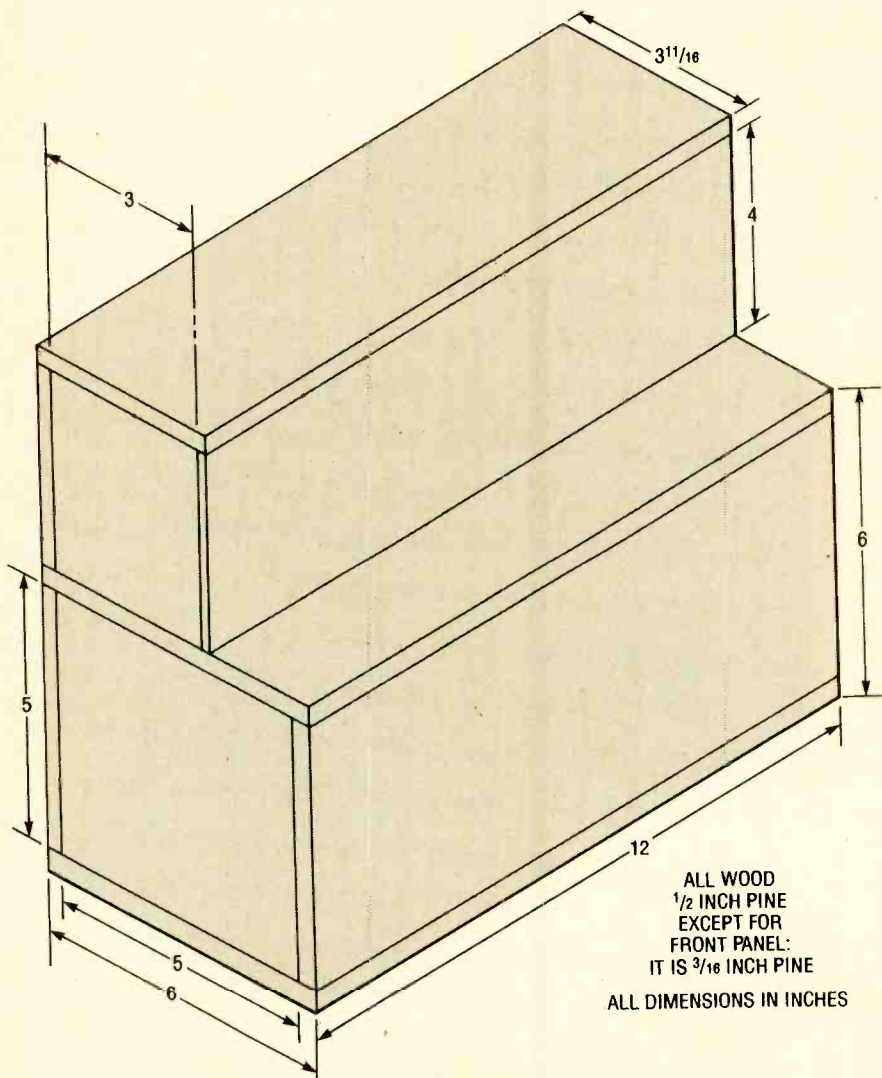

Fig. 9. These are the basic measurements of the cabinet. The top section is hinged to allow access to the bank's coin compartment and the reset button.

thing to build in the entire bank. Following Fig. 1, the connections are made using point-to-point wire-wrap techniques on a piece of perforated construction board. Be sure to use wire-

wrap DIP sockets for all of the IC's. The connections to the board from the batteries, switches, etc., are made with insulated stranded wire soldered to the appropriate points on the board.

Note: Although a TI914 optoisolator/coupler is specified for U6 both in the Part List and the schematic diagram, almost any optocoupler that has a transistor output can be used.

You should supply leads for the IR detectors and emitters to be connected later on. You need one pair of leads for each phototransistor and one pair for all three emitters, since they are connected in series. Leave a little extra length on the wires for now; it's also a good idea to label each wire.

A problem came up in trying to figure out how to mount the IR detectors and emitters because their diameter is larger than the height difference between a nickel and a quarter. Fiber-optic cable solved the problem; its diameter is comparable to the height difference. Fiber-optic cable is available from several sources; two of those are given in the Parts List.

Prepare the IR detectors and emitters as shown in Fig. 4. Twist and solder a length of wire onto each lead, and cover with heat-shrink tubing. Using a sharp blade, cut a length of fiber-optic cable, leaving as flat a face as possible. Hold a match to one end of the fiber-optic cable for a moment; a lip will form around the insulation. Now, using wider heat-shrink tubing, affix the piece of fiber-optic cable to the end of the assembly with the insulation lip facing the component as shown.

It's best to build the coin chute now. Don't waste time trying to get the circuit to work with a test fixture, since you'll only have to build the chute anyway and it's very hard to get the detectors to work without the chute.

The chute was made from two slats of wood with a narrow strip of wood—a little wider than a quarter—acting as a separator and forming the bottom. All three pieces are held together with screws, and the holes in the bottom strip of wood are slotted to allow for fine coin-height adjustments (see Fig. 5). You can add an adjustment screw to the top of the coin slot to decrease the width of the slot if the sensors seem to be somewhat insensitive.

Once cut to size, the pieces of wood should be painted black. Stack the wood pieces on top of each other as shown in Fig. 6, and tape them together to keep them stable as you drill so that the holes will match up perfectly. Use Fig. 7 as a drill guide, and remember to slot the holes in the narrow piece.

The sensor holes should match the
(Continued on page 85)

The Birth of the Vacuum Tube

BY JAMES P. RYBAK

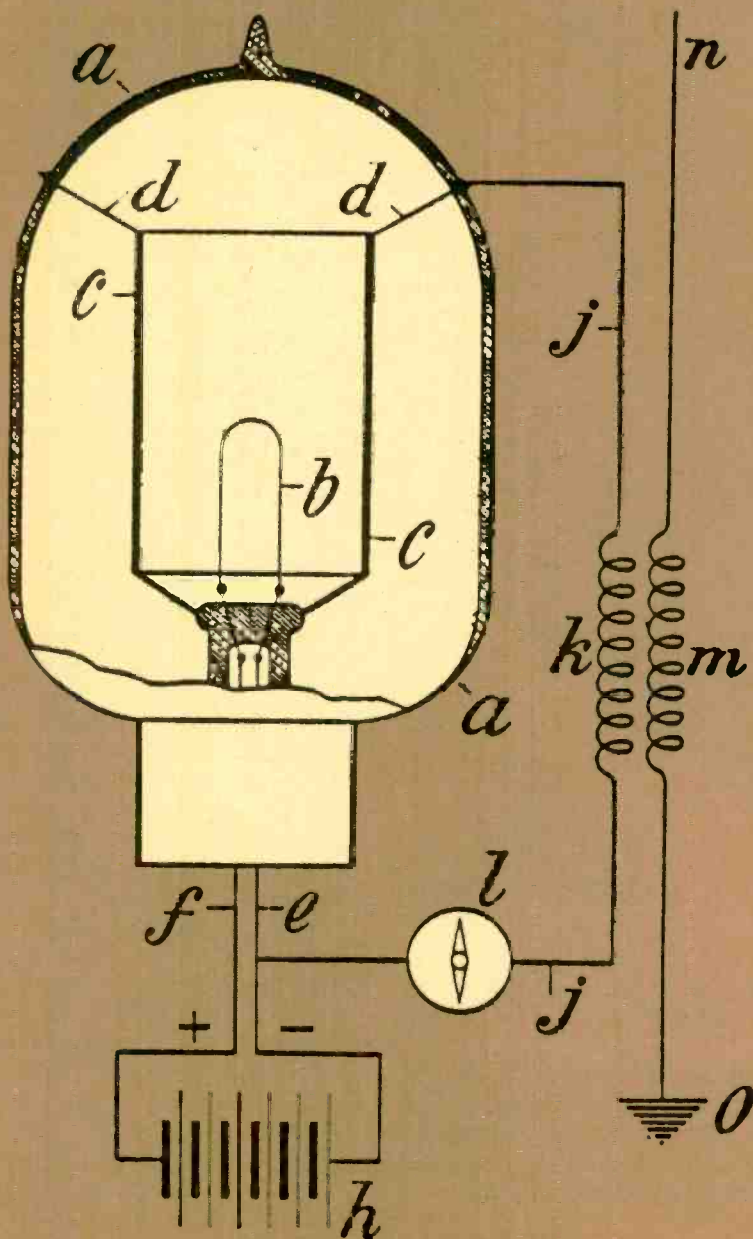

Lee de Forest claimed he got the idea for his triode "audion" from watching a gas flame burn. John Ambrose Fleming thought that story was just so much hot air.

Wireless telegraphy held exciting promise at the beginning of the twentieth century. People with imagination could see the potential that the remarkable new technology offered for worldwide communication. However, no one could have predicted the impact that the soon-to-be-developed "oscillation valve" and "audion" wireless-telegraphy detectors would have on electronics technology.

Background. Shortly before 1900, Guglielmo Marconi had formed his own company to develop wireless-telegraphy technology. He demonstrated that wireless set-ups on ships could exchange messages with nearby stations on other ships or on land.

The Marconi Company had also transmitted messages across the English Channel. By the end of 1901, Marconi extended the range of his equipment to span the Atlantic Ocean.

It was obvious that telegraph lines with submarine cables and their inherent limitations would soon disappear. Ships at sea would no longer be isolated. No location on Earth would be too remote to send and receive messages. Clearly, the opportunity existed for enormous financial gain once reliable equipment was available.

To that end tuned electrical circuits were developed to reduce the bandwidth of the signals produced by the spark transmitters. The resonant circuits were also used in a receiver to select one signal from among several transmissions.

Simple design principles for resonant antennas were also being explored and applied. However, the sensitivity and reliability of the devices used to detect the wireless signals were still hindering the development of commercial wireless-telegraph networks.

Inadequate Detectors. The detector most commonly used at the turn of the century was the coherer, developed by

Edouard Branly in 1890. Basically, the coherer consisted of a hollow, non-conducting tube filled with metallic filings. Normally, the coherer acted as an open circuit. However, when a voltage produced by a spark discharge was applied, the coherer became conductive and remained that way until the filings were shaken loose by tapping the tube.

The coherer was not a very sensitive or reliable detector and the tapping required between each telegraphic dot or dash meant that messages could not be transmitted very rapidly. Despite its limitations, the coherer was the best detector of wireless signals available at that time.

Marconi realized the need for an improved detector if his company was to attain its goal of establishing a worldwide wireless-telegraphy network. Already, he had modified the initial design of the coherer to increase its sensitivity and reliability as much as possible. Still, the coherer had too many fundamental limitations to ever become a satisfactory detector in commercial use, particularly on board a ship rolling in a stormy sea.

In 1902, Marconi developed and patented two types of magnetic detectors that overcame the need for mechanical tapping. They permitted messages to be sent at a more rapid rate than did the coherer. One design utilized a constantly rotating magnet, while the other employed a rapidly moving endless belt of iron wire.

Both magnetic-detector designs involved more mechanical complexity than was desirable and provided less sensitivity than was needed. The Marconi Company, however, did use magnetic detectors in its network of telegraph stations for many years until a better detector was available.

Which brings us to Lee de Forest. He also had dreams of establishing a commercially successful wireless-telegraphy company of his own. He, too, realized the need for a more sensitive and reliable detector and spent several years trying to develop a workable telegraph receiver, or responder, based on what was called the "anti-coherer-detector" principle.

Lee de Forest had gotten his idea for the detector from reading a report of a laboratory experiment that had taken place in Germany. The device initially consisted of a small piece of metal foil cemented to a glass plate. The foil was slit with a razor, a drop of water was

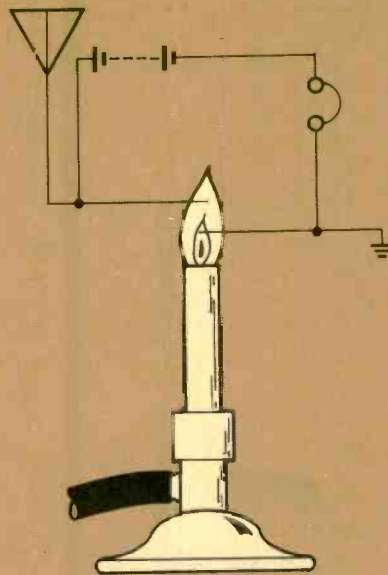

Fig. 1. Lee de Forest's first flame detector incorporated only one battery and needed no filament current.

placed across the slit, and electrical connections were made to the ends of the foil. The water drop acted as a short-circuit in the absence of a signal and as an open-circuit when a signal was present.

Tapping was not required between each telegraphic dot or dash, but the drop of water became electrically decomposed and unable to serve its function after a minute or two of use due to the minute electrical currents that flowed through it.

Lee de Forest refined the basic design and tried numerous substances as a replacement for the water drop. He never succeeded in producing a truly reliable anti-coherer detector for his telegraphic responder, or "sponder" as he called it.

However, Reginald Fessenden developed a sensitive fluid-based detector in 1902, which he called his "liquid barretter." Because it utilized a fine wire making shallow contact with a liquid (acid) surface, the barretter was not suited for shipboard use. Fessenden's patent on the barretter was also an obstacle to its commercial land use.

Both the Marconi Company and de Forest continued the search for a better detector. Their goals were the same and their searches led each to virtually identical thermionic devices by following what de Forest claimed were totally different approaches. The story of the development of the thermionic vacuum tube that follows clearly demonstrates how most significant advances

do not occur overnight and usually involve the efforts of more than one person.

Edison Lights the Way. Thomas Alva Edison contributed substantially to the development of the thermionic diode through his work with the incandescent lamp. In 1879, he had produced a practical lamp with a carbon filament that operated on DC.

After each lamp had operated for a while, Edison noticed that a black deposit of carbon formed on the inside of the glass envelope. The carbon seemed to be coming from the negative side of the filament, since that was the side that always burned out. The deposits appeared everywhere on the inside of the envelope except where the positive end of the filament blocked the flow of carbon particles, leaving a clear line or "shadow" of the filament on the glass.

Since the carbon particles obviously came from the filament, Edison wondered if they might be electrically charged. He hoped that there might be a way of preventing the deposits from occurring and reducing the light output of the lamp.

Edison found that a current could be measured by a galvanometer connected between a wire electrode inside the bulb (but not touching the filament) and the positive end of the power supply. However, no current could be measured when the galvanometer was connected between the electrode and negative pole of the power supply.

This unidirectional current indicated that the current producing particles were negatively charged. Edison assumed the negatively charged particles were carbon particles. The flow of electrons that he was actually measuring would not be "discovered" until 1897 by J.J. Thomson.

Edison soon replaced the wire current-collecting electrode with a flat metal plate located between the legs of the filament. The plate proved to be an even more effective current collector.

Edison noted that the current flowing to the metal plate varied with the temperature (brightness) of the filament and, hence, with the applied DC voltage. He proposed using the modified incandescent lamp as a voltage-measuring device and obtained a patent on the design in 1883.

Unfortunately, being a confirmed be-

liever in the use of DC voltages only, Edison never connected an AC voltage to the current-collecting electrode and never placed any greater significance on the unidirectional current flow he had observed. Hence, he never realized that his device could have been developed into the first thermionic rectifier diode. Nonetheless, Edison's device was later to have a significant influence on the development of the thermionic rectifier in England by John Ambrose Fleming.

William Preece, Chief Engineer for the British Post Office, came to America in 1884 to attend the International Electrical Exhibition in Philadelphia. While there, he saw some of Edison's inventions on display. Before returning home, Preece visited with Edison and obtained several of the incandescent lamps with the added metal-plate electrode.

Preece experimented with the modified lamps for a while. He was the first to use the term "Edison effect" to describe the thermionic emission from the filament that resulted in unidirectional current flow to the metal plate. Later, Preece apparently gave the lamps to the Edison Electric-Light Company of London.

Fleming Enters the Picture. John Ambrose Fleming would be knighted "Sir Ambrose" almost a half-century later by King George V for a lifetime of scientific achievement. In 1884, however, Fleming was a consultant to the Edison Electric-Light Company of London.

Fleming had noted the same darkening of incandescent lamps and the formation of a filament "shadow" observed by Edison. His initial experiments with the newly obtained modified incandescent lamps confirmed the other findings of Edison and Preece as well. However, Fleming made an additional and important contribution: he explicitly reported the unidirectional flow of current in an 1896 scientific paper.

He also observed that current flowed when the filament was heated by an AC voltage with a frequency between 80 and 122 cycles per second. With an AC filament voltage, it obviously didn't matter which side of the filament was connected through a galvanometer to the current-collecting electrode.

Fleming had thus come close to recognizing the potential use of this modified lamp as a rectifier of alternating

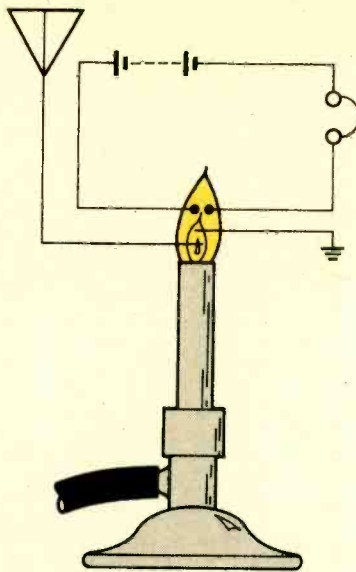

Fig. 2. The second style of flame detector had a local battery circuit which allowed it to operate better.

current. However, at the time, he never suggested this or any other practical use for the device.

Fortunately for the future development of radio technology, Fleming was hired in 1899 as a scientific adviser by the Marconi Wireless Telegraph Company. He spent the first several years developing better transmitters and power-generating equipment for them. In 1904, Fleming was assigned the task of developing an improved detector. A suitably sensitive and rugged detector was still sorely needed by the Marconi Company.

Fleming soon decided to try one of the modified incandescent lamps as a detector, remembering its ability to produce unidirectional current flow from low-frequency AC. The question in Fleming's mind was whether or not the rectification effect would work at wireless-telegraphy frequencies.

An induction-coil based oscillator circuit was built to produce electromagnetic waves. A second resonant circuit was located some distance from it and was tuned to the oscillator's frequency. The second circuit included one of the modified incandescent lamps, together with a galvanometer to indicate the hoped-for rectified current.

When the oscillating circuit was activated, the needle on the galvanometer deflected, indicating rectification of the high-frequency wireless signals. Fleming had found, in that October of 1904, the wireless telegraph detector he was seeking.

He named his detector the "oscillation valve." It is important to remember that, being a diode, Fleming's device could only *rectify* oscillating currents; it could never produce them. More commonly today, we know his detector as the thermionic "valve" or "tube."

After this first wireless-detector experiment, the unheated current-collecting electrode in the lamp was replaced by a hollow metal cylinder surrounding, but not touching, the filament. Fleming immediately applied for patents on his oscillation valve in England, the United States, and Germany. The artwork at the beginning of this story is a reproduction of the drawing of the oscillation valve and detector circuit he included in his application for an American patent.

The British and American patents were granted to Fleming on September 21, 1905 and November 7, 1905, respectively. Those dates would become significant in later priority disputes.

A Flame Sparks de Forest. In September, 1900 de Forest was working in his room by gas light with his sponder one night and noticed something very strange. When he operated the key of the spark transmitter, the gas light flickered. He immediately called his assistant to observe this phenomenon and together they pondered its significance.

Their first reaction was to believe that the flickering flame represented a new type of detector action which might overcome many of the problems that plagued the sponder.

The two excited experimenters watched the flame respond to the keying of the transmitter and took detailed notes for several weeks. However, when the transmitter was moved to an adjacent room and the door was closed, the flickering of the flame stopped. It then became clear that the flame was responding to the sound waves generated by the spark transmitter and not to the electromagnetic waves.

Very disappointed, de Forest stopped the flame experiments. He later maintained, however, that the flickering flame started a train of thought in his mind that ultimately led to the development of the triode audion.

By 1903, de Forest had developed a flame detector that worked. He inserted two platinum wire electrodes into the flame of a Bunsen burner. He next connected a battery and a telephone receiver in series with the wires. One

electrode was connected to an antenna and the other to a grounded water pipe. This arrangement as it was used, is shown in Fig. 1.

Signals from the antenna changed the conductivity of the flame which, in turn, changed the amount of battery current flowing. That produced an audible sound in the receiver's headset. The flame detector actually acted as a form of relay with the wireless signal triggering the flow of current from the battery. Lee de Forest's use of the word "relay" rather than "rectifier" would be crucial in his later legal battles.

With the flame detector, de Forest was able to copy transmissions from a ship in New York harbor. Two problems were immediately obvious, however. The ability of the flame to detect the signals was affected by air currents. Secondly, the two common electrodes used for both the antenna current and the battery current resulted in a by-pass path for the signal around the flame, resulting in decreased sensitivity.

The first problem was easily solved by shielding the flame against air currents. The second problem was solved by using one set of electrodes for the antenna and ground while a second set was used for the local battery circuit. That configuration is shown in Fig. 2.

The device's patent request was signed and witnessed on November 4, 1904 and filed on February 3, 1905. The 1904 signing date was twelve days before Fleming's patent application, was filed. Those dates would become important when de Forest argued that the flame detector, and not Fleming's valve, inspired his later "audion."

Lee de Forest believed that the gases ionized by the flame produced the relay action. The flame, itself, was only the mechanism for producing the gas ionization needed. Other means of heating the gases sufficiently to produce ionization would result in the same detector action.

The best way to obtain a stable detector, de Forest reasoned, was to place the electrodes in a glass envelope and heat the gases to ionization with an external bunsen burner or by passing an electric current through carbon or tantalum filaments. Both heating techniques were tried. Lee de Forest quickly realized the advantages of filament heating.

The air inside the envelope was evacuated only to the point where the filament would not be oxidized when heated. A sodium or potassium salt was

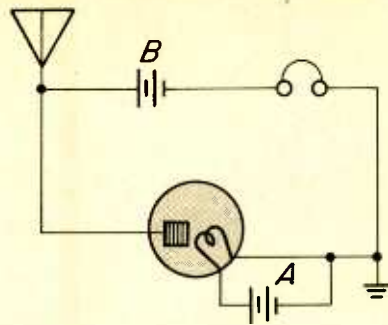

Fig. 3. Lee de Forest's diode audion detector allowed him to eliminate the flame by using a low-vacuum glass tube.

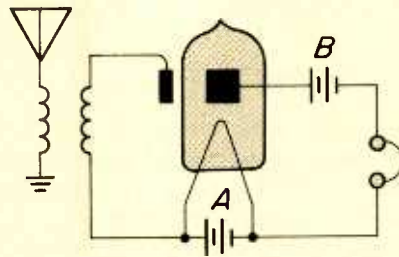

Fig. 4. The audion with external electrostatic control used a plate that was external to the tube. It was soon followed by a device with an external coil.

placed inside the envelope to produce increased ionization.

Lee de Forest filed for several patents on this two-electrode "oscillation-responsive device" (as it was called in the patent applications) during the first half of 1906. More commonly, however, de Forest referred to the device as his "audion." The patents were awarded before the year's end.

Initially, the two electrodes in de Forest's audion were both filaments. Soon he eliminated the need for one battery by replacing one of the filaments with an unheated plate electrode. Lee de Forest now found that the polarity of the "B" battery in the circuit (shown in Fig. 3) appreciably affected the operation of the detector.

At this point it started to become clear that the Edison effect (thermionic emission) was involved in the operation of the audion. Prior to that time, de Forest had been convinced that the ionized gases in the tube were responsible for its behavior.

This single-filament detector, which de Forest also called an "audion," was superior to anything he had used previously. He received a patent on this device in the later part of 1906. The fact that this two-element audion was virtually identical to Fleming's patented valve was of no concern to de Forest.

He later would argue that substantial differences existed between the two devices.

A Control Element is Added. Lee de Forest was convinced that his audion's sensitivity as a detector could be increased even more. Remembering the improvement the separate local circuit had made in his flame detector, he added an additional plate external to the glass envelope as shown in Fig. 4.

The external plate provided what de Forest called "electrostatic control" of the detector. He then built a similar device with a coil on the outside of the glass which produced "electromagnetic control."

The next audion de Forest built had two separate internal plates. The plates were located on opposite sides of the filament and the second plate was used as the control element. Lee de Forest was amazed with the performance of this audion. A patent application on this first triode audion was filed on October 25, 1906. Lee de Forest was granted the patent on January 15, 1907.

It did not take de Forest long to realize that the control element should exert an even greater effect if it were located between the filament and plate. Obviously, a solid control element would block the flow of current. A zigzag wire arrangement was used and was eventually developed into the "grid" found in today's tubes.

The three element "grid audion" proved to be a much better detector. The circuit in Fig. 5 is the one de Forest included with his January 29, 1907 grid-audion patent application. The patent was granted on February 18, 1908.

And that's how Lee de Forest's most famous and important audion was "born." It, like the earlier audions, was a low-pressure device. Therefore, calling it a "vacuum tube" is not correct.

It is important to realize, however, that the potential usefulness of the three-element (triode) audion was not immediately apparent. Few besides Lee de Forest initially were impressed with its operation as a detector.

The triode audion was expensive and its filament life was relatively short. The bulky and expensive batteries it required were another drawback. In contrast, the comparatively inexpensive crystal detectors, developed at approximately the same time, did not require batteries. The crystal detectors had added advantages in that they

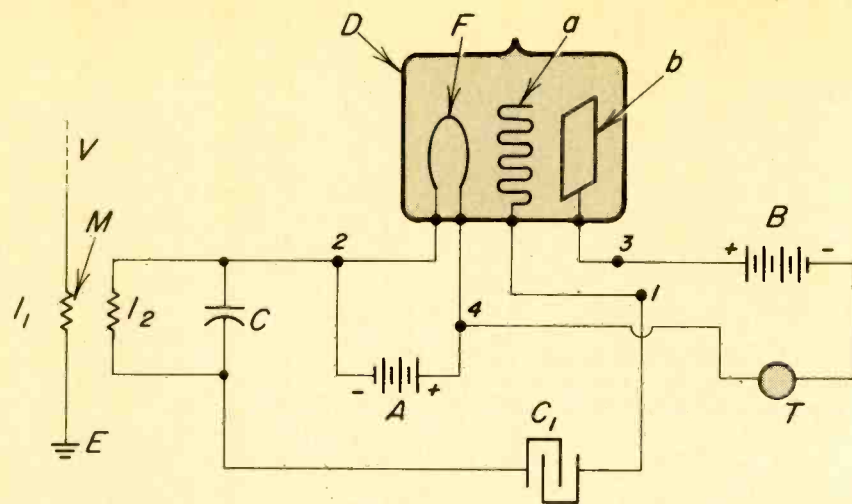

Fig. 5. Lee de Forest's grid audion was the first grid-containing low-vacuum tube. Multiple-electrode tubes were soon to follow.

were more reliable, simpler to operate, and virtually indestructible.

In his 1906 patent application, de Forest called the original triode audion a "device for amplifying feeble electric currents." The techniques necessary for using it as a true amplifier, however, would not be developed for almost six years.

Patent Problems. Other problems existed for de Forest, too. The Marconi Company of America owned the patent on Fleming's valve and maintained that de Forest's two-element (diode) audion infringed on that patent. Further, Lee de Forest's triode audion concept was based on his diode audion. Consequently, de Forest's right to manufacture and sell the triode audions was not without dispute.

Lee de Forest maintained that the idea for his diode audion came from his earlier flame audion, not from Fleming's valve. The records show, however, that de Forest knew about the Fleming valve and had some copies of it made for his own experiments late in 1905. In fact, one of de Forest's patent applications (for what he called a "static valve"), filed on December 9, 1905, refers to Fleming's valve by name. That patent application was filed several months before he applied for patents on his own diode audion.

A further claim by de Forest was that the use of a battery in the plate circuit of his diode audion distinguished it from Fleming's valve. He also argued that Fleming's valve was only a device for rectifying high-frequency wireless signals. Lee de Forest maintained that, unlike his own audion (which he still

considered to be a relay), Fleming's device could do nothing to increase the effective energy of the signals.

The explanation de Forest provided concerning how his detector functioned differently from Fleming's was wrong. Both Fleming's and de Forest's devices were rectifiers, virtually identical in appearance and operation. The battery de Forest used in the plate circuit of his audion put a positive bias on the plate, but was not necessary for its operation as a rectifier. Lee de Forest's device was not, in any sense of the word, a relay.

While the legal position of the de Forest diode and triode audions was not very clear, that of the Fleming valve also was in question: Strictly speaking, Fleming did not "invent" the oscillation valve.

Books and Articles.

"Lee de Forest and the Triode Detector," By Robert A. Chipman, *Scientific American*, March 1965, pp. 92-100.

Saga of the Vacuum Tube; By Gerald F.J. Tyne, Indianapolis, Howard W. Sams & Co., 1987.

70 Years of Radio Tubes and Valves; By John W. Stokes, Vestal, N.Y., The Vestal Press Ltd., 1982.

The Continuous Wave: Technology and American Radio; By Hugh G.J. Aitken, Princeton, N.J., Princeton University Press, 1985.

"The First Electron Tube"; By George Shiers, *Scientific American*, March 1969, pp. 104-112.

"The Life and Work of Lee de Forest"; (in 14 Parts), Edited by W.B. Arvin, *Radio News*, October 1924-November 1925.

He merely used the incandescent lamp Edison had modified and patented in 1883 for a new purpose—the detection of wireless signals. Edison's prior patent, together with some very broad claims in Fleming's patent application concerning the rectifying capabilities of the oscillation valve, made Fleming's legal position questionable.

As the markets for both Fleming's valve and de Forest's audion were initially relatively small, no resolution of the legal questions was pursued. The Lee de Forest Radio Telephone Company sold wireless equipment that incorporated grid-audion detectors to the U.S. Navy. It also sold the spherically shaped grid audions for commercial use. The Marconi Company used the Fleming valve, modified to include a grid similar to that in de Forest's triode audion, in its own network of wireless stations.

Amplifiers and Oscillators. In 1911, de Forest was hired by the Federal Telegraph Company. The company's goal of recording high-speed telegraph signals for later decoding created the need to increase the energy of the received signals. Lee de Forest now worked to get the triode audion to amplify at audio frequencies.

Lee de Forest and his co-workers achieved amplification in 1912 by using audio-frequency transformers to couple the signal to and from the audion. They also found it extremely beneficial to reduce even further the already low pressure inside the audion envelope. In time, the audion's spherical shape would become tubular and the generic name for this and similar devices, very appropriately, would become the "vacuum tube."

In the course of developing the amplifier, de Forest found that his circuit oscillated, a phenomenon commonly encountered by amplifier builders even today. The discovery that the triode also could be used as an amplifier or as an oscillator established it as a truly important electronic device.

Lawsuits and Stalemate. The Marconi Wireless Telegraph Company of America sued Lee de Forest and the Lee de Forest Radiotelephone and Telegraph Company in 1914 for infringement of its Fleming-valve patent. Lee de Forest and his company filed a countersuit for infringement of their triode-audion patents by the Marconi Company.

(Continued on page 85)

GIZMO

MAY 1991

A CHRONICLE OF CONSUMER ELECTRONICS

VOLUME 4,
NUMBER 5

Getting the Big Picture

SHARPVISION XV-100 LCD PROJECTION TV SYSTEM. Manufactured by: Sharp Electronics Corporation, Sharp Plaza, Mahwah, NJ 07430-2135. Price: \$3495.95.

What do you do if you're stuck at a ski house in Vermont for a long weekend with six adults, a bunch of kids, and no snow? You could cope by imbibing prodigious amounts of alcohol. But, if you're lucky, someone in each age group will have smuggled their favorite videotapes in along with their ski gear, and one of the grownups will have brought along a projection TV on which to watch them.

How, you might ask, could you possibly fit a projection-television system in a Toyota Corolla already jammed full of skis, boots, warm clothing, and four days' worth of food, and a couple of skiers? Without too much trouble—if you happen to have the *SharpVision XV-100 LCD Projection TV*. It bears little resemblance (except, perhaps, in the general price range) to either those huge rear-projection sets with 32- to 52-inch diagonal screens, or the standard three-tube front projectors that require precise setups. The LCD technology, which we'll explain later, is the start of a whole new ball game. Weighing in at just over 31 pounds, the XV-100 projector and the cable required to connect it to your TV or VCR fit in an optional carrying case that's about the size of a standard cooler. There's no need to bring along the screen; any bare light-colored wall will do just fine.

We originally thought of the SharpVision's portability as a pleasant perk, but not a very important feature. After all, wouldn't most people want a permanent installation in their living room or media room?

We soon realized that the same features that make the projector easy to move around also make it adaptable to rooms of almost any size, and installations of dif-



CIRCLE 50 ON FREE INFORMATION CARD

ferent levels of complexity. The projector's zoom lens allows you to quickly adjust the picture size. (When the projector is placed about 6½ feet from the screen, the picture range is 20 to 50 inches diagonally; at 15 feet away, the range is from 50 to 100 inches.) The XV-100's small size allows you to set it up in a relatively unobtrusive, permanent position—for instance, on a shelf, in an audio/video cabinet, or on a pedestal or table—or to store it in a closet when it's not being used. When it's time to watch TV, the projector simply can be set on a coffee table and be connected to the video source with a single wire. (Sharp also offers a ceiling-mount projector.) Several screen options exist. The standard system comes with a portable, adjustable screen mounted on a tripod stand. Retractable wall- or ceiling-mount screens, available in spring-roller or motor-driven versions, can be hidden behind valances to be virtually invisible when not in use.

Our ski-house hookup was the most basic: We connected the included cable to the VCR's video-out jack and one of the SharpVision's video-in jacks and removed the large painting hanging behind a couch, effectively creating a screen from the now-bare wall. The television, which was already connected to the VCR via its RF input, served as our (not very high-quality, and certainly not recommended) audio source.

Back at GIZMO headquarters, our setup got much more elaborate. The SharpVision system benefits tremendously from association with other high-performance audio and video components. In our test setup, we used a stereo amplifier, a Dolby surround-sound system, five speakers, a Hi-Fi stereo VCR, and a laserdisc player along with the SharpVision. Once all the assorted pieces were connected to each other, however, hooking up the SharpVision still required only that one cable between its video input and the VCR's video out and, of course, plugging in the AC power cord. The XV-100 has two standard video inputs and one S-video input. A monitor-output jack is also provided to feed the selected signal to another video device (but it won't work with the S-video input).

The manual recommends that the projector be placed anywhere from 6.6 to 15.1 feet from the screen to obtain proper picture focus, to align the height of the lamp with the bottom of the screen, and to set the projector directly centered between the sides of the screen. (Height-adjustment screws, or legs, located on the bottom of the projector, let you adjust its height within a 4° range.) In our tests, we moved the projector to about 18 feet away, set it off to the side a bit, and had it both higher and

(Continued on page 7)

TURN PAGE FOR CONTENTS

MAY 1991

This Month In GIZMO

SharpVision XV-100 Projection TV System	pg. 1
Nolo Press WillMaker 4.0	pg. 2
AT&T Digital Answering System 1337	pg. 3
Instant Replay Caption Master 610CM VCR	pg. 4
Fosgate•Audionics DSL Two Surround Sound	pg. 5
Intermatic Electraguard Surge Protector	pg. 6
Berlitz TriLingual Translator	pg. 9
Cordless Video Light	pg. 9
Home Computer	pg. 9
Home Theater Sound System	pg. 9
Digital Noise Absorber	pg. 10
Mega Watchman	pg. 10
Vacuum-Tube CD Player	pg. 10
Vegas Dream Video Game	pg. 10
Day-Glo Cassette Keeper	pg. 11
Electronic Spelling Ace	pg. 11
LineMinder Phone-Call Screener	pg. 11
RACE Remote Key	pg. 11
Dracula's Curse Videogame	pg. 12
Interchangeable-Lens Camcorder	pg. 12
Multi-Room Audio System	pg. 12
NEC-Compatible Joystick	pg. 12

Gizmo is published by Gernsback Publications, Inc., 500-B Bi-County Blvd., Farmingdale, NY 11735. Senior Writers: Chris F. O'Brian, Teri Scaduto. Contributors to this issue: Chris Kerwin, Colin Smeeling, Susan B. Lyons. © Copyright 1991 by Gernsback Publications. Gizmo is a registered trademark. All rights reserved.

Where There's a Will, There's a Way

WILLMAKER 4.0 WILL-PREPARATION SOFTWARE. Published by: Nolo Press, 950 Parker St., Berkeley, CA 94710. Price: \$59.95

No one likes to contemplate his own mortality. We all know we've got to go sometime, but admit it, you'd really rather not think about it at all.

As unpleasant as thinking about death might be, *not* thinking about it can make life even more unpleasant for those you leave behind. We're sure we're not the only ones who have seen a family torn apart as grieving heirs bickered over who got what when the deceased didn't have a will. Unfortunately, the loss of a close family member often triggers all sorts of strange reactions among the survivors. Besides simple grief, such a loss can shift the entire dynamics of a family. On a conscious or subconscious level people tend to reexamine family relationships, and slights and grievances from the past can come to the forefront again, triggering emotional outbursts that probably wouldn't occur under any other circumstances. Having no will, or a poorly planned one, is like holding a match to that potentially explosive situation—and gives your heirs tangible things to fight over.

Doing a bit of planning while you're still alive and kicking might not soothe any of the underlying emotional wounds associated with death, but it will assure that your estate will be distributed in the manner that you feel is fair. And while it might be true that "nothing's certain but death and taxes," proper estate planning can reduce the amount of money that goes to Uncle Sam upon your demise.

Even people who understand the importance of having a will often don't get around to preparing. They might not want to pay lawyers' fees, or they might feel that their estates are not valuable enough to require a will—even without considering the lawyer's fees.

Will-making kits, consisting of legal forms that must be filled out, have been available for years. While they can be used to create a legal will for a minimum of money, there's more to creating a will than just filling out forms. You need some understanding of the laws, and a source that will give you answers to the questions that are sure to arise.

Fortunately, there is a way for the average person with no background in the law to create a legal will. *WillMaker* from Nolo Press/Legisoft makes it easy for anyone to write—and update—a will that is valid in every state except Louisiana.

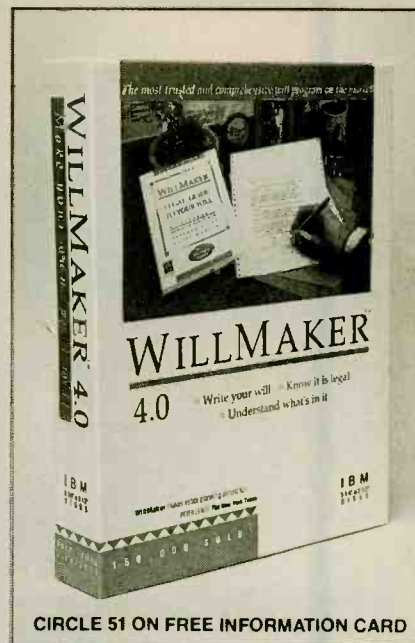

CIRCLE 51 ON FREE INFORMATION CARD

Nolo Press was founded in 1971 to publish self-help law books to show readers how to handle routine legal tasks without a lawyer. They started producing software (in partnership with Legisoft, Inc.) in 1985 with the introduction of *WillMaker*, the first program of its kind on the market. *WillMaker 4.0* is the latest release, and is available for the Macintosh and for the IBM PC (and compatibles), which is the version we examined.

Getting *WillMaker* up and running could hardly be easier. It comes on a single disk (both 3-1/2 and 5-1/4-inch diskettes are provided in the package) and a manual. The manual, although a hefty 300 pages, actually contains very little information about using *WillMaker*. The first 36 pages cover the installation and use of the program. The remaining 14 chapters cover the basics of wills and some more weighty subjects such as how to care for your children and their property, how to choose an executor, how to plan to pay debts and expenses, estate planning, and more.

What do you get when you cross a lawyer with a Godfather? An offer you can't understand. Fortunately, that joke doesn't apply to the *WillMaker* Legal Guide to Your Will. The book is very well written—even though it's written by lawyers—and makes for interesting reading. But you don't *have* to read it to use *WillMaker*.

When you run the software, you're prompted to enter all the information that's required. Help is available for all questions at the touch of a key, and, of course, the manual can be consulted for more detailed information.

WillMaker isn't the slickest program we've seen. It runs smoother than an earlier version we remember, but it still has some rough spots. For example, it's reasonable to assume that a husband and wife

(Continued on page 7)

Look, Ma, No Tape!

DIGITAL ANSWERING SYSTEM 1337.
Manufactured by: AT&T, 5 Wood Hollow Road, Parsippany, NJ 07054-2899.
Price: \$139.99.

In early 1990, when AT&T engineers first unveiled their newly designed digital-circuitry for a tape-less answering machine, company executives were quite impressed. So impressed, in fact, that they decided to spare no expense to speed up the design and manufacturing processes so that the device could hit the market by Christmas. AT&T hired frogdesign, a high-priced design firm with a reputation for meeting difficult deadlines. Late-night brainstorming sessions resulted in a design that was directly inspired by a portable CD-player that one of the designers had turned on its side to save desk space. That basic vertical concept was brought to reality in frogdesign's computer-aided design

system, which is connected to a computer-controlled milling machine. Once the design was approved by AT&T, it was time to get all the circuitry inside and make sure it worked correctly. With a few fine-tuning adjustments, the inside fit the outside, and the product—the *Answering System 1337*—was ready for mass production on schedule.

Although digital answering machines offer truly impressive advantages over standard tape machines, and are still rarities on the market, we can't call AT&T's Answering System 1337 unique on the basis of its digital technology alone. Its digital circuitry sets it apart from conventional answering machines; its truly unique, streamlined, vertical design sets it apart even from the few other digital machines on the market.

We like the aesthetically pleasing, space-saving profile of the Answering System 1337 almost as much as the convenience of all-digital circuitry. A 5-1/2-inch square, 1-1/8-inch piece rises vertically from an asymmetrical, 2-1/2-inch-deep base. The front of the vertical piece has a 2-digit LED message window, in

which appear various messages to help the user program the system and the number of incoming messages is displayed once the device is functioning. Below the LED, a curved speaker projects. It is mirrored by a twin speaker on the back of the unit. The top panel of the 1337 is devoted to the most often used function buttons; of those, the blue on/off and play buttons stand out from the gray repeat, stop, forward, memo, and delete buttons. The light in the center of the play button flashes when messages have been received. On the right and left sides of the unit are found controls for those functions that you would tend to set infrequently (or even just once), such as the security codes, the number of rings before pickup, and your outgoing announcement. Jacks for the phone line, power line, and phone set are on the bottom of the base. The device doesn't just look different, it looks *good*, and it takes up very little no space.

As much careful thought and effort went into the inside workings of the 1337 as the outside appearance. Effectively a high-speed computer designed to process speech with digital sound clarity, the device digitizes outgoing and incoming vocal messages and stores them in electronic memory. By eliminating the need for tapes and all those moving parts needed to play them, the all-digital system promises to be longer-lived and more reliable. The digitized voices sound as natural as voices recorded on tape—and never get cut off or dragged out as often happens with taped messages.

Digital technology offers several other advantages, most of them in the level of convenience. Just as a CD player immediately locates the track you select, as opposed to manually reversing or fast-forwarding a tape in a cassette player to try to find the selection you want, the 1337 gives you immediate access to the beginning of each message. If, for example, you've just listened to the three messages you received while you were out, and want to replay the second, there's no need to sit through the first message again. With AT&T's machine, pushing the play button immediately starts the first message—no time-consuming rewinding. If you don't want to hear it again right now, pressing play again instantly brings up the second message, and so on. If you *never* want to hear message one again, simply press the delete button as soon as it begins, and it is gone for good. That is especially convenient when a whole family depends on one answering machine. Each person can erase their own messages after hearing them without disturbing anyone else's messages. The 1337 will also play only new messages (once that you've never listened to before) when you hold down the play button instead of just pressing it.

The digital technology lets you stop on a dime. When you hear an incoming mes-

(Continued on page 7)

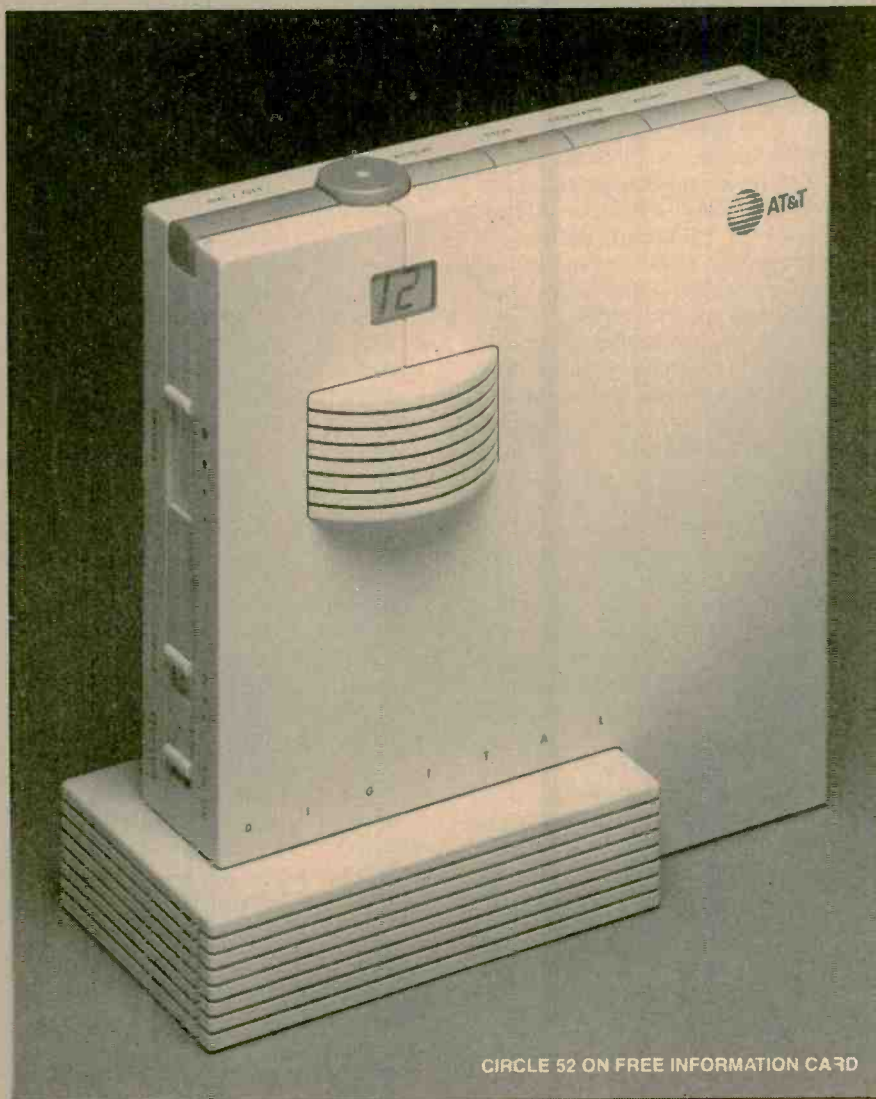

CIRCLE 52 ON FREE INFORMATION CARD

Capturing Captions

CAPTION MASTER 610CM CLOSED-CAPTION VCR. From: Instant Replay, 2601 South Bayshore Drive, Suite 1050, Coconut Grove, FL 33133. Price: \$795.

Let's face it: Television is such an intrinsic part of our lives that most of us take it for granted that 24 hours a day, 365 days a year, we can turn on the tube and see and hear our favorite programming.

Yet even now, when virtually every home in America has at least one television set, not everyone has the ability to enjoy that medium. Those who are blind can only listen to the soundtrack. And hearing-impaired individuals are limited to the visuals—unless they have access to closed captioning. Similar to subtitles on a foreign film, captions provide a printed version of the dialog in a video show. Captions, however, appear as white letters upon a rectangular black background, so they are more legible than most movie captions. And sound effects are included along with the dialog, so that a hearing-impaired viewer can more fully experience the show.

Closed captioning has been around for more than a decade. Thanks primarily to the efforts of the National Captioning Institute (NCI)—a non-profit organization based in Falls Church, VA, that has worked since 1979 to make closed captioning a viable communications medium—more than 400 hours a week of broadcast television (cable, network, and syndicated shows) have closed captions. Most of that programming is shown during prime time—in fact, the entire prime-time line ups of ABC, NBC, and CBS are closed-captioned. Inroads are being made in daytime programming—including sporting events, soap operas, talk shows, and news programs—and commercials, and NCI has done the captioning for more than 2200 home video titles. (NCI is responsible for approximately 80% of all captioning done for broadcast television and 95% of all video-cassette movie captioning.)

So, why can't you see any of those captions when you're watching television or videos? A special decoder is required at the viewer's end to extract the captioning from where it is stored (on line 21 of the vertical blanking interval between pictures, like teletext), convert it into characters, and insert those characters into the video signal at the appropriate time. NCI makes the only closed-captioning decoder on the market, and sells it for less than \$200. The decoder has a few drawbacks, which make it a less-than-perfect solution.

The future of closed captioning looks rosy indeed, however, since the recent passage of the Television Decoder Circuitry



CIRCLE 53 ON FREE INFORMATION CARD

Act of 1990. The bill, strongly backed by NCI, makes it mandatory for television manufacturers to include closed-captioning decoder circuitry in all larger-than-13-inch-screen sets built after July 1, 1993. NCI is hoping to co-produce such a set with an as-yet-undisclosed major manufacturer, and Zenith (which already manufactures teletext TV's) is planning to beat the crowd by offering closed-caption sets some time this year.

In the meantime, there is an alternative to hooking up a separate decoder. *Instant Replay* has introduced the *Caption Master 610CM*, a VCR that incorporates an NCI closed-caption-decoder module. Eliminating the decoder "middleman," the Caption Master connects directly to your TV. Two switches on the back of the unit provide several viewing options. The three-position upper switch allows you to choose TV, which is standard television with no captioning; CAP, which also shows the captions on any program that contains them; and TXT, which superimposes a translucent "blackboard" on which text messages appear whenever they are sent by the TV station. Not much is on TXT, except on ABC, which provides a programming guide to ABC shows that have closed captioning, and some public broadcasting stations, which provide news reports. The two-position lower switch allows you to switch between two channels, C1 and C2, of closed captions. To date, virtually all captioning appears on C1. In some midwestern states, farm reports and other information of local interest appears on C2. For general use, the switches can be left set at CAP and C1. In that configuration, any programming—broadcast or prerecorded—that contains captions will display those captions.

Quite frankly, we were astounded at the scope and quality of the captioning. Besides the dialog, the captioning lets the viewer in on all the background sounds—

when a phone or doorbell rings, a baby cries, a horn honks, etc.—that might influence the plot or the action. Even the lyrics to the theme songs were included, preceded by little musical notes. The captions don't follow the script word-for-word, but are gracefully edited when needed so that the meaning and feeling of the dialog comes across, yet the picture isn't obscured. According to NCI, the captioning process, which involves viewing the program, adding trial captions, and then repeatedly editing until all the captions accurately follow both the dialog and the action, costs about \$1500 to \$2000 per hour of programming. The final result is a show that provides a full, satisfying viewing experience—without sound.

The truly amazing shows are those that are recorded—and captioned—live and in real time. Those include sports events, news shows, and talk shows. During a football game, for instance, the sportscasters' banter appears in closed captions in between plays. (There are no captions while the clock is running.) Those guys talk fast! Of course, not every word is captioned, but enough is there to give viewers a good idea of what they're saying. Live captioning is made possible with an on-the-scene, computer-assisted stenographic machine. A highly trained court stenographer, who has also gone through an intensive captioning training program, "sits in the hot seat." That person "strokes phonetically" at a rate of 250 words per minute. The computer translates the phonetic input to words and transmits those words over the phone lines to the television station, where they are broadcast to our homes as captions.

All of that is accomplished with only a 3- to 4-second delay—and no proofreading. That can make for some interesting bloopers. On a recent Oprah Winfrey show dealing with sexual discrimination in the

(Continued on page 8)

Hear and Around

FOSGATE•AUDIONICS MODEL DSL TWO SURROUND PROCESSOR. Manufactured by: Fosgate•Audionics, P.O. Box 70, Heber City, UT 84032. Price: \$1299.

As the home theater becomes more popular, more small-screen TV owners—and these days, a small screen is anything under 25 inches—are being exposed to the idea that watching TV can be more than sitting across the room looking at a little box. For example, it's difficult to get through an evening of watching TV without seeing Tommy Smothers brag about how he owns the "theater."

Most people assume that the first step to turning their den or media room into a home theater is to invest in the largest-screened TV they can afford. We disagree! We've found that good sound can do more to make you part of the action than a large screen. Even a 25-inch TV can come alive when it's accompanied by a quality surround-sound system.

If you've never experienced surround sound, you might think we're exaggerating. Back a few years ago, we thought that it was all just hype, too. After all, we had seen several movies recorded in Dolby Stereo and were less than impressed. We're *still* generally unimpressed with the quality of the sound in most theaters we visit. But the first time we tried surround in our homes, we were *very* impressed. And the first time we tried the *Fosgate•Audionics model DSL Two*, we were even more impressed!

The feature we like best about the DSL Two is its flexibility. Eight different surround modes are provided to best match the audio or video program source. One of the modes is Dolby Pro Logic, the ultimate in Dolby Surround processing. Unlike standard Dolby Surround, which is more or less a passive decoding system, Pro Logic decoders contain active circuitry—known as steering logic—to sense the direction of soundtrack dominance and increase the gain in the appropriate channel or combination of channels so that the sound comes from the direction that it should come from. Although, by definition, only one sound can be dominant at a time, rarely does a movie soundtrack consist of only one sound. A Pro Logic decoder, therefore, must be able to time-division multiplex. That is, it must be able to correctly steer one source, then give attention to the next source, and then the next, without its switching actions being audible to the listener.

The DSL Two derives its name from what the manufacturer calls Digital Servo Logic. Fosgate•Audionics' proprietary

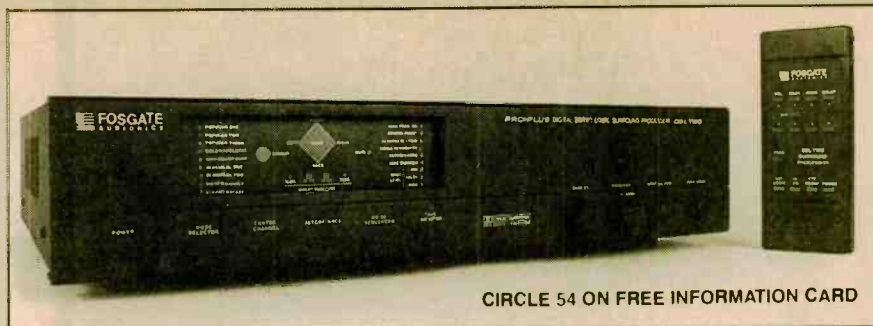

CIRCLE 54 ON FREE INFORMATION CARD

logic-steering system that is claimed to be 10 to 100 times faster than any other logic steering-type surround processor. It not only accurately recovers the Dolby Surround channels encoded on many videotapes, it is also claimed to be able to accurately recover the directional and spatial information from conventional stereo sources. (That seems like a bit of an exaggeration to us. After all, most stereo recordings these days are mixed to the point where directions and spaciousness are completely artificial. We do admit, however, that it sure *sounds* like it's doing what they claim!)

Setting up the DSL Two can be relatively easy—but it doesn't have to be. With ten different audio outputs (Left, Right, and Center Front Channels; Left, Right, and Mono Subwoofer outputs; Left and Right Side channels; and Left and Right rear channels) your speaker setup can get quite complex—and expensive. For most of us, however, ten speakers aren't necessary. The minimum setup requires two front speakers and two surround speakers. A built-in amplifier can be used to power the surround-channel speakers (or it can be used to amplify any two outputs, as chosen with two small patch cords on the rear panel of the processor).

The other outputs will require separate amplifiers, and they can be added at any time in building-block fashion. We would recommend adding a subwoofer amplifier and speaker, and front-center amplifier and speaker as the logical way to upgrade from a 4-speaker system. For very long rooms, side channels can be added to eliminate the discontinuity between the front and rear portion of the sound field. They are truly "fill" speakers, and should be part of the final upgrade.

Speaker placement is critical for good surround-sound reproduction. For proper reproduction, the sound from the surround speakers should reach your ears between 16 and 40 milliseconds after the sound from the front speakers. In small rooms, it's difficult to get the surround speakers far enough away for that to happen. The DSL Two makes speaker placement much easier thanks to the incorporation of Dolby Time Link, which delays the surround channel sound by user-selectable times of 16, 22, 28, and 32 milliseconds.

Setting the levels of the front and surround speakers can be tricky without some sort of reference, and it's rare that two people agree when the setting is correct. The DSL Two makes the setting easy—and eliminates the arguments—by providing a pink-noise source. A push of the Noise Sequencer button sends a pink noise signal to each speaker for about two seconds to allow for equal adjustment.

An Autobalance control can be used to automatically adjust the left and right input levels to achieve the maximum separation between the front and surround channels, although a manually adjusted Input Balance control can be used instead. A Bass EQ control provides up to 18 dB of boost at 40 Hz to the left front, right front, and subwoofer channels. Another rotary control, Panorama, lets you adjust the stereo stage width. The sound can be made to seem to come from beyond the front speakers, or from a narrow area between them.

We think that a better name for the DSL Two might have been the DSL Eight because of the eight different surround modes offered. We weren't able to determine a "best" mode because our preference depended on the source material. Three "Popular" modes are designed primarily for listening to music, and offer slightly different listening perspectives. Two "Classical" modes put you either close to the performers or in the middle of a concert hall. A Dolby Pro Logic mode is, of course, ideal for movies, and a Movie Surround mode promises to—and sometimes does—do an even better job on Dolby-encoded material. Finally, a Monophonic mode creates synthesized stereo surround from a mono audio source. Comparing the different modes, and choosing the one most appropriate for the source you're listening to, is easy because the supplied remote control can be used to switch from one mode to the next.

We were somewhat surprised that we liked using the DSL Two. We expected to enjoy using it with our video system. We didn't expect to enjoy using it when listening to music. We generally abhor listening to anything that is "mono processed for stereo" and find that most "enhancers" and soundfield processors create effects that quickly become tiring and that can at best be described as sounding artificial.

(Continued on page 8)

Power Happy

ELECTRA-GUARD CIRCUIT BREAKER PANEL PROTECTOR. Manufactured by: Intermatic, Intermatic Plaza, Spring Grove, IL 60081. Price: \$79.95.

As much as we like digital electronics, we'll admit that we don't like everything about it. Digital clocks are more difficult to set than their analog counterparts, although we guess that their accuracy makes up for that. Stereo systems with digital memory are nice, until the power goes out and your memory goes out with it. Those problems, however, are more design problems than inherent problems. We've seen some digital clocks that were designed to be—and actually are—very easy to set. We've also seen stereos with battery backup or with some other means of making the memory non-volatile. There is one problem, however, from which *all* line-powered digital-electronic devices suffer: susceptibility to damage from power-line surges.

Power-line surges are momentary increases in power-line current. They occur too quickly to trip circuit breakers, and in the past, they could be ignored. These days, however, it's difficult to ignore power surges because they can cause havoc with electronic devices, either destroying them outright or reducing their life span. Surges

can be caused by a number of things, including lightning strikes on power lines, large appliances being turned on and off, and power-company load switching. Far from being rare, it's estimated that you're hit with more than 5 surges each *day*! Fortunately, most of those surges are relatively small and don't cause any damage. But as most everyone has experienced, power surges can kill your electronic equipment.

Fortunately, there are ways to protect your electronic devices. Here at **GIZMO**, our computers are, of course, plugged into surge protectors, as is our main audio/video system. But we have gizmos all over the place! We'd need outlet protectors in every room if we wanted to be sure that all of our electronics—including our digital clocks, answering machines, telephones, and microwave oven—were protected. To be honest, we live dangerously—or we did until now. No, we didn't get a surge protector for each outlet in the house. We got a surge protector for *all* the outlets in the house: that is, we got the Electra Guard 240RC "Whole-Home" protector.

The 240RC mounts at the circuit-breaker panel box and must be connected across the AC power lines. If you've ever installed a circuit breaker, you can probably handle the installation of the 240RC. If you haven't, it might be a good idea to have a professional electrician install the protector, even though the installation is easy—about a 5- to 10-minute job.

The first step is to understand how to work around potentially dangerous voltages. On most circuit-breaker boxes there is a master circuit-breaker. You should start by turning that breaker off. That disables the rest of the box (not to mention your house). Now you can remove the front panel with relative safety.

Whenever we do any work at our service panel, we stand on a sheet of plywood (to insulate ourselves from ground) and always keep one hand in our pocket (to eliminate the possibility of creating a current path). For the relatively simple job of installing a circuit breaker, that might seem extreme, but it isn't—it's far too easy to make a mistake. (We should know; we make lots of them.)

When you're ready to begin the installation, you must turn off the main circuit breaker and remove the trim panel from the panel box. Then you have to remove a knockout through which the protector's four wires and mounting stud will pass. The mounting stud is tightened to the panel with a nut, and the wires are routed to their respective connections. The green wire goes to the ground bus bar (or to the neutral bus if your box doesn't have a separate ground bus), the white wire is connected to the neutral bus bar, and the two black wires are connected to two separate circuit breakers.

Picking the two circuit breakers correctly is important for full protection. The two wires must be connected so that they are across the full 240-volt AC line entering the house. (Don't forget: Even though residential service is commonly thought of as 120-volt service, the incoming line voltage is 240 volts. The three-wire service includes a neutral wire, and two lines at 120 volts with respect to the neutral, and at 240 volts with respect to each other.)

The manual (a folded sheet of 8½×11 inch paper) that comes with the surge protector does a reasonable job of explaining how the hookup is done, with one major exception: A figure illustrating how the hookup is done shows the hot wires connected to breakers that are on top of one another—that is, on the same side of the incoming line—rather than across from one another. If you install the protector following the step-by-step instructions, you'll do it correctly. If you look at the figure, you'll protect only one of the 120-volt lines in your house.

When the installation is complete, the trim panel is replaced and the main power breaker is thrown on. If all is well, two LED's on the front of the protector will glow to let you know that everything is working, and the 240RC is ready to absorb any surges that come down the line.

Now that those LED's are glowing, we can sleep a little easier at night knowing that all of our devices are protected from power surges. Our computer, however, is still plugged into its own surge protector. Why take chances? ■

CIRCLE 55 ON FREE INFORMATION CARD



THE BIG PICTURE

(Continued from page 1)

lower than the recommended height. None of those factors noticeably reduced picture quality—you do have some leeway in arranging the SharpVision system.

Once the projector and screen are in place, using the SharpVision system couldn't be easier. The main power on/off switch is located at the rear of the projector. The focus ring and zoom ring, located at the front of the projector, are conveniently placed for making the two most-common adjustments. The lamp/power button is located on top of the projector, as are lights that indicate power, lamp status, and video source. Hidden inside a door on top are less-frequently-used controls: pairs of buttons for adjusting contrast, brightness, color, sharpness, and tint; a reset button that resets to the factory-set picture; the video-source selection button; and the blue screen on/off switch, which lets you choose whether or not you want to look at a bright-blue screen when no video signals are input. The manual offers good directions on how to use each of those controls to obtain a clear picture.

And the picture certainly is clear. Sharp used three Twin-TFT (thin film transistor) active-matrix LCD panels, which deliver a total of 268,515 pixels and about 300 lines of horizontal resolution, in the XV-100. A specially developed 150-watt metal-halide bulb reaches color temperatures of 9000°K and projects clear, bright images. Instead of depending on three separate cathode ray tubes to project three beams of colored light through three lenses (which is how most other projection systems work, and which requires frequent realignment of the beams), the metal-halide bulb's light is separated into its pure red, green, and blue components by two dichroic mirrors. A second set of mirrors recombines the image's component colors into a single beam of light, right at the source. The result is an image that is permanently aligned. Three LCD panels within the projector take that beam of light and project the image onto the screen. Each of the three panels holds 89,505 separate picture elements, or pixels.

Under ideal conditions—the screen and projector properly positioned, watching a laserdisc in a darkened room, with viewers seated at a distance of about 1½ times the screen size—the effect is breathtaking. Once you add surround-sound, an adventure movie like *Indiana Jones and the Temple of Doom* can elicit gasps and screams from home viewers.

Under worst-case conditions—watching well-worn videotapes in that snow(less)-bound cabin in Vermont, during the day with no shades on the windows, with viewers sitting too close and off to the side of the screen, and with terrible audio—we were delighted to dis-

cover that even a four-year-old who had grown bored with countless viewings of *The Little Mermaid* on a small-screen set found it mesmerizing once again when played on a projection-TV system. (Two-year-olds tended to be more interested in the bright blue light generated by the projector; all the VCR-generation kids, who are rarely exposed to movie projectors, got a kick out of making shadow puppets on the wall/screen.) Once the younger kids, the mermaids, and the Ninja Turtles got put to bed (no one told them that they could have hooked up their Nintendo to the projection system), the rest of us got the chance to bone up on our skiing skills with a couple of how-to videos. Even those who'd never made it past the bunny slope got to experience expert slopes, runs full of moguls, and "hot-dog" skiing. And, despite the poor sound, "Jaws" was just as frightening shown on a wall in Vermont as it was when we first saw it in a theater. Steven Spielberg films and projection-TV systems seem to be made for each other.

As always, we have a few complaints. Because the XV-100 has no audio circuitry or tuner, your hookup must include an audio source. Chances are, you'll also want to add some upscale audio and video components to take full advantage of the system. Granted, the projector itself must be connected only to a VCR and an AC power outlet, but a really good setup requires a lot of wire juggling. The instruction manual falls short when it comes to explaining setup options. Two diagrams are provided, with absolutely no explanatory text to back them up or even headings like: "Use this setup if you intend to use such-and-such A/V equipment with your SharpVision." To inexperienced consumers, the diagrams are virtually no help. Here at GIZMO, where we spend hours every week connecting and disconnecting electronic equipment, we were able to get our test setup assembled without consulting the instruction manual. Perhaps Sharp assumes that if you're laying out \$3500 on a TV system, you either are financially able to spring for installation as well, or are a videophile who can wire up components blindfolded.

While the thought of carrying around a projection-television system wasn't one of the factors that originally attracted us to the SharpVision system, we've come to see the practicality of being able occasionally to bring a projector—one that is simple to set up and requires no realignment—to the office for a major business presentation. And, while we don't normally travel with children or spend much time in front of a TV screen when on vacation, with the SharpVision our snowless weekend was a lot of fun. We realize, now, that it can enhance family-style vacations. And now that we have the SharpVision XV-100 fully hooked up to stereo surround-sound, our Super Bowl party promises to be the best in town! ■

WHERE THERE'S A WILL

(Continued from page 2)

will want to use WillMaker to make their wills. With WillMaker, it's certainly possible to do that, but it should be easier. Instead of assigning a file name to the will when you start it, the program stores all wills under the same name, WILL-DATA.WMK. Of course you can always rename the data file to create new wills, but we'd like it handled more elegantly. One new feature that we do like, however, is that you can create a text version of the will for importation to your favorite word processor for formatting and printing. (You can also print directly from WillMaker.)

We had our resultant will reviewed by a lawyer who agreed that it met all the requirements of our state. We're not anxious to die, but at least we feel that we'd be leaving things in slightly better order now that our wishes are explicitly stated. In a sense, that's too bad—we always enjoyed a good family fight. ■

LOOK MA, NO TAPE

(Continued from page 3)

sage that says "Call me back at" you can hit the stop button while you get a pen and paper, hit play again, and the message will begin at precisely the spot you stopped. "... 555-5555." (Move quickly, though. Should you have a hard time locating a pen, after 30 seconds the system will beep four times and reset itself, and you'll have to hear the message from the beginning.)

Even those relentlessly non-technical consumers who still feel threatened by phrases like "digital technology" have nothing to fear from the 1337. It is quite simple to hook up, program, and use. As soon as the unit is plugged in, it begins to format its digital memory, with no help from the user. Recording an outgoing announcement requires simply holding down the "annc" as you speak the message in a normal voice and releasing the button when you've finished—and the other functions are similarly straightforward. The manual includes detailed, illustrated directions that are easy to follow. A quick reference card that can be kept near the device comes in handy, as does a wallet-sized card that explains all remote functions at a glance.

The Answering System 1337 provides the standard array of features—remote operation, a security code, and a personal memo that family members can use to leave messages for each other. A few non-essential niceties are also provided. One is call intercept, which stops the outgoing message as soon as any extension is lifted, so that you don't have to shout "Wait a

minute, I'm really here!" as the message plays. (If you manage to pick up an extension at the precise moment the machine picks up, as we somehow managed to do once, that feature doesn't work.) You can let frequent callers know that they can bypass the outgoing message by pressing the asterisk on their touch-tone phone as soon as it begins playing. And you can set the machine to only deliver an outgoing message without taking any messages. Virtually every feature can be operated remotely from any touch-tone phone, including changing the outgoing announcement and the security code.

Are there any drawbacks to digital answering systems? The only potential trouble spot we discovered is that the 1337 has only seven minutes total recording time (in up to 50 calls) and each message is limited to one minute. AT&T assures us that seven minutes is more time than any other digital answering machine on the market provides, and that their research has shown that the average message length is about 40 seconds.

Ever skeptical, we here at GIZMO thought the one-minute-per-message time limit seemed pretty stingy and the seven minutes total seemed very brief. Yet we realized it was difficult to speak to an answering machine—even now that we've completely overcome the aversion we felt for answering machines when they first became popular—for a whole minute. We timed some typical messages. "Hi, this is Chris O'Brian from Gizmo calling to confirm our appointment for Wednesday at 10 AM. If there's any problem, you can get back to me at XXX-XXX-XXXX. Otherwise, I'll see you then." (15 seconds) "Hi, mom, it's me. Nothing special—I'll talk to you later. Bye!" (5 seconds) Even a real chatty one—"Hi, Sue, it's Teri. It's 2:00 on Sunday, and I guess I missed you again! I was just calling to say what a good time we had at your house last night. Dinner was great! Remind me to get your recipe for barbecued salmon. Oh, yeah, I also wanted to let you know that we're thinking of seeing *Godfather III* next Friday, probably the 9:00 show so we can grab a bite to eat first. Are you interested in joining us? For dinner, too, if you feel like it, nothing fancy. Let me know any time before Friday, OK? Call me anyway. I really do want that recipe! Thanks again for dinner! Bye."—took only 34 seconds. Granted, here in New York we tend to speak quickly, but one minute certainly seems sufficient for anyone's needs. Of course, if you really do have a lot to say, you can always call back and use the next allotted minute to finish up!

We never received the allotted seven minutes worth of messages, either. Had we been away for several days on business or vacation, no doubt we would have used the 1337's entire memory. When the memory is full, the message indicator light flashes rapidly to let you know. Of course,

that doesn't help you when you're out of town. However, the system still answers the phone, but after ten rings. It won't play the outgoing message or record any new incoming calls: instead, it beeps twice and waits for further instructions. If no command is given, the system beeps once again and then hangs up. The reason that the system picks up at all when its memory is full is to allow you to use remote commands to replay, and delete some or all of your messages. With a full array of remote functions, you can just call in as often as it takes to keep some clear memory on the machine.

After using a digital answering machine for a few weeks, it seems that those AT&T executives had astutely recognized that digital technology could be the wave of the future in the answering-machine market. Although it is one of the first machines to incorporate digital technology, the Answering System 1337 has none of the quirks and kinks that are common in newly introduced consumer goods. It is as functional as it is attractive, and provides a fine introduction to digital answering machines. ■

CAPTURING CAPTIONS

(Continued from page 4)

workplace, Oprah said of a guest, "He can't help but stare at a good tush." The captioned version read: "He can't help but stare — stare at a good touch." In addition, the computer sometimes has trouble translating heavily accented speech, and might not recognize obscure foreign cities the first time they are encountered. But, overall, the live captioning provides an incredibly fast and accurate interpretation for those who can't hear.

Not all closed-caption viewers are deaf, however. Captioning also provides a valuable learning tool for those who are trying to master the English language, and for children who are just beginning to read. In homes where one individual is a bit hard of hearing, we're sure that other family members would prefer the relatively unobtrusive captions to keeping the volume turned all the way up. (We're thinking specifically about a retired older couple we know who are difficult to visit because one of them watches TV constantly at full volume—making holding a conversation impossible.)

The Caption Master brings the world of closed-caption video to your home with very little effort required on the part of the consumer—besides laying out \$795 (\$595 for hearing-impaired individuals or educational institutions) for a very standard VCR. Despite the innovative addition of a closed-caption decoder, the Caption Master is a throwback to the early days of user-unfriendly videocassette recorders. The most obvious, and distressing, omission is

on-screen programming. It's been quite some time since we've seen a VCR that is as difficult to program—especially in this price range. And placing the tiny programming buttons with even smaller labels inside a shadowed, hard-to-access front-panel compartment could make programming an impossibility for elderly consumers who might have poor eyesight as well as difficulty in hearing. The bare-bones remote control that is supplied with the unit operates only the basic tape-playing functions, real-time recording, channel selection, VCR/TV selection, and power on/off.

We've become accustomed to VCR's with certain "perks." We wouldn't expect MTS stereo on a unit aimed at the hearing impaired, but we would like to see four heads on a \$795 unit whose instructions include warnings that the captions on poor-quality tapes are harder to read. Instant Replay does offer a four-head Caption Master (model 611)—for an additional \$200. On the plus side, the Caption Master does offer tracking- and picture-adjustment knobs, to alleviate the most-common causes of distortions in captions: video noise during playback and pictures that aren't sharp.

The Caption Master might not offer much in the way of features—but it does offer one important feature that no other VCR has—closed captioning. And until closed-caption television sets hit the market, the Caption Master is the easiest way for consumers to access closed-caption programming. ■

HEAR AND AROUND

(Continued from page 5)

It's interesting to note that we have entered an age where sound shaping is just as important—perhaps more important—than accurate reproduction. Just a very few years ago, any audiophile worth his monster cable would have turned his nose up at the tricks we play with sound, claiming that they add only "cosmetic-realism" to audio.

The DSL Two, however, sounds natural. Granted, not all of its modes sound natural for all music, but we were always able to find one that perfectly suited what we wanted to listen to, whether it was classical, rock-n-roll, jazz, or new age. We even thought that the Mono Enhance mode did an excellent job on some old jazz recordings, putting us in the middle of the Onyx club on 52nd Street listening to the great Charlie Parker.

We were also impressed with the DSL Two's performance with our video system, as was everyone that we invited to hear it. Now a few more people really appreciate that the TV experience can be more than just sitting across the room looking at a little box. ■

For more information on any product in this section, circle the appropriate number on the Free Information Card.

ELECTRONICS WISH LIST

Home Theater Sound System

It doesn't matter how large your TV screen is—if it doesn't sound natural, you won't get that movie-house ambience. *Ohm Acoustic's* (241 Taaffe Place, Brooklyn, NY 11205) *Ohm Theater* video sound system, which includes two small satellite speakers and a center channel module containing a subwoofer as well as the center-channel speaker, not only provides big sound to support the big picture, but also physically supports the TV set. The center channel module doubles as a TV stand and can be used either vertically, for smaller sets, or horizontally, for large-screen TV's or video monitors. With an optional extension base and panel, it can hold up to 35-inch monitors. The Ohm Theater can be used with A/V systems of any level of sophistication. For simple, two-channel systems (a stereo VCR or videodisc player and a stereo amplifier), the Ohm Theater's built-in center-channel matrix derives the center-channel audio from the right and left stereo channels. Multiple-amplifier surround-sound systems are accommodated with inputs for a discrete center-channel processor and jacks for additional satellite speakers. The satellite speakers can be mounted on a bookshelf, hung on a wall, or mounted on optional speaker stands. Price: \$950.

CIRCLE 56 ON FREE INFORMATION CARD



Ohm Acoustics' Home Theater Sound System

Video Lite

Should you find yourself and your mini-camcorder in some less-than-well-lighted places, a cordless video light can brighten your pictures. The 20-watt *Cell Pack + Microlite V-0890* from *Ambico* (50 Maple Street, Norwood, NJ 07648-0427) is powered by six included "AA" NiCd batteries that recharge inside the cell pack with the provided recharger. The batteries can also be used to power many 6-volt, 8mm camcorders for more than 30 minutes, providing a portable back-up power supply. Price: \$69.95.

CIRCLE 57 ON FREE INFORMATION CARD



Ambico Cordless Video Light

Tri-Lingual Translator

Should your business or social engagements, or your vacation excursions, take you into international waters, plain-old English might not be sufficient. The *Berlitz TriLingual* English-Spanish-French translator from *SelecTronics* (Two Tobey Village Office Park, Pittsford, NY 14534) gives you some help in a couple more languages. Only slightly larger than a credit card, the unit instantly translates 37,500 words and 900 phrases between English, Spanish, and French. The translator is customized with each language's distinct words, characters, and marks. Any other features? Yes, *si, oui*: It also has a full-function calculator with currency-exchange function. Price: \$80.

CIRCLE 58 ON FREE INFORMATION CARD

Family Computer

Joining the rapidly expanding "home-computer-for-the-whole-family" market is *Atari Computer's* (1196 Borregas Avenue, Sunnyvale, CA 94088) *1040STE*. It is designed to provide serious home users and small-business professionals with the powerful tools needed for a variety of applications, and a graphics interface provides icons that make it easy for beginners to use the system. The 68000-based *1040STE*, an enhanced version of Atari's *1040ST*, has 1 MB of on-board RAM, operates at 8 MHz, and is compatible with thousands of existing ST software packages. The latest TOS operating system resides in the computer's ROM. The *1040STE* features an extended color palette, hardware scrolling, and digital stereo sound. A 3½-inch 720K floppy-disk drive is standard, and users have the option of adding a second floppy and a hard drive. The system includes a MIDI port, standard stereo output jacks, and enhanced game-controller ports in addition to standard I/O ports for a parallel printer, modem, mouse, and hard-disk drive. Price: Under \$700.

CIRCLE 59 ON FREE INFORMATION CARD



Atari Home Computer

ELECTRONICS WISH LIST

For more information on any product in this section, circle the appropriate number on the Free Information Card.



Sony Mega Watchman

Traveling Television

Can't bear to miss your soaps while you're at the supermarket? Does your family reunion fall on the same day as game seven of the World Series? *Sony Corporation of America* (9 West 57th Street, New York, NY 10019) lets you get on with your life without missing any televised action with the *FD-555 Mega Watchman* personal television. It combines a 4½-inch (measured diagonally) black-and-white TV screen with an AM/FM stereo receiver and a full-function cassette player in a portable unit. The 13¼ × 8¾ × 7¼-inch set also provides what Sony calls "surround-sound-enhanced audio" and a one-hour sleep timer. Price: \$199.99.

CIRCLE 60 ON FREE INFORMATION CARD

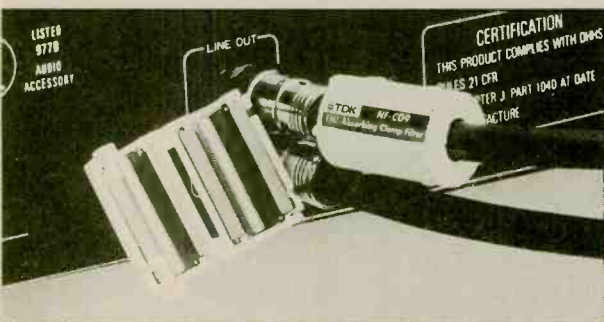

TDK Digital Noise Absorber

Digital Noise Absorber

One of the unfortunate "side effects" of state-of-the-art digital audio equipment is electromagnetic interference (EMI) caused by digital circuits. *TDK Electronics Corporation's NF-C09B* digital noise absorber clamps onto signal cables and power cords up to 9 mm in diameter to easily and effectively eliminate sound-muddying interference. The company says that its exclusive high-density ferrite core "absorbs ultra-high-frequency energy, thereby eliminating the high-range distortion associated with EMI." Price: \$10.

CIRCLE 61 ON FREE INFORMATION CARD

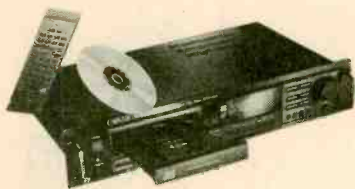

Carver Vacuum-Tube CD Player

Vacuum-Tube CD Player

Something old, something new ... *Carver* (20121 48th Ave. West, Lynnwood, WA 98036) has "borrowed" old-fashioned vacuum-tube technology for its new CD player (which doesn't happen to be blue). Aimed at "the many audiophiles who prefer the classic sound character of analog vacuum tubes over the exacting precision of modern digital technology," the *SD/A-490t* linear single-bit CD player uses two high-quality 6DJ8 vacuum tubes. Despite those "antique" components, the player provides the modern conveniences we've come to expect—24-track programming, remote control, time-edit taping feature, index programming, etc. To improve the sound of discs originally recorded in analog and converted to digital, the player also features "Soft EQ," which restores the tonal and out-of-phase spatial character of the music. Price: \$699.95.

CIRCLE 62 ON FREE INFORMATION CARD



Hal America's Vegas Dream

Gambling Game

Move over, kids—*Hal America* (7873 S.W. Cirrus Drive #25-F, Beaverton, OR 97005) has a game for your folks to play on your Nintendo system. *Vegas Dream* contains roulette, keno, blackjack, and slot-machine games. Players start with a \$700 grubstake and have the opportunity—albeit, as slim a chance as in real life—to hit a \$10 million jackpot. Besides the actual games, *Vegas Dream* has assorted "lifelike" casino characters including down-on-their-luck gamblers looking for a loan. We assume there are some more desirable characters as well, because if the players meet "the guy or girl of their dreams" the game offers a Vegas-style wedding. Price: \$53.95.

CIRCLE 63 ON FREE INFORMATION CARD

For more information on any product in this section, circle the appropriate number on the Free Information Card.

ELECTRONICS WISH LIST

How D'Ya Spell Suxess?

How do you look up a word in a dictionary if you have absolutely no idea how it's spelled? That's not a problem with *Franklin Electronic Publishers, Inc.'s* (122 Burrs Road, Mt. Holly, NJ 08060) *Spelling Ace* phonetic spelling corrector. It accepts words typed into its QWERTY-style keypad the way they sound (for example, "ustonushing") and will display the correct spelling—"astonishing." The portable spelling corrector measures 4 x 2-inches, weighs less than 2 ounces, and comes with a lithium battery and a carrying pouch. The *Spelling Ace* contains the correct spellings for more than 80,000 words, a built-in list of 1700 commonly confused words, a pattern-matching feature, and several built-in word games. We wonder how it would deal with the "dese," "dose," and "dats" of our native Brooklyn dialect. Price: \$39.95.

CIRCLE 64 ON FREE INFORMATION CARD



Franklin Electronic Publishers Spelling Ace

Roadster Remote

Although its primary purpose is to provide remote starting and climatization of your car in the cold of winter or heat of summer, *Remote Automation & Control Electronics (RACE) Inc.'s* (*The Carborundum Center, 345 Third Street, Suite 455, Niagara Falls, NY 14303*) *Remote Key* does everything but drive your car for you. The remote control system will operate the car's rear defogger, power door and trunk locks, horn, and lights. It also acts as a paging alarm system that can be remotely armed, disarmed, and monitored. The two-way radio system allows all control functions to be monitored from as far as 2000 feet away. (That could come in handy if you hang out with the sort of unsavory characters who know how to plant car bombs.) For safety's sake, the device will turn off the car if the emission sensor detects dangerous levels of carbon monoxide from a car idling in an enclosed space, if the engine attains excessive RPM's, if the hood is opened, or if someone without the ignition key tries to drive the car away. Price: Not Available.

CIRCLE 65 ON FREE INFORMATION CARD



RACE Remote Key

Phone-Call Blocker

Are you sick of getting phone calls at all hours from people trying to sell you aluminum siding or termite control, or give you the "free" prizes you've won in some contest you never entered? *LM Communications Corp.* (997 Senate Drive, Centerville, OH 45459) has a solution in the form of the *LineMinder*, a talking call-screening device that limits access to your phone to those callers to whom you've given the security code. When in its "on" mode, the *LineMinder* answers every incoming phone call before the phone rings with the message: "Hello, this is LineMinder. Please enter your security code." If the caller enters the proper code, the device responds, "Accepted, now ringing." If no code, or the wrong code, is entered, the *LineMinder* says, "Security violation!" and hangs up—before the phone rings to annoy you. We can think of some other things we'd prefer to say to unsolicited callers ... Price: Not Available.

CIRCLE 66 ON FREE INFORMATION CARD



LineMinder Phone-Call Screener

Day-Glo Cassette Storage

Fashion-conscious music buffs can now carry their cassettes around in cases that complement their clothing. The *Cassette Keeper* from *Memtek* (P.O. Box 901021, Fort Worth, TX 76101) is a sturdy plastic box with a handle for easy carrying that comes in a choice of "eye-popping" pink, yellow, purple, or green. The neon-bright case can hold as many as 15 audio cassettes. Price: \$3.95.

CIRCLE 67 ON FREE INFORMATION CARD

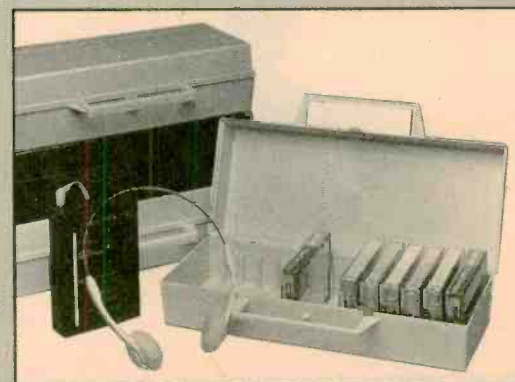

Memtek Day-Glo Cassette Keeper

ELECTRONICS WISH LIST

For more information on any product in this section, circle the appropriate number on the Free Information Card.

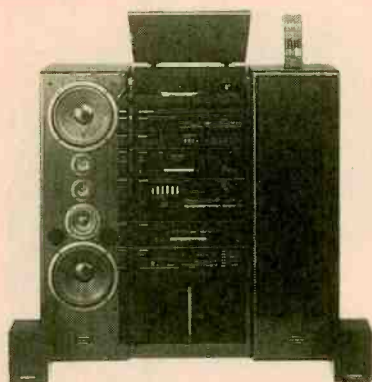

Pioneer Multi-Room Audio System

Multi-Room Audio System

The top model in *Pioneer Electronics (USA)*'s (2265 East 220th Street, Long Beach, CA 90801-1720) Syscom line is the *X9600SBK*, which has an "in-line" vertical, twin-woofer speaker design. A multi-play CD player and synchronized cassette deck provide full-function, hands-off continuous taping, extended play-back, and listening options. The multi-play cassette deck offers CD-deck synchro and auto-reverse record and play for six cassette tapes, and automatically rewinds six cassettes in consecutive order. The multi-room feature, when used with an optional infrared adapter, allows an extra set of speakers and system remote control to be added so that all components can be operated from anywhere in the house. The *X9600SBK* includes an AM/FM tuner, a turntable, and a Dolby Surround-processing amplifier that delivers a continuous average power output of 30 watts per channel. Price: \$2,000.

CIRCLE 68 ON FREE INFORMATION CARD



Konami's Dracula's Curse Videogame

Videogame Vampires

Any Nintendo player who made it through the first two games in the trilogy with their blood supply intact might want to take a shot at *Castlevania III—Dracula's Curse* from *Konami Inc.* (900 Deerfield Parkway, Buffalo Grove, IL 60089). In this "prequel" to *Castlevania I* and *II*, the player takes on the persona of "Trevor-Simon's forefather, the origin of the Belmont Warlord Chromosomes," to battle Count Dracula. To travel through 17 possible levels of "Paths of Fate," including haunted ships and cursed castles, the player gets three lives, an assortment of weapons to use, and the ability to "metamorphosize" into any of three spirits. What, no garlic or silver bullets? Price: \$49.95.

CIRCLE 69 ON FREE INFORMATION CARD



Canon L1 Interchangeable-Lens Camcorder

Interchangeable-Lens Camcorder

Aimed at advanced amateurs, semi-professional videographers, and even the pros, *Canon U.S.A., Inc.*'s (One Canon Plaza, Lake Success, NY 11042) *Canovision 8 L1* hi-band 8mm camcorder is the first consumer camcorder to provide interchangeable lens capability. The L1 comes with a 15x zoom lens, and can be used with an optional Canon 8.7-69.6mm f/1.4-1.8 8x zoom lens or with the *EOS Adapter VL*. That adapter allows you to use any of the lenses designed for use with Canon's EOS series of 35mm SLR cameras. The VL mount system—jointly developed by Canon, Hitachi, Matsushita, and Sony—allows any lenses from those companies that bear the special "VL" logo (which stands for "video lens") to be quickly released and attached to the camcorder while retaining full focus, iris, and zoom control with each lens. The L1 also offers a variety of creative options for producing special digital effects during recording and playback; automatic controls for focusing, exposure, white balance, and shutter speed; and hi-fi stereo sound. Keep tuned to *GIZMO* for a closer look at the L1 in an upcoming issue. Price: \$2,999 for the L1 and \$350 for the EOS Adapter VL.

CIRCLE 70 ON FREE INFORMATION CARD



Happ NEC-Compatible Joystick

"Star" Joystick

Happ Controls Inc.'s (106 Garlisch Drive, Elk Grove, IL 60007) model 901357 "Star" Joystick is specially designed for use with NEC PC-ENGINE. The joystick has a large chrome-steel handle, a translucent blue base, and two large microswitch fire buttons. Other features include auto fire, slow motion, run/pause, an extra-long cord, and six arcade-quality microswitches for extra reliability. Price: \$19.95.

CIRCLE 71 ON FREE INFORMATION CARD

Simple VCR Repairs



BY
SAM ALLEN

Depending on the malfunction, you might be able to fix your own VCR and avoid an expensive repair bill, or even having to buy a new one.

that
YOU
Can Do!

As soon as someone finds out that you are interested in electronics, they will usually ask you to fix something. For instance, they might want you to repair a malfunctioning VCR. If you are just getting started in electronics, you probably feel that VCR repair is way over your head. While you might be right to some extent, you'd be surprised how many VCRs are totally disabled by minor problems that even a beginner could fix. Surprisingly, a VCR that just won't work at all is usually easier to repair than one that just has poor picture quality.

In this article, I will present the repair techniques you'll need to know to cure some of the most common VCR problems. As you'll come across them more often, the solutions I'll provide are for front-loading VHS units. However, some of the problems I'll discuss are common to all types of machines, so the generalities of the techniques described may be useful for repairing different machines.

Sizing-Up the Job. Before you commit to work on a unit, there are a few things you should find out: First, make sure the machine is out of warranty, since you will void the warranty if you open the case. This is very important when repairing a friend's machine; sometimes people forget they have a warranty, so make sure it has expired.

Another thing to consider when working on someone else's VCR is the owner's attitude. If they are wary and think you may cause more damage to the machine, don't work on it or you are likely to lose a friend if the unit turns out to be unfixable. If their attitude is, "Oh well, it's no good now; you can't hurt it," then go ahead. I like to work on stuff that has already been into a commercial shop for an estimate. If the owner decided that the cost of repair is too high to make it worthwhile, then they won't get upset if I can't fix it, but they are pleasantly surprised if I can.

Finally, get a good idea of what the problem is; think about (or ask) how the

problem began. That can give you a clue as to what to look for. For example, if the problem began after the VCR was dropped, then you can suspect a broken circuit board. That is a problem that you should be able to find and fix without too much trouble with some tips I'll provide later.

If a VCR won't load after the kids were using it, it may have a foreign object jamming the mechanism; another problem you can fix. I worked on one VCR that wouldn't rewind after someone had kicked the button with his foot. Knowing this, I could center my attention on the button itself and the problem was easy to find and repair. On the other hand, a problem that appears out of the blue with no apparent cause may be harder to troubleshoot. Make your decision accordingly.

Some Basics. Before getting into repair procedures, I want to give you a few ground rules. The first tip may seem obvious, but before you disassemble a

unit, check all of the controls to see that they are set properly. I have had several people give me VCR's to repair that only needed to be set up properly. For example, if the unit won't record off the air, the problem may be that the tuning controls aren't set to a station or a switch may be in the "aux" position instead of the "tuner" position. Some models may be completely inoperative if a switch is set to the timer position. There are lots of other possibilities, and the more complex the controls, the more likely that one of the controls has been overlooked; so be sure to check out the control settings thoroughly.

The next rule on the list: be sure the power cord is not plugged in before working on a VCR. When you do need to make a powered-up test with the cover off, be sure to observe every safety precaution. I assume you have some electronics background, so you should know better than to touch any connections in the primary circuit during such phases of repair.

There are some rules that apply specifically to VCR repair. For example, when part of a mechanism seems to be jammed, the first impulse is to spray some lubricant on it—don't do it to a VCR. Spray lubricants cause more harm than good. More problems are due to slipping than the need for lubrication.

Also, while you are working inside a VCR, keep your fingers away from the head(s), rollers, and guides in the tape transport. Oil from your hands will damage the head and cause slipping in the tape transport system.

Last, don't randomly adjust things inside the VCR to try and correct a problem; you will usually end up creating further problems.

Foreign Objects in the Mechanism.

In a house with small children, the most common VCR malfunction is a unit that won't load. That problem is usually due to a toy or other object that has been pushed into the tape door. I have found crayons, pennies, toy cars, buttons, and candy inside VCR's.

To eliminate the problem, remove the case and look for the foreign objects inside the VCR. Usually all you need to do is remove the objects and the VCR will function.

In the case of candy, crayons or the like, you may need to do some clean up. For candy, you need a water-based solvent; window cleaner works well. Alcohol works for crayons.

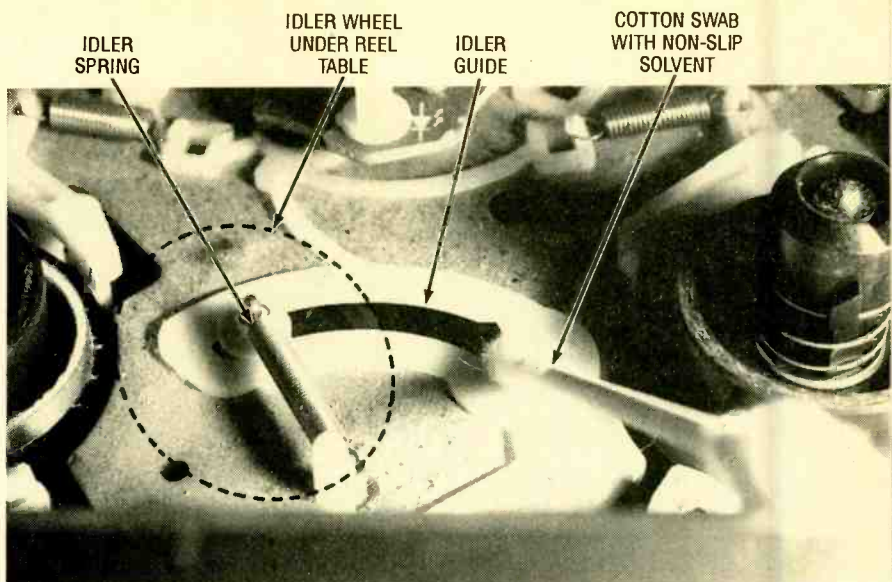

Fig. 1. A lot of problems can be traced to slipping idler wheels. If your VCR has a guide like the one shown here between the reel hubs, it uses an idler wheel. The idler wheel (indicated by the dashed outline) is below the reel table. To avoid a lot of disassembly, apply non-slip solvent to the rubber part of the idler by inserting a cotton swab through the hole in the guide.

Use a cotton swab moistened with the cleaner. Don't drip the cleaner onto circuit boards or motors. Wipe all surfaces dry with another swab. After the clean up, you should relubricate the gears with teflon grease (Radio Shack cat. #64-2326, for example). Don't use a lot; just swab on a very thin film. After the mechanism is working, insert a head-cleaning cassette and follow the cassette manufacturer's directions for cleaning the head. It provides insurance in case any foreign substance (cleaning fluid, finger oil, etc.) has gotten on the head or tape-transport components.

Slipping Transport Components.

Often times the source of trouble is in the tape-transport mechanism. Suspect such trouble if the VCR loads a tape, begins to play it, and then shuts down; a VCR has sensors and a system-control circuit that will turn off the power if the reels aren't moving. If the system control circuit didn't shut down the VCR when a drive component was slipping, the tape would go slack and get wrapped around the head, causing major damage.

If you suspect a slipping belt or idler, remove the case, then insert a tape and start the machine. Watch the tape movement. If one of the reels doesn't move or is slow and jerky, you need to look for a slipping or broken belt or "idler wheel."

A broken belt is usually easy to spot

once you have the machine opened up, but a slipping belt is hard to detect. If none of the belts are broken try cleaning them with a non-slip solvent (for example, Radio Shack #44-1013), then test the reel operation again. Incidentally, don't overlook the belt that drives the counter; many machines use the counter as a sensor in the system-control circuit to verify reel movement.

An idler wheel (see Fig. 1) transmits mechanical power by friction. A rubber "tire" around the edge of the wheel rubs against the motor shaft and another driven part. If the rubber becomes hard, glazed, or slippery, then there won't be enough friction for the idler to grip the other parts and turn them.

Quite a few VCR's use an idler wheel to drive the tape reels. You can tell if your machine uses one by looking between the "drive hubs" used to turn the tape reels. If there is a plastic guide that looks like the one shown in Fig. 1, then your machine uses an idler wheel.

To fix the problem, swab the rubber on the wheel with non-slip solvent. Wipe it dry, swab it again, then wipe it dry. If your VCR is the type shown in Fig. 1, you can avoid a major disassembly by applying the non-slip solvent to the idler by pushing a cotton swab moistened with solvent through the guide slot. Turn the tape-drive hub by hand as you press the swab against the rubber on the idler wheel.

Sometimes the spring that pulls on

the idler has lost some tension. Remove the spring and cut off a few turns, then make a new loop on the end with needle-nose pliers. Re-attach the spring and try out the machine.

Physical Damage. A VCR that has been dropped or abused may have a broken circuit board, broken controls, or bent metal parts. The display/control board directly behind the front panel is the most vulnerable. Remove the front panel and examine the board, particularly at the corners. If it is broken, you can sometimes salvage it by soldering jumper wires across all of the broken traces and replacing any broken components.

If one or more of the front-panel controls won't work but their functions can be performed via the remote, then the problems may simply be a damaged front-panel control. The pushbuttons on the front are mechanically linked to the actual switches mounted on the control/display circuit boards. Remove the front panel and try operating the VCR by pressing the switch located on the circuit board. If it operates normally, look at the rear of the front panel to find out what's wrong. Usually a plastic rod that connects the pushbutton to the circuit-board mounted switch has

been broken or misaligned. You can usually get it working by bending it back into alignment or gluing the parts back together. If a part is missing, you can make a replacement from a scrap of plastic. It doesn't have to be too elegant as long as it will depress the switch.

Sometimes the pushbuttons and the front panel are molded as a single unit. Small strips of plastic act as hinges and springs. If these strips break, then the button may slip out of alignment or simply fall out. You can use silicone glue (such as Radio Shack #64-2306) to re-attach the button. The silicone remains rubbery after it sets, so it will allow enough movement in the button to activate the switch on the circuit board.

Loading Problems. Front-loading VCR's use motor-driven cassette baskets to load cassettes onto their reel table (see Fig. 2). An inoperative cassette basket will completely disable a VCR. One common problem is that a cassette gets jammed in the basket. If the cassette can't be ejected, the system-control circuit will shut down the VCR.

There are several causes for jamming. Sometimes the cassette case is warped or damaged in a way that jams it in the basket. If the cassette has been

inserted upside down or backwards it will jam. Even inserting the cassette at a slight angle can cause it to jam. The solution to any of these problems is to open the VCR case and examine the stuck cassette. Try to wiggle it around and find the place where it is binding. Find the small motor that runs the loading mechanism. Gently turn the gear on the motor by hand to try to back out the cassette. If the problem is the cassette itself, then once you get it out, the VCR should function normally.

Sometimes there is a problem with the cassette basket that will cause a tape to jam. For example, inside the basket there are some springy metal fingers that grip the cassette; if they have lost tension, the cassette can slip backwards as the basket moves. That can cause the rear of the cassette to get wedged in the loading slot as the basket moves down. The solution is to gently bend the fingers to increase the tension. Too much tension on the fingers or some other cause of friction between the cassette and the basket can lead to the same problem, so be careful when making the adjustment.

Some VCR's have a switch that senses forward movement of the basket as a signal to start the loading motor. There are a variety of types, but most are leaf switches mounted on the cassette basket. The contacts are supposed to close when a tape is fully inserted. If that switch is activated before the cassette is all the way in, the tape will get wedged in the slot, so check that switch if the problem persists.

Also, check the loading switch if you can slide a cassette into the slot, but the motor that pulls the tape in won't turn on. Some have a small plastic finger attached to the end that presses against the cassette. That finger is prone to break off. Manually close the switch. If the loading mechanism starts, then you probably just need to glue a small piece of plastic onto the end or reposition the switch so it is activated by the cassette.

If manually closing the contacts won't activate the motor, try bypassing the switch with a jumper. If that activates the motor, then the switch contacts are dirty. Clean the switch with contact cleaner. Don't spray directly on the switch because over-spray will get on other components and could cause damage; instead spray a little cleaner on a piece of paper, then rub the paper between the contacts of the switch.

If the switch seems to be okay, then

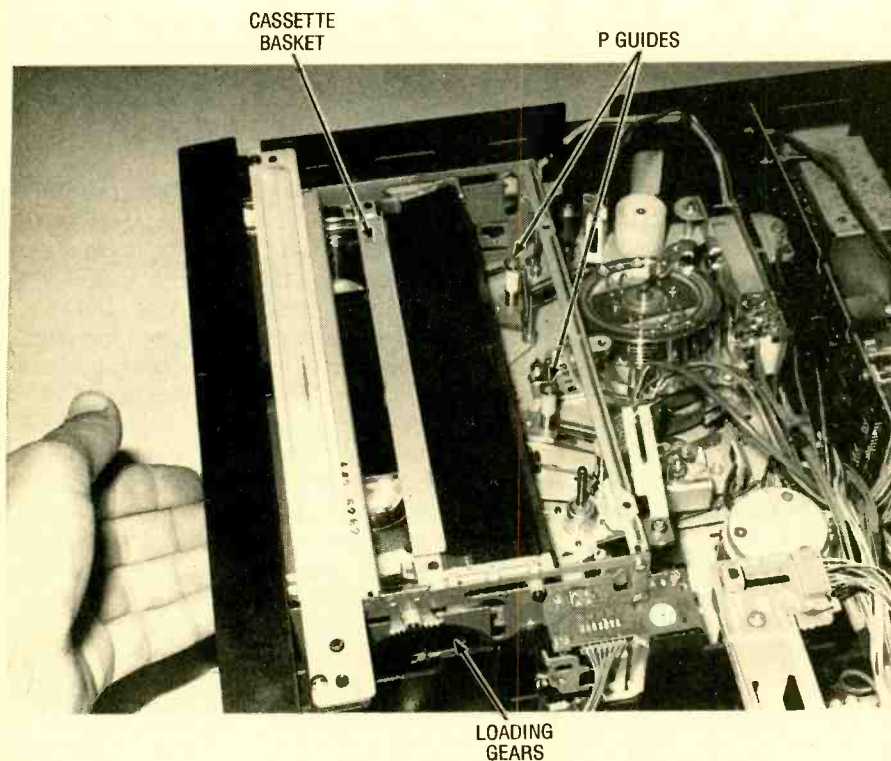

Fig. 2. When you insert a cassette, a switch activates a motor that drives the cassette basket. The basket pulls the cassette in and then lowers it onto the reel table. If the loading gears become out of time (slip a tooth), then the mechanism will jam as it lowers the basket.

check out the motor. Some of these motors will run on 9 volts, so (with the power cord unplugged) attach clip leads between the motor terminals and a 9-volt battery. You may need to reverse the polarity to get the motor to run. If it won't run with the battery, try a 12-volt supply. If it still won't run, you need to replace the motor. Sometimes you can get the motor working by spraying contact cleaner into the area of the brushes and manually rotating the shaft.

If the motor starts to turn then stalls, there is probably something jamming the loading mechanism. Look for a foreign object, a loose screw, or a bent part.

The motor drives a large gear that is connected by a shaft to a similar gear on the other side of the basket. If one of the gears slips a tooth, one side of the basket will jam as the basket changes from inward to downward motion.

The procedure for correcting this problem is called "timing the cassette basket." First mark the present location of the gears by making a dot with a felt tip pen on the two gears at the point where they mesh. Next remove the clip that attaches the gear to the shaft on the side opposite the motor. Remove the gear and reinstall it offset one tooth from the original position. Try loading a cassette and see what happens; if the problem is worse you've moved the gear the wrong way, so try again by moving the gear in the other direction. If the problem is better but still binds, move the gear another tooth in the same direction.

Power-Supply Problems. Most of the circuit boards in a VCR are too complex to troubleshoot unless you have a lot of experience, but the power-supply board is fairly easy for anyone with some basic electronics knowledge. When the VCR is totally dead, the power supply is an obvious starting point. The power supply can also be responsible for a number of other problems. If the supply isn't delivering the correct voltages to all of its outputs, some systems may not function correctly while others function normally; so if there is a mysterious problem that you can't explain, check each output of the power supply.

With a dead supply, I like to start by using an ohmmeter to check for continuity from one blade on the power plug to the other. If you have continuity, then the primary circuit is probably fine

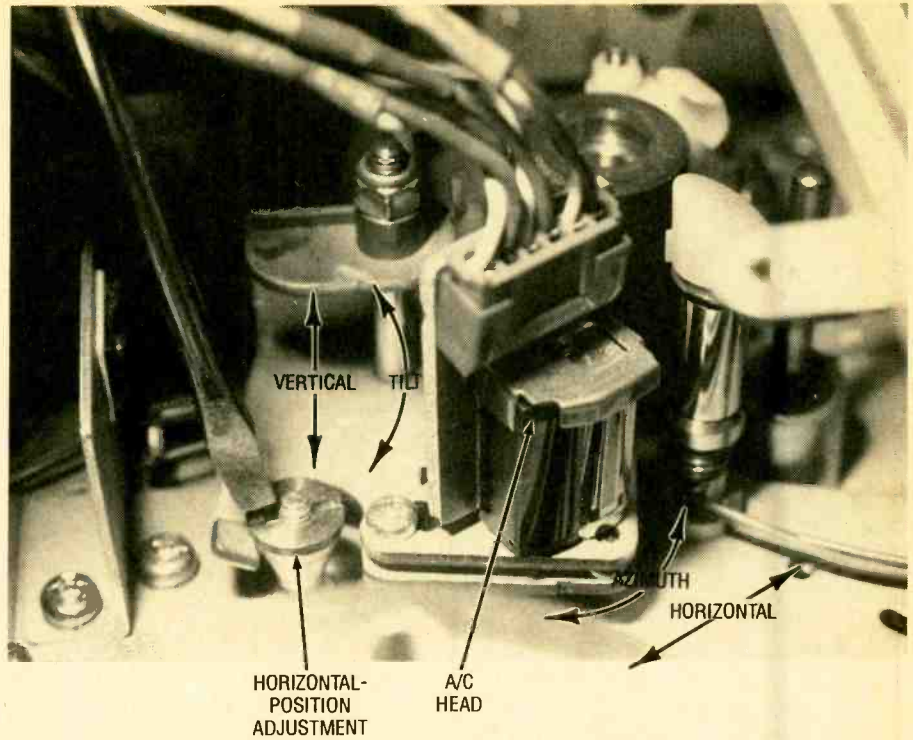

Fig. 3. This is the A/C (audio/control) head. There are four adjustments: horizontal position, vertical position, tilt, and azimuth. The adjustments affect sound quality and sync. They also have an effect on picture tracking.

and you can move on to check the secondary circuits. If you get an open-circuit reading, make another check with the probes on the terminals where the cord attaches to the board. If you get continuity here, then the cord or plug is bad.

If you still get an open circuit reading, look for a blown fuse. There are usually several fuses at different locations on the board. Check them with the ohmmeter since you can't always tell by looking. If the fuses are blown, replace them and try out the VCR. If they blow again, then there is a short or a component is drawing too much current; find the problem before you try any more fuses. If the unit functions normally, it's safe to assume that some transient blew the fuse and the VCR will be all right now.

If the fuses are intact, check for continuity through the primary transformer winding. If the primary checks out all right, then power up the VCR and use a voltmeter to measure the various outputs. Some boards will be marked with voltages. If there are no voltage markings on the board, you need a schematic to do a complete job; but as a basic test you can check each output and assume it is okay if you get a reading above 5 volts. If one of the outputs is dead, look for burned resistors or other components in the circuit. A good way

to locate a bad component is to start at the transformer end of the circuit and take a voltage reading. If there is no voltage at this point, then the problem is probably in the transformer. If there is voltage present, then follow the circuit and take voltage readings at each component. When you lose the voltage, you have found the defective component or a possible short.

Bad Sound or Slight Tracking Problems. VCR sound is recorded with a separate audio recording head similar to the recording head in a cassette recorder. That head also records a control pulse on the tape that is used to keep the video head tracking correctly. Because of its dual purpose, the head is called the audio/control head or A/C head. If it becomes misaligned, it can cause distorted sound or sound that is out of sync with the lip movements on the screen. Because the A/C head also controls the picture tracking, adjusting it can be tricky. There are usually several adjustment screws for horizontal position, tilt, azimuth, and vertical position (see Fig. 3).

If the sound is in sync but it's muffled or distorted, try adjusting the tilt and azimuth. Note the original position and count each half turn as you make the adjustments. Try the tilt first. Adjust about one and a half turns one way; if there is

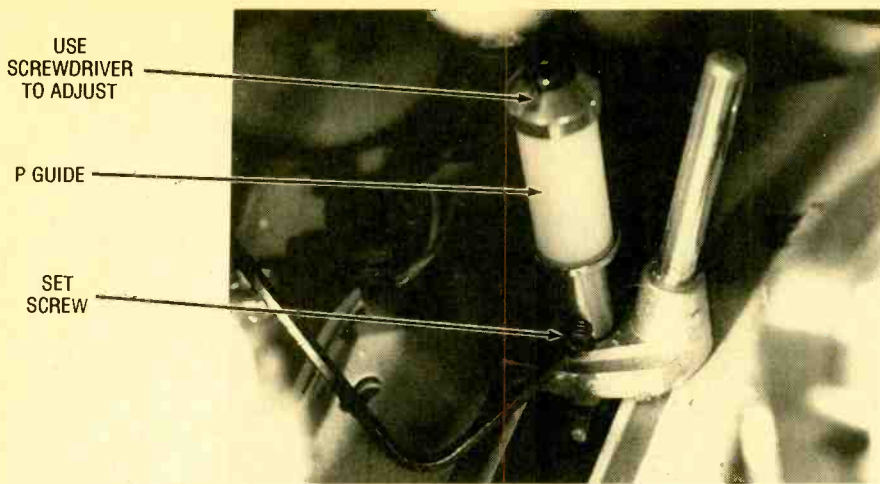

Fig. 4. The P guide adjustment affects picture tracking. Loosen the set screw with an Allen wrench before making the adjustment with a screwdriver.

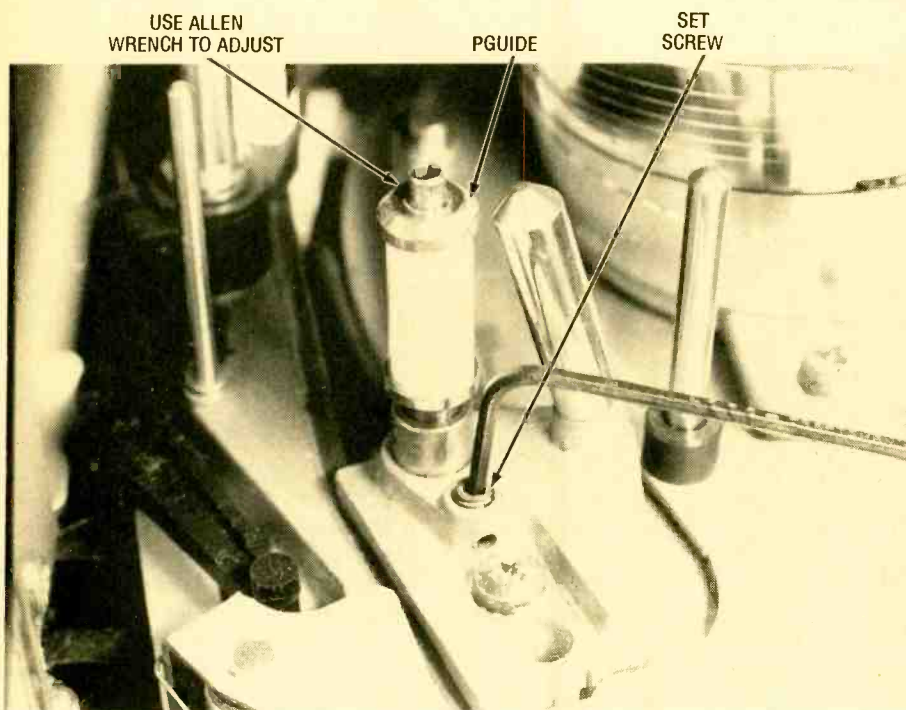

Fig. 5. This type of P guide needs an Allen wrench for both the set screw and the adjustment. Be sure to lock the adjustment with the set screw when you are done.

no improvement, adjust it back to the original position then one and a half turns the other way. If there is still no improvement, return to the original setting and try adjusting the azimuth using the same procedure. Watch the picture as you make the adjustments. If white lines begin to appear on the screen, adjust the head until the lines disappear making sure that the sound is still okay.

When the sound is out of sync with the lip movements on the screen, the horizontal position of the A/C head needs adjusting. First study a tape as it plays to analyze the exact nature of the prob-

lem—do the words begin before the person opens his mouth? Or does he open his mouth before the sound starts? If the sound comes first, then the head needs to move in the same direction as tape travel. If the sound occurs late, you must move the head in the opposing direction.

The horizontal position is adjusted by turning the large adjusting nut shown in Fig. 3 (the screwdriver is pointing to the horizontal adjustment nut). On some models, you may need to loosen the mounting screws and move the head slightly. Observe the picture as you move the head; tracking lines will ap-

pear and disappear. Position the head so that the sound is in sync and there are no tracking lines in the picture.

Tracking problems that can't be fixed using the tracking control on the front panel can usually be eliminated by adjusting the A/C head. Set the front-panel tracking control to the center position, and adjust the vertical and then the horizontal position of the head as you would for audio problems.

Severe Tracking Problems. If there are scratchy white lines in the picture that you can't clear up with the tracking control, and adjusting the A/C head doesn't help, then the problem may be with the P guides. The P guides are motor-driven pins that pull the tape out of the cassette and wrap it around the head (look back at Fig. 2 to help locate them). They control the position of the tape on the head. If they are out of alignment, tracking lines will appear.

There are two P guides; the one closest to the supply reel is called the entrance P guide and the one closest to the take-up reel is called the exit P guide. If the tracking lines are in the lower portion of the picture, then the exit P guide needs adjusting; if they are in the upper portion, the entrance P guide needs adjustment.

There are two types of P guides: one that can be adjusted with a screw driver (see Fig. 4) and one that requires an allen-head wrench (shown in Fig. 5). Before adjusting either type, you must first loosen an allen-head set screw. Note the position of the guide you want to adjust, loosen its set screw, then insert a tape and play it. Turn the adjustment on the top of the P guide a little and watch for an improvement in the picture.

After you have adjusted the P guides, remove the tape and unplug the machine, then lock the adjustment with the set screw. If you weren't able to correct the problem by adjusting a P guide, reset it to its original position.

A VCR that Damages Tapes. Tape follows a complicated path inside the VCR. When you press play or record, the two P guides pull the tape out of the cassette and wrap it around the video head. The tape is held in position by other guides and pulled across the heads at a uniform speed by a capstan and pinch roller. Problems anywhere along the tape path can lead to tape damage.

The most obvious symptom of prob-
(Continued on page 88)

Weather Alert Decoder

NOAA Weather Radio is a function of the National Oceanic and Atmospheric Administration (NOAA). The NOAA service provides the latest weather information directly from the National Weather Service offices. According to NOAA, about 90% of the U.S. population is within the broadcasting range of at least one of the nearly 380 stations operated in the United States; there are even stations operating across much of southern Canada.

NOAA Weather Radio consists of a network of FM stations broadcasting on one of seven frequencies:

162.40 MHz, 162.425 MHz, 162.45 MHz, 162.475 MHz, 162.50 MHz, 162.525 MHz, and 162.55 MHz. During severe weather, National Weather Service forecasters can interrupt regular programming and insert a special 1050-Hz tone (that lasts for several seconds), which activates specially designed receivers prior to an emergency announcement. It is that "alert tone" that activates the *Weather Alert Decoder* described in this article.

Once triggered, the decoder sounds a warning for several minutes, alerting you to listen to the upcoming message, and lights an "alert received" LED that stays lit until it's reset. The decoder can be used with any scanner or other receiver capable of receiving NOAA weather broadcasts to alert you to a weather emergency.

Circuit Description. Figure 1 shows a schematic diagram of the Weather Alert Decoder. The circuit—built around two IC's, a couple of additional semi-conductors, and a handful of support components—connects to your scanner via a plug selected to mate with the scanner's earphone jack. A resistor (R7), connected across the input to the circuit, provides a DC load for the scanner. The value assigned to that unit (1k) worked well with the author's equipment, but since its value is not critical to



Catch all the latest weather bulletins transmitted by the NOAA with this easy-to-build circuit that alerts you to impending NOAA broadcasts.

BY KEITH RAWLINSON

the rest of the circuit, feel free to make substitutions to accommodate your receiver.

The incoming signal is capacitively coupled to the base of Q1 (configured as a buffer amplifier), which is biased for a gain of around 2 by R1, R2, and R8. The buffer also prevents strong audio signals from damaging U1 by limiting such signals to the 6-volt supply level. The output of the buffer is capacitively coupled through C2 to pin 3 of U1 (a 567 tone decoder). The operating frequency of U1 (1050 Hz in our case) is set by R9, R10, and C4, and is adjustable via R9.

When the frequency of the signal applied to pin 3 matches the preset operating frequency of U1, pin 8 goes low. That low is coupled through R3 to pin 2 of U2 (a 555 oscillator/timer), triggering it into operation. At the same time, the low output of U1 at pin 8 causes C7 to discharge through R3, providing a delay of about 2 seconds. Since the "Alert Tone" falls within the range of the human voice, the system would trigger

Any correspondence for NOAA Weather Radio can be addressed to: National Weather Service (Attn. W/OM11), National Oceanic and Atmospheric Administration, Silver Spring, MD 20910

each time any incoming voice happened to hit the operating frequency if it weren't for the delay.

Once U2 is triggered, its pin 3 output goes high and stays high for a time determined by R6, R12, and C8 (or about three to four minutes depending on component tolerances for the values shown).

The output of U1 divides along two paths: In one path, the signal is used to sound a buzzer, BZ1; in the other path, the signal is fed to the gate of SCR1 through D1 (which helps isolate the SCR's gate from the buzzer) and R13 (which limits the SCR's gate current to a safe

level). Capacitor C9 is placed across the output of U2 to bypass any transition spikes, which might upset circuit operation, to ground.

The entire system can be manually reset at any time by pressing S2. Although a single SPDT switch is shown, it could be replaced by two separate pushbutton switches (one normally open and one normally-closed) if you find the single pushbutton unit difficult to locate. The circuit can be powered by any reasonably well filtered 6-volt DC power supply. Capacitor C3 is included in the circuit to provide additional filtering of the supply voltage at the circuit-board level. Be advised that the 567 is rated for a maximum supply voltage of 9 volts DC. Whatever supply you use, be sure not to exceed that value.

Switch S1 provides a means of testing the circuit from the output of U1 on. TP1 is a test point to be used later in tuning up the system.

Construction. Aside from keeping leads as short as possible, there is nothing critical about the construction of the Weather Alert Decoder, a printed-circuit board is, however, recommended. Figure 2 shows a template of the PC-board pattern used by the author in the construction of his prototype.

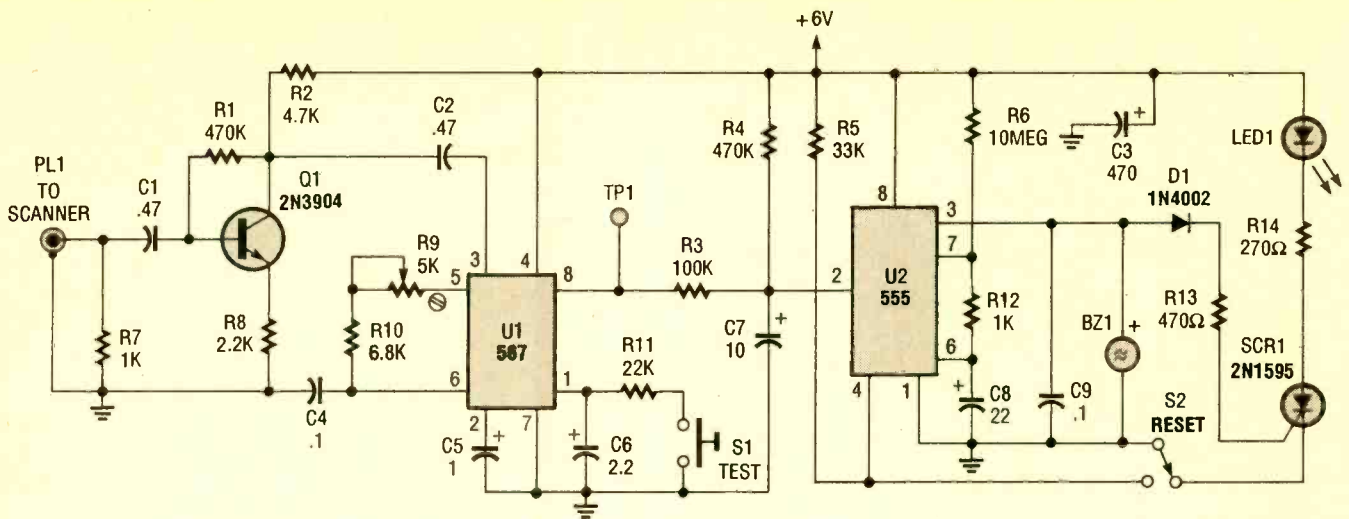

Fig. 1. The Weather Alert Decoder is built around two IC's, a couple of additional semiconductors, and a handful of support components. The heart of the circuit is the U1 (567 tone decoder), which locks onto any signal within its preset capture range.

A parts-placement diagram for the printed-circuit board is shown in Fig. 3. Note that, in the interest of space, R5, R7, and R11-R14, as well as D1, are vertically mounted. Also note that C3, C5, and C6 each have extra mounting holes in the PC board. That's to allow the use of either axial- or radial-lead capacitors (whichever you happen to have). TP1 can be any piece of wire soldered into place and protruding a quarter inch or so above the board. SCR1 can be any SCR with a low enough holding current and sensitive enough gate to operate at the low current levels used in the circuit.

Some of the pads and traces in the layout are close together, so be careful not to bridge them with solder during assembly. The circuit can be housed in any suitable enclosure.

Setup and Use. Once the circuit has been assembled and inspected for construction errors—solder bridges, cold solder joints, and improperly placed components—it's time to tune it up and put it to use. The easiest way to tune the circuit is to connect a frequency counter or oscilloscope to pin 6 of the U1 and adjust R9 for a frequency of 1050 Hz.

PARTS LIST FOR THE WEATHER ALERT DECODER

SEMICONDUCTORS

- U1—567 tone decoder, integrated circuit
- U2—555 oscillator/timer, integrated circuit
- Q1—2N3904 general-purpose, NPN silicon transistor
- SCR1—2N1595 silicon-controlled rectifier, or equivalent, see text
- D1—1N4002 1-amp, 100-PIV, general-purpose, rectifier diode
- LED1—Jumbo LED

RESISTORS

(All fixed resistors are ¼-watt, 5% units.)

- R1, R4—470,000-ohm
- R2—4700-ohm
- R3—100,000-ohm
- R5—33,000-ohm
- R6—10-megohm
- R7, R12—1000-ohm
- R8—2200-ohm
- R9—5000-ohm, 10-turn trimmer potentiometer
- R10—6800-ohm
- R11—22,000-ohm
- R13—470-ohm
- R14—270-ohm

CAPACITORS

- C1, C2—0.47-µF, ceramic-disc
- C3—470-µF, 25-WVDC, electrolytic
- C4, C9—0.1-µF, ceramic disc
- C5—1-µF, 50-WVDC, tantalum
- C6—2.2-µF, 25-WVDC, electrolytic
- C7—10-µF, 35-WVDC, electrolytic
- C8—22-µF, 15-WVDC, tantalum

ADDITIONAL PARTS AND MATERIALS

- S1—Normally open, momentary-contact, pushbutton switch
- S2—SPDT non-locking pushbutton switch
- BZ1—6-volt DC buzzer
- Printed-circuit board materials, phone plug, enclosure, IC sockets, 6-volt DC power supply, wire, solder, hardware, etc.

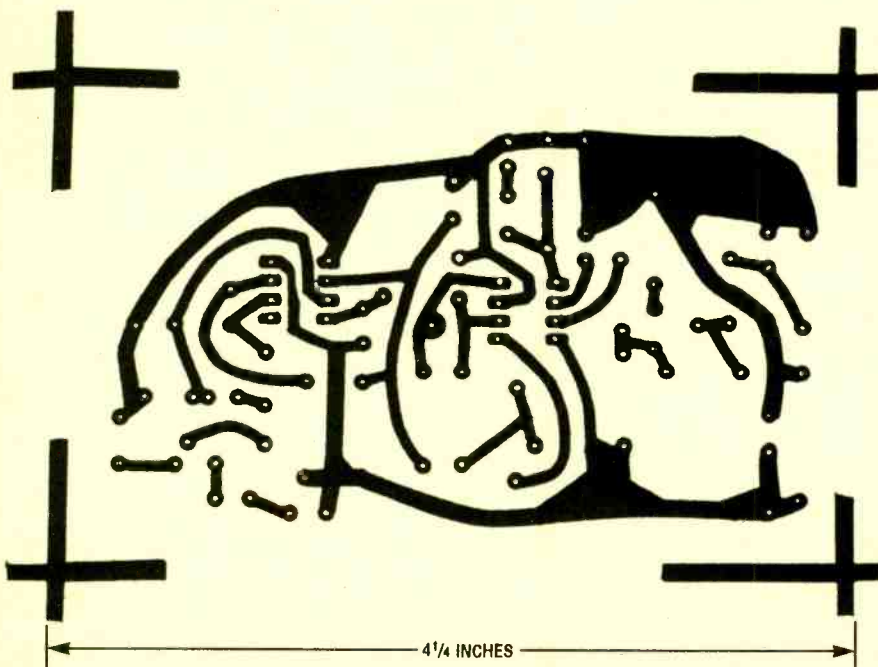

Fig. 2. While there is nothing critical about the construction of the Weather Alert Decoder, it is recommended that the circuit be assembled on printed-circuit board. Here is a template of the PC-board pattern used by the author.

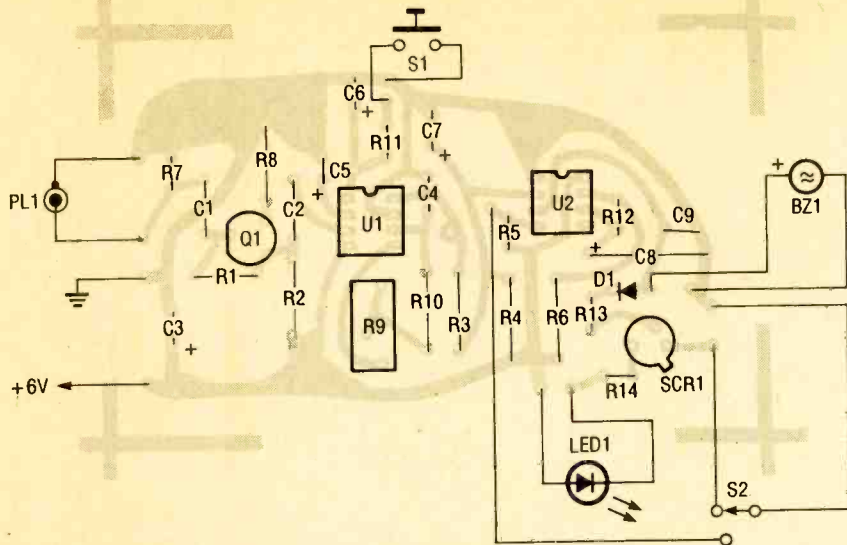

Fig. 3. Use this parts-placement diagram as a guide when assembling the Weather Alert Decoder's printed-circuit board. Note that R5, R7, and R11-R14, as well as D1, are vertically mounted, and that C3, C5, and C6 each have extra mounting holes to allow the use of either axial- or radial-lead capacitors.

If a scope or frequency counter is not available, a signal generator can also be used with only slightly more difficulty. First, solder a 470-ohm resistor to the cathode of an extra LED. Then solder a wire to the LED's anode and connect the other end to the plus supply. Then, connect the remaining lead of the 470 ohm resistor to TP1. Set the signal generator to 1050 Hz at about 0.1 volt and connect it to the input of the circuit. Finally, with R9 fully counterclockwise, rotate R9 slowly clockwise until the LED at TP1 just lights; then, rotate R9 another 3/4 turn.

If you're really a glutton for punishment, the circuit can be set up without any extra equipment. NOAA weather radio often broadcasts a test signal at certain times during the week; if you

write to NOAA at the address given elsewhere in this article you can find out when the tests are broadcast. Connect an LED to TP1 as described above and wait for the test signal. During the test, quickly plug the unit into your receiver and rotate R9 until the LED at TP1 lights. If you fail to get it before the test ends, you'll have to wait for the next test time and continue from where you left off.

Once set up, the circuit will monitor the NOAA broadcast until the alert tone is sent out, and sounds the buzzer for several minutes before resetting; the LED stays on until reset to inform you that an alert went out. Holding the TEST button down for about two seconds will set the system off manually, so you can check it.

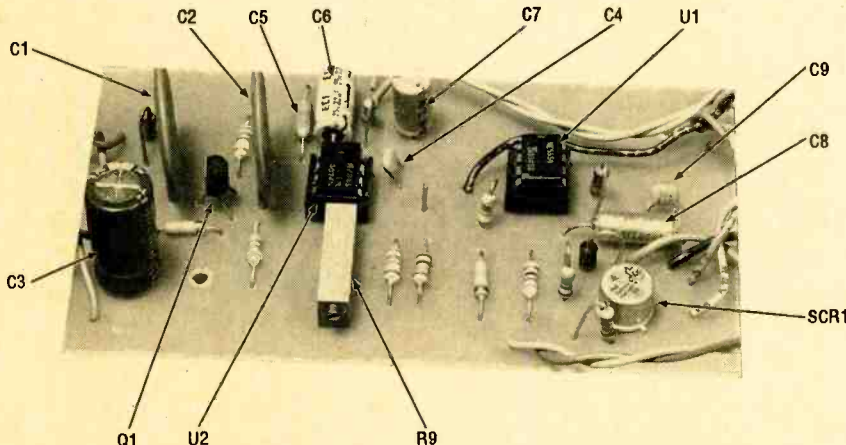

Here is the fully assembled printed-circuit board prior to being mounted in its enclosure. Note that five resistors (R5, R7, R11, R13, and R14) and diode D1 are vertically mounted to the board.

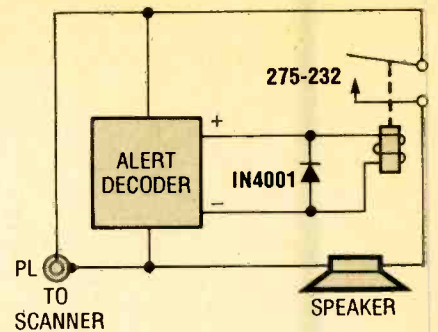

Fig. 4. The buzzer can be replaced by a reed relay provided that your receiver's output jack can drive a speaker directly, thereby allowing you to listen to the warning message.

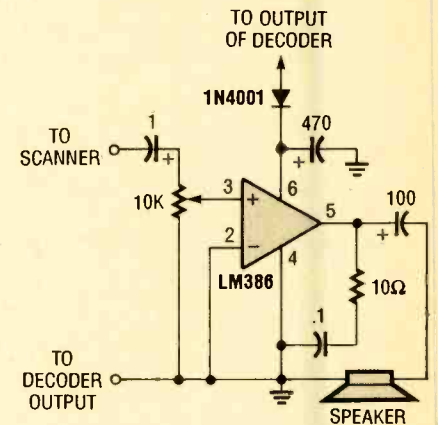

Fig. 5. If your receiver's output can't drive a speaker directly, this circuit will enable you to feed the receiver's output to a speaker.

Troubleshooting. If the LED indicator comes on, but goes out without being reset, try placing a 470-ohm resistor from the SCR anode to the LED anode. If the LED doesn't come on when the buzzer sounds, make sure that D1 is properly installed, then try reducing R13 to 270 ohms. If the buzzer doesn't time out after five or six minutes, try replacing C8 with the highest quality tantalum capacitor you can find. Bear in mind that any noisy signal with a lot of hiss may trigger the decoder constantly.

Modifications. If your receiver output jack can drive a speaker, you can replace the buzzer with a reed relay as shown in Fig. 4. Instead of a buzzer, the speaker will be activated so that you can listen to the warning message. If the output jack can't drive a speaker, try replacing the buzzer with the circuit in Fig. 5 to add the additional boost needed to drive the speaker.

With a little imagination, this circuit could be put to other uses. Just experiment and have fun. ■



THE LASER PC4 PORTABLE COMPUTER



CIRCLE 119 ON FREE INFORMATION CARD

If you need a high-powered number cruncher or database that can follow you wherever you go then check out this model.

It seems as if the majority of people today, in our techno-raptured society, believe that "more is better." In the computer world this has led to enormous complexity where simplicity should prevail. The Laser PC4 offers a refreshing reversal to this trend. For only \$250 you can now have a small, light, portable computer that boasts a full-size keyboard and many conventional functions.

The PC4 is not intended to be your only computer, but an off-site accessory to your desktop computer. It provides for simple file transfers and printouts. Instead of being limited to use only with the IBM PC, versions are also available for the Apple II series and the Macintosh. Actually, the PC4 itself is the same for all versions, but different accessories are included to offer compatibility with the target desktop or laptop. This report is of the IBM PC version.

Small, But Complete. Smaller and lighter than most laptops, and certainly a lot less expensive, the PC4 measures 7.6 inches by 10 inches, and is only 1.6 inches thick. It weighs less than 2 pounds. Unlike many laptops, where it is necessary to buy additional cables, a carrying case, a power adapter, and software, the Laser PC4 comes with everything you need.

Its built-in 2 megabytes of ROM has the following programs: powerful word-

processor with spelling checker; Lotus-compatible spreadsheet; expense account; calculator; BASIC programming language; telephone directory/dialer; appointment book; personal file; alarm clock; and various utilities (including file transfer). More on each of these later.

Three cables are provided. One 6-foot cable is for direct connection to a Centronics-parallel printer port; another 6-foot cable is for file transfer to a computer serial port; a third short cable is provided as an adapter between 9-pin and 25-pin serial ports common on IBM PC computers and compatibles.

An AC power adapter is included, but you can make the PC4 portable for about 40 hours of operation with four "AA" cells. Those same batteries keep your program files and data in memory for up to six months, depending on use. A very nice soft padded-vinyl zippered carrying case is also included. Actually, you don't need to buy anything but the four "AA" batteries—and those are only needed for portable use.

The full-travel typewriter-style keyboard is a pleasure to use. It has 57 keys, with special keys colored gray and regular keys black. It has a solid feel, and is very quiet, yet offers an optional "beep" for each keystroke for those who like the audible feedback. Many of the keys have dual or triple functions, but the CAPS LOCK and NUM LOCK keys, together with color-coded legends,

make access simple. Little things, like having a raised dash on the top of the F and J keys, and slightly wider major function keys, make it easy to touch-type with the PC4 keyboard.

Some Controversy. Two things make the PC4 controversial in today's marketplace. The first is compatibility. The PC4 is not in itself compatible with any other computer. However, using the included cables and software, it can transfer files to and from other machines. Even though I tested the IBM PC version, I had no trouble at all transferring word-processing files to a TRS-80 Model III or model IV!

The PC4's 15-pin output connector acts as either a serial or Centronics-parallel port, depending on your commands. As a serial port, it seems to conform to RS-232C standards. Using the serial cable supplied with the PC4, I uploaded to my TRS-80 using a standard terminal program, saved the resulting file on disk, and used the file in my regular TRS-80 wordprocessor program for cleanup and final formatting. That has freed me from having to work where my desktop computers happen to be—usually the hottest or coldest locations!

The other controversy has to do with displays. It seems to most users that any display with less than 80 characters on a line, or 25 lines, is crippled. Perhaps because of my satisfactory experience

with smaller computer displays (as little as two lines with only 20 characters each!) I'm less biased than many.

The PC4 offers a bright, sharp LCD readout of 4 lines with 40 characters on a line. I did not find this very limiting at all. If you are suffering with the 80 x 25 syndrome, however, you'll need to actually use the PC4 display before you believe how adequate it is. Incidentally, the PC4 display is perfectly clear even in direct sunlight, unlike some LCD laptop computer displays I've seen.

Documentation. In addition to all the cables, the power adapter, and the carrying case, the PC4 comes with some excellent documentation. For transferring files, an appropriate file-transfer program is provided. With the IBM version, for example, you get a special version of "PC Tools Desktop Manager Version 5.5," a program that normally sells for about \$100. It comes complete with a 312-page manual and two 360K, 5.25-inch floppy disks to use with any IBM PC or compatible. The telecommunications module of PC Tools has been revised to add special file-transfer capability for the PC4.

You also receive four other pieces of excellent documentation with the PC4. The "File Transfer Guide" covers the uploading and downloading of PC4 files with your PC, using the special PC Tools transfer program. The "Ten Minute Tour" takes you on a brief trip through each of the PC4's built-in programs, while the "User's Manual" is handy for reference to details. Help screens are available within the PC4 for each program, and the single-sheet two-sided "Quick Reference Guide" shows all the important commands for all the programs.

Programs. It would take a book (after all, the User's Manual is 278 pages) to explain all the features of the PC4's built-in programs, but here are the main points of each:

The word processor has most of the features you've probably come to expect, except block-copy or moves. Text is automatically word-wrapped on entry. You can search and replace text, spell-check individual words or the entire document, and provide detailed page formatting with 22 "dot commands." You can even specify headers and footers. Files can be dumped directly to a printer without transfer to a computer, or you can transfer the text file, with or without formatting, to your computer. You then save it on disk and

load it back into the PC4 or use it (if saved without formatting) as a generic text file. In order to load a file into the PC4 from a computer, however, it must first have been created and saved using the PC4.

With over 80,000 words in memory, the spellchecker can be accessed by itself, or from within the Word Processor. You type in the word the way you think it's spelled and the correct spelling (usually with several alternatives, if you've entered an incorrect spelling) is displayed. For example, I typed in "spelling" and got spelling, spewing, spellings, spilling, speaking, spearing, specking, speeding, spending, splint, spooling, spring, spying and swelling as possible choices!

The spreadsheet is by far the most elaborate program built into the PC4. By its very nature and size (256 columns, by 8192 rows for a total of over 2 million cells!), this Lotus-like and Lotus-compatible electronic worksheet will take some time to learn to use unless you're already "spreadsheet literate." The display only shows three cells across and two high at any one time, so this is where the limited display is at its greatest disadvantage. A "Range" command lets you navigate quickly around the spreadsheet, and macros are supported to eliminate repetitive keying. You can copy and move cells and retrieve, erase, or sort files. Support is provided for many financial, statistical, and date functions. You can send all or part of a spreadsheet to a printer, or upload it directly to a Lotus-compatible program on your computer for further manipulation. With the proper procedure, you can download spreadsheet files from your computer to the PC4.

The expense-account program allows you to record personal and business-related expenses. With seven built-in categories like "Lodging" and "Transportation," and subcategories, you can easily sort your expense records for quick reference. You can add, review, change, and delete entries, categories, or subcategories, and print a daily or weekly report for any or all categories.

With ten memories and seven scientific functions, the calculator permits you to perform a wide range of business and household calculations. You even have the option of converting between decimal and hexadecimal numbers. However, I was surprised that none of the calculations can be sent to a printer or saved in any way, except for

storing a result in one of the memories. For printouts, use the spreadsheet.

But what about programming in BASIC? I found at least 50 reserved words used by this version of BASIC. All the most common words and typical strings functions are supported. Multiple-character variables can be used, and various trigonometric and logarithmic functions are included. Surprisingly, I could not find any support for even simple arrays. Most of the keywords are directly accessible with CTRL key combinations, saving a lot of typing, and full-screen editing is allowed. You can LPRINT and LLIST to a printer, but I was unable to save a PC4 BASIC program to another computer. Ten different BASIC programs can be saved in memory at the same time.

The telephone directory/auto dialer is a mini-database for names, addresses, phone numbers, and a one-line note. You can add, search, change, delete, or list entries, and send output to a printer in any of two page formats or two mailing-label formats. You can also tone dial using a built-in speaker.

By using the built-in appointment book, you can list your appointments and print them out in any of two printer formats. You can also set an alarm for each appointment.

The personal file is like a collection of five-line cards for storing personal information, such as credit-card numbers, insurance-policy numbers, recipes, or other notes. Password protection is provided. The information in this file can be sent to the printer in two different page formats.

Using the alarm/date clock, up to sixteen alarms can be set as friendly reminders of important events. The alarms can be daily or weekly, and include the Appointment Book alarms.

Last, there are software utilities. These programs allow you to set serial transmit and receive parameters, configure the unit for different printers and ports, look at a memory map, erase files, or look at help files.

The built-in 32K RAM can be upgraded by popping out the 32K RAM chip and replacing it with an optional 128K RAM chip (\$40.) There is also an expansion slot for optional cartridges. The Roget's II Electronic Thesaurus cartridge with 500,000 synonyms (\$45) is presently available, with medical and legal dictionary cartridges promised.

I found the PC4 extremely friendly and forgiving, and capable of doing a

(Continued on page 85)

PRODUCT TEST REPORTS

By Len Feldman

Toshiba M-441 Video Cassette Recorder

The Toshiba M-441 video recorder is a VHS-format model that incorporates many features found only in more expensive units. Its frequency-synthesized tuner section automatically selects any of the up to 181 VHF, UHF, or cable-TV channels receivable in your viewing area. Extensive timer-record programming—8 events over a period of 1 full year—is provided, as are such special effects features as frame-by-frame viewing, still-frame viewing, and picture search at either 5-times normal

unit for timer recording. All of the on-screen functions are controlled by means of a supplied remote-control.

This VCR uses a quick-access system that enables you to switch operating modes rapidly. For example, a conventional VCR needs between 8 and 10 seconds to switch modes from play to rewind. With the quick-access system, the same operation can be accomplished in from 2 to 3 seconds. This function can be used for both playing and recording. In fact, this VCR starts recording almost

behind a drop-down hinged panel that runs the full width of the unit. With this panel in its closed position, only the power switch, an eject button, the cassette slot, and the display area are visible. Dropping down the hinged panel reveals the usual tape transport and record controls, a speed selector button (the unit records at either the SP or EP speeds, but can also play back tapes recorded at the LP speed), a TV/VCR selector switch, channel-up and -down buttons, and video and audio input jacks used for recording from an external source such as a camcorder, a TV monitor/receiver, or another VCR. When connection is made to this front-panel video-input jack, the line input rather than internal tuner is automatically selected as the program source to be recorded.

Virtually all of the special-effects mentioned earlier as well as all timer programming is accomplished using the infrared remote control rather than front-panel buttons. Direct channel access is also possible only via the remote.

The front-panel display area provides channel-number indications, current tape speed, clock time, and remaining tape-time indications in addition to a wide variety of status displays. The rear panel of the M-441 is equipped with the usual coaxial RF-input and -output jacks, audio- and video-output jacks, and a channel-3/-4 switch.

CIRCLE 120 ON FREE INFORMATION CARD

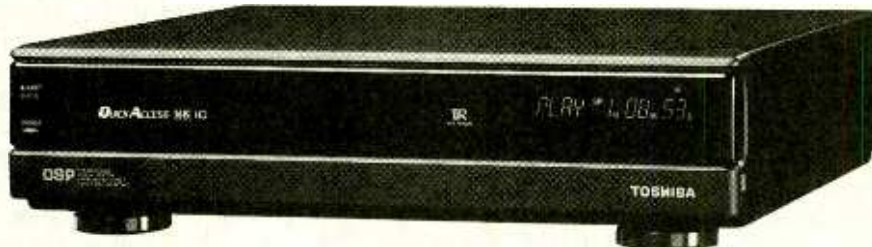

The Toshiba M-441 VHS VCR.

viewing speed or at 7-times normal speed in the SP tape-speed mode, or 21-times normal viewing speed in the EP tape-speed mode. One-touch instant recording within a period of 24 hours is also easily programmed.

On-screen menus are used for setting correct clock time, initial setup of antenna and automatic channel selection, auto-repeat-play of a tape, index marking and searching, and edit dubbing. Other menus guide the user, step by step, through the procedure used to set up the

immediately after the record button is pressed.

When a cassette is loaded into the tape slot, power is turned on automatically, and if the tape's safety tab has been removed (as in the case of a prerecorded tape), playback begins. At the end of such a tape's play, it is automatically rewind and ejected, and the power is turned off. Pressing the eject button, even when power is off, will eject a tape.

CONTROLS

Most of the M-441's operating controls are hidden

TEST RESULTS

As in previous video-product test reports, all laboratory performance measurements were made by the Advanced Product Evaluation Laboratory (APEL), under the direction of Frank Barr. The results of these lab tests, along with the sample actually tested, were then sent to our lab where further subjective testing and hands-on evaluations were done. As has been APEL's practice in the past, all measurements were made at the faster SP tape-speed, since that speed yields the best performance. If you use this machine at its slower EP speed (for a maximum of 8 hours of recording time using a T-160 tape), you can expect both video and audio performance to be somewhat poorer than the results obtained in APEL's tests.

The video-frequency response at 2.0 MHz was off by some 3.65 dB, which is about average for a basic VHS recorder of this type. At 3.0 MHz, the response had dropped to -17.8 dB. When in the edit mode, however, frequency response improved somewhat, so that at 2.0 MHz it was down by only 0.75 dB, and at 3.0 MHz it was down by only 1.75 dB. That mode is used when copying tapes from one machine to the next and the added response ensures that there will be less degradation of picture quality on the copy than might otherwise be the case.

APEL measures color signal-to-noise ratios in two ways: with respect to AM (amplitude modulation) noise and for PM (phase modulation) noise. In the case of this recorder, AM chroma noise measured an average 42 dB, while PM noise measured 38.5 dB. That is about average, or

TEST RESULTS—TOSHIBA M-441 VCR	
Specification	PE Measured
Video frequency response	
At 2.0 MHz	-3.65 dB
At 3.0 MHz	-17.8 dB
(See text regarding response in Edit mode)	
Video signal-to-noise ratios	
Chroma AM	42.0 dB
Chroma PM	38.5 dB
Luminance, 100 IRE reference	42.3 dB
Luminance, 50 IRE reference	42.7 dB
Luminance, 10 IRE	41.1 dB
0-dB audio reference level	0.5 volts
THD at 0-dB audio reference level	1.31%
THD at -10-dB reference level	0.33%
Audio frequency response	230 Hz to 13.5 kHz
Additional Data	
Power requirements	21.0 watts
Weight	13.0 lbs
Fast-forward time (T-120 tape)	3 min. 21 sec.
Fast-rewind time (T-120 tape)	3 min. 17 sec.
Dimensions (H x W x D, inches)	3 3/8 x 14 1/8 x 13 1/8
Suggested price:	\$389.95

perhaps just slightly below average for this basic type of video recorder. The signal-to-noise ratio for the luminance, or brightness portion of the video signal measured between 41.1 and 42.7 dB, depending upon the reference luminance level used when making the measurement.

The audio recording and playback performance of the VCR was also measured. The output for a 0-dB reference level was 0.5 volts at a total harmonic distortion level of 1.31%. At -10-dB levels, distortion decreased to 0.33%. A-weighted signal-to-noise

ratio for the audio track measured 46.2 dB, which is again about average for monophonic linear edge track audio recording on a standard VHS VCR. While the low-frequency response was poor (down 3 dB at 230 Hz), treble response was much better than average, extending to 13.5 kHz for the -3-dB cut-off point. All of the video and audio measurements made by APEL are summarized in the table that appears elsewhere in this report.

HANDS-ON TESTS

By far the best thing about this relatively inex-

pensive VHS VCR is its on-screen menu system. A study conducted by a noted research organization revealed that an astounding 80% of the people who own VCR's have never even used the unit's timer-recording capability. An almost as great percentage of VCR owners have never bothered to set the correct time on the VCR's clock display. Toshiba has simplified those tasks considerably with their on-screen menu system.

In our hands-on evaluation of picture and sound quality, we found that color reproduction when playing back a recording made on this machine was quite good and background noise levels were acceptable, if not superior. The quick-access feature described earlier really does cut down the time required to get into the record mode or, for that matter, to activate any of the other tape-transport functions. Still-frame viewing was accomplished with a minimum of noise streaks.

The owner's manual is well written, though it does apply to four models by Toshiba; though the differences between those are minor, you will need to be sure that you are referring to instructions for the correct model to avoid confusion. An antenna cable is provided with the unit, but if you want to make direct audio or video connections to other video equipment, you will have to purchase your own shielded audio/video connecting cables. If your TV-antenna transmission line is of the 300-ohm type, you will also have to purchase a 75/300-ohm transformer.

For more information on the M-441 VCR, contact Toshiba (82 Totowa Rd., Wayne, NJ 07470) directly, or circle No. 120 on the Free Information Card. ■

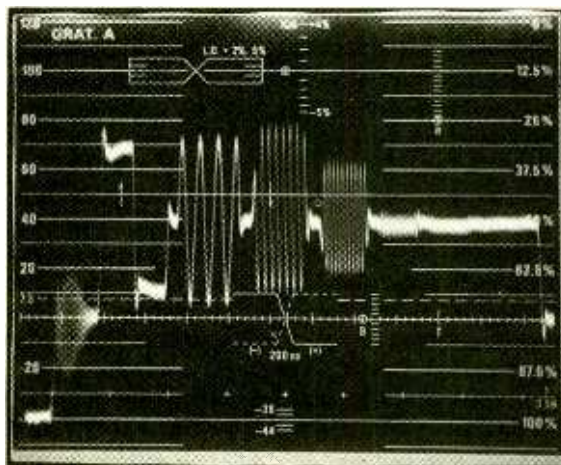

At 2.0 MHz, the video-frequency response was off by some 3.65 dB, which is about average for a basic VHS recorder of this type. At 3.0 MHz, the response had dropped to -17.8 dB. The frequency response of the VCR improved somewhat when the unit was in its edit mode.

ANTIQUE RADIO

By Marc Ellis

Operating The Cunningham Special

In the February, 1991 issue, we presented the schematic diagram for a tube tester I call "The Cunningham Special." The name came from the fact that the tester was adapted from a (1920's vintage) design by the engineers of the E.T. Cunningham tube company. Previous issues of the column (September, October, and December, 1990; January, 1991) had developed the theoretical basis for the tester, worked out modern methods for supplying and regulating filament and plate voltage to the tube under test, and

suggested methods for modifying and calibrating voltage and current meters for use in the instrument.

Though February's schematic was thoroughly tested breadboard-style and proven to be reliable, I hadn't yet built a complete, finished prototype of the unit. This month, we'll conclude the tube-tester series by giving you a look at the now-completed instrument and talking about how to operate it.

ONE MORE HONORABLE MENTION!

But before we get into The Cunningham Special, there's a bit of unfinished business from last month's column. Last month, you'll recall, I honored the entrants to our recent Theremin contest. In that contest, readers were encouraged to send in technical and historical information on the RCA Theremin—a vintage electronic musical instrument from the late 1920's.

Eight of the over 40 entrants received a reprint copy of the interesting 1920's-era Gernsback publication, *100 Radio Hookups*, but everyone's contribution was acknowledged in detail. Everyone's, that is, but David Ballinger's—which was accidentally omitted. Dave (who hails from Virginia Beach, VA) sent along a dub from the Clara Rockmore CD *The Art of the Theremin* (see last month's column for a discussion of that fascinating recording, which is still available in record stores) and also passed along some childhood memories of a Thereminist who performed at his grammar school.

Like everyone who entered but didn't win, Dave gets a warm thank-you and an honorable mention for his submission. And we'll be back with more on the Theremin story next month!

TUBE-TESTER CONSTRUCTION

Most key constructional details on The Cunningham Special have been covered in earlier issues (especially December, January, and February). However, here are a few points relating to the prototype shown on these pages.

The Cunningham Special is built almost completely of standard parts, but the cabinet is one exception. It's a neat sloping-front hammetone-gray job (Bud C-1587-H.G.) that I picked up at a hamfest flea market. You'd have to be lucky to come across another one like it, but it doesn't matter. Exercise your ingenuity and use whatever type of enclosure suits your fancy; the layout is not at all critical.

With the particular cabinet I used, it seemed natural to put the tube-socket array on the top cover and the control and metering circuitry on the front panel. The power-supply components were installed within the cabinet with plenty of room to spare. To give you a better feeling for the layout, I've marked all visible components with their designations from the February, 1991 schematic.

Of course, the tube sockets themselves aren't standard components either. The whole point of this tester is that it has been designed to accommodate



The Cunningham Special makes a neat package in its vintage sloping-front cabinet. Old-style round meters heighten the antique effect.

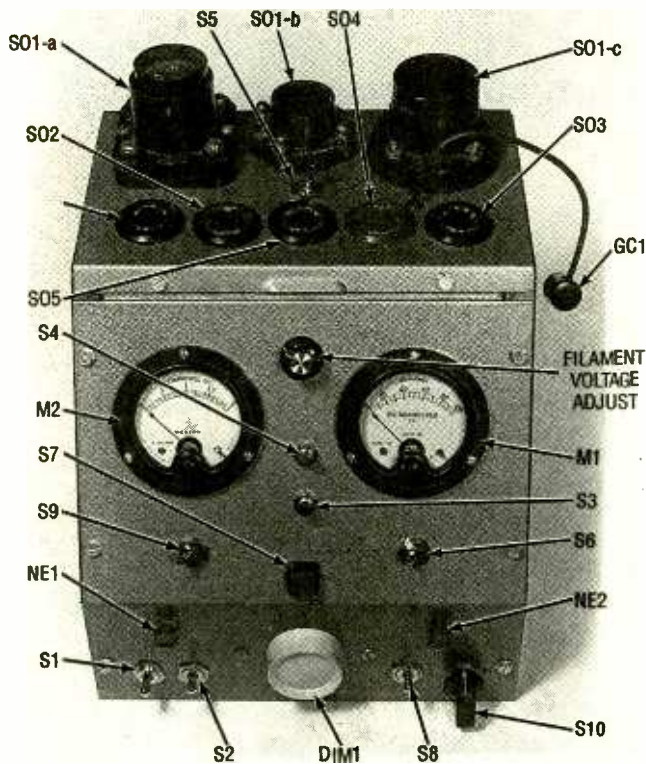

The tester's front-panel and top-cover layout. Part designations refer to the schematic diagram in the February, 1991 column.

tubes with archaic and obsolete bases. To acquire the needed units (particularly the ones in the back row), you'll have to do a bit of scrounging at electronic flea markets. I found mine at an Antique Wireless Association meet.

The socket on the extreme right in the back row takes short-pin, bayonet-mount tubes such as the UV-201-A. Just to the left of it is a similar socket in the "bantam" size; that one is for tubes such as the UV-199. I never was able to find a special socket for the type WD-11 (the one with one fat pin and three skinny ones rather than the usual two fat, two skinny configuration). However, the dummy socket at back row left serves as a holder for an adapter I happened to have that allows the WD-11 to be tested in the UV-201-A socket.

Even the much-more-recent, "standard" 4- and 5-prong sockets, as used in the front row, can be a bit of a problem to obtain.

They're not at all difficult to find at surplus dealers and electronic flea markets, but you certainly won't be able to walk into a Radio Shack and pick one up!

The only other unusual (by modern standards) part worth mentioning is grid cap GC1. I salvaged mine from a junker radio. If you can't find one to cannibalize, use an alligator clip for the time being. You can substitute the real thing after you succeed in scrounging one!

Now let's talk about how to operate this tester.

PRELIMINARY ADJUSTMENTS

Do not insert the tube to be tested until you've made preliminary adjustments as follows. (To make these instructions more meaningful, refer to the schematic diagrams in the December and February issues as you read.)

First apply power to the instrument by turning on switch S1. Pilot lamp NE1 should light. Check S2 to

make sure it's in the LO position. Now place switch S10 in the LINE position, make sure that the CURRENT RANGE switch S6 is set for the lower current range (which is the normal testing position), and rotate the LINE ADJUST control (DIM1) until the needle of meter M1 rests on the reference mark you established earlier (see the February issue).

If the tube is a type 80 or 81, test procedures will be covered later. For all other tube types handled by this tester, you should now set the filament voltage to the value shown in Table 1. To do that, set the VOLTAGE-RANGE switch, S9, to the lowest range that will handle the required voltage. Then rotate the FILAMENT VOLTAGE ADJUST control (the potentiometer in the voltage-regulator circuit discussed in December) until the correct value is indicated on meter M2.

The minimum voltage you will be able to obtain with that control is approximately 1.2 volts. So if the tube is a type 11 or 12 (1.1-volt fila-

ment), you should also open FIL RESISTOR switch S8, which inserts resistor R6 into the filament circuit. That drops the voltage an additional tenth of a volt or so, though its effect will not be seen until the tube is plugged into the socket.

If I seem to be splitting hairs by worrying about a tenth of a volt, it's because the types 11 and 12 are quite costly, difficult to obtain, and easy to damage! For all other types of tubes, resistor R6 is not needed, and switch S8 should be kept closed.

If you can't obtain a high enough filament voltage for the tube to be checked, move switch S2 to the HI position and try again. But to avoid unnecessary load on the voltage regulator circuit, leave S2 on LO whenever possible.

With the voltage set correctly, you may now insert the tube to be tested into the proper socket (see Table 1 and the schematic in the February column). If the tube has a top grid connection (types 22, 24, or

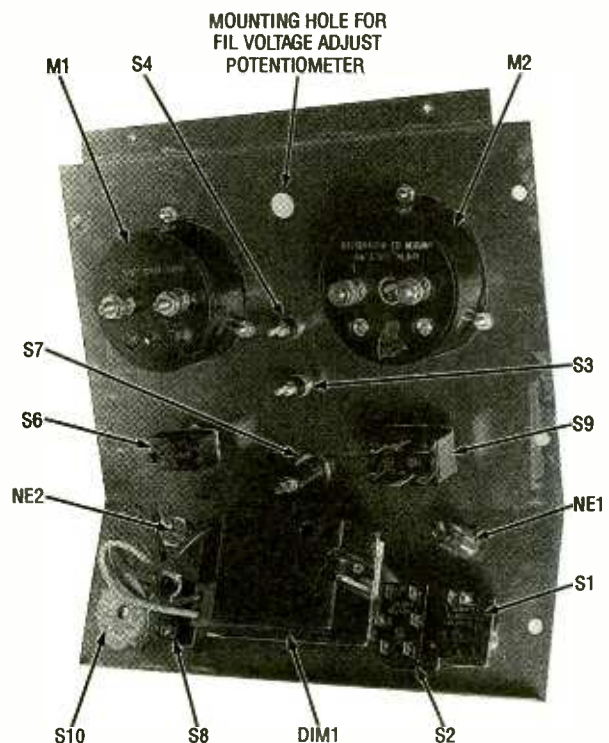

The back of front panel prior to beginning the wiring.

24A), be sure to attach grid cap GC1.

Watching meter M2, you'll see the filament voltage drop a bit under the load of the tube—then increase again as the voltage-regulator circuit re-establishes the correct value. **Under no circumstances is the tube to be inserted before the voltage is adjusted!** The voltage remains quite stable after it's set, but small movements of the voltage control can cause large swings in voltage, and you can burn out a filament before you know it.

I burned out a tube in just that manner (and a type 12 at that!) while testing the breadboard version of this instrument. To say that I'm still kicking myself is putting it mildly!

CHECKING AMPLIFIER TUBES

If the tube to be checked is an amplifier tube (any type on Table 1 except the 80 or 81—which are rectifiers), proceed as follows. First, move function switch S10 to the SHORTS position and watch neon lamp NE2. If it lights (ignore any momentary flickering), the tube is probably shorted, and you should avoid advancing switch S10 to the TEST position. Otherwise a large current surge could pass through meter M2, possibly burning it out.

If there is no short, move S10 to TEST and read the tube's plate current on meter M1. You should obtain a value near that shown in Table 1 under "S7 Not Pressed (mA)." Now press the GRID-SHIFT button (switch S7) and note the reading. It should have increased to a value near that shown in Table 1 under "S7 Pressed (mA)." The difference in readings is an indication of the amplifying ability of the tube.

Due to individual differences in construction,

TABLE 1—SPECIFICATIONS

Tube Type	Socket	Fil Volts	S7 Not Pressed (mA)	S7 Pressed (mA)
00A	S01 Series	5.0	1.5	3.5
01A	S01 Series	5.0	1.7	4.5-5.0
10	S01 Series	7.5	2.0	6.0
11	S01 Series	1.1	1.0-1.5	2.0-2.5
12	S01 Series	1.1	1.0-1.5	2.0-2.5
12A	S01 Series	5.0	2.0	6.5-7.0
20	S01 Series	3.3	2.5-3.0	5.5-6.0
22	S03	3.3	2.0	4.0-6.0
24	S04	2.5	1.0	2.6
24A	S04	2.5	1.0	2.6
26	S01 Series	1.5	1.5	4.0
27	S02	2.5	1.5-2.0	3.0-5.5
40	S01 Series	5.0	.7	1.7
45	S01 Series	2.5	3.0	11.0
50	S01 Series	7.5	3.0	10.5
71A	S01 Series	5.0	3.5-4.0	12.0-13.0
80	S05	5.0	100	—
81	S01 Series	7.5	100	—
99	S01 Series	3.3	1.5	3.0

the values you observe may not be exactly like the values in the table, but you should be somewhere in the same ballpark. To set more accurate standards, you might like to test several good tubes of each type, averaging the results and recording them for future reference.

To check for the presence of gas in the tube, press the GAS button (S4). There should be no change in the plate current observed on M1. If there is, gas is present to some degree. If the tube has a cathode (types 24, 24A, or 27), now press the LEAKAGE button (S3). The M1 meter reading should immediately drop to zero; if it doesn't, there is a leakage path—possibly a dead short—between heater and cathode.

CHECKING RECTIFIER TUBES

If the tube being checked is a type 81 rectifier, proceed with the preliminary adjustments exactly as described earlier. However, since rectifier tubes draw much more current than the amplifier tubes handled by this instrument, set the CURRENT-RANGE switch (S6) for its higher range after setting the LINE ADJUST control.

Make the SHORTS test just as if you were checking an amplifier tube, then move S10 to the TEST position and read M1. That is the only plate-current reading you can obtain, since the tube has no grid and hence there can be no grid-shift reading. Compare it with the reading given in Table 1 under "S7 not pressed (mA)." The GAS and LEAKAGE tests have no meaning for standard rectifier tubes.

The type 80 is tested in a similar manner to the type 81, with a couple of minor exceptions. First, the FILAMENT-VOLTAGE ADJUST control is not used with that tube since the filament draws too much current for it to be supplied from the adjustable voltage-regulator circuit. The filament is connected to the DC power supply, ahead of the regulator circuit, through a dropping resistor that reduces the supply voltage to the correct amount. The reading on meter M2 has no meaning in this case.

The type 80 receives the correct filament voltage only if switch S2 is set to the LO position. When S2 is set to HI, the type 80's filament is automatically disconnected to prevent burnout due to overvoltage.

The plate-current reading for the type 80 is taken in the same manner as for the type 81. However, the type 80 has two plates, so two separate plate-current readings must be taken. The 2ND PLATE switch, S5, selects one or the other of the two plates. The reading for each plate should be close to the value given in Table 1 under "S7 not pressed."

ADVANTAGES AND LIMITATIONS

In concluding the series on The Cunningham Special, I'd like to stress what this instrument will and won't do. It hasn't been designed to check hundreds of different kinds of tubes. For that, your best bet would be to acquire a commercial tube tester. And it won't give you a definite "good" or "bad" reading on the condition of a tube. But few testers (including those that do have "good/bad" scales) provide definitive information about the condition of a tube.

What the unit will do is provide a reliable check on about eighteen early tube types, comprising most of those available through about 1932. The earliest types in that group usually can't be handled by commercial checkers, which lack the required test data and/or special sockets.

Though you don't get a specific "good/bad" answer from the instrument, it will give you a very good indication of the general condition of a tube—and is also very useful in comparing a group of similar tubes to identify the best ones.

Finally, I wouldn't recommend The Cunningham Special as a project for an inexperienced builder.

If you feel that The Cunningham Special has a place on your workbench, go to it! And I hope you find this instrument as much fun to put together as I did! ■

COMPUTER BITS

By Jeff Holtzman

Hypertext: Hype or text?

This is a three-part story. Part I occurred in the 1940's. Part II occurred in the 1960's. Part III is happening right now (unfolding right before our very eyes). The basis of this story is a new technology variously called hypertext, hypermedia, and multimedia. Cynics say that hypertext is just another fad, soon to be replaced by another. A more sober assessment is that it's a solution in search of a problem.

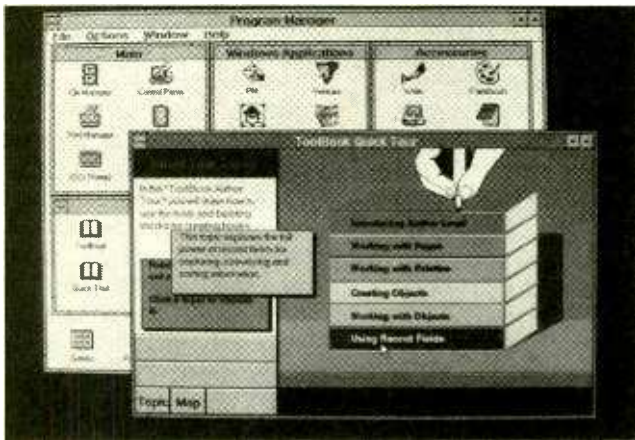

ToolBook is the premier hypertext-development environment for the PC. It contains powerful tools for creating attractive drawings, simple databases, and provides a means of linking its screens together in a natural, intuitive manner.

Visionaries think that hypertext is going to revolutionize everything from computer operating systems to application programs to games and entertainment to educational software to electronic mail and corporate communications generally. Pick any large computer company (IBM, Apple, Tandy, Fujitsu, HP, Microsoft), and it's a sure bet that extensive research on hypertext is going on therein.

* All quotes from the article as reprinted in CD ROM: The New Papyrus, Microsoft Press, 1986.

What is hypertext? Where did it come from? What's it good for? This time and next time we'll take a stab at answering those questions.

PART I

In 1945, Vannevar Bush (an electrical engineer credited with inventing the first analog computer, and who also happened to be President Roosevelt's science adviser) published an article in a popular magazine, the *Atlantic Monthly*. The article was entitled "As We May Think." The title indicates Bush's subject: cognition, how we think. In Bush's words, "The human mind...works by association. With one item in its grasp, it snaps instantly to the next that is suggested by the association of thoughts, in accordance with some intricate web of trails carried by the cells of the brain...the speed of action, the intricacy of trails, the detail of mental pictures, is awe-inspiring beyond all else in nature."

In the article, Bush laments issues familiar then and all the more so now: specialization of knowledge and professional function, and exponentially growing mounds of information in which the "truly significant attainments become lost in the mass of the inconsequential."

Bush's solution was a device he called the "Memex," a desk with a huge library of microfilm sheets, and mechanisms to manipulate them, view them, navigate among them, and annotate them. The crucial idea is that of "associative indexing, the basic idea of which is a

provision whereby any item may be caused at will to select immediately and automatically another."

By today's standards, the Memex has all the grace and subtlety of a Buck Rogers film. However, Bush's associative indexing has seeded a revolution whose full significance no one can yet foresee.

For the next twenty years or so, development of digital computers and solid-state devices proceeded briskly, while Bush's ideas lay fallow.

PART II

In the early 1960's, computer pioneer Ted Nelson took the idea of associative indexing and generalized it from an essentially individual method of presentation to a cross-cultural network of scientific and literary works, interconnected, cross-referenced, and annotated by anyone who cared to comment. Nelson also included a filtering mechanism to help screen useless comments, and a method of respecting copyrights, so that original authors would be paid royalties when their works were accessed.

Nelson dubbed his scheme hypertext, and defined it simply as "non-linear reading and writing." Nelson's ideas have been highly influential, but it took drastic advances in the amount of computer power available to the average person, along with the deployment of "user-friendly" devices and techniques (mice, bit-mapped graphics displays, non-batch operating systems) before hypertext was quite ready for prime time.

Another twenty years lapsed; for the most part, hypertext remained in the realm of esoteric academic research. In the meantime, the computer was getting a lot smarter—and a lot cheaper. And computer and cognitive scientists were learning much about the charms necessary to tame that savage beast.

PART III

In 1987, Apple Computer released a program for the Macintosh called HyperCard. With a single stroke, Apple unintentionally unleashed one of the most powerful forces in nature: human creativity. And, in an extremely unusual marketing move for Apple, the company simply gave the program away with every Mac sold thereafter.

What is HyperCard? Bill Atkinson, one of its creators, often describes HyperCard as a "software erector set." By way of analogy, imagine that cars were built out of standard components with standard interfaces. Using standard components, you could build your own car by choosing an engine here, a transmission there, a body somewhere else, and interior styling in yet another place. Bolt the whole thing together, and you'll have a serviceable vehicle that accomplishes the goal of any automobile (getting you where you want to go), does so in a highly individualized style, and does so without great design effort or expense.

That's what HyperCard did for the computer environment. And it just so happened that in doing so, HyperCard embodied several (but by no means all) of the most important ideas associated with hypertext. That, in turn, led to a groundswell of interest in hypertext academically, commercially, and even at the hobbyist level.

Academically, HyperCard's success served as a catalyst for increased funding and activity. Commercially, it spurred good old American competitiveness ("Anything you can do, I can do better"). Since HyperCard's release, several companies have released similar programs with greater capabilities; other companies have released similar products for the PC environment. Mac hobbyists got into the act by building their own HyperCard programs and sharing them on electronic-bulletin-board systems (BBS). Commercial developers have built and are now selling HyperCard stacks on diverse subjects.

SO WHAT?

Hypertext is catchy. If you don't believe that, find a friend with a Mac (or go to a local computer store) and get a demo of HyperCard. If you've got Windows 3.0, install the demo program DayBook and spend some time thinking about not so much what it does, but how it does it.

Hypertext is catchy. Why? Because it works the way the mind works—associatively. Because it uses all media: text, sound, still graphics, motion video. Because it gets you involved. Because it is fun.

Our age is often characterized as the age of information. After a couple more stages in its evolution, Hypertext is going to be the tool that brings the exponentially exploding mass of information under control. It's almost paradoxical that the very machines that

have helped create a rat's nest of information will also help us untangle the mess.

Looking for a business opportunity or a new (or first) career? Here's another quote from Bush's article: "There [will be] a new profession of trail blazers, those who find delight in the task of establishing useful trails through the enormous mass of the common record."

Want to play with hypertext? One of the older magazines dedicated to personal-computer programming, *Doctor Dobbs*, dedicated its June, 1990 issue to hypertext, and also published an electronic (hypertext) version of that issue. I'll post it on the Gernsback BBS (516-293-2283, 300/1200, 8N1); look for file DDJ6-90.ZIP. Even the ZIP file contains more than 800K, so you may want to order a disk directly from the company that built the hypertext version (Ntergaid,

2490 Black Rock Turnpike, Suite 337, Fairfield, CT 06430; Tel. 203-368-0632). For further reading, consult the October 1988 and February 1990 issues of *Byte* magazine. For additional references, contact me c/o **Popular Electronics** (500-B Bi-County Blvd. Farmingdale, NY 11735).

A couple of years ago, a cranky professor of mine stated categorically that hypertext was more hype than text. That statement may have been true then, but today there are more and more instances of truly wonderful hypertext products. Hypertext is definitely here to stay!

Next time, I'll talk about some commercial products that use hypertext, and about "ToolBook," a hypertext development environment for the PC that provides a superset of the functions provided by HyperCard. ■

AMAZING NEW Pocket Reference

480 pages of tables, maps, formulas, and conversions and it fits in your shirt pocket (3.2" x 5.4" x 0.6")!

\$9.95*



* Plus \$2.00 shipping & handling. Colorado residents add 56¢ tax.

Small sample of contents

Air Tool CFM vs PSI	Radio Alphabet
Battery Charging	TEN Radio Codes
Tire Manufacturer Codes	Telephone Area Codes
Lumber Sizes & Grades	Lost Credit Card Phones
Concrete & Mortar	Sound Intensities
Element Tables	Wind Chill Factors
Computer ASCII Codes	Frequency Spectrum
IBM® PC Error Codes	Geology Mineral Tables
IBM® Interrupts-I/O Map	Glues and Solvents
80286 Hard Disk Types	Bolt Torque Tables
Printer Control Codes	Wood Screw/Nail Sizes
Electric Wire Size vs Load	Math Formulas & Tables
NEMA Motor Frames	Plane/Solid Geometry
Wire & Sheet Gauges	Copper/Steel/PVC Pipe
Resistor/Capacitor Colors	Rope, Cable and Chain
Pilot Lamp Specs	Tap-Die-Drill Sizes
Fuse & Battery Specs	Sand Paper & Abrasives
RF Coil Winding Data	Weld Electrode & Solder
Wire Size vs Turns/Inch	3200 Conversion Factors

Money Back Guarantee - If not completely satisfied, return book postage prepaid, in mint condition for a 100% refund!

Sequoia Publishing Inc.
Dept 920, P.O. Box 620820
Littleton, CO 80162

CIRCLE 15 ON FREE INFORMATION CARD

VENDOR INFORMATION

ToolBook 1.0 (\$395)
Asymetrix Corp.
110 110th Avenue
Bellevue, WA 98004
Tel. 206-637-1600.

CIRCUIT CIRCUS

By Charles D. Rakes

Test Instruments and More!

This time around, the Circus deals with a number of unrelated circuits that can be used as simple test instruments or be incorporated into a future project. In any case, get ready for some building fun. The first circuit that we'll explore is a variable-frequency pulse generator.

PULSE GENERATOR

Figure 1 is a schematic diagram of a variable-frequency

pulse-generator circuit. The circuit has a frequency range of 2 Hz to over 50 kHz, and produces narrow, 7-volt, positive-going pulses. The pulses produced by the circuit have widths of about 7 microseconds at the circuit's maximum frequency and 10 milliseconds at its lowest frequency.

The circuit's operating frequency is determined by the value of one of the

charging capacitors, C1-C4 (as selected via S1, the range switch) and the values of resistors R1 and R2. The circuit's switching time is fairly rapid due to the regenerative action of the emitter-coupled transistors, Q1 and Q2. That quick switching action produces a fast rising output pulse. With S1 in position 1, the circuit oscillates in the range of 2 to 50 Hz; in position 2, the range is 15 to 500 Hz; in position 3, 120 Hz to 5 kHz; and in position 4, 1.5 to 55 kHz.

Potentiometer R8, a 5k or 10k unit (which can be omitted from the circuit if not needed) is included in the circuit to provide an adjustable pulsewidth. The pulse will increase in width as the resistance of R8 is increased.

The generator circuit isn't complicated, nor is there anything critical about the circuit, so it can be assembled on perfboard and housed in a small plastic cabinet. The circuit can be powered from a 9-volt transistor battery. Such a circuit can be a valuable aid in servicing or experimenting on an existing or future project.

PROXIMITY DETECTOR

Our next circuit, a proximity detector (see Fig. 2), is designed for those who enjoy modifying an existing circuit to produce a practical and working project. The detector consists of a 567 tone decoder (U1), a couple of transistors, and a few support components. The circuit's operation is simple. The 567 is configured as a decoder; R2 and C4 set its receive frequency to about 100 kHz.

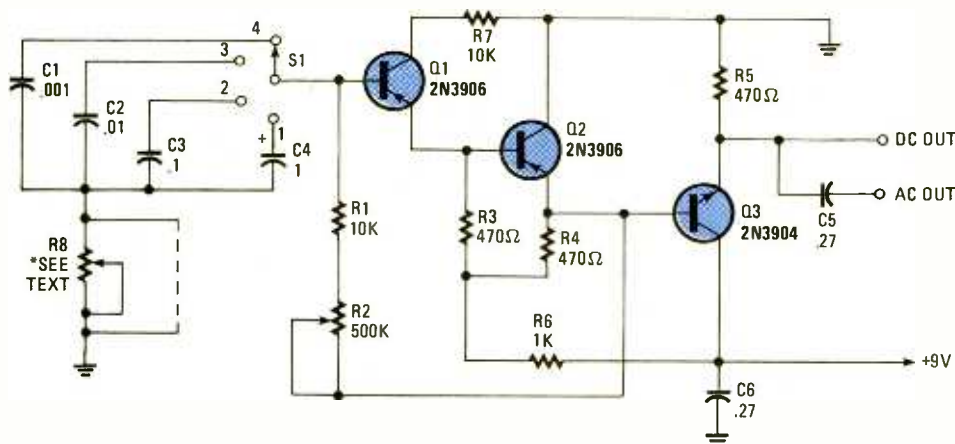

Fig. 1. The variable-frequency pulse generator produces narrow 7-volt positive-going pulses and has a frequency range of 2 Hz to over 50 kHz.

PARTS LIST FOR THE PULSE GENERATOR

RESISTORS

(All fixed resistors are 1/4-watt, 5% units.)

- R1, R7—10,000-ohm
- R2—500,000-ohm potentiometer
- R3-R5—470-ohm
- R6—1000-ohm
- R8—5000-ohm or 10,000-ohm potentiometer (see text)

CAPACITORS

- C1—0.001- μ F ceramic-disc
- C2—0.01- μ F ceramic-disc
- C3—0.1- μ F ceramic-disc
- C4—1- μ F, 100-WVDC, electrolytic
- C5, C6—0.27- μ F ceramic disc

ADDITIONAL PARTS AND MATERIALS

- Q1, Q2—2N3906 general-purpose PNP silicon transistor
- Q3—2N3904 general-purpose NPN silicon transistor
- Perfboard materials, enclosure, 9-volt transistor-radio battery and battery connector, wire, solder, hardware, etc.

Take any 3 PROFESSIONAL BOOKS for only \$4.95

when you join the **ELECTRONICS ENGINEERS & DESIGNERS BOOK CLUB**SM values to \$129.40

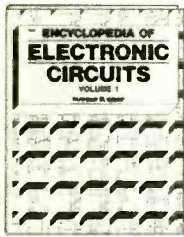

1938 \$60.00
Counts as 2

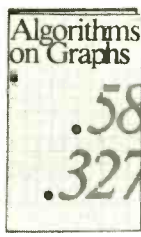

3429 \$29.95

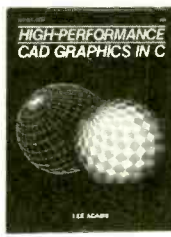

3059 \$34.95
Counts as 2



3199 \$52.00
Counts as 2

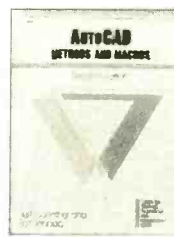

3544 \$34.95

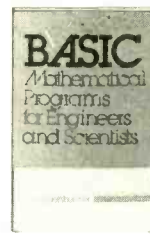

8225P \$19.95

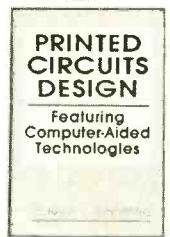

10016 \$39.95

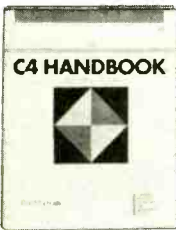

3098 \$44.50
Counts as 2



3212 \$34.95



9813 \$39.95

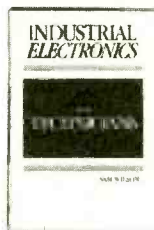

3321P \$16.95



3329 \$29.95

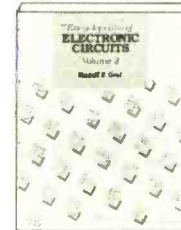

3138 \$60.00
Counts as 2



2672 \$49.50



3203 \$44.50
Counts as 2



3102 \$49.50
Counts as 2

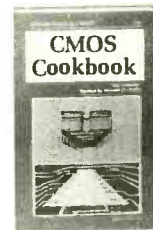

9244P \$18.95

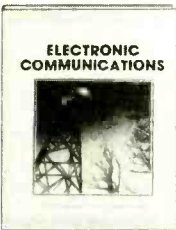

3365 \$34.95
Counts as 2

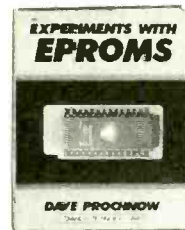

2962P \$17.95

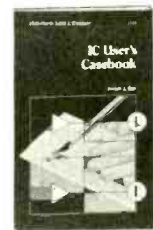

9243P \$12.95



3140 \$49.95
Counts as 2



10210P \$19.95



3151 \$39.95
Counts as 2



3100 \$75.00
Counts as 3



3279 \$36.95
Counts as 2

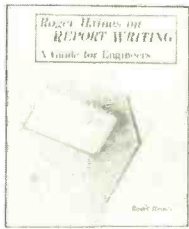

3313 \$22.95

How the Club Works

YOUR BENEFITS: You get 3 books for \$4.95 plus shipping and handling when you join. You keep on saving with discounts of up to 50% off as a member.

YOUR PROFESSIONAL BOOKSTORE BY MAIL: Every 3-4 weeks, you will receive the EE&D Book Club News describing the Main Selection and Alternates, as well as bonus offers and special sales, with scores of titles to choose from.

AUTOMATIC ORDER: If you want the Main Selection, do nothing and it will be sent to you automatically. If you prefer another selection, or no selection at all, simply indicate your choice on the reply form provided. You will have at least 10 days to decide. As a member, you agree to purchase at least 3 books within the next 2 years and may resign at any time thereafter.

BONUS BOOKS: Starting immediately, you will be eligible for our *Bonus Book Plan*, with savings of up to 80% off publishers' prices.

IRONCLAD NO-RISK GUARANTEE: If not satisfied with your books, return them within 10 days without obligation!

EXCEPTIONAL QUALITY: All books are quality publishers' editions especially selected by our Editorial Board. (Publishers' Prices Shown)

Your source for quality, affordable and timely authoritative engineering books.



ELECTRONICS ENGINEERS & DESIGNERS BOOK CLUBSM
Blue Ridge Summit, PA 17294-0860

YES! Please accept my membership in the *Electronics Engineers & Designers Book Club* and send the 3 volumes I have listed below, billing me \$4.95. If not satisfied, I may return the books within 10 days without obligation and have my membership cancelled. I agree to purchase at least 3 books at regular Club prices during the next 2 years, and may resign any time thereafter. A shipping/handling charge and sales tax will be added to all orders.

--	--	--

Name _____
 Address _____
 City _____
 State _____ Zip _____ Phone _____
 Signature _____

Valid for new members only. Foreign applicants will receive special ordering instructions. Canada must remit in U.S. funds. This order subject to acceptance by the *Electronics Engineers & Designers Book Club*. PPF591

All books are hardcover unless number is followed by a "P" for paperback.
 ©1991 EEDBC, Blue Ridge Summit, PA 17294-0860

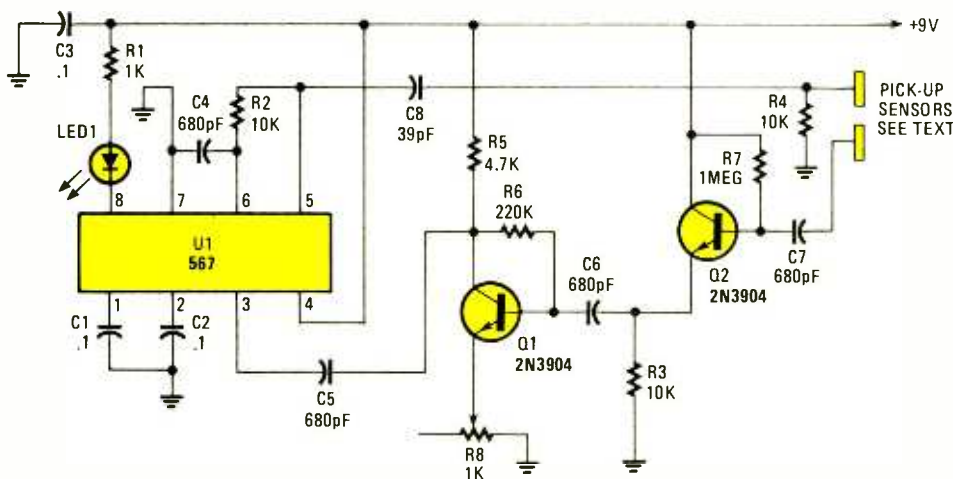

Fig. 2. The proximity detector consists of a 567 tone decoder, a couple of transistors, and a few support components.

PARTS LIST FOR THE PROXIMITY DETECTOR

SEMICONDUCTORS

U1—567 tone decoder, integrated circuit
 Q1, Q2—2N3904 general-purpose, NPN silicon transistor
 LED1—LED (any color)

RESISTORS

(All fixed resistors are 1/4-watt, 5% units.)

R1—1000-ohm
 R2—R4—10,000-ohm
 R5—4700-ohm
 R6—220,000-ohm
 R7—1-megohm
 R8—1000-ohm potentiometer

CAPACITORS

C1—C3—0.1-μF, ceramic-disc
 C4—C7—680-pF, ceramic-disc
 C8—39-pF, ceramic-disc

ADDITIONAL PARTS AND MATERIALS

Perfboard materials, enclosure, pick-up material (see text), IC socket, 9-volt transistor-radio battery and connector, wire, solder, hardware, etc.

An LED, connected to U1's pin 8 output, lights when an in-band signal is detected. The pin 5 output of U1 (a 100-kHz square-wave signal) is fed through C8 to R4 and one of the pick-up sensors. That RC combination causes the square-wave output to differentiate, shifting the phase of the signal at the pick-up sensor, and allowing U1 to detect its own output signal.

The other pick-up sensor is connected to the input of an emitter-follower amplifier, Q2, which operates like

a matching transformer, offering the sensor a high-input impedance and a low-output impedance, which matches the input impedance of Q1, whose gain is set by potentiometer R8. The amplified output of Q1 is fed to U1 at pin 3. When the input signal is about 100-millivolts or greater, U1 detects the signal and lights LED1.

The detector circuit is slightly more critical in the construction scheme used than most of the circuits presented in *Circuit Circus*,

so to avoid problems keep all component leads as short as possible, and avoid criss-crossing wires. The detector circuit can be used to detect metal objects, such as nails and electrical wiring in walls, objects traveling on an assembly line, and any object capable of coupling a signal from one pick-up to the other. For instance, the sensors can be attached to non-metal tubing to monitor the flow of conductive fluids.

The sensors can be made from almost any metal such as aluminum, aluminum foil, brass, copper, etc., and can be as small as two short pieces of hook-up wire or as large as needed. To achieve the best performance, bread-board the circuit and experiment with various size of sensors, the spacing between each sensor, the operating frequency, and different values for C8 and R4.

MOISTURE DETECTOR

Our next entry is a simple circuit that can be used as a "puppy puddle" detector. Now don't laugh; I know of a carpet cleaning company that paid over \$80 each for a number of commercial moisture detectors that didn't perform any better than the one shown in Fig.

3. The detector can help in locating those damp spots in your carpet in time to properly clean and dry them before they do permanent damage.

The moisture detector is little more than a single 2N3904 NPN transistor (in a common-emitter configuration) that's used to turn on a piezo sounder, BZ1. The one probe is connected to the base of Q1 through a 1k resistor (R2) and the other probe is tied to the +V terminal of a 9-volt transistor radio through current-limiting resistor R1 (another 1k unit). A desensitizing resistor, R3, is connected to the circuit via switch S1.

Since there's zero current drain when the circuit isn't in use, an on/off switch isn't needed and the 9-volt transistor battery should last its shelf life. The detector's maximum sensitivity is about 2.5 megohms with S1 in its normal position and about 100k when S1 is activated. Those two ranges will help in mapping wet spots.

There is nothing critical about the circuit; it can be built on a small piece of perfboard, with point-to-point wiring used to interconnect the components. Two heavy-duty, sewing-machine needles can be used as probes. The circuit can then be housed in a length of 1-inch plastic pipe to give it a manufactured look. If the circuit is to be housed in a plastic pipe, the needles should be long enough to extend at least 1½-inches past the end of the pipe.

Switch S1 can be mounted to the pipe above the circuit. It's a good idea to insulate the battery to prevent its metal case from shorting out the circuit components. That's easily done by stuffing a piece of foam rubber, or similar non-conductive material, into the pipe to

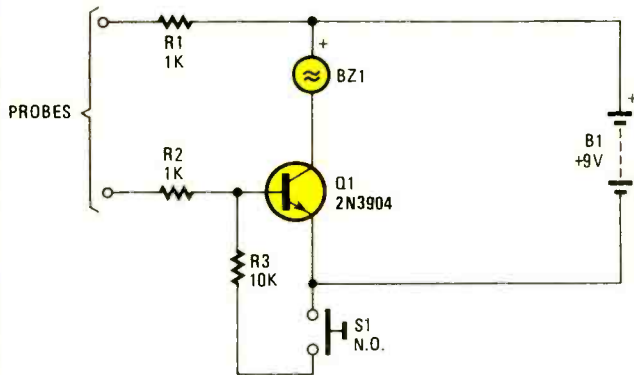

Fig. 3. The moisture detector is nothing more than a transistor (in a common-emitter configuration) that is used as a simple switch.

PARTS LIST FOR THE MOISTURE DETECTOR

- Q1—2N3904 general-purpose NPN silicon transistor
- R1, R2—1000-ohm, 1/4-watt, 5% resistor
- R3—10,000-ohm, 1/4-watt, 5% resistor
- B1—9-volt transistor-radio battery
- S1—Normally-open push-button switch
- BZ1—Piezo buzzer
- Perfboard materials, enclosure, probe, battery connector, wire, solder, hardware, etc.

maintain separation between the battery, switch, and perfboard-mounted components. The piezo sounder can be attached to the end of the pipe opposite the probes.

To check the circuit's operation, bridge a 2.2-megohm resistor across the probes; doing so should cause BZ1 to sound. With the 2.2-megohm resistor still in place, press S1 and the sound should cease. Remove the 2.2-megohm resistor and replace it with a 100k resistor and BZ1 should sound at full volume. Now press S1 and the volume should drop to a much lower level. If so your probe is ready for action.

VARIABLE RESISTANCE BOX

Often it seems like the simplest form of tester turns out to be one of the most valuable and frequently used gadgets on the workbench. Our next circuit—a variable resistor-substitution

box (see Fig. 4)—certainly falls into that category. Note that to conserve space only one potentiometer is shown, but keep in mind that the substitution box can have as many potentiometers as desired; say, five with values of 100 ohms, 1k, 10k, 100k, and 1 megohm.

Mount the potentiometers in a plastic cabinet with a scaled escutcheon for each. Bring out three different color test leads with alligator clips for each potentiometer. That gives you a variable substitution box that can take the place of an expensive resistance decade box. Of course the potentiometer's adjustment won't be as accurate as a decade box, but it will allow you to make a smooth resistance change that's not possible with a decade box.

If your experiments require accurate resistances, a digital ohmmeter can be used to set the selected potentiometer to the

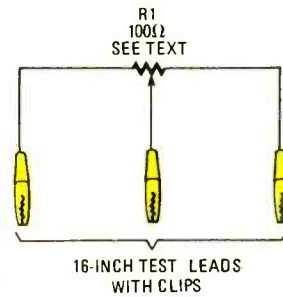

Fig. 4. The variable resistance box can be assembled from junkbox components, and will be of greater service than its simple appearance suggests.

PARTS LIST FOR THE VARIABLE RESISTANCE BOX

RESISTORS

- R1—100-ohm linear potentiometer
- R2—1000-ohm linear potentiometer
- R3—10,000-ohm linear potentiometer
- R4—100,000-ohm linear potentiometer
- R5—1-megohm linear potentiometer
- Cabinet, leads, alligator clips, etc. Perfboard materials, enclosure, AC molded power plug with line cord, battery(s), battery holder and connector, wire, solder, hardware, etc.

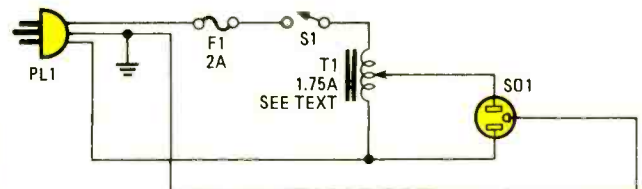

Fig. 5. A variable AC power supply is a very useful tool to have on your workbench when you're servicing malfunctioning electronic equipment, or you are preparing to put back into service equipment that has been idle for a long time.

PARTS LIST FOR THE VARIABLE AC SUPPLY

- T1—1.75-amp variable transformer
- F1—2-amp fuse
- SO1—AC socket
- PL1—AC plug
- S1—SPST switch
- Cabinet, wire, solder, hardware, etc.

needed value. I've found the variable resistance box of this type to be useful in setting up and checking single-transistor amplifiers; one potentiometer can be connected to the collector as a load resistor, another as the emitter resistor, and either one or two of the

other units can be used for setting the transistor's base bias.

There are several precautions you should be aware of and follow in using that simple testing procedure. Keep the leads from the potentiometers separated as much as possible to reduce coupling and oscillations, and don't allow current levels through the potentiometers to exceed their ratings. In addition, avoid destroying the tran-

sistor by making sure that the potentiometer is at its maximum resistance setting when power is applied to the unit under test.

VARIABLE AC SUPPLY

Our last entry is another simple circuit—a variable
(Continued on page 86)

By Joseph J. Carr, K4IPV

An audio-noise blanker

What do you hear when you tune between strong stations on the receiver? Hiss! Garbage! Noise! One of the uncomfortable aspects of operating on the ham bands is the large amount of pure trash that assaults one's ears. Anything that can reduce the level of the trash enhances your operating pleasure, and reduces the stress on your ears and head.

There are a number of things that can be done to make the received signal a

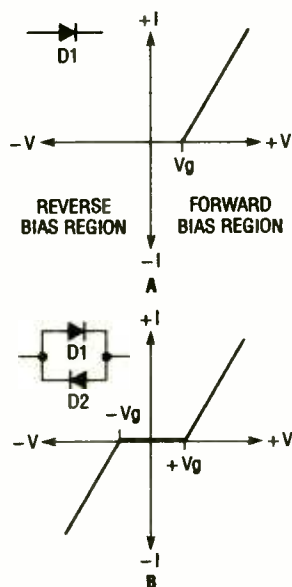

Fig. 1. Shown in A is the current (I) vs. voltage (V) curve for a PN diode; B is the curve for a pair of back-to-back diodes.

lot clearer. One could filter the signal, or use a high-priced noise blanker (which doesn't always work). The project that we'll present this month is a simple little device that can be built in one evening with ease, and can make a lot of difference, especially for CW operators.

This project is a passive noise limiter that is inserted between the audio output of the receiver and the earphones or loudspeaker (although it works best with headphones). The project serves two purposes: one is to reduce the noise between stations, and the second is to clip large signals and thereby add a little distortion to the CW note.

That's right, distortion, and no, I'm not crazy (at least not on this subject), for some operators report that a mildly distorted CW beat note is more comfortable to copy. The effect is especially noted when a stronger, desired station centered in the receiver passband is distorted, and slightly weaker interfering stations are not. Other operators disagree with that theory, so the project below makes the distortion feature optional.

BASIS FOR OPERATION

The passive noise limiter is based on the operation of the simple PN junction diode. Figure 1A shows the characteristic curve of such a diode. When the diode is operated in the reverse-bias region, no current flows (except a very tiny, reverse leakage current). But the current doesn't start flowing immediately when the reverse-bias negative voltage passes through zero to become positive. Until a certain critical junction potential (V_g) is reached, the diode does not pass current. At voltages above V_g , the diode operates in the "ohmic region" much like any other conductor; that is, current increases with increasing voltage. The value

of V_g is 0.2 to 0.3 volt in germanium (Ge) diodes, and 0.6 to 0.7 volt in silicon (Si) units.

When two diodes are connected back-to-back (see Fig. 1B), there is a "dead-band" between $-V_g$ and $+V_g$, with "ohmic" behavior at potentials greater than those values. That is, when two germanium diodes are connected back-to-back, no current flows when the signal voltage applied to the diode pair is between -0.2 volt and $+0.2$ volt.

There are two basic forms of passive noise limiters: the series type, which is shown in Fig. 2A and the shunt version shown in Fig. 2B. In the series (or "threshold") form of noise limiter, the signals must exceed the threshold set by V_g before it is passed along the signal line. In the shunt noise limiter, on the other hand, large signals are clipped off above V_g . Most passive noise limiters use some form of series current-limiting resistor to protect the driving circuit from a short circuit when the shunt diodes conduct.

THE PROJECT CIRCUIT

Figure 3 shows the schematic diagram for a passive noise-limiter circuit that contains both a series threshold noise limiter and a shunt noise limiter. The circuit is composed of two germanium diodes (D1 and D2) and two germanium PNP transistors connected in the "super-diode" configuration (*i.e.*, bipolar transistors, either NPN or PNP, with their respective collector and base terminals shorted together). Such a noise limiter can enhance

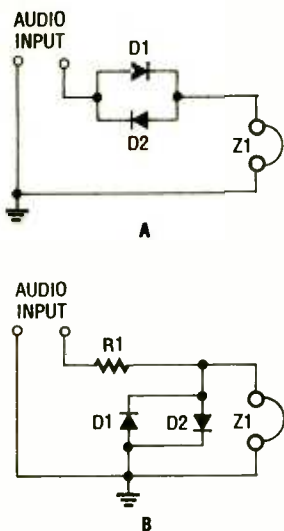

Fig. 2. There are two basic forms of passive noise limiters: the series type (A) and the shunt type (B).

the signal-to-noise ratio at the earphones as much as 40 dB (according to theory), but 20 to 30 dB is more likely (still not a shabby bit of performance improvement).

The series noise limiter is formed by "super-diodes" constructed from a pair of medium gain germanium PNP transistors. The transistors to use include the 2N404, 2N1305, and so forth, if you can find them. Modern equivalents from radio-TV repair replacement lines include the ECG-100, ECG-102, NTE-100, and NTE-102. The idea is to get a medium beta-gain PNP germanium (not silicon) transistor. A switch in parallel with the back-to-back super-diodes bypasses the threshold noise limiter when it's not wanted in the circuit. In other words, with S1 closed, Q1 and Q2 are switched out of the circuit.

The shunt noise-limiter portion of the circuit consists of a pair standard germanium diodes, D1 and D2, such as the 1N34, 1N60, ECG-109, and NTE-109. Such units are available from mail-order suppliers, as well as from Radio Shack in bulk form; i.e., a bunch of odd

diodes in a blister pack at a very low cost per diode. Switch S2 must be closed to turn on the shunt noise-limiter circuit (D1 and D2).

Note that there's a difference in the operation of switches S1 and S2; switch S1 is open when you want the series noise limiter in the circuit, while S2 is closed when the shunt noise limiter is to be in the circuit. The shunt noise limiter requires a series current-limiting resistor in order to protect the audio output stage of the receiver.

When the diodes are forward biased, a large current can flow, which can be detrimental to both the receiver audio-amplifier stage and the diodes themselves. A resistor of about 3.3 to 8 ohms (nominally 5 ohms) can be used as a current limiter. The power rating of the resistor must be sufficient to handle the entire audio output of the receiver. Most ham-radio receivers produce from about 250 milliwatts (mW) to 5 watts of audio power.

Select a resistor that will match your receiver's specification. Alternatively, pick a 5-watt resistor for R1 and be done with it.

The noise limiter can be built into a small metal or plastic box. The input and output jacks should be selected to match the earphones and receiver that you own. In my own case, the receiver's earphone jack is a ¼-inch phone jack. The noise limiter can then be connected to the receiver by a short jumper cable with mating male plugs on either end. In my case, a one-foot shielded cable with a male PL-55 on each end did the trick.

USING THE NOISE LIMITER

Plug the earphones into J2, and connect a jumper cable between J1 and the receiver's earphone jack. Close S1 (the our position in Fig. 3) and open S1 (also the our position). Turn on the receiver and tune across the CW portion of a busy

band. Next, open S1. The weaker signals—i.e., those that do not reach the 0.2- to 0.3-volt threshold—and the background hiss should either go away or be reduced a respectable amount.

Try the noise limiter in and out of the signal path on a number of different signal combinations in order to become familiar with the way the circuit works. You will find that you'll want to take the series noise limiter out of the circuit when copying weak signals.

Next, let's try the shunt noise limiter. Close switch S1 and then close S2. You'll find that on strong signals (play with the audio-gain control of the receiver), the CW beat note distorts somewhat; just how much depends on the signal level. If you find the signal when the circuit is in the latter mode easier and more comfortable, then you've improved matters. Otherwise, turn off the shunt limiter and don't use it unless some spark plug or motor noise is received. In some cases, the shunt noise limiter will clip off the high-voltage noise spikes from sparking electrical sources (such as passing cars) when copying weak signals. So it is possible to use the shunt noise limiter when the series noise limiter is out of the circuit.

Additional information on noise limiters, and the more complex noise-blanker circuits, can be found in various editions of *The ARRL Radio Amateur's Handbook*. My new book on ham radio antennas, *Practical Antenna Handbook* (TAB catalog number 3270) includes a large number of antenna construction projects and hints, as well as some BASIC programs for antenna design. The book is available from TAB Books, Inc., Blue Ridge Summit, PA, 17294-0850; 1-800-233-1128. ■

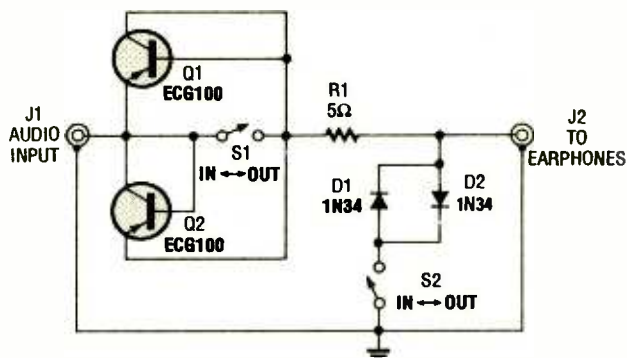

Fig. 3. This passive noise-limiter circuit contains both series ("threshold") and shunt noise-limiter configurations.

PARTS LIST FOR THE NOISE LIMITER

- Q1, Q2—2N404, 2N1305, ECG-100, ECG-102, NTE-100, NTE-102, or similar germanium PNP transistor
- D1, D2—1N34, 1N60, ECG-109, NTE-109, or similar germanium diode
- R1—5-ohm, ¼-watt resistor
- S1, S2—SPST toggle switch
- J1, J2—See text
- Perfboard materials, enclosure, wire, solder, hardware, etc.

DX LISTENING

By Don Jensen

Reader Mail

One of the most gratifying things about doing this column is hearing from you. Regular readers know that each month I include a letters section, called "Feedback," which is devoted to your comments and questions about shortwave listening. Since the mailbox has been really stuffed lately, let's start right out this month with your feedback, so that I can get to as many of your letters as space allows.



Andy Farley may be only 2, but he already seems attracted to radio listening. Andy's dad, Joe, is also an avid DX'er with nearly 190 countries logged. He is an electrical engineer and president of the Chicago Area DX Club.

LETTERS

"A few months ago," writes Jeff Johnson from Reno, NV, "you mentioned that *Radio Norway International* has English programming only on Sundays. I'm of Scandinavian heritage and would like to see Norway better represented on shortwave. Do you know why RNI has such an abbreviated English schedule?"

Sverre Fredheim, the station's foreign broadcasting chief, answered that question on the air awhile back. I liked his answer, so let me

quote, in part: "Well, Norway is a small country, inhabited by people who were already fed up with war, political ambition, and Mickey Spillane novels when the Vikings closed shop back in 1200 AD. So what can we teach the world? Not much, to be quite honest. Teach Americans how to do business? The Germans how to keep the trains on time? The Swiss how to make watches? The Swedes how to make cars? The Japanese to be efficient?"

"No we couldn't and I suspect our listeners wouldn't want us to. What we will try to do is to keep you informed on what's happening this far north."

I guess that means that the broadcasting world's littler guys ought to do what they do best, within the limits of their resources and broadcasting facilities. And that's what RNI is doing...once a week.

Next we hear from Leo Evans, who writes from Vieux Fort on the island of St. Lucia in the West Indies. "I've been a shortwave listener for the past 10 years," says Leo, "and I appreciate the great column in **Popular Electronics**." Leo, who now uses a Sony ICF-7600D, which he calls his "ultimate receiver," ranks DX listening and body surfing as his favorite activities.

He says he's "picked up stations from across the globe," but for regular SWL'ing, he likes *Trans World Radio* in the nearby Netherlands Antilles, particularly the "Bonaire Wavelengths" program hosted by Chuck Rosewell. "I wonder," Leo asks, "if you've heard *Radio Newyork Inter-*

national on the same frequency as WWCR in Nashville, TN?"

Yes, Leo, and it's because the onetime shipboard pirate station that stirred up such a fuss a few years ago has gone legit. RNI has been airing its programming over WWCR facilities for three hours weekly. It's actually the Nashville transmitter you're hearing.

At this writing, Radio Newyork International programs are heard on Monday mornings, Universal Coordinated Time (meaning Sunday night in the U.S. and Canada), from 0100 to 0400 on 7,520 kHz.

A question about an unidentified standard-time/frequency station comes from Mary Alice Barstow, Albuquerque, NM. "I tuned in to time station WWV on 5,000 kHz the other night and heard what seemed to be another time signal underneath. I know that WWVH in Hawaii uses the same frequency, since I can hear that one in the early mornings, mixing with, and sometimes stronger than WWV."

"But this station's time announcements seemed to be in Spanish, not English. Who is it?" Mary Alice queries.

There are quite a few time stations around the world, which operate on the standard frequency of 5,000 kHz. Several stations—in Argentina, Japan, and

*Credits: W. Karcheski, MA; Joe Howell, CA; Adrienne Barhydt, OR; Sheryl Paszkiewicz, WI; Fred Kohlbrenner, PA; Dale Park, HI; Ronald Purdue, MN; Tim Noonan, WI; North American SW Association, 45 Wildflower Road, Levittown, PA 19057

South Africa, for example—can be heard in North America, under optimum conditions, despite WWV or WWVH “interference.”

But it is likely that you heard YVTO, operated by Venezuela’s Cagical Naval Observatory. The Spanish identification that you heard probably was, “Observatorio Naval Cagical, Caracas, Venezuela,” announced each minute, amid the second pulses.

AFRICAN POPS

“Ever since I read your article in the new SWL book, *Passport To World Band Radio* about the programming on *Afrique Numero Un* and the *Voice of America’s* program, Music Time in Africa, I’ve been a regular listener. That music is baaaaaaad, if you get my meaning!” says Damien Taylor of Raleigh, NC. “Any more tips on great West African sounds?”

Alex Batman, SW programming expert for the North American Shortwave Association, one of the best shortwave listener clubs around, suggests the daily “Morning Strike” program on the *Voice of Nigeria*, 7.2555 kHz, at 0500 UTC. “Some of the best in African popular music, including information about the groups and the performers, and a lot of good songs,” Batman writes.

“I don’t know much about shortwave radio except my boyfriend is a nut about it,” writes a young lady from Florida who, for reasons that will become obvious, will remain nameless. “His birthday is coming up in a couple of months and I want to get him something both unusual and shortwave related. Any ideas?”

“PS. I want it to be a secret so don’t use my name. He reads your column every month.”

Dear Madame X: My suggestion is to write for the

free mail-order catalogue of the BBC (*British Broadcasting Corporation*) World Service Shop (Bush House, Strand, London WC2 4PH, England). Lots of good gift ideas there, including BBC-logo coffee mugs, shortwave-related books, audio and video cassettes of favorite BBC programs, language lesson tapes, great posters, and much, much more.

MOST POPULAR?

“Just curious,” writes Bob Lesniak, Des Moines, IA, “but which shortwave station is the most popular?” Now that depends on just exactly what you mean, Bob. The British Broadcasting Corp. claims to have the largest audience in the shortwave world, some 120-million listeners. Of that number, an estimated 25 million are English-speaking.

If you mean which international station’s programs are most popular with SW-hobby listeners like you and me, I’m not sure. But, I’d like to hear from the rest of you out there. The question is: Which is your favorite international SW broadcaster and why?

Your responses, in 100 words or less, please, will appear in a future column. A copy of the 1991 *Passport To World Band Radio*, which the New York Times has called the “TV guide for world-band radio,” will go to the best entry.

DOWN THE DIAL

Your listening reports are also wanted. What are you hearing on the shortwave-broadcast bands? Address your letters to Don Jensen, *DX Listening*, **Popular Electronics**, 500-B Bi-County Blvd., Farmingdale, NY 11735. A reminder: Coordinated Universal Time (UTC) is equivalent to EDT + 4 hours, CDT + 5 hours, MDT + 6 hours, or PDT + 7 hours.

ARGENTINA—15,000 kHz. Standard time and frequency station LOL occasionally can be heard here, WWV’s usual spot on the dial. Spanish announcements and Morse-code CW ID’s are broadcast every five minutes. The rest of the time, of course, there are time ticks and tones.

BOLIVIA—6,155 kHz. This landlocked Latin nation is not the easiest to hear. One of the best chances to hear Bolivia, though, is *Radio Fides*, owned by the Roman Catholic Church in La Paz, which broadcasts in Spanish on this frequency at around 0130 UTC.

FINLAND—9,670 kHz. *Radio Finland*, like Norway’s shortwave broadcaster mentioned earlier, has a Scandinavian focus to its news broadcasts. Look for the English language “Northern Report” at 0430 UTC. This one also operates on 11,755 kHz.

FRANCE—17,620 kHz. *Radio France International’s* English “Letterbox” program airs here at around 1630 UTC, with programming switching to French before 1700 UTC.

HUNGARY—9,800 kHz. News and commentary in English from *Radio Budapest* is noted at 0030 UTC.

IRAQ—11,830 kHz. *Radio Bagdad’s* English transmissions are noted on this frequency at around 0230 UTC and also at 2000 UTC on 13,660 kHz.

LIBYA—15,415 kHz. Arabic programming has been reported from Libya’s *Radio Jamahiriya* on this channel about 2250 UTC.

NEPAL—5,005 kHz. *Radio Nepal* is heard on the west coast of North America at around 1330 UTC with programming in Nepali, including a children’s chorus singing. A parallel frequency is 7,165 kHz. ■

Phonvu Videophone in a Chip
STILL FRAME TV PICTURE TELEPHONE
TRANCEIVER KIT
Sends Slow Scan TV pictures over the phone line in Twelve Seconds

Captures any TV Camera, Camcorder VCR, NTSC Video output and holds the display and sends on command

Auto Mode allows hands free send and receive. Displays on any TV

IC Chip Replaces 150 SSI Dips

50 Levels of Grey Scale Serves as: TV FAX

Camera 200 x 2425 High Res. 50,000 Pixels

Phonvu

Tel. Mon.

Modulator

Use VCR Mod. TV

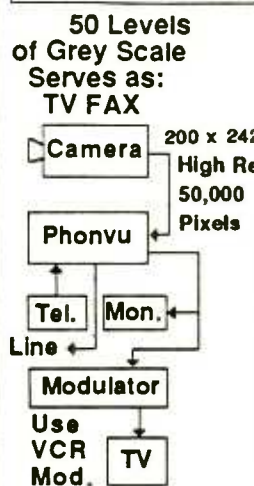
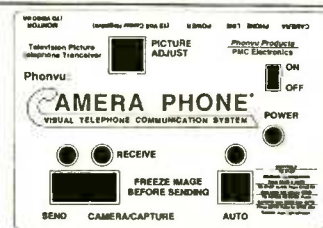
Videophone Chip and Schematic \$59.95
A/D, DRAM, & CHIP SET \$35.00
PC Board (BARE) \$18.95
DISCRETE COMPONENTS \$28.75
Cabinet (MOLDED) \$12.75
Power Pack \$8.75
KIT PRICE: \$164.15
ASSEMBLED TOTAL \$235.00

VISA/MC, PHONE & FAX Order (213) 827-1852
Electronics Box 1148
PMC Marina Del Rey, CA 90292

CIRCLE 17 ON FREE INFORMATION CARD

SCANNER SCENE

By Marc Saxon

High-Tech Turbo Scanner

Those who dance in the streets on the rare occasions that a new high-tech scanner is introduced should get out their top hats and tails, and dust off those dancing shoes! The Uniden MR-8100 Turbo Scanner has quietly arrived. It isn't being sold under their Bearcat or Regency labels, but that isn't to say you won't be interested in this unit.

Uniden advises us that the MR-8100 Turbo Scanner



Those who like all the bells and whistles on their scanners should check out the high-tech Uniden MR-8100 Turbo Scanner.

was "developed exclusively for public safety organizations," and describes the set as being "a high performance scanning radio receiver built to endure extreme environments encountered in mobile and emergency environments." Its frequency coverage is 29 to 54 MHz, 118 to 174 MHz, 406 to 512 MHz, and 806 to 956 MHz. There are 100 memory channels, with established banks of ten channels each. The cellular bands are locked out, but may be restored by using

an optional 3½- or 5¼-inch computer disk. The scanning rate is at nearly 100 channels per second. Sensitivity is less than 1 μ V at 12 dB SINAD. Some of the other features include oversized, illuminated controls and an alphanumeric LCD readout that shows programming prompts.

The MR-8100 may be field programmed, or can be programmed (via RS-232 input) from a PC. Each programmed channel is identified with the name of the service. There are many more features and the only usual scanner function that's absent is a search/scan mode. If you can be happy without that feature, the MR-8100 appears to have a lot of potential.

Not every Uniden scanner dealer seems to carry the MR-8100, but we have seen the unit being offered by several dealers. One price we noted was in the \$500 ballpark. You can obtain more information on the Uniden MR-8100 by contacting the Uniden America Corporation, 4700 Amon Carter Blvd., Fort Worth, TX 76155.

WHO STOLE THE SCOOP

Radio and TV broadcasters make heavy use of certain two-way bands designated for use by so-called Remote Pickup Broadcast stations. Those stations are frequently used by traffic helicopters, and by the media for dispatching news crews to fast-breaking events and for other functions required to keep newsroom operations hum-

ming at busy broadcast stations.

For years, scanner monitors have enjoyed tuning in the communications on these frequencies in order to hear the drama behind the headlines, as well as the bits and pieces that never made it on to the 11 o'clock news.

The problem has been that scanner hobbyists haven't been the only ones tuned in. Some radio and TV stations monitor the channels used by competing local broadcasters in order to keep posted on their rivals' activities. It isn't unknown for one station's reporters or camera crew to show up somewhere based solely upon information monitored over the channel used by another station's assignment desk. And getting traffic reports from another station's traffic helicopter is a lot less costly than sending up your own. You get the picture.

Some broadcasters, feeling scooped on their own stories, eventually began using analog voice scramblers. That generally involves some form of audio-frequency inversion, masking, or band-splitting, and offers only limited privacy inasmuch as it can be descrambled with simple devices. Broadcasters still complained to the FCC that other local stations were sealing their traffic reports and fast-breaking news scoops.

Now the FCC is going to allow those stations to install digital scramblers. Under existing technology, it's vir-

tually impossible for such transmissions to be understood by unauthorized parties. Of course, such equipment is very expensive, so it will probably find use only at the largest and most well-heeled stations around the nation. For the most part, the operations on those frequencies will continue to be conducted "in the clear," and therefore will still be easily monitored.

The frequency ranges used by Remote Pickup Broadcast stations are: 25.87 to 26.47 MHz, 152.87 to 153.35 MHz, 160.89 to 161.76 MHz, 450.01 to 450.925 MHz, and 455.01 to 455.925 MHz. Some frequencies below 162 MHz are also shared with other radio services.

FROM OUR READERS

Dave Weir, N9HQZ, is stationed at an Air Force Base in Florida. He wrote to tell us that he enjoys monitoring all of the base's VHF traffic, and can easily pick up the F-16 traffic in the 118-to-137-MHz VHF aeronautical band. His problem is that F-16's also use the 225-to-400-MHz UHF aeronautical band, and the F-15's are exclusively in the UHF aeronautical band, but Dave can't seem to get any reception at all in the 225-to-400-MHz band.

For starters, Dave can't use an outside antenna. Second, Dave doesn't know what mode is used: AM, NFM, or WFM. Reception in this band is always of interest, but never ceases to baffle scanner owners.

Military aeronautical communications between 225 and 400 MHz are always in AM mode. For local reception, any standard scanner antenna used for public-safety UHF frequencies should suffice, but an indoor antenna would probably be given a lot of help with the addition of a preamplifier such as GRE

Americas Super Amplifier.

Dave is at Elgin AFB, so we'd suggest starting out with trying to pick up signals on busy Elgin frequencies in this band, such as 342.5, 372.2, 273.5, 348.4, 355.8, 318.05, 328.025, 381.3, 390.9, 290.9, 398.2, 315.9, 322.6, 358.3, and 251.1 MHz. There are dozens of others in use, but if your scanner is put into AM mode and can't pick up activity on most of those frequencies, then the problem might involve more than just the indoor antenna system. But don't forget to use AM mode in this band.

FREE FREQUENCIES!

We always get a lot of requests from readers for us to suggest or recommend hot scanner frequencies. From time to time we are lucky enough to latch onto a limited supply of the "Scanner Log," which is a useful directory of almost 200 busy nationwide scanner frequencies—federal, aeronautical, maritime, military, public safety, etc. It also has almost 200 HF "ute" frequencies. We now have another supply on hand and will be happy to fill requests for them as long as our supply lasts. They are free, but to get one you must furnish us with a stamped (U.S.), self-addressed, long envelope for us to send it to you. These directories are nice. Get 'em while we have 'em available. They always go fast.

Our address for "Scanner Logs" and for questions and other mail is: *Scanner Scene, Popular Electronics*, 500-B Bi-County Blvd., Farmingdale, NY 11735. As always, your comments and suggestions, or questions on scanner related topics are welcome. Send your correspondence to the above address, and don't forget to join us here again next month. ■

AMAZING SCIENTIFIC & ELECTRONIC PRODUCTS

LASERS AND SCIENTIFIC DEVICES

VRL2K	3mw Vis Red Laser Diode System Kit	\$159.50
LLIS1K	Laser Beam "Bounce" Listener Kit	\$199.50
LHC2K	Visible Simulated 3 Color Laser Kit	\$44.50
LC7	40 Watt Burning Cutting Laser Plans	\$20.00
RUB4	Hi Powered Pulsed Drilling Laser Plans	\$20.00
LGU40	1 to 2mw HeNe Vis Red Laser Gun Assembled	\$199.00
LLS1	Laser Lite Show - 3 Methods Plans	\$20.00
SD5K	See in the Dark Kit	\$299.50
EML1K	Electromagnetic Coil Gun Kit	\$69.50
MCP1	Hi Velocity Coil Gun Plans	\$15.00
LEV1	Levitating Device Plans	\$10.00
EH1	Electronic Hypnotism Techniques Plans	\$10.00

HIGH VOLTAGE AND PLASMA DISPLAY DEVICES

HVM7K	75,000 Volt DC Variable Output Lab Source Kit	\$149.50
IOG3K	Ion Ray Gun Kit, project energy without wires	\$69.50
NIG9K	12V/115 VAC Hi Out Neg Ion Generator Kit	\$34.50
EMA1K	Telekinetic Enhancer/Electric Man Assembled	\$99.50
LG5K	Lightning Display Globe Kit	\$54.50
BTC1K	Worlds Smallest Tesla Coil Kit	\$49.50
BTC3K	250KV Table Top Tesla Coil Kit	\$249.50
BTC5	1.5 Million Volts Tesla Coil Plans	\$20.00
JL3	Jacobs Ladder - 3 Models Plans	\$15.00
GRA1	Anti Gravity Generator Plans	\$10.00
PFS20	Plasma Fire Saber Assembled	\$69.50
OPL20	Dancing Plasma to Music and Sounds Assembled	\$79.50

SECURITY AND PROTECTION DEVICES

ITM10	100,000 Volt Intimidator up to 20' Assembled	\$129.50
IPG70	Invisible Pain Field Blast Wave Gun Assembled	\$74.50
PSP4K	Phasor Sonic Blast Wave Pistol Kit	\$69.50
LIST10	Infinity Xmlr, Listen in Via Phone Assembled	\$199.50
TAT30	Automatic Tel Recording Device Assembled	\$24.50
VWPM7K	3 Mi. FM Auto Tel Transmitter Kit	\$49.50
FMV1K	3 Mi. FM Voice Transmitter Kit	\$39.50
HOD1K	Homing/Tracking Beeper Transmitter Kit	\$49.50

EASY ORDERING PROCEDURE TOLL FREE 1-800-221-1705
or 24 HRS ON 1-803-673-4730 or FAX IT TO 1-803-672-5406
VISA, MC, CHECK, MD IN US FUNDS. INCLUDE 10% SHIPPING. ORDERS
\$100.00 & UP ONLY ADD \$10.00. CATALOG \$1.00 OR FREE WITH DROER.

INFORMATION UNLIMITED
P.O. BOX 716, DEPT. PE, AMHERST, NH 03031

Be an FCC LICENSED ELECTRONIC TECHNICIAN!



No costly school. No commuting to class. The Original Home-Study course prepares you for the "FCC Commercial Radiotelephone License." This valuable license is your professional "ticket" to thousands of exciting jobs in Communications, Radio-TV, Microwave, Maritime, Radar, Avionics and more...even start your own business! You don't need a college degree to qualify, but you do need an FCC License.

No Need to Quit Your Job or Go To School
This proven course is easy, fast and low cost! **GUARANTEED PASS**—You get your FCC License or money refunded. **Send for FREE facts now. MAIL COUPON TODAY!**

COMMAND PRODUCTIONS

FCC LICENSE TRAINING, Dept. 100
P.O. Box 2824, San Francisco, CA 94126
Please rush FREE details immediately!

NAME _____
ADDRESS _____
CITY _____ STATE _____ ZIP _____

Enter A World Of Excitement with a Subscription to Popular Electronics®

Get the latest electronic technology and information monthly!

Now you can subscribe to the magazine that plugs you into the exciting world of electronics. With every issue of Popular Electronics you'll find a wide variety of electronics projects you can build and enjoy.

Popular Electronics brings you informative new product and literature listings, feature articles on test equipment and tools—all designed to keep you tuned in to the latest developments in electronics. So if you love to build fascinating electronics, just fill out the subscription form below to subscribe to Popular Electronics... It's a power-house of fun for the electronics enthusiast.

EXCITING MONTHLY FEATURES LIKE:

- CONSTRUCTION**—Building projects from crystal sets to electronic roulette
- FEATURES**—Educational training on digital electronics, Ohm's Law, Antennas, Communications, Antique Radio, Simplified Theory
- HANDS-ON-REPORTS**—User test comments on new and unusual consumer products
- SPECIAL COLUMNS**—Think Tank, Circuit Circus, Computer Bits, DX Listening, Antique Radio, Amateur, Scanner Scene

PLUS: ALL OUR GREAT DEPARTMENTS!

You'll get 12 exciting and informative issues of Popular Electronics for only \$18.95. That's a savings of \$16.45 off the regular single copy price. Subscribe to Popular Electronics today! Just fill out the subscription order form below.



FOR FASTER SERVICE CALL TODAY
1-800-435-0715
 (7:30AM-8:30PM)
 EASTERN STANDARD TIME

Popular Electronics® SUBSCRIPTION ORDER FORM

P.O. Box 338, Mt. Morris IL. 61054

YES! I want to subscribe to Popular Electronics for 1 Full year (12 Issues) for only \$18.95. That's a savings of \$16.45 off the newsstand price.

Payment Enclosed Bill me later
 Please charge my: Visa Mastercard

Acct. #

Signature _____ Exp. Date _____

PLEASE PRINT BELOW:

NAME _____

ADDRESS _____

CITY _____ STATE _____ ZIP _____

Allow 6 to 8 weeks for delivery of first issue. U.S. Funds only.
 In Canada add \$5.00 Postage. All Other Foreign add \$7.50 Postage.

APEE1

SLOT MACHINE

(Continued from page 39)

diameter of the fiber-optic cable for a snug fit, and the other holes should fit the hardware you're using.

Attach a U-shaped mounting bracket to the coin slot as shown in Fig. 8. Fit the emitter assemblies on one side of the coin slot and the detectors on the other. Now simply twist and solder them to the leads coming from the circuit board. Follow the polarity indications supplied with the exact parts you use in your circuit.

Make sure that the circuit is counting change properly before installing it inside a cabinet. Since this article is really about the electronics, we will not go into the details on how the cabinet was assembled, but the basic measurements are shown in Fig. 9. The electronic circuitry and the slot assembly mounts inside the top of the unit. The top and bottom half of the bank are attached with hinges to allow emptying of the change compartment and access to the reset button. The top half of the bank has a fairly large cutout in its base to allow the coins fall through into the bottom compartment. ■

LASER COMPUTER

(Continued from page 66)

lot more things than I need or want. I make use of the wordprocessor because of the convenience in writing when and where I feel in the mood, as opposed to being captive at a desktop location. The documentation is clear, the programs are largely intuitive, and file transfer is fast and easy.

A privately produced quarterly newsletter devoted to the PC4 is available from Michael Posner, LUGNuts (Laser User Group Nuts), 4200 Community Drive #1514, West Palm Beach, FL 33409, for \$10 a year. You can request a free sample copy.

The Laser PC4 is available directly from Laser Computer, Inc. (800 North Church St., Lake Zurich, IL 60047-1596), for \$249.95 plus shipping. The order phone number is 800-LASER43, or you can call Laser at 708-540-8911 for your local dealer. If you get a PC4 and need technical support, call Laser at 800-551-5742 or 708-540-5022. For more information contact the manufacturer or circle No. 119 on the Free Information Card. ■

VACUUM TUBES

(Continued from page 44)

The Marconi Company admitted its guilt and was prohibited from further infringement. On September 20, 1916, a U.S. District Court ruled that de Forest and his company similarly had violated the Fleming patent. In short, neither the Lee de Forest Company nor the Marconi Company could manufacture triode audions without infringing on the other's patent.

This legal impasse was not resolved until after World War I. During the war, however, de Forest was granted legal immunity to manufacture grid audions for the United States Government.

Legacy of the Audion. Once the triode audion's capabilities for amplifying and oscillating were discovered, the development of regenerative and superheterodyne receivers quickly followed. Commercial radio broadcasting began shortly thereafter. In just a few years, the triode vacuum tube was joined by its more sophisticated tetrode and pentode relatives to make possible even more sophisticated electronic circuits. ■

This publication is available in microform from University Microfilms International.



Please send information about these titles:

Name _____

Company/Institution _____

Address _____

City _____

State _____ Zip _____

Phone (____) _____

Call toll-free 800-521-3044. In Michigan, Alaska and Hawaii call collect 313-761-4700. Or mail inquiry to: University Microfilms International, 300 North Zeeb Road, Ann Arbor, MI 48106.

ATTENTION! ELECTRONICS TECHNICIANS

EARN YOUR B.S.E.E. DEGREE



THROUGH HOME STUDY

Our New and Highly Effective Advanced-Placement Program for experienced Electronic Technicians grants credit for previous Schooling and Professional Experience, and can greatly reduce the time required to complete Program and reach graduation. No residence schooling required for qualified Electronic Technicians. Through this Special Program you can pull all of the loose ends of your electronics background together and earn your B.S.E.E. Degree. Upgrade your status and pay to the Engineering Level. Advance Rapidly! Many finish in 12 months or less. Students and graduates in all 50 States and throughout the World. Established Over 40 Years! Write for free Descriptive Literature.

COOK'S INSTITUTE OF ELECTRONICS ENGINEERING

CIEE 4251 CYPRESS DRIVE
JACKSON, MISSISSIPPI 39212

CIRCLE 13 ON FREE INFORMATION CARD

LEARN VCR CLEANING/MAINTENANCE/REPAIR

EARN UP TO \$1000 A WEEK, WORKING
PART TIME FROM YOUR OWN HOME!



Secrets
Revealed!

NO Special
Tools or
Equipment
Needed.

EARN UP TO \$60
AN HOUR AND
MORE!

THE MONEY MAKING OPPORTUNITY OF THE 1990'S

IF you are able to work with common small hand tools, and are familiar with basic electronics (i.e. able to use voltmeter, understand DC electronics).

IF you possess average mechanical ability, and have a VCR on which to practice and learn. . . . then we can teach **YOU** VCR maintenance and repair!

FACT: up to 90% of ALL VCR malfunctions are due to simple MECHANICAL or ELECTRO-MECHANICAL breakdowns!

FACT: over 77 million VCRs in use today nationwide! Average VCR needs service or repair every 12 to 18 months!

Viejo's **400 PAGE TRAINING MANUAL** (over 500 photos and illustrations) and **AWARD-WINNING VIDEO TRAINING TAPE** reveals the **SECRETS** of VCR maintenance and repair—"real world" information that is **NOT** available elsewhere!

Also includes all the info you'll need regarding the **BUSINESS-SIDE** of running a successful service operation!

FREE INFORMATION

CALL TOLL-FREE 1-800-537-0589

Or write to: Viejo Publications Inc.

5329 Fountain Ave

Los Angeles, CA 90029 Dept. PE

CIRCLE 20 ON FREE INFORMATION CARD

THINK TANK

(Continued from page 23)

switch (S1) is pressed, current flows through each branch of the circuit. Any voltage over two volts will light LED1. The next LED (LED2) will light if the voltage is 9 volts or greater, LED3 will come on if the voltage is over 10.5 volts, and LED4 will come on if the voltage is greater than 12.25 volts. Note that D4 prevents the branch it's in from being blown out by incorrect polarity.

Depending on the LED's that you use, you might need to place a 5k potentiometer in series with the circuit to fine-tune it.

—Mike Giamportone, Yale, MI

Nice circuit. Those of you that might want to expand the circuit can do so easily. Just use more branches and select Zener diodes rated at about 2-volts less than the voltage the branch must measure.

ANSWERING-MACHINE BEEPER

Here is another application for the much-used 555

oscillator/timer. Since my telephone-answering machine is "beeperless," I missed a few calls because I forgot to check its blinking LED. I worked out this circuit (see Fig. 7) to buzz on cue from the LED.

Photoresistor R1 is mounted directly over the answering machine's LED and surrounded by a tube made of thick black paper to keep out room light. Resistors R3 and R4 divide the supply voltage to keep pin 2 of the 555 just above the switch-over point. That assumes that R1 is getting a steady amount of light from the machine's LED. With the LED on, R1's resistance is low. If the LED goes out, R1's resistance will rise, causing a drop in voltage across R2. The drop will be fed to R5 through C2, activating the 555 monostable.

The monostable activates the buzzer for about 0.2 second. Each time the LED flashes, the buzzer sounds. Note that capacitor C1 was added to the circuit to help it avoid false activation from power-supply transients.

—Jim Drake, Albuquerque, NM

If I'm not mistaken, there was a request for such a circuit that appeared in our letters column. Circuits like this one are useful for the blind, as they turn light from indicators into sound.

I liked your use of the LM317 adjustable voltage regulator. Everyone should take note of how it is used in the power supply. If the transformer is chosen wisely, a variable power supply built with that chip would be capable of providing from 1.3 to over 30-volts.

A TIME-DELAY CIRCUIT

When I was building an alarm, I had to design some kind of exit delay. So I came up with this simple circuit (Fig. 8) to do the job. Only two parts are required:

When voltage is applied to the capacitor, it charges. While it's charging, the relay remains latched. When the charging current falls below the level needed to hold the relay down, the relay unlatches. The higher the value of the capacitor, the longer the relay will remain latched.

—Ricky Furtado, Toronto, Canada

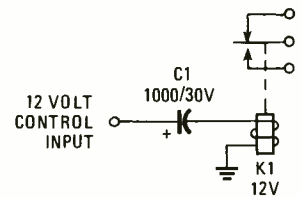

Fig. 8. This simple circuit is technically called a delay-off relay timer. The relay remains active as long as the charging current through C1 is high enough to engage the coil.

This is one I wish I had thought of. If anyone needs to figure out the time constant of the circuit, it is a little less than the capacitor's value times the resistance of the coil. If you don't know the coil's resistance, you can either measure it with an ohmmeter or divide its specified coil voltage by its coil current.

Well, it's time to close out another month. As always, you should send your contributions to *Think Tank*, Popular Electronics, 500-B Bi-County Blvd., Farmingdale, NY 11735. ■

CIRCUIT CIRCUS

(Continued from page 77)

AC supply—that's handy to have on the workbench. All you need is a variable 117-volt AC transformer, a power cord, fuse, switch, and an output receptacle. Wire the components together as shown in Fig. 5.

A variable AC-power source is a valuable tool to have when checking electronics gear that's been idle for years or when smoke testing a new project. It's usually a good idea to slowly bring up the AC line voltage to such equipment before attempting to use it. Try the surplus stores, flea markets, and hamfests first when trying to locate a variable transformer—a good used unit is cheaper than a new one. ■

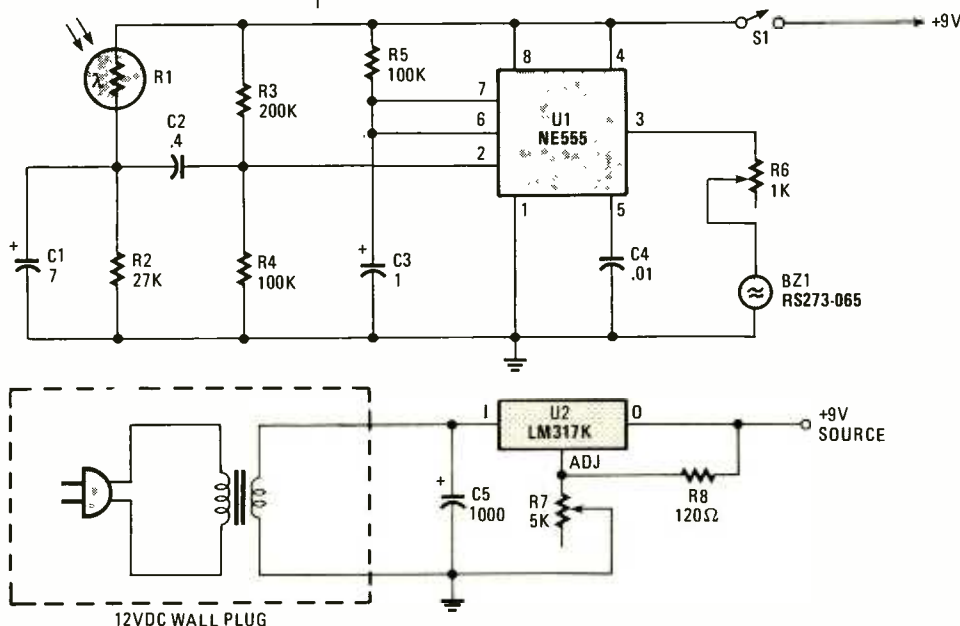

Fig. 7. This simple circuit can turn light into sound. The 555 IC is shown connected as a monostable timer that turns on a buzzer when light strikes R1.

METER FUNDAMENTALS

(Continued from page 34)

The great disadvantage of this circuit is the need for a negative reference voltage. But it is very important; it will ensure that the operational amplifier will produce a positive output across its range. A simple solution is to add a second 9-volt battery in the reverse direction to provide the required negative voltage.

Finally, there are a myriad of digital panel meters on the market. Feel free to experiment with various types of meters. Be sure to carefully consider their input ranges and alter your op-amp circuits accordingly. Many commercial DMM's are on the market. In many instances, their prices are comparable with analog meters.

Conclusion. Voltmeters, ammeters and ohmmeters are by no means the only types of meters available. A diverse array of other meters make use of the analog and digital techniques that we have discussed here. For example, wattmeters commonly measure power to a component by measuring voltage as well as current. Frequency meters indicate the rate of a signal's repetition. Meters can be found that specialize in measuring physical parameters such as temperature, pressure, capacitance, inductance, and transistor gain. There are many more.

In spite of this diversity however, VOM's and DMM's continue to be the fundamental electronic test instruments. Versatile, inexpensive, and easy to use, they can be found on just about any hobbyist's workbench.

The material covered here represents the basic technology and applications used to measure voltage, current, and resistance in both analog and digital forms. Go ahead and build some of the circuits here. You may be surprised at just how easy (and useful) they can be. ■

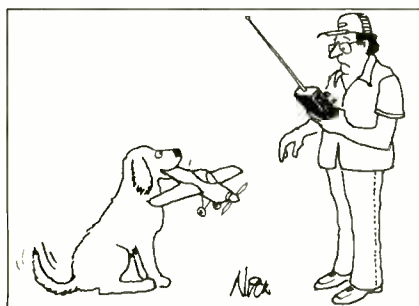

Popular Electronics® REPRINT BOOKSTORE

- | | |
|--|--|
| <ul style="list-style-type: none"> <input type="checkbox"/> 221 Popular Electronics (1991 back issues) \$4.00
Write in issues desired _____ <input type="checkbox"/> 220 Popular Electronics (1990 back issues) \$4.50
Write in issues desired _____ <input type="checkbox"/> 119 Popular Electronics (1989 back issues) \$4.75
Write in issues desired _____ <input type="checkbox"/> 118 Hands-On Electronics (1988 back issues)
Write in issues desired _____ \$5.00 <input type="checkbox"/> 117 Hands-On Electronics
(1987 back issues) \$5.25
Write in issues desired _____ <input type="checkbox"/> 116 Hands-On Electronics
(1986 back issues) \$5.50
Write in issues desired _____ <input type="checkbox"/> EH91 Experimenters Handbook (1991) ... \$4.50 <input type="checkbox"/> EH90 Experimenters Handbook (1990) ... \$5.00 <input type="checkbox"/> EH88 Experimenters Handbook (1988-89) \$5.50 <input type="checkbox"/> EH87 Experimenters Handbook (1987) ... \$6.00 <input type="checkbox"/> HH91 Popular Electronics Hobbyist Handbook
(1991) \$5.00 <input type="checkbox"/> HH90 Popular Electronics Hobbyist Handbook
(1990) \$5.50 <input type="checkbox"/> HH89 Popular Electronics Hobbyist Handbook
(1989) \$6.00 <input type="checkbox"/> 126 Radio-Electronics Annual 1986 \$6.00 <input type="checkbox"/> 211 Radio-Electronics (1991 back issues) \$4.00
Write in issues desired _____ <input type="checkbox"/> 210 Radio-Electronics (1990 back issues) \$4.50
Write in issues desired _____ <input type="checkbox"/> 109 Radio-Electronics (1989 back issues) \$4.75
Write in issues desired _____ <input type="checkbox"/> 108 Radio-Electronics (1988 back issues) \$5.00
Write in issues desired _____ | <ul style="list-style-type: none"> <input type="checkbox"/> 107 Radio-Electronics (1987 back issues) \$5.25
Write in issues desired _____ <input type="checkbox"/> 106 Radio-Electronics (1986 back issues) \$5.50
Write in issues desired _____ <p style="text-align: center;">REPRINTS REPRINTS</p> <ul style="list-style-type: none"> <input type="checkbox"/> 169 Think Tank (133 Circuits) \$3.50 <input type="checkbox"/> 169A Think Tank Vol. 2 \$3.00 <input type="checkbox"/> 168 Fact Cards (#34-66) \$4.00 <input type="checkbox"/> 168C Fact Cards (#67-99) \$3.50 <input type="checkbox"/> 168D Fact Cards (#100-132) \$3.50 <input type="checkbox"/> 167 Designing With IC's \$4.00 <input type="checkbox"/> 166 Collected Works of Mohammed Ulysses Fips
(62 pages, April Fools Collection) \$5.00 <input type="checkbox"/> 165 How to Repair CD Disc Players \$5.00 <input type="checkbox"/> 164 Modern Electrics (April 1908) \$3.00 <input type="checkbox"/> 163 Receiving Satellite TV \$5.00 <input type="checkbox"/> 162 Build Your Own Satellite TV Receiver \$5.00 <input type="checkbox"/> 161 Descrambling (Feb. 1984) \$3.00 <input type="checkbox"/> 160 New Ideas - 42 Circuits \$3.50 <input type="checkbox"/> 159 Low Frequency Receiving Techniques
Building and using VLF Antennas \$5.00 <input type="checkbox"/> 158 Electro Importing Co. Catalog
(Circa 1918) \$5.95 <input type="checkbox"/> 157 All About Kits \$2.00 <input type="checkbox"/> 156 How To Make PC Boards \$2.00 <input type="checkbox"/> 155 IBM Typewriter To Computer \$2.00 <input type="checkbox"/> 154 How To Repair VCR's \$3.50 <input type="checkbox"/> 150 Pay TV Decoder (1981) \$3.00 |
|--|--|

To order any of the items indicated above, check off the ones you want. Complete the order form below, **include your payment**, check or money order (DO NOT SEND CASH), and mail to **Popular Electronics**, Reprint Department, P.O. Box 4079, Farmingdale, NY 11735. Please allow 4-6 weeks for delivery.

If you need a copy of an article that is in an issue we indicate is unavailable you can order it directly from us. We charge 50¢ per page. Indicate the issue (month & year), pages and article desired. Include payment in full, plus shipping and handling charge. Make checks payable to Gernsback Publications, Inc.

ARTICLE _____

PAGES _____

MONTH _____

YEAR _____

TOTAL PAGES _____

@ 50¢ each

TOTAL PRICE _____

MAIL TO: Popular Electronics

Reprint Bookstore, P.O. Box 4079, Farmingdale NY 11735

All payments must be in U.S. funds

SHIPPING CHARGES IN USA & CANADA

\$0.01 to \$5.00 \$1.25	\$30.01 to 40.00 \$5.00
\$5.01 to \$10.00 \$2.00	\$40.01 to 50.00 \$6.00
\$10.01 to 20.00 \$3.00	\$50.01 and above ... \$7.50
\$20.01 to 30.00 \$4.00	

SORRY — We only ship to USA & Canada

Total price of merchandise \$ _____
 Sales Tax (New York State Residents only) \$ _____
 Shipping Charge (see chart) \$ _____

Name _____ Total Enclosed \$ _____

Address _____

City _____ State _____ Zip _____

PE591

MAY 1991

WATCH FOR THIS ISSUE

ON SALE APRIL 4

Radio Electronics®

TECHNOLOGY - VIDEO - STEREO - COMPUTERS - SERVICE

BUILD THIS DRAM TESTER



Plus: ★ Hardware Hacker
★ Audio Update
★ Video News
★ And Lots More!

OUR MAY ISSUE FEATURES:

BUILD A DRAM TESTER

Verify that your dynamic RAM chips are functioning properly and at the rated speed.

BUILD THE PHONE-COM

Use your telephones as a home intercom system.

BUILD THE PULSE-MATE

A handheld pulse generator is a handy troubleshooting tool.

MICROCELL:

Is the "poor man's cellular network" the telephone network of tomorrow?

**PLUS: Hardware Hacker
Video News
Drawing Board**

**Audio Update
Computer Connections
And Lots More!**

VCR REPAIRS

(Continued from page 61)

lems in the tape path is a loop of tangled tape sticking out of the cassette when it's ejected. If that only happens on rare occasions, it may be caused by a problem in the cassette itself. But if it occurs on a regular basis, then suspect a slipping belt or idler. After the tape stops, the P guides retract and the tape is rewound a little to pull the loose loop back into the cassette. If the drive belt or idler to the reel hubs is slipping, then the tape may not fully rewind into the cassette before the eject sequence starts. You can correct this problem as described earlier.

If the VCR "eats" a tape when it malfunctions, you can sometimes still salvage the tape, at least for one more play so you can dub a copy. There is a small latch release button on the left side of the cassette near the door hinge. Press in on the latch release and lift up the door. Now put your finger into one of the reel holes on the bottom of the cassette and turn the reel to rewind the tape into the cassette. Try to smooth out any wrinkles or creases as you go.

Some tape damage isn't obvious unless you open the door on the cassette. A crinkled or scalloped edge on the top or bottom edge of the tape can be caused by a misaligned guide or an oil seal on the capstan that has moved out of position. First look at the capstan. If there is a small plastic disc on the shaft, that may be the problem. The plastic disc is an oil seal. It should be positioned directly on top of the bearing. If it rides up the capstan, it will rub against the tape and crinkle the edge. To solve this problem, push the oil seal back down to its original position.

If the capstan is fine, play a tape with the VCR case open and observe what happens. The edges of the tape may be rubbing against something, or one of the guides may be out of alignment. Adjust the guilty part.

Scratches that run along the length of the tape are usually caused by a foreign particle on some part of the tape transport. Using a cleaning tape may solve the problem. If not, visually inspect all of the guides and rollers. Use a cotton-tipped swab moistened with rubbing alcohol to remove any dirt or accumulations you find. Don't use alcohol or cotton swabs on the video head. Use only head cleaner and special head-cleaning swabs for that. ■

ELECTRONICS MARKET PLACE

FOR SALE

DESCRAMBLERS. All brands. Special: Combo Jerrold 400 and SB3 \$165.00. Complete cable descrambler kit \$39.00. Complete satellite descrambler kit \$45.00. Free catalog. **MJH INDUSTRY**, Box 531, Bronx, NY 10461-0208.

IBM PC video digitizer, connects through printer port. 640 by 480 resolution. 256 gray levels \$89.98. Demo disk \$3.00. **COLORBURST**, Box 3091, Nashua, NH 03061.

RADIO tubes, capacitors. Extensive listings. \$.25 stamp. **DIERS**, 4276 North 50 Street #H5, Milwaukee, WI 53216-1313.

SECRET scanner frequencies: Directories list federal, police, surveillance, bugging, channels. Big free catalog. **CRB**, Box 56-PE, Commack, NY 11725.

STOP unwanted use of long distance with simple telephone product. Free details. **PO BOX 504**, Plattsburgh, NY 12903.

CABLE descrambler liquidation. Major makes and models available. Industry pricing! (Example: Hamlin Combo's, \$44 each... Minimum 10 orders). Call **WEST COAST ELECTRONICS**, 1 (800) 628-9656.

CLASSIFIED AD ORDER FORM

To run your own classified ad, put one word on each of the lines below and send this form along with your check to:

Popular Electronics Classified Ads, 500-B Bi-County Boulevard, Farmingdale, N.Y. 11735

PLEASE INDICATE in which category of classified advertising you wish your ad to appear. For special headings, there is a surcharge of \$11.00.

() Plans/Kits () Business Opportunities () For Sale
() Education/Instruction () Wanted () Satellite Television
()

Special Category: \$11.00

PLEASE PRINT EACH WORD SEPARATELY, IN BLOCK LETTERS.

(No refunds or credits for typesetting errors can be made unless you clearly print or type your copy.) Rates indicated are for standard style classified ads only. See below for additional charges for special ads. **Minimum: 15 words.**

1	2	3	4	5
6	7	8	9	10
11	12	13	14	15 (\$23.25)
16 (\$24.80)	17 (\$26.35)	18 (\$27.90)	19 (\$29.45)	20 (\$31.00)
21 (\$32.55)	22 (\$34.10)	23 (\$35.65)	24 (\$37.20)	25 (\$38.75)
26 (\$40.30)	27 (\$41.85)	28 (\$43.40)	29 (\$44.95)	30 (\$46.50)
31 (\$48.05)	32 (\$49.60)	33 (\$51.15)	34 (\$52.70)	35 (\$54.25)

We accept MasterCard and Visa for payment of orders. If you wish to use your credit card to pay for your ad fill in the following additional information (Sorry, no telephone orders can be accepted.):

Card Number

Expiration Date

PRINT NAME

SIGNATURE

IF YOU USE A BOX NUMBER YOU MUST INCLUDE YOUR PERMANENT ADDRESS AND PHONE NUMBER FOR OUR FILES. ADS SUBMITTED WITHOUT THIS INFORMATION WILL NOT BE ACCEPTED.

CLASSIFIED COMMERCIAL RATE: (for firms or individuals offering commercial products or services) \$1.55 per word prepaid (no charge for ZIP code)...**MINIMUM 15 WORDS.** 5% discount for same ad in 6 issues within one year; 10% discount for 12 issues within one year if prepaid. **NON-COMMERCIAL RATE:** (for individuals who want to buy or sell a personal item) \$1.25 per word, prepaid....no minimum. **ONLY FIRST WORD AND NAME** set in bold caps at no extra charge. Additional bold face (not available as all caps) 30¢ per word additional. Entire ad in boldface, \$1.85 per word. **TINT SCREEN BEHIND ENTIRE AD:** \$1.90 per word. **TINT SCREEN BEHIND ENTIRE AD PLUS ALL BOLD FACE AD:** \$2.25 per word. **EXPANDED TYPE AD:** \$2.05 per word prepaid. Entire ad in boldface, \$2.45 per word. **TINT SCREEN BEHIND ENTIRE EXPANDED TYPE AD:** \$2.55 per word. **TINT SCREEN BEHIND ENTIRE EXPANDED TYPE AD PLUS ALL BOLD FACE AD:** \$2.95 per word. **DISPLAY ADS:** 1" x 2 1/4"—\$205.00; 2" x 2 1/4"—\$410.00; 3" x 2 1/4"—\$615.00. **General Information:** Frequency rates and prepayment discounts are available. **ALL COPY SUBJECT TO PUBLISHERS APPROVAL. ADVERTISEMENTS USING P.O. BOX ADDRESS WILL NOT BE ACCEPTED UNTIL ADVERTISER SUPPLIES PUBLISHER WITH PERMANENT ADDRESS AND PHONE NUMBER.** Copy to be in our hands on the 18th of the fourth month preceding the date of issue (i.e.: Sept. issue copy must be received by May 18th). When normal closing date falls on Saturday, Sunday or Holiday, issue closes on preceding work day. Send for the classified brochure. Circle Number 49 on the Free Information Card.

CABLE TV DESCRAMBLERS! BARGAIN HEADQUARTERS!



•JERROLD™ •TOCOM •HAMLIN
•OAK •ZENITH
•SCIENTIFIC ATLANTA

6 month warranty! We ship C.O.D.!
Lowest retail/wholesale prices!

FREE CATALOG:

Global Cable Network
1032 Irving St. Suite 109
S.F., CA 94122
NO CALIFORNIA SALES!!!

ORDER TODAY! 800-327-8544

PRINTED circuit boards etched & drilled. Free delivery. **K & F ELECTRONICS, INC.**, 33041 Groesbeck, Fraser, MI 48026. (313) 294-8720.

HUGE 88 page communications catalog of short-wave, amateur and scanner equipment. Antennas, books and accessories too. Send \$1.00 to: **UNIVERSAL RADIO**, 1280 Aida Drive, Dept. PE, Reynoldsburg, OH 43068.

CB RADIO OWNERS!

We specialize in a wide variety of technical information, parts and services for CB radios. 10-Meter and FM conversion kits, repair books, plans, high-performance accessories. Thousands of satisfied customers since 1976! Catalog \$2.

CBC INTERNATIONAL

P.O. BOX 31500PE, PHOENIX, AZ 85046

WINDOWS software. Great game disk and catalog. Only \$5.00. **ONE-UP SYSTEMS**, Box 820, Pompano, FL 33061.

CABLE converters. All major brands. For information & orders call 1 (800) 782-0552. **FREEWAY INC.** s.m.p., PO Box 5036, Burnsville, MN 55337.

FREE CATALOG

FAMOUS "FIRESTIK" BRAND CB ANTENNAS AND ACCESSORIES. QUALITY PRODUCTS FOR THE SERIOUS CB'er. SINCE 1962

FIRESTIK ANTENNA COMPANY
2614 EAST ADAMS
PHOENIX, ARIZONA 85034

MAY 1991

Quality Microwave TV Antennas

WIRELESS CABLE - IFTS - MMDS - Amateur TV
Ultra High Gain 50db(+) • Tuneable 1.9 to 2.7 Ghz.

- 36-Channel System Complete \$149.95
- 12-Channel System Complete \$114.95
- Call or write (SASE) for "FREE" Catalog

PHILLIPS-TECH ELECTRONICS
P.O. Box 8533 • Scottsdale, AZ 85252
(602) 947-7700 (\$3.00 Credit all phone orders)
MasterCard • Visa • COD's • Quantity Pricing

LIFETIME WARRANTY

CABLE descramblers (Jerrold) from \$40.00. Tocom VIP test chip. Fully activates unit. \$50.00. Call (213) 867-0081.

PRINTED circuit boards — etched, drilled, tin plated. Single sided \$1.25/sq. inch. Free shipping. **CHELCO ELECTRONICS**, 61 Water Street, Mayville, NY 14757. (716) 753-3200.

FREE LISTS! NEW SURPLUS MERCHANDISE. Electronics, fans, motors, power supplies, switches, speakers, computer products, semiconductors, transformers, etc. **WE ARE ALSO INTERESTED IN PURCHASING LARGE QUANTITIES OF SURPLUS ELECTRONICS. HIGH COMMISSIONS PAID FOR REFERRALS! ELECTRONIC COMPONENTS TRADING CORP** 44 V Jeffry Blvd., Deer Park, NY 11729 1-800-942-9439 (NYS) 516-242-7733

PLANS & KITS

CATALOG: hobby/broadcasting/HAM/CB: Cable TV, transmitters, amplifiers, surveillance devices, computers, more! **PANAXIS**, Box 130-H5, Paradise, CA 95967.

BUILD — five-digit, ohms, capacitance, frequency, pulse, multimeter, Board, and instructions \$9.95. **BAGNALL ELECTRONICS**, 179 May, Fairfield, CT 06430.

SURVEILLANCE transmitter kits! Four models of each; telephone, room, combination telephone/room transmitters tune from 65 to 305 MHz. Catalog with **Popular Communication's** and **Popular Electronics** book reviews of "Electronic Eavesdropping Equipment Design," \$1.00. **SHEFFIELD ELECTRONICS**, 7223A Stony Island Ave., Chicago, IL 60649-2806.

MINIATURE FM transmitters! Tracking transmitters! Voice disguisers! Bug detectors! Phone devices! More! Available as kits or assembled and tested! Catalog \$2.00 (refundable): **XANDI ELECTRONICS**, Box 25647, Dept. 32D, Tempe, AZ 85285-5647.

FREE CATALOG!
1-800-648-7938
JERROLD HAMLIN OAK ETC
CABLE TV
DESCRAMBLERS

- Special Dealer Prices!
- Compare our Low Retail Prices!
- Guaranteed Prices & Warranties!
- Orders Shipped Immediately!

REPUBLIC CABLE PRODUCTS, INC.
4080 Paradise Rd. #15, Dept. PE501
Las Vegas, NV 89109
For all other information (702) 362-9026

LASER lighting entertainment systems and accessories. Create 3-dimensional laser light shows with these professional secrets! Electronic and mechanical designs for all budgets! \$20.00 **MILLENIUM**, 229 McAfee, Thousand Oaks, CA 91360.

DAZER II Personal protection device! Plans \$8.00. Lasers! Transmitters! Detectors! More! Kits or assembled! Catalog \$2.00. **QUANTUM RESEARCH**, 16645-113 Avenue, Edmonton, Alberta T5M 2X2.

SURVEILLANCE — Audio/video/infra-red/laser equipment. Industrial or private. 500 item catalog \$7.00. **SECURITY SYSTEMS**, 3017F Hudson, New Orleans, LA 70131.

BUILD from easy-to-follow schematics: audio mixers/equalizers (stage, studio, business, home, basic to sophisticated), feedback controllers, active filters, guitar super-fuzz box, loudspeaker enclosures (including car/van), power supplies, more. vSSE reliability. Send \$5.00 for descriptions. Reasonable prices. **VON SPRECKEN SOUND ENGINEERING**, Dept. A, Box 1315, Clinton, MS 39060.

SHORTWAVE — 1933. One-tube. Plug-in coils. DX radio. Free plans. **BOB RYAN**, PO Box 3039, Anaheim, CA 92803.

STOP! Don't let the gas pump cut into your standard of living. Alcohol fuel, easy to produce, \$.17 per gallon. Plans \$5.00. **PROSPECTS UNLIMITED**, 620 Dick Road, Suite 383, Depew, NY 14043.

CABLE DESCRAMBLERS OAK M35B COMBO \$39.95

Jerrold, Zenith, Hamlin, Sci. Atlanta Pioneer & MORE! OUR PRICES ARE BELOW WHOLESALE!
CABLE+PLUS
14417 Chase St. #481-B Panorama City, CA 91402
1-800-822-9955 • Other Info. 1-818-785-4500
NO CALIF. SALES — DEALERS WANTED

RECEIVER plans, kits. Simple to sophisticated. Thorough explanations included. All bands. Catalog and sample schematics \$3.00. **PREMIER ENTERPRISES**, 3850 Plymouth Blvd., Suite 104, Plymouth, MN 55446.

TRACER Circuit. Invaluable troubleshooting tool for professional or hobbyist. Test diodes, capacitors, resistors, FET's, transistors, UJT's, etc. with this amazingly simple device. Send \$8.00 for instructions to **R. THOMAS**, 216 Patterson Road, Barrie, Ontario, Canada L4M 4S7.

REMOTE car starter plan (\$19.90), or complete devices. **SCHLITZER**, 414 Alva, Grand Prairie, TX 75051. (214) 642-0338.

VIDEOCIPHER II manuals. **Volume 1** — Hardware, **Volume 2** — Software, — either \$34.95. **Volume 3** — Projects/Software, **Volume 5** — Documentation or **Volume 6** — Experimentation \$44.95 each. **Volume 7** — 032/Hacking \$54.95. **Volume 4** — Repair — \$99.95. **VC Primer** — \$9.95. **Scanner Hacker's Bible** — \$34.95. **Cable Hacker's Bible** — \$34.95. **Clone Hacker's Bible** — \$34.95. Catalog — \$3.00. CODs: (602) 782-2316. **TELECODE**, PO Box 6426-PE, Yuma, AZ 85366-6426.

KELVIN 200

AC/DC VOLTAGE
AC/DC CURRENT
RESISTANCE
LOW BATTERY WARNING
DIODE TEST \$39.95
ACCURACY +/- 0.5%
CONTINUITY TEST/BUZZER
TRANSISTOR CHECKER
CAPACITANCE CHECKER

Stock No 990091

VISA M/C

KELVIN Electronics
7 Fairchild Ave. Plainview, NY 11803
(516) 349-7620 1(800) 645-9212

SURVEILLANCE — countermeasures! Guaranteed lowest prices! Huge Catalog \$5.00 (refundable). **PROTECTOR**, PO Box 520294-E, Salt Lake City, Utah 84152.

FLOODED Basement due to a sump pump or float switch defect? Prevent it with the **Automatic Sump Pump Controller** with alarm. Complete plans \$6.00 (\$10.00 for dual control plans for backup pump). **ALDIS INDUSTRIES**, Box 208, Burlington, MA 01803.

KITS, over 100 electronic kits, sound effects, visual effects. Write for free catalog: **JM ELECTRONICS**, PO Box 150454, Altamonte Springs, FL 32715-0454.

Motion Control System \$59.00

Includes Computer, Monitor, Keyboard, Power supply, 4 Motors, and Software.

Call or Send for **Free Robotics Catalog**

Silicon Valley Surplus 4222 E. 12th St. Serving you since 1983
415 261-4506 Oakland, CA 94601 8 am to 4 pm PST

Cable TV Descramblers

If you find a better deal, we'll better our deal.

*Jerrold *Tocom *Hamlin *Oak
*Scientific Atlanta *Zenith
Ask about our extended warranty program.

COD, Visa, M/C welcome.
Free Call — Free Catalog.

Video Tech **800-562-6884**
2702 S. Virginia St., Ste. 160-304
Reno, NV 89502.

THE complete manual of pirate radio with schematics. Send \$5.95 plus \$1.00 postage. **ACME ENTERPRISES**, 1356 Coney Island Ave., Suite 200B, Brooklyn, NY 11230.

HOW to use surface mount techniques. Build ultra miniature projects. Included free, two sets plans. Infra red remote control, and light display. Send \$15.00 to **CHARLIE'S VIDEO**, Dept SMT, PO 7782, LaSierra, CA 92503.

BUILD your own remote control using the same type of circuitry found in many keychain remote controls. 20 page package gives info and schematics on encoder/decoder circuitry. Part sources included. \$5.00. **CONTINUOUS CONCEPTS**, PO Box 60414, San Diego, CA 92166. CA residents add 7% tax.

BIG PROFITS **ELECTRONIC ASSEMBLY BUSINESS**

Start home spare time. Investment knowledge or experience unnecessary. **BIG DEMAND** assembling electronic devices. Sales handled by professionals. Unusual business opportunity.

FREE: Complete illustrated literature
BARTA E-00 Box 248
Walnut Creek Calif 94597

BUSINESS OPPORTUNITIES

YOUR own radio station! AM, FM, TV, cable. Licensed/unlicensed. **BROADCASTING**, Box 130-H5, Paradise, CA 95967.

MAKE \$2000.00/week — reclaiming pure gold from scrap computers. Free report! (Worth \$25.00.) 1 (900) 246-2323 (\$2.00 min.).

LET the government finance your small business. Grants/loans to \$500,000. Free recorded message: (707) 448-0270. (KJ8)

EASY work! Excellent pay! Assemble products at home. Call for information (504) 641-8003 Ext. 5730.

DO you really believe in your invention/idea — need financial backing (seed — startup — first — stage). Venture capital is available (within two hours of your geographical area). Write **IICH**, 2112 Dan Rowe Dr., Waco, TX 76704.

ANTIQUE RADIO CLASSIFIED
Free Sample!
Antique Radio's
Largest Circulation Monthly. Articles, Ads & Classifieds.

6-Month Trial: \$13. 1-Yr: \$24 (\$36-1st Class).
A.R.C., P.O. Box 802-L5, Carlsisle, MA 01741

MAKE \$75,000.00 to \$250,000.00 yearly or more fixing IBM color monitors. No investment, start doing it from your home (a telephone required). Information, USA, Canada \$2.00 cash for brochure, other countries \$10.00 US funds. **RANDALL DISPLAY**, Box 2168-H, Van Nuys, CA 91404, USA.

CABLE TV "BOXES"

Converters — Descramblers
Remote Controls — Accessories

- ★ Guaranteed Best Prices ★
- ★ 1 Year Warranty — C.O.D.'s ★
- ★ Immediate Shipping ★
- ★ FREE CATALOG ★

Call or Write
TRANS-WORLD CABLE CO.

12062 Southwest 117th Court, Suite 126
Miami, Florida 33186
1-800-442-9333



MAKE \$50.00/hr working evenings or weekends in your own electronics business. Send for free facts. **MJPI INDUSTRY**, Box 531, Bronx, NY 10461.

JOIN the regulars! Televisions to fur coats, thousands of items, all under \$10.00. Free gift! **ALASKA OUTREACH**, Box 33685, Juneau, AK 99803.

WANTED

INVENTORS! Have an idea? Call **IMPAC** for free information package. US/Canada: 1 (800) 225-5800 (24 hours!).

NEED help with your electronic project, schematic or PCB artwork? Write to **TOP SECURITY**, PO Box 5275, Flint, MI 48505.

SATELLITE TV

FREE catalog — Do-it-yourself save 40—60%. **Lowest** prices world wide, systems, upgrades, parts, all major brands factory fresh and warranted. **SKYVISION**, 2008 Collegeway, Fergus Falls, MN 56537. 1 (800) 334-6455.

CABLE EQUIPMENT

CABLE TV secrets — the outlaw publication the cable companies tried to ban. HBO, Movie Channel, Showtime, descramblers, converters, etc. Suppliers list included. \$9.95. **CABLE FACTS**, Box 711-H, Pataskala, OH 43062.

GET OUT OF THE DARK.

Open your eyes and see just how many subjects are covered in the new edition of the Consumer Information Catalog. It's free just for the asking and so are nearly half of the 200 federal publications described inside. Booklets on subjects like financial and career planning; eating right, exercising, and staying healthy; housing and child care; federal benefit programs. Just about everything you would need to know. Write today. We'll send you the latest edition of the Consumer Information Catalog, which is updated and published quarterly. It'll be a great help, you'll see. Just write:

**Consumer Information Center
Department TD
Pueblo, Colorado 81009**

U. S. General Services Administration

CABLE TV CONVERTERS WHY PAY A HIGH MONTHLY FEE?

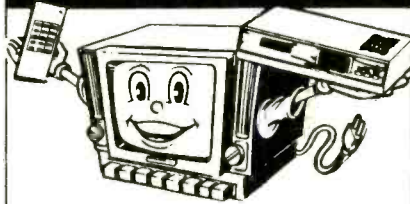

All Jerrold, Oak, Hamlin, Zenith, Scientific Atlanta, Magnavox and all specialized cable equipment available for shipment within 24 hours. For fast service MC/VISA or C.O.D. telephone orders accepted (800) 648-3030 60 Day Guarantee (Quantity Discounts) 8 A.M. to 5 P.M. C.S.T. **CLOSED WEEK-ENDS.** Send self-addressed Stamped envelope (60¢ postage) for Catalog.

MIDWEST ELECTRONICS INC.

P.O. Box 5000
Suite 311 (PE)
Carpentersville, IL 60110

No Illinois Orders Accepted.

EDUCATION/INSTRUCTION

MAGIC! Four illustrated lessons plus inside information shows you how. We provide almost 50 tricks including equipment for four professional effects. You get a binder to keep the materials in, and a one-year membership in the International Performing Magicians. Order now! \$29.95 for each course + \$3.50 postage and handling. (New York residents add applicable state and local sales tax). **THE MAGIC COURSE**, 500-B BiCounty Blvd., Farmingdale, NY 11735.

DON'T TAKE CHANCES! BREATH ALERT™ BLOOD ALCOHOL CONCENTRATION TESTER.

Same sensor as police units. Accurate to 0.01%. Kit form or ready to use. Kit incl. printed & drilled case 6"x3"x2", bat. hldrs, PC board, all components, manual, all you need to make BAC tester (Prod. #811) \$49.95; same with PCB components soldered on PCB (#812) \$59.95; Complete unit (#813) \$79.95. (8 AA bat. not incl.) [Manual only (#814) \$3.00 p.p. ck. or mo. only.] Add \$4.00 s&h **ORDERS:** toll free 1-800-334-0854 Ext. 651. or send ck or mo to **MICRON SALES CO.**, 170 Kerry Pl., Norwood, MA 02062. (617-326-8675). Satisfaction Guaranteed.



ELECTROPLATING — 75 minute video instructs plating chrome, nickel, gold on small parts. With textbook. \$29.00, or details: **REGAL PUBLICATIONS**, Box 1071, Provo, Utah 84603. 1 (800) 955-6014. Visa, MC, AX.

VCR repair. Save money — make big profits! Learn how from *How to Keep Your VCR Alive*. "This detailed, step-by-step manual enables anyone with no previous knowledge or experience to fix most VCR problems easily, quickly, and inexpensively with a few simple tools." — Small Press Review. Highly recommended by *Popular Electronics*, *Modern Electronics*, *Popular Communications*, *Electronic Servicing*, *Videomaker*, *Library Journal*, and many other electronics and video magazines. "Far better than Viejo at 1/7 the cost." 400+ page book, with 724 illustrations, plus professional head-cleaning tool, \$24.95. Check B. Dalton's and Waldenbooks. Or write **WORTHINGTON PUBLISHING**, PO Box 16691H, Tampa, FL 33687-6691. Or call 1 (800) 233-8277 toll-free for Visa or MC. Money-back satisfaction guarantee!

BUY BONDS

*** PRESENTING *** CABLE TV DESCRAMBLERS

***** STARRING *****
JERROLD, HAMLIN, OAK
AND OTHER FAMOUS MANUFACTURERS

- FINEST WARRANTY PROGRAM AVAILABLE
 - LOWEST RETAIL / WHOLESALE PRICES IN U.S.
 - ORDERS SHIPPED FROM STOCK WITHIN 24 HRS.
 - ALL MAJOR CREDIT CARDS ACCEPTED
- FOR FREE CATALOG ONLY 1-800-345-8927
FOR ALL INFORMATION 1-818-709-9937

PACIFIC CABLE CO., INC.
7325 1/2 Reseda Blvd., Dept. 2002
Reseda, CA 91335

TEST EQUIPMENT

SUPER low prices on computers, motherboards, hard and floppy drives, and add-on cards. We have everything. Full line of test equipment at unbeatable prices. Call for free catalog. **APPLIED ELECTRONIC RESEARCH**, Hollywood, FL (305) 987-9785. Fax (305) 987-5996.

T.V. FILTERS

T.V. notch filters, phone recording equipment, brochure \$1.00. **MICRO THINC.**, Box 63/6025, Margate, FL 33063. (305) 752-9202.

NAS CABLE BOXES FREE CATALOG 1-800-848-3997

Jerrold • Scientific Atlanta
Many Others
1 Year Warranty • COD's



CABLE TV DESCRAMBLERS ★ CONVERTERS ★ and ACCESSORIES.

SAVE MONEY. DON'T RENT!

**PANASONIC,
PIONEER, JERROLD, OAK,
SCIENTIFIC ATLANTA
AND MORE. LOWEST PRICES.
FREE CATALOG.**

**(800) 234-1006
CABLE READY COMPANY**

MAY 1991

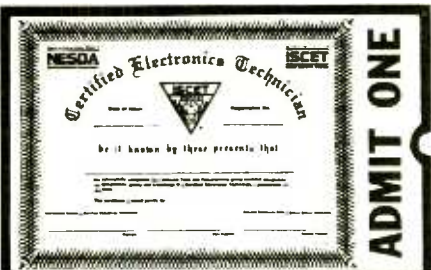

Your Ticket To SUCCESS

Over 28,000 technicians have gained admittance worldwide as certified professionals. Let your ticket start opening doors for you. IS CET offers Journeyman certification in Consumer Electronics, Industrial, Medical, Communications, Radar, Computer and Video. For more information, contact the International Society of Certified Electronics Technicians, 2708 West Berry Street, Fort Worth, TX 76109; (817) 921-9101.

Name _____
 Address _____
 City _____
 State _____ Zip _____

Send material about IS CET and becoming certified.
 Send one "Study Guide for the Associate Level CET Test." Enclosed is \$10 (inc. postage).

ADVERTISING INDEX

POPULAR ELECTRONICS magazine does not assume any responsibility for errors that may appear in the index below.

Free Information No.	Page
6	AMC Sales 8
16	Ace Communications 6
5	All Electronics 21
—	Amazing Concepts 83
—	Antique Radio Classified 90
—	Barta 90
9	C&S Sales 5
—	CBC International 89
—	CIE 11
—	Cable Plus 90
—	Cable Ready Company 91
—	Command Productions 83
13	Cook's Institute 85
—	EE&D Book Club 75
14	EKI 18
—	Electronic Components Trading 90
—	Electronics Book Club 24
—	Electronic Tech. Today CV2
—	Firestik II 89

—	Global Cable Network 89
—	Grantham College 23
10	Heathkit 19
—	IS CET 92
8	Jensen Tools 22
—	Kelvin 90
—	Micron Sales Company 91
—	Midwest Electronics 91
—	Monitoring Times 92
—	NRI Schools 17
17	PMC Electronics 81
7	Protel Technology 14
—	Pacific Cable 91
12	Parts Express 13
—	PE Reprint Bkst. 87
—	Phillips Tech. 90
11	Radio Shack CV4
—	Republic Cable 90
15	Sequoia Publishing 73
—	Silicon Valley Surplus 90
20	Viejo Publications 85
—	Trans World 91
—	Video Tech 90

POPULAR ELECTRONICS

Make the most of your general coverage transceiver with **Monitoring Times!**

Every month Monitoring Times brings everything you need to make the most of your general coverage transceiver: the latest information on international broadcasting schedules, frequency listings, international DX reports, propagation charts, and tips on how to hear the rare stations. Monitoring Times also keeps you up to date on government, military, police and fire networks, as well as tips on monitoring everything from air-to-ground and ship-to-shore signals to radioteletype, facsimile and space communications.

ORDER YOUR SUBSCRIPTION TODAY before another issue goes by. In the U.S., 1 year, \$18; foreign and Canada, 1 year, \$26. For a sample issue, send \$2 (foreign, send 5 IRCs). For MC/VISA orders (\$15 minimum), call 1-704-837-9200.

MONITORING TIMES
Your authoritative source, every month.
 P.O. Box 98
 Brasstown, N.C. 28902

Employers

Willing workers available now at as little as 1/2 your usual cost. This is your chance to get help you've needed, but thought you couldn't afford. **No business too large or too small.** Call your private industry council or write **National Alliance of Business**, P.O. Box 7207, Washington, D.C. 20044



ADVERTISING SALES OFFICE

Gernsback Publications, Inc.
 500-B Bi-County Blvd.
 Farmingdale, NY 11735
 1-(516) 293-3000
 President: **Larry Steckler**
 Assistant to the President: **Christina Estrada**

For Advertising ONLY
 516-293-3000
 Fax 1-516-293-3115
Larry Steckler
 publisher

Arlene Fishman
 advertising director
Denise Haven
 advertising assistant
Kelly McQuade
 credit manager

Customer Service/Order Form
 1-800-435-0715
 1-800-892-0753
 7:30 AM - 8:30 PM EST

SALES OFFICES

EAST/SOUTHEAST
Stanley Levitan, Eastern Sales Manager
 259-23 57th Avenue
 Little Neck, NY 11362
 1-718-428-6037, 1-516-293-3000
 Fax 1-718-225-8594

MIDWEST/Texas/Arkansas/Okla.
Ralph Bergen, Midwest Sales Manager
 540 Frontage Road—Suite 204
 Northfield, IL 60093
 1-708-446-1444
 Fax 1-708-446-8451

PACIFIC COAST/Mountain States
Marvin Green, Pacific Sales Manager
 5430 Van Nuys Blvd. Suite 316
 Van Nuys, CA 91401
 1-818-986-2001
 Fax 1-818-986-2009

Never before has so much professional information on the art of detecting and eliminating electronic snooping devices—and how to defend against experienced information thieves—been placed in one VHS video. If you are a Fortune 500 CEO, an executive in any hi-tech industry, or a novice seeking entry into an honorable, rewarding field of work in countersurveillance, you must view this video presentation again and again.



Wake up! You may be the victim of stolen words—precious ideas that would have made you very wealthy! Yes, professionals, even rank amateurs, may be listening to your most private conversations.

Wake up! If you are not the victim, then you are surrounded by countless victims who need your help if you know how to discover telephone taps, locate bugs, or “sweep” a room clean.

There is a thriving professional service steeped in high-tech techniques that you can become a part of! But first, you must know and understand Countersurveillance Technology. Your very first insight into this highly rewarding field is made possible by a video VHS presentation that you cannot view on broadcast television, satellite, or cable. It presents an informative program prepared by professionals in the field who know their industry, its techniques, kinks and loopholes. Men who can tell you more in 45 minutes in a straightforward, exclusive talk than was ever attempted before.

Foiling Information Thieves

Discover the targets professional snoopers seek out! The prey are stock brokers, arbitrage firms, manufacturers, high-tech companies, any competitive industry, or even small businesses in the same community. The valuable information they filch may be marketing strategies, customer lists, product formulas, manufacturing techniques, even advertising plans. Information thieves eavesdrop on court decisions, bidding information, financial data. The list is unlimited in the mind of man—especially if he is a thief!

You know that the Russians secretly installed countless microphones in the concrete work of the American Embassy building in Moscow. They converted

what was to be an embassy and private residence into the most sophisticated recording studio the world had ever known. The building had to be torn down in order to remove all the bugs.

Stolen Information

The open taps from where the information pours out may be from FAX's, computer communications, telephone calls, and everyday business meetings and lunchtime encounters. Businessmen need counselling on how to eliminate this information drain. Basic telephone use coupled with the user's understanding that someone may be listening or recording vital data and information greatly reduces the opportunity for others to purloin meaningful information.

The professional discussions seen on the TV screen in your home reveals how to detect and disable wiretaps, midget radio-frequency transmitters, and other bugs, plus when to use disinformation to confuse the unwanted listener, and the technique of voice scrambling telephone communications. In fact, do you know how to look for a bug, where to look for a bug, and what to do when you find it?

Bugs of a very small size are easy to build and they can be placed quickly in a matter of seconds, in any object or room. Today you may have used a telephone handset that was bugged. It probably contained three bugs. One was a phony bug to fool you into believing you found a bug and secured the telephone. The second bug placates the investigator when he finds the real thing! And the third bug is found only by the professional, who continued to search just in case there were more bugs.

The professional is not without his tools. Special equipment has been designed so that the professional can sweep a room so that he can detect voice-activated (VOX) and remote-activated bugs. Some of this equipment can be operated by novices, others require a trained countersurveillance professional.

The professionals viewed on your television screen reveal information on the latest technological advances like laser-beam snoopers that are installed hundreds of feet away from the room they snoop on. The professionals disclose that computers yield information too easily.

This advertisement was not written by a countersurveillance professional, but by a beginner whose only experience came from viewing the video tape in the privacy of his home. After you review the video carefully and understand its contents, you have taken the first important step in either acquiring professional help with your surveillance problems, or you may very well consider a career as a countersurveillance professional.

The Dollars You Save

To obtain the information contained in the video VHS cassette, you would attend a professional seminar costing \$350-750 and possibly pay hundreds of dollars more if you had to travel to a distant city to attend. Now, for only \$49.95 (plus \$4.00 P&H) you can view *Countersurveillance Techniques* at home and take refresher views often. To obtain your copy, complete the coupon below or call toll free.

**HAVE YOUR
VISA or MC CARD
AVAILABLE**

RADIO-ELECTRONICS VIDEO OFFER **PE**
500-B Bi-County Blvd.
Farmingdale, NY 11735

Please rush my copy of the Countersurveillance Techniques Video VHS Cassette for \$49.95 plus \$4.00 for postage and handling.

No. of Cassettes ordered _____
Amount of payment \$ _____

Bill my VISA MasterCard
Card No. _____
Expire Date _____ / _____

Signature _____
Name _____
Address _____
City _____ State _____ ZIP _____

All payments in U.S.A. funds. Canadians add \$4.00 per VHS cassette. No foreign orders. New York State residents add applicable sales tax.

RADIO SHACK PARTS PLACESM

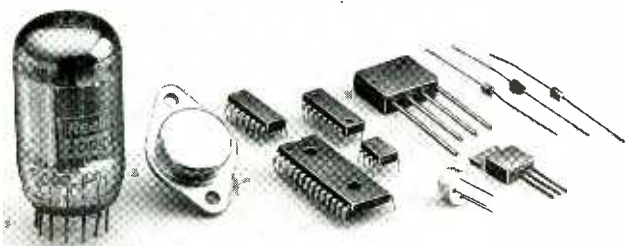

PARTS SPECIAL-ORDER HOTLINE. Your local Radio Shack offers a huge selection of electronic components. Plus, we can special-order over 10,000 items from our warehouse—ICs, tubes, semiconductors, crystals, phono cartridges and styli, even SAMS[®] manuals. Delivery time for most items is one week. And there are no postage charges or minimum order requirements.

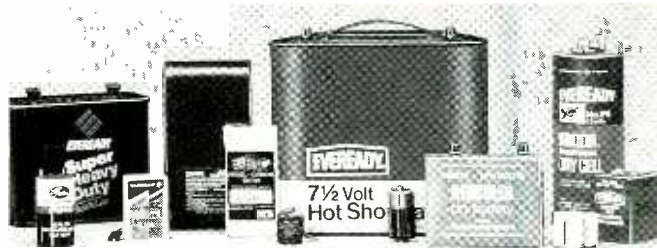

BATTERY SPECIAL-ORDER HOTLINE. In addition to our large in-store stock, Radio Shack can now supply almost any currently manufactured consumer-type battery—quality replacements for cordless telephones, computer memory, camcorders, transceivers, pagers and more. Discover the Radio Shack "hotline" advantage—fast service with no postage or handling charges.



(1) High-Speed 12VDC Motor. Up to 15,200 RPM. About 2" long (with shaft). #273-255 2.99
(2) Hobby Motor. For robotics and projects. 1½ to 3VDC. About 1½" long. #273-223 99¢

Heavy-Duty Plug-In DPDT Relays. Contacts rated 10 amps at 125VAC. Size: 1½ x 1 x ¾".
12VDC Coil. #275-218 5.99
125VAC Coil. #275-217 5.99
Relay Socket. #275-220 1.79

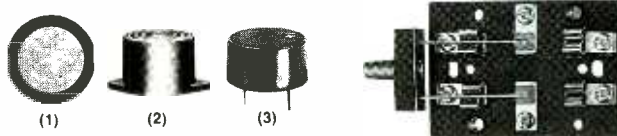

(1) Mini Piezo Speaker. Only 1¾" diameter. #273-091 . . 2.49
(2) "Ding-Dong" Chime. Requires 6 to 18VDC. #273-071 . . 8.99
(3) Mini Buzzer. Loud, yet only 7 mA at 12VDC. #273-074 . . . 2.99

DPDT Knife Switch. Just the thing for low-power switching in science projects, model railroads and more. Rated 0.5 amp at 200VDC. Screw terminals. Mounting holes on base. #275-1537 1.29

Lamp Holders. For indicators and projects. Figs. 1 and 2 accept E-10 threaded-base bulbs, available at Radio Shack.



(1) Round Style. Screw terminals. #272-357 79¢
(2) Compact. Solder lugs. #272-356 99¢
(3) Bayonet Base. #272-355 6/99¢

LCD DVM With Capacitance and Transistor Gain Ranges. Extra-feature digital multimeter with easy-to-read 0.5" display and 10 megohm input. 30 ranges—measures AC/DC voltage and current, resistance, capacitance and transistor gain. #22-194 79.95



(1) Telescoping Antenna. Extends to 24" (16 styles in stock.) #270-1413, 3.99
(2) "N" Battery Holder. (14 other styles in stock.) #270-405 59¢
(3) Mini-Hook Adapters. Slip on test probe tips. #270-334, Pr./2.59
(4) Micro-Hook Test Clips. #270-355 2.69

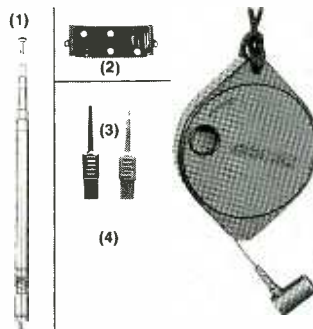

Portable Short-wave Antenna. Dramatically improves reception on worldband portables! Connector clips to telescoping rod antenna. Antenna wire extends up to 23 feet—and winds up on pocket-size reel for convenient storage, travel. #278-1374, 8.95

XLR Connectors
(1) Inline Socket. #274-011 2.99
(2) Three-Pin Plug. #274-010 2.99
(3) Panel Socket. #274-013 3.69
(4) Adapter Transformer. Connects XLR-type mike to equipment with ¼" phone jack input. #274-016 11.99
(5) Adapter Transformer. Connects mike with ¼" plug to XLR jack input. #274-017 11.99

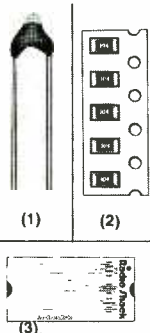

(1) Precision Thermistor. Resistance changes in proportion to temperature. Has measurement range from -50 to +110° C. #271-110 1.99
(2) Surface-Mount Resistors. Big 200-piece assortment! Popular values, rated ¼ watt, 5%. #271-313, Set 4.99
(3) Ohm's Law Guide. Fast answers to Ohm's law and parallel resistance problems. #271-1211 49¢

(1) Prewired Temperature Module. Just add one "AA" battery for use as a thermometer. You can also connect simple circuits to control external indicators and devices at temperatures you set. (Data included.) Has ½" liquid crystal display and selectable Fahrenheit or Centigrade modes. Module is easily panel-mounted. #277-123 19.95

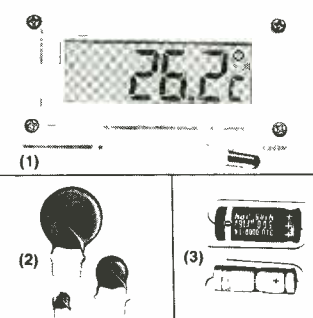

(2) Set of 100 Ceramic Disc Capacitors. A variety of popular styles and values at a bargain price. Ratings up to 1000 WVDC. Stock up! #272-801, Set 1.98

(3) Assortment of 20 Electrolytic Capacitors. Miniature and submini types in a variety of values with ratings up to 50 WVDC. #272-802, Set of 20/1.98

Since 1921 Radio Shack has been the place to obtain up-to-date electronic parts as well as quality tools, test equipment and accessories at low prices. Over 7000 locations to serve you—NOBODY COMPARES

Prices apply at participating Radio Shack stores and dealers. Radio Shack is a division of Tandy Corporation

Radio Shack[®]
AMERICA'S TECHNOLOGY STORESM

CIRCLE 11 ON FREE INFORMATION CARD