

Are We Receiving Signals From Space?

Popular Electronics[®]

APRIL 1991

BUILD A PEST REPELLER



Our tiny ultrasonic repeller makes outdoor fun bug free

MAKE YOUR OWN CASES

Add eye-appeal to your next project with a custom-made case

ISOLATING TELEPHONE EXTENSIONS

Guarantee privacy for your sensitive calls, faxes, and more with this simple circuit

BUILD A REGENERATIVE RADIO

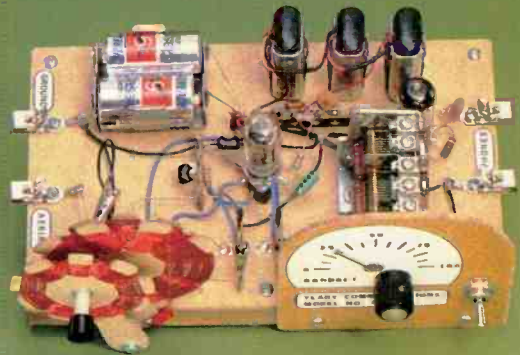

An entertaining radio project based on an age-old design

BUILD "SURE-LUCK" OHMS

A great project for the beginning hobbyist—use it to learn the resistor color code, or to take the guesswork out of determining a resistor's value

"ELECTRONIC" FISHING LURES



Some fun ideas for the adventurous angler

A
GERNSBACK
PUBLICATION



\$2.95 U.S.
\$3.75 CANADA

3 NEW
FactCards
IN THIS ISSUE

#2110***** 5-DIGIT 60506
#60506DHM997G4006# FEB92 40
ROBERT DAHM RESP
997 GRAND AVE 065
AURORA, IL 60506

Electronics Paperback Books

GREAT PAPERBACKS AT SPECIAL PRICES

BP248—TEST EQUIPMENT CONSTRUCTION \$5.95. Details construction of simple, inexpensive, but extremely useful test equipment. AF Gen, Test Bench Ampl, Audio Millivoltmeter, Transistor Tester and six more.



How to Use Oscilloscope and Other Test Equipment



BP267—HOW TO USE OSCILLOSCOPES AND OTHER TEST EQUIPMENT \$6.95. Mastering the oscilloscope is not really too difficult. This book explains all the standard controls and functions. Other equipment is also described.

BP265—MORE ADVANCED USES OF THE MULTIMETER \$5.95. Use these techniques to test and analyze the performance of a variety of components. Also see how to build add-ons to extend multimeter capabilities.



An Introduction to Loudspeakers and Enclosure Design

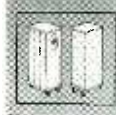

BP256—INTRO TO LOUDSPEAKERS AND ENCLOSURE DESIGN \$5.95. We explore the variety of enclosure and speaker designs in use today so the reader can understand the principles involved.

BP263—A CONCISE INTRO TO dBASE \$6.95. The dBASE series of programs are probably the best known database programs for microcomputers. This book is designed to help you get started working with them.



BP260—CONCISE INTRO TO OS/2 \$5.95. If you are a multitasking PC user and want to get the most out of your computer, then you must learn its OS/2 operating system. This book shows you just how to do that, quickly and easily.



BP249—MORE ADVANCED TEST EQUIPMENT CONSTRUCTION \$6.95. Eleven more test equipment construction projects. They include a digital voltmeter, capacitance meter, current tracer and more.



Digital Audio Projects



BP245—DIGITAL AUDIO PROJECTS \$5.95. Practical circuits to build and experiment with. Includes A/D converter, input amplifier, digital delay line, compander, echo effect and more.

BP247—MORE ADVANCED MIDI PROJECTS \$5.95. Circuits included are a MIDI indicator, THRU box, merge unit, code generator, pedal, programmer, channelizer, and analyzer.



BP257—INTRO TO AMATEUR RADIO \$6.95. Amateur is a unique and fascinating hobby. This book gives the newcomer a comprehensive and easy to understand guide to the subject.



PCP102—INTRODUCING DIGITAL AUDIO \$9.95. Covers all kinds of digital recording methods—CD, DAT and Sampling. Bridges the gap between the technician and the enthusiast. Principles and methods are explained.

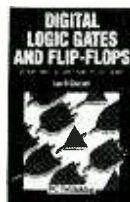

PCP107—DIGITAL LOGIC GATES AND FLIP-FLOPS \$10.00. Thorough treatment of gates and flip-flops for enthusiasts, student and technicians. Only a basic knowledge of electronics is needed.

BP251—COMPUTER HOBBYISTS HANDBOOK \$8.95. A wrapup of everything the computer hobbyist needs to know in one easy to use volume. Provides a range of useful reference material in a single source.

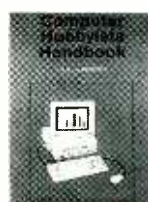

PCP108—COMPUTERS AND MUSIC \$9.95. Explains the basics of computers and music with no previous knowledge of computers needed. Covers types of music software and explains how to set up your own computer music studio.

- BP195—INTRODUCTION TO SATELLITE TV**.....\$9.95. A definitive introduction to the subject written for the professional engineer, electronics enthusiast, or others who want to know more before they buy. 8 x 10 in.
- BP190—ADVANCED ELECTRONIC SECURITY PROJECTS**.....\$5.95. Includes a passive infra-red detector, a fiber-optic loop alarm, computer-based alarms and an unusual form of ultrasonic intruder detector.
- BP235—POWER SELECTOR GUIDE**.....\$10.00. Complete guide to semiconductor power devices. More than 1000 power handling devices are included. They are tabulated in alpha-numeric sequence, by technical specs. Includes power diodes, Thyristors, Triacs, Power Transistors and FET's.
- BP234—TRANSISTOR SELECTOR GUIDE**.....\$10.00. Companion volume to BP235. Book covers more than 1400 JEDEC, JIS, and brand-specific devices. Also contains listing by case type, and electronic parameters. Includes Darlingtons transistors, high-voltage devices, high-current devices, high power devices.
- BP99—MINI-MATRIX BOARD PROJECTS**.....\$5.50. Here are 20 useful circuits that can be built on a mini-matrix board that is just 24 holes by ten copper-foil strips.
- BP82—ELECTRONIC PROJECTS USING SOLAR CELLS**.....\$5.50. Circuits with applications around the home that are powered by the energy of the sun. Everything from radio receivers, to a bicycle speedometer, to timers, audio projects and more.
- BP117—PRACTICAL ELECTRONIC BUILDING BLOCKS—Book 1**.....\$5.75. Oscillators, Timers, Noise Generators, Rectifiers, Comparators, Triggers and more.
- BP184—INTRO TO 68000 ASSEMBLY LANGUAGE**.....\$6.95. The 68000 is a great new breed of microprocessor. Programming in assembly language increases the running speed of your programs. Here's what you need to know.
- BP179—ELECTRONIC CIRCUITS FOR THE COMPUTER CONTROL OF ROBOTS** \$7.50. Data and circuits for interfacing the computer to the robot's motors and sensors.

- BP239—GETTING THE MOST FROM YOUR MULTIMETER**..... \$5.95. Covers basics of analog and digital meters. Methods of component testing includes transistors, thyristors, resistors, capacitors and other active and passive devices.
- BP97—IC PROJECTS FOR BEGINNERS**.....\$5.50. Power supplies, radio and audio circuits, oscillators, timers, switches, and more. If you can use a soldering iron you can build these devices.
- BP37—50 PROJECTS USING RELAYS, SCR'S & TRIACS**.....\$5.50. Build priority indicators, light modulators, warning devices, light dimmers and more.
- RADIO—100 RADIO HOOKUPS**.....\$3.00. Reprint of 1924 booklet presents radio circuits of the era including regenerative, neutrodyne, reflex & more.
- BP42—SIMPLE LED CIRCUITS**.....\$5.50. A large selection of simple applications for this simple electronic component.
- BP127—HOW TO DESIGN ELECTRONIC PROJECTS**.....\$5.75. Helps the reader to put projects together from standard circuit blocks with a minimum of trial and error.
- BP122—AUDIO AMPLIFIER CONSTRUCTION**.....\$5.75. Construction details for preamps and power amplifiers up through a 100-watt DC-coupled FED amplifier.
- BP92—CRYSTAL SET CONSTRUCTION**.....\$5.50. Everything you need to know about building crystal radio receivers.
- BP45—PROJECTS IN OPTOELECTRONICS**..... \$5.50. Includes infra-red detectors, transmitters, modulated light transmission and photographic applications.

BP185—ELECTRONIC SYNTHESIZER CONSTRUCTION \$5.95. Use this book to learn how to build a reasonably low cost, yet worthwhile monophonic synthesizer and learn a lot about electronic music synthesis in the process.

CHECK OFF THE BOOKS YOU WANT

ELECTRONIC TECHNOLOGY TODAY INC.
P.O. Box 240, Massapequa Park, NY 11762-0240

Name _____
Address _____
City _____ State _____ Zip _____

SHIPPING CHARGES IN USA AND CANADA

\$0.01 to \$5.00	... \$1.25
\$5.01 to 10.00	... \$2.00
\$10.01 to \$20.00	... \$3.00
\$20.01 to \$30.00	... \$4.00
\$30.01 to \$40.00	... \$5.00
\$40.01 to \$50.00	... \$6.00
\$50.01 and above	... \$7.50

SORRY No orders accepted outside of USA & Canada

Number of books ordered

Total price of merchandise \$ _____
Sales Tax (New York State Residents only) \$ _____
Shipping (see chart) \$ _____

All payments must be in U.S. funds

Total Enclosed .. \$ _____

P-491

Popular Electronics®

THE MAGAZINE FOR THE ELECTRONICS ACTIVIST!

CONSTRUCTION ARTICLES

BUILD A REGENERATIVE VACUUM-TUBE RECEIVER	Stanley A. Czarnik	29
<i>Recreate the feel of the early days of radio with this fun-to-build and fun-to-use project</i>		
BUG-OFF: THE Popular Electronics PEST REPELLER	John Yacono	36
<i>Build a personal-sized pest repeller that can make your outdoor fun bug free</i>		
BUILD AN ELECTRONIC FISHING LURE	Jerry Baumeister	39
<i>It may help you to catch the big one that always seems to get away</i>		
BUILD "SURE-LUCK" OHMS	Charles D. Rakes	55
<i>You don't need to know the resistor color code when you have this color-code sleuth in your corner</i>		

FEATURE ARTICLES

ISOLATING TELEPHONE EXTENSIONS	Daniel B. Cooper	41
<i>A phone extension can be a nice convenience, but it can also be a tool for the nosy</i>		
ARE WE RECEIVING BIOLOGICAL SIGNALS FROM OUTER SPACE?	L. George Lawrence	58
<i>Is there intelligent life elsewhere in the universe? The answer to that could surprise you</i>		
MAKE YOUR OWN CUSTOM CASES	Walter W. Schoop	64
<i>Dress-up your favorite electronics project with a well-designed enclosure</i>		
THE DIGITAL ELECTRONICS COURSE	Robert A. Young	67
<i>An introduction to one of the unsung "workhorses" of electronics circuits—PLL's</i>		

PRODUCT REVIEWS

GIZMO		43
<i>Including: Go Video VCR-2 Dual-Deck VCR, NEC VoicePoint Teleconferencing System, Radio Shack Realistic MD-1000 Combination Laser Videodisc/CD Player, and much more</i>		
HANDS-ON REPORT		69
<i>B&B Electronics Modem-Security Device</i>		
PRODUCT TEST REPORT	Len Feldman	71
<i>JVC XD-Z505 Digital Audio-Tape Recorder</i>		

COLUMNS

THINK TANK	John Yacono	22
<i>Opening-up your gates</i>		
ANTIQUE RADIO	Marc Ellis	74
<i>Theremin-contest results</i>		
CIRCUIT CIRCUS	Charles D. Rakes	77
<i>Meter-range extender circuits</i>		
COMPUTER BITS	Jeff Holtzman	80
<i>Maneuvering with Magellan</i>		
FUN SOFTWARE	Fred Blechman	82
<i>Hardware helpers for software fun</i>		
DX LISTENING	Don Jensen	84
<i>Radio fare from down under</i>		
HAM RADIO	Joseph J. Carr	86
<i>Collecting antique ham gear</i>		
SCANNER SCENE	Marc Saxon	88
<i>Hello "new-age" scanner, good-bye "old" workhorse</i>		

DEPARTMENTS

EDITORIAL	Carl Laron	2
LETTERS		4
ELECTRONICS LIBRARY		6
NEW PRODUCTS		14
ADVERTISER'S INDEX		102

Popular Electronics (ISSN 1042-170X) Published monthly by Gernsback Publications, Inc., 500-B Bi-County Boulevard, Farmingdale, NY 11735. Second-Class postage paid at Farmingdale, NY and at additional mailing offices. One-year, twelve issues, subscription rate U.S. and possessions \$21.95, Canada \$26.95, all other countries \$29.45. Subscription orders payable in U.S. funds only. International Postal Money Order, or check drawn on a U.S. bank. U.S. single copy price \$2.95. © 1991 by Gernsback Publications, Inc. All rights reserved. Hands-on Electronics and Gizmo trademarks are registered in U.S. and Canada by Gernsback Publications, Inc. Popular Electronics trademark is registered in U.S. and Canada by Electronics Technology Today, Inc. and is licensed to Gernsback Publications. Printed in U.S.A.

Postmaster: Please send address changes to Popular Electronics, Subscription Dept., P.O. Box 338, Mount Morris, IL 61054-9632.

A stamped self-addressed envelope must accompany all submitted manuscripts and/or artwork or photographs if their return is desired should they be rejected. We disclaim any responsibility for the loss or damage of manuscripts and/or artwork or photographs while in our possession or otherwise.

As a service to readers, Popular Electronics publishes available plans or information relating to newsworthy products, techniques, and scientific and technological developments. Because of possible variances in the quality and condition of materials and workmanship used by readers, Popular Electronics disclaims any responsibility for the safe and proper functioning of reader-built projects based upon or from plans or information published in this magazine.

Larry Steckler

EHF, CET

Editor-In-Chief and Publisher

EDITORIAL DEPARTMENT

Carl Laron

Editor

Robert A. Young

Associate Editor

John J. Yacono

Associate Editor

Byron G. Wels, K2AVB

Associate Editor

Teri Scaduto

Assistant Editor

Kathy Terenzi

Editorial Assistant

Marc Spiwak

Editorial Associate

Fred Blechman

Joseph J. Carr, K4IPV

Marc Ellis

Len Feldman

Jeffrey K. Holtzman

Don Jensen

Charles D. Rakes

Marc Saxon

Contributing Editors

PRODUCTION DEPARTMENT

Ruby M. Yee

Production Director

Karen S. Brown

Production Manager

Marcella Amoroso

Production Assistant

Janice Box

Editorial Production

ART DEPARTMENT

Andre Duzant

Art Director

Injae Lee

Illustrator

Russell C. Truelson

Illustrator

Jacqueline P. Cheeseboro

Circulation Director

Michele Torrillo

P-E Bookstore

BUSINESS AND EDITORIAL OFFICES

Gernsback Publications, Inc.

500-B Bi-County Blvd.

Farmingdale, NY 11735

1-516-293-3000

Fax: 1-516-293-3115

President: **Larry Steckler**

Vice President: **Cathy Steckler**

Customer Service/Order Entry

1-800-435-0715

In IL 1-800-892-0753

7:30 AM - 8:30 PM EST

Advertising Sales offices listed on page 102

Cover photography by Diversified Photo Services

Composition by
Mates Graphics



The
Audit
Bureau
of Circulation



The publisher has no knowledge of any proprietary rights which will be violated by the making or using of any items disclosed in this issue.

AT LAST!

It was a long time in coming, but by the time you read this it will be possible to obtain a Technician-class amateur-radio license without passing a Morse-code test. Prior to this FCC action, which was adopted last December and took effect in February, prospective hams needed to demonstrate code proficiency at a minimum of five words per minute, with higher speeds required to gain access to the more popular high-frequency voice bands. The new Technician-class codeless license grants holders all amateur privileges in the VHF and UHF bands above 30 MHz.

Although I'm sure that some of you will disagree, I think it's about time! Requiring a code exam for frequencies above 30 MHz was an anachronism. These days, those frequencies are used almost exclusively for short-distance communications, as well as for satellite communications, ATV (amateur TV), and computerized packet radio. To assure the technical competence of those using these frequencies, a 55-question written examination on radio and electronics theory, as well as FCC regulations and operating practices, will still have to be passed.

It is important to note that the FCC action makes no changes in the traditional HF-band privileges. To gain access to the shortwave bands used for international communications, code proficiency must still be demonstrated.

The decline of amateur radio over the past quarter century has been well documented. To attract new blood to this important national resource, it is vital that we give them a hobby that addresses today's interests. And, in these days of increased international competition, it is equally important that we not place artificial barriers in the way of those who can add to this country's technical expertise through their involvement in ham radio. The FCC action does this, and I applaud it.

Carl Laron
Editor

Never before has so much professional information on the art of detecting and eliminating electronic snooping devices—and how to defend against experienced information thieves—been placed in one VHS video. If you are a Fortune 500 CEO, an executive in any hi-tech industry, or a novice seeking entry into an honorable, rewarding field of work in countersurveillance, you must view this video presentation again and again.

Wake up! You may be the victim of stolen words—precious ideas that would have made you very wealthy! Yes, professionals, even rank amateurs, may be listening to your most private conversations.

Wake up! If you are not the victim, then you are surrounded by countless victims who need your help if you know how to discover telephone taps, locate bugs, or “sweep” a room clean.

There is a thriving professional service steeped in high-tech techniques that you can become a part of! But first, you must know and understand Countersurveillance Technology. Your very first insight into this highly rewarding field is made possible by a video VHS presentation that you cannot view on broadcast television, satellite, or cable. It presents an informative program prepared by professionals in the field who know their industry, its techniques, kinks and loopholes. Men who can tell you more in 45 minutes in a straightforward, exclusive talk than was ever attempted before.

Foiling Information Thieves

Discover the targets professional snoopers seek out! The prey are stock brokers, arbitrage firms, manufacturers, high-tech companies, any competitive industry, or even small businesses in the same community. The valuable information they filch may be marketing strategies, customer lists, product formulas, manufacturing techniques, even advertising plans. Information thieves eavesdrop on court decisions, bidding information, financial data. The list is unlimited in the mind of man—especially if he is a thief!

You know that the Russians secretly installed countless microphones in the concrete work of the American Embassy building in Moscow. They converted



**HAVE YOUR
VISA or MC CARD
AVAILABLE**

what was to be an embassy and private residence into the most sophisticated recording studio the world had ever known. The building had to be torn down in order to remove all the bugs.

Stolen Information

The open taps from where the information pours out may be from FAX's, computer communications, telephone calls, and everyday business meetings and lunchtime encounters. Businessmen need counselling on how to eliminate this information drain. Basic telephone use coupled with the user's understanding that someone may be listening or recording vital data and information greatly reduces the opportunity for others to purloin meaningful information.

The professional discussions seen on the TV screen in your home reveals how to detect and disable wiretaps, midjet radio-frequency transmitters, and other bugs, plus when to use disinformation to confuse the unwanted listener, and the technique of voice scrambling telephone communications. In fact, do you know how to look for a bug, where to look for a bug, and what to do when you find it?

Bugs of a very small size are easy to build and they can be placed quickly in a matter of seconds, in any object or room. Today you may have used a telephone handset that was bugged. It probably contained three bugs. One was a phony bug to fool you into believing you found a bug and secured the telephone. The second bug placates the investigator when he finds the real thing! And the third bug is found only by the professional, who continued to search just in case there were more bugs.

The professional is not without his tools. Special equipment has been designed so that the professional can sweep a room so that he can detect voice-activated (VOX) and remote-activated bugs. Some of this equipment can be operated by novices, others require a trained countersurveillance professional.

The professionals viewed on your television screen reveal information on the latest technological advances like laser-beam snoopers that are installed hundreds of feet away from the room they snoop on. The professionals disclose that computers yield information too easily.

This advertisement was not written by a countersurveillance professional, but by a beginner whose only experience came from viewing the video tape in the privacy of his home. After you review the video carefully and understand its contents, you have taken the first important step in either acquiring professional help with your surveillance problems, or you may very well consider a career as a countersurveillance professional.

The Dollars You Save

To obtain the information contained in the video VHS cassette, you would attend a professional seminar costing \$350-750 and possibly pay hundreds of dollars more if you had to travel to a distant city to attend. Now, for only \$49.95 (plus \$4.00 P&H) you can view *Countersurveillance Techniques* at home and take refresher views often. To obtain your copy, complete the coupon below or call toll free.

RADIO-ELECTRONICS VIDEO OFFER		PE
500-B Bi-County Blvd. Farmingdale, NY 11735		
Please rush my copy of the Countersurveillance Techniques Video VHS Cassette for \$49.95 plus \$4.00 for postage and handling.		
No. of Cassettes ordered	_____	
Amount of payment \$	_____	
Bill my	<input type="checkbox"/> VISA <input type="checkbox"/> MasterCard	
Card No.	_____	
Expire Date	____ / ____	
Signature	_____	
Name	_____	
Address	_____	
City	State	ZIP
All payments in U.S.A. funds. Canadians add \$4.00 per VHS cassette. No foreign orders. New York State residents add applicable sales tax.		

OUR READERS COME THROUGH

Thank you for printing my letter requesting advice on how to solder one-handed in the December "Letters" column. The response has been terrific: I've used up my stamp budget through mid-1991 responding to every suggestion I received. Thanks to everyone that took the time to write.

Ronald M. Berkey
Seattle, WA

UPDATE YOUR PC OR XT UPDATE

I recently read the article "Update Your PC or XT" (*Popular Electronics*, November 1990), and wish to tell you that it is something of a disservice to your readers. The article states that you can upgrade an XT into an AT compatible by using the Bullet 286 motherboard. That is not precisely true. The Bullet 286 is not a true AT board. An AT machine processes 16 bits at a time throughout. While the Bullet 286 does use a 16-bit processor, it is set to process only 8 bits at a time, like an XT. That means that many of the AT-only programs cannot be run on this board. The AT cards and peripherals will not work with it either.

Basically, the Bullet 286 offers only two advantages. First, it is a relatively inexpensive way to obtain a faster XT compatible and, second, it allows the user to continue using the old XT controller cards and memory. In fact, this last point should have been emphasized more by the author. If a would-be upgrader uses anything other than the Bullet 286, he or she will also have to buy all new memory chips plus a few controller cards as well, which greatly increases the upgrade costs.

In reality, while the Bullet 286 does provide a faster response over any XT, it most definitely is not a true AT machine.

P.E.Y.
Sellersburg, IN

MISLABELED

Unfortunately, I made a labeling error on a piece of artwork appearing in "The Portmaster Home-Automation System"

(*Popular Electronics*, February 1991). In Fig. 4B on page 62, the pin labeled as pin 5 of U7 is really pin 4. I'm sorry for any inconvenience the mistake might have caused anyone.

John Yacono

FOREIGN POLICY

I am a foreign subscriber to *Popular Electronics* and I am becoming more-and-more annoyed about the increasing number of U.S. businesses that refuse to sell outside of the U.S. The following companies that advertised in the November issue refuse to trade outside the U.S.: Science Probe, Electronics Technology Today, Damark, and Radio-Electronics Video Offer. Further, EKI, Inc., the parts supplier for the "Digital Entry Lock" article that appears in that issue, will also not accept foreign orders.

I cannot understand the reason for this when all they have to do is accept the order, check that payment is correct by credit card or whatever, parcel it, stick on stamps, and mail it just as if it was going to North Dakota. The only inconvenience is that they might have to drag themselves to the post office to get a green customs sticker and a rate chart for overseas postage.

I run a company in New Zealand and I import educational training videos from the United States and re-export them to Malaysia, Singapore, and Australia. I have also been selling electronics kits, technical books, radio tubes, and components that are imported primarily from England, the U.S., and Australia. I just finished buying computer parts and electronic parts from Jameco, JDR, and Mouser Electronics, among others. Whether I do so as a company or an individual makes no difference as there are no controls on the vast majority of imports here or in Australia.

I am an American citizen living here, so I do know what I

am talking about. I am afraid that the vast majority of American businesses either do not, or they are just too lazy to bother to find out. That is probably part of the reason for the decline of U.S. business compared to the rest of the world.

I had been a long-term subscriber to the old *Popular Electronics*, both when I lived in the U.S. and from overseas—until it went off the rails and went computer. I'm glad to see that your magazine is very similar to the old *Popular Electronics* I enjoyed so much.

D.H.R.

Christchurch, New Zealand

"dBm" DEBATE

In Joseph Carr's *Ham Radio* column in the November 1990 issue of *Popular Electronics*, he describes "dBm" as 1 milliwatt in 50 ohms.

In my 46 years with the Bell system, we referred to "dBm" as 1 milliwatt in 600 ohms, or approximately 0.775 volts across the load. Is there some new standard now that the rules are not being set by Bell Labs?

T.L.

Fort Meyers, FL

Both definitions of "0 dBm" are correct. The concept of "0 dBm" is always referenced to the standard system impedance for the specific class of system being discussed. You are correct that 0 dBm is 1 mW dissipated in 600 ohms in *audio systems*. Another term for this standard is *volume units* (VU), in which 0 VU is 1 mW in 600 ohms.

The use of 0 dBm to mean 1 mW in 50 ohms is appropriate for *RF systems*. Indeed, I suspect that the Bell system's RF engineers and technicians used that definition for many decades (otherwise, they would be behind the rest of the industry—which is never where Bell tried to be!).

By the way, readers who are somewhat older than you may recall when 0 dBm at Bell was 6

mW in 500 ohms. I found that one in a 1920's-vintage telephone/electrical handbook.—Joe Carr

HAVES AND NEEDS

I am blind and bedridden with arthritis. I enjoy listening to shortwave radio to keep in touch with what's happening around the world although I'm a shut-in. I am hoping that one of your readers might be able to donate a new or used shortwave radio, and that other readers would write to me about their shortwave listening hobbies. Thank you.

Richard Jastrow
5909 West 6th Street
Los Angeles, CA 90036

The article on Wimhurst Machines in the December 1990 issue listed in its resources table a book entitled *Electrostatics, Exploring, Controlling, and Using Static Electricity*, by A. D. Moore, published by Anchor Books. That book is out of print, and I would very much like to know if anyone knows where I could find a copy. I used to check it out of my local library from time to time, but the library no longer has the book. Thank you.

Barry Klein
32041 Pleasant Glen Road
Trabuco Canyon, CA 92679

I'm trying to locate some discontinued Motorola voltage-regulator IC's. The Motorola number is MFC6030 and the Sylvania number is ECG-762. I'd appreciate any help.

Bill Smith
88 12th Street
Wheatland, WY 82201

I have a Hallicrafters model S-38D shortwave receiver. Does anyone know where I can get a schematic/wiring diagram, a copy of the original manual, or any other information? I would appreciate any assistance you could give me.

Marcus C. Smith
Rt. 1, Box 276
Steele, AL 35987

SELECT 5 BOOKS

for only \$4.95

(values to \$123.75)

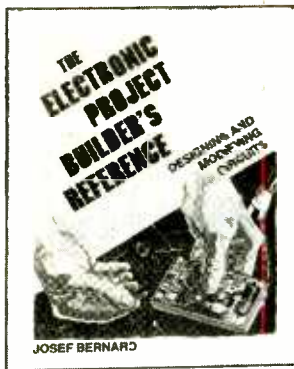

3260 \$22.95



3258 \$27.95
Counts as 2



2613P \$17.95



2867P \$18.95

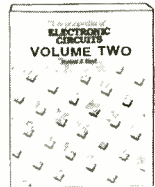

3138 \$60.00
Counts as 3

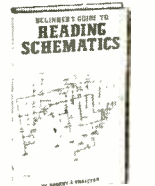

1536P \$11.95



1897P \$15.95



2826P \$16.95



2883P \$17.95



2804N \$29.95
Counts as 2



2898P \$15.95



2724P \$16.95



3205 \$24.95

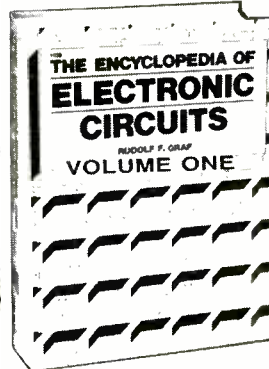
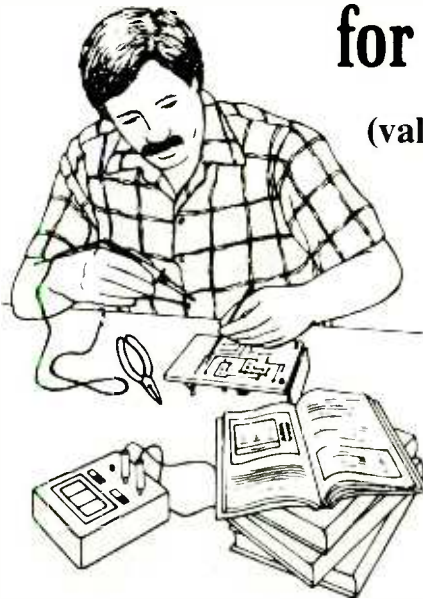

1938 \$60.00
Counts as 3

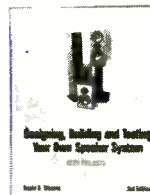

3374P \$16.95



3360 \$29.95
Counts as 2

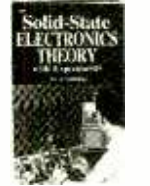

2926 \$25.95



3145 \$19.95

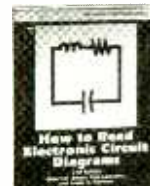

2880P \$14.95



3031P \$17.95

Your most complete source for electronics books for over 25 years.



804P \$21.95
Counts as 2



2790P \$14.95

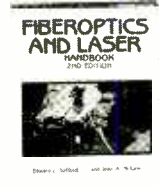

2981P \$16.95



3275 \$22.95

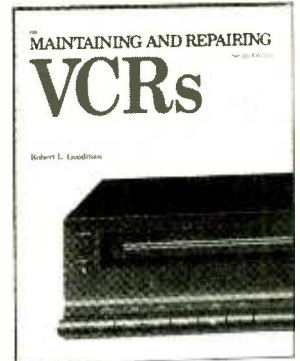

3103P \$17.95

Membership Benefits • Big Savings. In addition to this introductory offer, you keep saving substantially with members' prices of up to 50% off the publishers' prices. • **Bonus Books.** Starting immediately, you will be eligible for our Bonus Book Plan, with savings of up to 80% off publishers' prices. • **Club News Bulletins.** 15 times per year you will receive the Book Club News, describing all the current selections—mains, alternates, extras—plus bonus offers and special sales, with scores of titles to choose from. • **Automatic Order.** If you want the Main Selection, do nothing and it will be sent to you automatically. If you prefer another selection, or no book at all, simply indicate your choice on the reply form provided. You will have at least 10 days to decide. As a member, you agree to purchase at least 3 books within the next 12 months and may resign at any time thereafter. • **Ironclad No-Risk Guarantee.** If not satisfied with your books, return them within 10 days without obligation! • **Exceptional Quality.** All books are quality publishers' editions especially selected by our Editorial Board.



2972 \$23.95



1367P \$24.95

ELECTRONICS BOOK CLUBSM

Blue Ridge Summit, PA 17294-0810

Please accept my membership in the Electronics Book Club and send the 5 volumes listed below, billing me \$4.95. If not satisfied, I may return the books within ten days without obligation and have my membership cancelled. I agree to purchase at least 3 books at regular Club prices during the next 12 months and may resign any time thereafter. A shipping/handling charge and sales tax will be added to all orders.

Name _____

Address _____

City _____

State _____ Zip _____ Phone _____

Signature _____

Valid for new members only. Foreign applicants will receive special ordering instructions. Canada must remit in U.S. currency. This order subject to acceptance by the Electronics Book Club. **PE491**



3355 \$26.95
Counts as 2



3312 \$23.95



3445 \$21.95



3270 \$32.95
Counts as 2

1991 ELECTRONICS BOOK CLUB
Blue Ridge Summit, PA 17294-0810

All books are hardcover unless number is followed by a "P" for paperback.

ELECTRONICS LIBRARY

Home Satellite TV Installation and Troubleshooting Manual: 3rd Edition

by Frank Baylin, Brent Gale and Ron Long

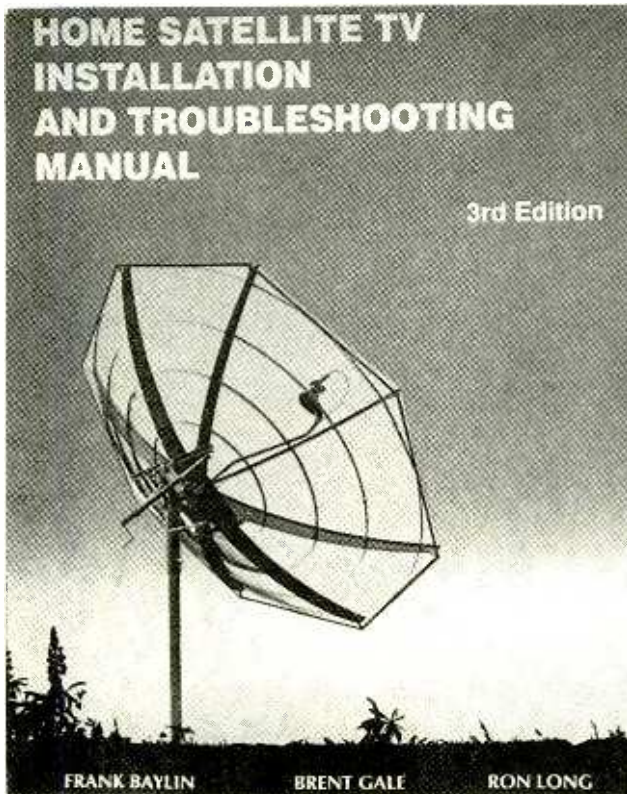

The new edition of this book has been thoroughly revised and includes two new chapters on small dish systems and upgrading an existing system. It also includes an expanded step-by-step installation procedure. The manual contains all the illustrations and tables needed to make installation and maintenance of trouble-free systems easy. It includes background theory and details on how satellites and TVRO's operate, methods to help consumers select and evaluate satellite-TV components, diagrams and text explaining multiple-receiver and multiple-television hookups, and ways to install unusually large antennas. An appendix provides a complete strategy for trou-

bleshooting any satellite-TV system, and includes a collection of useful equations, a glossary, and complete lists of satellite-equipment manufac-

turers and a list of references.

The Home Satellite TV Installation and Troubleshooting Manual: 3rd Edition is available for \$29.95 plus \$3.00 shipping and handling from Baylin Publications, 1905 Mariposa, Boulder, CO 80302.

CIRCLE 80 ON FREE INFORMATION CARD

THE BEST BOOK OF MICROSOFT WINDOWS 3

by Carl Townsend

This book introduces readers to the fundamentals of Windows and its new graphical interface. It explains how to fine tune PC's for impressive results and maximum efficiency. Practical tutorials give expert tips about the various applications of Windows 3, including the Calendar, Notepad, Windows Write, and Windows Paintbrush features. Power-user techniques show readers how to get the most from Windows. The book helps readers to master the software's intuitive desktop interface and learn to effectively run programs from the Program Manager. It explains how to use Window's advanced searching feature, manage files and directories, and transfer data.

The Best Book of Microsoft Windows 3 is available for \$24.95 from Sams, Division of Macmillan Computer Publishing, 11711 North College Avenue, Suite 140, Carmel, IN 46032.

CIRCLE 81 ON FREE INFORMATION CARD

VIDEO, STEREO, & OPTOELECTRONICS: 18 Advanced Electronic Projects

by Rudolf F. Graf and William Sheets

The projects presented in this book are sophisticated yet easy to build, and practical yet fun.

The emphasis is on entertainment-oriented projects in the audio, video, and photographic fields. Aimed at the general experimenter, they are based on both digital and RF techniques, primarily using parts that are available at Radio Shack. The projects include wireless headphones, a video-effects

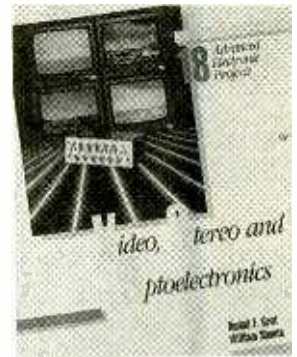

generator, an enlarging light meter, a multipurpose video-link transmitter, a frequency synthesizer, a universal shortwave converter, and a digital photo timer. Other projects are an FM-stereo transmitter, and receivers for longwave and FM-broadcast bands. PC-board layouts, construction tips, and parts lists are provided for each project. Each one has been built and tested for quality and practicality, and many are not available commercially.

Video, Stereo, & Optoelectronics is available for \$18.60 from Tab Books Inc., Blue Ridge Summit, PA 17294-0850; Tel: 1-800-233-1128.

CIRCLE 98 ON FREE INFORMATION CARD

STANDARD PRODUCTS CATALOG

from Bud Industries, Inc.

Bud Industries' entire line of standard cabinets, enclosures, and accessories for the electronics industry is included in

this 50-page catalog. The catalog provides full-color illustrations of many of the products, as well as design features, technical data, and ordering information on more than 3,000 standard product combinations. The enclosures range in size from large cabinet racks and computer workstations to smaller cabinets and desktop and portable instrument cases. Enclosure accessories such as desk tops, drawers, fans, blowers, and shelves, and an assortment of plastic enclosures are also included. The catalog provides information on Bud's custom fabrication services.

The Standard Products Catalog is free upon request from Bud Industries, Inc., 4605 East 355th Street, Willoughby, OH 44094; Tel: 216-946-3200; Fax: 216-951-4015.

CIRCLE 82 ON FREE INFORMATION CARD

FUNDAMENTAL ELECTRONIC DEVICES: Concepts and Experimentation (2nd Edition)

by Frederick W. Hughes

Intended to provide the reader with the necessary skills for an entry-level job in the electronics industry, this book puts an emphasis on reaching a thorough understanding of basic theory and proficiency at using the tools of the trade. It is designed to be used as an individualized learning package that uses numerous experiments, exercises, and self-checking quizzes to reinforce the text. The first few sections (or "units") cover safety precautions and test equipment, and subsequent units each follow the same format as different types of solid-state devices are explored, including semiconduc-

tor diodes, zener diodes, various field-effect transistors, other transistors, thyristors, op amps, and more. Each unit opens with a look at the theory and operation of the devices, followed by exercises that introduce terminology, problems that help teach basic drawing skills and familiarize the reader with schematic symbols, proper circuit-connection methods, and basic calculations. Basic experiments that demonstrate how to test the devices are followed by

fill-in questions and a basic trouble-shooting application in which the reader builds a simple circuit and then introduces problems. Still more exercises are introduced before the unit is rounded out with a review and two self-checking quizzes.

The second edition of this book features the addition of more in-depth study of the theory of semiconductor materials, a section on miscellaneous diodes and thyristors, four new op-amp experiments, and a

100-question final exam.

Fundamental Electrical Devices: Concepts and Experimentation (Second Edition) costs \$40.67 and is published by Prentice-Hall, Englewood Cliffs, NJ 07632.

CIRCLE 99 ON FREE INFORMATION CARD

DIGITAL ELECTRONICS FOR BEGINNERS

by Owen Bishop

Containing a dozen projects

The World's Most Popular Probe



Model SP100 \$45
100 MHz Switchable 1x-10x

More SP100 Probes Have Been Sold Worldwide Than Any Other Probe Ever Made

- For Tektronix, Hewlett Packard, Philips, Leader, B&K, Kikusui, Hitachi, Beckman and other oscilloscopes
- Immediate delivery from distributor stock
- **Economical** - Substantial savings compared to OEM probes
- **Durable** - Unique cable is slim, very flexible and resists breakage
- 10 day return policy - Guaranteed performance and quality

Free cross reference chart for all makes of scopes and probes. Call toll-free for chart and name of your local distributor.

TEST PROBES, INC. TPI

9178 Brown Deer Road
San Diego, CA 92121
Toll Free 1-800-368-5719

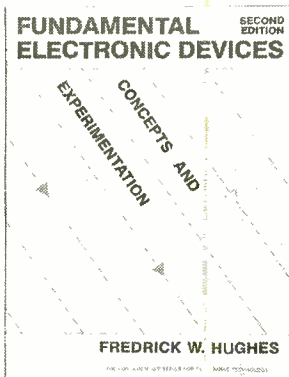

CIRCLE 10 ON FREE INFORMATION CARD

that newcomers to electronic construction should be able to build with a minimum of equipment, this book provides a hands-on approach to learning about electronics. The various digital-electronic projects range from instrumentation to home security to "just-for-fun" items. All but one of the projects are battery powered, so they are safe for beginners. Besides the illustrations, parts lists, circuit diagrams, and step-by-step instructions for building and testing the circuits, the book provides detailed explanations of the workings of each proj-

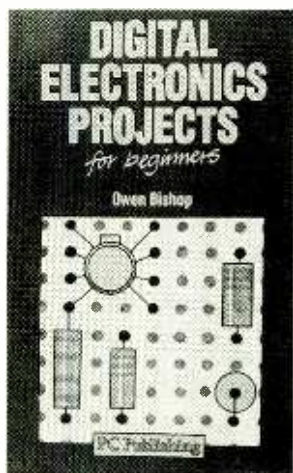

ect—and, in doing so, provides a practical introduction to the theory and applications of digital electronics. The opening chapter offers a basic overview of digital electronics, and the appendix provides helpful tips on working with solder and printed-circuit boards.

Digital Electronics for Beginners (order no. PCP112) is available for \$11.95 (including shipping and handling) from *Electronics Technology Today Inc.*, P.O. Box 240, Massapequa Park, NY 11762-0240.

CIRCLE 97 ON FREE INFORMATION CARD

DIGITAL VIDEO IN THE PC ENVIRONMENT: Second Edition

by Arch C. Luther

Focusing on digital-video interactive (DVI) technology, this book offers a convincing demonstration of the enormous potential of fully interactive video. The practical guide, written by one of the technology's developers, shows how the PC

user can implement DVI technology. The second edition has been extensively revised to reflect recent developments in the interactive-video field. New information includes in-depth coverage of the i750, Intel's new DVI chip set that makes the technology economically feasible for a wide range of PC applications. Full coverage is provided of the latest news in writable and erasable optical-storage media. The book includes examples of new C-language software written in accordance with Intel's revision of DVI software architecture, and has been updated to include 80386-based computers as the primary example system discussed.

Digital Video in the PC Environment: Second Edition is available for \$29.95 from *McGraw-Hill Book Company*, 11 West 19th Street, New York, NY 10011; Tel. 1-800-2-MCGRAW.

CIRCLE 96 ON FREE INFORMATION CARD

BUILD YOUR OWN MACINTOSH AND SAVE A BUNDLE

by Bob Brant

Readers need no prior technical experience to follow the step-by-step instructions for building a Macintosh computer that are provided in this book. The process requires no complicated electrical work and takes about the same level of skill needed to hook up a VCR or a TV set. The result is a "Cat Mac"—a Macintosh made up entirely of easy-to-obtain mail-order parts. Along with the construction details, the book provides a complete Cat Mac troubleshooting chart.

For readers who don't want to build a computer, the book ex-



plains how to make other improvements to existing Macintosh computers. It details how to upgrade a vintage Mac 128K for better performance, add a hard disk to a 512K to gain more storage space, add a bigger display to a Macintosh Plus, speed up a Macintosh SE with an accelerator card, build an inexpensive low-end Mac for word processing, and achieve the high-performance capabilities of the MacIIx without paying the high price.

Build Your Own Macintosh and Save a Bundle costs \$17.95 and is published by *TAB Books Inc.*, Blue Ridge Summit, PA 17294-0850; Tel. 1-800-233-1128.

CIRCLE 98 ON FREE INFORMATION CARD

PROCEEDINGS OF THE FIRST FIVE SYMPOSIA, 1980-1984 (VOLUME I) and PROCEEDINGS OF THE 6th, 7th & 8th SYMPOSIA, 1985-1987 (VOLUME II)

from *IEEE Computer Society Press*

Eight years of computer-security and -privacy papers are presented in this two volume set. With more than 1700 pages, the collection includes scores of practical and theoretical contributions that were presented originally at eight annual conferences. Volume I contains 956 pages of classic papers that lay the groundwork for later research and applications. During that early period, researchers began to identify problems, discuss solutions, and apply their results to the ongoing problems they faced. The second volume's 758 pages present significant newer material, including criteria for Trusted Computer System Evaluation (TSESC), systems for formal verification, network security models and policies, security projects, applications of cryptography to networks and databases, and more. The papers presented formed the basis for the production of new verification tools, new and efficient encryption algorithms, secure operating systems, and database-security architectures that are in widespread use.

Volume I, Proceedings of the

First Five Symposia, 1980-1984, and Volume II, Proceedings of the 6th, 7th & 8th Symposia, 1985-87 are available for \$100 and \$120, respectively from IEEE Computer Society Press, 10662 Los Vaqueros Circle, Los Alamitos, CA 90720; Tel: 714-821-8380; Fax: 714-821-4010.

CIRCLE 83 ON FREE INFORMATION CARD

HANDBOOK OF RADIO PUBLICITY AND PROMOTION: Third Edition

by Jack MacDonald and Curtis R. Holsopple

This broadcaster's guide to radio publicity, first published more than twenty years ago, has been updated with new promotional ideas designed to attract the listening audience of the 1990's. The revisions reflect the many changes those two decades have seen in popular culture, demographics, technology, and the radio industry itself. The book contains hundreds of contests, giveaways, and gimmicks—compete with on-air copy—as well as expert advice on how to build audience and staff excitement with an eight-week lead-in plan; determine the length of a publicity campaign, how much to promote it, and who should be involved in it; and make promotional campaigns run smoothly and fairly. In addition, the book discusses how to involve sponsors in promotions, using bonus prizes for weekly and daily contests, tie in daily and weekly promotions to a final grand prize, and set up seasonal and special monthly promotions.

The Handbook of Radio Publicity and Promotion: Third Edition is available for \$24.95 from *Tab Books Inc.*, Blue Ridge Summit, PA 17294-0850; Tel. 1-800-233-1128.

CIRCLE 98 ON FREE INFORMATION CARD

TREASURE HUNTERS BUYER'S GUIDE: Revised Edition

Edited by Rosemary Anderson

From the staff of *Western & Eastern Treasures* magazine comes this book designed to

(Continued on page 12)

Start a money-making career in video/audio servicing!

Only NRI gets you started fast with real-world training designed around state-of-the-art equipment you keep!

NRI's newly expanded training covers all the latest advances in home entertainment electronics, then takes you inside today's high-tech equipment as you learn to troubleshoot, diagnose, and service the complete home entertainment system included in your course: 13" color TV, programmable VCR, and integrated audio rack system. Only NRI makes it so easy to start a new career, earn part-time income, even start a video/audio servicing business of your own!

Billions of dollars of video/audio equipment means big opportunity for you

There's never been a better time to get involved in home entertainment electronics. Experts predict that consumers of video/audio equipment will spend over \$26 billion by 1995 as product manufacturers race to fill the demand for increasingly sophisticated technology.

This explosive acceleration of new product innovation means new opportunities for you in video/audio servicing. And NRI prepares you to take advantage of those opportunities by giving you the skills to troubleshoot and service a full range of TV, video, and audio equipment.

The most advanced, most complete video/audio training ever offered!

You start with lessons that give you a strong foundation in electronics fundamentals, mastering the basic circuits and components at the heart of today's video/audio equipment.

Then you build on that foundation as you explore the high technology of digital controls, CDs and digital audio tape players, advanced TV systems, cable TV, VCRs and camcorders, even microprocessors.

Best of all, you're prepared for the technology of today and tomorrow with hands-on training designed to give you invaluable practical experience.

Hands-on training with this incredible array of home entertainment equipment gives you the skills you need for success.



State-of-the-art equipment included in your training makes theory come to life

Only NRI gives you so much real-world equipment ... all yours to train with and keep! Get hands-on experience as you work with a complete, high-tech home entertainment system: a 13" color TV with remote, a programmable VCR, and an integrated remote-controlled audio system including AM/FM tuner, 100 watt amplifier, CD player, dual cassette player, turntable, speakers, and audio rack cabinet.

Theory comes to life as you learn to perform component-level diagnosis and service on advanced technology audio equipment ... conduct in-set demonstrations of TV circuits and components ... and discover first-hand how to maintain and service today's commercial VCRs.

Plus, NRI custom-produced videos

show you in close-up detail how to test, troubleshoot, and service TVs and VCRs like a pro.

No experience necessary ... NRI builds it in

You need no previous experience in electronics to succeed with NRI. Step by step, you accumulate the knowledge and practical experience that will make you uniquely qualified for today's opportunities in home entertainment electronics.

You learn at your own pace and on your own time. And all throughout your training, you have the full support of your personal NRI instructor and the entire NRI technical staff.

FREE catalog tells more

If the coupon is missing, write to NRI Schools, McGraw-Hill Continuing Education Center, 4401 Connecticut Avenue, NW, Washington, DC 20008.

SEND TODAY FOR FREE NRI CATALOG

NRI Schools

McGraw-Hill Continuing Education Center
4401 Connecticut Avenue, NW, Washington, DC 20008

Check one FREE catalog only

- TV/Video/Audio Servicing
- Microcomputer Servicing
- Computer Programming
- Telecommunications
- PC Systems Analysis
- PC Software Engineering Using C

- Desktop Publishing & Design
- Electronic Music Technology
- Word Processing Home Business
- Automotive Servicing
- Basic Electronics
- Bookkeeping & Accounting

For Career Opportunities approved under GI Bill
 check for details

Name _____ (Please print) _____ Age _____

Address _____

City _____ State _____ Zip _____

18-041



ELECTRONICS LIBRARY

(Continued from page 8)

help consumers select metal detectors to meet their specific needs and budgets. It is filled with information about more than 100 metal detectors and dozens of electronic locators, scoops, trowels, water hunting gear, and other accessories. The book is easy for treasure hunters of all levels of experience to use. Besides a glossary of terminology that goes beyond definitions to explain how detectors work, the book includes charts that compare detectors



head-to-head in more than 40 categories—such as weight, search modes, coin depth indicators, battery-check systems, power, and warranties. The detectors are grouped by price range on the comparison charts so that once the money decision has been reached, the consumer can immediately see the choices available. In addition, there are feature articles on how to choose the right detector and stay abreast of the latest technology.

Treasure Hunters Buyers Guide: Revised Edition is available for \$12.95 plus \$2.00 shipping from People's Publishing Company, P.O. Box 1095, Arcata, CA 95521.

CIRCLE 84 ON FREE INFORMATION CARD

HDTV: HIGH-DEFINITION TELEVISION

by Stan Prentiss

More than a dozen corporations around the world are currently scrambling to perfect HDTV technology, which promises to set off a video revolution that

will affect virtually every television-related field. This book is written to help marketing managers, engineers, technicians, and students prepare for the unveiling of high-definition television. It provides an inside look at the technical and legislative aspects of HDTV, and how those factors are influencing its progress. The competing delivery and receiving systems under development are described and compared in terms of their advantages and disadvantages.

The book presents both historical background and up-to-date information on a range of topics. It discusses the widely divergent industry standards in North America, Europe, and Japan that are impeding HDTV production. Current engineering proposals are highlighted, and FCC and congressional regulation of HDTV research and development is explored. The book presents a look at alternatives to HDTV, including improved-definition TV (IDTV) and extended-definition TV (EDTV), which enhance the performance of standard television receivers. In addition, the book examines system-test criteria and evaluates actual test results, and explores the potential problem areas in HDTV servicing.

HDTV: High-Definition Television is available for \$16.95 from Tab Books Inc., Blue Ridge Summit, PA 17294-0850; Tel: 1-800-233-1128.

CIRCLE 98 ON FREE INFORMATION CARD

HOW TO UPGRADE YOUR ASSOCIATE DEGREE TO A BACHELORS DEGREE WITHOUT STARTING OVER FROM SCRATCH!

by Paul E. Yost, CET

Many electronics technicians have associate degrees from two-year technical colleges—and many of them would like to be able to continue their education, without wasting any of the time and effort they've already invested. Yet four-year institutions are often reluctant to allow the use of credits from an associate degree toward a BS. This book, written by a college pro-

fessor, explains how electronics professionals who currently hold associate degrees can, relatively painlessly, go on to obtain their bachelors degrees by building on the education and credits they already have. It explains how to obtain maximum credit from an associate degree, and from related life and work experiences. Advice is provided on how to select the right college for specific individual needs, and how to organize and develop a degree plan. An emphasis is placed on how to achieve those goals while getting on with life—without going away to school or stopping work. Both standard colleges and correspondence schools are discussed, and all the basics—finances, curricula, credit transfers, applications, etc.—are covered.

How to Upgrade Your Associate Degree to a Bachelors Degree Without Starting Over from Scratch! is available for \$10.00 from Paul Yost CET, 2610 St. Joe Road West, Sellersburg, IN 47172; Tel: 812-246-9732.

CIRCLE 85 ON FREE INFORMATION CARD

1991 CATALOG OF ELECTRONIC COMPONENTS AND COMPUTER PRODUCTS

from Jameco

This comprehensive catalog contains virtually everything for the electronic technician, hobbyist, and computer buff. Its 89 pages include photographs, illustrations, product descriptions, specifications, and pricing information for hundreds of practical items. Included are an array of IC's, test equipment, tools and tool kits, computer kits, software and data books,



computer accessories, power-protection devices, cables, cases, power supplies, connectors, prototyping equipment, breadboards, anti-static devices, computer peripherals, floppy- and hard-disk drives, and components. New to this year's catalog are a 20-MHz and a 16-MHz 80386SX computer kit, several motherboards, a controller card, a 32-MB memory card, a 2400-baud mini external modem, and a 9600-baud fax board.

The 1991 Catalog of Electronic Components and Computer Product is free upon request from Jameco, 1355 Shoreway Road, Belmont, CA 94002; Tel: 415-592-8097; Fax: 415-592-2503.

CIRCLE 86 ON FREE INFORMATION CARD

VIDEOGAMES & COMPUTER ENTERTAINMENT'S COMPLETE GUIDE TO NINTENDO VIDEO GAMES

edited by Andy Eddy

Nintendo game sales topped 70 million in 1990, and Game Boy sales were close to 20 million. This book, edited by the executive editor of *VideoGames & Computer Entertainment* magazine, is intended to provide consumers with reliable product information needed to make informed purchases.

Approximately 200 Nintendo and Game Boy games are covered in the book. Accompanying a brief description of each game is an objective, expert review along with color-coded ratings that provide a quick overview. Categories included in the color-coded rating system are sound/music, graphics, playability, violence, and overall game quality. The book also features an index to game manufacturers that includes addresses and game counselor hot lines. "Sneak previews" of upcoming Nintendo releases are also provided.

VideoGames & Computer Entertainment's Complete Guide to Nintendo Video Games costs \$9.50 and is published by Hayden Books, 11711 North College Avenue, Suite 140, Carmel, IN 46032.

CIRCLE 87 ON FREE INFORMATION CARD

COMPUTER PROFESSIONAL'S DICTIONARY

by Allen Wyatt

The world of computers expands and changes so rapidly that it's difficult for even computer professionals to stay on top of the latest terminology. Written with experienced computer users in mind, it includes familiar words and phrases, terms that computer users understand only partially, and some that are totally unfamiliar. More than 3000 terms from virtually every aspect of computing are included—from "abbreviated addressing" to "Zmodem." Some are obscure, some are trendy, and many have become standard in everyday conversations. Many definitions are accompanied by illuminating illustrations. With entries arranged in absolute alphabetic order, it's easy for programmers, MIS managers, and other business computing professionals to quickly access the information they need.

Computer Professional's Dic-

tionary costs \$19.95 and is published by Osborne McGraw-Hill, 2600 Tenth Street, Berkeley, CA 94710.

CIRCLE 90 ON FREE INFORMATION CARD

THE AUDIO GLOSSARY

by J. Gordon Holt

Written by the founder of *Stereophile* magazine, this book includes not only a vocabulary for sound description, but also a comprehensive overview of more than 1900 technical and subjective audio terms. Many of those terms were actually coined by the author, who was faced with an extremely limited vocabulary of audio terms with which to write his reviews of equipment. Holt invented not only the techniques and disciplines of "subjective reviewing" of audio equipment, but also the language with which to do it.

The Audio Glossary costs \$9.95 in softcover, \$17.95 hardbound, or \$30.00 for a special limited edition signed by the author. It is published by Audio

Amateur Publications, Inc., 305 Union Street, P.O. Box 576, Peterborough, NH 03458-0576; Tel: 603-924-9464.

CIRCLE 88 ON FREE INFORMATION CARD

49 EASY ELECTRONIC PROJECTS FOR THE 747 DUAL OP AMP

by Delton T. Horn

Although the 741 operational amplifier is one of the most widely used integrated circuits, its "big brother," the 747 dual op amp, is actually the more practical and efficient choice. The 747 contains two independent 741's on a single chip, which allows for far more sophisticated applications. This book provides a useful collection of simple, inexpensive projects designed to introduce readers to the internal structure, specifications, and capabilities of the 747. Some of the projects featured include audio circuits, voltmeters, filter circuits, signal-generator circuits, mathematical and other analog computational circuits,

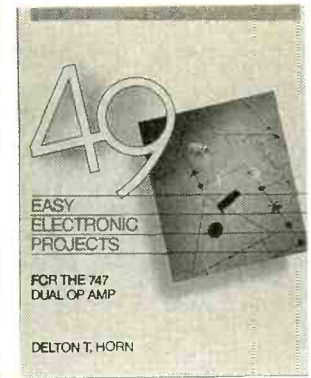

filter circuits, light and decibel meters, and modulator and pulse circuits. As the book guides the reader through each project's operation, it provides background information and specific component guidance necessary to customize those projects.

49 Easy Electronic Projects for the 747 Dual Op Amp costs \$15.95 and is published by TAB Books Inc., Blue Ridge Summit, PA 17294-0850; Tel. 1-800-233-1128.

CIRCLE 98 ON FREE INFORMATION CARD

The Ultimate in Home Control

Heath®



Just imagine, one press of a button and you can turn off your stereo, turn on your TV and VCR, start a videotape, and dim the lights. The best part is you've done it all from your favorite chair.

The One For All remote Whole House Controller, Command Center and Lamp Module make it all possible.

Installation is a snap. The remote Whole House Controller operates virtually any infrared-controlled device, and when used with the Command Center can control lights throughout your house. Just point the remote Whole House Controller at the Command Center and press a button. You've got home control.



CL-806R1

See our full line of home automation products and X-10 modules in the HEATH CATALOG. Call 1-800-44-HEATH for your FREE copy.

Order Today \$119.95*

Use Order Code 601-053 when ordering the One For All System URS-6000.

Call Toll-Free 1-800-253-0570

* Price does not include shipping and handling, or applicable sales tax for MI and CA deliveries



© 1990 Heath Company, Benton Harbor, MI



CIRCLE 6 ON FREE INFORMATION CARD

NEW PRODUCTS

PC Tool Kit

For the maintenance and care of all types of personal computers, *Jensen Tool's JTK-50 PC Mini-Kit* contains an assortment of fixed-handle tools designed to facilitate such tasks as the removal and installation of PC boards and memory chips, system upgrading, attaching peripherals, and repairing RS-232 connectors. The tool kit contains a variety of pliers, screwdrivers, and nut drivers; a



wire crimper/stripper; a four-inch compudriver; an RS-232 insertion extraction tool; a DIP inserter and a DIP extractor; an inspection mirror; and an adjustable 4-inch wrench. The tools are held securely in place in a compact (11½ × 10 × 2½-inch) case that features two roomy outside pockets.

The JTK-50 PC Mini-Kit costs \$145.00. For further information, contact Jensen Tools, Inc., 7815 South 46th Street, Phoenix, AZ 85044; Tel: 602-968-6231.

CIRCLE 100 ON FREE INFORMATION CARD

COMMUNICATIONS MONITOR

ACE Communication's AR-3000 receiver is part of a complete communications package with a computer-driven frequency logging and analysis system. It includes the receiver, which covers 100 kHz to 2036 MHz, plus control software and serial-interface hardware. The system

is designed for stand-alone, unattended monitoring and logging of any group of frequencies within the receiver's range, in Wide FM, Narrow FM, AM, or single-sideband operating modes.

The package offers two basic types of analysis and logging functions. The tabular method lists active calls by frequency, signal strength, date, and time, and even keys the call to a tape recording of the audio portion of the radio transmission. Tabular data can be printed or stored to disk. The spectrum-analyzer method displays on a computer monitor the "spikes" of received frequencies vertically ranked by signal strength, while the horizontal axis represents the radio frequencies being received. The display can either be viewed on a screen or printed on a dot-matrix or laser printer. The RS232C serial interface allows for remote operation and future expansion. A transfer rate of 4800 baud is supported.

The AR-3000 receiver and frequency logging and analysis system has a suggested retail



price of \$1,290.00. For further information, contact ACE Communications, Monitor Division, 10707 East 106th Street, Indianapolis, IN 46256; Tel: 1-800-445-7717; Fax: 1-800-448-1084.

CIRCLE 101 ON FREE INFORMATION CARD

LINEAR AMPLIFIER

The 600-watt *AL-811* linear amplifier from *Ameritron* uses three 811A tubes to deliver 600-watts PEP or 500-watts CW from

160–10 meters. (Easy modification instructions for 10/12 meters operation is available for those with valid amateur licenses.) A pi-network tuned-input circuit matches the tubes to 50-ohm exciters, allowing even the fussiest solid-state rig to perform flawlessly. A vernier-reduction drive on the plate control provides precise tuning. Dual illuminated meters give a complete picture of operating conditions—one meter gives a



continuous reading of grid current, and the second monitors high-voltage and plate current. The 811A tubes feature 3-second warm-up time and are inexpensive to replace. An operate/standby switch prevents harmful thermal shock to the tube filaments. Pressurized ventilation keeps the tubes and power supply components at temperatures that are safely below the manufacturer's ratings, even when operating continuously at 600 watts.

The AL-811 linear amplifier has a suggested retail price of \$599. For additional information, contact Ameritron, 116 Willow Road, Starkville, MS 39759; Tel: 601-323-8211 or 800-647-1800; Fax: 601-323-6551.

CIRCLE 102 ON FREE INFORMATION CARD

TEMPERATURE-CONTROLLED SOLDERING STATION

Including the purchaser's choice of either a 30- or a 40-watt soldering iron, the fully adjustable *Antex TCSU-1* temperature-controlled station is designed for use with heat- and voltage-sensitive components. Its slid-

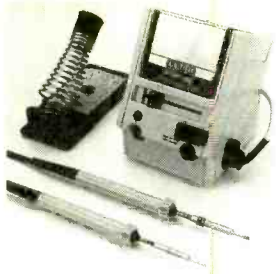

ing potentiometer can be used to adjust the tip temperature from 160° to 815°F with ±2% accuracy. The soldering iron has a thermocouple in the tip for positive feedback. Eliminating RF interference and magnetic fields, the TCSU-1 is powered by 115 VAC and converts line voltage to 24 volts for the soldering iron. Equipped with a four-foot burn-proof silicone cord and a 5-pin DIN connector, either iron accepts a full range of slide-on tips. The soldering station includes a spring holder and a stand with a stable metal base.

The Antex TCSU-1 temperature-controlled soldering station costs \$195.65 with either soldering iron. For further information, contact M.M. Newman Corporation, 24 Tioga Way, P.O. Box 615, Marblehead, MA 01945; Tel: 617-631-7100; Fax: 617-631-8887.

CIRCLE 103 ON FREE INFORMATION CARD

SILICON-RUBBER MULTIMETER LEAD

Available with right-angle or straight-shielded banana plugs, *Test Probes Inc.'s TL1000* multi-meter-lead set contains two leads and two fully insulated alligator clips. Those clips can be plugged onto the banana-plug measuring tip—as can other common accessories such as push-on hook tips, spade lugs, adaptors for meters



with recessed male inputs, and extender sleeves for linking cables. The TL1000 can test a maximum voltage of 1000 V RMS and a maximum current of 10 Amps. The cable length is 1.2 meters. The straight plugs are shielded with spring-loaded retractable safety sleeves, while the right-angle plugs have fixed-rubber sleeves.

The TL1000 silicon-rubber multimeter-lead set costs \$14.00. For more information, contact Test Probes, Inc., 9178

Brown Deer Road, San Diego, CA 92121; Tel: 800-368-5719.

CIRCLE 104 ON FREE INFORMATION CARD

PHONE-LINE SURGE PROTECTOR

Designed with today's fax- and modem-equipped home office in mind, the *Electra Guard EG6TC* surge suppressor from *Intermatic* provides full protection from transient voltage surges due to near lightning

strikes, heavy load switching, or utility-pole switching. The unit is designed especially for use with fax machines, answering machines, and other solid-state devices that require single telephone-line protection along with a standard NEMA 5-15 grounded receptacle.

The *Electra Guard* can protect up to six devices with a combined load of 1,875 watts, and has a response time of less than one nanosecond. It continuously monitors the incoming

ELENCO & HITACHI PRODUCTS AT DISCOUNT PRICES

NEW! RSOs (Real-Time & Storage Oscilloscopes) From HITACHI **NEW!**
View, Acquire, Test, Transfer and Document Your Waveform Data
The RSO - its the new solution

4-Channel, 100MS/s Model	Introductory Price
100MS/s (25MS/s on 4 channels simultaneously), 100MHz, 4kw x 1ch, 2kw x 2ch, 1kw x 4ch. VC-6145	\$4,695.00
Compact, Full Feature Models	
40MS/s, 100MHz, 4kw x 1ch, 2kw x 2ch. VC-6045	\$3,049.00
20MS/s, 50MHz, 2kw x 2ch. VC-6025	\$2,295.00
Low Cost/High Value Model	
20MS/s, 50MHz, 2kw x 2ch. VC-6024	\$2,049.00
20MS/s, 20MHz, 2kw x 2ch. VC-6023	\$1,749.00

RSOs from Hitachi feature such functions as roll mode, averaging, save memory, smoothing, interpolation, pretriggering, cursor measurements, plotter interface, and RS-232C interface. With the comfort of analog and the power of digital.

Compact Series Scopes

V-660 60MHz Dual Trace	\$1,195
V-1060 60MHz Dual Trace w/Cursor	\$1,345
V-1060 100MHz Dual Trace	\$1,425
V-1065 100MHz Dual Trace w/Cursor	\$1,695
V-1085 100MHz Quad Trace w/Cursor	\$2,045
V-1100A 100MHz Quad Trace w/Cursor	\$2,295
V-1150 150MHz Quad Trace w/Cursor	\$2,775

Delayed Sweep
Lightweight (13lbs)
2mV Sens
3 Yr Warranty
Model V-1065 Shown

This series provides many new functions such as CRT Readout, Cursor measurements (V-1085/1065/665), Frequency Ctr (V-1085), Sweeptime Autoring and Trigger Lock using a 6-inch CRT. You don't feel the compactness in terms of performance and operation.

20MHz Elenco Oscilloscope \$375
MO-1251

- Dual Trace
- Component Tester
- 6" CRT
- X-Y Operation
- TV Sync
- 2 p-1 Probes

FREE DMM with purchase of ANY SCOPE

SCOPE PROBES
P-1 65MHz, 1x, 10x \$19.95
P-2 100MHz, 1x, 10x \$23.95

Elenco 35MHz Dual Trace \$495
Good to 50MHz
MO-1252

- High Persistence 6" CRT
- 1mV Sensitivity
- 5KV Acceleration Voltage
- 10ms Rise Time
- X-Y Operation = 2 Axis
- Delayed Triggering Sweep
- Includes 2 P-1 Probes

All scopes include probes, schematics, operators manual, and 3 year (2 yrs for Elenco scopes) world wide warranty on parts & labor. Many accessories available for all Hitachi scopes. Call or write for complete specifications on these and many other fine oscilloscopes.

WE NOW CARRY COMPLETE LINE OF FLUKE MULTIMETERS Models	True RMS 4 1/2 Digit Multimeter M-7000 \$135 05% DC Accuracy .1% Resistance with Freq. Counter and deluxe case	10 Function Multimeter CM-365 \$65 AC + DC Voltage & Amps Resistance to 2000MΩ Diode, Logic, & Trans test Capacitance to 200pF	Digital Capacitance Meter CM-1550 \$58.95 9 Ranges 1pF-20,000uF 5% basic acy Zero control with case	Digital LCR Meter LC-1801 \$125 Measures: Coils 1uH-200H Caps 1pF-200uF Res. 0.1-20M
Function Generator Blox #9600 \$28.95 Provides sine, triangle, square wave from 0Hz to 1MHz AM or FM capability	Triple Power Supply XP-620 Assembled \$65 Kit \$45 2 to 15V at 1A, -2 to -15V at 1A (or 4 to 30V at 1A) and 5V at 3A	Wide Band Signal Generators SG-9000 \$129 RF Freq 100K-450MHz AM Modulation of 10KHz Variable RF output	SG-9500 w Digital Display and 150MHz built-in Counter \$249	
Soldering Station Temperature Controlled SL-30 \$99 Digital display Temp range: 300F-900F Grounded tip Overheat protect	Color Convergence Generator SG-200 \$69.95 Finest in the industry 10 rock steady patterns	10MHz Oscilloscope S-3000 \$275 10MHz DC or AC Triggered Sweep Calibrated Vert & Hor Reads Volts & Freq	Temperature Probe M-110CF \$29.95 Fits most digital multimeters Range: 58F-302F	Autoringing DMM M-5000 \$45 9 Functions Memory and Data hold 1/2 % basic acy 3 1/2 digit LCD
AC Current Meter ST-1010 \$69.95 1000 Amps Data & Peak hold 8 Functions Deluxe Case	Decade Blox #9610 or #9620 \$18.95 #9610 Resistor Blox 47 ohm to 1M & 100k pot #9620 Capacitor Blox 47pF to 10MFD	Quad Power Supply XP-580 \$59.95 2-20V at 2A 12V at 1A 5V at 3A 5V at 5A Fully regulated and short circuit protected XP-575 without meters \$39.95	LEARN TO BUILD AND PROGRAM COMPUTERS WITH THIS KIT! INCLUDES: All Parts, Assembly and Lesson Manual Model MM-8000 \$129.00 Starting from scratch you build a complete system. Our Micro Master trainer teaches you to write in RAML, POKe and run a 8085 microprocessor which uses similar machine language as IBM PC. You will write the initial instructions to tell the 8085 processor to get started and it will store instructions in permanent memory in a 256K EPROM. Teaches you all about input and output ports, computer timers. Build your own keyboard and learn how to scan keyboard and display. No previous computer knowledge required. Simple easy to understand instruction teaches you to write in machine language. ROBOTICS KIT FOR ABOVE (MM-8010) \$71.95	
Digital Triple Power Supply XP-765 \$249 0-20V at 1A 0-20V at 1A 5V at 5A Fully regulated. Short circuit protected with 2 limit control, 3 separate supplies XP-660 with Analog Meters \$175	GF-8016 Function Generator with Freq. Counter \$249 Sine, Square, Triangle Pulse, Ramp, 2 to 2MHz Freq Counter: 1 - 10MHz GF-8015 without Freq. Meter \$179	WE WILL NOT BE UNDERSOLD! UPS Shipping: 48 States 5% (\$10 Max) IL Res., 7% Tax		

C & S SALES INC.
1245 Rosewood, Deerfield, IL 60015
(800) 292-7711 (708) 541-0710

15 Day Money Back Guarantee
2 Year Warranty (Prices subject to change)
WRITE FOR FREE CATALOG

CIRCLE 5 ON FREE INFORMATION CARD

DIGITAL VIDEO STABILIZER ELIMINATES ALL VIDEO COPY PROTECTIONS



While watching rental movies, you will notice annoying periodic color darkening, color shift, unwanted lines, flashing or jagged edges. This is caused by the copy protection jamming signals embedded in the video tape, such as Macrovision copy protection. Digital Video Stabilizer: RXII completely eliminates all copy protections and jamming signals and brings you crystal clear pictures.

FEATURES:

- Easy to use and a snap to install
- State-of-the-art integrated circuit technology
- 100% automatic - no need for any troublesome adjustments
- Compatible to all types of VCRs and TVs
- The best and most exciting Video Stabilizer in the market
- Light weight (8 ounces) and Compact (1x3.5x5")
- Beautiful deluxe gift box
- Uses a standard 9 Volt battery which will last 1-2 years.

WARNING :
SCO
Electronics and
RXII dealers do
not encourage
people to use
the Digital
Video Stabilizer
to duplicate
rental movies
or copyrighted
video tapes.
RXII is in-
tended to stabi-
lize and restore
crystal clear
picture quality
for private
home use only.

(Dealers Welcome)

To Order: \$49.95 ea + \$4 for FAST UPS SHIPPING
1-800-445-9285 or **516-568-9850**
Visa, M/C, COD M-F: 9-6 (battery not included)
SCO ELECTRONICS INC.
Dept. CPE4 581 W. Merrick Rd. Valley Stream NY 11580
Unconditional 30 days Money Back Guarantee

CIRCLE 18 ON FREE INFORMATION CARD

CABLE TV DESCRAMBLER

How You Can Save Money
on Cable Rental Fees

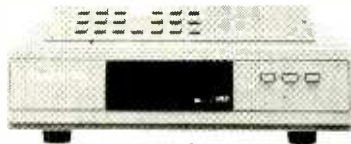

1 Unit 5+	
Jerrold SB w/Tri-Bi.....	\$99.....\$70
Super-Tri-Bi (TBM).....	\$109.....\$75
Jerrold 450 combo.....	\$189.....\$139
Scientific Atlanta.....	\$109.....\$75
SA 8536.....	\$250.....\$195
Pioneer.....	\$109.....\$79
Oak KN12 (w/VS).....	\$109.....\$65
Hamlin MLD 1200.....	\$89.....\$59
Tocom.....	\$169.....\$129
Stargate converter.....	\$89.....\$69
Panasonic TZPC145.....	\$99.....\$79

US Cable will
Beat Anyone's
Price
Advertised in
this Magazine!

30 Days Money Back Guarantee
Free 16 page Catalog

Visa, M/C, COD or send money order to:
US Cable TV Inc. Dept. KPE4
4100 N. Powerline Rd., Bldg F-4
Pompano Beach, FL 33073

1-800-445-9285

For Our Record

I, the undersigned, do hereby declare under penalty of perjury that all products purchased, now and in the future, will only be used on Cable TV systems with proper authorization from local officials or cable company officials in accordance with all applicable federal and state laws. FEDERAL AND VARIOUS STATE LAWS PROVIDE FOR SUBSTANTIAL CRIMINAL AND CIVIL PENALTIES FOR UNAUTHORIZED USE.

Date: _____

Signed: _____

No Florida Sales!

CIRCLE 19 ON FREE INFORMATION CARD



power line and telephone line and operates only when a surge or spike occurs, at which time it absorbs the overload while allowing normal voltage to pass through. The unit automatically resets to its monitoring mode after the disruption passes. The surge suppressor plugs into a standard grounded, dual, AC receptacle, providing six grounded outlets. Full protection is provided on all three lines: hot, neutral, and ground. Multi-stage telephone-line protection includes tip-ring, tip-ground, and ring-ground.

The Electra Guard EG6TC telephone, fax, and modem protector has a suggested retail price of \$42.95. For additional information, contact Intermatic Inc., Intermatic Plaza, Spring Grove, IL 60081-9698.

CIRCLE 105 ON FREE INFORMATION CARD

LINE CONDITIONER

Designed for use with computers, audio equipment, and other sensitive electronic equipment, the *Tripp Lite LC-1200* is a voltage regulator that corrects damaging low-voltage ("brownout") conditions and also guards against voltage surges. Complete spike, line-noise, and RFI/EMI filtering is built in, eliminating the need for external surge protection. The line conditioner provides up to 1200 watts of power from four "ISO-BAR" spike-protected AC-output receptacles. Two isolated

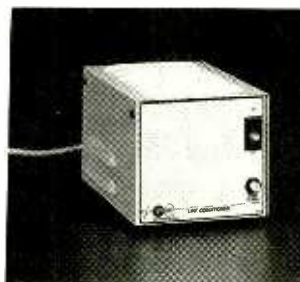

filter banks protect equipment, and isolation circuitry prevents interference between the electrical devices under protection. The compact LC-1200 features a 12-amp circuit breaker, a heavy-duty AC power cord, and a two-year warranty.

The LC-1200 has a suggested retail price of \$249.00. For additional information, contact Tripp Lite, 500 North Orleans, Chicago, IL 60610-4188; Tel: 312-329-1777; Fax: 312-644-6505.

CIRCLE 106 ON FREE INFORMATION CARD

HIGH-FREQUENCY SWR ANALYZER

The handheld *MFJ-207* high-frequency SWR analyzer allows users to obtain a complete picture of their antennas' SWR over a whole band, without using a transmitter, an SWR meter, or any other equipment. It plugs into the coax connector and is used by simply setting it to the desired frequency and reading the SWR. The MFJ-207 has a low-distortion RF generator that covers 10-60 meters, an SWR bridge that gives forward and reflected components, and circuitry that automatically



computes and displays the SWR. Frequency-counter output allows the unit to be connected to a frequency counter for precise digital readout. The MFJ-207 is powered by a 9-volt battery, or 117-VAC with an optional adapter (*MFJ-1312*).

The portable unit can take measurements directly from the antenna, eliminating the distorting effects of the coaxial cable.

Antenna adjustments, set-up, and trimming can be precisely made as SWR changes are measured on the spot. The MFJ-207 can be used to adjust a mobile whip, find the ideal place on a car for a mobile antenna, tune up an antenna tuner without transmitting, check the SWR of the input to a linear amplifier, and see how the SWR varies over the entire band to quickly locate the usable 2:1 SWR bandwidth. It also can be used to observe the effects of various conditions such as proximity to a power line, driving under an overpass, and rain or snow.

The MFJ-207 high-frequency SWR analyzer costs \$99.95; the MFJ-1312 adapter costs \$12.95. For more information, contact MFJ Enterprises Inc., P.O. Box 494, Mississippi State, MS 39762; Tel: 601-323-5869; Fax: 601-323-6551.

CIRCLE 107 ON FREE INFORMATION CARD

DIGITAL MULTIMETER

Leader's model 856 is a 4-1/2-

digit, true-RMS digital multimeter that provides comparison of measurement results, frequency measurement, and calculation functions (deviation, relative, and decibel measurements), as well as the conventional voltage, current, and resistance measurements. The auto-ranging, multi-function instrument uses a true-RMS method that provides extremely accurate measurements of



waveforms with crest factors up to 3. Frequency measurements range from 5 Hz to 300 kHz, with a maximum 30,000 count and up to 0.01-Hz resolution.

The bench-top DMM offers several convenience features. Deviations with respect to displayed data can be shown on

the 856, allowing elimination of test-lead resistance or the measurement of the variation above and below a center-referenced value. A last-memory function automatically saves front-panel key settings each time power is applied. A key-lock function helps eliminate errors when a specific, or continuous mode of operation is required. A three-level comparison function allows measured results to be indicated as High, Go, or Low with respect to upper and lower limits. AC voltage readings can be displayed in dBm or dB units, and an arbitrary voltage can be set as a reference for dB measurements. An LED bargraph readout and range indicator is also useful as an attenuator monitor for frequency measurements.

The model 856 digital multimeter costs \$800. For additional information, contact Leader Instruments Corporation, 380 Oser Avenue, Hauppauge, NY 11788; Tel: 800-645-5104 or 516-231-6900.

CIRCLE 108 ON FREE INFORMATION CARD

BOOKSHELF TWO-WAY SPEAKER

With their compact size and magnetic shielding, the PS-6a loudspeakers from *Design Acoustics* can be positioned in a variety of locations—even close to a television receiver with no danger of the magnetic field generated by the speaker distorting the picture. The PS-6a is said to image well because it minimizes baffle area



and the diffraction that cause distortion and image degradation. The tweeter is asymmetrically mounted so that the two speaker baffles are mirror images of each other, which also improves stereo imaging. The PS-6a is rated at 88dB/1W/1m, requires a mini-



2-1/2" SANYO TWEETER

Paper cone with gold tone dust cap. 8 oz. magnet. 8 ohm. 1/2" ferro fluid voice coil. Power handling: 50W RMS, 70W max. Frequency response: 3K-20KHz.



#PD-271-020 \$1³⁵ \$1⁷⁵ 95c
(1-9) (10-59) (60-up)

SUPER HORN TWEETER

Original piezo tweeter made by Motorola. SPL=94 dB 2.83V/1M. Response: 4KHz-27KHz. Handles approximately 50 watts.



#PD-270-010 \$5³⁰ \$4⁵⁰ \$3⁹⁵
(1-9) (10-79) (80-up)

2" DOME MIDRANGE

Textile dome midrange made by Philips. 8 ohm. SPL=90 dB 1W/1M. 30W RMS. 40W max. Response: 550-5KHz.



#PD-280-210 \$27³⁰ \$25⁷⁰
(1-3) (4-up)

15" SUBWOOFER



Dual voice coil. 40 oz. magnet. 6 ohm imp. 100W RMS, 140W max. Response 20-1.2KHz. Resonant frequency: 21Hz. SPL=93 dB 1W/1M

PIONEER
#PD-290-190 \$54⁵⁰ \$49⁸⁰
(1-3) (4-up)

SUBWOOFER COVER



200W RMS crossover designed specifically for use with dual voice coil subwoofers. 12 dB per octave roll-off at 150Hz

#PD-260-220 \$28⁸⁰ \$24⁴⁰

10" POLY WOOFER

Medium duty. 60W RMS 80W max. 14 oz. magnet. Response 25-2.5KHz fs=28Hz



#PD-290-096 \$18⁵⁰ \$16⁹⁰
(1-3) (4-up)

TITANIUM COMPOSITE TWEETER

The advantages of both hard and soft dome technologies 8 ohm. Ferro fluid cooled voice coil SPL=90 dB 1W/1M 50W RMS 70W max 4" round Polydax #DTW100T125



polydax
#PD-270-047 \$27⁵⁰ \$24⁸⁰
(1-9) (10-up)

SPEAKER BUILDING BOOK

Revised edition of David Weems' best selling book. Learn to build low cost speakers that rival the high priced models



#PD-500-021 \$16⁹⁵

12" CAST FRAME WOOFER



EMINENCE

12" woofer made in the USA by Eminence. Paper cone and dust cap with treated cloth surround. 80 oz. magnet. 2-1/2" vented voice coil. 8 ohm. 170W RMS, 235W max 40-4.5KHz response

#PD-290-147 \$72⁹⁰ \$69⁵⁰
(1-3) (4-up)



340 E. First St., Dayton, Ohio 45402
Local: 1-513-222-0173
Fax: 513-222-4644

* 15 day money back guarantee • \$15.00 minimum order • We accept Mastercard, Visa, Discover, and C.O.D. orders. • 24 hour shipping - Shipping charge = UPS chart rate + \$1.00(\$3.00 minimum charge) - Hours 8:30 am - 7:00 pm EST, Monday - Friday • Mail order customers, please call for shipping estimate on orders exceeding 5 lbs. Foreign customers please send \$5.00 U.S. funds for catalog postage.

CALL TOLL FREE
1-800-338-0531

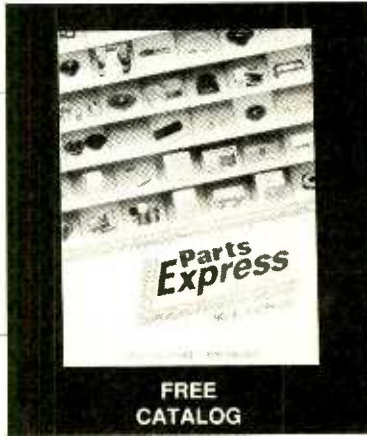

FREE CATALOG

CIRCLE 7 ON FREE INFORMATION CARD

mum of 10 watts, and can handle as much as 100 watts. Each speaker occupies less than a square foot of shelf space and is available in either a black wood-grain vinyl finish or a natural wood-grain vinyl finish.

The PS-6a loudspeaker has a suggested retail price of \$139.95 each. For additional information, contact Design Acoustics, 1225 Commerce Drive, Stow, OH 44224; Tel: 216-686-2600.

CIRCLE 109 ON FREE INFORMATION CARD

COMPUTER-THEFT ALARM

Providing an electronic alternative to anchored cables, the *PC Screamer* alarm from *Vantage Point Technologies* continually checks for unauthorized computer removal and then blasts a siren throughout the removal attempt. The device resets 30 seconds after the last unauthorized movement, and remains silent during normal computer use. *PC Screamer* is installed by using

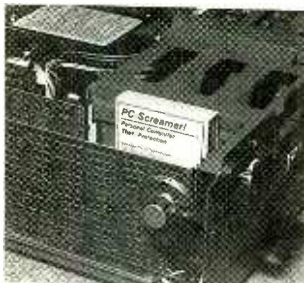

its self-stick backing to attach it to the inside of the computer case, and then plugging the power cable in-line with a disk-drive power cable. Sized to fit inside most desktop and tower computers, the device measures 3¼ × 2½ × 2 inches.

The *PC Screamer* computer-theft alarm costs \$39.50. For further information, contact *Vantage Point Technologies*, 1318 East Mission Road, Suite 376, San Marcos, CA 92069; Tel: 619-565-1863.

CIRCLE 110 ON FREE INFORMATION CARD

KEYBOARD STORAGE RACK

Designed to save valuable desk space while protecting key-

boards from dust, spills, and debris when not in use, *Curtis Manufacturing's Keyboard Space-Saver II (#SS-3)* is a combination monitor platform and keyboard storage rack with a drawer for office supplies. The sliding rack, which accepts any size keyboard, keeps the keyboard conveniently stored under

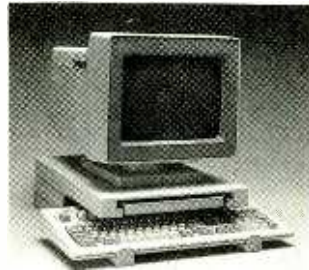

the monitor when not in use. The sturdy platform supports any size monitor at the proper viewing height. The drawer is large enough to hold legal-size paper along with an assortment of pens, pencils, paper clips, and other office supplies.

The *Keyboard Space-Saver II* has a suggested retail price of \$59.95. For additional information, contact *Curtis Manufacturing Company, Inc.*, 30 Fitzgerald Drive, Jaffrey, NJ 03452; Tel: 603-532-4123.

CIRCLE 111 ON FREE INFORMATION CARD

UNIVERSAL SWEEP/FUNCTION GENERATOR

A versatile 13-MHz universal sweep/function generator from *B&K Precision* has a built-in 6-digit, 30-MHz frequency counter. The *model 3040* includes a second, variable-signal source for sweeping the main generator, generating the burst gate, providing modulation (AM or FM), or for use as a second independent output.

The main generator produces sine, square, triangle, ramp, pulse, and TTL waveforms and offers triggered, gated-sweep, and gated-burst operation. Output frequency is adjustable from 0.1 Hz to 13 MHz. The second

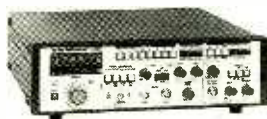

generator produces sine, square, triangle, ramp, and pulse waveforms with a 0.01-Hz to 10-kHz frequency range. When selected as an internal-modulation source, AM depth is adjustable from 0 to 100%; FM deviation is adjustable to ±5%. The second generator also could be used as a separate signal source, eliminating the need for two separate function generators.

The *model 3040* also features selectable internal or external AM or FM modulation, variable DC offset, and internal or external gated-burst operation. The output can be adjusted in three calibrated steps or continuously, using a variable attenuator. The output voltage can be varied from 0 to 10 volts peak-to-peak into 50 ohms. The six-digit LED readout can be used to indicate output frequency or to measure external signals to 30 MHz. The external counter mode offers five selectable gating times for resolution to 0.1 Hz.

The *model 3040* sweep/function generator has a suggested user price of \$1195. For further information, contact *B&K-Precision, Division of Maxtec International Corporation*, 6470 West Cortland Street, Chicago, IL 60635; Tel: 312-889-9087.

CIRCLE 112 ON FREE INFORMATION CARD

PC-BASED DIGITAL MULTIMETER

The *R860*, a PC-based, DVC/ACV/DCR multimeter card from *Rapid Systems* that plugs into a PC/XT/AT or compatible computer, provides all the features and accuracy of a standard 4½-digit bench-top DMM, and has the power and programmability of a computer-based instrument. For industrial users, the *R860* features integrated A/D and fully isolated inputs, resulting in higher accuracy and noise immunity. The *R860* is intended for use in multi-channel data logging, electronic lab work, and production testing. The PC-based DMM features programmable input ranges (200, 20, 2, or 0.2 volts or autorange); 0.03% accuracy; pop-up menu or command-line programming, and programmable conversion rate (10, 5, or 2.5 readings per second).

The *R860* PC-based digital



multimeter card costs \$695. For further information, contact *Rapid Systems, Inc.*, 433 North 34th Street, Seattle, WA 98103; Tel: 206-547-8311; Fax: 206-548-0322.

CIRCLE 113 ON FREE INFORMATION CARD

DIGITAL PYROMETER

A recent addition to *Amprobe Instrument's* line of temperature-sensing devices is the *model DP-2001* digital pyrometer. The instrument has a temperature range of -100°F (-73°C) to +2000°F (+1092°C) with the use of optional thermocouple accessories. It features a retrac-



table sensor with a range of -50°F (-46°C) to 300°F (149°C). It has both degrees-Fahrenheit and degrees-Centigrade capabilities.

The *model DP-2001* digital pyrometer has a list price of \$69.85. For further information, contact *Amprobe Instrument, Division of Core Industries Inc.*, 630 Merrick Road, Lynbrook, NY 11563; Tel: 516-593-5600. ■

CIRCLE 114 ON FREE INFORMATION CARD

CIE Gives You The Training You Need to Succeed... At Your Own Pace...& In Your Own Home!

Discover Your Career Potential In The Fast-Growing Field Of High-Tech Electronics!

If you're anxious to get ahead...and build a *real* career...you owe it to yourself to find out about the Cleveland Institute of Electronics!

CIE can help you discover your career potential in the fast growing field of high-tech electronics. A career that will challenge and excite you every day...reward you with a powerful feeling of personal accomplishment...and deliver a level of financial security you may have only dreamed of before!

As the leading school in home-study electronics, CIE has helped over 150,000 students in the U.S.A. and over 70 foreign countries get started in this exciting field. To find out how CIE could be helping you...read on...then send for a CIE catalog TODAY!

A Growing Need For Trained Professionals!

The career opportunities shown here are only a few of the challenging, high-paying careers you could enjoy as an electronics technician.

You could be the "brains" behind the scenes of an exciting TV broadcast...trouble-shoot life-saving medical equipment...design exotic new aeronautics systems...CIE's job-oriented programs offer you the quickest possible path to the career of your dreams! And CIE also features military and union re-training, to build on what you already know.

Dozens Of Fascinating Careers To Choose From!

Even if you aren't sure which career is best for you, CIE can get you started with core lessons applicable to *all* areas of electronics. As you advance, CIE makes job opportunities available to you through the bimonthly school paper, *The Electron*.



Data Communications



Automotive Electronics



Avionics



Computer-Assisted Manufacturing



Consumer Electronics



Military Electronics

Practical Training... At Your Own Pace.

Through CIE, you can train for your new career while you keep your present job. Each course allows a generous completion time, and there are no limitations on how fast you can study. Should you already have some electronics experience, CIE offers several courses which start at the intermediate level.

"State-Of-The-Art" Facilities & Equipment.

In 1969, CIE pioneered the first electronics laboratory course, and in 1984, the first Microprocessor Laboratory. Today, no other home study school can match CIE's state-of-the-art equipment. And all your laboratory equipment is included in your tuition cost. There is no extra charge—it's yours to use while you study at home and on the job after you complete your course!

Earn Your Degree To Become A Professional In Electronics!

Every CIE course you take earns you credit towards the completion of your Associate in Applied Science Degree, so you can work towards your degree in stages. And CIE is the only school that awards you for fast study, which can save you thousands of dollars in obtaining the same electronics education found in four-year Bachelor's Degree programs!

Personal Training From A Renowned Faculty.

Unlike the impersonal approach of large classroom study, CIE offers you one-on-one instructional help 6 days a week, toll-free. Each CIE lesson is authored by an independent specialist, backed by CIE instructors who work directly with you to answer your questions and provide technical assistance when you need it.

Send For Your Catalog Today!

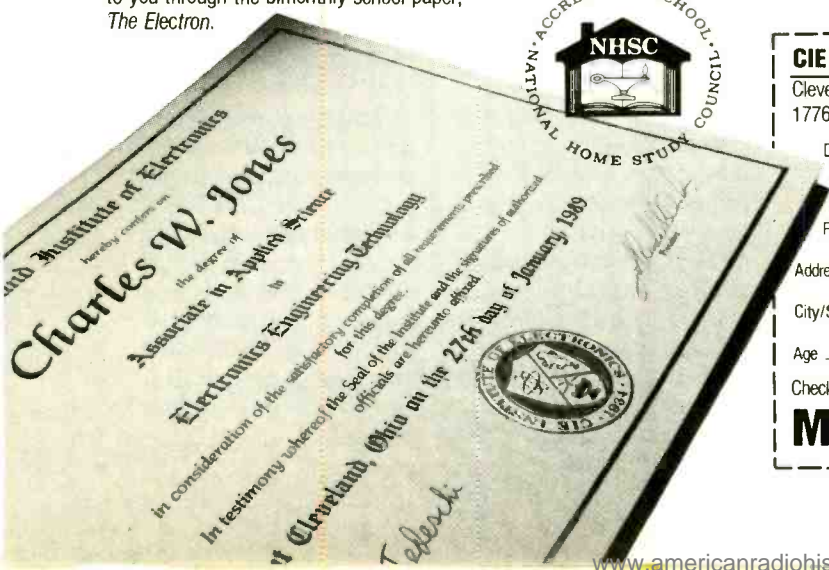

CIE World Headquarters

Cleveland Institute of Electronics, Inc.
1776 East 17th St., Cleveland, Ohio 44114

YES! Please send me your independent study catalog (For your convenience, CIE will have a representative contact you—*there is no obligation.*)

Print Name _____

Address _____ Apt # _____

City/State/Zip _____

Age _____ Area Code/Phone No. _____

Check box for G.I. Bill bulletin on educational benefits: Veteran Active Duty

Mail This Coupon Today!

AH05

APRIL 1991

THINK TANK

By John J. Yacono

Opening-up Your Gates

By way of introduction, my name is John and happily I've been given the responsibility for *Think Tank*. I've been an avid electronics tinkerer since I was a kid. To me there's nothing as much fun as being creative, except sharing creativity. So I'm really looking forward to reading and presenting your letters, and throwing in a few ideas of my own—so let's get to it.

Before we jump into the mailbag, I'd like to share a little off-the-beaten-path knowledge with you regarding old TTL logic gates. Because of their internal circuitry, you can sometimes reduce the number of TTL gates needed to do a certain job in an unusual yet simple way, as I'll show you.

I'll use the common NOR gate as an example. As you might know, you can wire-up NOR gates in a variety of ways to make them simulate other gates. The standard symbol for a NOR gate is shown in Fig. 1A and its truth table is shown in Fig. 1B. In negative-logic terms, it is like a negative-input AND gate (see Fig. 1C).

The simplest gate a NOR

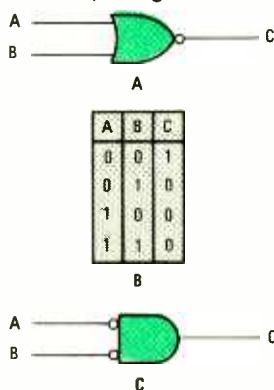

Fig. 1. A NOR gate (A) only goes high when both inputs are low, as shown in B. That is just what a negative-logic AND gate (C) does.

can imitate is an inverter, as shown in Fig. 2A. You just apply the input signal to both gate inputs, and its logical complement (inverse) will appear at the output (work out the truth

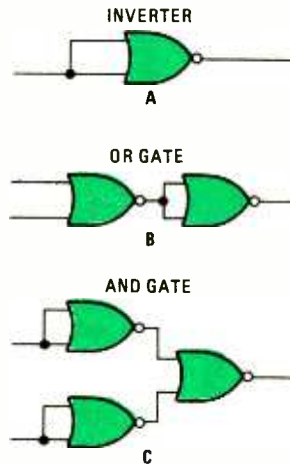

Fig. 2. You can easily make a NOR gate act like an inverter by connecting its inputs to the same signal (A). Coupling an inverting NOR gate to a plain NOR gate will cause it to act as an OR gate (B). By simply inverting its inputs (as shown in C), we can transform a NOR gate into an AND gate.

table to convince yourself). Of course, you can combine such an inverter with a NOR gate to get an OR gate, as shown in Fig. 2B.

As I mentioned before, a NOR is just an AND with inverted inputs. So if you invert the inputs to a NOR gate, you'll get a regular AND gate. The resulting circuit using only NOR gates is shown in Fig. 2C. We can take the process a step further by adding an inverter to the output to get a NAND gate (see Fig. 3).

Building XOR and XNOR gates is a little trickier, so we'll just present the two circuits in Fig. 4. Note that

the XOR circuit in Fig. 4A was implemented using five NOR gates. That's an unfortunate number of gates; most gates are available in IC packages that contain four gates each. That means you would need two IC's, but only use five out of the eight gates they provide.

However, there is a way to use only four gates provided that you have some really old TTL gates around. Some good candidates are the MC1010, MC1012, MC1210, and MC1212. Such gates use a negative power-supply voltage. They represent a logic high by a voltage a little less than zero volts, and a logic low with around -2 volts. However, if need be, such chips can be interfaced with modern circuits by connecting their ground terminal to 5-volts, their supply-voltage pin to the circuit ground, and using pull-down resistors at the outputs.

Those chips have a particularly interesting property: you can OR two gate outputs by just tying them together! In practical terms, that means you could replace the circuit in Fig. 4A with the circuit in Fig. 5. So you can implement an XOR gate with only one old quad NOR-gate chip and no waste.

No presentation of NOR-gate equivalents would be complete without mentioning R-S latches. The simple R-S data latch is shown in Fig. 6A, along with its truth table in Fig. 6B. A clocked version of the R-S latch is shown in Fig. 7A, and its truth table is presented in 7B. Now let's get to that mail.

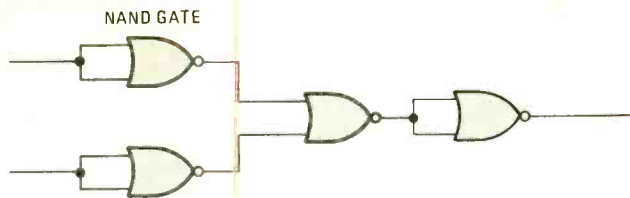
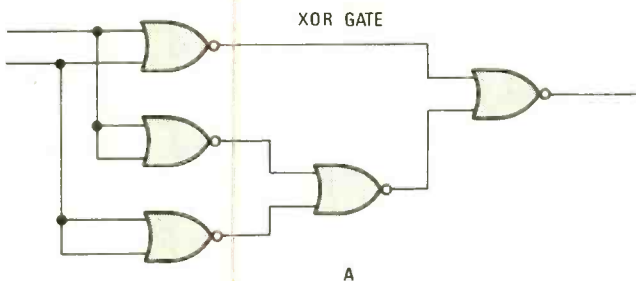
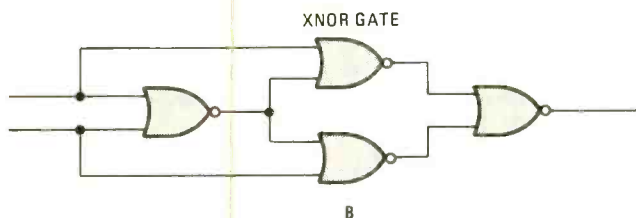

Fig. 3. By adding one more inverter, we can take or equivalent AND gate a step farther to turn it into an NAND gate.



A



B

Fig. 4. The logic required to make an XOR is not only a little complex, it requires five gates, as shown in A. The logic required to make an XNOR gate from NOR gates is a little complex, but we show such a circuit in B.

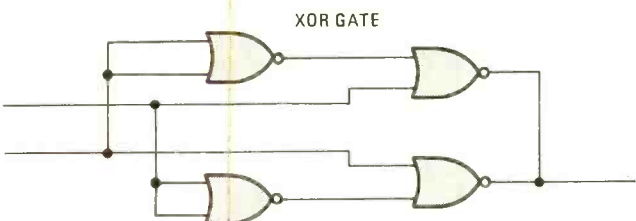

Fig. 5. If you use old TTL chips, you can fabricate an XOR from only four NOR gates. Note that the result of the two tied outputs is the OR of their values.

BURGLAR-ALARM UPGRADE

I was pleasantly surprised to see my burglar alarm mentioned in your column. I designed it to work in my old apartment; I have moved now and brought the alarm with me. It has been ganged together with two more circuits of newer design. The three circuits form a modular security system, with each responsible for a particular zone. I have included a drawing of the new version (Fig. 8). It has the same features as the

older one, but the design is "cleaner" and the parts are easier to find.

The alarm sensors should be the normally-closed types, connected in series to the terminals labeled LOOP. With switch S1 closed, the alarm is disabled. The low that the switch provides to pin 13 on U1 keeps pin 11 high. Diode D1 passes current to C2, keeping it charged. That applies a high to the inputs of a NAND gate connected as an inverter. The low output of the NAND-gate inverter cuts Q1

Become an EKI Certified Electronics Technician



with EKI's home-study program.

FREE
FREE
FREE
FREE
FULL COLOR CATALOG

Features:

- Low cost (only \$39 per module)
- 32 modules
- Used in schools all over the world
- Fast delivery
- No contract to sign
- Go at your own pace
- Can be completed in less than 6 months

CALL OR WRITE TODAY:



1-800-453-1708
1-714-833-8711



MEMBER

16631 NOYES AVE
IRVINE CA 92714

CIRCLE 16 ON FREE INFORMATION CARD

APRIL 1991

23

LEARN VCR

CLEANING/MAINTENANCE/REPAIR

EARN UP TO \$1000 A WEEK, WORKING PART TIME FROM YOUR OWN HOME!



Secrets Revealed!

NO Special Tools or Equipment Needed.

EARN UP TO \$60 AN HOUR AND MORE!

THE MONEY MAKING OPPORTUNITY OF THE 1990'S

IF you are able to work with common small hand tools, and are familiar with basic electronics (i.e. able to use voltmeter, understand DC electronics).

IF you possess average mechanical ability, and have a VCR on which to practice and learn. . . . then we can teach YOU VCR maintenance and repair!

FACT: up to 90% of ALL VCR malfunctions are due to simple MECHANICAL or ELECTRO-MECHANICAL breakdowns!

FACT: over 77 million VCRs in use today nationwide! Average VCR needs service or repair every 12 to 18 months!

Viejo's **400 PAGE TRAINING MANUAL** (over 500 photos and illustrations) and **AWARD-WINNING VIDEO TRAINING TAPE** reveals the **SECRETS** of VCR maintenance and repair—"real world" information that is **NOT** available elsewhere!

Also includes all the info you'll need regarding the **BUSINESS-SIDE** of running a successful service operation!

FREE INFORMATION
CALL TOLL-FREE 1-800-537-0589
 Or write to: Viejo Publications Inc.,
 5329 Fountain Ave.
 Los Angeles, CA 90029 Dept. PE

CIRCLE 8 ON FREE INFORMATION CARD

SUPER LONG PLAY TAPE RECORDERS

12 Hour Model — USES 120 TAPE

\$119.00*

Modified Panasonic Slimline, high quality AC-DC provide 6 continuous hours of quality recording & playback on each side of cassette for 12 hours total. Includes • Voice level control • Digital counter, etc. TDK -120 Cassette Furnished.



PHONE RECORDING ADAPTER

Records calls automatically. All Solid state connects to your telephone jack and tape recorder. Starts recording when phone is lifted. Stops when you hang up.

\$28.50*

FCC APPROVED

VOX VOICE ACTIVATED CONTROL SWITCH

Solid state. Self contained. Adjustable sensitivity. Voices or other sounds automatically activate and control recorder. Uses either recorder or remote mike.

\$28.50*

*Add for ship & hdlg. Phone Adapter & Vox \$150 ea. Recorders \$4.00 ea. Cal. Res. add tax. Mail order. VISA, M.C., C.O.D.'s OK. Money Back Guarantee. Qty disc. avail. Dealer Inquiries invited. Free data.

AMC SALES INC. Dept. B 9335 Lubec St. Downey, CA. 90241
 Box 928. Phone (213) 869-8519
 FAX (213) 923-1478

CIRCLE 13 ON FREE INFORMATION CARD

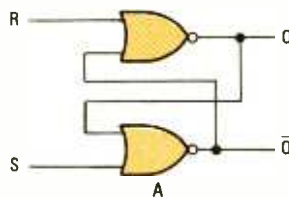

R	S	Q	Q̄
0	0	Q ₀	Q̄ ₀
0	1	1	0
1	0	0	1
1	1	FORBIDDEN	

Q₀ - PREVIOUS VALUE

B

Fig. 6. R-S data latches, like the one in A, are useful when you want to hold onto (latch) a binary value until you are ready to change it. Note that the circuit has a forbidden state (B).

off. That keeps K1 in its deactivated position. With pin 13 low, the state of the loop has no effect on the output of the circuit.

Opening S1 allows C1 to charge. The charging time of that capacitor provides you with some time to exit the house. You should check to see that LED1 is on, which indicates the loop is complete, before you leave. After about 22 seconds, the charge on C1 reaches the upper threshold value of U1, arming the alarm circuit.

As long as the loop is closed, the bistable latch made of the cross-connected NAND gates keeps pin 11 high and C2 charged. If the loop is opened, U1-a will place a low on pin 8, flipping the state of the bistable latch. Even if the loop is closed again, the circuit would remain in the "flipped" state. With pin 11 now low, C2 discharges through R3, which takes about 22 seconds (which gives you a chance to disable the alarm when you get home). When the lower threshold of U1-d is reached, its output will go high turning on Q1, which activates the relay, sounding the alarm.

Close switch S1 to silence the alarm. That places a low voltage on pin 13, flipping the bistable and setting pin 11 high. Capacitor C2 charges quickly through diode D1. With C2 charged, pin 4 goes low, cutting off transistor Q1, and relay K1 drops out silencing the alarm.

—Gordon Reeder,
 Rolla, MO

An excellent "re-think." As coincidence would have it, I'm installing an alarm system in my home and this circuit will allow me to add more zones without much cost. Each circuit can be connected to its own loop of sensors (a zone), and all of the circuits can be connected to a single siren.

For those interested, the inverter made from U1-a can be removed from the circuit if you wish to have a normally-open sensor loop. However, note that LED1 will be off until there is a breach of the zone.

Note the similarity between the NAND inverters and the NAND latch in this circuit and the NOR-gate versions we provided at the beginning of this month's

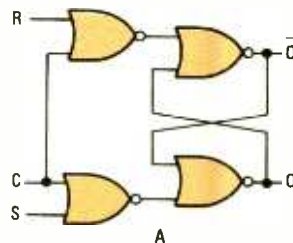

R	S	C	Q	Q̄
-	-	1	Q ₀	Q̄ ₀
0	0	0	Q ₀	Q̄ ₀
0	1	0	1	0
1	0	0	0	1
1	1	0	UNKNOWN	

B

Fig. 7. This latch (A) is similar to the simple latch in Fig. 6A, but, as you can see from the truth table (B), the circuit ignores any input until the C (clock) input is low.

Earn Your B.S. Degree in ELECTRONICS or COMPUTERS



By Studying at Home

Grantham College of Engineering, now in our 41st year, is highly experienced in "distance education"—teaching by correspondence—through printed materials, computer materials, fax, and phone.

No commuting to class. Study at your own pace, while continuing on your present job. Learn from easy-to-understand but complete and thorough lesson materials, with additional help from our instructors.

Our Computer B.S. Degree Program includes courses in the BASIC, PASCAL, and C languages — as well as Assembly Language, MS DOS, CADD, and more.

Our Electronics B.S. Degree Program includes courses in Solid-State Circuit Analysis and Design, Control Systems, Robotics, Analog/Digital Communications, and more.

An important part of being prepared to *move up* is holding the right college degree, and the absolutely necessary part is knowing your field. Grantham can help you both ways—to learn more and to earn your degree in the process.

Write or phone for our free catalog. Toll free, 1-800-955-2527, or see mailing address below.

Accredited by
the Accrediting Commission of the
National Home Study Council

GRANTHAM
College of Engineering
Grantham College Road
Slidell, LA 70460

APRIL 1991

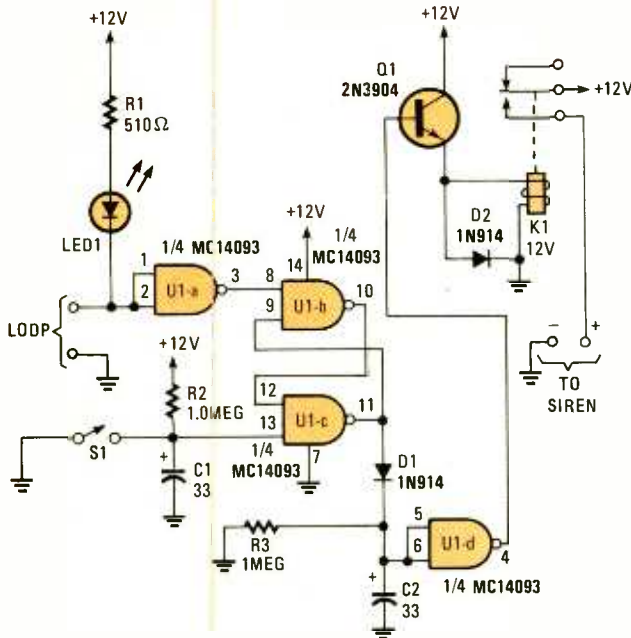

Fig. 8. This alarm-control circuit provides an entry delay, an exit delay, and latching action.

column. It just so happens that we have yet another burglar-alarm submission, but it is partly based on the NOR-gate circuits we've discussed.

INTRUSION ALARM

You can use this circuit (see Fig. 9) to alert you when someone opens any door or window that you wish to monitor. The circuit is built around a 4001 quad NOR-gate IC and an XOR gate from a 4070 IC.

The two NOR gates, U1-a and U1-b, act as a bounce-

less switch, more commonly known as an R-S latch. The XOR gate acts as a 1-bit comparator. It's a good idea to make switch S2 a key switch, as it is used to arm and disarm the alarm system.

Switch S1 is a home-made normally-closed switch used as a sensor. It was made from two metal plates, one placed on the frame of a door, and one on the door itself. The plates are positioned so they only make contact when the door is closed. Gate U2

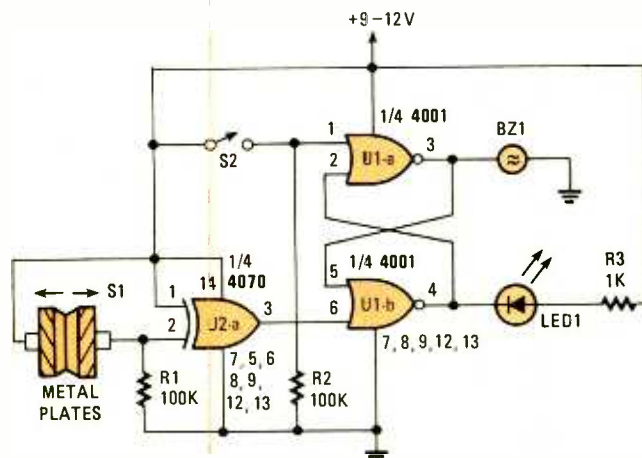

Fig. 9. When this alarm latches, it activates its own buzzer. Note the use of the NOR-implemented R-S latch.



FREE CATALOG TEST INSTRUMENTS & HARD-TO-FIND TOOLS

Packed with over 10,000 quality products for testing, repairing, and assembling electronic equipment. A full selection of test instruments, power protection equipment, precision hand tools, tool kits, soldering supplies, and much more. Products are shown in full color with detailed descriptions and pricing. All products come with a 100% satisfaction guarantee. SAME-DAY shipment program.

In a hurry to receive your catalog?

Call (800) 225-5370

In Massachusetts call (508) 682-2000

Contact East, Inc., Dept. R469

335 Willow St., No. Andover, MA 01845

CIRCLE 17 ON FREE INFORMATION CARD

AMAZING NEW Pocket Reference

480 pages of tables, maps, formulas, and conversions and it fits in your shirt pocket (3.2" x 5.4" x 0.6")!

\$9.95*



* Plus \$2.00 shipping & handling. Colorado residents add 56¢ tax.

Small sample of contents

Air Tool CFM vs PSI	Radio Alphabet
Battery Charging	TEN Radio Codes
Tire Manufacturer Codes	Telephone Area Codes
Lumber Sizes & Grades	Lost Credit Card Phones
Concrete & Mortar	Sound Intensities
Element Tables	Wind Chill Factors
Computer ASCII Codes	Frequency Spectrum
IBM® PC Error Codes	Geology Mineral Tables
IBM® Interrupts-I/O Map	Glues and Solvents
80286 Hard Disk Types	Bolt Torque Tables
Printer Control Codes	Wood Screw/Nail Sizes
Electric Wire Size vs Load	Math Formulas & Tables
NEMA Motor Frames	Plane/Solid Geometry
Wire & Sheet Gauges	Copper/Steel/PVC Pipe
Resistor/Capacitor Colors	Rope, Cable and Chain
Pilot Lamp Specs	Tap-Die-Drill Sizes
Fuse & Battery Specs	Sand Paper & Abrasives
RF Coil Winding Data	Weld Electrode & Solder
Wire Size vs Turns/Inch	3200 Conversion Factors

Money Back Guarantee - If not completely satisfied, return book postage prepaid, in mint condition for a 100% refund!

Sequoia Publishing Inc.
Dept 919, P.O. Box 620820
Littleton, CO 80162

CIRCLE 11 ON FREE INFORMATION CARD

compares the inputs at pins 1 and 2; if pin 2 is high (i.e. S1 is closed) the buzzer, BZ1, and LED1 remain off, but if the input at pin 2 is low (i.e. the door is opened) U2's output goes high, it sets the R-S latch, the buzzer sounds, and the LED glows. To reset the circuit, momentarily close switch S2.

The circuit has an interesting advantage: since it is wired for normally-closed operation, you need not protect the sensor wires by running them through a conduit. If a thief tries to break the wire the alarm will sound. However, the circuit and wires should be hidden or camouflaged to provide the element of surprise.

—Joe Louis Balpuesta, Texcoco, Mexico

As a matter of personal preference, I would still place the wires in a protective conduit. It's all too easy for a smart, skilled burglar to short the sensor wires, completing the circuit before opening the door. They've been known to use a razor (like the kind used to cut carpet) to cut out a section of luan doors to allow them to disable interior sensors. There's nothing to keep them from doing the same thing with a window, provided they have a glass cutter.

NOISE ON DEMAND

Enclosed is my second submission to *Think Tank*: a noise generator (Fig. 10). The heart of the circuit is an NPN transistor connected to operate with its emitter-base junction in the breakdown mode. That causes it to generate noise, which is amplified by op-amp U1-a. The other op-amp is fed the fortified signal via R1, which acts as a variable-tap voltage divider. The position of the wiper determines the signal level fed to the second op-amp, which is configured as a unity-gain follower. Because of the characteristics of the LF353 BI-FET op-amp, the circuit will drive almost any impedance. Note that the circuit does require a dual-voltage supply.

—Bob McVay, Troy, OH
Interesting circuit. If I'm not mistaken the transistor should emit "white" noise—noise of equal power over a range of frequencies. You can use the circuit to properly set the bands on an equalizer. Start by hooking up a microphone to provide input to the equalizer. Connect the noise generator to a speaker with flat frequency response over the range you wish to adjust. (You may have to use two or three different speakers to set the equal-

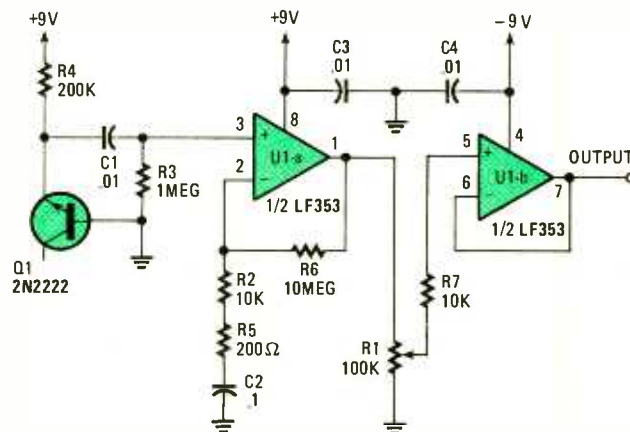

Fig. 10. There are times when noise is useful. This circuit can drive noise signals into any reasonable impedance because of the special op-amps it contains.

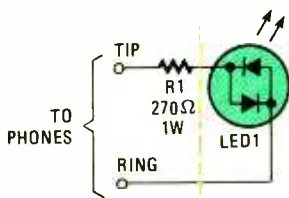

Fig. 11. A classic example of less is more, this small circuit can help you identify the tip and ring wires in a telephone junction box.

izer over the whole audio range.) Turn the circuit on and set it to output some arbitrary level of white noise into the microphone. Don't change the level for the rest of the procedure. Adjust the bands on the equalizer for flat response over the speakers' frequency range.

PHONE-LINE TESTER

My submission (Fig. 11) is a simple telephone-line polarity tester. At work, I deal with phones a lot and the tester is invaluable. The schematic is so simple I don't think it needs an explanation.

There are a couple of things that the builder should bear in mind, though. The first is that the unit should be wired so that the LED glows green (for "go") when the probes are connected to the tip and ring wires with the right polarity. Second, the high-voltage of a ring signal will

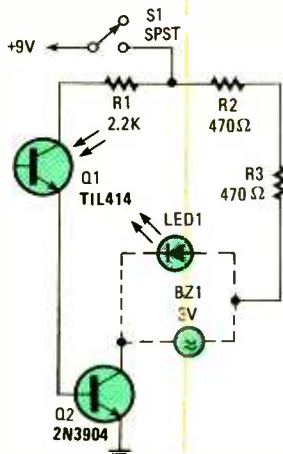

Fig. 12. This detector circuit provides audible as well as visual indications.

not damage the unit because the tester loads the line down enough to act like a phone off hook.

I hope others find this circuit as useful as I do.

—Sam Kapli, Minneapolis, MN

Short and sweet. You readers will need a way to check the polarity (color) of the tester. It should light up green when the ring probe's voltage is positive with respect to the tip probe. You can use a 9-volt battery to provide the voltage for the test.

HI-FREQUENCY IR DETECTOR

If you want an infrared detector with either audible or visual indication, try this on for size. (See Fig. 12.) It can really be helpful when attempting to carefully adjust a frequency. All that is required is an infrared phototransistor (Q1), a 2N3904 general-purpose NPN transistor (Q2), an LED, three resistors, and a piezo buzzer (3 volts maximum).

When infrared light strikes the phototransistor, it conducts and lights either the LED or sounds the buzzer. If you want to wire both into the circuit, put a single-pole, double throw (SPDT) switch in and you can select the one you want. The circuit is extremely sensitive to high infrared frequencies so use it in a darkened room.

I built my unit into a small plastic project box with the phototransistor on one side and the switch on the top. All parts are available at Radio Shack.

—Eric Eades, Midvale, UT
Okay Eric. Chalk up one Think Tank book!

Well, I should wrap this month up here. It's been fun and I look forward to the next time. Remember send your letters to *Think Tank*, Popular Electronics, 500-B Bi-County Blvd., Farmingdale NY, 11735.

Courteous Service • Discount Prices • Fast Shipping

ALL ELECTRONICS

P.O. Box 567 • Van Nuys, CA 91408

** New ** FLASH UNIT

This NEW compact flash unit comes from a U.S. manufacturer of cameras. Unit operates on 3 Vdc and measures 2 1/2" X 1 1/4".

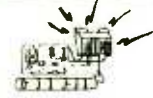

Ideal for use as a strobe, warning light or attention getter. Complete with instruction on how to wire.

CAT# FSH-1 \$3.75 each 10 for \$35.00

Special New Reduced Price PHOTOFASH CAPACITOR

Rubicon CE photoflash capacitor. 0.79" dia. X 1.1" high. These are new capacitors that have been prepped with 1.4" black and red wire leads soldered to the terminals.



210 Mfd 330 Volt CAT# PPC-210 \$1.25 each • 10 for \$11.00 • 100 for \$100.00

Large quantities available. Call for pricing

FLASHING L.E.D.

Diffused L.E.D. with built in flashing unit. PULSE RATE: 3 Hz @ 5 Volt/20 ma. Unit continually flashes when 5 Volts is applied. Operates between 4.5 Volts and 5.5 Volts. T 1 3/4 size. IDEAL AS AN INDICATOR.

RED CAT# LED-4
GREEN CAT# LED-4G
YELLOW CAT# LED-4Y



\$1.00 each • 10 for \$9.50 • 100 for \$90.00

HEAVY-DUTY NICKEL CADMIUM "C" BATTERY

Yuasa 1800C

Special purchase of new, rechargeable nickel-cad batteries. 1.2 volts, 1800 mA.H. PRICE REDUCED ON 10 OR MORE.



CAT# HDNCB-C

10 pieces for \$42.50 (\$4.25 each)
100 pieces for \$375.00 (\$3.75 each)

POWER SUPPLIES

5Vdc 3 AMP

ACDC Electronics #5N3-1 New, prepped power supply with wires and connectors soldered to the inputs and outputs. Open frame style. 4.94" X 4.03" X 2". Input: 115 Vac. UL and CSA listed. Regulated.



CAT# PS-53 \$10.00 each

12 Vdc 5 AMP

ACDC Electronics # 12N5 or equiv. Input: 100-240 Vac (wired for 115 Vac) Output: 12 Vdc @ 5 amps. Open frame style. 7" X 4 3/4" X 3" high. Regulated.

CAT# PS-125 \$37.50 each

24 Vdc 2.4 AMP

Power-One Inc. #HC-24-2.4 Input: 115/230 Vac (wired for 115 Vac) Output: 24 Vdc @ 2.4 amps. Open frame style. 5.62" X 4.87" X 2.50" CSA listed.

CAT# PS-2424 \$30.00 each

TOLL FREE ORDER LINES

1-800-826-5432

CHARGE ORDERS to Visa, MasterCard or Discover

TERMS: Minimum order \$10.00. Shipping and handling for the 48 continental U.S.A. \$3.50 per order. All others including AK, HI, PR or Canada must pay full shipping. All orders delivered in CALIFORNIA must include state sales tax (6 %, 6 1/2 %, 7 %). Quantities Limited. NO C.O.D. Prices subject to change without notice. Call Toll Free, or clip this coupon

FREE 60 Page Catalog

Containing over 4,000 ITEMS

ALL ELECTRONICS CORP.

P.O. Box 567 • Van Nuys, CA • 91408

Name _____

Address _____

City _____

PE391

State _____

Zip _____

CIRCLE 14 ON FREE INFORMATION CARD

Take any 3 PROFESSIONAL BOOKS for only \$4.95

when you join the **ELECTRONICS ENGINEERS & DESIGNERS BOOK CLUB**™

values to \$129.40

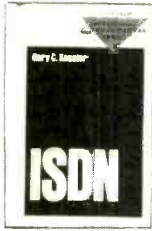

10015 \$42.95
Counts as 2

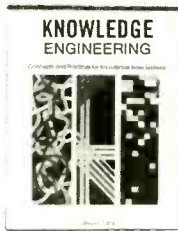

3297 \$39.95



3131 \$26.95

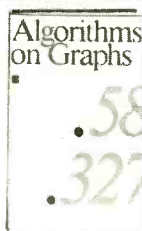

3429 \$29.95

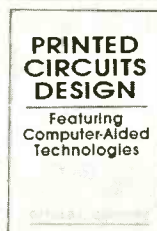

10016 \$39.95
Counts as 2



3279 \$36.95

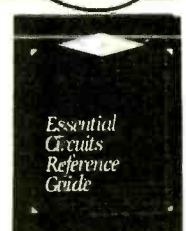

9319 \$59.50
Counts as 3

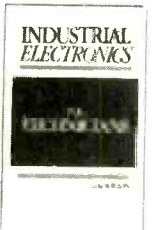

3321 \$24.95



3102 \$49.50
Counts as 2

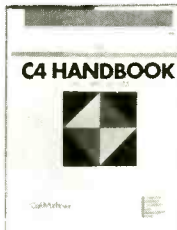

3098 \$44.50
Counts as 2



2672 \$49.50

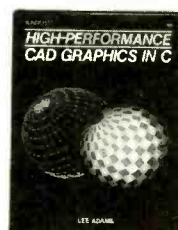

3059 \$34.95
Counts as 2



3151 \$39.95

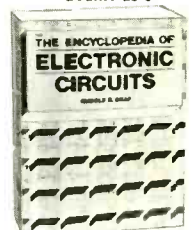

1938 \$60.00
Counts as 2



9813 \$39.95



3212 \$34.95



3147 \$38.95



3203 \$44.50
Counts as 2



9244P \$18.95



3140 \$49.95
Counts as 2

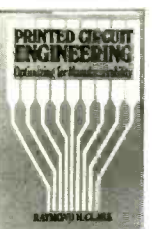

9245 \$46.95
Counts as 2



3199 \$52.00
Counts as 2

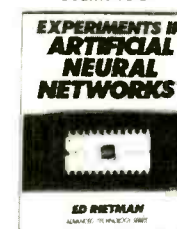

3037 \$24.95

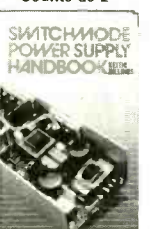

9305 \$59.50
Counts as 3

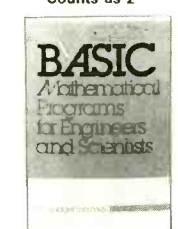

8225P \$19.95



9246 \$33.95
Counts as 2

How the Club Works

YOUR BENEFITS: You get 3 books for \$4.95 plus shipping and handling when you join. You keep on saving with discounts up to 50% off as a member.

YOUR PROFESSIONAL BOOKSTORE BY MAIL: Every 3-4 weeks, you will receive the EE&D Book Club News describing the Main Selection and Alternates, as well as bonus offers and special sales, with scores of titles to choose from.

AUTOMATIC ORDER: If you want the Main Selection, do nothing and it will be sent to you automatically. If you prefer another selection, or no selection at all, simply indicate your choice on the reply form provided. You will have at least 10 days to decide. As a member, you agree to purchase at least 3 books within the next 2 years and may resign at any time thereafter.

BONUS BOOKS: Starting immediately, you will be eligible for our *Bonus Book Plan*, with savings of up to 80% off publishers' prices.

IRONCLAD NO-RISK GUARANTEE: If not satisfied with your books, return them within 10 days without obligation!

EXCEPTIONAL QUALITY: All books are quality publishers' editions especially selected by our Editorial Board. (Publishers' Prices Shown)

Your source for quality, affordable and timely authoritative engineering books.

ELECTRONICS ENGINEERS & DESIGNERS BOOK CLUB™
Blue Ridge Summit, PA 17294-0860

YES! Please accept my membership in the *Electronics Engineers & Designers Book Club* and send the 3 volumes I have listed below, billing me \$4.95. If not satisfied, I may return the books within 10 days without obligation and have my membership cancelled. I agree to purchase at least 3 books at regular Club prices during the next 2 years, and may resign any time thereafter. A shipping/handling charge and sales tax will be added to all orders.

--	--	--

Name _____

Address _____

City _____

State _____ Zip _____ Phone _____

Signature _____

Valid for new members only. Foreign applicants will receive special ordering instructions. Canada must remit in U.S. funds. This order subject to acceptance by the *Electronics Engineers & Designers Book Club*.

PP1F491

Build A Regenerative

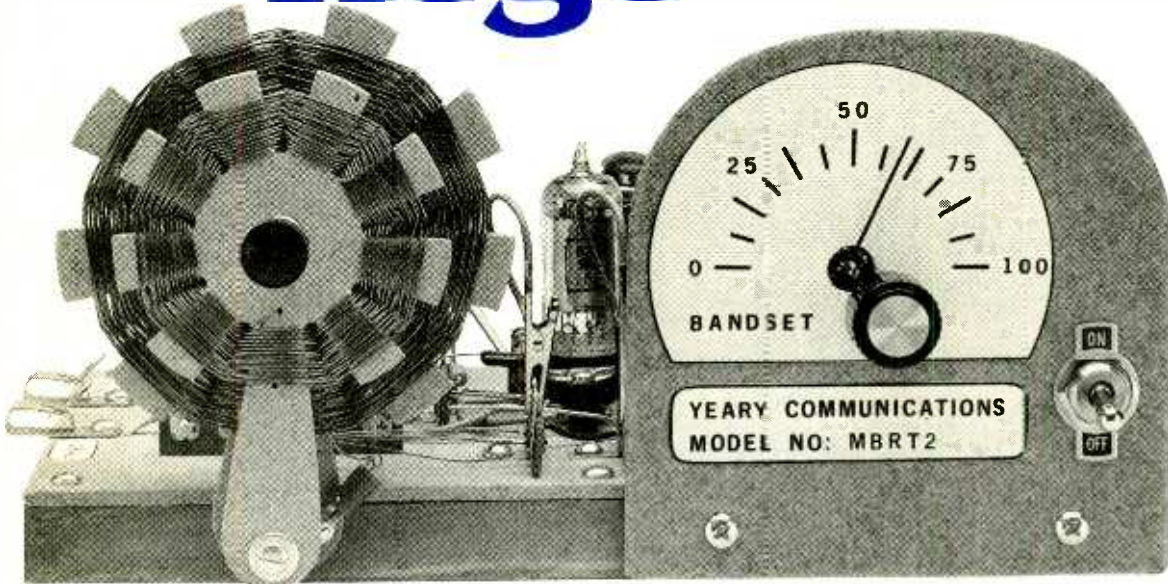

Vacuum-Tube Receiver

BY STANLEY A. CZARNIK

Recreate the feel of the early days of radio with this fun-to-build and fun-to-use regenerative radio receiver

Prior to the first commercial success of semiconductor devices in the 1950's, many vacuum-tube types were developed for a variety of applications. Since then, the use of tubes has steadily decreased. The transistor, developed in 1947, was for most purposes a superior device. Some of its advantages are that it has no glass to break, requires no warm-up time, has nothing to burn out, and is lighter, smaller, and faster than its predecessors. So, it is no wonder that traditional vacuum tubes have, for the most part, given way to solid-state components.

Still, the vacuum tube receives considerable attention. The physical princi-

ples that manifest themselves in the operation and design of vacuum tubes appear frequently in many spheres of electronic research and fabrication. Therefore, the study of those principles is certainly worth the effort.

The operation of most common vacuum tubes depends on two elementary electronic phenomena. The first is the emission of electrons by certain elements and chemical combinations when the energy of the atoms on the surface of the material is raised by the addition of heat. Such thermal agitation and electron release is called *thermionic* emission. The second is that the movement of electrons within an

evacuated chamber can be controlled by the manipulation of magnetic and electric fields.

The internal structure of a typical thermionic vacuum tube consists of an arrangement of at least two (usually three) different types of electrode: an electron emitter (usually called the cathode or the filament), an electron collector (the anode, usually called the plate), and one or more electron controllers (called grids).

A Look At The Circuit. Figure 1 shows a complete schematic diagram of the Regenerative Vacuum-Tube Receiver, plus a 1-tube resistance-coupled audio

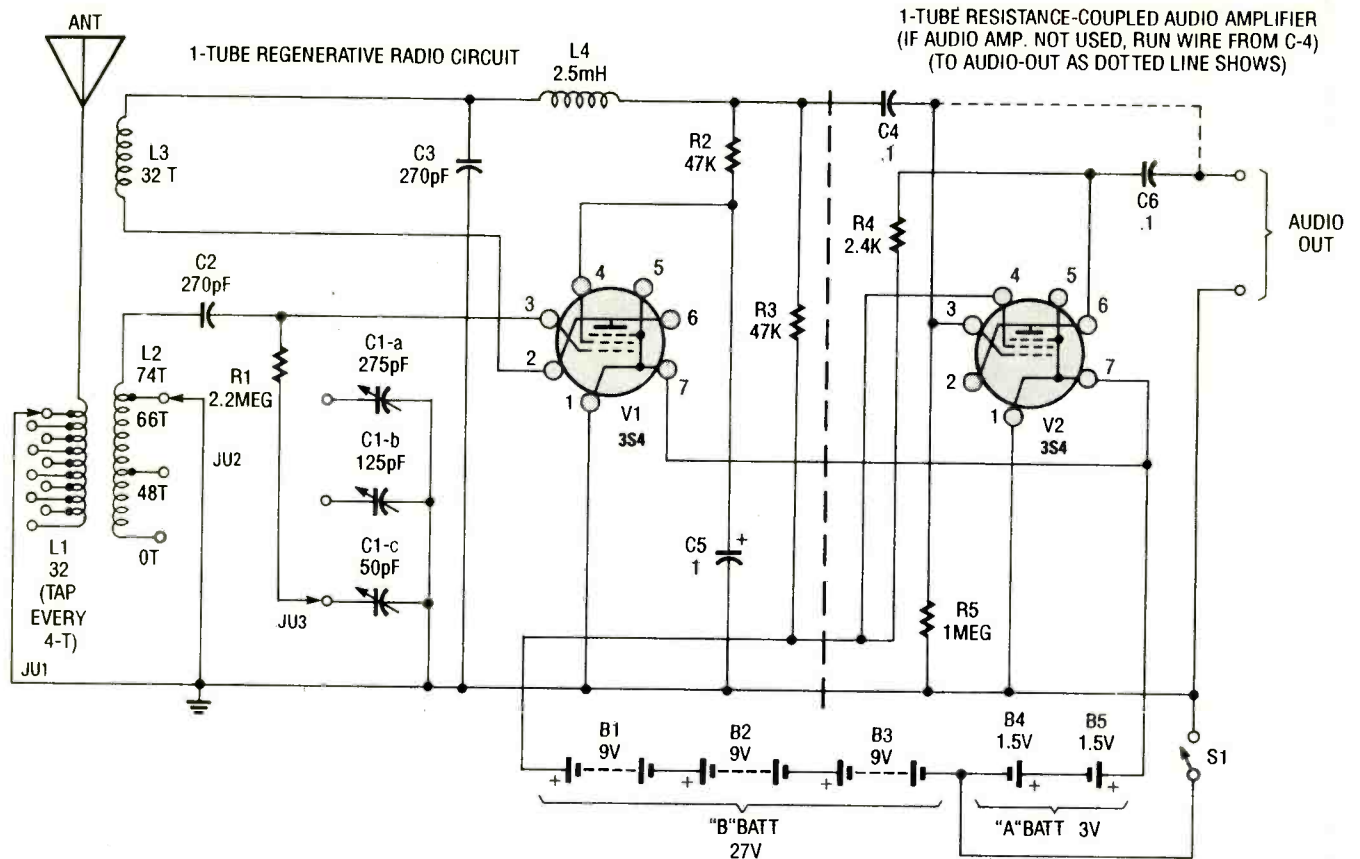

Fig. 1. Here is the complete schematic diagram of the Regenerative Vacuum Tube Receiver, feeding an optional (see text) 1-tube resistance-coupled audio amplifier.

amplifier. In the Fig. 1 circuit, the untuned radio-frequency (RF) signal picked up by the antenna (ANT) and applied to L1, a multi-tapped coil. The taps on L1 help to match the impedance of the antenna to the input impedance of the receiver, ensuring maximum signal transfer.

The RF signal from the antenna is inductively coupled to L2. The taps on L2 set the range of frequencies that can be tuned by the receiver (sort of a coarse-frequency control), while C1 determines the precise frequency (station) to which the receiver is tuned (in essence, a fine-frequency control). Components C2 and R1—which are connected to the first grid of V1 (a 3S4 pentode) at pin 3—comprise the “grid-leak” or “detector” portion of the circuit, which converts the incoming RF to an audio-frequency signal. The filament of V1 (at pins 1 and 7) is energized by the 3-volt “A” battery. That starts electron-flow through the four remaining elements of the tube where amplification, detection, and regeneration take place. A DC bias voltage is applied to the second grid of V1 at pin 4 through R2 and R3. Capacitor C5 bypasses any AC component superimposed on V1’s DC bias voltage to ground. The third

PARTS LIST FOR THE REGENERATIVE VACUUM-TUBE RECEIVER

RESISTORS

(All resistors are ½-watt, 5% units.)

- R1—2.2-megohm
- R2, R3—47,000-ohm
- R4—2400-ohm
- R5—1-megohm

CAPACITORS

- C1—Variable capacitor (see text for specifications)
- C2, C3—270-pF, mica
- C4, C6—0.1-μF, ceramic disc
- C5—1.0-μF, 50-WVDC, electrolytic

ADDITIONAL PARTS AND MATERIALS

- V1, V2—3S4 pentode vacuum tube
- L1–L3—See text
- L4—2.5-mH RF choke
- S1—SPST or DPDT toggle switch
- B1—Two 1.5-volt C-cell batteries
- B2—Three 9-volt transistor-radio batteries
- Baseboard, baseboard rails, tube sockets, battery holders, terminal

strips, Fahnestock clips, crystal earphone, magnet wire, hook-up wire, hardware, etc.

Note: The Regenerative Vacuum Tube Receiver kit (with audio amplifier circuit) is available from Yearly Communications, 12922 Harbor Boulevard #800, Garden Grove, CA 92640. The stock number is MBRT2-MBAT2 and the price is \$34.95. A set of three spiderweb coil forms (stock number SWCF3) is available for \$5.00. The five-section variable capacitor (stock number VTC55) is available for \$4.00. The radio kit without the audio amplifier option (stock number MBRT2) is available for \$29.95. The audio amplifier option alone (stock number MBAT2) is \$7.50. Add 12% of total cost for shipping, plus \$2.00 for handling to all orders. California residents add 6.25% sales tax.

grid of V1 at pin 5 is internally connected to ground through pin 1 of V1’s filament.

The plate of V1 (pins 2 or 6) is the output portion of the tube. That element is positively biased from B +

through R3, L3, and L4. So, how is the signal amplified? Note that each element of the tube from grid 1 (pin 3) through the plate has a negative, positive, negative, positive potential, respectively. With the filament starting the

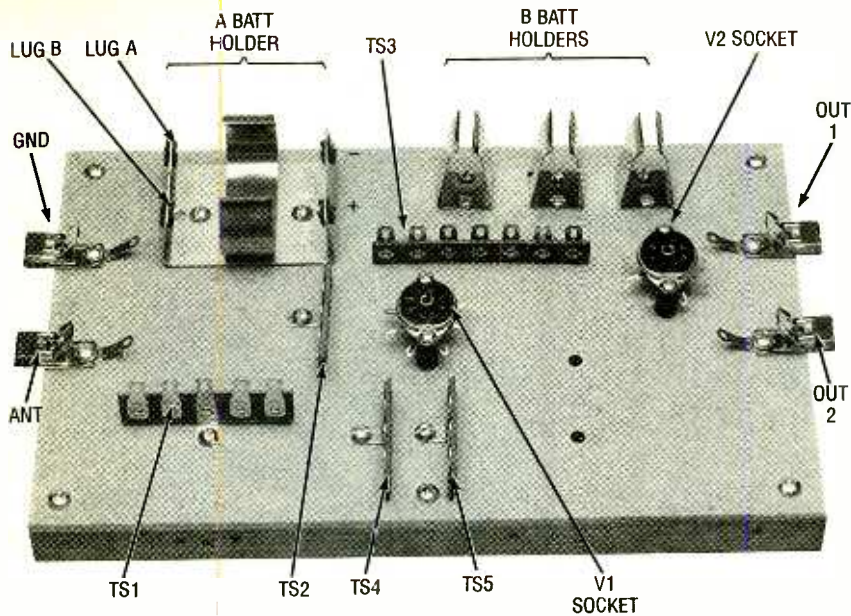

Fig. 2. Once the terminal strips, Fahnestock clips, battery holders, and vacuum-tube sockets have been mounted, the baseboard of your radio should look something like this. Refer to this illustration for the general layout of the baseboard and the locations of the terminal strips to which the interconnecting wires and components are connected.

electron-flow, the signal is collectively amplified from grid 1 through the plate as electrons flow from negative to positive, accelerating at each element.

Coil L3 (the tickler coil) and capacitor C3 make-up the "feed-back" or "regeneration" circuit. Regeneration is not difficult to understand since it is little more than a form of positive feedback. For those not familiar with the operation of regenerative circuits, let's take a closer look.

Note that the plate of V1 at pin 2 is connected to L3, and V1's control grid at pin 3 is connected to L2. When L3 is moved towards L2, a portion of the output signal from pin 2 of V1 is inductively coupled from L3 to L2 and fed back to the first grid of V1, thus regenerating the original signal. The reinforcement of the original voltage is possible because the frequency in the plate circuit is equal to the frequency in the grid circuit.

The fundamental principle involved in this type of regenerative circuit is electromagnetic induction. The amount of feedback cannot be increased beyond a certain point. Here's why: The energy fed back to the tuned circuit is impressed on the grid of the vacuum tube along with the original signal. If too much feedback is applied to the input of the circuit, the detecting action of V1 would soon be replaced by a tendency of the tube to oscillate at a frequency set by the coils in the plate and grid circuits.

The amount of feedback is controlled by the degree of coupling between L3 and L2. As such, L2 and L3 act as a variable-coupling transformer. The farther you move L3 from L2, the lower the coupling. The farther you move L3 toward the center of L2, the more coupling, or regeneration, will be obtained. The maximum regenerative effect is realized when the tickler is moved to a point just prior to the point of oscillation. In other words, you want to obtain maximum feedback without the circuit going into oscillation.

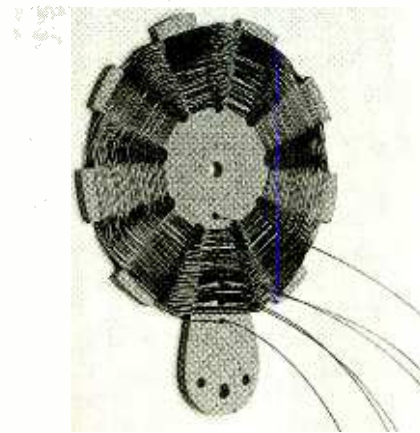

The rear surface of L2 should look something like this before it is mounted to the frame of the radio. Remember that the taps after turns 48 and 66 consist of two wires each, one coming from and one going to the coil form. The start wire extends up from the small hole on the left. The finish wire is pushed through the small hole on the right after turn 74.

The RF choke (L4) is used to prevent RF from being introduced to the audio-output circuit. The audio output of V1 is fed through C4 to grid 1 of V2 (a second 3S4 pentode tube, configured for Class-A audio-amplifier operation) at pin 3. Resistor R5 connected to pin 3 of V2 provides a negative bias and a high-impedance input resistance, as well. Grid 2 of V2 (at pin 4) is connected directly to B+ to provide maximum charge to that grid. A negative charge is provided through the filament for grid 3 of V2.

A 2.4k resistor, R4, connected between the plate and B+ is used as the plate-load. That value was chosen for maximum gain with minimum distortion. Capacitor C6 is used as a DC blocking capacitor to prevent DC from reaching the output device. Amplification in this stage of the circuit is produced in a similar manner to the action occurring in V1. The main difference is that no feedback is used and there is no detector.

Construction. The Regenerative Vacuum Tube Receiver can be built from scratch by the enterprising hobbyist, however, it is available in kit form from the supplier listed in the Parts List. The kit includes a wooden frame plus baseboard and all the necessary hardware to build the receiver. The supplier also makes available separately the audio amplifier portion of the circuit shown in Fig. 1. The amplifier may be installed at any time, even after the radio is built, however, the following instructions assume both are being installed at the same time.

If you wish to build the unit without benefit of a kit, you'll have to fabricate the baseboard, face plate, etc., yourself from wood. The layout is not critical, though you should follow the general scheme discussed. Use some scrap 1/2-inch stock to fabricate the chassis rails, and a 9 x 5 1/4-inch piece of thin particleboard stock for the baseboard. The balance of the article will assume that you are working with the kit.

Start by attaching the four baseboard rails to the bottom of the baseboard. Fasten the front and rear chassis rails to the bottom of the baseboard with five screws; three in front, two in back. The baseboard rail with five holes goes to the front of the baseboard, with the small cluster of three holes at the left (for the spiderweb coil forms), and the other two holes at the right (for the face plate).

Before inserting the screws, it will be necessary to punch small starter holes in the chassis rails with an awl or similar tool. Likewise attach the two side rails.

Then attach the four Fahnestock clips, with soldering lugs, to the baseboard (as shown in Fig. 2) with the screws provided. Those screws also hold the antenna, ground, and audio-output terminals. Next pick up the tube sockets, turn them over, and bend each of the seven metal pins outward from the body of the socket. Cut off the tiny metal cylinder attached to the center of the socket; halfway will be fine. Mount the tube sockets on the baseboard using plastic spacers. Mount the five terminal strips (TS1–TS5) and then mount the dual C-cell battery holder and three 9-volt battery holders where indicated in Fig. 2.

The Variable Capacitor. The variable capacitor requires a bit of preparation before it can be mounted. That unit has five sections: The first section is 250 pF; the second is 125 pF; and the remaining three sections are 20 pF each. Cut a piece of bus wire about 1½-inch long and straighten it. Fashion one end of the bus wire into a tiny circle, then bend the wire so that it forms a right angle with the little loop. About ¾ inch from the first bend, bend the wire again. After the second bend, the remaining long section of wire should be parallel to the plane of the loop and extended in the opposite direction.

Support the loop over the middle of the central gear drive of the variable capacitor. Secure the pointer in the proper place (see Fig. 3) with a drop of solder or glue. The section of the pointer that moves over the surface of the dial plate should be about 1 inch long. Once the pointer is attached, turn the capacitor over with the gear drive mechanism at the right. Be careful not to bend the wire dial pointer. With the capacitor flipped over, a row of five rectangular metal lugs should be visible. Mentally number the lugs 1 through 5, going from left to right.

Cut three pieces of bus wire; two to about 3½ inches long and the other about 4½ inches. Take one of the shorter sections of wire and solder one end to lug 2 of the capacitor, and bend the section back and away from the other lugs. Solder one end of the 4½-inch bus wire to lug 3 (the one in the middle) of the capacitor. Now manipulate that section away from lug 2 (see Fig. 4), bend it once around lug 1, and solder.

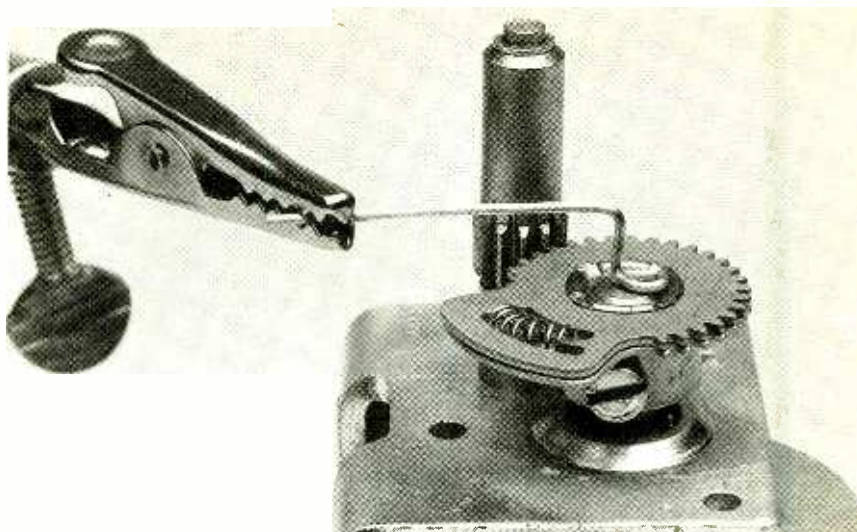

Fig. 3. The dial pointer on the variable capacitor is made from a piece of bare bus wire and is shaped as outlined in the text. The dial pointer is affixed to a gear mechanism with a bit of solder.

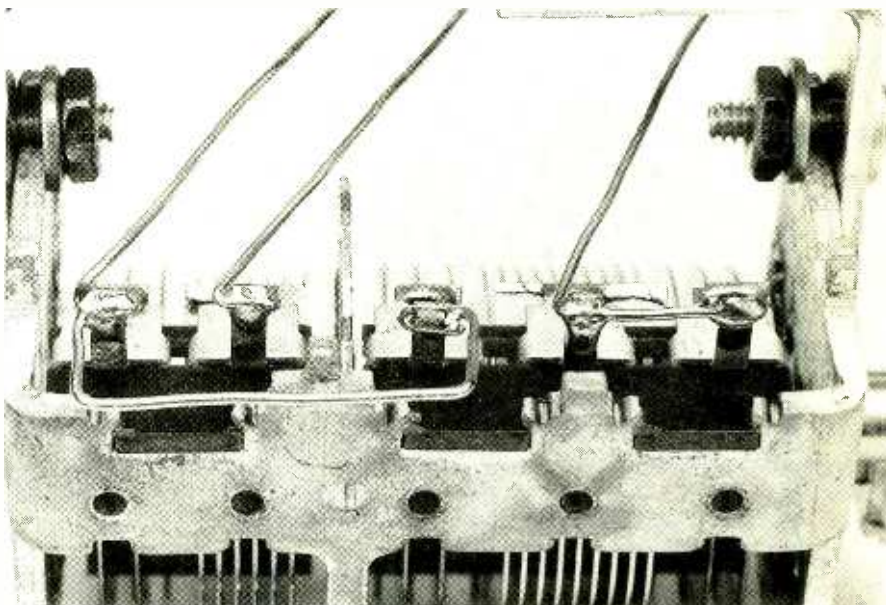

Fig. 4. The lugs on the variable capacitor must be wired and soldered before the unit is attached to the baseboard. Number the lugs in your mind (lug 1 on the far left and lug 5 on the far right), and then run sections of bare wire from lug 5 to lug 4, lug 3 to lug 1, and another piece from lug 2.

Do not permit that wire to make contact with lug 2.

Solder one end of the other 3½-inch bus wire to lug 5, bend it once around lug 4, and solder. When finished, you should have a wire coming off lug 2; a connection between lug 3 and lug 1 with a tail at lug 1, and a wire from lug 5 to lug 4 with a tail, as shown in Fig. 4. Once that's completed, look under the capacitor and locate the lug attached to the middle of the frame. That lug should be cut off. Otherwise, it may make contact with one of the bus wires.

With that out of the way, mounting brackets must now be attached to the frame of the capacitor. For the bracket

furthest away from the tuning shaft, place a solder lug on the bracket's retention screw. After preparing the capacitor, mount the unit to the baseboard. Keep all the hardware loose for the moment.

Notice the two rectangular notches cut into the corners of the capacitor's metal frame, one on each end. Mount the entire assembly on the base with two machine screws. Do not tighten those screws. The bus wires should run under the capacitor and be pushed through the lower holes of lugs 2, 3, and 4 on TS5 (see Fig. 2 for position of TS5) as follows: The bus wire coming off lug 4 of the capacitor goes through the lower

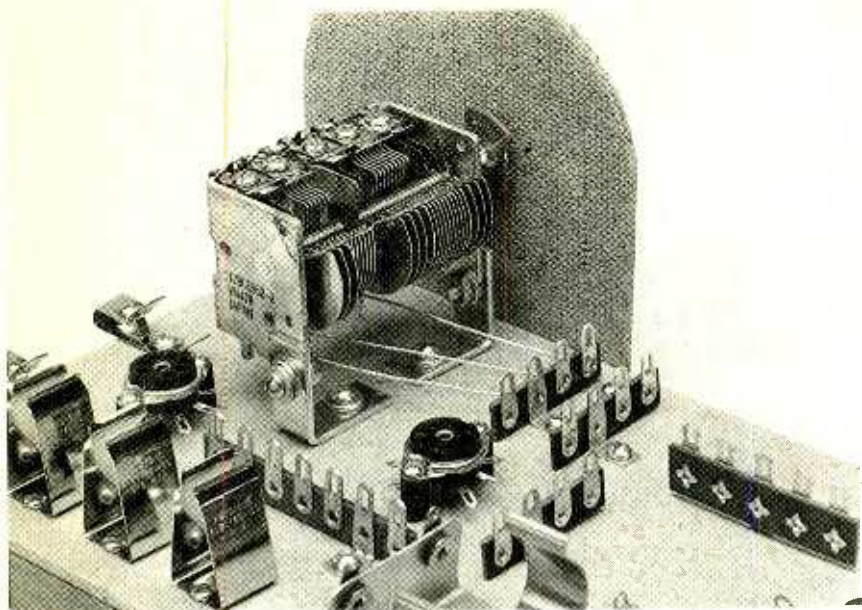

Fig. 5 The lengths of bare bus wire connected to the lugs on the variable capacitor, passed under the body of the unit, and are connected to a terminal strip mounted on the baseboard.

bus, blue, black, and red) are keyed to different areas of the circuit, each grouping will be taken individually.

Bus Wiring. See Fig. 2 for the locations of various terminal strips (TS1–TS5) referred to in the following instructions. Connect a 1½-inch length of bus wire from the antenna lug (solder) to the lower hole of lug 1 on TS1 (solder). Connect a 2-inch wire from the lower hole of lug 3 on TS1 (solder) to the lower hole of lug 4 on TS3, but don't solder this end. Connect a 2-inch wire from the lower hole of lug 4 on TS2 (solder) to the lower hole of lug 1 on TS5 (solder).

Connect a 1½-inch wire from the lower hole of lug 1 on TS2 (don't solder) to pin 1 of the socket for V1 (solder). Connect another 1½-inch wire from lug A on the A BATT holder (solder) to lug B on the same holder (solder). Connect a 1½-inch wire from the positive lug of the A BATT holder (solder) to the lower hole of lug 1 on TS3 (solder).

Connect a 1-inch wire from the negative lug of the A BATT holder (solder) to the lower hole of lug 2 on TS3 (don't solder). Connect a ⅜-inch wire from lug 1 of the power switch (don't solder) to lug 4 of power switch S1 (solder). Connect a ⅝-inch piece from lug 2 of the power switch (solder) to lug 5 of the power switch (don't solder). That completes the bus wire instructions.

Black Wiring. Again referring to Fig. 2, make the following connections, using the black wire only.

Connect a 2½-inch piece of black wire from lug 1 of the power switch (solder) to output lug 2 (don't solder). Connect a 7-inch wire from lug 5 of the power switch (solder) to the upper hole of lug 2 on TS3 (solder). Connect a 3½-inch wire from output lug J2 (solder) to the capacitor ground (don't solder). Note: the capacitor ground (CG) is the soldering lug screwed to the frame of the variable capacitor. A total of five connections go to the capacitor ground, so keep your wiring neat.

Connect a 3¼-inch wire from the capacitor ground (don't solder) to the lower hole of lug 1 on TS4 (solder). Connect a 2¾-inch wire from the capacitor ground (don't solder) to the lower hole of lug 1 on TS2 (solder). Connect a 2¾-inch wire from unit ground (don't solder) to lower hole of lug 2 on TS2 (solder.) Note: the unit ground is the ground terminal (Fahnestock clip) of the radio itself. It's located right next to the antenna terminal.

hole of lug 4 (as shown in Fig. 5); the wire coming off lug 2 of the capacitor goes through the lower hole of lug 3 of TS5; and the wire coming off lug 1 of the capacitor goes through the lower hole of lug 2 of TS5. Once in position, do not solder, just leave things as they are and go on to the front panel.

The Front Panel. Locate the power switch, the capacitor knob, the paper dial label, and the face plate. Using a sharp hobby knife, very carefully cut out the two circular holes in the paper dial label. Then glue the label to the face plate. Make sure the holes in the label are aligned with the ones in the face plate. Lower the face plate slowly over the wire dial pointer and screw it to the wooden frame of the radio. You may have to bend the pointer slightly in order to get the plate into position.

Once the face plate is in place, adjust the entire tuner assembly so that the pointer and the capacitor shaft are coming out from the center of the appropriate holes. When everything looks right, tighten all the hardware and solder the bus wires on the variable capacitor to the terminal strip. Install the black plastic knob on the capacitor shaft, tighten the setscrews, and install the power switch.

The next task is to interconnect the individual components of the circuit already mounted to the baseboard. Those are not the only components that go into the circuit but merely the ones that we'll be dealing with at this point. Also, because certain wires (bare

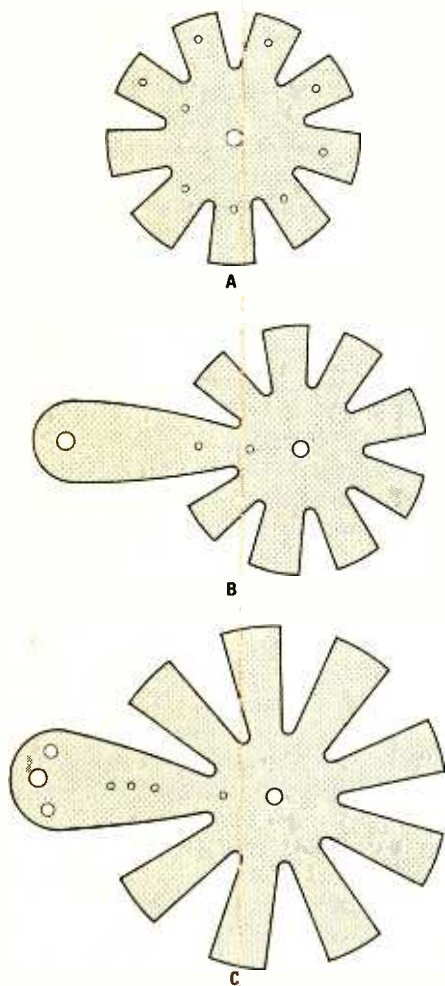

Fig. 6. Templates for the three coil forms on which the L1–L3 are wound are shown here at half size. The circles on the forms indicate the relative size and locations on the form where holes are drilled to accommodate the coil wires and coil-mounting hardware.

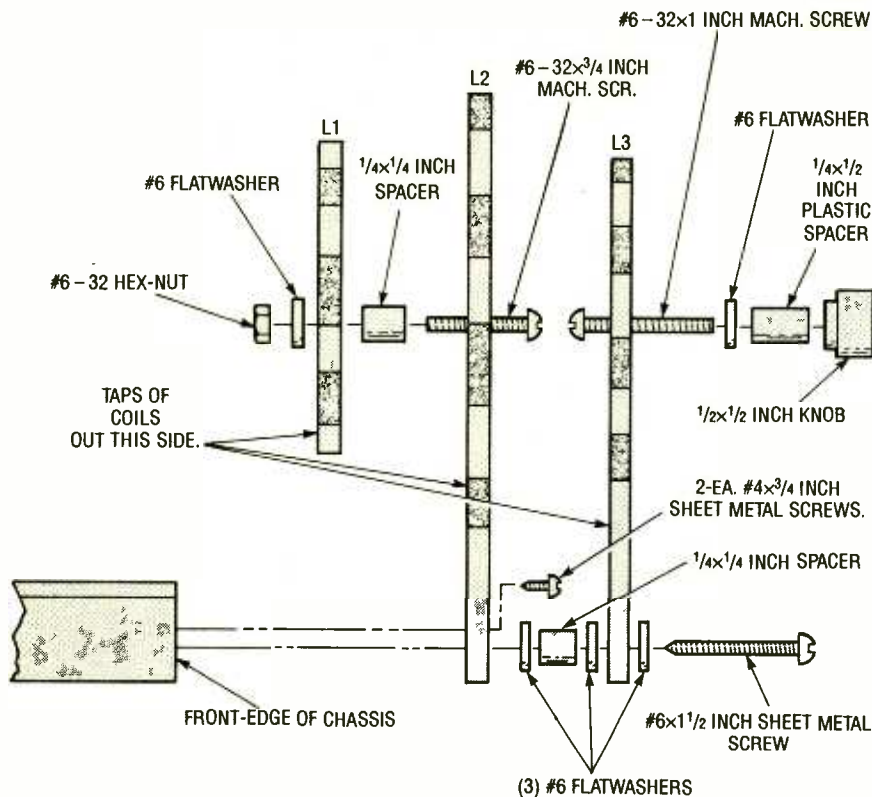

Fig. 7. Shown here are the mounting and final assembly instructions for the three coils. Refer to the text for details.

Connect a 3-inch wire from unit ground (solder) to the lower hole of lug 2 on TS1 (solder). Connect a 2-inch wire from the capacitor ground (don't solder) to pin 1 of the socket for V2 (don't solder). That completes this portion of the wiring instructions.

Red Wiring. Connect a 1½-inch length of red wire from the upper hole of lug 1 on TS3 (don't solder) to pin 7 of the V1 socket (solder). Connect a 4½-inch wire from the upper hole of lug 1 on TS3 (solder) to pin 7 of the V2 socket (solder). Connect a 3-inch wire from the upper hole of lug 4 on TS3 (don't solder) to pin 4 of the V2 socket (don't solder).

Blue Wiring. Connect a 4½-inch length of wire from lower hole of lug 4 on TS1 (solder) to the lower hole of lug 3 on TS3 (solder). Connect a 2½-inch length from the lower hole of lug 5 on TS1 (solder) to pin 2 of the V1 socket (solder). Connect a 2-inch wire from the lower hole of lug 2 on TS2 (solder) to pin 3 of the V1 socket (solder). Connect another 2-inch length from the upper hole of lug 7 on TS3 (don't solder) to pin 3 of the V2 socket (don't solder).

That completes the interconnecting wire instructions, however, we still have a ways to go before the Regenerative Vacuum Tube Receiver is complete.

Component Installation. Refer to Figs. 2 and 6 for the proper installation of the following components. Connect a 2.2-megohm resistor (color coded red-red-green) between the upper hole of lug 4 on TS2 (don't solder) and the upper hole of lug 2 on TS2 (don't

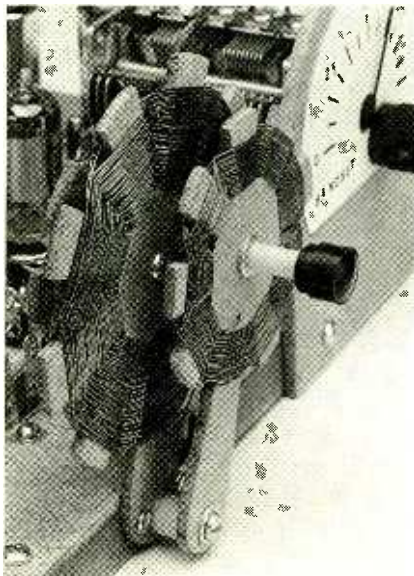

Here's how L2 and L3 are mounted to the front of the radio. Regeneration is controlled by moving L3 (the tickler coil) back and forth in front of L2. Note the short plastic spacer between the two coil forms near the bottom of the coil assembly.

solder). Connect a 270-pF capacitor (coded F271J) between the upper hole of lug 4 on TS2 (solder) and the upper hole of lug 2 on TS2 (solder).

Connect another 270-pF capacitor (F271J) between the upper hole of lug 1 on TS2 (solder) and the upper hole of lug 3 on TS3 (don't solder). Connect the 2.4-mH choke between the upper hole of lug 3 on TS3 (solder) and the upper hole of lug 5 on TS3 (don't solder). Note: The choke is the small brown coil of very fine wire. There's only one like it in the kit.

Connect a 0.1-μF ceramic-disc capacitor (coded 104) between the upper hole of lug 5 on TS3 (don't solder) and the upper hole of lug 7 on TS3 (solder). Then connect a 47,000-ohm resistor (yellow-violet-orange) between the upper hole of lug 4 on TS3 (solder) and the upper hole of lug 5 on TS3 (don't solder). Connect another 47,000-ohm resistor (yellow-violet-orange) between the upper hole of 5 on TS3 (solder) and pin 4 of the socket for V1 (don't solder).

Connect the 1-μF electrolytic capacitor between the variable capacitor ground (solder) and pin 4 of the socket for V1 (solder). Note: Remember to observe the proper polarity of that component! The negative end of the component should be connected to the capacitor ground lug and the positive end to the socket. Then connect a 1-megohm resistor (brown-black-green) between pin 1 of the socket for V2 (solder) and pin 3 of the socket for V2 (solder).

Connect a 2.4-megohm resistor (red-yellow-red) between pin 6 of the socket for V2 (don't solder) and pin 4 of the socket for V2 (solder). Connect a 0.1-μF ceramic-disc capacitor (104) between pin 4 of the socket for V2 (solder) and output lug 1 (solder). That completes this portion of the assembly instructions, but we are not finished yet.

Winding the Coils. The last major step involves winding the three spiderweb tuning coils. Read the following procedures and study the illustrations carefully before you begin. Once you get started, the entire operation can be quickly completed. Also, it helps to set up some sort of simple system that will allow the spool of magnet wire to rotate freely without falling on the floor. I recommend putting the spool over a wooden dowel rod clamped vertically in a small vise.

There are a total of three coil forms: two small ones (for L3 and L1), and one

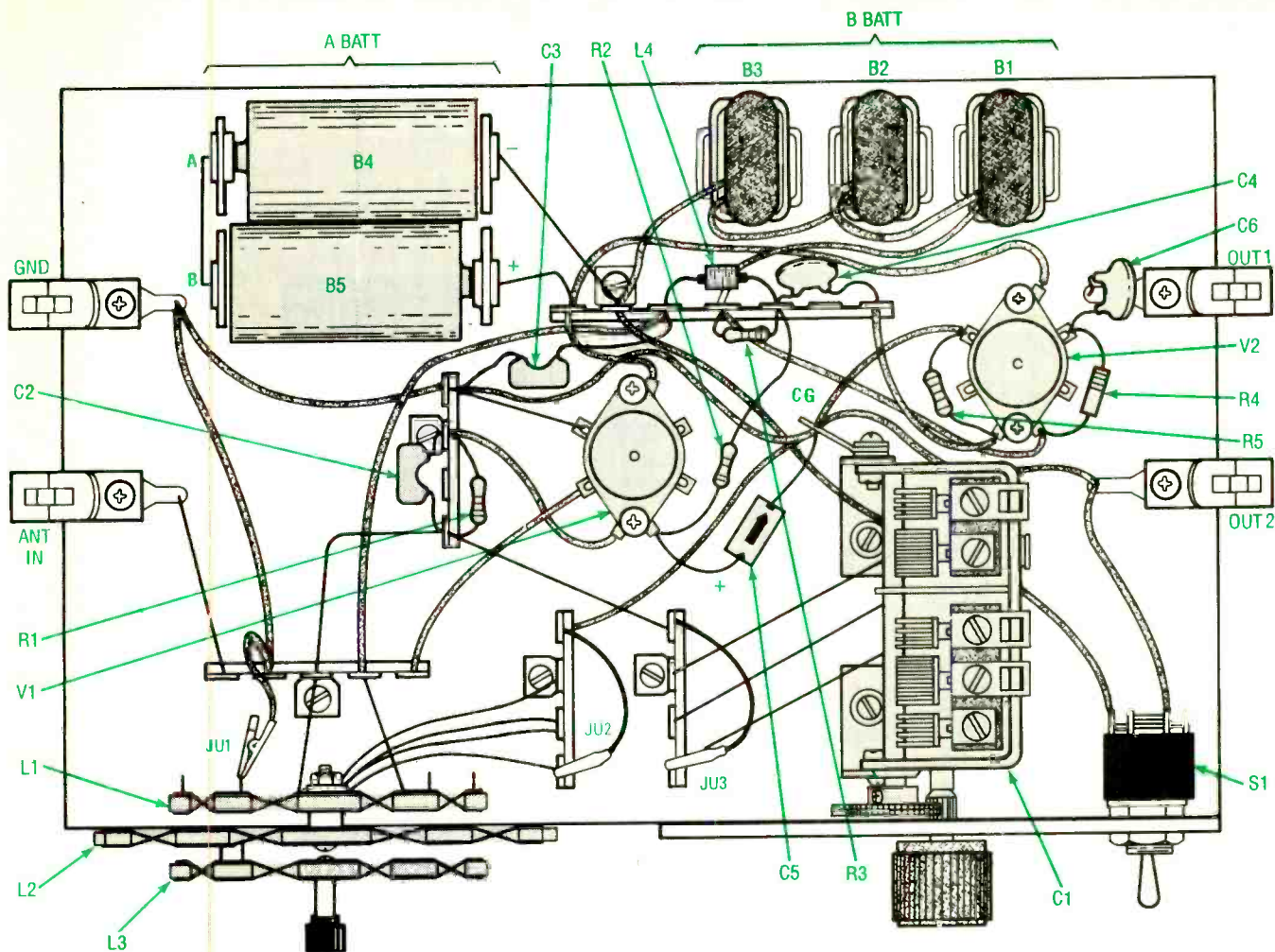

Fig. 8. Here is an overhead view of the finished receiver, showing the locations of the non-baseboard mounted components. Follow closely the instructions in the text while referring to this diagram and Fig. 2 for guidance.

large one (for L2). Full-scale templates for each are shown in Fig. 7 for those who have not purchased the kit. If you are making your own, don't forget to drill holes at the points indicated.

One of the small coil forms has a long arm on it. That one is intended for the "tickler" coil (L3) and is central to the process of regeneration. We'll be winding that coil first. Begin by placing the coil form on your work surface with the long arm pointing down and the smooth surface of the material facing up. You will note four holes: a large one at the center of the spiderweb form (for the handle), another large one at the bottom of the long arm (for attaching the form to the radio), and two smaller holes. The small holes receive the magnet wire.

Thread 6 or 7 inches of wire in through the front and out through the back of the form. Then, begin winding the coil in a clockwise direction. To get the spiderweb effect, the wire must be woven under, then over, then under, and then over the segments of the

form. Wind a total of 32 complete turns. Count the turns carefully as you go. When you're finished, measure off another 6 or 7 inch section of wire, cut the wire at that point, and thread it through the second small hole. You're done with L3.

The form for L2 is the large one. The coil is wound in the same manner as L3, with one exception: there are taps on it; one is made after turn 48, and another after turn 66. The coil is complete after turn 74. Again, the wind the turns in a clockwise direction, and make sure to begin with the smooth surface of the spiderweb form facing up. Here's how to make the taps on L2. After turn 48, measure off a 6 inch section of wire, cut it, and push it through the first tap hole. The first tap hole is the small hole nearest the large center hole in the circular portion of the form. Now measure off another 6 inch section of wire and then push it through the first tap hole. Twist the two wires together a few times with your fingers. The double 6 inch section of magnet wire is the first tap.

Continue winding the coil in the same direction and repeat the tap-making procedure after turn 66. Then continue winding in the same direction and finish after turn 74. Remember that the taps will be coming out the back surface (the rough surface) of the form.

Now let's move on to L1. Coil L1 is tapped at every 4th turn for a total of 32 turns and 7 taps. It is also wound in a counter-clockwise (the opposite) direction. Winding the wire in the proper direction is very important.

Place the coil form on your work surface with the smooth surface up. You will see a large center hole and a number of smaller holes. The small hole nearest the center hole is the point at which the windings begin. The small hole furthest away from the center hole is where the windings end. All the other holes are for the seven twisted taps, one per hole after turn 4, 8, 12, 16, 20, 24, and 28. The start wire plus the seven taps make for a total of eight connection points on L1.

(Continued on page 101)

Ahhh, the great outdoors! It's so nice to get out in the fresh air and enjoy nature. Unfortunately, sometimes nature can turn a pleasant picnic into a please-the-ants picnic. Every camping trip I've been on has turned into a swat fest as night fell. As for me, I've never been too fond of rubbing malodorous ointments on myself and spraying ozone-eating aerosols in Mother Nature's face. Not being one to give up my enjoyment of the outdoors or my principles, I set to work to build a portable electronic pest repeller, affectionately called *Bug-Off*.

If you haven't heard of one before, or don't know what makes them tick, such pest repellents send out ultrasonic pressure waves (at 22–65 kHz) that are an annoyance to insects and certain small animals. Note that the version shown here is only powerful enough to affect insects, although it is an easy matter to amplify the output using a low-power, wide-band op-amp. For those interested in this, several suitable circuits were shown in "Using Wide-

band Op-Amps" in the January, 1990 issue of **Popular Electronics**.

The basic Bug-Off unit is a very interesting little circuit. In it, a 556 dual-timer chip is suited-up with a few common components that turn it into a sweep-frequency oscillator. In the course of this article, I'll supply you with both construction and design details so that you can grant a 555 a 50% duty cycle and even use one as a voltage-controlled oscillator (something mentioned in text books, but never really covered).

Nuts, Bolts, and Paperwork. I have a commercially built, AC-powered pest repeller at home that works pretty well, so I decided to look inside of it before designing anything. To my surprise I

BUG-OFF: The

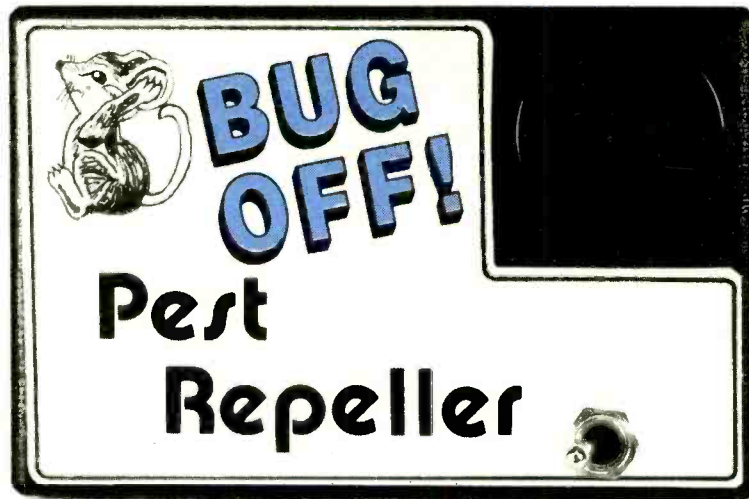

Popular Electronics® Pest Repeller

Build a project to protect you from pests while hiking, or lounging 'round the pool, and learn something new about the 555 timer in the bargain!

BY JOHN YACONO

found a lone 555 with support components that caused it to operate as a VCO (voltage-controlled oscillator). I had always known that was possible, but oddly enough I didn't remember ever seeing any design equations for VCO operation.

After checking two manufacturer's data books, and two 555-timer cookbooks, I realized my memory was not faulty (not this time anyway). Undaunted, I went on to figure out the equations for voltage-controlled operation for myself. Before giving you the results of my labor, a brief summary of 555-timer operation is a very good idea.

A 555 wired for astable operation is shown in Fig. 1. Let's ignore the control

terminal for now, and just assume it's not connected. If you apply power to the circuit, capacitor C starts to charge through R_A and R_B , and the output is high. The FET in the 555 can initially be ignored as it is off. The rate of charge is thus determined by R_A , R_B , C, and V_{CC} .

The resistor network composed of R_{11} – R_{13} (all equal to 5 kilohms) divides the supply voltage (V_{CC}) into $\frac{1}{3}V_{CC}$ and $\frac{2}{3}V_{CC}$ (called the "trigger" and "threshold" voltages, respectively). Note that both comparators (C1 and C2) monitor the voltage stored in the capacitor; Comparator C1 compares the capacitor voltage to the threshold voltage and C2 compares it to the trigger voltage.

When the capacitor charges up to the threshold voltage, C1 goes momentarily high, toggling the flip-flop. That causes the internal FET to start draining the charge off the capacitor via R_B (without any of the discharge current flowing through R_A), and the output terminal goes low. The rate of discharge is thus determined by R_B , C, and V_{CC} (but not R_A). Once the capacitor voltage drops to the trigger voltage, C2 is triggered and toggles the flip-flop. The FET then turns off, the output goes high, and the capacitor begins to charge again.

There are a few interesting facts about the process. First, the timing is independent of the power-supply voltage (V_{CC}). That's because even though you may increase the charge rate by increasing the supply voltage, the threshold voltage is also increased, so it takes longer for the capacitor to reach that voltage (neat, huh?). The capacitor dissipates that higher voltage slower, but the trigger voltage is also higher, so the capacitor doesn't have to go as low. The time it takes for the capacitor to

charge from $\frac{1}{3}V_{CC}$ to $\frac{2}{3}V_{CC}$, which is the time the output remains high, is given by:

$$t_h = 0.693(R_A + R_B)C$$

The time it takes for the capacitor to discharge from $\frac{2}{3}V_{CC}$ to $\frac{1}{3}V_{CC}$, which is also the length of time the output is low, is given by:

$$t_l = 0.693(R_B)C$$

Note the absence of R_A in the last equation. That's because only R_B is in the discharge path. Note also that that prevents us from attaining a 50% duty cycle (t_h can't equal t_l). Some may propose doing away with R_A , but that would short the power supply through the discharge pin at the beginning of the discharge cycle. However, there is another method for obtaining a 50% duty cycle, as you'll see.

Special Operation. A 50% duty cycle can be easily obtained by putting a diode pointing down (cathode toward the capacitor) in parallel with R_B , and setting R_A equal to R_B . That way R_B is bypassed during charging, but it is still in the discharge path.

Now let's upset the scheme a different way by applying a voltage (V_{CON}) to the control terminal (but without using the diode trick for now). Doing so doesn't change the characteristics of the basic charging circuit (composed of R_A , R_B , and C), but it does change the values of the threshold and trigger voltages. However, that does not affect the discharge time (t_l) of the capacitor for the same reason a different supply voltage doesn't affect it (go back to the previous section if you forgot why). It does change the charging time (t_h), which can be computed with the following formula:

$$t_h = (R_A + R_B)C(-0.693 + \ln[1 + 1/(1 - V_{CON}/V_{CC})])$$

There are a few implications to all this: The first is that by changing the control voltage you can perform pulse-width modulation. You can also modulate the frequency and simultaneously modulate the duty cycle. In fact, using this technique, you can't change one without changing the other. By swinging the control voltage up and down, you can sweep a range of frequencies. That's exactly what the Bug-Off circuit does to ensure maximum effectiveness—it sweeps a range of frequencies to disturb the widest possible variety of species.

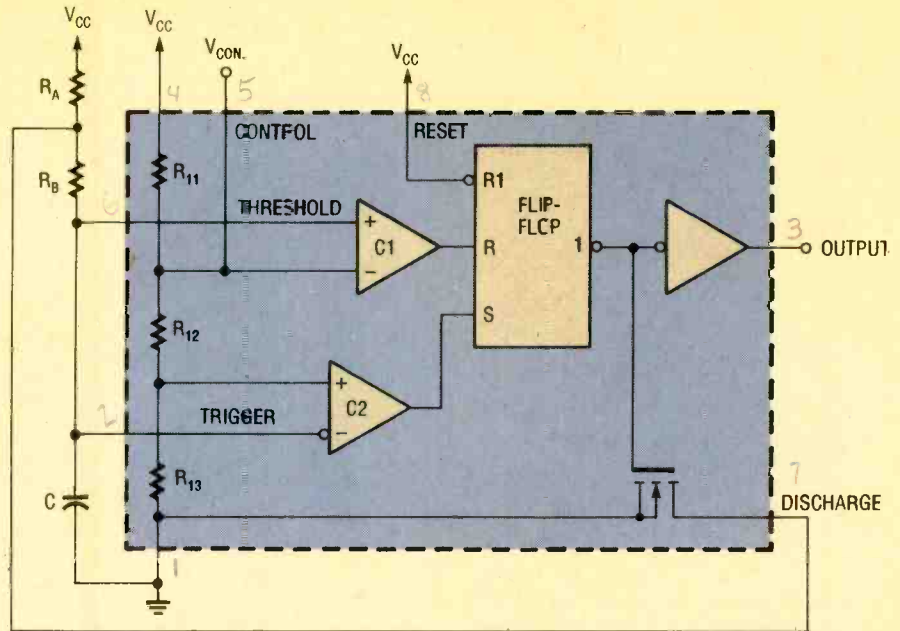

Fig. 1. This is a 555 timer IC (depicted in block-diagram form) connected to some support components to form a basic astable multivibrator.

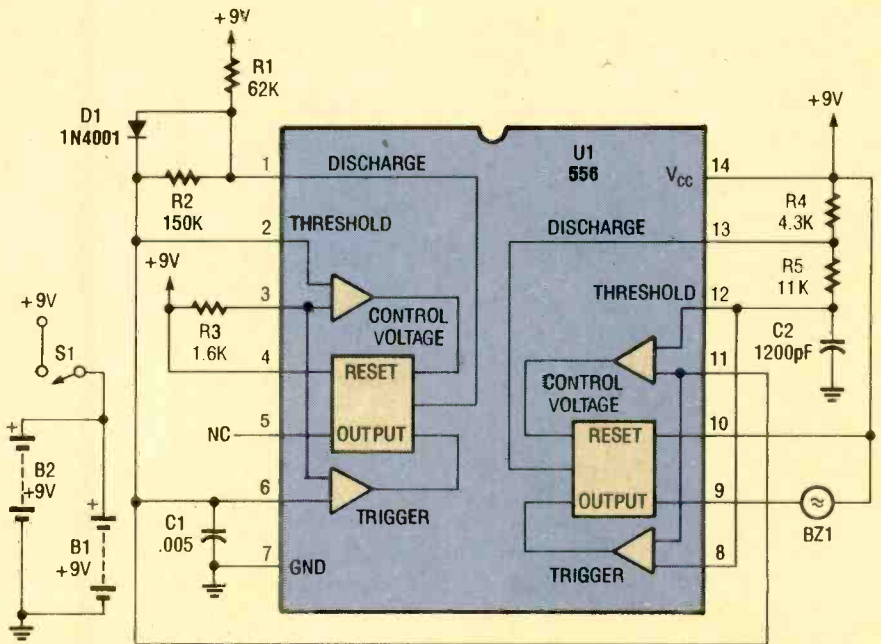
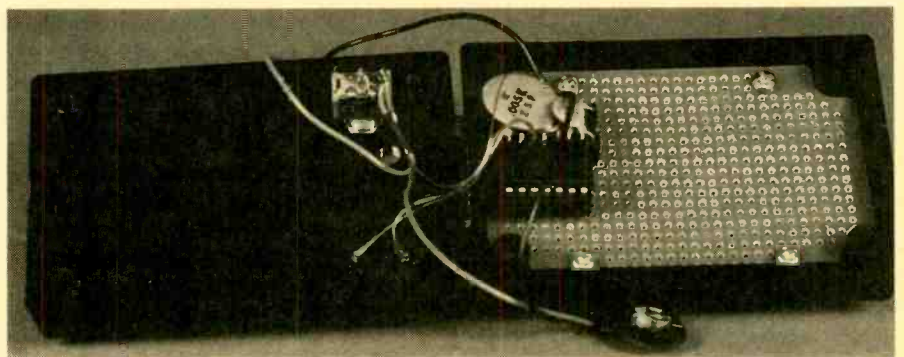

Fig. 2. The two timers in the full-blown project have some interesting characteristics. Both of them have their thresholds externally set, the oscillator on the left has a 50% duty cycle, and the oscillator on the right acts as a VCO.



Here's a peek under the hood of the pest repeller. Note the capacitors are neatly bent to permit the cover to be put on.

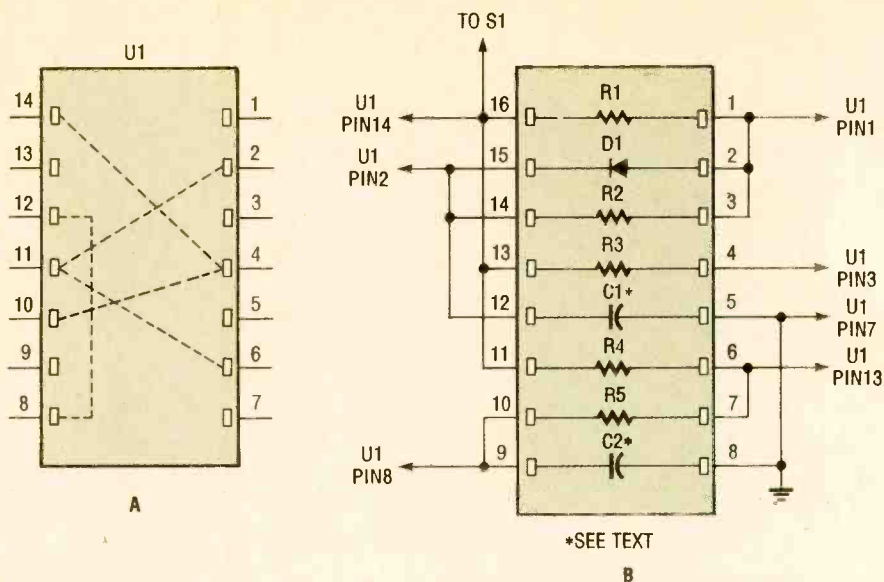

Fig. 3. If you wire the socket for U1 as shown in A, and the component socket as shown in B and interconnect them, you'll only have to connect the buzzer, battery, and switch to get your project up and running.

PARTS LIST FOR THE BUG-OFF ELECTRONIC PEST REPELLER

RESISTORS

(All resistors are 1/4-watt, 5% units.)

- R1—62,000-ohm
- R2—150,000-ohm
- R3—1600-ohm
- R4—4300-ohm
- R5—11,000-ohm

ADDITIONAL PARTS AND MATERIALS

- BZ1—Piezo buzzer element
- D1—1N4001 1-amp, 50-PIV, rectifier diode
- U1—556 dual oscillator/timer, integrated circuit
- C1—0.005- μ F, ceramic-disc capacitor
- C2—1200-pF, ceramic-disc capacitor
- S1—SPST on/off toggle switch
- B1, B2—9-volt transistor radio battery

Battery clips, perfboard, project case, 14-pin and 16-pin wire-wrap sockets, wire-wrap wire, solder, etc.

The Circuit. The Bug-Off circuit is shown in Fig. 2. The internal resistors are not shown for the sake of clarity. Note that it actually makes use of two 555 timers (both packaged in one 556 case). One timer circuit is shown on the left of the IC package, and the other is on the right. They are both set up as oscillators with some special features.

The oscillator on the right is a VCO and is used to sweep frequencies between 25.8 and 65.2 kHz. Its duty cycle varies from 40 to 76%. Keeping the duty cycle as close to 50% as possible is a good idea because it ensures that piezo element BZ1, which is the output

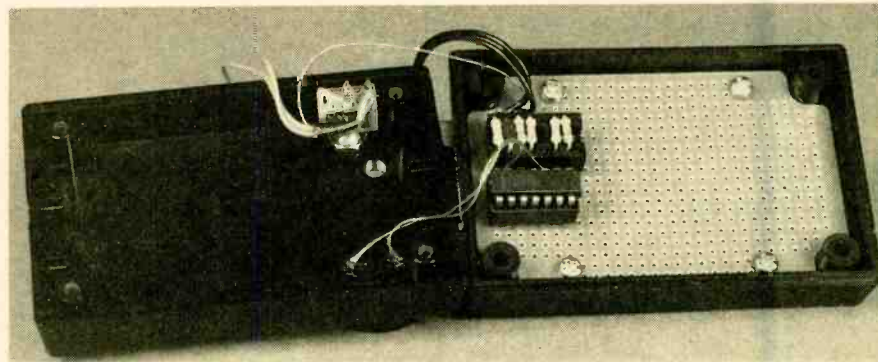

The components are more visible with the two capacitors out of the way. As you can see, using an IC socket keeps the project neat and small.

transducer, will fully charge and discharge, and generate harmonics that are close to fundamental. Such piezo elements are great at creating pressure waves, and are sometimes used as sound generators in water (such as for sonar), which requires high-pressure transducers in order to operate over long distances.

One more thing should be mentioned concerning the transducer: get a high-efficiency type that operates with the highest resonant frequency possible. However, don't worry that the resonant frequency is not near the ultrasonic range. The voltage swing applied to the crystal forces it to electrostrict (contraction due to an applied voltage) without the need for resonance; We are really concerned with generating noise in the form of pressure waves, not pure tones.

The VCO receives its control voltage from the oscillator on the left. Note that the voltage on capacitor C1 is used rather than the output from pin 3. That's

because a timer's output simply swings between V_{CC} and ground, but the charging capacitor gradually moves between the trigger and the threshold voltages. The capacitor will thus cause the VCO to sweep a range of frequencies rather than jump between two of them.

The oscillator on the left has two interesting characteristics: a 50% duty cycle, and modified threshold and trigger voltage levels. The voltage levels are modified by R3 to cause C1 to charge from 4 to 8 volts. The reason that is done is to allow the VCO to have a wide voltage sweep (thus, a wide frequency range), without causing it to have a ridiculously high or low duty cycle.

The oscillator on the left is configured for a 50% duty cycle because of the exponential charging curve of the capacitor. When the capacitor (C1) starts

to charge, its voltage changes rapidly, causing the VCO to rush through the frequencies generated during the beginning of the charging cycle. During discharge the opposite happens—the frequencies generated with the control pin near its maximum are rushed through. So over one complete charge/discharge cycle, the frequencies are given fairly equal treatment as long as the charge and discharge times are the same (i.e., the duty cycle is 50%).

Note that R1 and R2 are not equal, though we mentioned they should be for a 50% duty cycle. That's because the use of R3 alters the duty cycle so that the values of R1 and R2 have to be adjusted to re-establish the 50% duty cycle.

The oscillator runs at a frequency of 980 Hz, sweeping the VCO twice (once up, once down) each cycle. That means a creature will be zapped at least around 1960 times a second
(Continued on page 102)

Does your present lure fail to attract the fish to your line? If so, perhaps an illuminated lure will change your luck, and enable you to catch the big one that always seems to get away.

Build an Electronic Fishing Lure

It rained all weekend again. I had planned to go fishing but it just wasn't in the cards. So, I thought I would tinker around with my electronic stuff and wait for the rain to stop. Obviously, my heart wasn't in it, because what grew out of that weekend was a strange, but effective, fishing lure. Perhaps, it is stretching the definition of "electronics" to call it an electronic device, but it does use electricity and in some mysterious way it communicates with fish.

The lure is the essence of simplicity (see Fig. 1). Using a paper clip, a calculator battery, and a light-emitting diode (LED) or micro lamp, you can make an effective multi-purpose fish-catching device and amaze your friends at the same time. If you're like me, your friends have come to expect strange ideas from you and this device will certainly strengthen that image. I think it may even be legal, but you better check the local laws governing your favorite fishing hole to be sure.

The lure consists of a large paper clip, a flat, wafer-type battery (1.5 or 3 volt), an LED or micro lamp, a treble hook, and a pair of needle-nose pliers. The author's version uses a 3.0-volt lithium battery (CR-2430), but the lure can be modified to use any size wafer battery. There is one problem though; if you are going to use an LED as the light source, you'll need to use a 3-volt battery. It takes 1.6 volts of junction potential to "light" an LED and the 1.5 volt batteries just don't have enough voltage.

How it Works. The circuit behind the fish lure (see Fig. 2) is so simple—a battery, resistor, and a lamp—that it is almost not worth showing. A resistor can be added (as shown) to limit current through the light-producing element and to regulate the brightness of the light, but it is not usually needed because the internal resistance of the battery will keep the current at about 33 mA.

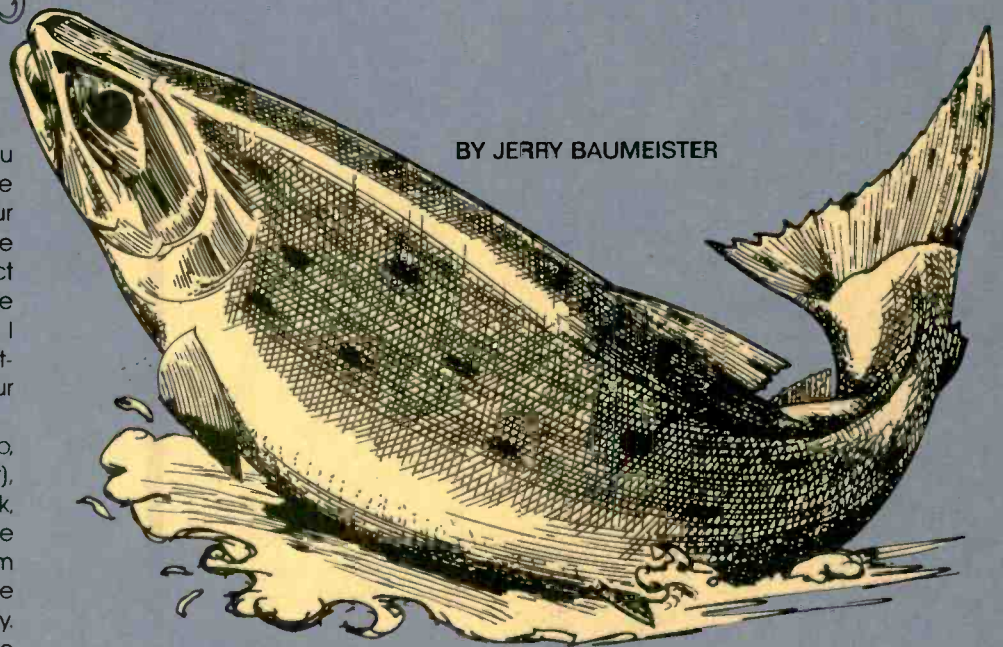
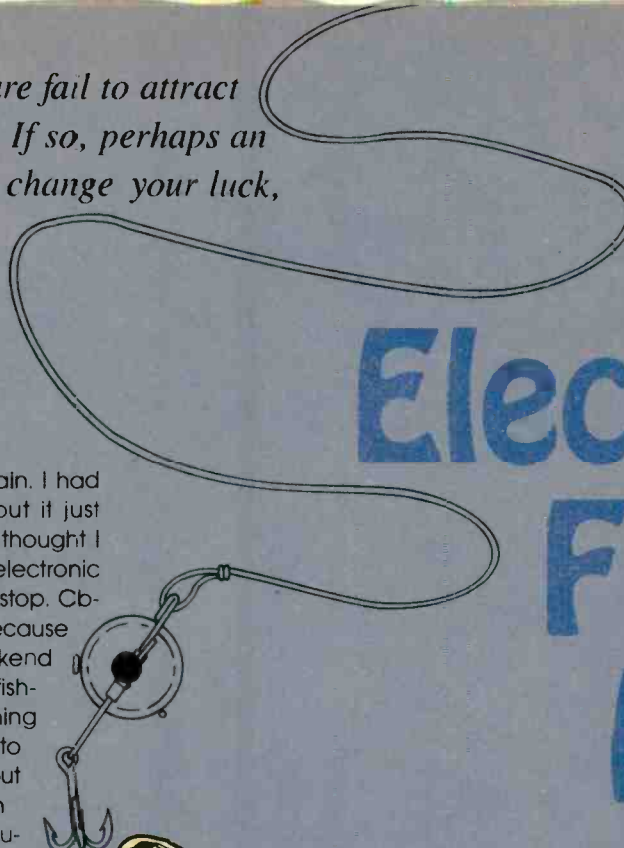

BY JERRY BAUMEISTER

The prototype unit used a 1.5-volt lamp powered from a 3-volt battery. That's a bit over the lamp's designed voltage, and tends to shorten both battery and lamp life a bit. However, the extra brightness is attractive to the fish and since catching fish is what this is all about, operating the lamp a little "hotter" than the lamp designers had intended seems a worthwhile tradeoff.

You can use either an LED or micro lamp. You can even use one of those flashing LED's, but make sure it can operate from a 2.5-volt source. I have found that in the waters around my

home, diffused yellow LED's work best for black bass. (I don't know why. I guess it's just part of the mystery that makes fishing so interesting.)

Water proofing was not necessary for the ponds where I fish. The resistance of local pond water around here is about 10,000 ohms per cm. Since the resistance through the lamp circuit is about 11 ohms, most of the current flows through the lamp circuit and not the water (current follows through the path of least resistance). The resistance of the circuit using an LED instead of a micro lamp is a bit higher, but it is still low

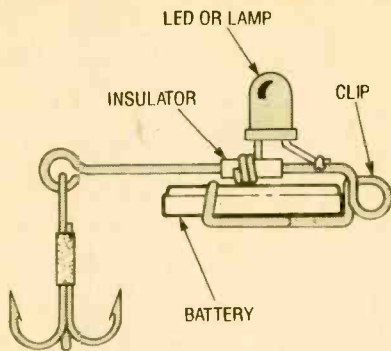

Fig. 1. The Electronic Fish Lure was created from an ordinary paper clip twisted so as to hold the leads of an LED in contact with both poles of a battery.

PARTS LIST FOR THE ELECTRONIC LURE

- LED1—Light-emitting diode or micro lamp
- R1—Optional, see text
- B1—1.5–3-volt, flat wafer-type, calculator battery, see text
- Paper clip, cellophane tape, thin-plastic or film insulating material (see text), treble hook, fingernail polish (see text), etc.



Fig. 2. Here is the simple circuit that comprises the electrical portion of the Electronic Fish Lure. Note: The resistor (R1) may or may not be needed; that will have to be determined by experimentation.

enough to feed the lion's share of the current through the lamp.

In chlorinated water, water that has a high ionic concentration, or in salt water, water proofing is necessary. A little fingernail polish works just fine. Just paint the entire lure, battery and all. You can even use different colors to jazz it up a little. I favor yellow lures with red dots, but use whatever color scheme or pattern that works for you.

The lure can be turned on and off by removing the battery or by sliding a small piece of plastic or film between the battery and the point where it touches the lamp lead. Push the film in to turn the lamp off, remove it to turn the lamp on.

Construction. The wire clip is everything. Take your time and get it right. Start, as shown in Fig. 3, by straightening a large paper clip. Figure 3A shows the

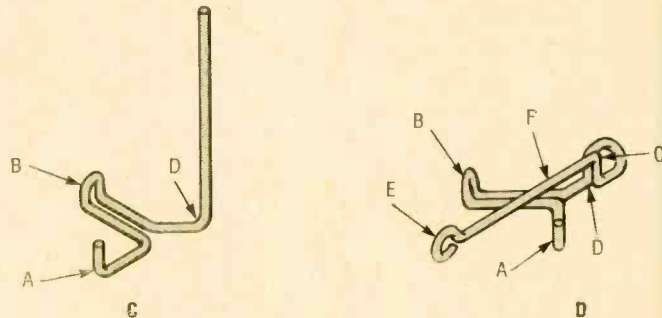
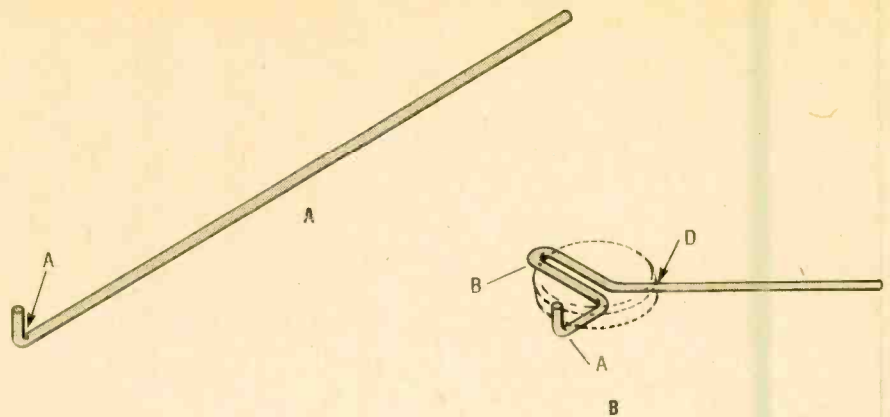
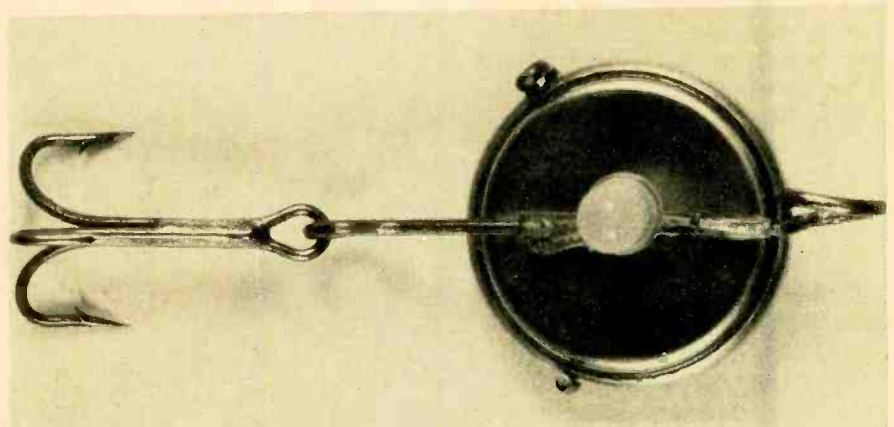

Fig. 3. Follow this clip-bending diagram to form the battery holder for the Electronic Fish Lure. Starting with a straightened large paper clip, make a bend at point A (A), follow by the bend at point B (B), and then the bend at point D (C). Then form a loop at point C and another at point E (D).



Here is the finished lure. Under some circumstances, depending on the conductivity of the waters you fish, it may be necessary to insulate the electrical portion of the unit. Should insulating be necessary, a coat or two of fingernail polish works well.

first bend, a 0.2-inch, 90-degree bend. With the bend pointing toward the ceiling, bend the wire to conform to the diagram in Fig. 3B. Next bend the last 0.2-inch of the double wire at point B in the same direction as point A (toward the ceiling).

Lay a battery, with cellophane tape covering the negative side, on the wire form. The cellophane tape is to keep the battery from shorting during construction. You will need to remove the tape before using the battery in the finished lure. The positive (+) side of the battery should be resting on the wire

and firmly against the bends at points A and B.

Next bend the wire at point D toward the ceiling forming a 90-degree bend tight against the battery (as shown in Fig. 3C). Bend the wire at point C and form a loop as shown in Fig. 3D. At the point where the loop reaches point D, bend the wire 90 degrees to the vertical and then again 90 degrees at a point 0.2-inch away to extend over the negative side of the battery. Finally, bend a loop in the wire at point E as shown.

(Continued on page 91)

A phone extension can be a nice convenience, but it can be turned into a tool for the nosy. This article shows you how to prevent snooping, and more.

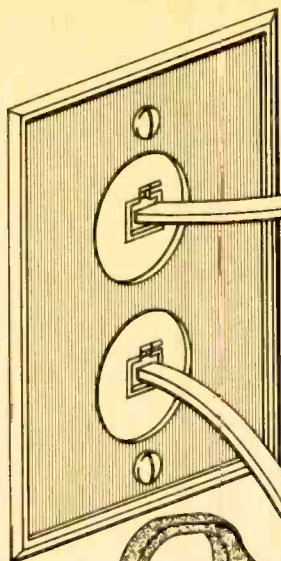

Isolating Telephone Extensions

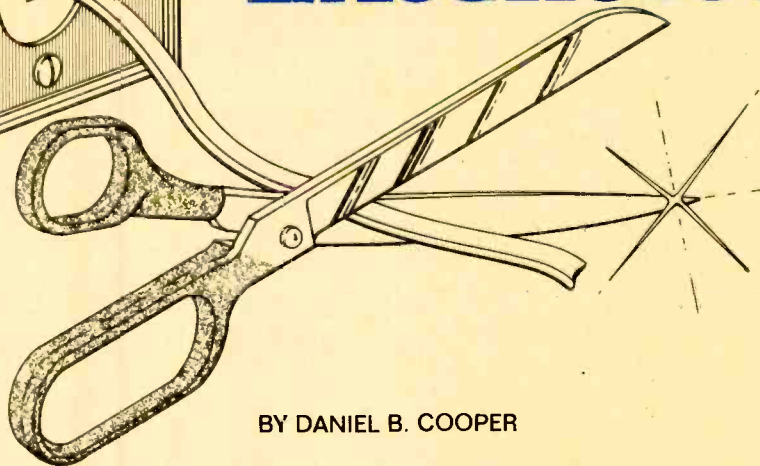

BY DANIEL B. COOPER

There are a number of circumstances in which it would be convenient to be able to isolate one telephone extension from others on the same line. The simplest reason would be to ensure absolute privacy against snoopers surreptitiously listening at other extensions. Another reason, especially in homes with a single phone line, is to give a fax machine or a modem-equipped computer total control of the phone, either to prevent interruption during a data exchange, or to prevent the other phone(s) from ringing upon receiving an incoming data call.

All you need to isolate an extension is an extra pair of wires—which may already be present in your home's wiring—and a couple of support components. Many family dwellings built since the mid-1970's have bundles of telephone wiring running to wall boxes in almost every room. Some homes have eight wires (which form four pairs); others have sixteen wires (or eight pairs). Incorporating an extension-silencing feature into such a home is often particularly easy as it is likely to have an unused pair of wires that you can take advantage of. However, as it has become common practice to use such wiring for alarm systems, remote controls, and intercoms, as well as phones, it might be possible that even a new home has no wires to spare. In such circumstances, or if the house is wired for a single phone, you will have to run a pair of wires, but you can still install the feature using the technique we describe.

Some Telephone Basics. To isolate a

phone jack in the manner we'll describe, it's necessary to understand the fundamentals of home-telephone wiring. All phone circuits require two wires, called (for historical reasons) tip and ring. When the phone is not ringing, the wires carry a direct current with the ring wire at a negative potential with respect to the tip wire.

When no phone or other communications device is "off-hook" (using the phone line), the voltage will be about 48 volts. When a phone, modem, or fax machine goes off-hook, the line is pulled down to about 6 volts. Neither voltage has enough current behind it to be dangerous.

However, the ring signal is a 90-volt peak-to-peak AC signal that is applied to the line, and it packs enough of a punch to give a painful shock. For this reason, and to avoid shorting live phone wires and sending spurious noise and on-hook signals to the phone company equipment, it's best to disconnect the telephone wiring at the incoming terminal block before doing any rewiring.

The wiring from the phone company ends at the terminal block, which may be on an external wall or in the basement. The wiring that leads from the terminal block into the house is yours, both to maintain and to do with as you

please, provided that you don't have a service agreement with the phone company. If you have such an agreement, you can still play with the wiring, but the phone company can charge you if they have to clear up any errors you make. Certain restrictions must be met; primary among them is that all equipment attached to a live telephone line must be FCC registered. But the wiring is still yours to use and modify as you wish, without charge or permission from the phone company.

Phone wiring is color coded. The standard four colors used in single-line systems are black, yellow, red, and green. In most phones, the yellow and black wires are not used. The red and green wires are the ring and tip wires, respectively. Also, when connections are made to wall terminals and the like, the ring wire always goes to the right-hand terminal. You can keep all that straight by remembering the simple mnemonic "red-ring-right."

The multiple wiring pairs that run through homes use another color-coding system. One wire of each pair will be a solid color with white bands; the other will be white with bands of the matching color. The solid-color wire with the white bands is always the ring wire.

The usual colors for four-pair wiring

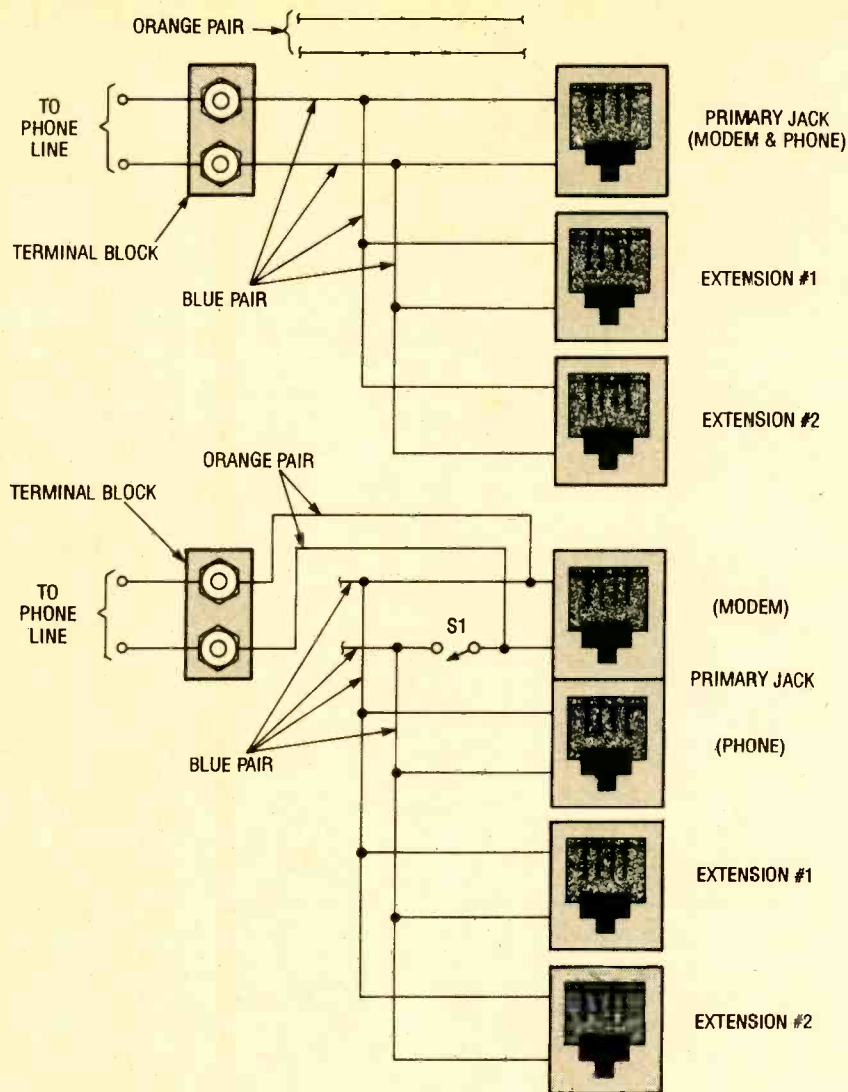

Fig. 1. This is the basic-isolation wiring. At top is the phone system before modification, with the orange pair unused. At bottom, the orange pair is used to connect the primary jack to the terminal block. Note that the old primary jack has been replaced by a dual jack and a switch has been added.

are red, green, orange, and blue (with white used as mentioned). Of course, more colors are used in eight-pair wiring, but the color-coding scheme is the same. Take note the blue pair is usually used for the first or only phone line.

The wiring pairs that run through the house to the various phone jacks or blank wall boxes are "continuous runs." What that means is that all wires go to every box and none are terminated till they reach the last box. Even if a wire is needed at a certain box it is not cut. Instead, a 1/4- to 3/8-inch piece of its insulation is removed, the bare section is formed into a loop, and the loop is wrapped around the desired screw terminal. That allows the wire to pass through the box uninterrupted. You should follow this practice any time you do your own home wiring. Further, if you

remove a jack or change the wiring pair, be sure to insulate the bare strips of the old wires with electrical tape.

The Basic Technique. The basic technique for isolating one phone extension can be summed up easily. For descriptive purposes, it is assumed that your current phone jacks are all connected to the blue pair, and you will be using the orange pair to perform the modification. After examining your home's phone wiring, you may substitute whatever colors you have available as long as you use the standard color-coding scheme. For those of you that must run a new wire pair, that pair will take the place of the orange pair we mention in our discussion.

Throughout our discussion the jack that is to be isolated (and in control) is

referred to as the "primary jack," and all others are "secondary jacks." The names "primary" and "secondary" have no bearing on where the jacks are located along the phone wiring.

The basic steps, diagrammed in Fig. 1, are as follows:

- Disconnect the blue wiring pair from the terminal block.
- Disconnect the blue wiring pair from the terminals of the primary jack.
- Connect the orange wiring pair to the primary jack's terminals.
- In the primary jack's wiring box, connect the blue pair to the orange pair via a switch.
- Connect the orange pair to the terminal block. When the switch is closed, all of the secondary jacks on the blue pair will be active. When this switch is open, the secondary jacks will be cut off, while the primary or isolated jack still functions.

This basic procedure can be used as the starting point for a number of variations. Let's look at what could be considered a basic installation, and then discuss some possible alternatives.

PARTS LIST FOR THE EXTENSION ISOLATER

- J1—Two-conductor jack
- PL1—Two-conductor plug
- S1—SPST switch
- A dual modular phone jack (if not present), twin-lead cable (see text), solder, etc.

Basic Installation. In this example installation, two things are assumed: that a simple manual switch will be used to isolate the jack, and that both an isolated and non-isolated jack are desired at the primary extension.

For security, the switch should be able to be removed from the primary jack without causing the phones on the blue pair to be cut off. That can be accomplished using an audio jack with terminals that short together when the plug is removed. The jack wiring for the basic installation is shown in Fig. 2.

A standard duplex telephone jack has two modular sockets, each with four screw terminals on the rear side. Short jumper wires connect the corresponding terminals on each jack. That is usually desired. However, in this case we want the two jacks to be separated. Cut or remove the green jumper wire, leaving the rest intact.

(Continued on page 96)

GIZMO

APRIL 1991

VOLUME 8,
NUMBER 4

A CHRONICLE OF CONSUMER ELECTRONICS

Ready, Sue, Go!

GO-VIDEO VCR-2 DUAL-DECK VCR.
From: Go-Video, 14455 North Hayden Road, Suite 219, Scottsdale, AZ 85260-6949. Price: \$1,099.95.

Every year, hundreds of consumer-electronics products are introduced, often accompanied by a flurry of advertising copy reading "new," "improved," "innovative," and sometimes even "fascinating" or "intriguing." In reality, most of the products can rightfully claim only the "new." Color television was innovative: dozens of lines of televisions in fashionable colors were merely new (although perhaps interior designers found them fascinating).

Now a truly innovative product has hit the consumer-electronics market: the first consumer VCR to offer two cassette decks, and the first VCR of any sort to be designed and engineered in the United States. Yet the "intriguing" part—and most of the press it's received—surrounds the tiny American company that developed the dual-deck VCR and the long, circuitous path that brought the device to the stores. For those of you who missed the story of *Go Video* and their *VCR-2* in the pages of *Time*, *Newsweek*, *The New York Times*, *The Los Angeles Times*, *Video*, and *Popular Science*—and also managed to miss the *20/20* segment—we'll provide an overview before we get to telling you what the *VCR-2* does, and how well it does it.

Granted, the *VCR-2* saga is a good story: A little guy takes on all the big guys and triumphs against all odds, with healthy doses of patriotism, American ingenuity, and the pioneering spirit thrown in to boot. The "little guy" is Arizona lawyer R. Terren Dunlap, an energetic, outspoken entrepreneur who conceived the idea for the *VCR-2* back in 1983 and co-founded *Go-Video* with a partner by drawing \$60,000 cash against a stack of personal credit cards. *Go-Video* applied for a patent on its dual-deck VCR in 1984.

When they began to look for someone to actually manufacture the device, the "big guys"—several of the most powerful Japanese consumer-electronics companies—



CIRCLE 50 ON FREE INFORMATION CARD

came out in force. (No American companies had the capacity to produce it.) *Go-Video* couldn't find anyone in Japan or Korea willing to manufacture the *VCR-2* or to supply parts for it. An arrangement with NEC that had appeared to be virtually in the bag in 1985 suddenly fell through—due, according to Dunlap, to a secret meeting at which the Japanese consumer-electronics leaders decided as a group to block the American company's attempts to manufacture the dual-deck units. In 1987, Dunlap brought suit in a U.S. federal court against more than 20 Japanese and Korean electronics manufacturers, charging that they had illegally formed a cartel that suppressed competition, and against another "big guy"—the Motion Picture Association of America (MPAA), which adamantly opposed a device that promised to make easy work of direct tape copying. (The MPAA dropped their opposition when *Go-Video* agreed to include circuitry that would prevent duplication of copy-protected movies.) In short, Dunlap decided to legally pit the American free-enterprise system against Japan's successful, but inherently different, system—one that condones mutual back-scratching, if not actual collusion, between major corporations.

Several of the original defendants opted early to settle out of court, paying *Go-Video* some \$2,000,000, which enabled the company to stay afloat and continue product development during the legal battle that continues against the remaining

defendants: Matsushita, JVC, Sony, Sanyo, and NEC. Meanwhile, South Korea's Samsung Electronics, one of the original defendants, agreed to manufacture the *VCR-2* for *Go-Video* in return for the charges against them being dropped.

By the end of 1990, two major milestones were reached. *Go-Video* managed to get the first units on the shelves of (very select) stores in time for the 1990 Christmas rush—and Hammacher Schlemmer and The Sharper Image have been hard pressed to keep those shelves stocked in the face of consumer demand. And the U.S. courts have decided that the company has amassed sufficient evidence to proceed with their billion dollar anti-trust suit against the five remaining defendants.

The outcome of the trial is far from certain, but Dunlap is busy pulling some emotional strings to influence public and political opinions. The *Go-Video* chairman, who *20/20* called a "hustling entrepreneur" is the first to point out the "David and Goliath" appeal of his case and the potentially dramatic benefits to the beleaguered American consumer-electronics industry a win in court would represent. (The announcement that *Go-Video* was listed on the American Stock Exchange was made on a boat in the New York harbor, with Dunlap's speech timed to coincide with a loop around the Statue of Liberty, as patriotic songs played in the background.) Unfortunately, as he states

(Continued on page 7)

TURN PAGE FOR CONTENTS

APRIL 1991

This Month In GIZMO

Go-Video VCR-2 Dual-Deck VCR	pg. 1
Radio Shack Realistic MD-1000 Multi-Disc Player	pg. 2
NEC VoicePoint Teleconferencing System.....	pg. 3
Cobra Traveler Portable Answering/Dictation Machine.....	pg. 4
Bioclok Jet-Lag Computer	pg. 5
Virgin Mastertronic Scrabble: The Deluxe Computer Edition	pg. 6
Compact-Disc Cleaner	pg. 9
Garbage-Band Scanner	pg. 9
High-Security Data Disks	pg. 9
Subwoofer System.....	pg. 9
AM/FM Stereo Receiver	pg. 10
Outdoor Timer.....	pg. 10
Portable Car Alarm.....	pg. 10
The Miracle Piano Teaching System.....	pg. 10
Car Audio System.....	pg. 11
Fax/Shredder Combo.....	pg. 11
Speaker Switcher.....	pg. 11
2000-Channel Scanner	pg. 11
Camcorder Holder	pg. 12
Graphic Equalizer.....	pg. 12
Interactive Multimedia CD.....	pg. 12
TV/VCR Combo	pg. 12

Gizmo is published by Gernsback Publications, Inc., 500-B Bi-County Blvd., Farmingdale, NY 11735. Senior Writers: Chris F. O'Brian, Teri Scaduto. Contributors to this issue: James E. Tarchinski, Carolyn Kerwin, Patricia Fenton. ©Copyright 1991 by Gernsback Publications. Gizmo is a registered trademark. All rights reserved.

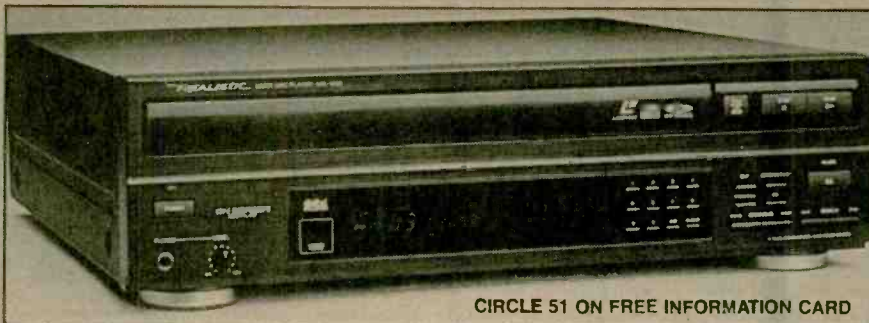

CIRCLE 51 ON FREE INFORMATION CARD

Pick A Disc, Any Disc

REALISTIC MD-1000 MULTI-DISC PLAYER: Distributed by Radio Shack, 500 One Tandy Center, Fort Worth, Texas 76102. Price: \$499.95.

We have to admit that we're a little surprised that videodisc players were less than an instant success back in a decade ago when they were first introduced. Of course, in the beginning there were several competing formats (Philips' Laser Vision, RCA's CED, and JVC's VHD.) But the VCR survived (and how!) the VHS/Beta competition, and the compact camcorder market is thriving and growing even though two non-compatible formats are vying for the consumer's dollars. The initial lack of success is all the more surprising when you consider that more than 60 percent—and some estimates go as high as 80 percent—of VCR owners don't use their machines to record! (Although that's due more to the difficulty of programming than to a lack of desire to record.) Early videodisc players were expensive, but so were VCR's.

Despite poor sales, the videodisc is still around. The LaserDisc won the format wars over its competitors, but for a while there it looked like an empty victory. Videodiscs had a small but loyal following of those who liked the high resolution and the hi-fi sound of the discs. Most viewers, however, were content to record 6 hours of low-resolution video on their VCR's or, since most people don't record, run down to the local video store for the latest VHS release.

In a sense, it's amazing that the laserdisc format survived through its lean times—consumer electronics rarely survive long stretches of mediocre sales—but the future of laserdiscs looks brighter than ever, thanks to its audio cousin, the compact disc. Now that consumers are familiar with the high quality and convenience of the CD, they seem more willing to look at the laserdisc, with its high-quality digital sound and high-resolution picture. What really helped the format was the *combi player*, which can play compact discs as well as laserdiscs, and all variants includ-

ing 3-inch and 5-inch CD's, 8-inch and 12-inch laserdiscs, and 5-inch CDV's or CD videodiscs, which contain up to 5 minutes of video with twenty minutes of audio.

Radio Shack's Realistic MD-1000 Multi-Disc Player is one such combi player. It's perhaps the lowest-priced such player on the market, but it isn't short on features and performance. Like other laserdisc players, it offers superb horizontal video resolution. Its 425-line resolution is better than the Super-VHS maximum resolution of 400 lines, and far superior to standard TV reception of 330 lines. (Standard VHS has even worse resolution, below 300 horizontal lines. That's why it's so difficult to read the credits as they scroll by at the end of the movie.) The quality difference was quite obvious in the movies we viewed on laserdisc. Both audio and video quality far exceeded prerecorded VHS films.

Since most consumers are unfamiliar with the finer points of the laserdisc standard, we'll review some of the basics. Laser videodiscs come in two flavors: standard and extended play. Standard-play discs can hold up to 30 minutes of video and audio on each side of a 12-inch disc, while the extended-play discs can provide twice that.

That extra storage doesn't come for free, however. The extended-play discs are also called CLV discs because they're recorded and played back at a Constant Linear Velocity—as the laser reads the information from the center to the outside of the disc, the speed changes from 1800 rpm to 600 rpm. Standard play or CAV (Constant Angular Velocity) discs rotate at a constant 1800 rpm. You lose some important features, such as still-frame and multi-speed play, with CLV extended-play discs. Their advantage is that you don't have to get out of your chair as often to flip or change a disc.

The necessity to flip and change discs is the one area where laserdiscs fall short of VCR's. The laserdiscs we've seen don't seem to mind that the breaks between sides of the disc don't come at any convenient time. Where they fall is where they fall, even if it's in the middle of a sentence. The other side picks up the program just where it was left off, with no re-introduction to the scene, no repetition of the beginning of the sentence, etc. But before we get car-

(Continued on page 8)

I Can Hear Clearly Now

NEC VOICEPOINT AUDIO TELECONFERENCING SYSTEM. Manufactured by: NEC America, Inc., Data and Video Communications Systems Division, 14040 Park Center Road, Herndon, VA 22071. Price: \$1299.

We hate speaker phones. We hate talking on them almost as much as we hate being on the receiving end of a speaker-phone call. Nevertheless, we have a speaker phone on our desk. Although dialing without lifting the receiver is convenient, we almost always pick up the handset once the connection is made. About the longest conversation we had over that speaker phone was to ask our secretary to come into our office. We couldn't hear her reply, since our computer's cooling fan was loud enough to consistently "grab hold" of the speaker phone's voice channel. She couldn't have responded if she wanted to—although if she did have some choice words she could have safely voiced them without our ever knowing.

That inability of both people to talk at the same time is our main complaint about speaker phones. If you do talk when the other person is speaking, you'll cut off his sentence. That's called "half-duplex" communications. Without a voice switch to cut off one side of the conversation, the incoming voice would be heard over the speaker and sent out over the microphone, which would come back over the speaker (only louder), and so on. That *feedback* is heard as a loud howling or screeching.

Because they are half-duplex, speaker phones are nothing more than hands-free telephones. You can't hold spontaneous conversations, and if you try to have a conference, everyone ultimately ends up screaming at the telephone to be heard. Unfortunately for those whose businesses demand teleconferencing, the only alternatives to speaker phones have been very expensive (\$5000 to \$20,000) full-duplex systems or more-affordable systems comprising base units that require users to wear microphones and headsets. And there are a lot of businesses that do depend on teleconferencing. In 1989, the teleconferencing industry posted revenues of over \$800 million, and had a growth rate of almost 24%. So, what's an executive to do?

NEC Data and Video Communications Systems Division has provided a more viable alternative in their VoicePoint audio teleconferencing system. It most definitely is not a speaker phone. The VoicePoint is a fully integrated teleconferencing unit that uses a digital echo canceler (we'll come back to that later) for full-duplex communication over an analog telephone line. That means that you can simultaneously

talk to and listen to the party at the other end, in any acoustic environment, with no clipped sentences, no echo, and no feedback. It requires no headsets, and it's comparatively inexpensive.

The VoicePoint looks like no other teleconferencing equipment we've seen. It's a slate-gray, 9 × 9-inch square unit, about 2-inches high, that contains a microphone at each of its four corners and a speaker in a rounded bump in the center of its top. The only controls on the unit are a volume control and three buttons for "Tel," "Conf," and "Mic Off." There's no handset or dial. The VoicePoint is connected to your usual telephone, the power line, and a modular wall outlet or jack, using the three jacks at the lower back of the unit and the supplied phone cords, AC adaptor, and modular-jack adaptor if necessary. (Somewhat more complex hookups allow the VoicePoint to be connected to any Key System or digital PBX that offers a standard analog port or interface.)

The standard setup takes no time at all. And, with its small size and 3-pound weight, the VoicePoint can easily be carried from its usual home atop an executive's desk into a conference room when needed. It can even be carried along on business trip, according to NEC, but we don't think we'd enjoy carrying the extra bulk if we could avoid it.

To use the VoicePoint for outgoing calls, you press the Tel button, lift your phone's handset, dial the number, hit the Conf button, and replace the handset. LED lamps indicate which mode you're in at any given time. (Incoming calls also involve first the picking up the telephone and then switching to the VoicePoint.) A hissing sound, the test signal for the automatic adjustment of the echo cancelers, is followed by a beep that indicates everything's ready. Unfortunately, if the receiv-

ing party picks up their phone on the first ring, they're likely to hear some of the hiss. That's about the only noise they'll hear, however, other than the sounds of your voice, the voices of the other conference attendees, and some ambient room sounds. The ambient sounds generally are not intrusive. Basically, the person at the other end of the line hears the same things the people at the sending end do. Depending on the room's acoustics, as many as 12 or 15 people can participate in the conference call from up to 20 feet away.

We generally don't have 12 or 15 people in our GIZMO offices, and we try to be closer than 20 feet from someone with whom we're having a conversation, but we tested the VoicePoint in a 17 × 20-foot room with several people and some audio and video equipment in the background. According to each person we called, the audio quality was far superior to that of any standard speaker phone. A person sitting across the room could be heard as clearly, and almost as loudly, as someone sitting right next to the VoicePoint. The television could also be clearly heard. We were able to speak all at once, and at the same time as the person on the other end of the line—whose voice was highly audible from across the room. While nobody's words were cut off or chopped up by the phone, it did get a bit confusing when everyone talked at once!

We also tried the VoicePoint from the other side of the call. Once the newness of the unit wore away, what struck us about the conversations was that they seemed so natural. And the quality was really quite good.

That high-quality audio is due primarily to the echo canceler, a digital signal-processing circuit that includes an acoustic echo canceler (AEC), which eliminates

(Continued on page 8)



CIRCLE 52 ON FREE INFORMATION CARD

Travel TAD

COBRA TRAVELER PORTABLE ANSWERING AND DICTATION SYSTEM.

Manufactured by: Cobra Electronics Group/Dynascan Corp., 6500 West Cortland Street, Chicago, IL 60635. Price: \$229.95

In our relentless pursuit of new gizmos to tell you about, we often find ourselves at one trade show or another searching for the latest innovations. Of course when we're on the road, we can't neglect our duties back at our home offices. And as you might expect, we have found that the business traveler's most important tool is the pay telephone.

The pay phone, of course, is useful only for outgoing calls. For incoming calls, we have to rely on hotel operators who don't always relay messages accurately or who are unwilling to take a lengthy message. And by the time we get back to our hotel room, it's usually too late to return a call anyway.

To help us and other travelers out, Cobra has introduced a portable answering and dictation system called, appropriately enough, the *Traveler*. Billed as the world's first unit of its kind, the *Traveler* works wherever you can get access to a modular plug. It does everything you'd expect an answering machine to do, and adds a couple of features that travelers will appreciate: a dual-time-zone clock so you can keep track of what's going on back at home, and a rather loud alarm (which we especially like because we've learned first hand that hotel wakeup calls aren't always reliable.)

Although the *Traveler* is the smallest answering machine we've ever seen, it's not exactly tiny. With dimensions of about $6\frac{1}{2} \times 3\frac{1}{2} \times 1\frac{1}{8}$ inches, it's about 33-percent larger than a personal stereo radio/cassette player. At 13 ounces, it weighs more, too. However, it fits easily in a briefcase and comes with a convenient leatherette carrying case that's large enough to hold the *Traveler* and its accessories.

The *Traveler* is powered by an AC adapter or four "AAA" batteries. In the best of cases, it's powered by both—the batteries can provide memory backup in the event of a power failure (which, at the very least, will happen every time you check out of a hotel and unplug the unit). Without the batteries you would lose not only the dual-time zone clocks, but also the outgoing message, which is recorded digitally and stored in memory. Fortunately, even without batteries, a power failure won't really erase your outgoing message—a backup is always stored on the unit's microcassette tape.

The *Traveler* isn't short on the features you've come to expect from full-sized answering machines. For example, full re-



CIRCLE 53 ON FREE INFORMATION CARD

mote operation is possible, so we can retrieve messages at any time during the day. All calls that come in are stored with the time of the call, which is displayed on the unit's LCD readout. (Of course, you can't see it during remote operation, but we guess you can't have everything.)

Setting the unit up is quite easy. A modular cord is supplied to connect the *Traveler* to the phone line. The existing phone plugs into the back of the *Traveler*. For AC operation, the adapter also plugs into the rear of the answering machine. As long as your hotel uses modular connectors (as most do) and doesn't take any special precautions to prevent you from disconnecting the telephone cord, you'll be able to use the *Traveler*. In most hotel rooms we've been in, the more difficult problem is finding an open electrical outlet. Apparently the people who tested the *Traveler* had the same experience—they include a small extension cord/cube tap to ensure you'll be able to get power.

If you're like us and like to travel light, you probably don't like the idea of carrying an AC adapter around. For shorter trips, you might want to rely solely on the batteries. In the TAD mode, a battery-saver feature puts the unit to sleep after about 2½ minutes of non-use, but it wakes up again with each incoming call.

We found the wallet-sized remote-operation guide to be a little bit confusing—the first time. We'll blame ourselves. Re-reading the card, we realized that it was actually quite simple. The only place where things can go wrong is if you can't distinguish three long beeps from three short ones. The long beeps signal that you have

messages, while the short beeps signal that you don't. If you enter a remote command after the short beeps, the *Traveler* will erase your outgoing message and try to record a new one. If you don't leave a new message, the *Traveler* won't answer calls.

Of course, only one half of the *Traveler* is an answering machine. The other half is a dictation machine. We sometimes had to debate whether to leave the *Traveler* back in the hotel room or take it with us for recording notes. We generally left it back at the hotel. After all, the take-along answering machine was the unique feature that originally appealed to us—and one that we quickly came to depend on. Another reason, however, is that the unit is a little too large to use conveniently, since it doesn't fit in a shirt pocket. It's great for using on an airplane (a headphone jack is provided so you can listen without disturbing others) or to set on a table top to record a conversation.

Before taking the *Traveler* on the road, we tried it at our home base to get familiar with some of its features. We found it to be as much at home there as it was on the road. We did discover one shortcoming: Messages are indicated by small numbers on the LCD, which aren't visible from a distance, and don't stand out unless you look for them. Our only other complaint is with the positioning of the microphone. For use as a dictation machine, the unit has to be held upside down for best results.

Our overall impression of the *Traveler* is that Cobra has come up with a winner. We would expect that the competition is hard at work trying to match it. ■

Jet-Set Gizmo

BIOCLOK JET-LAG COMPUTER. Marketed by: The marketing Clinic, The Cracker Factory, 16 Church Street, Keene, NH 03431. Price: \$129.00

We envy the travelers of yesterday. While cruising across the ocean in five days might seem slow, it's a lot easier on our bodies than doing it in five hours. These days, it would seem absurd to travel on business to the opposite coast on a train—which would take a few days. God forbid! A jet airplane lets us do it in a few hours. And with deregulation, at least in the short run it's as affordable and, we hope, as safe as any other alternative. We have to put up with only a few hassles—trips to and from the airport that often take as long as the flight, no leg room, awful food; and jet lag.

We remember reading, many years ago, a newspaper account that explained that the reason for our favorite baseball team's dismal performance in a game was jet lag—they had flown in the previous evening from the opposite coast. A poor excuse, we thought. But then, as children, we had never flown anywhere, let alone

cross-country. Maybe our team wouldn't have ended up some 10 games out of contention if they'd had the *Bioclok*, the Jet-Lag Computer.

Jet lag is a real phenomenon, although a relatively new one that has gained recognition only after the introduction of jet travel. Originally, it was theorized that it was the jet's high speed that disturbed sleep patterns and made people sluggish. Then it was noted that jet lag occurred after flights from east to west and vice versa, but not on similar flights from north to south or vice versa. Apparently, it was the rapid travel across time zones that caused jet lag, not rapid travel itself.

The explanation is that all animals have a body clock. Experiments with subjects kept in complete isolation from outside stimuli, have shown that the human clock has a natural period of close to 25 hours. Although its period is about an hour longer than our 24-hour day, the body clock or circadian rhythm is reset every day by external environmental factors: daylight, our alarm clocks, our jobs, etc. When flying across time zones, our bodies are too far out of sync to adjust quickly, so we end up feeling sluggish, and performing at less than our best.

Of course, jet travel isn't the only activity that can upset our internal clocks.

Shift workers who must rotate their work schedules also have trouble adjusting to the disruption of their circadian rhythms.

Although it was previously believed that the human circadian pacemaker was not affected by exposure to light, the most recent studies show just the opposite. In fact, the pineal gland, which is the seat of our biological clock, produces melatonin—a sleep-inducing hormone—only in darkness. Its production is suppressed by bright light, even if your eyes are closed. Thus, by controlling your exposure to light, you can control your internal clock and compensate for time-zone changes. That's the whole idea behind the *Bioclok*. It calculates the amount of exposure you need to compensate for long flights across different time zones.

The *Bioclok* is very easy to use, and easy to carry, too. Its dimensions of about $2\frac{3}{4} \times 3\frac{1}{2} \times \frac{1}{2}$ inches let it fit easily in a shirt pocket. The three controls and a 2-inch square LCD are hidden under a flip-top cover. An almost complete set of operating instructions is printed on the inside of the panel, so there's no need to bring the small operation guide along as well.

To start, you enter the local departure time, the duration of the flight, and the local time of arrival. (If your flight requires any stop-overs, you simply consider them as adding to the duration of a long flight.) The *Bioclok* also needs to know which direction you are traveling in order to compute its recommendations. Its computations are displayed on a 24-hour clock with shaded and non-shaded areas. Using the local time of your destination, you should avoid sunlight during the hours indicated by the shaded area, and be outside—or at least by a window—during the hours indicated by the light area.

In theory, it sounds OK. In practice, that's not always the case, as we'll show with some examples: A flight from New York to Chicago, which crosses one time zone, normally doesn't produce jet lag—it's the same as the switch from daylight savings time back to standard time. Plugging the flight data into the *Bioclok* for an afternoon flight leaving New York at 12:37 PM and arriving in Chicago at 2:00 PM (a flight time of 2 hours, 23 minutes) yields a suggestion that you stay outdoors from 5 PM to 11 PM, and get out of the sun shine (moon shine?) after that. After a stay in Chicago, we return to New York with a suggestion to expose ourselves to sunlight from 6 PM to midnight. As this report is being written, our local sunset is at 4:40 PM!

Since jet lag usually doesn't bother us on trips as short as one to Chicago, and since we're usually asleep by midnight, we decided to ignore the *Bioclok*'s recommendations, and woke up the next morning—more refreshed, we imagine, than if we had stayed up until midnight looking for the sun.

(Continued on page 7)



CIRCLE 54 ON FREE INFORMATION CARD

Furzy Logic

SCRABBLE™: THE DELUXE COMPUTER EDITION. Manufactured by: Virgin Mastertronic, 18001 Cowan Street, Suite A, Irvine, CA 92714. Price: 59.95.

Americans have a long history of standing on line to buy the fad of the moment, be it a Pet Rock, Trivial Pursuit, a Cabbage Patch Doll, or a hoola hoop. One item that had people quietly queuing up back in the 1950's was the newly marketed Scrabble Crossword Game. It was originally called "Crisscross Words" by its creator, Alfred Mosher Butts, an avid word-puzzle fan who invented the game during the depression, when he couldn't find work as an architect. While the game was an instant hit with Butts' family and friends, it wasn't until after World War II that he struck up a partnership with James Brunot, who arranged for the board to be professionally designed. The newly packaged game, with its snappy "Scrabble" moniker, became an overnight success. Since the 1950's, more than 100 million copies have been sold worldwide.

A few of those copies belong to GIZMO staffers. We've played the game since we were kids. And just because our Scrabble sets have spent most of the last few years tucked away in closets, they've never become outmoded. It's just that we're continually bombarded with so many electronic toys that we rarely have time for playing with old favorites.

Then we received a copy of *Scrabble: The Deluxe Computer Edition* from Virgin Electronics. We jumped at the chance to pit our somewhat rusty skills against a computer—and to have an excuse to play Scrabble once again (and actually get paid for it!).

We attempted to load the game into our computer, following the scanty instructions supplied in the manual. It was an easy procedure. We put the first floppy in drive A:, typed "install," and let the computer take care of the rest. Well, we actually had some trouble and, since the manual provided no help, we had to call Virgin Mastertronic to ask what was essentially a stupid question. (They don't list any customer service number on their game material.)

The manual might skip on installation instructions and breeze through the directions on using the pull-down options menus and setting up game play, but it goes all out on the rules and strategies behind the game of Scrabble. It provides full details on how words are formed, what types of words are acceptable, the values of the letter tiles and how many of each are included, taking advantage of the "premium" (double- and triple-letter-score and double- and triple-word-score) squares, and scoring. Unfortunately, the



illustrated examples of word formation and scoring given in the manual do not add up correctly, no matter how often we totaled the tiles and what "premium" squares we used in our figuring. Luckily, we were already familiar with how to score the game—and, in any case, the computer does all the totaling. (We hope it does a better job than the authors of the manual!)

Also appearing in the manual is a reprint of an article on advanced Scrabble strategy that would have totally turned us off the game if we weren't already Scrabble enthusiasts. For example: "First, all of the *Official Scrabble Player's Dictionary's* two-letter words must be memorized. Also learned are which ones can be pluralized and which ones cannot ... Next, all three-letter words ... then all four-letter words are memorized." And it doesn't end there. It seems that master players can actually recite the five 8-letter English words that contain six vowels (*eulogiae*, *epopoeia*, *aboideau*, *abouteau*, and *au-reolae*). Then, of course, you must decide what to do if you get the "Q" tile, how best to use your "S" tiles, whether or not to save an "I" "N" "G" grouping in the hopes of making a seven-letter word and scoring the 50-point bonus. Despite the article, we decided to see if we could have

some fun playing computerized Scrabble.

You can play Scrabble against up to three other human players, or against the computer (up to three computer players). If you opt for the computer opponent(s), you can select a skill level from 1 (novice) to 9 (expert) for each. The board is the familiar, crossword-style square, but not much else seems the same. For one thing, unless you specifically choose the Racks Off option from one of the pull-down menus, you can see all the other players' tiles displayed to the left of the board. That's called cheating where we come from! If you really want to cheat, this game gives you plenty of other ways to go about it. First, you can ask for hints and the computer will generate possible plays for you to use. (Its suggestions are often *not* the highest scoring possibilities, but might inspire you to come up with a good word.) The anagram feature will take a bunch of letters that you select and scramble them to form any possible words. The crossword option is similar to anagrams, but lets you add wild cards. You can even manipulate the timer function so that only the computer is under a deadline. (When you see how many words the computer has "on the tip of its tongue" scrolling across the screen, and how long it takes

(Continued on page 8)

READY, SUE, GO!

(Continued from page 1)

his case, Dunlap indulges in a vociferous, steady stream of Japan-bashing that we find disturbing. We'd prefer to hear an enthusiastic description of the VCR-2's unique capabilities than an unrestrained attack on Go-Video's enemies.

If the product seems to get lost in the hoopla surrounding its creation, there might be good reasons. The VCR-2 *does* offer capabilities beyond the scope of any other VCR. The additional deck allows you to watch a prerecorded videotape while you tape a program, copy one tape to another with the push of a button, or combine scenes from several home videos onto one tape without much trouble. You can even tape two programs at the same time—provided you have a TV with video output to serve as the second tuner, are physically present at the time of the recording, and are willing to do some wire-juggling (which, we suspect, the VCR-2's intended customers wouldn't be willing to do).

The lack of a second tuner is symptomatic of VCR-2's engineering/market-targeting flaws. The dual-deck VCR, at more than \$1000, is priced out of the range of the average consumer, yet it doesn't offer several features that a videophile would consider essential in a VCR—particularly one to be used for tape editing. That leaves the small segment of the consumer-electronics market for whom novelty and convenience are more important than quality, and who are willing to pay a lot for an item that's unique. (We suspect that's why the VCR-2 was initially sold only at those two exclusive retailers.)

And the VCR-2 is both unique and easy to use for most purposes. Those of you who are still struggling to program your old-fashioned, single-deck VCR's can rest easy—a video instruction manual comes with each VCR-2 and clearly demonstrates how to do each of those things. Once we'd perused the video manual, we were able to take advantage of most of the VCR-2's features without ever consulting the more detailed, and very well-developed, written manual. Programming the VCR-2's two decks to record shows at a later date with the timer, via an on-screen menu, was easier than programming many single-deck VCR's we've seen.

Duplicating a tape that isn't Macrovision encoded couldn't be easier. It requires simply that you put the source tape in deck 1, a blank tape in deck 2, and press the Copy Tape button. Editing out unwanted scenes is almost as easy—as is editing in scenes from several different original tapes—using first the Copy Tape button and then pressing Pause and Record as needed. We had a bunch of lengthy vacation videos that made for some pretty boring viewing, and it was a delight to be able to quickly and easily edit them down to

something we could show without alienating friends and relatives.

We'll admit, we tried to copy tapes that were encoded to prevent duplication. We loaded the prerecorded movie into deck 1, hit the Copy Tape button, copying began—and stopped after about two minutes, when a "Tape is Copy Protected" message appeared on the screen. Immediately pushing the Copy Tape button got the process rolling again, but at intervals of about two minutes that message would appear again, and the recording would stop. If you have the patience to keep pushing Copy Tape every few minutes, you actually can record—albeit illegally, though we're not sure *why*—an entire copy-protected tape. The copy is watchable, but somewhat annoying, since every two minutes or so (corresponding to the warning messages on the original) a second or two of snow replaces the picture. That didn't bother the less-discriminating GIZMO reviewers, and we suppose that kids who can watch the same movie a dozen times in a row wouldn't be the fussiest of viewers. But even borderline videophiles would not be very happy with the copy.

On non-copy-protected tapes, the quality of duplicates is good but not great; videophiles would not be happy with them either. And some problems arise during editing. The VCR-2 lacks such features as a flying erase head, frame advance, and slow motion that are necessary for accurate, clean cuts and edits—and each of the decks has two heads, not four. More demanding consumers would sorely miss those features, although the convenience of trouble-free editing will more than compensate for those shortcomings for many less technically inclined people, and in less demanding situations.

The VCR-2 provides several other convenience features, including automatic play and rewind of tapes and remote tape load/eject, which finishes loading (or ejecting) a tape that is partially pushed into the slot. Each of those features can be turned off using the on-screen video menu, for situations that call for more manual control over the VCR-2. (For example, you wouldn't want a tape that you were editing to automatically start playing.) The 16-event, lifetime timer is also a plus, as is MTS Stereo. It's quite simple to set the VCR-2 to record one program while you watch a tape. And if you're running out of the house and want to tape a program that's about to start without using the menus, you can use "One Two Recording" (OTR) to set the VCR-2 to record in half-hour increments by pressing the record button. There are two fast-forward/rewind search speeds, and you can mark one position on the tape counter at which the search will automatically stop. All of those features make the VCR-2 extremely easy to use.

Virtually every feature offered by the

VCR-2 can be activated using either the front panel or the remote control. Both the unit itself and the remote are larger than average. The VCR-2 measures 20¼(W) × 4¼(H) × 16½(D)—too large to fit in the compartment in our entertainment center that our regular VCR occupies. Each side of the deck holds a tape hatch with the control buttons underneath, and a set of covered controls that include some of the lesser used functions along with knobs for adjusting tracking and sharpness. The lower center front panel has an LCD status readout and source indicators. The controls—both on the front panel and on the remote—were a bit sluggish. Many high-priced VCR's have a command buffer; with the VCR-2 you have to wait for one command to be fully completed before you can input the next command. That's another example of a high-quality feature that was left out of the high-priced VCR-2.

Our reactions to the VCR-2 were mixed. Some of us really loved the convenience of one-step copying and easy edits. Some of us were sorely disappointed that several features that have come to be considered basic in high-priced VCR's are missing. We all agreed that the VCR-2 is a step in a new direction, and that a second tuner is essential.

We're looking forward to the next generation of VCR-2. We envision virtually the same set, with the addition of a second tuner, and some basic editing functions, and a way to insert other equipment (such as a video titler) between the two decks—but priced a bit closer to the average consumer's budget (a price drop generally occurs once the novelty wears off a new consumer-electronics item). Another version would also incorporate those features that would endear it to videophiles, and could be priced as the market would bear. At that point, we'll begin arguing about which type of VCR-2 we "need." For now, however, we'll get better results using two VCR's. ■

JET-SET GIZMO

(Continued from page 1)

A flight from one coast to another yields similar results. A typical flight from New York to Los Angeles, with one stop, takes about 8 hours. Our local airport gives us two scheduled flights on our favorite carrier, one leaving at 6:56 AM, the other at 12:28 PM. If we take the morning flight, Bioclok tells us that we should stay outdoors from 3 PM to 9 PM. If we take the afternoon flight, we should stay in the sun from 3 AM to 9 AM. Well, we won't get any California tan that way! To be fair, the manual points out that if the Bioclok recommends that you expose yourself to light at a time of day when there is no natural light available, then you should concentrate on avoiding light exposure at the stip-

ulated times. But that's not always possible, either.

Our final example is a flight from New York to Osaka, Japan. A polar flight, including a stop in Tokyo, takes about 19 hours. The Bioclok's recommendation: Avoid exposure to the sun after 12 noon, which is fine as long as you're not conducting any business in the afternoon.

As it turns out, we tried to give the Bioclok a fair workout. But its recommendations were so inconvenient to follow that we were never able to determine whether or not it really works. If we were willing to put up with its inconvenience, we'd probably already be taking the train to the coast instead of flying. And we wouldn't be upsetting our circadian rhythms with all that coffee we drink. But if you're looking for the perfect gift for the jet-setter who has everything ... ■

PICK A DISC

(Continued from page 2)

ried away with a diatribe, we'll point out that our complaints are against the movie industry. The player only plays back what it's fed.

Integrating the MD-1000 into your video system can be the simplest of operations, or it can be quite involved if you have a lot of equipment that you want to operate in harmony. In the simplest of cases, you simply connect your antenna or cable to the laserdisc player, and use the supplied coaxial cable to feed the antenna on to the TV (or VCR). If you want to use the direct audio and video connections (which we would highly recommend) and you have a VCR in the picture, the hookup gets a little more complicated, and some sort of audio/video switch box would be the best way to handle the situation.

In our case, we wanted to watch movies and experience them using our Dolby surround-sound processor. We still wanted our VCR in the picture, and our stereo system is also part of our surround system (and a must, of course, if we wanted to listen to CD's.) As you might imagine, our wiring got reasonably complex because we had to use a number of Y adapters. The manual probably could have spent a little more time covering the multitude of possibilities that often bewilder the average consumer.

Once the MD-1000 is installed, it's easy to use. Simply pop in a disc, close the tray, hit Play, and the player does the rest. It automatically recognizes what format and size disc is inserted. An array of search features that have become familiar standards on CD players are provided. For example, you can start playing at a specific time from the beginning of a CLV laserdisc, search for a specific chapter (laserdisc) or track (CD), automatically skip to the next chapter or track, or automatically

play the first 10 seconds of every chapter or track on a disc. It's possible to search rapidly through discs in either direction, and to program the player to play tracks in random order or to play them in any order you choose. You can also repeat a chapter or track, or a small section of any chapter or track.

Our favorite features come into play for standard laserdiscs, those recorded in the CAV format. With CAV discs, you can change the play direction, change the speed from 1/10th of normal to three times normal, freeze the picture, advance one frame at a time—all with perfect picture quality.

For those who like to record their CD's onto audio tape for playing in a car or portable stereo, the MD-1000 has some special editing functions that allow it to automatically select the tracks on a CD or CDV that will fit on one side of a cassette tape. An on-screen display shows you ahead of time what tracks will be recorded. It doesn't do any re-arranging of tracks for a perfect fit.

Although the laserdisc is experiencing unprecedented growth, it still has a long way to go. While we have dozens of video-rental stores within a five-mile radius, we found only one that rents laserdiscs. But as more companies make players, and as the price goes down and versatility goes up, the laserdisc player is beginning to make its way from Videophile-land into the mainstream consumer market. ■

I CAN HEAR CLEARLY

(Continued from page 3)

the acoustic coupling that can cause a howling sound when the microphone and speakers are activated at the same time, and a transmission-line echo canceler (TEC), which eliminates feedback at the hybrid circuit.

Echo cancelers like the VoicePoint's TEC have been used before, to address the echo that plagues the various types of long-distance telecommunications systems, such as satellite communications or overseas lines. The VoicePoint's AEC applies the same technology to eliminate acoustic coupling as well as the echo sound emitted from the speaker when it is reflected by the room walls, ceiling, furniture, and even people. Since NEC has plenty of experience with modem and satellite-transmission systems, we're not surprised that they were able to do a good job with the VoicePoint; they used similar types of signal-processing chips—one of the keys to its relatively low price.

But even if we can't afford the VoicePoint, and our GIZMOing really doesn't require its capabilities, we're impressed with how well it works. It seems that we have a speaker-phone budget, and teleconferencing-system tastes. ■

FURZY LOGIC

(Continued from page 6)

to make up its mind, you might decide that giving it a time limit is only fair!) Another option allows you to take back a word that's been played—yours or the computer's. The computer, however, will usually play the same word again, unless you use the timer to limit how long it has to come up with it.

Challenging the computer didn't always satisfy us. We challenged its use of the word "Furzy," which we couldn't find in any of our dictionaries. It's answer: "Abounding in furze." "Furze" was in our dictionary, as a prickly evergreen shrub.

The only other trouble we had occurred the first time we tried to store a game. When we went back to it, we were able to recall it, partially. The system brought up the last two racks of tiles that were to be played, and a *totally blank* board. When we tried using the tiles to start a new game on the blank board, it became apparent that the computer could see the invisible tiles of the game that had been saved. Subsequent attempts at saving and recalling half-finished games went smoothly.

The game can be played using either a mouse, a joystick, or a keyboard, although a mouse is highly recommended. We can see why, after trying to play with a keyboard! Each tile must be picked up and carried using the direction arrows, quite a tedious process. Accessing the menus and using the options are also frustrating and time-consuming procedures when using a keyboard because no keyboard shortcuts are provided. Even when requesting the definition of a word, you must use the cursor keys to move the arrow to point to each letter. Not being able to type in words when you're playing a word game is like having a calculator where you have to spell out the entries.

Still, it's nice to be able to play Scrabble without rounding up a friend or two to make up the game. You can learn by playing against the computer (practice makes perfect, or so they say) and you can even print out a blow-by-blow description of the game to analyze what you did right or wrong. The game could be more challenging, however. Even when setting the computer at level 9 we were usually able to win (without cheating). We haven't played the game in years, and none of us has any two-, three-, or four-letter words memorized. Most of all, we missed the camaraderie of sitting around a table with friends, arranging and rearranging those smooth wooden tiles, calling out "I challenge!" when someone comes up with a particularly bizarre word ("furzy" would have been right up there), and thumbing through a well-worn dictionary to find out who is right. ■

For more information on any product in this section, circle the appropriate number on the Free Information Card.

ELECTRONICS WISH LIST

Subwoofer System

So you'd like nothing better than to annoy your pain-in-the-neck downstairs neighbors with some loud music, but your wife is unwilling to compromise her decorating scheme with your components. As long as her decor is ultra modern, Memtek's TS-5 subwoofer system combining a stand-alone, obelisk-shaped, sleek black subwoofer and two very compact satellites should fit the bill. The satellites should be separated from the obelisk—on a bookshelf, for instance—for optimum midrange and treble response. A four-inch midrange driver provides high-clarity transient response, while a combination of main tweeters with a 5/8-inch diaphragm and a supplementary rear-firing tweeter spreads the high frequencies throughout the room. For bass clarity, the woofer uses four high-power 5 1/4-inch drivers that provide the same radiating area as a 12-inch woofer without the heavy single cone. Price: \$649.

CIRCLE 56 ON FREE INFORMATION CARD

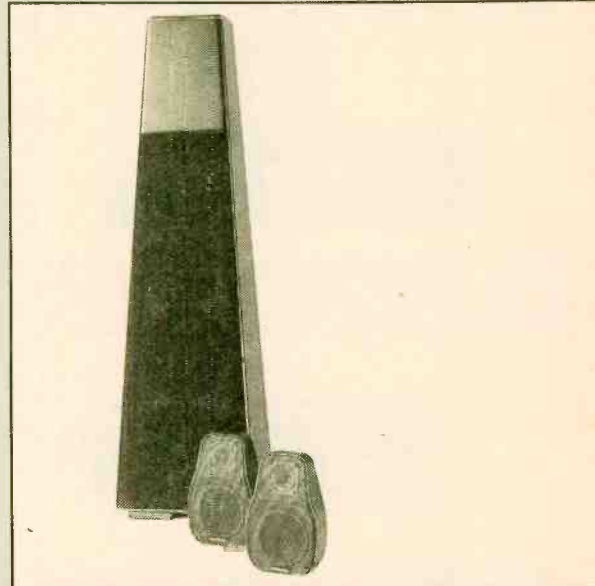

Memtek Subwoofer System

Garbage-Band Scanner

For years people have used scanners to keep track of the life-and-death action of the law-enforcement and fire-fighting professions. With the introduction of the model GB-1 scanner, Stolid Devices Inc. (1234 Main Street, Spotsville, AK 99991) hopes to get enthusiasts hooked on an entirely new world of scanning—the fast-paced world of garbage collection. Now you can tune in on your local sanitation workers as they make their runs. With the GB-1 you won't miss out on any of the excitement: "Trash cans overturned at Forth and Elm," "Glass debris on highway near the 214-mile marker," "Take your lunch break now." As if that wasn't enough, the GB-1 gives you complete access to the taxi and road-construction bands as well. Price: \$122.

CIRCLE 4/1 ON FREE INFORMATION CARD

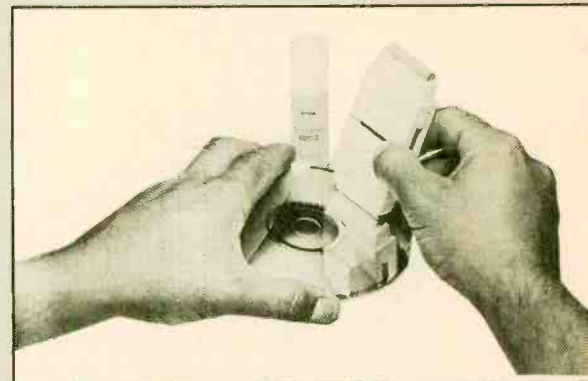

TDK Compact-Disc Cleaner

Tidy Discs

In the audio world, cleanliness is next to godliness. While compact discs don't require the tender loving care that LP's need, they still must be kept clean. To help you keep your CD's sparkling, TDK (12 Harbor Park Drive, Port Washington, NY 11050) has introduced the CD-C1 compact-disc cleaner. The unit features a unique "two-headed" construction. One side consists of a non-linting sponge, used to wipe the disc clean with a few drops of cleaning fluid. The other side is a lint-free drying pad, used to wipe the CD optically clear. Price: \$14.00.

CIRCLE 57 ON FREE INFORMATION CARD

High-Security Disks

Chalk it up to yet another example of how this country spends billions of dollars annually on military pursuits. Originally designed to the specifications of the Department of Defense, the Flippy Corporation (5000 Spendthrift Lane, Washington, DC 20000) has started marketing its new ROWMaT disk technology. ROWMaT (Read-Once/Write-Many-Times) disks are the converse cousins of the more familiar WORM (Write-Once/Read-Many-times) hard-disk drives. At a price of \$3.00 per byte of storage, however, the new ROWMaT drives may be out of the financial reach of most computer enthusiasts. Flippy is also concerned about the number of potential users of this new technology. As Flippy's president has publicly commented, "Besides the military and designers of airline baggage-handling systems, who would have a use for a read-once device?" Price: \$62.9 million (for a 20-megabyte drive).

CIRCLE 4/1 ON FREE INFORMATION CARD



High-Security Data Disks

ELECTRONICS WISH LIST

For more information on any product in this section, circle the appropriate number on the Free Information Card.



The Miracle Piano Teaching System



Yamaha AM/FM Stereo Receiver



Intermatic Outdoor Timer



Cobra Portable Car Alarm

Electronic Piano Teacher

Those parents who have been unsuccessful in their attempts to pull their kids away from the Nintendo long enough to take piano lessons—let alone practice every day—will be interested in *The Miracle Piano Teaching System* from *Software Toolworks* (19808 Nordhoff Place, Chatsworth, CA 91311). The system includes a stereo MIDI keyboard that can be used on its own, a Nintendo-based cartridge that teaches kids (or adults) how to play the piano, and a patent-pending interface. The progressive lessons are entertaining—for instance, ducks on a staff are “shot down” when the student touches the right note on the keyboard, and a robot teaches rhythm. (Adult lessons are more sophisticated.) Artificial-intelligence technology allows the Miracle to know which key is being pressed at all times, and to isolate the student’s trouble spots in note recognition, rhythm, and fingering. The system plugs into the Nintendo joystick port, and can be connected to a home stereo system. Price: \$349.

CIRCLE 58 ON FREE INFORMATION CARD

Entry-Level Receiver

Yamaha Electronics Corporation's (6722 Orangethorpe Avenue, Buena Park, CA 90620) lowest-priced AM/FM stereo receiver is the 40-watt-per-channel *RX-350*, which incorporates a new transformer that yields greater power capacity and lower impedance drive capability. Control features include a CD-direct switch that sends the CD signal directly to the output stage, bypassing other circuitry; continuously variable loudness control, a four-position rotary input selector; and provisions for two sets of speakers with selectors to activate either or both. The receiver’s LCD readout includes a five-segment signal-quality display that allows user to monitor the tuned signal and instantly shows the result of tuning adjustments. The *RX-350* also features “rounded-edge European styling” and extra large feet for improved anti-vibration characteristics. Price: \$239.

CIRCLE 59 ON FREE INFORMATION CARD

Outdoor Timer

The *All-Season Outdoor Timer* from *Intermatic, Inc.* (Intermatic Plaza, Spring Grove, IL 60081-9698) can be used year-round for such functions as controlling bug zappers and pool filters in the summer and engine-block heaters and holiday lights in the winter. Two sets of trippers let you program the timer for two “on” times and two “off” times per day. A clear window/cover lets you see the timer while maintaining a water-tight seal. Made of a tough, industrial-grade plastic, the timer “will never corrode,” according to Intermatic. Price: \$28.95.

CIRCLE 60 ON FREE INFORMATION CARD

Portable Car Alarm

Shaped like a padlock, *Cobra Electronics Group's* (6500 West Cortland Street, Chicago, IL 60635) *VAS-110 PRO-LOCK Portable* provides a visual deterrent as it sits on the user’s dashboard. The portable alarm provides four-way protection with motion, shock, glass-breakage, and current sensors. The self-contained security system plugs into the car’s cigarette lighter and is activated by a remote keychain transmitter, which features a “panic control” to activate the siren remotely. The *VAS-110* has a bright Xenon strobe light, a 120-dB siren, and user-selectable remote coding. Price: \$119.95.

CIRCLE 61 ON FREE INFORMATION CARD

For more information on any product in this section, circle the appropriate number on the Free Information Card.

ELECTRONICS WISH LIST

Mobile Audio System

If you still have anything left to spend on your car after you've filled the tank, *Sony Corporation of America* (Corporate Communications Department, 9 West 57th Street, New York, NY 10019) can put at your fingertips AM/FM, CD, and cassette capabilities with their *CDX-A30* 10-disc CD changer and their *XR-7500* cassette player/tuner/CD controller. The CD changer has 4X oversampling and a silicon-oil damped suspension for improved vibration resistance. The *XR-7500* features a full-logic cassette transport, 18 FM and 6 AM station presets, a variety of playback features, and a remote control unit to operate the most often used functions. The *XR-7500's* convertible chassis allows for either fixed or pull-out installation, and is hooked up to the CD changer with one easy connection. Price: *CDX-A30*, \$499.95; *XR-7500*, \$549.95.

CIRCLE 62 ON FREE INFORMATION CARD

Speaker Switcher

With the ability to handle two different sources at the same time, *AudioControl's* (22313 70th Avenue West, Mountlake Terrace, WA 98043) *The Director* makes it easier to control audio speakers in different rooms. Because *The Director* uses speaker wires and speaker level, several different speaker systems can be run by one amplifier. Up to six speaker "zones" are controlled. Five are dedicated to one source—for instance, the stereo system—while the main zone can come from the same source or from a different one—for example, the TV. With that setup, one person can be watching TV while music plays throughout the rest of the house. A separate volume control for the main zone is provided. *The Director* is a full-sized unit, designed to be stacked with other audio components in a system. Price: \$299.

CIRCLE 63 ON FREE INFORMATION CARD

2000-Channel Scanner

Designed for either table-top or under-dash use, the *AR-2500* is nothing if not versatile. The receiver, from *Ace Communications* (Monitor Division, 10707 East 106th Street, Indianapolis, IN 46256) covers 1 MHz to 1500 MHz at 36 channels per second, and has a built-in RS-232 port for programmed, unattended control and frequency-surveillance logging. Its broad coverage range lets it pull in distant shortwave broadcasts, super-high-frequency microwave broadcasts, and everything in between. The receiver can scan 62 banks of 32 frequencies each, and an additional 16 memory locations are set aside for beginning and ending search-limit frequency pairs. Price: \$499.

CIRCLE 64 ON FREE INFORMATION CARD

The Next Office Craze

Move over, Ollie ... *Detritus Communications Corporation* (999 Federal Way, Borderville, VA 22332) has just done your favorite office device one better. The *ShredFax* is a facsimile machine and a paper shredder combined in a single desk-top unit. Now you can destroy those important faxes immediately after you read them. Or, if the incoming information is even too classified for even your eyes, by sliding a convenient lever the fax output can be automatically directed into the shredder. For further data protection, a \$75 "invisible ink" option can be purchased so that even if anyone got to the document before it hit the shredder, the faxed message would still be invisible to them. Price: \$1950.

CIRCLE 41 ON FREE INFORMATION CARD



Sony Car Audio System

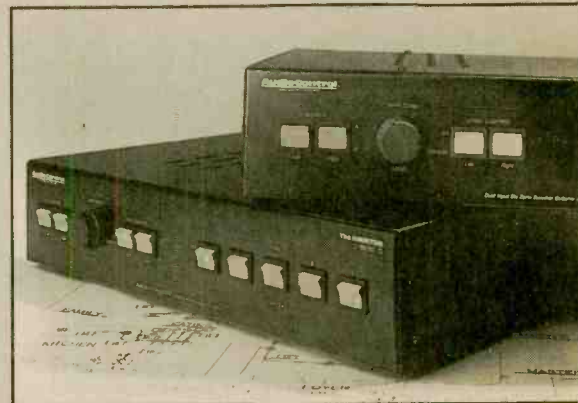

AudioControl Speaker Switcher



Ace 2000-Channel Scanner

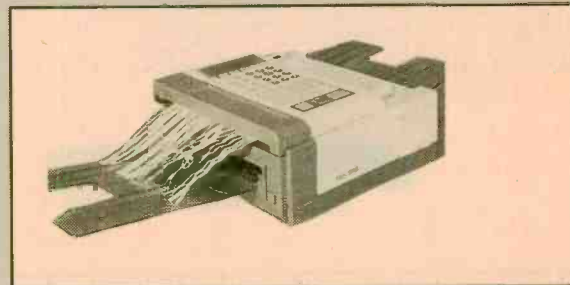

Fax/Shredder Combo

ELECTRONICS WISH LIST

For more information on any product in this section, circle the appropriate number on the Free Information Card.

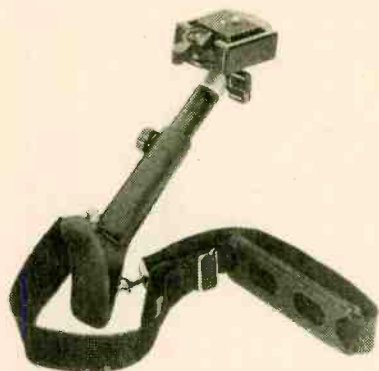

Ambico Camcorder Holder

Camcorder "Chest Pod"

Those who have trouble keeping their ultra-compact camcorders steady might want to check out *Ambico, Inc.*'s (50 Maple Street, Norwood, NJ 07648) model *V-0515 Chest Pod*. The accessory provides stability by bracing the camcorder securely and comfortably against the user's chest. It can be adjusted to different height levels, and a quick-release mount makes it easy to attach and detach the camcorder. Price: \$29.95.

CIRCLE 65 ON FREE INFORMATION CARD

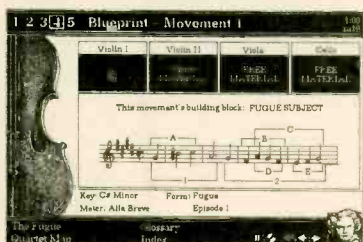

Interactive Multimedia CD

Interactive Multimedia CD

IMCD's, or interactive multimedia compact discs, provide the listener with a computerized verbal and visual encyclopedia to accompany the music. A new edition to *Warner New Media's* (3500 Olive Avenue, Burbank, CA 91505) "Audio Notes" series of computer-enhanced CD-ROM musical presentations is *Beethoven's String Quartet No. 14*, a comprehensive presentation of that highly influential piece and of the entire subject of chamber music. The IMCD features the complete 39-minute string quartet produced by Wolfgang Mohr with the Vermeer Quartet, enhanced by 34 minutes of additional audio, thousands of pictures, commentaries, analysis, historical data, and glossary and index entries—all interactively accessible with a Macintosh computer. The disc requires an Apple Macintosh Plus (or later), an AppleCD SC ROM (or compatible) drive, HyperCard 1.2.2 or later, and speakers. Price: \$66.

CIRCLE 66 ON FREE INFORMATION CARD



Magnavox TV/VCR Combo

Magnavox TV/VCR Combo

Not everyone has the space for a dedicated "media room." Those with less-than-spacious living quarters—or an inherent aversion to wires—comprise the bulk of the combination-TV/VCR market at which *Philips Consumer Electronics Company* (One Philips Drive, Knoxville, TN 37914-1810) is aiming its *Magnavox CRL191*. A 28-function unified remote controls the VCR and the 19-inch monitor. It offers 155-channel digital quartz auto-scan tuning, six-event/two-week on-screen programming, two-way latching/high-speed forward/reverse search, and one-touch recording. The CRL191 provides a built-in 5 × 3-inch speaker, an earphone jack, and audio/video input/output jacks. Price: \$749.95.

CIRCLE 67 ON FREE INFORMATION CARD



dbx Graphic Equalizer

Single-Rack Graphic Equalizer

The model *1531X* professional graphic equalizer from *dbx Professional Products* (Division of AKG Acoustics, Inc., 1525 Alvarado Street, San Leandro, CA 94577) features switchable dual 15-band, or mono 31-band, operation and selectable hi-pass filters. It can be configured for either single-channel 1/3-octave or dual-channel 2/3-octave use, and offers symmetrical peak/dip combining filters on ISO centers. Front-panel configuration switches allow bypass, selection of fader throw between ± 15 dB and ± 7.5 dB, and high-pass filter in/out with turnover at 20, 60, or 120 Hz. Professional net price: \$399.

CIRCLE 68 ON FREE INFORMATION CARD



If selecting a required resistor solely by color code is giving you headaches, or if you simply don't know the code well enough to use it accurately, check out Sure-luck Ohms—the easy-to-build color-code sleuth!

About The Circuit. The schematic diagram for Sure-luck Ohms is shown in Fig. 1. The circuit is little more than a well-thought-out switching arrangement—built around three single-pole 10-position (SP10T) rotary switches—that are used to decipher the resistor color code that's stamped in the unit's body. To operate Sure-luck Ohms, the three switches are rotated to match the resistor's three colors. A pushbutton READ switch is then used to apply power to the circuit, and light the proper LED's to indicate the resistor's value. In between the switches and LED's is a bit of "diode-transistor logic" that turns on a flashing decimal point LED, the ohm LED, the k, or the M LED as required.

The function of S1 is the simplest of the three selector switches. When S1 is pressed, battery power is applied through a 470-ohm current-limiting resistor and the wiper of S1 to the selected LED to indicate the first digit of the resistor's value.

The second rotary switch, S2, selects the LED for the resistor's second digit. The first position on all switches is marked black indicating a zero. Since S1 selects the resistor's first digit, a zero LED isn't needed, but in the second and third digit, the zero is necessary. If a resistor has a color code of brown-black-red, S1 will be in the brown (number 1) position and the S2 will be in the black (zero) position, and S3 will be in the red (number 2) position. But for the circuit to show a reading of 1k, the zero LED for the second digit must not light. That's where Q1 and D1–D3 come into play.

The wiper of S3 connects the 9-volt bus to the number-2 (red) position and on to the base of Q1 through D1. That turns Q1 on, clamping the voltage across the zero LED to ground, keeping it from lighting. The positive voltage at position 2 of S3 also supplies current

Build "Sure-Luck" Ohms

BY CHARLES D. RAKES

Do you experience the "color-code blues" every time you search through your junkbox for a resistor? And do you make like a magician and vanish when a color-code question comes your way? Have you tried to teach a budding electronic enthusiast the resistor color code without resorting to some off-color memory scheme? If so build our *Sure-luck Ohms* color-code decoder and never ever again suffer from those resistor color-code blues.

Why, might you ask, should I go to the trouble of building an electronic gadget to read resistor color-code values when I can use a chart or color-code wheel? For one thing our Sure-luck Ohms is easier to read and the resistor values are indicated in ohms, k ohms, and meg ohms without showing

all of those zeros that complicate the process when using a chart or wheel. If you can read numbers from 0 to 9 and know that "k" is the prefix for 1000, and "M" is the prefix for 1,000,000, you will not have any problem converting the colors on a resistor into a resistance value.

Take a look at any construction project, in this publication and most others, and you will find in the parts list and on the schematic diagram that the resistor values are usually shown in their shortest possible form. A two-thousand-two-hundred ohm resistor (2,200) will be shortened to read 2.2k and a two-million-two-hundred-thousand ohm resistor (2,200,000) will read 2.2 megohms. And that's what the circuitry in Sure-luck Ohms does to make decoding the color code on a resistor's body a snap.

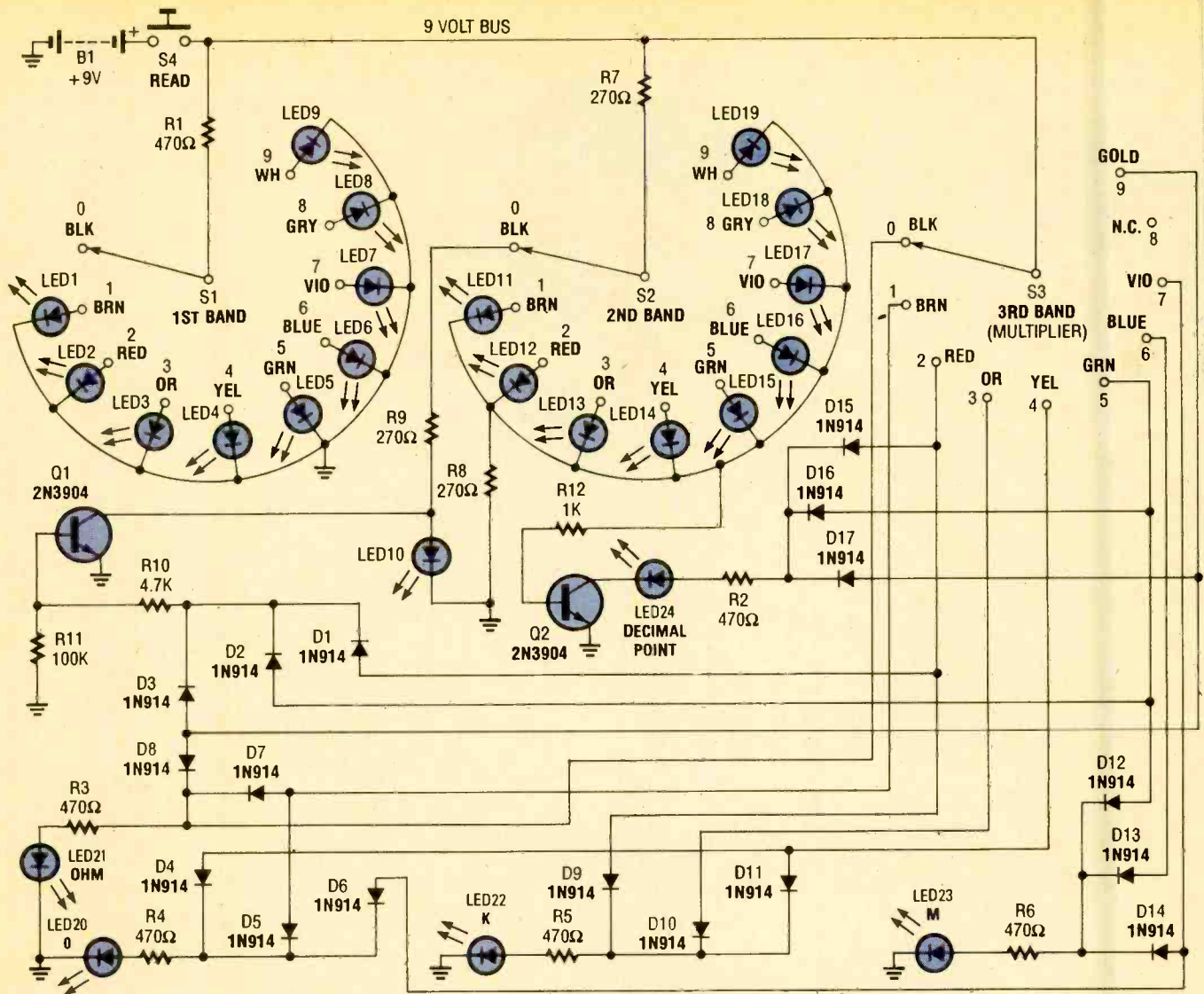

Fig. 1. Sure-luck Ohms is little more than a well-thought-out switching arrangement—comprised of three single-pole 10-position (SPIOT) rotary switches—and LED's to decipher the resistor color code that's stamped on a resistor's body.

through D9 to turn on the OHM LED. Of course the READ switch must be activated for the LED's to light.

If the resistor had been a 1.5k (brown-green-red) instead of a 1k, the wiper of S2 would be on the number 5 (green) position. Current would then flow through R7, LED15, R8, R12, and the base-emitter junction of Q2, turning it on and bringing the cathode of LED24 to ground. The wiper of S3 supplies a 9-volt source to its number-2 (red) position and on through D15, R2, and on to light the blinking, decimal-point indicator LED24.

The third zero (LED20), as well as the k (LED22) and M (LED23) indicators, are controlled by switch S3 and their simple diode logic.

Construction. In the author's unit, the majority of the components are circuit-board mounted and housed in a 6 1/4 x

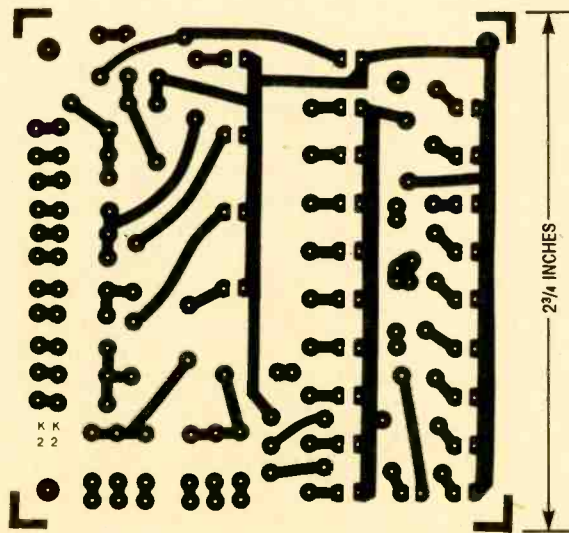

Fig. 2. To simplify assembly and reduce the possibility of error, printed-circuit construction is recommended. Here's a template for the circuit-board layout used by the author.

3 3/4 x 1 5/16-inch plastic cabinet. The circuit is by no means complicated or critical, and can be built breadboard style if you wish. However, to simplify

assembly and reduce the possibility of error, printed-circuit construction is recommended. Figure 2 shows a template for the printed-circuit layout used by the

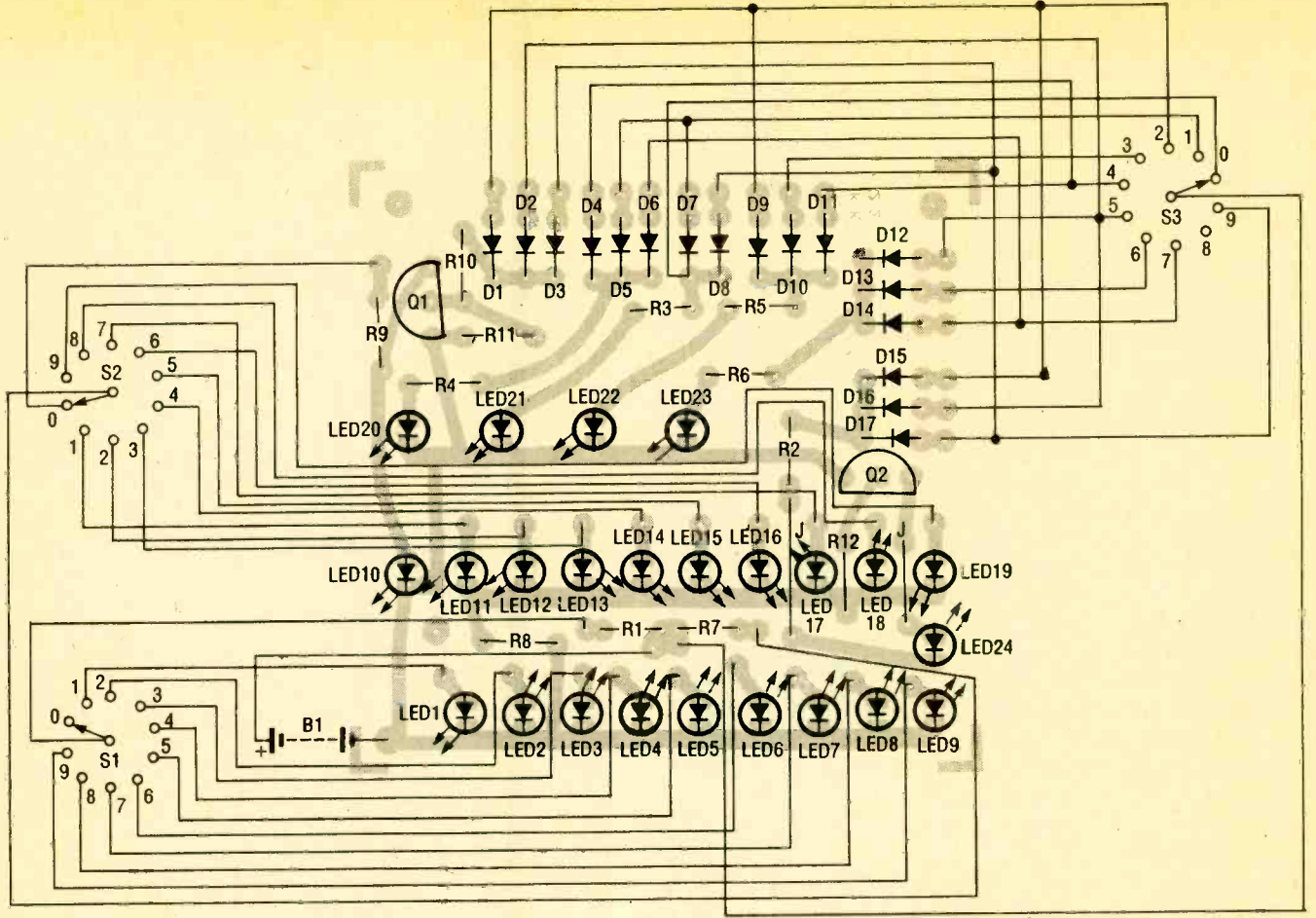
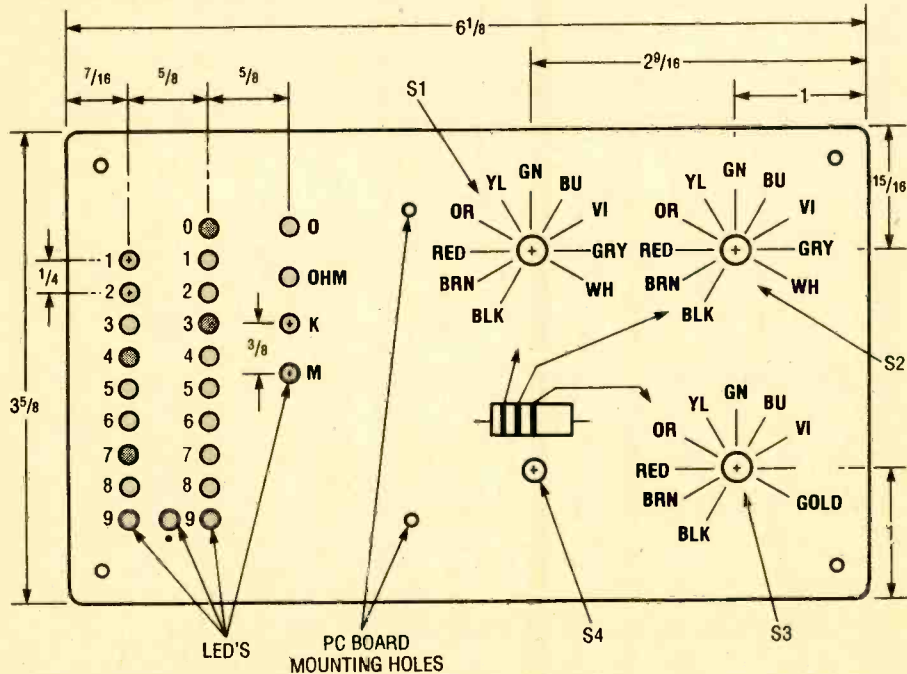

Fig. 3. Assemble the printed-circuit board using this illustration as a guide. When mounting the components to the board, be sure that the polarized parts (diodes and LED's) are properly oriented.



ALL DIMENSIONS IN INCHES

Fig. 4. Once the board has been assembled, prepare the front panel of the enclosure using this layout as a guide. Note that the front panel of the enclosure has 24 holes spaced to match the LED's mounted on the board.

using Fig. 3 as a guide. When mounting the components to the board be sure to orient the polarized parts (diodes and LED's) as shown. Note that all the LED's, except LED24, are mounted with their cathodes facing the left edge of the board. Also note that the cathodes of all of the LED's in row 1 and all but one in row 2 are common. The anode of LED24 is facing the left edge of the circuit board.

If you want to save a dollar, you can substitute a regular LED for the flashing unit used for the decimal point, LED24. All 17 of the 1N914 diodes are mounted on the board with their anodes connected to the pads that are located along the outside rim of the printed-circuit board. A jumper from the cathodes of D7 and D8 to S3 position zero (0) will have to be added for the OHM LED to light when decoding resistor values of 100 ohms and less. There's no hole in the circuit board for that jumper so just tack a wire on the back side of the board at the junction of R3, D7, and D8. Also note that there are two additional short jumpers on the board.

author. Regardless of the method of construction taken, you should be able to build your own for under \$20, or even

less if you maintain a well stocked junkbox. Assemble the printed-circuit board

Using color-coded wiring between the board and the switches will help
(Continued on page 97)

There have been many hints that a dominant biological force is responsible for our creation. To lend credence to that theory we now have some evidence, provided by the techniques of remote astrobio-logical-image sensing (RAIS for short), that the human form or "likeness" may indeed be typical of all intelligent life in space. Before we discuss the evidence, we should explain the technology involved.

Not to be confused with radio astronomy, RAIS is made possible with "biosensors." The data they produce is called a "signature plate" or "biogram." These deep-space scans are conducted from uninhabited desert regions at night to safeguard the equipment against electro-magnetic interference. Encompassing 18 years of research, this article will profile the general aspects of RAIS and show the evolution of its equipment. Literature and patent references are provided in a boxed text for experimenters desiring to make their own contributions to this promising field.

Biosensors. Biosensors, also known as biological transducers, emerged from general research in chemistry, biology, and electronics. Basic sensors are comprised of biologically sensitive materials such as an enzyme, antibody, organelle, bacterial or other cell, sections of plant or animal tissue, or proprietary substrates capable of converting a biochemical signal into an electrical signal. Such a material can be sensitized to render an electronic signal in the presence of external fields and forces. The signal(s) can be detected, taped, and further processed by conventional means.

One of the easiest biosensors to make is the quartz type, as shown in Fig. 1. There, a 10-MHz AT-cut crystal is used in an oscillator circuit driven by U2, a SN74122N. The crystal itself is housed in a protective Faraday chamber and the organic substance is bonded to one side of the crystal plate.

If the sensory substance is exposed to, say, a gas capable of acting on it, the absorption of the gas will cause a change in the oscillator's frequency. Sensors of this type are able to detect gas at ultra-low (part-per-billion or part-per-trillion) concentrations, an ability which equals the sensitivity of a dog's nose.

Aside from astronomical applications, the quartz-crystal technique has

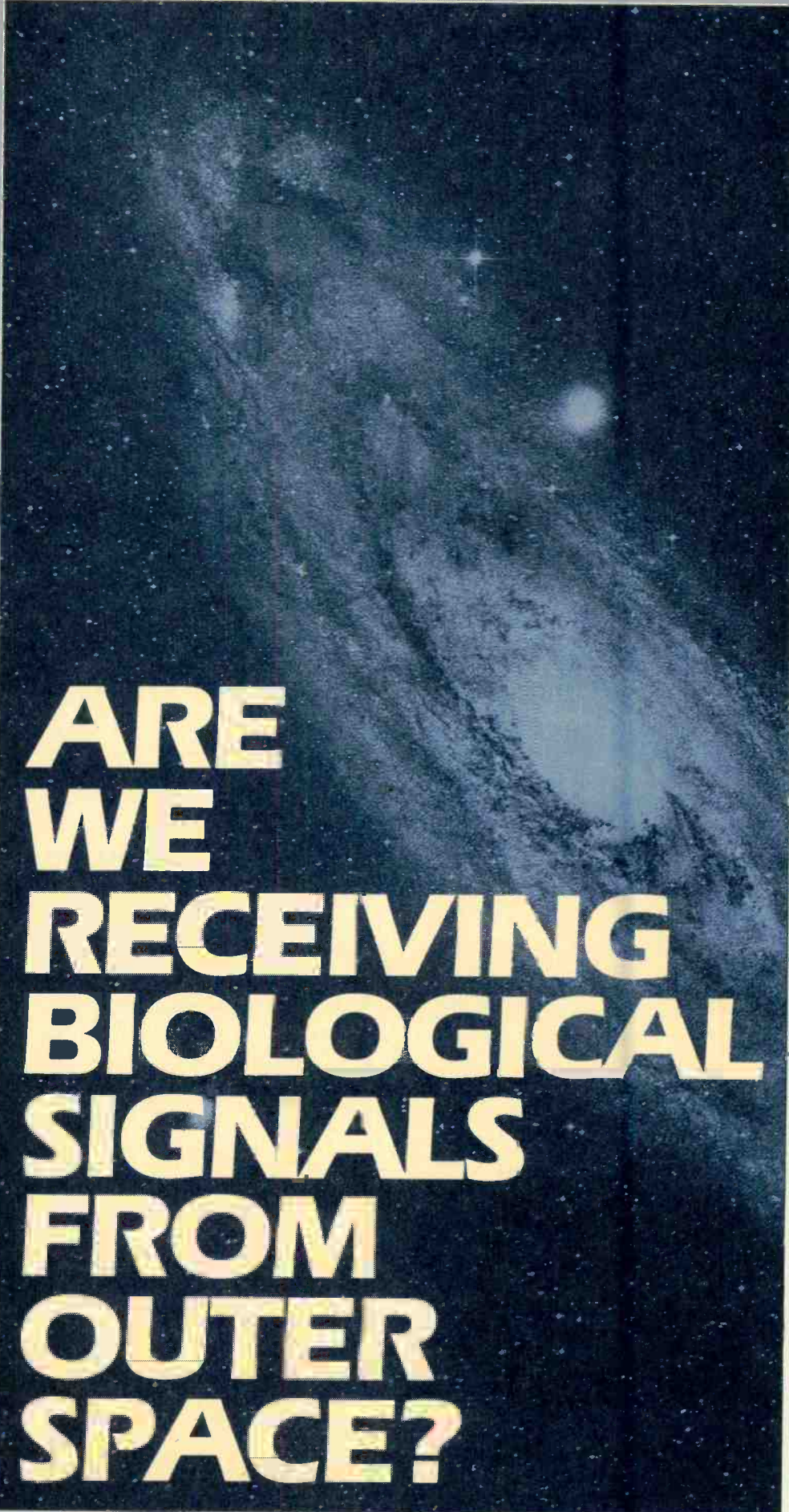

ARE WE RECEIVING BIOLOGICAL SIGNALS FROM OUTER SPACE?



Is there intelligent life elsewhere in the universe, and if so, what form does it take? Some new evidence points to some surprising, yet familiar, answers.

BY
L. GEORGE LAWRENCE

proven exceptionally useful for an assay of substrates: formaldehyde in the air can be detected with formaldehyde dehydrogenase, contraband drugs can be detected with cocaine or morphine antibodies, etc. In all of these instances, the key for inducing changes in crystals is the use of highly reactive organic materials. The crystal plates must be washed prior to use. See the patents mentioned in the boxed text for information on sample preparation.

Living biosensors containing active cells have special properties. The membranes of most cells act as insulators at low electrical frequencies. Currents will flow around them, but not through them. Between 1 kHz and 100 kHz, the impedance of a single suspension of cells drops quite sharply to a lower value. The impedance of the living cytoplasm may then be represented as a resistivity, expressed in ohms/cm.

The most impressive aspect of cell resistivity is the similarity from one cell type to another. Egg cells, plant cells, animal cells, and nerve axons all overlap in their electrical constants. It is only by means of judicious catalyzation and excitation that a particular function can be established for a sensor.

Figure 2 shows a basic arrangement for image acquisition. The biosensor is placed in a shielding Faraday chamber. Any arising signals are amplified and fed into the modulator. Functioning in an AM mode to secure strong carrier modulation, the signal then enters the line amplifier for final processing and transcription.

The photos show the actual field instruments. Figure 3 depicts the signal-processing operations required. The building blocks shown can be arranged and combined in various degrees of sophistication.

Background. The initial discovery of biological signals of galactic origin dates back to 1971. Accidental and unexpected, the discovery transpired during ecological remote-sensing research at Oak Grove Park, California, then using experimental organic semiconductors as primary-event transducers.

First apparent as a strange sequence of audio modulations, which were recorded on tape, the signals or induced continuum modulations (ICM's) reached the ecological field station from astronomical coordinates 10h

40m right ascension, +56° north declination. It placed the source in the Ursa Major sector and eventually directed attention to a large number of galaxies in the vicinity of Phecda, one of the Big Dipper's most prominent stars. Over a period of years, investigations shifted toward reasonably close galaxies such as Andromeda and its companions, the elliptical galaxies M32 and NGC 205. The local Milky Way system was explored as well.

It was during these decade-long operations that the nocturnal data tapes began to reveal discrete intensity modulations, which implied the presence of coherent visual information.

Most startling were the long time intervals of 2 minutes or more, plus the absence of sync information as we understand it. It would appear that an entire image was transmitted at once, similar to a picture produced by a film projector. Like a film projector's imagery, the pictures expand as they travel through space. The propagation width of the biological pictures are enormous—truly astronomical! These observations and others led to the conclusion that the source is at some cosmological distance from us, and that the images are not a purely natural phenomenon.

Astronomical Systems. Astronomy, as other disciplines, has its own vocabulary of words and phrases with precise technical definitions. However, its terminology is less complex than computer jargon. It is necessary to use a little astronomical vocabulary to describe the mechanical functioning of blogram apparatus. Don't let the new words throw you, we just want to give you a feeling of the large number of factors the designer of such machines must take into account.

Our galactic system is a member of many systems occupying an ellipsoidal volume of space. Our system is near one end, Messier 31 (the Andromeda galaxy) is at the other. Surveys by astronomers Shapley and Adams at Harvard Observatory of the 1,025 bright extragalactic systems has made the distribution of these bodies apparent.

To capture and lock onto a single target, it is necessary that telescope systems can automatically track the object and overcome the effects of the Earth's motion. A stationary, non-tracking telescope would only obtain circumpolar star trails—streaks in the film from the motion of the Earth. It is ob-

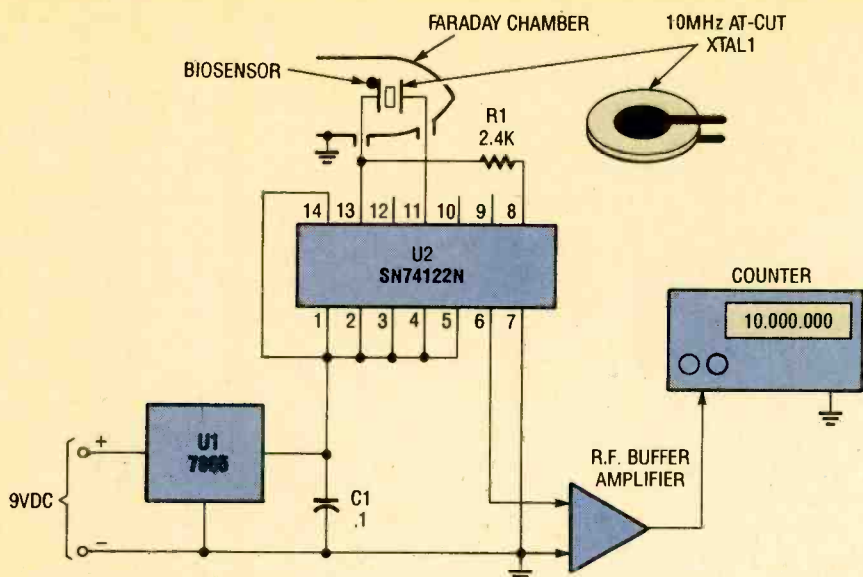

Fig. 1. This is a quartz-crystal biosensor assembly complete with oscillator and AT-cut quartz plate. Changes in the biosensor affect the operating frequency and thus the counter readout.

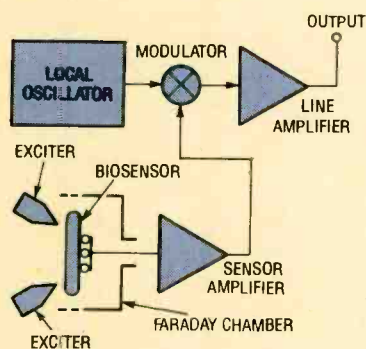

Fig. 2. A cell-type biosensor assembly beats the biological signals with a local carrier oscillator via a modulator.

vious that no viable galactic phenomena can be captured and recorded with such a device.

A tracking telescope must take into account right ascension and declination, the ecliptic, the galactic center, and the vernal and autumnal equinoxes for setting sidereal time (star time). Figure 4 shows some of these mandatory astronomical elements. Note that half of the celestial equator is above the horizon. Northward, the daily courses of the stars come up more and more over the horizon until they are entirely above it. Southward from the celestial equator, they are depressed more and more until they disappear completely. The vernal equinox (0h right ascension, 0° declination) is the point where the sun crosses the celestial equator on its way north, about March 21st. The autumnal equinox (12h right ascension, 0° declination) is the

point where the sun crosses the celestial equator on its way south, about September 21st. The sidereal day is about 3m 56s shorter than the solar day. The sidereal day ends when the Earth has made a complete rotation, bringing the vernal equinox again to upper transit. For those interested in astronomy, electronic clocks are available that produce a concise sidereal time-display.

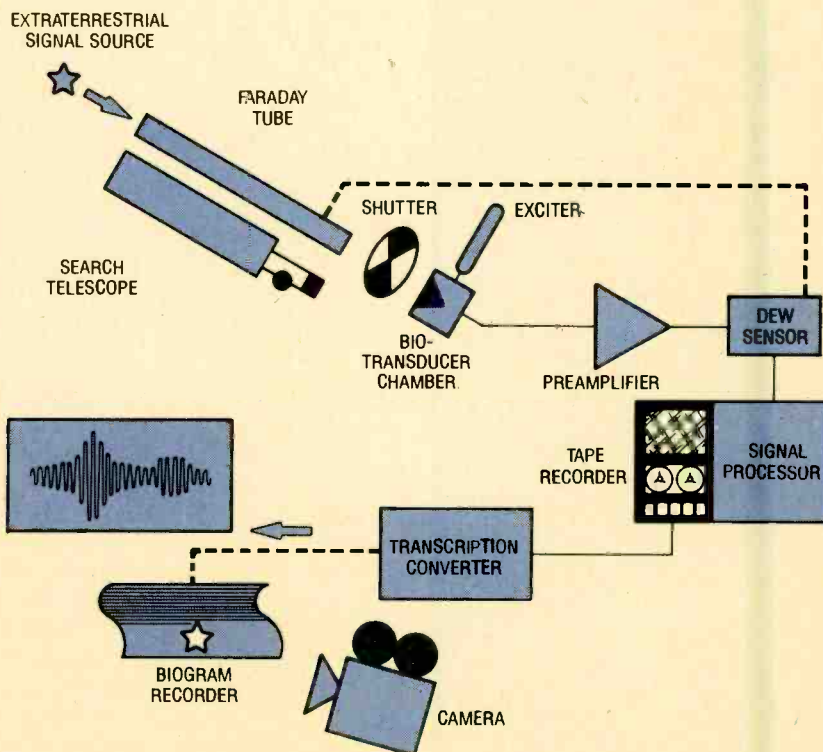

Fig. 3. This represents the data flow of a biogram field unit. The Biogram is recorded in helical-scan mode.

Past and Current Systems. As was mentioned, a telescopic system must have the ability to track stars. Practically any solid, motor-driven mount suffices for astrobiological-image acquisition. However, large drives and mounts of the alt-azimuth type are required if the biosensor complex must be combined with a radiotelescope for detecting incident electromagnetic interference.

Such a system was constructed in 1973 and operated for one year. The instrument confirmed the existence of biological signals as a new, non-electromagnetic reality. It also provided other insights which, in time, permitted the construction of a variety of portable field systems for desert use. The apparatus had a skirted radiotelescope with three biosensors, one of which is in the black QRB field holding the Faraday tube. A dust shroud kept the internal antenna and electronics clean. Pre-amplifiers, feeders, and auxiliaries were mounted on the telescope body.

One of the more recent equipment systems is a highly flexible search telescope adapted for biological sensing. The machine is largely all-electronic in terms of telescope operations, including tracking at both solar and sidereal rates of speed. The Faraday tube with its biological complex is mounted on the top. The motor-driven shutter aids in the

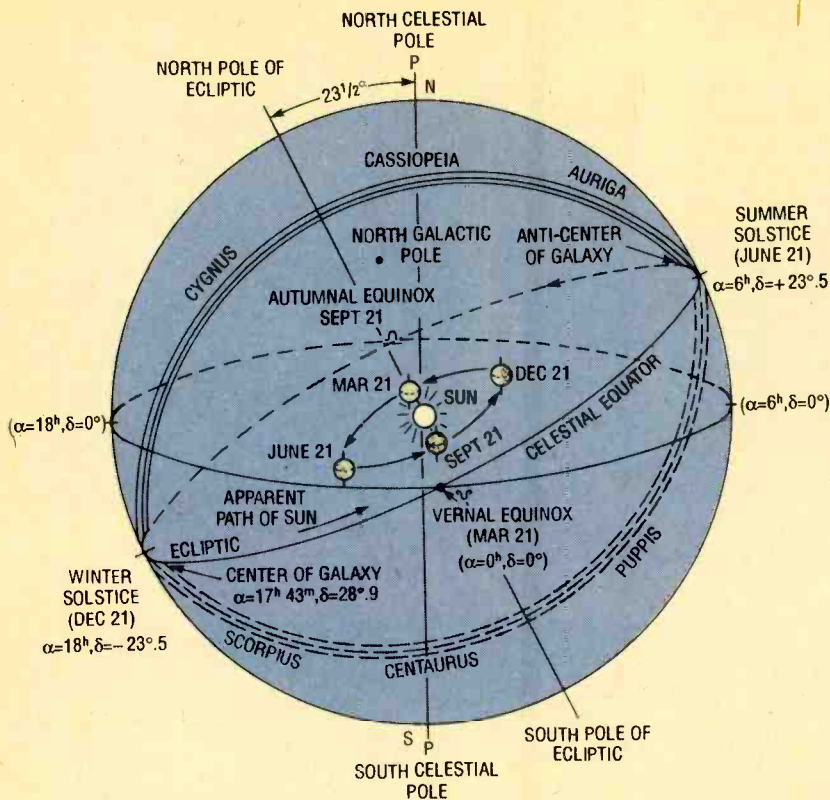

Fig. 4. All the aspects of the ecliptic system must be taken into account when tracking an astronomical body.

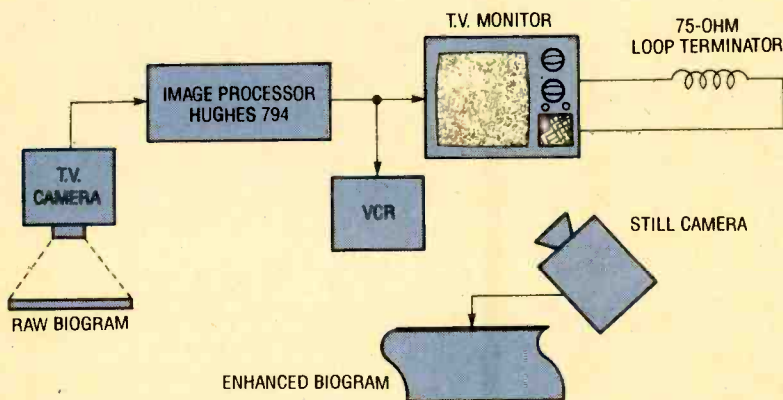

Fig. 5. This biogram image-enhancement system uses a Hughes Model 794 Processor to clarify incoming pictures.

detection of incident electromagnetic interference, which may cause sharp undulations in the biological signal train. The shutter eliminated the need for a heavy radiotelescope.

The unit was also equipped with television gear for pictorial extensions and video recording. It is hoped that, in time, moving renditions of biological images can be obtained. Much hinges on the quality of the biological substrates and on the ability of SuBiCon's (summing biological-image converters) to operate under various forms of

excitation using the traditional NTSC television format. Respective research is in progress.

It was by means of such and related equipment systems that the first few biograms could be recorded over a period of years. Image enhancement, has greatly assisted their evaluation.

Image Enhancement. Basically, image enhancement is a process whereby signature plates such as photographs and/or pictorial biograms are converted into digital information. The

process provides a high degree of heretofore unobtainable resolution.

Typically, a small area on a given plate is scanned with a microdensitometer and evaluated in terms of image density. The readings may be spaced only .015 to .05 millimeters apart. Each density number (DN) is then recorded as an 8- or 10-bit binary number. In the case of 8-bit data, for example, each DN records one of 256 levels of brightness numbered from 0 to 255, which is the value of the highest 8-bit binary number, 1111111. Pure black is equal to a DN of zero, while the highest DN (say, 255) is set at white. Gray tones result in intermediate DN's. That generates an immense amount of data. A 3 cm² portion of a plate may yield as much as 1,000,000 values. The digitized image is then reconstructed for video or photographic recording, or viewing via a monitor. Figure 5 shows a block diagram of the standard processing steps.

The biograms shown in Figs. 6-9 were image-enhanced with the Hughes Model 794 Television-Image Processor. The instrument's 16-bit memory provided up to 256 frames of image integration. The biogram's original grey level image was processed at 640 x 482 x 8 bits. Recursive filtering was used to improve signal-to-noise ratios.

The photos show the complete interception of a biogram from beginning through final image enhancement as follows: After having recorded countless blanks during thousands of desert nights, an image begins to form on the left-hand side of the frame (Fig. 6). Its enormous size is startling. Figure 7 shows a large white form with a smaller satellite image emerging (20 minutes have passed at this point). In Fig. 8 the large white image and satellite image have resolved into distinct, coherent forms. The data for the right-hand section of Fig. 8 was subjected to integration, continuous image-frame subtraction, and grey-level enhancement. Figure 9 shows the enhanced biogram's final appearance. That the biogram would indicate a glorious relief was totally unexpected. And so human an arm and form, yet big! It gave rise to cosmological reviews.

Biological Cosmology. In an important field such as this, it goes without gainsaying that no progressive course can be charted without a map. That map is an understanding of the dynamics of biological cosmology. We

Literature and Patents.

Charge and Field Effects in Bio-systems, by W.J. Aston, Abacus Press, Turnbridge, UK, 1984, pp. 491-498.

Electrophysiological Methods in Biological Research, by J. Bures, Academic Press, N.Y., 1967.

Organic Semiconductors, by F. Gutmann and L.E. Lyons, Wiley, N.Y., 1967.

"Biosensors," by C.R. Lowe, *Trends in Biotechnology*, Elsevier, Amsterdam, 2:3, 1984, pp. 59-65.

Biosensors: Fundamentals and Applications, by A.F.P. Turner, Oxford Univ. Press, Oxford, UK, 1987.

Sensor Having Piezoelectric Crystal for Microgravimetric Immunoassays, U. S. Patent 4,735,906, G.J. Bastiaans, April 5, 1988

Immunoassay For Antigens, U. S. Patent 4,242,096, Oliveira, R.J. and S.F. Silver, December 30, 1980

Sandwich Immunoassay Using Piezoelectric Oscillator. U.S. Patent 4,314,821, T.K. Rice, February 9, 1982

need to determine the fundamental principles that define how life emerges and the shape it takes. Such studies are not an esoteric exercise, but vital to instrumentation development.

Historically, physics and chemistry have come to an almost complete union in their understanding of the structure of matter. By contrast, biology deals with structures of an infinitely more complicated type. Thus the laws that govern their design are more complex.

Take, for example, an experimental biosensor substrate shown in Fig. 10. Section A is the root of a Jerusalem artichoke; section B is the root of asparagus. Both items have a profound similarity, but that is due to their function rather than some universal law. Obviously the forces at play here must be handled with greater caution than processes of mechanical physics, chemistry, or electronics.

Nobel laureate Niels Bohr described this situation by saying that in biology, one is concerned with manifestations of possibilities. But where are the universal constants—the characteristic quantities—to support said possibilities? Universal constants determine the scale of nature. The velocity of light is one constant, Plank's constant is another. But judging from the immensity of our biograms, there must exist a third constant for purely dimensional purposes.

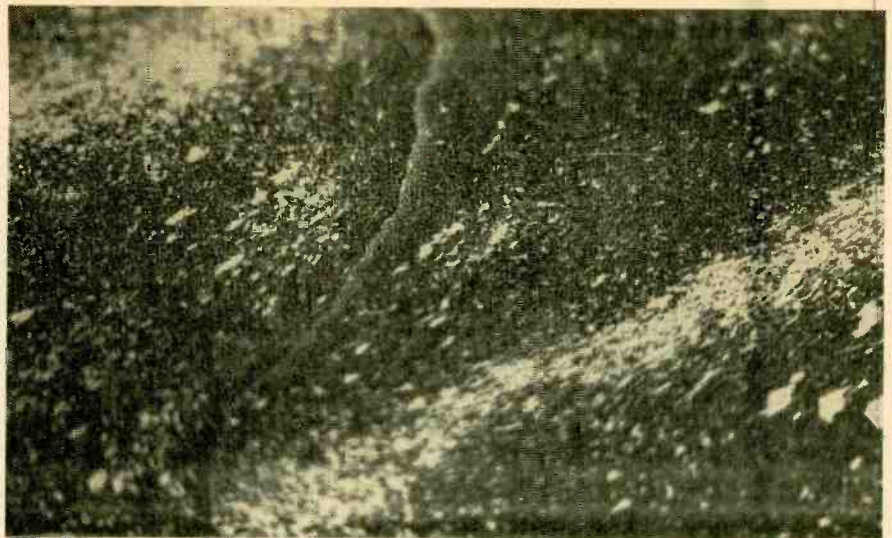
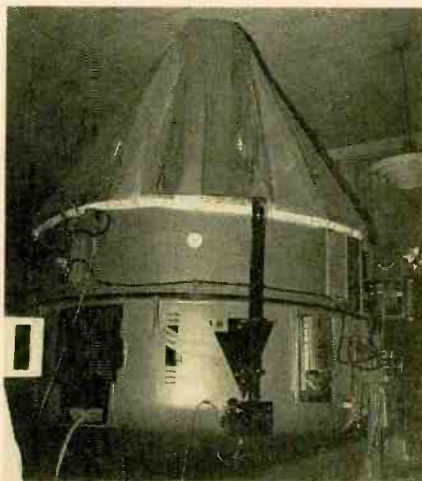

Fig. 6. The biogram shows the commencement of a biological image transmission. The image begins to form at upper left-hand side of the frame.



Fig. 7. The biogram shows a narrowing and intensification of the inflage. A white form with a satellite image begins to emerge.



This is a biosensor assembly (used from 1973 to 1974) combined with skirted radio-telescope for detection of electromagnetic interference. A dust shroud protects the internal parts.

While searching for constants, some researchers have tried to set forth new cosmological principles involving the phenomenon of time, which is observed but not fully understood. Others have suggested that we simply live in so-called "privileged time" in which the special conditions that are benevolent for the evolution of biological life exist. But was time created at the moment of the big bang? Was there a biological precursor that initiated the big bang? Deep waters, these!

Who and Why? Today we must wonder if such transmissions over vast astronomical distances are the preferred mode of communication between advanced cultures in space. Of the four main classes of civilization, there are two types that could have acquired

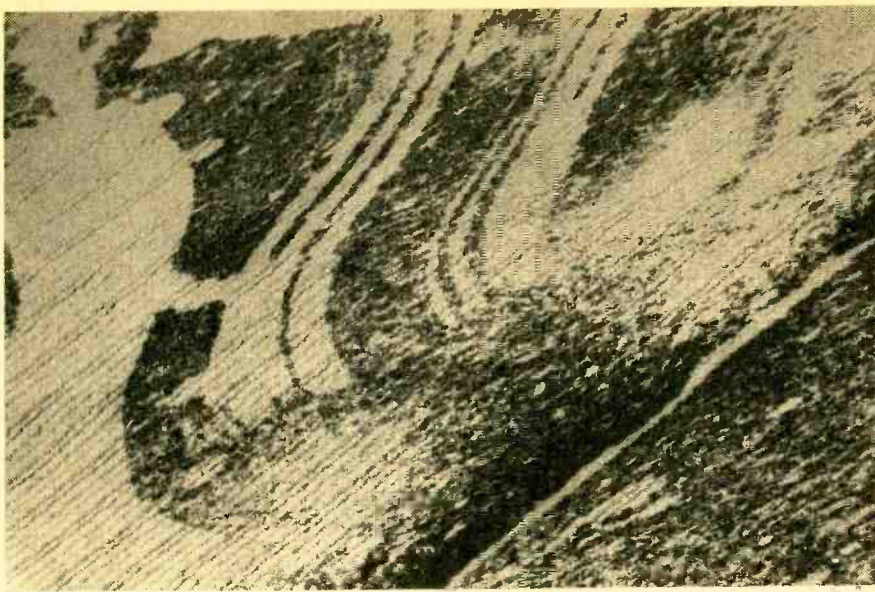

Fig. 8. The image clears into a coherent form. The right-hand section was subjected to image enhancement using $640 \times 482 \times 8$ bits.

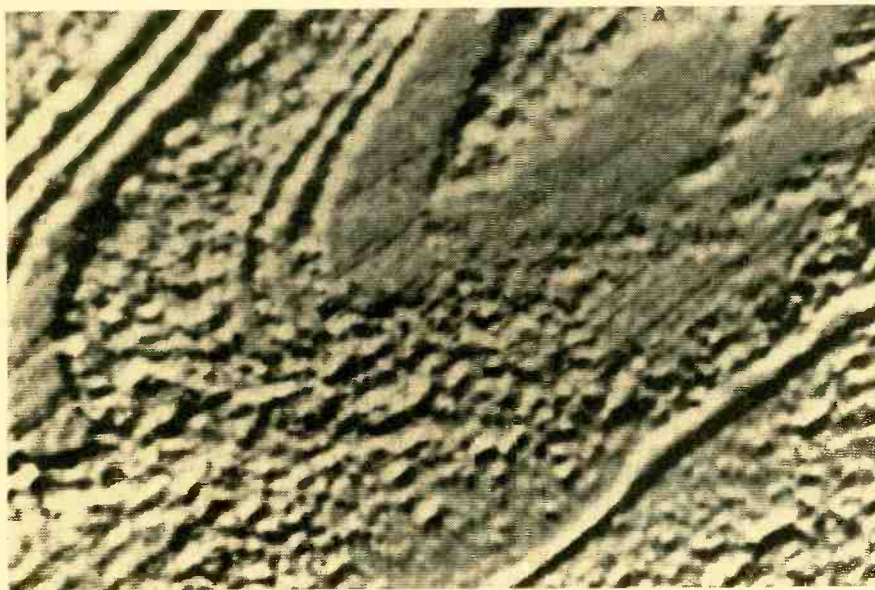

Fig. 9. This is the fully enhanced biogram. An unexpected form has emerged in relief.

such an advanced technology: The "type-1 civilization" as it is called, would also be capable of interstellar and intergalactic travel, be immortal, and have missionary objectives. The "type-2 civilization" would only be capable of interstellar travel using fusion power with the gravity problem solved. Such beings would be regarded as "Gods of renown" by underdeveloped cultures.

The other two basic types reflect our own *status quo*: The "type-3 civilization" has electricity, basic creature comforts, is close to having fusion power, performs marginal interplanetary travel, but also has polluting industries, no gravity technology, and cancer. The "type-4 civilization" is primitive. It has basic tools, and fire, but no written lan-



This is an electronically controlled search telescope with top-mounted biosensor assembly. The Faraday tube is shuttered to prevent electromagnetic interference.

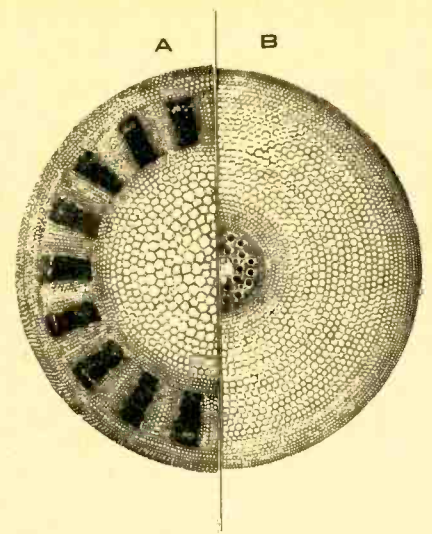

Fig. 10. These experimental biosensor substrates are taken from the root of a Jerusalem artichoke (A), and the root of an asparagus plant (B).

guage. Eidetic imagery dominates the spiritual life of such peoples.

Thus, then, only another type-3 civilization would have a technology similar to our own. Type-3 radio astronomers would know the precession frequency of neutral hydrogen (1.42 GHz) and frequency of the hydrogen radical (1.662 GHz). They would believe that interstellar communication is conducted at these universal constants—because that's the way we understand it.

Unfortunately, throughout its 58-year-long history, radio astronomy has failed to detect one single, non-Gaussian signal from space. That's not surprising since truly advanced type-1 or type-2 civilizations are likely to have transcended electromagnetic communication altogether and would not step backwards just to accommodate scientifically underdeveloped cultures.

And so, if all of this is taken together, a totally new universe of technical possibilities unfolds before us. That biology holds the key to those communications should come as no surprise.

However, no matter what you might believe, biosensing is an exciting field. The secret ingredient is time. The deep-space image searches require great patience and the equipment must be frequently updated to suit arising technical and environmental situations. Emphasis is placed on electrophysiological phenomenon and technology, which come from the medical sector. The references provided in the boxed text should aid you in your own study of the field.

So you've just finished that special project and you are proud of the way it works, but it has an odd size printed-circuit board and now you need an enclosure in which to house it. Since you've spent a lot of time designing and building the project, you want an enclosure that will dress up its appearance. Leafing through parts catalogs you turn up a variety of enclosures—some that are either too long, some too wide, others too tall, or too expensive.

Under most circumstance, you usually have to settle for a larger enclosure that fits your project like a marble fits in a shoe box—oh well, at least its within your budget. But have you ever thought about producing your own custom-fitted project enclosure? Such an enclosure can add a lot of eye appeal to your project.

What's Needed. Making your own plastic enclosures can be just as enjoyable as building the project itself, and doing so is easier than you may think. The three ingredients that go into producing your own enclosure are the materials (plastic-sheet stock), the tools (basically, a few wood working tools),

*Dress up your favorite
electronic project
by designing
and building
a customized plastic
enclosure that
will fit it
like a glove*

BY WALTER W. SCHOPP

Build Your Own Custom Cases

and the "know how" (which we'll supply). The plastic-sheet stock needed to produce small enclosures is fairly inexpensive and easy to find. Checking the yellow pages of the phone book will turn up retail plastic-supply stores that will even cut your pieces to size. Many stores will even make your enclosure for you, for an additional charge.

The plastic-sheet stock comes in all thicknesses and colors. It also comes in rods, square bars, and tubing of all sizes. Acrylic cement and applicators, special drills, and just about anything else you'll need to work with plastics are usually available at the plastic-supply house, and many of them even provide a catalog of stocked items.

Few tools are needed for working with plastics and you may even have them already. A small table saw with the correct blade is a basic tool needed for cutting plastic sheet stock. In order to cut plastic smooth enough for joining, a special blade is required. An 8- or 8½-inch carbide, fine-tooth blade with a minimum of 60-teeth per inch is needed. The blade should have all the teeth evenly spaced with little or no set. Such blades are often used for cutting aluminum or copper and can be found in most hardware or tool-supply stores.

The rest of the tools needed are minimal; small coarse and fine flat files and some medium-grade sand paper.

What Size Enclosure? The most rudimentary element of enclosure fabrication is knowing what size enclosure is required. It may seem silly to make such a point, but a great deal of plastic can be turned into scrap by ignoring that simple principle. A basic enclosure consists of six parts: the top and bottom, and two sides and two ends. The sides and ends (as shown in Fig. 1) are glued to the bottom, and the top is removable.

A simple but effective way to determine the length and width of the enclosure is to take the size of your printed-circuit board, add to that the thickness of the two sides and end pieces plus the clearance needed for the additional plastic parts used for attaching the lid to the enclosure (more on that later). That gives you the overall size of the top and bottom pieces. The side and end pieces are cut to the height, as determined by the parts to be housed, needed for your project. Be sure to allow ample space for any off-

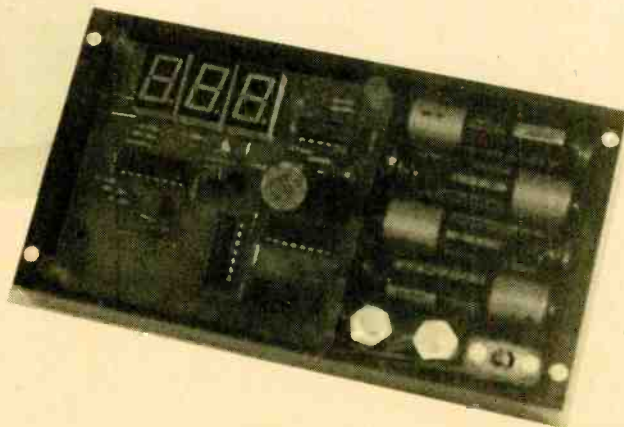
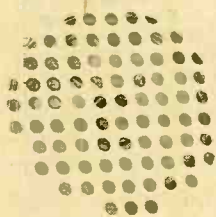

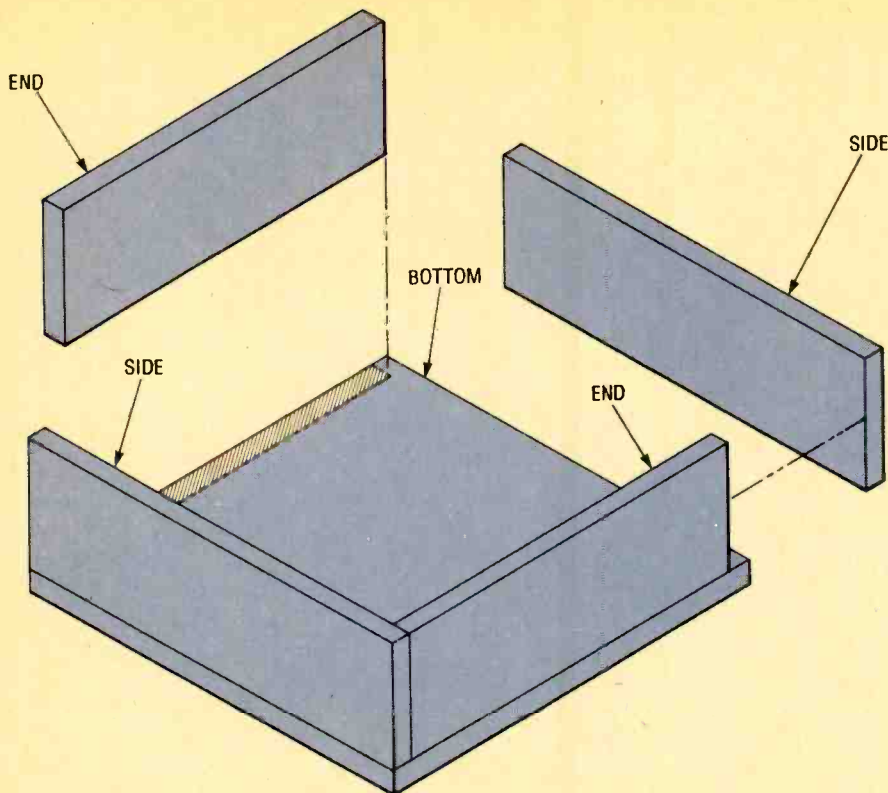

Fig. 1. A simple enclosure consists of six parts: a removable top and a stationary bottom, two sides, and two ends.

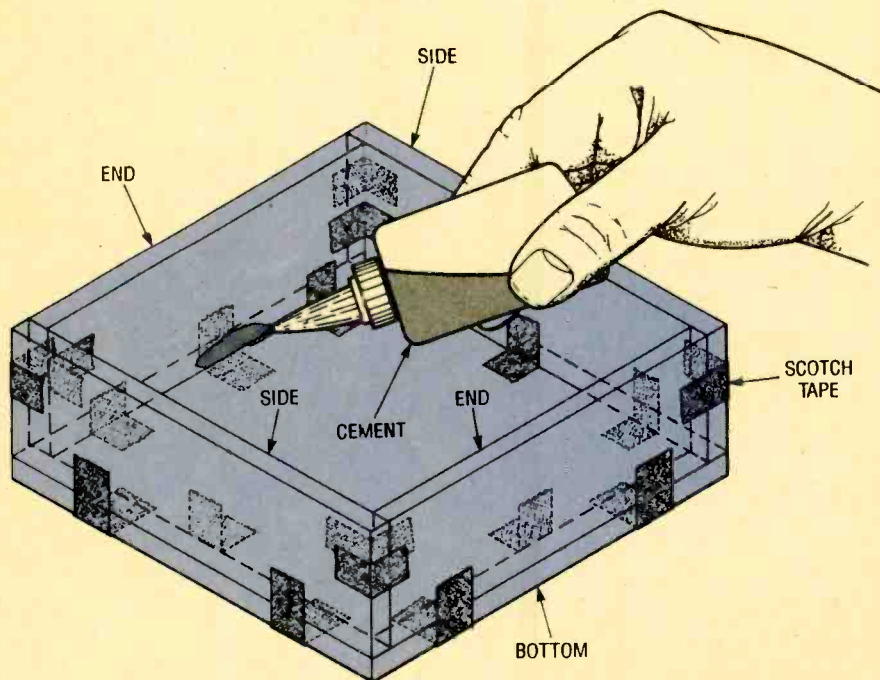

Fig. 2. Once you have all the parts cut, tape the sides, ends, and the bottom together, making sure that all the joints are tight and square. Then use liquid-acrylic cement to make the joints permanent.

board components, including a battery holder if used.

Building The Enclosure. Once you have all the parts cut, tape the sides, ends, and the bottom together with Scotch tape, making sure that all the

joints are tight and square. Use the tape wherever it is needed to make a good, tight joint. When the enclosure is taped correctly, it will be surprisingly sturdy (see Fig. 2). Acrylic cement, in liquid or paste form, is available from plastic-supply stores.

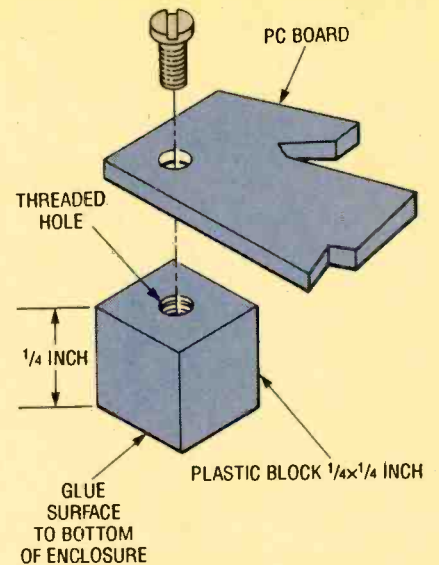

Fig. 3. Printed-circuit mounts can be added to the enclosure by first screwing 1/4-inch square scraps of acrylic to the board, applying a little acrylic cement to the bottom surfaces of the acrylic squares, and placing the assembly in the desired location within the enclosure.

Because paste-type cement must be applied to the edges and narrow surfaces of parts before they are joined, it is not suitable for this application. The liquid form is easily applied with an applicator bottle that has a long metal capillary tip that can reach into corners. A plastic, disposable hypodermic needle makes a wonderful cement dispenser.

The liquid cement has the consistency of water, so when the cement is ap-

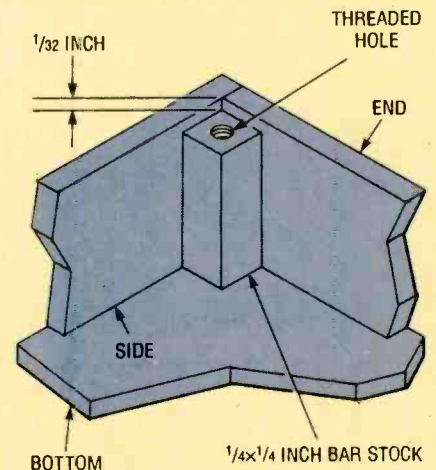

Fig. 4. One way to handle lid mounting is to cut 1/4-inch square bars of acrylic to about 1/32-inch shorter than the height of the sides. Cement the four pieces into the four corners of the enclosure. Once dry, place the lid on the enclosure and drill screw holes through the lid and into the lid mounts.

plied to the joints, capillary action will take the cement between the joint. Do the bottom joints first and allow about 30 minutes or so before handling. After sufficiently dry, place the enclosure on its side, do the lower two corners, and allow to set. Once the side joints are dry, flip the enclosure to the other side and complete the other two corners.

Use the cement sparingly, with just enough liquid to go into the joint without running over the flat surfaces or running out the back side of the joint. Liquid cement will etch the surface of the plastic if left to dry; any cement that is outside of the actual joint should be wiped off quickly. A little practice will make you very proficient at applying just the right amount.

Once you have the basic enclosure and the separate lid, the next thing that is needed is a way of mounting the printed-circuit board to the bottom of the enclosure and a way of attaching the lid to the enclosure itself. Making small pads on which to secure the board to the enclosure is one method for mounting the board. Cut four small squares of 1/4-inch thick scrap acrylic to about 1/4-inch square, see Fig. 3.

Use a #43 drill bit to make a hole in the center of each piece and tap the hole for a 4-40 thread. Mount the pads to the bottom of your circuit board with

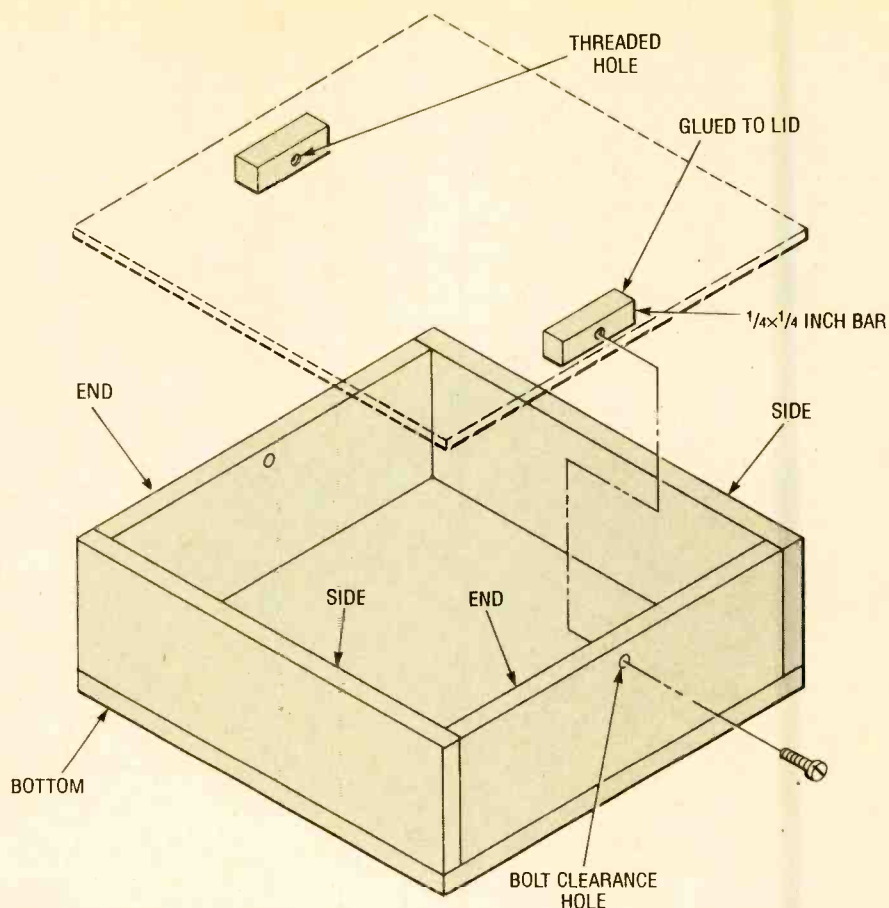
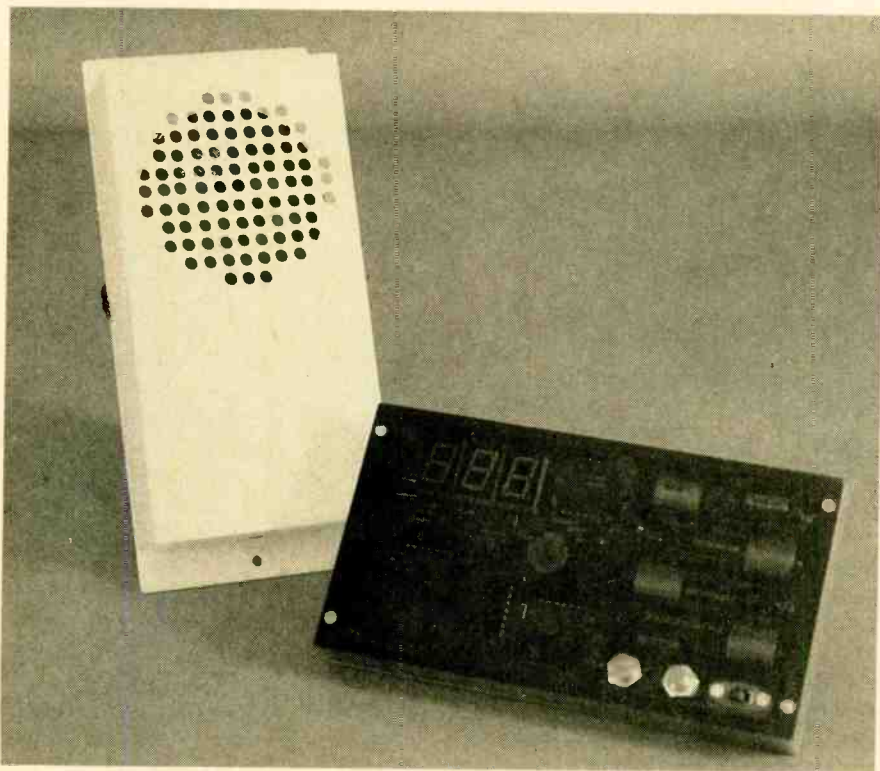

Fig. 5. Another way to handle lid mounting is to cement lengths of an acrylic bar to the lid on both ends, and drill screw holes through the side or end panels of the enclosure and the acrylic bar.



Here are two custom fitted project enclosures. The one to the left has a perforated speaker area near the top; the other has its front panel made of tinted translucent acrylic eliminating the need of a cutout area for the display.

4-40 x 1/4 inch screws making sure the screws do not extend below the bottom surface of the pads. With all four pads mounted to the board, wet the pads with cement and set the board into your enclosure where you want it. To ensure a tight bond, place a little weight at the center of the board while the cement dries. After 30 minutes, the screws and PC board can be removed and the pads will be permanently bonded in the desired location.

Mounting the lid is easy, however, since plastic parts needed to mount the lid are located inside the enclosure. You'll need to decide on your mounting scheme before you layout and cut the enclosure parts. One way to handle lid mounting is to cement four lengths of a 1/4-inch square bar, cut to about 1/32-inch shorter than the height of the sides, into the four corners of the enclosure (see Fig. 4). Then just put the lid in place and drill a pilot hole using a #43 drill through the lid into the center of the corner pieces. Tap the four holes in the corner pieces for 4-40 screws and enlarge the holes in the lid to accept the screw.

(Continued on page 91)

THE DIGITAL ELECTRONICS COURSE

GETTING FAMILIAR WITH A/D CONVERTERS

Read about phase-locked loops and learn how to take advantage of these powerful but easy-to-use devices in your own circuits.

BY ROBERT A. YOUNG

The phase-locked loop (PLL) is a linear circuit that is often used in conjunction with digital circuits in consumer electronics—for instance, in tone decoders, FSK (frequency-shifted keying), FM demodulators, frequency-synthesizer applications, and tuner systems. It is primarily used to perform demodulation—where it is used to follow phase or frequency—and for synchronization—where it is used to track a carrier or a synchronizing signal that may vary with time.

Inside the PLL. A functional block diagram of the typical PLL circuit is shown in Fig. 1. As shown, a PLL is made up of three sections: a phase comparator (also called phase detector), a low-pass filter, and a voltage-controlled oscillator (or VCO, as it is commonly called). The VCO is an oscillator whose free-running frequency is determined by an external resistor and capacitor (denoted R_e and C_e , respectively) that form an RC network. The output of the PLL is taken at the output of the VCO. The VCO is assumed to have a free-running frequency and a frequency shift that is proportional to the input control voltage.

Our gratitude is extended to the EIA/CEG for the creation of this course, especially to the consultants who brought it to fruition: Dr. William Mast, Appalachian State University; Mr. Joseph Sloop, Surry Community College; Dr. Elmer Poe, Eastern Kentucky University.

The Digital Microprocessor Course is reprinted here with the permission of the Electronic Industries Association/Consumer Electronic Group (EIA/CEG). The complete parts kit is available from EIA/CEG. For further information, contact EIA/CEG Product Services Department, 1722 Eye Street, NW, Suite 200, Washington, DC 20006; or call 202/457-4986.

The input to the PLL (e_i) is a sinewave of arbitrary frequency, while the VCO output (e_o) is a sinewave of the same frequency, but of arbitrary phase. If:

$$e_i = \sqrt{2}E_i \sin(\omega_o t + \theta_1(t))$$

and

$$e_o = \sqrt{2}E_o \cos(\omega_o t + \theta_2(t))$$

then the output of the phase detector is:

$$e_d = e_i \times e_o$$

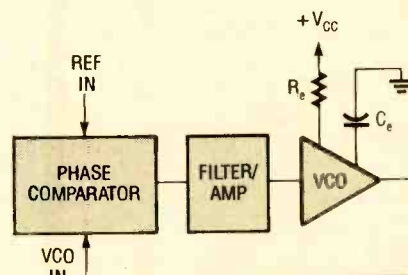

Fig. 1. The typical PLL circuit is made up of three sections: a phase comparator (also called phase detector), a low-pass filter, and a voltage-controlled oscillator (VCO).

The low-pass filter removes the AC components of the detector output, and the DC term is seen as a function of the difference in phase angle between the VCO output and the input signal.

A better understanding of the PLL may be obtained by considering that initially the frequency of the input signal and the VCO output are very close in frequency, but not identical. Under those conditions, the output of the detector is equal to the frequency difference of the VCO output and the input signal.

If no input signal were applied, the VCO would oscillate at a center frequency—usually selected to be within the desired output frequency range—which is set by the external RC network. The VCO's output frequency is referenced to the phase comparator. The phase comparator accepts two inputs; one from an input reference and the other a sampling of the VCO output. The phase comparator detects phase differences between the input reference signal and the VCO output. Since the phase difference is a function of the frequency difference, the comparator might be said to detect frequency differences.

The comparator converts the difference between the input reference signal and the VCO output into an output signal that is applied to the low-pass filter. The low-pass filter (or integrator) converts the signal received

from the comparator into a DC voltage by averaging the output of the phase comparator. That DC voltage is then fed to the VCO's control input.

Let's suppose that the loop feeding the VCO is closed with no input reference signal applied to the phase comparator. Under that condition, the VCO oscillates at its center frequency, drifting at every opportunity. But when a stable frequency is applied to the phase comparator's reference input, assuming that the input frequency is within the PLL's capture range, or is a harmonic thereof, a voltage will be developed at the output of the low-pass filter. That voltage, when applied to the VCO, causes the VCO to lock onto the incoming frequency.

With the loop in lock, the difference-frequency output of the phase detector is a voltage that is a function of the phase difference. If the input frequency is equal to the VCO's free-running frequency, the control voltage into the VCO must be zero.

PARTS LIST FOR THE PLL EXERCISE

- U1—555 oscillator/timer, integrated circuit
- U2—7476 dual J-K flip-flop, integrated circuit
- U3—565 phase-locked loop, integrated circuit
- C1—C3—0.1- μ F, ceramic-disc capacitor
- C4, C5—0.01- μ F, ceramic-disc capacitor
- R1, R2—100,000-ohm potentiometer
- R3—R5—1000-ohm, 1/4-watt, 5% resistor
- Breadboard materials, dual 5-volt power source, wire, etc.

Let's now assume that the input (reference) frequency increases, causing an instantaneous phase difference between the VCO output and the input (reference) frequency. That would

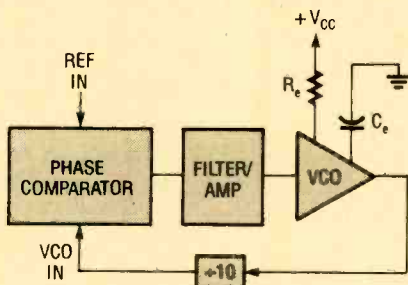

Fig. 2. By feeding the VCO's output to a divide-by-ten counter/divider prior to the PLL's phase comparator (as shown here) a PLL can be used as a frequency synthesizer.

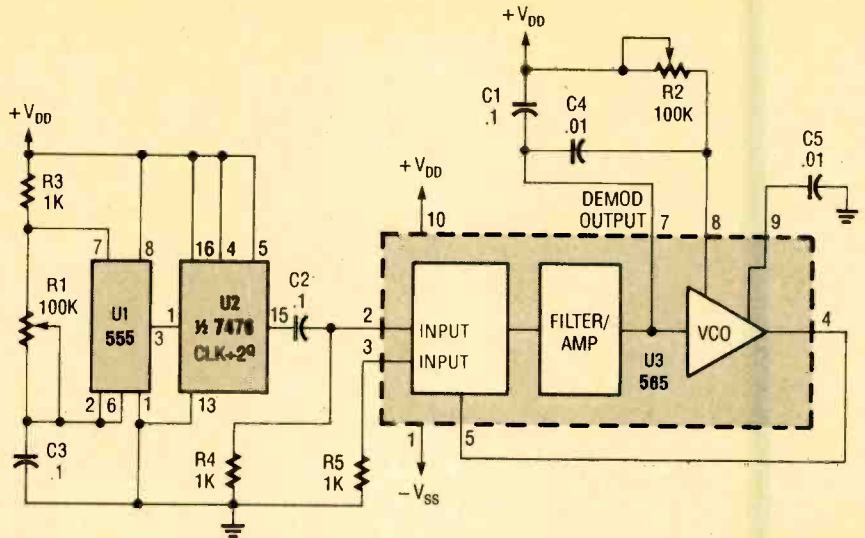

Fig. 3. A 555 oscillator/timer configured for astable operation supplies a reference signal, which is fed through a flip-flop that's used to divide the signal by a factor of two before it is applied to the PLL. Varying the output frequency of the oscillator will cause a corresponding change in the oscillating frequency of the PLL's VCO.

cause an increase in the voltage developed in the low-pass filter. When that voltage is fed to the VCO's control input, the VCO's output frequency would increase until it equals the input frequency. A decrease in frequency would have the opposite effect.

The range of frequencies that the PLL can lock onto is called the capture range; the range of frequencies over which the VCO output will follow the input reference is called the lock range.

Frequency Synthesis. Figure 2 shows a block diagram of a PLL-based frequency synthesizer. Note that the VCO's output is fed to a divide-by-ten counter/divider prior to application to the phase comparator. Under that condition, the phase comparator always sees a 10-to-1 phase relationship between the input reference and the VCO output and therefore forces the VCO to produce an output signal that's ten times the input reference signal.

If a divide-by-eight counter/divider is substituted for the divide-by-ten unit, the VCO's output would go to 8 times the input reference. Programmable counter/dividers used in consumer products use this scheme to generate a wide range of frequencies.

PLL Exercise. In this exercise, the 565 phase-locked loop is powered from a split 5-volt (± 5 -volt) supply, which can be formed by connecting two 5-volt supplies. The reference input to the circuit is supplied by a 555 oscillator/timer (U1) configured for astable operation (see Fig. 3). The output of the astable

multivibrator is then fed through a flip-flop (half of a 7476 dual J-K flip-flop), which divides the frequency of the signal applied to it by two. The output of the flip-flop (U2) is AC-coupled to the input of the PLL (U3). Resistors R4 and R5 are used to bias the inputs to U3's internal comparator to accept the astable signal generated by U1.

For this exercise you'll need a dual-trace oscilloscope to view the input (reference) signal and to set the input to U3's internal VCO to 1 kHz. If only a single-trace oscilloscope available, it will be necessary to switch the scope probes from location to location to view the various signals.

Assuming that you are using a dual-trace scope, connect one channel input between the output of U2 and capacitor C2. Connect the other scope channel to the output of U3's VCO at pin 4, and sync the scope on that input signal. The VCO should be running at the reference frequency. Slowly adjust the frequency of the oscillator (U1) either up or down by varying the resistance of potentiometer R1 and observe the output of the VCO. Note that the VCO will free run for a while, and then lock onto the new input frequency.

Now, cascade the two flip-flops of U2—producing a divide-by-four circuit—while keeping the rest of the circuit intact. Feed the oscillator output to the input to PLL. Observe the output of the VCO. Next, disconnect one of the cascaded flip-flops from its present position, and place it in the PLL's feedback loop, between pins 4 and 5 of U3. What effect does that have? ■



B&B Electronics Model 232 Modem Security Device

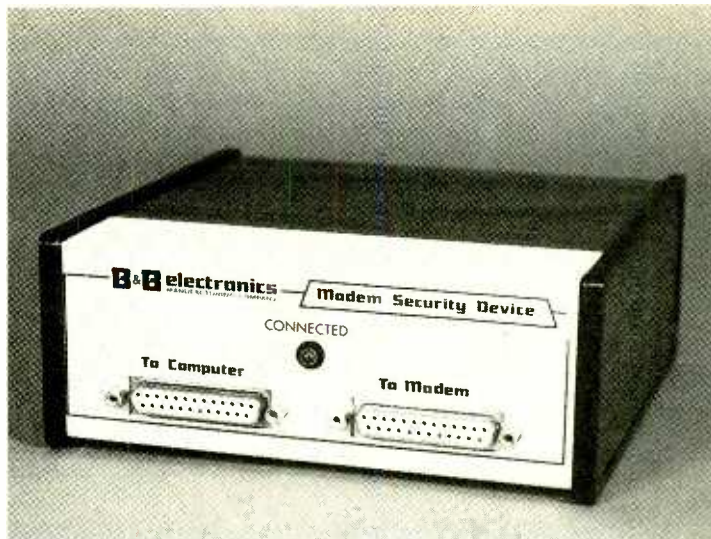

CIRCLE 119 ON FREE INFORMATION CARD

Protect your computer system from illegal entry.

Harvey loaded a custom search program into his computer before he went home for the evening. At some late hour his office computer would begin to dial about one-hundred modems used by major businesses in his local calling area. The program would try three passwords at each number attempting to get into the computers. He was successful and broke into one system.

Harvey had originally planned to insert a virus into the violated computer as a prank, but he didn't. What he discovered by viewing some of the files in the breached system gave him the opportunity to make some money on the stock market. Harvey was no longer a vandal, he was a thief!

For every one prankster, there must be tens or hundreds of prying professionals seeking and stealing information. They commit what are considered victimless crimes, which they are not. The fact that it may cause a corporation to fail, robbing millions of dollars from honest investors, makes this type of crime one that must be reckoned with.

One way to protect a computer from outside intrusion is to connect it to a B&B Electronics Model 232 Modem Security Device (or MSD). The B&B Modem Security Device (MSD) is a micro-computer add-on that limits off-site telephone access to a computer or computer network. Note that the MSD is only active when receiving calls via modem; calls originating from the computer are not blocked.

Remote access to the computer is controlled in two ways: First, access is limited to only the individuals who can enter a password that matches one of 50 pre-selected passwords stored in the MSD. Second, the MSD calls the user back at a phone number that is linked to the password that the individual entered. Therefore, even if a password is compromised, the MSD denies unauthorized access because only authorized phone numbers are called by the MSD.

Requirements. To use the MSD you need a computer with a serial port that conforms to EIA RS232-C standard. An external Hayes-compatible modem that conforms to that standard is also required. You should be sure that the modem works properly with your computer before you install the MSD.

The MSD should be installed between the modem and the computer. Two cables are required: one to connect the computer to the MSD and the other to connect the MSD to your modem. The MSD has two 25-pin female D-series connectors, so each cable should have at least one 25-pin male connector. The other connectors should be selected to mate with the computer and the modem—most installations require cables with male connectors at both ends.

Table 1 lists the minimum lines that should be in the cable connecting the MSD to the computer port. Note that the table contains the wiring informa-

tion needed for both 9-pin and 25-pin computer ports. You will need a straight-through cable to connect the MSD to the modem and it should at least contain lines 2-8 and 20.

Installation and Setup. The easiest way to get started with the MSD is for the operator/owner to read the manual to get acquainted with the unit. To install the unit, you just connect the correct cable between the computer and the MSD and run the other cable from the MSD to the modem. A wall-plug power pack is also supplied with the MSD and should be connected to complete the installation.

The data rate (or baud) used by the modem, the MSD, and the communications software you use must all agree. The maximum rate for the MSD can be set via 8 tiny DIP switches. The MSD maximum rate should be equal to the maximum rate your modem can handle. That is because the MSD will send your modem some special set-up commands (called the "initialization string") at the maximum rate a few seconds after it's turned on. The maximum rate is preset at the factory to 1200 baud. If your modem's maximum rate is 300, 600, 2400, 4800, 9600, or 19,200 baud, the switches should be reset according to the manual's instructions.

Note that once the initialization string is sent to the modem, the MSD will automatically adjust itself to the data rate it detects coming from the modem or the computer.

TABLE 1—MSD CABLES

MSD 25-pin Connector	RS232-C Signal	IBM PC Compatible RS232-C Connector	
		25 Pin	9 Pin
2	Transmit Data	2	3
3	Receive Data	3	2
4	Request to Send (*)	4	7
5	Clear to Send (*)	5	8
6	Data Set Ready (*)	6	6
7	Signal Ground	7	5
8	Carrier Detect	8	1
20	Data Terminal Ready	20	4

Note: The signals marked with a (*) are not used by the MSD, but are typically required for a modem cable. The MSD passes lines 1, 4-7, 12, 15, and 22-24 from the computer connector to the modem connector in case your computer may have a special application that requires additional lines in the cables.



The MSD is shown sitting on top of an ADC MDI202 modem. Its small footprint takes minimal space. The MSD can be situated out of sight since, once installed, it needs no human direct control. Its front-panel LED is useful only during installation and orientation.

TABLE 2—MODEM SWITCHES FOR THE HAYES SMARTMODEM 1200

Switch	Setting	Meaning
1	Down	Ignore DTR.
2	Up	Word result codes displayed.
3	Down	Result codes sent.
4	Down	Do not echo characters in command state.
5	Down	Auto-answer enabled.
6	Up	Carrier detect is high only when the modems are on the line.
7	Up	Single line RJ-11 phone jack.
8	Down	Enables commands.
9	Up	Compatible with Bell 103/212A modems.
10	Up	Modem reset when turned on.

The above switch settings are for the Hayes Smartmodem 1200. Your modem may not have the exact same meanings for each switch position. Check your modem's manual.

The MSD can receive data with either 8 data bits, no parity, and 1 stop bit; or 7 data bits, even or odd parity, and 1 stop bit. It transmits information using 8 data bits, no parity, and 1 stop bit, so those are the settings you should use for your computer. Furthermore, the MSD does not echo the characters you type, so you should set your computer to local-echo (which is also called half-duplex) mode.

The correct switch settings for a Hayes 1200 Smart Modem are shown in Table 2. If you prefer, the modem can be set up by using the appropriate AT commands as part of the initialization string (see the MSD manual for more information on that).

With the hardware all set up, you can now create the password table by entering the systems "Password-Edit" mode, as described in the MSD's instruction manual. That gives you the chance to specify the password, and "dial command" (i.e. the initialization string and telephone number) for each user. You can only enter this "password-edit" mode if you know the "System Manager's Password."

If you change the system manager's password from the factory setting (which is "pass") and forget the new password, you can *not ever* get into the MSD password-edit mode again. There is no "back door." So, while you are becoming familiar with the system, leave the system manager's password set to the factory setting until you are confident you understand how the editor works.

Although the intent of the MSD is to call back a user who telephoned and presented a valid password, immediate access to the computer can be granted to a user whose telephone number is specified as "+C*" in the password table. In such a case you only have to specify that password and the MSD turns the computer directly over to you without hanging up and calling you back.

The 232 Modem Security Device performs exactly as the maker claims, and is easy to install, even by a novice. It can be purchased from B&B Electronics (P.O. Box 1040, Ottawa, IL 61350) for \$149.95 including shipping via UPS surface. Illinois residents must include 6.25% sales tax.

For more information on the B&B Electronics Model 232 Modem Security Device, contact the manufacturer directly, or circle No. 119 on the Free Information Card. ■

PRODUCT TEST REPORTS

By Len Feldman

JVC XD-Z505 Digital Audio Tape Recorder

Digital Audio Tape (DAT) recorders are now available in this country, some three years after they were introduced in Japan. The first company to introduce these new tape recorders to U.S. audio enthusiasts was Sony, back in June of 1990. JVC was not far behind, having introduced their first model about one month after Sony's celebrated introduction. That Model, the XD-Z505, carries a suggested retail price of an even \$1000.00. We've just put a production sample of this model through extensive lab and listening tests.



The JVC XD-Z505 Digital Audio Tape (DAT) player.

Like all consumer DAT machines being made now and in the future, the XD-Z505 incorporates SCMS, or the Serial Copy Management System, that allows you to make one generation of a digital-to-digital copy of any copyrighted program material, such as a CD or a prerecorded DAT. And what bears clarifying here is the fact that you can make as many such first-generation copies as you please—you simply can't make copies of the copies, at least not in the digital-to-digital mode.

Most of the features

found in this DAT recorder have to do with access codes that can be implanted in the sub-code areas of each data block, a major feature of the DAT format. These include high-speed direct search; skip search for finding programs in either direction on a recorded tape; applying starting-point identification (ID) and skip ID, which come in handy when editing tapes; a fine cue function; a program renumbering function; end search (finding the last point recorded on a partially recorded tape); and various displays of recording time (absolute time, program time of the current selection, remaining time on a tape).

Tape can be fast-forwarded and rewind at about 200 times normal playing speed, cutting rewind time to a fraction of that required by conventional analog cassette decks; with this machine it is possible to reach any selection on a 2 hour tape in less than 1 minute! This recorder can handle five 2-channel recording modes: 48-kHz sampling rate, 44.1-kHz sampling rate, 32-kHz sampling rate, and 44.1-kHz wide-track sampling rate (used for pre-recorded DAT's), all using 16-bit linear digital quantization, and a long-playing 32-kHz sampling mode that uses 12-bit non-linear quantization in order to increase recording time to a maximum of 4 hours on a tape that normally holds 2 hours of programming.

The XD-Z505 analog-to-digital circuitry uses a sophisticated fourth-order type of 1-bit conversion that, according to JVC, results in extremely linear quantization. During playback, 1-bit technology is used once again to recover the originally recorded analog signals. JVC calls their 1-bit DAC a Pulse-Edge Modulation System and, as we learned soon enough when the recorder was tested on the lab bench, the innovative system does result in extremely linear low-level recording and playback. It is at low levels that most digital systems have their greatest problems, so JVC and others are turning to 1-bit digital conversion to solve such problems.

The JVC XD-Z505 front-panel control layout is similar in many ways to that of other DAT recorders we have seen. The cassette tray opens and closes smoothly, at the touch of a button that's just below and to the right of it. An elaborate display area to the right of the tray reveals such details as record/play levels, status of the transport, sampling frequency in use, the various counter/time displays, program numbers and sub-code activities (as described earlier) in progress. Transport and record buttons, virtually identical to those we've come to expect on CD players, are found below the display area, while the recording-level control (for use when analog input signals are being used) is at the extreme right of the panel.

Below the master level control are a stereo phone jack and its associated level control.

Timer, input selector (analog, optical or coaxial digital), and Standard/LP Record mode switches are located beneath the power switch at the extreme left of the panel. Small buttons dealing with sub-code functions such as Start ID, Renumbering, Automatic ID edit, and the like are positioned just below the display area, above the main transport controls.

Most functions of the XD-Z505 can be initiated with the supplied wireless remote control. Exceptions include turning power on or off, adjusting input level, switching input mode, switching the timer on or off, and adjusting the headphone listening level. The remote control is equipped with numbered buttons that enable you to access a given selection on a tape directly, providing that the numbering or renumbering function has been used in connection with that tape.

The rear panel of this DAT recorder is equipped with analog (line-level) -input and -output jack pairs, digital optical-input and -output terminals, and digital coaxial-input and -output terminals. Also found here are terminals for use with JVC's "Compu-Link II" system, which, when connected to certain other JVC components such as a CD player, amplifier, or receiver, permits switching of inputs of the entire system by means of the remote control. Synchronized recording, in which the DAT recorder starts recording in sync with the associated CD player, is also made possible with this system.

TEST RESULTS

We tested the performance of this DAT recorder using its analog inputs as

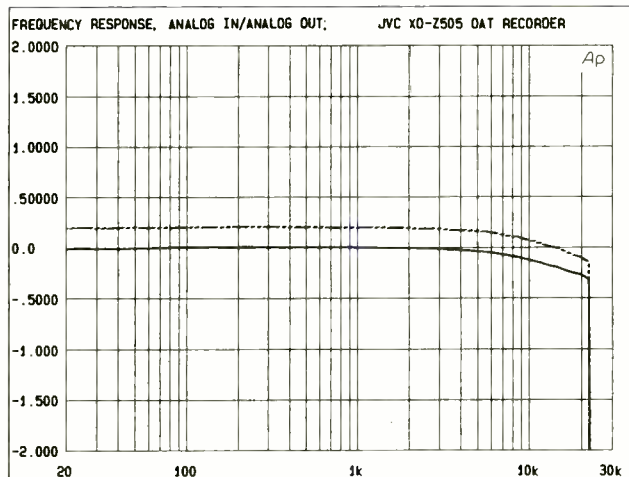

Fig. 1. The frequency response using the analog inputs was essentially flat out to 22 kHz. At that frequency, response was down only 0.25 dB.

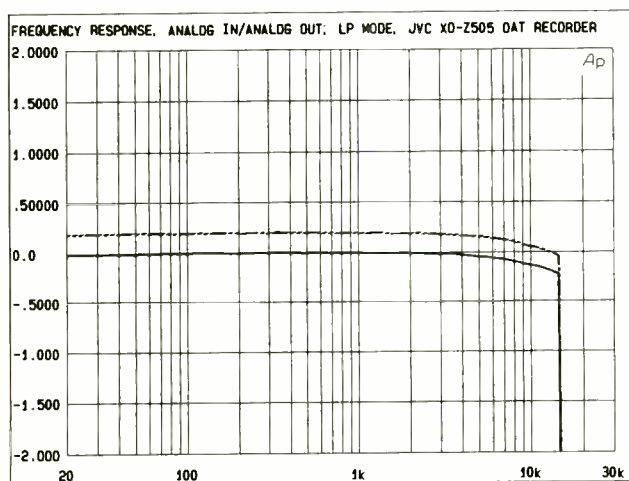

Fig. 2. Since the LP mode uses a 32-kHz sampling rate, the highest frequency that can be recorded in this mode is around 15 kHz.

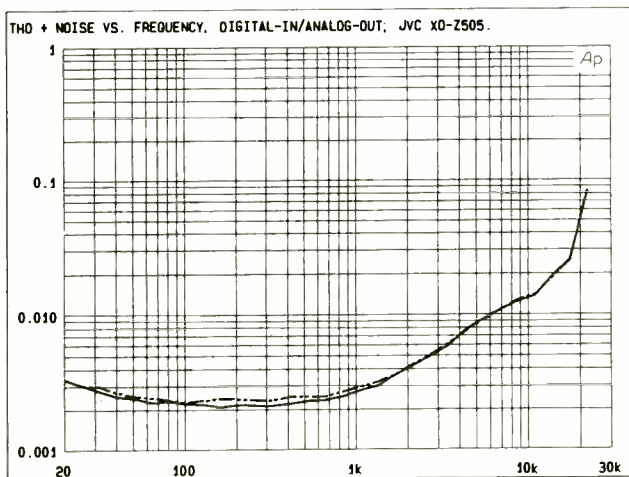

Fig. 3. Using a 44.1-kHz sampling rate, THD plus noise was approximately 0.002% for a 1-kHz test signal. While distortion did increase with frequency, at worst it never exceeded 0.08%.

well as its digital inputs, with all measurements made at the analog outputs. This approach corresponds to the

way most owners of a DAT recorder are likely to use such equipment. As shown in Fig. 1, the frequency re-

sponse via the analog inputs was essentially flat out to 22 kHz. At that frequency, response was down only 0.25 dB. The solid-line trace represents left channel output while the dashed-line trace corresponds to output from the right channel. In this mode there was a slight unbalance of about 0.2 dB between channels.

Note that the response in this mode was actually a bit better than that obtained with CD players simply because the sampling rate used when selecting analog inputs is 48 kHz, as opposed to 44.1 kHz used for CD's. The fundamental Nyquist theorem dealing with digitization of analog signals tells us that higher sampling frequencies in any digital system make it possible to record higher frequencies.

Switching to the digital inputs, frequency response measured by recording signals at a 48-kHz sampling rate was again essentially flat out to 22 kHz, staying within 0.15 dB for both channels.

One of the penalties of using the LP or long-play mode is a reduction in high-frequency response. Since the LP mode uses a 32-kHz sampling rate, the highest frequency that can be recorded in this mode is around 15 kHz, as shown in Fig. 2.

Plotting THD plus noise versus frequency for a maximum-level recorded signal, at either the 48-kHz or the 44.1-kHz sampling rate, which is shown in Fig. 3, resulted in THD plus noise levels of approximately 0.0035% (for the first case) or 0.002% (in the case of the 44.1 kHz sampling rate) for a 1-kHz test signal. In both cases, however, distortion increased with frequency, although, at worst, it never exceeded 0.08%.

A-weighted signal-to-noise ratio, whether measured using the analog measured inputs and outputs or using the digital inputs and the analog outputs, was almost exactly as claimed by JVC. We measured 91.6 dB using the digital inputs and 91.4 dB using the analog inputs. Using the 32-kHz sampling rate and the LP mode, signal-to-noise was virtually the same; an unexpected result at first glance. However, the reason for this was quickly realized. Although the 32-kHz LP mode uses 12-bit samples instead of 16-bit samples (and should therefore have a theoretical maximum S/N of only 72 dB), the system is a non-linear, or compressed 12-bit system and therefore its S/N can approach that of the higher-bit 44.1-kHz and 48-kHz sampling systems used in this DAT recorder.

One of the most important characteristics of any digital-audio component is its low-level linearity—or the lack of it. Unlike analog-audio equipment whose distortion tends to rise with increasing input and output levels, digital equipment (CD players and now DAT recorder/players) tend to exhibit higher distortion levels as signal levels decrease. Accordingly, we measured linearity of the system from maximum recording level (nominal 0 dB) all the way down to -90-dB signal levels. Using the analog inputs and a 48-kHz sampling rate, the deviation from linearity at -90 dB was only 1.14 dB. Using a 44.1-kHz sampling rate, and applying the signal to the digital input, the deviation was actually a bit higher at the -90-dB level, measuring slightly more than 2 dB. Applying 48-kHz sampling-rate signals to the digital input resulted in a deviation from perfect linearity at -90 dB of only

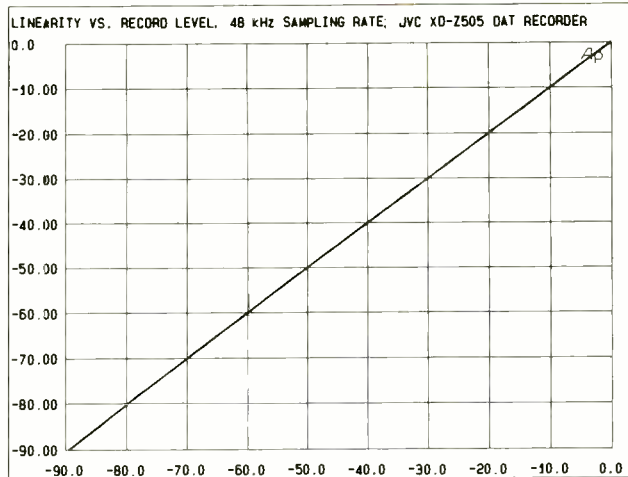

Fig. 4. One problem with all digital-audio gear is that distortion tends to increase at low levels. However, applying 48-kHz sampling-rate signals to the digital input of this DAT recorder resulted in only a 0.48-dB deviation from perfect linearity at -90 dB.

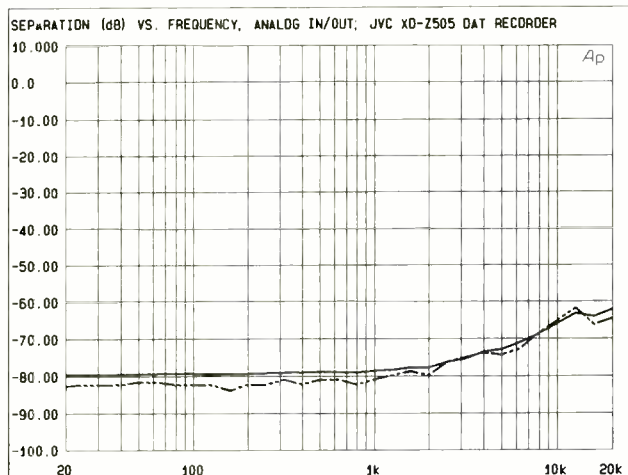

Fig. 5. Stereo separation at 1 kHz measured around 80 dB, but decreased to between 62 and 65 dB at 20 kHz. While we have measured higher, these separation figures are certainly more than adequate for good stereo reproduction.

TEST RESULTS—JVC XD-Z505 DAT RECORDER

Specification	PE Measured
Frequency Response	
48-kHz Mode	20 Hz–22 kHz, -0.25 dB
44.1-kHz Mode	20 Hz–20 kHz, -0.18 dB
32-kHz (LP) Mode	20 Hz–14.5 kHz, -0.25 dB
Signal-to-Noise Ratio	
Digital Inputs	91.6 dB
Analog Inputs	91.4 dB
Harmonic Distortion + Noise, 1 kHz, 0 dB	
48-kHz Mode	.0035%
44.1-kHz Mode	.002%
32-kHz (LP) Mode	.08%
Stereo Separation, 1 kHz	80 dB
Input Level for 0-dB Indication	500 mV
Output Level for 0-dB Indication	2.0 V
Fast Forward/Rewind Time (R-120 tape)	53 seconds
Max. Access Time (R-60 tape)	31 seconds
Power Requirements	120 V, 60 Hz AC, 24 watts
Dimensions (W × H × D, inches)	17 ³ / ₁₆ × 5 ³ / ₈ × 13 ¹ / ₄
Weight	15.5 lbs.
Suggested Price:	\$1000.00

0.48 dB (see Fig. 4). Surprisingly, the least deviation from perfect linearity occurred when we switched to the LP mode, using a 32-kHz sampling rate via the analog inputs. Under those conditions, the deviation from perfect linearity at -90 dB was measured at a mere 0.18 dB.

Finally, we measured stereo separation between channels. Separation at 1 kHz measured around 80 dB, but decreased to between 62 and 65 dB at 20 kHz (see Fig. 5). While we have measured considerably higher separation for many CD players, the separation figures obtained for this JVC DAT recorder are certainly more than adequate for good stereo reproduction.

HANDS-ON TESTS

Having completed our lab tests, it was time to check out the recording capabilities of the XD-Z505. To do that, we transcribed several of our favorite CD's to DAT tape, using the digital-to-digital mode as well as the analog-output-to-analog-input mode of the DAT recorder.

Controls were easy to understand and the automatic Start ID and numbering function worked perfectly in all but one case. That case involved a CD that did not provide the required 3-second pause between "cuts." When transcribing that particular CD, the system failed to recognize and "mark" the start of a couple of tracks. Of course, the remedy here would be to manually mark the start of these closely spaced selections, and that can be done during playback without in any way affecting the audio portion of the recording.

We used the LP recording mode to transcribe programs received via FM
(Continued on page 92)

ANTIQUÉ RADIO

By Marc Ellis

Theremin Contest Results!

Back in the October, 1990 issue, I announced that I needed information on the RCA Theremin. The reason: I had just obtained one of those 1929-era electronic musical instruments from reader Tony du Bourg (Summit, NJ), who wanted to see a series of columns devoted to its history and restoration.

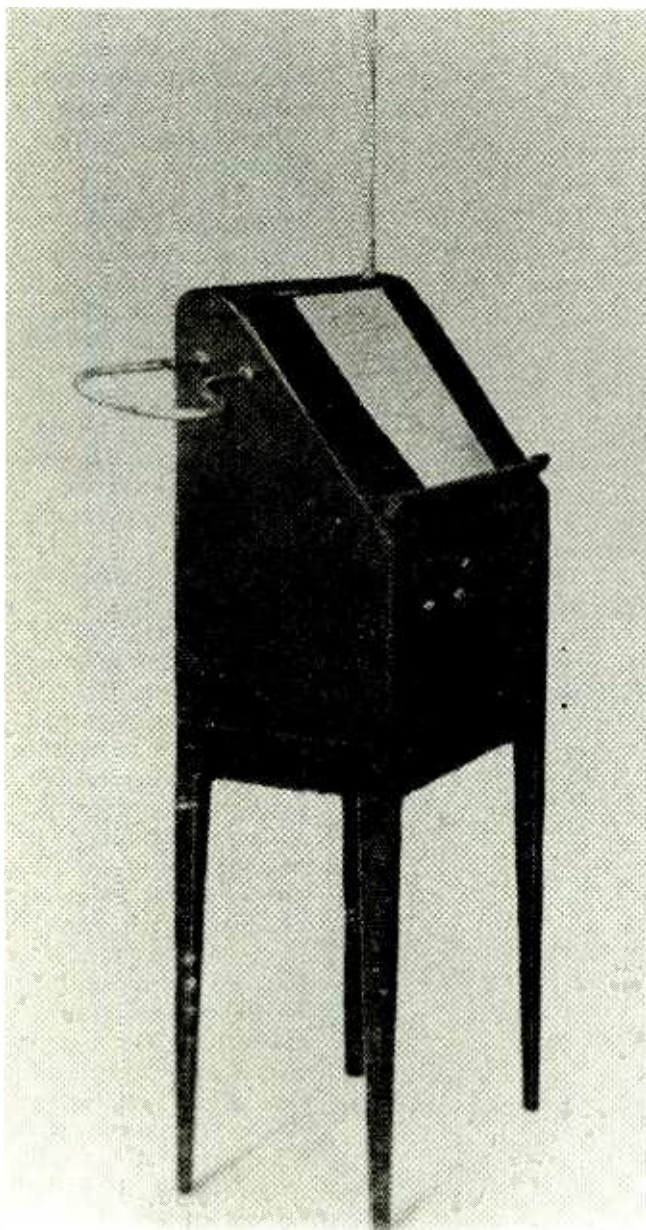

A photo of the Theremin taken from RCA advertising literature. The straight rod controls pitch while the loop controls volume.

Tony, who teaches physics and music at a private high school, had acquired the Theremin from a colleague some years back. When he offered it to me, it was in storage, having last been used some time in the 1950's. To say that I was intrigued is putting it mildly. So I quickly made arrangements to visit Tony (a delightful host and a most interesting person) and pick up the vintage electronic music maker.

Now the Theremin was safely ensconced in my basement workshop, but I had a problem to solve before I could begin work on a series of articles. My own personal library contained very little useful reference material on the instrument. Accordingly, I decided to ask the readers for some help.

As an inducement to respond, I offered to reward the writers of the eight best letters received before Thanksgiving 1990 with reprints of a neat little 1924 Gernsback publication. Titled *100 Radio Hookups*, the booklet contains over 100 schematics, each with an explanatory caption, covering virtually every radio-receiving circuit in use at that time.

As this column is being written, the Thanksgiving deadline has just passed, the last few letters received before the holiday have been forwarded to me, and I've picked out the winners. But it wasn't an easy job! Participation in the contest was much greater than expected, with interesting contributions received from over forty readers.

The quality of almost all the contributions was very

high, and I would really like to award a prize to each one. But, of course, it wouldn't be much of a contest if all entries were winners. So I've done my best to pick out what seem to be the eight most useful, interesting, and/or unique submissions. First I'll announce those winners, then I'll go on to acknowledge each of the other contributions.

AND THE WINNERS ARE ...

Each of the following readers will receive a copy of *100 Radio Hookups*. **Alfonso E. Patron** (Mazatlan, Mexico) sent photocopies of four fascinating articles on the Theremin taken from trade and technical magazines of the early 1930's.

Hank Schormann

(Miami, OH), whose fact-filled three-page letter concentrated on the history of the development of the Theremin and of the artists who composed for the instrument and performed on it, also included photocopies of the Theremin articles from a couple of definitive musical dictionaries, as well as some interesting biographical material on composer Miklos Rozsa—who pioneered the use of the Theremin to produce eerie effects for movie soundtracks.

John G. Pere (Akron, OH) receives a reprint for sending along a copy of *Moog Music*, the information-packed newsletter/catalog of the R.A. Moog Co. for Fall-Winter, 1962. At that time Robert Moog, who is legendary for his work on music synthesizers, was

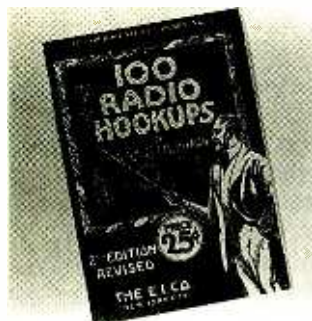

Eight lucky readers won copies of this 1924 Gernsback Publication for sending in information about the RCA Theremin.

manufacturing a line of modern semiconductor Theremins adapted from the original vacuum-tube design.

Norm Lehfeldt (San Francisco, CA) sent me a dub from an early Victor 78, featuring one Lennington H. Shewell performing on the "Victor Theremin." That affords a rare opportunity to hear a Theremin performance from the era when the instrument was first being introduced.

Don Paterson (Las Cruces, NM) is an electronics engineer for NASA. Besides being a collector and restorer of antique radios, Don collects piano rolls and 78-rpm records. Don's winning entry includes dubs from three of the 11,000 discs in his collection, comprising selections for Theremin, vocal group, and orchestra (late 40's or early 50's era). Don also sent a photocopy of the original Theremin schematic accompanied by an analysis of the circuit operation.

Frank Krantz (Somerdale, NJ) was the first person to respond to my call for Theremin information. Frank is a long-time supporter of this column, and was very generous with information from his files when I was restoring the Pilot Super-Wasp some months ago. This time, Frank sent a com-

plete copy of the official RCA service notes for the Theremin, along with a chatty letter telling of his experiences with the instrument. It seems that Frank actually met Leon Theremin, the instrument's inventor, while the latter was demonstrating his brainchild at the Sesqui-centennial Exhibition in Philadelphia (1927). In a later postcard, Frank also alerted me to the Theremin article that appeared in the October, 1990 *Antique Radic Classified*.

Alan Jerig (Port Orange, FL) wins a reprint for sending me a videotape featuring a rare TV performance by Theremin virtuoso Clara Rockmore. Ms. Rockmore has been associated with the Theremin since it was first introduced, having learned to play it from the inventor himself. She is considered to be the preeminent artist on this instrument.

By the way, a compact disc of Clara Rockmore's Theremin performances is currently available at record stores (Delos D/CD 1014 *The Art of the Theremin*). I purchased one immediately after receiving the instrument from Tony, in order to get an idea of what properly performed Theremin music should sound like. The liner notes for this recording are by none other than Robert Moog. And in addition to providing background on Ms. Rockmore, they constitute a mini-encyclopedia on the history and technology of the instrument.

George Livingston (Miami, FL), who now owns and operates a TV production and postproduction facility, first encountered the RCA Theremin as a boy in the early 1950's. Owned by a musician who worked for George's bandleader father, the instrument was kept at the Livingston home

for a couple of years—giving the fascinated boy ample time to doodle with it. George read and saved every construction article he could find on the Theremin because, one day, he wanted to build his own. George hasn't built the theremin yet, but he still has the articles—taken from electronics hobby magazines of the 1950's and 1960's—and sent copies of them to me as his entry.

And now for the honorable mentions which, because of the high quality of all the contest entries, includes everyone else who sent in a submission. Although these folks will not receive reprints, they've also made fine contributions to the Theremin project and I'd like to acknowledge each one individually. The contributions have been arbitrarily divided into three categories: Construction Articles, Technical Information, and General Background.

HONORABLE MENTIONS—CONSTRUCTION

Bob Kjaln (Portland, OR) sent along a construction article, by Robert Moog, from *Electronics Illustrated* (January 1961). He also included a dub from the Clara Rockmore disk I mentioned earlier. A long letter from **Jorge Resines** (Buenos Aires, Argentina) included references to several American- and Spanish-language articles, also from the 1960's. Thanks to **Norman Weliky** (Monterey Park, CA) for a construction article from **Popular Electronics** (November 1967), copies of later reader letters concerning it, and a page of instructions from the related kit. **Dr. Curtis Marshall** (Brooklandville, MD) and **Bruce Thorpe** (Phoenix, AZ) sent copies of the Moog construction article from

Electronics Illustrated. Dr. Marshall and his sons actually built the transistorized Theremin described in the article. **Bob Mailhot** (Las Vegas, NV) submitted a hand-copied diagram and parts list (source unknown) of a simple one-transistor Theremin that "broadcasts" through an AM radio.

Charles Doughty (Sacramento, CA) sent construction articles from **Popular Electronics** (April 1955) and *Electronics Hobbyist* (1972). He says he's very happy to see the Theremin back in the pages of **Popular Electronics!** From **Bill Collish** (Harrison, NY) came a copy of the November 1967 **Popular Electronics** construction article, as well as construction articles from our immediate predecessor magazine, **Hands-On Electronics**, and a 1966 edition of the *Electronic Experimenters Handbook*. Finally, thanks to reader **Louis R. Suppek** (Brunswick, OH) for referencing the interesting transistorized Theremins from TAB Books *Experimenting With Electronic Music* (1974).

HONORABLE MENTIONS—TECHNICAL

Kevin Adams' (Mississauga, Ontario, Canada) submission was an original copy of the *Radio Broadcast* magazine for February 1930, including a technical article on the RCA Theremin on the RCA Theremin. **Robert L. Oberholtzer** (North Cape May, NJ), who was a technical writer and editor for RCA for 30 years, sent me a letter describing the operation of the Theremin, as well as a manuscript of an article he'd written on the history of the instrument. **Jerry Toth** (British Columbia, Canada) sent an enlarged copy of the Theremin's schematic diagram.

Copies of the RCA service notes for the Theremin

arrived from **Tom Tompkins** (Shelburne, Vermont), **Larry Baker** (San Angelo, TX), **Russell E. Worthy** (North Adams, MA), **Webb Hardeman** (Mechanicsburg, PA), and **Arthur Fisher** (Phoenix, AZ). Larry also included a letter of personal reminiscences about the instrument and some interesting excerpts from *The History of Music Machines*. Arthur sent reminiscences too, as well as a copy of the data sheet for the RCA Model 106 loudspeaker, which was usually used with the Theremin. Russell supplemented his entry with a couple of articles on the Theremin from early trade magazines and a veritable avalanche of photocopies of interesting book and magazine articles on other antique-radio topics.

Thanks to **James Hawkins** (Hialeah, FL) for his letter explaining the circuitry of the Theremin and calling my attention to the Clara Rockmore CD. And

rounding out our file of technical submissions is that of **Charles T. Muller**, whose letter told of his experiences in repairing and playing a Theremin many years ago—and who included a copy of the Theremin article from the recent *Antique Radio Classified*.

HONORABLE MENTIONS—GENERAL BACKGROUND

Daniel Berg (Waukesha, WI), **Jon Mancher** (Hopewell, VA), **Kipp A. McCleary** (Fawn Grove, PA), **Charles Scanlon** (Simsbury, CT), and **Lawrence Little** (Fresno, CA) all wrote to tell me about some relatively recent Theremin work. Mentioned were a 1960's California rock group known as "Lothar and the Hand People" ("Lothar" was the Theremin); the legendary Led Zeppelin group, whose guitarist Jimmy Page used a modern version of the Theremin in several

numbers; and a late 1950's Capitol album *Music For Peace of Mind* performed by movie sound track Thereminist Dr. Samuel Hoffman.

Charles also sent along a copy of an interesting vignette about the Theremin (which includes quite a bit of background about Clara Rockmore) from *The New Yorker* for September 17, 1990. And a copy of that article was also sent by **Leonard Vanderpot** (Croton-On-Hudson, NY), **Leonard P. Meola** (Huron, OH) sent a clipping from *The Cleveland Plain Dealer* telling about how a Theremin had been recently used to accompany a silent Russian science-fiction film.

Alan MacDonald (Cedar Knolls, NJ), **Robert Johnson** (Portland, OR), and **Bruce Baxley** (Savannah, GA) each sent a photocopy of a Theremin article dating from the late '20s or early '30s. **Fred Geer** (Jacksonville, FL) wrote me about a

Theremin he'd built from a kit in the late 1960's, and **Dan McNeil** (Skillman, NJ) wrote about one his father built in 1948. It seems that the sounds from both instruments had an uncanny ability to upset dogs, making them howl and bark. **Bobby Halplett** of Raleigh, NC (I'm not sure I'm reading your last name right, Bobby, but I hope it's close!) sent me reminiscences about a Theremin that had been used in an old movie house and also a schematic of a simple photocell-controlled version of the instrument.

I'd like to thank **Dave Overton** (Austin, TX) and **M.A. Griner** (Nashville, TN) for sending suggestions on where to look for additional Theremin material. And I'd also like to acknowledge perhaps the most original submission of all. **Arthur Clay** (Roland, AR) made a point of writing to tell me he'd never heard of the Theremin. Well, keep watching the column, Arthur, because with all of the wonderful material now in my files, you'll soon be very well briefed about this pioneering electronic music maker!

For those who'd like to follow up on some of the materials that came to light as a result of this contest, I'm including a bibliography of all of the books and articles that were referenced by our entrants.

Before we finish up for this month, I'd like to apologize to readers who are waiting for the final installment of the tube-tester project. As you can see, the response to the contest was so heavy that it took the entire column just to acknowledge it! Finally, if you've sent a submission to the Theremin contest and didn't find your name listed here, please contact me c/o *Antique Radio*, **Popular Electronics**, 500-B Bi-County Blvd., Farmingdale, NY 11735. ■

THEREMIN BIBLIOGRAPHY

Construction Articles:

- Daniels, Steve. "Ultra Simple Theremin." *Electronics Hobbyist*, Fall-Winter, 1972
- Garner, Louis E. Jr. "Electronic Music with the Theremin." *Popular Electronics*, April, 1955
- Garner, Louis E. Jr. "Lumenin Steals the Show." *Electronics Experimenter's Handbook*, 1966 Fall Edition
- Garner, Louis E. Jr. "Music a la Theremin." *Popular Electronics*, November, 1967
- Heller, Joseph L. "Musical Tones from a Beat Note Audio Oscillator." *Radio News*, June, 1930
- Heller, Joseph I. "A Volume Control for the Musical Tone Oscillator." *Radio News*, July, 1930
- Horowitz, Dan. "A Professional's Theremin." *Electronics Illustrated*, January, 1961
- Moog, Robert. "A Transistorized Theremin." *Electronics World*, January, 1961
- Walker, David. "Wide-Range Theremin." *Electronics Illustrated*, May, 1968
- Fischer, C.R. "Build the Digital Theremin" *Hands-On Electronics*, September, 1987

Informational Articles:

- Finn, Robert. "A Seldom-Heard Musical Sound." *The Cleveland Plain Dealer*, November 11, 1990
- Joseph, James. "Music From Nowhere." *Electronics Illustrated*, June, 1960
- Kitner, Michael L. "The Theremin." *Antique*

- Radio Classified*, October, 1990
- Mahanay, Stuart C. "The Modern Music Box." *Radio News*, March, 1930
- "The R.C.A. Theremin." *Radio Broadcast*, February, 1930
- RCA Theremin Service Notes, (New York: Radio-Victor Corporation of America, 1929)
- Saxl, Irving J. "Music From Electrons." *Radio News*, August, 1932
- Secor, H. Winfield. "Hands Create Radio Music." *Science and Invention*, December, 1927
- Talk of the Town Column. "Theremin, Theremin." *The New Yorker*, September 17, 1990
- Various Topics *Moog Music*; Newsletter. Fall-Winter, 1962
- Books:**
- Experimenting With Electronic Music, New Grove Dictionary of Music & Musicians*, (Washington, D.C.: Grove Dictionaries of Music, 1980)
- New Grove Dictionary of Musical Instruments*, (Washington, D.C.: Grove Dictionaries of Music, 1984)
- The History of Music Machines*, New York: Drake Publishers Inc., 1975
- Rosza, Miklos. *Double Life*, (New York: Wynwood Press, 1989)
- Palmer, C. Rosza, (Publisher and date unknown.)

CIRCUIT CIRCUS

By Charles D. Rakes

Meter-Range Extender Circuits

This time around, we're starting the Circus off with a circuit that increases the sensitivity of an analog current meter. Usually the price of a meter is based primarily on its sensitivity, size, and overall accuracy. A 0-1-mA meter can often be purchased for considerably less than a comparable 50- or 100-mA microammeter, and is generally easier to find.

AMPLIFIED DC MICROAMMETER

The circuit in Fig. 1 turns a 0-1-mA milliammeter into a sensitive microammeter, while providing a choice of

port components, and an inexpensive 0- to 1-mA meter, you can build your own 0- to 1- μ A meter for a fraction of the cost of commercial microammeters. Magic? Not at all, just a small dose of good old electronic circuitry applied to an electro-mechanical device, turning it into a more useful tool.

In Fig. 1, a 741 op-amp is connected in a conventional inverting-amplifier circuit with the gain set by the resistor combinations of R1, R2, R3, and R4. Resistor R1 is connected to the input of the op-amp and serves as a current-sampling re-

to half the supply voltage, allowing the meter to be zeroed for each current range. With S2 in position 1, the feedback resistor, R2, sets the op-amp's voltage gain to 10. With a current flow of 100 microamps through R1, the voltage across it normally would be 100 millivolts. ($E = IR$, or $.0001 \times 1000 = 0.1$ volt) But due to the action of the op-amp's feedback current, the voltage will actually measure close to zero.

Now, if we make the resistor value that's connected to the op-amp's output ($R11 + M1$'s internal resistance) equal in value

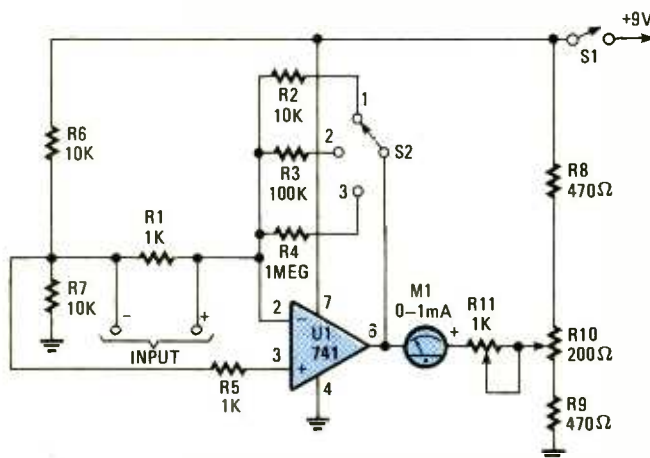

Fig. 1. The ammeter add-on circuit uses a 741 general-purpose low-power op-amp to boost micro-range current levels sufficiently to drive a 1-mA full-scale meter movement.

three current ranges. The first step increases the meter's sensitivity by a factor of 10 (0 to 100 microamps), the second step by a factor of 100 (0 to 10 microamps), and the third step increases the meter's sensitivity 1000 times (0 to 1 μ A).

Even if you could locate an analog 0- to 1- μ A meter, the cost would be prohibitive for most of us. But with a single IC, a few sup-

port components, and an inexpensive 0- to 1-mA meter, you can build your own 0- to 1- μ A meter for a fraction of the cost of commercial microammeters. Magic? Not at all, just a small dose of good old electronic circuitry applied to an electro-mechanical device, turning it into a more useful tool.

With no signal applied to the input of the circuit, the voltage at pin 6 of U1 is about half the supply voltage. The voltage at the center of R10 is also equal

to R1, the voltage developed across it should be ten times greater than the voltage across R1 with the op-amp gain of $\times 10$. That produces a voltage of about 1 volt across the meter and R11. Divide 1 volt by 1k and you end up with a 1-mA current flow through the meter and R11, and the meter will read full scale. By changing the op-amp's

PARTS LIST FOR THE AMPLIFIED DC MICROAMMETER

RESISTORS

(All fixed resistors are 1/4-watt, 5% units.)

- R1, R5—1000-ohm
- R2, R6, R7—10,000-ohm
- R3—100,000-ohm
- R4—1-megohm
- R8, R9—470-ohm
- R10—200-ohm potentiometer
- R11—1000-ohm potentiometer

ADDITIONAL PARTS AND MATERIALS

- U1—741 op-amp, integrated circuit
- M1—0-1-mA meter
- S1—SPST switch
- S2—SP3T switch
- Perfboard materials, enclosure, IC socket, test terminals, 9-volt battery, battery holder and connector, wire, solder, hardware, etc.

gain for each range, the output-voltage changes for a full-scale reading are about the same.

Because of the circuit's simplicity, the fixed resistors can be assembled on a 1 × 2 inch section of perf-board and connected to the meter, switches (S1 and S2), and control potentiometers (R10 and R11) through hook-up wire. The circuit can then be housed in an inexpensive plastic cabinet that's large enough to accommodate the perf-board and the off-board components.

To use the circuit, simply connect a 9-volt battery to the circuit and apply power. Place S2 in position 1 and adjust R10 for a zero meter reading. To calibrate the full-scale meter reading, take a new general-purpose "C"- or "D"-cell battery and measure its open circuit voltage with an accurate digital voltmeter. I've found most 1.5-volt cells to check out at about 1.54 volts. Connect a 15,400-ohm resistor (actually a 15k one will be close enough, with an induced error of less than 3%) in series with either a "C" or "D" cell, and adjust R11 for a full-scale reading of 100 microamps. Use a 150k resistor for the 10-microamp range, and a 1.5-megohm resistor for the 1-microamp range.

LOW-VOLTAGE VOLTMETER

Our next entry, see Fig. 2, turns the current amplifier circuit in Fig. 1 into a sensitive low-voltage voltmeter that provides full-scale readings of 0–1 volt, 0–100 mV, and 0–10 mV. With S2 set to position 1, op-amp U1 provides a DC-voltage gain of about 100 (voltage gain = R_6/R_3); in position 2 the gain is ×10; and in position 3 the gain is ×1.

The voltmeter's operation is very similar to that of the previous circuit. The input

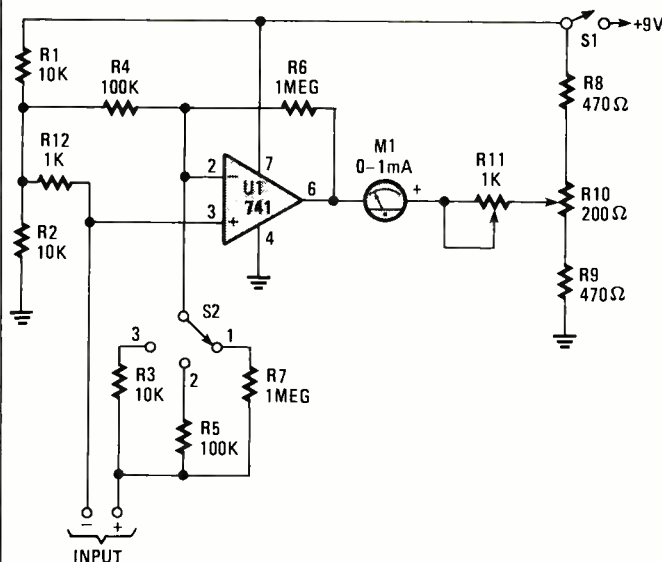

Fig. 2. A slight modification to the microammeter circuit of Fig. 1 transforms it into a low-voltage voltmeter.

PARTS LIST FOR THE LOW-VOLTAGE VOLTMETER

RESISTORS

(All fixed resistors are ¼-watt, 5% units.)

- R1-R3—10,000-ohm
- R4, R5—100,000-ohm
- R6, R7—1-megohm
- R8, R9—470-ohm
- R10—200-ohm potentiometer
- R11—1000-ohm potentiometer

ADDITIONAL PARTS AND MATERIALS

- U1—741 op-amp, integrated circuit
- M1—0-1-mA meter
- S1—SPST switch
- S2—SP3T switch
- Perfboard materials, enclosure, IC socket, test terminals, 9-volt battery, battery holder and connector, wire, solder, hardware, etc.

voltage is fed to the inverting input of U1 at pin 2 through one of three multiplier resistors (R3–R5), which are selected by S2. The output of U1 is monitored on the same 0–1 mA meter that's used in the previous circuit.

METER-CALIBRATION CIRCUIT

Before the circuit can be expected to function properly, it must be calibrated. That is easily done with the handy little voltage calibrator circuit shown in Fig. 3. In that circuit, R4 the 3-

ohm unit, was made by paralleling one 27-ohm and three 10-ohm resistors. A low-cost D-cell battery, in conjunction with a resistor divider network, makes up a simple calibrator circuit that supplies output voltages of 1 volt, 100 mV, and 10 mV. You'll need an accurate DC voltmeter in setting R1 for a 1-volt output at switch position 1. If an accurate voltmeter isn't available, use an ohmmeter and set R1 to 150 ohms. That will get you close enough for calibrating our voltmeter circuit.

Set the voltmeter's input switch, S2, to position 1, and

connect the input to the calibrator. Zero the meter with R10, and with the calibrator switch in the 1-volt position, press S1, and adjust R11 for a full-scale meter reading. Each voltmeter range can be checked and re-calibrated in the same manner.

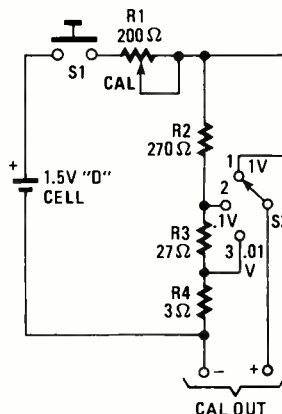

Fig. 3. As with all circuits used to monitor some quantity, the voltmeter circuit of Fig. 2 must be calibrated against a standard. This circuit is ideally suited to that task.

LOW-RANGE OHMMETER

Our next circuit, see Fig. 4, turns the meter amplifier into a linear low-range ohmmeter with ranges of 0–1, 0–10, and 0–100 ohms. Transistor Q1 and its associated components make up a constant-current circuit that supplies a 1-mA current to the test terminals. Two 9-volt batteries provide power for the circuit, allowing the input and output circuitry to be referenced to ground. That power arrangement helps to simplify the overall circuit. Two 1N914 silicon diodes, D1 and D2, offer some overload protection to the meter. Potentiometer R9 can be used to zero the meter, while R10 is used to set the meter for a full-scale reading.

If we connect a 1-ohm resistor to the test terminals (R_x), the constant-current circuit will pass 1 mA of

PARTS LIST FOR THE METER CALIBRATION CIRCUIT

RESISTORS

(All fixed resistors are 1/4-watt, 5% units.)

- R1—200-ohm potentiometer
- R2—270-ohm
- R3—27-ohm
- R4—3-ohm, see text

ADDITIONAL PARTS AND MATERIALS

- B1—1.5-volt D-cell battery
- S1—Normally-open pushbutton switch
- S2—SP3T switch
- Perfboard materials, enclosure, test terminals, wire, solder, hardware, etc.

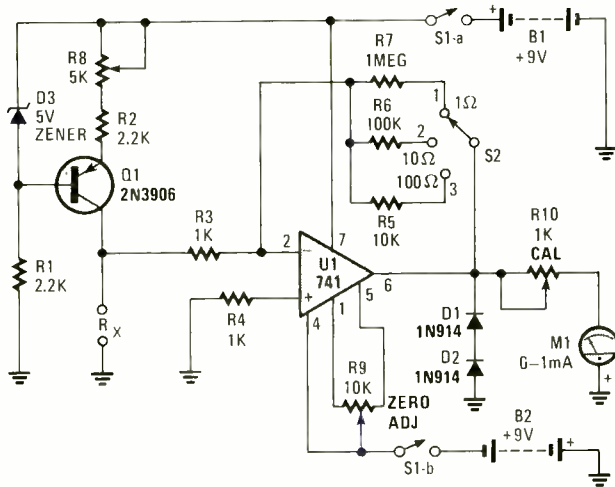

Fig. 4. In this circuit, a general-purpose PNP transistor (Q1) and a 741 op-amp (U1) combine to provide a low-resistance range for your ohmmeter.

PARTS LIST FOR THE LOW-RANGE OHMMETER

SEMICONDUCTORS

- U1—741 op-amp, integrated circuit
- Q1—2N3906 general-purpose silicon PNP transistor
- D1, D2—1N914 general-purpose small-signal silicon diode
- D3—5-volt Zener diode

RESISTORS

(All fixed resistors are 1/4-watt, 5% units.)

- R1, R2—2200-ohm
- R3, R4—1000-ohm
- R5—10,000-ohm
- R6—100,000-ohm
- R7—1-megohm
- R8—5,000-ohm potentiometer
- R9—10,000-ohm potentiometer
- R10—1000-ohm potentiometer

ADDITIONAL PARTS AND MATERIALS

- B1, B2—9-volt transistor-radio battery
- M1—1-mA meter
- S1—DPST switch
- S2—SP3T switch
- Perfboard materials, enclosure, AC molded power plug with line cord, battery(s), battery holder and connector, wire, solder, hardware, etc.

current through the resistor, developing a 1-mV drop across the resistor. The op-amp's input is connected in parallel with the test resistor and senses the minute DC voltage. The amplifier's gain in the 0-1-ohm range is 1k. The 1-mV signal is amplified 1000 times, producing a negative 1-volt output at pin 6 of U1.

The 1-volt signal is fed to the 0-1-mA meter through R10 to indicate a full-scale reading, which converts to the value of the test resistor, or 1 ohm.

Since the ohm scale is linear, all meter markings will read in ohms. For example, 0.5 mA = 0.5 ohms, and 0.25 mA = 0.25 ohms, etc. Of course, in the 0-100-ohm range, the values would be 100 times greater; i.e., 0.5 mA would equal a 50-ohm reading.

In all three ranges, the current flow through the test resistor remains at 1 mA,

and only the amp's gain is changed. If you would like to build a low-ohm meter for your test bench, the cost, if you already have a 1-mA meter and a full junkbox, should be minimal. Be sure to use an IC socket for the 741 op-amp.

Before a reading can be taken, the circuit must be calibrated. To do that, set R8 to its maximum resistance and S2 to 100 ohms (position 3). Connect an ammeter in series with the test terminals (R_x) and apply power. Adjust R8 for a 1-mA reading on the ammeter connected across R_x. Remove the ammeter from R_x, short the test terminals together, and zero M1 by adjusting R9. Connect a 100-ohm, 1% resistor to R_x and adjust R10 for a full-scale reading. The other two ranges can be calibrated in the same manner with a 10-ohm and a 1-ohm resistor. ■

Protel Easytrax 2™

Outstanding value in Printed Circuit Board/CAD for your Macintosh and PC

Protel Easytrax 2 is a new, low-cost design package for PC and Macintosh users that includes everything required to produce professional quality Printed Circuit Board artwork.

Our easy-to-learn menu-driven design system breaks the 'expert barrier' you'll be designing in minutes, not hours. Our comprehensive tutorials guide you through the program's extensive features that take the tedium out of board layout.

- Comprehensive library of Through-hole devices

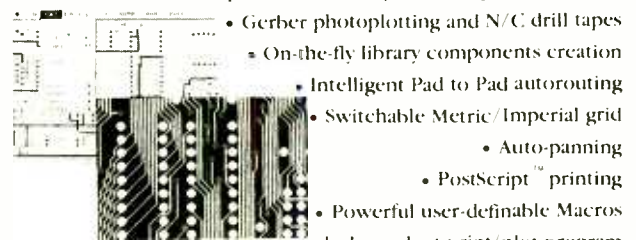

- Gerber photoplotting and N/C drill tapes
- On-the-fly library components creation
- Intelligent Pad to Pad autorouting
- Switchable Metric/Imperial grid
- Auto-panning
- PostScript™ printing
- Powerful user-definable Macros
- Independent print/plot program

- Multi-layer boards of up to 32 X 32 inches.

At Protel, we offer free technical support, 24-hour BBS, and 30-day money back guarantee. Prices start at

\$450

Free Evaluation Package

Toll Free: 800-544-4186

Protel Technology, Inc.

50 Airport Parkway, San Jose, CA 95110

Tel: 408-437-7771 Fax: 408-437-4913



COMPUTER BITS

By Jeff Holtzman

Maneuvering with Magellan

After working on the same type of computer for several years, one tends to build up a repertoire of tools and techniques for accomplishing common tasks. Techniques vary, of course, depending on the power of the available tools. Generally speaking, more-powerful tools lead to either simpler techniques or

But who needs yet another utility program, I thought.

Then Lotus released version 2.0 last summer; again my interest was aroused, but I still wasn't inspired enough to get a copy. What finally moved me to check out the program was a free demo copy that Lotus bound in the October 1990 issue of *Byte* magazine. I installed it on my

can use it as a backup/restore utility. You can use it to view a wide variety of files in their native formats, including popular database, graphics, and word-processing formats. You can use it for file compression and decompression (in the popular PKZIP format). You can use it to protect yourself against viruses. You can—well, you get the idea.

HOW DOES IT WORK?

Like many DOS shells, Magellan presents a split-screen view of your hard disk. The left window contains a list; the contents of the right window varies as you move a highlight bar through the list. In the tree view, for example, the list window shows all drives attached to your PC. As you scroll through the list, the right window displays the contents of the root directory of each drive. If you press the right arrow key, you log onto the root directory of that drive; the list window then shows all files in the root, as well as the top-level directories. As you scroll through this list, the right window's contents show the contents of the current directory or file.

If the current entry is a file, Magellan does its best to present it in its native format. Viewers shipped with version 2.0 include Word (4.0, 5.0), PFS: Write, WordPerfect (4.2, 5.0, 5.1) WordStar (2.1—5.5), XyWrite (I—III Plus), Excel, 1-2-3 (1—3), dBASE (II—IV), Paradox (2, 3, 386), graphics files in the PIC and PCX formats, and many others. The list is remarkably comprehensive, but still incomplete. For example, Magellan cannot

more-powerful results. Even knowing this, however, when more-powerful tools become available, one tends to ignore them unless there is a really obvious benefit to be gained by upgrading.

That's the way I thought when Lotus released Magellan 1.0 in the spring of 1989. Sure, it got rave reviews, and people I respected recommended it.

hard disk and fifteen minutes later knew that I had to try out the real thing. I wasn't disappointed.

What is Magellan? It's the "Swiss army knife" of utility programs. You can use it as a DOS shell for managing files and launching programs. You can use it as the front end to your own personal database—which can consist of all the text files on your hard disk. You

Lotus Magellan Use F1 to view file, * to list

Tree: C:\UP

Left window file list:

- BIGGER.WKS
- BIGGEST.WKS
- BUDGET89.WKS
- DISKINT.WKS
- DISKINT.XLC
- DISKINT.XLS
- LJTEST.WKS
- MIPS.WKS
- PHONES.TAB
- PHONES.WKS
- PORTBNCH.WKS
- PROFIT.WKS
- RAMCACHE.WKS
- TEST.WKS
- TURBOSPC.WKS
- UGA16.WKS
- UP.CNF
- UP.COM
- UP.HLP
- UP.TXT

Right window: DB: (F1) READY

Following is data for various numbers of DOS buffers

BUF NO	W-BLK	R-BLK	W-RAN	R-RAN	W-SEQ	R-SEQ
0	24.5	21.0	68.5	40.9	24.2	21.7
5	28.7	25.5	74.0	44.2	24.2	21.7
10	33.2	29.8	71.5	41.3	24.2	21.7
15	24.7	21.0	71.9	40.6	24.3	21.7
20	24.7	21.0	68.1	40.4	25.0	21.9
25	28.0	21.0	65.7	38.3	25.9	22.0
30	27.6	20.8	63.7	37.5	26.0	21.7
35	27.6	20.9	62.1	38.0	25.7	20.8
40	27.8	20.9	60.4	36.1	25.7	20.8
45	28.1	18.7	58.9	36.8	25.9	20.7

25-Oct-90 04:20 PM

File: 20 of 20 C:\UP\RAMCACHE.WKS Lotus 1-2-3 30,294 Bytes

Function keys: F1 Help, F2 Copy, F3 Delete, F4 Print, F5 Gather, F6 Sort, F7 Launch, F8 Zoom, F9 Explore, F10 Quit

Magellan presents a list of files and directories in the left window, and a display of file contents in the right window, in this case a 1-2-3 spreadsheet. The program includes viewers for many common graphics, word-processing, spreadsheet, and database programs.

display TIFF and MAC graphics files, and Word For Windows text files. However, if Magellan has no viewer for a file, generic text and hex/ASCII viewers are always available. Here's one extremely convenient function: If you highlight a ZIP or ARC file, Magellan displays a list of the contents of the file. Even better, Magellan can display files embedded in ZIP files (in their native formats).

Of course, Magellan does much more than simply display files. For example, you can use the program to copy, move, and delete files, make and remove directories (unlike DOS, Magellan allows you to remove non-empty directories, something I previously used a separate utility to do), rename files and directories (again, DOS won't do this, so another utility is required), and compare files and directories. The compare function is weak; for example, if you compare directory A to directory B, and B has files not in A, Magellan won't tell you unless you also compare B to A.

I normally perform tape backups on a weekly basis, and backups to floppy daily. There is nothing wrong with my floppy backup program. However, Magellan will allow me to define backup sets that include multiple drives. Scratch another stand-alone utility.

Magellan has a highly useful File Undelete command: Using a special deleted-file viewer, Magellan can show you the contents of a file before you undelete it. However, you can't get in at the track and sector level, so don't throw away your Norton utilities.

ADVANCED FEATURES

Magellan not only lets you view and manipulate

Vendor Information
 Magellan 2.0 (\$139)
 Lotus Development Corp.
 55 Cambridge Parkway
 Cambridge, MA 02142
 Tel. (800) 635-8887, (617) 577-8500

your files, the program also helps you locate them in the first place. When you first load Magellan, the program creates a list of all files on all attached disk drives. You can sort that list by name, time/date, extension, size, and several others. That way you could find all PCX files, all ZIP files, all BAT files, etc. In addition, the Path command allows you to limit the file names that are displayed in the list. For example, you could specify C:*.*BAT to list all BAT files on drive C. Or you could specify *.*.*BAT to list all BAT files on all attached drives. You can also include multiple file specifications, so to view all program files on all attached drives, you'd give a file spec like this: *.*.*BAT *.*.*COM *.*.*EXE.

The most powerful way of locating files is by indexing them. Creating an index takes time and disk space, but if you need to locate text files by their contents, indexing is well worth it.

Another extremely useful command is Gather, which lets you capture information displayed in the list screen or any non-graphical viewer and print it or save it to a disk file.

Magellan includes a powerful macro facility that lets you record macros and subsequently edit them. In fact, Magellan uses macros to provide an on-line tutorial. The printed documentation is excellent; it includes quick-start instructions, a full reference guide, and an Idea Book that makes excellent suggestions for using Magellan to accomplish difficult or unusual tasks.

Be an FCC LICENSED ELECTRONIC TECHNICIAN!



Earn up to \$30 an hour and more!

Learn at home in spare time. No previous experience needed!

No costly school. No commuting to class. The Original Home-Study course prepares you for the "FCC Commercial Radiotelephone License." This valuable license is your professional "ticket" to thousands of exciting jobs in Communications, Radio-TV, Microwave, Maritime, Radar, Avionics and more...even start your own business! You don't need a college degree to qualify, but you do need an FCC License.

No Need to Quit Your Job or Go To School
 This proven course is easy, fast and low cost! **GUARANTEED PASS**—You get your FCC License or money refunded. **Send for FREE facts now. MAIL COUPON TODAY!**

COMMAND PRODUCTIONS
 FCC LICENSE TRAINING, Dept. 100
 P.O. Box 2824, San Francisco, CA 94126
 Please rush FREE details immediately!

NAME _____
 ADDRESS _____
 CITY _____ STATE _____ ZIP _____

FREE CATALOG

Call (800) 992-9943

Over 35,000 Electronic Components

Call Today for Your FREE SUBSCRIPTION

If You Order Today, WE SHIP TODAY!!



MOUSER ELECTRONICS

(800) 992-9943

Stocking Locations Across America.

CIRCLE 8 ON FREE INFORMATION CARD

FUN SOFTWARE

By Fred Blechman

Hardware Helpers for Software Fun

This month we'll be discussing some special hardware—a trackball and a sound board. You may not have either of these yet, but both are probably in your future if you are seriously into entertainment software.

We'll also look into a form of fun enjoyed by millions of people—collecting coins, stamps, comic books, and sports cards—and see how one software company has carved out a niche supplying quality computer software for this market.

And we'll end up with information on some hot new fun software!

MICROSPEED'S PC-TRAC TRACKBALL

In the late 1970's, arcade games like Centipede, Millipede, Missile Command, and others used joysticks and rheostats for controls.

In the early 1980's, when personal-computer graphics software began to emerge, existing trackballs were neither cost competitive with mice nor well suited for the available software applications. They didn't have the necessary input buttons, high precision, software drivers, and interface compatibility.

That has since changed. All sorts of trackballs have made their appearance in the last few years. Those trackballs compete with other pointing devices such as mice, joysticks, and graphic tablets. Keyboards are still necessary for most applications, but most keyboard functions involving cursor movement are more easily and quickly accomplished with a pointing device.

But what are the advantages of a trackball compared a mouse, which is its closest competitor for most applications? Moving a trackball involves only the fingers, eliminating the repetitive arm and wrist motions that can lead to fatigue and distress. A trackball only requires a small space on your work surface, and you always know exactly where it is. Furthermore, the fingertip operation of a trackball greatly enhances cursor control, making precise placement of the cursor faster and easier. When you press a button there is no annoying "creep" caused by inadvertent hand movement. The trackball is also an ideal pointing device for users with reduced hand and arm functionality, such as stroke or arthritis victims.

Our concern here, however, is how a trackball

might be used in a game environment. The sad fact is, most can't! Unless the game specifically enables the option of mouse control, most trackballs are not usable. However, if the program does allow the use of a mouse, you can sometimes plug in a trackball in place of the mouse and it might work.

Microspeed's PC-TRAC trackball overcomes most trackball objections with several special features. The physical size and location of the three buttons allows use by both left and right-handed people. The ball is large for more precise control. A center button may be used as a drag-lock. PC-TRAC claims to be 100% Microsoft-Mouse compatible, making it interchangeable with a mouse in many applications.

Microspeed includes a program called "Keymap" with PC-TRAC that allows you to create "templates" to trap keyboard strokes and convert them into trackball inputs. And, just to prove the templates work, over twenty of them are included with PC-TRAC to allow the trackball to replace keyboard input for many popular application programs, including Spectrum Holobyte's extremely popular Tetris and Welltris games!

In fact, that is what got my attention. Marked packages of PC-TRAC actually contain a full copy of Welltris, with manual and registration card, at no extra charge! Although the list price for all but the bus version of PC-TRAC is \$119, the "street price" is around \$89 for the serial, InPort, and the PS/2 versions, with

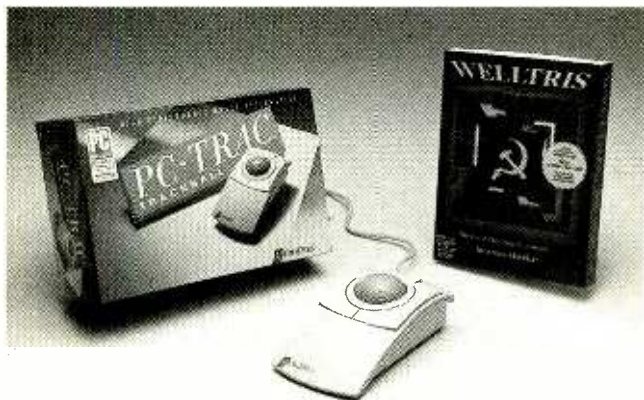

The PC-TRAC Trackball from Microspeed can improve playing fun for those games that can support it. One such game is Welltris from Spectrum Holobyte.

Eventually, those types of controls were replaced by trackballs for high-speed cursor positioning. Home versions of these games soon followed, using low-resolution (15- to 30-dots-per-inch) trackballs.

the bus version costing about \$40 more.

I used the serial version to control Electronic Arts' "Stormovik" flight simulator, which I reviewed in last month's column. I selected the mouse-control option, but plugged in the PC-TRAC instead. After some wild gyrations I got accustomed to the use of the trackball and it was entirely usable, though (probably because of my fighter-flying experience) I still preferred a joystick. However, using the included Keymap templates, the PC-TRAC worked like a charm with Tetris and Welltris, and I found the trackball much more comfortable to use for these games than a keyboard.

This led me to create a template to use with Spectrum Holobyte's "F.A.C.E.S."—but for some reason it didn't work. Apparently, while Keymap is intended to convert trackball movement to program keystrokes (which you specify when creating the template), the application program is expected to behave in a certain manner, and F.A.C.E.S. doesn't.

PC-TRAC can add a whole new dimension to your software. I found it worked easily, and usually more effectively than a mouse, in conventional software applications. With entertainment software, if the program uses a mouse, PC-TRAC should be able to work as a substitute. If common keyboard commands are used, a template made with Keymap will probably (but not always) convert the keystrokes to trackball action.

(Microspeed Inc., 44000 Old Warm Springs Blvd., Fremont, CA 94538, Tel. 415-490-1403. IBM PC serial, PS/2, and InPort versions \$119; bus version \$139. Serial version tested on 12MHz 286 AT clone with VGA.)

CIRCLE 137 ON FREE INFORMATION CARD

AD LIB MUSIC SYNTHESIZER CARD

Part of the overall effect when playing a game is the sound. The IBM PC is one of the weakest performers among personal computers in its inherent sound-generation capabilities. The built-in tiny speaker is supported by meager circuitry, so most games sound puny when played on a PC.

To add better sound and to provide the PC with true musical composition and playback ability, several manufacturers offer special plug-in sound boards. Typically, these are simply installed inside the computer the same way as any other add-on board, by just pushing it down into an empty slot.

Perhaps the best-selling and best-supported (in terms of software) of these boards is the Ad Lib Music Synthesizer Card. Dozens of game-software developers now offer Ad Lib sound as an included option in their programs.

This half-length card fits into any 8- or 16-bit PC slot, and requires no external power. You plug a monaural or stereo speaker system, headphone, or amplifier into a rear phone jack, and a knob on the back of the board controls the volume.

There is no trick to using the board; all you need is the software to drive it. A "Juke Box" program is included on a diskette that comes with the board. It plays 17 synthesized tunes, none of which I recognized (but perhaps that shows my advanced age).

Almost all new entertainment programs, and many older ones, provide Ad Lib drivers within them. Some require you to select the Ad Lib sound option, others simply find the board installed and automatically route all sound to it.

In all cases where the Ad Lib board is supported by the program in use, the sound is drastically improved. Even if you are not a hi-fi enthusiast, you won't be able to overlook the effect of having full sound as compared to the normal PC beeps and tinny tones. Flight simulators, which happen to be my particular passion, suddenly become even more authentic. The engine sounds, the fire-power, the inevitable crashes—and the "raspberry" frequently used to tell you how badly you've done—are far more faithfully reproduced, adding to the overall sensations of the simulation. Sound, after all, is one of the five acknowledged senses.

If you are a musician, this board (which can play up to eleven instruments at once) and various software music composition packages offered by Ad Lib will be of particular interest.

(Ad Lib Inc., 50 Staniford St., Suite 800, Boston, MA 02114, Tel. 800-463-2686. IBM PC or compatible, 256K RAM, DOS 2.0 or higher, CGA, EGA, or MGA. Suggested retail price: \$179.95)

CIRCLE 138 ON FREE INFORMATION CARD

PROGRAMS FOR COLLECTORS

Many millions of people around the world are collectors. They collect everything from butterflies to bottlecaps for entertainment, and sometimes for investment. Although the closest I come to this is my "collection" of about 12 personal computers, most find fun in collecting stamps, coins, comic books, and sports cards. In particular, baseball-card collecting has become pervasive, with other sports cards gaining ground.

The fun is in the collecting, trading, and selling. The

less-fun part, for most, is the record keeping of what you have, where you got it, what you paid for it, what it's worth, and which ones are missing to complete a set. What better way to keep track of all this than with a computer?

The problem with using a computer is the effort it takes to enter information about your collection, and then retrieving it. Virtually any database program can be used to some advantage, but a program that is properly custom-designed for your particular application is going to be the most effective.

Compu-Quote started out in 1982 with a program called COINS for (you guessed it!) coin collectors. The big features of this program, now called COINS/PLUS, are fast data entry (even for multiples of the same coin, or a series sequence) and a database of prices for 2300 U.S. coins in various conditions. Also, a "wantlist" can be created automatically.

COINS was followed by STAMPS, with versions for several countries, and then CARD/FAX for baseball-card collectors. Most recently, Compu-Quote has released Comickeeper for comic-book collectors.

All the programs share the common elements of full-screen data entry and a valuation database, with periodic valuation updates. There are versions for IBM, Apple, and Macintosh, though not all of the programs are available for all machines. If you need more information, I suggest you call their toll-free phone number and request their 28-page illustrated catalog. It's free! (Compu-Quote, 6914 Berquist Ave., Canoga Park, CA 91307. Tel. 800-782-6775.)

CIRCLE 139 ON FREE INFORMATION CARD

(Continued on page 90)

DX LISTENING

By Don Jensen

Radio Fare From Down Under

It's no less amazing today than it was in shortwave radio's infancy, more than six decades ago. A radio signal can span the world, skip across oceans and continents from Australia to North America in less than a second!

There's something—and surely distance has much to do with it—about tuning in Australia that has intrigued shortwave listeners since the early days of international broadcasting. Today, *Radio Australia* continues to have a special place in the hearts of SWLs. Whatever



Two well known DX'ers, Bill Matthews, Columbus OH (left), and Gerry Dexter, Lake Geneva WI, relax during a national gathering of shortwave-listening enthusiasts.

time it is, this "Down Under" broadcaster is on the air in one of nine programming languages, bringing Australian news, entertainment, education, and information to millions of listeners around the globe.

Australia's international broadcasting began with experiments by the then

*Credits: David Swaringen, NC; Michael Olson, CA; Rufus Jordan, PA; John Prath, FL; North American SW Association, 45 Wildflower Road, Levittown, PA 19057

Postmaster General's Department as early as the 1920's. By the 1930's, test broadcasts on shortwave were going out from transmitters at Lyndhurst, Victoria, near Melbourne. The stations carried regular AM medium-wave broadcasts of the Australian Broadcasting Commission to remote parts of the Outback, and to the more distant Pacific islands.

International broadcasting became a practical reality in 1939, when spurred by the outbreak of war in Europe and China, worldwide communication took on a greater importance. The "Australia Calling" service on SW was aired then by 10-kilowatt stations at Lyndhurst and Sydney.

When the war reached the Pacific, there was a new urgency in reaching international audiences. A high-powered—for its day—50-kilowatt transmitter began operations from Shepparton, which is about 200 km north of Melbourne, in 1944. Soon the new site had an additional pair of shortwave stations, each outputting 100-kilowatts. Today there are six such stations, in addition to one 50,000-watt unit.

The 1960's brought a second international-broadcasting site on the air, this one near Darwin in northern Australia. But that transmitting station was devastated by Cyclone Tracy in 1974. It took 10 years and \$10 million to rebuild the Darwin facility, which now has three 250-kilowatt SW transmitters.

The third Radio Australia station, located at Carnarvon on the central coast of West Australia, began oper-

ations in 1976, initially as a replacement for the destroyed Darwin facility. Now it uses a 300-kilowatt French-built transmitter, the most powerful of the Radio Australia stations, plus 250- and 100-kilowatt units. Darwin and Carnarvon are links in RA's broadcasts to the Asian mainland, an important target area.

Responsibility for the transmissions belongs with Telecom Australia, acting as an agent of the Australian Department of Transport and Communications. They are responsible for designing, constructing, operating, and maintaining the service's broadcasting facilities.

Radio Australia's fourth transmission center began operating in 1989, with the opening of an interim facility at Brandon, near Townsville. It uses the three 10-kilowatt shortwave units, formerly located at Lyndhurst, which was shut down the previous year. One of its main purposes is to provide quality signals over medium distances, specifically to the near-Pacific and Papua New Guinea.

Telecom's establishment of the Brandon station brought Radio Australia's shortwave-transmitter network to 16, which, collectively, are on the air about 1,600 transmission hours weekly.

Radio Australia is not a difficult SWL catch in North America. As of this writing, some of the best times and places to hear this one, in English, were 0200 to 0400 UTC on 17,795 and 21,740 kHz; 0830 to 1500 UTC on 9,580 kHz, and 2200 to 2400 UTC on 21,740 kHz.

You can address your reception reports, or write for updated schedule information, to Radio Australia, P.O. Box 428G, G.P.O., Melbourne, Australia 3001.

BACKTALK

Do you have any questions about SWL'ing, stations you're looking for, or how-to-do-it queries; any comments about this fascinating listening hobby; or tips on SW stations you're hearing lately? Why not drop a line to *DX Listening*? Our address is **Popular Electronics**, 500-B Bi-County Blvd., Farmingdale, NY 11735.

The first letter this month comes from Art Bassingdale, Miami Beach, FL, who asks about the World Service of the *British Broadcasting Corporation*.

"I hear the BBC on many frequencies, day and night. I know that while these English-language programs originate in London, they're not all broadcast from transmitters in Great Britain. Some are relayed from shortwave transmitters elsewhere in the world. Where are some of these signals really coming from?"

Yes, Art, the BBC has an extensive system of relays to provide good signals to listeners throughout the world. Some are from BBC-operated shortwave relays. Others utilize leased, or swapped, air time on other international broadcasting stations, such as the *Voice of America* and *Radio Canada International*.

In answer to your question, though, here are some of frequencies and times of BBC World Service programming and the corresponding transmitter locations: 5,975 kHz: 0000-0600 UTC, Antigua, West Indies; 6,175 kHz: 0000-0300 UTC, Radio Canada International, Sackville, New Brunswick, Canada; 7,325 kHz: 0000-0300 UTC,

United Kingdom; 9,740 kHz: 1200-1500 UTC, Singapore; 15,400 kHz: 2100-2300 UTC, Ascension Island, South Atlantic; and 21,470 kHz: 1400-1600 UTC, Cyprus.

Bill Markes, High Point, NC, writes: "Hey, Don, did you hear about the guy at *Radio Mogadishu* in Somalia who supposedly wants \$50 before he will QSL their listeners' short-wave receptions? Boy that takes nerve!"

True, Bill. Early last year, SWL's who had sent reception reports to this East African shortwaver did get replies from a Mohammed Hassan Had, supposedly a station official, who demanded payment before he would verify loggings. A German DX'er complained and, months later, got another reply from another official. Mohammed Hassan Had, this fellow wrote, was an impostor whose attempted scam "tarnished the image of our station." No payment is needed for a QSL from Radio Mogadishu, the second letter-writer said. But Radio Mogadishu now seems to be off the air, so maybe it's all a moot point.

DOWN THE DIAL

Next let's look at some SW catches being reported by North American shortwave listeners.

JORDAN—13,655 kHz. *Radio Jordan*, broadcasting from Amman, is heard in Arabic before 1100 UTC. Then following a nine-note tuning signal, the program continues in English.

PORTUGAL—9,705 kHz. *Radio Portugal* is noted here in English at 0245 UTC with a program for stamp collectors.

SWEDEN—21,500 kHz. *Radio Sweden International* has been logged on this frequency at 1530 UTC, with Swedish rock, interviews, a mailbag program, and the news. ■

Enter A World Of Excitement with a Subscription to Popular Electronics

Get the latest electronic technology and information monthly!

Now you can subscribe to the magazine that plugs you into the exciting world of electronics. With every issue of *Popular Electronics* you'll find a wide variety of electronics projects you can build and enjoy.

Popular Electronics brings you informative new product and literature listings, feature articles on test equipment and tools—all designed to keep you tuned in to the latest developments in electronics. So if you love to build fascinating electronics, just fill out the subscription form below to subscribe to *Popular Electronics*... It's a power-house of fun for the electronics enthusiast.

EXCITING MONTHLY FEATURES LIKE:

- **CONSTRUCTION**—Building projects from crystal sets to electronic roulette
- **FEATURES**—Educational training on digital electronics, Ohm's Law, Antennas, Communications, Antique Radio, Simplified Theory
- **HANDS-ON-REPORTS**—User test comments on new and unusual consumer products
- **SPECIAL COLUMNS**—Think Tank, Circuit Circus, Computer Bits, DX Listening, Antique Radio, Amateur, Scanner Scene

PLUS: ALL OUR GREAT DEPARTMENTS!

You'll get 12 exciting and informative issues of *Popular Electronics* for only \$18.95. That's a savings of \$16.45 off the regular single copy price. Subscribe to *Popular Electronics* today! Just fill out the subscription order form below.



Save 46% OFF THE REGULAR ADVERTISING RATE

FOR FASTER SERVICE CALL TODAY
1-800-435-0715
(7:30AM-8:30PM)
EASTERN STANDARD TIME

Popular Electronics SUBSCRIPTION ORDER FORM

P.O. Box 338, Mt. Morris IL, 61054

YES! I want to subscribe to *Popular Electronics* for 1 Full year (12 issues) for only \$18.95. That's a savings of \$16.45 off the newsstand price.

PLEASE PRINT BELOW:

Payment Enclosed Bill me later
Please charge my: Visa Mastercard

NAME _____

ADDRESS _____

Acct. # | | | | | | | | | | | | | | | | | | | | | |

CITY _____ STATE _____ ZIP _____

Signature _____ Exp. Date _____

Allow 6 to 8 weeks for delivery of first issue. U.S. Funds only. In Canada add \$1.00 postage. All other countries add \$1.50 postage.

Make the most of your general coverage transceiver with *Monitoring Times!*

Every month *Monitoring Times* brings everything you need to make the most of your general coverage transceiver: the latest information on international broadcasting schedules, frequency listings, international DX reports, propagation charts, and tips on how to hear the rare stations. *Monitoring Times* also keeps you up to date on government, military, police and fire networks, as well as tips on monitoring everything from air-to-ground and ship-to-shore signals to radioteletype, facsimile and space communications.

ORDER YOUR SUBSCRIPTION TODAY before another issue goes by. In the U.S., 1 year, \$18; foreign and Canada, 1 year, \$26. For a sample issue, send \$2 (foreign, send 5 IRCs). For MC/VISA orders (\$15 minimum), call 1-704-837-9200.

MONITORING TIMES

Your authoritative source, every month.

P.O. Box 98
Brasstown, N.C. 28902

HAM RADIO

By Joseph J. Carr, K4IPV

Collecting Antique Ham Gear

One of the many interesting aspects of amateur radio, and one that is indulged by increasing numbers of hams, is collecting antique ham gear. Or, excuse me, in order to stay in context ...antique "wireless" communications equipment. Although my own modest collection includes a lot of non-ham gear, I also have a number of different ham rigs.

Collecting old radios extends way beyond amateur

the country, the season never really ends; the mammoth Dayton Hamfest is nearly on us. Next month, the hamfesters really get serious, and bargains come out of basements and garages.

The happy hunting grounds for antique ham-gear collectors is the old-fashioned hamfest. "Tail-gaters" and table-gaters (Fig. 1) abound, and their selection is both highly variable and enticing. Every hamfest has a different se-

antique-radio market. Figure 2 shows a World War I vintage receiver owned by a friend of mine. That gem probably costs a pretty penny, but some similar models may show up on the market at a cost that is quite attractive. Radios of that sort may be a simple crystal set with a vacuum-tube audio amplifier to boost the sound. Or it may be a regenerative detector and audio amplifier.

One of my own units is shown in Fig. 3. That radio is a tuned radio-frequency (TRF) model made in the mid-1920's. It has a nice wooden cabinet that looked a whole lot nicer after I stripped and re-finished it. There are a lot of different TRF radios on the market, although most of them are not communications receivers. In fact, a lot of ham-radio receivers were homebrew, or kit built, and are therefore a bit cheaper than factory-built radios.

When you get into the 1930's, the sophistication of radio receivers begins to increase. Those radios look and feel a whole lot like post-WWII radios, although the tube line up will be different. By the late 1930's, crystal filters, bandspread controls, and other niceties were routinely used on amateur-radio rigs. Also available from that era are commercial and maritime radio equipment. Brand names to look for include Hammarlund (HQ-100, HQ-120, HQ-129), Hallicrafters (S-20R, S-40B, SX-28), National (NC-1, HRO), RCA Radiomarine, McMurdo-Silver, and others.

Some models may be both pre-WWII and post-



Fig. 1. Scene from Gaithersburg Hamfest, 1990. Antique ham-gear collectors find much to choose from at an old-fashioned hamfest, where "tail-gaters" and table-gaters abound, and their selection is both highly variable and enticing.

radio, as the popularity of Mark Ellis' *Antique Radio* column attests. But hams have a slight advantage. Although anyone can collect both receivers and transmitters, licensed hams can put the transmitters on the air (in most cases)—but don't try it with a spark-gap rig!

ANTIQUE HAM GEAR

It is now April, and the hamfest season has already started in some areas of the country (in fact, with the various Winterfests around

lection, although there is a certain similarity from one year to the next. In some cases, you will see the same rigs at successive hamfests. That situation may indicate that the guy didn't sell it last time, or that he bought it and someone is making him resell it—fast (XYL's have a habit of viewing hamfests as playing a game of musical electro-junk).

WHAT'S OUT THERE

A wide variety of equipment can be found on the

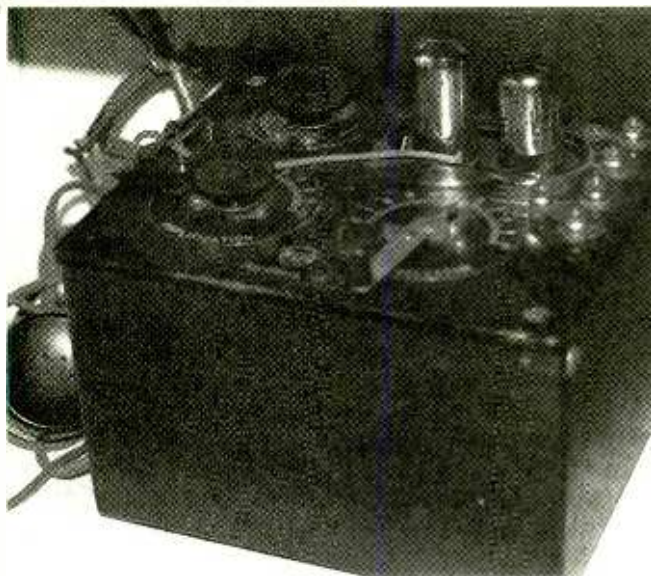

Fig. 2. A wide variety of equipment can be found on the antique-radio market. This World War I vintage receiver (circa 1919) likely costs a pretty penny, but some similar models may show up on the market at very attractive prices.

WWII, depending on the design. The Hallicrafters SX-28, for example, is available in three configurations. The straight SX-28 is a pre-war design, and used phenolic coil forms (which caused a little bit of temperature-sensitive frequency drift). The SX-28A, on the other hand, was built after World War II. It used ceramic coil forms and that improved the thermal drift a great deal.

During World War II, there was a military model that was part of a communications truck. The truck was a "deuce-and-a-half" (2½ tons, for you non-military types) that included a BC-610 transmitter, two SX-28-series receivers (two operating positions), and

had a 5000-watt power generator towed along behind.

After World War II, a new series of tube-type receivers was built, although many of the designs were the same as pre-war receivers. By the mid to late 1950's, receivers such as the Hallicrafters SX-100 (Fig. 4) were available. Those receivers used glass-envelope miniature vacuum tubes.

The type of vacuum tubes used in the radio receiver will give some hint as to the age of the unit. Figure 5 shows several types of older vacuum tube. Shown are the glass envelope four and five pin tubes used in the early to late 1920's. The four-pin tubes were triodes,

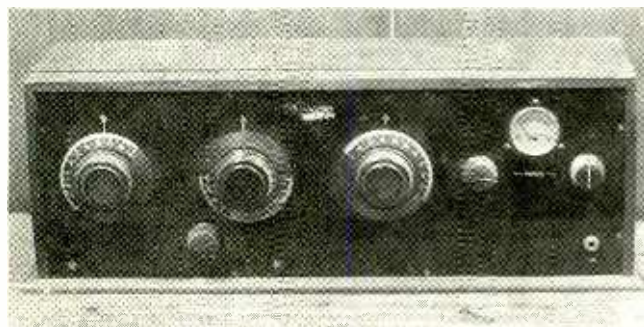

Fig. 3. This 1920's vintage tuned radio-frequency (TRF) receiver has a nice wooden cabinet. Many TRF radios on the market are not communications receivers.

while the five-pin tubes were mostly tetrodes. By the early 1930's, tubes like those shown in Fig. 6—some having a grid cap on the top of the glass envelope—began to appear. Most of them were four-, five-, six-, or seven-pin types.

CAUTION! Receiving tubes have a grid cap, and some people believe that it is safe to test the radio by touching the grid cap.

DON'T DO IT! If the coupling capacitor is shorted, a high voltage may be present at that point. Also, if the tube is a transmitting type, then the cap is not a "grid cap," but rather it is a high-voltage plate cap and can deliver quite a jolt!

evenly spaced pins that are all the same size. The keyway on the prong is what guides the tube correctly into the socket. Octal tubes that have a type number beginning with "6" have 6.3-volt filaments, while type numbers beginning with "12" are 12.6-volt filament types.

There is another version of the octal socket that had eight pins, as other octals, but the pins are wire-like. The center prong on the base is specially designed with a groove that fits into a locking socket. Thus, such tubes are called *locktal* tubes. Most locktal tubes have type numbers that begin with a "7."

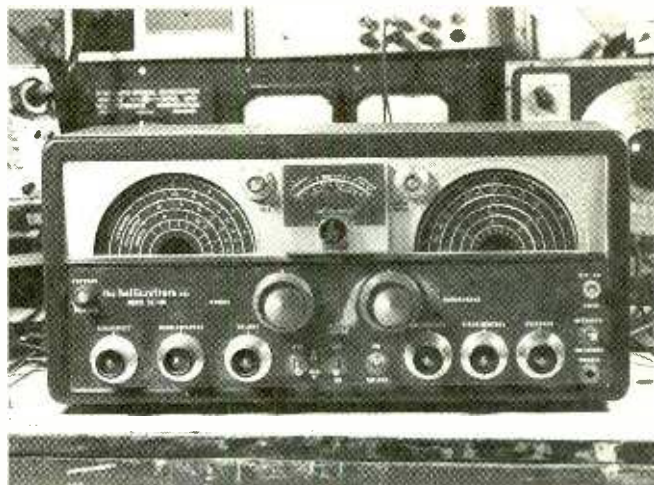

Fig. 4. By the mid to late 1950's, receivers such as this Hallicrafters SX-100 receiver, which used glass-envelope, miniature vacuum tubes, were available.

In the mid-1930's, the octal tube (see Fig. 7) became available. Some of the early types were glass envelope tubes, while later versions were metal envelope (as shown). The key feature is eight pins on the base of the tube. Those units have a plastic prong (or a small ridge) on the bottom of the base that serves as a keyway. That keyway matches a slot on a hole in the accompanying socket.

Older tubes used a pair of large pins to mark pin 1 and the higher numbered pin. But octal tubes have

For factory-built rigs, the tubes serve as a ready guide to the approximate era of manufacture. Those tubes also indicate the earliest that a homebrew rig could have been built. But hams often used older tubes than the "state-of-the-art," so a receiver could have been built in the mid-1930's, but use four-pin tubes of ten years earlier.

So far, we have talked mostly about ham-radio receivers. Transmitters are also on the market, and often at prices that are less than the equivalent re-

(Continued on page 92)

SCANNER SCENE

By Marc Saxon

Hello "New-Age Scanner," Goodbye "Old Warhorse"

What better way to swing into spring than with a new scanner—especially one that has 2,000 memory channels. A good example is the *AR-2500* from Ace Communications, one of those new-age scanners with all sorts of exotic features.

The AR2500's frequency coverage begins in the HF band at 5 MHz and runs all the way up to 1,500 MHz,



A scanner for the 90's, the AR2500 from ACE Communications offers 2000 memory channels and a built-in serial interface for computer control.

with user-selectable tuning increments of 5, 12.5, and 25 kHz. A BFO is included for tuning SSB and CW communications. The AR2500 is capable of scanning 62 banks of 32 frequencies each, for a total of 1,984 channels. An additional 16 memory locations are set aside for beginning and ending search-limit frequency pairs. Band 1 can be designated as a priority bank, which gives a higher priority to as many as 32 different frequencies. The scan rate of 36 channels

(or search increments) per second will automatically slow to compensate for tuning lags if adjacent frequencies are more than 30-MHz apart.

Its sensitivity is rated at better than 0.35 μ V (about 12 dB SINAD) in FM mode, and better than 1.2 μ V (for 10 dB S/N) in AM mode. A built-in RS-232 interface device allows the AR2500 to be controlled or programmed by any computer with a standard serial port. An optional software package is available to handle frequency databases and even to provide spectral analysis graphics.

The AR2500 carries a manufacturer's suggested retail price of \$499. It comes from ACE Communications Monitor Division, 10707 East 106th Street, Indianapolis, IN 46256. The telephone number is 317-842-7115. It's a fine-looking scanner, in our opinion.

SHIP SHAPE

If you're lucky enough to be within monitoring range of the nation's busiest harbors, you might want to put an ear on the channels used for the Coast Guard's Vessel Traffic Services (VTS) activities. VTS is an advisory service to coordinate vessel movement and prevent collisions in high ship-traffic areas. Vessels report information related to position, navigation, and any conditions affecting their ability to navigate. The Coast Guard maintains communications with those vessels (primarily tankers, cargo ships, passenger liners, and

naval vessels, rather than small craft) and tracks their positions and movements.

In ports where VTS is in operation, certain frequencies are dedicated exclusively to VTS use. In Seattle, VTS operates on 156.25 and 156.70 MHz. Houston uses 156.55 and 156.60 MHz. New York City recently reactivated its VTS activities and is utilizing 156.55, 156.60, and 156.70 MHz. New Orleans had VTS at one time, but it was (perhaps temporarily) discontinued due to a lack of funds. In the event that VTS does go back into service in New Orleans, it will again be found on 156.66, 156.60, and 156.70 MHz.

There are some interesting communications to be heard—somewhat like the maritime equivalent to airport-control towers. VTS has never received much exposure, so here's your chance to tune in now.

OLD WARHORSE

It's amazing how many old Bearcat 250 scanners are still in operation—and how much mail we receive asking about possible modifications, service problems, etc. for the units. To put it as gently as possible, so as not to hurt anybody's feelings or insult their venerable BC-250's, those were fantastic scanners ... about ten years ago. Today they are just tired, old, outmoded radios that can't be modified or updated. In many cases, they can't even be repaired because certain critical chips they require are no longer available. The 450-MHz band can't be

programmed to accept 12.5-kHz offset frequencies, which makes the scanner virtually useless today for monitoring that band (or for use with an 800-MHz converter).

We have a BC-250, too. We treat it with the kindness and respect it deserves, but we haven't considered it our first-line scanner for many years. We wouldn't invest a nickel into fixing the set, however, should it suddenly sputter out a message and go silent.

HANDY HANDHELD

Michael Herman, of New York City, writes to say that he's been unable to locate the frequency used by NYC firefighters when they're using handheld transceivers to communicate with one another at fires. He asks if we can help.

The primary fire-ground frequency of the NYFD is 153.83 MHz. The secondary fire-ground frequency is 153.89 MHz, which is also the input frequency for the citywide repeater (154.43 MHz output).

The handheld units have a somewhat limited transmitting range, so unless you're within a mile or two, or have an exceptionally high antenna, you're not going to hear much. The NYFD uses satellite receivers placed at many areas throughout the city to feed the 153.89-MHz transmissions into its repeater.

In fact, Michael also asks about increasing his monitoring range with his handheld scanner. He mounted an antenna outside his apartment but found that it didn't bring in stations as well as the scanner's own rubberized whip antenna. Our suggestion would be to stick with the rubberized whip, especially if it's a high-performance type, and then enhance things with a scanner pre-amplifier. The GRE America

Super Amplifier is made for use with handhelds and provides user-adjustable signal boosting up to 20 dB between 100 and 1,000 MHz. The device is effective, relatively inexpensive, and generally available to scanner owners from leading stores and mail-order suppliers. We've had a preamplifier on our handheld scanner for well over a year, and have found that it brings in many stations that would otherwise have been missed.

The Super Amplifier is small and is powered from its own internal 9-volt battery. When you switch it off, the circuit is bypassed and the scanner returns to normal operation, which means that you can leave it connected at all times. The device attaches in seconds to any handheld scanner that has a BNC-type antenna connector. All you do is unscrew the rubberized whip from the scanner and screw it onto the pre-amplifier. Then you screw the preamplifier onto the scanner's antenna connector. No tools, no internal connections, no fuss, no muss, and no technical expertise required. It's a very clever gizmo that turns a handheld into a real tiger.

We'll be back next month with more news from the world of scanners, and we hope you'll be here with us. We're always looking for any questions or comments you may have. Our address is **Scanner Scene, Popular Electronics**, 500-B Bi-County Blvd., Farmingdale, NY 11735.

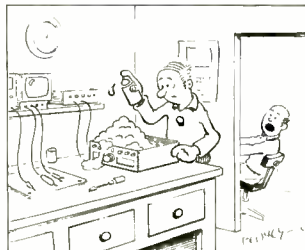

"Hey Phil, have you seen my can of whipped cream?"

ATTENTION! ELECTRONICS TECHNICIANS



EARN YOUR B.S.E.E. DEGREE

THROUGH HOME STUDY

Our New and Highly Effective Advanced-Placement Program for experienced Electronic Technicians grants credit for previous Schooling and Professional Experience, and can greatly reduce the time required to complete Program and reach graduation. No residence schooling required for qualified Electronic Technicians. Through this Special Program you can pull all of the loose ends of your electronics background together and earn your B.S.E.E. Degree. Upgrade your status and pay to the Engineering Level. Advance Rapidly! Many finish in 12 months or less. Students and graduates in all 50 States and throughout the World. Established Over 40 Years! Write for free Descriptive Literature.

COOK'S INSTITUTE OF ELECTRONICS ENGINEERING

 4251 CYPRESS DRIVE
JACKSON, MISSISSIPPI 39212

CIRCLE 15 ON FREE INFORMATION CARD

Wireless Video Sender 2 (VS2): How You Can Multiply Cable and VCR and Save Money!



VS2 is a wireless home broadcasting system that has just made legal in all 50 states by FCC in 1990. You can save a lot of money with the VS2. There is no need to buy a second VCR or cable box. VS2 multiplies them. VS2 lets you transmit video/audio signal from cable or VCR to any room in your house. Imaging the fun and the many applications you can have with the VS2. You can send your favorite Cable programs or Video from the family room to the TV in your upstairs bedroom, downstairs in the basement, or to the workshop, bobby room, backyard, etc. With a camcorder, you can broadcast a "live" show to your family room, living room, or anywhere in the house that has a TV. Great fun for parties! Turn your camcorder or a security camera and VS2 into a surveillance system. You can watch who is coming to the front door, how baby is doing in the upstairs bedroom, while you work in the kitchen.

If you have two VCRs, you'll find how easy it is to transmit signal from one VCR to another. Now making copies of home videos and other tapes is a snap.

Features:

- VS2 comes with a wireless transmitter and a receiver
- Transmits signals from VCR, cable, satellite receiver, video disc player, camcorder, security camera and more
- 120 ft radius range
- Easy to use and a snap to install
- The best and most exciting wireless video sender
- A/C powered
- Similar units sold elsewhere for \$99 or more
- FCC approved and UL listed—100% Legal!
- 1 year warranty
- Unconditional 30 days Money back guarantee

\$79.95
(\$6 P&H)

To Order: **1-800-445-9285** or **516-568-9850**
Visa/MC, COD, Money Order M-F: 9-6
Zentek Corp. Dept. SPE 4
581 W. Merrick Rd. Valley Stream, NY 11580

CIRCLE 20 ON FREE INFORMATION CARD

WATCH ^{FOR} THIS ISSUE ON SALE MARCH 5

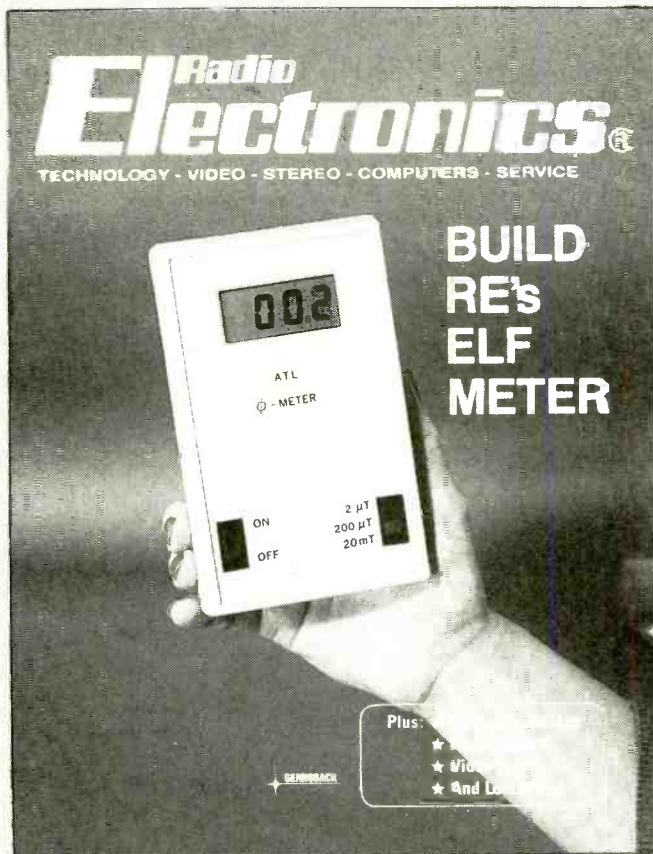

OUR APRIL ISSUE FEATURES:

BUILD A MAGNETIC-FIELD METER

Determine your exposure to ELF magnetic fields.

BUILD A 40-WATT POWER INVERTER

Converts 12 volts DC to 120 volts AC.

BUILD A VIDEO TELEPHONE

Add a new dimension to your phone calls.

BUILD YOUR OWN ROBOT

And learn how to use stepper motors in the process.

INSIDE SWITCHING POWER SUPPLIES

The basics of switching regulator circuits.

**PLUS: Hardware Hacker
Audio Update**

**Video News
And lots more!**

FUN SOFTWARE

(Continued from page 83)

NEW FUN SOFTWARE

Here are some recently announced programs you can order from your regular software supplier:

"The Price is Right" (GameTek, IBM/Commodore/Apple, \$14.95) tests your shopping skills by having you guess the price of the prize in the opening round, and then moves you on to play one of the 17 special pricing games, just as seen on the popular television show of the same name.

"The Secret of Monkey Island" (Lucasfilm Games, IBM/Amiga/Atari ST, \$59.95) features high-resolution graphics and special animation. A comedy set in the age of Caribbean piracy, the twisty plot leads the hero on a hilarious, complex, swash-buckling search for the fabled secret of Monkey Island.

"Spirit of Excalibur" (Virgin Mastertronic, IBM/Apple/Amiga/Atari ST, \$49.99) combines the best features of fantasy roll-playing games, adventure games, combat simulations, and arcade games. In the richly detailed world of mountains and rivers, townships and cities, and the castles and ruins of medieval England, there are objects to find and puzzles to solve. Knights, lords, wizards, clerics of Camelot, peasants, warriors, nobles, and bandits all interact.

"COMMAND HQ" (MicroProse, IBM, \$59.95) allows you to compete in either World War I or II, or in World War III or other future wars as the Supreme Commander of your military forces. You determine strategy and then move armies, navies, and air power to conquer territories and assimilate nations and resources.

CUSTOM CASES

(Continued from page 66)

Another method for attaching the lid is to glue small blocks to the bottom of the lid, and drill and tap the blocks attached to the lid. Mounting screws are inserted through the sides of the enclosure into the blocks attached to the lid (as shown in Fig. 5) to hold the lid panel in place.

After the enclosure is completed, allow about 24 hours for curing and then carefully file off any rough edges and protrusions. The sharp corner edges can be beveled using a fine-grit sandpaper.

Any plastic battery holders, which are available for all battery sizes from "N" cells to "D" cells, can be cemented to the inside of the enclosure with fast-curing epoxy. Lightly sand the bottom surface of the battery holder and the place where it is to be mounted. That gives the epoxy a better gripping surface. To complete the enclosure, stick-on rubber or plastic feet can be applied to the bottom corners.

This And That. Working with plastics, you will find that new designs for those special projects can be made easily with just a little thought before actually cutting the parts. It's always a good idea to "build" the enclosure on paper first to avoid unpleasant surprises. It should be noted that the specified thickness of plastic sheet is not always true. For instance, an eighth-inch thick sheet may vary as much as 20%. To avoid problems from thickness tolerances, purchase enough of the plastic sheet to make all the parts from the same piece. The piece can then be measured and the dimensions of the enclosure adjusted to take into account variances in thickness.

An extra advantage of the plastic enclosure is that it can be made using colored plastic, so that the finished enclosure doesn't need painting or finishing of any kind. And if your project has a digital readout, the entire top panel can be made of translucent plastic so the readouts can be seen without the need of a cutout window.

Small holes for wires can be drilled without too much pain using standard drill bits. And there are bits designed specifically for plastics work, which have long tapered tips (similar in shape to a tapered reamer), and will not grab as it goes through the sheet. ■

ELECTRONIC FISHING LURE

(Continued from page 40)

The battery should be held in place by the clip. If not, remove the battery and adjust the bends at points A and B so that when the battery is slipped into place, it "clicks." Once you have the battery clip working correctly test the assembly. To test it, simply tie it to a string and spin it around. Make sure there are no breakables or anyone else in the room. If the battery doesn't fly out, you've made a good clip and can continue on to complete the lure, if not adjust the bends until you get it right.

Take a 1/2-inch piece of 1/4-inch wide cellophane tape and wrap around the wire as shown in Fig. 1 at the point labeled "insulator." Make the wrap several layers thick. Next wrap the negative leg of the LED or the micro lamp around the cellophane-tape insulator. Flow some solder on the windings on the side that contacts the battery. Solder the other wire to the clip just beyond the cellophane-tape insulator.

The lamp or LED can be mounted to face in a variety of directions—for example, pointing directly out away from the battery or, perhaps, pointing toward the hook end of the lure. The switch is the essence of simplicity—a thin piece of plastic or film slid between the battery and battery-contact lead of the LED. Cut the plastic or film into a strip about 1/8-inch wide and an inch or two long.

Use. Use the lure as a spinner bait by attaching a treble hook to the loop at point E and your fishing line at the other end. Cast it out, let it sink a little, and reel it in with a jerking motion. If you are a bait fisherman, especially one who likes to fish at night, position the lamp to point towards the loop at point E. Fasten a leader with hook on loop-point E, bait the hook with a live minnow, and your bait will be swimming in the spotlight. ■



AMAZING SCIENTIFIC & ELECTRONIC PRODUCTS

LASERS AND SCIENTIFIC DEVICES

VRL2K	3mw Vis Red Laser Diode System Kit	\$159.50
LLIS1K	Laser Beam "Bounce" Listener Kit	\$199.50
LHC2K	Visible Simulated 3 Color Laser Kit	\$44.50
LC7	40 Watt Burning Cutting Laser Plans	\$20.00
RUB4	Hi Powered Pulsed Drilling Laser Plans	\$20.00
LGU40	1 to 2mw HeNe Vis Red Laser Gun Assembled	\$199.00
LLS1	Laser Life Show - 3 Methods Plans	\$20.00
SD5K	See in the Dark Kit	\$299.50
EML1K	Electromagnetic Coil Gun Kit	\$69.50
MCP1	Hi Velocity Coil Gun Plans	\$15.00
LEV1	Levitating Device Plans	\$10.00
EH1	Electronic Hypnotism Techniques Plans	\$10.00

HIGH VOLTAGE AND PLASMA DISPLAY DEVICES

HVM7K	75,000 Volt DC Variable Output Lab Source Kit	\$149.50
IDG3K	Ion Ray Gun Kit, project energy without wires	\$69.50
NIG9K	12V/15 VAC Hi Dut Neg Ion Generator Kit	\$34.50
EMA1K	Telekinetic Enhancer/Electric Man Assembled	\$99.50
LGSK	Lightning Display Globe Kit	\$54.50
BTC1K	Worlds Smallest Tesla Coil Kit	\$49.50
BTC3K	250KV Table Top Tesla Coil Kit	\$249.50
BTC5	1.5 Million Volts Tesla Coil Plans	\$20.00
JL3	Jacobs Ladder - 3 Models Plans	\$15.00
GRA1	Anti Gravity Generator Plans	\$10.00
PFS20	Plasma Fire Saber Assembled	\$69.50
DPL20	Dancing Plasma to Music and Sounds Assembled	\$79.50

SECURITY AND PROTECTION DEVICES

ITM10	100,000 Volt Intimidator up to 20' Assembled	\$129.50
IPG70	Invisible Pain Field Blast Wave Gen Assembled	\$74.50
PSP4K	Phasor Sonic Blast Wave Pistol Kit	\$59.50
LIS10	Infinity Xmr, Listen in Via Phone Assembled	\$199.50
TAT30	Automatic Tel Recording Device Assembled	\$24.50
VMPM7K	3 Mi. FM Auto Tel Transmitter Kit	\$49.50
FMV1K	3 Mi. FM Voice Transmitter Kit	\$39.50
HDD1K	Homing/Tracking Beeper Transmitter Kit	\$49.50

EASY ORDERING PROCEDURE TOLL FREE 1-800-221-1705
or 24 HRS DN 1-603-673-4730 or FAX IT TO 1-603-672-5406
VISA, MC, CHECK, MO IN US FUNDS. INCLUDE 10% SHIPPING. ORDERS
\$100.00 & UP ONLY ADD \$10.00. CATALOG \$1.00 OR FREE WITH ORDER.

INFORMATION UNLIMITED
P.O. BOX 716, DEPT. PE, AMHERST, NH 03031

It keeps
more than
memories
alive.

THE AMERICAN HEART
ASSOCIATION
MEMORIAL PROGRAM®



American Heart
Association



This space provided as a public service.

APRIL 1991

91

HAM RADIO

(Continued from page 87)

ceiver. We've covered old transmitters in this column before, so won't do it again in depth. But the transmitter part of ham collecting is very much a part of the hobby. You commonly can find CW-only, AM-CW, and AM-CW-SSB rigs from the 1920's to the 1960's.

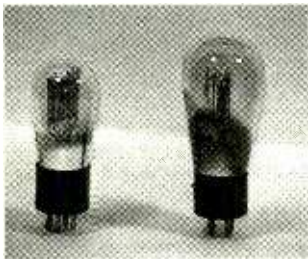

Fig. 5. Here are some glass-envelope four-pin (triodes) and five-pin (mostly tetrodes) tubes used in the early to late 1920's.



Fig. 6. By the early 1930's, four-, five-, six-, or seven-pin tubes like these (some having grid caps) began to appear.



Fig. 7. In the mid-1930's, octal tubes became available. Some versions were glass-envelope tubes, while later versions were metal-envelope types.

A WORD OF WARNING

Older transmitters can be put on the air if they meet

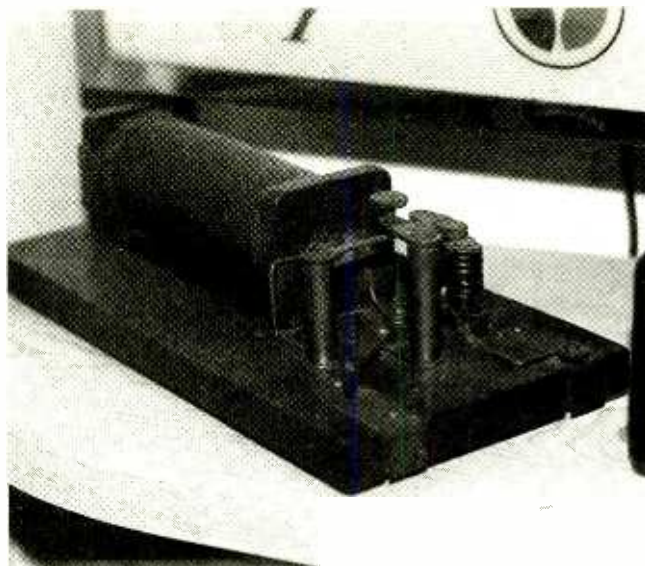

Fig. 8. Is this a piece of communications gear or quack medical equipment? Does anyone know for certain?

present-day standards. Be careful of vacuum-tube transmitters built in the 1930's and before, for they may not have the stability to stay in the band. Also, never use a spark-gap transmitter on the air; they tear up the airwaves for megahertz around the alleged operating frequency. For more modern transmitters, be sure that the rig is in good repair before going on the air. Bad tubes, dried out power-supply filter capacitors, and other defects can put out a 571 CW signal, or a screeching, humming AM voice signal.

Don't risk an F.C.C. "Notice of Violation" for a test. Use a dummy load first, and listen for the tone on a nearby receiver. Repair any defects before going on the air.

COLLECTING ACCESSORIES

A collateral-collecting activity is scooping up ham radio accessories. Perhaps the most common accessory collected is telegraph keys. From old brass "straight keys" to "North Atlantic" cold-weather keys, to semi-automatic "bugs," the old-fashioned telegraph key is a popular keepsake of another era (and one that

can still be used on "straight key night" contests).

Other amateurs collect microphones, while still others collect the add-ons such as antenna tuners, Q-multipliers, Select-O-Jects, and other devices.

WHATZITS?

One of the little joys of collecting antique ham gear is finding those things that no one can identify. Figure 8 shows an electrical device (radio?) that some say is a part of a spark-gap transmitter, while others say it is a quack medical device of the early 1900s. I prefer the latter explanation, but some disagree. Does anyone know for certain? By the way, there were many quack electrical devices offered because no one regulated them.

Besides, electricity was new, miraculous and wonderful, so people thought it could cure anything...and unethical pseudo-physicians were happy to accommodate them.

Well, that's all the room for now. Until next time, if you have any questions, comments, etc., send them to *Ham Radio*, **Popular Electronics**, 500-B Bi-County Blvd., Farmingdale, NY 11735. ■

TEST REPORT

(Continued from page 73)

radio and even a couple of stereo-TV broadcast sound tracks. Our reasoning here was that since both FM and TV sound are restricted to a maximum treble frequency of 15 kHz, no sacrifice in quality would result from using the 4-hour recording mode for recording those types of sources, and more economical use of blank tape would result.

Currently, a 120-minute blank tape of good quality has a suggested retail price of between \$14.00 and \$16.00, so doubling the recording time when program sources don't require full audio bandwidth response makes good sense. In fact, while listening to tapes that were made in this way, we were unable to detect any difference between the sound of the resulting recording and that of the original program source.

Considering the fact that first-generation DAT recorders, offered for sale in other parts of the world more than three years ago, cost more than twice as much as this new JVC model, the XD-Z505 offers excellent value for its \$1000 suggested price. Remember, too, that those first DAT units were not even able to record CD's via their digital inputs, but could only record such copyrighted material using the analog inputs. So, in fact, the JVC XD-Z505 and other newly introduced DAT recorders actually offer more features than did their predecessors, and they do so at a considerably lower cost.

For more information on the JVC (41 Slater Dr., Elmwood Park, NJ 07407) XD-Z505 DAT player, contact the manufacturer directly, or circle no. 120 on the Free Information Card. ■

Now! Experience the electronics behind the MIDI revolution as you build your own computer-controlled music center

Only NRI's innovative, at-home training in Electronic Music Technology gives you hands-on experience with the equipment that's revolutionizing the music industry—Atari ST Series computer with built-in MIDI ports, Casio HT-3000 synthesizer with advanced MIDI operations, and ingenious MIDI software that links computer keyboard to synthesizer keyboard—all yours to train with and keep!

This year, over \$1.5 billion worth of digital electronic music instruments, from keyboards to drum machines, will be sold in the U.S. alone. Enthusiasts everywhere—professional musicians and recording technicians, even people who have never touched a musical instrument before—are discovering the excitement of today's electronic music technology.

At the heart of this excitement is MIDI (Musical Instrument Digital Interface), an innovation that's transformed musical instruments into the ultimate computer peripherals... and opened up a whole new world of opportunity for the person who knows how to use, program, and service this extraordinary new digital equipment.

Now NRI's breakthrough Electronic Music Technology course puts you at the forefront of this booming new technology with exclusive training built around a MIDI-equipped computer, MIDI synthesizer, and MIDI software you keep.

Dynamic new technology opens up new career opportunities

The opportunities are unlimited for the person who's trained to take advantage of today's electronic music phenomenon. Now you can prepare for a high-paying career as a sound engineer, recording engineer, or road technician... even start your own business selling and servicing today's high-tech musical instruments. Or simply unleash your own musical creativity with the breakthrough training and equipment only NRI gives you.

Only NRI gives you hands-on training with today's MIDI technology

The Atari ST Series computer included in your course becomes the heart of your own

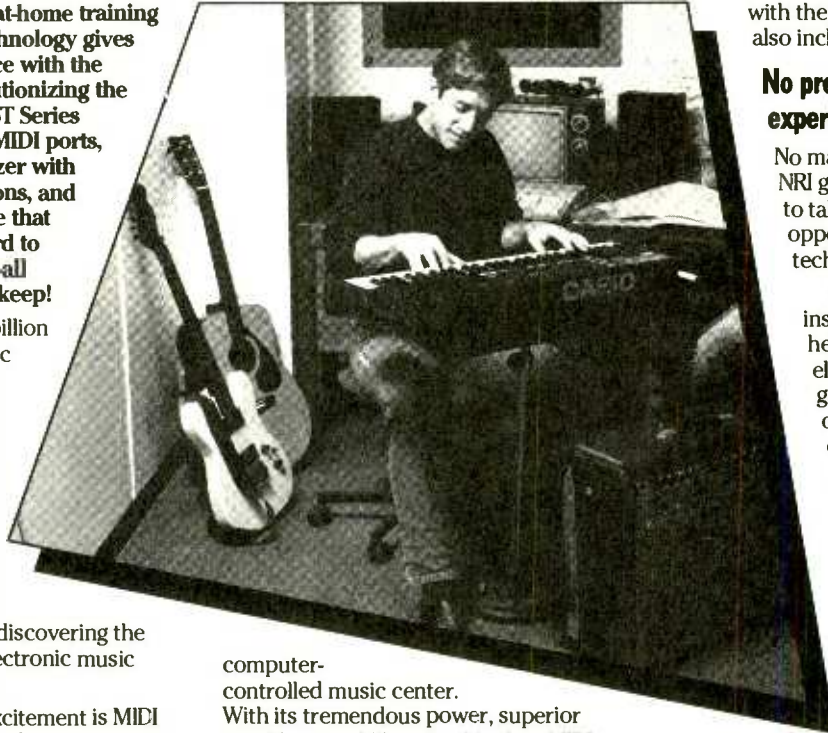

computer-controlled music center. With its tremendous power, superior graphics capabilities, and built-in MIDI interface, the 16/32-bit Atari ST has almost overnight become the computer of choice for today's most knowledgeable electronic musicians.

Your Casio HT-3000 synthesizer features a five-octave, MIDI-compatible digital keyboard with built-in monitor speakers, advanced tone editing and writing, pattern memory, keyboard split, tone and rhythm banks, chord memory, and dozens more state-of-the-art capabilities.

Plus you get ingeniously designed MIDI software that opens up amazing new creative and technical possibilities... you actually build your own 4-input audio mixer/amplifier... and you test the electronic circuits at the core of today's new equipment



NRI training includes an Atari ST computer, Casio synthesizer, exclusive MIDI software, and much more—all yours to train with and keep! (TV not supplied)

with the hand-held digital multimeter also included in your course.

No previous electronics or music experience necessary

No matter what your background, NRI gives you the skills you need to take advantage of today's opportunities in electronic music technology.

With your experienced NRI instructor always available to help, you master the basics of electronic theory step by step, gaining the full understanding of electronics that's now so essential for technicians and musicians alike.

You move on to analyze sound generation techniques, digital logic, microprocessor fundamentals, and sampling and recording techniques... ultimately getting first-hand experience with today's explosive new technology as you

explore MIDI, waveshaping, patching, sequencing, mixing, special effects, and much more.

Plus, even if you've never been involved with music before, NRI gives you enough basic training in music theory and musical notation to appreciate the creative potential and far-reaching applications of today's electronic music equipment.

Send today for FREE catalog

If the coupon is missing, write to NRI Schools, McGraw-Hill Continuing Education Center, 4401 Connecticut Avenue, NW, Washington, DC 20008.

NRI Schools

McGraw-Hill Continuing Education Center
4401 Connecticut Avenue, NW, Washington, DC 20008



Check One FREE Catalog Only

For Career courses approved under GI bill check for details.

Electronic Music Technology

Microcomputer Servicing

Computer Programming

TV/Video/Audio Servicing

Desktop Publishing and Design

Security Electronics

Fiction/Nonfiction Writing

Basic Electronics

Bookkeeping & Accounting

Name _____ Age _____

Address _____

City/State/Zip _____

Accredited Member, National Home Study Council

9-041

ISOLATING EXTENSIONS

(Continued from page 42)

Between the two modular sockets, and to one side on the faceplate, drill a hole to mount the closed audio jack, J1. Mount the jack and wire it between the two separated green terminals as shown in Fig. 2. When correctly wired, the two green terminals should be connected together when no plug is in the audio jack, and should run to the switch when the plug is inserted.

Connect the orange wiring pair to the upper jack, with the solid-color wire going to the red or ring terminal. That jack will be the primary jack. Connect the blue pair to the lower jack, again ensuring that the solid-colored wire goes to the red terminal. Neatly stow the wiring into the jack's wiring box and screw the faceplate in place. All phone extensions in the house should operate normally. Insert an unused audio plug into the audio jack. The lower modular socket on the new duplex jack, and all other phone extensions, should now be disconnected while the upper socket on the duplex jack remains functional.

The plug and switch assembly can be built in any convenient fashion. The switch, S1, should be a toggle, slide, or rocker type instead of a locking push-button so that its position can be recognized at a glance. Mount it in a small, attractive box and connect it to the control plug, PL1, using an appropriate length of 22–24-gauge 2-conductor cable. When the plug is inserted into the audio jack, the switch will control whether the primary jack is isolated or not. With the switch open, the phone extension, modem, or fax machine connected to the primary jack will have exclusive use of the phone line.

If the primary jack is used by a modem or fax machine, you have two options for connecting a telephone at the same location. If you want to be able to isolate the phone for the sake of privacy, plug it into the modem or fax's "phone" jack. The phone will remain connected when the isolating switch is open. If you want that phone to be disconnected when using your fax or modem, plug it into the other (secondary) socket of the wall jack.

Modifications. The basic installation can be extended and modified in a variety of ways. For example, if the isolated jack is intended only to be used to guarantee privacy, you can use a single

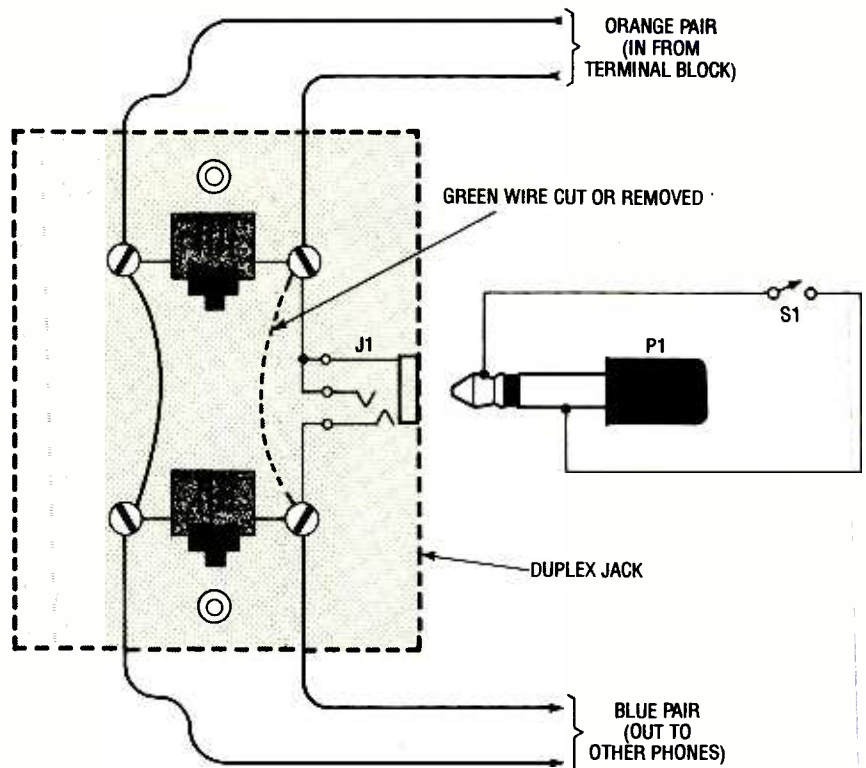

Fig. 2. This is the schematic for modifying the duplex jack. The red wire jumpering the two jacks should be left in place, while the green wire is cut or removed. The switch and its wiring may be modified as necessary for your particular needs.

modular jack instead of a duplex type. (However, the duplex jack is a bit easier to install, since it provides two sets of screw terminals for easy connection to the two wiring pairs.)

You could use a timed switching arrangement to isolate the primary jack at selected times. That is the arrangement I use to accommodate an electronic mail system that must be ready for incoming calls during one hour in the early morning. To prevent the telephones from ringing, the computer is connected to the primary jack, and a timer-controlled switch disconnects the other phones during "incoming-mail hour."

Or you could replace the manual switch with a fax machine or a modem's internal switching hardware to automatically shut down the extensions. In such a system there is no need for J1, but the green wire in the duplex jack should still be cut. The primary jack is connected to the modem or fax "line" jack, while the second (blue-pair) jack is connected to the modem or fax's "phone" jack. As long as the modem or fax machine is not in operation, the other phone extensions will be connected to the phone line. When the modem or fax connects to the line, the

others will be automatically disconnected.

That is appealingly simple, but it has two drawbacks: The machine will be able to rudely interrupt calls being made via the other phone extensions. Also, disconnecting either cable, or a fault anywhere in the loop formed by the machine and the cables, will disable the other phone extensions.

Whether to ensure privacy or to enhance the operation of a phone-line-using machine, the technique outlined here of isolating one phone jack from others on a single line can be easily adapted to your own needs. ■

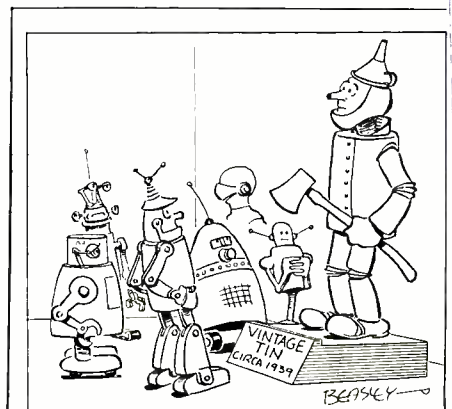

"ROBOT MUSEUM"

SURE-LUCK OHMS

(Continued from page 57)

simplify the job of keeping track of where you are and where you are headed. The rotary switches in the prototype are actually 12-position switches, which for some reason are easier to locate than 10-position units, but either will do.

Once the board has been assembled, prepare the front panel of the enclosure using the layout shown in Fig. 4. The 24 holes in the front panel of the enclosure are spaced to match the spacing of the LED's that are mounted on the board.

In the author's arrangement, the LED's do not extend through the front panel of the enclosure, but instead are mounted so that the crest of the LED lenses rest on the inside surface of the enclosure at the proper positions so that lighted LED's can be seen. The off-

PARTS LIST FOR SURE-LUCK OHMS

SEMICONDUCTORS

Q1, Q2—2N3904 or 2N2222 general-purpose NPN silicon transistor
 D1—D17—1N914 general-purpose small-signal silicon diode
 LED1—LED23—Jumbo red LED
 LED24—Flashing (Radio Shack 276-036) or standard LED, see text

RESISTORS

(All resistors are 1/4-watt, 5% units.)
 R1—R6—470-ohm
 R7—R9—270-ohm
 R10—4700-ohm
 R11—100,000-ohm
 R12—1000-ohm

ADDITIONAL PARTS AND MATERIALS

B1—9-volt transistor-radio battery
 S1—S3—SP10T or SP12T rotary switch, see text
 S4—SPST normally-open pushbutton switch
 Printed-circuit board materials, enclosure, battery holder and connector, knobs, wire, solder, hardware, etc.

Note: The following items are available from Krystal Kits, P.O. 445, Bentonville, AR 72712. A kit containing the circuit board and all parts (excluding the cabinet, switches, knobs, and flashing LED) is available for \$14.95 postage paid; the circuit board only is available for \$7.95 postage paid. Arkansas residents please add applicable sales tax.

board components, which consists of four switches (three rotary and one pushbutton), are positioned on the front panel as shown in Fig. 4.

There are several schemes that can be used to label the front panel of the enclosure—anything from rub-on letters to cut-out letters and numbers glued in place. The ten colors used to mark the switch positions can be made with marking pencils. After finishing with the front panel's lettering and coloring, give it a good coat of clear plastic spray.

Check Out And Use. To check the circuit's operation, first set the three rotary switches (S1—S3) to black-black-black and press S4. The α (LED10) and ω LED's should light. Switch S1 to brown and LED1, LED10, and the ω LED should light. Set S1 to brown, S2 to green, and S3 to red and you should read 1.5k with the decimal point indicator, LED24, flashing. Keep checking each switch out one position at a time to be sure there are no wiring errors between the switches and circuit board.

Position 9 (GOLD) on S3 does not indicate the resistor's tolerance, but is used to decode a resistor of 10 ohms or less. You won't come across such values too often, but when you do the circuit will read them, too.

You can also work backwards: If you need a particular value of resistance, but do not know the color code for that value, the circuit can be used to figure it out. Simply press switch S4 and hold while rotating switches S1—S3. For instance, let's say you need a 1.2k resistor. Simply rotate S1 until the 1-position LED, which is located in the rightmost column, lights; then do the same for S2 until the 2-position LED lights; and finally rotate S3 until the κ LED lights.

Finding the color codes of resistors with values of a hundred-thousand ohms is only slightly more difficult, because the α LED must be taken into account. For example, if a 750k resistor is needed, you would rotate S1 and S2 as described above, but S3 must be rotated until both the κ and α LED's light—that's 75 followed by 0 for 750, and the κ to indicate that that number is multiplied by 1000 for a total value of 750,000 or 750k.

You'll soon discover that old timers and new comers alike will find Sure-luck Ohms a valuable ally in decoding those hard to remember color-code values.

SPECIAL FROM ETT

SAVE \$\$ TODAY

□ **2617T—BUILD A REMOTE-CONTROLLED ROBOT** regular \$9.95 **SPECIAL \$8.95.** Fool-proof instructions for putting together your own full-size working robot at a fraction of the commercial cost.



□ **2645T—117 PRACTICAL IC PROJECTS YOU CAN BUILD** regular \$10.95 **SPECIAL \$9.95.** Dozens of fully tested ready-to-build circuits you can put together from readily available, low-cost ICs.

□ **BP53—PRACTICAL ELECTRONICS CALCULATIONS AND FORMULAE** regular \$6.95 **SPECIAL \$5.95.** Six basic sections: Units and Constants, Direct Current Circuits, Passive Components, Alternating Current Circuits, Networks and Theorems, Measurements.

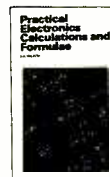

□ **2706T—BUILDING METAL LOCATORS** regular \$9.95 **SPECIAL \$8.95.** A treasure hunter's project book. Build your own high-quality metal detector for a fraction of the factory-built cost.

□ **BP234—TRANSISTOR SELECTOR GUIDE** regular \$10.00 **SPECIAL \$9.00.** Offers a range of selection tables compiled so as to be of maximum use to all electronics engineers, designers and hobbyists.



□ **ETTCAT—ELECTRONIC TECHNOLOGY TODAY INC. CATALOG** **\$2.00.** 36-pages list a wide variety of electronics books. Included with catalog is a coupon good for \$3.00 off your first purchase.

MAIL TO: Electronic Technology Today, Inc.
 P.O. Box 240
 Massapequa Park, NY 11762-0240

SHIPPING CHARGES IN USA AND CANADA

\$0.01 to \$5.00	... \$1.25	\$30.01 to \$40.00	\$5.00
\$5.01 to 10.00	... \$2.00	\$40.01 to \$50.00	\$6.00
\$10.01 to \$20.00	\$3.00	\$50.01 and above	\$7.50
\$20.01 to \$30.00	\$4.00		

SORRY, No orders accepted outside of USA and Canada

Total price of merchandise \$	_____
Shipping (see chart) \$	_____
Subtotal \$	_____
Sales Tax (NYS only) \$	_____
Total Enclosed \$	_____

Name _____
 Address _____
 City _____ State _____ Zip _____

ELECTRONICS MARKET PLACE

FOR SALE

DESCRAMBLERS. All brands. Special: Combo Jerrold 400 and SB3 \$165.00. Complete cable descrambler kit \$39.00. Complete satellite descrambler kit \$45.00. Free catalog. **MJH INDUSTRY**, Box 531, Bronx, NY 10461-0208.

CABLE descrambler liquidation. Major makes and models available. Industry pricing! (Example: Hamlin Combs, \$44 each... Minimum 10 orders). Call **WEST COAST ELECTRONICS**, 1 (800) 628-9656.

PRINTED circuit boards etched & drilled. Free delivery. **K & F ELECTRONICS, INC.**, 33041 Groesbeck, Fraser, MI 48026. (313) 294-8720.

HUGE 88 page communications catalog of short-wave, amateur and scanner equipment. Antennas, books and accessories too. Send \$1.00 to: **UNIVERSAL RADIO**, 1280 Aida Drive, Dept. PE, Reynoldsburg, OH 43068.

CABLE descramblers (Jerrold) from \$40.00. Tocom VIP test chip. Fully activates unit. \$50.00. Call (213) 867-0081.

SURVEILLANCE TELEPHONE

Monitor room conversations \$175.00
Monitor room & telephone conversations \$275.00
Dialer tap, calls you when phone is used \$305.00



Available in the telephone or small plastic case

Range Unlimited - 6 month warranty - Phone Tap Catalog \$3.00
LISTEN ELECTRONICS, 603 Elgin, Muskogee, OK 74401
1-800-633-TAPS

RADIO tubes, capacitors. Extensive listings. \$.25 stamp. **DIERS**, 4276 North 50 Street #H5, Milwaukee, WI 53216-1313.

STOP unwanted use of long distance with simple telephone product. Free details. **PO BOX 504**, Plattsburgh, NY 12903.

SURVEILLANCE Countersurveillance electronic equipment catalog, 50 pages, \$5.00, **EDE**, PO Box 337, Buffalo, NY 14226.

CLASSIFIED AD ORDER FORM

To run your own classified ad, put one word on each of the lines below and send this form along with your check to:

Popular Electronics Classified Ads, 500-B Bi-County Boulevard, Farmingdale, N.Y. 11735

PLEASE INDICATE in which category of classified advertising you wish your ad to appear. For special headings, there is a surcharge of \$11.00.

() Plans/Kits () Business Opportunities () For Sale
() Education/Instruction () Wanted () Satellite Television
()

Special Category: \$11.00

PLEASE PRINT EACH WORD SEPARATELY, IN BLOCK LETTERS.

(No refunds or credits for typesetting errors can be made unless you clearly print or type your copy.) Rates indicated are for standard style classified ads only. See below for additional charges for special ads. **Minimum: 15 words.**

1	2	3	4	5
6	7	8	9	10
11	12	13	14	15 (\$23.25)
16 (\$24.80)	17 (\$26.35)	18 (\$27.90)	19 (\$29.45)	20 (\$31.00)
21 (\$32.55)	22 (\$34.10)	23 (\$35.65)	24 (\$37.20)	25 (\$38.75)
26 (\$40.30)	27 (\$41.85)	28 (\$43.40)	29 (\$44.95)	30 (\$46.50)
31 (\$48.05)	32 (\$49.60)	33 (\$51.15)	34 (\$52.70)	35 (\$54.25)

We accept MasterCard and Visa for payment of orders. If you wish to use your credit card to pay for your ad fill in the following additional information (Sorry, no telephone orders can be accepted.):

Card Number

Expiration Date

PRINT NAME

SIGNATURE

IF YOU USE A BOX NUMBER YOU MUST INCLUDE YOUR PERMANENT ADDRESS AND PHONE NUMBER FOR OUR FILES. ADS SUBMITTED WITHOUT THIS INFORMATION WILL NOT BE ACCEPTED.

CLASSIFIED COMMERCIAL RATE: (for firms or individuals offering commercial products or services) \$1.55 per word prepaid (no charge for ZIP code)...**MINIMUM 15 WORDS.** 5% discount for same ad in 6 issues within one year; 10% discount for 12 issues within one year if prepaid. **NON-COMMERCIAL RATE:** (for individuals who want to buy or sell a personal item) \$1.25 per word, prepaid...no minimum. **ONLY FIRST WORD AND NAME** set in bold caps at no extra charge. Additional bold face (not available as all caps) 30¢ per word additional. Entire ad in boldface, \$1.85 per word. **TINT SCREEN BEHIND ENTIRE AD:** \$1.90 per word. **TINT SCREEN BEHIND ENTIRE AD PLUS ALL BOLD FACE AD:** \$2.25 per word. **EXPANDED TYPE AD:** \$2.05 per word prepaid. Entire ad in boldface, \$2.45 per word. **TINT SCREEN BEHIND ENTIRE EXPANDED TYPE AD:** \$2.55 per word. **TINT SCREEN BEHIND ENTIRE EXPANDED TYPE AD PLUS ALL BOLD FACE AD:** \$2.95 per word. **DISPLAY ADS:** 1" x 2 1/4"—\$205.00; 2" x 2 1/4"—\$410.00; 3" x 2 1/4"—\$615.00. **General Information:** Frequency rates and prepayment discounts are available. **ALL COPY SUBJECT TO PUBLISHERS APPROVAL. ADVERTISEMENTS USING P.O. BOX ADDRESS WILL NOT BE ACCEPTED UNTIL ADVERTISER SUPPLIES PUBLISHER WITH PERMANENT ADDRESS AND PHONE NUMBER.** Copy to be in our hands on the 18th of the fourth month preceding the date of issue (i.e.; Sept. issue copy must be received by May 18th). When normal closing date falls on Saturday, Sunday or Holiday, issue closes on preceding work day. Send for the classified brochure. **Circle Number 49 on the Free Information Card.**

CABLE TV DESCRAMBLERS! BARGAIN HEADQUARTERS!



•JERROLD™ •TOCOM •HAMLIN
•OAK •ZENITH
•SCIENTIFIC ATLANTA

6 month warranty! We ship C.O.D.!
Lowest retail/wholesale prices!

FREE CATALOG:

Global Cable Network
1032 Irving St. Suite 109
S.F., CA 94122

NO CALIFORNIA SALES!!!

ORDER TODAY! 800-327-8544

SECRET scanner frequencies: Directories list federal, police, surveillance, bugging, channels. Big free catalog. **CRB**, Box 56-PE, Commack, NY 11725.

FREE programs!! Free disks!! Choose game, utility, or business. And we will send you an IBM compatible program free. On 5-1/4" 360K or 3-1/2" 720K disk. You choose category, we choose program. Also get our electronics surplus/closeouts catalog and rental/shareware catalogs on another disk free! Just send \$2.00 (refundable) for shipping! **BEACH RADIO**, PO box 548, Boston, MA 02112-0548.

FREE CATALOG

FAMOUS "FIRESTIK" BRAND CB ANTENNAS AND ACCESSORIES. QUALITY PRODUCTS FOR THE SERIOUS CB'er. SINCE 1962

FIRESTIK ANTENNA COMPANY
2614 EAST ADAMS
PHOENIX, ARIZONA 85034

PRINTED circuit boards — etched, drilled, tin plated. Single sided \$1.25/sq. inch. Free shipping. **CHELCO ELECTRONICS**, 61 Water Street, Mayville, NY 14757. (716) 753-3200.

STOP prank phone calls electronic device displays phone number of person calling you. Brochure \$1.00, **EDE**, PO Box 337, Buffalo, NY 14226.

CB RADIO OWNERS!

We specialize in a wide variety of technical information, parts and services for CB radios. 10-Meter and FM conversion kits, repair books, plans, high-performance accessories. Thousands of satisfied customers since 1976! Catalog \$2.

CBC INTERNATIONAL

P.O. BOX 31500PE, PHOENIX, AZ 85046

IBM PC video digitizer, connects through printer port. 640 by 480 resolution. 256 gray levels \$89.98. Demo disk \$3.00. **COLORBURST**, Box 3091, Nashua, NH 03061.

FREE Catalog: Save hundreds on sought after electronic, electro mechanical, and computer related hardware and components — including hard-to-find items. Call toll free: 1 (800) 776-3700. **AMERICAN DESIGN COMPONENTS/Dept.** 114-041, 815 Fairview Avenue, Fairview, NJ 07022.

Quality Microwave TV Antennas

WIRELESS CABLE - IFTS - MMDS - Amateur TV
Ultra High Gain 50db(+)
• Tuneable 1.9 to 2.7 Ghz.
• 36-Channel System Complete \$149.95
• 12-Channel System Complete \$114.95
• Call or write (SASE) for "FREE" Catalog

PHILLIPS-TECH ELECTRONICS
P.O. Box 8533 • Scottsdale, AZ 85252
(602) 947-7700 (\$3.00 Credit all phone orders)
MasterCard • Visa • COD's • Quantity Pricing

LIFETIME WARRANTY

PLANS & KITS

CATALOG: hobby/broadcasting/HAM/CB: Cable TV, transmitters, amplifiers, surveillance devices, computers, more! **PANAXIS**, Box 130-H4, Paradise, CA 95967.

BUILD — five-digit, ohms, capacitance, frequency, pulse, multimeter. Board, and instructions \$9.95. **BAGNALL ELECTRONICS**, 179 May, Fairfield, CT 06430.

SURVEILLANCE transmitter kits! Four models of each; telephone, room, combination telephone/room transmitters tune from 65 to 305 MHz. Catalog with **Popular Communication's** and **Popular Electronics** book reviews of "Electronic Eavesdropping Equipment Design," \$1.00. **SHEFFIELD ELECTRONICS**, 7223A Stony Island Ave., Chicago, IL 60649-2806.

MINIATURE FM transmitters! Tracking transmitters! Voice disguisers! Bug detectors! Phone devices! More! Available as kits or assembled and tested! Catalog \$2.00 (refundable): **XANDI ELECTRONICS**, Box 25647, Dept. 32C, Tempe, AZ 85285-5647.

TUBES - 2000 TYPES DISCOUNT PRICES!

Early, hard-to-find, and modern tubes. Also transformers, capacitors and parts for tube equipment. Send \$2.00 for 28 page wholesale catalog.

ANTIQUE ELECTRONIC SUPPLY
6221 S. Maple Ave. • Tempe, AZ 85283 • 602-820-5411

SURVEILLANCE — Audio/video/infra-red/laser equipment. Industrial or private. 500 item catalog \$7.00. **SECURITY SYSTEMS**, 3017F Hudson, New Orleans, LA 70131.

NEW devices: proximity switch, static snooper, personal defender, laser supplies, bug snooper, PC interfaces and more. Catalog \$2.00. **BAUER**, 35 Soucy, Delson, Quebec, JOL 1G0.

BUILD from easy-to-follow schematics: audio mixers/equalizers (stage, studio, business, home, basic to sophisticated), feedback controllers, active filters, guitar super-fuzz box, loudspeaker enclosures (including car/van), power supplies, more. vSSE reliability. Send \$5.00 for descriptions. Reasonable prices. **VON SPRECKEN SOUND ENGINEERING**, Dept.A, Box 1315, Clinton, MS 39060.

SHORTWAVE — 1933. One-tube. Plug-in coils. DX radio. Free plans. **BOB RYAN**, PO Box 3039, Anaheim, CA 92803.

LASER lighting entertainment systems and accessories. Create 3-dimensional laser light shows with these professional secrets! Electronic and mechanical designs for all budgets!! \$20.00 **MILLENIUM**, 229 McAfee, Thousand Oaks, CA 91360.

DAZER II Personal protection device! Plans \$8.00. Lasers! Transmitters! Detectors! More! Kits or assembled! Catalog \$2.00. **QUANTUM RESEARCH**, 16645-113 Avenue, Edmonton, Alberta T5M 2X2.

★★★★PRESENTING★★★★

CABLE TV DESCRAMBLERS

★★★★ STARRING ★★★★★

JERROLD, HAMLIN, OAK

AND OTHER FAMOUS MANUFACTURERS

- FINEST WARRANTY PROGRAM AVAILABLE
- LOWEST RETAIL / WHOLESALE PRICES IN U.S.
- ORDERS SHIPPED FROM STOCK WITHIN 24 HRS
- ALL MAJOR CREDIT CARDS ACCEPTED

FOR FREE CATALOG ONLY 1-800-345-8927
FOR ALL INFORMATION 1-818-709-9937

PACIFIC CABLE CO., INC.
7325 1/2 Reseda Blvd., Dept. 2001
Reseda, CA 91335

STOP! Don't let the gas pump cut into your standard of living. Alcohol fuel, easy to produce, \$.17 per gallon. Plans \$5.00. **PROSPECTS UNLIMITED**, 620 Dick Road, Suite 383, Depew, NY 14043.

ETCH your own printed circuit boards using the photographic method. The only inexpensive step by step process that guarantees professional results. A book that every serious electronics hobbyist should have. Send \$12.95 to **ETCHING INFO**, PO Box 8064, Westfield, MA 01086-8064.

RECEIVER plans, kits. Simple to sophisticated. Thorough explanations included. All bands. Catalog and sample schematics \$3.00. **PREMIER ENTERPRISES**, 3850 Plymouth Blvd., Suite 104, Plymouth, MN 55446.

Motion Control System → \$159.00



Includes Computer, Monitor, Keyboard, Power supply, 4 Motors, and Software.

Call or Send for **Free Robotics Catalog**

Silicon Valley Surplus 4222 E. 12th St. Serving you since 1983
415 261-4506 Oakland, Ca. 94601 8 am to 4 pm PST

TRACER Circuit. Invaluable troubleshooting tool for professional or hobbyist. Test diodes, capacitors, resistors, FET's, transistors, UJT's, etc. with this amazingly simple device. Send \$8.00 for instructions to **R. THOMAS**, 216 Patterson Road, Barrie, Ontario, Canada L4M 4S7.

STEREO TV: Don't buy a new one; upgrade your mono TV! Send \$4.95 for schematics, PCB layout, and instructions to: **JLB INNOVATIONS**, PO Box 72011, Kanata, Ontario, K2K 2P4, Canada.

PROJECTION TV from pocket LCD TV! Bright, crisp, cheap! Detailed instructions \$4.95. **PETERSON ENTERPRISES**, 7 Grove Street, Haydenville, MA 01039.

WORK or play at your peak. Find out when with this simple to build meter. Electronic and mechanical versions. Great fun at parties. Plans \$5.00. **PHYSIOGAUGE**, PO Box 233, Tremont City, OH 45372.

REMOTE car starter plan (\$19.90), or complete devices. **SCHLITZER**, 414 Alva, Grand Prairie, TX 75051. (214) 642-0338.

CABLE EQUIPMENT

CABLE TV secrets — the outlaw publication the cable companies tried to ban. HBO, Movie Channel, Showtime, descramblers, converters, etc. Suppliers list included. \$9.95. **CABLE FACTS**, Box 711-H, Pataskala, OH 43062.

CABLE T.V. CONVERTERS
WHY PAY A HIGH MONTHLY FEE?

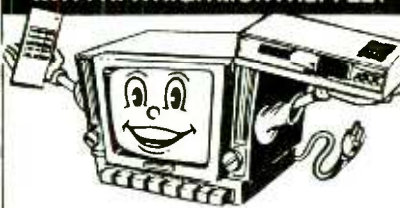

All Jerrold, Oak, Hamlin, Zenith, Scientific Atlanta, Magnavox and all specialized cable equipment available for shipment within 24 hours. For fast service MC / VISA or C.O.D. telephone orders accepted (800) 648-3030 60 Day Guarantee (Quantity Discounts) 8 A.M. to 5 P.M. C.S.T. **CLOSED WEEK-ENDS.** Send self-addressed Stamped envelope (60¢ postage) for Catalog

MIDWEST ELECTRONICS INC. P.O. Box 5000
Suite 311 (PE) Carpentersville, IL 60110
No Illinois Orders Accepted

SATELLITE TV

FREE catalog — Do-it-yourself save 40—60% **Lowest prices** world wide, systems, upgrades, parts, all major brands factory fresh and warranted. **SKYVISION**, 2008 Collegeway, Fergus Falls, MN 56537. 1 (800) 334-6455.

LPTV transmitters, attention Mexico & Latin America, for communities outside USA and Canada, low power TV transmitters to serve TV to towns, from satellite dishes. Call (62) 150199 (Mexico). Write: **ELECTRONICA SONORA**, 252 Grand Ave., Nogales, AZ 85621.

T.V. FILTERS

T.V. notch filters, phone recording equipment, brochure \$1.00. **MICRO THinc.**, Box 63/6025, Margate, FL 33063. (305) 752-9202.

AC/DC VOLTAGE RESISTANCE DIODE TEST LOW BATTERY Warning ACCURACY +/- 0.5% CONTINUITY TEST/BUZZER TRANSISTOR CHECKER CAPACITANCE CHECKER

KELVIN 200

\$39.95

Stock No 990091

KELVIN Electronics VISA M/C
7 Fairchild Ave., Plainville NY 11803
(516) 349-7620 1(800) 645-9212



CABLE TV DESCRAMBLERS ★ CONVERTERS ★ and ACCESSORIES.

SAVE MONEY. DON'T RENT!

PANASONIC,
PIONEER, JERROLD, OAK,
SCIENTIFIC ATLANTA
AND MORE. LOWEST PRICES.
FREE CATALOG.

(800) 234-1006
CABLE READY COMPANY

SPECIAL FROM ETT

□ **PCP107—DIGITAL LOGIC GATES AND FLIP-FLOPS ... \$10.00.** Establishes a firm foundation for the user who wants to design and troubleshoot digital circuitry and wants to know more than a few rules of thumb. No background beyond a basic knowledge of electronics is assumed.



□ **PCP108—COMPUTERS AND MUSIC ... \$9.95.** Helps you learn the basics of computing, running applications programs, wiring a MIDI system and using the system to good effect. In fact, just about everything you need to know about hardware and programs.

□ **PCP109—EVERYDAY ELECTRONICS DATA BOOK ... \$10.00.** Presents the essential theory of electronic circuits and also deals with a wide range of practical electronic applications. Info is presented in the form of a basic electronics recipe book.



□ **PCP110—ELECTRONIC POWER SUPPLY HANDBOOK ... \$10.00.** All types of power supplies are covered, starting with cells and batteries, on to rectified supplies and linear stabilizers, to modern switch-mode systems, IC switch-mode regulators, DC-DC converters and inverters.



□ **BP285—BEGINNERS GUIDE TO MODERN ELECTRONIC COMPONENTS ... \$6.50.** Basic functions of resistors, capacitors, inductors, diodes (including Zeners and Varicaps), transistors, Thyristors, optoelectronic devices, op-amps, logic IC's, speakers and microphones, and meters are all described. Sort of a beginners bible of electronics.



MAIL TO: **Electronic Technology Today, Inc.**
P.O. Box 240
Massapequa Park, NY 11762-0240

SHIPPING CHARGES IN USA AND CANADA

\$0.01 to \$5.00	\$1.25	\$30.01 to \$40.00	\$5.00
\$5.01 to 10.00	\$2.00	\$40.01 to \$50.00	\$6.00
\$10.01 to \$20.00	\$3.00	\$50.01 and above	\$7.50
\$20.01 to \$30.00	\$4.00		

SORRY, No orders accepted outside of USA and Canada

Total price of merchandise	\$	_____
Shipping (see chart)	\$	_____
Subtotal	\$	_____
Sales Tax (NYS only)	\$	_____
Total Enclosed	\$	_____

Name _____
Address _____
City _____ State _____ Zip _____

Cable TV Descramblers

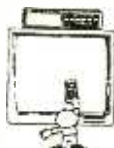

If you find a better deal, we'll better our deal.

**Jerrold *Tocom *Hamlin *Oak
*Scientific Atlanta *Zenith*

Ask about our extended warranty program.

COD, Visa, M/C welcome.
Free Call - Free Catalog.

Video Tech **800-562-6884**

2702 S. Virginia St., Ste. 160-304
Reno, NV 89502.

BUSINESS OPPORTUNITIES

YOUR own radio station! AM, FM, TV, cable. Licensed/unlicensed. **BROADCASTING**, Box 130-H4, Paradise, CA 95967.

MAKE \$2000.00/week — reclaiming pure gold from scrap computers. Free report! (worth \$25.00) 1 (900) 246-2323 (\$2.00 min.).

LET the government finance your small business. Grants/loans to \$500,000. Free recorded message: (707) 448-0270. (KJ8)

EASY work! Excellent pay! Assemble products at home. Call for information (504) 641-8003 Ext. 5730.

FREE CATALOG!
1-800-648-7938
JERROLD HAMLIN OAK ETC
CABLE TV
DESCRAMBLERS

- Special Dealer Prices!
- Compare our Low Retail Prices!
- Guaranteed Prices & Warranties!
- Orders Shipped Immediately!

REPUBLIC CABLE PRODUCTS, INC.
4080 Paradise Rd. #15, Dept.
Las Vegas, NV 89109
For all other information (702) 362-9026

MAKE \$\$\$! Become an American electronics dealer! Profit opportunities since 1965. Call **WAYNE MARKS**, 1 (800) 872-1373.

WHY rent? Homes for \$1.00, repos. Gov't give away programs! For information (504) 649-0670 ext. R-5730.

DO you really believe in your invention/idea — need financial backing (seed — startup — first — stage). Venture capital is available (within two hours of your geographical area). Write **IICH**, 2112 Dan Rowe Dr., Waco, TX 76704.

BEST BY MAIL

Rates: Write National, Box 5, Sarasota, FL 34230

BUSINESS OPPORTUNITIES

FREE NEW AUTOMOBILES AND VACATIONS FOR LIFE! Intermedia, Box 1441-(PE), Ballwin, MO 63022-1441.

START YOUR OWN SHOP



Complete Neon Course, clearly written, with photos and diagrams. 4 books, over 300 illustrations. How to earn while you learn, how to set up your shop, where to buy neon sign kits ready to assemble, where to get wholesale materials in the U.S. Postpaid \$68.00 (US). VISA okay. (Canadian \$75.00). Write for details.

Peter Horsley Publications
115 Riverbirch Cres, SE, Calgary, Canada T2C 3M1

NAS CABLE BOXES

FREE CATALOG

1-800-848-3997

Jerrold • Scientific Atlanta
Many Others

1 Year Warranty • COD's



WANTED

INVENTORS! Have an idea? Call **IMPAC** for free information package. US/Canada: 1 (800) 225-5800 (24 hours!).

NEED help with your electronic project, schematic or PCB artwork? Write to **TOP SECURITY**, PO Box 5275, Flint, MI 48505.

CABLE DESCRAMBLERS OAK M35B COMBO \$39.95

Jerrold, Zenith, Hamlin, Sci. Atlanta, Pioneer & MORE! OUR PRICES ARE BELOW WHOLESALE!

CABLE + PLUS

14417 Chase St. #481-B Panorama City, CA 91402
1-800-822-9955 • Other Info. 1-818-785-4500
NO CALIF. SALES — DEALERS WANTED

EDUCATION/INSTRUCTION

MAGIC! Four illustrated lessons plus inside information shows you how. We provide almost 50 tricks including equipment for four professional effects. You get a binder to keep the materials in, and a one-year membership in the International Performing Magicians with a plastic membership card that has your name gold-embossed. You get a one-year subscription to our quarterly newsletter, "IT'S MAGIC!" Order now! \$29.95 for each course + \$3.50 postage and handling. (New York residents add applicable state and local sales tax). **THE MAGIC COURSE**, 500-B BiCounty Blvd., Farmingdale, NY 11735.

SUPERNATURAL cloud — Earth rotation displacement nuclear warfare \$1.00. **NIEDER**, PO Box 5162, San Antonio, TX 78201.

ANTIQUÉ RADIO CLASSIFIED

Free Sample!

Antique Radio's

Largest Circulation Monthly.

Articles, Ads & Classifieds.

6-Month Trial: \$13. 1-Yr: \$24 (\$36-1st Class).

A.R.C., P.O. Box 802-L5, Carlisle, MA 01741

CABLE TV "BOXES"

Converters — Descramblers
Remote Controls — Accessories

- ★ Guaranteed Best Prices ★
- ★ 1 Year Warranty — C.O.D.s ★
- ★ Immediate Shipping ★
- ★ FREE CATALOG ★

Call or Write

TRANS-WORLD CABLE CO.
12062 Southwest 117th Court, Suite 126
Miami, Florida 33186
1-800-442-9333



VACUUM-TUBE RECEIVER

(Continued from page 35)

The taps on L3 are made in the same manner as the taps on L2. They are, however, much shorter, only about 1/4 to 3/8-inch long. The wires of each twisted tap should be scraped clean of all insulation and soldered carefully together to guarantee a dependable electrical connection. Note that the taps on L3 come out the front surface (the smooth surface) of the coil form.

Mounting the Coils. Take two #4 x 3/4-inch sheet metal screws and the large coil L2, find the two starter holes on the left side of the front of the radio's baseboard and attach the coil with the screws. The taps should be coming out of the rear of the coil. Connect the start wire of L2 (that's the one nearest the center) to the lower hole of lug 4 on TS4. Keep the wire between the coil and the strip as short as possible.

Now connect the two wires that identify the tap after turn 48 to the lower hole of lug 3 on TS4. Similarly, the two wires of the tap after turn 66 are attached to lug 2 of TS4. And finally, the last wire after turn 74 is fastened to the upper hole of lug 3 on TS1. The ends of all the tap wires must be scraped clean before making any of the connections permanent.

Take the 1/2 x 1/4-inch plastic spacer, one 6-32 x 1-inch machine screw, one #6 flat washer, the little black knob, and coil L3. Insert the machine screw through the rear of the coil form and use the spacer, washer, and knob to make a small handle as shown in Fig. 8.

Now you'll need the #6 x 1 1/2-inch sheet metal screw, the 1/4 x 1/4-inch plastic spacer, and three #6 flat washers. Mount L3 to the frame of the radio with the screw, the three washers, and the spacer. The spacer goes between L3 and L2. Note that L3 must be free to move, so don't over tighten the screw.

Solder the start wire of L3 to the upper

hole of lug 5 on TS1. The other wire is connected to lug 4 of TS1. The wires must be long enough to allow the coil to be moved all the way to the right and all the way to the left.

Now, attach L1 to the back of L2 with the last plastic spacer, a 6-32 x 3/4-inch machine screw, a washer, and a hex nut. The taps should extend back towards the internal area of the radio. The single lead wire coming off L1 is soldered to the upper hole of lug 1 on TS1.

Finishing Up. Take the three 9-volt battery snaps and the three small alligator clips. Each clip has a 3 inch lead wire already attached. Solder one alligator clip lead to the upper hole of lug 2 on TS1, another to the upper hole of lug 1 on TS4, and another to the upper hole of lug 1 on TS5.

Now solder the battery snaps together in series and cover the exposed connections with some heat shrink tubing. Attach the remaining black lead wire to the lower hole of lug 2 on TS3 and the red one to the lower hole of lug 4 on TS3.

Finally, plug the two 3S4 pentodes into the empty sockets, connect one 9-volt battery to each of the three battery snaps, and place two 1.5-volt C-cell batteries in the holder for the B BATT with the positive and negative poles in the right place.

Operation. Obtain a piece of wire at least 25 feet long, attach one end to the antenna terminal, and drop the other end out of a window. Hanging it over the top of a nearby door should work, too. Get another long piece of wire and connect one end to a water pipe and the other end to the ground terminal. Then hook up a crystal earphone; one is included in the kit.

Next you must decide what frequency range you wish to receive, and set the taps on TS4 and TS5 accordingly. Table 1 is provided as a guide. Note that the frequencies specified assume an antenna that's resonant at between 3

and 4 MHz. Further, the frequencies given are merely ballpark figures. Experimentation is the best way to achieve maximum performance.

As a starting point, pick up the alligator clip connected to lug 2 of TS1 and attach it to the first tap (the start tap) on L1. Once again, that's the tap nearest the center of the coil. Attach the alligator clip soldered to lug 1 of TS4 to lug 4 of TS4. Then attach the clip connected to lug 1 of TS5 to lug 4 of TS5. Your radio is now ready to receive the standard broadcast band (535 to 1605 kHz).

Finally, swing the tickler coil (L3) all the way over to the left. Turn the radio on and rotate the variable capacitor until you hear a station. If you are not satisfied with the reception, change the tap on L1. You can also try changing the capacitor taps on TS5 and the L2 taps on TS4. Now, slowly move L3 towards the central area of L2. The signal will become stronger. At some point, as the tickler gets closer and closer to the center of L2, the system will begin to oscillate, which means a loud squeal in the earphones. Move L3 back a bit, the squeal will disappear, and the station will return. ■

TABLE 1—FREQUENCY-RANGE CHART

TAPS		FREQUENCY RANGE
TS4	TS5	
0 T	275 pF	550 kHz to 1350 kHz
0 T	125 pF	850 kHz to 1750 kHz
48 T	275 pF	1150 kHz to 2.5 MHz
48 T	125 pF	1700 kHz to 3.3 MHz
66 T	275 pF	3.0 MHz to 3.8 MHz
66 T	125 pF	3.5 MHz to 4.0 MHz
66 T	50 pF	3.7 MHz to 3.95 MHz



ADMIT ONE

Your Ticket To SUCCESS

Over 28,000 technicians have gained admittance worldwide as certified professionals. Let your ticket start opening doors for you.

ISCTET offers Journeyman certification in Consumer Electronics, Industrial, Medical, Communications, Radar, Computer and Video. For more information, contact the International Society of Certified Electronics Technicians, 2708 West Berry Street, Fort Worth, TX 76109; (817) 921-9101.

Name _____

Address _____

City _____

State _____ Zip _____

Send material about ISCTET and becoming certified.

Send one "Study Guide for the Associate Level CET Test." Enclosed is \$10 (inc. postage).

APRIL 1991

ADVERTISING INDEX

POPULAR ELECTRONICS magazine does not assume any responsibility for errors that may appear in the index below.

Free Information No.	Page	6	Heathkit	13	
13	AMC Sales	24	—	ISCET	101
14	All Electronics	27	—	Kelvin	99
—	Amazing Concepts	91	—	Listen Electronics	98
—	Antique Electronic Supply	99	—	Midwest Electronics	99
—	Antique Radio Classified	100	—	Monitoring Times	85
5	C & S Sales	15	8	Mouser	81
—	CB City	99	—	NRI Schools	11, 95
—	CIE	21	—	North American Services	100
—	Cable Plus	100	12	Protel Technology	79
—	Cable Ready Company	99	—	Pacific Cable	99
—	Command Productions	81	7	Parts Express	17
17	Contact East	26	—	Phillips Tech	99
15	Cook's Institute	89	—	Republic Cable	100
—	EIA	CV 3	18, 20	SCO Electronics	16, 89
16	EKI	23	11	Sequoia Publishing	26
—	Electronics Book Club	5	—	Silicon Valley Surplus	99
—	EE&D Book Club	28	10	Test Probes	7
—	Electronic Tech. Today	97, 100	—	Trans World	100
—	Electronic Tech. Today	CV 2	19	U.S. Cable	16
—	Firestik II	98	—	Video Tech	100
—	Global Cable Network	99	9	Viejo Publications	24
—	Grantham College	25	—	Windjammer	CV 4

ADVERTISING SALES OFFICE

Gernsback Publications, Inc.
500-B Bi-County Blvd.
Farmingdale, NY 11735
1-(516) 293-3000
President: Larry Steckler
Vice President: Cathy Steckler

For Advertising ONLY
516-293-3000
Fax 1-516-293-3115
Larry Steckler
publisher

Arline Fishman
advertising director
Denise Haven
advertising assistant

Christina Estrada
advertising associate
Kelly McQuade
credit manager

Customer Service/Order Form
1-800-435-0715
1-800-892-0753
7:30 AM - 8:30 PM EST

SALES OFFICES

EAST/SOUTHEAST
Stanley Levitan, Eastern Sales Manager
259-23 57th Avenue
Little Neck, NY 11362
1-718-428-6037, 1-516-293-3000
Fax 1-718-225-8594

MIDWEST/Texas/Arkansas/Oklahoma
Ralph Bergen, Midwest Sales Manager
540 Frontage Road—Suite 339
Northfield, IL 60093
1-708-446-1444
Fax 1-708-446-8451

PACIFIC COAST/Mountain States
Marvin Green, Pacific Sales Manager
5430 Van Nuys Blvd. Suite 316
Van Nuys, CA 91401
1-818-986-2001
Fax 1-818-986-2009

BUG OFF

(Continued from page 38)

(ouch!) no matter what its hearing range may be.

Also note the power supply; Two batteries in parallel are a good idea because, unlike common 555 circuits, the two oscillators are both supply-voltage dependent. A drop in voltage will reduce the unit's effectiveness. Besides, if you're out in the wild, you'll want the device to work a long time with little tending.

Construction. I wire-wrapped my Bug-Off because of the circuit's simplicity. I started by placing the IC socket for U1 on a small piece of per-board sized to accommodate it, a 16-pin IC socket (which I'll explain in a little bit), and the two 9-volt batteries. I then wired the pins of the 14-pin socket as shown in Fig. 3A (note that the figure shows the wire side).

I used an unusual wiring technique for the rest of the Bug-Off circuit. I cut the leads of all the discrete components and inserted them into a 16-pin wire-wrap socket (see Fig. 3B). It makes for neat, and sparing use of perboard

surface area. That's important to make the unit easily portable. When preparing your own DIP socket, you might need to bend the capacitors back against the other components. It'll depend on the size of your project box. Once the components are in the socket, install the socket on the board. You can use Fig. 3B as a wiring-side diagram as long as you position D1 correctly. First wire the support-component jumpers, and then run the necessary wires to the IC.

Make appropriate holes in the unit's case for the switch and piezo element. Put them in place and wire them to the board and the battery clips (note that BZ1 goes to the switch and pin 9 on the IC). Before you close up the case, you should test the unit. Get two good batteries, preferably from the same package to help ensure their internal resistances are the same. Connect them to the circuit, and flip the power switch on. If you place your ear very close to the transducer, you should hear a hard-to-notice high-pitched whine.

If the tone is easily audible, then the VCO is not operating in the right range. That could be due to a poor battery, mis-wiring, poor component connections, or poor component tolerances. I

would check for each in the order just listed. If you can't hear the tone at all, don't worry; your component tolerances might be pushing the frequency up, or, more likely, your hearing may be poor at such frequencies. That's very common and nothing worth worrying about. To make sure the unit is operating, press your finger against the leads of C2. That should cause its tone to drop to a more noticeable frequency.

Frills. You can soup-up the unit by running it off of a wall adapter for indoor use. However, without some amplification, the unit will have a limited range. You can use a good-size switching transistor running full-open to slam the crystal up and down at higher voltage levels to do just that. Just be sure you don't alter the operating voltage of the oscillators.

It's perfect for sleeping-bag use, especially if a clip or velcro is added to hold it in place. The pest repeller should provide you with many carefree hours to enjoy nature's bounty, or just a little patio R&R, without pesky bugs spoiling the fun. You can leave your battery of repellents and bite disinfectants home on that next family outing because you have Bug-Off. ■

The Importance Of Setting Standards.

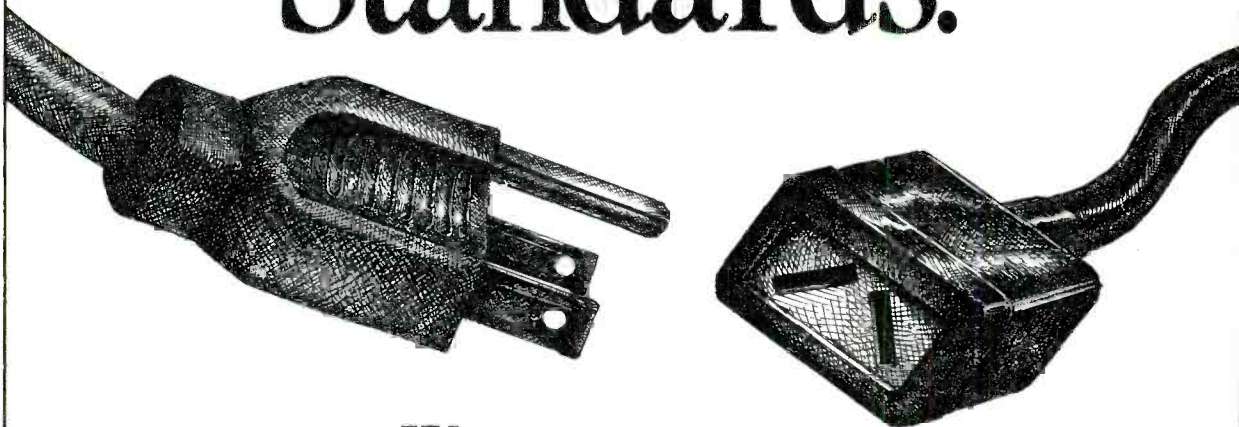

Without standardization in electronics, television wouldn't be seen, radio wouldn't be heard, computers wouldn't share information.

Fortunately the Electronic Industries Association (EIA) has been setting electronics standards since 1924 for everything from early tube radios to today's cellular telephones and stereo TV's.

Standards create *markets and jobs*. Today EIA, an internationally accredited standards making body, is helping to make HDTV a reality by working with the federal government and other industry organizations, to develop a timely, uniquely American transmission standard. For home automation,

EIA also is close to completing a standard which will permit all home electronic products to communicate with each other.

Our more than 1,000 member companies are manufacturers representing every facet of the American electronics industry—from defense to consumer products.

EIA is proud of the contributions it has made through its standards making process toward the growth and vitality of the U.S. electronics industries.

Setting the standard for more than 66 years.



ELECTRONIC INDUSTRIES ASSOCIATION

1722 Eye Street, N.W., Suite 300, Washington, D.C. 20006

East of the sun. West of the moon. Windjammer.



A place to live your fantasies.
A place to free your soul.
To cozy up to the Caribbean sun.
To dance among a thousand stars
to the rhythms of steel drums.
To play on sparkling white and
pink sand beaches.
To discover the underwater
paradise of the reefs.
To find a new friend and share the
intimacies of a sensuous night.
To come alive and live.
To remember for a lifetime.
6 days and 6 nights. From \$675.
Reservations toll free
1-800-327-2600
In Florida 305/373-2090.

**Windjammer
Barefoot Cruises**

Post Office Box 120,
Miami Beach, Florida 33119.



Capt'n Mike, rush me my free, full color Great Adventure booklet and show
me the way to Paradise for 6 days and 6 nights from \$675.
Windjammer 'Barefoot' Cruises,
P.O. Box 120, Dept. 1612 Miami Beach, Fla. 33119.

Name _____
Address _____
City _____
State/Zip _____