

Is Foolproof VCR Programming Finally Here?

48784

# Popular Electronics

FEBRUARY 1991

## THE PORTMASTER HOME-AUTOMATION SYSTEM

Bring your castle into the 21st Century with a PC and this easy-to-build home controller

## BUILD AN AUTOMATIC FISH FEEDER

It never forgets to feed your finny friends, even when you're away

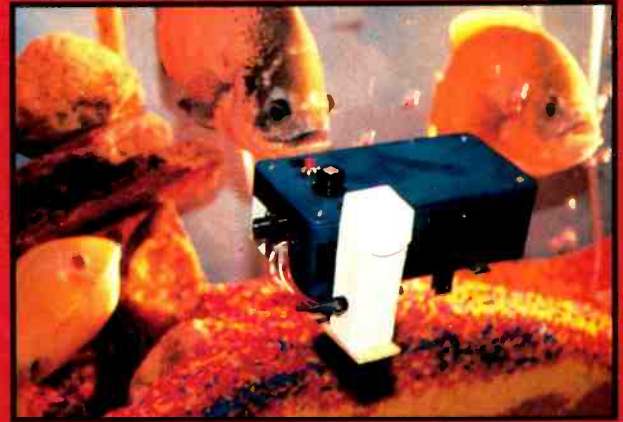
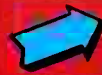

## WHEN DISASTER STRIKES

When workbench mishaps happen, these useful tips can save the day, and your project

## ELECTRONICS WIRING FOR THE HOME

Update your home to accommodate all of your present, and future, electronics gear



## THE SENTRYSTROBE ALERT SYSTEM

Build an eye-catching warning system with a variety of applications, and learn the ins and outs of light-strobe circuits in the bargain



A GERNSBACK PUBLICATION



\$2.95 U.S.  
\$3.75 CANADA

3 NEW  
FactCards  
IN THIS ISSUE

#2110\*\*\* CAR RT SORT \*\* CR24  
#60506DHM997G4006# FEB92 59  
ROBERT DAHM RESP 063  
997 GRAND AVE 60506  
AURORA, IL

# Electronics Paperback Books

GREAT PAPERBACKS AT SPECIAL PRICES

**BP248—TEST EQUIPMENT CONSTRUCTION** ..... \$5.95. Details construction of simple, inexpensive, but extremely useful test equipment. AF Gen, Test Bench Ampl, Audio Millivoltmeter, Transistor Tester and six more.

Test Equipment Construction



**BP267—HOW TO USE OSCILLOSCOPES AND OTHER TEST EQUIPMENT** ..... \$6.95. Mastering the oscilloscope is not really too difficult. This book explains all the standard controls and functions. Other equipment is also described.

How to Use Oscilloscopes and Other Test Equipment



**BP265—MORE ADVANCED USES OF THE MULTIMETER** ..... \$5.95. Use these techniques to test and analyze the performance of a variety of components. Also see how to build add-ons to extend multimeter capabilities.

More Advanced Uses of the Multimeter



An Introduction to Loudspeakers and Enclosure Design

**BP256—INTRO TO LOUDSPEAKERS AND ENCLOSURE DESIGN** ..... \$5.95. We explore the variety of enclosure and speaker designs in use today so the reader can understand the principles involved.



**BP263—A CONCISE INTRO TO dBASE** ..... \$6.95. The dBASE series of programs are probably the best known database programs for microcomputers. This book is designed to help you get started working with them.

A Concise Introduction to dBASE

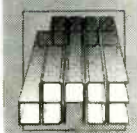

**BP260—CONCISE INTRO TO OS/2** ..... \$5.95. If you are a multitasking PC user and want to get the most out of your computer, then you must learn its OS/2 operating system. This book shows you just how to do that, quickly and easily.

A Concise Introduction to OS/2



**BP249—MORE ADVANCED TEST EQUIPMENT CONSTRUCTION** ..... \$6.95. Eleven more test equipment construction projects. They include a digital voltmeter, capacitance meter, current tracer and more.

More Advanced Test Equipment Construction



Digital Audio Projects



**BP245—DIGITAL AUDIO PROJECTS** ..... \$5.95. Practical circuits to build and experiment with. Includes A/D converter, input amplifier, digital delay line, compander, echo effect and more.

**BP247—MORE ADVANCED MIDI PROJECTS** ..... \$5.95. Circuits included are a MIDI indicator, THRU box, merge unit, code generator, pedal, programmer, channelizer, and analyzer.



An Introduction to Amateur Radio



**BP257—INTRO TO AMATEUR RADIO** ..... \$6.95. Amateur is a unique and fascinating hobby. This book gives the newcomer a comprehensive and easy to understand guide to the subject.

Introducing Digital Audio



**PCP102—INTRODUCING DIGITAL AUDIO** ..... \$9.95. Covers all kinds of digital recording methods—CD, DAT and Sampling. Bridges the gap between the technician and the enthusiast. Principles and methods are explained.

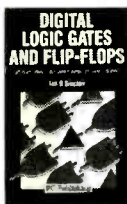

**PCP107—DIGITAL LOGIC GATES AND FLIP-FLOPS** ..... \$10.00. Thorough treatment of gates and flip-flops for enthusiasts, student and technicians. Only a basic knowledge of electronics is needed.

**BP251—COMPUTER HOBBYISTS HANDBOOK** ..... \$8.95. A wrapup of everything the computer hobbyist needs to know in one easy to use volume. Provides a range of useful reference material in a single source.

Computer Hobbyists Handbook



Computers Music



**PCP108—COMPUTERS AND MUSIC** ..... \$9.95. Explains the basics of computers and music with no previous knowledge of computers needed. Covers types of music software and explains how to set up your own computer music studio.

**BP195—INTRODUCTION TO SATELLITE TV** ..... \$9.95. A definitive introduction to the subject written for the professional engineer, electronics enthusiast, or others who want to know more before they buy. 8 x 10 in.

**BP190—ADVANCED ELECTRONIC SECURITY PROJECTS** ..... \$5.95. Includes a passive infra-red detector, a fiber-optic loop alarm, computer-based alarms and an unusual form of ultrasonic intruder detector.

**BP235—POWER SELECTOR GUIDE** ..... \$10.00. Complete guide to semiconductor power devices. More than 1000 power handling devices are included. They are tabulated in alpha-numeric sequence, by technical specs. Includes power diodes, Thyristors, Triacs, Power Transistors and FETs.

**BP234—TRANSISTOR SELECTOR GUIDE** ..... \$10.00. Companion volume to BP235. Book covers more than 1400 JEDEC, JIS, and brand-specific devices. Also contains listing by case type, and electronic parameters. Includes Darlingtons, transistors, high-voltage devices, high-current devices, high power devices.

**BP99—MINI-MATRIX BOARD PROJECTS** ..... \$5.50. Here are 20 useful circuits that can be built on a mini-matrix board that is just 24 holes by ten copper-foil strips.

**BP82—ELECTRONIC PROJECTS USING SOLAR CELLS** ..... \$5.50. Circuits with applications around the home that are powered by the energy of the sun. Everything from radio receivers, to a bicycle speedometer, to timers, audio projects and more.

**BP117—PRACTICAL ELECTRONIC BUILDING BLOCKS—Book 1** ..... \$5.75. Oscillators, Timers, Noise Generators, Rectifiers, Comparators, Triggers and more.

**BP184—INTRO TO 68000 ASSEMBLY LANGUAGE** ..... \$6.95. The 68000 is a great new breed of microprocessor. Programming in assembly language increases the running speed of your programs. Here's what you need to know.

**BP179—ELECTRONIC CIRCUITS FOR THE COMPUTER CONTROL OF ROBOTS** ..... \$7.50. Data and circuits for interfacing the computer to the robot's motors and sensors.

**BP239—GETTING THE MOST FROM YOUR MULTIMETER** ..... \$5.95. Covers basics of analog and digital meters. Methods of component testing includes transistors, thyristors, resistors, capacitors and other active and passive devices.

**BP97—IC PROJECTS FOR BEGINNERS** ..... \$5.50. Power supplies, radio and audio circuits, oscillators, timers, switches, and more. If you can use a soldering iron you can build these devices.

**BP37—50 PROJECTS USING RELAYS, SCR'S & TRIACS** ..... \$5.50. Build priority indicators, light modulators, warning devices, light dimmers and more.

**RADIO—100 RADIO HOOKUPS** ..... \$3.00. Reprint of 1924 booklet presents radio circuits of the era including regenerative, neutrodyne, reflex & more.

**BP42—SIMPLE LED CIRCUITS** ..... \$5.50. A large selection of simple applications for this simple electronic component.

**BP127—HOW TO DESIGN ELECTRONIC PROJECTS** ..... \$5.75. Helps the reader to put projects together from standard circuit blocks with a minimum of trial and error.

**BP122—AUDIO AMPLIFIER CONSTRUCTION** ..... \$5.75. Construction details for preamps and power amplifiers up through a 100-watt DC-coupled FED amplifier.

**BP92—CRYSTAL SET CONSTRUCTION** ..... \$5.50. Everything you need to know about building crystal radio receivers.

**BP45—PROJECTS IN OPTOELECTRONICS** ..... \$5.50. Includes infra-red detectors, transmitters, modulated light transmission and photographic applications.

**BP185—ELECTRONIC SYNTHESIZER CONSTRUCTION** ..... \$5.95. Use this book to learn how to build a reasonably low cost, yet worthwhile monophonic synthesizer and learn a lot about electronic music synthesis in the process.

## CHECK OFF THE BOOKS YOU WANT

**ELECTRONIC TECHNOLOGY TODAY INC.**  
P.O. Box 240, Massapequa Park, NY 11762-0240

### SHIPPING CHARGES IN USA AND CANADA

\$0.01 to \$5.00	... \$1.25
\$5.01 to 10.00	... \$2.00
\$10.01 to \$20.00	... \$3.00
\$20.01 to \$30.00	... \$4.00
\$30.01 to \$40.00	... \$5.00
\$40.01 to \$50.00	... \$6.00
\$50.01 and above	... \$7.50

**SORRY** No orders accepted outside of USA & Canada

Number of books ordered

Name \_\_\_\_\_  
Address \_\_\_\_\_  
City \_\_\_\_\_ State \_\_\_\_\_ Zip \_\_\_\_\_

Total price of merchandise ..... \$ \_\_\_\_\_  
Sales Tax (New York State Residents only) ..... \$ \_\_\_\_\_  
Shipping (see chart) ..... \$ \_\_\_\_\_

All payments must be in U.S. funds

Total Enclosed ... \$ \_\_\_\_\_

# Popular Electronics®

THE MAGAZINE FOR THE ELECTRONICS ACTIVIST!

## CONSTRUCTION ARTICLES

<b>THE SENTRYSTROBE ALERT SYSTEM</b> .....	Anthony Charlton	33
<i>Build an eye-catching warning system, and learn about strobe circuits in the bargain</i>		
<b>BUILD AN AUTOMATIC FISH FEEDER</b> .....	Jan Axelson	39
<i>Even if you sometimes forget to feed your aquatic pets, this circuit won't</i>		
<b>THE PORTMASTER HOME-AUTOMATION SYSTEM</b> .....	John Yacono and Marc Spiwak	59
<i>Control virtually every appliance in your home with a PC and this easy-to-build and -use interface circuit</i>		
<b>THE 3 X 3 ALARM</b> .....	Rich Hampton	67
<i>Get your feet wet in electronics by building this circuit designed especially for the beginning hobbyist</i>		

## FEATURE ARTICLES

<b>ELECTRONICS WIRING FOR THE HOME</b> .....	Sam Allen	43
<i>Upgrade your wiring for safety, and make it easier to add new technologies later on</i>		
<b>WHEN DISASTER STRIKES</b> .....	Marc Spiwak	64
<i>Here are some tips and techniques that can save your projects from common workbench mishaps</i>		
<b>THE DIGITAL ELECTRONICS COURSE</b> .....	Robert A. Young	69
<i>Get the facts on how digital-to-analog conversion is accomplished</i>		

## PRODUCT REVIEWS

<b>GIZMO</b> .....		47
<i>Including: Gemstar VCR Plus+ Instant Programmer, Fisher Pref-5 Compact Audio System, VoicePrint Voice-Activated Telephone, and much more</i>		
<b>HANDS-ON REPORT</b> .....		72
<i>Zaphod Industries File Fetch Program</i>		
<b>PRODUCT TEST REPORT</b> .....	Len Feldman	74
<i>Panasonic CQ-ID90EU Car Audio Tuner/Cassette Deck</i>		

## COLUMNS

<b>THINK TANK</b> .....	Byron G. Wels	22
<i>Reviewing the ground rules</i>		
<b>ANTIQUE RADIO</b> .....	Marc Ellis	78
<i>Build the "Cunningham Special"</i>		
<b>COMPUTER BITS</b> .....	Jeff Holtzman	80
<i>Love those meeses</i>		
<b>CIRCUIT CIRCUS</b> .....	Charles D. Rakes	82
<i>Test gear for the beginner</i>		
<b>FUN SOFTWARE</b> .....	Fred Blechman	84
<i>A "top-flight" simulator, and more</i>		
<b>HAM RADIO</b> .....	Joseph J. Carr	86
<i>The skinflint's special; a homebrew antenna for the cheapskate</i>		
<b>DX LISTENING</b> .....	Don Jensen	88
<i>Diversity from the Asian continent</i>		
<b>SCANNER SCENE</b> .....	Marc Saxon	90
<i>Digging into the mailbag</i>		

## DEPARTMENTS

<b>EDITORIAL</b> .....	Carl Laron	2
<b>LETTERS</b> .....		4
<b>ELECTRONICS LIBRARY</b> .....		6
<b>NEW PRODUCTS</b> .....		14
<b>ADVERTISERS INDEX</b> .....		104

Popular Electronics (ISSN 1042-170X) Published monthly by Gernsback Publications, Inc., 500-B Bi-County Boulevard, Farmingdale, NY 11735. Second Class postage paid at Farmingdale, NY and at additional mailing offices. One year, twelve issues, subscription rate U.S. and possessions \$21.95, Canada \$26.95, all other countries \$29.45. Subscription orders payable in U.S. funds only; International Postal Money Order or check drawn on a U.S. bank. U.S. single copy price \$2.95. © 1991 by Gernsback Publications, Inc. All rights reserved. Hands-on Electronics and Gizmo trademarks are registered in U.S. and Canada by Gernsback Publications, Inc. Popular Electronics trademark is registered in U.S. and Canada by Electronics Technology Today, Inc. and is licensed to Gernsback Publications. Printed in U.S.A.

Postmaster: Please send address changes to Popular Electronics, Subscription Dept., P.O. Box 338, Mount Morris, IL 61054-9932.

A stamped self-addressed envelope must accompany all submitted manuscripts and/or artwork or photographs if their return is desired should they be rejected. We disclaim any responsibility for the loss or damage of manuscripts and/or artwork or photographs while in our possession or otherwise.

As a service to readers, Popular Electronics publishes available plans or information relating to newsworthy products, techniques, and scientific and technological developments. Because of possible variances in the quality and condition of materials and workmanship used by readers, Popular Electronics disclaims any responsibility for the safe and proper functioning of reader-built projects based upon or from plans or information published in this magazine.

**Larry Steckler**

*EHF, CET  
Editor-In-Chief and Publisher*

## EDITORIAL DEPARTMENT

**Carl Laron**

*Editor*

**Robert A. Young**

*Associate Editor*

**John J. Yacono**

*Associate Editor*

**Byron G. Wels, K2AVB**

*Associate Editor*

**Teri Scaduto**

*Assistant Editor*

**Kathy Terenzi**

*Editorial Assistant*

**Marc Spiwak**

*Editorial Associate*

**Fred Blechman**

**Joseph J. Carr, K4IPV**

**Marc Ellis**

**Len Feldman**

**Jeffrey K. Holtzman**

**Don Jensen**

**Charles D. Rakes**

**Marc Saxon**

*Contributing Editors*

## PRODUCTION DEPARTMENT

**Ruby M. Yee**

*Production Director*

**Karen S. Brown**

*Production Manager*

**Marcella Amoroso**

*Production Assistant*

**Janice Box**

*Editorial Production*

## ART DEPARTMENT

**Andre Duzant**

*Art Director*

**Injae Lee**

*Illustrator*

**Russell C. Truelson**

*Illustrator*

**Jacqueline P. Cheeseboro**

*Circulation Director*

**Michele Torrillo**

*P-E Bookstore*

## BUSINESS AND EDITORIAL OFFICES

Gernsback Publications, Inc.

500-B Bi-County Blvd.

Farmingdale, NY 11735

1-516-293-3000

Fax: 1-516-293-3115

President: **Larry Steckler**

Vice President: **Cathy Steckler**

Customer Service/Order Entry

1-800-435-0715

In IL 1-800-892-0753

7:30 AM - 8:30 PM EST

Advertising Sales offices listed on page 103

Cover photography by Diversified Photo Services  
and Robert A. Young

Composition by  
Mates Graphics



The  
Audit  
Bureau  
of Circulation



The publisher has no knowledge of any proprietary rights  
which will be violated by the making or using of any items  
disclosed in this issue.

## IS FOOLPROOF VCR PROGRAMMING FINALLY HERE?

Here's a fair warning to the stand-up comics of the world: One of your favorite targets is about to disappear. We are referring to the VCR, or, more specifically, programming a VCR.

This month, **Gizmo** looks at the first of several systems designed to eliminate the difficulties, either perceived or actual, involved in VCR programming. That system, called VCR Plus +, lets users do their programming "by the numbers." That is, programming is done by looking up and entering a desired program's six- or seven-digit code number, which presumably will appear along with the program in local TV listings. The VCR Plus + unit then takes care of the rest.

While VCR Plus + is the first such system to reach the market, others, more technically elaborate, are close behind. Instant Guide, scheduled for introduction later this year, is an on-screen programming guide that will be broadcast in the vertical-blanking interval of participating PBS stations. Using the system requires purchasing an adapter, or a VCR with a built-in converter, and paying a monthly subscription fee. Once that's done, the user simply selects the program from the on-screen listings and pushes a button for instant programming.

Finally, there's SuperGuide, a proposed service that's similar to Instant Guide. With SuperGuide, a viewer receives a broadcast database that contains only the programming services to which he subscribes. Using an on-screen menu, the user selects the program desired and the system takes care of the rest.

VCR-programming jokes do seem funny, until you miss a once-in-a-lifetime event, like the Super Bowl, because you accidentally set the timer for A.M. instead of P.M. or set the wrong channel. Which, if any (remember Panasonic's bar-code reader programming system?), of these systems will succeed is open to debate. But to learn more about the merits and shortcomings of one system, turn to the review of VCR Plus + in **Gizmo**, which begins on page 47.

Carl Laron  
Editor

**Never before has so much professional information on the art of detecting and eliminating electronic snooping devices—and how to defend against experienced information thieves—been placed in one VHS video. If you are a Fortune 500 CEO, an executive in any hi-tech industry, or a novice seeking entry into an honorable, rewarding field of work in countersurveillance, you must view this video presentation again and again.**

*Wake up!* You may be the victim of stolen words—precious ideas that would have made you very wealthy! Yes, professionals, even rank amateurs, may be listening to your most private conversations.

*Wake up!* If you are not the victim, then you are surrounded by countless victims who need your help if you know how to discover telephone taps, locate bugs, or “sweep” a room clean.

There is a thriving professional service steeped in high-tech techniques that you can become a part of! But first, you must know and understand Countersurveillance Technology. Your very first insight into this highly rewarding field is made possible by a video VHS presentation that you cannot view on broadcast television, satellite, or cable. It presents an informative program prepared by professionals in the field who know their industry, its techniques, kinks and loopholes. Men who can tell you more in 45 minutes in a straightforward, exclusive talk than was ever attempted before.

### Foiling Information Thieves

Discover the targets professional snoopers seek out! The prey are stock brokers, arbitrage firms, manufacturers, high-tech companies, any competitive industry, or even small businesses in the same community. The valuable information they filch may be marketing strategies, customer lists, product formulas, manufacturing techniques, even advertising plans. Information thieves eavesdrop on court decisions, bidding information, financial data. The list is unlimited in the mind of man—especially if he is a thief!

You know that the Russians secretly installed countless microphones in the concrete work of the American Embassy building in Moscow. They converted



**HAVE YOUR  
VISA or MC CARD  
AVAILABLE**

what was to be an embassy and private residence into the most sophisticated recording studio the world had ever known. The building had to be torn down in order to remove all the bugs.

### Stolen Information

The open taps from where the information pours out may be from FAX's, computer communications, telephone calls, and everyday business meetings and lunchtime encounters. Businessmen need counselling on how to eliminate this information drain. Basic telephone use coupled with the user's understanding that someone may be listening or recording vital data and information greatly reduces the opportunity for others to purloin meaningful information.

The professional discussions seen on the TV screen in your home reveals how to detect and disable wiretaps, midget radio-frequency transmitters, and other bugs, plus when to use disinformation to confuse the unwanted listener, and the technique of voice scrambling telephone communications. In fact, do you know how to look for a bug, where to look for a bug, and what to do when you find it?

Bugs of a very small size are easy to build and they can be placed quickly in a matter of seconds, in any object or room. Today you may have used a telephone handset that was bugged. It probably contained three bugs. One was a phony bug to fool you into believing you found a bug and secured the telephone. The second bug placates the investigator when he finds the real thing! And the third bug is found only by the professional, who continued to search just in case there were more bugs.

The professional is not without his tools. Special equipment has been designed so that the professional can sweep a room so that he can detect voice-activated (VOX) and remote-activated bugs. Some of this equipment can be operated by novices, others require a trained countersurveillance professional.

The professionals viewed on your television screen reveal information on the latest technological advances like laser-beam snoopers that are installed hundreds of feet away from the room they snoop on. The professionals disclose that computers yield information too easily.

This advertisement was not written by a countersurveillance professional, but by a beginner whose only experience came from viewing the video tape in the privacy of his home. After you review the video carefully and understand its contents, you have taken the first important step in either acquiring professional help with your surveillance problems, or you may very well consider a career as a countersurveillance professional.

### The Dollars You Save

To obtain the information contained in the video VHS cassette, you would attend a professional seminar costing \$350-750 and possibly pay hundreds of dollars more if you had to travel to a distant city to attend. Now, for only \$49.95 (plus \$4.00 P&H) you can view *Countersurveillance Techniques* at home and take refresher views often. To obtain your copy, complete the coupon below or call toll free.

RADIO-ELECTRONICS VIDEO OFFER		PE
500-B Bi-Country Blvd. Farmingdale, NY 11735		
Please rush my copy of the Countersurveillance Techniques Video VHS Cassette for \$49.95 plus \$4.00 for postage and handling.		
No. of Cassettes ordered _____		
Amount of payment \$ _____		
Bill my <input type="checkbox"/> VISA <input type="checkbox"/> MasterCard		
Card No. _____		
Expire Date _____ / _____		
Signature _____		
Name _____		
Address _____		
City _____ State _____ ZIP _____		
All payments in U.S.A. funds. Canadians add \$4.00 per VHS cassette. No foreign orders. New York State residents add applicable sales tax.		

# LETTERS

## TWO-WIRE, NO WAY!

I enjoy **Popular Electronics** very much. Being retired from the electrical industry after 45 years, I still enjoy browsing through the pages to keep up on all the new and exciting innovations in the field.

I especially enjoy "Think Tank" and I often build some of the circuits to "keep my hand in." However, in looking over the November issue, I discovered a circuit that periodically crops up and must be put back in its place. I refer to the two-wire, three-way switch.

That circuit was common many years ago when homes were wired using a system called open "knob and tube" wiring. It saves stringing a separate wire (called a traveler) between the switches.

Throwing any of the switches will reverse the state of the lights, but it will also switch the "neutral" wire. That is in violation of the National Electric Code and can set up a very dangerous condition, as it leaves the "hot" wire at the lights still energized even though the lights are off. Anyone working on the lights, or merely changing a light bulb, might not know that the wiring is still energized and might receive a severe (even fatal) shock. All electrical installations should be in compliance with local and national codes.

E.F.  
Putnam, IL

## HOT-WIRE GLASS-CUTTER

When I received my copy of the December issue of **Popular Electronics**, I spotted an error in my article "Hot-Wire Glass Bottle Cutter." T1, the transformer for the project, really needs to be 5 or more amps at 12 VAC, and not 2-5 amps, as listed. Anything less than 5 amps won't have enough "oomph" to heat the wire.

Anthony Charlton

## LIGHTNING EFFECTS

When I received the October issue of **Popular Electronics**, I immediately read the article "Living with Lightning." I am sure your readers can relate thousands of weird lightning

"effects," but some that I have witnessed cast doubt on many of Mr. Doubek's solutions.

For instance, consider the case when lightning struck a TV antenna that was grounded to the outside water hydrant. The hydrant ran straight across the basement over a hanging ceiling and "T'd" into the below-ground point of entrance. The lightning did start a roof fire, but it also left equal burn marks on all four corners of every crossing of the hanging-ceiling grid. That is no more, or no less, near the cold-water pipe conductor than the farthest corner. That would seem to discount Mr. Doubek's recommendation to connect antennas, etc., to the cold-water system. It might have been better to drop the antenna ground straight to the ground rod by the most direct route and keep it out of the house.

Consider another case in which the power diodes of the TV and the stereo blew. In my experience as a TV repairman, that is a very common experience. In this case, however, the TV was left turned on, but was unplugged just before the storm. Yes, it had an outside antenna. The stereo was on the opposite side of the room, plugged in, turned off, and with no antenna. It, too, had the power diodes blown—along with an adjacent burned table lamp and exploded light bulb. The lamp was not on, and other lamps and the telephone in the same area were not affected. Recommendations by Mr. Doubek and others to disconnect modems, etc., do not seem to guarantee protection.

I would be interested in further articles on the subject, and possible explanations of the more bizarre occurrences. One interesting explanation is that the terrific currents and the inherent magnetic fields associated with nearby bolts induce damaging potentials depending on how close to parallel with the direction of the bolt a conductor is.

G.B.W.  
Glyndon, MD

## FERRIC-CHLORIDE ADVICE

Some manufacturers of ferric-chloride printed-circuit-board etching solution do not mention in their directions that the solution can be used more than one time; in fact, it does *not* have to be discarded after only one use. Many people who are new to hobby electronics are not aware of that fact, due to those misleading directions.

A bottle of ferric-chloride solution will last quite a long time, depending on how many PC boards are etched with it, how much copper is to be removed from each board, etc. Simply pour the used solution back into the bottle after use, and reuse it until it no longer removes copper in a reasonable amount of time. At that point, the solution should be brought to a facility that can safely dispose of it, rather than following the manufacturers' recommended disposal method of flushing it down the toilet. Check with your local fire department for the location of a hazardous-waste disposal facility.

C.I.,  
Pawtucket, RI

## MISSING E-Z MATH

I enjoy every issue of **Popular Electronics**, especially the continuing "Digital Electronics Course," which has helped me immensely. The same must be said about your construction articles.

I've been wondering what ever happened to the series called "E-Z Math" by Louis E. Frenzel. I would very much like to see those articles continued in **Popular Electronics**.

C.L.C.  
Kingston, Jamaica  
West Indies

*That series ran for about a year and a half, and had pretty much exhausted the topic area that was appropriate for this magazine. Since we want to include instructional articles that benefit the largest segment of our readership, it was moved aside for "The Digital Electronics*

*Course." You can expect, however, to see other math-oriented features sometime in the future—Editor*

## HAVES & NEEDS

I'm trying to find an operations manual and schematic for a Sprague model TO-5 capacitor analyzer. I'd appreciate any help your readers could give me.

Larry Cook  
362 East South St.  
Richland Center, WI 53581

I am looking for software for the Apple IIc computer. If anyone has any software pertaining to any aspects of radio, please write and let me know what you have and any costs involved. I'd really appreciate any help, since it seems that all software is geared to the IBM PC computers. I'd also like to correspond with Apple-IIc-family owners. Thanks.

Ryan Lughermo  
P.O. Box 413  
Midland, MI 48640-0413

I've tried other sources for several months with no success, so now I'm turning to **Popular Electronics**. Perhaps you or your readers could help me locate a manual and a schematic for a Conar model 223 tube tester. According to the imprint on the tester, Conar Instruments is or was a division of NRI, Washington, DC, but so far I have been unable to get anything from NRI or find any listing for Conar. I will be more than happy to buy these items or a copy of same from any source.

W. G. Halstead  
3194 Sugarplum Road, NE  
Atlanta, GA 30345

I'm seeking information on an old Micronta frequency counter, model 351 (Radio Shack Catalog No. 22-351). Can anyone offer advice on where I might get a schematic?

John Bubob  
412 Dodge St. #5  
West Lafayette, IN 47906 ■

# SELECT 5 BOOKS for only \$4.95

(values to \$127.70)  
and get a **FREE Gift!**

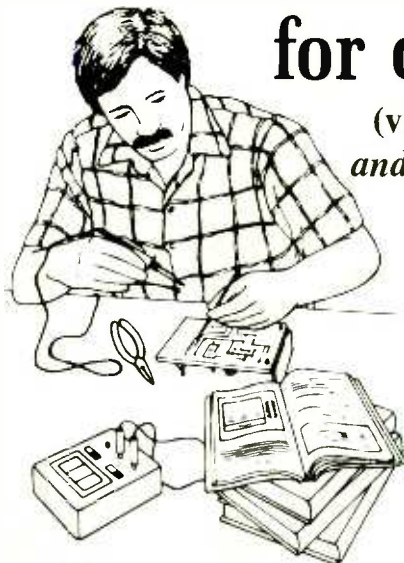

3329 \$29.95  
Counts as 2



10018 \$39.95  
Counts as 2



2898P \$15.95



2826P \$16.95



3279 \$36.95  
Counts as 2



3031P \$17.95

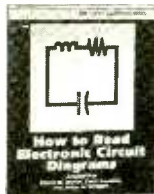

2880P \$14.95



864P \$21.95  
Counts as 2



3370 \$25.95  
Counts as 2



3205 \$24.95



3241P \$16.95



3312 \$23.95



2613P \$17.95

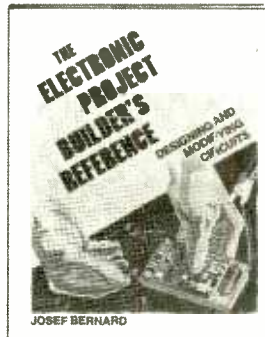

3260 \$22.95

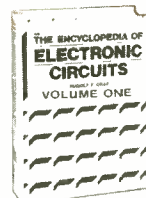

1938 \$60.00  
Counts as 3



2867P \$18.95

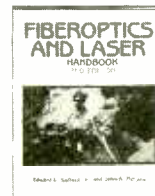

2981P \$16.95



3276 \$22.95



1367P \$24.95

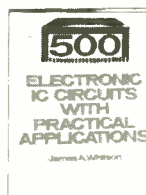

2920 \$29.95  
Counts as 2

For over 25 years, your most complete source for electronics books.

**Membership Benefits • Big Savings.** In addition to this introductory offer, you keep saving substantially with members' prices of up to 50% off the publishers' prices. • **Bonus Books.** Starting immediately, you will be eligible for our Bonus Book Plan, with savings of up to 80% off publishers' prices. • **Club News Bulletins.** 15 times per year you will receive the Book Club News, describing all the current selections—mains, alternates, extras—plus bonus offers and special sales, with scores of titles to choose from. • **Automatic Order.** If you want the Main Selection, do nothing and it will be sent to you automatically. If you prefer another selection, or no book at all, simply indicate your choice on the reply form provided. You will have at least 10 days to decide. As a member, you agree to purchase at least 3 books within the next 12 months and may resign at any time thereafter. • **Ironclad No-Risk Guarantee.** If not satisfied with your books, return them within 10 days without obligation! • **Exceptional Quality.** All books are quality publishers' editions especially selected by our Editorial Board. (Publishers' Prices Shown)

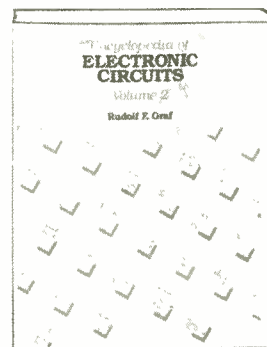

3138 \$60.00  
Counts as 3

## FREE when you join

### 15 Easy Electronic Projects From Delton T. Horn

Projects you can build—some unique, some old favorites— from the author's vast treasury of electronics know-how.

A \$7.95 Value!



2925P \$9.95



3355 \$26.95  
Counts as 2



## ELECTRONICS BOOK CLUB<sup>SM</sup>

Blue Ridge Summit, PA 17294-0810

Please accept my membership in the Electronics Book Club and send the 5 volumes listed below, plus my FREE copy of Delton T. Horn's All-Time Favorite Electronic Projects (3105P), billing me \$4.95. If not satisfied, I may return the books within ten days without obligation and have my membership cancelled. I agree to purchase at least 3 books at regular Club prices during the next 12 months and may resign any time thereafter. A shipping/handling charge and sales tax will be added to all orders.

--	--	--	--	--

Name \_\_\_\_\_  
Address \_\_\_\_\_  
City \_\_\_\_\_  
State \_\_\_\_\_ Zip \_\_\_\_\_ Phone \_\_\_\_\_  
Signature \_\_\_\_\_

Valid for new members only Foreign applicants will receive special ordering instructions Canada must remit in U.S. currency This order subject to acceptance by the Electronics Book Club PE291

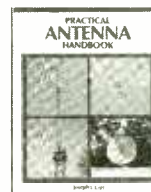

3270 \$32.95  
Counts as 2



2735P \$16.95



2790P \$14.95



2883P \$17.95

(Publishers' Prices Shown)  
1991 ELECTRONICS BOOK CLUB

All books are hardcover unless number is followed by a "P" for paperback

# ELECTRONICS LIBRARY

## Integrated Electronics: Operational Amplifiers And Linear ICs With Applications

by Joseph J. Carr

Here's a name familiar to **Popular Electronics** readers. Joe Carr's expertise is certainly not limited to ham radio. In this book he tackles the large—and growing—field of integrated circuits, a "required" subject for well-trained technicians. The book covers the devices and their operation in full detail, with an emphasis on practical applications in which IC's play a major role.

Because technicians need to understand how integrated circuits work, as well as how to apply them, the book opens with a general introduction to the fundamentals of linear IC technology, with separate chapters devoted to op amps, microwave linear IC devices, and high-frequency devices. A wealth of applications circuits are presented, including timers,

ators, and physical-instrumentation circuits. Rounding out the subject area are chapters on the design and construction of DC power supplies, and on troubleshooting discrete and IC circuits. Each chapter opens with brief statement of its objective, highlighting the important points to be covered, and a "prequiz" to help readers test their knowledge of the subject before reading. A point-by-point summary and a set of problems and questions are included to wrap up each chapter.

*Integrated Electronics: Operational Amplifiers and Linear ICs with Applications is available in hardcover for \$35.00 from Harcourt Brace Jovanovich, Inc., College Department, 1250 Sixth Avenue, San Diego, CA 92101.*

**CIRCLE 81 ON FREE INFORMATION CARD**

### THE TALKING TELEPHONE: And 14 Other Custom Telephone Projects

by Steve Sokolowski

This book shows readers how to transform basic rotary or dial-tone telephones with an array of state-of-the-art innovations. Using inexpensive, easily obtainable parts, the book shows how to add speech synthesizers that alert the user to incoming calls and read back numbers as they are dialed, digital displays, music adapters, and sophisticated control circuitry. Some of the projects include a talking phone, a late-night phone guard, an electronic ringer, a flip/flop hold button, a music-on-hold adapter, a programmable dialer, LED readouts, a melody ringer, off-hook detectors, and a digital phone lock. The book supplies all of the circuit de-

signs, schematics, and building instructions needed, and even includes the names and addresses of many major mail-order component distributors.

*The Talking Telephone: And 14 Other Custom Telephone Projects is available for \$17.95 from TAB Books Inc., Blue Ridge Summit, PA 17294-0850; Tel. 1-800-233-1128.*

**CIRCLE 98 ON FREE INFORMATION CARD**

### TECH TIPS #2: MICROCOMPUTER BUSES OVERVIEW

from Keithley MetraByte

The second in a series of technical notes from Keithley MetraByte reviews bus architectures such as the PC, PC/AT, Micro Channel, EISA, and NuBus. Characteristics including bus width (data and address), interrupt capability (number and type), and DMA performance (channels, transfer



rates, and latency) are discussed. In addition, *Tech Tip #2* explores some of the design limitations and concerns that yielded alternate bus architectures.

*Tech Tips #2: Microcomputer Buses Overview is free upon request from Keithley MetraByte, 440 Myles Standish Blvd., Taunton, MA 02780; Tel: 508-880-3000.*

**CIRCLE 82 ON FREE INFORMATION CARD**

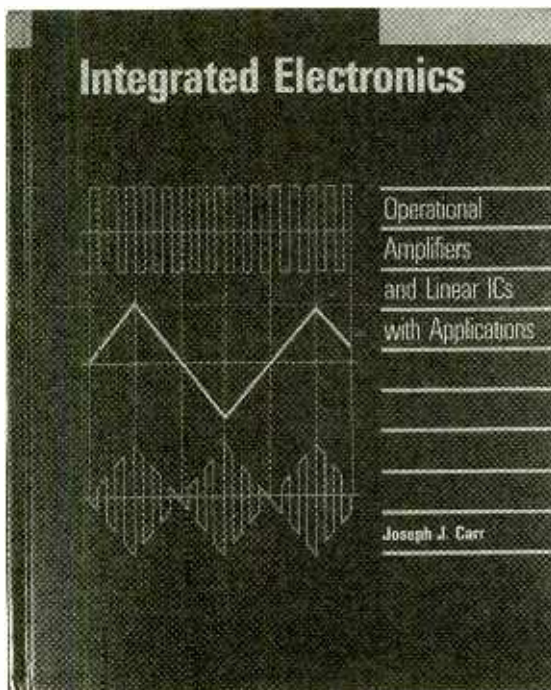

signal-processing circuits (such as logarithmic amplifiers, integrators, and differentiators), audio circuits, waveform gener-



**DXER'S DIRECTORY:  
1990-91 Edition**

compiled by Fred Osterman

The expanded edition of this "Who's Who" of shortwave listeners and DX'ers, which lists more than 1800 listeners from 75 countries, addresses two problems that have plagued DX'ers: lack of communications and difficulty in forming radio clubs. While it's easy to copy signals from around the world, it's not easy to find other hobbyists in one's own area. This book strives to promote friendships and enhance the hobby for those who read it. Listener entries include address, call sign, radio interest, and club affiliations. The directory also serves as an accurate source of club activity; it includes any size club, from well-established national organizations to informal "get-together" groups of listeners. More than 125 radio club listings are provided, and each includes address, coverage, publication name, dues, and restrictions.

*The DXer's Directory: 1990-91*

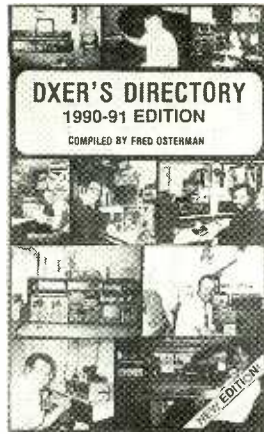

Edition is available for \$4.95 plus \$1.00 shipping from Universal Radio Research, 1280 Aida Drive, Reynoldsburg, OH 43068; Tel: 800-431-3939 or 614-866-4267.

**CIRCLE 83 ON FREE INFORMATION CARD**

**THE AUDIO SOURCE CATALOG**

From Sescom, Inc.

Reflecting their rapidly growing

product line, Sescom's current catalog has been expanded to 64 pages of professional audio equipment. Included are audio-signal processors, direct boxes, mic-line drivers, mixers, test equipment, transformers, portable devices, modules, and in-line accessories. The catalog is fully illustrated, and contains complete product descriptions and pricing information.

The Audio Source catalog is available from Sescom, Inc., 2100 Ward Drive, Henderson, NV 89015-9998; Tel. 702-565-3400; Fax 702-565-4828.

**CIRCLE 84 ON FREE INFORMATION CARD**

**MONTHLY UPDATES OF USED TEST EQUIPMENT**

from RAG Electronics, Inc.

These free monthly updates highlight RAG Electronics' latest arrivals, best values, and one-of-a-kind clearance items. Each update features test equipment from respected manufacturers,

including Hewlett-Packard, Tektronix, and Fluke. A wide variety of oscilloscopes, spectrum analyzers, DMM's, power supplies, signal sources, environmental chambers, and more is featured. All used equipment is calibrated by RAG's NIST-traceable lab for performance to the manufacturer's original specifications, and comes with a six-month parts and labor warranty.

The monthly updates are free from RAG Electronics, Inc., 2418 Parthenia Street, Canoga Park, CA 91304.

**CIRCLE 85 ON FREE INFORMATION CARD**

**GETTING THE MOST FROM YOUR PC'S HARD DISK**

by J. W. Penfold

Providing speed and convenience, the hard-disk drive is an essential part of any computer used for serious purposes. The hard disk lets the user have all applications and data files on hand as soon as the computer

**Parts Express International Inc**

**2-1/2" SANYO TWEETER**  
Paper cone with gold tone dust cap. 8 oz. magnet. 8 ohm. 1/2" ferro fluid voice coil. Power handling: 50W RMS, 70W max. Frequency response: 3K-20KHz.  
#PC-271-020 \$1<sup>95</sup> \$1<sup>75</sup> 95c  
(1 9) (10-59) (60-up)

**SUPER HORN TWEETER**  
Original piezo tweeter made by Motorola. SPL=94 dB 2.83V/1M. Response: 4KHz-27KHz. Handles approximately 50 watts.  
#PC-270-010 \$5<sup>30</sup> \$4<sup>50</sup> \$3<sup>95</sup>  
(1 9) (10-79) (80-up)

**2" DOME MIDRANGE**  
Textile dome midrange made by Philips. 8 ohm. SPL=90 dB 1W/1M. 30W RMS. 40W max. Response: 550-5KHz.  
#PC-280-210 \$27<sup>30</sup> \$25<sup>70</sup>  
(1 3) (4-up)

**15" SUBWOOFER**



Dual voice coil. 40 oz. magnet. 6 ohm imp. 100W RMS, 140W max. Response 20-20KHz. Resonant frequency: 21Hz. SPL=93 dB 1W/1M.

**PIONEER**  
#PC-290-190 \$54<sup>50</sup> \$49<sup>80</sup>  
(1 3) (4-up)

**SUBWOOFER XOVER**

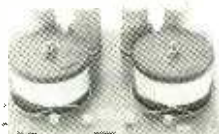

200W RMS crossover designed specifically for use with dual voice coil subwoofers. 12 dB per octave roll-off at 150Hz.

#PC-260-220 \$28<sup>80</sup> \$24<sup>40</sup>

**10" POLY WOOFER**

Medium duty. 60W RMS, 80W max. 14 oz magnet. Response 25-2.5KHz fs=28Hz



#PC-290-096 \$18<sup>50</sup> \$16<sup>90</sup>  
(1 3) (4 up)

**TITANIUM COMPOSITE TWEETER**

The advantages of both hard and soft dome technologies. 8 ohm. Ferro fluid cooled voice coil. SPL=90 dB 1W/1M. 50W RMS. 70W max. 4" round Polydax #DTW100T125



**polydax**  
#PC-270-047 \$27<sup>50</sup> \$24<sup>80</sup>  
(1 9) (10-up)

**SPEAKER BUILDING BOOK**

Revised edition of David Weems' best selling book. Learn to build low cost speakers that rival the high priced models.



#PC-500-021 \$16<sup>95</sup>

**12" CAST FRAME WOOFER**



**EMINENCE**

12" woofer made in the USA by Eminence. Paper cone and dust cap with treated cloth surround. 80 oz magnet. 2-1/2" vented voice coil. 8 ohm. 170W RMS. 235W max. 40-4.5KHz response.

#PC-290-147 \$72<sup>90</sup> \$69<sup>50</sup>  
(1 3) (4 up)

**Parts Express**

**FREE CATALOG**

**Parts Express**  
340 E. First St., Dayton, Ohio 45402  
Local: 1-513-222-0173  
FAX: 513-222-4644

• 15 day money back guarantee • \$15.00 minimum order • We accept Mastercard, Visa, Discover, and C.O.D. orders. • 24 hour shipping • Shipping charge = UPS chart rate + \$1.00 (\$3.00 minimum charge) • Hours 8:30 am - 7:00 pm EST. Monday - Friday • Mail order customers, please call for shipping estimate on orders exceeding 5 lbs • Foreign customers please send \$5.00 U.S. funds for catalog postage

**CALL TOLL FREE  
1-800-338-0531**

**CIRCLE 6 ON FREE INFORMATION CARD**

www.americanradiohistory.com

### Getting The Most From Your PC's Hard Disk



is switched on, and permits programs and files to be quickly loaded. This book is written both for those who are about to add a hard disk to their computers and for those who are already using hard disks. For newcomers, the book offers important background information on hard-disk types and standards, formatting and preparing disks, and installing DOS. For existing hard-disk users, the book explains how to organize files in subdirectories and use batch files, and outlines backup and security procedures. The information in the book is suitable for IBM PC's and compatible computers running under MS-DOS, PC-DOS, and DR DOS.

*Getting the Most From Your PC's Hard Disk (BP280) is available for \$8.95 (including shipping) from Electronics Technology Today Inc., P.O. Box 240, Massapequa Park, NY 11762-0240.*

**CIRCLE 97 ON FREE INFORMATION CARD**

### '90/'91 CATALOG

*from Parts Express*

For electronics technicians, engineers, and hobbyists, this catalog is a comprehensive source of electronic parts and accessories. Included in its pages are semiconductors; capacitors; resistors; switches; speakers and accessories; connectors; cable and wire; TV, CATV, and VCR repair parts; chemicals; tools; technical books and schematics; alarm equipment; and computer accessories.

*The '90/'91 Catalog is free*

*upon request from Parts Express International, Inc., 340 East First Street, Dayton, OH 45402; Tel: 513-222-0173; Fax: 513-222-4644.*

**CIRCLE 86 ON FREE INFORMATION CARD**

### HOW TO BUY OR SELL USED COMPUTERS

*from National Computer Exchange*

For those who don't require cutting-edge technology, used computers are a cost-effective alternative. This easy-to-read brochure from the National Computer Exchange (NACOMEX)—a nationwide brokerage service through which individuals and companies buy and sell used computers—provides an inexpensive way to investigate equipment value in nine major market segments—Macintosh, AT-386, AT-28, XT-compatible, PS/2, portables, laptops, Apple II, and laser printers. The booklet offers advice on how to quickly and conveniently buy or sell used computers.

*How to Buy or Sell Used Computers is free upon request from National Computer Exchange, 118 East 25th Street, New York, NY 10010; Tel: 212-614-0700; Fax: 212-777-1290.*

**CIRCLE 87 ON FREE INFORMATION CARD**

### IC PINOUT GUIDE

*from Global Engineering Documents*

To help technicians stop wasting valuable time hunting down connection data they need to replace integrated circuits in consumer-electronics items, this guide makes it easy to quickly locate IC-pinout information. In it, repair technicians can find IC circuit-connection data or pinouts for more than 175,000 IC's currently in use worldwide. The book also includes a part-number locator index, IC descriptions, function information, package-style drawings, and a directory of manufacturers.

*The IC Pinout Guide is available at a special pre-publication price of \$99.00 through the end*

*of November 1990 (the regular list price is \$175.00) from Global Engineering Documents, P.O. Box 19539, Irvine, CA 92713; Tel: 800-854-7179; Fax: 714-261-7892.*

**CIRCLE 88 ON FREE INFORMATION CARD**

### THE ILLUSTRATED DICTIONARY OF MICROCOMPUTERS: THIRD EDITION

*by Michael F. Hordeski*

Reflecting rapid changes in the world of microcomputers, the third edition of this comprehensive reference contains more than 1200 new entries. Covering such fields as microcomputer applications, hardware, software, desktop publishing, computer-aided design, word processing, networking, and graphics, the dictionary provides up-to-the-minute definitions at a glance. Numerous illustrations help clarify and simplify the book's more than 9500 definitions, and meticulous cross-referencing directs readers to related terms.

*The Illustrated Dictionary of Microcomputers: Third Edition is available for \$19.95 from TPR, Division of TAB Books Inc., Blue Ridge Summit, PA 17294-0850; Tel: 1-800-233-1128.*

**CIRCLE 98 ON FREE INFORMATION CARD**

### ELECTROSTATIC DISCHARGE PROTECTION FOR ELECTRONICS

*by Neil Sclater*

Static electricity might seem harmless—or just a minor annoyance—but it's responsible for millions of dollars in damage to electronic equipment each year. For anyone involved in the assembly, storage, shipment, testing, or repair of sensitive electronic devices, controlling electrostatic discharge (ESD) is vitally important. This book provides manufacturers, dealers,



technicians, and hobbyists with practical, up-to-date solutions to the ESD problem. It takes an in-

*(Continued on page 12)*

# FREE

**POPULAR ELECTRONICS  
1990 EDITORIAL INDEX  
FREE COUPON**

Return this FREE coupon together with a No. 10 (business-size) envelope on which your name and address appear and to which you have affixed a 25-cent postage stamp and we will send you a copy of the POPULAR ELECTRONICS 1990 EDITORIAL INDEX. Send your request to: Popular Electronics Annual Index, 500-B Bi-County Blvd., Farmingdale, NY 11735. This is a limited offer so act today!

**THIS FREE OFFER EXPIRES APRIL 30, 1991  
AFTER APRIL 30, 1991 THERE WILL BE  
A \$1.00 CHARGE.**

# FREE

# How to build a high-paying career, even a business of your own, in computer programming.



**RICK BRUSH,  
NRI PROGRAMMER/ANALYST**

**Start with training that gives you hands-on programming experience—at home and at your own pace. Training that begins with BASIC, then continues with Pascal, C, and COBOL—today's hottest computer languages. Training that even includes a powerful IBM-compatible computer, modem, and programming software you keep.**

**Start with real-world training. The kind of training only NRI provides.**

Now with NRI's new at-home training in Computer Programming, you can be one of today's highly paid, creative team of computer wizards who give computers the power to carry out an astonishing range of business, professional, and personal applications. Now, with NRI, you can be a computer programmer, ready to build a high-paying career—even a business of your own—making computers do anything you want them to do.

**The only programming course that includes a powerful computer system and software you keep.**

Unlike any other school, NRI gives you hands-on programming experience with a powerful IBM compatible West Coast computer system, including 2400

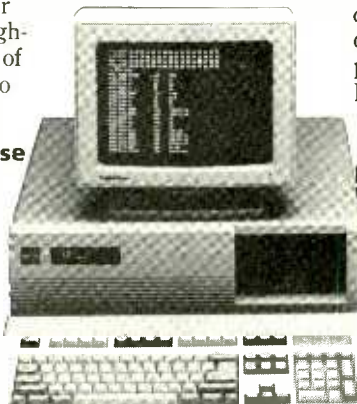

**Only NRI gives you an IBM-compatible computer with modem, 640K RAM, disk drive, monitor, and software—BASIC, Pascal, C, and COBOL—all yours to keep!**

baud internal modem, 640K RAM, disk drive, monitor, and invaluable programming software—BASIC, Pascal, C, and COBOL—all yours to keep.

You get the experience and the know-how, the computer and the software to get to the heart of every programming problem, design imaginative solutions, then use your choice of four key computer languages to build original, working programs.

**No matter what your background, NRI gives you everything you need to succeed in programming, today's top-growth computer career field.**

You need no previous experience to build a successful programming career with NRI training. Indeed, your NRI lessons start by walking you step by step through the fundamentals, giving you an expert understanding of the programming design techniques used every day by successful micro and mainframe programmers. And then the fun really begins.

C, and COBOL. Then, rounding out your training, you use your modem to "talk" to your instructor, meet other NRI students, even download programs through NRI's exclusive programmers network, PRONET.

**Your career in computer programming begins with your FREE catalog from NRI.**

For all the details about NRI's at-home training in Computer Programming, send the coupon today. Soon you'll receive NRI's fascinating, information-packed, full-color catalog.

Open it up and you'll find vivid descriptions of every aspect of your NRI training. You'll see the computer system included in your course up close in a special, poster-sized foldout section. And, best of all, you'll find out how your NRI training will make it easy for you to build that high-paying career—even a business of your own—in computer programming.



**You master today's hottest computer languages, gaining the skills you need to build programs for a wide variety of real-world applications.**

With your personal NRI instructor on call and ready to help, you use your computer and software to actually design, code, run, debug, and document programs in BASIC, Pascal,

**Send for your NRI catalog today. It's yours, free.**

If the coupon is missing, write to us at the NRI School of Computer Programming, McGraw-Hill Continuing Education Center, 4401 Connecticut Avenue, NW, Washington, DC 20008.

IBM is a Registered Trademark of the IBM Corporation

## **NRI** School of Computer Programming

McGraw-Hill Continuing Education Center  
4401 Connecticut Avenue, NW  
Washington, DC 20008



**YES!** Please rush me my FREE catalog describing NRI's at-home training in Computer Programming.

NAME \_\_\_\_\_ (please print) AGE \_\_\_\_\_

ADDRESS \_\_\_\_\_

CITY/STATE/ZIP \_\_\_\_\_ Accredited Member National Home Study Council 5413-021

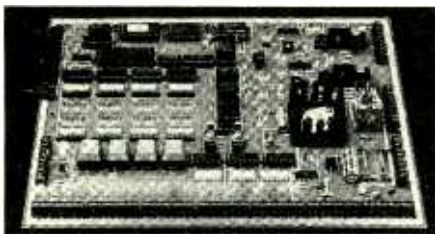

### Knight Patrol™ Talking Home Alarm Kit

A high end alarm system at an affordable price!

Features include:

- ◆ State of the art PCF 8200 Speech Synthesizer
- ◆ 21 Sensor Zones, 2 Arming Circuits
- ◆ 2 Five Watt Audio Amplifiers
- ◆ Auxiliary Alarm
- ◆ Real Time 24 Hr. Clock
- ◆ A 10A & 3A Relay Circuit for Sirens, etc.
- ◆ Alert/Sleep Monitoring Modes (verbal status)
- ◆ Trigger Memory (verbal status)
- ◆ Self Diagnostics & Performance Monitoring
- ◆ Microprocessor Controlled
- ◆ Pleasant Female Voice
- ◆ Expandibility & so much MORE!

Available as a kit or pre-assembled  
Send \$3 for full-line catalog A  
complete line of peripherals is  
also available. Complete circuit  
board kit \$220.00 + \$10.50 S & H.  
(CA residents add 6.75% tax)  
Complete systems starting from  
\$440.00. Instructional video tape  
(VHS \$9.95 + \$2.50 S & H)

#### Paladin Electronics

19425 B Soledad Cyn Rd  
Suite 333 Dept PE  
Canyon Country, CA 91351

"We protect your castle"



CIRCLE 16 ON FREE INFORMATION CARD

## AMAZING NEW Pocket Reference

480 pages of tables, maps,  
formulas, and conversions  
and it fits in your shirt pocket  
(3.2" x 5.4" x 0.6")!

**\$9.95\***



\* Plus \$2.00 shipping & handling.  
Colorado residents add 56¢ tax.

#### Small sample of contents

Air Tool CFM vs PSI	Radio Alphabet
Battery Charging	TEN Radio Codes
Tire Manufacturer Codes	Telephone Area Codes
Lumber Sizes & Grades	Lost Credit Card Phones
Concrete & Mortar	Sound Intensities
Element Tables	Wind Chill Factors
Computer ASCII Codes	Frequency Spectrum
IBM® PC Error Codes	Geology Mineral Tables
IBM® Interrupts-IO Map	Glues and Solvents
80286 Hard Disk Types	Bolt Torque Tables
Printer Control Codes	Wood Screw/Nail Sizes
Electric Wire Size vs Load	Math Formulas & Tables
NEMA Motor Frames	Plane/Solid Geometry
Wire & Sheet Gauges	Copper/Steel/PVC Pipe
Resistor/Capacitor Colors	Rope, Cable and Chain
Pilot Lamp Specs	Tap-Die-Drill Sizes
Fuse & Battery Specs	Sand Paper & Abrasives
RF Coil Winding Data	Weld Electrode & Solder
Wire Size vs Turns/Inch	3200 Conversion Factors

Money Back Guarantee - If not completely satisfied, return  
book postage prepaid, in mint condition for a 100% refund!

Sequoia Publishing Inc.  
Dept 917, P.O. Box 620820  
Littleton, CO 80162

CIRCLE 18 ON FREE INFORMATION CARD

## ELECTRONICS LIBRARY

(Continued from page 8)

depth look at the devices, techniques, and shielding methods currently in use in many companies, and shows readers how to set up full-scale ESD-control programs at their companies. The book explores ESD measurement and monitoring, and describes environmental controls such as proper conditioning of flooring and work surfaces, regulating humidity and ionization in the workplace, designing static-free workstations and protective packaging, and built-in component and circuit-board protection. For protecting employees, the book explains personnel training, the use of proper tools and accessories, and personal grounding techniques. The ESD-prevention techniques described in this book can be employed at all levels from product design and manufacturing to distribution management and on-the-job repair.

*Electrostatic Discharge Protection for Electronics is available in hardcover for \$29.95 from TRP, Division of TAB Books Inc., Blue Ridge Summit, PA 17294-0850; Tel. 1-800-233-1128.*

CIRCLE 98 ON FREE INFORMATION CARD

## ECG AUDIO AND VIDEO: Replacement Parts and Service Aids

from Philips ECG

Philips' expanded audio- and video-product line, which now includes a larger selection of VCR mechanical replacement parts and replacement RF modulators, is described in the second edition of this catalog and cross-reference guide. Consolidating several previous ECG publications, the catalog cross references 31 popular VCR brands and more than 2400 industry model/part numbers to the corresponding ECG replacement part. It contains illustrated selector guides, specifications, cross references, and related replacement information on a variety of VCR modulators, opto-sensing devices, pinch

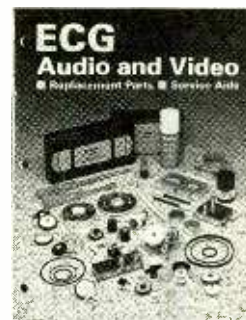

rollers, idler wheels, assemblies and tires, individual belts and belt kits, and VHS/Beta replacement heads. Service aids for making fine adjustments to tape equipment are also featured in the catalog. Included are precision adjustment tools, audio and video test cassettes, and lubricants and cleaning materials.

*The ECG Audio and Video Replacement Parts and Service Aids catalog is available from Philips ECG, Discrete Products Division, 2001 West Blue Heron Blvd., Riviera Beach, FL 33404; Tel: 800-526-9354.*

CIRCLE 89 ON FREE INFORMATION CARD

## RADIO PRODUCTION: Art and Science

by Michael C. Keith

Taking an integrated approach to the subject of radio production, this book emphasizes the influence of programming on the entire mixdown process. The insights of more than 100 broadcast professionals, quoted throughout the text, add depth, humor, and a sense of reality that are often missing in text-style books. The book is divided into five main sections. In the first, a brief history of radio production and a look inside a modern production studio are followed by an examination of the skills and qualities needed to meet the responsibilities of a career in radio production. The second section covers studio design and equipment, including state-of-the-art digital processors, MIDI, and synthesizers. A discussion of the basics of copy preparation and good announcer delivery, as well as an examination of the tape-editing techniques, make up the third section. The fourth

explains how commercials, public-service announcements, promos, and features are produced. The book concludes with a look at several aspects of producing noncommercial radio.

*Radio Production: Art and Science is available for \$29.95 from Focal Press, 80 Montvale Avenue, Stoneham, MA 02180.*

**CIRCLE 90 ON FREE INFORMATION CARD**

## NEWARK CATALOG NUMBER 111

from Newark Electronics

This 1280-page electronics catalog contains complete technical information and dimensions on more than 100,000 products from 250 leading manufacturers. Twenty new manufacturers are represented in this catalog, and more than 15,000 new products in a variety of categories appear.

Highlights of Catalog #111 are a 16-page, four-color prod-



uct section; an easy-to-follow "how to" section for using the catalog; an expanded surface-mount devices section; and an indexed premises-wiring products section.

*Catalog number 111 is available from Newark Electronics, 4801 North Ravenswood Avenue, Chicago, IL 60640-4496.*

**CIRCLE 91 ON FREE INFORMATION CARD**

## ELECTRONIC INSTRUMENTS AND MEASUREMENTS: Second Edition

by Larry D. Jones and A. Foster Chin

Obtaining reliable, accurate, and cost-effective measure-

ments depends not only on the test instrument, but also on the technician's ability to select the right instrument, use it properly, and interpret the measurement data.

This book provides the information needed to gain an understanding of the basic theory of operation and the capabilities and limitations of test instruments. An emphasis is placed on laboratory practice, and the lab experiments that are offered in the book are

designed to help readers develop proficiency in the use of laboratory-quality instruments.

The book provides a comprehensive introduction to instrumentation; electrical units; measurement standards; and the selection, care, and use of a wide range of test equipment, including AC and DC meters, oscilloscopes, signal generators, transducers, recording instruments, and signal analyzers. Discussions of digital instruments include a com-

parison of digital and analog meters, digital multimeters, electronic counters, and analog-to-digital converters. Other topics that are discussed in the book include fiber optics and troubleshooting.

*Electronic Instruments and Measurements is available in hardcover for \$47.00 from Prentice Hall, Englewood Cliffs, NJ 07632.*

**CIRCLE 99 ON FREE INFORMATION CARD**

# ELENCO & HITACHI PRODUCTS AT DISCOUNT PRICES

**NEW!** RSOs (Real-Time & Storage Oscilloscopes) From HITACHI **NEW!**

The RSO - its the new solution  
View, Acquire, Test, Transfer and Document Your Waveform Data

4-Channel, 100MS/s Model	Introductory Price
100MS/s (25MS/s on 4 channels simultaneously), 100MHz, 4kw x 1ch., 2kw x 2ch., 1kw x 4ch.	VC-6145 \$3,695.00

**Compact, Full Feature Models**

40MS/s, 100MHz, 4kw x 1ch., 2kw x 2ch	VC-6045 \$3,049.00
20MS/s, 50MHz, 2kw x 2ch	VC-6025 \$2,295.00

**Low Cost/High Value Models**

20MS/s, 50MHz, 2kw x 2ch	VC-6024 \$2,049.00
20MS/s, 20MHz, 2kw x 2ch	VC-6023 \$1,749.00

RSOs from Hitachi feature such functions as roll mode, averaging, save memory, smoothing, interpolation, pre-triggering, cursor measurements, plotter interface, and RS-232C interface. With the comfort of analog and the power of digital.

### Compact Series Scopes



Delayed Sweep  
Lightweight (13lbs)  
2Mv Sens  
3 Yr. Warranty  
Model V-1065  
Shown

This series provides many new functions such as CRT Readout, Cursor measurements (V 1085, 1095, 665), Frequency Cir (V-1085), Sweepline Autoringing and Trigger Lock using a 6-inch CRT. You don't feel the compactness in terms of performance and operation.

V-660 60MHz Dual Trace	\$1,195
V-665 60MHz Dual Trace w/Cursor	\$1,345
V-1060 100MHz Dual Trace	\$1,425
V-1065 100MHz Dual Trace w/Cursor	\$1,895
V-1085 100MHz Quad Trace w/Cursor	\$2,045
V-1100A 100MHz Quad Trace w/Cursor	\$2,295
V-1150 150MHz Quad Trace w/Cursor	\$2,775

### Hitachi Portable Scopes

**\$435**  
DC to 50MHz, 2-Channel, DC offset function, Alternate magnifier function

V-212	\$995
V-525 CRT Readout, Cursor Meas	\$1,025
V-523 Delayed Sweep	\$995
V-522 Basic Model	\$895

### 20MHz Elenco Oscilloscope

**\$375**  
MO-1251

- Dual Trace
- Component Tester
- ± CRT
- X-Y Operation
- TV Sync
- 2 p. 1 Probes

**FREE DMM**  
with purchase of ANY SCOPE

**SCOPE PROBES**

P-1 65MHz, 1x, 10x	\$19.95
P-2 100MHz, 1x, 10x	\$23.95

### Elenco 35MHz Dual Trace

Good to 50MHz **\$495**  
MO-1252

- High luminance 6" CRT
- 1mV Sensitivity
- ±6KV Acceleration Voltage
- ±10ns Rise Time
- X-Y Operation - Z Axis
- Delayed Triggering Sweep
- Includes 2 P-1 Probes

All scopes include probes, schematics, operators manual, and 3 year (2 yrs for Elenco scopes) world wide warranty on parts & labor. Many accessories available for all Hitachi scopes. Call or write for complete specifications on these and many other fine oscilloscopes.

#### WE NOW CARRY COMPLETE LINE OF FLUKE MULTIMETERS Models

21F	83
23F	85
25F	87
27F	8050A
73	8060A
75	8062A
77F	+ More

CALL FOR SPECIAL PRICING

#### True RMS 1/2 Digit Multimeter

M-7000  
**\$135**

.05% DC Accuracy  
1% Resistance with Freq. Counter and deluxe case

#### 10 Function Multimeter

CM-365  
**\$65**

AC + DC Voltage & Amps  
Resistance to 2000MΩ  
Diode, Logic, & Trans test  
Capacitance to 200F

#### Digital Capacitance Meter

CM-1550  
**\$58.95**

9 Ranges  
.1pF-20,000uF  
5% basic acy  
Zero control with case

#### Digital LCR Meter

LC-1801  
**\$125**

Measures:  
Coils 1uH-200H  
Caps 1pF-200uF  
Res. 0.1-20M

#### Function Generator

Blox  
**\$28.95**

Provides sine, triangle, square wave from 1Hz to 1MHz AM or FM capability

#### Triple Power Supply

XP-620  
Assembled \$65  
Kit \$45

2 to 15V at 1A  
-2 to -15V at 1A  
(or 4 to 30V at 1A)  
and 5V at 3A

#### Wide Band Signal Generators

SG-9000  
**\$129**

RF Freq 100K-450MHz  
AM Modulation of 10KHz  
Variable RF output

#### SG-9500 w Digital Display and 150MHz built-in Counter

**\$249**

#### Soldering Station

Temperature Controlled  
SL-30 **\$99**

Digital display  
Temp range: 300F-900F  
Grounded tip  
Overheat protect

#### Color Convergence Generator

SG-200  
**\$69.95**

Finest in the industry  
10 rock steady patterns

#### 10MHz Oscilloscope

S-3000  
**\$275**

10MHz DC or AC  
Triggered Sweep  
Calibrated Vert & Hor  
Reads Volts & Freq

#### Temperature Probe

M-110CF  
**\$29.95**

Semiconductor type  
Range -58F-302F  
Fits most digital multimeters

#### Autorangeing DMM

M-5000  
**\$45**

9 Functions  
Memory and Data hold  
1/2 % basic acc  
3 1/2 digit LCD

#### AC Current Meter

ST-1010  
**\$69.95**

1000 Amps  
Data & Peak hold  
8 Functions  
Deluxe Case

#### Decade Blox

#9610 or #9620  
**\$18.95**

#9610 Resistor Blox  
47 ohm to 1M & 100k pot  
#9620 Capacitor Blox  
47pF to 10MFD

#### Quad Power Supply

XP-580  
**\$59.95**

2-20V at 2A  
12V at 1A  
5V at 3A  
-5V at 5A

Fully regulated and short circuit protected  
XP-575 without meters \$39.95

#### LEARN TO BUILD AND PROGRAM COMPUTERS WITH THIS KIT

INCLUDES: All Parts, Assembly and Lesson Manual  
Model MM-8000  
**\$129.00**

#### Digital Triple Power Supply

XP-765  
**\$249**

0-20V at 1A  
0-20V at 1A  
5V at 5A

Fully regulated, Short circuit protected with 2 limit control, 3 separate supplies  
XP-560 with Analog Meters \$175

#### GF-8016 Function Generator

with Freq. Counter  
**\$249**

Sine, Square, Triangle  
Pulse, Ramp, 2 to 2MHz  
Freq. Counter: 1 - 10MHz

GF-8015 without Freq. Meter \$179

**WE WILL NOT BE UNDERSOLD!**  
UPS Shipping: 48 States 5% (\$10 Max) IL Res. 7% Tax

## C & S SALES INC.

1245 Rosewood, Deerfield, IL 60015  
(800) 292-7711 (708) 541-0710

**15 Day Money Back Guarantee**  
2 Year Warranty Prices subject to change  
**WRITE FOR FREE CATALOG**

**CIRCLE 5 ON FREE INFORMATION CARD**

# NEW PRODUCTS

## Universal Counter

As a stand-alone calibration tool or as one "rack-and-stack" component in a complete test-bench setup, Tektronix's model CDC250 dual-channel counter provides multiple measurement capabilities. It will count the frequency of sine, square, and triangle waves from 5 Hz to 175 MHz at input levels from 20-mV to 24-volts peak-to-peak. The UL-listed and CSA-certified universal counter also provides period measurements, frequency-ratio, and time-interval measurement functions. Its temperature-compensated time base ensures reliable performance in situations with changing ambient temperature.

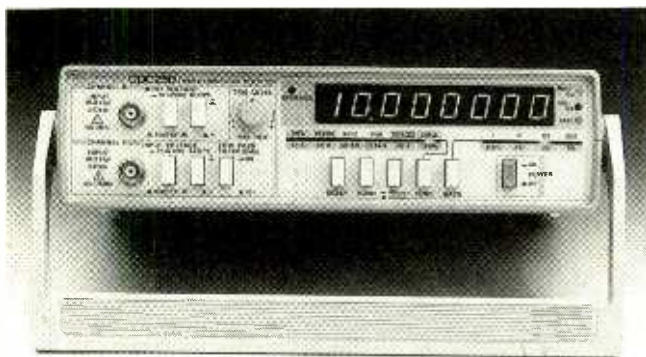

The CDC250 universal counter costs \$595.00. For further information, contact Tektronix, Inc., P.O. Box 500, Beaverton, OR 97077; Tel: 800-426-2200.

**CIRCLE 101 ON FREE INFORMATION CARD**

## PRINTER-SHARING SYSTEM

Data Spec's Para-Link Plus modular printer-sharing system allows as many as 16 users to send data to a single parallel printer over a 1200-foot area. Instead of tying users to a large central sharing box, the system's daisy-chain topology lets users place their equipment exactly where they want it. The Para-Link is installed by plugging individual transmitters into the parallel ports of IBM PC or

compatible computers and attaching a single receiving unit to the printer's parallel port. RJ-11 cable to connect the units is included. The system requires no external power. Para-Link reliably transmits data at up to 6000 characters per second. Collision avoidance technology

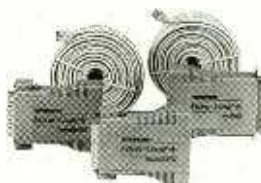

provides selectable time-outs for each PC.

The Para-Link Plus starter kit (model PL3), for sharing one parallel printer between two PC's, includes two transmitters, one receiver, and two 25-foot modular cables. Other computers can be added to the system using the model PL4 expansion kit, which includes one transmitter and one 25-foot expansion cable.

Para-Link Plus has a suggested retail price of \$199.00; and each expansion kit has a suggested price of \$74.95. For further information, contact Data Spec, 9410 Owensmouth Avenue, Chatsworth, CA 91311; Tel: 818-772-9977.

**CIRCLE 102 ON FREE INFORMATION CARD**

## FILE-TRANSFER UTILITY

The unique anti-virus protection scheme provided by TREND Micro Devices' PCopy file-transfer program is used to detect and protect against infection from all known software viruses during laptop-to-desktop and desktop-to-desktop file transfers. The anti-virus software uses two programs: the Virus Scan Program and the Virus Pattern Bank. The scan program acts as a highly effective filter, examining the executable

file and comparing it to the virus patterns in the second program. If the file matches any of the patterns in the Pattern Bank, the user is given the chance to delete that file before transfer to the hard disk, assuring a "clean" file transfer.

Besides its anti-virus protection, PCopy provides fast (over 500,000 baud), cost-effective file transfer. With its advanced error checking and data-correction algorithm, the program can be used for hard-disk backup. It can be operated from DOS or a batch file from a single-screen menu. Features include browsing through multiple levels of subdirectories; transfer to hidden files; and sorting by size, name, date, and extension.



PCopy is available in both 5¼- and 3½-inch formats and includes a six-foot parallel cable.

PCopy anti-virus file-transfer utility has a suggested retail price of \$119.00; ask about the special introductory price. For further information, contact TREND Micro Devices, Inc., 2421 West 205th Street, Suite D-100, Torrance, CA 90501; Tel: 800-228-5651; Fax: 213-328-5892.

**CIRCLE 103 ON FREE INFORMATION CARD**

## FREON DUST SPRAY

Containing no CFC's, Jensen Tool's Dust-A-Way freon-gas dust spray removes dust, lint, and other foreign particles from delicate electronic devices with no risk to the ozone layer. Depressing the trigger valve on the 12-ounce can directs a burst of



dry, inert freon gas precisely where it is needed. The spray is recommended for use on electronic, electrical, optical, and delicate mechanical devices.

Dust-A-Way spray costs \$7.95 in a 12-ounce can. For further information, contact Jensen Tools, Inc., 7815 South 46th Street, Phoenix, AZ 85044; Tel: 602-968-6241.

**CIRCLE 104 ON FREE INFORMATION CARD**

### AUTORANGING DMM

The uniquely designed case of

B&K-Precision's model 2701 digital multimeter holds one or both probes in position, allowing single-handed operation, and, when not in use, conveniently stores its test leads wrapped and clipped in place. Well-suited for field applications, the instrument is drop-resistant to five feet, operates for up to 800 hours on a 9-volt battery, and measures just 6.9 x 2.3 x 1 inches.

The autoranging multimeter offers seven major functions. It measures voltage to 1000 VDC and 750 VAC, DC and AC



current, and resistance, and features a diode check as well as an audible continuity checker. A data-hold function will freeze any displayed reading. Basic DC accuracy is 0.5%. The DMM comes with test leads, storage pouch, instruction manual, schematic diagram, and parts list.

The model 2701 digital multimeter has a suggested user price of \$69.00. For more information, contact B&K-Precision, Division of Maxtec International Corporation, 6470 West Cortland Street, Chicago, IL 60635; Tel: 312-889-9087.

**CIRCLE 105 ON FREE INFORMATION CARD**

### CAMCORDER "SHOE" BRACKET

For adding a video light or a microphone to compact 8mm camcorders that do not come equipped with a camera shoe, Sunpak's VB-1 integrated bracket attaches between the camera body and the battery pack. Providing an alternative to bulky



brackets that screw into the camcorder's tripod socket and bend around the camcorder body, the small, lightweight VB-1 doesn't add much bulk to the camcorder. It was designed specifically for Sony TR-4/5/6/7 camcorders and equivalent Nikon, Ricoh, and Kyocera models.

The VB-1 integrated bracket has a suggested retail price of \$29.95. For more information, contact Sunpak, ToCAD America, Inc., 401 Hackensack Avenue, Hackensack, NJ 07601; Tel: 201-342-9503.

**CIRCLE 106 ON FREE INFORMATION CARD**

# The Ultimate in Home Control

# Heath®

Just imagine, one press of a button and you can turn off your stereo, turn on your TV and VCR, start a videotape, and dim the lights. The best part is you've done it all from your favorite chair.

The One For All remote Whole House Controller, Command Center and Lamp Module make it all possible.

Installation is a snap. The remote Whole House Controller operates virtually any infrared-controlled device, and when used with the Command Center can control lights throughout your house. Just point the remote Whole House Controller at the Command Center and press a button. You've got home control.

Expand your reach to additional lights and small appliances with other X-10 modules available from the Heath Catalog. Call 1-800-44-HEATH for your FREE copy.

**Order Today**  
**\$119.95\***

Use Order Code 601-049 when ordering the One For All System URS-6000.

**Call Toll-Free**  
**1-800-253-0570**

\* Price does not include shipping and handling, or applicable sales tax for MI and CA deliveries



© 1990 Heath Company, Benton Harbor, MI



Lamp Module    Controller    Command Center

**CIRCLE 11 ON FREE INFORMATION CARD**

## PROJECTION TV SET

A 52-inch projection TV from Sylvania, the model *RSL450AK*, features the 50-watt Dolby Pro Logic surround-sound system, SuperWindow color picture-in-picture, and menu setup. It comes with the Sylvania 3-in-1 SuperRemote that controls the television and virtually any brand of VCR and cable box. The projection TV features a color-corrected five-element

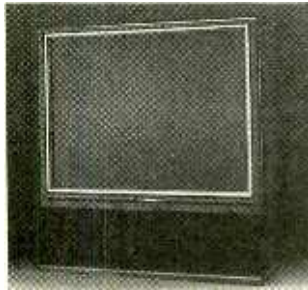

lens design that provides improved color accuracy. It also includes an improved video-processing amplifier, a beam limiter, automatic sharpness, and dynamic focus. The

RSL450AK provides 350+ foot lamberts, and offers two S-video inputs, audio-video inputs/outputs, and two six-inch and two two-inch speaker drivers.

The RSL450AK projection TV has a suggested retail price of \$2,600.00. For more information, contact Sylvania Consumer Affairs Department, One Philips Drive, P.O. Box 14810, Knoxville, TN 37914-1810; Tel: 615-475-0317.

**CIRCLE 107 ON FREE INFORMATION CARD**

## DSP FFT ANALYZER

Rapid System's R340 is a one-channel, 250-kHz, FFT spectrum analyzer peripheral for personal computers. It features a TI TMS320C10 digital-signal-processing engine for fast computation and display of the FFT frequency spectrum. For ease of use, the R340 features BNC signal inputs, programmable gain, and menu-driven software. The device automatically saves spectrums to the PC's hard



disk. It provides sample rates from 1 to 500 kHz, and gain ranges from 1.6 to 320 volts peak to peak. The R340 can be used as an educational tool, or for vibration analysis, power-line analysis, transducer checking, and audio analysis.

The R340 DSP FFT analyzer costs \$995.00. For more information, contact Rapid Systems, Inc., 433 North 34th Street, Seattle, WA 98103; Tel: 206-547-8311; Fax: 206-548-0322.

**CIRCLE 108 ON FREE INFORMATION CARD**

## CLAMP-ON METER

Amprobe's model ACD-10 is a digital amp/volt/ohm meter that directly measures AC current,

voltage, and resistance. The portable 8-ounce instrument is drop resistant and only 6 3/4 inches long. The autoranging meter has an easy-to-read 1/2-inch display that provides over-range and low-battery warnings. The ACD-10 offers circuit protection to 550 volts. It comes with a wrist strap, a removable belt clip, a 9-volt battery, safety test leads, a carrying case, and



## Phonvu Videophone in a Chip

STILL FRAME TV PICTURE TELEPHONE  
**TRANCEIVER KIT**  
Sends Slow Scan TV pictures over  
The phone line in Twelve Seconds

Captures any TV Camera, Camcorder  
VCR, NTSC Video output and holds  
the display and sends on command

Auto Mode allows hands free send  
and receive. Displays on any TV

IC Chip Replaces 150 SSI Dips

50 Levels  
of Grey Scale  
Serves as:  
TV FAX

THIS DEVICE IS COMPLETE AND  
READY TO COMMUNICATE. PLUG  
IN THE CAMERA AND TV AND GO!  
TWO SETS ARE REQUIRED FOR  
END TO END COMMUNICATION.



BLACK AND WHITE ONLY

Camera 200 x 242.5  
High Res.  
50,000  
Pixels

RECORD PICTURES TO AUDIO CASSETTE RECORDERS  
ENHANCE YOUR PHONE COMMUNICATIONS

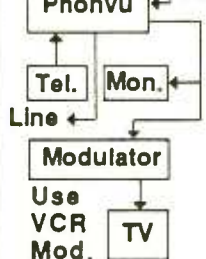

Videophone Chip	48P DIP
and Schematic	\$59.95
A/D, DRAM, D-Reg.	\$35.00
PC Board (BARE)	\$18.95
50 Res. Cap. Diode	\$28.75
Cabinet (uncut)	\$12.75
Power Pack	\$8.75
KIT PRICE:	\$164.15
ASSEMBLED	TOTAL \$235.00

PHONE and FAX Order (213) 827-1852  
**PMC** Electronics Box 11148  
Marina Del Rey, CA 90292

CIRCLE 20 ON FREE INFORMATION CARD

## Turn Your Electronics HOBBY into a CAREER



Love exploring electronics in your spare time? Imagine what it would be like to make a full-time career of it. The demand for qualified electronics technicians has never been greater. Peoples College can give you the qualifications you need.

- Specialized Associate Degree in Electronics Technology
- Computer Servicing
- Microprocessor Technology

Call or write today for a color catalog! There is no obligation and no salesperson will call. Programs in computer programming and computer applications also available.

**1-800-765-7247**



**PEOPLES COLLEGE**  
OF INDEPENDENT STUDIES

233 Academy Drive • P.O. Box 421768 • Kissimmee, FL 34742-1768  
Member D.L. Peoples Group **E0291**

CIRCLE 12 ON FREE INFORMATION CARD



instructions.

The ACD-10 clamp-on digital amp/volt/ohm meter has a suggested list price of \$89.95. For additional information, contact Amprobe Instrument, 630 Merrick Road, P.O. Box 329, Lynbrook, NY 11563; Tel: 516-593-5600.

**CIRCLE 109 ON FREE INFORMATION CARD**

## RADIO-FREQUENCY FINDER/COUNTER

Small enough to fit in a shirt pocket, the model 1500A 1-1500-MHz counter from Startek International is also sensitive enough to accurately identify and measure transmit frequencies from handheld, mobile, or fixed radio transmitters. The model 1500A is housed in a rugged anodized-aluminum case and has an 8-digit LED display and a telescoping RF antenna. A TCXO time base provides accuracy of ± 1ppm. The counter has two



overlapping ranges—1-500 MHz and 200-1500 MHz—and two switch-selectable gate times. The fast gate time of 0.25 seconds yields a 1-kHz resolution; the slow gate time of 2.5 seconds yields a 100-Hz resolution.

The counter runs on 117-VAC, 12-VDC, or optional rechargeable NiCd batteries will provide up to five hours of continuous operation. With an AC adapter/battery charger (also optional), the instrument can be used while the batteries are charging.

The model 1500A RF finder/counter costs \$99.95; the optional NiCd batteries and adapter/charger cost \$20.00

and \$9.00, respectively. For further information, contact Startek International, Inc., 398 NE 38th Street, Fort Lauderdale, FL 33334; Tel: 800-638-8050; Fax: 305-561-9133.

**CIRCLE 110 ON FREE INFORMATION CARD**

## ORGANIZER SOFTWARE

Owners of Casio B.O.S.S. (Business Organizer Scheduling System) products have two new software programs to help them get organized. The OAG Travel Planner lets users download travel information about hotels, restaurants, airline reservations, and car rentals for the 25 U.S. cities most often visited on business. Hotels are listed by city with address and phone number, location, and price range; restaurant listings include the type of cuisine and a



star rating. Car-rental agencies and all major airlines are listed by city and include the reservation numbers. Barron's Business and Travel Translator contains both words and phrases in French, Spanish, German, and Italian, along with their English translations. Designed for business use, the program offers translations of technical terms in ten categories including chemicals, electronics, motor vehicles, printing, winemaking, fashion, and pharmaceuticals. The software packages each contain a 3½- and a 5¼-inch disk and directions.

The OAG Travel Planner and Barron's Business and Travel Translator have suggested retail prices of \$22.95 each. For more information, contact Casio, Inc., 570 Mt. Pleasant Avenue, P.O. Box 7000, Dover, NJ 07801; Tel: 201-361-5400; Fax: 201-361-3819.

**CIRCLE 111 ON FREE INFORMATION CARD**

Courteous Service • Discount Prices • Fast Shipping

# ALL ELECTRONICS

P.O. Box 567 • Van Nuys, CA 91408

## Special New Reduced Price PHOTOFLASH CAPACITOR

Rubicon CE photoflash capacitor. 0.79" dia. X 1.1" high. These are new capacitors that have been prepped with 1.4" black and red wire leads soldered to the terminals. 210 Mfd 330 Volt CAT# PPC-210 \$1.25 each • 10 for \$11.00 • 100 for \$100.00 Large quantities available. Call for pricing.



## FLASHER LED

Diffused L.E.D. with built in flashing unit. PULSE RATE: 3 Hz @ 5 Volt/20 ma. Unit continually flashes when 5 Volts is applied. Operates between 4.5 Volts and 5.5 Volts. T 1 3/4 size. IDEAL AS AN INDICATOR.

RED CAT# LED-4  
GREEN CAT# LED-4G  
YELLOW CAT# LED-4Y  
\$1.00 each • 10 for \$9.50 • 100 for \$90.00



## 6 Volt 1 Amp/Hour RECHARGEABLE BATTERY

JAPAN STORAGE BATTERY CO. Portalace# PE6V1 6 Volt 1 Ah rechargeable sealed lead-acid (gel cell). 2" X 1.635" X 2" high. Batteries are prepped with 5" black and red leads terminated with 2 pin connector. Ideal for rechargeable reserve power. CAT# GC-61 \$4.75 each • 10 for \$42.50



## HEAVY-DUTY NICKEL CADMIUM "C" BATTERY

Yuasa 1800C Special purchase of new, rechargeable nickel-cad batteries. 1.2 volts, 1800 mA.H. PRICE REDUCED ON 10 OR MORE.

CAT# HDNCB-C  
10 pieces for \$42.50 (\$4.25 each)  
100 pieces for \$375.00 (\$3.75 each)



## Experimenter's Delight CORDLESS TELEPHONE/TRANSCIVER



Phonemate# IQ 4210T Base station for a cordless telephone, this transceiver contains hundreds of useful parts. Includes power transformer, 600 ohm phone coupling transformer, crystals, heat sinks, voltage regulator, power cord, phone cord and jack, relay and 30" telescoping antenna. The beige chassis box has only a few holes in the back panel and would be an excellent housing for other projects. 7.25" X 5.87" X 2.15". CAT# PMB-1 \$3.75 each **SOLD AS-IS For Parts Only. No returns accepted.**

## PHOTO RESISTOR

100 ohms light  
16K ohms dark. 0.182" dia. X .08" high.  
0.18" long leads. CAT# PRE-7 2 for \$1.00



## TOLL FREE ORDER LINES

**1-800-826-5432**

CHARGE ORDERS to Visa, MasterCard or Discover

TERMS: Minimum order \$10.00. Shipping and handling for the 48 continental U.S.A. \$3.50 per order. All others including AK, HI, PR or Canada must pay full shipping. All orders delivered in CALIFORNIA must include state sales tax (6 1/4 %, 6 3/4 %, 7 1/4 %). Quantities Limited. NO C.O.D. Prices subject to change without notice.

**Call or Write For Our FREE 60 Page Catalog**  
(Outside The U.S.A. Send \$2.00 Postage)  
**ALL ELECTRONICS CORP.**  
P.O. Box 567 • Van Nuys, CA • 91408

**CIRCLE 14 ON FREE INFORMATION CARD**

# Take any one of these HANDBOOKS ELECTRONICS and CONTROL

- your one source for engineering books from over 100 different publishers
- the latest and best information in your field
- discounts of up to 40% off publishers' list prices

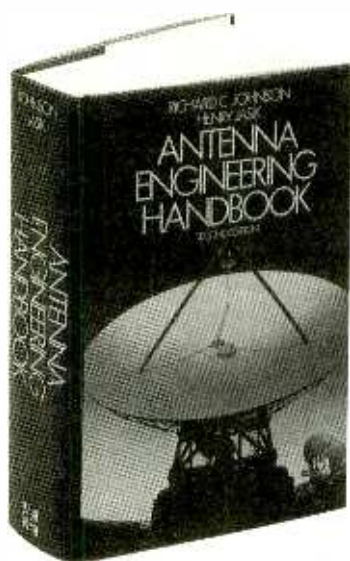

322/910

*Publisher's Price \$119.50*

## **ANTENNA ENGINEERING HANDBOOK, Second Edition**

Edited by R. C. Johnson and H. Jasik

- 1,408 pages, 946 illustrations
- covers all types of antennas currently in use with a separate chapter devoted to each
- provides detailed data on physical fundamentals, operating principles, design techniques, and performance data
- up-to-the-minute information on antenna applications
- a must for those involved in any phase of antenna engineering

*Publisher's Price \$94.50*

## **MAGNETIC RECORDING HANDBOOK**

### **Technology and Applications**

Edited by C.D. Mee and E.D. Daniel

- 1,100 pages, 400 illustrations
- the most comprehensive reference available on all aspects of magnetic recording technology
- features contributions from 25 international experts
- includes coverage of error correction coding and magneto-optical recording

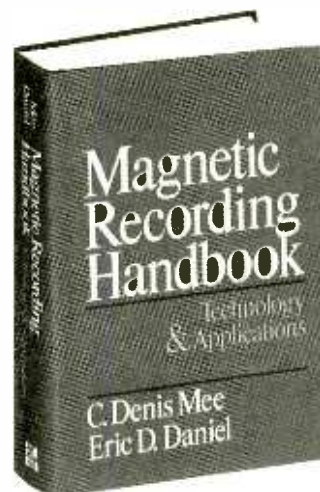

412/74X



047/774

*Publisher's Price \$86.95*

## **AUDIO ENGINEERING HANDBOOK**

Edited by K.B. Benson

- 1,056 pages, 722 illustrations
- the ideal on-the-job reference for all designers, operators, and servicers of professional and consumer audio equipment
- a one-volume source of fundamentals and how-to information encompassing all aspects of audio engineering
- coverage includes DSP, CDs, DAT, and noise reduction developments
- contributors include Ray Dolby, R.C. Cabot, and many more

# for only \$14.95 — when you join the ENGINEERS' BOOK CLUB

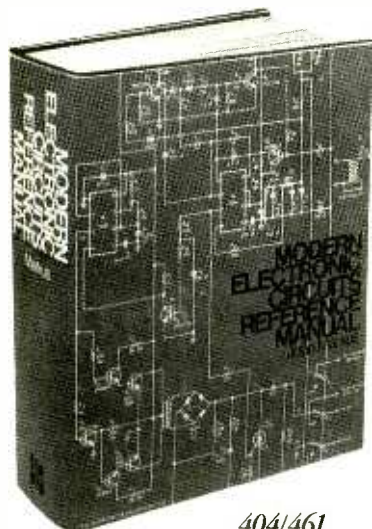

404/461

*Publisher's Price \$94.95*

## MODERN ELECTRONIC CIRCUITS REFERENCE MANUAL

By J. T. Markus

- 1,264 pages, 3,666 circuit diagrams
- a handy, desktop reference with 103 chapters organized by "family" grouping
- filled with predesigned and use-tested circuits to save you production time and money
- includes concise summaries of all the recent applications notes, journal articles, and reports on each circuit, efficiently organized and indexed for the practicing engineer



### 4 reasons to join today!



**1. Best and newest books from ALL publishers!** Books are selected from a wide range of publishers by expert editors and consultants to give you continuing access to the best and latest books in your field.

**2. Big savings!** Build your library and save money, too! Savings range up to 40% off publishers' list prices.

**3. Bonus books!** You will automatically be eligible to participate in our Bonus Book Plan that allows you savings up to 70% off the publishers' prices of many professional and general interest books!

**4. Convenience!** 14-16 times a year (about once every 3-4 weeks) you receive the Club Bulletin FREE. It fully describes the Main Selection and alternate selections. A dated Reply Card is included. If you want the Main Selection, you simply do nothing — it will be shipped automatically. If you want an alternate selection — or no book at all — you simply indicate it on the Reply Card and return it by the date specified. You will have at least 10 days to decide. If, because of late delivery of the Bulletin you receive a Main Selection you do not want, you may return it for credit at the Club's expense.

As a Club member you agree only to the purchase of two additional books during your first year of membership. Membership may be discontinued by either you or the Club at any time after you have purchased the two additional books.

*Publisher's Price \$89.95*

## ELECTRONICS ENGINEERS' HANDBOOK, Third Edition

Edited by D. G. Fink and D. Christiansen

- 2,496 pages, 1,600 illustrations
- the definitive reference to electronics engineering
- fully updated to cover all recent advances and developments
- ranges from essential principles and data to the latest design solutions and practical applications — with an all-new chapter on standards
- written and compiled by more than 170 contributors — all experts in their fields

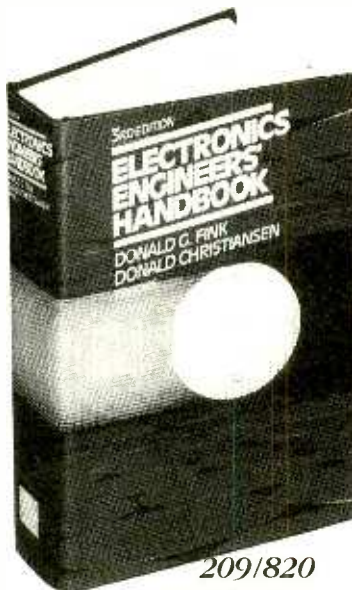

209/820

**McGraw-Hill Book Clubs**  
**Electronics and Control Engineers' Book Club®**  
P.O. Box 582  
Hightstown, NJ 08520-9959

Please enroll me as a member of the Electronics and Control Engineers' Book Club® and send me the book I have chosen for only \$14.95 plus local tax, postage and handling. I agree to purchase a minimum of two additional books during my first year as outlined under the Club plan described in this ad. Membership in the club is cancellable by me or McGraw-Hill any time after the two book purchase requirement has been fulfilled. A shipping and handling charge is added to all shipments.

I wish to order the following book:

- ANTENNA ENGINEERING HANDBOOK (322/910)
- MODERN ELECTRONIC CIRCUITS REFERENCE MANUAL (404/461)
- ELECTRONICS ENGINEERS' HANDBOOK, 3/e (209/820)
- AUDIO ENGINEERING HANDBOOK (047/774)
- MAGNETIC RECORDING HANDBOOK (412/74X)

Signature \_\_\_\_\_

Name \_\_\_\_\_

Address/Apt. # \_\_\_\_\_

City/State/Zip \_\_\_\_\_

This order subject to acceptance by McGraw-Hill. Offer good only to new members. Foreign member acceptance subject to special conditions

**ECGB-040**

# THINK TANK

By Byron G. Wels, K2AVB

## Reviewing The Ground Rules

We're running a bit low on circuits for Think Tank, so this would be a good time to go over the rules. We want your original schematics and write-ups. They have to be original however, for if they are lifted from other publications, you're leaving yourself wide open for a plagiarism lawsuit and that can be very expensive.

It is important to draw the schematics clearly, and be certain that all component values are included. Our staff is *not* clairvoyant, so you must accurately show

what you have in mind for us to consider it.

Provide sufficient text to go with the diagram. Explain carefully why you built the circuit, what it does, and how it works. If your submission fills those requirements, and isn't something that's been done to death, you'll be rewarded with a free copy of the Think Tank book and, in time, you'll get to see your name in print as well. If you've already submitted a schematic and already have a copy of the Think Tank book, mention that

and we'll find another book for you. (We've got lots of books!)

Understand too, that we cannot return materials. If your offering doesn't make the grade, it will be disposed of here. And allow enough time! There's usually a delay of at least three months from the time we receive suitable materials until they appear in print.

We're also using "Helps 'n' Hints," which are rewarded with books as well. Get busy and before long, you'll find that you're a published author!

There are a couple of other things I wanted to go over with you. First of all, are any of my readers named Hiram? If so, drop me a line and tell me where you hale from.

If there are any errors in this column, you can blame it all on Pyewacket. I've acquired a black (yes, all black) kitten and named him Pyewacket, from *Bell, Book, and Candle*. He also answers to the shortened version, "Pi" (3.1416). And he delights in sitting on my lap while I'm inputting these words, and occasionally he assists by striking a wrong key. Usually I catch his errors in the proofreading, but he sometimes manages to slip one by me.

A wise man once said that "when your avocation earns more than your vocation, they automatically change places." I find myself in the happy situation where both my avocation and vocation are one and the same. I entered the publishing business many, many years ago, and have held every position in the industry for which titles are

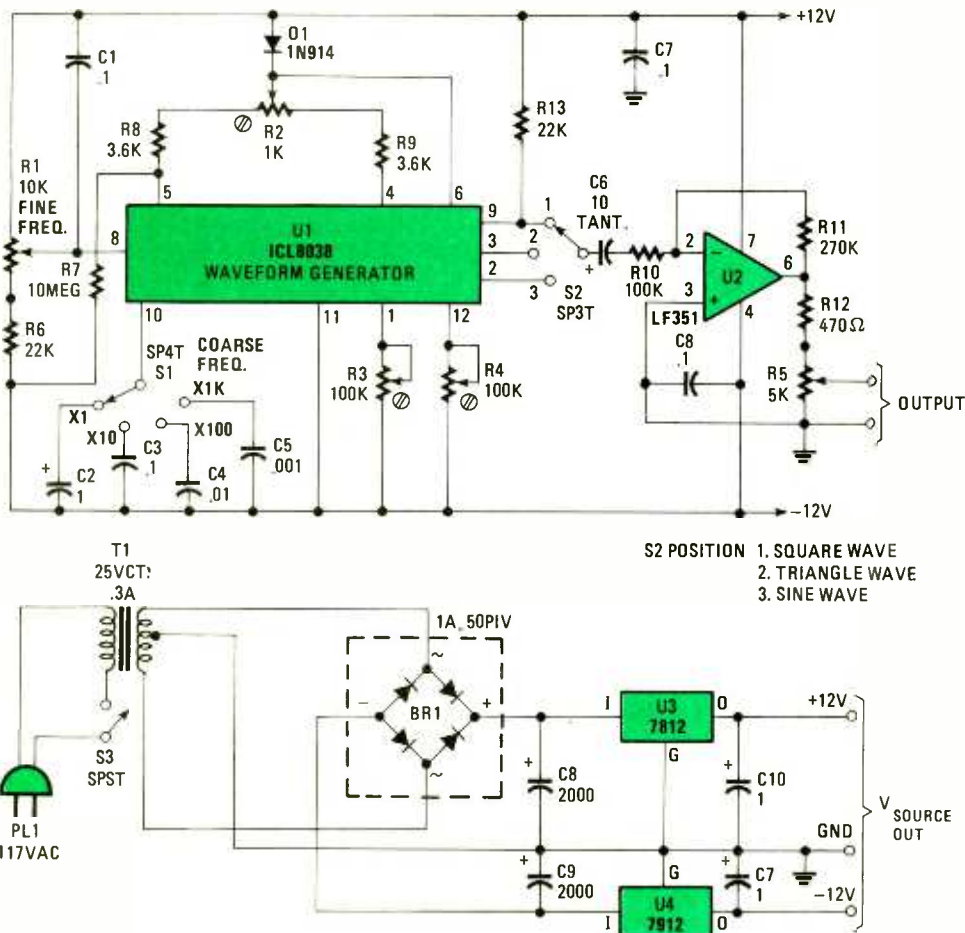

Fig. 1. The Function Generator is built around Intersil's ICL8038 waveform generator. With the addition of a few support components, the circuit was given the ability to switch through several coarse frequencies in decade steps.

bestowed, from space salesman to publisher. Having achieved, I no longer need to fight and claw for advancement and recognition. The result is a comfortable feeling, and one that allows me to simply relax, do my job, and enjoy it to its fullest. And enjoy it I do! After all, how many people can be paid to communicate with nice people like you?

So on that note, let's open that mail bag and see what you've been up to.

### FUNCTION GENERATOR

Before I get into this, let me tell you that my last offering to the Think Tank resulted in a telephone call from a chap in Knoxville, TN who took the trouble to look up my telephone number and called to thank me for bringing the device to his attention!

A very useful and inexpensive function generator can be built using the Inter-sil ICL8038 waveform generator. The basic circuit has been around for years. To make the generator more useful, the circuit was modified (see Fig. 1). Switch S1 selects the capacitor that controls the coarse frequency. The exact values are relatively unimportant as long as they are within 1%. If the capacitors are carefully chosen, each position of the range switch changes the coarse frequencies in accurate decade steps. Switch S2 selects square-, triangle-, or sine-wave outputs. The selected waveform is routed to a JFET op-amp, U2 (an LF351 unit). **Do not** use other op-amps, such as the 741 in this circuit.

The circuit is adjusted using a frequency counter and oscilloscope. Set the

range switch at  $\times 100$  and S2 for a triangle-wave output. Adjust R1 so that the counter reads about 2 kHz. Adjust R2 so that the waveform observed on the scope is perfectly linear (not tilted left or right). Set S2 to position 2 (sine) and adjust R3 and R4 for minimum distortion. In most cases, that will be at the center of their range.

The generator output does not vary more than  $\frac{1}{2}$  dB. It's very stable through the range of 1 Hz to over 80 kHz. Smaller timing capacitors will extend the range to well over 100 kHz, but with increasing distortion. The power supply (shown below the function generator) furnishes  $\pm 12$ -volts DC to the generator. The supply lines to the LF351 should be bypassed with 0.1- $\mu$ F disc capacitors.

—Robert O. Barg,  
Rochester, NY

*You went and did it again Bob! Your book is on the way, and you can chalk up another one in your favor. Thanks.*

### TOUCH SWITCH

I'm gonna try again for a copy of the book, Byron. This switch reacts to the touch of a finger to turn lights and/or appliances on or off. See Fig. 2. The device uses the human body as an antenna to pick up 60 Hz hum, which is applied to a metal plate by your finger. The signal is fed to the input of U1—an LM380 audio-power amplifier. An LM386 should work as well. I selected the LM380 to make use of its differential inputs.

With the IC configured normally, you'd probably have a single-ended input with the other input grounded. That may work alright for an audio amp, but in this application, the

# Train at Home to be an Electronics Technician!

Professional training and equipment can help you qualify for a dynamic, high-paying career in your spare time.

As the demand for computers and microprocessors in business and manufacturing continues to grow, so does the need for qualified technicians. It's not unusual for experienced technicians to earn from \$35,000 to more than \$40,000 a year.\* Now there's a way you can train for this exciting field without interrupting your job or home life.

### Choose From These Programs of Study

- Electronics & Microprocessor Technology
- Industrial Electronics & Microprocessor Technology
- Computer Servicing & Electronics Technology
- Specialized Associate Degree In Electronics Technology

### You Get Professional Equipment For Professional Training

Depending on the program you select, you'll perfect your skills using this advanced equipment, included in the price of tuition:

- IBM-Compatible Personal Computer
- Digital Multimeter
- Digital Logic Probe
- Elenco Oscilloscope

### Exclusive Extras That Enhance Your Training

Peoples College introduces some training firsts to make your learning experience more complete:

- Accelerated Learning System — a scientifically proven study system that lets you learn faster and easier than ever before.
- Optional One-Week Seminar — available with our advanced programs. Conducted on our campus near Orlando, Fla. Not required for graduation, but a valuable opportunity to fine tune your skills with personal guidance.
- Video Tutor Training Tapes — give you a permanent, visual record of informative lectures and close-up demonstrations.
- Experience Labs — professionally designed experiments that give you hands-on "bench" experience.
- Industry Certification Training Guide — provided with three of our programs. Gives you first-hand insight into the examination you may take for your professional license.



For COLOR CATALOG Mail Coupon or Call TOLL FREE

1-800-765-7247

Programs offered only in United States, Canada, Puerto Rico and Virgin Islands. No Obligation. No sales person will call.

Our programs are accredited by the Accrediting Commission of the National Home Study Council

**YES! I would like to know more about your training programs. Send a catalog to:**

Name \_\_\_\_\_

Address \_\_\_\_\_

City \_\_\_\_\_

State \_\_\_\_\_ Zip \_\_\_\_\_

**PEOPLES COLLEGE**  
OF INDEPENDENT STUDIES  
233 Academy Drive • P.O. Box 421768  
Kissimmee, FL 34742-1768

Member, D.I. Peoples Group E0291

\* Source: U.S. Bureau of Labor Statistics

# 25.613

## ELECTRONIC COMPONENTS

Whether you order 1 part or all 25,613... MOUSER stocks and... can ship today!!

Call or Write...

**(800) 346-6873**

2401 Hwy 287 N  
Mansfield, TX 76063



for your  
**FREE**  
CATALOG

**MOUSER**  
ELECTRONICS  
Stocking Locations Across America

CIRCLE 7 ON FREE INFORMATION CARD

## SUPER LONG PLAY TAPE RECORDERS

12 Hour Model —  
USES 120 TAPE

**\$119.00\***

Modified Panasonic Slimline, high quality AC/DC provide 6 continuous hours of quality recording & playback on each side of cassette for 12 hours total. Includes • Voice level control • Digital counter, etc. TDK - 120 Cassette Furnished.



### PHONE RECORDING ADAPTER

Records calls automatically. All Solid state connects to your telephone jack and tape recorder. Starts recording when phone is lifted. Stops when you hang up.

**\$28.50\***

FCC APPROVED

**VOX VOICE ACTIVATED CONTROL SWITCH**  
Solid state Self contained Adjustable sensitivity. Voices or other sounds automatically activate and control recorder. Uses either recorder or remote mike.

**\$28.50\***

\*Add for ship & hdlg. Phone Adapter & Vox \$1.50 ea. Recorders \$4.00 ea. Cal. Res. add tax. Mail order. VISA/MIC, COD's OK. Money Back Guarantee. City disc avail. Dealer Inquiries invited. Free data.

**AMC SALES INC.** Dept. B 9335 Lutec St.  
Box 928, Downey, CA 90241  
Phone (213) 869-8519  
FAX (213) 923-1478

CIRCLE 15 ON FREE INFORMATION CARD

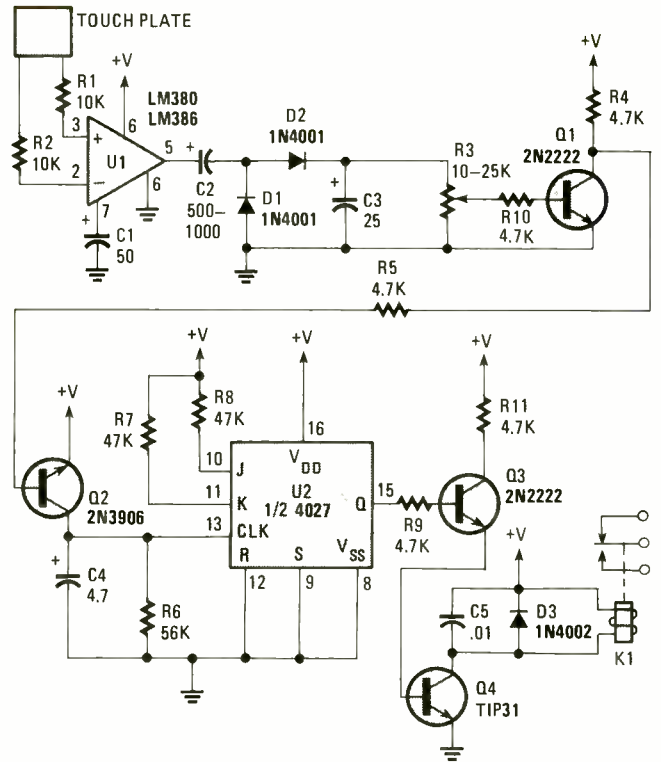

Fig. 2. The Touch Switch reacts to the touch of a finger on the sensor plate to turn lights and/or appliances on or off.

single-ended input would pick up a lot of AC even with nobody touching the plate, which would desensitize the circuit. In this circuit, wires from each input are routed to the touch plate with only one (either one) being connected to it. That provides a balanced input.

When the sensor plate is touched, the signal voltage is applied to one amplifier input and greatly amplified. The 60-Hz output from the amplifier is rectified by D1 and D2, then filtered by C3. Potentiometer R3 sets the trigger voltage used to saturate Q1. When Q1 turns on, the collector end of R4 goes almost to ground, providing the needed voltage to turn on Q2. Transistor Q2 turns on and clocks the flip-flop. Capacitor C4 debounces the clock pulse. The flip-flop is configured for toggle-mode operation, so its output switches states with each clock pulse.

The 4027 (U2) is wired to toggle by tying the J and K inputs high and the set and

resets low. Transistor Q3 is connected to either the Q output through the 4.7k resistor. Transistor Q3 drives Q4, the relay driver. Be sure that the load does not exceed the relay ratings.

After building the circuit on a piece of perfboard, place it in position and connect the leads to the touch plate. Route the dummy input lead near the one actually connected. With the arm of the potentiometer at its high end, touch the sensor plate. There should be several volts of DC present between the wiper of R3 and ground. That voltage should drop to near ground when the sensor plate is released. If the voltage does not drop to a tenth of a volt or less, try rearranging the dummy lead.

Be careful when working around 117-volt AC circuits. I recommend placing the relay in a junction box of the kind used in house wiring.

—Jon Danford, Joplin, MO

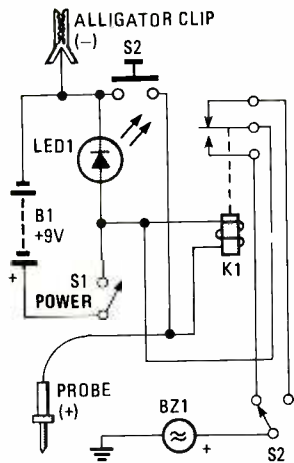

Fig. 3. The only thing that may be confusing about this Continuity Tester is the test/hold switch, which is used to test the buzzer by making it sound in both the normally-open and normally-closed modes.

Excellent circuit, Jon! You provided a clear, lucid schematic, top notch description, in fact all that we're ever looking for. I'm certain that a lot of our readers are going to try this one. Now send us another.

### N.O./N.C. CONTINUITY TESTER

Need a good continuity tester that's very versatile and very inexpensive? This circuit (see Fig. 3) is easy to assemble and it's very rug-

ged. All of the components are available at Radio Shack, and I built mine into a plastic toothbrush holder that I bought at the local supermarket. (You get the toothbrush as a bonus!) I've constructed several of these units and never had a problem.

The only thing that might be confusing is the test/hold switch. It's actually simple. The button is used to test the buzzer by making it sound in the normally-open mode and in the normally-closed mode, press the button while changing connections so the buzzer won't sound. Worth a book, Byron?

—Brad Cobo, Duncanville, TX

Interesting Brad. I would have liked some more text to go along with this, but examining the schematic, it hardly seems necessary! One book on the way.

### ANSWERING DEVICE

Every time my phone rings, my son races to answer it. The problem is that he can't take messages. I devised an automatic telephone recorder. After a lot of experimentation, we came up with this circuit

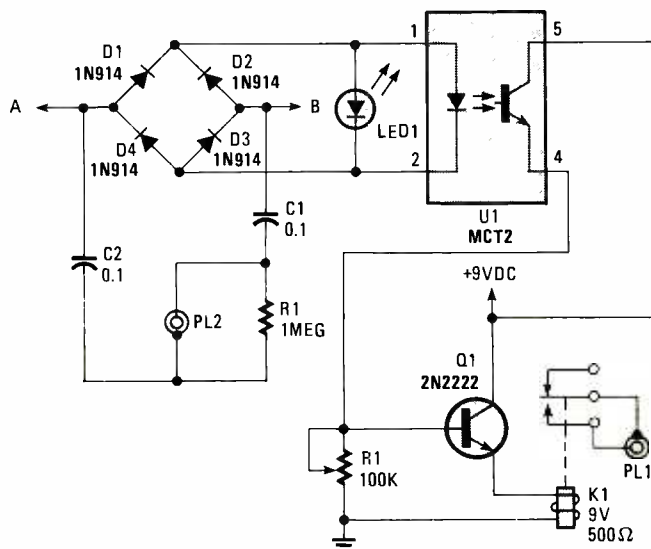
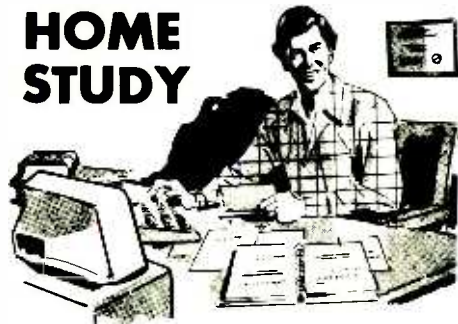

Fig. 4. Built around an optocoupler, a transistor, and a few additional components, this circuit will trigger a tape recorder to take messages.

## Put Professional Knowledge and a COLLEGE DEGREE in your Technical Career through HOME STUDY



Add prestige and earning power to your technical career by earning your Associate or Bachelor degree through directed home study.

Grantham College of Engineering awards accredited degrees in **electronics and computers.**

An important part of being prepared to *move up* is holding the right college degree, and the absolutely necessary part is knowing your field. Grantham can help you both ways—to learn more and to earn your degree in the process.

Grantham offers two degree programs—one with major emphasis in **electronics**, the other with major emphasis in **computers**. Associate and bachelor degrees are awarded in each program, and both programs are available completely by correspondence.

No commuting to class. Study at your own pace, while continuing on your present job. Learn from easy-to-understand lessons, with help from your Grantham instructors when you need it.

Write for our free catalog (see address below), or phone us at toll-free 1-800-955-2527 (for catalog requests only) and ask for our "degree catalog."

Accredited by  
the Accrediting Commission of the  
National Home Study Council

**GRANTHAM**  
College of Engineering  
Grantham College Road  
Slidell, LA 70460

# Take any 3 PROFESSIONAL BOOKS for only \$4.95

when you join the **ELECTRONICS ENGINEERS & DESIGNERS BOOK CLUB**™

values to \$129.40

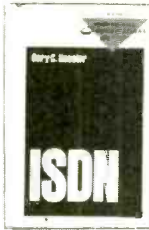

10015 \$42.95  
Counts as 2

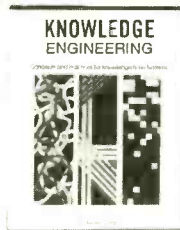

3297 \$39.95



3131 \$26.95

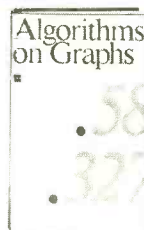

3429 \$29.95

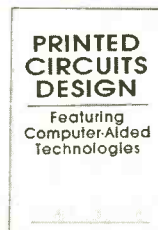

10016 \$39.95  
Counts as 2



3279 \$36.95



9319 \$59.50  
Counts as 3



3321 \$24.95



3102 \$49.50  
Counts as 2

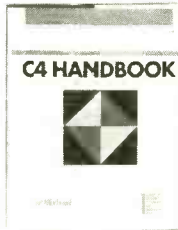

3098 \$44.50  
Counts as 2



2672 \$49.50



3059 \$34.95  
Counts as 2



3151 \$39.95

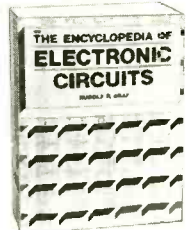

1938 \$60.00  
Counts as 2

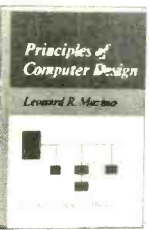

9813 \$39.95

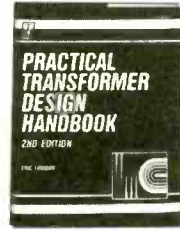

3212 \$34.95



3147 \$38.95



3203 \$41.50  
Counts as 2



9244P \$18.95



3140 \$49.95  
Counts as 2



9245 \$46.95  
Counts as 2



3199 \$52.00  
Counts as 2

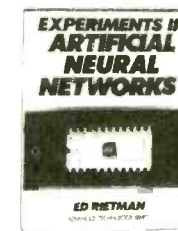

3037 \$24.95



9305 \$59.50  
Counts as 3

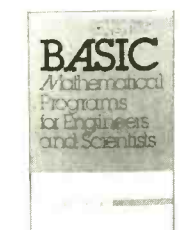

8225P \$19.95



9246 \$33.95  
Counts as 2

## How the Club Works

**YOUR BENEFITS:** You get 3 books for \$4.95 plus shipping and handling when you join. You keep on saving with discounts up to 50% off as a member.

**YOUR PROFESSIONAL BOOKSTORE BY MAIL:** Every 3-4 weeks, you will receive the EE&D Book Club News describing the Main Selection and Alternates, as well as bonus offers and special sales, with scores of titles to choose from.

**AUTOMATIC ORDER:** If you want the Main Selection, do nothing and it will be sent to you automatically. If you prefer another selection, or no selection at all, simply indicate your choice on the reply form provided. You will have at least 10 days to decide. As a member, you agree to purchase at least 3 books within the next 2 years and may resign at any time thereafter.

**BONUS BOOKS:** Starting immediately, you will be eligible for our *Bonus Book Plan*, with savings of up to 80% off publishers' prices.

**IRONCLAD NO-RISK GUARANTEE:** If not satisfied with your books, return them within 10 days without obligation!

**EXCEPTIONAL QUALITY:** All books are quality publishers' editions especially selected by our Editorial Board. (Publishers' Prices Shown)

**Your source for quality, affordable and timely authoritative engineering books.**



**ELECTRONICS ENGINEERS & DESIGNERS BOOK CLUB**™  
Blue Ridge Summit, PA 17294-0860

**YES!** Please accept my membership in the *Electronics Engineers & Designers Book Club* and send the 3 volumes I have listed below, billing me \$4.95. If not satisfied, I may return the books within 10 days without obligation and have my membership cancelled. I agree to purchase at least 3 books at regular Club prices during the next 2 years, and may resign any time thereafter. A shipping/handling charge and sales tax will be added to all orders.

--	--	--

Name \_\_\_\_\_  
Address \_\_\_\_\_  
City \_\_\_\_\_  
State \_\_\_\_\_ Zip \_\_\_\_\_ Phone \_\_\_\_\_  
Signature \_\_\_\_\_

Valid for new members only. Foreign applicants will receive special ordering instructions. Canada must remit in U.S. funds. This order subject to acceptance by the *Electronics Engineers & Designers Book Club*. PPIE291





## FREE CATALOG TEST INSTRUMENTS & HARD-TO-FIND TOOLS

Packed with over 10,000 quality products for testing, repairing, and installing electronic equipment. A full selection of test instruments, power protection equipment, precision hand tools, tool kits, soldering supplies, and much more. Products are shown in full color with detailed descriptions and pricing. All products come with a 100% satisfaction guarantee. SAME-DAY shipment program.

*In a hurry to receive your catalog?*

Call (800) 225-5370

In Massachusetts call (508) 682-2000

Contact East, Inc., Dept. R468  
335 Willow St., No. Andover, MA 01845

CIRCLE 8 ON FREE INFORMATION CARD

No costly school. No commuting to class. The Original Home-Study course prepares you for the "FCC Commercial Radio-telephone License." This valuable license is your professional "ticket" to thousands of exciting jobs in Communications, Radio-TV, Microwave, Maritime, Radar, Avionics and more...even start your own business! You don't need a college degree to qualify, but you do need an FCC License.

**No Need to Quit Your Job or Go to School**  
This proven course is easy, fast and low cost! **GUARANTEED PASS**—You get your FCC License or money refunded. **Send for FREE facts now. MAIL COUPON TODAY!**

**COMMAND PRODUCTIONS**  
FCC LICENSE TRAINING, Dept. 100  
P.O. Box 2824, San Francisco, CA 94126  
Please rush FREE details immediately!

NAME \_\_\_\_\_  
ADDRESS \_\_\_\_\_  
CITY \_\_\_\_\_ STATE \_\_\_\_\_ ZIP \_\_\_\_\_

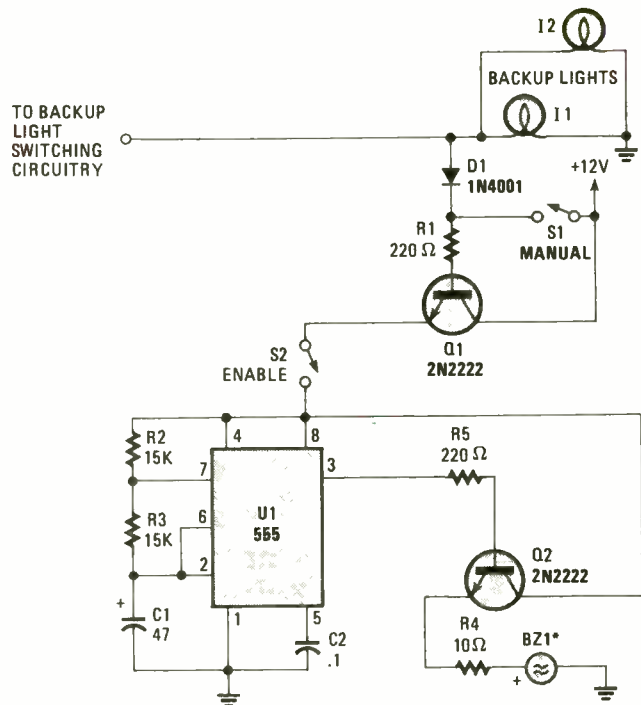

Fig. 5. The Backup Beeper is an extremely simple circuit, consisting of very few, easily available components.

(see Fig. 4) which is adaptable to any tape recorder and uses easy-to-obtain parts. The optoisolator MCT2 can be replaced by a photocell and an LED held together with black electrical tape. Break one side of the telephone line at any convenient point and connect the broken end at point A, the other at point B. When the phone is being used, a drop of 1.5 to 1.75 volts across A and B is very small and doesn't interfere with the telephone loop circuitry.

The LED will be lit if the telephone is being used or during the ringing period. You can substitute any NPN transistor as long as it can drive a 500 ohm relay.

—Fernando Afable, Vancouver, BC Canada.

*Find a need and fill it Fernando, and what do you get? You get a Think Tank book!*

### BACKUP BEEPER

My dad always told me that he wanted a backup warning beeper for his

truck. Now that I designed one, he thinks he doesn't really need it. I decided to send the design to Think Tank in the hope that somebody might get some use out of it.

It's an extremely simple circuit (see Fig. 5), consisting of very few, easily available components. When the vehicle's backup lights kick on, or when the manual switch, S1, is closed, a small current is led to the base of Q1. Transistor Q1 allows current to flow through it and, if the enable switch (S2) is closed, it sends 12 volts to U1, a 555 timer. Timer U1 sends high pulses lasting 0.97713 seconds and low signals lasting 0.488565 seconds to the base of Q2. When U1 switches Q2 on, it sends 12 volts to BZ1, a piezo buzzer. For best results, the buzzer should be mounted under the vehicle, somewhere where people around the car can hear the warning beeps.

—Stan Blosser, Fruitport, MI

*Stan, I'll bet a lot of readers are going to be putting*

this one together. No reason why backup warnings should be restricted to trucks, either!

### IR HINT

By, I'm writing because I saw another infrared-detector circuit in the October issue, and can't believe that nobody knows about the old "AM Radio" trick! Just take an ordinary AM radio and aim the IR remote near the antenna coil. You can actually hear the beeps. It may sound strange, but it does work. It makes a quick-and-dirty check of battery power and there's no need to open the radio. Let the cat out of the bag, Byron!

—Lebert J. Patzius, St. Louis, MO

Meow, Lebert! Your book is coming, and as you can see, we've gotten your name in print, too.

### STEREO HINT

Hi Byron! I work as an electronics tech at the Iowa Air National Guard, but that's just part time. My full-time job is as a consumer-electronics tech for a TV shop here in Wesley. I repair TV's, radios, and install satellite systems and a lot of auto AM/FM cassette stereos. That's what my hint is all about. You can tell which speaker is which by using an ohmmeter. Just put it on the  $R \times 1$  scale and touch the probes to two of the speaker wires. You'll hear a crackly sound from the speaker. I use an inexpensive analog meter from Radio Shack, which seems to work best.

If you get the left and right channel speakers crossed, there's a chance of ruining the audio output IC's. I'd guess that 90% of those IC's that I've replaced was because of the speaker leads being misconnected. Most amateurs just hook up the wires until they get sound, and

that defeats the purpose of stereo.

—Donna Noll, Corwith, IA  
Thanks again, Donna!  
You've earned another book, and we're always happy to hear from you and others of the distaff side!

### PULSE-WIDTH MODULATION CIRCUIT

This circuit (see Fig. 6) allows the effective power to a load, such as a DC motor or heater, to be regulated without dissipating power in the regulating FET. The first half of the dual op-amp (U1-a) is configured as a square-wave oscillator. Resistor R4 and capacitor C2 filter the square wave into a triangle wave, and resistor R5 adjusts the zero offset. The second half of the op-amp (U1-b) is configured as a comparator.

When the input to pin 6 of U1-b is greater than any portion of the triangle wave presented to pin 7, the output of U1-b at pin 10 is at its maximum positive value. When pin 6 is less than pin 7, the output is at its maximum negative value. That means that as the voltage on pin 6 is adjusted up and down, the amount of time the output is pulsed high is adjusted proportionally. Resistor R7 and diode D1 eliminate the negative portion of the output and

feed the power FET, Q1.

Because the control voltage to Q1 is pulsed between 0 and the maximum output of the op-amp, Q1 is either off or saturated. That means that as the input at pin 6 of U2-b is increased, the effective power to the load is increased without significantly increasing the power dissipated by Q1.

I use this circuit in a feedback temperature control loop. That is done by replacing resistor R6 with the temperature error signal.

—James Peterson, No. Logan, Utah

Nice job, Jim! And we loved the way you presented it. The schematic was clear, indicated parts values, and it went through without a hitch. Your book is on the way to you now. Do try us again.

### RESISTOR HINT

I learned in one of my electronics classes that anyone can make precision resistor values from ordinary 5% resistors by using a file and some nail polish. Since a resistor's value is proportional to its cross sectional area, a triangular file can be used to "trim" the resistor by filing into the resistor while monitoring its value with a DVM. When the desired value is achieved, seal the resistor with nail polish

and allow to dry. I tried it and found that fat 1/2-watt resistors work best. You have to be careful however, because you can only increase the value, never decrease it. You can damage the resistor by cracking it open. You can increase the value by a few tenths of an ohm or several hundred ohms. Worth a book Byron?

—Omer Joly, Jr., Lompoc, CA

Sure, Omer, and it's on the way.

### SOME FINAL THOUGHTS

While that will fill the bill for this month, there are a few things left to clear up. We got a letter from Frank Weyer in Mountain View, CA. Frank is a patent attorney who became an attorney so he could save money by patenting his own inventions. He pointed out that the "valuable information" we provided on patenting in the November, 1990 Think Tank was based mostly on old wives tales. There are (he explained) only two ways to protect an invention. Either keep it secret or get it patented. Thanks for the corrections Frank. We're sending you a Think Tank book for your trouble.

There is another item we have to correct: The mail has been flooded here with letters complaining about a circuit in our November Think Tank. The "Two-Wire, Three-Way Switch" can present a severe shock hazard. For more information about its potential hazard's, see the "Letters" column, which appears on page 4.

That's a wrap for this month, and I'll be talking to you again next month. Meanwhile, do send your ideas and Helps 'n' Hints to Think Tank, Popular Electronics, 500-B Bi-County Boulevard, Farmingdale, NY 11735.

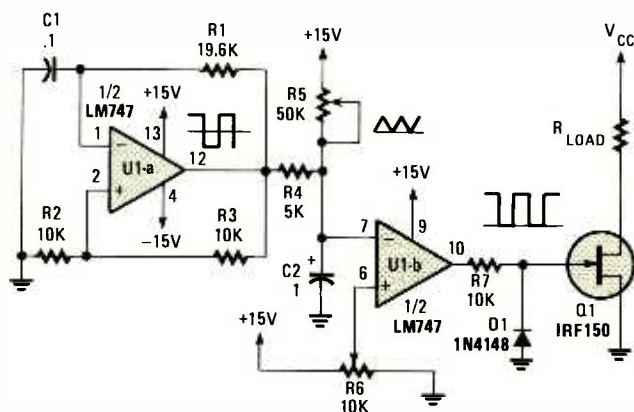

Fig. 6. This Pulse Width Modulation Circuit uses an op-amp to lessen the amount of power dissipated by the FET transistor.

# Discover Your Career Potential In The Fast Growing Field Of High-Tech Electronics!

CIE Gives You The Training You Need to Succeed...  
At Your Own Pace...& In Your Own Home!

If you're anxious to get ahead...and build a *real* career...you owe it to yourself to find out about the Cleveland Institute of Electronics!

CIE can help you discover your career potential in the fast growing field of high-tech electronics. A career that will challenge and excite you every day...reward you with a powerful feeling of personal accomplishment...and deliver a level of financial security you may have only dreamed of before!

As the leading school in home-study electronics, CIE has helped over 150,000 students in the U.S.A. and over 70 foreign countries get started in this exciting field. To find out how CIE could be helping you...read on...then send for a CIE catalog TODAY!

## A Growing Need For Trained Professionals!

The career opportunities shown here are only a few of the challenging, high-paying careers you could enjoy as an electronics technician.

You could be the "brains" behind the scenes of an exciting TV broadcast...trouble-shoot life-saving medical equipment...design exotic new aeronautics systems...CIE's job-oriented programs offer you the quickest possible path to the career of your dreams! And CIE also features military and union re-training, to build on what you already know.

## Dozens Of Fascinating Careers To Choose From!

Even if you aren't sure which career is best for you, CIE can get you started with core lessons applicable to *all* areas of electronics. As you advance, CIE makes job opportunities available to you through the bimonthly school paper, *The Electron*.



Data Communications



Automotive Electronics



Avionics



Computer-Assisted Manufacturing



Consumer Electronics



Military Electronics

## Practical Training... At Your Own Pace.

Through CIE, you can train for your new career while you keep your present job. Each course allows a generous completion time, and there are no limitations on how fast you can study. Should you already have some electronics experience, CIE offers several courses which start at the intermediate level.

## "State-Of-The-Art" Facilities & Equipment.

In 1969, CIE pioneered the first electronics laboratory course, and in 1984, the first Microprocessor Laboratory. Today, no other home study school can match CIE's state-of-the-art equipment. And all your laboratory equipment is included in your tuition cost. There is no extra charge—it's yours to use while you study at home and on the job after you complete your course!

## Earn Your Degree To Become A Professional In Electronics!

Every CIE course you take earns you credit towards the completion of your Associate in Applied Science Degree, so you can work towards your degree in

stages. And CIE is the only school that awards you for fast study, which can save you thousands of dollars in obtaining the same electronics education found in four-year Bachelor's Degree programs!

## Personal Training From A Renowned Faculty.

Unlike the impersonal approach of large classroom study, CIE offers you one-on-one instructional help 6 days a week, toll-free. Each CIE lesson is authored by an independent specialist, backed by CIE instructors who work directly with you to answer your questions and provide technical assistance when you need it.

## Send For Your Catalog Today!



### CIE World Headquarters

Cleveland Institute of Electronics, Inc.  
1776 East 17th St., Cleveland, Ohio 44114

**YES!** Please send me your independent study catalog (For your convenience, CIE will have a representative contact you—there is no obligation.)

Print Name \_\_\_\_\_

Address \_\_\_\_\_ Apt # \_\_\_\_\_

City/State/Zip \_\_\_\_\_

Age \_\_\_\_\_ Area Code/Phone No. \_\_\_\_\_

Check box for G.I. Bill bulletin on educational benefits:  Veteran  Active Duty

**Mail This Coupon Today!**

AHO2

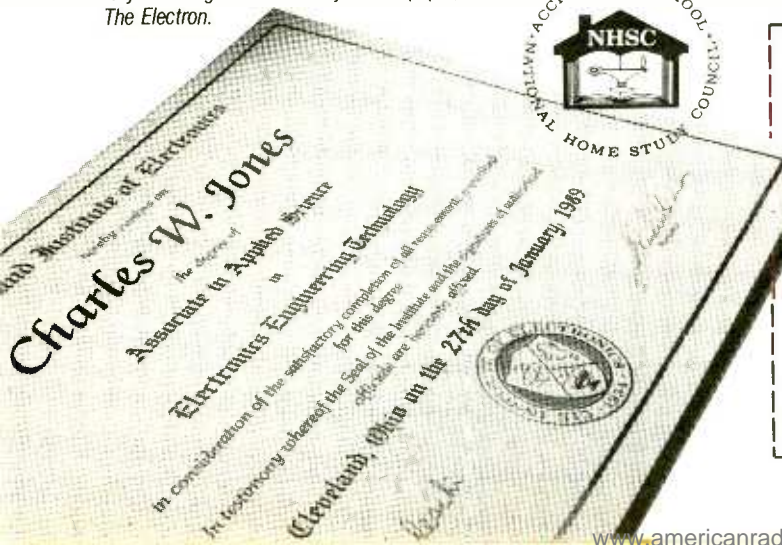

FEBRUARY 1991



Welcome to . . .

# SCIENCE PROBE!®

The Amateur Scientist's Journal

Embark on an irresistible new journey into the realm of mystery, challenge, and exploration! The perfect magazine for the budding scientist, the serious amateur, the professional who would like to relax, and those who simply want to gaze at the stars.

**SCIENCE PROBE!** — the *only* magazine devoted entirely to Amateur Scientists! If you are fascinated by science in all its many forms . . . if you can't stay away from a microscope, telescope, calipers, or test tube — we invite you to share the wonders in every issue of **SCIENCE PROBE!** You will join a community of Amateur and Student Scientists who enthusiastically seek scientific knowledge or follow scientific pursuits for their own sakes and not merely as a profession.

Obtain your personal *premier* edition of **SCIENCE PROBE!** by visiting a quality Newsstand, Convenience Store, or Supermarket this Fall or by reserving your personal copy through the mail by completing the coupon below.

From the very first issue of **SCIENCE PROBE!** you will be involved in a world of scientific facts, experiments, and studies pursued by amateur scientists who are university students, inventors, academicians, engineers, or office workers, salesmen, farmers—whose *quest* is to probe into the mysteries of science and reveal them to all.

Plan to become a **SCIENCE PROBE!** reader!

Articles to appear in early issues of **SCIENCE PROBE!** are:

**LIGHTNING—CAPTURE IT ON FILM**  
**MONITORING ULTRAVIOLET FROM THE SUN**  
**MOBILE-MOUNT EXPERIMENTAL WIND TUNNEL**  
**CHECKING OUT ACID RAIN**  
**AERIAL PHOTOGRAPHY FROM KITES AND BALLOONS**  
**MINIATURE TRACKING TRANSMITTER**  
**KILLER BEE IDENTIFICATION**  
**HOW TO OBTAIN ANIMAL EYESHINE PHOTOGRAPHS**

If you're fascinated by science in all its many forms, if you are compelled to experiment and explore, then **SCIENCE PROBE!** is your kind of magazine!

**SCIENCE PROBE!**

7PB14

500-B Bi-County Boulevard  
 Farmingdale, NY 11735

Please forward my Premier Edition of **SCIENCE PROBE!** as soon as it comes off the press. I am enclosing \$3.50-U.S.A. (\$3.95-Canada) plus \$1.00 for shipping and handling. Better still, please enroll me as a charter-member subscriber and send the next four (4) quarterly issues of **Science Probe**. I am enclosing \$9.95-U.S.A. (Canada: \$14.95 U.S.A. Funds)

Premier Edition only     First Four Issues (1 Year)

Offers valid in the U.S.A. and Canada only. No foreign orders.

Name \_\_\_\_\_

Address \_\_\_\_\_

City \_\_\_\_\_ State \_\_\_\_\_ ZIP \_\_\_\_\_

All Orders payable in U.S.A. Funds only.

**ON SALE AT QUALITY NEWSSTANDS, CONVENIENCE STORES AND SUPERMARKETS**  
**STARTING SEPTEMBER 13, 1990 — \$3.50-U.S.A. — \$3.95-Canada**

**F**or some metaphysical reason, the phone seems to ring most often when a person is a dozen or so steps away getting groceries out of the car, weeding the vegetable garden, or in the shop running a power saw. Sometimes you hear the phone ringing—then comes the mad dash as you race to answer before the caller hangs up. Similarly, if I had a quarter for every TV dinner that has burnt while I was engaged in some project in the workshop, I would certainly be a rich man!

I've always wanted a gizmo to attach to an appliance or the telephone to let me know it needs attention. One of those loud, startling bells was out of the question, and besides, they're ineffective if noisy equipment is operating. The *SentryStrobe* presented in this article was developed as an answer to that need. A Xenon lamp is used to produce eye-catching flashes, offering a silent but highly effective visual indicator.

The unit may be placed anywhere; inside the house (such as in a noisy garage workshop), in an industrial work area (such as a machine shop) or out-of-doors. People with hearing impairments will find the *SentryStrobe* a real

boon too, as it can offer the security of not missing important alerts.

You can even turn the project into a burglar alarm that will scare the daylights out of any thief! The strobe can be configured to respond to virtually any type of sensor. Later we'll show you how to adapt the circuit to various types of sensor inputs, but first let's explain how the strobe, and its power-supply circuit operates.

**How It Works.** Figure 1 is a schematic diagram of the *SentryStrobe*. The circuit is activated by a special device called an LED/photoconductor isolator (U1), which is a combination of a light-dependent resistor (LDR) and LED in a single package. That device was chosen because of its high isolation (2000 volts) characteristic, which is necessary because the strobe part of the circuit is directly connected to the AC line.

A voltage divider is formed by R2, U1's internal resistance, and R3. When U1's internal LED is off, U1's internal LDR has a very high resistance—on the order of 10 megohms. The output voltage of the divider under that condition is

# THE SENTRY STROBE ALERT SYSTEM

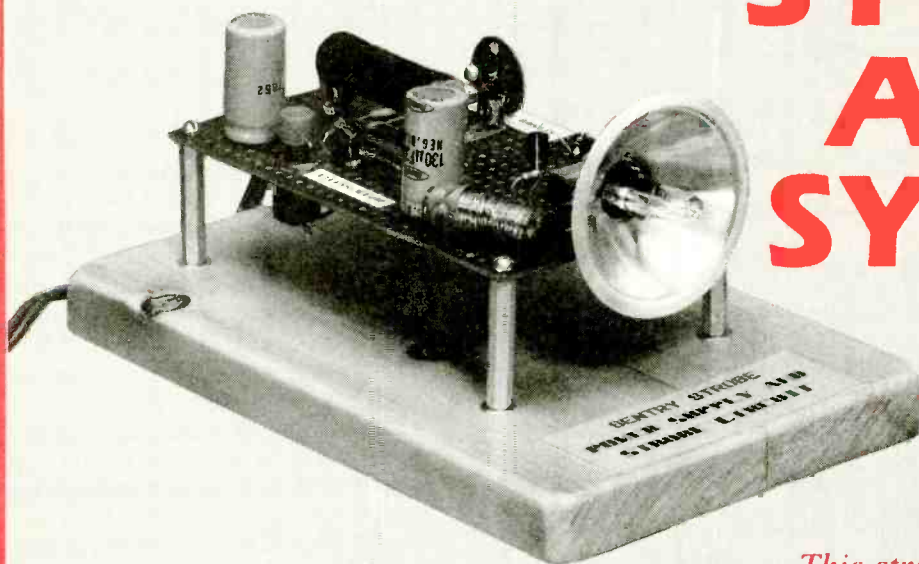

BY ANTHONY CHARLTON

*This strobe circuit does more than just flash; it can be used to call your attention to a ringing phone, entry into a secured area, temperature conditions, and more!*

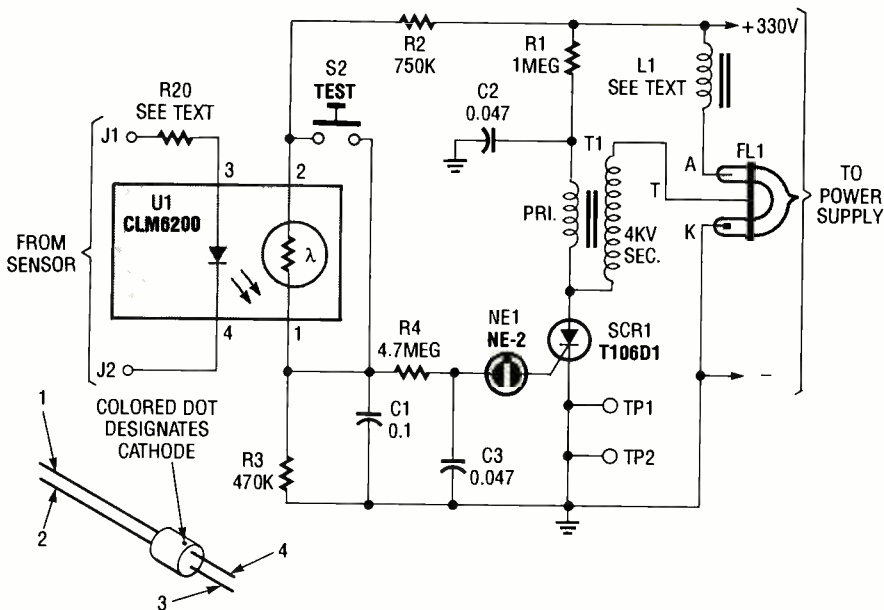

Fig. 1. The SentryStrobe is built around a trigger transformer, a Xenon flash lamp, an SCR, and a neon lamp (which is used to trigger the SCR). A CLM6200 optoisolator/ coupler accepts trigger inputs from an external signal source to fire the strobe circuit.

very low. Thus, the voltage applied to NE1 is considerably below its ignition voltage of approximately 90 volts DC.

The optoisolator's internal LED is activated by a DC signal supplying 10 mA. The external sensor(s) that supply the signal are connected to the strobe part of the circuit at J1 and J2. The resistance at J1, R20, limits the current through U1's internal LED to 10 mA. That resistance varies in value with different sensor types.

When the internal LED lights, the LDR's resistance decreases to around 10k. Under that condition, about 125 volts AC is applied across C1, R4, and C2—more than enough to ignite NE1. The neon lamp periodically fires and extinguishes as capacitor C2 charges through R4, and discharges via NE1 and the SCR gate. (What we have here is a "relaxation oscillator," which is one of the simplest oscillators around.) Resistor R4 restricts the current input to C2, and thereby controls the firing rate of NE1—about three times per second. The discharge through NE1 is applied to the gate of SCR1.

SCR1, a sensitive-gate unit, snaps on immediately when NE1 conducts, which completes the ground circuit for transformer T1 (a 4-kV trigger transformer). As SCR1 toggles on and off in time with the firing of NE1, capacitor C3 (connected in parallel with T1's primary) charges via R1, and then discharges very rapidly through T1's primary winding. The on/off action of SCR1 generates a rising and collapsing field about T1's primary winding, which induces a 4-kV pulse in its secondary winding. That

voltage pulse is applied to the trigger input of FL1, a Xenon flashlamp, ionizing the xenon gas inside, and rendering it highly conductive to current flow.

In order to ignite a Xenon flashlamp, you need to meet two conditions. First, the Xenon gas must be ionized (which is accomplished via the circuit in Fig. 1). Next, there must be a large capacitor to store energy at a high enough voltage to sustain the arc inside the flashlamp after it is triggered. A power supply is also needed to charge that capacitor. The circuit at Fig. 2 provides that function with a minimum of parts.

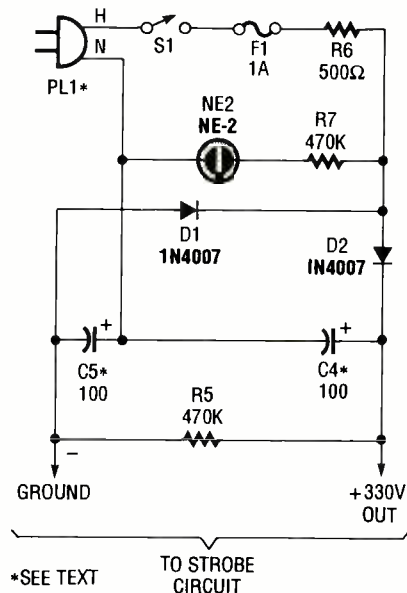

Fig. 2. The power supply for the SentryStrobe is a simple voltage doubler/rectifier circuit, which provides 330 volts DC to the primary winding of the trigger transformer in the strobe circuit.

## PARTS LIST FOR THE SENTRYSTROBE

### SEMICONDUCTORS

- U1—CLM6200 photocoupler (Clairex), integrated circuit
- SCR1—T106D1 4-amp, 400-PIV, sensitive-gate, silicon-controlled rectifier
- D1, D2—1N4007 1-amp, 1000-PIV, general-purpose rectifier diode

### RESISTORS

(All fixed resistors are 1/4-watt, 5% units, unless otherwise noted.)

- R1—1-megohm
- R2—750,000-ohm
- R3—470,000-ohm
- R4—4.7-megohm
- R5—470,000-ohm, 1/2-watt
- R6—500-ohm, 25-watt, power resistor
- R7—470,000-ohm, 1/2 watt
- R20—see text

### CAPACITORS

- C1—0.1-μF, 250-WVDC polyester
- C2—0.047-μF, 250-WVDC polyester
- C3—0.047-μF, 400-WVDC polyester
- C4, C5—100-μF, 250-WVDC electrolytic

### ADDITIONAL PARTS AND MATERIALS

- L1—See test
- F1—1-amp fuse
- FL1—Xenon flashlamp, U-shaped, 45 W/s
- NE1, NE2—NE-2 neon lamp
- S1—SPST snap switch
- S2—SPST normally-open pushbutton switch
- T1—4-kV trigger transformer with center-tapped secondary
- Perfboard materials, non-conducting enclosure, AC molded power plug with line cord, optional reflector, wire, solder, hardware, etc.

It is important to remember that the circuit is connected directly to the AC line. Resistor R6 is included in the circuit of Fig. 2 to limit the amount of line current available to the circuit. The value of R6 may be decreased if you intend to modify the circuit for more flash power. **Warning:** Even though the circuit is fuse-protected, the circuit can still be dangerous if handled carelessly.

When the AC line voltage is applied to the circuit in Fig. 2, it is stepped-up (about 2.8 times) by a voltage-doubler circuit consisting of D1, D2, C4, and C5. Diodes D1 and D2 (in addition to their other duties) rectify the incoming AC line voltage, which is then stored as DC in the two large capacitors (C4 and C5), and provides an output of about 330 volts DC, which is an ideal voltage level to ignite the flashlamp.

Note that a second neon lamp, NE2, is included in the circuit as a safety feature, and is there to remind you when the unit is plugged in and full AC line voltage is present.

Flashlamp FL1's luminescence is directly related to the total capacitance and voltage rating across it. Since C4 and C5 are identical units and are connected in series, their combined capacity is one-half the value of either unit, while the voltage across both is doubled. Be sure to use exactly the same size and type capacitor for each. And it is a good idea to test each part for its actual value, rather than rely on its specification. Do not use those that differ by more than  $\pm 20\%$ .

To determine the flashlamp's output in watt/seconds (W/s), use:

$$W/s = .5 (C \times V)$$

where C is the total capacitance across FL1 in microfarads and V is the voltage across FL1 in kilovolts (kV). Thus, plugging in 50  $\mu$ F for C and with 330 volts across the lamp, you get about 2.5 W/s of output. In practice, the actual light output is somewhat less; that's because the lamp flashes quickly in this design, which does not allow the capacitors to charge fully between flashes. Remember the SentryStrobe is designed primarily for intermittent operation, and the lamp should not run until it's super heated, or its life expectancy will be diminished.

If the lamp gets too hot, increase the value of R4 to 10 megohms to reduce the flash rate. Alternately, you can either reduce the capacitance of C4 and C5, or use a lamp with a higher W/s rating. Note that decreasing the values of C4 and C5 will have no effect on the circuit other than its light output.

It is interesting to note that FL1 consumes all the energy in the two capacitors in about  $\frac{1}{10000}$ th of a second. For that brief interval, FL1 is as bright as a 35,000 watt lamp! That extreme brightness makes the lamp easy to see, especially on overcast days or at night.

Your application will determine the amount of light needed, as well as the required duty cycle of the lamp. For instance, if the project is used in place of a telephone-ring detector, it likely will flash only a few seconds at a time and not have a chance to overheat. If it is used as a thunderstorm alert, it may have to flash much more brightly and for longer periods at a time. In the latter case, the component and power supply ratings will have to be beefed up.

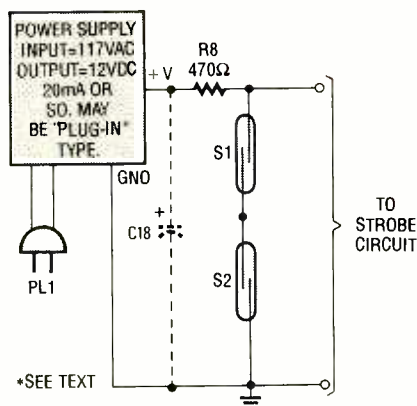

Fig. 3. The SentryStrobe can easily be configured as a burglar-alarm by connecting the appropriate sensor/power supply combination to the input of the strobe circuit. A closed-loop circuit, consisting of a couple of magnetic reed switches and its own power supply (like that shown here) can be used to monitor specific areas of your home or the entire house.

### PARTS LIST FOR THE INTRUDER DETECTOR

- R8—470-ohm ¼-watt, 5% resistor
- R20—1000-ohm ¼-watt, 5% resistor
- C18—220- $\mu$ F, electrolytic capacitor, see text
- S1, S2—Normally-closed magnetic-reed switches, see text
- 12-volt DC, 20-mA or more power-supply or plug-in transformer, optional back-up battery, wire, solder, hardware, etc.

Greater light outputs are possible by using larger capacitors for C4 and C5 to store more energy. For instance, substituting two 750- $\mu$ F capacitors will give a light output per flash of about 20 W/s. The limit of the flashlamp specified in the Parts List is 45 W/s per 15-second shot, or less when flashed at a higher rate. Lamps up to 500 W/s are available from the supplier in the Parts List.

You may use photoflash capacitors to store the energy for FL1. However, if you do, a choke will be required between the anode of the lamp and the positive side of the power supply. The reason for that is that photoflash capacitors are low-inductance devices when compared to ordinary electrolytic types. As a result, FL1 will flash with a short, powerful pulse generating a lot of ultraviolet light.

That invisible light reduces the output of FL1, and the fast flash conspires to

shorten the flashlamp's life. The author used a home-made choke that was comprised of 70 turns of #22 magnet wire wound on a ferrite core (like that used in AM radios with built-in antennas). The home-made choke provided an inductance of 25 millihenries (mH), which is adequate for the series-wired 130- $\mu$ F photoflash capacitors used in the prototype.

If you require such a choke, it is suggested that you use 0.2 to 0.5 mH of inductance per microfarad of capacitance across FL1. A good test is to watch the flashlamp from a distance of 20 feet during the daytime hours. If it is blinding white, your choke is large enough, but if it has a blue tint, add more inductance. Finally, do not omit R5—a 220k, ½-watt resistor connected across C4 and C5; that resistor is used to bleed off the heavy charge on the large capacitors when the project is unplugged.

**Power Supply Assembly.** The author's prototype was assembled on a 6- $\times$  3½-inch section of perfboard, with point-to-point wiring used to join the circuit elements. Once you've obtained all the parts, begin construction with the power supply, using Fig. 2 as a guide. Fuse F1 should preferably be a fast-blow type. When installing R6, keep about a ¼-inch space between R6 and the circuit board to allow that unit to dissipate heat freely.

Be sure to use a polarized plug on the line cord, and wire it (as shown) so that the hot side of the plug (the smaller terminal) is connected to R6, F1, and S1. Once the power supply is complete, it's a good idea to make a visual check of the assembly to see if there are any errors in construction—misconnected components, solder bridges, and the like. If no construction errors are found test the circuit by plugging the power supply into a polarized outlet, and flipping on S1. Neon lamp NE2 should come on immediately.

Measure the voltage across C5 and C6. You should get about 330 volts DC. Then test the voltage across each capacitor separately. The readings across the individual units should be about half the total applied voltage and within  $\pm 20\%$  of each other. If they differ significantly, suspect that one of the capacitors is defective, or is of substantially different value than its companion. Replacement is warranted if the individual voltages across the two are not within  $\pm 20\%$  of each other.

There is a shock hazard associated with this type of circuit. You must be especially careful to wire the power-supply circuit as shown with the neutral prong of a polarized plug mating with the neutral side of the AC wall socket. Be sure to mount the SentryStrobe in a non-conducting case—especially if the project is to be located outside, where it may be exposed to adverse weather conditions.

If everything checks out okay, it is time to move on to the strobe section of the project.

**Strobe Assembly.** Assembly of the strobe portion of the project is relatively straightforward, except for the flashlamp, which we'll get to in a moment. The concern of the moment is the high-voltage output of T1. The secondary leads must be kept away from the other components so as not to destroy them. Fortunately, the output of T1 is too weak for people to feel. But do allow adequate spacing around T1's secondary and the +330-volt line. With certain trigger transformers, the pinout may be confusing. Make sure the proper windings are connected to conform to the schematic diagram shown in Fig. 1.

Note that the flashlamp, FL1, is a polarized component. That means that its cathode lead must be connected to ground, and its anode connected to the +330-volt line. The cathode is easily identified by a small cylinder of sintered, gray-colored metal bonded to it. In the authors' prototype, the flash lamp was mounted to a small section of perfboard; a reflector was then fitted to the board to concentrate the light.

You may also install a colored filter or lens over the reflector to tint the concentrated flash. Light-colored filters are best, as dark ones tend to absorb the infrared energy generated by the lamp. After mounting FL1 to the perfboard, do not clip its leads. They will be used to connect the flashlamp to the rest of the strobe circuit.

To test the strobe section of the circuit, connect it to the power supply that you've just built. Energize the circuit and press S2. The lamp should flash at about 3 Hz. Troubleshooting the circuit, if required, is fairly simple. Problems usually appear in the area connected with SCR1. Another sore spot lies with the trigger transformer not supplying enough energy to ionize the lamp's Xenon gas. A few simple tests will tell you if T1 and SCR1 are functioning correctly.

First take a disc capacitor with a high voltage rating—400-WVDC or so—and with a capacitance of a few hundred picofarads or more. Unplug the circuit, disconnect the trigger lead to FL1, and connect one end of the capacitor to the high voltage output lead of T1. Attach a neon lamp to the free end of the capacitor. Now connect the remaining lead of the neon lamp to circuit ground. Power up the circuit, and press S2. The test lamp should give a weak flash each time NE1 flashes. If it does not, suspect SCR1 or T1 to be defective.

If that checks out, test SCR1 by first opening the circuit between TP1 and TP2 and connect a speaker across TP1 and TP2. Press S2, TEST; that should cause NE1 to flash. Each time NE1 flashes, the speaker should emit a distinct click. Lack of a click means either the SCR is defective, or the primary of T1 is open.

You can also check T1 with an ohmmeter. Its primary should give a very low resistance reading (on the order of a fraction of an ohm); the secondary should give a reading of several tens of ohms. If both tests pass, and the lamp still doesn't flash, suspect the lamp itself or its accompanying section of perfboard to be the culprit. Problems of the latter type can be frustrating to solve, because the circuit appears to be functioning correctly, but the lamp just won't flash.

Usually the trouble can be traced to a short across the lamp leads, passing the charge from T1 to ground. Make sure the lamp and board are clean, dry, and free of solder-flux residue. The wire going to FL1 must be in good condition. Sometimes slipping a piece of heat-shrink tubing over the lead, or taping it, will solve an elusive problem.

Problems related to flash speed are often due to a low (or high) line voltage in your area, or to variations in the ignition voltage of the neon lamp—not all neon lamps are created equal! The author noted while assembling some prototypes that the values of R2 and R3 needed to be adjusted to compensate for the different firing points of individual neon lamps, so be prepared to experiment.

After the flashlamp part of the circuit is verified as working properly, you may test FL1 to see if it overheats. Press S2 and hold it for about a minute, while checking the flashlamp. Even during normal operation, the lamp will get very hot, but if it gets so hot that the flash rate begins slowing down, skips, or halts altogether, the lamp is overheating. A

## PARTS LIST FOR THE FAULTY FURNACE DETECTOR

### SEMICONDUCTORS

- U2—MC7812ACT 12-volt, 1-amp, precision voltage regulator, integrated circuit
- U3—LM335 voltage-mode temperature sensor, integrated circuit
- U4—LM311 high-performance voltage comparator, integrated circuit
- Q1—2N3906 or equivalent general-purpose PNP silicon transistor
- LED1—Extra bright light-emitting diode

### RESISTORS

- (All fixed resistors are 1/4-watt, 5% units, unless otherwise noted.)
- R9—10,000-ohm, 1%, metal film
  - R10—200-ohm, cermet 20-turn potentiometer
  - R11—2940-ohm, 1%, metal film
  - R12—10,000-ohm
  - R13—100,000-ohm
  - R14—3300-ohm
  - R15—1000-ohm
  - R16—10,000-ohm, sealed, single-turn potentiometer
  - R20—1000-ohm

### CAPACITORS

- C7—1- $\mu$ F, 50-WVDC, electrolytic
- C8, C11—0.1- $\mu$ F, ceramic-disc
- C9, C10—10- $\mu$ F, 6.8-WVDC, Tantalum

### ADDITIONAL PARTS AND MATERIALS

- Perfboard materials, enclosure, 8-pin IC socket, AC molded power plug with line cord, thermometer (for calibration), probe case, wire, solder, hardware, etc.

thermometer is handy for testing the circuit, especially if it has a small probe. The temperature with continuous flashing should not exceed 250°F.

The circuit is now ready to accept the output of a suitable sensor. Once again, be sure that the sensor output does not exceed 10 mA to prevent damage to U1. Input resistor R20 is placed in the circuit to limit the level of current flowing to the input of U1. The value of that component is selected to match the type of sensing circuit connected to the SentryStrobe's sensor input.

**Sensor Suggestions.** There are many types of sensors that can be attached to your SentryStrobe. For instance, you might want to attach a toxic-gas sensor, like the one that appeared in "Build An Exhaust Monitor For Your Car" (*Popular Electronics*, June 1990), to detect carbon monoxide and other deadly gases.

Or perhaps you're into gardening,



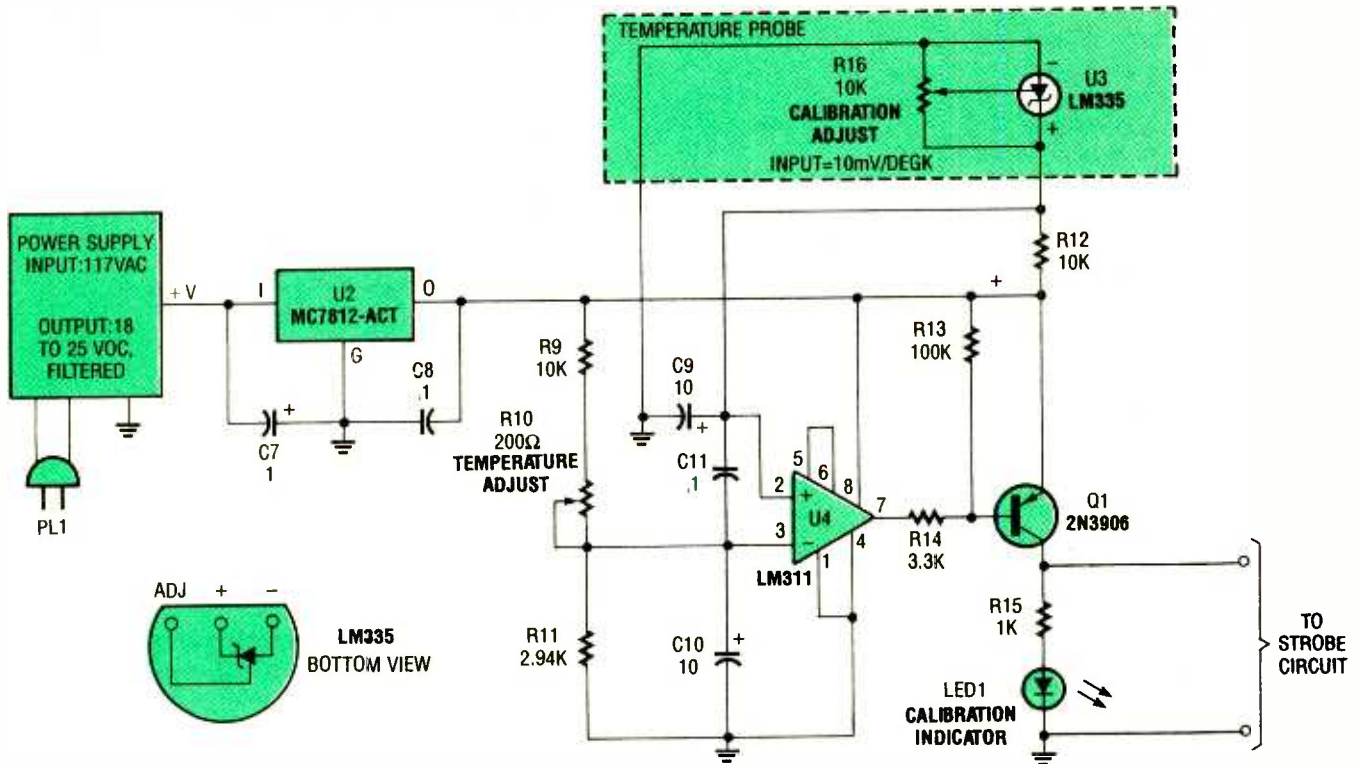

Fig. 4. This circuit—built around an LM335 precision temperature sensor, an LM311 voltage comparator, and an MC7812-ACT 12-volt 1-amp voltage regulator—can be used to monitor temperature changes at a given site, and trigger the strobe circuit when preset conditions are met.

and “vegetable-eatin’ critters” have been celebrating the “feast of plenty” in your backyard at night. Rigging the SentryStrobe to a simple microphone circuit or capacitance sensor can provide a way for animals to trip the project. Perhaps a strong blast from a flashtube will frighten them off.

Yet another application of the circuit might be to use it in conjunction with a thunderstorm-sensing apparatus like “Sferic-Level Monitor” (**Popular Electronics**, August 1989). Let’s look at some other sensors in more detail.

**Intruder Sensor.** The magnetic reed switches shown in Fig. 3 are the simplest type of sensor that can be used to turn the SentryStrobe into an intruder alarm. Any number of sensors can be connected in series. A small amount of power is run through the alarm loop, whose normal path is through the normally-closed, magnetic-reed switches (S1 and S2). When any switch is opened by an intruder, current is no longer shunted to ground. As a result, the current flows through U1, causing the SentryStrobe to immediately begin flashing. The magnetic-reed switches can be replaced by a relay, or a normally-closed pushbutton switch, which could then be used as a “panic button.”

The power supply for the circuit in Fig. 3 is not critical. A plug-in wall transformer with a 12-volt regulated output at 20 mA or so is ideal. However, you may use any low-voltage power supply that you might have on hand. If you use an unregulated plug-in power supply, be aware that such units often run several volts in excess of their published specifications, which could easily exceed the safe operating parameters of the optocoupler. The current fed to the input of U1 should be limited to no more than 10 mA.

It will be necessary to determine an appropriate value for R20. To do so, first determine the approximate resistance required to limit the input current to 10 mA using Ohm’s law. Then place a resistor of the nearest standard value in series with a milliammeter, an LED, and the sensor power supply. If the meter indicates an input current of 10 mA or less, use that value; if a higher current is indicated, substitute the next higher standard value resistor for R20, and take another current reading. It’s better to take the time to go through this procedure than to risk the much more expensive optocoupler.

The power supply output should be filtered; a 220- $\mu$ F electrolytic capacitor of the appropriate voltage rating is rec-

ommended for C18. A battery back-up is recommended for maximum security to frustrate the would-be intruder who should attempt to defeat the alarm by cutting off the AC power.

**Faulty-Furnace Sensor.** Another application for the SentryStrobe is to monitor furnace operation. For example, imagine you are vacationing in the middle of February. At your residence up north, the weather is close to zero degrees, and snowing. The furnace quits, and the house temperature drops rapidly. The falling temperature is detected by a low-temperature sensor. The unusual coolness activates the temperature-monitoring circuit, which then triggers the SentryStrobe. The flashing signals your neighbor to call the furnace repairman before the water pipes freeze and break. You just saved yourself a \$1000 plumbing bill.

Figure 4 shows a precision, adjustable, low-temperature sensing circuit that’s built around three inexpensive integrated circuits—an LM335 precision temperature sensor, an LM311 voltage comparator, and an MC7812-ACT 12-volt 1-amp voltage regulator.

The regulator (U2) feeds a constant voltage to the temperature sensor (U3), whose output voltage changes propor-

tionally to temperature—exactly 10-mV-per-degree Kelvin (10 mV/°K). Integrated circuit U3 can be thought of as a precision Zener diode whose reverse breakdown voltage (Zener voltage,  $V_Z$ ) is temperature dependent—as temperature goes up, the unit's Zener voltage goes up.

The Zener voltage of U3 is fed to the non-inverting input of U4 at pin 2. The inverting input of U4 at pin 3 is tied to an adjustable voltage-divider, consisting of R9, R10 (precision 20-turn potentiometers), and R11. Resistors R9 and R11 are precision 1% tolerance units that exhibit

## PARTS LIST FOR THE SOUND AND RINGER SENSOR

### SEMICONDUCTORS

- U5—LM386 low-voltage audio-power amplifier, integrated circuit
- D3—1N4148 general-purpose small-signal silicon diode
- LED2—Extra-bright light-emitting diode

### CAPACITORS

- C12, C15—100- $\mu$ F, 16-WVDC, electrolytic
- C13—0.1- $\mu$ F, ceramic-disc
- C14—10- $\mu$ F, 25-WVDC, electrolytic
- C16—0.047- $\mu$ F, ceramic-disc
- C17—680-F ceramic-disc

### ADDITIONAL PARTS AND MATERIALS

- R18—10-ohm, 1/4-watt, 5% resistor
- R19—820-ohm, 1/4-watt, 5% resistor
- R20—0-ohm (jumper)
- MIC1—Electret condenser microphone cartridge
- Perfboard materials, enclosure, regulated 12-volt power source, wire, solder, hardware, etc.

**Note:** The following parts are available from Allegro Electronic Systems (Dept. XFT, 3 Mine Mountain Road, Cornwall Bridge, CT 06754): U-shaped 45 W/s Xenon flashlamp \$4.95, (order part XFT-45U); 4 kV Trigger Transformer, \$2.05 (order part TR4-FX) Please add \$2.85 per order for shipping and handling. All Connecticut residents, please add appropriate sales tax.

All integrated circuits, 1% resistors, and several other components are available from Digi-Key (P.O. Box 677, Thief River Falls, MN 56701-0677). The magnetic reed switches, LED's plug-in transformers, and other components are available from All Electronics (P.O. Box 567, Van Nuys, CA 91408).

Free technical assistance for this project and a catalog of related parts are available by calling 203-672-0123 from 9 AM to 12 noon E.S.T. weekdays.

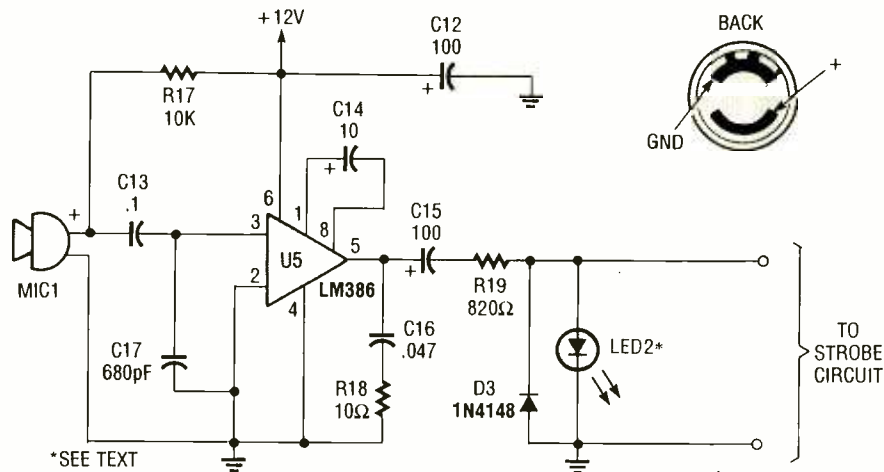

Fig. 5. This simple circuit allows the strobe circuit to be used as a sound detector; such a circuit might be used to detect sounds within a covered area, indicating that the perimeter has been breached.

virtually no change in resistance with temperature changes.

Under normal room-temperature conditions, U3 keeps the voltage at pin 2 of U4 high, placing pin 2 at a higher potential than pin 3. That forces the output of U4 at pin 7 high. That high is fed to the base of Q1 through R14, keeping it at cutoff. As the temperature decreases, U3 causes the voltage presented to pin 2 of U4 to decrease. When the voltage at pin 2 drops below the reference voltage applied to pin 3, the output of U4 swings negative, causing Q1 to conduct. That, in turn, triggers the strobe.

In this application, the strobe's input resistor, R20, should be 1k. Capacitors C9 and C10 are solid Tantalum units, which were chosen for their low-leakage characteristics. Those capacitors provide a delay that allows the circuit to ignore minor temperature fluctuations. Capacitor C11 is placed close to U4 to dampen oscillations that may occur.

The LM335 (U3) is mounted in a probe located at the point you wish to monitor. The probe housing should allow the end of U3 to stick out a bit so that it can contact the medium to be monitored. The wires connected to U3 should be sealed in silicone RTV to form a leak-tight container, making it immune to high humidity or water immersion. The CALIBRATION potentiometer, R16, should be located inside the case with the rest of the electronic circuitry; it should require no further adjustment after the initial calibration.

Shielded cable must be used if U3 is to be located more than a few feet from the rest of the circuit to prevent the wire from acting like an antenna for radio-frequency interference.

The accuracy and stability of the regulator (U2) determines the accuracy of the circuit. A pair of capacitors, C7 and C8, are attached to the input and output of U2 to dampen unwanted oscillations that might develop.

**Calibration.** It is important to note that the Kelvin (K) scale starts at *absolute zero* ( $-273.15^{\circ}\text{C}$ ), and a  $1^{\circ}\text{K}$  change in temperature equals precisely a  $1^{\circ}\text{C}$  change. On the Kelvin scale, the freezing point of water ( $32^{\circ}\text{F}$  or  $0^{\circ}\text{C}$ ) is  $273.15^{\circ}\text{K}$ . At the exact freezing point of water, U3's Zener voltage ( $V_Z$ ) will be  $V_Z = 10 \text{ mV} \times 273.15^{\circ}\text{K}$  or 2.7315 volts.

Obtain a good quality thermometer and digital voltmeter. Place the sensor (U3) in a medium at exactly  $25^{\circ}\text{C}$  ( $77^{\circ}\text{F}$ ). Be sure not to get R16 soaked. Adjust R16 so that the voltage at the cathode (pin 2) of U3, and thus the comparator, is exactly 2.98 volts. Once calibrated, U3 is accurate to  $\pm 1^{\circ}\text{C}$ .

Now R10, TEMPERATURE ADJUST, must be set to the trigger-point temperature chosen for the SentryStrobe. Let's say that we want the circuit to trigger the strobe at  $40^{\circ}\text{F}$ . The trigger point ( $40^{\circ}\text{F}$ ) correlates to  $4.4^{\circ}\text{C}$ . Add 273.15 to the centigrade temperature to obtain temperature in Kelvin degrees;  $4.4^{\circ}\text{C} + 273.15 = 277.55^{\circ}\text{K}$ . That value can be rounded off to the nearest tenth or  $277.6^{\circ}\text{K}$ . Multiply that value by .01 and you get 2.776, which we'll round off to 2.78. Adjust R10 for 2.78 volts at pin 3 of U4. (Potentiometer R10 is adjustable from 2.72 to 2.86 volts, which corresponds to  $30^{\circ}\text{F}$  to  $55^{\circ}\text{F}$ ) Now whenever the temperature falls below  $40^{\circ}\text{F}$  the SentryStrobe will start flashing.

Since component tolerances, volt-  
(Continued on page 98)

# Build an AUTOMATIC



## FISH FEEDER

*Tropical fish are among the easiest pets to care for—all you need do is remember to feed them once the aquarium is set up. And with this automatic fish feeder, you can forget even that task!*

BY JAN AXELSON

Compared to most other household pets, tropical fish are easy to care for, but even fish need their regular feedings. If you own tropical fish, wouldn't it be nice to have a way to feed them automatically for those times when you're vacationing or otherwise aren't at home to give them their recommended twice-a-day feeding?

Well now you can with the *Auto-Feeder* fish feeder described in this article. Every twelve hours, the Auto-Feeder briefly activates a solenoid, which in turn flips a flipper, allowing granulated fish food to fall from a bin into your fish tank. The amount of fish food dispensed at each feeding is adjustable. In addition, the feeder has a FEED switch that lets you feed your fish manually any time you wish, and there is also a REFILL

indicator that warns you when the food supply in the bin is low.

Although the circuit was designed as a fish feeder, the Auto-Feeder may also give you ideas on how to assemble other circuits that perform mechanical functions after specified time delays.

**About The Circuit.** Figure 1 is the complete schematic diagram for the Auto-Feeder. Power for the circuit is provided by a 12-volt, 0.8-amp, unregulated plug-in AC-to-DC adapter or "wall transformer." The 12-volt output of the power source is fed to a voltage regulator (U1), which provides a regulated 8-volt output to power the digital circuitry in the project.

Regulator U1 impresses a 1.25-volt reference across resistor R2, and the constant current through the series

combination of R2 and R1 sets U1's output to 8 volts DC. Capacitors C1-C4 are filter and bypass capacitors for the 8-volt supply, and LED1 and R3 comprise a power-on indicator.

The 12-hour delay between feedings is provided by U2, an LS7210 programmable timer that contains its own binary counting circuitry. The counting circuitry makes it easy to program the IC for long delays without using the huge timing resistors and capacitors that many other timer IC's would require.

Leaving U2's mode-select inputs (pins 1 and 2) unconnected puts U2 in its dual-delay mode—after either a low-to-high or high-to-low transition at pin 3 (trigger), U2 begins to time a delay. When the delay times out, U2's output at pin 13 changes state, going from high-

## PARTS LIST FOR THE AUTO-FEEDER

### SEMICONDUCTORS

- U1—LM317 positive, adjustable voltage regulator, integrated circuit  
 U2—LS7210 programmable delay timer, integrated circuit (Radio Shack part 276-1307)  
 U3—4538B CMOS dual monostable multivibrator, integrated circuit  
 D1, D2—1N914 or similar general-purpose, small-signal silicon diode  
 LED1—Jumbo green light-emitting diode  
 LED2—infrared light-emitting diode  
 LED3—Jumbo red light-emitting diode  
 Q1—TIP120 Darlington NPN silicon transistor  
 Q2—TIL414 infrared NPN phototransistor  
 Q3—MPS2907 or similar PNP general-purpose silicon transistor

### RESISTORS

- (All fixed resistors are 1/4-watt, 5% units unless otherwise indicated.)  
 R1—1200-ohm  
 R2—220-ohm  
 R3, R11, R13—470-ohm  
 R4—1-megohm, PC-mount potentiometer  
 R5—47,000-ohm  
 R6, R7—470,000-ohm  
 R8, R9—10,000-ohm  
 R10—1-megohm, linear rotary potentiometer  
 R12—1-megohm

### CAPACITORS

- C1, C6, C7—0.1-μF, ceramic disc  
 C2—470-μF, 25-WVDC, electrolytic  
 C3—1.0-μF, 25-WVDC, Tantalum  
 C4—220-μF, 25-WVDC, electrolytic  
 C5, C8—1.0-μF, polyester film

### ADDITIONAL PARTS AND MATERIALS

- S1—Normally open, momentary-contact, pushbutton switch  
 SOL1—Rotary solenoid (All Electronics, P.O. Box 567, Van Nuys, CA 91408, Tel. 1-800-826-5432; part SOLR-675 or similar)  
 J1—Power-supply jack  
 Perfboard materials, enclosure, 12-volt DC 800-milliamp unregulated plug-in power supply, fish-food bin, mounting brackets, self-stick hook-and-loop fasteners, LED holders (4), mounting hardware, 3/8-inch rubber grommet, heat-shrinkable tubing, hook-up wire, solder, hardware, etc.

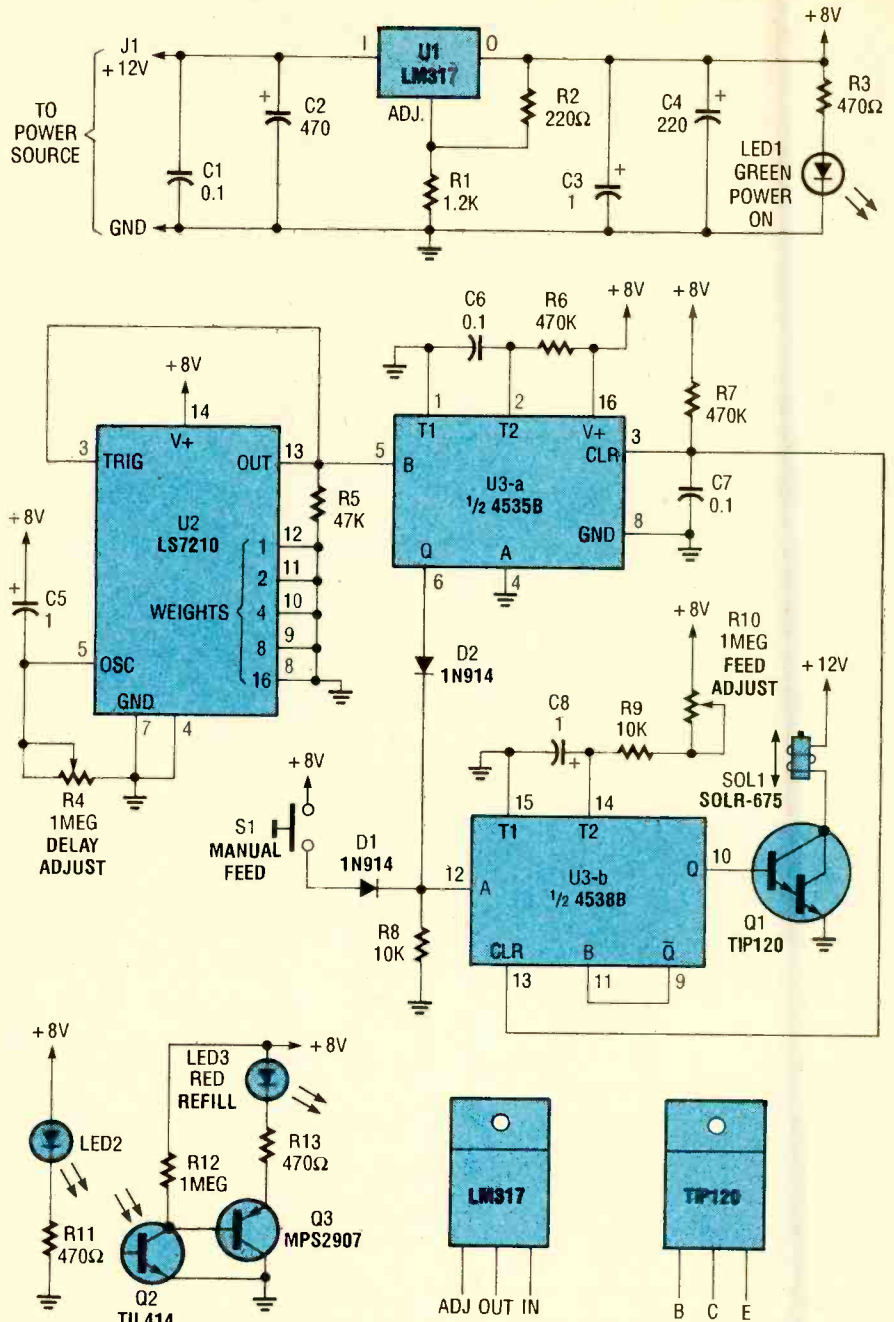

Fig. 1. The heart of the Auto-Feeder is U2, an LS7210 programmable delay timer, which institutes a 12-hour delay, between feedings. At the end of the delay, U2 triggers a dual monostable (U3), that activates a solenoid (SOL1), which moves a flipper, allowing fish food to fall into the tank.

period to begin. The result is that pin 13 oscillates high and low, with its period of oscillation equal to twice the IC's programmed time delay.

The delay between triggering and output switching of U2 can be calculated using:

$$\text{Delay} = (1 + 1023N)/f$$

where N is the sum of U2's selected weighting inputs and f is the frequency of U2's on-chip oscillator. The weighting inputs at pins 8–12 have binary "weights" of 1, 2, 4, 8, and 16. In the Auto-

Feeder, U2 is programmed for its maximum delay by grounding all five inputs to give a total weighting of 31. Capacitor C5 and potentiometer R4 set the on-chip oscillator to a frequency of about 1.47 Hz.

Using the above formula with our circuit, N equals 31 and f equals 1.47, which gives a delay of 21,574 seconds, or about 6 hours. That means that pin 13 changes from high-to-low once every 12 hours, which coincides with the desired frequency of fish feeding. Resistor R5 is a pull-down resistor and is necessary

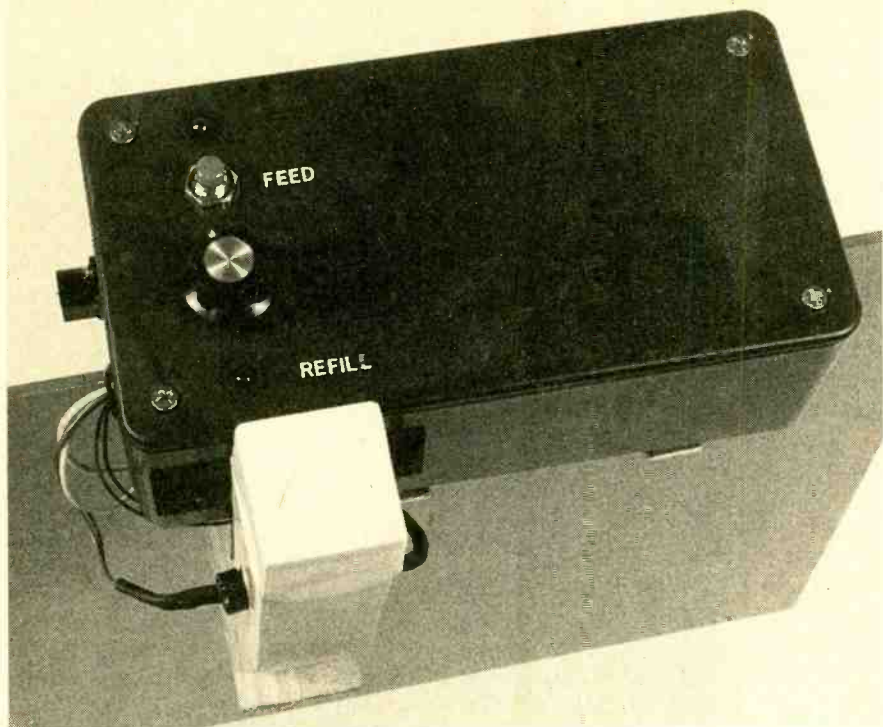

Four holes were drilled in the lid of the enclosure to accommodate S1 (MANUAL FEED), LED1 (POWER ON), LED3 (REFILL), and R10 (FEED ADJUST).

for obtaining the proper digital switching voltages at pin 13.

Using the LS7210 does have one tradeoff: the time-delay isn't as precise as, for example, a crystal-controlled time delay circuit would be. But you can easily achieve delays of 12 hours plus-or-minus 15 minutes—certainly accurate enough to satisfy most fish!

Now what's needed is a way to use our once-per-12-hour signal to feed the fish. That task is entrusted to U3, a 4538B dual monostable multivibrator (also known as a one-shot) and the components associated with it. Half of U3 generates a short positive-going pulse after each low-going transition at pin 13 of U2. Capacitor C6 and resistor R6 set the pulse length to about 50 milliseconds. For each high-to-low transition applied to pin 5 of U3-a, a positive pulse is produced at U3-a's pin-6 output.

The other half of the dual monostable, U3-b, generates pulses that control solenoid SOL1. That monostable, U3-b, can be triggered in two ways: by the rising edge of the output (pin 6) of U3-a, or by pressing momentary switch S1.

When either of those two triggering conditions occurs, pin 12 of U3-b is pulled high via D1 and D2, respectively, producing a short positive pulse at pin 10 of U3-b. Resistor R9, potentiometer R10, and capacitor C8 set the length of U3-b's output pulse, which can be as long as 1 second.

Pins 9 and 11 of U3-b are tied together to make the monostable non-retriggerable, so that switch bounce at S1 will not effect the pulse at pin 10. On power-up, the charging of C7 through

R7 resets both halves of U3 to prevent the monostables from triggering as power is applied.

**The Solenoid.** The output of U3-b is tied to the base of Q1 (a TIP120 Darlington transistor). When pin 10 of U3-b pulses high, Q1 turns on and energizes the solenoid (SOL1). A solenoid consists of a coil of wire wound around a movable magnetic core. When current flows through the coil, the resulting magnetic field causes the core to move.

In the rotary solenoid used in this project, the moving core controls the rotation of a circular plate. The center of the circular plate is attached to one end of the movable core. When no current flows through the solenoid, a coiled spring holds the plate in a set position against the solenoid's housing. When current flows through the coil, the solenoid is energized and the core pushes out slightly, causing the circular plate to rotate about 20 degrees. When the solenoid is de-energized, the spring pulls the circular plate back to its original position.

In the Auto-Feeder, a lightweight wooden flipper is attached to the rotating circular plate; the flipper is positioned under a food bin that has a hole

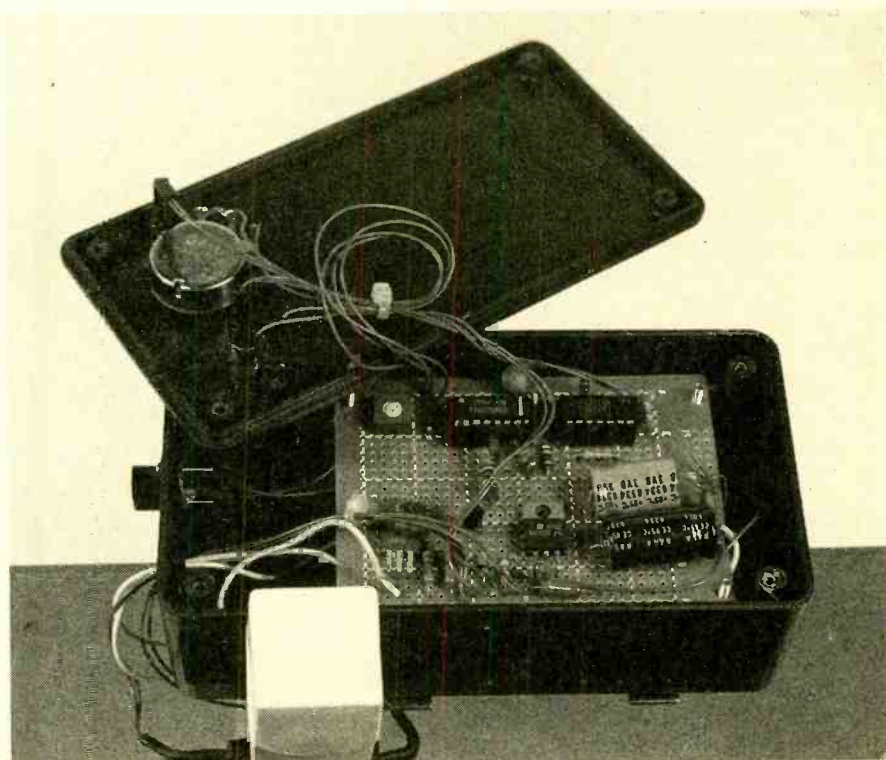

The Auto-Feeder's circuitry may be wire-wrapped on perforated board, as in the prototype. Off-board components S1, LED1, LED3, and R10 are mounted to the lid of the enclosure. Wires, attached to the leads of the off-board components, are then connected to the appropriate points on the circuit board.

in its bottom. When the solenoid is energized, the flipper moves away from the hole, and fish food falls through the hole into the fish tank.

Solenoid SOL1 draws about 400 milliamperes when it is energized. It operates from the unregulated 12-volt supply, to eliminate any effects its current drain might have on the regulated 8-volt supply.

**The Refill Detector.** A final feature of the Auto-Feeder is its REFILL detector. Components LED2 and Q2 are, respectively, an infrared-light transmitter and detector. The two components are mounted on opposite sides of the fish-food bin, about  $\frac{2}{3}$  of the way down.

When the bin is full, the food blocks the light transmitted by LED2, and Q2, Q3, and LED3 are off. When the food supply falls sufficiently below the "eye" level of the LED1 and Q2 combination, light striking Q2's IR-sensitive area causes it to conduct. That, in turn, causes Q3 to turn on, pulling the cathode of LED3 to ground potential. With its cathode at ground, LED3 lights, indicating that it's time to add food to the bin. Resistors R11 and R13 limit the current through LED2 and LED3, respectively; R12 is used as a load resistor for Q2.

**Building the Project.** The enclosure for the Auto-Feeder may be any appropriately sized project case. You'll also need some type of bin for the fish food. Look for something that is lightweight, large enough to hold a few ounces of fish food, and able to be worked easily. In the prototype, the author used a rectangular dental-floss container—having flat sides that make it easy to mount on the enclosure—as the food bin.

You'll also need a way to mount the feeder to the edge your fish tank. The author used four screw-on corner braces to make mounting brackets that grip the side of the tank, but any system that is secure and safe is acceptable.

The electronic portion of the Auto-Feeder may be wire-wrapped or point-to-point soldered on perforated board. IC sockets are recommended for U2 and U3. Whichever method you choose, assemble the circuit using Fig. 1 as a guide. If you go with perfboard construction, start by mounting the IC sockets first and then building the circuit around the sockets as if they were the IC's; but **do not** insert U2 or U3 into their sockets yet. And when wiring the capacitors into the circuit, be sure to observe proper polarity for C2, C3, C4

(and C5 and C8 if polarized types are used), and for D1 and D2.

For the off-board connections (to S1, R10, Q2, LED1–LED3, and J1), cut fourteen 8-inch lengths of hook-up wire and strip about  $\frac{1}{4}$  inch of insulation from the ends of each, and solder them to the off-board components (except for the LED's, Q2, and SOL1). Then solder the other ends of the hook-up wires to the appropriate points on the circuit board. Before soldering the LED leads to the board, however, slide a  $\frac{1}{2}$ -inch piece of heat-shrinkable tubing on each of their leads.

After soldering, slide the heat-shrinkable tubing over the soldered connections and shrink them into place to keep the connections from shorting to other circuit elements.

The solenoid's leads must be routed through a hole in the enclosure before being soldered to the circuit board. So the next thing that must be done is to prepare the circuit's enclosure, bin, and flipper.

Any rigid piece of lightweight wood or plastic may be used for the flipper. A piece measuring about  $1 \times 3 \times \frac{1}{16}$  inches is about right. The flipper will screw into the three holes on the circular plate on the solenoid, but don't do this step until you've determined the placement of the flipper (which we'll cover shortly).

On the lid of the enclosure, drill four holes for LED1, LED3, S1, and R10. Mounting holes for J1 and a  $\frac{3}{8}$ -inch hole for routing the wires to Q2, LED2, and SOL1



*The Auto Feeder uses a rotary type solenoid (SOL1), which draws about 400 milliamperes when energized and is operated from the unregulated 12-volt supply, to eliminate any effects its current drain might have on the regulated 8-volt power supply. When this rotary solenoid is energized, the circular plate on top rotates about 20 degrees. On de-energizing, the circular plate returns to its original position.*

may be made on a side panel of the enclosure. The floor of the enclosure requires holes for mounting the circuit board, the mounting brackets, and SOL1.

Solenoid SOL1 mounts beneath the enclosure, with its two mounting screws protruding through holes in the floor of the enclosure. Drill SOL1's mounting holes about  $\frac{3}{4}$ -inch from the outside edge of the enclosure, so that the flipper will have a swing of  $\frac{1}{2}$  inch or so at the edge of the enclosure. The fish-food bin will mount on the side of the enclosure, directly over the flipper.

When you mount the solenoid, slide eighth-inch spacers on its mounting screws between the solenoid and the enclosure, to ensure that the solenoid can rotate freely without bumping against the enclosure. Once you've made the mounting holes for the solenoid, you can attach the flipper. Temporarily mount the solenoid on the enclosure, then position the flipper on the solenoid's circular plate so that the flipper extends at right angles from the enclosure. Mark the desired placement of the flipper's mounting holes, drill the holes, and mount the flipper with three short screws.

With the flipper mounted, be sure that the solenoid's circular plate can still move freely. If necessary, switch to shorter screws or add washers or spacers between the flipper and the screw heads to raise the screws out of the way.

Hook-and-loop fasteners are convenient for mounting the food bin on the enclosure. They allow you to adjust or remove the bin whenever you want, simply by pulling it off and pressing it back in place. Fasteners with self-stick backing are easiest to work with. Cut one piece for the back of the bin and a complementary piece for the side of the enclosure where the bin will be mounted, and press each into place.

The food bin requires three holes. Make two  $\frac{1}{4}$ -inch holes in the food bin for LED holders for LED2 and Q2. The holders should be positioned on opposite sides of the bin, about  $\frac{2}{3}$  of the way down, so that the light from LED2 hits the face of phototransistor Q2.

In the bottom of the food bin, make a hole about  $\frac{3}{8}$  inch in diameter for the fish food to fall through. The size of the hole is not super-critical, since placement of the bin and adjustment of R10 can control the amount of food that will be fed.

*(Continued on page 94)*



# Electronics Wiring For The Home

BY  
SAM ALLEN

*Update your wiring for safety, and to make it easier to add new technologies to your household.*

**A**s an electronics hobbyist, you probably have installed wiring in your home for extension speakers, intercoms, antennas, or other electronic devices. Usually the wiring gets stapled to the baseboard or run under a carpet (a real "no-no" without the right cable) using any type of cable you have on hand. Next time you add some wiring to your home, you should consider doing a professional-quality job by following Code requirements and installing the wire in a way that will protect it and make it easy to make changes or additions. The investment in time could save you many, many hours in the future.

**Code Requirements.** All home-wiring standards are governed by the National Electrical Code (or by a local code that is usually based on the national code). If you follow the Code requirements, you will have a safe and effective wiring system.

The Code has been very lenient

about low-voltage wiring in the past, simply stating that the wire should be "suitable" for the application. The 1987 National Electrical Code imposed restrictions on the types of cable that can be used and the 1990 Code expands upon the cable requirements.

The requirements are to ensure fire safety; the insulation of some cables is very flammable. Listed cables are rated for flame resistance and smoke production. For your own safety, you should use listed cables, although the Code allows for unlisted cables that are in an exposed location and are less than 10-feet long.

The Code is organized into a number of articles on various subjects. There are separate articles for audio, communication, remote-control, radio, television, CATV, and fiber-optic cables. In this discussion, I will give the National Electrical Code article numbers that apply to various types of electronics wiring so you can look up the complete requirements if you have a question. Most li-

braries will have a copy of the National Electrical Code and local codes in the reference section.

**Limited-Power Circuits.** A lot of electronics wiring fits into what the Code calls class-2 wiring, covered in Article 725. Class-2 wiring carries low voltage at limited amperage. Usually power is supplied from a transformer with a limited output. Dry-cell batteries can also be considered a limited-current source.

Generally, if the output of the device is less than 30 volts and the current is limited to less than 8 amps, you can use class-2 wiring. In certain applications, you can use class-2 wiring with voltages up to 150 volts when the current is limited to .005 amp or with power supplies that contain over-current protection circuitry. Consult the Code for further details on such circuits.

The Code requirements are lenient for class-2 wiring because the low voltage and limited amperage don't pres-

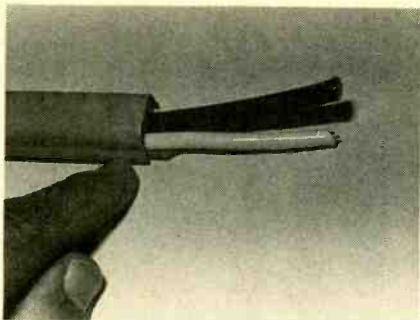

*A surface raceway hides and protects electronics wiring. They provide a good way to add wiring to an existing building.*

ent a fire or shock hazard. But there are a few requirements that you should always observe whenever you install class-2 wiring. First, class-2 wires should never be installed in an outlet or switch box that contains AC line-voltage wiring unless the box is designed with a barrier that separates the two systems. Second, never run class-2 wiring in the same conduit or raceway with AC line-voltage wiring, in fact keep class-2 wires at least 2 inches away from any other type of wiring in the home.

The Code makes a few exceptions to these rules; but in most cases, you're better off to just follow the rules, although sometimes you must take advantage of the exceptions. If you must attach a class-2 wire to a device that is powered by house current (a low-voltage control circuit to a relay for example), the Code will allow you to bring the class-2 wires into the same box solely for the purpose of making the connection. The wires must be separated by at least 1/4 inch.

There is also an exception to the 2-inch separation rule: if either cable is enclosed in a raceway. If either cable is metal sheathed, metal clad, non-metallic sheathed, or type-UF cable; if they are permanently separated by a porcelain tube, or in flexible tubing, then you can place them closer together. Today most homes are wired using nonmetallic-sheathed cable (Type NM, often referred to by the trade name *ROMEX*), and you can place class-2 cables closer than 2 inches to type NM cable. That would allow you to use the same hole in a stud for both NM cable and class-2 cable, but I prefer to drill separate holes anyway.

Cable used for class-2 wiring now must meet flame-resistance requirements. Cables that meet the requirement will be marked CL2 or CL2X. The latter is limited to use in one- or two-family dwellings.

Audio wiring is covered in Article 640. Most audio wiring is considered class-2, so you should follow the requirements given for class-2 cables.

The Code classifies telephone wiring, antenna lead-ins, and cable TV differently. Let's look at those next.

**Telephone Wiring.** Telephone wiring must now meet flame-resistance standards. Wiring that meets the standards will be marked CM or CMX. Type CM cables can only be used in one- or two-family dwellings. Telephone cables must be separated from full voltage wiring as explained for class-2 wiring. In the past, splices and connections have been allowed anywhere, but the Code now recommends that they be made in a plastic or metal box. This is only a recommendation made in the Code, but it's a good idea to follow the advice anyway.

Telephone cables can be placed in the same conduit or box with class-2 cables, fiber-optic cables, and CATV cables, but not with AC line-voltage cables. The Code does make an exception for hybrid power/communications cabling that contain both house current and telephone cables in a single jacket. Those cables must be specifically listed for this application. Article 800 of the Code gives more details.

#### **Receiving Antennas and Lead-Ins.**

Article 810 covers radio and television circuits. Cable TV is covered in article 820. On the outside of the building, lead-in wires must be positioned so that they cannot swing closer than 2 feet to wires carrying 250 volts or less and no

closer than 10 feet to wires carrying more than 250 volts.

An important thing to know is that antenna masts should be grounded using wire that is not smaller than No. 10 copper, No. 8 aluminum, or No. 17 copper-clad steel or bronze.

A properly connected grounding terminal should be placed at the the point where the lead in enters the building. The grounding wire to it should run in a straight, direct path to the ground connection—usually a cold-water pipe.

Inside the building, the distribution wiring should not be placed closer than 2 inches to other wires. Further, antenna leads should not be placed in the same box with other wiring unless a barrier is installed in the box.

Coaxial cable used in cable-TV systems must be marked CATV on the outer jacket. Coax used for other purposes is usually listed CL2. Cable marked CATVX is allowed in one- or two-family dwellings. The outer shield must be grounded at the point the cable enters the building. Coaxial cable should not be placed closer than 2 inches to AC lines, but it can be run together with class-2 or telephone wiring.

**Fiber-Optic Cables.** Fiber-optic cables are becoming more prevalent all the time. Article 770 of the Code lists requirements for optical cables. The cables must be listed for flame resistance and marked OFC or OFN. There are three types of fiber-optic cables: Non-conductive cables (OFN) have no conductive material in them; conductive cables (OFC) have noncurrent-carrying conductive material added

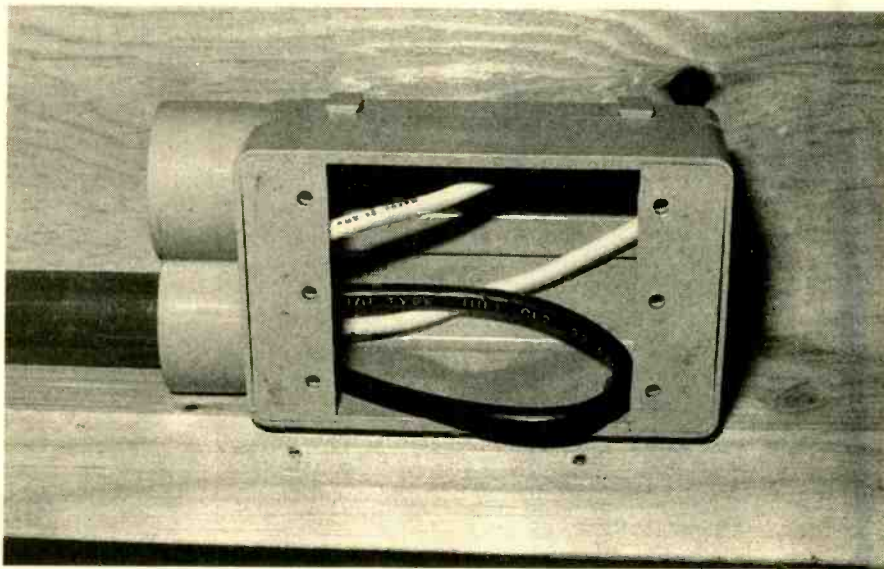

*PVC conduit and boxes can be used for household wiring. Using conduit adds to the construction cost, but it makes it easy to make changes or additions later.*



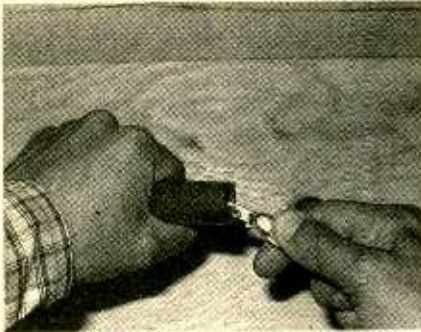

Remove the rough edges left on the conduit before you apply the glue. A small knife can be used for this job.

for strength or as a vapor barrier; and hybrid cables combine current-carrying conductors and optical fibers in the same cable. Hybrid cables are classified as electrical cables and must meet the requirements set for the conductors they contain; the other two types are not considered electrical cables, but they still must follow certain provisions of the Code.

Non-conductive cables may be placed in the same raceway or cable tray with power cable of 600 volts or less, but conductive cables are not allowed in the same cable tray or raceway with power cables. Fiber-optic cables are not allowed in the same box as power circuits unless the function is directly associated with the circuit. But fiber-optic cables can be run together with class-2 cable, telephone cables, and CATV cable. The conductive materials in type OFC cable should be grounded.

**Hierarchy of Cables.** In addition to the types of cables already covered, there are multipurpose (MP), riser, and plenum cables. A riser is a vertical shaft inside a building that is used for distributing wiring and other utilities to various floors in a building. Riser cable must be more flame resistant than other types. Cable suitable for use in risers will have an R at the end of the cable marking. For example, communications cable for use in a riser will be marked CMR.

Plenum cable is used when the cable is run inside heating or air-conditioning duct work. Those cables must meet stricter standards for flame resistance and smoke production. Plenum cables will have P at the end of the cable marking. CMP for example would indicate communications cable that can be run in air-handling ducts.

You can always substitute a cable with better ratings for a lower grade cable, but not the other way around.

That can reduce your inventory of cables. At the top of the hierarchy is multipurpose plenum cable (MPP). It can be substituted for any type of communication or class-2 cable. At the bottom of the hierarchy is type CL2X. That cable cannot be used for any purpose besides class-2 wiring in one- or two-family dwellings.

Table 1 shows the hierarchy of multipurpose, communications and class-2 cables. Cable substitution can be determined by using the chart: A cable can be used in place of any other cable that is to the right of it on the same row, below it in the same column, or to the right and below it. Starting at the top left of the chart, the first cable listed (MPP) can be used in place of any cable on the chart. Type CM can be used in place of CL2 because CL2 is in the same row to the right. It can also be

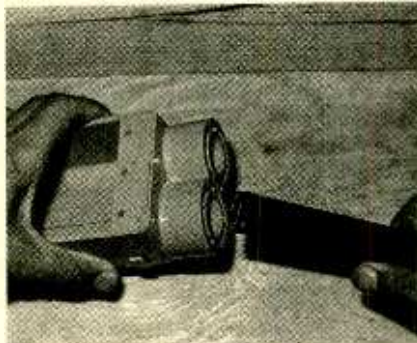

The conduit slips into a hole in the box. Follow the directions on the glue can when you apply the glue.

used in place of CMX, because it is in the same column but below it; and it can replace CL2X because it is below and to the right.

CATV and fiber-optic cables also come in plenum and riser types. The hierarchy of these types is listed in Tables 2 and 3, respectively. Read from the top down, a cable may be used as a substitute for any listed below, but not for those listed above it on the chart. Also, non-conductive cable can be substituted for conductive cable.

**Installation Tips.** If you have ever fished wires through a wall you have probably wished that homes were designed to make the job easier. Even if you wire a home wisely during construction, it is hard to plan for new technologies.

The normal practice when wiring a home for electronics is to staple wires to studs before the interior walls are covered; this method is fast and inexpensive but makes it hard to add wiring later. I have found that it is worth the

TABLE 1—CABLE HIERARCHY

MPP	CMP	CL2P
MPR	CMR	CL2R
MP	CM	CL2
	CMX	CL2X

extra time and expense to use conduit for electronics wiring, because you can easily slide in new wires at any time (we'll get into how to do that later).

If that is out of the question next time you make additions to the wiring in an existing structure, you can still fish wires through the walls or staple them to base boards, but be sure to use the proper cable. If you need to run cable under a carpet, only use type CMUC.

For a nice installation that allows for later expansion or cable replacement, use a plastic or metal raceway attached to the baseboard. A raceway protects and hides the cable. You can make later changes by pushing in new cable when necessary. Most electrical supply houses will carry this type of raceway and associated fittings.

If you are fortunate enough to be in the early stages of planning a new home, start thinking about wiring for any electronic systems you can anticipate. Make a list of all of them. The list

TABLE 2—HIERARCHY OF CATV CABLES

CATVP
CATVR
CATV
CATVX

TABLE 3—HIERARCHY OF FIBER-OPTIC CABLES

Non-Conductive	Conductive
OFNP	OFCP
OFNR	OFCR
OFN	OFC

might include: a TV-signal distribution system, telephone lines, intercoms, stereo extension speakers, computer cables, alarms, or remote-control circuits. Although your list will include all that you might want to install, keep in mind that new technologies will be developed after you finish the house.

It's a good idea to discuss your plans with your architect or contractor at this stage. He may have suggestions that will make the installation easier. Before the final plans are drawn, get a rough version of the floor plan of the house and mark the location of all of the

things you know you want; that way you can place a wiring box at the exact location. Now start thinking about system expansion. As a minimum, I would recommend a wiring box on each wall of each room likely to need electronics in the future. Rooms that you don't think will need wiring should have at least one box to allow for unexpected developments. I would also recommend several weatherproof boxes on the outside of the house.

In many cases you need a power outlet near the location of the main electrical box; for example, a central TV amplifier needs a power outlet and an antenna connection. Mark the location of these power outlets on the floor plan so your architect can draw them in on the electrical plan.

When you are wiring a new building, you'll have access to the interior of the walls and floors so you can hide the wiring inside the walls. You can run the cables through holes drilled in the studs and joists or staple them along the side of studs; keep the cables at least 2 inches from the finished surface of the wall so that misguided nails driven through the studs won't damage the cable. Use plastic or metal boxes at cable terminations.

For the ultimate in wiring, use conduit. PVC conduit is easy to work with so the job can be a do-it-yourself project. The main idea is to get the wires through the walls and into an area that is easily accessible. If you have an unfinished basement or attic, you can run conduit from a box in the wall to the unfinished area, and back up to where you need it. If the basement will be finished, run the conduit to a central location where you can mount a distribution panel.

When it comes time to choose a contractor, talk with him about your plans; if you want to do the work yourself, be sure to work out the details with him. You will need to be prepared to do the work quickly when needed so you won't hold up other subcontractors. Most of your work must be done after the rough electrical work, but before the interior walls are covered. If you plan ahead and have the materials on hand, you can do the work in one or two days. If it is possible to buy the cable, conduit, and boxes through the electrical subcontractor, you will probably be able to get a better price than you can at a retail outlet. You will need to provide him with a complete list of the supplies needed. If you prefer, you can have the work done by the electrical contractor.

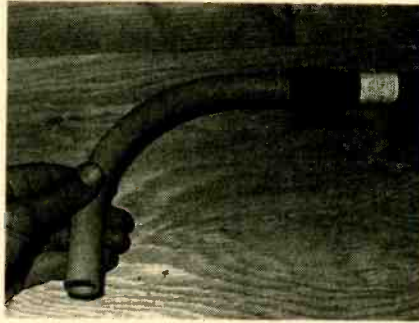

*A factory-made 90° bend eliminates the need for a conduit bender. Just cut the conduit to length and glue the parts together.*

**Distribution Panel.** The distribution panel needs to be centrally located. A closet or utility room is an ideal location. If there isn't a closet, build a box with a door to enclose the panel. Have the electrician install a power outlet nearby.

After the drywall or plaster is finished, attach a piece of plywood to the wall. This will give you a firm mounting for any equipment installed on the panel.

**PVC Conduit.** If you choose to run conduit from the distribution panel to the wall boxes, you can use EMT or PVC conduit. EMT is metal thin-wall conduit; it takes experience and special bending tools to do a good job with EMT. PVC conduit is probably easier for the do-it-yourself installer because you simply cut it to length with a hack saw and glue it into special fittings. Conduit is available in several sizes. Choose a size large enough to allow for additional wires later. You will need PVC wall boxes, fittings, and a can of PVC cement.

Begin at the box location. Drill a hole through the sole plate of the wall into the space between the joists below. Next cut a short length of conduit using a hacksaw. Use a knife to remove the rough edges left by the saw. The piece needs to be long enough to reach from the bottom of the box through the floor with an inch or two extra. Using the applicator attached to the lid of the cement can, wipe some cement inside the fitting on the box and around the outside of the conduit end. Push the conduit into the box with a slight twisting motion, then hold it in place for a few seconds as the cement grabs.

Now slip the free end of the conduit through the hole in the sole plate. Mount the box to a stud. Since you should be doing your work after the electrician has done the "rough in" (the basic wiring required in your house) you

can measure the height of the boxes that are installed in the house to make sure yours match. Also notice how far the electrician has extended the front of the box past the edge of the stud. That distance will vary depending on the type of wall covering that will be installed.

Most of the boxes will be close to floor level, but a box for a wall phone, an intercom, or light switch should be placed at a convenient height higher on the wall. Boxes for extension speakers may be placed close to the ceiling.

If the house has a second story, you can run a length of conduit out the top of the distribution box to a box directly above on the next floor. Keeping the conduit runs straight and short simplifies installation and makes it easier to push the wires in.

Install all of the boxes, then move to the basement. Boxes in basement walls should have the conduit run out of the top and into the space between the joists above. When all of the boxes are installed, you can make the conduit runs to the distribution panel. Keep the runs as straight as possible and run them alongside a joist. You won't need to do any drilling unless there is some solid bracing in the way. Glue a 90° fitting to the stub of conduit that extends through the floor from the box. Then glue in a section of conduit running toward the distribution panel.

If a run is too long, you will need to glue several lengths together using couplings. Cut the last piece to length before gluing it to the coupling. Use PVC straps to attach the conduit to the joists. When the conduit needs to run across at a 90° angle to the joists, you can attach the conduit to the bottom of the joists. That is easier than drilling through the joists. Group all of the conduits together and run them next to a wall or support beam; that will make it easier for the carpenters to box over and conceal the conduit run.

**Antenna Mast.** A provision for an outside antenna is a nice feature to add to the system. Use 1-1/4-inch EMT thin-wall metal conduit for that. It is one job that should be done early in the framing of the house, as soon as the decking for the roof is on but before the roofers come.

Choose a location for the antenna that is directly above a wall and close to the distribution panel. Drill a hole through the sole plate of the wall and

*(Continued on page 93)*

# GIZMO

FEBRUARY 1991

VOLUME 8,  
NUMBER 2

A CHRONICLE OF CONSUMER ELECTRONICS

## Easy as 9-6-4

**GEMSTAR VCR PLUS+ INSTANT PROGRAMMER.** Manufactured by: Gemstar Development Corporation, 119 South Atlantic Blvd., Suite 307, Monterey Park, CA 91754. Price: \$59.95.

We have a friend in another city who has never been able to get her VCR to properly record what she wanted when she wanted, despite asking for help from everyone she knew. By the time it was examined by someone (with a degree in Gizmology) both knowledgeable and confident enough to determine that the VCR was actually defective, the warranty had expired.

Perhaps her case is extreme, but had it been any consumer-electronics item other than a VCR she would not have been so quick to assume that the problem was on her part. (After all, everyone knows that VCR's are impossible to program, right?) Had the timer on her microwave not functioned properly, she would have had it repaired, and not assumed that she was doing something wrong. While we're sure that part of the problem with programming VCR's is a "self-fulfilling prophesy," the fact remains that many people can't do it. And when you add a cable-TV descrambler to the picture, most people just give up.

Over the years, there have been numerous attempts to remedy that situation, with varying degrees of success. Some manufacturers tried to make their units easier to use, and their manuals more legible. (Our current VCR's on-screen programming is a breeze.) Other approaches included a seemingly promising one from Panasonic, which offered VCR's with bar-code scanners that would "read" the bar codes printed in the TV listing guide and automatically program the VCR to record the scanned shows. Two major drawbacks led to its demise: the need to buy a specially equipped VCR, and the fact that bar codes did not reproduce well in newsprint.

Now Gemstar is offering a similar solution, without those two fatal flaws, in its VCR PLUS+ (the final + is silent). The device is an accessory to existing VCR's,

CIRCLE 50 ON FREE INFORMATION CARD



and said to be compatible with most "virtually any type of wireless [remote-controlled] VCR." And the code printed in the newspapers and television guides is an easy-to-read 3- to 6-digit number. Once the VCR PLUS+ is set to work with your equipment, programming the VCR requires only that you punch in the code number, and whether you want to record the show once, daily, or weekly. The system is based on a proprietary coding scheme developed by Gemstar's founders, Henry Yuen and Daniel Kwok. Several publications—including *The New York Times*, *TV GUIDE*, *The Los Angeles Times*, *The San Francisco Chronicle*, and *The Chicago Sun-Times*—have committed to print the code numbers next to each listing in their program guides. The system will be introduced in late 1990 in New York, California, Colorado, Michigan, Illinois, Texas, Florida, Washington DC, Baltimore, and Virginia.

The last thing Gemstar wanted to do was to scare off potential users with either a

complex-looking device or a highly technical manual. The VCR PLUS+ resembles (yet another) remote control, but once it is programmed, it rests in its cradle atop your VCR or cable box, and doesn't contribute to the electronics clutter scattered about. The device has an LCD readout and only 15 visible buttons, with another eight buttons tucked away under a flip-up panel above the display. A multidirectional infrared remote control operates the VCR and cable box while the VCR PLUS+ rests in its cradle, and a flashing red light lets you know when recording is about to begin.

With the non-threatening, pocket-sized manual, setup is unthreatening and quite easy. The manual—divided into four setup steps, a placement diagram, and how-to-use directions—clearly defines the proper procedure to use if you don't have cable (Steps 1 and 2), if you have cable but no converter box (Steps 1, 2, and 4), and if you do have a converter box (Steps 1, 2, 3,

*(Continued on page 7)*

TURN PAGE FOR CONTENTS

# This month in GIZMO

Gemstar VCR PLUS+ Instant Programmer.....	pg. 1
Memorex AV4 Audio Video Remote Control.....	pg. 2
Fisher Pref-5 Compact Audio System.....	pg. 3
VoicePrint Voice-Activated Telephone.....	pg. 4
Radio Shack Realistic DX-440 Communications Receiver.....	pg. 5
Synetic Systems Mindseye Synergizer Audio/Video Stimulation Tool.....	pg. 6
Jondy Water Watch.....	pg. 9
NEC Teleconferencing Unit.....	pg. 9
Rolydisc CD-Storage System.....	pg. 9
Clarion Hand-Held CD-Changer Controller.....	pg. 10
Colby Systems Pocket Info Pac.....	pg. 10
Nakamichi Single/Multi-Play CD Player.....	pg. 10
Stay Alert Auto Alarm.....	pg. 10
Blaupunkt TravelSafe Car Security Systems.....	pg. 11
Carver Pro-Phile Tuner/Preamplifier.....	pg. 11
Cinema Products Steadicam JR Case.....	pg. 11
Sharp Wizard Signature Series Organizer.....	pg. 11
Canon Personal Typewriter.....	pg. 12
Philips VHS-C Camcorder.....	pg. 12
Sansui AM/FM Receiver.....	pg. 12
Sima 8mm Videotape Rewinder.....	pg. 12

Gizmo is published by Gernsback Publications, Inc., 500-B Bi-County Blvd., Farmingdale, NY 11735. Senior Writers: Chris F. O'Brian, Teri Scaduto. Contributors to this issue: Toni Vames, Joe Fenton. Copyright 1990 by Gernsback Publications. Gizmo is a registered trademark. All rights reserved.

## Simplicity, Simplicity, Simplicity!

MEMOREX AV4 AUDIO VIDEO REMOTE CONTROL. Manufactured by: Memtek Products, P.O. Box 901021, Fort Worth, TX 76101. Price: \$49.95.

In his classic *Walden*, Henry David Thoreau laments, "But lo! men have become the tools of their tools." Anyone who has spent the better part of a weekend struggling to learn to use a new "time- and labor-saving" device can certainly relate to that. We here at GIZMO tend to get buried up to our ears in such gadgets, and sometimes we do feel that they've taken over our lives. While not many of us are likely to respond to Thoreau's call for "Simplicity, simplicity, simplicity!" by moving into the woods (where there's no electricity to power all our time- and labor-saving devices), we are more than ready for some simplicity in our lives.

So when we first heard of Memtek's AV4 preprogrammed audio/video remote control, its lack of complexity seemed refreshingly appealing. *Preprogrammed* is the key word. Unlike the "universal" remote control with which you might be familiar, the AV4 doesn't have to be "taught" the correct commands for each component. Instead, Memtek has programmed the unit to recognize the commands used by popular brands of televisions, VCR's, cable boxes, CD players, and laserdisc players. The idea is to replace four remote controls with the AV4, and be able to operate four different components simply by telling it which components you have. You do that by inputting the three-digit manufacturer's code for each.

The AV4, which is sold in a plastic "clamshell" package, looks much the same as many other remote controls—and much less elaborate than most universal remotes. Both its price and packaging are intended to appeal more to the mass market than to sophisticated consumer-electronics buffs—as is its easy-to-follow manual, which promises in its first sentence, "nothing technical" and keeps that promise almost all the way through its pages.

Following its simple set-up steps, we looked up manufacturers' codes in the back of the manual, and entered them using the command keys located at the top of the AV4's keypad. Our TV and VCR responded immediately—the process was delightfully easy (especially when compared to putting two remotes head-to-head and pushing 30 or so buttons). The cable box was only slightly more difficult to set up, because there were three possible

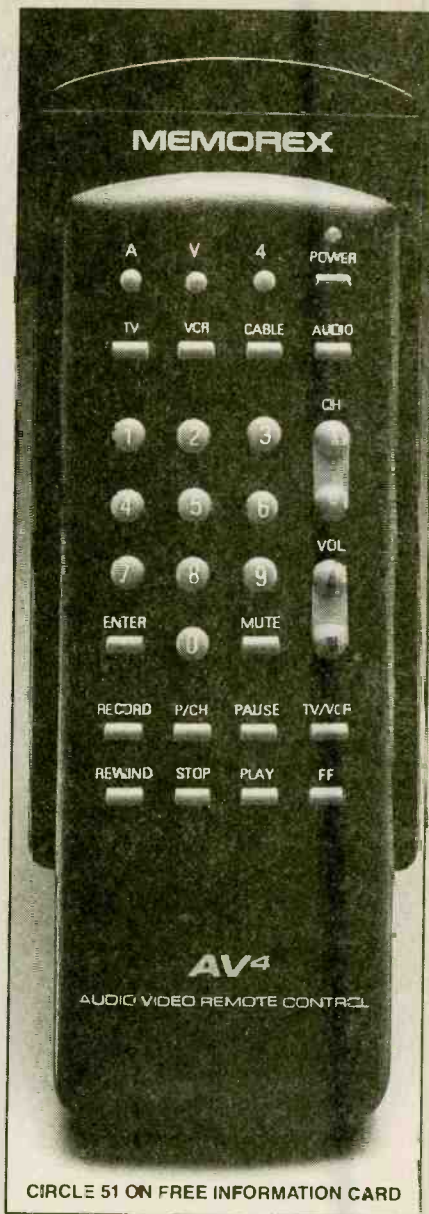

CIRCLE 51 ON FREE INFORMATION CARD

codes listed for Jerrold converters. Of these three, ours ignored the first and seemed to respond correctly to the second—until we realized that the power button had turned into a toggle between the current station and the last one tuned (rapid-tune). The third code did the trick.

When we got to the CD player, however, we found ourselves wondering who, or what, was the tool—us or the AV4. The manual had no listing for Shure CD players, and when we tried the alternate (time-consuming) method of manually searching through the AV4's entire library of CD-manufacturer codes, we drew a blank. A phone call to Memtek's toll-free "Help" number revealed that our Shure CD player (a brand that the Memtek technical-support operator had never heard of) was not compatible with the AV4. Nor did we have any luck trying to set the device to control the CD player of the Sanyo/Fisher (another unlisted manufacturer!) Pref-5 system re-

(Continued on page 8)

## Little Big Sound

FISHER PREF-5 COMPACT AUDIO SYSTEM. Manufactured by: Sanyo Fisher (USA) Corporation, 21350 Lassen Street, Chatsworth, CA 91211-2329. Price: \$799.95.

If you were reading *Playboy* 20 years ago (we know, you only bought it for the articles!), you probably remember that between the pictures of the Playmates could be found slick "life-style" features describing the accoutrements of bachelorhood that promised to enhance one's sex appeal. Most of those items had four wheels, hot red (or cool black, or shiny silver) paint jobs, and sticker prices that not many aspiring playboys could afford. At the somewhat-more-attainable end of the spectrum were hi-fi components, whose main qualification in the "impressing women" category, other than supplying mood music, was their tremendous size.

No one ever seemed to ask women what they thought of those supposedly seductive, oversized sound systems, but—despite the scantily-clad blondes draped over speakers in magazine pages—we suspect that one's male friends were much more impressed than were their dates. Had those young men ever thumbed through the *women's* magazines, they might have been surprised to learn that women, in general, tend to prefer substance to size.

In any case, time passes, and styles certainly do change. Perhaps the "Euro-style" trend has nudged out the old American "bigger is better" attitude. But, whatever the reason, today's stereo systems are likely to be streamlined bookshelf units.

One entry in the compact-stereo field is *Fisher's Pref-5*, which includes an AM/FM tuner/amplifier with timer functions, a dual-cassette deck, and a CD player, all in one neat unit. Rounding out the system are a pair of direction-adjustable satellite speakers, a universal remote control, and a component closely resembling a large speaker that appears at first glance to be a throwback to the "bigger is better" era: It's a subwoofer, because, after all, big sound has never gone out of style. The "superwoofer" doesn't ruin the Pref-5's slim line; it can be tucked out of sight.

That, in fact, is the whole trick of getting big sound out of small boxes. Normally, a subwoofer is added to a stereo system to add powerful, room-shaking bass that's ideal for getting the most out of surround sound or just for annoying your neighbors. In the Pref-5, however, the subwoofer is an essential component, without which the system has no bottom end at all.

Because the main speakers don't output any sound under 100 Hz, they can be very small. The subwoofer, which handles the frequencies from 40 Hz to 100 Hz, is



CIRCLE 52 ON FREE INFORMATION CARD

larger. But because we humans aren't too good at determining which direction low-frequency sounds are coming from, the subwoofer can be tucked away in a corner, under a bed, etc. The result isn't a system that sounds bottom heavy, but one that sounds balanced. But people who see the Pref-5 for the first time won't believe that all that full sound is coming from such small speakers.

One nice feature of today's smaller stereos is how easily they can be moved around to obtain the best acoustics and most convenient location. The Pref-5 is no exception. While not exactly lightweight (22.2 pounds), the 12.2 × 8.25 × 13-inch main section combines tuner, tape, CD, and timer functions with no need for connecting cables. The simplified hookup doesn't mean that the Pref-5 is limited. Jacks are provided for video equipment, a DAT player, a turntable, headphones, and an external FM antenna. An AM loop antenna and FM antenna wire are provided. Unfortunately, no additional speakers can be accommodated.

The front panel features a mechanized volume control; balance, tone, and dynamic-bass control knobs; and push-button controls for loudness, speaker/headphone selection, mute, and source selection. In addition, there are buttons to control each component, and two displays. The larger indicates tuner and timer functions and has level meters for each channel and the dynamic base. The second display is for the CD player, and provides information needed for CD-to-cassette recording.

Many of the same, and some additional controls are featured on the 64-function

"universal" remote. For example, a remote "scan" button will play each of the preset stations for 5 seconds. The front panel offers instead "automatic tuning," which scans through the entire band pausing at any strong enough station. We seriously wish that manufacturers would supply remote controls that more closely duplicated front-panel controls, and components that didn't require the remote to perform certain functions. On the Pref-5, station presets can be set in memory only from the front panel, and can be recalled only from the remote. (We have similar complaints about virtually every piece of remote-controlled equipment that we handle.) Some of the remote's keys control more than one component depending upon which source mode you choose; for instance, the numbered keys are used to select tracks when in CD mode, and to recall preset stations when in tuner mode. Setting the stations in memory was a relatively simple procedure, and a memory backup let us unplug the Pref-5 and move it around, without having to reset the stations each time.

Setting the time was also simple, although that did have to be reset whenever the power was interrupted. The Pref-5 has a wealth of clock-related functions, including a wake-up timer (no alarm, but we can think of several musical selections that would certainly jar one from even the deepest sleep) and a sleep timer that gradually fades out for 30 seconds before it goes off, so that the sudden silence won't wake you. Both can be set for CD, tape, or radio. The timer can also be set for unattended recording of radio programs.

(Continued on page 8)

# Telephone Calling Machine

**VOICEPRINT VOICE-ACTIVATED TELEPHONE.** Manufactured by Innovative Communications, 300-1(C) Route 17, Lodi, NJ 07644. Price: \$249.99

Since the earliest days of science fiction, writers have described various machines that communicate verbally—and that idea is present in today's science fiction as well. When you think of the starship *Enterprise's* computer system, what comes to mind is not its speed or power, but its ability to use the form of communication most familiar, and easiest, for us—speech.

About a dozen or so years ago, electronics manufacturing took a step toward realizing those science-fiction expectations. Once voice synthesizers could be integrated on a single chip, they began appearing in everything from our toys to our cars. The novelty wore off pretty quickly (about the time you discovered that if you ignored the repeated droning of "You are running out of fuel" long enough, it would be followed by a smug "You are out of fuel" as your car sputtered to a stop). We realized that we didn't need a digitized voice telling us that our doors were ajar or our seatbelts unfastened. Detroit got the message, and returned to the equally effective, and less annoying, buzzers and idiot lights.

Voice recognition, of course, is a much more difficult problem for engineers to solve. Teaching a machine to understand an infinite number of sounds is a formidable task compared to teaching a machine to speak some digitally canned phrases or to string together the phonemes of which our language is composed. Yet voice recognition is a reality, as evidenced by the *VoicePrint* telephone from *Innovative Communications*.

The *VoicePrint* promises to make our lives easier by allowing us to use our voices to dial the telephone. Simply pick up the handset, say the name of the person you want to call, and the phone does the rest. So now that your memory phone has let you forget your friends' phone numbers, we suppose that it's only one step further until you forget their memory locations. Presumably, it'll be more difficult to forget their names.

The *VoicePrint* isn't for everybody. Actually, it might be suitable for everybody, but not at the same time. That's because it uses *speaker-dependent* technology as opposed to *speaker-independent* voice recognition. Before the phone will respond to your voice commands, you have to teach it what to recognize. And since no two people speak the same way, each person who wants to use the phone must teach it his or



CIRCLE 53 ON FREE INFORMATION CARD

her voice—even if the two people want to call the same number. But, since each of the 50 voice/number memories are independent, more than one person can use the phone; five people can program 10 numbers each, for example.

Programming the phone is quite simple: You pick up the handset, press the "Voice" key and are prompted by a message on the phone's LCD to say the full name. It then asks you to say the name at least once more so that it has a good sample from which to work. Once it's satisfied (meaning that it has two samples that match very closely), you're asked to type in the name using the telephone keys.

Since the *VoicePrint* is storing sound samples, and doesn't understand any of the intelligence behind the sounds, you can program it in any language. You can also program it with whistles and a variety of other sounds. Since we try to have fun with the items we review, we also discovered that if you can closely imitate the voice of the person who programmed the phone, the phone will dial correctly.

A user who hasn't taught the phone any numbers can still take advantage of the numbers stored in memory—without practicing impersonations—by scrolling through the voice directory and pressing the redial key when the right name and number appear on the display.

The 2-line  $\times$  16-character LCD helps to make the *VoicePrint* look like a modern office telephone. The time, date, and status of the phone are normally on the display, which changes as you move from one mode to the next. Below the LCD are three programming "soft" keys that take on the functions shown on the LCD.

Although most people buy the *VoicePrint* for its voice-calling ability, voice recognition is only one of the high-tech features that the telephone provides. Call

answering, call screening, pager forwarding, and call logging round-out the capabilities and are, perhaps, the more important features.

If you set the *VoicePrint* to the answering mode before you leave the house, the phone answers incoming calls with the message: "Hello. You've reached a Touch-Tone answering device. Please dial in your phone number so your call can be returned." When you get home, you can simply scan the new numbers entered, and hit the redial key to automatically call someone back. A nice feature is that if the entered number matches one in your other directories, the corresponding name will also be shown on the display.

For times when you are home, but don't want to be disturbed by "junk" calls, the *VoicePrint* provides a screening mode. It answers with the same message, but does not ring for just *any* call. Callers who don't know your special code will simply enter their numbers. Those in the know, however, will enter your 4-digit code (which you can select and change as you see fit), and the phone will ring to alert you to the call.

Users who have pagers will like the pager-forwarding feature in which the *VoicePrint* takes the caller's number, calls the paging company, and sends the number. It will continue to send the number every 10 minutes for a user-specified number of times unless someone uses the phone, or you call the phone from a remote location and enter the correct security code.

Call logging is automatic. Each time you make a call that lasts more than 30 seconds, the *VoicePrint* stores the date and time of the call, the number dialed, and the length of the call. It has a capacity of one hundred numbers. When it's full, the oldest number will "roll off."

(Continued on page 7)

# A Window on the World

**REALISTIC DX-440 COMMUNICATIONS RECEIVER.** Manufactured by: Radio Shack, Fort Worth, TX 76102. Price: \$199.95

We don't like watching the news. It's not that we don't like to be informed ... quite the opposite. It's just that at the end of the program, we usually have more questions than we do answers. We supplement our TV news with a healthy helping of newspapers and magazines yet still end up with more questions. Then, we turn on our shortwave radio.

We'll be honest. We got interested in shortwave radio long before we were interested in world politics. The excitement of receiving broadcasts from halfway around the world was second only to receiving a QSL card that verified our reception. Our only interest in the program content was because we needed to provide some details if we wanted to receive that QSL card.

Now, however, we enjoy shortwave listening just because it's so interesting. The dramatic changes in the Soviet Union and in Eastern Europe are reflected in the programming of Radio Berlin and Radio Prague. While thousands of stories in the U.S. media have told us about the changing order of the world, we didn't actually *feel* the changes until we heard rock-n-roll music on Radio Moscow, or heard a western pop star talk about a campaign to get Muscovites to use condoms.

We've always wondered why shortwave listening is not more popular than it is, even though we realize that most of the programming isn't done for entertainment. Perhaps people just don't feel com-

fortable with shortwave because they think it's something that strange, "nerdy" people do in their basements. Or they might mistakenly believe that you need a license to listen and that the necessary equipment is big, expensive, and difficult to operate.

Well strange people don't make up any more of the population of shortwave listeners than they do the general population, many countries beam English-language programs to North America, and no license is required to receive them. And while ease-of-use might have been an issue in the past, things have never been easier than they are with *Radio Shack's Realistic DX-440*. For example, once we bought some batteries (neither batteries or power supply are included with the radio) installed them, and raised the built-in telescopic antenna, we were ready to go.

When we powered up the radio, we started at the bottom of the FM band. We moved up the band using the tuning knob on the side of the unit. Because the receiver features digital frequency synthesis, the tuning knob operates in discrete steps. Each click of the knob increases the frequency of the receiver by a given amount (which depends on the band to which you're tuned). Because we are familiar with digital receivers, that came as no surprise to us. And we weren't surprised by the Up and Down pushbuttons that offered an alternate way to tune the receiver, or the keypad that allowed for direct entry of the frequency of interest. However, we *were* surprised when we realized that when we spun the knob faster, it allowed us to move up the band in larger steps than when we turned it slowly.

The DX-440 is not a large radio. It measures about 11½ × 6¼ × 2¾ inches and weighs less than four pounds without the batteries installed. Its frequency range is from 150 kHz (which is below the AM

broadcast band) to 30 MHz. The FM band from 87.5 to 108 MHz is also included, which makes the DX-440 an all-purpose radio that you might even want to keep on your night stand—especially since the built-in (24-hour) clock does offer alarm and sleep features.

There are various ways to tune through the wide frequency range. There's the tuning knob and Up/Down tuning buttons mentioned earlier, plus a keypad for direct entry of the frequency of interest. Below the keypad are five band switches that let you jump quickly to a given band—from FM to AM to LW (longwave) to MW (mediumwave or standard broadcast) and SW (shortwave). Each push of the SW button lets you jump to one of twelve sub bands of special interest to shortwave listeners.

Of course there's plenty happening outside of the shortwave bands. A BFO, or beat-frequency oscillator, allows you to hear the Morse code and single-sideband communications that are used by amateur-radio operators on the ham bands. A Scan button lets you quickly find the next station and skip over inter-station noise. Although there's no squelch control to vary the sensitivity of the scan, and although you can scan in one direction only, the feature is nonetheless very useful. It definitely isn't for someone interested in DX-ing, the hobby of hunting down distant, hard-to-get stations. But newcomers to shortwave listening or someone who wants to listen casually, will find that it makes finding stations much easier.

Other features that we liked on the receiver are a 9-station memory, a wide/narrow bandwidth switch that lets you trade off fidelity for reduced adjacent-station interference, a keyboard lock that lets you pack or ship the receiver without worrying about it turning on accidentally. Other convenience features include a signal-strength indicator and a dial light.

A shortwave receiver's features and its ease-of-use are important. But the most important characteristic, of course, is how well it does its main job of receiving stations. The DX-440 comes through superbly. It has excellent sensitivity, stability, and selectivity—the "three S's" of shortwave radios. Even using only the built-in 54-inch telescopic antenna, its DX-ing performance seemed superior.

An evening of casual listening—not DX-ing—netted us fine reception of English-language broadcasts from such stations as Radio Prague, Radio Moscow, Radio France International, The Voice of Free China, Radio Havana Cuba, Radio Kiev, Swiss Radio International, the BBC, Spanish Foreign Radio, Radio Baghdad, Radio Canada, Voice of America, and many more that even a first-time user could expect to hear.

The radio was such a pleasure to operate, and a solid performer. It's perfect for beginners and experienced listeners alike, and we recommend it highly. ■



CIRCLE 54 ON FREE INFORMATION CARD

# Chill Out, Man!

**MINDSEYE SYNERGIZER A/V STIMULATION TOOL.** Manufactured by Synthetic Systems, Inc., P.O. Box 95530, Seattle, WA 98145. Price: \$395.

Instant gratification has become a way of life, and, in a sense, it's electronics that's to blame. We've been so spoiled by the speed and convenience of today's gadgets and gizmos that it's difficult to imagine life without microwaves and automated cash machines. The fax has replaced those pokey overnight couriers. Satellites have shrunk the size of our world so that we've become accustomed to hearing the news as it breaks—and yesterday's news is just that.

Of course, all that instant gratification has its dark side, in that few people are willing to devote the hard work needed to reach so many laudable goals. After all, why exercise and count calories when you can get your stomach stapled, get your jaw wired, or drink a miracle-weight-loss formula? And when it comes to relaxing, too many of us simply numb our minds with alcohol, television, or even illicit drugs.

Some people do opt for the slower path, turning to meditation, yoga, and other relaxation techniques that require time, discipline, and practice. Although many people would like to achieve the altered consciousness reached through those age-old techniques, few have the patience, or are willing to devote the time required to master them.

Well, once again electronics offers a quick fix. *Synetic System's* audio/video stimulation device, called the *MindsEye Synergizer* consists of a plug-in card for an IBM-PC or compatible and ski goggles that have been modified to block out most ambient light and to deliver light pulses from eight LED's. Software-generated audio tones can be heard through user-supplied stereo headphones. A portable, self-contained system is also available but, since we're often "stressed out" by the hours we have to spend in front of our computers, we thought it only fitting that we should try to make our computer relax us, too.

How can computer-controlled LED's and sound generators help you relax? The idea is that brainwave activity can be controlled by external stimuli, such as flashing lights and pulsing sounds. Although the idea is often attributed to the New Age phenomenon that's been gripping the country for the last few years, it's actually quite a bit older than that. Since about the 1950's, hypnotherapists have experimented with photic driving, in which lights flashing at a certain frequency helped improve the effectiveness of hypnosis. Later, adding audio stimulation was found to improve the effect. To understand

CIRCLE 55 ON FREE INFORMATION CARD



why photosonic stimulation works, you have to understand something about mental states and brainwave activity.

The brain generates waves that vary in frequency from about 0.5 to about 40 Hz. That general frequency spectrum is divided into four main groups called *Alpha*, *Beta*, *Delta*, and *Theta*. Normally, most of us spend our waking hours in the Beta state, in which our brainwaves are above 13 Hz. Alpha waves, which are in the range of 8–13 Hz, are produced when we're more calm and relaxed—daydreaming, for example (where *some* of us spend our waking hours). Theta waves, which are in the 4–8 Hz range, are generated during meditation, hypnosis, or a state of extreme relaxation. The slowest waves, those below 4 Hz, are called Delta waves, and occur usually during deep sleep.

Theta waves are produced when you are in the relaxed state that is most conducive to learning. If you can get your brain to produce theta waves, you will enter a relaxed state and be more receptive to learning. So, by flashing the LED's and pulsing the sound generators at the right frequency, you can, in theory, put yourself in any state you wish.

Before we could find out if it works, we had to install the Synergizer. Those of you who get jittery at the thought of using computers—especially at the thought of installing a circuit card—should opt for the complete *MindsEye Courier* portable system and skip the next several paragraphs (start reading again with "Now that we've told you how it works..."). The Courier doesn't provide all of the Syn-

ergizer's functions, but it does come with headphones and less bulky goggles—and it doesn't require a computer.

Installing the Synergizer is much the same as installing any other PC card—perhaps even easier because, as far as we could determine, there is no way to select the port addresses or interrupts that the Synergizer uses. Although we didn't experience any conflicts, we assume that they could happen. We would have been able to work our way out of a problem by changing the address of the card that was conflicting with the Synergizer. We doubt, however, that most of the card's intended customers would be able to do the same. We hope that future versions of the card and manual resolve the potential problem.

The rear of the card has four interface connectors. A miniature (1/8-inch) stereo audio-output jack accepts a pair of stereo headphones, and an 8-conductor modular jack accepts the goggles that contain the eight LED's. An audio-input jack is also provided, but is not yet supported by the software. We expect that future versions would accept an audio input and provide output signals based on that input. A 9-pin D connector lets an external control unit vary some of the audio and visual parameters. Although we didn't examine the optional controller, we're sure it's easier to use than groping around for the keyboard trying to find the right keys with dark, flashing ski goggles on.

All the software you need is supplied on a single 5 1/4-inch diskette. An executable program, SYN.EXE, controls the board

(Continued on page 8)



## EASY AS 9-6-4

(Continued from page 1)

and 4). The set-up keys are all located under the VCR PLUS+'s flip-up cover. A list of codes, corresponding to different brands of VCR's and cable boxes, is provided. By turning the VCR on, tuning to channel 3 or 4, turning it off again, and then aiming the VCR PLUS+ at it and pressing the 2-digit manufacturer's code, the VCR is set. If done correctly, it will respond by turning on and switching to channel 9. The same type of programming is required for setting the cable box; setting the time and date is even easier.

Things get only slightly more complex if your channel numbers don't correspond with those listed in the program guide, a common situation with cable subscribers (or exurbanites whose network affiliates don't correspond to the "big-city" stations listed in major metropolitan newspapers). The VCR PLUS+ provides an on-(LCD)screen method of getting the channels to correspond that simply requires you to fill in the blanks that appear beneath the headings "Guide CH" and "TV CH."

Commonly encountered programming set-backs are addressed in the pocket-sized manual. A supplementary guide answers other questions, explains error messages, and provides special instructions for those who have preset-channel VCR's. We had no need to refer to that guide during our set-up, but for those who might, it is also kept simple (our favorite example is: "Check (look at) your VCR..."). The display messages include "LO BATT," "Err: ENTRY," "Err: CODE," or "Err: DATE" (you've entered an invalid entry during setup, code during programming, or date that's past or more

than seven days ahead); "FULL" (all 14 events have been programmed); "EMPTY" (no programs are entered); and "CLASH" (you've entered overlapping programs).

Once set up is successfully completed—it took us just a few minutes—the VCR PLUS+ is set on top of the VCR or cable box (or between the two). To program it, you press the code number into the keypad and select from the three record options how often you want the show recorded. The display will indicate the date, channel, start time, and length of the show you've chosen. If you've entered the wrong number, a "cancel" key lets you correct your mistake. Should you program several shows, and not remember precisely which ones, a press of the "review" button will scroll through your selections in chronological order. During the review process, the cancel button can be used to un-program any show. For those shows that might run over their scheduled time (for instance, live sports events) the "add time" key lets you add a safety cushion in 15-minute increments—even while the game is being recorded. Time bars (— —), which each represent up to an hour of tape, running across the bottom of the display even indicate the amount of blank tape you need to record the next 24 hours of programming. You need only remember to insert a videotape, leave the VCR off, and the cable box on. That means that in multi-viewer households, everyone should be trained to consult the VCR PLUS+'s "review" screen to avoid messing up someone else's programming. One last caveat: An iota of advanced planning is required because the device won't accept any programming commands during the two minutes prior to the start and end of a recording.

Other than a couple of pre-release-date

program-code glitches, the VCR PLUS+ worked as promised: It recorded the shows we wanted, with very little effort on our part. The device can store an impressive 14 programs. A major added "plus" for users of a VCR with cable is that the VCR PLUS+ can change the cable channel, including scrambled ones, so that you can tape shows on different cable channels when you're away from home.

On the "minus" side, we had one minor complaint about the placement of the VCR PLUS+. Set up as directed, inside our entertainment center, we couldn't see its screen well enough to use the unit without removing it from its cradle. (We said it was minor.)

Now that we know that the VCR PLUS+ is technologically capable of delivering as promised, the only misgivings we have concern the fact that its success depends on an outside factor: the availability of the programming codes. That will depend, in turn, on consumer acceptance of the device—big sales will assure the continued printing of codes and their spread beyond today's big-city test markets, and that will set cautious consumers at ease and lead to more popularity for the VCR PLUS+.

To get the ball rolling, United Media, a newspaper licensing representative, is promoting the licensing of the "Plus-Code" system to newspapers. The VCR PLUS+ devices will be sold in national retail chains including Sears and Montgomery Ward, and the newspapers who have signed on at the beginning are hardly "fly-by-night" operators. However, since Gemstar wouldn't tell us what financial arrangements had been made with the papers—including who is paying whom—we remain cautiously guarded, but hopeful, that we'll see PlusCodes this time next year. ■

## TELEPHONE MACHINE

(Continued from page 4)

If you're a private person, you might not like having a list of your last one hundred calls sitting on your desktop for anyone to see. A security lock prevents anyone from changing or searching your directories and logs. A second security mode prevents outgoing calls except those from the three single-touch speed-dial keys.

We found the phone's many features very easy to get accustomed to, and now that we are, they seem difficult to live without. The ability to review a list of all calls made is an especially useful way to get a handle on how much time we're spending on what. Having a display that shows how much time you've been on the current call can prompt you to finish up your business faster. And the alarm-clock feature is handy for those of us who lose

track of quitting time.

Although we liked the voice dialing feature, and found it more convenient than entering a speed-dial number, it's probably more of a status symbol and conversation piece than a "must-have" feature for most of us. It did, however, work quite well. The only problem was in noisy situations, where the phone has trouble determining what it's supposed to hear and what is noise. (In those cases, the phone's display reports "Too Noisy.")

Although similar names are difficult for the VoicePrint to tell apart—and you're encouraged to use a full first and last name to avoid ending up with similar names—we found it did rather well distinguishing "Billy" from "Willy" and "Perry" from "Teri." It rarely got them wrong. However, if there was a lot of background noise, or if we spoke unclearly, it sometimes wasn't sure. In those cases, the phone's guess showed up in the display,

along with a question mark. The three programming keys let you answer Yes, No, or Retry.

We do have a few complaints (of course) about the VoicePrint. We didn't like having to plug the phone into the AC line to power all those features that we really did like. (Four "AA" batteries provide a healthy 16 hours of backup in case of power failures.) Also, the speaker-phone operation was only mediocre—but then we've never seen a speaker phone that we really liked.

Although we are not convinced that voice recognition is an essential feature for us, we can think of some potential applications—and it's fun to use. Now, if only the people at Innovative Communications could build a phone that would verbally respond (and not necessarily politely) to all those annoying telephone sales calls that always seem to come at the worst possible times... ■

## SIMPLICITY

(Continued from page 2)

viewed elsewhere in this issue. A quick scan of the Manufacturer Code listings showed 5½ pages of television codes, 3½ pages of VCR codes, a short but thorough list of cable converter codes—but less than one page of CD player codes and only three videodisc-player codes. (The AV<sup>4</sup> is not intended to work with any other types of audio components. In light of that, perhaps it should more realistically be called the aV<sup>4</sup>.)

If you don't have a compatible CD- or laserdisc-player, however, you can still get full four-component use out the remote by setting the "Audio" function to operate a second VCR or television.

Another—very practical—application for the device is as a replacement for a broken or misplaced remote control. The AV<sup>4</sup> easy to purchase, without having to deal with (or pay) cable-TV representatives, or trying to locate manufacturer's service representatives for TV or VCR remote controls. Our local cable company charges for a replacement a price similar to, if not more than, the AV<sup>4</sup>'s suggested retail—and the one they sell cannot operate three other devices. (An unadvertised application is to arm yourself with the AV<sup>4</sup> in "self-defense" against the person—every family has one—who hogs the remote control and switches stations relentlessly!)

Using the AV<sup>4</sup> is quite easy—as long as you stick to the basic functions. The set-up keys at the top of the unit are also used to select the device to be controlled. To turn on the television set, for instance, you would first press "TV" and then "Power," and the AV<sup>4</sup> keys perform as marked to change the volume and channels. To switch to another device, you simply press that device's labeled key. (Unfortunately, there is no indicator to remind you which device has been selected; we often compensated by pressing the device key before each function key when unsure.) So far, so good.

However, some of the more sophisticated functions of the original three remote controls were not duplicated by the AV<sup>4</sup>. With the "back-to-basics" spirit upon us, we decided it wasn't too much of a sacrifice to keep the VCR remote tucked in a handy but unobtrusive spot to be used solely to operate the VCR's on-screen programming. Unfortunately, a dozen pages of the user's manual fall under the heading "Alternate Function Keys" and contain confusing charts intended to clarify which keys on the AV<sup>4</sup> correspond to other, differently marked, keys on the original remotes. Under the chart heading for our VCR appeared, for example:

"P/CH ..... Display"

We had high hopes, at first, that this would translate to our on-screen program-

ming display. Instead, pressing "P/CH" on the AV<sup>4</sup> recalled the last station tuned. In that same vein, there were no alternate function keys listed for our TV, yet a bit of experimentation revealed that "P/CH" corresponded to "recall," and "Enter" to "rapid-tune." While we generally relish that sort of experimentation, and were quite happy to discover that those functions still worked, the process did not fall into the realm of simplicity.

Once those bugs were worked out and the AV<sup>4</sup> was properly set up, it was a pleasure to use with our TV, VCR, and cable box. We do feel strongly, however, that the 16 brands of CD players and three brands of videodisc players that *are* compatible with the AV<sup>4</sup> should be prominently listed on the package.

Although we're still up to our ears in electronic equipment, we now have two fewer remote controls floating around the GIZMO offices. We haven't attained the uncomplicated tranquility of life on Walden Pond, but the AV<sup>4</sup> is a step in the right direction. ■

## LITTLE BIG SOUND

(Continued from page 3)

Convenience carries over to the CD part of the system. The Pref-5 can play regular and 3-inch discs. CD's can be played from first track to last, or the remote can be used to select individual tracks, or you can use front-panel controls to program the selections to play in the order you desire. Other modes include repeat play and random play, and the Pref-5 offers a 10-second "introscan" of each track, along with track search and track skip functions. Besides letting you know which track is currently playing, the LCD readout indicates tracks selected during programming and allows you to see the total playing time, the elapsed time of a track, or the remaining time of a disc or a track.

That display also comes in handy when recording CD's onto cassettes. Several options are provided, allowing you to record all the tracks in order, to manually select the order in which you want the tracks, or to use any of the four "computer recording" modes.

The Pref-5 provides "backward-skip edit recording," in which the track playing when the tape reverses sides begins anew on side B; "time-edit recording" that automatically programs the tracks that will fit on each side of the tape; "fade-out edit recording," in which the sound of the track playing at the end of each side is faded out; and "program-edit recording," in which you select the order of the tracks. An "auto space" button can be used to insert a five-second pause between each track.

Basic (backward-skip) computer recording requires only that you tell the Pref-5 what length tape you're using and

push the "computer rec" button—which automatically rewinds the tape, sets the optimum recording levels, and starts the recording process. Yet, believe it or not, we ran into a bit of trouble. Misunderstanding the manual (which is actually slightly better than most), we thought it was asking for the time on each side of the tape, since the word "EACH" is prominently displayed next to the time. Because of that, we said that our 90-minute tape was a 45-minute one, which caused the Pref-5 to try to reverse it in the middle of a side, resulting in the tape being "eaten" by the tape mechanism. Once we realized the nature of our error, and mended our ways by reading all the instructions and studying every illustration before attempting recording, each type of computer recording went quite smoothly. The procedure is somewhat similar to selecting programming options for listening to CD's. Manual recording requires a bit more diligence, of course, but the procedure is relatively straightforward. Manual recording provides the option of fading out the end of each track.

Recording from tape to tape (dubbing) also can be done automatically—using high- or normal-speed dubbing of an entire tape—or manually. You can listen to other sources during dubbing. The automatic music-selection system lets you skip or repeat a selection on tapes that have at least four seconds of silence between selections. Synchronous playback provides continuous playback alternating between deck 1 and deck 2.

So, the Pref-5 looks good and sounds good—but will it attract women? It probably won't have them falling at your feet, but when you combine the sound and the size with the convenience and lack of clutter, we're sure that women as well as men will be attracted to the Pref-5 as consumers. ■

## CHILL OUT, MAN

(Continued from page 6)

based on the contents of "session" files, which contain the instructions that board should follow. For example, you might create a half-hour session (using a second file, the SYNED.EXE editor) that sets the LED's pulsing at a given rate, with a given sound for the first 15 minutes, and then switches to a lower frequency for the last 15 minutes. Fortunately, since you're not likely to know what you want when you first take the Synergizer out the box, several demonstration sessions, all more elaborate than the one we described, are included.

After running through the demonstrations, we found a few things that we liked and a few we didn't. The LED's, for example, always seemed too bright. So, using the editor, we simply set the intensity to a lower valued that we liked—experiment-

ing with different settings is very easy with the editor. It's even possible to do so with the goggles on (they do have small holes through which you can see) so you can see the effects.

The SYNED.EXE editor gives you control over a large number of parameters, including the flashing frequency, whether the LED's flash synchronously or alternate back and forth between eyes, and the flashing rate (in tenths of a hertz).

The Synergizer's sound synthesizer contains three tone generators for each ear, and you can set the frequency and volume of each. The frequency can be entered as a numerical value or as a musical note.

You can also vary the synthesizer's sound parameters, including the envelope (which is varied by setting the attack, decay, and release times), the waveform (triangle, sawtooth, and square waves are

offered), and filters (low-, high-, and band-pass filters can be used, and their cutoff points varied). A complete set of synthesizer sound parameters can be stored to a disk file and called up along with the session.

Now that we've told you how it works, let's examine whether it works to alter your mindset. The manual takes pains to point out that Synergetic Systems does not claim that the Synergizer benefits the user's mental health, or even that it actually will alter brainwave activity. Like other relaxation techniques, the results depend to a large extent on the individual. If you *want* it to work, and if you *think* it will work, then it probably will. If you're skeptical, or if you're the sort of person who must always be in full control, then it probably won't.

Accordingly, our results varied with the

subject. One tester found the flashing lights and pulsing tones to be utterly unnerving, and tore the goggles and headphones off after a few seconds. (People with seizure disorders such as epilepsy should not use the Synergizer.) Another soon got used to the sounds and flashing colors (surprisingly, when your eyes are closed, you don't see only red because different flashing frequencies produce different colors), and found it easy to slip into a relaxed, day-dreamy state. And one person found that the simple act of blocking out virtually all ambient light and sound was, in effect, enforced relaxation. After all, you can't do much work if you can't see the computer or hear the phone ring. If you don't usually take the time to sit down and relax, then the Synergizer will make you slow down, at least, even if it doesn't vary the frequency of your brainwaves. ■

For more information on any product in this section, circle the appropriate number on the Free Information Card.

## ELECTRONICS WISH LIST

### Thirsty Watch

Watches that keep running when submerged in water are nothing new, but this one *won't* run until it has been dunked—or, more accurately, filled up—with H<sub>2</sub>O. Instead of batteries, the *Water Watch* from *The Jondy Company* (6936 Longwood, Canton, MI 48187) gets its power from ordinary tap water. It gets "thirsty" every couple of weeks, evidenced by a dimming of its LCD face. Adding water restores the watch to full power. It shows the hour, minutes, seconds, month, and date. The *Water Watch* comes in white, gray, or transparent styles for men and women, and in black or white for children. Of course, you can wear it swimming! Price: \$19.95, plus \$2.50 shipping.

CIRCLE 56 ON FREE INFORMATION CARD

### Audio Teleconferencing Unit

Unfortunately, most of us have been on the receiving end of a boomy, hard-to-hear speaker-phone call at one time or another. To replace conventional microphones and speaker phones with natural-sounding conversation, *NEC America Inc.* (Data and Video Communication Systems Division, 14040 Park Center Road, Herndon, VA 22071) has come up with the *VoicePoint* audio teleconferencing unit. The fully interactive, or "full-duplex," system also allows several speakers to talk at once. *VoicePoint* also uses a newly developed technology featuring two "echo cancellers" to eliminate such typical speaker-phone problems as chopped-up sentences, echo-chamber effects, and feedback. Depending on the acoustics of the room, up to 15 people at each site can participate in a teleconference; multiple sites can be connected with the system. The *VoicePoint* is fully portable, and can be installed anywhere by connecting it to a phone jack, an ordinary telephone, and an AC power outlet. Price: \$1299.

CIRCLE 57 ON FREE INFORMATION CARD

### CD Storage Racks

It's a fact of life that the more things you accumulate, the more you must also accumulate in which to store them. For all those CD's you've amassed, *Rolykit Inc.* (division of Verdomolen, BV, The Netherlands) has introduced *Rolydisc* CD storage systems. The black plastic units have "roll-top" doors (actually, they roll up to close) to keep the discs free from dust. The 20-disc *CDR-20* and 40-disc *CDR-40* interconnect either vertically or horizontally, and can be stacked on shelves or wall mounted. Price: \$17.99 (*CDR-20*) and \$29.99 (*CDR-40*).

CIRCLE 58 ON FREE INFORMATION CARD



Jondy Water Watch



Rolydisc CD-Storage System

# ELECTRONICS WISH LIST

For more information on any product in this section, circle the appropriate number on the Free Information Card.



Clarion Hand-Held CD-Changer Controller

## Hand-Held CD-Changer Controller

Clarion Corporation of America's (661 West Redondo Beach Blvd., Gardena, CA 90247) FMC303 CD-changer controller is easy to add to any existing car-audio system—including factory-installed ones—via the antenna input. A push of a button changes discs or tracks, or pauses or plays the disc. The user can listen to the radio or tape deck while the controller is in the stop mode. A backlit display on the FMC303 indicates the track and disc number of the song playing. Price: \$169.99.

CIRCLE 59 ON FREE INFORMATION CARD



Nakamichi Single/Multi-Play CD Player

## Top-of-the-Line CD Player

Multi-disc CD players offer long-play and convenience, but don't match the smooth, easy operation and sonic performance of single-disc players. If you're not sure which to buy, Nakamichi America Corporation (19701 South Vermont Avenue, Torrance, CA 90502) thinks it has the answer in its CDPlayer2 incorporating their MusicBank single/multi-disc player mechanism. The MusicBank system handles a single disc in the same manner as an ordinary single-disc player, but includes an internal stocker mechanism that stores up to six discs—for a total of seven CD's at once. Nakamichi says the system is "significantly quieter and faster than conventional changer mechanisms," offering users "the best of both worlds." The CDPlayer2's other distinct features include its Enhanced Linearity (EL) 20-bit digital-to-analog converter, a large-diameter disc stabilizer to reduce the effects of external vibrations, and synchro recording automated CD dubbing. Price: \$649.

CIRCLE 60 ON FREE INFORMATION CARD

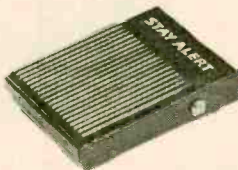

Stay Alert Auto Alarm

## Awake at the Wheel

Interstate travel can be deadly dull, especially if it makes you begin to doze off at the wheel. For any long-distance driver who has been in that situation, the Stay Alert Company (6926 Market Street, Upper Darby, PA 19082) has developed Stay Alert, a battery-operated, lightweight warning device that is placed on the floor board near the driver's left foot. Once it's positioned, the device is automatically placed in standby mode. You activate it by pressing and holding it firmly in place as soon as you begin to feel drowsy. That deliberate action in itself, according to the manufacturer, can help keep you awake—but if you still doze off, your leg will relax and let up on the Stay Alert. That sets off an alarm to jar you fully awake. We'd hope that would be enough to make you pull off the road for a rest; if not, you can reset the device—and turn off the alarm—by applying full pressure again. Pressing it twice turns off the alarm and places the device back in standby mode. Price: \$19.95.

CIRCLE 61 ON FREE INFORMATION CARD



Colby Systems Pocket Info Pac

## Tiny Computer Reader

A common image in futuristic fiction is a subway rider—or Maglev train commuter—carrying a pocket-sized electronic reader instead of a bulky newspaper. The Pocket Info Pac from Colby Systems Corporation (2991 Alexis Drive, Palo Alto, CA 94304) is that sort of device. Using Reflection Technology's Private Eye ultra-miniature virtual screen as its display, the Pocket Info Pac lets users call up text or images by pressing a series of buttons or by scrolling through menu options. The entire hand-held information-storage and -retrieval system weighs less than one and a quarter pounds, yet the Private Eye display gives the illusion of viewing a full 12-inch, high-resolution image—through a one-inch window. Priced well out of the daily-newspaper range, it's intended primarily for business use—such as storing airplane-maintenance manuals for mechanics. Price: \$899 to \$2,999 (depending on the type of memory).

CIRCLE 62 ON FREE INFORMATION CARD

For more information on any product in this section, circle the appropriate number on the Free Information Card.

# ELECTRONICS WISH LIST

## Hocus Pocus

Updated to meet the needs of executives on the go, *Sharp Electronics Corporation's Signature Series* of Wizard electronic business organizers offer the original's built-in calendar; calculator; world clock; and telephone, memo, and schedule modes; and several additional features. Those include an increased standard memory—64K in the OZ-8000 and 128K in the OZ-8200—along with a QWERTY-style keyboard, a larger high-contrast display, and an on-line help function. In addition, the new Wizards provide an outline processor for report-writing, and a business-card format for telephone entries. The Signature Series are compatible with all Wizard IC cards and peripherals. Price: \$359.95 (OZ-8000), \$399.95 (OZ-8200).

CIRCLE 63 ON FREE INFORMATION CARD

## In the Thin of It

Subscribing to the old "you can never be too rich or too thin" maxim, *Carver Corporation's* (20121 48th Avenue West, P.O. Box 1237, Lynnwood, WA 98046) *CT-6 Pro-Phile* is billed as "the world's thinnest tuner/preamplifier." The 19-inch-wide unit is just 1 3/4 inches tall. The CT-6 has a 28-button remote control, 20 random AM/FM station presets with Carver's Asymmetrical Charge-Coupled FM circuitry, four audio inputs, two tape inputs, preset/auto scan, a headphone monitor jack, and a motorized volume control. Being rich, of course, doesn't hurt. Price: \$549.95.

CIRCLE 64 ON FREE INFORMATION CARD

## Steadicam JR Travel Case

What do you get someone who has everything? How about something in which to carry some of it? For Steadicam JR owners, *Cinema Products Corporation* (3211 South LaCienega Blvd., Los Angeles, CA 90016) has introduced the *Steadicam JR Travel Case*. A custom-fit insert cradles the JR and attached camcorder, and a zippered carrier in the top cover of the case holds the "Obie light." Adjustable straps allow the case to be used as a shoulder bag, backpack, or fanny pack. Made of water-repellent black nylon over high-density foam, the pack also provides front and back pockets to hold batteries, a manual, tapes, cables, and other accessories. Price: \$75.00.

CIRCLE 65 ON FREE INFORMATION CARD

## Charging to the Rescue

The threat of theft is the price we pay for putting high-quality sound systems—even removable ones—in our cars. As a manufacturer of such equipment, *Blaupunkt* (Robert Bosch Corporation, Mobile Communications Division, 2800 South 25th Avenue, Broadview, IL 60153), is well aware of the problem, and has come up with three *TravelSafe* (models CS 1210, CS 2210 and CS 3210) keyless entry and security systems for automobile protection. In addition to the standard security-alarm features, the systems can control a car remotely using a matchbook-size transmitter that attaches to a keychain. The transmitter can also lock or unlock electric door locks, open and close power windows and trunks, and flash the headlights from a distance of up to 100 feet away. In addition, a panic button can be used to trigger the car alarm's siren if someone threatens the owner outside of the vehicle. Up to five people can have three-channel remote transmitters capable of operating nine functions on each of three different vehicles. The models CS 2210 and CS 3210 even throw in a musical rendition of "Charge!" for tailgate parties—or to trick gullible would-be thieves into thinking the Cavalry is on the way. Price: \$199.95 (CS-1210), \$269.95 (CS 2210), \$349.95 (CS 3210).

CIRCLE 66 ON FREE INFORMATION CARD



Sharp Wizard Signature Series Organizer



Carver Pro-Phile Tuner/Preamplifier

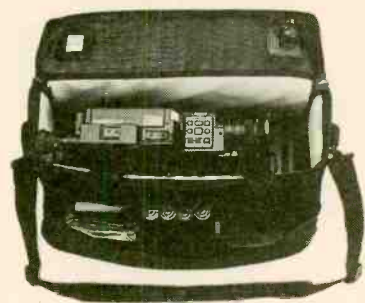

Cinema Products Steadicam JR Case



Blaupunkt TravelSafe Car Security Systems

# ELECTRONICS WISH LIST

For more information on any product in this section, circle the appropriate number on the Free Information Card.



Canon Personal Typewriter

## Personal Typewriter

Those who find more satisfaction in word-crafting on a typewriter, or simply don't need the high-tech complexity of computers or word processors, needn't scrounge around antique shops to find a suitable typewriter. The *Typestar 110 II*, from *Canon U.S.A., Inc.* (One Canon Plaza, Lake Success, NY 11042) offers a bit of both worlds, with high-resolution type; four kilobytes of text memory; a one-line, 16-character LCD readout; automatic centering; and a search/replace function. The *Typestar 110 II* has 325 characters and 160 scientific and graphic symbols, two built-in type styles, 20-language capability, variable-size printing, and a spelling checker. The portable typewriter weighs about six pounds and runs on batteries or AC power. So, if you're a diehard who wants to feel the weighty heft of black metal and hear the clatter of hard-pounded keys, head for the second-hand stores. Price: \$249.95.

CIRCLE 67 ON FREE INFORMATION CARD



Sansui AM/FM Receiver

## Affordable Receiver

Taking the stance that a component doesn't have to be audiophile-quality and priced in the stratosphere to look and sound good, *Sansui USA Inc.* (1250 Valley Brook Avenue, Lyndhurst, NJ 07071) has come up with a line of mid-priced receivers that includes the 35-watt-per-channel *R-550*. The sleek black tuner has 24 station presets (16 FM/8 AM) with preset scan and both automatic and manual tuning. It provides four audio inputs, and its monitor output functions on both tape settings for convenient dubbing. The receiver provides connections and switching for two pairs of speakers, a headphone jack with gold-trimmed insulators, motorized volume control, and a 32-key remote control. Price: \$249.95.

CIRCLE 68 ON FREE INFORMATION CARD



Philips VHS-C Camcorder

## Compact-VHS Camcorder

Throwing its hat in the VHS-C ring, *Philips Consumer Electronics Company* (One Philips Drive, P.O. Box 14810, Knoxville, TN 37914-1810) has introduced the model *CPL915* compact camcorder. Weighing just two pounds with the one-hour battery pack, the camcorder features a flying erase head, a two-position high-speed shutter, and an edit-search function that lets the user review the recorded footage at forward- or reverse-search speed. The *CPL915* also offers 3-lux brightness, digital auto focus, a tape-remaining indicator, automatic iris control, and a still-frame function. If you carry all the supplied accessories around with you, you'll be adding some weight; they include an AC adaptor with DC-output cord, an RF adapter, a cassette adapter, a shoulder strap, a date-memory battery, A/V-output cable, VHF connecting cable, and a 300/75-ohm antenna adapter. Price: \$999.

CIRCLE 69 ON FREE INFORMATION CARD



Sima 8mm Videotape Rewinder

## 8mm Videotape Rewinder

One sure sign that a new format is catching on is that a slew of accessories for it begin popping up. Reflecting the increasing popularity of 8mm videotapes, *Sima Products Corporation* (8707 North Skokie Blvd., Skokie, IL 60077) has come up with the *8mm HQ Rewinder*. The videotape rewinder saves wear and tear on the motors in VCR's and camcorders, and frees those units for use while tapes are being rewound—the kids can watch "The Little Mermaid" for the zillionth time while "ET" rewinds yet again. The rewinder has a built-in digital counter, an auto-stop sensor, and a UL-approved AC adapter. Price: \$69.95.

CIRCLE 70 ON FREE INFORMATION CARD

# The PORTMASTER



## Home-Automation System

*If you're a computer owner who'd like to connect your machine to the real world, but are afraid it would be expensive or difficult, then this is the project for you: A down and dirty interface that can be expanded to control up to 240 devices!*

It doesn't take a genius to realize that computers are quickly changing our lives. They help us perform calculations that balance our checkbooks, they keep both our business and personal lives in order, and even help us reach out and grab data from remote locations (not that we don't have enough to sort through already).

With all that computers already do, it probably comes as no surprise that they can also manage the relatively simple tasks of life, like turning on the coffee pot in the morning and waking you up with gentle music. A question that you may have is "How do I get my computer to do that sort of stuff?" Simple; just build the *Portmaster*.

The Portmaster is a very simple device that provides an active low at one

BY JOHN YACONO AND MARC SPIWAK

of its outputs based on data it receives from any IBM-compatible parallel-printer port sporting a DB-25 connector. The simplest version of the Portmaster possible (containing only three chips including a voltage regulator!) can operate 16 devices. In its most potent form, it is capable of handling 240 external AC and/or DC devices!

Along with more everyday uses, the stripped-down, 16-output version is excellent for pulsed operation of robot arms with up to 8 degrees of freedom. (For those of you not into robotics, a human arm—sans fingers—has only four degrees of freedom.) Common robot arms made for hobbyists have

only four degrees of freedom. That means you can operate two of them with the Portmaster (the possible uses for such an arrangement we'll leave to your imagination).

We'll show you how to connect the Portmaster to household devices, too. By using the program we provide and a toggle circuit, you can operate any electrical device, AC or DC, either remotely or on a time schedule. The program provided contains some example inputs that operate a toaster, air conditioner, stereo system, table lamp, outdoor-lighting system, and sets a burglar-alarm system for day and night operation. All that, and we still use only seven of the prototype's 32 outputs! Now, let's get to the nuts and bolts of the circuit.

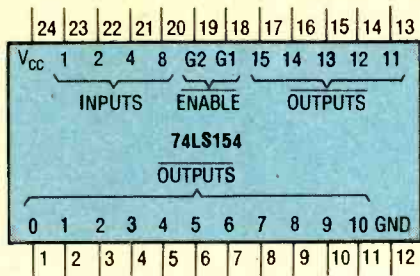

Fig. 1. Here's the 74LS154 demultiplexer's pinout diagram. They decode the output from the computer.

**4-to-16 Converter Chips.** The design of the Portmaster revolves around chips called 4-to-16 converters—also known as demultiplexers. When a converter receives a 4-bit number (called a "nibble," as opposed to the common 8-bit "byte"), it sets one of its sixteen outputs low based on the nibble's value.

The demultiplexers we used (see Fig. 1) are 74LS154 types. The four inputs (which accept the nibble in parallel fashion) are pins 20–23. Pin 23 accepts the least-significant bit (with a decimal value of 1), and pin 20 receives the most-significant bit (decimal value 8). The outputs (assigned values 0–15) are, in numerical order, pins 1–11 and 13–17. Two enable pins (numbers 18 and 19) will allow the chip to respond to input only when they are both low.

Let's assume that both the enable pins of an IC are low, which enables the chip. When binary 0000 (decimal value 0) is received by the device, output 0 (i.e. pin 1) goes low. If binary 0001 (decimal value 1) is received by the chip, output 1 (i.e. pin 2) goes low, etc. To summarize, the value of the nibble selects (addresses) the output that should

### PARTS LIST FOR THE PORT MASTER

- U1—LM7805 5-volt, 1-amp voltage regulator, integrated circuit
- U2–U4—74LS154 4-to-16 line demultiplexer, integrated circuit
- C1–C4—0.01  $\mu$ F, Mylar
- PL1—Male DB-25 connector
- J1—Coaxial DC-power jack
- S1—SPST on/off switch
- Perfboard materials, four 16-contact terminal strips (or other suitable output jacks), 25-pin ribbon cable, three 24-pin wire-wrap sockets, 6-volt DC wall adapter, cabinet, perforated construction board, hardware, wire, solder, etc.

go low. If an output is not selected, it floats high. If a chip is not enabled, all its pins are high.

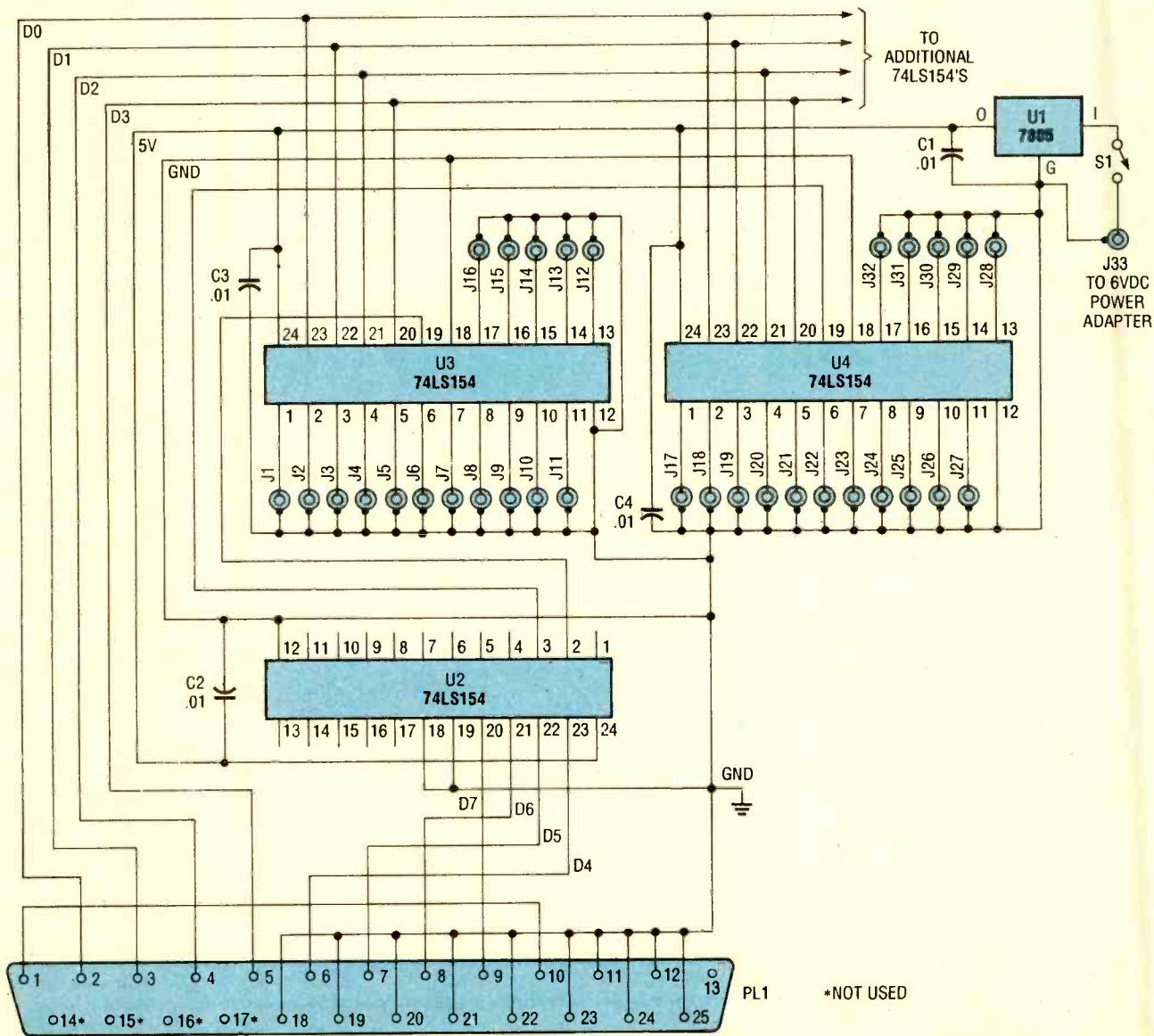

Fig. 2. This is the schematic diagram of the Portmaster. Despite its versatility, it doesn't take many parts at all to build the circuit.



**Handling 8-Bits with 4-Bit IC's.** So how do chips that handle 4 bits deal with the 8 bits from a computer? To help answer that question, take a look at Fig. 2. The data bits, D0-D7, come from the computer via pins 2-9 on a DB-25 connector, PL1. When they arrive at the Portmaster, they are separated into two groups: a low nibble (D0-D3) and a high nibble (D4-D7).

The low nibble is sent along a bus to a series of demultiplexers (we show two, U3 and U4). The number of demultiplexers you use along the bus depends on how many outputs you want. If you want sixteen outputs, one chip will do; if you want thirty-two outputs, two chips are needed. Each chip you add provides another 16 outputs.

If all the chips receive the same nibble, why won't they all operate in unison? To answer that question, take a look at the enable pins (pins 18 and 19) of both U3 and U4. Pin 18 of both chips is tied low, but their pin 19's are controlled by outputs of U2, another demultiplexer. That IC is controlled by the high nibble from the computer. So the high nibble is used to enable only one of the chips on the bus at a time via U2. Thus, only one output can be activated at a time; the chip is chosen by the high nibble (through U2) and the particular output is selected by the low nibble on the bus.

Notice that output "0" (pin 1) of U2 is not used. It is avoided for a few reasons: When a computer's parallel-port is idling (no data is being sent), it usually keeps the bits of the high nibble low. That would put a low on U2's "0" output, enabling any chip connected to it. Parallel ports usually keep a couple of lines in the low nibble active when they idle. With a chip enabled and data in the low nibble, an output will be enabled every time the port idles.

Another reason involves the way DOS and some programs handle parallel-printer output. When DOS, and programs that depend on DOS, send characters to the port, DOS keeps track of how many characters have been sent. If too many have been sent since the last carriage-return/linefeed command, then DOS automatically generates one. It does that by sending ASCII characters number 12 (carriage-return) and number 10 (linefeed) out the port. That would activate outputs "12" and "10" of any chip enabled by output "0" of U2. So, unless you know what you're doing, don't use pin 1 of U2. Besides, even without using that pin, you can control 240 devices!

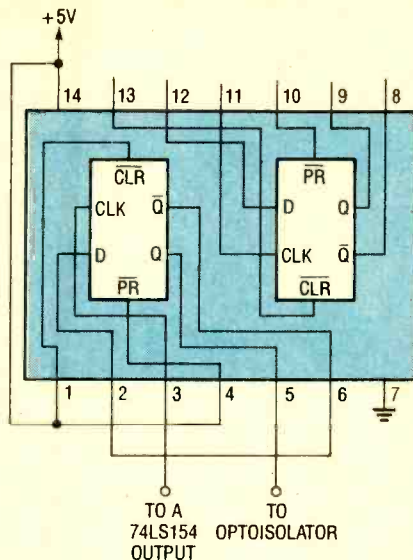

Fig. 3. You can configure any of the outputs for toggled operation by adding a D-type flip-flop as shown. (Note only one flip-flop in the package is wired ready for use.)

### Momentary and Toggled Outputs.

The outputs of the 74LS154's are active low. That, as we've mentioned, means they go low when selected, and float (they are "inactively" high) when not selected or when their chip is not enabled. So an output is only low (active) as long as the character that selects it is coming from the port. When there is another character at the port, or no character, that output floats.

Thus, the outputs are momentary, which is perfectly okay for some applications. For example, it's alright for the outputs to be only momentary if you wish to pulse several outputs one after another in a multiplexed fashion, such as in a robot-arm controller or a fancy light display. Or, if you only wish to activate one device at a time (in an exclusive fashion), you can transmit the appropriate character to the Portmaster over and over again. That leaves the output continuously low until your computer stops transmitting the character. Then you can activate another device.

You can configure any of the outputs for toggled operation as well. That will permit you to latch the outputs high or low and operate multiple devices at once. All you need do is add a D-type flip-flop configured for toggled operation as shown in Fig. 3. That IC contains two flip-flops and can be used to convert two outputs to toggled operation. To use the second flip-flop in the IC, connect its "D" and  $\bar{Q}$  terminals together and tie its CLEAR, and PRESET pins high.

**Connecting It to the "World."** The Portmaster outputs, with or without flip-flops, are TTL compatible, so its outputs can be directly connected to any TTL device without the need for interface circuitry. If you want to control a CMOS-compatible or some other low-current DC load (i.e. a robot-arm motor for example), then connect the circuit shown in Fig. 4A between the appropriate output and the device it will control.

To control an AC device, again with or without flip-flop assistance, use the circuit in Fig. 4B as an interface between the Portmaster and the AC load. If the AC device is a household device, you'll probably want to connect a bypass switch across TR1. That will allow you to operate the device without computer intervention.

### Parallel-Interface Handshaking.

Computers transmit more than just character data through their parallel ports; they also send control signals. The computer also expects to receive signals generated by the printer. Let's examine how the Portmaster deals with those signals.

Figure 5 shows the four important signal types and their relationship in time. At the top of the diagram are the eight data lines lumped together as a single band. Don't let that confuse you though; the value of the bits is not important. What is important is the time at which data is present at the output port.

The data that is being output on lines D0-D7 starts to change at time t1, and it's available for use by time t2. At t2, the computer sends a momentary low-going pulse, called the strobe signal, through pin 1 to the printer to indicate that the data is ready and waiting on the data lines. After t2, the printer can either output a busy signal (through pin 11), which keeps the computer from sending more data to the port, or it can wait until it's ready before sending an acknowledge signal (through pin 10), which will also keep the computer from proceeding. There are some printers that halt the computer in both ways, even though that's a little redundant.

How does the Portmaster do any handshaking without any pulse-generating components? Simple—the device lets the computer "shake" its own "hand." The busy line is tied low, because the computer doesn't care whether or not the busy line goes through any transitions. As long as it's never high, it will just wait for the acknowledge signal. The level of the busy

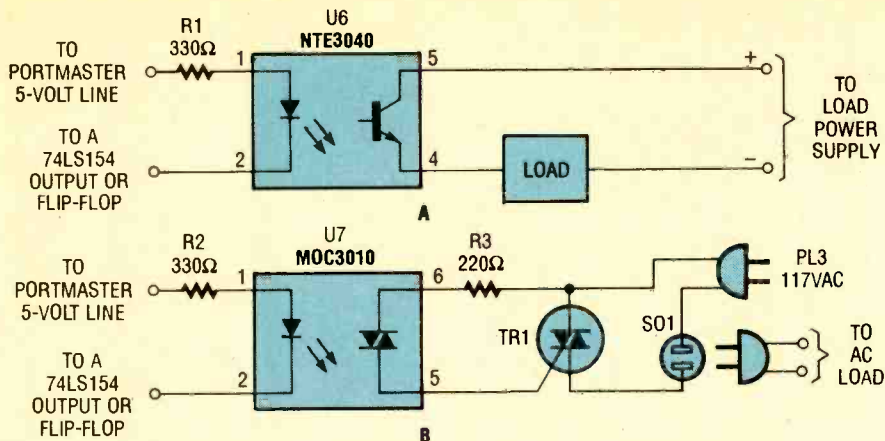

Fig. 4. To control a CMOS-compatible DC load, connect the circuit shown in A. To control an AC device, with or without flip-flop assistance, use the circuit in B.

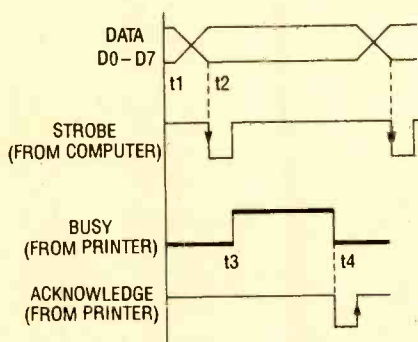

Fig. 5. Here are the four important computer signals and their relationship in time. Don't feel unsettled about not knowing the actual bits given at the top, they're not important.

line is what's important, not its transitions. That's why the busy-line levels are drawn in bold in the illustration.

The computer must therefore rely on the acknowledge line to detect the device's readiness. When the computer sends the strobe pulse, it considers the falling edge to be the start of transmission (indicated by the arrow on that edge). By the time the strobe line is low, the computer has already begun waiting for the acknowledge pulse. Interestingly enough, the computer only concerns itself with the rising edge of the acknowledge pulse; it pays no attention to the pulse's logic level or its falling edge.

Since the computer starts waiting for the rising edge of the acknowledge pulse right after the falling edge of the strobe pulse, we can use the rising edge of the strobe pulse in place of the rising edge of the acknowledge pulse. To accomplish that, the Portmaster has an internal connection between pins 1 and 10 and the computer sends itself what it thinks is the rising edge of the acknowledge pulse.

**Pulsing an Output.** Turning on a given output is as easy as addressing that output. The lowest address is address 16 and it activates output 1. So to activate output 1, all you have to do is send ASCII value 16—i.e., CHR\$(16) in BASIC—to the printer port. Accordingly, to activate output 2, send ASCII character 17, etc. To summarize:

$$\text{ASCII value} = 15 + \text{output number}$$

See the Table 1 for a list of pertinent characters, their ASCII value, and the ports they control.

You can control the Portmaster using DOS, a batch file, a program written in any language, or any other piece of software that lets you send characters to the parallel-printer port.

Note: If the data-output duration of your computer port is too brief to activate the devices you use, simply output the required character more than once at a time.

We have included a program written in BASIC that gives you the ability to remotely control any devices con-

nected to the Portmaster in both an interactive and timed way.

**The Program.** Listing 1 is a program you can use to control any device you have in your house. The program was written under the assumption that you would use D-type flip-flops configured to toggle as inputs to the controlling optoisolators.

The first two lines initialize the variables and set up a two-dimensional array called "TOGGLE." TOGGLE is a 32-by-3 array (remember arrays in basic start with element "0" with the indexes used as follows:

TOGGLE(device-output number - 1, device data)

The device data stored for each device output consists of two "toggle times" (stored in elements "0" and "1"), and the device name (stored in element "2"). A toggle time, simply enough, is a string representing the time (given in 24-hr. format) that you want a device output to be toggled. The device-name string is used by the program to tell you which device has been toggled when toggling occurs.

Lines 30-340 initialize the values of the toggle array. There is some sample data provided for outputs 1, 2, 3, 4, 5, 7, and 8. If you analyze the data you will notice that we skipped device 6 (which is element 5). Skipping devices just leaves them unused and will cause no harm. Also note that a device's first toggle time can be earlier or later than its second toggle time; as you will see, the order doesn't matter. We took the liberty of putting colons in the blank toggle times just to keep ourselves from having to enter them later.

Line 350 just initializes a string used for

TABLE1—IBM CHARACTERS

Character	ASCII Value	Output	Character	ASCII Value	Output
▲	16	1	(Space)	32	17
▼	17	2	!	33	18
↑	18	3	"	34	19
↓	19	4	#	35	20
!!	20	5	\$	36	21
π	21	6	%	37	22
\$	22	7	&	38	23
↑	23	8	'	39	24
↓	24	9	(	40	25
↑	25	10	)	41	26
↓	26	11	.	42	27
↑	27	12	+	43	28
↓	28	13	,	44	29
↑	29	14	-	45	30
↓	30	15	.	46	31
↑	31	16	/	47	32

**LISTING 1—  
PORTMASTER HOME-CONTROL PROGRAM**

```

10 CLEAR
20 DIM TOGGLES(31,2)
30 TOGGLES(0,0)="18:00":TOGGLES(0,1)="08:00":TOGGLES(0,2)="air
  conditioner"
40 TOGGLES(1,0)="11:00":TOGGLES(1,1)="06:00":TOGGLES(1,2)="outdoor
  lights"
50 TOGGLES(2,0)="13:00":TOGGLES(2,1)="06:15":TOGGLES(2,2)="night-time
  burglar alarm"
60 TOGGLES(3,0)="08:00":TOGGLES(3,1)="18:00":TOGGLES(3,2)="daytime
  burglar alarm"
70 TOGGLES(4,0)="07:15":TOGGLES(4,1)="07:20":TOGGLES(4,2)="toaster"
80 TOGGLES(5,0)="":TOGGLES(5,1)="":TOGGLES(5,2)=" "
90 TOGGLES(6,0)="06:15":TOGGLES(6,1)="6:45":TOGGLES(6,2)="stereo"
100 TOGGLES(7,0)="06:30":TOGGLES(7,1)="06:45":TOGGLES(7,2)="table
  lamp"
110 TOGGLES(8,0)="":TOGGLES(8,1)="":TOGGLES(8,2)=" "
120 TOGGLES(9,0)="":TOGGLES(9,1)="":TOGGLES(9,2)=" "
130 TOGGLES(10,0)="":TOGGLES(10,1)="":TOGGLES(10,2)=" "
140 TOGGLES(11,0)="":TOGGLES(11,1)="":TOGGLES(11,2)=" "
150 TOGGLES(12,0)="":TOGGLES(12,1)="":TOGGLES(12,2)=" "
160 TOGGLES(13,0)="":TOGGLES(13,1)="":TOGGLES(13,2)=" "
170 TOGGLES(14,0)="":TOGGLES(14,1)="":TOGGLES(14,2)=" "
180 TOGGLES(15,0)="":TOGGLES(15,1)="":TOGGLES(15,2)=" "
190 TOGGLES(16,0)="":TOGGLES(16,1)="":TOGGLES(16,2)=" "
200 TOGGLES(17,0)="":TOGGLES(17,1)="":TOGGLES(17,2)=" "
210 TOGGLES(18,0)="":TOGGLES(18,1)="":TOGGLES(18,2)=" "
220 TOGGLES(19,0)="":TOGGLES(19,1)="":TOGGLES(19,2)=" "
230 TOGGLES(20,0)="":TOGGLES(20,1)="":TOGGLES(20,2)=" "
240 TOGGLES(21,0)="":TOGGLES(21,1)="":TOGGLES(21,2)=" "
250 TOGGLES(22,0)="":TOGGLES(22,1)="":TOGGLES(22,2)=" "
260 TOGGLES(23,0)="":TOGGLES(23,1)="":TOGGLES(23,2)=" "
270 TOGGLES(24,0)="":TOGGLES(24,1)="":TOGGLES(24,2)=" "
280 TOGGLES(25,0)="":TOGGLES(25,1)="":TOGGLES(25,2)=" "
290 TOGGLES(26,0)="":TOGGLES(26,1)="":TOGGLES(26,2)=" "
300 TOGGLES(27,0)="":TOGGLES(27,1)="":TOGGLES(27,2)=" "
310 TOGGLES(28,0)="":TOGGLES(28,1)="":TOGGLES(28,2)=" "
320 TOGGLES(29,0)="":TOGGLES(29,1)="":TOGGLES(29,2)=" "
330 TOGGLES(30,0)="":TOGGLES(30,1)="":TOGGLES(30,2)=" "
340 TOGGLES(31,0)="":TOGGLES(31,1)="":TOGGLES(31,2)=" "
350 $$=""
360 PRINT "Do you want to toggle a";$$;INPUT " device [Y/<CR]";AS
370 IF AS<>"Y" AND AS<>"y" GOTO 430
380 INPUT "Number of device";I
390 LPRINT CHR$(I+15)
400 PRINT "Device number ";I; " (";TOGGLES(I-1,2);") toggled."
410 $$="nother"
420 GOTO 360
430 TS=LEFT$(TIMES,5)
440 IF TS=OLDTS GOTO 430.
450 PRINT TS
460 FOR I=0 TO 31
470 FOR J=0 TO 1
480 IF TOGGLES(I,J)=TS THEN LPRINT CHR$(I+16);:PRINT "Toggling device
  # ";I+1; "(";TOGGLES(I,2);")"
490 NEXT J
500 NEXT I
510 OLDTS=TS
520 GOTO 430
530 END

```

the following line. Lines 360-420 form a loop that puts you in a "remote-operation" mode. As long as you stay inside that loop (by responding to the question in line 360 with a "Y") you can toggle any device on or off from your computer. Just type in the device number when prompted by line 380. (Note that the \$\$ string is redefined in line 410 to simply provide the program with good grammar for the prompt in line 360.)

The remote-operation mode also allows you to turn devices on and off to set their initial state before entering the "timed-operation" mode. If you don't

answer the question in line 360 with a "Y," you end up at line 430, the beginning of the timed-operation loop.

At line 430, the time is placed in string TS with the seconds trimmed off by the LEFT\$ function. Ignoring line 440 for a moment, the current time is printed on the monitor (by line 450) and the computer enters two FOR/NEXT loops where the current time is compared to all the toggle times. If any toggle times match the current time (see line 480), then the appropriate character is sent to the Portmaster and a message appears on the monitor to give you the device number and name.

When the FOR/NEXT loops are completed, the time string is transferred to the OLDTS string and the program jumps back to line 430. There it gets an updated time and, if the time hasn't changed since the last time the program requested it, line 430 forces the program to keep requesting the time until it does. That keeps the program from printing the same time over and over again from line 450, and it also keeps it from entering the FOR/NEXT loops until there's a need to.

**Construction.** The Portmaster was assembled on a piece of perfboard and installed inside a metal project cabinet; both items are available at Radio Shack. The connections between components were made with wire-wrap wire and an inexpensive hand tool. We chose to go with a much larger case and PC board than necessary for three reasons: it's easy to work that way, there's plenty of room on the board for expansion, and 32 outputs take up a lot of room on the outside of the cabinet. We also chose metal for its shielding properties, but you can probably get away with a plastic case.

On the front of the cabinet we installed the DC power jack and on/off switch. The ribbon cable also exits from the front. Four terminal strips, with sixteen contacts each, are mounted on the back of the unit. They provide the Portmaster's thirty two outputs, with a ground connection for each one.

The first step in building the unit is to cut off a strip of the perfboard as wide as the cabinet's height. That was used to mount the four terminal strips on. Four holes were drilled in the corners of what was left of the perfboard, with matching holes drilled in the bottom of the cabinet. Later on, those holes will be used for mounting the board in the case. The next step is to test-position the components on the board, keeping in mind future expansion. During the construction, it's a good idea to leave the IC's out of the wire-wrap sockets.

The ribbon cable was attached to the board using individual wire-wrap pins soldered to the ends of the wires. The pins are arranged on the board in the pattern that you would see them on the DB-25 connector that's crimped on the free end of the cable; that makes wiring the board a little easier. You can see from Fig. 2, that pins 14-17 are not used, so they are simply cut off the cable after entering the cabinet. You'll

*(Continued on page 104)*

# WHEN DISASTER STR

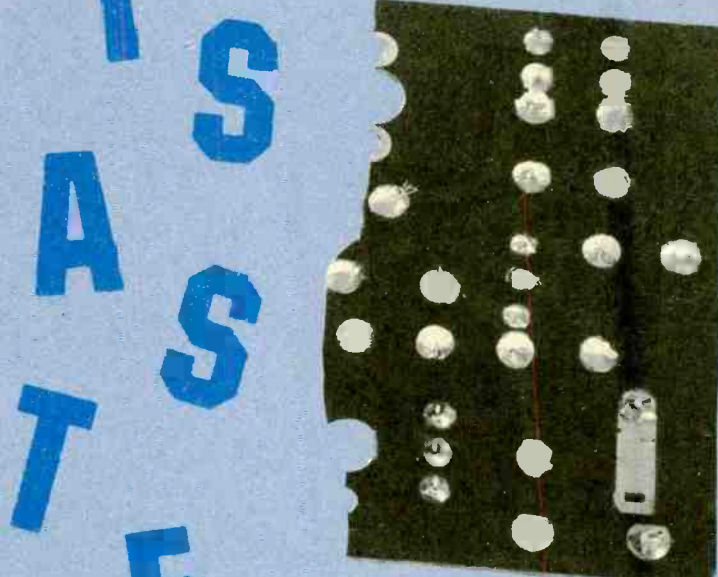
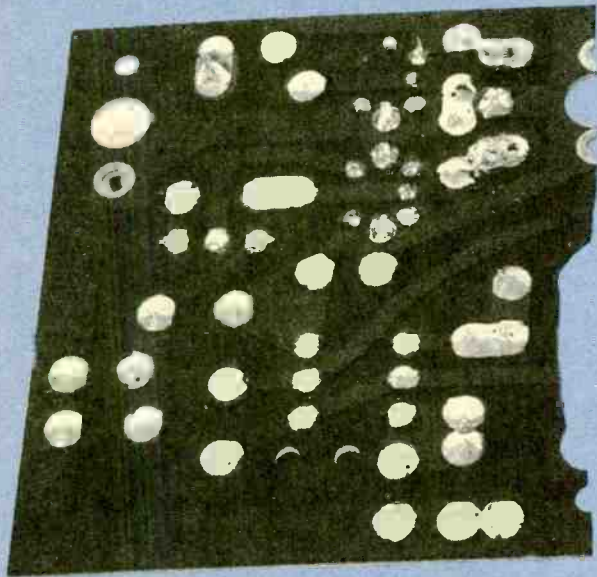

BY MARC SPIWAK,  
EDITORIAL ASSOCIATE

**R**epair work in electronics requires delicate handling and a lot of patience. So, it's very easy to get yourself in deep trouble by damaging a PC board or component. But it's not always as bad as it seems because, quite often, there's a technique you can use to pull yourself out and get your project back in working order.

However, because most damage is caused by poor soldering or desoldering, let's first talk about how to do those things properly.

**Soldering.** Solder is a mixture of tin and lead in various proportions, and it usually contains flux, as well. Acid-core solder (which contains an acidic flux) is seldom used for electronics, and you probably won't ever come across it. If you do, don't use it—it's not for PC boards. You should use rosin-core solder, where the rosin is the flux. If you cut solder of this type in half with a razor blade, you can actually see the rosin core. The flux is absolutely necessary to get a good solder joint; it cleans and prepares the surfaces to be soldered to allow the solder to flow properly.

A general-purpose 60/40 light-duty rosin-core solder is good for most applications, and be sure to use the thin stuff (0.032-inch diameter or thereabouts) for soldering PC-boards. The thicker stuff is best used on heavier work such as heavy-gauge wire or large metal surfaces.

A 30–40 watt iron is best for most work, as it will quickly heat the components, but beginners might be better off with one of lower wattage, say 25 watts. A 1/8-inch diameter pencil-type tip is good for most applications, but choose a size that best suits your needs. Above all, don't use a tip that's too big for the job, or you run the risk of creating solder shorts.

Small things like surface-mount components require thin solder and a low-wattage iron. On the other hand, if you are soldering something that dissipates heat quickly, it's often easier, but not necessary, to use a heavy-duty soldering iron. There are also adjustable soldering irons that allow you to vary the wattage, but they are expensive and you don't really need one.

Some soldering irons will advertise a grounded tip. Such units help prevent

static damage to delicate IC's. You don't have to worry too much about static unless you're working with something like CMOS IC's, in which case you'd probably want to use a static-grounding wrist strap also.

If you've got an old soldering iron laying around, you're probably better off getting a new one of a known wattage with a fresh tip. Or, at the very least, start with a new tip. Most soldering irons have screw-on tips, and it's a good idea to put some anti-seize compound on the heating-element threads before screwing the new tip on. Otherwise you may have to get rid of your heating element along with the worn out tip after they have seized together.

A new tip needs tinning. After you put the new tip on, plug in the iron and wait until it's fully hot—you'll know it's hot when it melts solder. When it's hot enough, melt a good amount of rosin-core solder onto the tip, allowing it to flow over the entire surface. Then let the tip "soak up" the solder for a minute or two. After that, wipe the excess solder onto a damp sponge, and repeat the tinning process at least once more.

It's a good idea to get a soldering-

*If you get yourself in trouble working on a project, here are a few tips to help you bail yourself out. And we'll even throw in a short course on soldering to help you avoid one of the most common causes of project failure.*

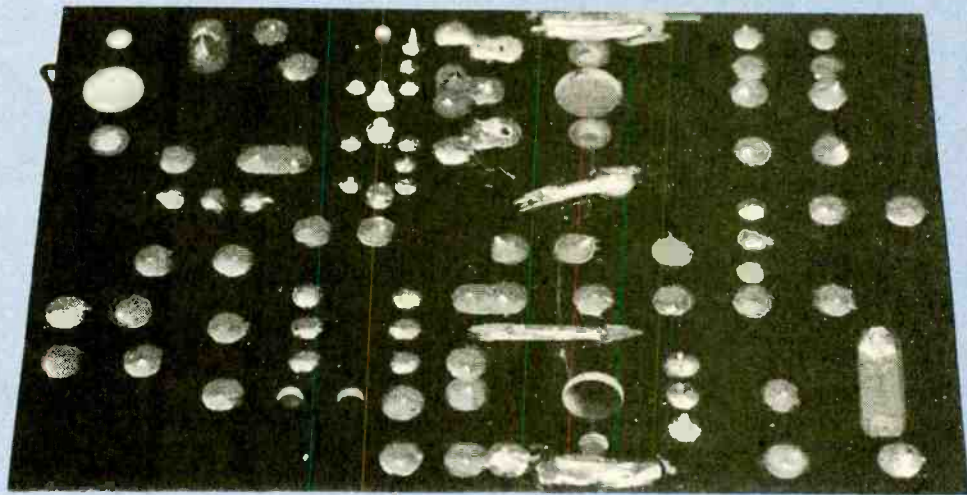

# IKES

iron stand (if your soldering iron doesn't have one of its own) to prevent you from burning your benchtop. They usually contain sponges for wiping off the tip. You should keep the sponge thoroughly moist throughout each soldering job.

Now you are ready to solder. In order to make a proper solder joint, the iron must be held in such a position that both work pieces (a component lead and PC foil for instance) are heated at the same time. Solder will not take to a cool surface. A near 45° angle allows both surfaces to touch the tip for maximum heat transfer. Figure 1 shows the angle at which the tip should be positioned. It should take only a second or two, at the most, to adequately heat the surfaces. Above all, make sure you don't heat the board too much, or the PC pad may lift right off the board.

When soldering, think of the resistor lead, the PC pad, and the iron tip as forming a small triangle where they all intersect. After the surfaces are hot, the strand of solder should be fed right into the center of that triangle. It takes only a little bit of solder to make a perfect joint. Too much solder makes for a messy,

looking joint and leads to solder shorts, while too little won't make adequate contact. By the way, you've probably heard the term "a cold-soldered joint." That is the result of the surfaces not being hot enough to properly accept solder, and a joint of that type will have a dull appearance.

**Desoldering.** Now let's talk about desoldering. For starters, there are many ways to remove solder, and all of them require heat. Since, even when in a liquid state, solder will tend to cling to the surface on which it was placed, it must be drawn away from it by an air vacuum or absorbed by another surface.

As far as the vacuum method goes, the most basic tool is a rubber squeeze bulb with a narrow heat-proof nozzle. To remove solder, you simply squeeze the bulb, heat the joint with a soldering iron, place the bulb nozzle over the joint, and release it. Although in theory it should work all the time, this method has a few drawbacks. For one, if some solder remains, you may have to actually add fresh solder and start all over again. Furthermore, every time you heat the board, you are weakening the pad's hold on it.

Another similar device is a desoldering pump, or solder sucker. These are plastic or metal devices that look like syringes, except that the plunger is spring loaded and clicks into place. After the plunger is pushed into place

(loaded), you heat the solder joint with an iron, place the sucker's tip over the joint, and press the release button. The spring makes the plunger retract, sucking up the solder. These are a lot easier to use than squeeze bulbs, and come in different styles, sizes, and materials; some are anti-static, some are conductive, some are metal, etc. However, they do have the same problem of not always removing all of the solder.

One of the best methods of solder removal is an electric desoldering system. Basically it's a soldering iron with a hollow tip and an electric pump. The tip stays hot, and you press it on a solder joint and squeeze the trigger. The hot solder gets sucked right out of the hole. This type of system is better than the two previously described methods, because it never runs out of "breath" and the solder is heated directly by the tip. Its drawbacks are that such systems are quite expensive, they clog up easily, and replacement parts are very expensive.

The best *inexpensive* way to remove solder is good, old-fashioned solder wick. Basically, solder wick is flat, braided, copper wire, impregnated with flux. To remove solder, you lay the wick over a joint and press it up against the joint with a hot iron. When the solder melts, it is drawn right into the wick. If the wick gets saturated, you must move fresh wick into place while keeping the iron over the joint. When you are done,

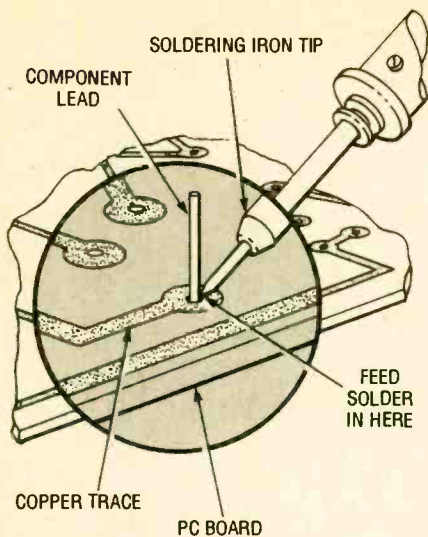

Fig. 1. If you hold the iron as shown, both surfaces will get hot, and the solder will flow properly.

you simply throw away the spent wick. One thing, though: if the joint to be removed has very little solder on it in the first place, it's a good idea to add a little bit of fresh solder before wicking it.

One last note on desoldering, and this applies especially to double-sided boards with plated-through holes: Sometimes, even though it appears that you have removed all of the solder from all of the leads or pins of a component, it will still be stuck solid. All you have to do is, on the solder side of the board, gently wiggle the protruding end of each lead or pin with a pair of long-nosed pliers until it breaks free of the surrounding hole. Make sure you get all of the leads before attempting to remove the part, or else you risk peeling a land right off the board. The part should simply lift right off the board.

**Repairs.** Now let's talk about what to do if damage has already been done. Let's say that you were trying to desolder a component and, when you removed it from the board, the little pad and trace peeled right off. Don't worry—all you have to do is cut the land off the board at the point where it is still attached. Then, strip about an 1/8-inch from one end of a piece of insulated wire (wire-wrap wire works well because it is so thin). Solder that end to the component lead where the pad is missing, and cut the wire to reach to where the original land went. Remember to leave enough wire to strip that end, as well. Then solder it in place.

If you are repairing a double-sided board, make sure that the new compo-

nent lead makes contact with both sides of the board (you may have to put a dab of solder on the undamaged side as well.) Assuming that there are no other problems on your board, it will now work like new.

Now let's suppose that you have a cracked PC board. The first thing you should do is physically mend the board with instant glue to hold it together while you work on it. If the board has a



Here is a typical solder sucker pump. The plunger is not cocked, but when it is it can be released by pressing the button to the right of the label.

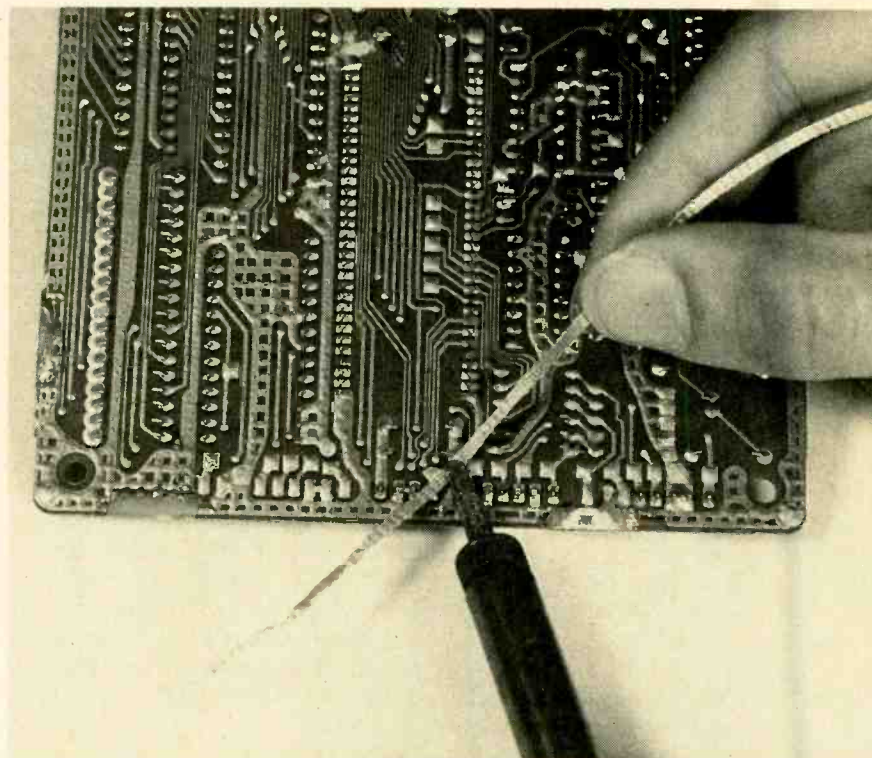

If the solder wick gets saturated, you must move fresh wick into place while keeping the iron over the joint.

solder mask over the traces, carefully scrape the coating away from the broken traces with an X-acto knife to at least 1/4-inch away from the break. Tin the bare traces with a hot iron and a tiny bit of solder, being careful not to create bridges between traces. You may have to sand the traces lightly with some fine emery cloth in order for the solder to take.

Next, tin pieces of thin bus wire or scraps of resistor leads and cut them to fit the broken traces. Use a piece of masking tape to hold one side of the repair lead in place while you solder the other. Simply take your iron and press the lead down on the trace; they should bond almost instantly, but you can add just a little bit of solder if necessary. Remember, though, that the trick to doing a neat job is to use as little solder as possible.

The next step is a bit more difficult:

After you peel off the tape you have to solder the other side of the lead, and you have to be quick with the iron, or the first connection will melt. You may have to hold a lead in place with a knife blade during this step.

If you have trouble using that method, try this one: Bend a piece of repair wire into an "L" shape, cut one end to size to repair the damaged trace, and then tin that end of the wire and the damaged trace. The other end of the wire (the handle) should be long enough so that when you heat the tinned end, you don't burn your fingers. Hold the tinned portion in place over the damaged trace and press the soldering iron on it. It should bond right to the trace. Trim off the excess lead when it is set in place. The only problem with this method is that it's hard to add solder if you have to, without a third hand.

(Continued on page 98)

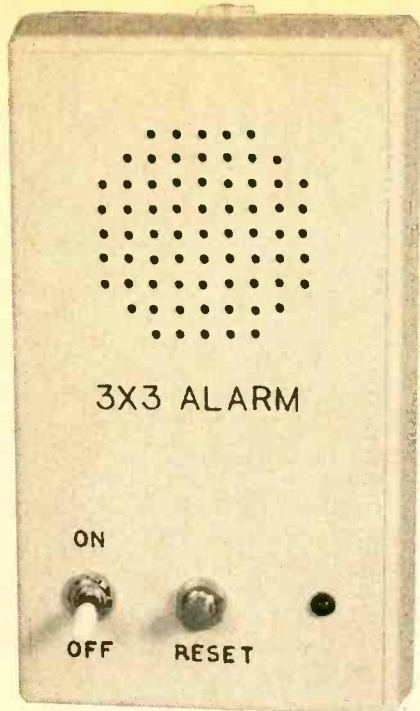

# THE 3X3 ALARM

BY RICH HAMPTON

*If you are just getting started in electronics, here's the first in a series of projects designed especially for the beginning builder*

**T**his is the first in a series of projects presented by **Popular Electronics** developed around a 3 × 3-inch printed-circuit board. The series will offer circuits that are good for the first-time electronic-project builder. The circuits also have practical applications that the more advanced hobbyist might want to incorporate in other projects.

The first circuit in this series is a low-cost alarm circuit, dubbed the 3 × 3 Alarm. The alarm provides the familiar two-tone, he-haw, sound. The circuit, which draws almost no current in the standby mode, is powered from a 9-volt, transistor-radio battery.

**Circuit Description.** Figure 1 is a schematic diagram of the 3 × 3 Alarm. The circuit consists of two IC's (U1 and U2), a silicon-controlled rectifier (SCR1), a speaker (SPKR1), and a few support components. The circuit's he-haw sound is produced by two astable (oscillator) circuits—one controlling the other. One oscillator is built around U1 (a 4011 quad 2-input NAND gate), and the other consists of the familiar 555 oscillator/timer configured for astable operation.

The first oscillator is formed by two gates of the 4011, U1-a and U1-b. The oscillating frequency of that portion of the circuit is governed by the values of R1 and C1. With the values specified in Fig. 1, the circuit oscillates at 2 Hz. The 2-Hz output of the NAND-based oscillator is tied to the threshold (pin 6) and trigger (pin 2) inputs of U2 through a 100k re-

sistor, R2. That has the affect of altering the operating frequency of U2 as the 2-Hz oscillator signal swings back and forth.

The oscillating frequency of U2 is determined by C2 and R6–R8. Potentiometer R6 (50k) allows you to alter the operating frequency of U2, and thus the tone emitted by the circuit. The values of C2, R7, and R8 have been selected to keep U2's oscillating frequency within the audio range for all settings of R6. The audio output of U2 (pin 3) is fed to speaker SPKR1 through C3, which is capacitively coupled to ground. That arrangement has the same affect as conventional capacitive coupling in that the DC component of U2's output

would be effectively blocked and therefore produces no sound in the speaker.

A third NAND gate, U1-c—fed from the output of U1-a—is connected as an inverting buffer, and used to drive LED1. When the circuit is activated, by closing any of the normally-open sensor switches (S2–S4), a positive voltage is applied to the gate of SCR1 through a current-limiting resistor (R4), causing it to turn on. Any number of switches can be wired in parallel depending on the application you have for the alarm. With SCR1 turned on, a path to ground is provided for the IC's, which allows the two astable multivibrators to oscillate, causing the alarm to sound, and continue to do so until the RESET (S1) switch is closed. Gate U1-c's output now alternates at the same rate as the output of the NAND-based oscillator, causing LED1 to flicker in time with the oscillations.

Switch S1 is a normally-open push-button that bypasses current around SCR1 when the switch is closed. When current flow through SCR1 is interrupted, the latch condition is stopped, and the alarm remains silent until triggered again. Resistor R5 is a hold-down resistor and is used to reduce false firing of SCR1.

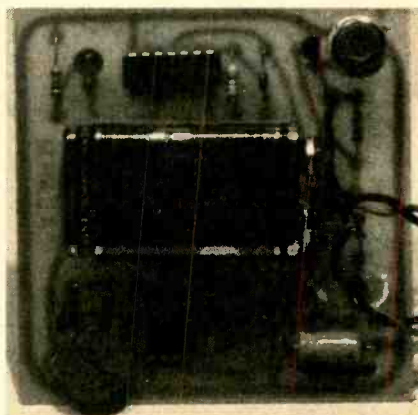

*In the author's prototype, a U-shaped 9-volt transistor-radio battery holder was mounted to the center of the board using screws and nuts. If desired, and provided that space within the case permits, the battery can be located somewhere off-board.*

**Circuit Construction.** There is nothing critical about the construction of the 3 × 3 Alarm. In fact, it could be built on perforated board with wire wrap or other techniques used to complete the circuit. However, printed-circuit construction offers the easiest method of

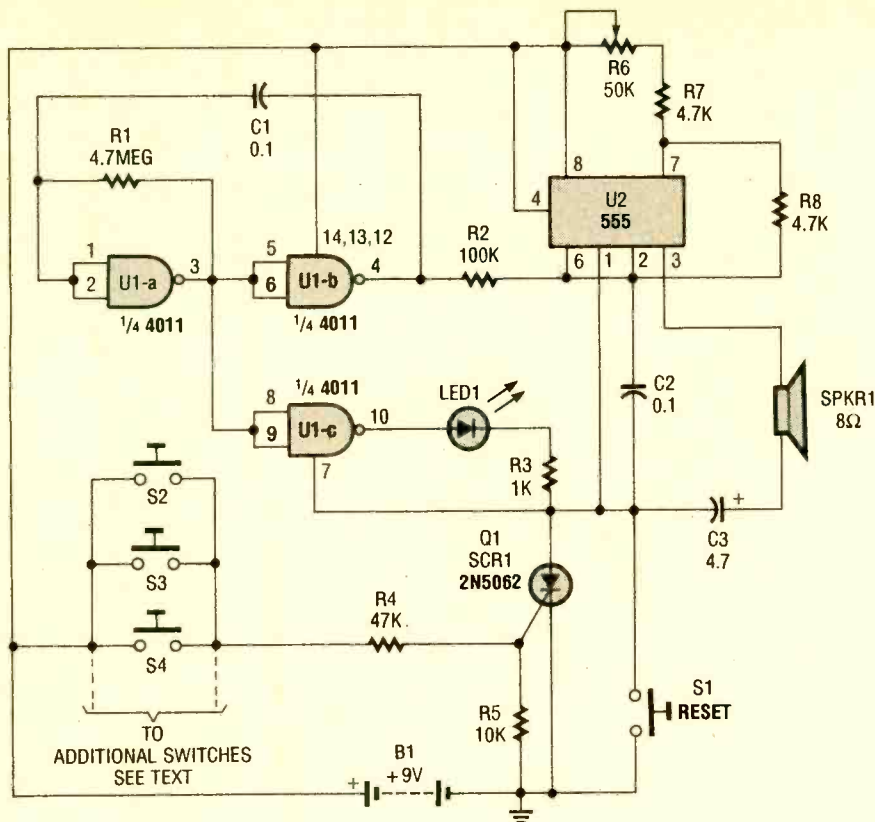

Fig. 1. The 3 x 3 Alarm consists of two IC's (U1 and U2), a silicon-controlled rectifier (SCR1), a speaker (SPKR1), and a few support components.

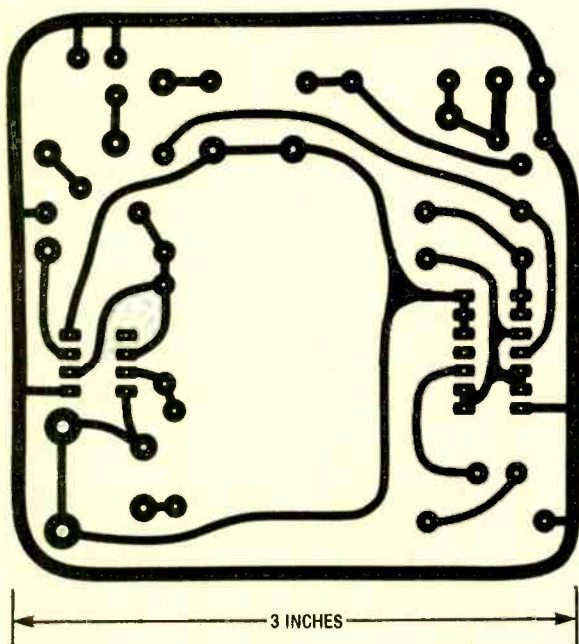

Fig. 2. While there is nothing critical about the construction of the 3 x 3 Alarm to preclude its being built on perfboard, printed-circuit construction is recommended for ease of assembly. Here's the author's printed-circuit board foil pattern.

assembly. The author's prototype was built on a printed-circuit board, the foil pattern for which is shown in Fig. 2.

Once you've obtained the relatively few parts that comprise the 3 x 3 Alarm and have etched your circuit

board (or obtained one from the source given in the Parts List), assemble the project using Fig. 3 as a guide. For ease in construction, the parts that lay close to the board, such as resistors, should be installed first.

## PARTS LIST FOR THE 3 x 3 ALARM

### SEMICONDUCTORS

- U1—CD4011 quad 2-input NAND gate, integrated circuit
- U2—555 oscillator/timer, integrated circuit
- SCR1—2N5062 or similar silicon-controlled rectifier
- LED1—Jumbo light-emitting diode

### RESISTORS

(All fixed resistors are 1/4-watt, 5% units.)

- R1—4.7-megohm
- R2—100,000-ohm
- R3—1000-ohm
- R4—47,000-ohm
- R5—10,000-ohm
- R6—50,000-ohm, PC-mount rheostat (see text)
- R7, R8—4700-ohm

### ADDITIONAL PARTS AND MATERIALS

- C1, C2—0.1- $\mu$ F, Mylar capacitor
- C3—4.7- $\mu$ F, 25-WVDC, electrolytic capacitor
- B1—9-volt transistor-radio battery
- SPKR1—8-ohm speaker
- S1—SPST momentary contact, pushbutton switch
- S2-S4—See text
- Printed-circuit board materials, enclosure, battery holder and connector, wire, solder, hardware, etc.

**Note:** An etched and drilled printed-circuit board (part AL-1) is available from Richard Hampton, 17005 East 4th Street South, Independence, MO 64056, for \$5.00 postage paid. Missouri residents please add \$0.29 state sales tax

**Note:** The 50k variable resistor, R6, is not a potentiometer, which has three terminals, but is instead a PC-board mounted rheostat with only two terminals. It is possible to use a potentiometer in its stead by first determining which terminal is the wiper (usually the center terminal); the wiper can then be connected to one of the fixed terminals, and mounted to the board like a rheostat. You might also consider removing one of the fixed terminals, and using remaining fixed and wiper terminals. Of course, doing so will likely require some lead manipulation to get it to fit the board.

In any event, follow the resistors with the capacitors and watch the orientation of the electrolytic unit (C3). Note that capacitor C3 appears twice in the parts-placement diagram. That's done (Continued on page 99)



# THE DIGITAL ELECTRONICS COURSE

## DIGITAL TO ANALOG CONVERSION

In the world of electronics, it is often necessary to convert a binary quantity into an equivalent analog voltage to activate or control some linear device. In this article, we take a look at how that conversion is accomplished.

BY ROBERT A. YOUNG

**D**igital-to-analog (D/A) and analog-to-digital (A/D) conversion are two very important facets of data processing. D/A conversion is the process by which digital information is translated into its analog equivalent; thus, a D/A converter can be considered a decoding device. The output of such a system might be used to drive a pen recorder, servo motors, the arms of a plotter, etc. D/A conversion is a straightforward process and is considerably easier than A/D conversion. Oddly, a D/A converter is often a critical part in an A/D converter.

The main problem in changing a digital signal into an equivalent analog signal lies in changing digital voltage levels into an equivalent binary-weighted analog voltage (or current). That task is most readily performed by a resistive network.

As an example of what is meant by "equivalent binary weight," consider the truth table for the four-bit binary values shown in Table 1. Let's say that we want to change the 16 possible binary values shown into equivalent analog voltages.

We would start with the smallest value in the truth table (0000), which we'll

The Digital Microprocessor Course is reprinted here with the permission of the Electronic Industries Association/Consumer Electronic Group (EIA/CEG). The complete parts kit is available from EIA/CEG. For further information, contact EIA/CEG Product Services Department, 1722 Eye Street, NW, Suite 200, Washington, DC 20006; or call 202/457-4986.

make equal to zero volts as shown. The largest binary number is 1111; for the sake of simplicity, let us make that equal to 15 volts. As you can see from the truth table, each time you increase the binary value by 1, the analog voltage increases by 1 volt. (We could have chosen 30 volts—or anything really—as the maximum, which would have caused the voltage to increase in 2-volts/digit steps, but our example is easier to understand.)

Therefore, the resistive divider we will use as a converter must produce a 1-volt signal at the output when only the 2<sup>0</sup> bit (the least-significant bit, or LSB) is high. Since the 2<sup>1</sup> position has twice the value of 2<sup>0</sup>, it follows that the 2<sup>1</sup> bit represents a number that is twice the size of the 2<sup>0</sup> bit. Following that reasoning, a 1 in the 2<sup>1</sup>-bit position must cause the analog output voltage to change by twice as much as the 2<sup>0</sup> bit.

The resistive divider must, therefore, be designed so that a 1 in the 2<sup>1</sup>-bit position causes a 2-volt change in the analog output voltage. Similarly, the di-

vider must be designed so that a 1 in the 2<sup>2</sup> bit position produces a 4-volt change and a 1 in bit position 2<sup>3</sup> produces an 8-volt change in the analog output voltage, and so on. Second, the voltages produced by the bits must be summed to form the total analog output voltage.

Another way of saying all this is that the 2<sup>0</sup> bit must be able to output 1/16 of the supply voltage, the 2<sup>1</sup> bit must supply 1/8 of the supply voltage when high, the 2<sup>2</sup> bit must supply 1/4 of the supply voltage when high, etc. We can put that into the form of a simple equation that will help you convert a binary number into its analog-voltage equivalent:

$$V_A = B_0 \times V_{CC}/16 + B_1 \times V_{CC}/8 + B_2 \times V_{CC}/4 + B_3 \times V_{CC}/2$$

where  $V_{CC}$  is the maximum output voltage, and  $B_0$ – $B_3$  are the ones and zeros that make up the binary number being converted (i.e.  $B_0$  is the LSB, and  $B_3$  is the most significant bit, or MSB). We'll use that equation a little later so you can see how it works.

A resistive divider capable of handling that task is shown in Fig. 1. The resistors ( $R_0$ ,  $R_1$ ,  $R_2$ , and  $R_3$ ) form a divider network.  $R_L$  represents the load to which the divider network is connected and is selected to be large enough so that it does not significantly load the divider network.

Now let's assume that the digital input to the circuit is 0001. The analog output

\*Our gratitude is extended to the EIA/CEG for the creation of this course, especially to the consultants who brought it to fruition: Dr. William Mast, Appalachian State University; Mr. Joseph Sloop, Surry Community College; Dr. Elmer Poe, Eastern Kentucky University.

voltage ( $V_A$ ) can be found through Millman's theorem, which states that: *the voltage appearing at any node in a resistive network is equal to the sum of the currents entering the node divided by the sum of the conductances connected to the node (assuming the node voltage is zero)*. If a logic high is represented by 15 volts in the circuit of Fig. 1, then if you apply Millman's theorem you'll find the circuit generates the desired voltages shown in Table 1. Note that the maximum output voltage occurs when all the inputs are high.

Our resistive divider network has two serious drawbacks: First each resistor in the network has a different value, which would make such a circuit prohibitively expensive because such dividers are usually built using precision resistors. In addition, the resistor used for the MSB would have to handle a much greater current than the LSB resistor. For those reasons, another type of resistive network, called a *binary ladder*, was developed.

**Binary Ladder.** The binary ladder is a resistive network whose output voltage is a properly weighted sum of the digital inputs. A ladder designed for four bits, using only two resistor values, is shown in Fig. 2A.

The left side of the ladder is terminated in a resistance of  $2R$ ; let's assume for the moment that the right end of the ladder (the output) is open-circuited. Assuming that all the digital inputs are at ground potential, beginning at node A, the total resistance looking into the terminating resistance is  $2R$ . The total resistance looking out toward the  $2^0$  input is  $2R$ . Those two resistors can be combined to form an equivalent resistor that has a value  $R$  as is shown in Fig. 2B.

Now, moving to node B, we see the total resistance looking into the branch toward node A is  $2R$ , as is the total resistance looking out toward the  $2^1$  input. Therefore, those resistors can be combined to simplify the network as is shown in Fig. 2C. From that, it can be seen that the total resistance looking from node C toward node B, or out toward the  $2^2$  input is still  $2R$ . That circuit can then be further reduced to the circuit that is shown in Fig. 2D.

From that circuit, it is clear that the resistance looking back toward node C is  $2R$ , as is the resistance looking out toward the  $2^3$  input. From that, we can surmise that the total resistance looking from any node back toward the termi-

### PARTS LIST FOR THE D/A CONVERSION EXERCISE

- R1-R3—10,000-ohm, ¼-watt, 5% resistor
- R4-R8—20,000-ohm, ¼-watt, 5% resistor
- S1-S4—SPDT switch
- Breadboard materials, 5-volt power source, wire, etc.

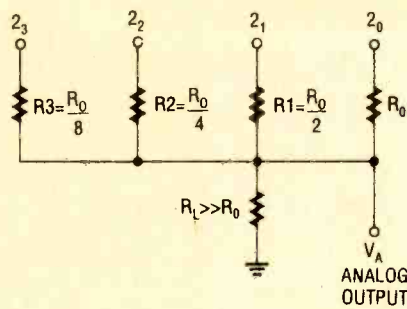

Fig. 1. The analog output voltage ( $V_A$ ) of our resistor divider can be most easily found through Millman's theorem, which states that the voltage appearing at any node in a resistive network is equal to the sum of the currents entering the node divided by the sum of the conductances connected to the node.

TABLE 1—BINARY AND ANALOG VALUES

Binary Value				Analog Digit
$2^3$	$2^2$	$2^1$	$2^0$	
0	0	0	0	0
0	0	0	1	1
0	0	1	0	2
0	0	1	1	3
0	1	0	0	4
0	1	0	1	5
0	1	1	0	6
0	1	1	1	7
1	0	0	0	8
1	0	0	1	9
1	0	1	0	10
1	0	1	1	11
1	1	0	0	12
1	1	0	1	13
1	1	1	0	14
1	1	1	1	15

nating resistor or out toward the digital input is  $2R$ . Note that that's true regardless of whether the digital inputs are at ground or  $+V$ . (The above analysis assumes that we're using an *ideal*

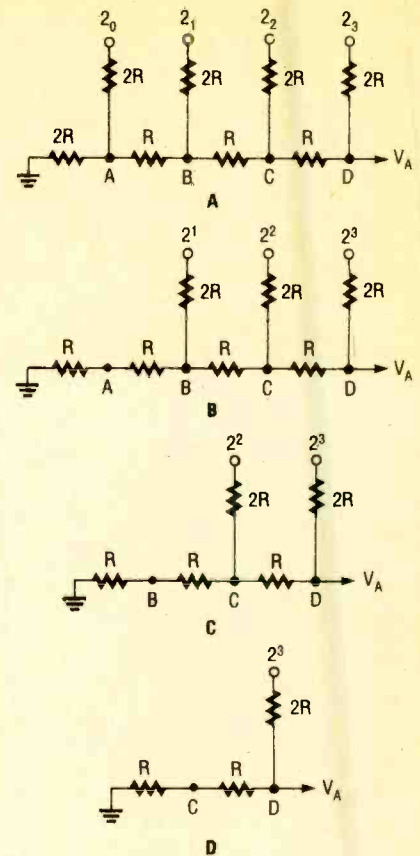

Fig. 2. A "binary ladder" is a resistive network whose output voltage is the properly weighted sum of all digital inputs. As you progress from A to D we simplify the network to show how it works.

voltage source, which has an internal impedance of 0 ohms.)

We can use the resistance characteristics of the ladder to determine output voltages for various digital inputs. And because the ladder is a linear network, the principle of superposition can be used; meaning that the total output voltage due to a combination of inputs can be found by simply taking the sum of the output levels caused by each input individually.

To keep the ladder in perfect balance and to maintain symmetry, the output of the ladder should be terminated in a resistance of  $2R$ .

Doing that ensures that the input resistance to the ladder seen by each of the digital input sources is constant. With the ladder balanced in that manner, the resistance looking into any branch from any node has a value of  $2R$ . Thus, the input resistance seen by any source is  $3R$ .

**Controlling the Input.** Figure 3 shows the resistor ladder from Fig. 2 con-

*(Continued on page 97)*

# Give a Friend a Year of Electronics Fun this Christmas. . .

Does fighting the crowds at Christmas short-circuit your holiday fun? Don't blow a fuse this year. . .for the friend who shares your love of project-oriented electronics — or a youngster who may need only a spark to ignite a life-long interest — give a gift subscription to Popular Electronics.

. . .Because when you give him Popular Electronics, you're giving month after month of challenging construction projects — including complete plans for testing equipment, electronic worksavers for home and car, add-ons and modifications for hi-fi, computers, radio and TV.

He'll get the how-to he needs to build exciting, useful projects like these. . .a touch light dimmer. . .a traveler's theft alarm. . .an economy NiCd battery charger. . .a voice synthesizer. . .a wave form generator. . .the ultimate burglar alarm. . .a stereo graphic equalizer. . .and many, many more!

PLUS. . .testbench tips and techniques. . .circuit design. . .electronics fundamentals. . .book reviews and new product news including our 12-page "Gizmo" section . . .regular columns on computers, scanners, dx'ing, ham and antique radio. . .the list goes on and on!

**SAVE MONEY.** . .A great gift to receive, Popular Electronics is also a great gift for *you* to give! The Special Holiday Rate saves you \$16.45 off the newsstand price on each gift. You can save another \$16.45 when you start or extend your own subscription at the same time. It's our "thank-you" for sharing Popular Electronics with a friend this Christmas.

Send no money, unless you prefer. We'll be glad to bill you in January, Next Year. Just take a brief moment to go over your gift list and make sure you haven't forgotten anyone who might appreciate the many benefits of Popular Electronics. Then write the names on the attached Gift Certificate and mail it back in the postage-paid reply envelope. . .we'll take it from there!

Your friends will receive a handsome gift announcement card signed with your name just before Christmas. And all through the new year they'll remember and appreciate your thoughtful gift!

So don't blow a fuse. . .take it easy and enjoy the holidays. Give Christmas gifts of Popular Electronics!



**A  
Hands-on  
Electronics  
REPORT**

# ZAPHOD INDUSTRIES FILE FETCH PROGRAM



CIRCLE 119 ON FREE INFORMATION CARD

*File Fetch provides a simple, uniform way to find files and directories from within any program.*

**T**he major difficulty that computer users face is that they are human and that computers are machines! Guess who causes most, if not all, of the trouble? The correct answer is "people."

One very common human request is, "Where is that file stored?" If the hard disk on your computer contains more than a few subdirectories (or, even

worse, you have multiple drives), you probably don't know where every one of your files is stored. Finding it using DOS (Disk Operating System) is cumbersome at best.

Furthermore, DOS does not provide a way to search for files once you are in an application. DOS just surrenders control to the program, so you're limited to whatever capabilities the pro-

gram has. If a file-search function is not provided by the application, then you are forced to exit the software to locate the file you need. Even if a search feature is provided in the application, its methodology is probably unique to the specific software package. That means you'll need to remember how to perform file searches from within each piece of software you own that supports such a feature.

File Fetch, a utility program from Zaphod industries, does much to alleviate the difficulty of finding files both at the DOS prompt and from inside your programs. Since File Fetch can work while you're inside almost any software package, it can provide a uniform way to find files and directories. Further, when File Fetch tells you where a file is, you won't have to memorize the path and filename and then type it in—File Fetch will pass the file name, with a complete path specification, to your software for you!

File Fetch is a TSR (Terminate-and-Stay-Resident) program. Once it's loaded into memory, you just hit a special hotkey—a key or combination of keys file fetch looks for—to invoke it. Then a File Fetch window pops up over whatever might have been on the screen. The window contains a display of all the directories and subdirectories. By positioning a highlight bar over the name of a subdirectory, you can view the con-

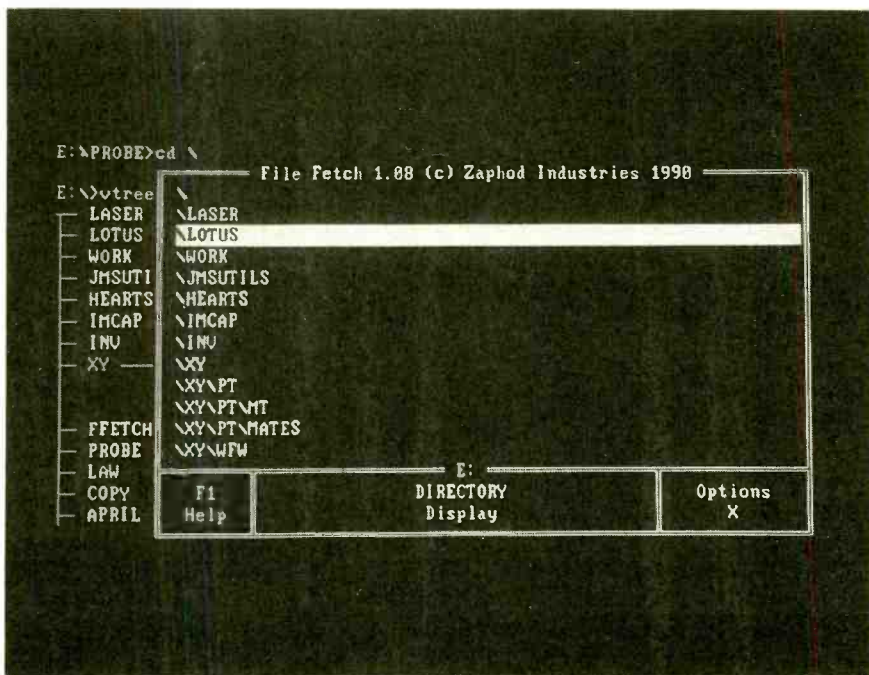

The first image you see when File Fetch main window pops up is a directory listing for the current disk drive.

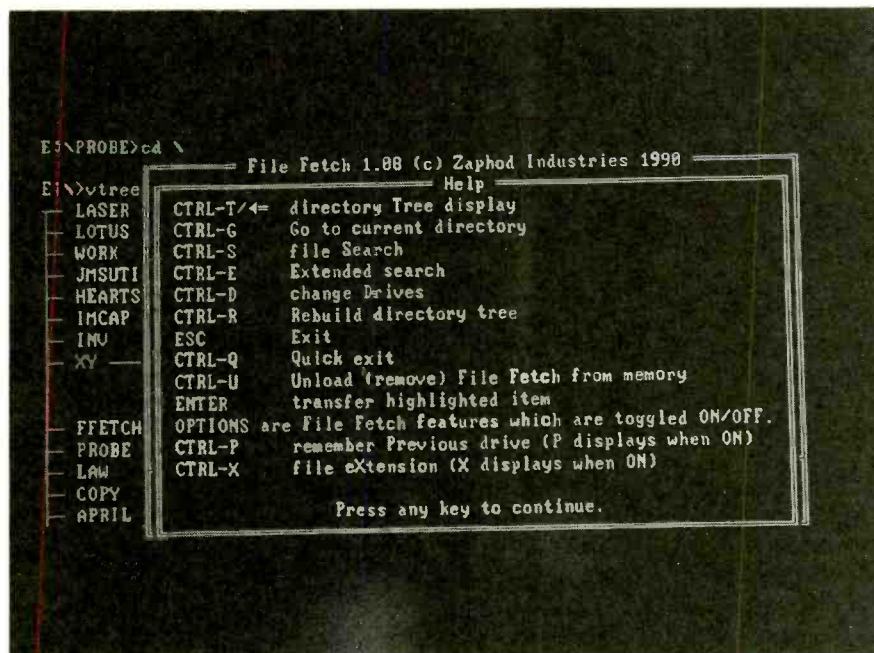

File Fetch makes use of 16 keys, all of which you won't remember the first few times you use the application, that's why context-sensitive help screens are provided.

tents of that subdirectory, and point to the file you seek. At your request File Fetch can then pass the path and file name to the program you were in, and at the position you were at on the screen, and return you to that program.

**Getting Started.** File Fetch runs on IBM PC's and compatibles using DOS 2.0 or higher. For systems without extended memory, File Fetch requires 32K of conventional memory. If your system has at least 32K of unused expanded memory, it will use it plus 1K of conventional memory. You don't need to know whether or not your computer has extended memory, because File Fetch will find out for itself.

File Fetch can be used with computer systems with one or two floppy drives and one or more hard disks. The program was tested on a two-floppy, two-hard-disk system with good results.

A hard-disk installation/configuration program is supplied with the software for you to use if needed. To start it move to the A: drive and type:

INSTALL<ENTER>

After that just follow the prompts that appear on the screen. During the installation procedure you can change the hotkey sequence from the default (<CTRL><LEFT-SHIFT>F) to whatever other sequence you like. That can keep File Fetch from using the same hotkey sequence as another TSR program you might want to use.

Like any other TSR program, File Fetch

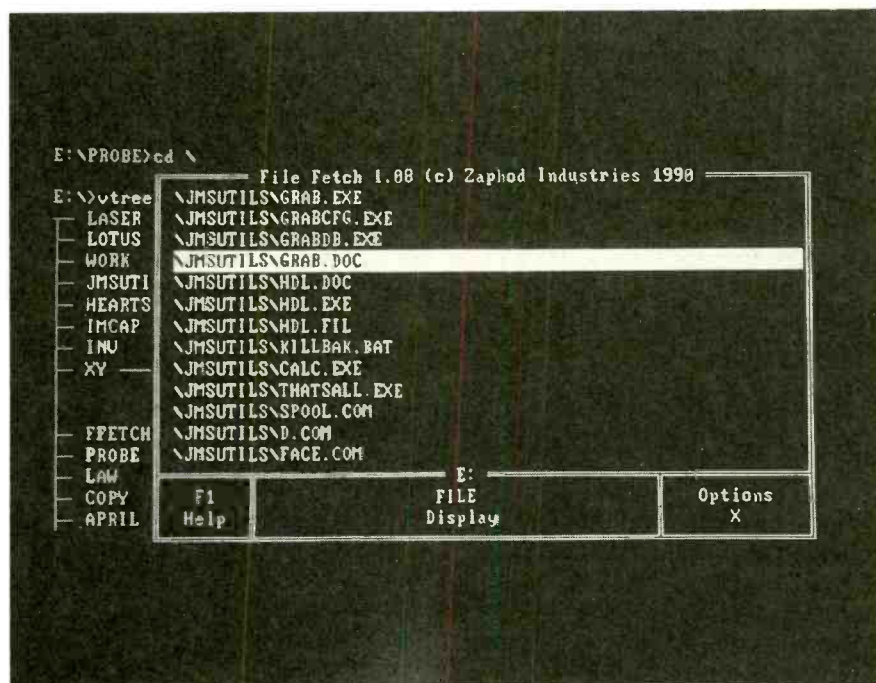

File Fetch permits you to move easily from the directory list to the corresponding files. To do so, highlight the desired directory in the first window and press the right-arrow key. The files in that directory will be listed.

may be loaded into memory by requesting it at the DOS prompt, or loaded during boot up by your AUTOEXEC.BAT file. Either way the command to load File Fetch is:

FFETCH<ENTER>

(Remember to specify the appropriate path if File Fetch is not in the current directory.) File Fetch will then be at your

beck and call with a press of the hotkey sequence.

At times you may want to remove File Fetch from memory to make room for other stuff or to avoid other possible contention problems. That's simple, just type <CTRL>U and File Fetch releases all its resources.

**What to Do and What You See!** When you press the hotkey a File Fetch window pops up to show a list of all the directories and subdirectories. The window also tells you the current drive, reminds you that help is available by pressing the <F1>, and tells you if the "file-extension" or "two-drive" options are in effect (which we'll describe in a little while).

There are sixteen different keys used to operate File Fetch. Information on each of them is provided on "help screens." You activate help by pressing the <F1> key. The help screen that appears is "context sensitive"—the soft-

ware keeps track of what you're trying to do and displays only relevant help text.

Pressing <CTRL>E enables File Fetch to search for a file(s). The program allows you to type in a filename using the usual DOS wildcards if needed, and then goes to work. It then displays a list of matching filenames with their ap-

(Continued on page 97)

# PRODUCT TEST REPORTS

By Len Feldman

## Panasonic CQ-ID90EU Car Audio Tuner/Cassette Deck

Anyone who travels cross-country by car knows that finding a good radio station in an unfamiliar area can be a major headache. More often than not, you have to fumble with the tuner as you listen to static from weak signals or to station formats you're not happy with. However, a system that *Panasonic* (One Panasonic Way, Secaucus, NJ 07094) has dubbed "ID Logic" eliminates the need for scanning. All you have to do is pre-program the city you live in into the tuner's memory. Then, as you travel, you touch directional buttons to indicate your direction and a format button

kW or more, in over 4300 cities in North America. ID Logic offers six programming formats: classical, country/folk music, rock and roll, jazz (including rhythm and blues, reggae, and urban contemporary), easy listening, and talk shows. Since stations do tend to change their formats from time to time, there is even provision for changing the format of as many as eight of the stations already stored in memory.

In addition to the ID Logic features, you can store your favorite stations into any one of the 6 preset locations for each band; since there are two FM bands and one AM band avail-

music programs in a pre-recorded tape, the ability to scan and preview each song for several seconds, to repeat a selection, and to skip unrecorded portions on a tape during playback. A metal-tape selector alters playback equalization to suit high-bias or metal-particle tapes.

The CQ-ID90EU is essentially a car-audio "head end." That is, it delivers a suitable output signal voltage to drive a separate power amplifier which, in turn, would be connected to the front- and rear-mounted speakers in your car.

### CONTROLS

This car-audio unit has one of the most unusual control panels we have ever seen. There are no protruding knobs. Instead, along the top of the front panel, are up and down buttons that take on different functions depending upon the sequential setting of a selector button (marked "sel") nearby. For example, if the selector button is pushed once, the up and down buttons adjust the volume level. Further pushing of the selector button brings up bass, treble, balance, and fade indications on a display below these buttons, and the up and down buttons can then be used to adjust the selected audio parameters. A button next to the selector button is labeled "R-M," which stands for radio monitor. Pressing that button while listening to a tape returns you to the radio-

CIRCLE 120 ON FREE INFORMATION CARD



The Panasonic CQ-ID90EU Car Audio Tuner/Cassette Deck.

to indicate the type of music you want to hear and the CQ-ID90EU tuner/cassette deck takes over and finds an appropriate station for you.

The CQ-ID90EU contains a huge database that includes 4700 AM and 5600 FM stations, each with a broadcasting power of 1

able, a total of 12 FM and 6 AM stations can be stored in this manner for instant recall. Manual and seek tuning are also available.

The cassette player incorporated in the CQ-ID90EU features Dolby B and Dolby C noise-reduction circuitry, the ability to find the starting point of up to nine

listening mode, or vice versa. Further to the right, and adjacent to the cassette slot, is a dual-function button that either attenuates audio level to  $\frac{1}{10}$ th its normal value or introduces loudness compensation when listening at low levels. To the right of the cassette slot are a cassette-eject button and the main power button.

By far, the more interesting control arrangement is found along the lower half of the front panel of the unit. Called "3-Face Glass Panel Switching" by Panasonic, besides the display area already mentioned, it features symbols, numerals, and other printed designations behind a single solid pane of glass. All the user has to do is press against the glass at an appropriate designation and the unit responds.

Further, those designations change to suit the unit's mode. For example, when in the tuner mode, along the upper half of this glass panel is the word "band," the four directional designations (N, E, W, and S) used while traveling to inform the ID Logic about your trip direction, manual- or seek-tuning up and down designations, and a preset designation used to store stations in the various numbered preset memories. However, when playing a cassette, the designations change and touching the appropriate point on the glass panel handles all tape transport functions such as switching from side A to side B, pause, fast forwarding or rewinding the tape, stopping the tape, and tape scanning.

Designations behind the lower section of the glass panel also change depending on the unit's mode. While functioning as a tuner, that section is used to select the desired station format as described earlier.

When in the tape-play mode, pressing the glass over those same areas serves to select metal-tape equalization, Dolby B or Dolby C noise reduction, find the starting point of music selections, repeat playing of the current selection, and to skip unrecorded sections of a tape.

Hooking up the CQ-ID90EU is an easy task. The front and rear output jacks are of the standard RCA phono type and are clearly labeled. A separate 4-wire cable plugs into a matching socket on the rear of the chassis and the wires are clearly labeled for connection to your car battery, to the ignition or accessory terminal of the fuse block, to a motorized antenna relay (if available in your car), and to the light-switch terminal that provides dimming of your dashboard lights. The chassis requires a standard DIN cutout in the dashboard for proper installation; a mounting collar, front trimplate, and all necessary hardware are supplied with each unit.

### TEST RESULTS

For all of its novel tuning and station storage features, we were interested in determining just how good an FM-tuner circuit was incorporated in the CQ-ID90EU. After all, a database of thousands of stations would be of little use if the tuner could not pick up those stations with reasonably good fidelity and with low noise at some reasonable distance from each transmitter. Accordingly, we first measured the frequency response of the FM-tuner section; the results are plotted in Fig. 1. At 15 kHz, response was off by only 2.5 dB as against the  $\pm 3$  dB quoted by Panasonic.

Figure 2 shows how noise varied as a function of input

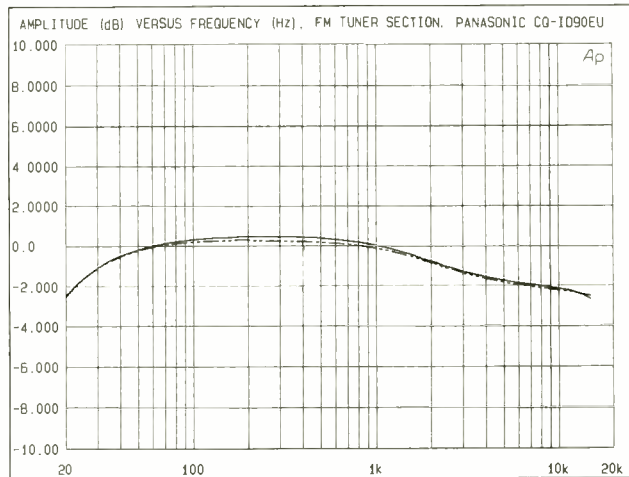

Fig. 1. At 15 kHz, the frequency response of the FM-tuner section was off by only 2.5 dB.

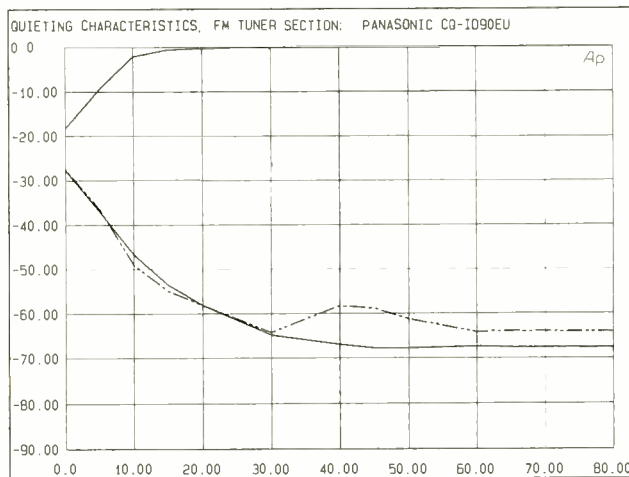

Fig. 2. In mono (lower solid trace), the best S/N was 68 dB, which is adequate for a car FM tuner. In the stereo mode (upper solid trace), the S/N was almost as good, measuring 65 dB for strong signals.

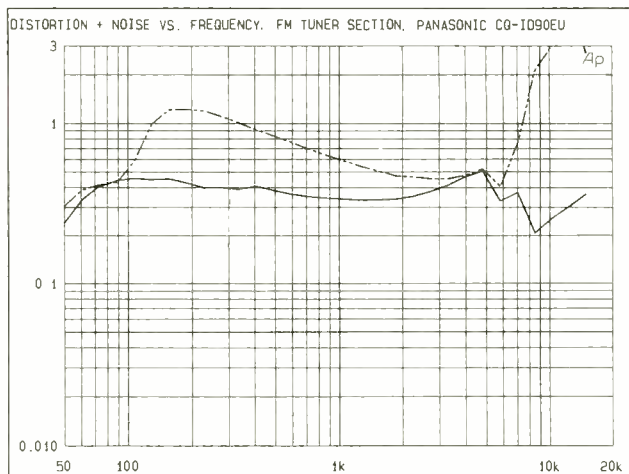

Fig. 3. At mid-frequencies, mono distortion plus noise (solid trace) measured 0.33%, while in stereo (dashed line), the distortion increased to 0.6% at that same test frequency.

## TEST RESULTS—PANASONIC CQ-ID90 EU CAR AUDIO TUNER/CASSETTE DECK

Specification	Mfr's Claim	PE Measured
<b>FM Tuner Section</b>		
Usable sensitivity (mono)	12 dBf	12 dBf
50-dB quieting sensitivity	15.2 dBf	12 dBf
Frequency response (20–15kHz)	±3 dB	-2.5 dB
Capture ratio	1.5 dB	1.5 dB
Stereo separation (1 kHz)	42 dB	33 dB
Signal-to-noise ratio		
Mono	70 dB	68 dB
Stereo	N/A	65 dB
Selectivity	75 dB	76 dB
<b>AM Tuner Section</b>		
Frequency response (-6dB)	N/A	22Hz-4kHz
<b>Tape Player Section</b>		
Frequency response (±3dB)		
Metal tape,	30 Hz-20 kHz	Confirmed
Normal tape,	30 Hz-17 kHz	30 Hz-15 kHz
Signal-to-noise ratio		
Dolby off	52 dB	52.4 dB
Dolby B	62 dB	60 dB
Dolby C	72 dB	69 dB
Wow-and-flutter (WRMS)	0.07%	0.08%
<b>General Specifications</b>		
Dimensions (W × H × D, inches)	7 × 1 <sup>5</sup> / <sub>16</sub> × 5 <sup>1</sup> / <sub>2</sub>	Confirmed
Weight	3 lbs. 15 oz.	Confirmed
Suggested Price:	\$799.00	

signal strength in both mono and stereo. In mono, the best S/N was 68 dB, or just short of the 70 dB claimed, but still adequate for a car FM tuner. In the stereo mode, the S/N was almost as good, measuring 65 dB for strong signals. 50-dB quieting was attained in mono with only 12 dBf of signal strength, significantly better than the 15.2 dBf specified by Panasonic.

Figure 3 shows how harmonic distortion plus noise varied with audio modulating frequencies for the FM-tuner section of the product. At mid-frequencies, mono distortion plus noise measured 0.33%, while in stereo, the distortion increased to 0.6% at that same test frequency. A plot of distortion plus noise versus input signal strength is shown in Fig. 4. From this plot, we can determine the so called usable sensitivity of the tuner (the point at which distortion plus noise reaches 3%). In mono, that point was reached at 12 dBf, exactly as claimed by Panasonic.

FM stereo separation is

plotted in Fig. 5 for two conditions. With strong input signals, separation reached more than 33 dB at mid-frequencies. As with most automotive tuners, however, separation is deliberately reduced for weak signals in order to minimize the background noise that would otherwise be present in the full stereo mode. By partially "blending" the left and right stereo channels during weak-signal reception, noise is partially cancelled while enough separation is retained to maintain a stereo sound field. In the case of this tuner circuit, at 45 dBf of input signal, separation decreased to just over 10 dB (the distance between the two innermost curves of Fig. 5).

AM frequency response may come as a surprise, but, as plotted in Fig. 6, response of the AM-tuner section of this car audio head-end was actually better than that of most AM-tuner sections found in this type of equipment. AM frequency-response reached the -6-dB cut-off point at 4

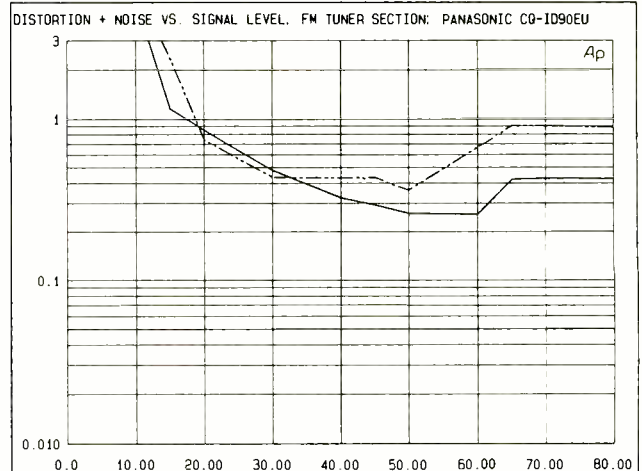

Fig. 4. This plot shows distortion plus noise versus input signal strength. The solid trace is for mono; the dashed trace is for stereo.

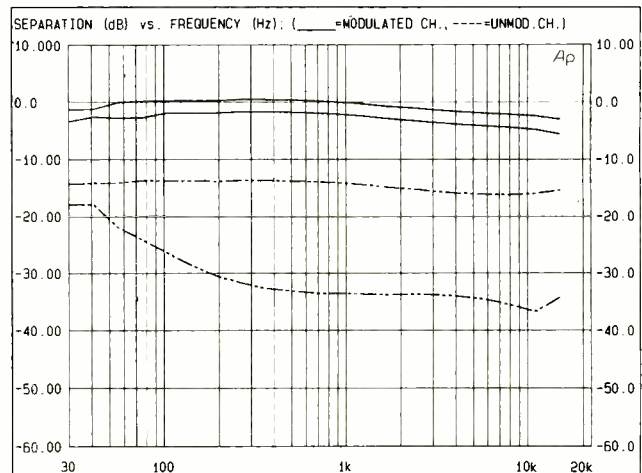

Fig. 5. With strong input signals (outer traces), stereo separation reached more than 33 dB at mid-frequencies. For weaker signals (inner traces), at 45 dBf of input, separation decreased to just over 10 dB.

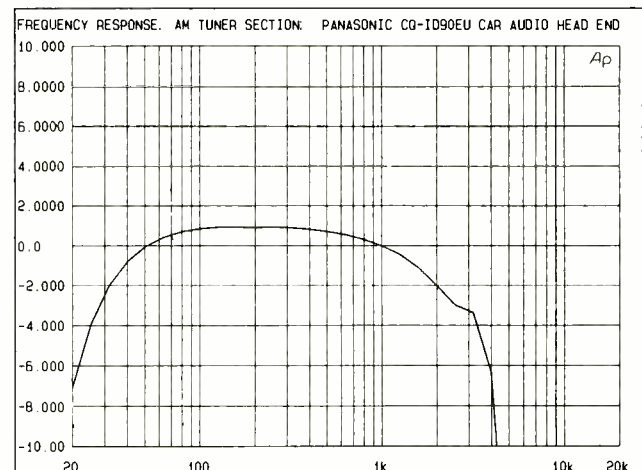

Fig. 6. While the AM frequency response could and should be much better, this tuner still outperformed most AM-tuner sections found in this type of equipment.



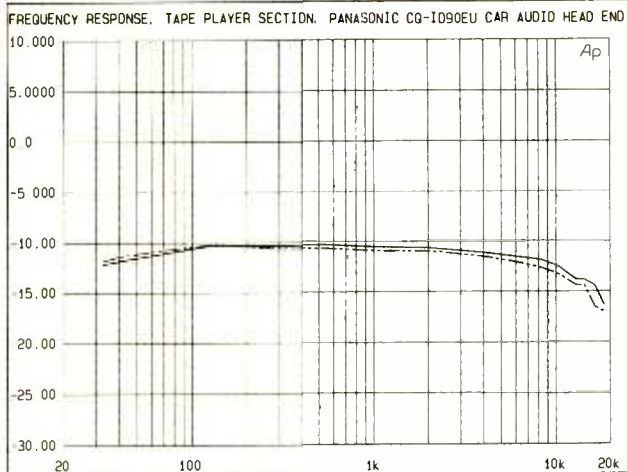

Fig. 7. Using normal-bias tape played back at  $-10$  dB below the reference level, frequency response was down by approximately 7 dB at 18.5 kHz, the highest frequency available on the test tape.

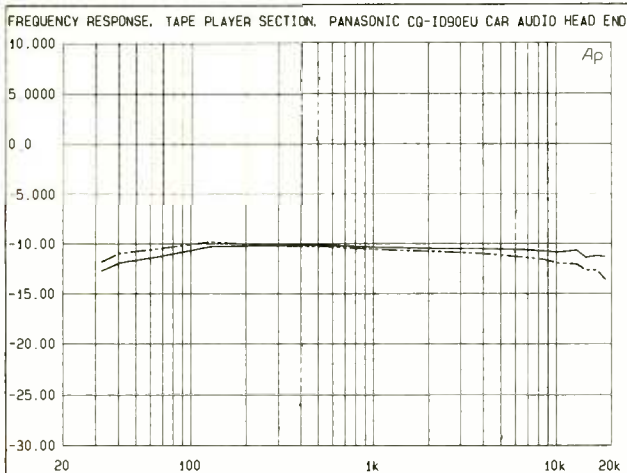

Fig. 8. Using high-bias tape and the unit's metal-equalization setting, frequency response was down less than 1.5 dB at 18.5 kHz for the left channel and about 3 dB for the right channel.

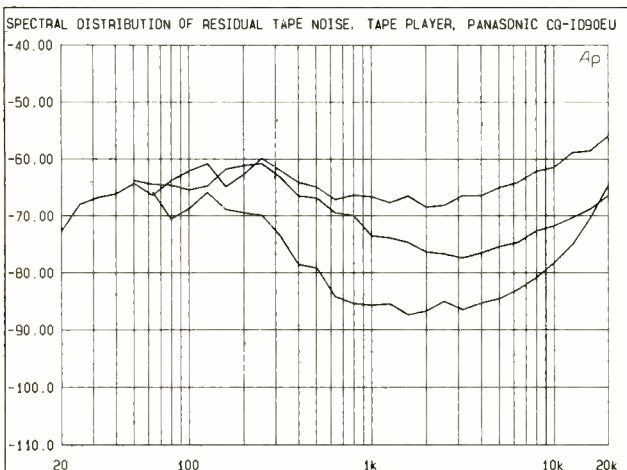

Fig. 9. The top trace shows residual noise versus frequency without Dolby. With Dolby B applied (middle trace), noise levels are reduced primarily at higher frequencies, corresponding to tape hiss. Using Dolby C (lowest curve), the noise recedes by another 10 dB or so and the reduced noise level extends down to middle and even some low frequencies.

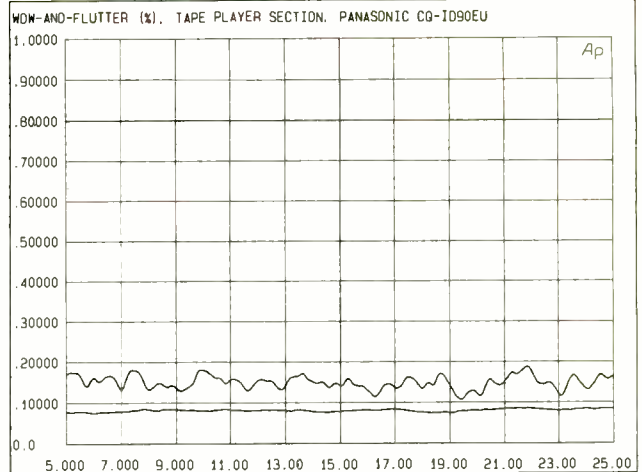

Fig. 10. Using WRMS weighting (lower trace), wow-and-flutter was measured at 0.08%. Using IEC weighting (upper trace) wow-and-flutter averaged about 0.15%.

kHz and at 22 Hz. We have measured many AM-tuner sections that don't have response much beyond 2.0 or 3.0 kHz, although it is possible, with proper design, to provide response out to 7.5 kHz or higher, as recommended by recent studies of the subject.

Next, we turned our attention to the tape-player section. Using a standard calibrated pre-recorded tape prepared by TDK, we measured the playback response of the player when handling normal-bias tape. Results are shown in Fig. 7. The lowest frequency recorded on these test tapes was 32 Hz, which explains why the plot ends at that frequency instead of extending down to 20 Hz. The reference level was  $-10$  dB with respect to standard Dolby level of 200 nanowebers/meter. At the highest frequency available on this tape, 18.5 kHz, response was down by approximately 7 dB. While that is better than the average for car-audio tape players, response for high-bias tape was even better, as shown in Fig. 8. With that tape, and using the unit's metal-tape equalization setting as is appropriate, response was down less than 1.5 dB at 18.5 kHz for

the left channel and about 3 dB for the right channel. Again, the reference level is at  $-10$  dB in that graph.

A weighted signal-to-noise ratio for a normal tape played back without Dolby noise reduction measured 52.4 dB as against 52 dB claimed. With Dolby B, residual noise was reduced to  $-60$  dB, while with Dolby C in use, residual noise decreased further to  $-69$  dB with respect to the Dolby reference level. You can add a few dB to those figures to arrive at the S/N values with respect to maximum recording level, or the 3% distortion point.

To get some idea of just how effective Dolby noise reduction was in this tape player, we plotted residual noise as a function of frequency, using a  $1/3$ -octave tracking filter. Results are shown in Fig. 9. The top trace shows residual noise versus frequency without Dolby. With Dolby B applied, (middle trace), notice that reduced levels of noise are primarily at higher frequencies, corresponding to tape hiss. Using Dolby C (lowest curve), not only does the noise recede by another 10 dB or so, but, as the graph shows, the reduced noise level extends down to mid-  
(Continued on page 100)

# ANTIQUE RADIO

By Marc Ellis

## Build The Cunningham Special!

In the September and October issues of this column, we discussed the theoretical principles of some very useful tube-testing circuitry from the late 1920's. In December we began work on the job of developing a modern tube tester based on such circuitry. That month, we built an adjustable regulated power supply—using modern semiconductors—for providing filament voltage to the tubes under test. In January, we worked out a method for supplying, and regulating, the necessary

plate voltage. January's issue also contained some suggestions for obtaining, modifying, and calibrating voltage and current meters for use in the tube-tester project.

This month, we present a schematic diagram (Fig. 1) for a practical tube tester based on the principles worked out so far. Unlike previous schematics discussed to date, the current one is not a simplified version; it's complete, bench-tested, and ready for construction. Because the basic circuitry was originally

worked out by engineers from the E.T. Cunningham tube company, I'm calling our tube-tester project *The Cunningham Special*.

### WHAT IT WILL AND WON'T DO

Before you decide whether to build the Cunningham Special, let's review what was said in earlier columns about what this tester can and can't be expected to do. First of all, it *can't* be expected to provide accurate tests of hundreds of types of tubes. For that job, you need a

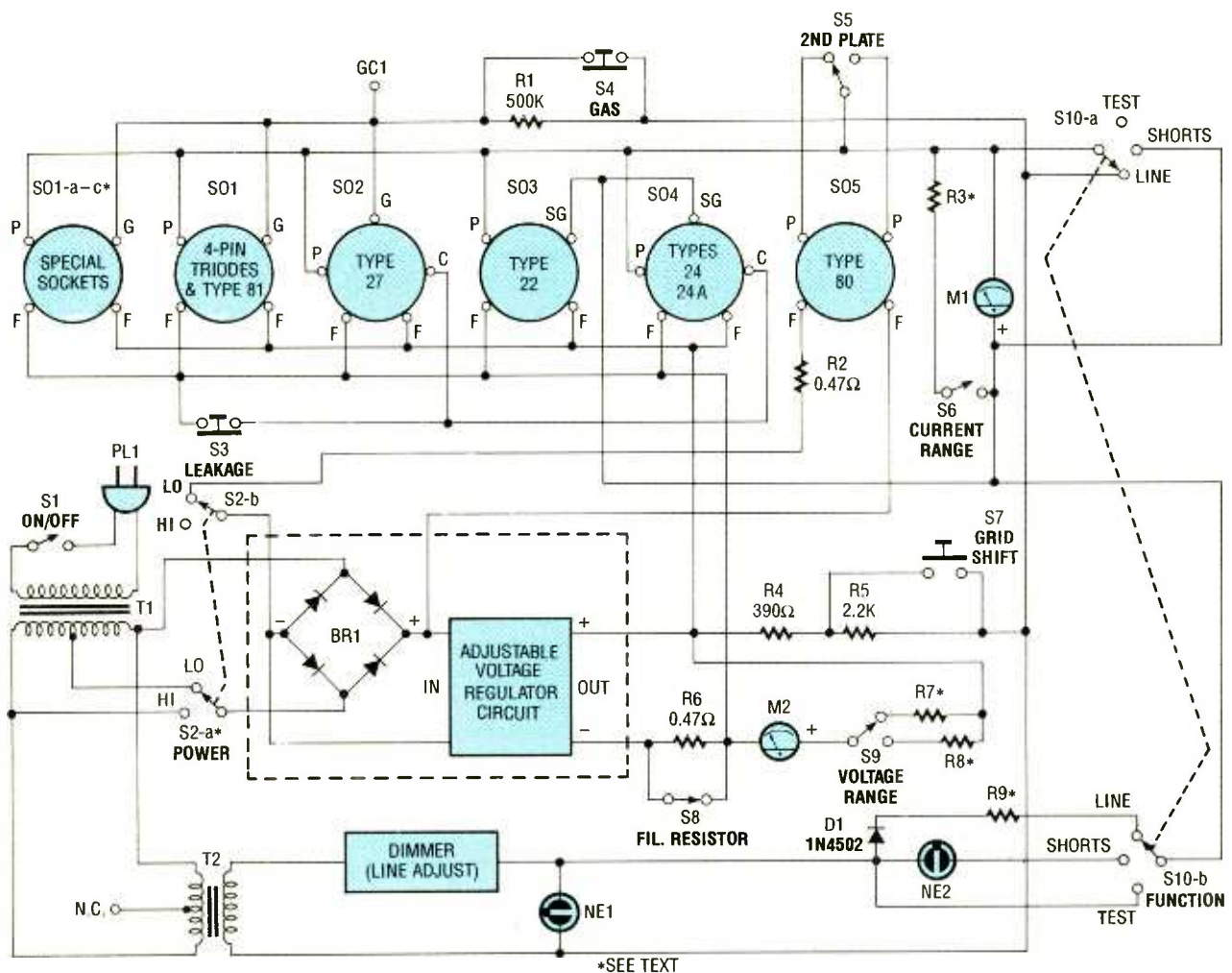

\*SEE TEXT

Fig. 1. The schematic of the tested, ready-to-build version of the Cunningham Special.

## PARTS LIST FOR THE CUNNINGHAM SPECIAL

### RESISTORS

(All fixed resistors are 1/2-watt, 5% units, unless otherwise noted.)

R1—500,000-ohm  
R2, R6—0.47-ohm, 5-watt  
R3, R7, R8, R9—See text  
R4—390-ohm  
R5—2200-ohm

### SWITCHES

S1, S6, S8—SPST  
S2—DPDT  
S3, S4—SPST normally-closed, momentary-contact pushbutton  
S5, S9—SPDT  
S7—SPST normally-open pushbutton  
S10—Dual-gang, 3-position rotary

### SOCKETS

SO1, SO3, SO5—Standard 4-pin tube socket  
SO2, SO4—Standard 5-pin tube socket  
SO1a-c—See text

### ADDITIONAL PARTS AND MATERIALS

BR1—4-amp, 50-PIV full-wave bridge rectifier  
D1—1N4502 or similar rectifier diode  
DIM1—Wall-type household lamp dimmer  
GC1—Spring clip for top cap. connection  
NE1, NE2—NE-2 neon lamp with resistor (RS 272-1100 or equivalent)  
M1, M2—0-15 volts DC milliammeter (RS 270-1754 or equivalent) see text  
T1, T2—12-volt CT, 3-amp power transformer  
Perfboard materials, enclosure. AC molded power plug with line cord, wire, solder, hardware, etc.

good quality dynamic-mutual-conductance tube tester of commercial manufacture. It simply wouldn't be practical for a hobbyist to build and calibrate such an instrument in a home workshop. And, in any case, a bit of serious shopping at a large electronics flea market is sure to turn up a good commercial unit at

the right price.

What the Cunningham Special *is* intended to do is what most good commercial units aren't usually equipped for: checking the earliest types of radio tubes used in home radio sets. Even the older testers usually lack the data and/or the specialized sockets to handle all of these tubes. For example, 01-A's are reasonably common tubes, and it's not hard to find a tester that will handle them—*unless* they happen to be the short-pin, bayonet-mount variety. Then there'll be a socket problem. The same problem can arise with other tubes of the era—assuming that the tester even has data for checking them.

But because those "problem" tube types are simple in construction and few in number (less than two dozen), it's relatively easy to put together a special tester for them. The Cunningham Special is such a tester. It doesn't require the banks of sockets or complicated switching circuits found in the commercial general-purpose units. And it's possible to develop test-data standards simply by checking some samples of each type that are known to be good.

In addition to the tubes used in early battery sets, such as types 00-A, 01-A, 11, 12, 20, 22, and 99, the Cunningham Special will test the full range of tubes used in AC-powered radios through about 1930. That includes types 24, 24A, 26, 27, 45, 71A, 81, and 83. Less-often-seen early types such as the 10, 40, and 50 can also be tested.

About half of those tube types (especially the ones in the AC group) can be readily checked on commercial tube testers. They are included in the "repertoire" of the Cunningham Special to make it a little

more complete and because adding them didn't cause much increase in complexity. If you are among the collectors who specialize in pre-1930 sets, you may not need any tester other than this one. But if, like the rest of us, your tastes are more general, you'll use this neat little unit to supplement your more sophisticated commercial tester.

### INTERPRETING THE READINGS

Another thing the little tester can't do is give you an "English" (good, fair, poor) meter reading on the condition of your tube. As you know from previous discussions, this is a "grid shift" instrument. Its results are given in the form of a pair of plate-current readings: The first is observed when the tube is inserted; the second is observed after pressing the "grid shift" button, which alters the voltage on the grid of the tube.

The size of those readings and the difference between them, compared with a table of values for tubes known to be good, is a measure of the condition of the tube and its amplifying ability. In the case of rectifier tubes, which have no grid and don't amplify, the first reading alone is used to judge tube condition.

You'll know that your tube is good if the values come close to those given in the table; you'll know your tube is bad if no plate-current reading is observed or if no "shift" occurs.

The plate-current readings, in conjunction with the leakage and gas tests provided by the tester, should give you a good all-around estimate of the tube's condition. The inability to establish subtle grades of tube quality really isn't too much of a drawback. An-

tique radio tubes are a bit too valuable to throw away, whatever their quality.

### CIRCUIT NOTES

If you agree that the Cunningham Special would make a worthwhile addition to your test bench, you'll first want to study the schematic diagram of Fig. 1. This schematic, which is a practical and construction-ready version, pulls together all of the design considerations that were discussed in previous columns using simplified diagrams.

For example, if you compare the schematic with the simplified version shown in the October, 1990 column, you'll see that the crude filament and plate-voltage regulation systems have been replaced by the more sophisticated ones covered in the December, 1990 and January, 1991 columns. The regulated-filament supply (within the dashed rectangle) is not shown in detail because its design and construction were completely documented in December.

Most of the features shown on the schematic were explained previously and don't need to be repeated here. However, there are a few new points that should be discussed. For instance, filament voltage for SO5 is no longer taken from the output of the voltage regulator, but from the bridge rectifier (BR1) feeding the input of the regulator. That's because the filament of the type 80 tube to be tested in SO5 draws more current than can be supplied by the regulator.

The bridge rectifier, BR1, is more than capable of supplying the required current to the tube. Although there's no way of controlling the voltage output of BR1, it's about right for the 80 (provided that power switch S2  
*(continued on page 92)*

# COMPUTER BITS

By Jeff Holtzman

## Love Those Meeses

**W**ith the growing popularity of Windows and graphical software in general, I thought I'd take a look at pointing devices: mice, trackballs, etc. Things haven't changed a whole lot since the last time I looked at this product category, so I'm going to skip over some products and background information. For that, see "Of Mice and More" in the October 1988 issue of **Hands-on Electronics**, this magazine's progenitor.

### OVERVIEW

A mouse is a device used for interacting with a computer. The typical mouse

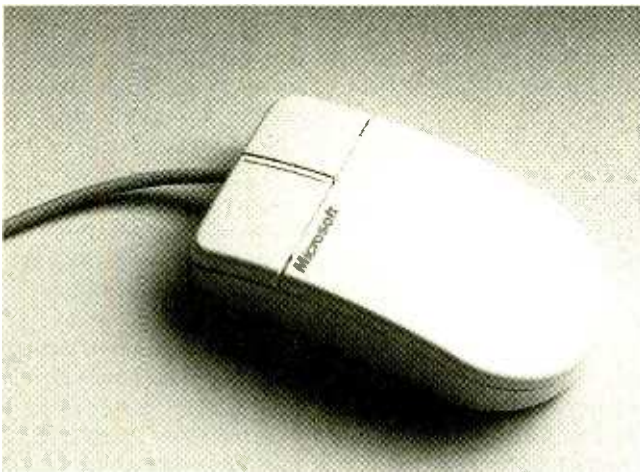

*A mouse—a device used for interacting with a computer—has a ball in its base that, as it rotates, converts raw data into something a computer can understand.*

has a ball that rotates and transfers its motion to a pair of optical encoders mounted at right angles to one another. Each encoder interrupts a light beam traveling between an LED and a photodiode, and a microprocessor converts that raw data into something a computer can deal with.

Usually you must load a device driver to communicate with the mouse at that

level, but some programs have built-in low-level drivers. Each manufacturer has its own format for the low-level data, but more and more manufacturers provide hardware emulation of Microsoft's format. For example, all of the devices discussed in this article run with Microsoft's drivers, MOUSE.COM and MOUSE.SYS. Mice from Logitech and Mouse Systems typically require their own drivers. Many inexpensive clones run with Microsoft's drivers.

A trackball is like a mouse lying on its back. Instead of pushing a mouse around your desk, you rotate the ball with your fingertips directly. The advantage of a trackball is that you don't have to have a clear space in which to operate it; the disadvantage is that some operations can be physically difficult to accomplish. However, several of the latest generation of devices have pretty much overcome that type of difficulty.

Mice generally come with either two or three buttons, and there is much theoretical debate about the optimum number. However, most software packages use only a single button, so the number of buttons shouldn't be a deciding factor unless you are certain your software uses the extra ones effectively.

You connect a mouse to your PC via either a serial port or a bus-interface card. Some people claim that bus mice provide better operation, but I've never been able to tell the difference. More relevant may be the number of free expansion slots or RS-232

ports on your PC. Most mice come with auxiliary software that lets you add mouse control to ordinary text-only programs. That type of software can be marginally useful, but unless you use the most popular software (WordPerfect, etc.), count on creating your own menu control scripts.

As stated previously, all the devices here are hardware compatible with the Microsoft mouse, hence will run with any Microsoft-compatible driver. However, to take advantage of the special capabilities of a device, you must load its own driver. Depending on the application, doing so may be a problem. For example, all devices discussed here ran with the unmodified Microsoft mouse driver in Windows 3.0, but manufacturer-specific drivers for that software were incomplete as of this writing.

### THE MICROSOFT MOUSE

Microsoft's mouse sets the standard against which all other input devices are measured. The design is sleek and comfortable to use for long periods of time. The two buttons have the best feel of any buttons on any mouse or trackball I've ever used. The current version of the mouse doubles resolution (to 400 pulses per inch) over the previous version, which makes use with super VGA (800 × 600) and larger screens more efficient.

Another new addition is ballistic gain control, which varies the rate of on-screen motion according to the speed with which you move the mouse. If you move the

mouse quickly, more on-screen distance is covered than for slower motion. In practice, it takes some getting used to, but on large screens, the result is worth the trouble. Microsoft provides several gain curves; you can create your own by editing an ASCII file and experimenting. The previous version had a small module containing the control electronics near the end of the cord; in the new version, all of the electronics are contained within the mouse itself.

The serial version comes with 9-to-25 pin and PS/2 adapters. The serial or bus version of the mouse by itself lists for \$125; it is also available with Windows (\$225) or PC Paintbrush (\$150). You can spend less on a mouse, but there is a reason why Microsoft is the market leader.

## THE MOUSEPEN

One traditional way of pursuing the American dream is to build a better mousetrap. In the PC industry, that translates to building a better mouse—or alternate input device. The latest in that tradition is a device that looks like a highlighting marker with a tail. The appeal of Appoint's MousePen is that you can operate it in a just a few square inches of desk space. Unfortunately, the implementation of the device leaves something to be desired. Although it's a marvel of miniaturization, the device still feels chunky.

The biggest problem is button operation. It's almost impossible to operate the main button (lowest on the shaft) without causing the mouse cursor to move. I found myself actually lifting the device off the desk, pressing the button, and then lowering it, but that still caused undesirable motion.

In addition, the upper button is almost impossible

to use. Either I had to curl my index finger so far under that my fingernail pressed the button, or else I had to slide my hand up the device. The buttons also require too much pressure to operate. Even the cord conspires against easy operation; it's so stiff that it restricts free motion. The MousePen comes in serial (\$149), PS/2 (\$149), and Macintosh (\$129) versions. The IBM versions include menu software and a serviceable paint program called TelePaint.

## PC-TRAC

The PC-Trac is the latest incarnation of the trackball from one of my favorite trackball companies, MicroSpeed. MicroSpeed has been making and refining their trackballs for quite some time; the current version represents one of the finest devices on the market. What distinguishes the new PC-Trac from the previous version is that the buttons have been moved from the front of the device to the side, which in turn means that it's much easier for your hand to make the transition from button to ball.

A potential problem with any trackball is the operation known as dragging, in which you roll the trackball while holding a button. Dragging can be quite difficult on a trackball because you must hold a button with one finger and somehow use the others to roll the ball. MicroSpeed's solution was to add a third button at the far end of the trackball, located symmetrically between the other two. By pressing that button, PC-Trac subsequently acts as if you were holding the left button and rolling the ball.

The long, sloping buttons along both sides of the ball are easy to click no matter where your hand ends up after rolling the trackball;

the ball itself has a very smooth feel. My only complaint is the height of the device. I find that after using it for awhile, I tend to rest my elbow on the table and tilt my arm up so that my palm rests just above the ball. The problem is that my lower arm muscles get tired after remaining in that position for awhile.

On the other hand, PC-Trac has the best documentation of the group, including a technical overview of how the device works. Serial, PS/2, and In-Port versions list for \$119; the bus version is \$139.

## ROLLERMOUSE

A newcomer to the trackball scene, CH Products has come out with a very strong contender in the RollerMouse. Like PC-Trac, RollerMouse provides a drag-emulation function, but with a pair of buttons located above the left and right main buttons. Because there are separate drag buttons, left-button dragging and right-button dragging are simpler than on the PC-Trac. In addition, RollerMouse has a lower

### VENDOR INFORMATION

Microsoft Mouse (\$125)  
Microsoft Corp.  
16011 NE 36th Way, Box 97017  
Redmond, WA 98073-9717  
Tel. 206-882-8080

PC-Trac (\$119, \$139)  
MicroSpeed, Inc.  
44000 Old Warm Springs Blvd.  
Fremont, CA 94538  
Tel. 415-490-1403

MousePen (\$149)  
Appoint, Division of IMCS  
1332 Vendels Circle  
Paso Robles, CA 93446  
Tel. 805-239-8976

RollerMouse (\$129.95,  
\$149.95)  
CH Products  
1225 Stone Drive  
San Marcos, CA 92069  
Tel. 619-598-2518

profile that pretty much matches that of a standard 101-key keyboard.

I find the lower profile less tiring because I can rest my entire arm on the work surface. Further, the RollerMouse has a DIP switch that lets you swap the left and right button functions, disable the drag buttons, and set cursor speed. On the other hand, the RollerMouse buttons have a slightly indistinct, mushy feel. RollerMouse lists for \$129.95 for serial and PS/2 versions, \$149.95 for the bus version, and \$119.95 for the Macintosh version.

## CONCLUSION

A few years ago PC users had a macho attitude towards mice and other alternate input devices. Nowadays, it's simply a question of utility. If you use graphical software, you need a pointing device. Almost any pointing device is better than none at all, but there are subtle differences between such devices that spell the difference between frustration and satisfaction. The best way to ensure satisfaction is to try before you buy. If possible, go to a computer store and try different models. But if you must buy blind, the Microsoft mouse is a pretty sure bet.

For trackballs, RollerMouse, and PC-Trac are both high-quality, refined instruments, but I give a slight edge to PC-Trac. As for choosing between a mouse and a trackball, in spite of ergonomic improvements, I still find a mouse less tiring. On the other hand, I appreciate the convenience of not having to clear space to use a trackball. I've been using both types of devices off and on for three years; only the latest generation of trackballs provides serious competition for a mouse.

# CIRCUIT CIRCUS

By Charles D. Rakes

## Test Gear For The Beginner

Once again it's time to drag out your junkbox and join me here at the Circus as I share a few circuits that I've worked up especially for your experimenting pleasure. There's one unique aspect about our hobby when it comes to experimenting with a new circuit; if we don't like the performance, we can dig in and modify or redesign it to meet our own special needs. Just about any circuit that's not buried in epoxy can be modified for better or worse.

Patience and a thorough understanding of the circuit's operation are a must if your modification is to be

him a simple and inexpensive capacitor checker. His only requirements were to determine if a capacitor was open or shorted, if it would withstand at least a 100-volt charge without breaking down, and, if possible, indicate a "rough" value of the capacitance.

And to make the job less difficult, all of the capacitor values would fall between 0.1- $\mu$ F and 0.5- $\mu$ F. The circuit in Fig. 1 meets the above requirements and shouldn't cost more than two or three dollars to duplicate. Power for the circuit is taken from any AC outlet and will cost zilch to operate.

neon lamp will glow for the time that it takes the capacitor to charge and then will slowly dim and go out completely. If the lamp remains on, or even shows a slight glow, the capacitor has an internal leak and should be discarded.

The value of the capacitor can be estimated by the time it takes the lamp to go out after S1 is pressed. The larger the capacitor's value, the longer it takes to charge and for the lamp to go out. Select several known values of capacitors in the range of 0.1 to 0.5  $\mu$ F and check each one, while noting the charge time. With a little practice, you'll

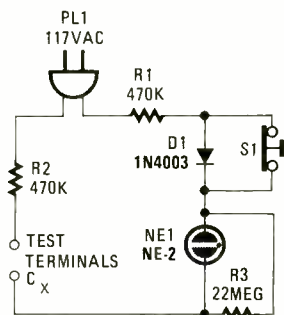

Fig. 1. This simple Capacitor Checker is ideally suited to the beginning electronics builder.

successful. In any case, proceed with caution and do nothing that can't be undone, so that, at the very least, you can go back to square one and either stay with the original or start over. Our circuits here at Circuit Circus are designed to be "modifier" friendly, so have at it.

### CAPACITOR CHECKER

Our adventure begins with a circuit that came about when an old-timer friend asked if I could build

### PARTS LIST FOR THE CAPACITOR CHECKER

D1—1N4003 1-amp, 200-PIV, general-purpose silicon rectifier diode

NE1—NE-2 neon lamp

R1, R2—470,000-ohm, 1/4-watt, 5% resistor

R3—22-megohm, 1/4-watt, 5% resistor

S1—Normally-closed pushbutton switch

Perfboard materials, enclosure, molded AC-power plug with line cord, test terminals, wire, solder, hardware, etc.

Here's how the checker operates. With power applied and nothing connected to the test terminals, the circuit draws no current so the neon lamp (NE1) is off. If a capacitor is connected to the test terminals (denoted  $C_x$ ), and if the capacitor isn't open, the lamp will glow. That test can be used to weed out open capacitors only, not shorted ones; the lamp would glow if the capacitor is good or even shorted.

Pushing S1 changes the voltage applied to the capacitor under test from AC to DC. If the capacitor is good, one element of the

be able to determine if the capacitor under test is near its marked value.

Also, capacitors with values less than 0.1  $\mu$ F can be successfully tested with the circuit. Just keep in mind that small-value capacitors require very short charging times, so you'll have to keep a close watch on the neon lamp to see the brief glow.

### SQUARE-WAVE SIGNAL GENERATOR

Our next entry, see Fig. 2, uses a 555 oscillator/timer as the basis of a variable-frequency audio square-wave generator that can be used as a square-wave

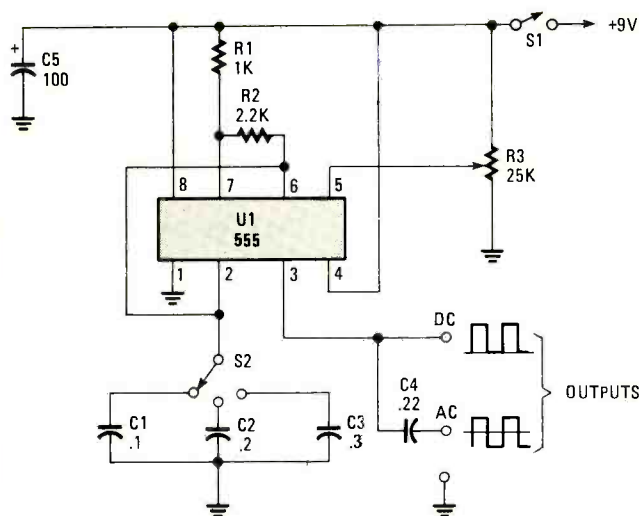

Fig. 2. Built around a 555 oscillator/timer, this audio-frequency, square-wave generator makes an inexpensive addition to your electronics workbench.

### PARTS LIST FOR THE SQUARE-WAVE SIGNAL GENERATOR

#### RESISTORS

(All fixed resistors are 1/4-watt, 5% units.)

- R1—1000-ohm
- R2—2200-ohm
- R3—25,000-ohm potentiometer

#### CAPACITORS

- C1—0.1-μF, ceramic-disc
- C2—0.2-μF, ceramic-disc
- C3—0.3-μF, ceramic-disc
- C4—0.22-μF, ceramic-disc
- C5—100-μF, 16-WVDC, electrolytic

#### ADDITIONAL PARTS AND MATERIALS

- U1—555 oscillator/timer, integrated circuit
- S1—SPST toggle switch
- S2—SP3T rotary switch
- Perfboard materials, enclosure, molded AC power plug with line cord, test terminals, wire, solder, hardware, etc.

or pulse generator for troubleshooting or to supply a drive signal for a new circuit design. The 555 (U1) is configured as a VCO (Voltage-Controlled Oscillator).

Switch S2 sets the frequency range of the circuit (from about 500 Hz to over 4 kHz), while R3 (which feeds U1's voltage-control input at pin 5) determines the actual operating frequency of the VCO. Additional ranges may be added, or the existing ranges changed, to go above and/or below the frequencies presently avail-

able. With S2 in the position shown (connected to C1), the circuit provides the highest output-frequency range available; as S2 is switched to C2 and C3, the frequency range decreases. (In other words, as the switched capacitance increases, the output frequency-range decreases.)

Extremely low-frequency operation can be obtained by using an electrolytic capacitor in the timing circuit. Just be sure to tie the negative end of the unit to ground and the positive end to S2.

### PARTS LIST FOR THE AC/DC INDICATOR

#### SEMICONDUCTORS

- Q1—2N3904 general-purpose NPN silicon transistor
- Q2—2N3906 general-purpose PNP silicon transistor
- LED1—Jumbo red light-emitting diode
- LED2—Jumbo yellow light-emitting diode

#### RESISTORS

(All resistors are 1/4-watt, 5% units.)

- R1—100,000-ohm
- R2—1-megohm
- R3, R4—470-ohm

#### ADDITIONAL PARTS AND MATERIALS

- S1—Normally-open pushbutton switch
- B1, B2—9-volt transistor-radio battery
- Perfboard materials, plastic enclosure, probe, alligator clip, battery holders and connectors, wire, solder, hardware, etc.

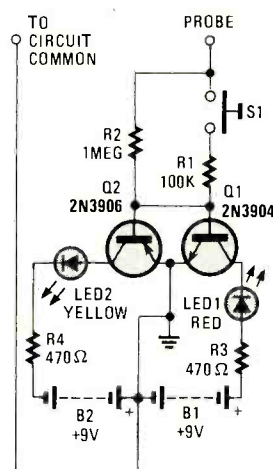

Fig. 3. The AC/DC Indicator can help you in your electronics lab by distinguishing between AC and DC signals, and more.

The output waveform is symmetrical near the center position of R3 and degrades as it approaches either end of rotation. Experiment with the values of R1 and R2 to modify the shape of the output waveform. The circuit also provides both AC- and DC-coupled output signals.

#### AC/DC INDICATOR

Our next circuit is a simple but extremely useful project that could become one of the most often used little test gadgets on your electronics workbench. The unit can distinguish between AC or DC voltages;

positive or negative DC voltages; and indicate the presence or absence of a voltage. Figure 3 is a schematic diagram of the AC/DC Indicator.

The circuit operation is simple. If the probe is connected to a positive source of 1 volt or more, current flows into the base of Q1 (a 2N3904 NPN transistor) turning it on, which then causes LED1 (red) to turn on, indicating a positive DC input. If, on the other hand, the applied voltage is negative, current flows to the base of Q2, causing LED2 (yellow) to light indicating a negative DC input.

If the probe is connected to an AC source, both LED's light alternately—yellow during the negative half cycle and red during the positive half cycle. The two LED's will alternate so rapidly that both units will appear constantly lit. Very low-frequency AC or pulsating DC will cause the LED(s) to turn off and on at the same rate. Switch S1 should be closed to check input levels below ten volts.

Since there are so few parts in the circuit, it can easily be assembled on perfboard and housed in a small plastic enclosure. The probe can be fabricated from almost anything from  
(Continued on page 91)

# FUN SOFTWARE

By Fred Blechman

## A "Top-Flight" Simulator, and More

I have "flown" and reviewed about two dozen flight simulator programs over the years, and Strike Aces is easily one of the best—if you have a reasonably fast machine (at least 10 MHz) and decent graphics (EGA or VGA).

Strike Aces does just about everything you could expect, except carrier landings. It does standard field takeoffs and landings, unlimited aerobatics, and has

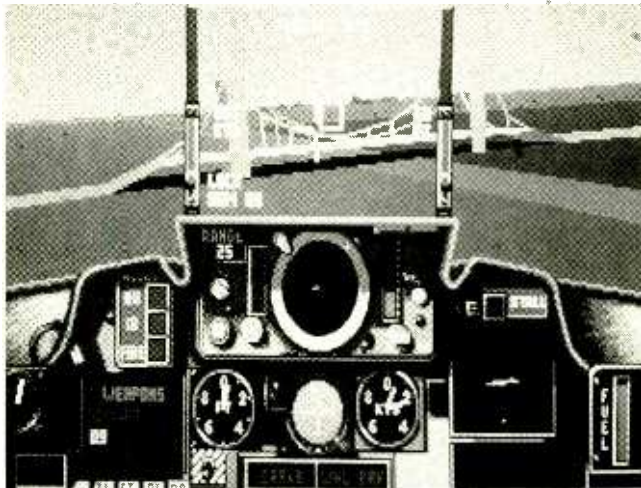

*Strike Aces from Accolade tests your flying skills in a wide variety of competitive settings.*

a very wide array of aircraft, weapons choices, and missions.

Instead of "real" combat, which might be limited to certain aircraft or missions, Strike Aces simulates an international competition involving your choice of six high-speed strike aircraft for you to pilot, and your choice of seven deadly interceptors as challengers. You can select payloads based on any of the air-to-air or air-to-ground bombing missions, or use defaults. A Mission Design feature lets you create additional missions. You even get to rendezvous with a refueling tanker—if you can!

The graphics and seamless animation of Strike Aces is exceptionally good with a fast machine that supports high-resolution graphics. I ran Strike Aces on three machines. One was a slow 4.77-MHz PC/XT with floppy drives and a CGA monitor. It worked, but screen updating was so slow (about once a second) that you could not effectively control the aircraft either from the keyboard or with a joystick. There was just too long a delay between control commands and implementation. There was a big improvement when I went to turbo (10-MHz) speed, but the control was still choppy. CGA graphics were surprisingly good considering the relatively low resolution and color limitations.

But Strike Aces really shined on my 12-MHz PC/AT with a VGA adapter. The color and graphics were outstanding, and the control was excellent. Unfortunately, I was restricted to keyboard use; a joystick created uncontrollable rolling. There is no joystick calibration evident in the program, and I had the same problem with different joysticks. Adjusting the joystick trimmers had virtually no effect. While I personally prefer joystick operation, I found the keyboard cursor keys sufficiently responsive.

The most important panel instruments are included, although I missed a rate-of-climb indicator when landing, or refueling from the tanker. The heads-up and instrument displays are clear and easy to read, and the three most important readings (altitude, airspeed, and direction) are

displayed even when you select a full-screen that eliminates the entire cockpit. There are all kinds of external view choices, including tracking your own aircraft from about 250-feet behind.

With the 12-MHz AT, I used a hard drive, but the short delays when using a floppy are not bothersome. I would assume that by the time you read this, the AT/joystick problem will be corrected, which should make some critical functions (like landing and tanker refueling) more easily accomplished. After only a short time I was able to land successfully almost every time, but I spent a couple of hours practicing refueling with only one successful hookup. The other couple of dozen tries resulted in missing the "basket" with my refueling probe, and colliding with the tanker at least five times—which, I guess, makes me a "tanker ace!" Here's a big hint that's not mentioned in the manual: the tanker is flying on a heading of 180° at about 370 knots and 30,000 feet—although the altitude and speed seem to vary slightly, especially when you are about to snag the basket!

Seven practice scenarios are available before going into competition. You can choose free-flight at 30,000 feet; ready for takeoff; lined-up for a landing; heading for a bridge (pull up fast or you'll crash into it!); heading straight for Mount Rushmore; right over Rapid City, South Dakota; or within sight of the refueling tanker.

The four 360K 5.25-inch diskettes provided include the game disk, and dif-



ferent disks depending on your display: CGA, EGA, VGA, Hercules monochrome, Tandy 16 color. Although the diskettes are not copy protected, you need a four-digit code from a circular 3-layer code-wheel to gain admission to the program. You can send your original game disk with a form provided and \$5 for 720K 3.5-inch micro-diskettes.

The 5- by 7-inch 64-page staple-bound manual is well written and highly illustrated. Between the detailed manual and the complexities of the program, I doubt if you'll be ready for competition without at least ten hours of practice before choosing a mission. There are enough variations and challenges within Strike Aces that you may never need another combat flight-simulator program. You can easily spend tens of dozens of hours with this program just as it is.

Me? I'm still trying to refuel without wiping out another huge tanker and its crew!

*(Accolade, 550 South Winchester Blvd., Suite 200, San Jose, CA 95128; Tel. 408-985-1700. Retail Prices: IBM PC/Tandy/Compatibles or Amiga: \$49.95; Commodore 64/128: \$39.95.)*

**CIRCLE 124 ON FREE INFORMATION CARD**

## EGOTRIP

Here's a fun program that's somewhat off the beaten path. Graphology, the analysis and interpretation of handwriting, has been a controversial "science" for many years. Proponents claim that handwriting can be a window into the personality of the writer, revealing behavioral traits, moods, feelings, attitudes, ambitions, emotions, and other traits.

Apparently graphology is widely accepted by criminologists, psychologists, and

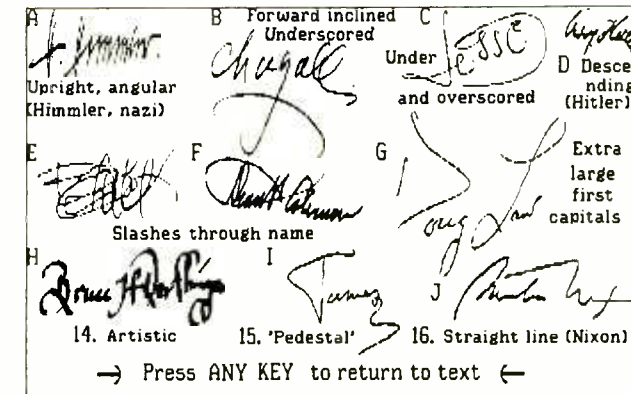

*EgoTrip introduces you to the science of graphology, more commonly known as handwriting analysis.*

some employers, and when used by experts in the field is claimed to be close to 100% accurate.

I make no claims whatsoever except that "EgoTrip" is an easy program to use, and that it ought to be great fun at parties. Based upon some authoritative texts, EgoTrip has you respond to over 120 questions on 17 text screens, with another 16 graphic screens that show all kinds of writing samples to help you answer the questions.

Obviously, you start with a writing sample—the longer, the better. Then you progress through the text screens, which ask you about specific characteristics of the writing sample. In each case, you hit the F1 key and the appropriate graphic writing samples appear, illustrating the different characteristics presently under discussion.

EgoTrip will not attempt to analyze writing that is all in block letters, or calligraphy, but upper/lower case script "printing" is fine. Analysis is limited when only a signature is provided, and some additional considerations are described when analyzing a child's writing.

No results are disclosed until you have answered all the questions, after which you can get a screen or printer report. The printed report is typically almost two single-spaced pages in

length, or about four full screens. Several references are made to the fact you are probably not an expert in handwriting analysis, so your judgment in answering the questions may lead to less than perfect results. Accordingly, you are warned that any decisions you make based on the use of the program are at your own risk. EgoTrip is recommended for entertainment and educational purposes only.

The files are provided in compressed form if you receive EgoTrip on a 360K 5.25-inch floppy disk. If you have a 720K or 1.44MB 3.5-inch drive, request that format (no extra charge) since the files are provided in normal form.

A nicely printed 5.25- by 7.5-inch staple-bound 28-page manual is included. This is very handy, since it contains all the screen text, questions, and graphic screens. You can proceed without the manual, since it is merely a convenience. However, after you get the results, it is handy to refer back to it to correlate the terms used in the report, such as "middle zone," "cross bars," and other terms that are clearly described and illustrated in the manual.

I tested EgoTrip on three different PC/XT's and two PC/AT's, running from 4.77 MHz to 12 MHz, with and

without floppy drives, and with CGA or VGA. The software will not work with a Hercules or clone monochrome-graphics adapter. Speed differences were not significant, and neither was the difference between hard drive and floppy use.

EgoTrip is easy to use, it's fun, and—based on my own analysis of my own handwriting—reasonably accurate, even when used by a non-graphologist. I've never been so politely insulted in my life!

*(H.C. Jacoby, Inc., 7433 Varna Ave., North Hollywood, CA 91605; Tel. 818-763-5004. Price: \$28 plus \$3 shipping. Requires IBM PC/XT/AT/PS2 or compatible, DOS 3.0 or better, 128K RAM, CGA/EGA/VGA hard drive or 720K 3.5-inch drive.)*

**CIRCLE 125 ON FREE INFORMATION CARD**

## THE ENTER-TAINER

Here's an entertaining and educational software package that contains 300 music and sound effect programs for you to listen to, or "clip" into your own BASIC programs, royalty free!

Be forewarned, however, that the "music" played by this program may be downright offensive to your ear if you are a musical connoisseur. The ENTER-tainer can do no better than the hardware and the BASIC interpreter allows.

You don't need anything special to run The ENTER-tainer. I tested it on a plain-vanilla IBM PC/XT running PC-DOS 2.1 at 4.77 MHz using only one 360K 5.25-inch floppy drive and either a monochrome or color display. Color is nicer, but not required. It doesn't matter what your computer clock speed is, since BASIC uses a hardware timing chip that is independent of machine clock speed to

*(Continued on page 100)*

# HAM RADIO

By Joseph J. Carr, K4IPV

## A Homebrew Antenna For The Cheapskate

I'm cheap, just ask anyone who knows me. When it comes to parting with my money, even for so grand an enterprise as ham radio, I'm as tight as a hotband. I view myself as a true conservative (read that skinflint) when it comes to buying radio stuff, although my wife would probably become hysterical with laughter over that one! (I

bet she thinks I'm one of ham gear's more prolific spenders.) Seriously though, not all of us have a lot of money to spend, and for such people it is difficult to afford a large antenna array.

So this month, we are going to look at a very cheap vertical that I put up once-upon-a-time. That antenna was quite versatile, and worked very well for a number of years. The only reason it's not still standing is that I moved—and a non-ham bought the old QTH, and looked darkly at that antenna thing on the back of the house.

The mechanical construction details of the antenna are shown in Fig. 1. The antenna was mounted to the house (a cinder-block wall) using a pair of six- or eight-inch (as needed to clear the rain gutter at the roof line) TV-antenna stand-off brackets, which can be bought at electronics parts distributors like Radio Shack, which was the source of mine. I found it prudent to back-up the brackets with segments of 2- x 4-inch lumber between the bracket and the cinder-block wall. The 2 x 4 tends to distribute the weight of the antenna a bit, and so can be especially useful on wood or types of walls other than cinder block.

The 2 x 4 sections were attached to the wall with ordinary lag bolts (the kind with the little expandable wings). Be careful to locate the holes in the cinder block at points where the block is hollow. The center line on a cinder block is solid, so you'll need to offset the holes a little bit. You can

make the holes with either a carbide drill bit or with a manually operated star drill. Of course, you should wear approved safety goggles when making the holes. (I'm not an ophthalmologist, but it's obvious to me that the little bits of flying cinder block can do quite a bit of damage to the eyes.)

The main antenna support was made from a convenient length (6 or 8 feet) of treated 2 x 4 lumber. You can use ordinary construction grade 2 x 4, the kind used for studing or framing, but it should be treated with several generous layers of spar varnish or polyurethane coating. Otherwise, use 2 x 4 treated for outdoor use. The kind sold for building unpainted outdoor decks is the type needed.

The radiator element (which we'll cover in a moment) is held to the 2 x 4 support using either beehive insulators, or (because beehive insulators are increasingly difficult to find at a reasonable price) by a clamp. Use an insulated clamp (such as a hose clamp or extra large wire clamp) made of plastic, rubber, nylon, or some other insulating material. If the clamp does not protect the side of the radiator element that would be in contact with the 2 x 4, then insert a plastic or lucite block between the clamp and it with 1/4-20 bolts.

The radiator element was made of aluminum tubing or pipe. For the upper high-frequency bands (17 meters and up), it might be possible to use a single section. But even at those frequen-

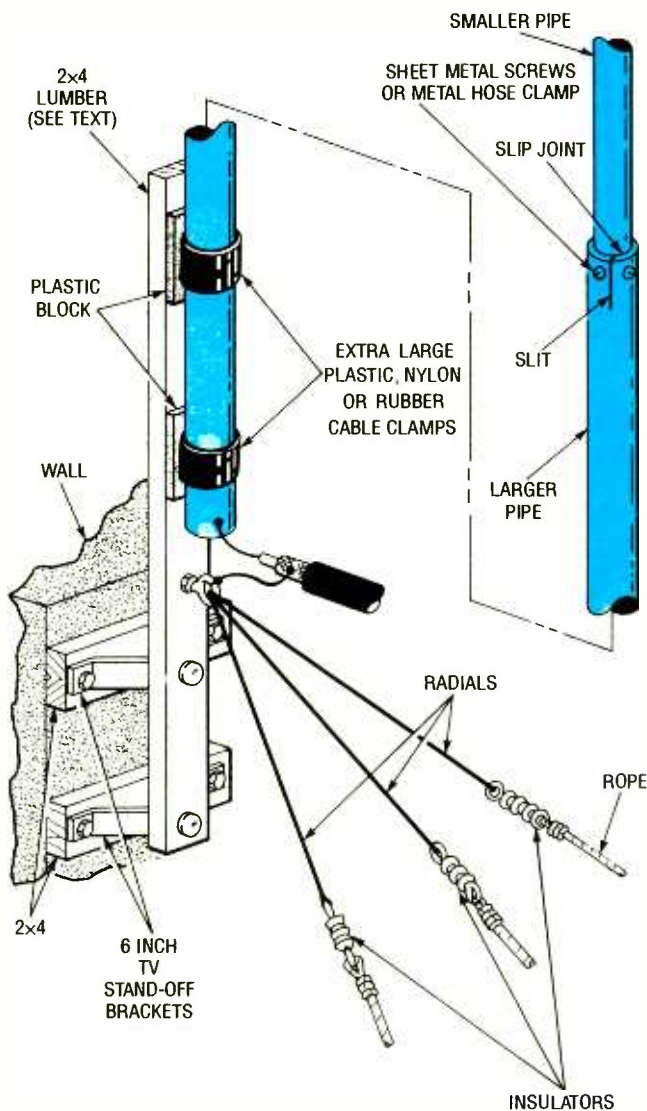

Fig. 1. The mechanical construction details of my vertical antenna are shown here. The antenna radiator was assembled from lengths of aluminum tubing, and was then mounted to the house using a pair of six- or eight-inch TV-antenna stand-off brackets.

cies, two-section construction is preferred because it allows easy adjustment of the overall length during the tuning process.

Keep in mind when selecting tubing that adjacent sizes will form a slip fit. In other words, the outside diameter of the smaller tubing is the same (or nearly so) as the inside diameter of the next-larger size tubing. Use as large a diameter pipe (1-inch or more) as you can find for the larger of the two pipes. Cut a 2-inch slit in the upper end of the larger pipe, so that slipping the smaller pipe into the larger one is made easier. The slit, once the smaller pipe is inserted in the larger one, will be compressed with a hose clamp or sheet metal screw when the antenna is finished.

The length of the radiator element depends on what you want to do with the antenna. If it is a single-band antenna, then the length is simple to calculate:

$$L = 234/f$$

where  $L$  is length in feet and  $f$  is frequency in megahertz. The length found from the above equation must be adjusted for ground effects and other anomalies. Keep in mind, however, that this is a starting length, and the actual length should be found by the cut and try method (i.e., tuning).

Cut the two pieces of aluminum tubing to allow about 8 to 12 inches more length than is needed. The extra length not only gives you some adjustment room, but also makes the joint between the two sections a bit stronger.

The radials are made from #14 or #12 wire, and are a quarter-wavelength long. The radial lengths are found from the same formula as the radiator element, except that the 234 is replaced with 246; e.g.,  $L = 246/f$ .

### MULTIBAND OR WIDEBAND OPERATION

The radiator element of a vertical antenna need not

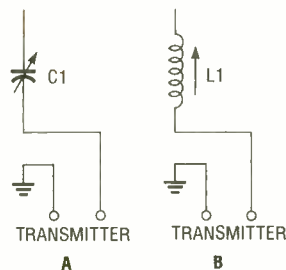

Fig. 2. A capacitor (A) can be connected in series with the antenna to electrically shorten it; placing an inductor (B) in series with the antenna electrically lengthens it.

be resonant if some operational limitations are an acceptable trade-off for convenience. The resonant antenna works best, for most situations, but it is quite possible to modify the frequency of a vertical by using either an inductor or a capacitor. A series capacitor (see Fig. 2A) will reduce the effective length of the antenna. That is, it will raise the effective resonant frequency. A change of electrical length of about 15 to 25 percent is practical using that method. I bought a motor-driven, vacuum-variable capacitor with a maximum capacitance of 1000 pF at a hamfest. That capacitor is ideal because it can be operated with a 6- to 28-volts DC power supply from the operating position inside the house.

A series inductor (as shown in Fig. 2B) will lower the resonant frequency; using that scheme, it is quite possible to make the antenna work on almost any HF band even with as little as 8-feet of radiator. Mobile antenna manufacturers use that trick all the time. The inductor can be a fancy rotary inductor, such as might be used in an antenna tuner, or it might be a fixed coil.

The coil can be tapped at various points to provide for other bands (I recommend using a proper RF

switch or relay rather than alligator clips for the coil tap selection—the alligator-clip tap method apparently can catch fire and destroy the coil's plastic supports).

Another method of making the antenna work on other bands is to use an antenna tuner at the base. In this case, the antenna acts like a random-length wire antenna, rather than a simple vertical, but it will work on all bands if the tuner has a wide enough range (some coax-to-coax models do not).

### SAFETY NOTE

Vertical antennas work well, and are cheap to install, but they also present some dangers. By far the most critical safety problem is making sure that it is installed in a location where it absolutely cannot fall over and hit the AC power line (either during installation or after having been erected). There is no such thing as a safe electrical line, and any antenna that falls against electrical power lines can cause fatal injuries to the installer.

Also, make sure that the materials used for the antenna are sturdy enough so that the antenna won't fall onto the line if it comes down in a storm, wind or otherwise. Potential wind conditions vary from one locale to another, but you probably know better than I what might happen at your QTH. It also a good idea to make certain that the materials and method of construction are sturdy enough to satisfy the local codes.

Antennas "on the cheap" need not be terrible performers, nor need they, in any way, be second rate. Amateur radio operators have traditionally been quite eager to experiment with antennas, and indeed have extended the state of the art on occasion. ■



Here is what my antenna actually looked like. Six to eight lengths of  $2 \times 4$  were first mounted to the wall to provide a stable mounting surface for the antenna.

# DX LISTENING

By Don Jensen

## Diversity From The Asian Continent

To the serious DX listener, Asia offers a wide spectrum of fascinating shortwave targets. It's a place that tickles the imagination, and is both exotic and exciting. There is, in fact, no one Asia. Asia is diversity, running from the Arctic to the palm-lined shore of the Indian Ocean, from the high peaks of the Himalayas to the arid Gobi, from the Pacific, thousands of miles westward to its common border with Europe. The continent includes one-third of the Earth's land mass. Its people

are yellow and brown and white. They speak scores of languages and dialects. And nowhere is that babel of language more apparent than on the shortwave bands.

For the newer SWL and the more experienced listener, let's take a look at just some of the stations that operate from Asia, some of which easy to hear, while other are considerably more difficult; some of those broadcasters offer English programming, while others broadcast in their native languages.

In the mideast, North American listeners should find Iraq's *Radio Baghdad* an easy one during its English broadcast to Europe at 2000 UTC on 11,720 and 13,660 kHz. English-language programming beamed to North America can be heard on 11,830 kHz, from 0130 to 0330 UTC.

Vietnam's home service programming from the regional station at Son La has been reported on 4,676 kHz at around 1200-1400 UTC. Another station with programming in the Vietnamese language is the transmitter at Hoang Lien Son, which has been noted on 5,600 and 6,600 kHz, at 1200 UTC.

Although probably not logged as often as the two other SW'ers on the Indian subcontinent, *All India Radio*, *Radio Pakistan*, and *Radio Bangladesh* have

been reported on 11,862 kHz around 1830 UTC with its English broadcasts intended for Europe.

China's *Radio Beijing* can be found with English programming at 1200 UTC on 17,855 kHz. *United Arab Emirates Radio* at Dubai on the Persian Gulf is being heard on 21,605 kHz at about 1330 UTC and also at around 1600 UTC.

The *British Broadcasting Corporation* has rebroadcasts of its World Service programs aired by several Asian relay stations, including one at Singapore. You may find world news via this transmitter at 1700 UTC on 15,310 kHz. *Radio Korea*, from Seoul, South Korea, is heard at around 0100 UTC on 9,750 kHz.

### LEARNING YOUR LINGOS

It's no easy game when the announcers are speaking some unidentified language and you know only English. It's tough, especially for the newer SWL to figure out whether the program he's just tuned in is in Arabic, German, Japanese, or Spanish. Or maybe it's Swahili or Amharic! Fortunately, there is help. The Ontario DX Association again is making available a 90-minute audio cassette, the "Foreign-Language Recognition Course."

The tape was originally produced and aired by *Radio Canada International* and was last available on cassette in 1983. The course consists of spoken and identified examples of 55 different languages, which have been broadcast on shortwave, along with comments by language expert



This cartoon mascot, Galo the Galapagos Tortoise, appears on the program schedule of HCJB, the Voice of the Andes, one of South America's pioneer shortwave broadcasters. He is decked out for the beach, reminding North American SWL's that although it's winter here, southern hemisphere SW stations are experiencing summer. And Galo's Panama hat, despite its name, originates in Ecuador, too.

\*Credits: Larry Royston, HI; Pete Tutak, WA; Adrienne Barhydt, OR; Brian Alexander, PA; David Clark, ONT.; Richard Wallace, CT; Richard D'Angelo, PA; North American SW Association, 45 Wildflower Road, Levittown, PA 19057.

and DX'er, Dr. Richard E. Wood. Dr. Wood gives many useful tips on pronunciation and explains how you can recognize the different languages you hear on SW.

The tape is designed to give the SWL the basic means to recognize and sort out the jumble of different languages heard on shortwave. Once you've got a clue as to the language you're hearing, it is that much easier to determine from which country the broadcast originates. The Foreign Language Recognition Course is available from ODXA, PO Box 161, Station A, Willowdale, Ontario, M2N 5S8, Canada for \$5 postpaid to locales in the U.S.; six dollars in Canadian funds for residents of Canada. ODXA is donating the proceeds to a program to assist handicapped Canadian SWLs.

### OUT OF WORK?

What happened to East Germany's "spooks?" It's a question SWLs may well be pondering. For years, listeners had noted the so-called numbers stations, some of them broadcasting in German, and rightly assumed that the monotonous, mechanical readings of 5-digit number groupings, were coded spy instructions.

With the unification of Germany last year, those numbers transmissions, which had fascinated and mystified SWLs for the past 40 years, ended. As a communications system in a technological age, the system seemed crude, but apparently it was effective and inexpensive. It didn't really take much investment to outfit an East German agent with a code pad and a simple shortwave receiver that could pull in the signals on 3,220 kHz.

Western intelligence sources estimate that when the Berlin Wall came tum-

bling down, East Germany had as many as 5,000 spies undercover in the western Federal Republic and another 2,000 elsewhere in Europe. But where are they now? Despite promises of amnesty by the West German government, only several hundred of those spies (according to reports)—many of whom presumably took West German citizenship and blended into society there years ago—voluntarily came in from the cold.

Presumably, most of them are still out there, laying low and wondering if someday, some new spy boss will resume sending coded instructions on the shortwave bands.

### DOWN THE DIAL

What are you hearing on the SW world bands? Why not share your receptions. The address is *DX Listening*, Popular Electronics, 500-B Bi-County Blvd., Farmingdale, NY 11735. Here are some recent reports:

**NIGERIA**—6,050 kHz.

*Radio Nigeria's* domestic service from Ibadan, in the northern part of this African country, has been noted in English at around 0530 UTC, with African pops, an identification, and a newscast.

**TAIWAN**—7,445 kHz. The

*Voice of Asia* has been heard on this frequency during the morning hours, after 1135 UTC, with news and a Chinese language lesson for English-speakers.

**USSR**—12,060 kHz. *Radio Kiev* is one of several Soviet listening alternatives to

*Radio Moscow*. English programming—news, music, reports from the local newspapers, etc.—can be heard at around 2300 UTC.

**VENEZUELA**—9,540 kHz.

*Radio Nacional* in Caracas signs on the air shortly after 1100 UTC. It is in Spanish, but the station identification isn't hard to catch if you listen carefully. ■

## AMAZING SCIENTIFIC & ELECTRONIC PRODUCTS

PLANS ARE IN STOCK		
GRA1	ANTI GRAVITY GENERATOR	\$10.00
LC7	40 WATT BURNING CUTTING LASER	\$20.00
RUB4	HI POWER PULSED DRILLING LASER	\$20.00
BTC5	1 MILLION VOLT TESLA COIL	\$20.00
MCP1	HI VELOCITY COIL GUN	\$15.00
LLS1	LASER LIGHT SHOW 3 METHODS	\$20.00
EH1	ELECTRONIC HYPNOTISM TECHNIQUES	\$8.00
EML1	LOWER POWERED COIL GUN LAUNCHER	\$8.00
JL3	JACOB LADDER 3 MODELS	\$10.00
SD5	SEE IN THE DARK	\$10.00
LEV1	LEVITATION DEVICE	\$10.00

KITS ASSISTANCE PROGRAM AVAILABLE		
FMV1K	3 MILE FM VOICE TRANSMITTER	\$34.50
PFS1K	HAND CONTROLLED PLASMA FIRE SABER	\$49.50
NIG7K	HI FLUX NEGATIVE ION GENERATOR	\$34.50
PG5K	PLASMA LIGHTNING GLOBE	\$49.50
LHC2K	VISIBLE SIMULATED 3 COLOR LASER	\$44.50
HOD1K	HOMING/TRACKING BEEPER TRANSMITTER	\$44.50
LGU6K	2.5 MW HAND-HELD VISIBLE LASER GUN	\$249.50
BTC3K	250,000 VOLT TABLE TOP TESLA COIL	\$249.50
IOG2K	ION RAY GUN, project energy without wires	\$129.95
TKE1K	TELEKINETIC ENHANCER/ELECTRIC MAN	\$79.50
VWPM7K	3 MILE AUTO TELEPHONE TRANSMITTER	\$49.50

ASSEMBLED	ASSEMBLED IN OUR LABS	
LIST10	INFINITY XMTR Listen in via phone lines	\$199.50
IPG70	INVISIBLE PAIN FIELD BLAST WAVE GENERATOR	\$74.50
ITM10	100,000 VOLT INTIMIDATOR UP TO 20"	\$99.50
TAT30	AUTOMATIC TELEPHONE RECORDING DEVICE	\$24.50
PSP40	PHASOR SONIC BLAST WAVE PISTOL	\$89.50
ONE10	ALL NEW 26" VIVID COLORED NEON STICK	\$74.50
LGU20	5 TO 1MW VISIBLE RED HeNe LASER GUN	\$199.50
BLS10	100,00 WATT BLASTER DEFENSE WAND	\$89.50

**EASY ORDERING PROCEDURE** - TOLL FREE 1-800-221-1705 or 24 HRS ON 1-603-673-4730 or FAX IT TO 1-603-672-5406  
VISA, MC, CHECK, MO IN US FUNDS. INCLUDE 10% SHIPPING. ORDERS \$100.00 & UP ONLY ADD \$10.00. CATALOG \$1.00 OR FREE WITH ORDER.

**INFORMATION UNLIMITED**  
P.O. BOX 716, DEPT. PN, AMHERST, NH 03031

# ATTENTION! ELECTRONICS TECHNICIANS



## EARN YOUR B.S.E.E. DEGREE

### THROUGH HOME STUDY

Our New and Highly Effective Advanced-Placement Program for experienced Electronic Technicians grants credit for previous Schooling and Professional Experience, and can greatly reduce the time required to complete Program and reach graduation. No residence schooling required for qualified Electronic Technicians. Through this Special Program you can pull all of the loose ends of your electronics background together and earn your B.S.E.E. Degree. Upgrade your status and pay to the Engineering Level. Advance Rapidly! Many finish in 12 months or less. Students and graduates in all 50 States and throughout the World. Established Over 40 Years! Write for free Descriptive Literature

## COOK'S INSTITUTE OF ELECTRONICS ENGINEERING

4251 CYPRESS DRIVE  
JACKSON, MISSISSIPPI 39212

CIRCLE 9 ON FREE INFORMATION CARD

# SCANNER SCENE

By Marc Saxon

## Digging Into The Mail Bag!

When word got out that Radio Shack was coming up with a new handheld scanner, rumor had it that it was going to replace their famous PRO-34 handheld. Thanks to the powers-that-be at Tandy, the rumor proved to be unfounded. The new PRO-36 is an addition to the product line, but the PRO-34 remains in the catalog.

The PRO-36 is a 20-chan-

nnel scanner, which includes the VHF aeronautic band and all of the valuable 406–420-MHz federal band that some handhelds either skimp on or else ignore completely.

This scanner has the standard channel lockouts, switchable two-second scan delay, keyboard lock to avoid accidental entries, and a backlit LCD readout. The PRO-36 scans at eight channels per second. Selectivity is rated as +10 kHz at -6 dB, +20 kHz at -50 dB.

Physically, it is just over six inches tall, 2½ inches wide, and 1½ inches deep. It has a BNC connector, an ear-phone jack, and a belt clip, plus a jack for an optional external antenna. The set runs on six AA-size rechargeable batteries or on an optional AC or DC adapter. A memory-backup circuit maintains the frequencies when you change the batteries.

The PRO-36 looks to us like a nice addition to the Radio Shack scanner lineup. See it at any of Radio Shack's 7,000 retail outlets.

### INTO THE MAIL SACK

A letter from Forrest Ray, of Twin Falls, ID, poses a commonly asked question. Forrest has a scanner (in his particular case, a Regency Turbo-Scan) that picks up all of the standard bands. But he wants to get in on monitoring the action taking place in the 225–400-MHz military-aeronautic band. He wants to know if there are any modifications or accessories that can

bring that band into his scanner.

In a word, the answer is "no."

That swath of frequencies spans 175-MHz worth of spectrum. The military-aeronautic communications there are in AM mode, and (with a few 50-kHz exceptions) the channels are spaced at 100-kHz increments. That makes the band rather difficult to add to the functions of regular scanners. We know of no companies presently manufacturing converters—like the one you can get to hear the 800–900-MHz band on your UHF scanner—to accomplish the task.

It appears that the only way to tune in on that interesting band is to buy a scanner that was designed for the job. That would include (among others): Radio Shack's PRO-2004, PRO-2005, and PRO-2006; and AOR's AR1000, AR2515, and AR3000.

A note from Steve Fleckenstein, Middletown, NY advises that he runs a computer bulletin board (BBS) for scanner enthusiasts. He calls his BBS the "Red Onion Express," and it operates 24 hours a day, every day, at 300, 1200, and 2400 baud. It's free and open to anyone with a computer or terminal and a modem. The text files are not compressed, so that callers with non-IBM compatible computers can read the files. Steve tells us that the BBS has files that contain frequencies, PC programs for logging fre-



Not a replacement for the PRO-34, Radio Shack's PRO-36 stands on its own merits. The 20-channel programmable picks up some interesting bands that many other handhelds omit.

nel programmable that is selling in the \$200 price range. Frequency coverage is 30–54 MHz, 108–174 MHz, and 380–512

quencies, and other information. The telephone number is 914-342-4585.

Brendan S. McCormack of Greensburg, PA, suggests that when driving through McDonald's, try tuning the car's radio to 105.1 MHz, which is in the standard FM broadcast band. Many McDonald's restaurants use 35.02 MHz at their drive-up windows, and the third harmonic of that frequency falls on 105.06 MHz. You might just be close enough to pick up that harmonic and hear some of the great—rude—comments over those intercoms. The remarks might offer opinions on the customers' cars, wives, orders, etc. If they say something about you, make sure to astound them by repeating it when you pull up to the window to get your Big Mac and pay your tab.

Brendan also notes that the Pennsylvania Department of Corrections operates on 45.16 MHz.

## MAKING MODIFICATIONS

A letter from Magella Bouchard, Riviere-du-Loup, Quebec, describes a modification attempted on a Realistic PRO-2003 in an effort to add coverage of 68–88 MHz, 380–410 MHz, and 800–900 MHz. Three diodes were clipped out. But, although those frequencies now appear on the display, Magella discovered, getting numbers to show up on a display doesn't necessarily mean that a scanner has been made operational on the bands that have been apparently added.

Frequency modifications can (easily) be added on any number of scanners by clipping out specific diodes, the PRO-2003, however, isn't one of those known to produce worthwhile results. The diode-clipping trick works only in instances where the scan-

ner was originally designed to have the ability to receive those bands, but that ability was blocked out (for whatever reason) at the factory by the manufacturer. To do that, the manufacturer places diodes at certain locations on the scanner's central processor unit (CPU). That effectively cuts out your ability to program in the deleted frequencies.

But keep in mind that the ability of a scanner to operate involves more than the CPU chip. The scanner also requires VCO, mixer, and preselector circuits that will function on all of the bands for which the set is designed to function. While the CPU chip in sets such as the PRO-32, PRO-2002, PRO-2003, and PRO-2021 might be identical to the one used in other scanners that had some frequencies blocked out at the factory, it doesn't necessarily mean that every scanner in which it is used has the other operating circuits required for such reception. In such sets, the diodes were factory installed just to avoid confusing the user into thinking that reception was possible on those frequencies simply because they could be brought up on the display. Restoring the ability of the display to show those frequencies doesn't always restore the ability to receive them.

Sets known to be able to have blocked-out frequencies restored include the Radio Shack PRO-34, PRO-2004, PRO-2005, and PRO-2006; Bearcats BC760/950XLT, and BC200/205XLT (Regency R4030); and, possibly, some versions of the Realistic PRO-2021.

If you have any questions, comments to pass along, we hope to hear from you. Our address is *Scanner Scene*, **Popular Electronics**, 500-B Bi-County Blvd., Farmingdale, NY 11735. ■

## CIRCUIT CIRCUS

(Continued from page 83)

a ballpoint-pen housing and a nail to an old meter probe. In any case, attach the probe to one end of the enclosure in a location where the two LED's can be easily seen when the probe is in use.

Also locate S1 in a convenient position so it can easily be pressed while making a test. Use a 24-inch length of test lead wire with alligator clip attached at one end for the circuit's ground return lead. A power switch may be added to the circuit if desired, but it's really not necessary because the standby current is too low to measure.

## DC ADAPTER

How many times have you needed to use a battery-operated device only to find out too late that the batteries have gone dead. Even if your batteries are always good, you might still consider the circuit in Fig. 4 as a way to save the batteries for a real emergency.

The circuit in Fig. 4 is a simple series regulator that can supply about 1 amp at 6 or 9 volts to an external load. The circuit can be used to run most radios and other similar battery-operated devices. And if you happen to need an output other than 6 or 9 volts, you can either replace one of the Zener regulators or substitute a three position

### PARTS LIST FOR THE DC ADAPTOR

#### SEMICONDUCTORS

Q1—2N3055 NPN silicon power transistor  
D1—6.6 to 6.9-volt, 1-watt, Zener diode  
D2—9.6 to 9.9-volt, 1-watt, Zener diode

#### ADDITIONAL PARTS AND MATERIALS

R1—270-ohm, 1-watt, 5% resistor  
R2—1000-ohm, ½-watt, 5% resistor  
C1, C2—470-µF, 25-WVDC, electrolytic capacitor  
S1—SPDT shorting-type switch  
Perfboard materials, enclosure, 3 × 3-inch piece of aluminum (see text), output jacks, wire, solder, hardware, etc.

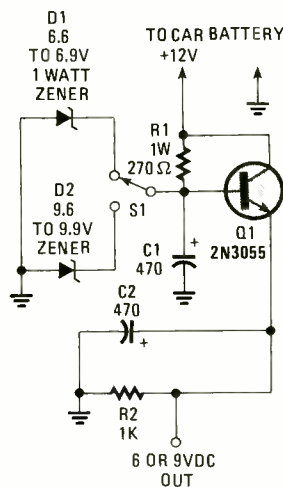

Fig. 4. This simple regulator circuit uses a power transistor in a common- or grounded-base configuration.

switch for S1 and add another suitable Zener diode.

If you are going to take the latter route, keep in mind that the regulator's output is going to be about 0.6 volt less than the Zener diode's rated voltage.

Since there are only eight parts to the circuit, you can follow any construction scheme as long as you heat sink the power transistor sufficiently. A 3- × 3-inch piece of aluminum will suffice. Switch S1 should be a shorting-type rotatory switch (that's the one that connects with the new contact before breaking with the old). ■

## ANTIQUE RADIO

(Continued from page 79)

is set to 10), being just a bit on the high side. Resistor R2 drops it to the correct value. Section S2-b of switch S2 cuts filament power to SO5 when S2 is switched to HI. Otherwise, the voltage boost could easily burn out a type 80 accidentally left plugged into SO5.

Resistor R6 is also used to drop a too-high filament voltage. It's placed in series with the filament line (by opening switch S8) when testing type-11 or -12 tubes. The filaments of those tubes are rated at 1.1–1.2 volts, but the regulated filament supply can't be adjusted much lower than 1.3 volts. It's a small difference, but 11's and 12's are difficult to get and expensive. With R6 cut into the circuit, the 11 or 12 filament voltage drops to just about the correct value.

On this new schematic, as on the simplified version shown in October 1990, 4-pin triodes are tested at socket SO1—which is the standard friction-fit version used for long-pin tubes. But you'll notice a new socket to the left of SO1, labeled SO1a–c. That actually represents three specialized sockets—also for 4-pin triodes. One is the familiar bayonet-lock socket for holding short-pin type 01A's; another is a smaller ("Bantam") version of the socket, for accommodating short-pin type 99's; the third is a friction-fit socket for accommodating type 11's, which have long pins in an odd configuration.

When wiring in those special sockets, simply connect like terminals on the socket to like terminals on the tester: plate to plate, grid to grid, etc. Be careful, though; only the socket for short-pin 01A's should be wired according to the pattern of the SO1 and SO1a–c sockets shown on the

schematic. The socket connections for the type 99 short-pin and type 11 don't conform to the standard, and are illustrated in Fig. 2. Those connections are shown looking at the bottom of the socket, which is also the case for the socket connections on the schematic diagram.

## MORE ON METERS

As you know, Meters M1 and M2 are both milliammeters. I happen to be using a 0–15 mA meter at M1. That size is perfect for measuring plate current during most tube tests. But to check type-80 rectifier tubes, you have to deal with plate currents on the order of 100 mA. For that reason, I constructed shunt R3 (see last month's column) which, when switched in by S6, converts M1 to a 0–150 mA meter.

Meter M2 is used to measure the filament voltage supplied by the adjustable regulated power supply. It's basically a 0–2 mA unit, but it's been converted to read either 0–2 volts or 0–20 volts by switching in series resistances R7 or R8 via switch S9.

Those who don't want to search out used flea-market meters as I did can make use of Radio Shack's 0–15 volt panel meter (cat.# 270-1754). This is really a 0–1 mA meter having an external 15,000-ohm series resistor. Its calibration reads 0–15.

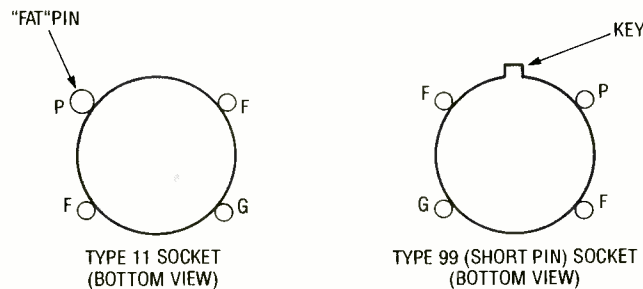
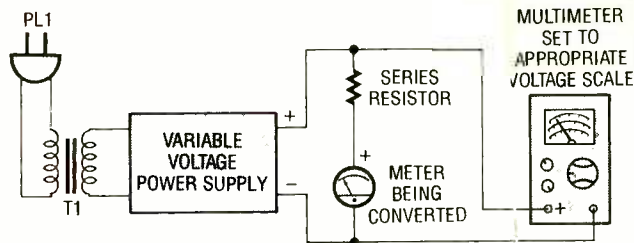

Fig. 2. Connections for Type-11 and Type-99 (short-pin) sockets. The Type-99 long-pin tube has standard pin configuration and is tested in a normal socket (SO1 in Fig. 1).



Oops! The multimeter was shown connected incorrectly in Fig. 2A of last month's column. Here's the proper method

Use one such meter at M1, discarding its series resistor and adding a pair of shunts (one permanently connected across M1 to make it read 0–15 mA; the other switchable, like R3 in the schematic, to make it read 0–150 mA). Use a second #270-1754 unit at M2, keeping the existing series resistor at R7 for making the meter read 0–15 volts. Add another series resistor at R8 for changing the range to 0–1.5 volts.

## THE FUNCTION SWITCH

The function switch (S10) associated with meter M1 also needs further explanation. When switched to the LINE position, the meter measures the voltage supplied by line-adjust control DIM1—an ordinary household lamp dimmer. Resistor R9 converts M1 to a voltmeter and diode D1 changes the line voltage to DC so that it can be read by the meter. Note section S10-b of the function switch. In the LINE position, that section completes the circuit so that line current can flow through M1, D1, and R9; in

the other two positions, it opens that circuit so the tester can operate normally.

The best way to select a value for R9 is to wait until the tester is almost completely constructed. Then put a reliable AC voltmeter across pilot light I'; there it will read the output of DIM1. Set DIM1 for 90 volts, which will be the operating plate voltage for our tester. Now set S10 to LINE and M1 for its lower current range.

Experiment with the value of R9 until you find one that makes M1's needle move to a main marking about midway up the scale. That will be your reference point for setting the plate voltage each time you turn on the tube tester. In my case, the value of resistor R9 was about 5,000 ohms. Resistor R9 should be at least a 2-watt unit.

The SHORTS position of S10 places the checker in normal testing configuration, except that pilot lamp I2 is substituted for Meter M1 (note how S10-b bypasses M1 in the SHORTS position). If there should be a short between the filament (or cathode) and the plate of the tube being tested, I2 would light up.

The function switch is normally placed in SHORTS position before being moved to TEST (which places M1 in the circuit for the actual quality test). With the advance warning provided by an illuminated I2, you'll be able to avoid switching to TEST position if the tube being tested is shorted. ■



## ELECTRONICS WIRING

(Continued from page 46)

another hole through the top plate of the wall and another through the roof; all three holes should be in line if possible. Push the conduit up through the top plate and the roof, adding sections with couplers as necessary. Push the conduit through the roof until there is about 4 feet extending past the roof deck, then put the bottom end into the hole through the sole plate and lower the conduit one foot. That should still leave about 3 feet of conduit extending above the roof. Anchor the conduit firmly to the roof trusses using straps and screws. You can finish the work on the antenna mast after the roof is shingled.

The Code requires that the antenna mast be grounded. Attach a grounding clamp to the conduit. Connect No. 10 copper wire to the ground clamp and take the straightest and shortest path to the pipe that serves as the electrical-system ground. Attach a ground clamp to the pipe next to the one used for the electrical system and connect the antenna ground to it. Don't use the same clamp that the electrical ground used, but be sure to connect your clamp to the same pipe. After the roofers are done, attach a weather head to the top of the conduit. That is a cap that fits over the end to keep rain out.

The conduit is strong enough to serve as the mast for small antennas and the download that enters the weather head and feeds down to the distribution panel. Larger antennas will require a separate mast, but you can still use the conduit to feed the download.

**Finishing Touches.** When you have completed your work, you can relax until the house is finished. You don't need to install anything else until the interior walls are finished.

When you start to install your own electronics in the house, you will first need to pull wires through the conduit. An electrician's fish tape is an essential tool at this stage.

Start at the first box and feed the fish tape through the conduit until the end appears at the box at the other end. If more than one wire will be fed to that box initially, pull all of the wires at the same time. Attach the wire to the hook on the end of the fish tape by bending a loop in the wire, and secure it with vinyl tape. Pulling in the wires takes two people, one to feed the wire in and

straighten out kinks and snarls, and another to pull on the fish tape. When the ends of the wires appear at the box, pull out enough extra to make up the connections, then remove the fish tape.

There are a wide variety of faceplates made to fit standard-size electrical boxes. They range from antenna connections to speaker terminals. If you can't find one that fits your needs, you can use a blank cover and drill holes for the type of connector you need. Cover any unused boxes with blank covers.

After the initial installation, you will be happy with things for a month or two, then you will think of some new project that will make life more convenient, like a closed-circuit TV camera in the backyard to keep an eye on the kids. Well, all you need to do is open the closest box and push in the wire.

If the time comes when a single fiber optic cable delivers voice, video, and computer information to your home, all you will need to do is have the installer route it through one of the outside boxes of your system into the distribution panel. Put the associated electronics on the distribution panel and pull cables to the monitors located throughout your home. ■

### LEARN VCR REPAIR

**CLEANING/MAINTENANCE/REPAIR**

**EARN UP TO \$1000 A MONTH WORKING PART TIME FROM YOUR OWN HOME!**



**Secrets Revealed!**

**NO Special Tools or Equipment Needed.**

**EARN UP TO \$60 AN HOUR AND MORE!**

### THE MONEY MAKING OPPORTUNITY OF THE 1990'S

If you are able to work with common small hand tools, and are familiar with basic electronics (i.e. able to use voltmeter, understand DC electronics).

If you possess average mechanical ability, and have a VCR on which to practice and learn... then we can teach YOU VCR maintenance and repair!

**FACT:** up to 90% of ALL VCR malfunctions are due to simple MECHANICAL or ELECTRO-MECHANICAL breakdowns!

**FACT:** over 77 million VCRs in use today nationwide! Average VCR needs service or repair every 12 to 18 months!

Viejo's 400 PAGE TRAINING MANUAL (over 500 photos and illustrations) and AWARD-WINNING VIDEO TRAINING TAPE reveals the SECRETS of VCR maintenance and repair—"real world" information that is NOT available elsewhere!

Also includes all the info you'll need regarding the BUSINESS-SIDE of running a successful service operation!

#### FREE INFORMATION

CALL TOLL-FREE 1-800-537-0589

Or write to: Viejo Publications Inc

5329 Fountain Ave

Los Angeles, CA 90029 Dept. PE

CIRCLE 17 ON FREE INFORMATION CARD



One tree can make 3,000,000 matches.



One match can burn 3,000,000 trees.



A Public Service of The Ad Council  
© The Advertising Council

## Protel Easytrax 2™

### Outstanding value in Printed Circuit Board/CAD for your Macintosh and PC

Protel Easytrax 2 is a new, low-cost design package for PC and Macintosh users that includes everything required to produce professional quality Printed Circuit Board artwork.

Our easy-to-learn menu-driven design system breaks the 'expert barrier'-you'll be designing in minutes, not hours. Our comprehensive tutorials guide you through the program's extensive features that take the tedium out of board layout.

- Comprehensive library of Through-hole devices
- Gerber photoplotting and N/C drill tapes
- On-the-fly library components creation
- Intelligent Pad to Pad autorouting
- Switchable Metric/Imperial grid
  - Auto-panning
  - PostScript™ printing
- Powerful user-definable Macros
- Independent print/plot program
- Multi-layer boards of up to 32 X 32 inches.

At Protel, we offer free technical support, 24-hour BBS, and 30-day money back guarantee. Prices start at

**\$450**

**Free Evaluation Package  
Toll Free: 800-544-4186**

**Protel Technology, Inc.**

50 Airport Parkway, San Jose, CA 95110

Tel: 408-437-7771 Fax: 408-437-4913



CIRCLE 19 ON FREE INFORMATION CARD

**Final Assembly.** Now you're ready to put the project together. Mount your mounting brackets and SOL1 on the bottom of the enclosure. Slide a rubber grommet onto SOL1's two wires and route the wires through the prepared hole in the enclosure. Solder SOL1's wires to the collector of Q1 and to the +12-volt unregulated supply on the circuit board. Then mount J1, LED1, LED3, S1, and R10 on the enclosure. Mount a knob on the shaft of R10. Route LED2 and Q3 through the rubber grommet and its hole in the enclosure and push the grommet into place in the hole. Mount the circuit board in the enclosure.

Press the food bin into place on the enclosure so that its bottom hole is covered by the flipper, and so that the bottom of the bin is just above the flipper. Move the flipper back and forth to ensure that it doesn't bump the bin, and to ensure that the hole is uncovered when the flipper moves. Adjust the position of the bin as necessary.

Mount LED2 and Q2 in the holes provided on the bin. Slide the ring half of a plastic LED holder onto each pair of wires. From the inside of the bin, insert the clip halves of the holders into the holes. Push LED2 and Q2 into the holders with their wires extending away from the bin, and press the ring halves of the

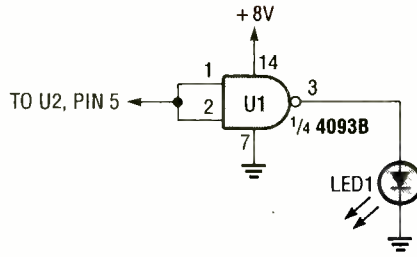

Fig. 2. A 4093B Schmitt trigger may be used as a buffer for monitoring the oscillator frequency of the LS7210.

holders around the clips. Be sure that the wires are routed out of the way of the flipper.

**Circuit Checkout and Use.** The first step is to check that the 8-volt supply is functioning correctly. With U2 and U3 removed from their sockets, plug your 12-volt supply into J1. Check for +8 volts DC (plus-or-minus 0.5 volt) between ground and the following points: the output of U1, pin 14 of U2, and pin 16 of U3. (Of course, for U2 and U3 you'll actually be checking for the proper voltage at pins 14 and 16 of their respective empty sockets.) The unregulated supply (at the input of U1) may be as high as +18 volts, though that voltage level will drop several volts when the solenoid is energized.

If you discover any problems as you check out your Auto-Feeder, refer back to Figure 1 and its circuit description for clues about where to look to track down your problem.

If all looks okay, power down and insert U2 and U3 in their respective sockets, being sure to orient them correctly. Set R10 and R4 to midrange. Reapply power to the circuit and press S1. The flipper should swing to one side momentarily, then return to its original position.

To test the timer circuitry fully requires a wait of 12 hours, but there are some tests and adjustments you can do right away. For one, you can monitor U2's oscillator frequency (at pin 5) using a logic probe or you can breadboard a mini-logic probe, like the one shown in Fig. 2. In that circuit, a 4093B CMOS Schmitt trigger buffers the signal at pin 5 of U2 and lights an LED once per oscillator cycle.

Do not connect any test probe, other than a logic probe, directly to pin 5 of U2, as even a 10-megohm oscilloscope probe will have a loading effect on the circuit and will give you misleading results. Whichever method you use, adjust R4 for an oscillator period at pin 5 of 0.68 seconds. That works out to about 88 cycles (LED flashes) per minute.

To check the operation of U3—a without waiting 12 hours for it to trigger, you can use a logic pulser to pulse pin 5 from high to low. That should cause the flipper to swing to the side as it did when you pressed S1.

To test the operation of the REFILL indicator (LED3), put your finger into the food bin to block the light on the face of Q2. LED3 should be dark. Remove your finger, and LED3 should light. Now you can fill the bin with fish food and press S1 to see how much food falls through the hole. Adjust how long the hole is unobstructed by adjusting R10. Press S1 repeatedly to be sure that fish food falls through the hole on each feeding. If the food tends to get hung up inside the bin, try enlarging the hole.

To use your Auto-Feeder, mount it on your fish tank so that the food bin hangs over the water. Be sure that the solenoid and all other circuit elements are held safely away from the water in the tank. To begin the timing cycle, plug in the power supply. In 12 hours, and every 12 hours thereafter, your fish will be fed automatically.

That's all there is to it. Once the feeder is set up and working, your fish will always get their regular feeding and you'll have one less chore to worry about. The only thing you need to do is to remember to check the REFILL indicator occasionally to see if it's time to add food. ■



The solenoid mounts underneath the project enclosure. One end of a wooden flipper mounts on the solenoid's rotating circular plate, the other end rests under a fish-food bin, which has a hole in its bottom. When the solenoid is energized, the flipper moves away from the hole, and fish food falls through the hole into the fish tank. In addition to automatic feeding, you can manually feed your fish by pressing S1 (FEED).

## FILE FETCH

(Continued from page 73)

propriate paths. By placing a highlight bar over a path and filename it can be sent to the program you were in at the time you pressed the hotkey.

From the first File Fetch window you can request to see a list of all the files in a given subdirectory. To do that, you just place the highlight bar over the desired subdirectory and hit the right-arrow key. You can then send any file name in the list directly to the program you were in.

Some programs like AutoCAD do not permit the user to enter file extensions. That is common in spreadsheets, data bases, desk-top publishing, and the like. If you are using such a program, you can toggle a file-extension option on and off at the main window by pressing <ctrl>x. Turning the option off inhibits File Fetch from providing a file extension. When the option is on, an "X" appears at the lower right of the main window to advise you of that fact. There is also a "P" option that allows you to switch between two hard disks, but obviously only two-hard-disk owners will be interested in that feature.

**Why It's Valuable?** By now you have a good idea of what File Fetch can do for you. The program is unique in two important ways. It enables you to find files without leaving the application (program) in which you are working, and it retrieves and copies file or directory names into your applications. The latter saves a lot of keyboarding time, and the former saves software-manipulation time by eliminating the necessity of leaving an application, and then entering again.

The excellent quality of the clear and concise 52-page manual cannot be overstressed. The text and illustrations combine to make it an excellent tutorial and reference for making maximum use of the program. It comes with a two-page index that supplements the manual's contents page.

**Fetch File Fetch.** Zaphod's File Fetch DOS utility program has a suggested retail price of \$39.96 and is available at most quality software retail and mail-order outlets. For more information on File Fetch, write to Zaphod Industries, PO. Box 442, Northwood, New Hampshire 03261 directly (or telephone 603-942-5077), or circle No. 119 on the Free Information Card. ■

## DIGITAL COURSE

(Continued from page 70)

connected to a switching network, consisting of four single-pole double-throw switches. Note that instead of the 15-volt source we used for the above discussion, we'll be using a 5-volt source for the discussion that follows.

The input to each 2R resistor can be tied high or low—corresponding to logic 1 or logic 0—via its respective switch. The analog voltage at ANALOG OUT will always be proportional to the binary number determined by the switch settings.

To illustrate, let's examine a binary number and determine the equivalent analog voltage. Let's suppose that we have a binary number of 1001 to be converted. If we write out the bits individually we get:

$$\begin{aligned} B_0 &= 1 \\ B_1 &= 0 \\ B_2 &= 0 \\ B_3 &= 1 \end{aligned}$$

so only  $B_0$  and  $B_3$  contribute any voltage. Using the equation we gave earlier, and setting  $V_{CC}$  to 5 volts we get:

$$\begin{aligned} V_A &= 1 \times 5/16 + 0 \times 5/8 + 0 \times 5/4 + 1 \times 5/2 \\ &= .313 + 2.5 = 2.813 \text{ volts} \end{aligned}$$

Thus the analog equivalent to the 1001 input with an input voltage ( $V_{CC}$ ) of 5 volts is 2.813 volts (the sum of voltage of the MSB and LSB).

**D/A Converter Exercise.** Assemble the circuit shown in Fig. 3 on your sol-

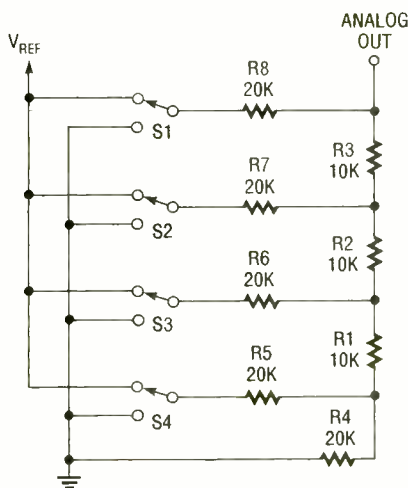

Fig. 3. Here we have the resistor ladder from Fig. 2 connected to a switching network. It contains four single-pole, double-throw switches. Note that we're using 5 volts as the reference voltage.

derless breadboard. Note that the circuit diagram calls for S1–S4 to be single-pole, double-throw (SPDT) switches. (The SPST DIP switch used in previous exercises is not used in this application.) The reference voltage for the circuit will be the 5-volt source that was used in the previous exercises of this series. Prepare a table for the circuit similar to Table 1; that table should give input combinations and their expected analog output voltages.

Once you've wired up the circuit of Fig. 3 and prepared a table, simulate all binary-input combinations to the circuit by applying either +V or ground to the inputs of the circuit as prescribed by your table. Then using a voltmeter, monitor the analog output of the circuit that is produced by each input combination. Do your findings agree with your table?

If the answer to that question is yes, would the analog output agree with your table if—keeping the same ratio between the resistors in the ladder—the resistor values were changed to, perhaps, 15k and 30k. Try it and see if there is any great difference in the analog output of the circuit with the new resistor values. ■

### The LOW COST, EASY Way To Learn About Computers

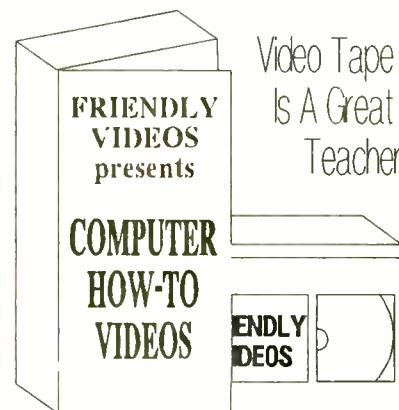

- \*"HOW TO BUILD YOUR OWN IBM 286/386 CLONE" \$39.95 + SHIPPING AND SALES TAX
- \*"SHAKE HANDS WITH YOUR IBM PC/XT/AT COMPUTER" \$29.95 + SHIPPING AND SALES TAX
- \*"UPGRADE YOUR PC TO A 286-AT FOR UNDER \$150" \$24.95 + SHIPPING AND SALES TAX
- \*"HOW LASER PRINTERS WORK" \$39.95 + SHIPPING AND SALES TAX

**ORDER NOW!**



Friendly Videos  
PO Box 5684



Garden Grove, CA 92645  
(714) 898-4055

FEBRUARY 1991

## WHEN DISASTER STRIKES

(Continued from page 66)

It's important to use a soldering-iron tip and wire that are the appropriate size. Very thin traces may have to be repaired with stripped wire-wrap wire. And remember, use very little solder.

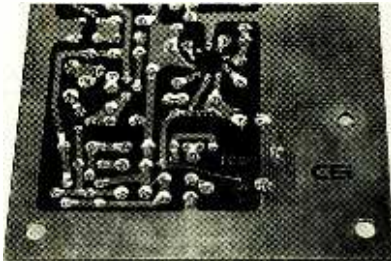

A missing land on this board has been replaced by a small wire as shown. That technique can save many a board along the way.



This IC has a clear plastic body. You can see how the leads are arranged.



Can you tell which pin on this IC has been broken and repaired?

**Broken IC pin.** It's always frustrating when you break a pin off an IC. It can not only be a costly error, but it can also delay your repair job. The first step in repairing the chip depends on whether or not there's enough of the pin left attached to it. If there is, your job is a lot easier. Simply solder a piece of wire of the appropriate diameter (resistor leads work well) to the IC pin and cut it to length. You can also use a pin that's been broken off some other chip that you don't need.

If the pin has broken off right at the body of the chip you obviously have a bigger problem. But fortunately, in most cases, there is a solution. The silicon chip inside most IC's is very small—perhaps less than a 1/4-inch square. So there's actually more metal inside the IC leading to the chip than what shows

outside. You have to scrape away enough of the body of the IC surrounding the broken pin to expose some of the metal. The tip of a jeweler's screwdriver is often good for that purpose. When enough metal is exposed, simply solder a new pin to it.

Now for the problem: Most IC's are packaged in a plastic that's soft enough to scrape away. However, some are housed in a ceramic package, and it will be extremely difficult, if not impossible, to repair such a chip in that manner. If you are unsure as to the packaging material, try scraping the underside of the IC with a sharp metal object; if it scratches easily, it's plastic, but if not, it's ceramic and you're out of luck.

The last step is to get a socket that fits the IC. After the new pin is installed, put the IC in the socket and install the socket on the board as you normally would.

**A Few Neat Tricks.** If you ever have to mend a wire, or lengthen an existing wire, here is a neat way to do it. First, strip 1/2-inch off both ends, and slip a piece of heat-shrink tubing over one end. Push the wires together end-to-end, until the strands are completely meshed. Then, solder them together, and shrink the tubing over the mend.

A stripped plastic knob can always be repaired with some glue, but it may be difficult to remove afterward. One way to fix it is to drill and tap a hole in the side of the knob and insert a screw with a sharp tip. Position the knob on the shaft, and tighten the screw until the knob stays in place.

What do you do if you need an odd-value resistor, but you don't have one? Well, you can increase the resistance of a carbon resistor simply by scraping away the body of it with a knife! All you have to do is get one that's slightly less than what you need. Then scrape the body a little bit at a time, measuring the resistance as you go, until you reach the desired value. What you're actually doing is decreasing the diameter of the resistor. And if you think of it as a piece of wire, remember that the resistance of wire increases as the diameter decreases. That's why you need heavy-gauge wire for high-current applications.

By following the tips we've presented, you should be able to stay out of trouble. In the unlikely (although human) event that you make a mistake you should now know the techniques that will save your project. ■

## SENTRYSTROBE

(Continued from page 38)

meter accuracies, and circuit tolerances will vary from project-to-project, we strongly recommend that you familiarize yourself with the accuracy of your particular setup before trusting it totally. To check your sensor's accuracy, place ice and water in a thermally insulated container (such as a Thermos), and adjust R10 for a 33°F trip point (2.74 volts). Immersing the probe in the ice/water mixture should cause LED1 to come on almost immediately. If LED1 does not light, adjust R10 until it just does. That gives you an indication of exactly where 32°F is and an indication of the accuracy of the circuit's response.

The circuit can be modified to react to any temperature between -10°C (14°F) to 100°C (212°F), by varying the ratio of divider resistors R9 and R11, and changing the value of R10. The circuit can also be modified to alert you to "over" temperature conditions, by simply reversing the pin-2 and -3 connections of U4. That tells U4 to trip when the probe encounters a temperature greater than the corresponding voltage provided by the fixed voltage divider. A relay or other device may be wired to signal additional equipment when the alarm condition occurs.

**Sound and Ringer Sensor.** Another way that the strobe circuit might be triggered is through an audio-detector circuit like that shown in Fig. 5. An electret microphone MIC1 picks up the sound, which is amplified via the microphone's internal FET transistor. The transistor requires a few milliamps of bias current (supplied through R17). The amplified signal is then fed into U5, an LM386 low-voltage, audio-power amplifier. The amplifier's voltage gain is fixed at 200 by the unit's internal components and feedback capacitor C14.

A 680-pF bypass capacitor (C17) at the input of U5 ensures that it does not amplify ultrasonic acoustical energy from MIC1. Capacitor C16 and resistor R18 form a snubber circuit that prevents oscillations from occurring at U5's output. Capacitor C15 blocks the DC content of U5's output (which is biased internally at half the supply voltage).

Sound energy picked up by MIC1 and amplified by U5 appears as an AC signal to diode D3. That unit clips the negative swing of that AC signal, leaving a positive DC voltage of varying

amplitude. That voltage is fed through a current limiting resistor, R19, to the strobe circuit via J1 and J2. In this application, R20 (in Fig. 1) should be eliminated, or jumpered out of the circuit.

The LED in Fig. 5 is optional, and must be removed when the sensor is placed in service, or else U1 (in Fig. 1) will receive insufficient current to trigger it. The LED can be helpful, however, in locating the mike in the best spot for sound pickup.

When assembling the circuit, the leads of MIC1 should be kept short. If the leads are long, unwanted oscillations may occur. Keep the 12-volt power source close to the amplifier board. A regulated power source is required to keep U5 from amplifying unwanted power-supply ripple along with the desired signal. Place MIC1 near the object to be monitored, such as a telephone.

A loud sound, such as a telephone ringing will now activate the strobe circuit. Occasionally, spurious sounds such as loud conversation or power equipment will trigger the strobe. To eliminate false triggering, place MIC1 inside a small case, a 35-mm film holder works well; insulate the sides of MIC1 with a sound dampening material, such as

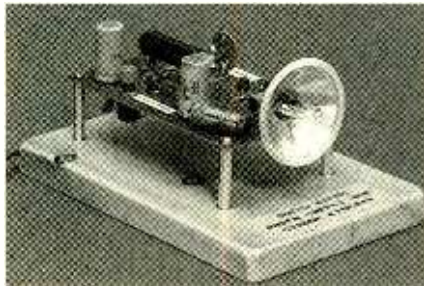

The author's prototype of the SentryStrobe was mounted on stand-offs to block of wood for testing. The dark object between the two capacitors is the 500-ohm, 25-watt ceramic power resistor (R6) used in the power-supply circuit.

cotton or polyester wool, and place the assembly near the object to be monitored. The case will now serve to focus sound entering its front, and eliminate pick-up from the sides.

We hope you enjoy the SentryStrobe. It will maintain a vigil over almost any type of equipment, and will alert you to either normal or abnormal functioning of the monitored condition, depending on how it's wired.

We welcome communication regarding this project, and also suggestions as to how to use and improve it. Send your correspondence to Allegro Electronic Systems at the address provided in the Parts List. ■

### 3 × 3 ALARM

(Continued from page 68)

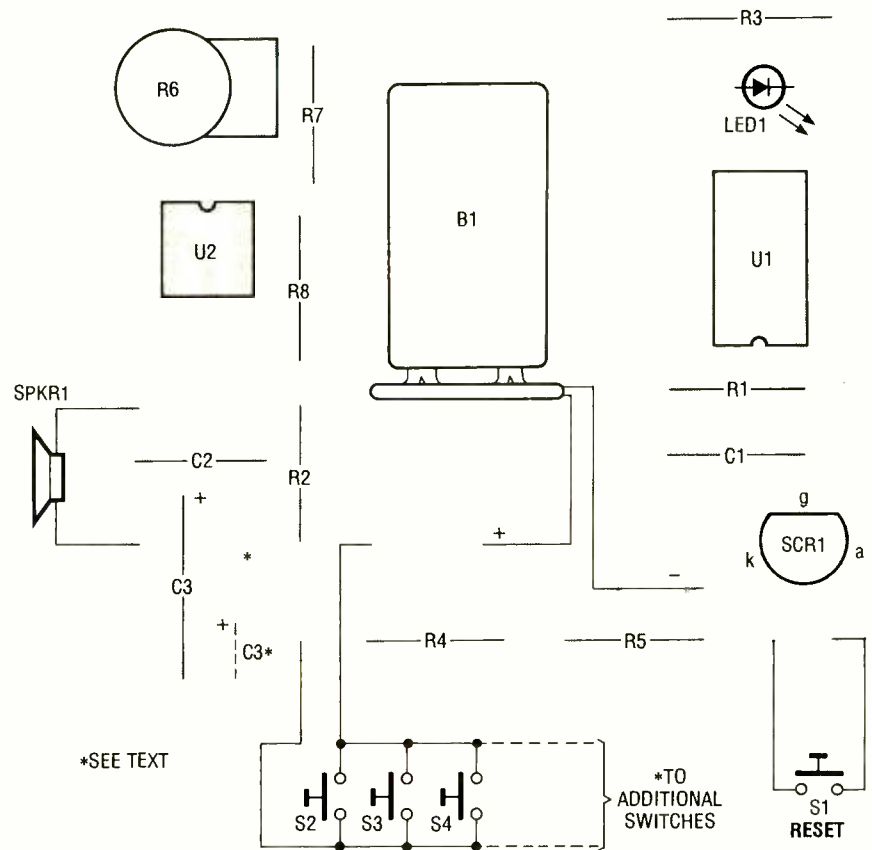

Fig. 3. Once you've obtained the relatively few parts that comprise the 3 × 3 Alarm and etched your circuit board, assemble the project using this figure as a guide.

to give the builder the option of using either a radial- or axial-lead unit. Pay special attention to the orientation of the semiconductors. If the integrated circuits are incorrectly oriented, the oscillators will not function. If the SCR is incorrectly oriented, no ground path will be established and the circuit will fail to operate.

Mount a 9-volt battery holder in the open area of the board; wire a 9-volt battery snap-on connector to the circuit board, being sure to observe the proper polarity. Even though the alarm is battery powered, it should provide many hours of standby use as almost no current flows when the SCR is off. If you wish, other power sources would also work quite well with the circuit as long as care is taken to ensure that the voltage ratings of the integrated circuits are not exceeded.

Wire the sensor and RESET switches to the circuit. Any type of normally-open switch can be used as the trigger—pressure sensors, magnetic-reed

switches, etc. Finally wire the speaker to the circuit board with stranded wire to complete construction.

Connect a 9-volt transistor-radio battery, and insert the battery into its holder. Press switch S1 (that switch doubles as a test button) and the alarm should sound. The LED should flash as the 2-Hz oscillator changes states. If your alarm does not function, recheck the orientation of all semiconductors; also check all solder connections and inspect the board for other construction errors.

Next check circuit's triggerability; close any one of the sensor switches (S2–S4). The alarm should sound and remain on even after the switch is released. The alarm can then be turned off by pressing S1.

You can now detect when intruders enter the protected areas using the 3 × 3 Alarm. You might even use the circuit detect when the kids (of all ages) raid the refrigerator or when someone removes one of your tools from your workbench. ■

## PANASONIC TUNER

(Continued from page 77)

dle and even some low frequencies.

The final measurement made for this tape player section was wow-and-flutter, the variation in pitch heard when listening to some tape machines whose speed is not constant. Using the WRMS (weighted root-mean-square) method of measurement favored by the manufacturer, we measured a wow-and-flutter value of 0.08%, or close enough to the 0.07% value specified by Panasonic. The measurement, taken over a time period of 25 seconds, is shown as the lower trace of Fig. 10. Measuring wow-and-flutter using the weighted IEC method is more revealing of the actual nature of the tape speed variations and is represented by the upper trace in Fig. 10. Using this method, wow-and-flutter averaged about 0.15%.

## HANDS-ON TESTS

While we did not actually install this unit in an automobile, we did put it through its paces in our listening room by hooking it up to an FM indoor antenna and to a stereo amplifier and speakers. We can attest to the fact that the Logic ID worked perfectly. We keyed in our location city and, having done so, asked for our local classical stations first. Three stations came up from which we could choose our favorite. Next, we asked for stations having a jazz format, and sure enough, a couple of those stations appeared, complete with call letters and frequencies, which were displayed by the unit at our option.

Needless to say, when we called for rock-and-roll selections we were fairly

swamped with more than two dozen to choose from. Just for fun, we "made believe" that we were in a city actually located some 30 miles from us, out in the distant suburbs. A different selection of stations (far fewer than before) appeared for the various formats we called up and, since we had "faked" our actual location, only a few of these stations were received with low enough background noise to be enjoyed. Clearly, this innovative Logic ID system works and works well.

The glass "touch screen" system of selection is also very practical while driving a car. With many competing units covering their front panels with buttons too small to be pushed (let alone found) by human fingers while driving, that type of approach clearly makes a lot of sense for a car head-end.

We should note, too, that for those whose knowledge of geography is limited, Panasonic supplies, in addition to the regular owner's manual, an ID Logic Guide Map in which the Continental U.S. is divided into 24 full-page detailed maps of various areas, each listing states and key cities that are programmed into that enormous database.

Admittedly, \$799 is a pretty steep price to pay for a car head-end tuner/tape player, especially when you consider that an amp and speakers still need to be added to complete the system, but for frequent long-distance travelers who use their cars to get from one area of the country to another, the ID Logic scheme may well be worth the extra cost.

For more information on the Panasonic CQ-ID90EU, please contact the manufacturer directly, or circle No. 120 on the Free Information Card. ■

## FUN SOFTWARE

(Continued from page 85)

manage frequencies. A hard drive is not required.

The ENTER-tainer user manual is, in a word, terrific. It is really a 180-page 6- by 9-inch bound book. A six-page Table of Contents and detailed Index make it easy to use as a reference. It covers getting started, using The ENTER-tainer, legal issues, advanced applications, BASIC's music features, creating your own selections, placing songs in your own programs, and troubleshooting. A major section of the manual (al-

ENTER-tainer driver program and all musical selections and sound effects are written in interpreted, unprotected, listable BASIC, making this an exceptional programming tool.

Once you load in BASIC and run the main program, you get a neat sign-on screen with a short rendition of Scott Joplin's "The Entertainer." From then on everything is selected using simple screen menus. First you pick an album, and then a selection within it. As the selection file is loaded, a fancy-bordered colored screen comes up with information in large characters, suitable for classroom use.



The ENTER-tainer featuring musical selections that can be added to other programs.

most 50 pages) is devoted to short biographies of all known authors of the songs included in The ENTER-tainer. This manual alone is worth the price if you have any interest in programming sounds in BASIC.

The only tricky thing about The ENTER-tainer is that there are over 300 programs on two 360K 5.25-inch diskettes or one 720K 3.5-inch microdiskette. In addition to the tunes and sound effects, there are various utility and sample files. This means they can't all fit in the regular disk root directory (which is limited to 112 files), so a subdirectory, which allows an unlimited number of files, is used. The

The information screen stays on during the playing of the melody. The borders, colors, and text change with each selection. Instead of playing the different selections, you can just display the screens, change drive directories, or make or modify albums.

(PDI Music Software, 1511 48th St., Boulder, CO 80303; Tel. 800-727-4140 (303-440-4140 in CO). Price: \$45.00 + \$4.00 S/H (\$8 foreign) VISA/MC accepted. Requires IBM PC/XT/AT/PS2 or compatible, 256K RAM, DOS 2.0 or better, and BASIC interpreter. Specify 5.25 or 3.5-inch disks.) ■

CIRCLE 126 ON FREE INFORMATION CARD

# ELECTRONICS MARKET PLACE

## FOR SALE

**DESCRAMBLERS.** All brands. Special: Combo Jerrold 400 and SB3 \$165.00. Complete cable descrambler kit \$39.00. Complete satellite descrambler kit \$45.00. Free catalog. **MJH INDUSTRY**, Box 531, Bronx, NY 10461-0208.

**CABLE descrambler liquidation.** Major makes and models available. Industry pricing! (Example: Hamlin Combo's, \$44 each... Minimum 10 orders). Call **WEST COAST ELECTRONICS**, 1 (800) 628-9656.

**PRINTED** circuit boards etched & drilled. Free delivery. **K & F ELECTRONICS, INC.**, 33041 Groesbeck, Fraser, MI 48026. (313) 294-8720.

**HUGE** 88 page communications catalog of shortwave, amateur and scanner equipment. Antennas, books and accessories too. Send \$1.00 to: **UNIVERSAL RADIO**, 1280 Aida Drive, Dept. PE, Reynoldsburg, OH 43068.

**WIRELESS CABLE RECEIVERS 1.9 TO 2.7 GHz**

	30 CH PARABOLIC DISH SYSTEM \$173.90
	30 CH RFD ANTENNA SYSTEM \$193.90
	30 CH CRYSTAL CONTROLLED SYSTEM \$294.95

SUN MICROWAVE INT'L. INC. SEND \$1.00 FOR P.O. BOX #34522 CATALOG ON THESE PHOENIX, AZ 85067 AND OTHER FINE (602) 230-0640 VIDEOS PRODUCTS QUANTITY DISCOUNTS

VISA/MC/AMEX MEMBER OF THE BETTER BUSINESS BUREAU

**CABLE** descramblers (Jerrold) from \$40.00. Tocom VIP test chip. Fully activates unit. Also Zenith test board. Fully activates Z-Tacs. \$50.00. Call (213) 867-0081.

**LASERS** 1mW to 2kW, world's largest selection of new & used surplus. Free catalog. **MWK INDUSTRIES**, 1269 Pomona Road, Corona, CA 91720. (714) 278-0563.

**ELECTRONIC** muscle stimulator! Grow your muscles quickly and effortlessly or resale for huge profits. Complete kit - \$69.95; assembled and tested - \$98.00. **TECHNIX**, Box 55249, Bridgeport, CT 06610.

**FREE** catalog. Electronic parts kits, and more. No minimum orders. **WELSH ELECTRONICS**, 620 Olive Lane, Ambridge, PA 15003-2458.

**SECRET scanner frequencies:** Directories list federal, police, surveillance, bugging, channels. Big free catalog. **CRB**, Box 56-PE, Commack, NY 11725.

**CB RADIO OWNERS!**

We specialize in a wide variety of technical information, parts and services for CB radios 10-Meter and FM conversion kits, repair books, plans, high-performance accessories. Thousands of satisfied customers since 1976! Catalog \$2.

**CBC INTERNATIONAL**  
P.O. BOX 31500PE, PHOENIX, AZ 85046

**STOP** unwanted use of long distance with simple telephone product. Free details. **PO BOX 504**, Plattsburgh, NY 12903.

**EXPLORE** the cult of electronic super-hearing! **Surveillance audio amplifiers**, 8.5x11, 277p. The spook audio cookbook! \$33.00 domestic PPD. **REGISTRY DISTRIBUTING**, 1616 17th St., Suite 372-Y, Denver, CO 80202.

**LONG play cassette recorders**, 12 hour recording per standard C-120 cassette. (6 hours per side). All standard features including auto-stop. Only \$89.00. Voice-activated model with adjustable sensitivity - \$139.00. Add \$4.00 per unit S&H. Satisfaction guaranteed! **PRODUCTIVE PRODUCTS**, Box 930024, Norcross, GA 30093.

**LEARNING** electronic troubleshooting? Basic electronics simulations and problems program can help. PC/MSDOS \$32.95 EES-PE2, POB 1391, Lubbock, TX 79408.

**FREE CATALOG**

FAMOUS "FIRESTIK" BRAND CB ANTENNAS AND ACCESSORIES. QUALITY PRODUCTS FOR THE SERIOUS CB'er. SINCE 1962

**FIRESTIK ANTENNA COMPANY**  
2614 EAST ADAMS  
PHOENIX, ARIZONA 85034

**FREE** Catalog: Save hundreds on sought after electronic, electro mechanical, and computer related hardware and components - including hard-to-find items. Call toll free: 1 (800) 776-3700. **AMERICAN DESIGN COMPONENTS/Dept.** 114-021, 815 Fairview Avenue, Fairview, NJ 07022.

**FREE** programs!! **Free** disks!! Choose game, utility, or business. And we will send you an IBM compatible program free. On 5-1/4" 360K or 3-1/2" 720K disk. You choose category, we choose program. Also get our electronics surplus/closeouts catalog and rental/shareware catalogs on another disk free! Just send \$2.00 (refundable) for shipping! **BEACH RADIO**, PO box 548, Boston, MA 02112-0548.

## PLANS & KITS

**CATALOG: hobby/broadcasting/HAM/CB: Cable TV**, transmitters, amplifiers, surveillance devices, computers, more! **PANAXIS**, Box 130-H2, Paradise, CA 95967.

**BUILD** - five-digit, ohms, capacitance, frequency, pulse, multimeter. Board, and instructions \$9.95. **BAGNALL ELECTRONICS**, 179 May, Fairfield, CT 06430.

**SURVEILLANCE transmitter kits!** Four models of each; telephone, room, combination telephone/room transmitters tune from 65 to 305 MHz. Catalog with **Popular Communication's** and **Popular Electronics** book reviews of "Electronic Eavesdropping Equipment Design," \$1.00. **SHEFFIELD ELECTRONICS**, 7223A Stony Island Ave., Chicago, IL 60649-2806.

## REMOTE CONTROL KEYCHAIN



Complete w/mini-transmitter and +5 vdc RF receiver  
Fully assembled including plans to build your own auto alarm  
Quantity discounts available

**\$24.95** Check, Visa or M/C Add \$3 shipping

VISITECT INC./Dept. P (415) 872-0128  
PO BOX 5442, SO. SAN FRAN., CA 94080

**SURVEILLANCE - countermeasures!** Guaranteed lowest prices! Huge catalog \$5.00 (refundable). **PROTECTOR**, PO Box 520294-E, Salt Lake City, Utah 84152.

**KITS** - alarms, games and test equipment. Send \$1.00 for catalog. **RAKJAB**, PO Box 1875, Apopka, FL 32704.

**LASER** lighting entertainment systems. Create your own 3-dimensional laser light shows with these professional secrets! Detailed mechanical and electrical schematics, designs for any budget! \$20.00 **MILLENIUM**, 229 McAfee, Thousand Oaks, CA 91360.

**DAZER II** Personal protection device! Plans \$8.00. Lasers! Transmitters! Detectors! More! Kits or assembled! Catalog \$2.00. **QUANTUM RESEARCH**, 16645-113 Avenue, Edmonton, Alberta T5M 2X2.

## CABLE TV DESCRAMBLERS! BARGAIN HEADQUARTERS!



- JERROLD™ • TOCOM • HAMLIN
- OAK • ZENITH
- SCIENTIFIC ATLANTA

6 month warranty! We ship C.O.D.!  
Lowest retail/wholesale prices!

### FREE CATALOG:

Global Cable Network  
1032 Irving St. Suite 109  
S.F., CA 94122  
NO CALIFORNIA SALES!!!

**ORDER TODAY! 800-327-8544**

**VIDEOCIPHER II** manuals. **Volume 1** - Hardware, **Volume 2** - Software - either \$34.95. **Volume 3** - Projects/Software, **Volume 5** - Documentation or **Volume 6** - Experimentation \$44.95 each. **Volume 7** - 032/Hacking \$54.95. **Volume 4** - repair - \$99.95. **Cable Hacker's Bible** - \$34.95. **Clone Hacker's Bible** - \$34.95. Catalog-\$3.00. CODs: (602) 782-2316. **TELECODE**, PO Box 6426-PE, Yuma, AZ 85366-6426.

**MINIATURE FM transmitters!** Tracking transmitters! Voice disguisers! Bug detectors! Phone devices! More! Available as kits or assembled and tested! Catalog \$2.00 (refundable): **XANDI ELECTRONICS**, Box 25647, 32A, Tempe, AZ 85285-5647.

**PARABOLIC** microphone for under \$60.00. Detailed plans and sources. Send \$6.00 to: **PARA-PLANS**, POB 511, Crab Orchard, WV 25827.

**REMOTE** car starter plan. Construction, testing installation instructions \$19.90. **SCHLITZER**, 414 Alva Dr., Grand Prairie, TX 75051. (214) 642-0338.

**CABLE T.V. CONVERTERS**  
WHY PAY A HIGH MONTHLY FEE?

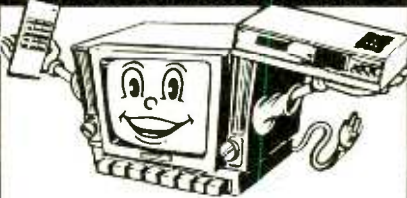

All Jerrold, Oak, Hamlin, Zenith, Scientific Atlanta, Magnavox and all specialized cable equipment available for shipment within 24 hours. For fast service MC / VISA or C.O.D telephone orders accepted (800) 648-3030 60 Day Guarantee (Quantity Discounts) 8 A.M. to 5 P.M. C.S.T. **CLOSED WEEK-ENDS.** Send self-addressed Stamped envelope (60¢ postage) for Catalog.

**MIDWEST ELECTRONICS INC.** P.O. Box 5000 Suite 311 (PE) Carpentersville, IL 60110

No Illinois Orders Accepted

## SURVEILLANCE TELEPHONE

Monitor room conversations \$175.00  
 Monitor room & telephone conversations \$275.00  
 Dialer tap, calls you when phone is used. \$305.00



Available in the telephone or small plastic case

Range Unlimited - 6 month warranty - Phone Tap Catalog \$3.00  
 LISTEN ELECTRONICS, 603 Elgin, Muskogee, OK 74401  
 1-800-633-TAPS

**BUILD** a light activated motion sensor. Chimes when triggered. Similar units sold for \$45.00. Great project! Fun! Educational! Easy to build! Plans \$2.00. Plans and kit \$8.50. **FUN PROJECTS**, Box 284, Brookings, SD 57006.

**BUILD your own remote control** using the same type of circuitry found in many keychain remote controls. 20 page package gives info and schematics on encoder/decoder circuitry. Part sources included. \$5.00. **CONTINUOUS CONCEPTS**, PO Box 60414, San Diego, CA 92166. CA residents add 7.25% tax.

**REDUCE** heating cost up to 60%. System developed in last oil embargo in New England. Plans \$24.95. **QUALITY ELECTRONICS**, 3128 Lake Washington Road, Suite 148, Melbourne, FL 32934.

**SURVEILLANCE** - Audio/video/infra-red/laser equipment. Industrial or private. 500 item catalog \$7.00. **SECURITY SYSTEMS**, 3017F Hudson, New Orleans, LA 70131.

**Motion Control System** → \$59.00

Includes Computer, Monitor, Keyboard, Power supply, 4 Motors, and Software.  
 Call or Send for **Free Robotics Catalog**

Silicon Valley Surplus 415 261-4506    4222 E. 12th St. Oakland Ca. 94601    Serving you since 1983 8 am to 4 pm PST

**PROJECTION TV** Convert your TV to project 7 foot picture... Easy!... Results comparable to \$2,500 projectors... **Plans and 8" lens \$27.95**... Professional systems available... Illustrated catalog free. **MACROCOMA**, 15HE Main Street, Washington Crossing, PA 18977. Creditcard orders 24 hrs. (215) 736-3979.

**TALK** to your PC! Build a voice interface for your IBM compatible. Details, sample schematics \$.75. **PANG ENTERPRISES**, 45 Park Home, Willowdale, Ontario, Canada M2N 1W7.

**STEREO power meter.** 3 color, 10 step LED or incandescent to 100/W each. Fun attention getter. Inexpensive, build any size. Plans PCB layout \$5.00. **CACTUS CREATIONS**, Box 901055, Palmdale, CA 93590.

**NEW** devices: proximity switch, static snooper, personal defender, laser supplies, bug snooper, PC interfaces and more. Catalog \$2.00. **BAUER**, 35 Soucy, Delson, Quebec, J0L 1G0.

**FORTY-FIVE** cent stamp brings our latest catalog of kits, parts, HV capacitors. **TWO FOX**, POB 721, Pawling, NY 12564-0721.

**STEREO TV:** Don't buy a new one; upgrade your mono TV! Send \$4.95 for schematics, PCB layout, and instructions to: **JLB INNOVATIONS**, PO Box 72011, Kanata, Ontario, K2K 2P4 Canada.

**KELVIN 200**

AC/DC VOLTAGE  
 AC/DC CURRENT  
 RESISTANCE  
 LOW BATTERY Warning  
 ACCURACY +/- 0.5%  
 CONTINUITY TEST/BUZZER  
 TRANSISTOR CHECKER  
 CAPACITANCE CHECKER

**\$39.95**

Stock No 990091

■ **KELVIN** Electronics VISA M/C  
 7 Fairchild Ave Plainville NY 11803  
 (516) 349-7620 1(800) 645-9212

## AUTOMATION

**\$460** Dual stepper motor kit connects to PC. \$700 XY positioning table plus other low cost automation products. Perfect for engineers and educators. **ARRICK ROBOTICS** (817) 571-4528.

## FREE CATALOG!

### 1-800-648-7938

For all information 1-702-362-9026

**JERROLD HAMLIN OAK ETC.**

## CABLE TV DESCRAMBLERS

• Compare our low Low Retail Prices!  
 • Guaranteed Prices & Warranties!  
 • Orders Shipped Immediately!

**REPUBLIC CABLE PRODUCTS INC.**  
 4080 Paradise Rd. #15 Dept. PE-90  
 Las Vegas, NV 89109

## BUSINESS OPPORTUNITIES

**YOUR own radio station!** AM, FM, TV, cable. Licensed/unlicensed. **BROADCASTING**, Box 130-H2, Paradise, CA 95967.

**MAKE \$50/hr** working evenings or weekends in your own electronics business. Send for free facts. **MUJI INDUSTRY**, Box 531, Bronx, NY 10461.

**MAKE \$2000.00/week** — reclaiming pure gold from scrap computers. Free report! (worth \$25.00) 1 (900) 246-2323 (\$2.00 min.).

**LET** the government finance your small business. Grants/loans to \$500,000. Free recorded message: (707) 448-0270. (KJ8)

**EASY** work! Excellent pay! Assemble products at home. Call for information (504) 641-8003 Ext. 5730.

**EARN thousands now!** With small investment, start and run your own profitable home-based business. We show you how. For free details, write: **CSR**, Dept. PE, 122 MacArthur Drive, Edison, NJ 08837.

## TUBES - 2000 TYPES DISCOUNT PRICES!

Early, hard-to-find, and modern tubes. Also transformers, capacitors and parts for tube equipment. *Send \$2.00 for 28 page wholesale catalog.*

**ANTIQUE ELECTRONIC SUPPLY**  
 6221 S. Maple Ave. • Tempe, AZ 85283 • 602-820-5411

## EDUCATION/INSTRUCTION

**MAGIC!** Four illustrated lessons plus inside information shows you how. We provide almost 50 tricks including equipment for four professional effects. You get a binder to keep the materials in, and a one-year membership in the International Performing Magicians with a plastic membership card that has your name gold-embossed. You get a one-year subscription to our quarterly newsletter, "IT'S MAGIC!" Order now! \$29.95 for each course + \$3.50 postage and handling. (New York residents add applicable state and local sales tax). **THE MAGIC COURSE**, 500-B BiCounty Blvd., Farmingdale, NY 11735.

**LEARN** IBM PC assembly language. 80 programs. Disk \$5. Book \$18. **ZIPFAST**, Box 12238, Lexington, KY 40581-2238.

**SUPERNATURAL** cloud - highlighting on Earth's rotational displacement. Water-stained cross. \$5.00. **NIEDER**, PO Box 311972, New Braunfels, TX 78130.

## CABLE DESCRAMBLERS OAK M358 COMBO \$39.95

Jerrold, Zenith, Hamlin, Sci. Atlanta, Pioneer & MORE! OUR PRICES ARE BELOW WHOLESALE!

## CABLE+PLUS

14417 Chase St. # Panoramia City, CA 91402  
 1-800-822-9955 • Other Info. 1-818-785-4500  
 NO CALIF SALES — DEALERS WANTED

## WANTED

**INVENTORS!** Have an idea? Call **IMPAC** for free information package. US/Canada: 1 (800) 225-5800 (24 hours!).

**HAVE a new idea?** Invention? Call **THE "CONCEPT NETWORK"** for free confidential kit at 1 (800) 835-2246 ext. 197 US/Canada 24 Hrs. day.

**100'S** of Silicon Valley companies hiring technical professionals. For current listings send \$15.00 to **EXCEL SERVICES**, PO Box 36046, San Jose, CA 95158.

**NEEDED** Cyclops video camera project kit. Last seen Popular Electronics Magazine February 1975. Contact: **BILL ELLIS**, (404) 691-0845, 1420 New Hope Road, Atlanta, GA 30331.

**NEED** help with your electronic project, schematic or PCB artwork? Write to **TOP SECURITY**, PO Box 5275, Flint, MI 48505.

**WANTED:** Casio ML-81 "Melody" calculator. To sell call **DAVID** weekdays 10AM-4PM (212) 558-3585.

## THE JOY OF PROGRAMMING!

# Algorithm

THE PERSONAL PROGRAMMING NEWSLETTER

► features how-to projects for beginners and experts: fractals, moiré patterns, ecological simulations, black holes, sand-piles, wallpaper for the mind and much more!

► Write today for a free sample issue to:

Algorithm - Special Order Department  
 P.O. Box 29237, Westmount Postal Outlet  
 785 Wonderland Road South  
 London, Ontario, CANADA N6K 1M6

## SATELLITE TV

**FREE** catalog — Do-it-yourself save 40—60% lowest prices world wide, systems, upgrades, parts, all major brands factory fresh and warranted. **SKY-VISION INC.**, 2008 Collegeway, Fergus Falls, MN 56537. 1 (800) 334-6455.

## CABLE EQUIPMENT

**CABLE TV** secrets — the outlaw publication the cable companies tried to ban. HBO, Movie Channel, Showtime, descramblers, converters, etc. Suppliers list included. \$9.95. **CABLE FACTS**, Box 711-H, Pataskala, OH 43062.

## ENERGY

**FREE** power from the sun! Build your own power company using solar energy. Guide with plans \$10.00. **ZAUGGWATT**, 3812 South Country Club Way, Tempe, AZ 85282.

## BEST BY MAIL

Rates: Write National, Box 5, Sarasota, FL 34230

### OF INTEREST TO ALL

**EARN EXTRA CASH.** Send \$3.00 to: P.O. Box 72087, C.C. TX 78472-2087.

**NEW! MUSICAL MOVING** Santa. Plays holiday favorites. Brightens your Christmas. Free brochure. DC Distributors, PO Box 347D, New Castle, AL 35119.

### PERSONAL MISCELLANEOUS

**INTRODUCTIONS UNLIMITED-MEET** right person through Nationwide singles network. Information \$1.00 postage; handling. **METACOM**, Dept. PE, Box 6778, Fort Myers, FL 33911.

### RELIGION

**THE CREATOR HAS A Name!** Few people know it, Yet wonder why prayers aren't answered! Free information, Write: **NAME**, Box 2442, Abilene, TX 79604.





**LISTEN IN ON THE "TUBE".** Listen to those distant wildlife sounds, or reach out and grab a whisper with our **LONG RANGE LISTENING "TUBE"**. COMPLETE KIT \$45.00.....Read about the "TUBE" in the Jan. 1988 issue of **HANDS-ON ELECTRONICS**.....

Is it safe? Is someone eavesdropping? If so, ferret out that unwanted RF source with **McSNIFF**. Detects RF from 10 kHz to near 1GHz. Complete kit \$34.95. Factory built and tested \$64.95. See article in the Aug. 1988 issue of **HANDS-ON ELECTRONICS**.....



**LISTEN** to what you've never heard before with our **TUNABLE ULTRASONIC RECEIVER**. TUNE in on the world of bugs and bats, or check out HF noise in engines; leaks in high pressure steam, gas, or air systems, etc. Now used in **DOLPHIN** research. Complete kit with **PIEZO TRANSDUCER** \$44.95...See the article in the Feb. 1989 issue of **POPULAR ELECTRONICS**...ADD \$3.00 S&H TO EACH ORDER. **KRYSTAL KITS**, P.O. BOX 445, BENTONVILLE, ARK. 72712 501-273-5340 CAT. ONE DOLLAR

### ANTIQUE RADIO CLASSIFIED Free Sample!

Antique Radio's  
Largest Circulation Monthly.  
Articles, Ads & Classifieds.



6-Month Trial: \$13. 1-Yr: \$24 (\$36-1st Class).  
A.R.C., P.O. Box 802-L5, Carlisle, MA 01741

### T.V. FILTERS

T.V. notch filters, surveillance equipment, brochure \$1.00. **D.K. VIDEO**, Box 63/6025, Margate, FL 33063. (305) 752-9202.

### TEST EQUIPMENT

**FACTORY** direct test equipment. Function generators, frequency counters and security devices. Call for free brochure. **APPLIED ELECTRONIC RESEARCH INC.**, Hollywood, FL. (305) 987-9785.

## CABLE TV "BOXES"

Converters — Descramblers  
Remote Controls — Accessories

- ★ Guaranteed Best Prices ★
- ★ 1 Year Warranty — C.O.D.'s ★
- ★ Immediate Shipping ★
- ★ FREE CATALOG ★

Call or Write

**TRANS-WORLD CABLE CO.**

12062 Southwest 117th Court, Suite 126  
Miami, Florida 33186  
1-800-442-9333



★★★★PRESENTING★★★★

## CABLE TV DESCRAMBLERS

★★★★STARRING★★★★

**JERROLD, HAMLIN, OAK**  
AND OTHER FAMOUS MANUFACTURERS

- FINEST WARRANTY PROGRAM AVAILABLE
- LOWEST RETAIL / WHOLESALE PRICES IN U.S.
- ORDERS SHIPPED FROM STOCK WITHIN 24 HRS.
- ALL MAJOR CREDIT CARDS ACCEPTED

FOR FREE CATALOG ONLY **1-800-345-8927**  
FOR ALL INFORMATION **1-818-709-9937**

**PACIFIC CABLE CO., INC.**  
7325 1/2 Reseda Blvd., Dept.  
Reseda, CA 91335

## NAS CABLE BOXES

FREE CATALOG  
**1-800-848-3997**

Jerrold • Scientific Atlanta  
Many Others  
1 Year Warranty • COD's



## Cable TV Descramblers

If you find a better deal,  
we'll better our deal.

*"Jerrold" "Tocom" "Hamlin" "Oak"*  
*"Scientific Atlanta" "Zenith"*

Ask about our extended warranty  
program.

COD, Visa, M/C welcome.

Free Call — Free Catalog.

Video Tech **800-562-6884**

2702 S. Virginia St., Ste. 160-304  
Reno, NV 89502.



### ADVERTISING SALES OFFICE

**Gernsback Publications, Inc.**  
500-B Bi-County Blvd.  
Farmingdale, NY 11735  
1-(516) 293-3000

President: **Larry Steckler**

Vice President: **Cathy Steckler**

For Advertising ONLY  
516-293-3000  
Fax 1-516-293-3115

**Larry Steckler**  
publisher

**Arlene Fishman**  
advertising director

**Denise Haven**  
advertising assistant

**Christina Estrada**  
advertising associate

**Kelly McQuade**  
credit manager

**Customer Service/Order Entry**

1-800-435-0715  
1-800-892-0753  
7:30 AM - 8:30 PM EST

### SALES OFFICES

#### EAST/SOUTHEAST

**Stanley Levitan**  
Radio Electronics  
259-23 57th Avenue  
Little Neck, NY 11362  
1-718-428-6037, 1-516-293-3000  
Fax 1-718-225-8594

#### MIDWEST/Texas/Arkansas/ Okla.

**Ralph Bergen**  
540 Frontage Road—Suite 339  
Northfield, IL 60093  
1-708-446-1444  
Fax 1-708-446-8451

#### PACIFIC COAST/Mountain States

**Marvin Green**  
5430 Van Nuys Blvd., Suite 316  
Van Nuys, CA 91401  
1-818-986-2001  
Fax 1-818-986-2009

## SPECIAL FROM ETT

□ **PCP107—DIGITAL LOGIC GATES AND FLIP-FLOPS ... \$10.00.** Establishes a firm foundation for the user who wants to design and troubleshoot digital circuitry and wants to know more than a few rules of thumb. No background beyond a basic knowledge of electronics is assumed.



□ **PCP108—COMPUTERS AND MUSIC ... \$9.95.** Helps you learn the basics of computing, running applications programs, wiring a MIDI system and using the system to good effect. In fact, just about everything you need to know about hardware and programs.

□ **PCP109—EVERYDAY ELECTRONICS DATA BOOK ... \$10.00.** Presents the essential theory of electronic circuits and also deals with a wide range of practical electronic applications. Info is presented in the form of a basic electronics recipe book.

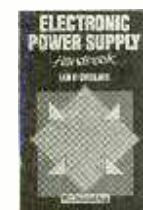

□ **BP285—BEGINNERS GUIDE TO MODERN ELECTRONIC COMPONENTS ... \$6.50.** Basic functions of resistors, capacitors, inductors, diodes (including Zeners and Varicaps), transistors, Thyristors, optoelectronic devices, op-amps, logic IC's, speakers and microphones, and meters are all described. Sort of a beginners bible of electronics.



MAIL TO: **Electronic Technology Today, Inc.**  
P.O. Box 240  
Massapequa Park, NY 11762-0240

### SHIPPING CHARGES IN USA AND CANADA

\$0.01 to \$5.00	\$.125	\$30.01 to \$40.00	\$5.00
\$5.01 to 10.00	\$2.00	\$40.01 to \$50.00	\$6.00
\$10.01 to \$20.00	\$3.00	\$50.01 and above	\$7.50
\$20.01 to \$30.00	\$4.00		

**SORRY, No orders accepted outside of USA and Canada**

Total price of merchandise	\$	_____
Shipping (see chart)	\$	_____
Subtotal	\$	_____
Sales Tax (NYS only)	\$	_____
Total Enclosed	\$	_____

Name \_\_\_\_\_  
Address \_\_\_\_\_  
City \_\_\_\_\_ State \_\_\_\_\_ Zip \_\_\_\_\_

## ADVERTISING INDEX

POPULAR ELECTRONICS magazine does not assume any responsibility for errors that may appear in the index below.

Free Information No.		Page
15	AMC Sales .....	24
—	Algorith .....	102
14	All Electronics .....	17
—	Amazing Concepts .....	89
—	Antique Electronic Supply .....	103
—	Antique Radio Classified .....	102
5	C&S Sales .....	13
—	CB City .....	101
—	CIE .....	31
—	Cable Plus .....	102
—	Command Productions .....	27
8	Contact East .....	27
9	Cook's Institute .....	89
—	EIA .....	CV3
—	Electronics Book Club .....	5,26
—	Electronic Tech. Today .....	CV2,103
—	Firestik II .....	101
—	Friendly Videos .....	97
—	Global Cable Network .....	101
—	Grantham College .....	25
11	Heathkit .....	15
—	Kelvin .....	102
—	Krystal Kits .....	103
—	Listen Electronics .....	102
—	McGraw Hill Book Club .....	18
—	Midwest Electronics .....	101
7	Mouser .....	24
—	NRI Schools .....	11
—	North American Services .....	103
19	Protel Technology .....	93
—	Pacific Cable .....	103
16	Paladin Electronics .....	12
6	Parts Express .....	7
12	People's College .....	16,23
—	Phillips Tech. .....	101
—	Republic Cable .....	102
18	Sequoia Publishing .....	12
—	Silicon Valley Surplus .....	102
—	Video Tech .....	103
17	Viejo Publications .....	93
—	Visitect .....	101
—	Windjammer .....	CV4

## PORTMASTER SYSTEM

(Continued from page 63)

also notice that pins 1 and 10 are connected only to each other, so the two wires are simply twisted together inside the cabinet—and that's two less wires that have to be connected to the board.

All of the connections on the board were wire wrapped, with the following exceptions: the row of connected pins coming from the ribbon cable were soldered together using bus wire, and the connections to the power jack and on/off switch were made with heavier wire. As for the outputs, a 6-inch length of wire-wrap wire was attached to each pin and left hanging for the moment. After all of the connections are checked out, the board can be put aside.

The next step is to fabricate the rear panel. First, the terminal strips are mounted on the cut-off piece of per-board. Each terminal strip consists of 16 contacts, so pairs of two were used for each one. All of the ground leads were connected together with bus wire, leaving a free pin for each IC output.

The openings in the front and rear of

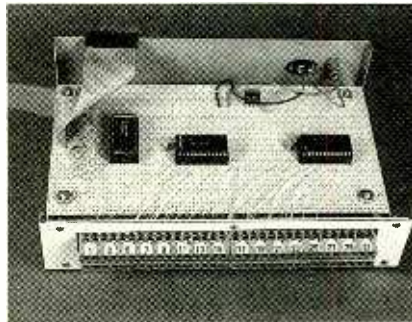

Here is the rear of the cabinet and the inside-front. If terminal strips aren't your cup of tea, you can use any sockets or plugs you wish

the cabinet were started with pilot holes, and cut out to size with a nibbling tool. A bit of metal was also cut away for the ribbon cable to enter the unit. After properly fitting the rear panel in the opening cut in the cabinet, six small screws secured it in place. Next, the per-board was mounted in place using standoff, and the power jack and switch were connected. A ground wire from the board was then soldered to the bus-wire ground on the rear panel.

The last step, which is probably the most tedious, is to solder each wire-wrap lead from the IC outputs to the corresponding pin on the terminal strip.

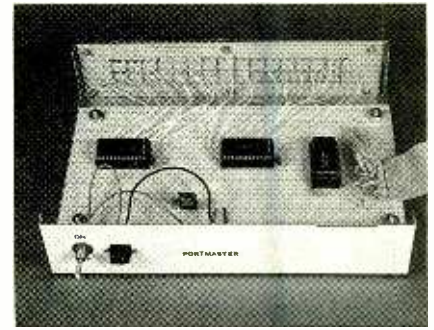

Here is the front of the cabinet and the inside-rear. As you can see it takes relatively few components to achieve a lot.

After inserting the IC's in the sockets, be sure to test all of the outputs to be make certain that they're done correctly.

As finishing touches, rubber feet were put on the bottom of the cabinet, and electrical tape was wrapped around the bus wire as extra insulation where it leaves the cabinet.

### Some Modifications You Can Make.

It is assumed that data is reaching the device at a relatively slow rate, so the Portmaster has been designed to function asynchronously. Thus, the computer is always free to proceed with whatever tasks it must perform without interference from the unit. Because of that, you must make sure the computer doesn't transmit characters at too rapid a rate (as mentioned before), although it is unlikely.

If that solution is inadequate, the low-power Schottky chips can be replaced by faster chips of other TTL-compatible architectures, provided that their pin-outs are the same and that all the IC's (except the 7805 voltage regulator) are changed accordingly.

**Setting-up the System.** Turn the computer off and plug the Portmaster's DB-25 connector into the parallel port. Plug the wall-transformer power supply into a surge-protected AC socket and connect its output plug to the Portmaster. Connect the devices to be controlled to the unit's outputs, making sure that the outputs have been properly configured for each device (AC/DC/momentary/toggled). Turn the unit on and power-up your computer.

Assuming you wish to enter and use the program supplied in Listing 1, be sure to use the initialization portion to test the operation of both the unit and your software. Strobe all outputs and check the connected devices' response. If everything checks out, your system is ready for use. ■

# The Importance Of Setting Standards.



Without standardization in electronics, television wouldn't be seen, radio wouldn't be heard, computers wouldn't share information.

Fortunately the Electronic Industries Association (EIA) has been setting electronics standards since 1924 for everything from early tube radios to today's cellular telephones and stereo TV's.

Standards create *markets and jobs*. Today EIA, an internationally accredited standards making body, is helping to make HDTV a reality by working with the federal government and other industry organizations, to develop a timely, uniquely American transmission standard. For home automation,

EIA also is close to completing a standard which will permit all home electronic products to communicate with each other.

Our more than 1,000 member companies are manufacturers representing every facet of the American electronics industry—from defense to consumer products.

EIA is proud of the contributions it has made through its standards making process toward the growth and vitality of the U.S. electronics industries.

Setting the standard for more than 66 years.



**ELECTRONIC INDUSTRIES ASSOCIATION**

1722 Eye Street, N.W., Suite 300, Washington, D.C. 20006

# East of the sun. West of the moon. Windjammer.



A place to live your fantasies.  
A place to free your soul.

To cozy up to the Caribbean sun.  
To dance among a thousand stars  
to the rhythms of steel drums.  
To play on sparkling white and  
pink sand beaches.  
To discover the underwater  
paradise of the reefs.  
To find a new friend and share the  
intimacies of a sensuous night.

To come alive and live.  
To remember for a lifetime.  
6 days and 6 nights. From \$675.

Reservations toll free  
1-800-327-2600  
In Florida 305/373-2090.

**Windjammer  
'Barefoot' Cruises**

Post Office Box 120,  
Miami Beach, Florida 33119.



[www.americanparadiahistory.com](http://www.americanparadiahistory.com)

"Cap'n Mike, rush me my free full color 'Great Adventure' booklet and show  
me the way to Paradise for 6 days and 6 nights from \$675."  
Windjammer 'Barefoot' Cruises,  
P.O. Box 120, Dept. 1642, Miami Beach, Fla. 33119.

Name \_\_\_\_\_  
Address \_\_\_\_\_  
City \_\_\_\_\_  
State/Zip \_\_\_\_\_