

A FIRST LOOK AT IBM'S NEWEST "PERSONAL" PC

48784

# Popular Electronics

DECEMBER 1990

## THE WIMSHURST MACHINE

Learn a basic principle of electronics when you experiment with 75,000 volts of static electricity

## BUILD THE BITGRABBER

Use this interface circuit to test your PC, or to control almost anything in your home or office

## BUILD AN ELECTRONIC GLASS-BOTTLE CUTTER

Turn out great holiday presents and conversation pieces with this fun project

## THE LONG ISLAND SPY STATION

A true story of high-tech intrigue

## WHAT TO DO WHEN YOUR PRINTER FAILS

These troubleshooting and repair tips could save you lots of time and money

A  
**GERNSBACK**  
PUBLICATION



\$2.50 U.S.  
\$2.95 CANADA

3 NEW  
FactCards  
IN THIS ISSUE

### Product Test Report

- Onkyo TX-SV90PRO  
Audio/Video Receiver



# RADIO SHACK PARTS PLACE <sup>SM</sup>

## WHERE SANTA STOCKS HIS WORKSHOP!

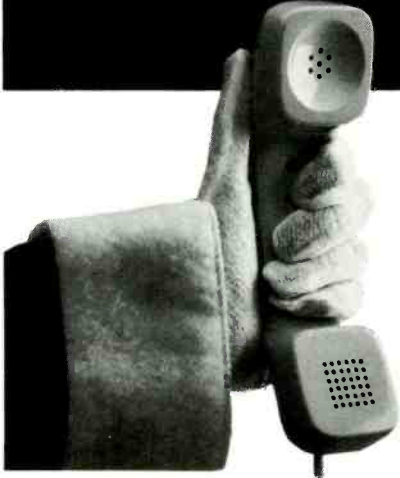

### PARTS HOTLINE

Radio Shack has a huge selection of popular electronic components. Plus, we can special-order 10,000 items from our warehouse—ICs, tubes, semiconductors, phono cartridges and styli, even SAMS® manuals. Service is fast and there's no minimum order or postage charge.



### BATTERY HOTLINE

In addition to our large in-store stock, we can now supply almost any currently manufactured consumer-type battery—for cordless phones, computer memory, camcorders, transceivers, pagers and more. Service is fast and there are no postage or handling charges.



**Studfinder.** Ends guessing, easy to use! Senses changes in wall density to find wooden studs fast—also wires, conduit, pipes. Battery extra. #64-2825 ..... **19.95**



**Super Calculator!** The EC-4035 makes electronics math a snap. Displays units—V, A, mA, mW. 110 functions. #65-983 ..... **39.95**



**16-Piece Precision Tool Kit.** Top-quality jeweler's-type philips, blade and nutdrivers plus hex keys and a torque bar. Fitted molded case. #64-1961 ..... **10.95**



**100-Watt Soldering Gun.** Pull the trigger for full temperature in seconds. Built-in light. The comfort-molded handle stays cool. UL listed AC. #64-2193 ..... **10.95**



**NEW! Semiconductor "Sub" Book.** Our 1991 edition lists over 95,000 types and the Radio Shack replacements. #276-4014 ..... **3.99**

**Getting Started in Electronics.** By Forrest Mims III. The perfect introduction to project building. 128 pages. #276-5003 ..... **2.49**

## ELECTRONICS STOCKING STUFFERS!



**Engineer's Mini-Notebook Series.** By Forrest Mims III. Great gifts! Project ideas and useful data in Mims' famous, friendly style—big diagrams, handlettered text. With tips and suggestions for further experiments.

- NEW! Science Projects.** #276-5018 ... **1.49**
- Timer ICs.** 555/556 ICs. #276-5010 ... **99¢**
- Op Amp ICs.** #276-5011 ..... **1.49**
- Optoelectronics.** #276-5012 ..... **1.49**
- Basic Circuits.** #276-5013 ..... **1.49**
- Digital Logic Circuits.** #276-5014 ..... **1.49**
- Communications Projects.** #276-5015, **1.49**
- Formulas and Tables.** #276-5016 ..... **1.49**
- Schematic Symbols.** #276-5017 ..... **1.49**

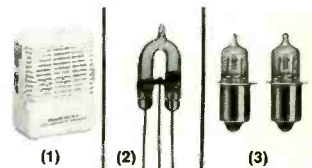

(1) **Mini Audio Amp/Speaker.** Ideal testbench amp, also great for computer voice/music synthesis. Battery extra. #277-1008 ..... **11.95**

(2) **Long-Life Xenon Strobe Tube.** With data. #272-1145 ..... **3.29**

(3) **Halogen Flashlight and Lantern Bulbs.** HPR50. 6-volt. #272-1189. HPR52. 3V. #272-1190 ... **Each 3.95**



**Pocket-Size Digital Multimeter With Autoranging.** Super gift for anyone working with electronics. This tester folds, with its probes, to fit a shirt pocket. Features easy-to-read LCD display, continuity sounder. Measures to 400 volts AC/DC, 2 megohms resistance. 4 1/4 x 2 1/8 x 5/16". #22-171 ..... **39.95**

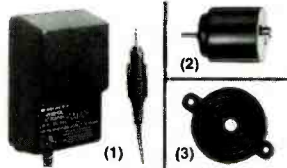

(1) **Universal AC Adapter.** 3, 4.5, 6, 7.5 or 9VDC output. With 6-piece Adaptaplug® set. #273-1650 ..... **12.95**

(2) **1 1/2-VDC Motor.** About 1 1/2" long. #273-223 ..... **99¢**

(3) **DC Pulsing Buzzer.** Extra loud! #273-066 ..... **4.29**

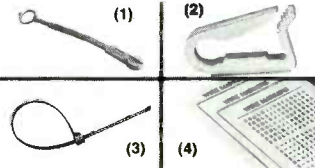

(1) **NEW! Reusable Cable Ties.** #278-1622 ..... **Pkg. of 10/4.99**

(2) **"Universal" Cable Clips.** #278-1647 ..... **Pkg. 10/2.79**

(3) **NEW! In/Outdoor Wire Ties.** #278-1652 ..... **Pkg. of 30/2.99**

(4) **Markers.** 630 stick-on letters. #278-1650 ..... **Set/1.79**

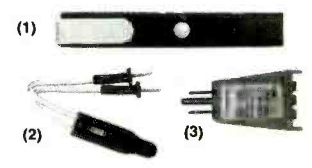

(1) **NEW! AC Sensor.** Indicates presence of 70 to 440VAC without direct electrical connection. Safety first! #22-103 ..... **9.95**

(2) **NEW! Circuit Tester.** 90-300V AC/DC. #22-102 ..... **1.99**

(3) **AC Outlet Fault-Finder.** 3-prong for grounded outlets. #22-101 ... **5.95**

Since 1921 Radio Shack has been the place to obtain up-to-date electronic parts as well as quality tools, test equipment and accessories at low prices. Over 7000 locations to serve you—NOBODY COMPARES

Prices apply at participating Radio Shack stores and dealers. Radio Shack is a division of Tandy Corporation

**Radio Shack**  
AMERICA'S TECHNOLOGY STORE

CIRCLE 20 ON FREE INFORMATION CARD

www.americanradiohistory.com

# Popular Electronics®

THE MAGAZINE FOR THE ELECTRONICS ACTIVIST!

## CONSTRUCTION ARTICLES

<b>BUILD THE BITGRABBER</b> .....	John Yacono and Marc Spiwak	33
<i>Take the drudgery out of testing parallel computer I/O ports with this handy little circuit</i>		
<b>THE "HOT-WIRE" GLASS BOTTLE CUTTER</b> .....	Anthony Charlton	36
<i>Create colorful decorative ornaments and useful implements with an easy-to-build electronic cutting assembly</i>		
<b>BUILD A BURGLAR ALARM</b> .....	Marc Spiwak	41
<i>Protect your property without the expense and bother of a professionally installed, commercial burglar alarm</i>		
<b>ELECTRONIC NOVELTY LIGHT</b> .....	Stanley A. Czarnik	43
<i>Build this circuit and learn how light dimmers work</i>		

## FEATURE ARTICLES

<b>THE WIMSHURST MACHINE</b> .....	Gregory B. Putz	29
<i>Get in on the fun and excitement of high-voltage experiments with a device that has earned its place in history</i>		
<b>THE LONG ISLAND SPY STATION</b> .....	Robert Angus	57
<i>Read a true tale of espionage that would have made Ian Fleming proud</i>		
<b>ALL ABOUT THERMISTORS</b> .....	Harry Trietley	60
<i>Gain a full understanding of what thermistors are and how you can take advantage of them</i>		
<b>TROUBLESHOOTING YOUR PRINTER</b> .....	Stephen Bigelow	65
<i>Don't needlessly spend money on printer repairs that you can probably do yourself</i>		
<b>THE DIGITAL ELECTRONICS COURSE</b> .....	Robert A. Young	71
<i>An introduction to latches</i>		

## PRODUCT REVIEWS

<b>GIZMO</b> .....		45
<i>Including: IBM PS/1 Personal Computer, Di-Tron Systems VP1410 Video Printer, and much more</i>		
<b>PRODUCT TEST REPORT</b> .....	Len Feldman	72
<i>Onkyo TX-SV90PRO Audio/Video Receiver</i>		
<b>HANDS-ON REPORT</b> .....		76
<i>Individual training for Lotus 1-2-3</i>		

## COLUMNS

<b>THINK TANK</b> .....	Byron G. Wels	22
<i>Holidaze</i>		
<b>ANTIQUÉ RADIO</b> .....	Marc Ellis	78
<i>Tube-testing power</i>		
<b>CIRCUIT CIRCUS</b> .....	Charles D. Rakes	81
<i>More generator circuits</i>		
<b>COMPUTER BITS</b> .....	Jeff Holtzman	84
<i>Fun with windows</i>		
<b>FUN SOFTWARE</b> .....	Fred Blechman	86
<i>A "risky" landing</i>		
<b>DX LISTENING</b> .....	Don Jensen	88
<i>Two-hundred years of Mozart</i>		
<b>SCANNER SCENE</b> .....	Marc Saxon	90
<i>The gift that keeps on giving</i>		
<b>HAM RADIO</b> .....	Joseph J. Carr	92
<i>Choosing the right transmission line</i>		

## DEPARTMENTS

<b>EDITORIAL</b> .....	Carl Laron	2
<b>LETTERS</b> .....		4
<b>ELECTRONICS LIBRARY</b> .....		6
<b>NEW PRODUCTS</b> .....		14
<b>ADVERTISERS INDEX</b> .....		102

Popular Electronics (ISSN 1042-170X) Published monthly by Gernsback Publications, Inc., 500-B Bi-County Boulevard, Farmingdale, NY 11735. Second-Class postage paid at Farmingdale, NY and at additional mailing offices. One-year, twelve issues, subscription rate U.S. and possessions \$21.95, Canada \$25.95, all other countries \$29.45. Subscription orders payable in U.S. funds only, International Postal Money Order, or check drawn on a U.S. bank. U.S. single copy price \$2.50. © 1990 by Gernsback Publications, Inc. All rights reserved. Hands-on Electronics and Gizmo trademarks are registered in U.S. and Canada by Gernsback Publications, Inc. Popular Electronics trademark is registered in U.S. and Canada by Electronics Technology Today, Inc. and is licensed to Gernsback Publications. Printed in U.S.A.

Postmaster: Please send address changes to Popular Electronics, Subscription Dept., P.O. Box 338, Mount Morris, IL 61054-9932.

A stamped self-addressed envelope must accompany all submitted manuscripts and/or artwork or photographs if their return is desired should they be rejected. We disclaim any responsibility for the loss or damage of manuscripts and/or artwork or photographs while in our possession or otherwise.

As a service to readers, Popular Electronics publishes available plans or information relating to newsworthy products, techniques, and scientific and technological developments. Because of possible variances in the quality and condition of materials and workmanship used by readers, Popular Electronics disclaims any responsibility for the safe and proper functioning of reader-built projects based upon or from plans or information published in this magazine.

Larry Steckler

*EHF, CEF*

*Editor-in-Chief and Publisher*

## EDITORIAL DEPARTMENT

Carl Laron

*Editor*

Robert A. Young

*Associate Editor*

John J. Yacono

*Associate Editor*

Byron G. Wels, K2AVB

*Associate Editor*

Teri Scaduto

*Assistant Editor*

Kathy Terenzi

*Editorial Assistant*

Marc Spiwak

*Editorial Associate*

Joseph J. Carr, K4IPV

Marc Ellis

Len Feldman

Jeffrey K. Holtzman

Don Jensen

Charles D. Rakes

Marc Saxon

*Contributing Editors*

## PRODUCTION DEPARTMENT

Ruby M. Yee

*Production Director*

Karen S. Tucker

*Production Manager*

Marcella Amoroso

*Production Assistant*

Janice Box

*Editorial Production*

## ART DEPARTMENT

Andre Duzant

*Art Director*

Injae Lee

*Illustrator*

Russell C. Truelson

*Illustrator*

Jacqueline P. Cheeseboro

*Circulation Director*

Michele Torrillo

*P.E. Bookstore*

## BUSINESS AND EDITORIAL OFFICES

Gernsback Publications, Inc.

500-B Bi-County Blvd.

Farmingdale, NY 11735

1-516-293-3000

Fax: 1-516-293-3115

President: Larry Steckler

Vice President: Cathy Steckler

Customer Service/Order Entry

1-800-435-0715

In IL 1-800-892-0753

7:30 AM - 8:30 PM EST

## Advertising Sales offices listed on page 101

Cover photo by R.A. Ford, and appears courtesy of TAB Books, Blue Ridge Summit, PA

Composition by  
Mates Graphics



The  
Audit  
Bureau  
of Circulation



The publisher has no knowledge of any proprietary rights which will be violated by the making or using of any items disclosed in this issue.

# EDITORIAL

## LEARNING BY DOING

I'd like to start off this month by wishing all of you a heartfelt Seasons Greetings and Happy New Year from everyone here at Popular Electronics. The past year was one that was just chock full of fun and surprises for all of us. And if you've only had half as much fun reading our magazine and building our projects as we've had bringing it all to you, then we know you've had a ball, too!

But while having fun is what this magazine is all about, we have a serious side, too. Most likely, one of the reasons you are reading this magazine is to gain a greater knowledge of electronics, which in turn can give you a more enjoyable hobby.

But a knowledge of electronics can give you a lot more. It is a valuable skill that can serve you in many ways as you continue your education or your career.

With that in mind, we try to pack each issue with as much information as possible. Of course, you've got to take the initiative to make the most of it. Read the articles that focus on electronics principles and concepts. Work out the formulas for yourself, and make sure that you totally understand the concepts presented.

And why not try some of the projects? Each month, we present something that's just right for every level of builder, including those who's hands have never held a soldering iron.

But don't treat the construction details like a cookbook recipe. Take the time to also read the theory and circuit-description sections of the article so that you understand what the various parts of the project do, and how each affects everything else. That's the best way to get the most out of each project, and it can help you quickly pinpoint problems should things not work properly on the first try.

Once you start building, you're sure to be hooked for life. After all, it's fun, it's relaxing, and it's a great way to learn even more about electronics.

Carl Laron  
Editor





# LETTERS

## CONSUMER-ELECTRONICS FOR THE BLIND

I am a totally-blind reader who has enjoyed **Popular Electronics** for many years. Using an Optacon, a device that provides a raised image of the text under a small camera moved by hand across the page, I am able to read the text and many of the schematics quite well. I particularly enjoy *Think Tank* and *Circuit Circus*, which feature small circuits that can be used alone or in other projects.

Your *Gizmo* section is very interesting, but it would be more helpful in many instances if the reviews indicated more clearly whether the products could be successfully operated without sight. Many products would be of great interest to visually-impaired individuals if they could operate them without sighted assistance. Clock radios must be set by holding a button until the desired time appears on an LED/LCD display, and so are totally unusable without sight. In moments of anger and frustration, I call that system "idiot data entry" as opposed to direct keyboard entry of data. We who are blind want just as much to have convenient and independent access to a clock radio as those who can see. Another example is cordless phones. Most cordless phones—which are audible devices—have only an LED for low-battery indication, but no audible indicator.

My wife (who is also blind) and I gain much enjoyment from shortwave scanners. The most important feature to give us satisfactory access to those units is direct keyboard entry. The next-most-important feature is a "feel-able" keyboard—with real buttons! Some membrane keyboards can be "brailled" but, all else being equal, real buttons provide more reliable operation. And some "keyboards" are merely smooth printed panels that provide no tactile assistance in locating keys; the devices usually don't provide any audible or tactile feedback when a "key" is pressed. (The "beep" associated with the keyboards on most microwaves has been an invaluable help to those of us without sight.)

I realize that many products, such as hand-held electronic

dictionaries, fast-action arcade games, and light displays, are manifestly intended for visual-only use. But when devices that could potentially be useful to blind people are reviewed, I would like to know if we could really operate them, or whether they contain visual-only barriers that would prevent or seriously hamper our use of them. In an age when great strides are being made to give handicapped people access to the mainstream of society, I think it is time for the consumer-electronics manufacturing community to consider operation of its products by people with little or no sight. In addition to providing information to visually-impaired users, appropriate mention of device characteristics (keyboard, clock-set method, etc.) that facilitate product operation without sight would increase public awareness of the desire of most blind people to have as much access as possible to new and exciting consumer electronics.

D.P.  
Independence, MO

## SOUND-EFFECTS GENERATOR CORRECTION

After submitting my article "Build an IR-Triggered Sound-Effects Generator" (**Popular Electronics**, October 1990), I discovered a couple of errors had crept into the artwork. Transistor Q1 in Fig. 2 should be drawn as a PNP transistor. Its emitter connects to +5V, its base to R6, and its collector to R8. In Fig. 6, the pinout of the 2N2907 (Q1) should be the same as that for the 2N2222 (Q2).

Jan Axelson

## LIGHTNING-GENERATOR ALERT

I just received the September issue of **Popular Electronics**, and found the article "Tesla's Lightning Generators" quite interesting. However, I would like

to clarify some areas of possible hazard and poor performance.

There is a potentially *fatal* flaw in the schematic shown on page 30. In that representation, it appears that the low-potential (ground) side of the secondary is connected to one side of the primary-tank circuit. That can create a high RF potential in the high-voltage (60-Hz) transformer, which can break down the insulation—shorting out the transformer, possibly causing a fire, or even electrocution in some situations. A much safer way is to use the inherent neutral point in the transformer itself. The transformer core is designed to always operate at ground potential, with each high-voltage winding appearing at opposite potential (essentially, a center-tapped secondary, with the midpoint grounded). That ensures that the windings nearest the core will always be at the lowest possible potential. In any event, it is imperative that separate grounds be used for the primary and secondary sides of the circuit.

As to the author's claim that a 15KV DC capacitor will work with 10KV AC, that is not only wrong, but *dangerous*! Recall that the AC waveform has both a positive as well as a negative peak. Each peak will have an equivalent DC potential of 1.414 times the RMS AC rating. So, if both the positive as well as negative portions are used, that will impose an equivalent DC voltage of 2.828 times the RMS AC voltage! Capacitors have been known to *explode* when over-stressed in that fashion! I speak from experience; it happened to me some time ago. Luckily, I wasn't nearby at the time it decided to go.

The author also claims that ceramic "door knob" capacitors work best. While those types of capacitors will stand up to a great deal of abuse, they are extremely lossy at the RF frequencies created in the spark-gap oscillator section of the coil. A better type of capacitor to use is one that is suited to a pulse-

discharge service. Polyethylene or polypropylene capacitors work best, but a Mylar unit will work almost as well, and can be obtained off the shelf from Plastic Capacitors in Chicago, IL.

B.C.T  
Orange, CA

## HAVES AND NEEDS

Can anyone help me find a schematic or the service literature for an Atari 2600 video-game machine? Thank you.

Ray Simmons  
800 N. Columbia Ave.  
Campbellsville, KY 42718

I would like to exchange information and ideas with others who are interested in preserving and/or improving the audio-amplifier circuit known as "Ultra-Linear." This milestone vacuum-tube circuit was patented by Hafler and Keroes around 1951. Many of you are probably more familiar with its popular descendant, the Dynaco Stereo 70. Thousands of them were sold, many as kits. It is my impression that many of them are still in use, and that there may be other hobbyists who are also interested in keeping the circuit alive.

Milton Maxwell  
13 Billingsley Drive  
Livingston, NJ 07039

## A CALL FOR HELP

I was a Journeyman electrician for 20 years, until I lost all use of my left arm and hand in an accident. I'd still like to tinker around a bit as an electronics hobbyist, but I'm having a hard time figuring out a way to solder one-handed. I've tried some of the obvious solutions, including a swivel vise, but without much success. Can any of your readers come up with an idea for me?

Ronald M. Berkey  
1629 Harvard Ave. #311  
Seattle, WA 98122

If anyone can help Ronald out, please write directly to him.—  
Editor



# SELECT 5 BOOKS for only \$4.95

(Values to \$114.70)  
and get a **FREE Gift!**

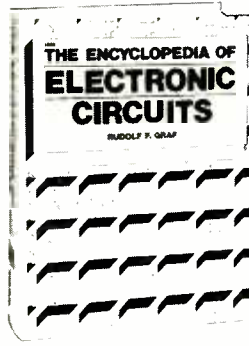
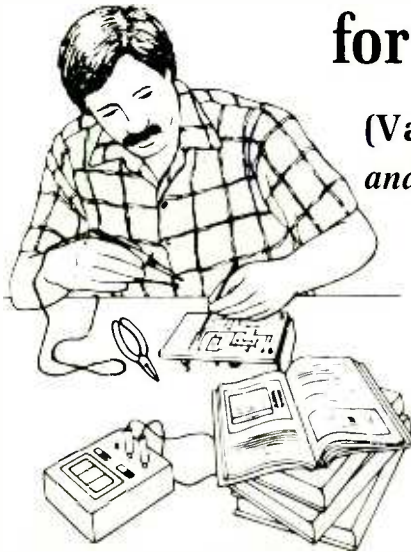

1938H \$60.00  
Counts as 3

For over 25 years, your most complete  
source for electronics books.

**Membership Benefits • Big Savings.** In addition to this introductory offer, you keep saving substantially with members' prices of up to 50% off the publishers' prices. • **Bonus Books.** Starting immediately, you will be eligible for our Bonus Book Plan, with savings of up to 80% off publishers' prices. • **Club News Bulletins.** 15 times per year you will receive the Book Club News, describing all the current selections—mains, alternates, extras—plus bonus offers and special sales, with scores of titles to choose from. • **Automatic Order.** If you want the Main Selection, do nothing and it will be sent to you automatically. If you prefer another selection, or no book at all, simply indicate your choice on the reply form provided. You will have at least 10 days to decide. As a member, you agree to purchase at least 3 books within the next 12 months and may resign at any time thereafter. • **Ironclad No-Risk Guarantee.** If not satisfied with your books, return them within 10 days without obligation! • **Exceptional Quality.** All books are quality publishers' editions especially selected by our Editorial Board.

(Publishers' Prices Shown)

## FREE when you join!

### 15 Easy Electronic Projects From Delton T. Horn

Projects you can build—some unique, some old favorites—from the author's vast treasury of electronics know-how.

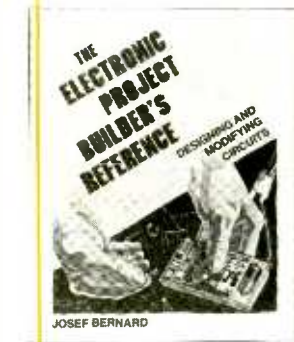

3260 \$22.95



3258 \$27.95  
Counts as 2



2707 \$26.95  
Counts as 2



2613P \$17.95



2883P \$17.95



2-67P \$18.95



2809 \$29.95  
Counts as 2



2-25P \$9.95



3337 \$35.95  
Counts as 2

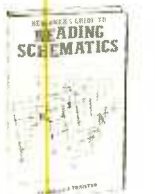

1531P \$11.95



2724P \$16.95



1811P \$14.95



2981P \$16.95

All books are hardcover unless number is followed by a "P" for paperback.

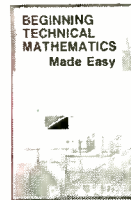

3383 \$14.95

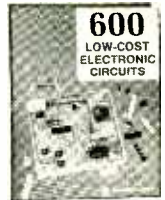

3219 \$27.95  
Counts as 2

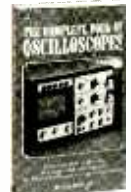

1532P \$14.95



3145 \$19.95



3329 \$29.95  
Counts as 2



3031P \$17.95

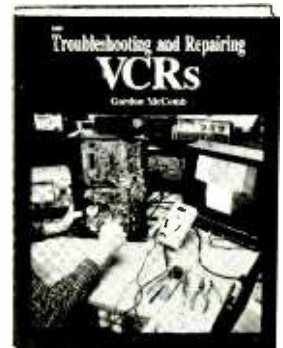

2960 \$27.95  
Counts as 2

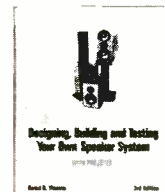

3374 \$24.95



2980P \$19.95

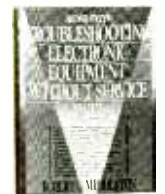

9290 \$36.00  
Counts as 2



2800P \$16.95

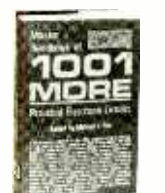

804P \$21.95  
Counts as 2

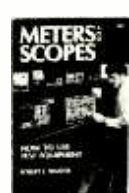

2826P \$16.95

**ELECTRONICS BOOK CLUB<sup>SM</sup>**  
Blue Ridge Summit, PA 17294-0810

Please accept my membership in the Electronics Book Club and send the 5 volumes listed below, plus my FREE copy of *Delton T. Horn's All-Time Favorite Electronic Projects* (3105P), billing me \$4.95. If not satisfied, I may return the books within ten days without obligation and have my membership cancelled. I agree to purchase at least 3 books at regular Club prices during the next 12 months and may resign any time thereafter. A shipping/handling charge and sales tax will be added to all orders.

--	--	--	--

Name \_\_\_\_\_  
 Address \_\_\_\_\_  
 City \_\_\_\_\_  
 State \_\_\_\_\_ Zip \_\_\_\_\_ Phone \_\_\_\_\_  
 Signature \_\_\_\_\_

Valid for new members only Foreign applicants will receive special ordering instructions Canada must remit in U.S. currency This order subject to acceptance by the Electronics Book Club PE1290

© 1990 ELECTRONICS BOOK CLUB  
Blue Ridge Summit, PA 17294-0810

# ELECTRONICS LIBRARY

## How To Test Almost Everything Electronic: 2nd Edition

by Jack Darr and Delton T. Horn

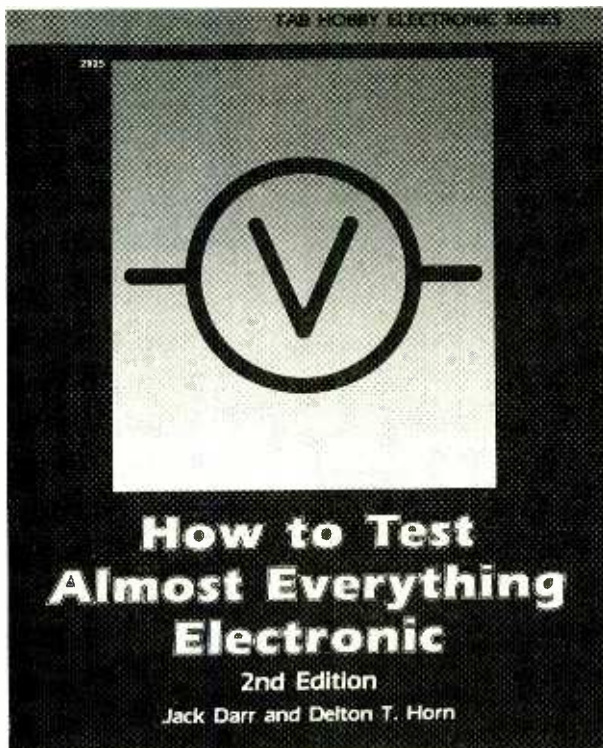

Originally written back in 1966—by two authors whose work is probably familiar to everyone who reads about electronic servicing—this popular book has been completely updated to reflect the drastic changes that have occurred since then. Tubes have become rarities, and IC's and digital circuitry are now the norm, yet when it comes to servicing electronic devices, some basic techniques remain the same. The new edition retains the original's practical, common-sense approach to troubleshooting and diagnostics, and applies

them to today's electronics. Some of today's test equipment has changed as much as the devices to be tested; this edition also covers the new types of test equipment available.

The book includes easy-to-follow instructions for using electronic test equipment, accompanied by examples of typical circuit types and basic

principles of troubleshooting and interpreting test results. Most of the information is kept as general as possible, so it is applicable to various types of equipment. It covers power-supply, DC-voltage, VOM, VTVM, signal-tracing, alignment, oscilloscope, component, and TV tests. An overview of electronic test instruments discusses ammeters, voltmeters, oscilloscopes, logic probes, and analyzers. A new section on testing digital circuitry has been added.

*How to Test Almost Everything Electronic: 2nd Edition is available for \$9.95 from TAB Books Inc., Blue Ridge Summit, PA 17294-0850; Tel. 1-800-233-1128.*

**CIRCLE 98 ON FREE INFORMATION CARD**

### INDUSTRIAL ELECTRONICS CET EXAM STUDY GUIDE

by Sam Wilson

Passing the Journeyman Certified Electronics Technician (CET) exam is an important career step, offering the possibility of more rapid advancement, increased earning potential, enhanced professional standing, and new job opportunities. For those who are planning to take the Journeyman CET test in the Industrial Electronics Option, or who are simply curious to find out what it requires, this book offers a comprehensive review of all the information needed to achieve certification.

Written as a companion to *Industrial Electronics for Technicians* (Electronics Library,

**Popular Electronics**, November 1990), the study guide helps reader review related subjects before taking the CET test. Practice questions help readers to pinpoint their areas of strength and weakness so they can determine which

areas to concentrate on. The book helps readers become familiar with test terminology and procedures as well as the subject areas covered by the exams. In addition to the questions presented in each chapter, a complete practice exam is included.

*Industrial Electronics: CET Exam Study Guide is available for \$16.95 from TAB Books Inc., Blue Ridge Summit, PA 17294-0850; Tel. 1-800-233-1128.*

**CIRCLE 98 ON FREE INFORMATION CARD**

### WORDPERFECT FROM 5.0 TO 5.1

by Karen L. Acerson

Having been involved in almost every aspect of WordPerfect, from development to documentation, including a stint as head of Customer Support at WordPerfect Corporation, Karen L. Acerson is certainly qualified to help WordPerfect users upgrade from 5.0 to the newest Release 5.1. In this book she discusses all the "hot" features of the latest version, detailing exactly what has changed and explaining how to take advantage of those changes. Included are discussions of WordPerfect 5.1's mouse support and pull-down menus, improved mail-merge functions, ability to create tables and complex equations, enhanced macro language, and the ability to import

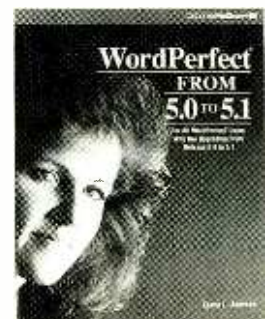



spreadsheets from other software programs. The book contains descriptions of every WordPerfect 5.1 command, feature, and function, along with convenient tips for the best usage and applications. Also covered are the later enhancements to version 5.0.

*WordPerfect: From 5.0 to 5.1* is available for \$17.95 from Osborne McGraw-Hill, 2600 Tenth Street, Berkeley, CA 94710.

**CIRCLE 93 ON FREE INFORMATION CARD**

## FISHER WORLD TREASURE NEWS

from Fisher Research Laboratory

Whether you're a dedicated treasure-hunter, or are simply curious about what's been going on in the world of metal detecting, you'll enjoy browsing through this 16-page newspaper-style periodical. Its articles cover the professional and hobby use of land and underwater metal detectors around the world—including recent valuable finds (a five-pound gold nugget); how-to



pieces on beach-combing and prospecting; and a story titled "The World's Longest Metal Detector" that was written by the commander of a California-based dive/rescue team. Special sections include "Treasure Hunters and the Law," "Metal Detectors and Archaeology," and "Underwater Treasure." This issue also features a "Guess the Coins" contest with a \$660 land/sea metal detector as first prize.

*Fisher World Treasure News* is free upon request from Fisher Research Laboratory, Dept. WL-44, 200 West Willmott Road, Los Banos, CA 93635. Extra copies are available to diving

clubs, treasure-hunting clubs, and search-and-rescue organizations.

**CIRCLE 90 ON FREE INFORMATION CARD**

## WORDSTAR 5.5 MADE EASY

by Walter A. Ettlin

The latest update of WordStar, Release 5.5, has several new features—preformatted paragraph styles, simplified newspaper-style columns, and

the ability to print directly from the keyboard. In addition, the "InSet" program allows users to work with graphics files. This book, an update of Walter Ettlin's original *WordStar Made Easy*, is designed to make it easy for experienced users to become familiar with those new features, and to help new users gain proficiency. It demonstrates all the skills required for most general word-processing tasks.

To make learning easier, the book is divided into lessons.

Each lesson contains a set of instructions, sample exercises, and example text to be used in the lesson that matches the illustrations in the book. Readers are guided, step by step, through everything from basic document creation and editing to macros, calculations, and word searches. Two WordStar Command Cards, which summarize the most commonly used commands in the WordStar manual, are included. Appendices list the new and

# ELENCO & HITACHI PRODUCTS AT DISCOUNT PRICES

**NEW!** RSOs (Real-Time & Storage Oscilloscopes) From HITACHI **NEW!**  
The RSO - its the new solution  
View, Acquire, Test, Transfer and Document Your Waveform Data

4-Channel, 100MS/s Model	Introductory Price
100MS/s (25MS/s on 4 channels simultaneously), 100MHz, 4kw x 1ch., 2kw x 2ch., 1kw x 4ch.	VC-6145 \$4,695.00
<b>Compact, Full Feature Models</b>	
40MS/s, 100MHz, 4kw x 1ch., 2kw x 2ch.	VC-6045 \$3,049.00
20MS/s, 50MHz, 2kw x 2ch.	VC-6025 \$2,295.00
<b>Low Cost/High Value Models</b>	
20MS/s, 50MHz, 2kw x 2ch.	VC-6024 \$2,049.00
20MS/s, 20MHz, 2kw x 2ch.	VC-6023 \$1,749.00

RSOs from Hitachi feature such functions as roll mode, averaging, save memory, smoothing, interpolation, pretriggering, cursor measurements, plotter interface, and RS-232C interface. With the comfort of analog and the power of digital.

V-422 40MHz Dual Trace \$795

**Hitachi Portable Scopes**  
DC to 20MHz, DC offset function, Alternate magnifier function

V-525 CRT Readout, Cursor Meas. \$1,025  
V-523 Delayed Sweep \$895  
V-522 Basic Model \$895

**Compact Series Scopes**

Model V-1065 Shown

This series provides many new functions such as CRT Readout, Cursor measurements (V-1085/105/565), Frequency Ctr (V-1085), SweepTime Autoranging and Trigger Lock using a 6-inch CRT. You don't feel the compactness in terms of performance and operation.

V-660 60MHz Dual Trace	\$1,195
V-665 60MHz Dual Trace w/Cursor	\$1,345
V-1060 100MHz Dual Trace	\$1,425
V-065 100MHz Dual Trace w/Cursor	\$1,695
V-1085 100MHz Quad Trace w/Cursor	\$2,045
V-100A 100MHz Quad Trace w/Cursor	\$2,295
V-1150 150MHz Quad Trace w/Cursor	\$2,775

**20MHz Elenco Oscilloscope**  
MO-1251

• 6" Trace  
• Component Tester  
• 6" CRT  
• X-Y Operation  
• TV Sync  
• 2 p 1 Probes

**\$375**

**FREE DMM**  
with purchase of  
**ANY SCOPE**

**SCOPE PROBES**  
P-1 65MHz, 1x, 10x \$19.95  
P-2 100MHz, 1x, 10x \$23.95

**Elenco 35MHz Dual Trace**  
Good to 50MHz  
MO-1252

- High luminance 6" CRT
- 1mV Sensitivity
- 8KV Acceleration Voltage
- 10s Rise Time
- X-Y Operation = Z Axis
- Delayed Triggering Sweep
- Includes 2 P-1 Probes

**\$495**

All scopes include probes, schematics, operators manual, and 3 year (2 yrs for Elenco scopes) world wide warranty on parts & labor. Many accessories available for all Hitachi scopes. Call or write for complete specifications on these and many other fine oscilloscopes.

<p><b>WE NOW CARRY COMPLETE LINE OF FLUKE MULTIMETERS Models</b></p> <p>83 85 87 8050A 8060A 8062A 77F + More</p> <p><b>CALL FOR SPECIAL PRICING</b></p>	<p><b>True RMS 4 1/2 Digit Multimeter M-7000</b></p> <p><b>\$135</b></p> <p>05% DC Accuracy 1% Resistance With Freq. Counter and deluxe case</p>	<p><b>10 Function Multimeter CM-365</b></p> <p><b>\$65</b></p> <p>AC + DC Voltage &amp; Amps Resistance to 2000MΩ Diode, Logic, &amp; Trans test Capacitance to 2000F</p>	<p><b>Digital Capacitance Meter CM-1550</b></p> <p><b>\$58.95</b></p> <p>9 Ranges 1pt-20,000uF 5% basic acy Zero control with case</p>	
	<p><b>Function Generator Blox #9600</b></p> <p><b>\$28.95</b></p> <p>Provides sine, triangle, square wave from 1Hz to 1MHz AM or FM capability</p>	<p><b>Triple Power Supply XP-620</b></p> <p><b>Assembled \$65 Kit \$45</b></p> <p>2 to 15V at 1A, 2 to -15V at 1A (or 4 to 30V at 1A) and 5V at 3A</p> <p>Contains all the desired features for doing experiments. Features short circuit protection, all supplies.</p>	<p><b>Wide Band Signal Generators SG-9000</b></p> <p><b>\$129</b></p> <p>RF Freq 100K-450MHz AM Modulation of 1kHz Variable RF output</p>	
<p><b>Soldering Station</b> Temperature Controlled SL-30 \$99</p> <p>Digital display Temp range 300F-900F Grounded tip Overheat protect</p>	<p><b>Color Convergence Generator SG-200</b></p> <p><b>\$69.95</b></p> <p>Finest in the industry 10 rock steady patterns</p>	<p><b>10MHz Oscilloscope S-3000</b></p> <p><b>\$275</b></p> <p>10MHz DC or AC Triggered Sweep Centrally Vets &amp; Hor leads Volts &amp; Freq</p>	<p><b>Temperature Probe M-110CF</b></p> <p><b>\$29.95</b></p> <p>Semiconductor Type Range -50F-302F</p> <p>Fits most digital multimeters</p>	<p><b>Autoranging DMM M-5000</b></p> <p><b>\$45</b></p> <p>9 Functions Memory and Data hold 1% basic acy 3 1/2 digit LCD</p>
<p><b>AC Current Meter ST-1010</b></p> <p><b>\$69.95</b></p> <p>1000 Amps Data &amp; Peak hold 8 Functions Deluxe Case</p>	<p><b>Decade Blox #9610 or #9620</b></p> <p><b>\$18.95</b></p> <p>#9610 Resistor Blox 47 ohm to 1M &amp; 100K pot #9620 Capacitor Blox 47pF to 10MF</p>	<p><b>Quad Power Supply XP-580</b></p> <p><b>\$59.95</b></p> <p>2-20V at 2A 12V at 1A 5V at 3A 5V at 5A</p> <p>Fully regulated w/ short circuit protected XP-575 without meters \$39.95</p>	<p><b>LEARN TO BUILD AND PROGRAM COMPUTERS WITH THIS KIT!</b> INCLUDES: All Parts, Assembly and Lesson Manual</p> <p><b>Model MM-8000</b></p> <p><b>\$129.00</b></p> <p>Starting from scratch you build a complete system. Our Micro-Master trainer teaches you to write in BASIC, PASCAL and run a ROMS microprocessor, which uses similar machine language as IBM PC. You will write the initial instructions to tell the 8085 processor to get started and store these instructions in permanent memory in a 2816 EP PROM. Teaches you all about input and output ports, computer timers. Build your own keyboard and learn how to scan keyboard and display. No previous computer knowledge required. Sample easy to understand instruction. Includes you to write in machine language.</p> <p><b>ROBOTICS KIT FOR ABOVE (MM-8010) \$71.95</b></p>	
<p><b>Digital Triple Power Supply XP-765</b></p> <p><b>\$249</b></p> <p>0-20V at 1A 0-20V at 1A 5V at 5A</p> <p>Fully regulated, Short circuit protected with 2 limit control, 3 separate supplies XP-660 with Analog Meters \$175</p>	<p><b>GF-8016 Function Generator</b> with Freq. Counter</p> <p><b>\$249</b></p> <p>Sine, Square, Triangle Pulse, Ramp, .2 to 2MHz Freq Counter 1 - 10MHz</p> <p>GF-8015 without Freq. Meter \$179</p>	<p><b>WE WILL NOT BE UNDERSOLD!</b> UPS Shipping - 48 States 5% (310 Max) IL Reg. 7% Tax</p>		

**C & S SALES INC.**  
1245 Rosewood, Deerfield, IL 60015  
(800) 292-7711 (708) 541-0710

**15 Day Money Back Guarantee**  
**2 Year Warranty** (Please subject to change)  
**WRITE FOR FREE CATALOG**

**CIRCLE 17 ON FREE INFORMATION CARD**

modified commands, and direct the reader to the lesson where each is discussed; list standard screen characters; show how to personalize WordStar; and present DOS commands.

*WordStar 5.5 Made Easy* is available for \$19.95 from Osborne McGraw-Hill, 2600 Tenth Street, Berkeley, CA 94710.

**CIRCLE 93 ON FREE INFORMATION CARD**

## THE SECRET LIFE OF QUANTA

by Dr. M. Y. Han

If there's one thing that's keeping pace with the rapid development of computers, telecommunications equipment, laser research, and superconductivity, it's the layman's growing feeling of bewilderment. Millions of people—including many who work in technological fields—are hard pressed to keep up with the latest advances in science, let alone to understand the impact those



advances will have on our lives.

This high-tech physics handbook for the layman explains how the laws of quantum physics govern the modern technical world. Concentrating on the nature of atomic particles, molecular structure, and electromagnetic radiation—the cornerstones of the physical universe—Dr. Han introduces general readers to a branch of physics that is relative to their daily lives. He examines principles that are used every day by scientists and engineers. Using simple language, lively analogies, and clear descriptions, Dr. Han explains the basic properties of atoms; light, electricity, magnetism, and electromagnetic radiation; molecular bonds; superconductors and

semiconductors; lasers, masers, "xasers," and fiber optics; the Superconducting Super Collider; nucleons, quarks, and strong and weak forces; and nuclear technologies. He relates complex theories to non-scientific readers, without using mathematics, to bridge the information gap and make "science literacy" possible for the layman. An interpretation of what those developing technologies mean for the future is also included.

*The Secret Life of Quanta* is available in hardcover for \$17.95 from TAB Books Inc., Blue Ridge Summit, PA 17294-0850; Tel. 1-800-233-1128.

**CIRCLE 98 ON FREE INFORMATION CARD**

## THE AHSA ZONING INFORMATION PACKAGE

from The American Home Satellite Association

This comprehensive package on zoning regulations affecting dish ownership and use was developed by the American Home Satellite Association (AHSA) in response to widespread concern over regulations that fail to comply with the FCC's 1986 order preempting local zoning ordinances that discriminate against and restrict the installation of satellite antennas, or "dishes." It is not intended as a substitute for legal representation, but was designed as a resource to help dish owners, dealers, and their attorneys defend the right to install and use satellite-TV receiving systems.

The package includes a summary of the issues; a model zoning ordinance; and an 11-page "Legal Background Memorandum," which was prepared by Lauritz S. Helland, the AHSA's general counsel and an authority on satellite-communications law, and which can be sent to local government officials. It contains information essential to understanding the communications benefits and operating requirements of a home satellite-TV receiving system, and also highlights court decisions on zoning matters. Publication of the package, which will help meet the growing demand from dish owners

for expert assistance on zoning matters, is the first step in an AHSA effort to create an atmosphere of informed awareness that could help do away with discriminatory restrictions against satellite-TV installations.

*The AHSA Zoning Information Package* is available at \$24.95 for AHSA members and \$39.95 for non-members, from the American Home Satellite Association, 16 Broadway, Valhalla, NY 10595; Tel: 800-321-AHSA.

**CIRCLE 89 ON FREE INFORMATION CARD**

## PROTOTYPING CATALOG

from RF Prototype Systems

This 10-page booklet provides photographs, block diagrams, and other pertinent information regarding RF Prototype Systems' full product line. Highlighted in the completely updated brochure are the latest designs from San Diego Company, including the PLL Universal Serial Synthesizer Controller Board. Also featured are parts kits, connectors, and mounting hardware.

*The Prototyping Catalog* is free upon request from RF Prototype Systems, 9393 Activity Road, Suite C, San Diego, CA 92126; Tel: 800-874-8037 (in CA, 619-689-9715); Fax: 619-689-9733.

**CIRCLE 88 ON FREE INFORMATION CARD**

## ELECTRONIC TROUBLESHOOTING PROCEDURES AND SERVICING TECHNIQUES

by J. A. Sam Wilson

Offering "tricks of the trade" along with the basics of troubleshooting and servicing, this book is a comprehensive collection of tests, measurements, procedures, and servicing techniques. In addition, it provides material on how to repair and replace various components. The book focuses on symptoms, showing readers how to interpret them to zero in on the faulty section. The book describes the specific measurements used for locating faulty components, circuits, and systems. To aid in understand-

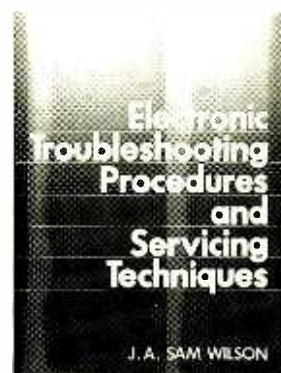

ing, each chapter includes an overview of the subject, a list of specific objectives, a summary, and a self-test quiz. Examples of circuits and components are widely used throughout the text, along with almost 200 illustrations.

*Electronic Troubleshooting Procedures and Servicing Techniques* is available in hardcover for \$36.80 from Prentice Hall, Englewood Cliffs, NJ 07632.

**CIRCLE 99 ON FREE INFORMATION CARD**

## THE WONDERFUL WORLD OF HAM RADIO: AN INTRODUCTION FOR YOUNG PEOPLE

by Richard Skolnik, KB4LCS

Sometimes it takes more than just owning a ham radio to spark a young person's interest in the hobby. This fun-to-read book helps young people learn all the ins and outs of the hobby, and helps them appreciate what a valuable part of their lives it can be. It shows how hams can learn about other subjects, including electronics, geography, and computers, through their hobby. It explains how hams provide vital communications services during emergencies such as hurricanes and earthquakes, and even includes an actual emergency QSO. The book is written at a level that's easy for young readers to understand, and is jam-packed with photographs of radios, ham shacks, field-day setups, and students learning about and using ham radio. The book even explains how to get a ham license and set up a station to talk with other hams around the world.

*The Wonderful World of Ham Radio: An Introduction for*  
(Continued on page 12)



# How to build a high-paying career, even a business of your own, in computer programming.



**RICK BRUSH,  
NRI PROGRAMMER/ANALYST**

**Start with training that gives you hands-on programming experience—at home and at your own pace. Training that begins with BASIC, then continues with Pascal, C, and COBOL—today's hottest computer languages. Training that even includes a powerful IBM-compatible computer, modem, and programming software you keep.**

**Start with real-world training. The kind of training only NRI provides.**

Now with NRI's new at-home training in Computer Programming, you can be one of today's highly paid, creative team of computer wizards who give computers the power to carry out an astonishing range of business, professional, and personal applications. Now, with NRI, you can be a computer programmer, ready to build a high-paying career—even a business of your own—making computers do anything you want them to do.

**The only programming course that includes a powerful computer system and software you keep.**

Unlike any other school, NRI gives you hands-on programming experience with a powerful IBM compatible West Coast computer system, including 2400

baud internal modem, 640K RAM, disk drive, monitor, and invaluable programming software—BASIC, Pascal, C, and COBOL—all yours to keep.

You get the experience and the know-how, the computer and the software to get to the heart of every programming problem, design imaginative solutions, then use your choice of four key computer languages to build original, working programs.

**No matter what your background, NRI gives you everything you need to succeed in programming, today's top-growth computer career field.**

You need no previous experience to build a successful programming career with NRI training. Indeed, your NRI lessons start by walking you step by step through the fundamentals, giving you an expert understanding of the programming design techniques used every day by successful micro and mainframe programmers. And then the fun really begins.



**You master today's hottest computer languages, gaining the skills you need to build programs for a wide variety of real-world applications.**

With your personal NRI instructor on call and ready to help, you use your computer and software to actually design, code, run, debug, and document programs in BASIC, Pascal,

C, and COBOL. Then, rounding out your training, you use your modem to "talk" to your instructor, meet other NRI students, even download programs through NRI's exclusive programmers network, PRONET.

**Your career in computer programming begins with your FREE catalog from NRI.**

For all the details about NRI's at-home training in Computer Programming, send the coupon today. Soon you'll receive NRI's fascinating, information-packed, full-color catalog.

Open it up and you'll find vivid descriptions of every aspect of your NRI training. You'll see the computer system included in your course up close in a special, poster-sized foldout section. And, best of all, you'll find out how your NRI training will make it easy for you to build that high-paying career—even a business of your own—in computer programming.

**Send for your NRI catalog today. It's yours, free.**

If the coupon is missing, write to us at the NRI School of Computer Programming, McGraw-Hill Continuing Education Center, 4401 Connecticut Avenue, NW, Washington, DC 20008.

IBM is a Registered Trademark of the IBM Corporation

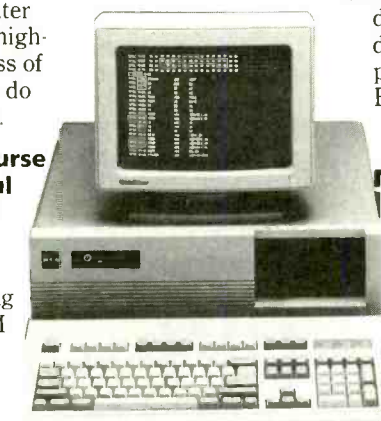

**Only NRI gives you an IBM-compatible computer with modem, 640K RAM, disk drive, monitor, and software—BASIC, Pascal, C, and COBOL—all yours to keep!**

## **NRI** School of Computer Programming

McGraw-Hill Continuing Education Center  
4401 Connecticut Avenue, NW  
Washington, DC 20008



**YES!** Please rush me my FREE catalog describing NRI's at-home training in Computer Programming.

NAME \_\_\_\_\_ (please print) AGE \_\_\_\_\_

ADDRESS \_\_\_\_\_

CITY/STATE/ZIP \_\_\_\_\_ Accredited Member National Home Study Council 5413-120

# AMAZING SCIENTIFIC & ELECTRONIC PRODUCTS

PARTS ARE IN STOCK PLANS	GRA1 — ANTI GRAVITY GENERATOR	\$10.00
	LC7 — 40 WATT BURNING CUTTING LASER	\$20.00
	RUB4 — HI POWER PULSED DRILLING LASER	\$20.00
	BTC5 — 1 MILLION VOLT TESLA COIL	\$20.00
	MCP1 — HI VELOCITY COIL GUN	\$15.00
	LLS1 — LASER LIGHT SHOW 3 METHODS	\$20.00
	EH1 — ELECTRONIC HYPNOTISM TECHNIQUES	\$8.00
	EML1 — LOWER POWERED COIL GUN LAUNCHER	\$8.00
	JL3 — JACOB LADDER 3 MODELS	\$10.00
	SD5 — SEE IN THE DARK	\$10.00
LEV1 — LEVITATION DEVICE	\$10.00	

KITS PROGRAM AVAILABLE ASSISTANCE	FMV1K — 3 MILE FM VOICE TRANSMITTER	\$34.50
	PFS1K — HAND CONTROLLED PLASMA FIRE SABER	\$49.50
	NIG7K — HI FLUX NEGATIVE ION GENERATOR	\$34.50
	PG5K — PLASMA LIGHTNING GLOBE	\$49.50
	LHC2K — VISIBLE SIMULATED 3 COLOR LASER	\$44.50
	HOD1K — HOMING/TRACKING BEEPER TRANSMITTER	\$44.50
	LGU6K — 2.5 MW HAND-HELD VISIBLE LASER GUN	\$249.50
	BTC3K — 250,000 VOLT TABLE TOP TESLA COIL	\$249.50
	IOG2K — ION RAY GUN, project energy without wires	\$129.95
	TKE1K — TELEKINETIC ENHANCER/ELECTRIC MAN	\$79.50
VWPM7K — 3 MILE AUTO TELEPHONE TRANSMITTER	\$49.50	

ASSEMBLED	LIST10 — INFINITY XMTR Listen in via phone lines	\$199.50
	IPG70 — INVISIBLE PAIN FIELD BLAST WAVE GENERATOR	\$74.50
	ITM10 — 100,000 VOLT INTIMIDATOR UP TO 20'	\$99.50
	TAT30 — AUTOMATIC TELEPHONE RECORDING DEVICE	\$24.50
	PSP40 — PHASOR SONIC BLAST WAVE PISTOL	\$89.50
	DNE10 — ALL NEW 26" VIVID COLORED NEON STICK	\$74.50
	LGU20 — 5 TO 1MW VISIBLE RED HeNe LASER GUN	\$199.50
	BLS10 — 100,000 WATT BLASTER DEFENSE WAND	\$89.50

EASY ORDERING PROCEDURE - TOLL FREE 1-800-221-1705  
or 24 HRS ON 1-603-673-4730 or FAX IT TO 1-603-672-5406  
VISA, MC, CHECK, MO IN US FUNDS. INCLUDE 10% SHIPPING. ORDERS  
\$100.00 & UP ONLY ADD \$10.00. CATALOG \$1.00 OR FREE WITH ORDER

**INFORMATION UNLIMITED**  
P.O. BOX 716, DEPT'N, AMHERST, NH 03031

# 25,613

## ELECTRONIC COMPONENTS

Whether you order 1 part or  
all 25,613... **MOUSER** stocks  
and... *can ship today!*

Call or Write...

**(800) 346-6873**



2401 Hwy 287 N  
Mansfield, TX 76063

for your  
**FREE**  
**CATALOG**  
Subscription

**MOUSER**  
**ELECTRONICS**  
Stocking Locations Across America

CIRCLE 21 ON FREE INFORMATION CARD

## ELECTRONICS LIBRARY

(Continued from page 8)

*Young People is available for \$7.95 from any MFJ dealer, or contact MFJ Enterprises, Inc., P.O. Box 494, Mississippi State, MS 39762; Tel: 601-323-5869, or 800-647-1800 for orders; Fax: 601-323-6551.*

**CIRCLE 87 ON FREE  
INFORMATION CARD**

## THE ILLUSTRATED DICTIONARY OF MICROCOMPUTERS: THIRD EDITION

by Michael F. Hordeskis

Reflecting rapid changes in the world of microcomputers, the third edition of this comprehensive reference contains more than 1200 new entries. Covering such fields as microcomputer applications, hardware, software, desktop publishing, computer-aided design, word processing,



networking, and graphics, the dictionary provides up-to-the-minute definitions at a glance. Numerous illustrations help clarify and simplify the book's more than 9500 definitions, and meticulous cross-referencing directs readers to related terms.

*The Illustrated Dictionary of Microcomputers: Third Edition is available for \$19.95 from TPR, Division of TAB Books Inc., Blue Ridge Summit, PA 17294-0850; Tel. 1-800-233-1128.*

**CIRCLE 98 ON FREE  
INFORMATION CARD**

## TECHNI-TOOL CATALOG #39

from Techni-Tool Inc.

Easy-to-follow icons make it simple to locate the items you need from the more-than-18,000 selections in this 248-page cat-

alog of tools, tool kits, and test equipment. It includes everything from electromechanical and assembly devices to electronic, telecommunication, and field-service tool kits. Full lines of items for aerospace production, computer maintenance, and surface-mount technology are also featured. More than 850 manufacturers are represented.

*Techni-Tool Catalog #39 is available from Techni-Tool Inc., 5 Apollo Road, P.O. Box 368, Plymouth Meeting, PA 19462; Tel: 215-825-4990; Fax: 215-828-5623.*

**CIRCLE 86 ON FREE  
INFORMATION CARD**

## USING 1-2-3 RELEASE 2.2

by The LeBlond Group—  
Geoffrey T. LeBlond, William B. LeBlond and Suzanne Polen Berry

Designed to serve as both a tutorial and a reference work, this book should suit the full range of Lotus 1-2-3 users, from beginner to advanced. The early chapters show new users how to quickly get up and running, and contain a detailed treatment of all 1-2-3 features. Later chapters provide more in-depth information to help users with some degree of experience become more proficient. Intermediate level users will appreciate a quick review of 1-2-3 concepts, as well as the hands-on explanations of its major features including file-linking, macro recording, enhanced graphics, and printing options, and the "Always" spreadsheet publishing options. For advanced users, the book covers the new macro-library manager. In addition, the book includes a bonus disk that contains an add-in word processor, "Spreadsheet Writer," along with documentation developed specifically to work in tandem with 1-2-3. Spreadsheet Writer can be used to write reports that include 1-2-3 spreadsheets with just a few keystrokes.

*Using 1-2-3-Release 2.2 is available for \$24.95 (including diskette) from Osborne McGraw-Hill, 2600 Tenth Street, Berkeley, CA 94710.*

**CIRCLE 93 ON FREE  
INFORMATION CARD**



## METERS AND SCOPES: HOW TO USE TEST EQUIPMENT

By Robert J. Traister

As a primer for the novice, or as a ready reference source for the more experienced technician, this book strives to help readers use today's complex test equipment to perform tests and make accurate measurements. It examines the function and use of various devices, including ammeters, voltmeters, ohmmeters, oscilloscopes, universal test in-

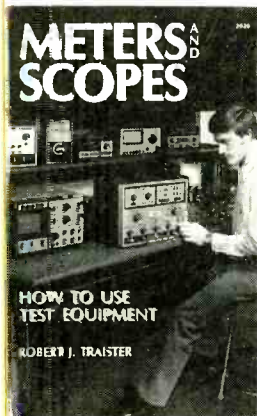

struments, tube testers, SWR meters, and more. Discussions on the measurement of light, heat, force, and pressure are included, and formulas, symbols, and electronics color coding are examined. The book explains how to troubleshoot circuits and diagnose problems. Pointers for buying test equipment are provided, as well as discussions on how to build your own test instruments.

*Meters and Scopes: How to Use Test Equipment* is available for \$16.95 from TAB Books Inc., Blue Ridge Summit, PA 17294-0850; Tel. 1-800-233-1128.

CIRCLE 98 ON FREE  
INFORMATION CARD

## THE PC USER'S SURVIVAL GUIDE

by Jim Aspinal, Rory Burke, and Mike Todd

Aimed at anyone who uses a PC—from those who've just bought their first home computer to experienced programmers—this book pro-

vides specific "how-to" solutions for common computer problems. It explains exactly what steps to take when confronted with a locked keyboard, an unreadable disk, or lost files. It shows readers how to set up and manage their PC environment, choose the best utility software for their system, use preventative measures to maintain their systems, and troubleshoot board-level and hardware peripheral problems. Separate chapters are devoted to anti-virus packages, public-domain and user-supported software, and sources of technical support. Several convenient appendices provide software and literature references, error listings, disk-drive tables, keyboard codes, ASCII charts, and technical tips. In addition, the authors, who have 20 years combined computer experience, include their electronic-mail addresses for further advice and for downloading many of the application programs mentioned in the book.

*The PC User's Survival Guide* is available for \$22.95 from

M&T Publishing Inc., 501 Galveston Drive, Redwood City, CA 94063; Tel. 415-366-3600.

CIRCLE 85 ON FREE  
INFORMATION CARD

## QUE'S COMPUTER USER'S DICTIONARY

from Que Corporation

This easy-to-use resource for personal-computer users places an emphasis on practicality. It contains hundreds of definitions, explanations, examples, and illustrations intended to take the confusion out of personal computing on IBM's, compatibles, and Macintosh PCs. Also included are numerous tips and troubleshooting warnings to help users avoid many of the common computer mistakes.

*Que's Computer User's Dictionary* is available for \$9.95 from Que Corporation, 11711 North College Avenue, P.O. Box 90, Carmel, IN 46032; Tel. 317-573-2500.

CIRCLE 84 ON FREE  
INFORMATION CARD

# The Ultimate in Home Control

# Heath®



Just imagine, one press of a button and you can turn off your stereo, turn on your TV and VCR, start a videotape, and dim the lights. The best part is you've done it all from your favorite chair.

The One For All remote Whole House Controller, Command Center and Lamp Module make it all possible.

Installation is a snap. The remote Whole House Controller operates virtually any infrared-controlled device, and when used with the Command Center can control lights throughout your house. Just point the remote Whole House Controller at the Command Center and press a button. You've got home control.

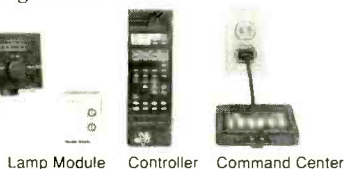

Lamp Module    Controller    Command Center

Expand your reach to additional lights and small appliances with other X-10 modules available from the Heath Catalog. Call 1-800-44-HEATH for your FREE copy.

**Order Today**  
**\$119.95\***

Use Order Code 601-043 when ordering the One For All System URS-6000.

**Call Toll-Free**  
**1-800-253-0570**

\* Price does not include shipping and handling, or applicable sales tax for MI and CA deliveries



© 1990 Heath Company,  
Benton Harbor, MI



CIRCLE 18 ON FREE INFORMATION CARD

# NEW PRODUCTS

## CAR-SECURITY SYSTEM

A new concept in vehicle security, *Kraco's Electronic Nightstick* combines a carbonized-steel steering-wheel lock with an integrated alarm system. The system requires no installation, and includes a built-in flashlight with a high-intensity krypton bulb. Unlike other steering-wheel locks, the Electronic Nightstick locks on to the top of the steering wheel and extends horizontally, providing the added deterrence of high visibility. A



button inside the hardened-steel lock arms and disarms the alarm system. The Electronic Nightstick features a patented motion and shock sensor that detects illegal entry, an internal roller bar that makes it virtually impossible to cut, and a high-energy siren. Designed for use in cars and trucks, the lightweight unit is simple to mount and remove, and it fits easily under the seat.

The Electronic Nightstick has a suggested retail price of \$109.95. For additional information, contact Kraco Electronics, 505 East Euclid Avenue, Compton, CA 90222; Tel: 213-639-0666.

**CIRCLE 101 ON FREE INFORMATION CARD**

## DESOLDERING STATION

To address the problem of desoldering PCB's with high thermal

demands, *OK Industries* has introduced the *SA-600* desoldering station. The SA-600 design incorporates a unique high-capacity nozzle, a high-power heating element, and a quick-rise vacuum pump, for optimal rework efficiency. The station has a safe 20-volt hand-piece with a 65-watt heating



element. The high-mass desoldering nozzle provides superior heat capacity to allow efficient solder flow at lower temperatures. The SA-600 features vacuum and hot-air blow functions. Its has a variable temperature range of 660°F (350°C) to 840°F (450°C).

The SA-600 desoldering station has a list price of \$557.50. For additional information, contact OK Industries, Inc., 4 Executive Plaza, Yonkers, NY 10701; Tel: 800-523-0067.

**CIRCLE 102 ON FREE INFORMATION CARD**

## SHORT-HAUL MODEM

Incorporating ISDN technology, the model 214 *Fastwire* short-haul modem from *Telebyte Technology* allows full-duplex transmission up to 38,400 bps on a single pair of wires over several miles. Performance is improved through the use of on-board adaptive echo cancellation. When two *Fastwire* modems are operating on a link, one is switched to master mode while the other is switched to slave mode, and a dedicated internal scrambler is used with different scrambling algorithms for the master and slave modes. The scrambled data is differentially encoded, making the data on the line polarity independent.

The time base for both modems is referenced to a highly

stable crystal clock and is phase locked to the received-data stream. The signaling rate between two model 214's is 156K bps, and is maintained over distances of three miles on 22-gauge wire or 1.5 miles on 26-gauge wire at any full duplex data rate from 0 to 38,400 bps. The *Fastwire* can be used on DTE or DCE ports by positioning a slide switch to the appropriate position. It is available with a male, DB-25 connector and both an RJ-11 and screw terminals for the



composite link. Power is supplied by a small, wall-mounted transformer.

The model 214 *Fastwire* modem costs \$138 each. For further information, contact Telebyte Technology Inc., 270 East Pulaski Road, Greenlawn, NY 11740; Tel: 800-835-3289 or 516-423-3232; Fax: 516-385-8184.

**CIRCLE 103 ON FREE INFORMATION CARD**

## MULTI LASERDISC PLAYER

Three years after their introduction of the first multi laserdisc player on the market, *Philips* has a new entry: the *CDV600*. The player incorporates the Philips Bitstream one-bit D/A converter system with 256 × oversampling and four-DAC digital differential mode. Other features include digital frame memory; a tilting feature; and a 50-button jog/shuttle remote control that operates a variety of digital special effects including picture recall, freeze, and strobe. The laserdisc player can program up to 20 audio tracks or video chapters per disc, and



features "favorite track selection," which lets the user store favorite programs from up to 226 discs. Error-free copying from disc to audio cassette is ensured by the player measuring the running time of the disk against the recording time available on the cassette. The CDV600 will put as many full

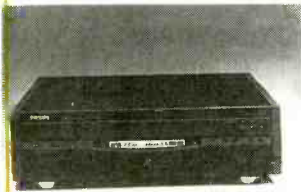

selections as possible on the tape's first side, pause so that the user can turn the tape over, and then finish recording. The multi-laserdisc player also offers automatic music scan, random play, five-mode repeat, S-video output, and a programmable color background. A "laserdisc starter package" is included, and features the film *For All Mankind* as well as savings coupons for other popular films.

The CDV600 multi-laserdisc player has a suggested retail price of \$1099. For more information, contact Philips Consumer Electronics Company, Consumer Affairs Department, One Philips Drive, P.O. Box 14810, Knoxville, TN 37914-1810; Tel: 615-475-0317.

CIRCLE 104 ON FREE INFORMATION CARD

### WHOLE-HOME SURGE PROTECTION

To provide reliable protection from power surges and voltage spikes for appliances in each room of the house, *Intermatic* has introduced the *Whole Home Surge Protection Kit*. The kit's components are easy to install and are designed to protect a wide variety of sensitive electronic equipment, including microwave ovens, personal computers, VCRs, TV's, telephone-answering machines, workshop tools, and household appliances. The components act only when a power surge strikes, responding within one nanosecond by absorbing the destructive overload and allowing normal current to flow through the line.



The kit includes the EG240RC circuit-breaker panel protector, the EG6EC TV and VCR protector, the EG3C single-outlet surge suppressor, and the EG111B phone and fax protector. The EG240RC mounts

on the home's electrical panel box with four wires. Two wires are connected to the load side of any two circuit breakers, another leads to the ground wire, and the fourth is connected to the neutral wire. That device offers protection against EMI/RFI as well as from both transverse- and common-mode noise. All the components are UL-listed, exceed IEEE specifications, and are backed by a three-year limited warranty.

The Whole Home Surge Pro-

tection Kit has a suggested retail price of \$119.95. For more information, contact Intermatic, Inc., Intermatic Plaza, Spring Grove, IL 60081-9698.

CIRCLE 105 ON FREE INFORMATION CARD

### CB RADIO/WEATHER MONITOR

Featuring Mic-ro-tune II safety tuning, *Midland International's* model 77-116 combination 40-

# Lindsay's STRANGE! Electrical Books

## INCREDIBLE BOOKS!

If you haven't received your copy of Lindsay's Electrical Books catalog, you've really missed something! You'll find one of the most bizarre collections of paperbacks, pamphlets, industrial references on incredible plans, lost secrets, forgotten events, and strange theories ever assembled!

## CATALOG PACKED WITH UNUSUAL PLANS!

Write for a catalog! Learn how to make neon signs, rewind motors, get high power from auto alternators and generators, build a spot welder, an electric scooter, an arc furnace to melt metal, build a storage battery, a high performance crystal set, even a dangerous X-Ray machine! It's all here. Write for your copy today!

## Build SOLAR CELLS!

Build a genuine working solar cell! Turn sunlight into electricity! Perhaps not the highest efficiency, but low cost! Really works! It's for real. Complete plans!

## Write for CATALOG!

Write for your copy of Lindsay's new Electrical Books catalog and see for yourself what you've been missing! Send \$1.00 (US & Canada) or \$4.00 foreign airmail. We'll send your catalog immediately! Write today!

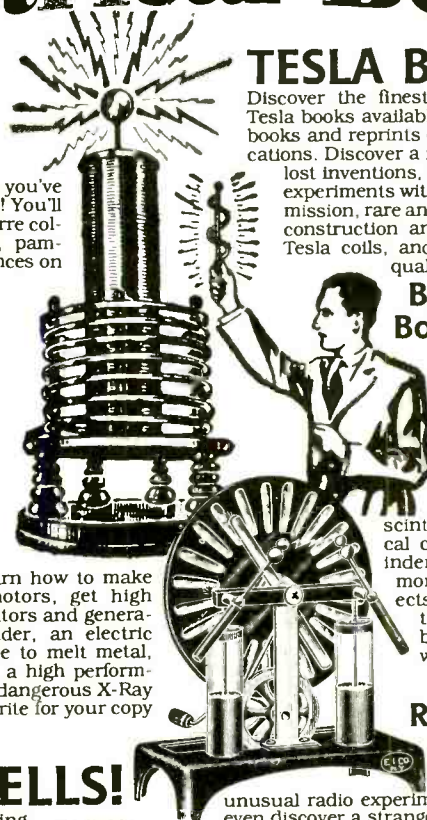

## TESLA BOOKS!

Discover the finest collection of quality Tesla books available, including both new books and reprints of very old, rare publications. Discover a new booklet on Tesla's lost inventions, a 1904 book on Tesla's experiments with wireless power transmission, rare and unusual books on the construction and use of high voltage Tesla coils, and much more! Highest quality guaranteed!

## Build Lightning Bolt Generators!

Build a Wimshurst machine, Tesla Coil, Oudin Coil, Induction Coil, Winter static electric machine! More! Build Jacob's Ladder, condensing electroscopes, Leyden jars, scintillating tubes, electrical cannons, Cavallo's cylinder machine and much more! Great science projects! Most complete collection of high voltage books you'll find anywhere!

## RARE EARLY RADIO BOOKS!

Incredible collection of early shortwave radio books, disc television, unusual radio experiments, and more! You'll even discover a strange collection of books on "Fringe Science" - lost continents, perpetual motion, unusual phenomena recorded throughout the centuries, and much more. Explore the strange world that lies between fact and fiction!

## Lindsay's Electrical Books Box 583-WG1, Manteno IL 60950

Enclosed is \$1.00. Send me a copy of Lindsay's Electrical Books catalog via first class mail!

Name \_\_\_\_\_

Address \_\_\_\_\_

City \_\_\_\_\_ St \_\_\_\_\_ Zip \_\_\_\_\_

Put Professional Knowledge and a  
**COLLEGE DEGREE**  
 in your Technical Career through  
**HOME STUDY**

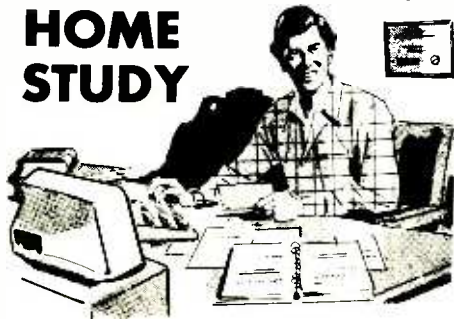

Add prestige and earning power to your technical career by earning your Associate or Bachelor degree through directed home study.

Grantham College of Engineering awards accredited degrees in **electronics and computers.**

An important part of being prepared to *move up* is holding the right college degree, and the absolutely necessary part is knowing your field. Grantham can help you both ways—to learn more and to earn your degree in the process.

Grantham offers two degree programs—one with major emphasis in **electronics**, the other with major emphasis in **computers**. Associate and bachelor degrees are awarded in each program, and both programs are available completely by correspondence.

No commuting to class. Study at your own pace, while continuing on your present job. Learn from easy-to-understand lessons, with help from your Grantham instructors when you need it.

*Write for our free catalog* (see address below), or phone us at toll-free 1-800-955-2527 (for catalog requests only) and ask for our "degree catalog."

Accredited by  
 the Accrediting Commission of the  
 National Home Study Council

**GRANTHAM**  
*College of Engineering*  
 250 Frontage Road  
 Slidell, LA 70460

channel CB and VHF weather monitor allows channels to be changed either remotely from the microphone or from the set's front panel. The 77-116 offers many advanced CB features, such as full ETR electronic frequency control, instant Emergency Channel-9 access, and a noise-limiter switch to reduce or eliminate background



noises. The built-in weather monitor receives most NOAA VHF weather channels, providing 24-hour weather reports. The 77-116 has a green, high-intensity LED readout for easy viewing, an S/Rf meter that displays incoming-signal strength and power output, and a double-layered RF-output heat sink for long transistor life. A quick-disconnect bracket and DC cord simplify installation.

The 77-116 CB/weather monitor has a suggested retail price of \$149.00. For additional information, contact Midland International Corporation, Consumer Communications Division, 1690 North Topping, Kansas City, KS 64120.

**CIRCLE 106 ON FREE INFORMATION CARD**

**DESKTOP WORLD-BAND ANTENNA**

With its 15–22-dB internal amplifier and its 20-foot piece of wire, *Electron Processing's ANTENNA PLUS-2* desk-top antenna brings in shortwave signals like much larger antennas. Reception is "peaked" for shortwave frequencies and is further enhanced by a special filter that eliminates interference caused by local FM/TV/VHF/UHF transmitters. The ANTENNA PLUS-2 brings in 0.3–30 MHz (10–1000 meter bands) without creating an eyesore or



taking up much space, thanks to its compact size, rugged construction and unobtrusive styling. It is easy to install using adapting cables (not included) available for most receivers. The antenna comes with choices of BNC, Phono, SO239 (UHF), and F connectors. A version with a built-in antenna splitter and a second output jack is also available.

The ANTENNA PLUS-2 desk-top antenna costs \$89.95 for the standard model and \$109.95 for the dual-output model. An introductory sale price of \$79.95 is currently offered on the standard model. For more information, contact Electron Processing, Inc., P.O. Box 68, Cedar, MI 49621; Tel: 616-228-7020.

**CIRCLE 107 ON FREE INFORMATION CARD**

**2-MHZ FUNCTION GENERATOR**

Providing a full range of capabilities, including variable duty cycle, *B&K-Precision's* model *3011B* function generator fills the need for an accurate signal source for sine, triangle, and square waveforms, as well as TTL and CMOS pulse signals. A built-in frequency counter with 10-ppm time base allows precision frequency settings. The compact instrument



covers from 0.2 Hz to 2 MHz in seven ranges. Special features include a 4-digit LED readout, coarse- and fine- frequency controls, a separate TTL- and CMOS-pulse output, and external sweep/source capability. The duty cycle is continuously variable from 1:1 to 10:1 and, when inverted, from 10:1 to 1:1. For engineering applications, a switchable variable-DC offset introduces a DC signal on the generator output—a useful feature for matching the DC voltage at the signal input point



to prevent changes when the test signal is applied, and for evaluating the effects of DC bias on AC circuits.

The model 3011B function generator has a suggested list price of \$249.00. For additional information, contact B&K-Precision, Division of Maxtec International Corporation, 6470 West Cortland Street, Chicago, IL 60635; Tel: 312-889-9087.

**CIRCLE 108 ON FREE INFORMATION CARD**

### CAMCORDER-BATTERY CHARGER

Incorporating special circuitry to eliminate the "memory build-up" problem that plagues NiCd rechargeable batteries, the *Arkor Turbo Camcharger* can provide a full-capacity recharge every time it is used. Many camcorder owners have noticed that, after several recharging cycles, the batteries are no longer providing the full one- or two-hour charge indicated by the manufacturer. That's because, if a NiCd battery is recharged before it is



fully discharged, it chemically "remembers" the reduced level of its previous charge, resulting in increasingly shorter usage times. The Turbo Camcharger's electronic reconditioning circuitry controls the discharge/recharge process and eliminates battery "memory" while preventing cell reversal. Full-charge capacity is restored even to NiCd batteries that already have memory build-up. Other features include a "quick charge" mode, AC/DC capability, and a regulated-voltage output to provide direct power to camcorders and other types of portable equipment. Two versions are available. Model *TC-200-6* is for 6-volt Sony-type batteries and model *TC-200-12*

is for 12-volt Panasonic-, RCA-, and Hitachi-type NiCd rechargeables.

The models TC-200-6 and TC-200-12 Turbo Camcharger, equipped for DC operation, have suggested retail prices of \$99.95 each. With an AC power supply added, each costs \$119.95. For further information, contact Arkon Resources, Inc., 11627 Clark Street, Suite 101, Arcadia, CA 91006; Tel: 818-358-1133; Fax: 818-383-6157.

**CIRCLE 109 ON FREE INFORMATION CARD**

### EXTRA-LONG COMPUTER-CABLE SYSTEM

Providing computer users with the flexibility to lay out their systems as they like, *Data Spec's Para-Link II* interface extender enables a parallel printer to be placed far from the computer. Neither speed nor reliability are sacrificed; Para-Link II's ultra-high-speed transmission rate produces parallel-



like performance. The system is compatible with PC-type computers, and no additional hardware or software is required. Para-Link II consists of one transmitter for the computer's printer port, one receiver for the parallel printer's input port, and 50 feet of straight-through modular cable. Because no outside power source is needed, Para-Link II can be installed virtually anywhere that's convenient to all devices.

The Para-Link II interface extender has a suggested retail price of \$124.95. For additional information, contact Data Spec, 9410 Owensmouth Avenue, Chatsworth, CA 91311; Tel. 818-772-9977.

**CIRCLE 110 ON FREE INFORMATION CARD**



### 2-1/2" SANYO TWEETER

Paper cone with gold tone dust cap. 8 oz. magnet. 8 ohm. 1/2" ferro fluid voice coil. Power handling: 50W RMS, 70W max. Frequency response: 3K-20KHz.



#PM-271-020 \$1<sup>95</sup> \$1<sup>75</sup> 95c  
(1 9) (10 59) (60 up)

### SUPER HORN TWEETER

Original piezo tweeter made by Motorola. SPL=94 dB 2.83V/1M Response: 4KHz-27KHz. Handles approximately 50 watts.



#PM-270-010 \$5<sup>30</sup> \$4<sup>50</sup> \$3<sup>95</sup>  
(1 9) (10 79) (80 up)

### 2" DOME MIDRANGE

Textile dome midrange made by Philips. 8 ohm. SPL=90 dB 1W/1M. 30W RMS, 40W max. Response: 550-5KHz.



#PM-280-210 \$27<sup>30</sup> \$25<sup>70</sup>  
(1 3) (4-up)

### 15" SUBWOOFER



Dual voice coil. 40 oz. magnet. 6 ohm imp. 106W RMS, 140W max. Response: 20-1.2KHz. Resonant frequency: 21Hz. SPL=93 dB 1W/1M.

**PIONEER**  
#PM-290-190 \$54<sup>50</sup> \$49<sup>80</sup>  
(1 3) (4 up)

### SUBWOOFER XOVER



200W RMS crossover designed specifically for use with dual voice coil subwoofers. 12 dB per octave roll-off at 150Hz.

#PM-260-220 \$28<sup>80</sup> \$24<sup>40</sup>

### 10" POLY WOOFER

Medium duty. 60W RMS, 80W max. 14 oz. magnet. Response: 25-2.5KHz. fs=28Hz.



#PM-290-096 \$18<sup>50</sup> \$16<sup>90</sup>  
(1 3) (4 up)

### TITANIUM COMPOSITE TWEETER

The advantages of both hard and soft dome technologies. 8 ohm. Ferro fluid cooled voice coil. SPL=90 dB 1W/1M. 50W RMS, 70W max. 4" round.



Polydax #DTW100T125.

**polydax**  
#PM-270-047 \$27<sup>50</sup> \$24<sup>90</sup>  
(1 9) (10 up)

### SPEAKER BUILDING BOOK

Revised edition of David Weems' best selling book. Learn to build low cost speakers that rival the high priced models.



#PM-500-021 \$16<sup>95</sup>

### 12" CAST FRAME WOOFER



### EMINENCE

12" woofer made in the USA by Eminence. Paper cone and dust cap with treated cloth surround. 80 oz magnet. 2-1/2" vented voice coil. 8 ohm. 170W RMS, 235W max. 40-4.5KHz response.

#PM-290-147 \$72<sup>90</sup> \$69<sup>50</sup>  
(1 3) (4 up)



340 E. First St., Dayton, Ohio 45402  
Local: 1-513-222-0173  
FAX: 513-222-4644

• 15 day money back guarantee • \$15.00 minimum order • We accept Mastercard, Visa, Discover, and C.O.D. orders. • 24 hour shipping • Shipping charge = UPS chart rate + \$1.00 (\$3.00 minimum charge) • Hours 8:30 am - 7:00 pm EST, Monday - Friday • Mail order customers, please call for shipping estimate on orders exceeding 5 lbs. Foreign customers please send \$5.00 U.S. funds for catalog postage

**CALL TOLL FREE**  
**1-800-338-0531**

**CIRCLE 19 ON FREE INFORMATION CARD**



**FREE CATALOG**

## CELLULAR PASSIVE REPEATER

ORA Electronics' IVR-3 is a mobile, glass-mount, cordless antenna that allows portable cellular phones to be effectively used inside the car by reducing drop-outs or no-service conditions. Employing a specially developed technology, radio waves picked up by the antenna



are gathered and directed toward the phone inside the car. Because the IVR-3 has no coupling box, no coupling losses are introduced. The repeater features a 3-dB gain on the mast and 4-dB forward gain on the horizontal components. Simple to install and use, the IVR-3 does not require hole drilling or a cable or power hookup.

The IVR-3 cellular repeater has a suggested retail price of \$69.95. For further information, contact ORA Electronics, 9410 Owensmouth Avenue, Chatsworth, CA 91311; Tel: 818-772-2700.

**CIRCLE 111 ON FREE INFORMATION CARD**

## KNIGHT PATROL ALARM

Combining the benefits of professional-type alarm systems with speech synthesis, *Paladin's Knight Patrol* offers peace of mind at a reasonable price. The microprocessor-controlled alarm system is available either as a kit (pictured) or as a pre-assembled PC board. The firmware supplied with the kit EPROM offers a preprogrammed, 240-word vocabulary for alarm responses or status updates. With a 24-hour real-time

clock, the trigger memory can tell you, in a pleasant female voice, where and when the security system was violated. Other features include 21 sensor zones for fire and security, two arming circuits, an auxiliary alarm, "Alert" and "Sleep" monitoring modes, two 5-watt audio amplifiers, and 10- and 3-Amp relay circuits for sirens or other alerting devices. In addition, the Knight Patrol features



self-diagnostics and is easily expandable. A complete line of peripherals is also available, including sensors, a custom steel enclosure, sounders, and batteries.

The Knight Patrol talking security system costs \$250.00 in kit form and \$295.00 pre-assembled. Shipping and handling charges are an additional \$10.50. For further information, contact Paladin Electronics, 19425-B Soledad Canyon Road, Suite 333, Dept. P.E., Canyon Country, CA 91351.

**CIRCLE 112 ON FREE INFORMATION CARD**

## REPEATER CONTROLLER WITH AUTOPATCH

The MFJ-2040 repeater controller with built-in phone patch offers programmable Morse-code ID, ring detection for reverse autopatch, input and output ports, and cross-band linking. An optional voice ID (MFJ-50) is also available. Installation is easy; the instruction manual provides step-by-step instructions, and standard "D"-style connectors for all control and audio lines are included. Hardware schematics are also provided. The software puts the



user in complete control, with choices of toll restriction, no toll restriction, or selected area-code dialing. The MFJ-2040 can be programmed to dial only in selected areas and lock out others. The input and output ports control a variety of remote devices—including link radios, pagers, and local speakers—via touch-tone commands. Transistor drivers are provided on all output ports to allow direct connections or driving relays. An optional five-second voice-message PROM (MFJ-51) is also available. Users can program their own private prefix code for controlling the repeater. Touch-tone commands and DIP switches are used to control the repeater options, such as the courtesy tone, transmitter hang time, time-out timer, toll restriction, autopatch, Morse code ID, repeater on/off, and line on/off.

The MFJ-2040 repeater controller costs \$449.95. The MFJ-50 voice ID and MFJ-51 5-second voice-message PROM each cost \$39.95. For more information, contact MFJ Enterprises, Inc., P.O. Box 494, Mississippi State, MS 39762; Tel: 601-323-5869 or 800-647-1800 for orders; Fax: 601-323-6551.

**CIRCLE 113 ON FREE INFORMATION CARD**

## SURROUND-SOUND SPEAKER SYSTEMS

To use as complete systems or to supplement their other speaker systems, *Now Hear This, Inc.* has introduced the model 1C center-channel speaker and the Zero 3-Pack, which consists of three mini speakers. The 1C center-channel speaker has magnetically

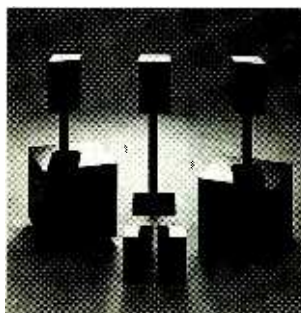

shielded drivers, a high-gloss black finish, and measures only 12 x 7½ x 8½ inches. The Zero 3-pack contains both rear and center-channel speakers in one

convenient package. Included are three high-performance, two-way, 4-inch video shielded mini speakers.

The 1C center-channel speaker and the Zero 3-Pack have suggested retail prices of \$170.00 and \$270.00, respectively. For further information, contact Now Hear This, Inc., 537 Stone Road, Suite E, Benic, CA 94510.

**CIRCLE 114 ON FREE INFORMATION CARD**

## DESK-TOP DATA BANK/CALCULATOR

Featuring an extra-large 10-digit LCD and sophisticated Euro-style design, *Texas Instruments' TI-3400 Europa* data bank/calculator stores up to 125 names and telephone numbers and provides calculator, clock/alarm, and appointment-schedule functions as well. Each two-line entry in the telephone directory can accommodate a name, an address, and several phone numbers, with 36 characters on each line. Long listings can be read by scrolling the display left and right. Confidential entries can be protected with a secret



password. The appointment-schedule function allows users to store information about appointments by date in chronological order. An alarm function is provided that can be set to give the user an audible reminder. A 12-hour digital clock conveniently displays the time, day, and date. As a calculator, the TI-3400 Europa adds, subtracts, multiplies, divides, and has a three-key memory.

The TI-3400 Europa has a suggested retail price of \$65.00. For additional information, contact Texas Instruments, Consumer Relations, P.O. Box 53, Lubbock, TX 79408; Tel: 806-747-1882.

**CIRCLE 115 ON FREE INFORMATION CARD**



# Discover Your Career Potential In The Fast Growing Field Of High-Tech Electronics!

CIE Gives You The Training You Need to *Succeed...*  
At Your Own Pace...& In Your Own Home!

If you're anxious to get ahead...and build a *real* career...you owe it to yourself to find out about the Cleveland Institute of Electronics!

CIE can help you discover your career potential in the fast growing field of high-tech electronics. A career that will challenge and excite you every day...reward you with a powerful feeling of personal accomplishment...and deliver a level of financial security you may have only dreamed of before!

As the leading school in home-study electronics, CIE has helped over 150,000 students in the U.S.A. and over 70 foreign countries get started in this exciting field. To find out how CIE could be helping you...read on...then send for a CIE catalog TODAY!

## A Growing Need For Trained Professionals!

The career opportunities shown here are only a few of the challenging, high-paying careers you could enjoy as an electronics technician.

You could be the "brains" behind the scenes of an exciting TV broadcast...trouble-shoot life-saving medical equipment...design exotic new aeronautics systems...CIE's job-oriented programs offer you the quickest possible path to the career of your dreams! And CIE also features military and union re-training, to build on what you already know.

## Dozens Of Fascinating Careers To Choose From!

Even if you aren't sure which career is best for you, CIE can get you started with core lessons applicable to *all* areas of electronics. As you advance, CIE makes job opportunities available to you through the bimonthly school paper, *The Electron*.



Data Communications



Automotive Electronics



Avionics



Computer-Assisted Manufacturing



Consumer Electronics



Military Electronics

## Personal Training From A Renowned Faculty.

Unlike the impersonal approach of large classroom study, CIE offers you one-on-one instructional help 6 days a week, toll-free. Each CIE lesson is authored by an independent specialist, backed by CIE instructors who work directly with you to answer your questions and provide technical assistance when you need it.

## Practical Training... At Your Own Pace.

Through CIE, you can train for your new career while you keep your present job. Each course allows a generous completion time, and there are no limitations on how fast you can study. Should you already have some electronics experience, CIE offers several courses which start at the intermediate level.

## "State-Of-The-Art" Facilities & Equipment.

In 1969, CIE pioneered the first electronics laboratory course, and in 1984, the first Microprocessor Laboratory. Today, no other home study school can match CIE's state-of-the-art equipment. And all your laboratory equipment is included in your tuition cost. There is no extra charge—it's yours to use while you study at home and on the job after you complete your course!

## Earn Your Degree To Become A Professional In Electronics!

Every CIE course you take earns you credit towards the completion of your Associate in Applied Science Degree, so you can work towards your degree in stages. And CIE is the only school that awards you for fast study, which can save you thousands of dollars in obtaining the same electronics education found in four-year Bachelor's Degree programs!

## Send For Your Catalog Today!



### CIE World Headquarters

Cleveland Institute of Electronics, Inc.  
1776 East 17th St., Cleveland, Ohio 44114

**YES!** Please send me your independent study catalog (For your convenience, CIE will have a representative contact you—*there is no obligation.*)

Print Name \_\_\_\_\_

Address \_\_\_\_\_ Apt # \_\_\_\_\_

City/State/Zip \_\_\_\_\_

Age \_\_\_\_\_ Area Code/Phone No. \_\_\_\_\_

Check box for G.I. Bill bulletin on educational benefits:  Veteran  Active Duty

**Mail This Coupon Today!** AHO-158



# THINK TANK

By Byron G. Wels, K2AVB

## Holidaze

This is the time of year that we all celebrate the holidays and enjoy our families. Most of us tend to eat and drink a bit too much. As a result, we make new year's resolutions—promising to take off some weight, watch our diets, and in general, behave a bit better—but usually falter on that promise by no later than January 2nd, and go right on with our feeding

I recently lost my medical as a pilot. That doesn't mean that I'm not allowed to fly anymore, I just can't fly as "pilot-in-command." My friend Hawk (he owns a Cessna 172 Skyhawk) and I discovered a restaurant at the New Haven, Connecticut airport, where they serve two 1½- to 2-pound lobsters, fixed any way that you like them for thirteen dollars. Occasionally, we'll

day's electronic schools can keep the students constant with the changes. To add to the complexity of electronic life, the new developments demand a constant and continuous course of study, which has resulted in specialization. We become interested in one specific area of electronics, and hone our skills in that area to a fine edge, often ignoring other areas. That's a shame, too.

The guy who devotes and dedicates himself to amateur radio or communications, might miss the opportunity to apply some of the technology now available in, for example, laser technology, to his own sphere of interest! While nobody can know all things, it's a good idea to occasionally take a sideward glance into another field and just see what's doing on. For those ready to take that sideward glance, let's see what's in this month's mail.

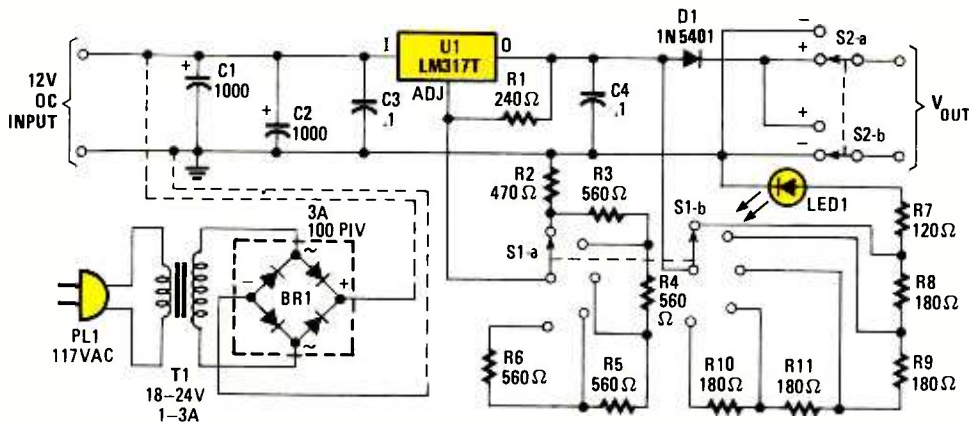

Fig. 1. The Step-Variable AC Adapter uses a common three-terminal regulator circuit with adjustability provided in an uncommon way.

## STEP-VARIABLE AC ADAPTER

After getting "snookered" by all the under \$10 adapters that use small, multi-tap transformers that vanish after any sort of load demand, I came up with the following variation of the LM317T adjustable voltage regulator to yield this step-variable DC power-supply (see Fig. 1), which can be fed from an AC outlet or from your car battery.

At the heart of the circuit is the LM317T adjustable regulator, which is set up pretty-much in the conventional way, except instead of a single 5k potentiometer tied to the regulator's ADJ terminal, a switch with a

frenzy! Oh well, to tell the truth, I don't drink anymore (or any less, either!).

I'm sure you've heard the expression "computer illiterate." I've got a friend who's a "technological illiterate." I first discovered that to be true when he asked me how long it takes to have videotape developed. Then on a trip by air, he tells me that he knows it's the wind blowing over the wing that makes an airplane fly, and that he understands that the propeller blows wind over the wing. But a jet plane has the engines in the rear. How does a jet fly? The capper came when he looked out the window of the plane and asked "How far away is the horizon?"

fly up there for dinner, and really pig out. And occasionally, when he thinks of it, he'll let me take the controls. It's a real hoot.

In most industries, you learn your craft or trade, become more proficient with practice, and (provided that luck is with you) you manage to make out through the course of your working life. Electronics doesn't work like that. No, our field is constantly changing and improving. If you don't keep abreast of it, you simply drop out. So very much has changed in so few years, that it becomes a constant, never-ending struggle just to stay on top of the latest developments.

I often wonder how to-



number of fixed resistors are used. That variation gives regulated fixed output voltages of 3, 6, 9, and 12 volts DC depending on the level of voltage fed to the circuit.

Resistors R2–R6 control and set the voltage output of the regulator (U1). Resistors R6–R10 control the current to the power-on LED by adding series current limiting as the different voltage settings are used.

Diode D1 offers reverse protection if a device is wired for reverse polarity, and if it is, just flip switch S2 to reverse the voltage polarity. Since some tape players and other equipment draw lots of current, the LM317T should be mounted with a heat sink.

That's about it, except for one afterthought: An optional DPDT switch and a 5k potentiometer between the regulator and S1 would offer you the best of both worlds—a step-variable,

and continually variable power supply rolled into one simple circuit!

—Bob McVay, Troy, OH  
*Good going Bob. It just goes to show you that with a little imagination and a bit of know-how, anything can be accomplished!*

### PRINTER "ERROR" ALARM

What can be more frustrating than to have a

printer quietly shut down while it's spitting out a file or report, especially when you're away from it and you return when it should be complete only to find that nothing has happened? Unfortunately, until now, my printer never had a beeper, buzzer, or anything else to alert me to such a condition. Whenever it had a paper feed or format error problem, it just quietly shut

itself down and waited for me to correct the situation.

See Fig. 2. Somewhere, in the deep, dark recesses of digital circuitry, one can find an "output" logic level that is either high or low whenever the printer is in the normal operating state. The output can be from a control flip-flop or other logic device. The idea is to find such a place that changes logic level from either a high to low or a low to high state when the printer shuts off due to any error.

If you find an output that goes from low to high then wire it to INPUT A in the circuit. If the output goes from high to low, feed the signal to INPUT B. Diode D1, resistor R1 and capacitor C1 form a very good time-out circuit to let you manually use the paper feed button on the printer for the time you select before allowing the two oscillators of U1-c and U1-d

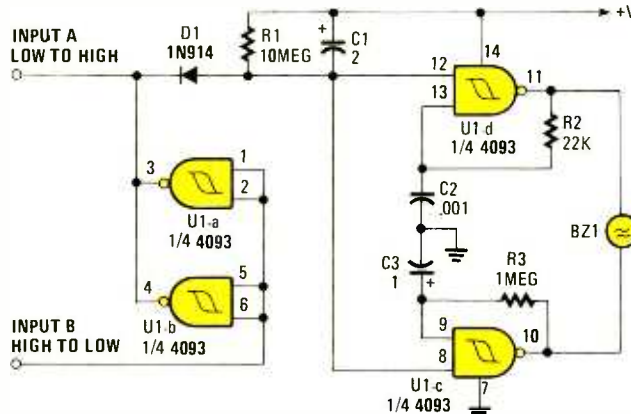

Fig. 2. Built around a single 4093 quad NAND Schmitt trigger, this circuit is designed to provide print-error indications.

# Train at Home to be an Electronics Technician!

Professional training and equipment can help you qualify for a dynamic, high-paying career in your spare time.

As the demand for computers and microprocessors in business and manufacturing continues to grow, so does the need for qualified technicians. It's not unusual for experienced technicians to earn from \$35,000 to more than \$40,000 a year.\* Now there's a way you can train for this exciting field without interrupting your job or home life.

### Choose From These Programs of Study

- Electronics & Microprocessor Technology
- Industrial Electronics & Microprocessor Technology
- Computer Servicing & Electronics Technology
- Specialized Associate Degree In Electronics Technology

### You Get Professional Equipment For Professional Training

Depending on the program you select, you'll perfect your skills using this advanced equipment, included in the price of tuition:

- IBM-Compatible Personal Computer
- Digital Multimeter
- Digital Logic Probe
- Elenco Oscilloscope

### Exclusive Extras That Enhance Your Training

Peoples College introduces some training firsts to make your learning experience more complete:

- Accelerated Learning System — a scientifically proven study system that lets you learn faster and easier than ever before.
- Optional One-Week Seminar — available with our advanced programs. Conducted on our campus near Orlando, Fla. Not required for graduation, but a valuable opportunity to fine tune your skills with personal guidance.
- Video Tutor Training Tapes — give you a permanent, visual record of informative lectures and close-up demonstrations.
- Experience Labs — professionally designed experiments that give you hands-on "bench" experience.
- Industry Certification Training Guide — provided with three of our programs. Gives you first-hand insight into the examination you may take for your professional license.



For COLOR CATALOG Mail Coupon or Call TOLL FREE

1-800-765-7247

Programs offered only in United States, Canada, Puerto Rico and Virgin Islands. No Obligation. No sales person will call.

Our programs are accredited by the Accrediting Commission of the National Home Study Council

YES! I would like to know more about your training programs. Send a catalog to:

Name \_\_\_\_\_

Address \_\_\_\_\_

City \_\_\_\_\_

State \_\_\_\_\_ Zip \_\_\_\_\_

**PEOPLES COLLEGE**  
 OF INDEPENDENT STUDIES  
 233 Academy Drive • P.O. Box 421768  
 Kissimmee, FL 34742-1768  
 Member, D.L. Peoples Group P1290

(\* Source: U.S. Bureau of Labor Statistics)

CIRCLE 11 ON FREE INFORMATION CARD

www.americanradiohistory.com

# LEARN VCR

## CLEANING/MAINTENANCE/REPAIR

EARN UP TO \$1000 A WEEK, WORKING PART TIME FROM YOUR OWN HOME!



Secrets Revealed!

NO Special Tools or Equipment Needed.

EARN UP TO \$60 AN HOUR AND MORE!

### THE MONEY MAKING OPPORTUNITY OF THE 1990'S

IF you are able to work with common small hand tools, and are familiar with basic electronics (i.e. able to use voltmeter, understand DC electronics).

IF you possess average mechanical ability, and have a VCR on which to practice and learn. . . . then we can teach YOU VCR maintenance and repair!

**FACT:** up to 90% of ALL VCR malfunctions are due to simple MECHANICAL or ELECTRO-MECHANICAL breakdowns!

**FACT:** over 77 million VCRs in use today nationwide! Average VCR needs service or repair every 12 to 18 months!

Viejo's 400 PAGE TRAINING MANUAL (over 500 photos and illustrations) and AWARD-WINNING VIDEO TRAINING TAPE reveals the SECRETS of VCR maintenance and repair—"real world" information that is NOT available elsewhere!

Also includes all the info you'll need regarding the BUSINESS-SIDE of running a successful service operation!

#### FREE INFORMATION

CALL TOLL-FREE 1-800-537-0589

Or write to: Viejo Publications Inc.

5329 Fountain Ave.

Los Angeles, CA 90029 Dept. PE

CIRCLE 9 ON FREE INFORMATION CARD

## CABLE TV DESCRAMBLER

### How You Can Save Money on Cable Rental Fees



1 Unit 10 Lot	
Jerrold SB w/Trimode...	\$99...\$70
Super Tri-Mode.....	\$109...\$75
Oak KN12 (w/V5).....	\$109...\$65
Scientific Atlanta.....	\$109...\$75
SA (Combo).....	\$250...\$195
Pioneer.....	\$109...\$79
Hamlin MLD 1200.....	\$89...\$59
Tocom.....	\$169...\$129
Stargate converter.....	\$95...\$75
Panasonic converter.....	\$99...\$79

US Cable will Beat Anyone's Price Advertisd in this Magazine!

### 30 Days Money Back Guarantee

Free 16 page Catalog

Visa, M/C, COD or send money order to:  
**US Cable TV Inc. Dept.KPE12**

4100 N. Powerline Rd., Suite F-4  
Pompano Beach, FL 33073

**1-800-445-9285**

#### For Our Record

I, the undersigned, do hereby declare under penalty of perjury that all products purchased, now and in the future, will only be used on Cable TV systems with proper authorization from local officials or cable company officials in accordance with all applicable federal and state laws. FEDERAL AND VARIOUS STATE LAWS PROVIDE FOR SUBSTANTIAL CRIMINAL AND CIVIL PENALTIES FOR UNAUTHORIZED USE.

Date: \_\_\_\_\_

Signed: \_\_\_\_\_

No Florida Sales!

CIRCLE 15 ON FREE INFORMATION CARD

to operate, which then sounds an "interrupted" tone alarm after the time-out period has expired. Whenever the printer is placed back into a normal operating condition, the circuit becomes inactive.

The time-out part of the circuit can be established by using  $T = RC$  and the only IC that you can use is a 4093, preferably an HEF4093B because it's faster than a CD4093B. The values shown are what I used, but you can experiment if you like.

—John Mastromoro, Pennellville, NY

*John, I've had the exact same problems with my own printer, but it won't bother me anymore. I'm busy wiring that circuit up for myself!*

### KEYLESS LOCK

I wanted to construct a keyless lock for my home, and toyed around with all kinds of ideas. I knew that I'd need a sequential switch using latches and finally arrived at this circuit.

See Fig. 3. The circuit uses

a four-bit latch (U1). What makes the circuit sequential is that the set input of the first bit latch is tied to the reset of the second bit latch, and so forth. That insures that any bit latched will be reset by the previous bit latch. The ECG8314 also has a master reset (pin 9) that is tied to the first bit-latch reset (pin 3). That provides an added measure of security for the lock.

The outputs of U1 are fed to a four-input AND gate (U2), then to Q1 (used as switching transistor), which is used to drive relay K1. A lot of keypads have common line switches and that's what makes the circuit ideal. You might also be interested in knowing that the ECG8314 has an enable low (pin 1) that can be used as a timing circuit, should that be desired. I hope that this circuit is good enough for a book, Byron!

—Robert P. Johnson, Jr., Camden, ME

Good enough indeed, Bob. The book is on the way to you and I hope you enjoy it.

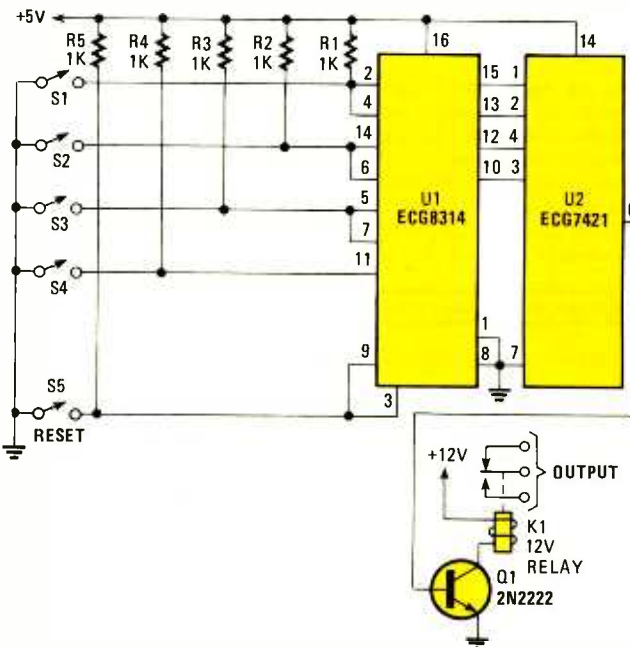

Fig. 3. The Keyless Lock is built around an ECG8314 four-bit latch (U1), a 7421 four-input NAND gate (U2), and a few additional support components.



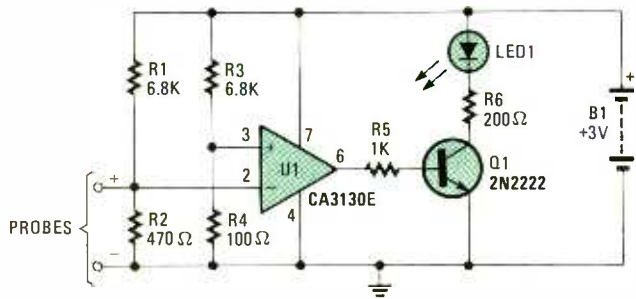

Fig. 4. When continuity is detected by the Low Voltage Continuity Tester, the output of U1 goes high, turning on the transistor, which in turn causes the LED to light.

### LOW-VOLTAGE CONTINUITY TESTER

This tester is handy for troubleshooting digital-electronics circuits. Most commercial continuity testers apply approximately +2.8-volts DC at the positive probe to the circuit-under-test. This inexpensive unit applies a mere +0.3-volts DC at the positive probe. It assembles quickly and easily on a piece of per-board and can be housed in a plastic tube. It uses an LED to signify the on state.

A schematic diagram of the circuit is shown in Fig. 4. Here's how it works: When continuity is detected by the probes, the output of the op-amp (U1) goes high, turning on the transistor, which in turn causes the LED to light indicating the on state. When no continuity is detected, biasing resistors R1 and R2 set the negative input of the op-

amp so that the reference voltage is more negative than the positive input; under that condition, the output of U1 is low and the LED is off. The op-amp (U1) is a CA3130E CMOS-in/bi-polar-out device that requires only a single supply voltage and is therefore appropriate for this circuit. The voltage of +0.3-volts DC at the positive probe is low enough so that a PN junction cannot be turned on when checking for shorts.

—Francisco Serna, Escondido, CA

Francisco, this circuit is one that all of our readers ought to have on their test benches! And I'm certain that many readers will be building this one.

### INTERIOR CONVENIENCE LIGHT

This simple circuit adds a measure of convenience in

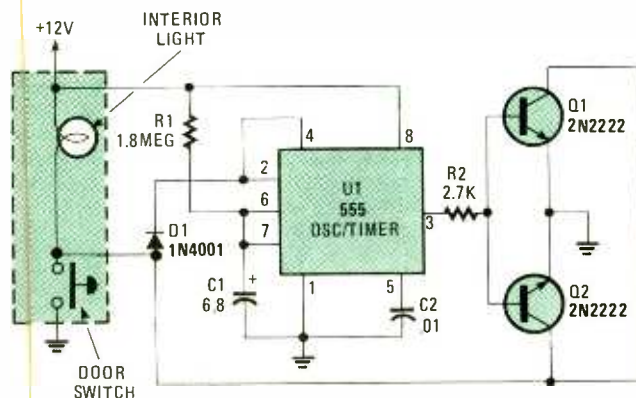

Fig. 5. This circuit can be added to your auto's dome-light circuit so that rather than the dome light turning off the moment that the door is closed, it remains on for a pre-determined period of time.

Courteous Service • Discount Prices • Fast Shipping

# ALL ELECTRONICS

P.O. Box 567 • Van Nuys, CA 91408

## 12 Vdc 5 AMP POWER SUPPLY

ACDC Electronics# 12N5 or equiv. Input: 100-240 Vac (wired for 115 Vac) Output: 12 Vdc @ 5 amps. Open frame power supply. 7" X 4 3/4" X 3" high. Regulated. CAT# PS-125 \$37.50 each

## 210 MFD 330 VOLT PHOTOFLASH CAPACITOR

Rubicon CE photoflash capacitor. 0.79" dia. X 1.1" high. These are new capacitors that have been prepped with 1.4" black and red wire leads soldered to the terminals. CAT# PPC-210 \$2.50 each • 10 for \$22.50 • 100 for \$200.00 Large quantities available. Call for pricing

## FLASHER LED

Diffused L.E.D. with built in flashing unit. PULSE RATE: 3 Hz @ 5 Volt/20 ma. Unit continually flashes when 5 Volts is applied. Operates between 4.5 Volts and 5.5 Volts. T 1 3/4 size. IDEAL FOR USE AS AN INDICATOR.

RED CAT# LED-4  
GREEN CAT# LED-4G  
YELLOW CAT# LED-4Y  
\$1.00 each • 10 for 9.50 • 100 for \$90.00

## REFLECTIVE OPTO SENSORS

These units have an IR emitter and sensor pair pointing in the same direction. Light from emitter bounces off object to be detected by sensor. Effective range approx. 0.15". Three types available:

TRW/ Optron# OPB5447-2 Rectangular w/ 28" wire leads CAT# OSR-4 2 for \$1.00

TRW/ Optron# OPB703A Wedge shape with PC pins. CAT# OSR-3 75¢ each

TRW/ Optron# OPB711 Rectangular with PC pins. CAT# OSR-2 75¢ each

Optek# K-8711 Wedge shaped device CAT# OSR-1 75¢ each

## RG 11/U 75 OHM VIDEO CABLE

Ivory RG 11/U terminated with heavy-duty F connectors. Also includes a F-61 splicer and a 75 ohm terminator load. New cables manufactured for IBM pc networks. UL listed. Specs: 75 ohm Impedance. Cable jacket O.D. 0.405". Dielectric 0.285" dia. Center conductor 0.047" diameter. IBM P/N 1501908 COM/SCOPE. CAT# RG-11-1 100 foot roll \$15.00 CAT# RG-11-2 200 foot roll \$27.50

## TOLL FREE ORDER LINES

# 1-800-826-5432

CHARGE ORDERS to Visa, MasterCard or Discover.

TERMS: Minimum order \$10.00. Shipping and handling for the 48 continental U.S.A. \$3.50 per order. All others including AK, HI, PR or Canada must pay full shipping. All orders delivered in CALIFORNIA must include state sales tax (6 1/4 %, 6 3/4 %, 7 1/4 %). Quantities Limited. NO C.O.D. Prices subject to change without notice.

Call Toll Free, or clip this coupon

FREE 60 Page Catalog  
Containing over 4,000 ITEMS

## ALL ELECTRONICS CORP.

P.O. Box 567 • Van Nuys, CA • 91408

Name \_\_\_\_\_  
Address \_\_\_\_\_  
City \_\_\_\_\_ State \_\_\_\_\_ Zip \_\_\_\_\_

PE 10/90

# Take any **3** PROFESSIONAL BOOKS for only \$**4.95**

when you join the **ELECTRONICS ENGINEERS & DESIGNERS BOOK CLUB**<sup>SM</sup> values to \$119.40

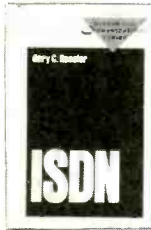

10015 \$42.95  
Counts as 2

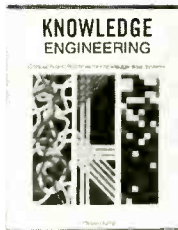

3297 \$39.95



3131 \$26.95

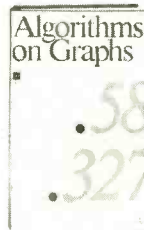

3429 \$29.95

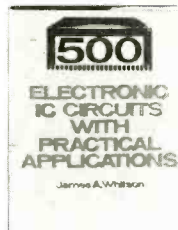

2920 \$29.95



3279 \$36.95  
Counts as 2

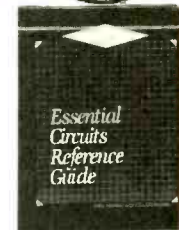

9319 \$59.50  
Counts as 2



3321 \$24.95

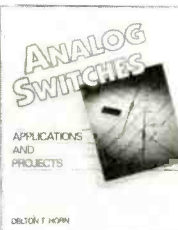

3445 \$21.95

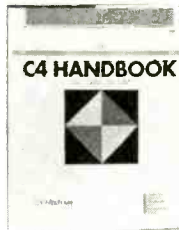

3098 \$44.50  
Counts as 2

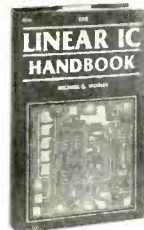

2672 \$49.50

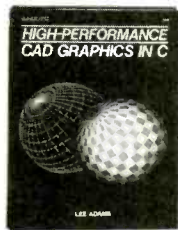

3059 \$34.95  
Counts as 2



3151 \$39.95  
Counts as 2

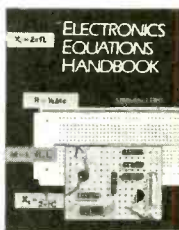

3241P \$16.95

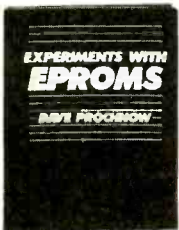

2962P \$17.95

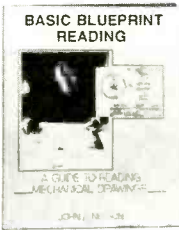

3273 \$28.95



3147 \$38.95  
Counts as 2



3203 \$44.50  
Counts as 2



9244P \$18.95



3140 \$49.95  
Counts as 2



9245 \$46.95  
Counts as 2



3199 \$52.00  
Counts as 2

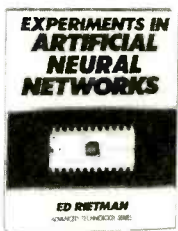

3037 \$24.95

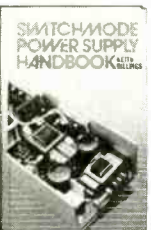

9305 \$59.50  
Counts as 3

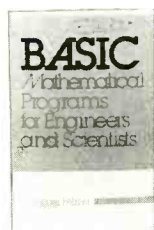

8225P \$19.95



9246 \$33.95  
Counts as 2

## How the Club Works

**YOUR BENEFITS:** You get 3 books for \$4.95 plus shipping and handling when you join. You keep on saving with discounts up to 50% off as a member.

**YOUR PROFESSIONAL BOOKSTORE BY MAIL:** Every 3-4 weeks, you will receive the EE&D Book Club News describing the Main Selection and Alternates, as well as bonus offers and special sales, with scores of titles to choose from.

**AUTOMATIC ORDER:** If you want the Main Selection, do nothing and it will be sent to you automatically. If you prefer another selection, or no selection at all, simply indicate your choice on the reply form provided. You will have at least 10 days to decide. As a member, you agree to purchase at least 3 books within the next 2 years and may resign at any time thereafter.

**BONUS BOOKS:** Starting immediately, you will be eligible for our *Bonus Book Plan*, with savings of up to 80% off publishers' prices.

**IRONCLAD NO-RISK GUARANTEE:** If not satisfied with your books, return them within 10 days without obligation!

**EXCEPTIONAL QUALITY:** All books are quality publishers' editions especially selected by our Editorial Board. (Publishers' Prices Shown)

**Your source for quality, affordable and timely authoritative engineering books.**

**EE&D** **ELECTRONICS ENGINEERS & DESIGNERS BOOK CLUB**<sup>SM</sup>  
Blue Ridge Summit, PA 17294-0860

**YES!** Please accept my membership in the *Electronics Engineers & Designers Book Club* and send the 3 volumes I have listed below, billing me \$4.95. If not satisfied, I may return the books within 10 days without obligation and have my membership cancelled. I agree to purchase at least 3 books at regular Club prices during the next 2 years, and may resign any time thereafter. A shipping/handling charge and sales tax will be added to all orders.

--	--	--

Name \_\_\_\_\_  
 Address \_\_\_\_\_  
 City \_\_\_\_\_  
 State \_\_\_\_\_ Zip \_\_\_\_\_ Phone \_\_\_\_\_  
 Signature \_\_\_\_\_

Valid for new members only. Foreign applicants will receive special ordering instructions. Canada must remit in U.S. funds. This order subject to acceptance by the *Electronics Engineers & Designers Book Club*. PPIF1290



the form of light while you're looking for the correct key, or fastening seat belts. The circuit doesn't require any cutting into the car's existing system; it attaches in parallel with the existing wiring.

See Fig. 5. The circuit is built around a 555 timer and uses very few support components. It's a conventional circuit, except for pin 4 (reset), which is tied to pin 2 (trigger) instead of pin 8 (+V<sub>cc</sub>) as usual. That's so that when the car door is open (the door switch is closed and the interior light is on), pins 2 and 4 are in a standby mode just waiting for the door to be closed (and the door switch to open) to trigger the 555 and start the "on" cycle. By doing so, the time the interior light stays on is always the same, regardless of how long the car's door was open.

I used two 2N2222A's in

parallel as the "electronic switch" for the interior light to handle the required power without the need for a heat sink. The 1N4001 diode (D1) is required to keep current from retriggering the 555 timer IC at pins 2 and 4. The time constant can be varied by changing the values of resistor R1 and capacitor C1.

I used a 6.8- $\mu$ F Tantalum capacitor for two reasons: I already had one, and its small size. The circuit was assembled on a small piece of perfboard measuring  $\frac{3}{4} \times \frac{3}{4}$  inch. I installed the circuit directly where the interior light was located inside the car's roof.

Make certain that the pin-8 connection to the 555 and the resistor go to the hot (+12V) side of the inside light bulb. The diode and the collector of the 2N2222A goes to the "open" side of the lamp. You can use any of the

exposed metal of the car for a ground.

—Pedro R. Schaeffer,  
Mexico, D.F.

Good shot, Pedro! Your book is headed down Mexico way.

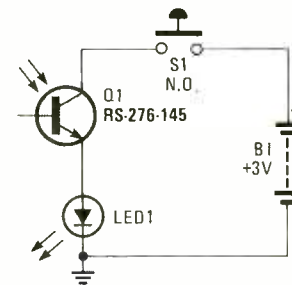

Fig. 6. The Infrared Tester was assembled from readily available parts and operates as a go-no-go test for infrared controls.

### INFRARED TESTER

Anybody that works on VCR's knows that all of the new units use an infrared LED and two infrared phototransistors in the end-of-tape detection system. At

times, it can be difficult to determine whether or not the infrared LED is operating. While there are infrared-detector cards available, it is often difficult to get them inside a VCR.

This circuit (see Fig. 6) is constructed of readily available parts and operates as a go-no-go test for infrared controls. When S1 is pressed, power is applied to the phototransistor and the transistor is biased on by the presence of infrared light. The transistor conducts, causing the LED to light.

—Delbert LaBo, Rittman, OH

Okay, Delbert! It's super-simple, and that's the way we like 'em.

That just about fills our space for this month. Until next time, send your pet ideas to *Think Tank*, **Popular Electronics**, 500-B Bi-County Blvd., Farmingdale, NY 11735.

## Protel Easytrax®

### Outstanding value in Printed Circuit Board/CAD

Protel Easytrax is a new, low-cost design package for PC and Macintosh users that includes everything required to produce professional quality Printed Circuit Board artwork.

Our easy-to-learn menu-driven design system breaks the 'expert barrier' - you'll be designing in minutes, not hours.

Our comprehensive tutorials guide you through the program's extensive features that take the tedium out of board layout.

When we say professional - we mean through-hole component boards of up to 32 x 32 inches with 6 signal layers plus ground and power planes. A fully independent print/plot program is included which supports standard plotters, dot matrix and laser printers, Gerber® photoplotting and NIC drill tapes.

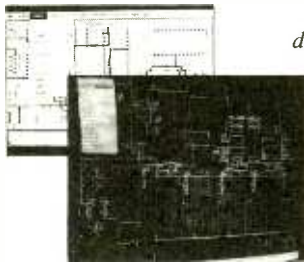

# ONLY \$395

Easytrax can be run on your PC or Mac!

CALL TOLL FREE (800) 544-4186

for complete specs and FREE evaluation disks.

50 AIRPORT PARKWAY, SAN JOSE, CA 95110, USA (408) 437-7771, FAX (408) 437-4913



CIRCLE 10 ON FREE INFORMATION CARD

## Professional Tool Case

**SPECIAL \$59.95**

Reg. \$90.00

Makes a Great Holiday Gift!

Model RLIM5

- Two removable pallets hold over 60 tools
- Case top has built-in document holder
- Case bottom is partitioned into 3 areas

A handsome black case to organize and transport your valuable tools and instruments. This is the same quality case used by literally thousands of professional field engineers. Case is made of high impact polypropylene, and has snap-action key locks and a padded handle.

Size: 17½" x 12½" x 5".

Tools are not included.

Offer expires December 31, 1990.

To order call:

**1-800-225-5370**

In MA: (508) 682-2000

**Same Day Shipment!**

**Money Back Guarantee!**

Terms: Visa, MC, Amex;  
P.O.'s from qualified firms accepted.  
Add \$5.50 for packing and delivery



## FREE CONTACT EAST CATALOG

Contains thousands of products for testing, repairing & assembling electronic equipment. To get your free catalog, call (508) 682-2000.

CIRCLE 12 ON FREE INFORMATION CARD

# Countersurveillance

**Never before has so much professional information on the art of detecting and eliminating electronic snooping devices—and how to defend against experienced information thieves—been placed in one VHS video. If you are a Fortune 500 CEO, an executive in any hi-tech industry, or a novice seeking entry into an honorable, rewarding field of work in countersurveillance, you must view this video presentation again and again.**

## ORDER LINE—CALL TOLL FREE

*Wake up!* You may be the victim of stolen words—precious ideas that would have made you very wealthy! Yes, professionals, even rank amateurs, may be listening to your most private conversations.

*Wake up!* If you are not the victim, then you are surrounded by countless victims who need your help if you know how to discover telephone taps, locate bugs, or “sweep” a room clean.

There is a thriving professional service steeped in high-tech techniques that you can become a part of! But first, you must know and understand Countersurveillance Technology. Your very first insight into this highly rewarding field is made possible by a video VHS presentation that you cannot view on broadcast television, satellite, or cable. It presents an informative program prepared by professionals in the field who know their industry, its techniques, kinks and loopholes. Men who can tell you more in 45 minutes in a straightforward, exclusive talk than was ever attempted before.

### Foiling Information Thieves

Discover the targets professional snoopers seek out! The prey are stock brokers, arbitrage firms, manufacturers, high-tech companies, any competitive industry, or even small businesses in the same community. The valuable information they filch may be marketing strategies, customer lists, product formulas, manufacturing techniques, even advertising plans. Information thieves eavesdrop on court decisions, bidding information, financial data. The list is unlimited in the mind of man—especially if he is a thief!

You know that the Russians secretly installed countless microphones in the concrete work of the American Embassy building in Moscow. They converted what was to be an embassy and private residence into the most sophisticated recording studio the world had ever



**HAVE YOUR  
VISA or MC CARD  
AVAILABLE**

**1-800-522-6260**

known. The building had to be torn down in order to remove all the bugs.

### Stolen Information

The open taps from where the information pours out may be from FAX's, computer communications, telephone calls, and everyday business meetings and lunchtime encounters. Businessmen need counselling on how to eliminate this information drain. Basic telephone use coupled with the user's understanding that someone may be listening or recording vital data and information greatly reduces the opportunity for others to purloin meaningful information.

The professional discussions seen on the TV screen in your home reveals how to detect and disable wiretaps, midget radio-frequency transmitters, and other bugs, plus when to use disinformation to confuse the unwanted listener, and the technique of voice scrambling telephone communications. In fact, do you know how to look for a bug, where to look for a bug, and what to do when you find it?

Bugs of a very small size are easy to build and they can be placed quickly in a matter of seconds, in any object or room. Today you may have used a telephone handset that was bugged. It probably contained three bugs. One was a phony bug to fool you into believing you found a bug and secured the telephone. The second bug placates the investigator when he finds the real thing! And the third bug is found only by the professional, who continued to search just in case there were more bugs.

The professional is not without his tools. Special equipment has been designed so that the professional can sweep a room so that he can detect voice-activated (VOX) and remote-activated bugs. Some of this equipment can be operated by novices, others require a trained countersurveillance professional.

The professionals viewed on your television screen reveal information on the latest technological advances like laser-beam snoopers that are installed hundreds of feet away from the room they snoop on. The professionals disclose that computers yield information too easily.

This advertisement was not written by a countersurveillance professional, but by a beginner whose only experience came from viewing the video tape in the privacy of his home. After you review the video carefully and understand its contents, you have taken the first important step in either acquiring professional help with your surveillance problems, or you may very well consider a career as a countersurveillance professional.

### The Dollars You Save

To obtain the information contained in the video VHS cassette, you would attend a professional seminar costing \$350-750 and possibly pay hundreds of dollars more if you had to travel to a distant city to attend. Now, for only \$49.95 (plus \$4.00 P&H) you can view *Countersurveillance Techniques* at home and take refresher views often. To obtain your copy, complete the coupon below or call toll free.

<b>RADIO-ELECTRONICS VIDEO OFFER</b>	<b>PE</b>
500-B Bi-County Blvd. Farmingdale, NY 11735	
Please rush my copy of the Countersurveillance Techniques Video VHS Cassette for \$49.95 plus \$4.00 for postage and handling.	
No. of Cassettes ordered _____	
Amount of payment \$ _____	
Bill my <input type="checkbox"/> VISA <input type="checkbox"/> MasterCard	
Card No. _____	
Expire Date _____ / _____	
Signature _____	
Name _____	
Address _____	
City _____ State _____ ZIP _____	
All payments in U.S.A. funds. Canadians add \$4.00 per VHS cassette. No foreign orders. New York State residents add applicable sales tax.	

**CALL TODAY TO ORDER 1-800-522-6260**



*It's a high-voltage apparatus that has earned a place in history. Now it's your turn to get in on the fun!*

**“W**imshurst machine? So that's what it's called!” my neighbor said, his eyes as wide as half dollars. I often heard that comment.

I took the Wimshurst machine off the shelf in my den and placed it on the desk before him. I turned the handcrank, the black plastic plates spun, and sparks jumped between the metal globes. “It will create 75,000 volts,” I commented. He leaned away from the machine. As the plates spun, the machine hummed and sparks snapped between the globes. The smell of ozone soon filled the room.

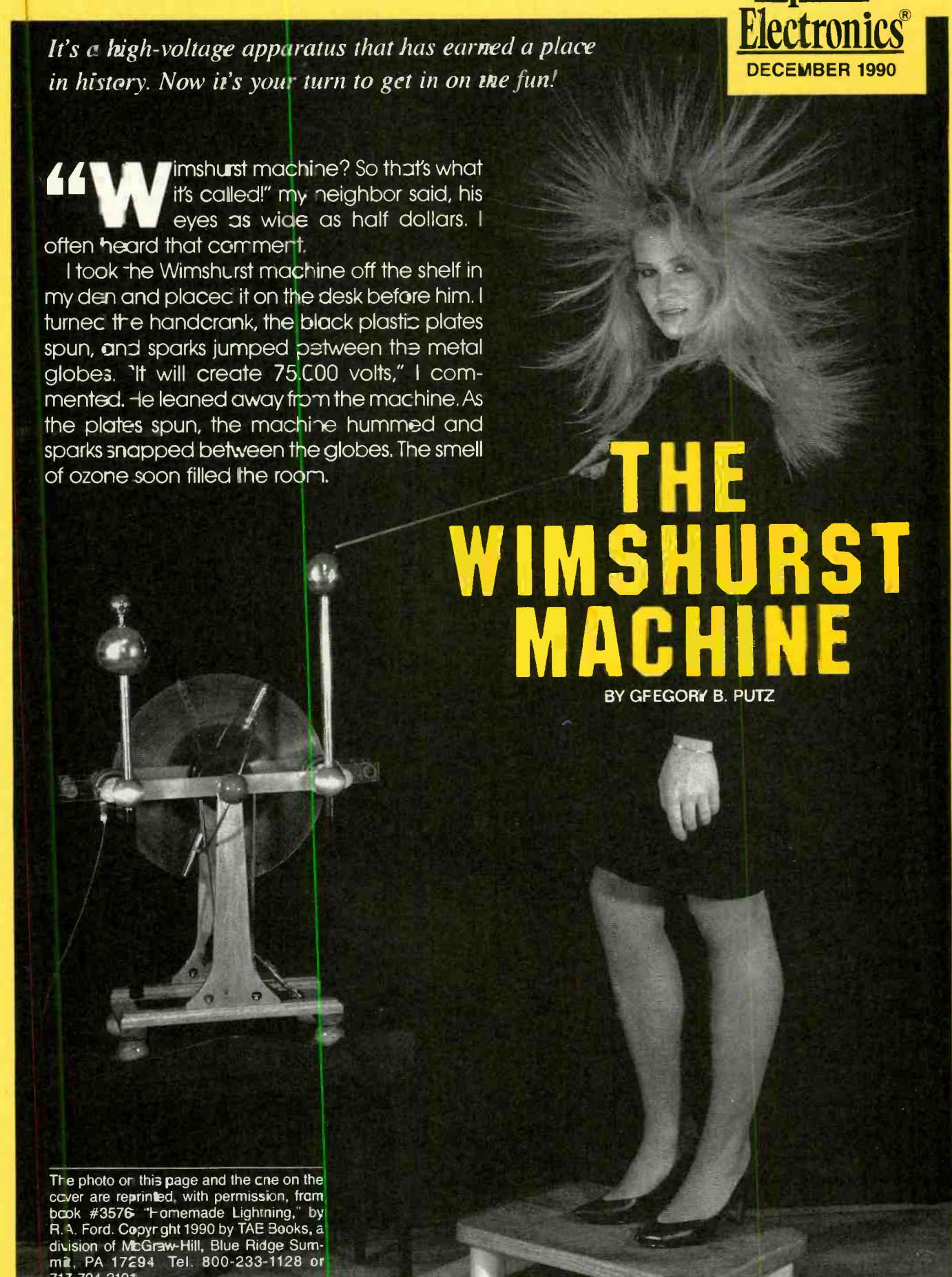

# THE WIMSHURST MACHINE

BY GREGORY B. PUTZ

The photo on this page and the one on the cover are reprinted, with permission, from book #3576 “Homemade Lightning,” by R. A. Ford. Copyright 1990 by TAE Books, a division of McGraw-Hill, Blue Ridge Summit, PA 17294. Tel. 800-233-1128 or 717-794-2191.



I'm sure that you, too, have seen a Wimshurst machine although you may not have known its name. You probably know more about its cousin, the Van de Graaff generator. Both are electrostatic generators, but that is where the similarity ends. The Van de Graaff generator creates static charges by friction, while the Wimshurst device does it by induction. In the early days of electrostatics, the principle of induction was also known as "influence." In fact, the machine is more correctly called a "Wimshurst influence machine."

The Wimshurst machine played an important role in the early years of electrostatics. It provided high-voltages necessary for experiments in X-ray. But before I tell you how the Wimshurst machine works, let's take a quick look at the science of electrostatics.

**Electrostatics.** Electrostatics was first noticed sometime in 600 BC when the Greek philosopher Thales discovered that amber attracted light objects when rubbed. The phenomenon not only demonstrated a fundamental concept of electrostatics, but also gave us the word "elektron," meaning amber in Greek:

When Italian physicist Alessandro Volta invented the "voltaic pile" (or battery) in 1800, the science of electrostatics changed forever. Volta's new invention provided scientists with a stable, dependable source of moving charges (i.e., DC). This invention was a turning point in electricity because now scientists could study *electrodynamics*, whereas before they were limited to studying *electrostatics*.

**Triboelectric Effect.** It's been a while since the days of Thales, but we all know a few modern ways to make electricity by rubbing. Shuffling our shoes across the carpet on a dry day causes a spark between our finger and a metal door-knob. Likewise, rubbing a glass rod with flannel and then pulling them apart causes the flannel to hang unnaturally towards the rod. The rubbing action causes the glass to develop an abundance of positive charges and the flannel an abundance of negative ones. Once pulled apart, the difference in charge of the two materials causes the attraction of the flannel to the glass.

The same happens when you rub paper against a plaster wall or wooden door. It sticks to the vertical surface because the rubbing creates opposite charges on the paper and the wall. Try

it with a balloon and you'll see the same effect. In each of these cases, rubbing creates segregated electric charges and static electricity is the result.

In high school, you probably saw a Van de Graaff generator. It made sparks fly, fluorescent tubes glow, and your hair stand on end when you touched its dome. The Van de Graaff generator works in a way that is similar to rubbing glass with flannel, except

that the rubbing is made continuous by using a moving belt inside the generator (see Fig. 1). As an electric motor turns the belt, metal combs in the generator's dome and base strip charges from the belt. As a result, the dome and base develop opposite charges. Small, classroom-sized Van de Graaff generators produce 200,000 volts. Larger ones, like those used for sub-atomic particle research, create several-million volts.

Glass rubbed with flannel, and paper, or balloons sticking to a wall, and the Van de Graaff generator are all examples of creating static electricity using friction. That is also known as *triboelectric* charging. As we mentioned, there is another way to create static electricity and that is by induction.

**Induction.** John Canton, in 1753, was the first to put forward the concept of induction of charge. He demonstrated that when a charged body is brought close to a neutral body, the neutral body develops a charge of equal magnitude but opposite polarity. One of the earliest devices to demonstrate induction was the "electrophorus." The electrophorus is the simplest electrostatic generator.

Later in 1787, Abraham Bennet, the inventor of the gold-leaf electroscope, developed the first simple machine to induce electrostatic charges. The device was called a "doubler" because of its ability to progressively accumulate static charges. His doubler did not use friction, but used Canton's induction concept to generate separate positive and negative charges.

New varieties of doublers, or "influence machines" as they were soon called, were developed by Nicholson in 1788, Belli in 1831, and Lord Kelvin in 1860. Also in 1860, Varley built the first successful high-voltage influence machine. Other induction devices were subsequently developed by August Toepler and Wilhelm Holtz. But it wasn't until 1878 that British engineer James Wimshurst invented the first dependable device to inductively generate static electricity. The Wimshurst influence machine was born.

**The Machine Itself.** Before we explain how a Wimshurst machine works, it's a good idea to describe its structure. The Wimshurst machine has three major parts: rotating parallel plates, neutralizing rods, and collecting combs

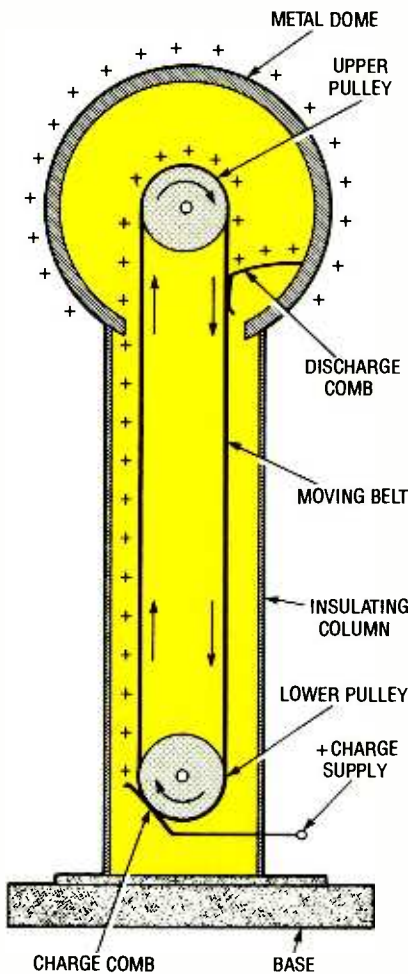

Fig. 1. A Van De Graaff generator places a high-voltage charge on its metal dome by friction, whereas a Wimshurst machine charges via induction.

**WARNING!!!** This article deals with and involves subject matter and the use of materials and substances that may be hazardous to health and life. Do not attempt to implement or use the information contained herein unless you are experienced and skilled with respect to such subject matter, materials and substances. Neither the publisher nor the author make any representations as to the accuracy of the information contained herein and disclaim any liability for damages or injuries, whether caused by inaccuracies of the information, misinterpretations of the directions, misapplication of the information or otherwise.



(see photos). Today's bench-sized demonstration units typically have 12-inch diameter plates. During the heyday of electrostatics, larger Wimshurst machines (used for research or powering early X-ray machines) had multiple pairs of plates several feet in diameter.

Each Wimshurst machine develops a maximum electrostatic potential based on the number of plates used, their diameter, and the spacing between them. Interestingly enough, increasing the rotating speed of the plates does not increase the maximum discharge voltage. Only increasing the number of pairs of plates increases the discharge voltage.

The plates can be any sturdy, non-conducting material, such as glass or plastic (see Fig. 2). The plates are mounted in pairs, separated by a quarter-inch gap, on a horizontal shaft. The closer the plates are mounted to each other, the better the machine will operate. The plates are turned by belts and pulleys from a common crankshaft, but they rotate in opposite directions. A difference in pulley diameters causes the plates to spin several times faster than the handcrank.

Metal-foil strips called "sectors" are

## Resources.

Wimshurst electrostatic generators are available from Edmund Scientific Company (Cat. No. B70,070), 101 E. Gloucester Pike, Barrington, NJ 08007-1380; Tel. 609-573-6250, and from The Chem Shop, 1151 South Redwood Road, Salt Lake City, UT 84104; Tel. 801-973-7966.

See the following books for more information:

*The Wimshurst Machine: How to Make and Use It*, by Alfred W. Marshall; Lindsay Publications, Inc., P.O. Box 12, Bradley, IL 60915-0012.

*Electrostatics: Exploring, Controlling and Using Static Electricity*, by A.D. Moore; Anchor Books, 1968.

*Handbook of Electrostatic Discharge Controls*, By Bernard S. Matisoff; Van Nostrand Reinhold Company, 1986.

*Electrostatics: Principles, Problems and Applications.*, By Jean Cross; Adam Hilger, 1987.

*Homemade Lightning*, By R.A. Ford, Book #3576, TAB Books, Blue Ridge Summit, PA 17294; Tel. 800-233-1128 or 717-794-2191.

evenly spaced along the outer surface of each plate. Those help extract excess charges from the non-conductive plates.

The charges that accumulate on the sectors are removed by pairs of collect-

ing combs made of tinsel threads. Each pair of combs is mounted on a U-shaped bracket, with one brush touching the front plate and the other brush touching the rear plate. The two U-shaped brackets are mounted opposite one another. They carry the accumulated charges to the machine's discharge balls.

There are two "neutralizing rods" that span the diameter of each plate and also have metal tinsel combs on each end. The front and rear rods are perpendicular to each other and are positioned at an angle of 45° to 60° from the machine's base.

In addition to the three basic parts of a Wimshurst machine, they typically have two built-in Leyden jars, which are very simple glass and foil capacitors. Each Leyden jar can be electively connected to a collecting comb by means of a hinged rod. If the Leyden jars are not connected to the collecting combs, then a continuous arc jumps between the discharge balls when the handcrank is turned. If the connecting rods are lifted to touch the collecting combs, then a sharp (and intense) snap of electricity jumps between the discharge balls every few seconds.

It is important to notice that all the metal parts of a Wimshurst machine are built with rounded edges. A fundamental rule of electrostatics is that charges find it much easier to "jump" from a pointed surface than from a rounded one. Any sharp points on the machine would allow the charges to dissipate quickly.

**How it Works.** Remember that the Wimshurst machine is an induction device. It doesn't depend on friction to make an electrostatic charge. As you'll see, quadrants of negative and positive charge are created across the plates by induction between the front and rear plates. As the plates rotate, these positive and negative charges are syphoned off through the metal sectors by the collecting combs.

As you may recall, the principle of induction requires that an object be initially charged before you can use it to induce a charge in something else. That holds true for the plates on the Wimshurst machine. Even before you crank the handle the plates have some static charges on their surface. The charge is created from the incidental rubbing and handling of the machine, and the machine actually amplifies this initial imbalance of charge.

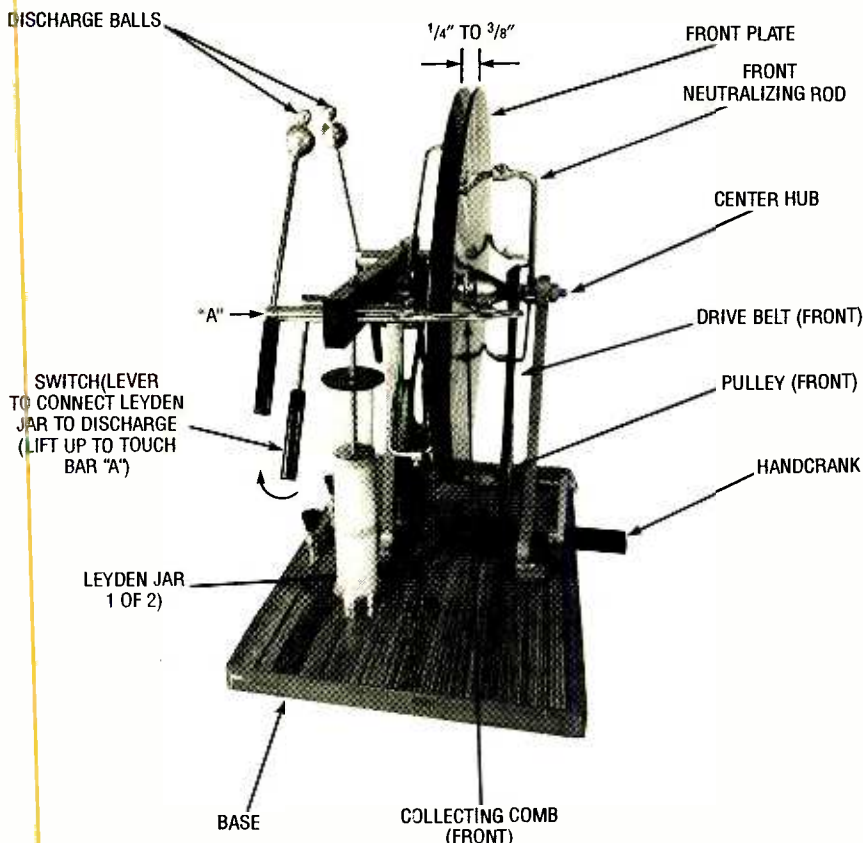

The Wimshurst machine is composed of many parts. However, not all Wimshurst machines have Leyden jars although this one does.

Looking at Fig. 2 let's say that quadrant CD of the rear plate had a slight negative charge before the crank was turned. That would induce a small positive charge on the front plate in the same sector. As you turn the crank, electrons on the front plate sector at point C are repelled by the electrons built up on the rear plate. That pushes them up the neutralizing rod to A, which is a more desirable place to be because the rear plate has a positive charge there. That leaves electron-starved quadrant CD with a net positive charge, and electron-rich quadrant AB becomes more negatively charged.

Note that the rear plate—rotating in the opposite direction—works in a reciprocal fashion: Electrons move through the rear neutralizing rod from B to D. So on the rear plate, quadrant AB becomes more positive and quadrant CD becomes more negative. That permits the front neutralizing rod to scoop up more repelled electrons and so on.

In the region of the collecting combs, the front and rear plates have the same charge. The charges on the plates repel each other in those areas. That permits the collecting combs to scoop up the excess charges and send them to the discharge balls. The charges will continue to accumulate until surface leakage or a spark between the discharge balls dissipates them.

You can see the charge leakage by placing the device in the dark, setting the discharge balls a good distance apart, and looking at its corona discharge radiating from the edges of the plates. You'll also see tiny, purple arcs around all combs.

Setting the gap between the discharge balls an inch or two apart, causes a continuous shower of sparks to jump between the spheres. Connecting the Leyden jars to the discharge spheres allows you to separate the balls by a larger distance to produce big crackling sparks.

**Demonstrations.** Here are some demonstrations that you can try with a Wimshurst machine. For instance, with the Leyden jars disconnected, move the discharge balls far enough apart so that there is no spark when you turn the handcrank. Light a candle and hold it close to one ball and then the other. At the positive ball, the flame will be attracted toward it, and at the negative one, the flame will be repelled.

For another experiment, hold a piece of cardboard between the dis-

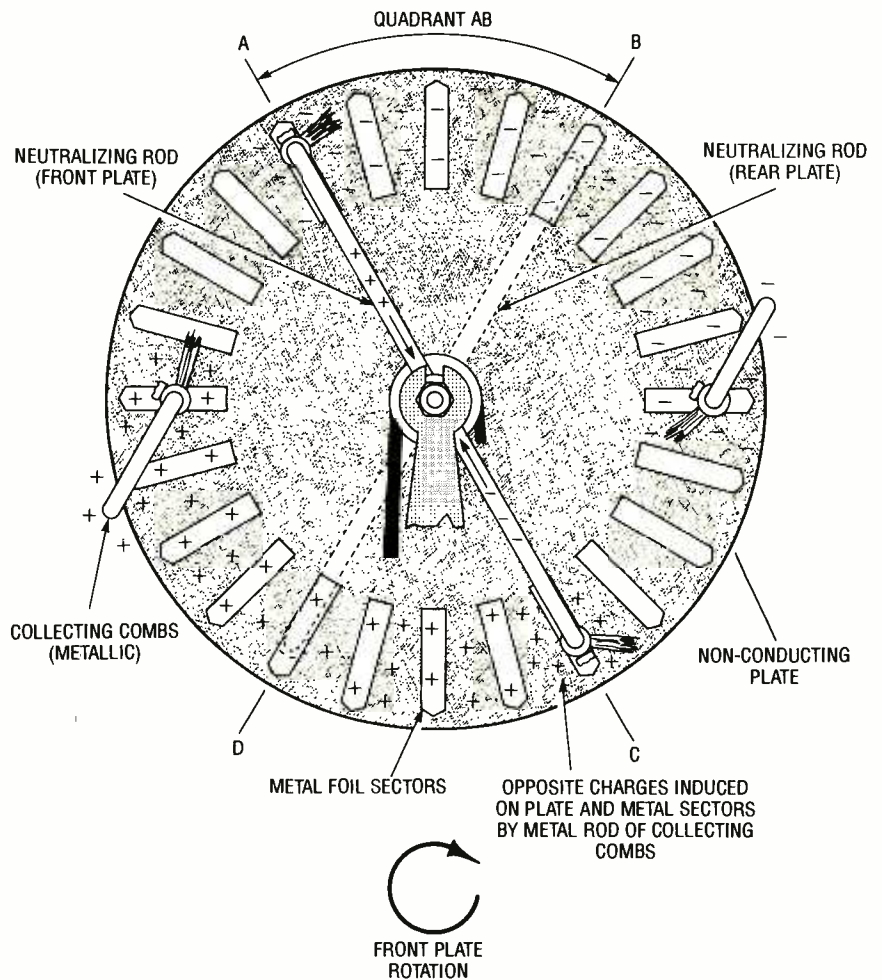
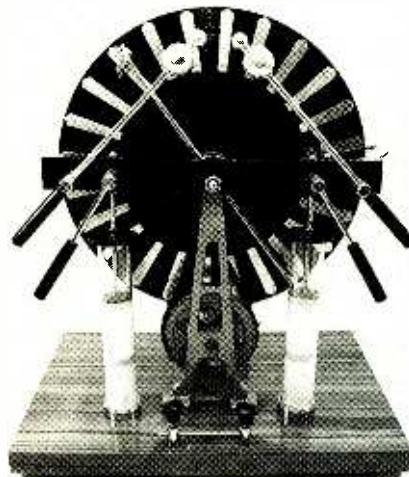

Fig. 2. This is the charge distribution on the front plate. Front and rear neutralizing rods scoop the charges up and move them to more desirable quadrants. The collecting combs can then whisk them away.



Here you can plainly see the Leyden jars and discharge spheres. The jars are connected to the spheres by lifting up the levers attached to them.

charge balls (again with the Leyden jars disconnected). Allow the shower of sparks to jump through the cardboard. Inspect the cardboard and notice that the hole caused by the spark is bulged

on both sides. That shows that sparks act like AC current, they oscillate between the discharge balls.

For a different effect, start by cutting some kind of shape out of a piece of aluminum foil. A good example is a letter, such as T or L. Paste the aluminum design to a piece of cardboard. Using a knife or razor blade, cut the design in several places to create discontinuities in the foil (don't let the cuts exceed  $\frac{1}{32}$  inch wide). Connect each end of the shape to one of the discharge balls. Run the machine and watch the arcs as the charges jump the cuts in the foil.

**Safety.** You must respect the potential of any electrostatic generator. Under normal use, they are safe, but you should not let that lull you into a false sense of security. **You must never attempt to condense, or store, the charge they produce without full knowledge of its dangers. Simply said, avoid connecting any capacitor to any electrostatic generator.**



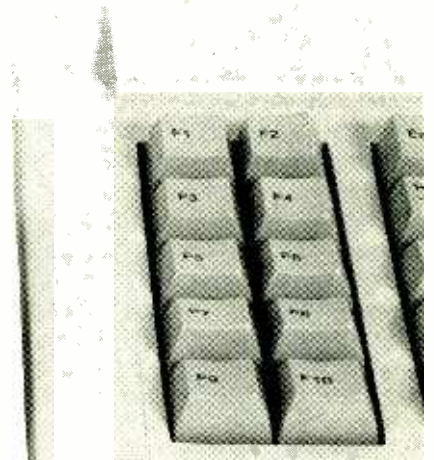

# Build The Bitgrabber

BY JOHN YACONO AND MARC SPIWAK

*Here's an interesting little gadget that you probably have a use for—even though you may not be aware of it!*

**A** computer is a black box in many respects to most people. Especially where something like the output of your parallel port is concerned. Let's face it: even using a logic analyzer, which is something that most computer hackers are not familiar with (not to mention that it's really expensive), it would still be an arduous task to try and figure out what character is present at the port. You would have to examine the logic levels on the eight-bit bus, convert them to a binary number, and look for a match on an ASCII table.

But why go through all that when you don't have to? Our *Bitgrabber* provides you with an RCA output jack that pulses low when any preselected ASCII code is detected. The low pulse can be seen easily with a logic probe, oscilloscope, or another, similar instrument. You could even attach an LED to the output, although the pulse may be too short to "see"—but more on overcoming that later.

Many of you are probably saying "why don't you just connect a printer to the port and see what it prints?" Well, that would be fine, except that graphics characters can't be printed on some printers, and there are some characters that can't be printed on any printer. Also, one reason that you may want to know what character is being

output at the port is if your printer isn't working; in which case you obviously can't see the character. The *Bitgrabber* is an easy way to see if the problem is with your printer or the port itself.

There are other uses that may not be as obvious. The *Bitgrabber* can be used to buzz out parallel-printer and straight RS-232 cables. It can activate a device via a relay, optocoupler, or other similar device upon receiving the right signal. With a modified output stage, it can control a large number of devices using only twisted-pair wiring (very good for timed remote operation of household devices for people who already own a computer—and who doesn't?).

It can also be used as a test instrument for logic chips. You would set the detector's DIP switches to correspond to the proper input and output values for a given chip, connect the detector to the chip with a DIP clip, and see if a low pulse appears at the detector's output jack at the appropriate time.

**Circuit Theory.** The theory behind the circuit's operation is pretty simple. Let's say we wanted to detect the ASCII character represented by the binary number 11111111 (character 255) at your printer port. That character is used for special purposes and can't be printed like other characters, so simply

using your printer to detect its presence won't work.

If we feed those bits into an eight-input AND gate, the gate's output would go high—but only if all eight inputs are high. Now, if we were to use an eight-input NAND gate instead, the only difference would be that the gate output would go low when all inputs are high. As a matter of fact, using a NAND gate is actually preferred, because IC's are very poor at supplying current to other devices, but they are pretty good at sinking it. And we assume that the output will be used to turn on something. Also, by grounding a device to turn it on, the detector's power supply can be isolated from the device you want to control. They will share only a common ground.

Now all that's great if you are only interested in detecting ASCII character 255. What about characters with zeros in them? The obvious answer is to invert each bit that should be zero before sending it to the NAND gate. However, using inverters is a bad idea because you'll have to rewire the circuit whenever you want detect a different character. Not only that, you could wind up with phase-delay problems.

A chip's phase delay is the time difference between a change at the input and the corresponding change at the output. It's like when you're playing

catch with someone; there is a time difference between when you catch the ball and when you throw it. That's not to be confused with rise time; the output of the chip takes time to reach the peak voltage after it has "made up its mind." Just like when you throw a ball up in the air; it takes a certain amount of time for the ball to reach its peak altitude after it has left your hand. If an inverter is used along one of the data lines, it will slow that line down so all the bits on the bus will not arrive at the NAND gate at the same time. If the phase delay is long enough in comparison to the transmission speed, the device will fail to function properly.

What we need, then, is a gate that can be used as an inverter or a buffer. That way, signals that need inverting will pass through the same number of gates as signals that are simply buffered. Further, if that gate can be programmed to be an inverter or a buffer with a simple switch, then there'll be no need to rewire the circuit to detect a different character. Simply set the switches to invert the lines you expect to be low, and buffer the rest.

The perfect gate for that purpose is the XOR gate. If you hold one of an XOR gate's inputs high, the compliment (inverse) of the other input appears at the output. If you hold one input low, the signal at the other input will be buffered through unchanged.

If you take a look at Fig. 1, you'll see that the quad XOR-gate chips, U1 and U2 do just that. Let's follow the path of the least-significant bit, D0, for clarity. It comes into the unit via pin 2 on the DB-25 connector, and goes straight to one of the XOR-gate inputs. The other input to that gate would be held low if the switch connected to it is closed, or it will float high through its pull-up resistor in R1 if that switch is open. So with a switch open, its gate is a buffer, with a switch closed, its gate is an inverter. If we invert all the inputs that we want to be zero, and buffer those we want to be one, then when the incoming character matches the one we're waiting for, all the inputs to the NAND gate will be high, thus its output will go low.

**Parallel-Interface Handshaking.**  
Computers transmit more than just

character data through their parallel ports; they send control signals as well. They also expect to receive signals generated by the printer. Let's examine those "handshaking" signals and see how the Bitgrabber deals with them.

Start by taking a look at Fig. 2. There we show the four important signal types and their relationship in time. At the top are the eight data lines lumped together as a single band. Don't let that throw you, the value of the bits is not important. What is important is the time at which data is present at the port.

The data being output on lines D0-D7 starts to change at time t1 and is available for use by time t2. At t2, the computer sends a momentary low-going pulse, called the strobe signal, through pin 1 to the printer to indicate that the data is ready and waiting on the data lines. After t2, the printer can either output a busy signal (through pin 11), which keeps the computer from sending more data to the port, or it can wait until it's ready before sending an acknowledge signal (through pin 10), which also keeps the computer from proceeding. There are a few printers

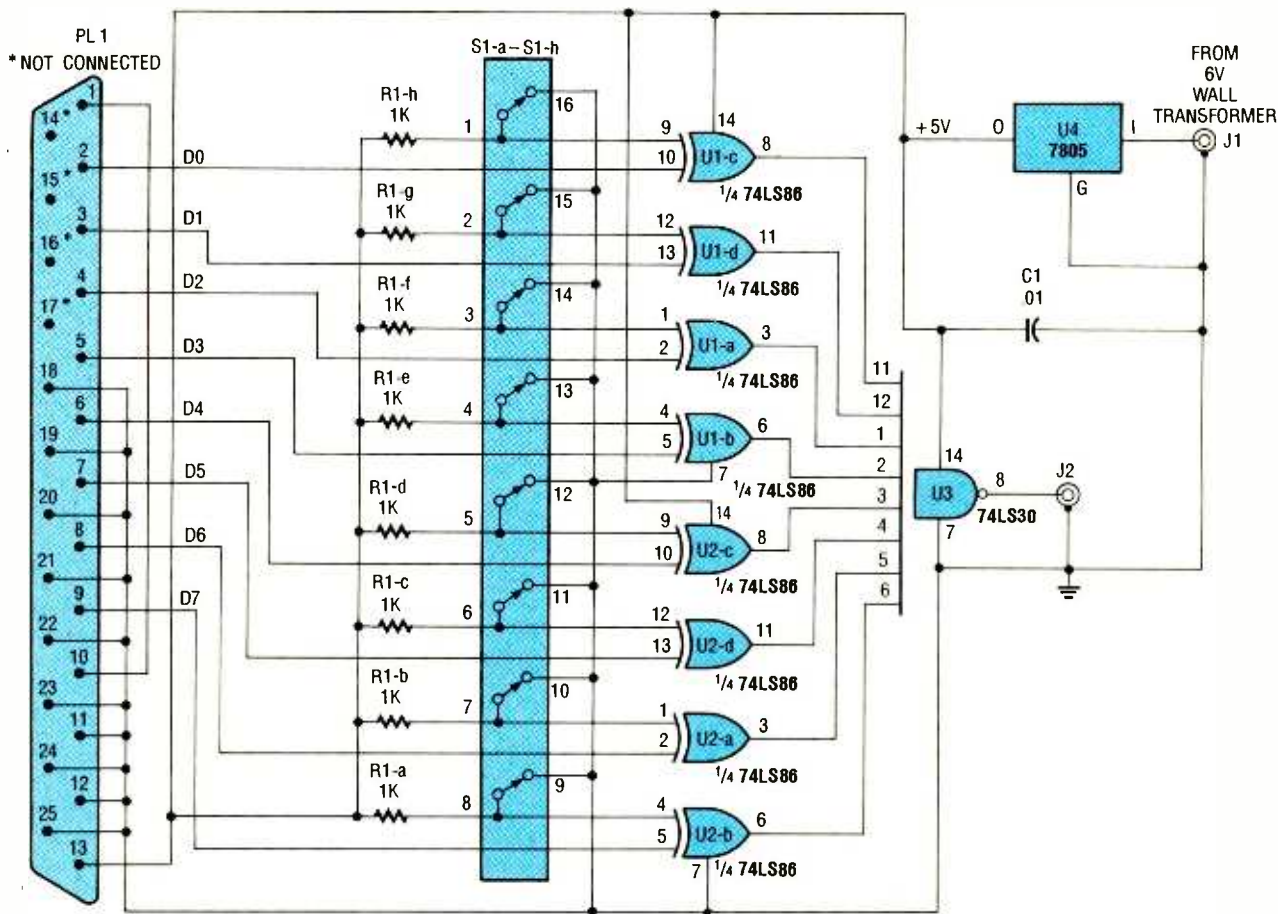

Fig. 1. Here is the schematic diagram of the Bitgrabber. The DIP switches allow you to set the unit to indicate the presence of any ASCII character.



that halt the computer in both ways, although to do so is redundant.

Now you might be wondering how the character detector does any hand-shaking without any pulse-generating components. Well, the detector lets the computer "shake" its own "hand." The busy line is tied low, which is okay because the computer doesn't care whether or not the busy line goes through any transitions. As long as the line isn't high the computer will just wait for the acknowledge signal. The level of the busy line is important, not its transitions; that's why the busy-line levels are drawn bold in the illustration.

The computer must therefore rely on the acknowledge line to detect the device's readiness. When the computer sends the strobe pulse, it considers the falling edge the start of transmission (that's indicated by the arrow on that edge). By the time the strobe line is low, the computer has already begun waiting for the acknowledge pulse. Interestingly enough, the computer only concerns itself with the rising edge of the acknowledge pulse; it pays no attention to the pulse's logic level or its falling edge.

Since the computer starts waiting for the rising edge of the acknowledge pulse right after the falling edge of the strobe pulse, we can use the rising edge of the strobe pulse in place of the rising edge of the acknowledge pulse. To accomplish that, the detector has an internal connection between pins 1 and 10 and the computer sends itself what it thinks is the rising edge of the acknowledge pulse.

**Construction.** The Bitgrabber is built using very few components, so its size can be kept to a minimum. All things considered, wire wrap is the best way to go for this project. So be sure to use IC sockets with wire-wrap pins on them for all of the components except the capacitors and the voltage regulator. The wiring job will be easier if you lay out the parts as they are arranged in the schematic.

All of the connections on the underside of the board are wire-wrapped, except in instances where there are many pins right next to each other that must be connected together. For example, one entire side of the DIP-switch package must be wired together, so a piece of bus wire was soldered directly to the row of pins. Using bus wire that way will save you from a lot of wire wrapping.

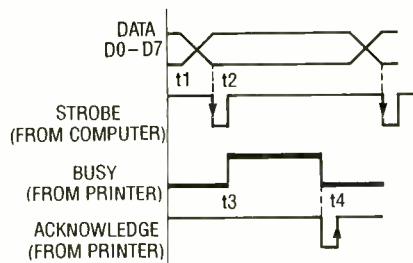

Fig. 2. Here are the important timing signals on your parallel port.

The unit connects to your computer with a DB-25 connector (PL1) crimped onto the end of a length of ribbon cable. If you look at the schematic, you'll see that pins 14-17 are unused, so don't connect them to the perfboard. Also, pins 1 and 10 just have to be connected to each other, so that's two more wires that don't have to be connected to the board.

Altogether, only 19 of the 25 wires in the ribbon cable have to be connected to the board. For added strength though, the unneeded wires are cut off *after* entering the case (more on selecting the case in a moment), and pins 1 and 10 are connected inside the cabinet. The other 19 wires are soldered to individual wire-wrap pins on the top of the board, to make wire wrapping on the underside neater.

Other components, such as the RCA-type output jack for J2, and the coaxial DC power jack (J1) are optional. You can use any kind of output jack that best suits your needs, and an on/off switch can be substituted for J1. You could omit the on/off switch as well, and simply plug in the unit when you need it.

The connections to the jacks were made using stranded wire soldered directly to the wire-wrap pins on the IC

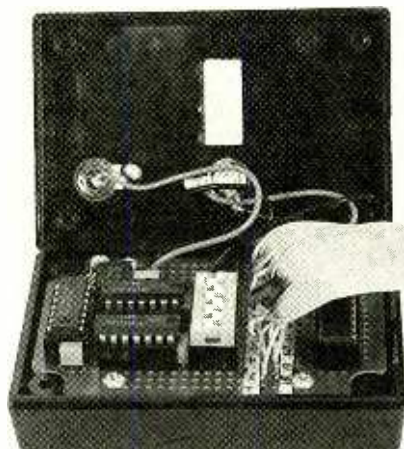

A small piece of perforated construction board is all you need to build the circuit.

## PARTS LIST FOR THE BITGRABBER

### SEMICONDUCTORS

- U1, U2—74LS86 quad 2-input XOR-gate, integrated circuit
- U3—74LS30 8-input NAND gate, integrated circuit
- U4—7805, 5-volt regulator, integrated circuit

### ADDITIONAL PARTS AND MATERIALS

- R1—1000-ohm, 16-pin, DIP resistor network (Digi-Key 761-1-R1000, or similar)
- C1-C4—0.01- $\mu$ F monolithic capacitor
- S1—8-position DIP switch
- PL1—DB-25 male connector
- J1—DC power socket
- J2—RCA phono jack

Cabinet, circuit board, 6-volt DC power supply, 25-conductor ribbon cable, 16-pin wire-wrap sockets, 14-pin wire-wrap sockets, solder posts, wire-wrap wire, bus wire, solder, etc.

sockets. Wire-wrap wire can be used, but it breaks quite easily when wiggled back and forth.

The prototype was built with the intention of it being the only thing connected to the parallel port. However, if you wish to connect it in-line with a printer, for example, simply crimp an additional connector of the appropriate gender and type onto the ribbon cable, and disconnect the wires from pins 1, 10, and 11 inside the project box.

**Testing the Unit.** Let's test the circuit now, before installing it in a case, but be sure to put the board on a non-conductive surface during this step. With your computer off, plug the Bitgrabber's DB-25 connector into the parallel port. Plug the wall-transformer power supply into a surge-protected AC socket and connect its output plug to the Bitgrabber. Connect a logic probe, a pulse-detecting multimeter, or an oscilloscope to the detector's output. Now set the switch bank.

The desired character is selected by setting the bank of switches to the character's ASCII code as mentioned earlier. Table 1 contains the binary code for all 256 IBM-compatible characters. Note that on = 1, off = 0, S1-h sets the most-significant bit, and S1-a sets the least-significant bit. Now you're ready to power up your computer and send data to the port.

You needn't write a program just to  
(Continued on page 96)

# THE "HOT WIRE"

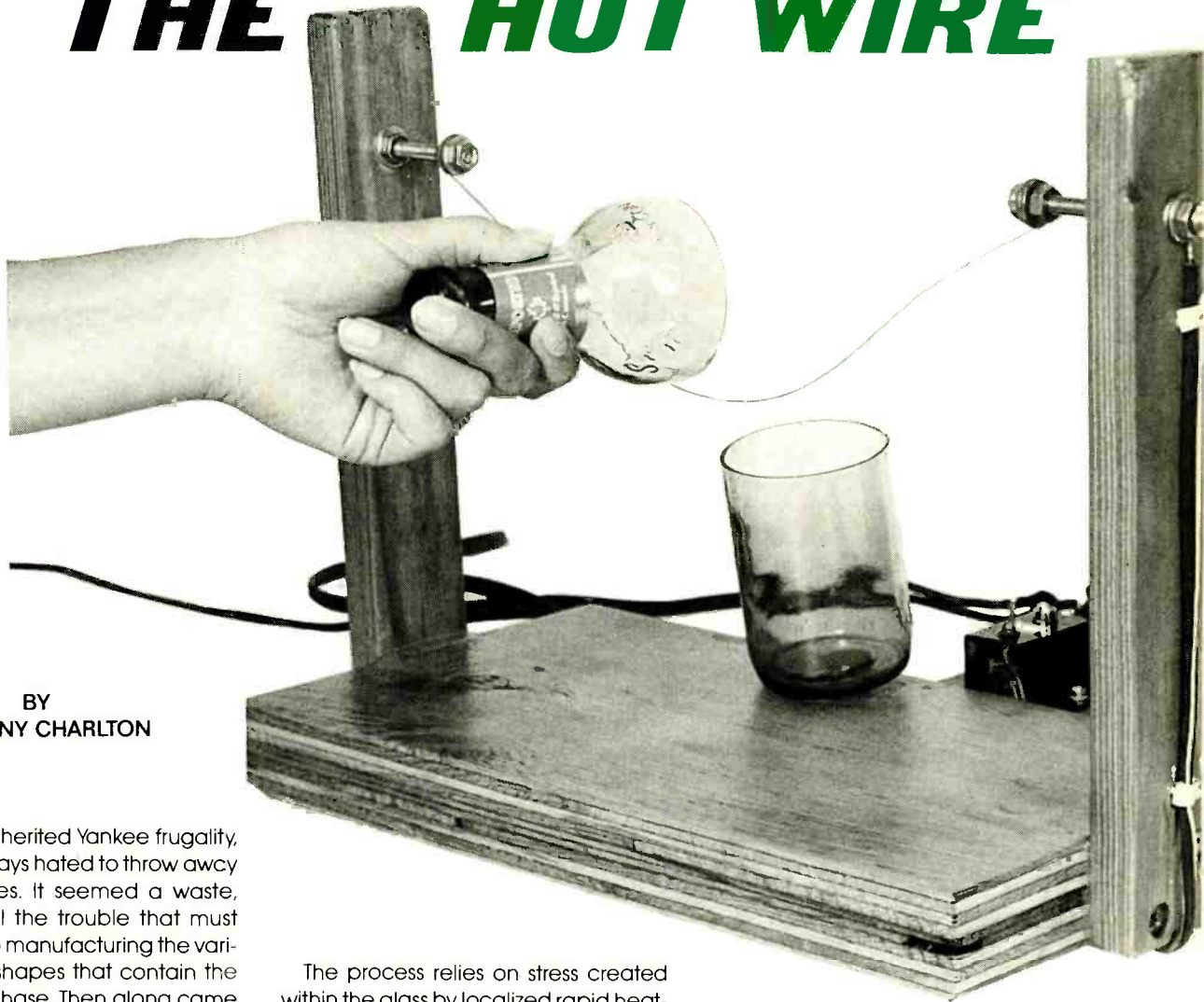

BY  
ANTHONY CHARLTON

I guess it's inherited Yankee frugality, but I've always hated to throw away glass bottles. It seemed a waste, considering all the trouble that must have gone into manufacturing the various sizes and shapes that contain the liquids we purchase. Then along came an idea on how to salvage some of those bottles and turn them into useful items. Cut off the neck, and then you can then make drinking glasses, planters, vases, lab ware, decorations, artistic creations, terrariums, and even fish bowls! But how?

Regular glass cutters of the wheel or scoring-point type proved frustrating and unreliable since the bottle would almost always break in the wrong place. The result was a ruined job, or one that required extensive grinding to get it only halfway decent.

Then, in an inspiration, the *Hot-Wire Glass-Bottle Cutter* was created. The Hot-Wire Glass-Bottle Cutter combines two techniques. The bottle is first scored lightly and evenly with an ordinary wheel-type cutter. Then a red-hot wire heating element is guided over the score line until a crack forms and neatly moves along the score line until the two pieces separate.

The process relies on stress created within the glass by localized rapid heating that causes the glass to crack. The score line then guides the advancing crack accurately to its ultimate end. With practice, that one-two approach produces a perfect job nearly every time. After separation, the cut glass is smoothed with emery cloth or a similar product to remove the sharp edges.

**The Secret.** The core of the project is its nichrome—a semi-flexible, but very tough alloy of nickel (61%), chromium (15%), and iron (24%)—wire heating element. Nichrome has an electrical resistance of about 65 times that of pure copper. Because of its high resistance, it heats up rapidly as current is forced through it.

There are several alloys of nichrome made. The prototype was made with the most often used type and is known by the names (other than nichrome): Alloy C, MWS-675, Tophet C, Chromel C, and Nikrothal-6. Nichrome is widely

used for resistance-heater type devices, such as toasters, electric blankets, and giant high-temperature heaters used to remove welding stresses in oil and nuclear power-plant piping.

Perhaps its most useful property is its very high maximum working temperature of around 1800°F. Indeed, heat of that magnitude can easily melt glass. However, in this project, the nichrome wire is heated to cherry red; roughly 1200°F, which is still below the 1285°F melting point of common bottle glass.

Wire temperature is very important. If the wire heating element is allowed to get too hot, the glass will begin to melt, leaving a sticky build-up on the wire, thereby making accurate cutting extremely difficult at best. On the other hand, if the wire does not reach a high enough temperature, the glass won't develop sufficient stress at the score line to cause separation.

There are two factors that control wire



# BOTTLE CUTTER

*Create colorful decorative ornaments and useful implements with an easy-to-build cutting assembly*

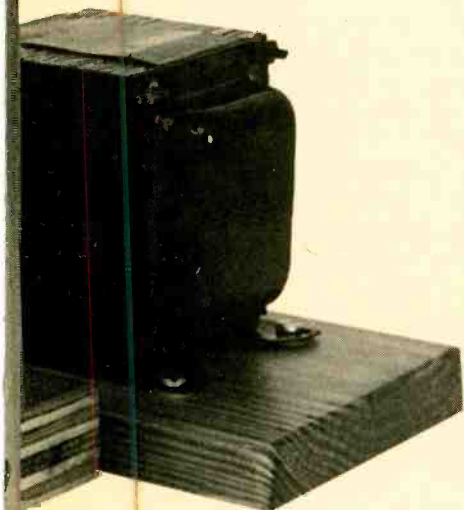

temperature; resistance and current. The resistance of the wire depends on its gauge and length. Current depends on the resistance of the wire (including all of the wire in the current path) and the applied voltage across it.

Once the proper length of wire is "calibrated" to the supply voltage, you can replace the old heating element with another of the same gauge and length over and over again without altering the operating temperature of the element. Although calibration is easier using a digital thermometer with a small probe, it is not essential for building the project.

**The Power Supply.** The power supply (see Fig. 1) consists of nothing more than a heavy-duty, 12-volt, step-down transformer capable of supplying at least 5 amps continuously to heat the 24-gauge nichrome wire. Heavier gauges of nichrome wire require more energy. A big filament transformer salvaged from an old tube-type color TV was used in the prototype. Surplus deal-

ers often have high-current transformers on sale for virtually peanuts.

At this point, it is important to note that AC transformers exhibit peculiarities under differing load conditions. Under light loads, the voltage output of an AC transformer may vary substantially from that specified by its manufacturer. For instance, the transformer used in our prototype put out 13.1-volts AC under light load, and 11.8 volts under a moderate-to-heavy load. That's a fluctuation of 11%—even though the unit is a massive and well-built transformer. So to avoid voltage fluctuations a heavy-duty transformer rated for 12 volts AC (and no less) is recommended.

A fuse is installed on the primary winding of T1, along with S1, which is included for safety and convenience. A high-brightness LED (LED1) is used to show that power is being delivered to the heating element for safety. That's because, although the wire may have a red glow (hot enough to sear flesh), under bright-light conditions the human eye cannot easily detect that glow. For that reason, it is recommended that the project not be left on unattended by a responsible person. There is also a second indicator (neon lamp NE1) on the primary side of the transformer, which is used to show AC power integrity.

The nichrome-wire heating element is strung between posts of a wooden frame and is held clear of the frame with bolts and nuts. It is important that the frame be very sturdy so that the wire does not flex while cutting, or separating the bottle will be difficult.

**Frame Fabrication.** Construction details for the frame are shown in Fig. 2. The base of the frame is made from a 2-inch thick piece of plywood (or other sturdy, non-conductive material) cut to 8 × 14 inches. Two uprights are attached to opposite ends of the 14-inch long base. The uprights are fashioned from 3/4- × 2-inch plywood or hard pine (yellow pine, for instance) cut to 12 inches. Once the uprights have been cut to specification, align the two uprights with each other and drill holes through the uprights large enough in diameter to allow the bolts to slide

through. Countersink the holes if needed.

Place the two uprights at opposite ends of the 14-inch length of the base and align them with each other and square them with the base. If you happen to have a wood dowel, tubing, or rod of some type lying around, thread it through the holes in the two uprights and center the uprights on the base to aid the alignment process. Once the uprights are aligned and squared with the base, drill a pilot hole through the uprights and into the base. That prevents splitting of the wood when the screws are tightened down.

Dry-assemble the frame, not quite tightening the screws all the way. Disassemble the frame and coat the mating surfaces with a fast-drying epoxy. Reassemble the frame, tightening the screws to achieve the tightest joint possible. Once the epoxy has set, the frame will be very strong.

Install the hardware at the top of the uprights as shown in Fig. 2 and begin wiring the circuit, guided by the schematic diagram in Fig. 1. The connections to the heating element and to the power supply must be clean and tight. Since nichrome will not hold a solder joint (it gets much too hot in operation) and the alloy doesn't braze easily, the connection is best made by wrapping a few turns of the nichrome wire around the bolts at the tops of the uprights, and squeezing the wire tightly between two washers by tightening the nuts.

The bolt must be long enough to prevent the heat from the heating element from charring the wood frame. A 3-inch bolt was used in the prototype, and had the added advantage of providing length adjustability for the wire. Eventually, the heating element will become tarnished and the connection to the bolt will increase in resistance. When that happens, the wire can be removed, cleaned with sandpaper, and then re-attached.

The transformer (which is the bulk of the power supply) may be bolted on the frame or (as in the prototype unit) located separately; use the configuration that you find most convenient. Heavy conductors must be used between the power supply and nichrome

heating element to minimize energy loss. The author used heavy-duty, 16-gauge, two-conductor lamp cord. Heavier gauge wire (14 gauge, for instance) may also be used, and if the lead between the transformer and the heating element is to exceed 3 feet, a

larger gauge wire should be used to minimize power losses. The ends of the lead connected to the frame should be stripped back 1.5 inches, tinned, wrapped around the bolts, and the retaining nuts securely tightened.

is accurate enough; and if possible, you can borrow or rent one from your local auto repair shop.

Remember, the support and power-supply dimensions given are matched to a 24-gauge wire heating element. Once you get the nichrome wire, carefully stretch out a section about 2 feet long. Remove the coiling by clamping one end in a vise and tugging at the other end until the wire is fairly smooth. Don't worry if it's a bit wavy; the heating and pressure that it will be subjected to will straighten it out as you cut your first bottle.

Assuming that you use 24-gauge nichrome wire and a 12-volt power supply, the active length of the element will be 10–12 inches. Since each transformer is a little different, you may need to experiment with the wire length to achieve the proper temperature range.

When the heating element is subjected to current, the glow is clearly visible in a darkened room; a blood-red glow is too cold, cherry-red is okay, or-

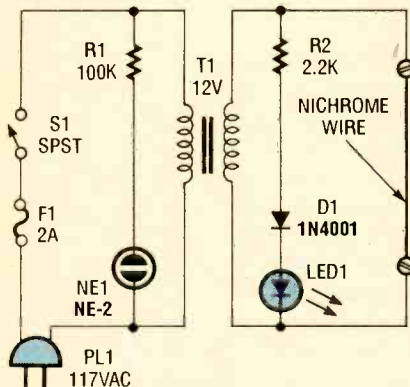

Fig. 1. The power supply for the Hot Wire Glass Bottle Cutter consists of nothing more than a heavy-duty 12-volt step-down transformer capable of supplying 2–5 amps continuously to heat the 24-gauge nichrome wire.

**Getting Nichrome Wire.** Nichrome wire can be obtained from several sources. The supplier listed in the Parts List sells small quantities of the wire. Mail-order surplus dealers often carry inexpensive coils of nichrome wire. And some well-stocked hardware and electrical supply stores carry it for use in heating appliances. Heating elements may also be removed from some discarded older-model toaster ovens, hot plates (the coiled-wire type), waffle and clothes irons, etc.

For the salvage operation, a micrometer is a handy instrument to have around. It will enable you to determine the gauge of salvaged heating elements. Micrometers are available from suppliers of machinists tools and automobile repair parts. An inexpensive unit

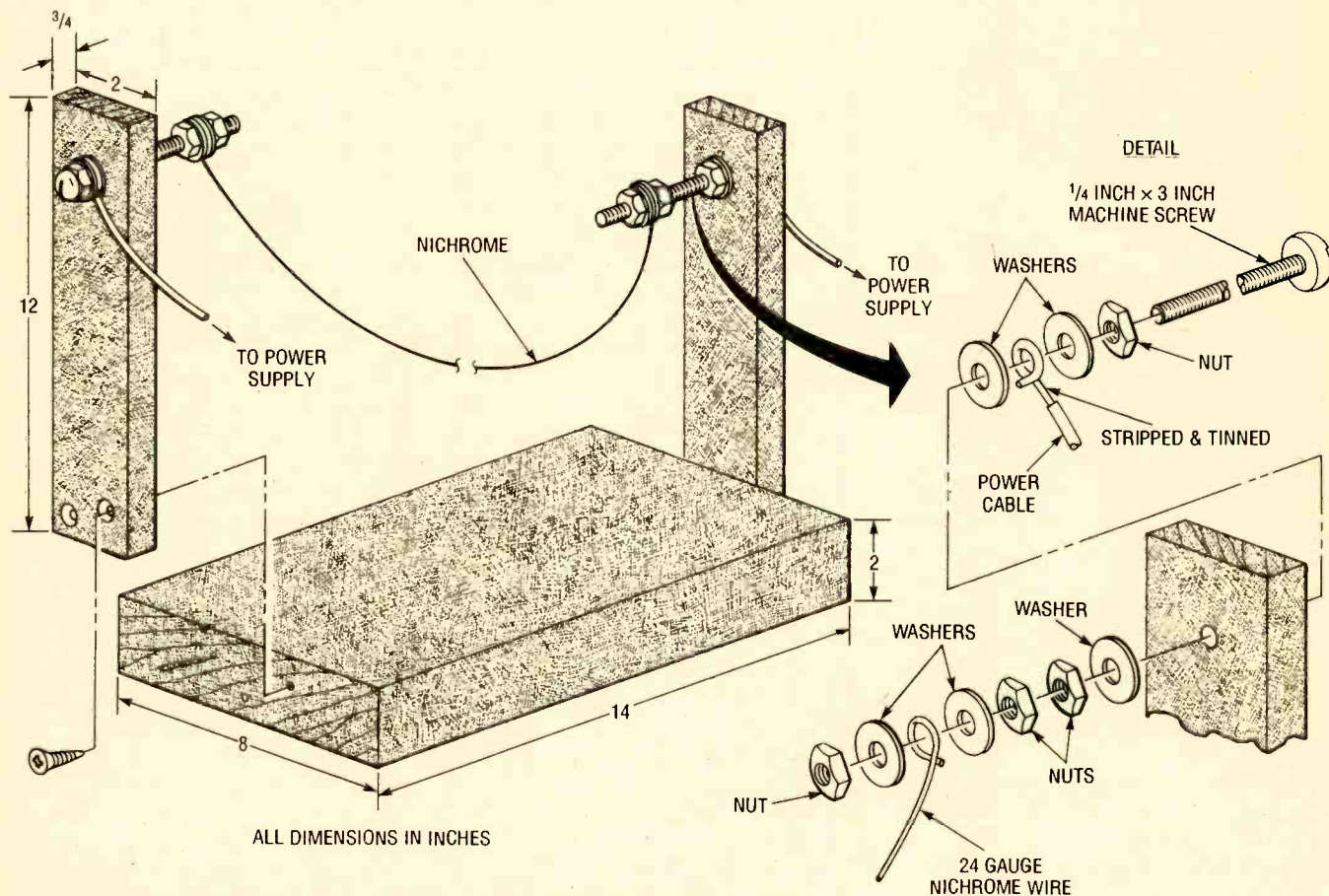

Fig. 2. Construction details for the frame. The base of the frame is made from a 2-inch thick piece of plywood (or other sturdy non-conductive material) cut to 8 × 14 inches. The uprights are fashioned from 3/4- by 2-inch plywood or hard pine cut to about 2 × 12 inches. Uprights are then cut to specification, aligned on opposite ends of the length of the base. The heating element is then suspended between the uprights supported by 3-inch bolts.



## PARTS LIST FOR THE HOT-WIRE GLASS-BOTTLE CUTTER

DI—1N4001 1-amp, 50-PIV rectifier diode  
 LED1—Bright red light-emitting diode  
 R1—100,000-ohm, ¼-watt, 5% resistor  
 R2—2200-ohm, ¼-watt, 5% resistor  
 T1—12-volt, 2–5 amp, heavy-duty transformer  
 NE1—NE-2 neon lamp  
 S1—SPST switch  
 F1—2-amp fuse  
 PL1—Line cord with molded plug  
 24-gauge nichrome wire, ¼-inch diameter 3-inch bolts, ¼-inch hex nuts, ¼-inch flat washers, coarse-thread machine screws, C clamp, 90-degree angle bracket, wood, 16-gauge or (larger) line cord, 5-minute epoxy, emery cloth, wheel-type glass cutter, wood screws, fuse holder, insulated staples, etc.

**Note:** A 3-foot length of 24-gauge nichrome wire is available for \$3 postpaid from Allegro Electronic Systems, 3 Mine Mountain Road, Cornwall Bridge, CT 06754. Order stock number 3-MWS-675. Free Technical Assistance for this project is available by calling 203-672-0123 weekday mornings from 9 until noon Eastern time.

ange-red is the best. Caution: The wire should not get orange (that's too hot) or yellow (way too hot). Too short a length, or too much power will result in excess temperatures, which will produce an orange or yellow glow. The wire should be hot enough to immediately char any piece of wood that contacts it. It should not be hot enough to stick to glass.

Start with 16 inches of nichrome wire. Stretch the wire between the two uprights, and fasten one end, and temporarily attach the other end to the opposite support. Check for the proper temperature range by turning on the power supply. After about 6 to 8 seconds the heating element should glow cherry-red to orange-red.

The wire's hot resistance is quite a bit more than its cold resistance. Because of that, the power supply has to work hardest when the wire is cold. Shorten the wire as needed to obtain the correct cherry- to orange-red glow. Once the proper temperature is obtained, fasten the ends of the heating element permanently to the supports.

Cut off the excess wire by making a nick with a file and flex it until it breaks.

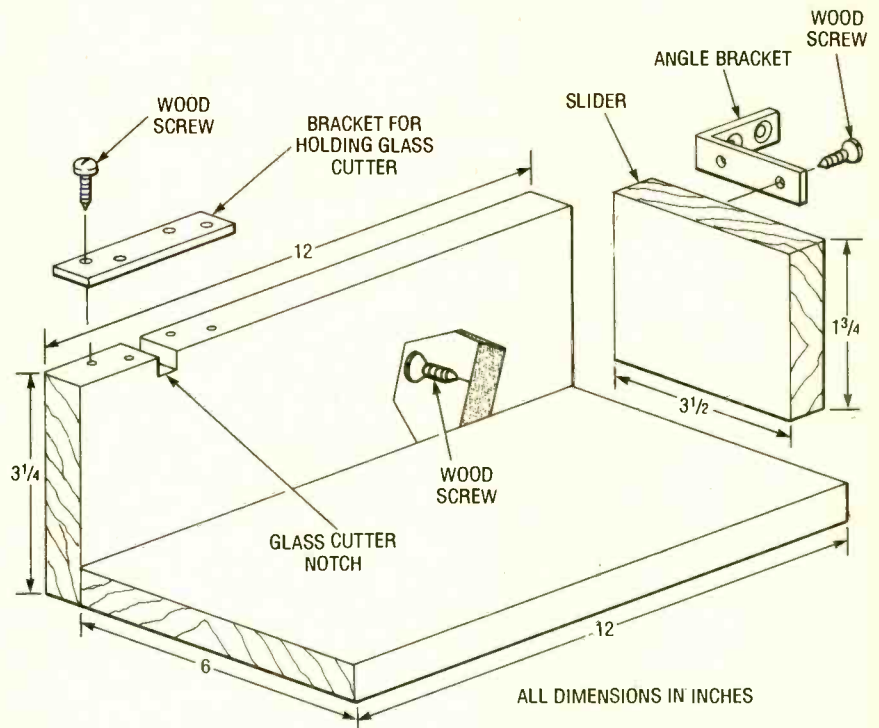
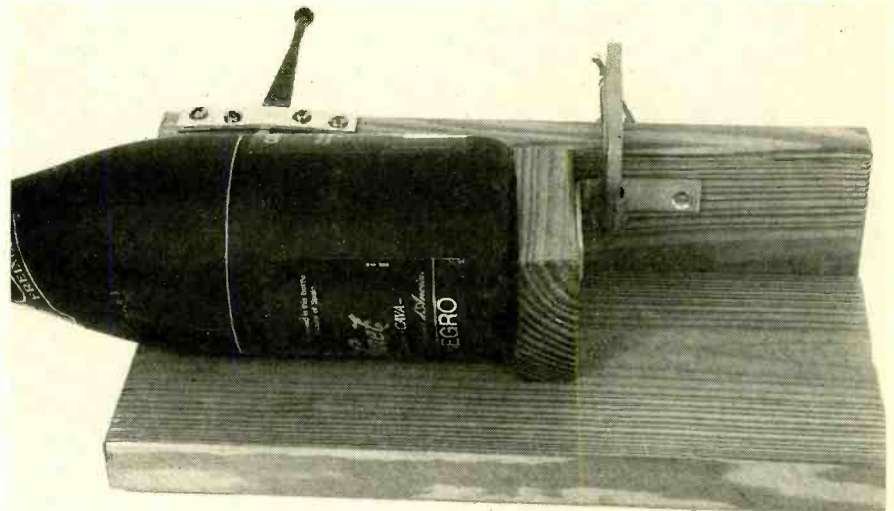

Fig. 3. Details of the scoring jig's construction. The scoring jig is nothing more than two pieces of hard wood attached at a right angle, and a slider made from a block of wood and an angle bracket. The jig also has a slot cut into one edge for a glass cutting tool.



The adjustable slider makes for easy positioning of the score line along the bottle's length, allowing you to sever the bottle at almost any point along its length.

(Ordinary wire cutters will not work on nichrome as it is such a hard alloy.) Once the proper temperature is achieved, measure the length of the heating element and put a sticker with the measurement somewhere on your project for reference when the element is replaced.

**Building the Scoring Jig.** The second part of the project consists of a scoring jig; see Fig. 3 for details of its construction. The dimensions given assume that you'll be using the jig for fifth- (25.4 milliliter) or liter-sized bottles. An ordi-

nary wheel-type glass cutter is positioned in the scoring jig to etch a score line around the circumference of the bottle. Here the most critical dimension is determined by relationship of the cutting wheel angle to the bottle side. The cutting wheel of the glass cutter should contact the bottle at about the center to slightly above it. An easy way to determine the proper position to draw a line down the center of both sides, level the bottle, and see where the wheel touches the bottle.

Smaller diameter bottles may be scored on the same jig by putting a

board of the proper thickness underneath to bring the wheel's touch point into compliance. Interestingly, larger diameter bottles are more forgiving of wheel angle.

Once you determined the proper position for the glass cutter, the glass cutter is mounted in the scoring jig as a permanent fixture. For real flexibility, you should make the score line position adjustable along the length of the bottle, enabling you to move the score line up and down the length of the bottle. The prototype was designed with a movable slider (back stop) for positioning the score line along the length of the bottle.

The scoring jig was made from hard pine or plywood for mechanical strength. A steel angle bracket was then screwed to the wooden block to form the slider. A "C" clamp is then used to clamp the angle bracket, and thus the slider, securely to the jig at the desired position. You may want to varnish the jig on the inside to allow the bottle to turn more freely as it is rotated against the cutting wheel. Another trick is to put a small amount of talcum powder or a Teflon-based drawer lubricant on the jig base to allow the bottle to turn more freely.

The glass cutter is held securely in place by a tight-fitting notch sawed into the side of the jig (see Fig. 3), and prevented from jumping out by a metal brace screwed to the wood. When the cutter needs replacement, the brace can easily be removed, and a new one installed.

**Cutting Technique.** Cutting bottles does involve a little skill. First make sure the bottle is clean and totally dry. Score the bottle lightly and evenly (see Fig. 4). A deep score line actually is self-defeating as more paths are created for the crack to follow. Scores must meet at the ends. Once the bottle has been scored, turn on the power to the heating element, and allow 6 to 8 seconds for the element to reach operating temperature.

Rest the score line on the heating element, as shown in Fig. 5, and gently rock the bottle back and forth against the hot wire. Pressing the glass forcibly against the heating element will not do the job any faster and may even break the hot wire. Watch the crack crawl around the bottle, and precede it slightly with the wire. Viewing the bottle from an angle will help. The crack will look dark and the score line white. Sev-

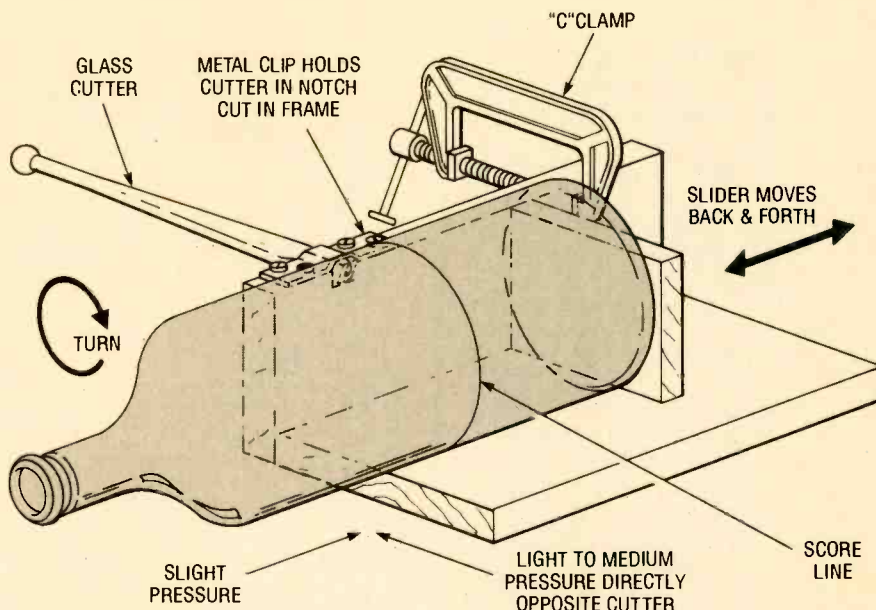

Fig. 4. Starting with a clean and totally dry bottle, score the bottle lightly and evenly, with the end of the score line meeting its beginning.

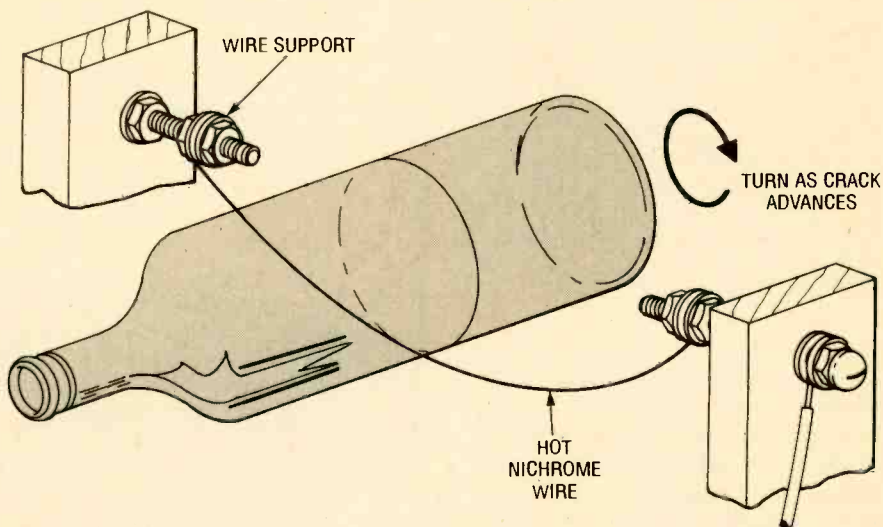

Fig. 5. Rest the bottle at the score line on the heating element, and gently rock the bottle back and forth against the hot wire. After a short time (determined by the thickness of the bottle being severed), a crack will form and crawl along the score line, eventually severing the bottle.

eral passes are needed in most cases to cut the bottle through.

Let the wire determine the cutting pace. Thick glass will take longer to separate. Thin glass can cut quite fast. A wine bottle will take one to two minutes to cut; a large mayonnaise jar perhaps only half a minute due to the thin glass wall. If the wire is not cutting at all, it may be necessary to raise the heating element's operating temperature. If a cut refuses to be finished, set the bottle aside until it cools, then try again; the crack will advance more easily if the wire touches cold glass than hot.

One technique that might help with stubborn cuts (thicker glass in particular) is to cool the glass surface in the

area of the score with an ice cube and then quickly and thoroughly dry the surface with a hand towel. Before the glass has a chance to return to room temperature, place the scored area back on the hot heating element. The rapid temperature change should cause the two halves to separate. Never force a stubborn cut apart; use a gentle pulling apart pressure, holding the bottle away from your body.

Be prepared for the bottle halves to fall apart in your hands! It's a good idea to wear gloves when cutting larger bottles. Very heavy bottles such as 5-gallon jars require that bath towels be laid on either side of the bottle.

(Continued on page 96)



*If your security needs don't require the expense and bother of a professionally installed, commercial burglar alarm, then perhaps this project is just what your budget needs!*

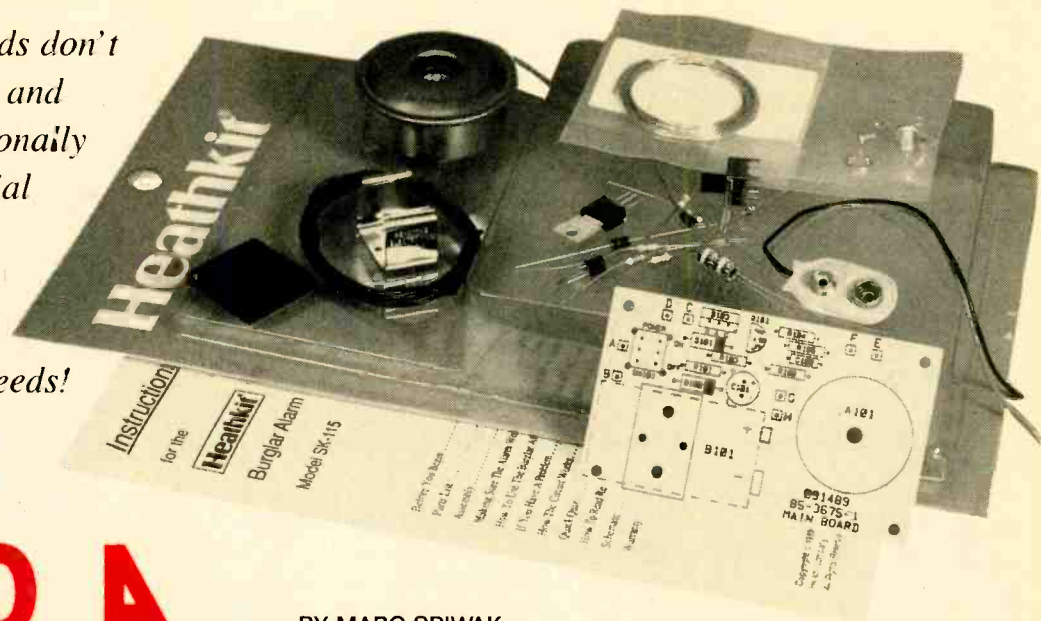

# BUILD A Burglar ALARM

BY MARC SPIWAK

Let's face it, security equipment is not just for overly paranoid people anymore. It just makes good sense these days to have some kind of security system guarding your property and person. And it doesn't matter if your equipment warns you of intruders or keeps them out, as long as it provides some protection or, at the very least, gives you some peace of mind.

One major problem with security systems is that they are often quite expensive, especially when you consider the installation cost of such equipment. Even if you are an exceptional do-it-yourselfer, the job of installing an entire home-security system is enormous, and could take an individual several days to do. And then there's the monthly cost that's associated with some types of alarm systems. It's no wonder that spending several thousand dollars or several days of labor on an alarm system is not appealing to many people.

So what do you do? An alternative is to build the simple and inexpensive burglar alarm kit described in this article. Designed by Heathkit, and sold by them as their SK-115 Burglar Alarm kit (see ordering information in the Parts List), it's a simple circuit that drives a loud buzzer when either of its two zones are triggered—but more on that later.

Some of you are probably thinking that such a simple circuit can't possibly

be very effective. But, on the contrary, the circuit itself is as reliable as any other, as long as it is properly triggered. Just because the circuit is very simple does not mean that the unit can't provide adequate protection for at least one room, such as your bedroom. The sound emitted from the buzzer is certainly enough to wake even the deepest sleeper should an intruder enter either the door or window.

**Zones.** Looking at the schematic diagram in Fig. 1, you can see that the unit has two zones. What that means, is that two separate entry points can be monitored, either both at the same time, or individually. That would be useful if, for example, you wanted to monitor the front door of your home for intruders, but were having a cookout in the backyard and wanted to leave the back door free for people to go in and out. Of course, if you were going to be out, you would want to have both doors monitored.

The way that the circuit is set up, Zone 1 should be connected to a normally closed switch and Zone 2 to a normally open one. Zone 1 is well-suited for notifying you if a window with foil tape is being broken into, but can be operated with any kind of normally closed switch that you can find, and it does not have to be used on a window. Zone 2 is

suited for use with a mercury switch, which will lend itself to many unusual applications. But, of course, any kind of normally open switch will do for Zone 2. Keep in mind, though, that there are all kinds of specialized switches for security applications, and they come in a wide variety of normally open and closed configurations. So you can use either zone for just about any kind of application you can think of. You could even monitor a window for either being broken or lifted open.

**Circuitry.** As for the circuit itself, you can see from Fig. 1 that it is very simple. Switch S1 is the main power switch, and S2 and S3 are for Zones 1 and 2, respectively. Switches S2 and S3 operate as follows: S2 normally pulls the anode of D1 to ground, preventing it from conducting. If S2 is opened, D1 is allowed to conduct, which puts a positive voltage on the base of Q1, causing that transistor to turn on.

Switch S3 is normally open, but if it is closed, it directly supplies a positive voltage to the base of Q1 and, again, it turns on. Whenever Q1 conducts, SCR1 turns on, which in turn drives the buzzer, BZ1. Because an SCR is used, the buzzer will remain on even if S2 or S3 is returned to its original position. Only if the power is removed from the circuit via S1, will the buzzer shut off. Even then, if the

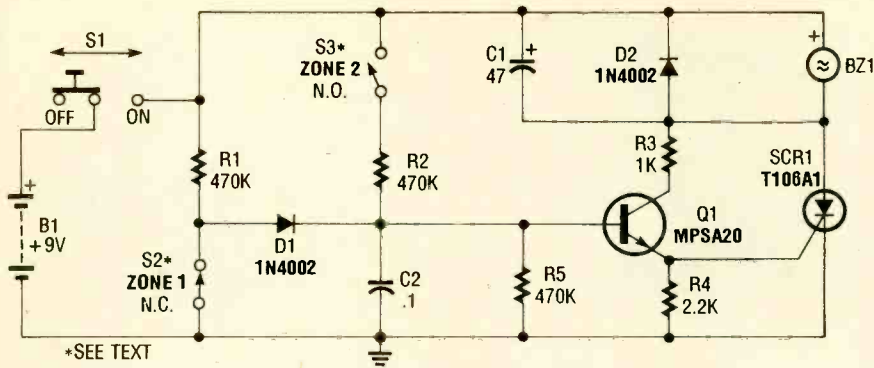

Fig. 1. The alarm is a simple circuit that drives a loud buzzer when either of its two zones are triggered.

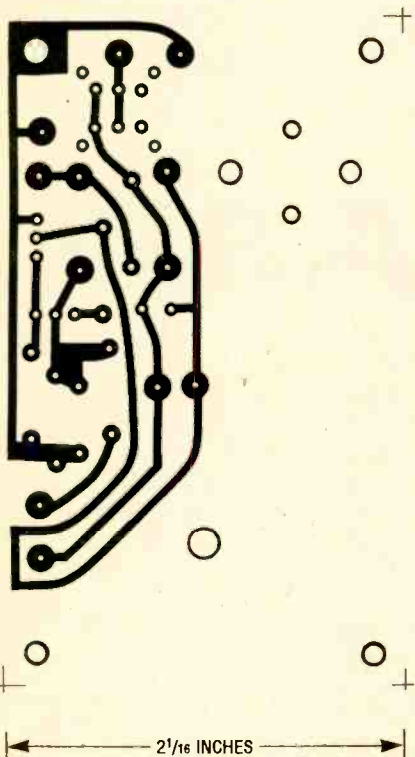

Fig. 2. If you want to build the project from scratch, here is a foil pattern for the printed-circuit board.

power is not left disconnected for approximately 15 seconds, the alarm will turn on again.

The circuit is powered from an ordinary 9-volt battery, for which a battery clip is provided. However, you can power the circuit from a 9-volt AC adapter or other similar supply. With a little bit of experimenting, you could probably use a much more powerful siren, provided that you power it from an appropriate source. But those kinds of circuit modifications are left entirely up to you.

**Construction.** Building the circuit requires no special skills other than basic soldering techniques. For those of you

who want to build the project from scratch, a foil pattern for the PC board is provided in Fig. 2, and Fig. 3 is a parts-placement diagram. Simply install each part on the printed-circuit board in the order that they appear in the Parts List.

The only thing that requires some additional explanation is the buzzer. It's an ordinary 9- to 12-volt DC buzzer with the positive lead pre-installed. The buzzer has a tab attached to the back to which a ground lead is soldered. Actually, if you were mounting the buzzer on a conductive surface, such as inside a metal cabinet, where the cabinet itself is ground, the ground lead would be unnecessary. But for our purposes, the

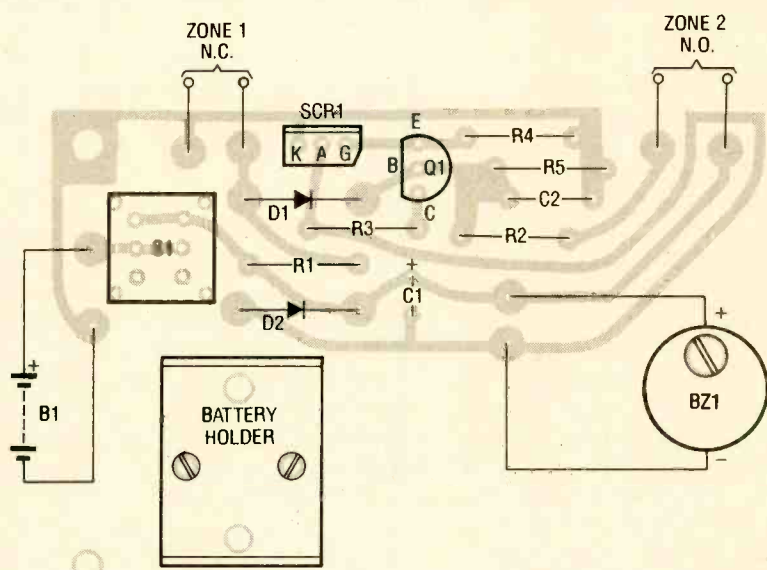

Fig. 3. When installing the board-mounted parts, be sure that each component is placed in the correct position, with the proper orientation.

ground lead is required. So you must solder a length of wire to the tab, and then connect it to the printed-circuit board, as shown in Fig. 3.

Also note that the kit (more on that in a moment) comes with a battery hold-

### PARTS LIST FOR THE SIMPLE BURGLAR ALARM

**SEMICONDUCTORS**  
 D1, D2—1N4002 1-amp, 100-PIV rectifier diode  
 Q1—MPSA20 NPN silicon transistor  
 SCR1—T106A1 4-amp, 30-PIV, silicon-controlled rectifier

**RESISTORS**  
 (All resistors are 1/4-watt, 5% units.)  
 R1, R2, R5—470,000-ohm  
 R3—1000-ohm  
 R4—2200-ohm

**ADDITIONAL PARTS AND MATERIALS**  
 C1—47-µF, 16-WVDC, electrolytic capacitor  
 C2—0.1-µF, ceramic-disc capacitor  
 S1—SPST toggle switch  
 S2, S3—See text  
 BZ1—9- to 12-volt DC buzzer  
 B1—9-volt transistor-radio battery  
 Printed-circuit materials, enclosure, battery holder and connector, foam rubber feet, wire, solder, hardware, etc.

**Note:** The SK-115 Burglar Alarm kit is available from Heathkit (Heath Company, P.O. Box 8589, Benton Harbor, MI 49022; Tel. 800-253-0570) for \$14.95. Contact Heathkit for shipping and handling information, or visit your local dealer

er that mounts to the printed-circuit board. That's a nice feature, but you don't have to use one. Four small squares of foam rubber are used as feet to prevent the unit from shorting on  
 (Continued on page 96)



# ELECTRONIC NOVELTY LIGHT

If you've been looking for an inexpensive and simple, yet unusual construction project with a number of attractive applications, here's just the thing. It's a small lamp-dimmer circuit, the variable output of which is wired to nine tiny parallel-connected lamps that are lined up inside a long rectangular plastic tube. The bulbs look like neon bulbs, the kind we're all familiar with. But look again. Neon bulbs are clear. These bulbs are white. Neon bulbs produce an orange light. The light from this collection of bulbs is a bright fluorescent green.

**Essence of Fluorescence.** The physics of fluorescent light is quite interesting. Certain substances, called phosphors, are able to absorb one or more types of electromagnetic radiation (ultraviolet, for example) and convert at least part of the absorbed radiation into light. Note that in this case the wavelength of the energy going in (UV) is shorter than the wavelength of the energy coming out (visible light). The relationship involved is known as Stoke's Law. Energy absorbed by the phosphor but not emitted as light is dissipated as heat.

Early in the commercial development of fluorescent lighting devices, it was decided that the source of energy would be the ultraviolet radiation of a low-pressure mercury arc. That automatically placed a limitation on how the lamps could be designed. The resonance line of mercury is 2537 angstroms. Phosphors that did not respond, or responded poorly, to the 2537-angstrom wavelength could not be used.

The nineteenth-century physicist William Crookes is famous for his original work on gaseous discharge, cathode rays, and fluorescence. One of the luminous substances used by Crookes was the mineral willemite—a naturally-occurring form of zinc silicate. The maximum sensitivity of zinc silicate is very close to the critical 2537-angstrom wavelength. That means that mercury vapor tubes lined with the compound are highly efficient sources of illumination. Zinc silicate containing a trace of manganese gives off a bright-green light and is considered an excellent fluorescent material.

**The Dimmer Circuit.** The lamp dimmer is a very simple circuit built around a T106D1 silicon-controlled rectifier (SCR). A 100k potentiometer (R1) is used

to vary the current presented to the gate of the SCR. That, in turn, determines the level of current moving through the SCR, which is the electricity available to light the lamps.

The remaining electronic components are as follows: a 2k resistor which is used to limit the current applied to the gate of the SCR, and a .033  $\mu$ F, 250-volt capacitor, which upon reaching a sufficient charge level causes NE1 to turn on. The in-rush of current through NE1 is then applied to the gate of SCR1, causing it to conduct. With SCR1 conducting, a pulsating DC voltage is supplied to the string of fluorescent lamps, exciting the gasses within the glass envelopes. The neon lamp is used as a gate-trigger device in this application.

**Construction.** First of all, you must obtain the miniature fluorescent strip light. These lights are available from JerryCo, a science surplus mail-order company in Evanston, Illinois. The strips are about 11 inches long and require no assembly or special preparation. See the Parts List for more information.

Putting the strip-light controller together is not difficult. But remember that the circuit runs on 117 volts AC. That

BY STANLEY A. CZARNIK

*Have you ever wondered how light dimmers work? ...or what components are used to accomplish the task? Well here's your chance to peer into the circuitry behind such devices*

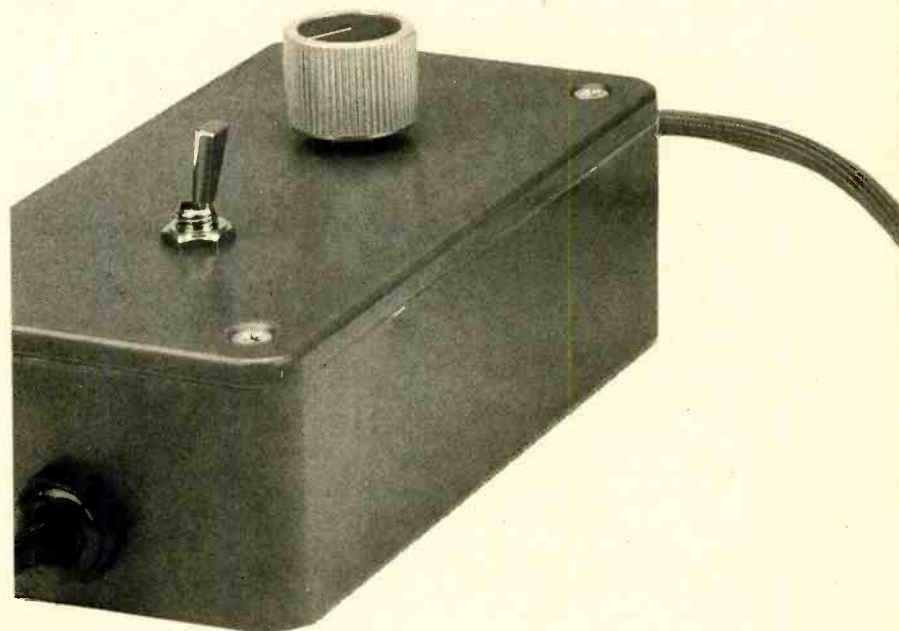

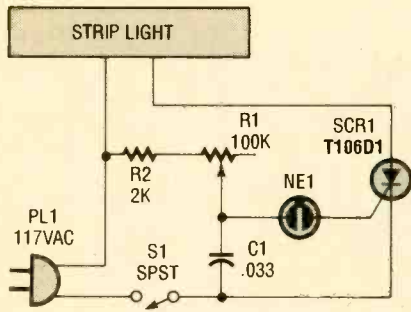
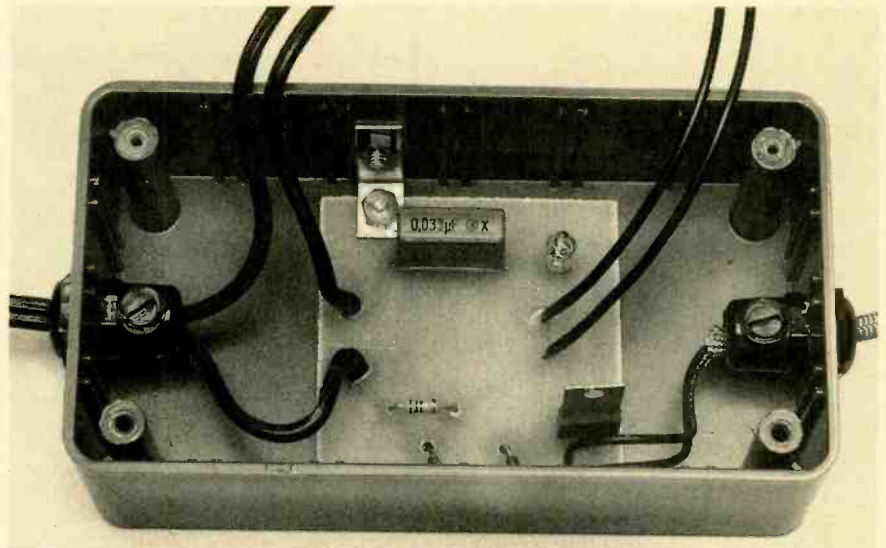

Fig. 1. The light strip controller is a simple circuit built around a T106D1 SCR. A 100k potentiometer (R1) is used to vary the current presented to the gate of the SCR. That, in turn, determines the level of energy moving through the SCR, which is the energy available to light the lamp.



The fluorescent light controller's printed-circuit board is fastened to the inside of a small plastic project box. The two wires at the upper left are connected to a SPST toggle switch. The wires at the upper right are connected to the 100k potentiometer. The 117-volt AC input passes through the strain relief at the far left. The variable output passes through another strain relief at the far right.

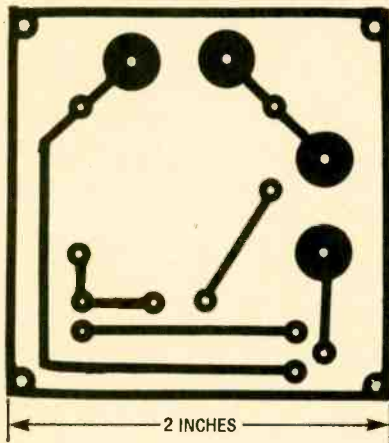

Fig. 2. While the Electronic Novelty Light is simple enough to be assembled on a small section of perfboard, this foil pattern is provided for those who prefer printed-circuit board construction.

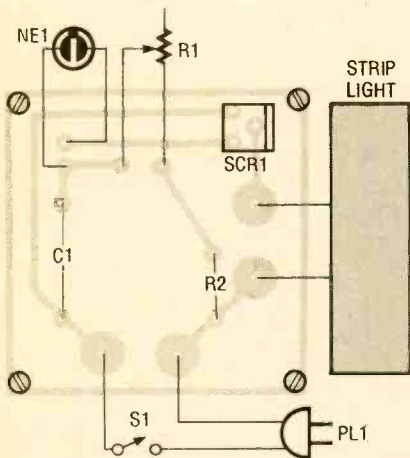

Fig. 3. There are only four components mounted to the printed-circuit board—hardly enough parts to screw up. In fact, the only error that might occur during construction has to do with the orientation of the SCR.

means that a plastic project box, or some other kind of non-conductive enclosure is necessary to protect the user. The box should be at least 4 inches long and 1½ inches wide.

To make things even more simple, a foil pattern for the author's printed-circuit board is shown in Fig. 2. After etching your board, install the board-mounted components guided by Fig. 3.

Once you've selected the enclosure that will house the circuit board, drill a hole at both ends of the enclosure; one for the power cord and another through which to connect the string of lamps to the board. It will also be necessary to drill two holes in the lid (or front panel) of the enclosure for potentiometer R1 and switch S1. The exact location of the controls is not critical, but make sure your switch is designed for 117-volt AC operation. Run a 117-volt AC line cord through a strain relief on one end of the project box, and the wires leading to the strip light through another strain relief on the opposite end.

After connecting all the components, as well as the input and output wires, place the PC board somewhere near the center of the box and attach it to the inside of the enclosure with a small metal bracket and a couple of screws.

**Applications.** There are lots of things you can do with your new novelty light. The first thing I thought of is to suspend the strip light over a small fish tank or attach it to the inside of a display case

### PARTS LIST FOR THE ELECTRONIC NOVELTY LIGHT

- SCR1—T106D1 silicon-controlled rectifier
  - R1—100,000-ohm potentiometer
  - R2—2000-ohm ¼-watt, 5% resistor
  - C1—0.033-μF, 250-WVDC, ceramic-disc capacitor
  - NE1—NE2 neon lamp
  - S1—SPST toggle switch
  - PL1—117-volt AC plug with line cord
- Printed-circuit board materials, miniature fluorescent strip light, enclosure, strain reliefs, small metal bracket, wire, solder, hardware, etc.

**Note:** Miniature fluorescent strip lights are available from JerryCo Inc., 601 Linden Place, Evanston, Illinois 60202. Telephone: (312) 475-8440. One strip light (catalog number 20204) sells for \$2.25. The company requires a \$12.50 minimum order and a flat \$4.00 fee for shipping and handling. The JerryCo catalog is 50 cents.

or a bookshelf. A fluorescent art project is yet another possibility.

One final note. The dimmer circuit seems to work best after the unit has been switched on for a few minutes. Then turn the potentiometer knob back and forth slowly for the desired level of illumination. Set the control carefully to a high resistance and the fluorescent glow will begin to flicker. It's an interesting effect.



# GIZMO<sup>®</sup>

DECEMBER 1990

VOLUME 7,  
NUMBER 12

A CHRONICLE OF CONSUMER ELECTRONICS

## One Computer, with the Works!

**PS/1 COMPUTER.** Manufactured by IBM Corporation, US Marketing & Services, 1133 Westchester Avenue, White Plains, NY 10604. Price: \$999 to \$1999.

There are innumerable people out there who would like to use a computer, but who are terrified of them—or, more accurately, fearful of looking and feeling dumb when they try to buy or use one. To some extent, that anxiety is realistic: to the uninitiated, the world of computing is a complex, almost unnavigable maze. Some opt to hire a guide—usually someone who doubles as a computer salesman—but after the guide walks them through once or twice, the new users are on their own when they lose their way or hit a dead end. Many have opted, instead, to stick with their typewriters, calculators, and ledger sheets, and leave the computers to the experts—and the kids.

IBM, recognizing an untapped wealth of potential customers, polled thousands of people with little or no computing experience and, taking their responses to heart, came up with a PC designed, in its simplicity, to allay their fears and to meet their needs. The PS/1 is intended to be a breeze to hook up even for complete beginners, and—with DOS, an integrated software package, and a modem built in—ready to go for the most popular home applications.

This isn't IBM's first attempt to reach that market. In the early 1980's, their PCjr was introduced with great fanfare, but never lived up to the hoopla. Its embarrassingly low sales figures were blamed on a combination of factors: high price, limited computing power, lack of expandability, and a poorly designed keyboard. There were lessons to be learned from the PCjr debacle, and it seems that IBM has learned its lessons well.

The PS/1 is no PCjr. It's powerful, competitively priced, and expandable. Basically, the PS/1 is an AT-class machine, running an 80286 microprocessor at 10 MHz. Four configurations are available, ranging in price from \$999 to \$1999.



CIRCLE 50 ON FREE INFORMATION CARD

The least expensive (and least useful) configuration has a single high-density 3½-inch diskette drive, a black-and-white VGA display, and 512K of memory. The next step up swaps the monitor with a color VGA display, and costs \$1449. Neither of those configurations make too much sense these days. We'd recommend one of the more expensive variations, which feature a 30-megabyte hard disk, 1 megabyte of RAM, and either a black-and-white (\$1649) or color VGA (\$1999) display.

All models come with DOS 4.0 in ROM, and all offer a number of standard features, including a two-button mouse, a parallel port, and a built-in 2400-baud modem. A number of add-ons are also available, including: a 512K memory expansion card (\$199), a 5¼-inch diskette drive (\$299 for either the 360K or 1.2MB versions), an audio card and joystick (\$249), and more.

While the PS/1 isn't directly compatible with standard PC plug-in cards, an add-on

adapter card unit, which will allow you to add up to three standard cards, is available for \$169. The PS/1 isn't directly compatible with standard monitors, either. That's because the VGA monitor (which IBM insists on calling a "Photo Graphic" display) also contains the power supply for the computer.

We'd prefer to see a fully standard and compatible PS/1. But then again, we're not the type of people IBM is trying to reach with this product. So how does it rate on its main selling point, ease-of-use?

We tried to choose a reviewer who fit IBM's target market as closely as possible. Although she is not a total stranger to computing—she uses a word-processing program at work, and has tried a couple of popular database and spreadsheet applications—her attitude fits the profile. She has expressed the opinion that computers not only have personalities, but that they are secretive, malevolent, and vindictive

*(Continued on page 6)*

TURN PAGE FOR CONTENTS

# This month in GIZMO

IBM PS/1 Personal Computer . . .	pg. 1
Di-Tron Systems VP1410 Video Printer . . . . .	pg. 2
Worlds of Wonder Jaminator Hi-Tech Guitar . . . . .	pg. 3
Heath SD-6230 House Sitter Security Monitor/Dialer . . . . .	pg. 4
HTS MasterMind Universal Remote Control . . . . .	pg. 5
Remote Pause Control . . . . .	pg. 7
Remote Video System . . . . .	pg. 7
Cordless Headphones . . . . .	pg. 8
Japanese/English Translator . . . . .	pg. 8
"Laptop" Organizer . . . . .	pg. 8
Videophile Satellite Receiver . . . . .	pg. 8
Fax Organizer . . . . .	pg. 9
Infrared Repeater . . . . .	pg. 9
Pure Preamp . . . . .	pg. 9
Ultra-Compact Camcorder . . . . .	pg. 9
Anti-Car-Theft Card . . . . .	pg. 10
Fiber-Optic Car-Stereo Link . . . . .	pg. 10
6½-Hour Videocassette . . . . .	pg. 10
Personal Copier . . . . .	pg. 11
Surround-Sound System . . . . .	pg. 11
Talking Thesaurus . . . . .	pg. 11
Audio/Video Amplifier . . . . .	pg. 12
Cordless Telephone . . . . .	pg. 12
Portable Answering/Dictation Machine . . . . .	pg. 12
Portable Vacuum/Flashlight . . . . .	pg. 12

Gizmo is published by Gernsback Publications, Inc., 500-B Bi-County Blvd., Farmingdale, NY 11735. Senior Writers: Christopher O'Brien, Teri Scaduto. Contributors to this issue: Toni Vames. © Copyright 1990 by Gernsback Publications. Gizmo is a registered trademark. All rights reserved.

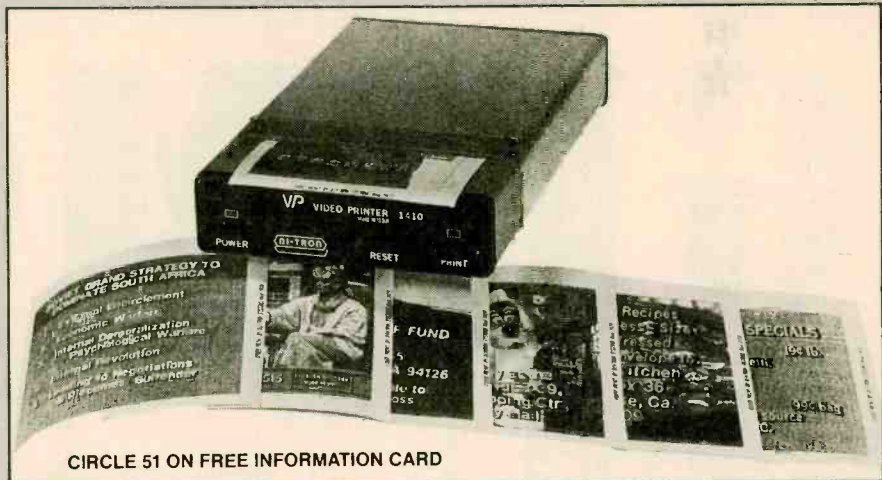

CIRCLE 51 ON FREE INFORMATION CARD

## Cut! Print It!

**DI-TRON SYSTEMS VP1410 VIDEO PRINTER. Manufactured by Di-Tron Systems, 1760 Industrial Way #1, Napa, CA 94558. Price: \$499.95.**

Gee, we *really* wanted that Slice-O-Matic. But the commercial came on just as we were drifting off to sleep. Now how are we going to find out where to send our \$9.95? What was that phone number? By the time we woke ourselves up enough to grab a pencil, the information had vanished from the screen. There's got to be a better way! Wait! You mean if we had *Di-Tron's VP1450 video printer* we'd be able to simply press a button to get a hard-copy printout of the screen?

That's right. Once you've hooked the Di-Tron printer up to your TV, it's just as easy to get a photo-sized printout as it is to turn off your alarm clock. A 4½-by-3½-inch printout on thermal paper might be just fine for gadget freaks like us. But after we were done playing around a bit, we asked ourselves why anyone would want a still picture of a video screen—except for our hypothetical situation mentioned above. Since you've probably asked yourself the same question by now, here's what we've come up with.

Nintendo players who record that elusive high score when nobody is looking can get an instant print of the screen to prove it to everyone. Would-be do-it-yourselfers can make a print of each step of a project as detailed on one of PBS's handyman shows. You can print your favorite scene from a home video movie to send to friends and family. And if a commercial highlights an upcoming show that you don't want to miss, just print out the picture and tack it up as a reminder.

We've received word of one user who has the printer hooked up to his security-system camera. Whenever his doorbell is rung, the "ringee" is captured in a video print.

If none of those applications does anything for you, then maybe you'll like our favorite: sending a video image to your computer for use in desktop publishing. Or perhaps you'd prefer using a transfer ribbon to make iron-on images. Unfortunately, we'll have to call those *potential* applications. During our tests, we couldn't get the software to do its job properly. To be fair, we were using a pre-publication version of the software that we had pressured Di-Tron to send us. It had no user interface, and our instruction sheet was written in pencil by the people at Di-Tron. We were able to view and print the



A sample printout shows President Bush answering reporters' questions about Iraq's invasion of Kuwait.

images sent to us by the software, but were unable to save our own images. We were, however, able to download data using a standard communications program. We even were able to display the data in the form of an image, but the image was barely discernible. That's because Di-Tron's software also takes care of some house-keeping functions that we were unable to duplicate. A working model of the software wasn't due to arrive until the day after our press deadline, but by the time you read this, Di-Tron should have its official release ready at a price of \$35, or \$70 for the advanced version.

The printer operates quietly because of the thermal paper and printhead that it uses. The quality of the image depends on the paper used. Standard fax-type paper

(Continued on page 7)



# So You Wanna Be a Rock'N'Roll Star

**JAMINATOR HI-TECH GUITAR.** Manufactured by Worlds of Wonder, Inc., 4209 Technology Drive, Fremont, CA 94538. Price: Under \$120.

Jamming certainly isn't new to us: We were practically raised on rock and roll. When we were six or seven years old, we received our first album: "Meet the Beatles." Immediately, a couple of old childhood standbys—our sets of wooden building blocks and Tinker Toys—were pressed into roles we're sure their manufacturers' hadn't foreseen. The longest wooden blocks became "guitars," and the Tinker Toy cross pieces were transformed into drum sticks, as we took on the *personas* of John, Paul, George, and Ringo. We turned up the volume on our little portable phonograph and spent hours dancing around the "rec" room, jamming to "I Wanna Hold Your Hand."

As teenagers, too sophisticated for building-block guitars and not talented enough for the real thing, we jammed on "air guitars." We turned up the volume on the stereo and strutted around with imaginary guitars, becoming as cool as Keith Richards, as dazzling as Eric Clapton, and sometimes wildly smashing our "instruments" in a frenzied Who finale.

At age thirty-something, we realize how silly that must have looked and have more or less shelved our "I-wanna-be-a-rock-and-roll-star" fantasies. While we might still get up and dance at an occasional concert, our jamming days are over.

Or are they?

We suspect not, now that we've tried the *Jaminator* from *Worlds of Wonder*, the company that brought us *Lazer Tag* and *Teddy Ruxpin*, the animated talking bear. Combining a guitar, keyboards, and percussion with full rock accompaniment, the *Jaminator* creates the sounds of an entire band. The press release promises that on first try "you can truly wail like a psycho speed metal beast." We weren't striving for quite that effect. However, the same pair of hands that once spent six months futilely trying to coax "Hang on Sloopy" from an acoustic six-string, simply strapped on the *Jaminator*, hit the power switch, plugged in a music Pak, and began playing "Foxy Lady" *almost* like Jimi Hendrix.

We say "almost" first, because you don't play the *Jaminator* so much as it plays itself and, second, because by pressing the wrong button at the wrong time—an easy thing to do until you get the hang of it—you can create some pretty awful sounds (or perhaps we merely stumbled upon the "psycho speed metal beast"



CIRCLE 52 ON FREE INFORMATION CARD

effect). Finally, the player's level of musical training and aptitude goes a long way toward determining the quality of music created on the *Jaminator*.

After it's powered up, you can play different guitar riffs by pressing one of the thirteen "frets" and then pressing one of the three "strings." Four keys, normally used to provide accents, can also be used to generate stored keyboard routines. Three percussion pads add drum effects. The music you can create is interesting, but not necessarily exciting—until you push the Start button.

The Start button is what gets your backup band in gear. The *Jaminator* comes with five generic rock-and-roll tunes built in, and six different *Jaminator* Paks are currently available to increase your repertoire. We tried the "Lead Rock Guitarists" *Jaminator* Pak, which included Chuck Berry's

"Johnny B. Goode," "Hey Bo Diddley," and Hendrix's "Foxy Lady." The fascinating thing is that while the "backup band" was going through the chord changes, the guitar riffs that we were playing actually sounded like something those artists might play. And unless you have absolutely no sense of timing, you can sound pretty good. You never have to worry about hitting the wrong note—a built-in "harmonics compensator" adjusts the pitch of the riffs so that you're always in key.

The other five *Jam-Paks* include "Classic Rock I & II," featuring selections originally recorded by the likes of the Rolling Stones and Led Zeppelin; "Modern Rock," with songs from the Police, U2, and Dire Straits; and "Hard Rock I & II," on which we didn't recognize the title of single song, but we suspect represents the

(Continued on page 7)





CIRCLE 53 ON FREE INFORMATION CARD

## Home, Phone E-T

**HEATH SD-6230 HOUSE SITTER SECURITY MONITOR/DIALER.** Manufactured by: Heath Company, Benton Harbor, MI 49022. Price: \$129.95.

What does your house do when you're away? Nothing it's not supposed to, we hope. Unfortunately, unless you're "blessed" with nosy neighbors, you have no way of knowing for sure. And even if your house doesn't normally get itself into trouble, there are plenty of opportunities for problems—burglars, fires, and heating-system failure, to name a few.

If you're like us, you don't feel comfortable leaving your house or vacation home to fend for itself. But wouldn't you feel better if your house would call you at the first sign of trouble? That idea isn't as far-fetched as you might think. *Heath's House Sitter* can keep tabs on such things as temperature, strange (loud) noises, power failures, and more. If the House Sitter senses a problem, it will call up to four different telephone numbers and give a spoken report.

The problem with most telephone add-ons is that they rarely operate in harmony with answering machines. The House Sitter has an interesting way around any conflict. If it's set to answer on a higher ring than your answering machine, then for most calls the answering machine will pick up. However, if you call back within three minutes, the House Sitter will answer on the second ring and give its status report. So after you call in to check for any messages on your answering machine, you can call back and see if your house has anything to add about the temperature, loud noises, or power outages. You can also listen to the sounds in the room where the House Sitter is located. Of course, that does defeat the "toll saver" feature of your

answering machine but, we suppose, it's a small price to pay for peace of mind.

The House Sitter is powered by a wall transformer. Six "AA" batteries (not included) provide an emergency backup power supply. The backup supply is very important. Without it, even a brief power failure would cause the House Sitter's memory to be erased—including the numbers to be called, the high- and low-temperature limits, and which ring to pick up on. We found that out the hard way: A brief power failure reset the House Sitter's default conditions, including its default to pick up on the fourth ring—the same as our answering machine. For that day, our messages consisted of nothing but the House Sitter's status reports.

When the batteries grow weak, you will be reminded—verbally—to replace them. But we'd prefer to use the built-in battery charger with nickel-cadmium batteries. (A switch in the battery compartment lets you select the type of batteries you install.) The batteries will power the unit for three (alkaline) or four (Ni-Cd) hours.

Installing the House Sitter is as easy as installing an answering machine—you simply plug in to the power and telephone lines. However, Heath inexplicably thinks it unnecessary to include a duplex jack that would allow a phone and the House Sitter to share the same phone jack. Granted, such jacks are readily available. But we think that not having one in the box will certainly frustrate a lot of buyers who will find that they can't initially use what they bought for the lack of a \$2 jack.

However, when you do get it all hooked up, a friendly "Hello!" will greet you. The digitally recorded voice is very clear and easy to understand—unless you make a key-entry error. Then, you'll be able to understand what the error message says, but you might not be able to make sense of it without referring to the manual. Other than that, the voice messages are very helpful. An interesting feature is that when you enter, for example, the low tempera-

ture limit at 40°, you're prompted with the words "four" and "zero" as you press those keys. If you later hit the "What is" and "Low Temp" keys, the House Sitter will respond, "Forty degrees."

Programming the House Sitter is reasonably easy. Its front panel features an 18-key membrane keypad that's clearly marked. Most of the functions can be programmed intuitively. We barely had to refer to the manual to get things up and running. That process includes setting the home-telephone number and up to four numbers to be called in the event of an emergency; setting the low and high temperatures that will cause an alert condition; determining the duration of a power failure (from 0 to 199 seconds) that will cause an alert condition; and programming the length of time you can listen to sounds when you call in.

Under normal conditions, after the preset number of rings the House Sitter answers your phone with a status report. After that, you can listen to the ambient sounds for the length of time you selected. Then the status report is repeated, and the House Sitter signs off.

When the House Sitter detects a problem, it calls each of the numbers programmed, and reports on its condition. However, the unit doesn't detect when a call has been answered. It repeats its ID telephone number (your number) and then runs through its status report. At the end of its report, it asks for a return call within 30 seconds as an acknowledgement of receipt of a message. If it doesn't receive a call within 30 seconds, it will go on to the next number. It will run through its status report whether or not it receives an answer.

When you call in after an alert condition has prompted the House Sitter to place those calls, its out-going message will include an announcement of the phone number (or numbers) that it called. That allows you to call those numbers to see if the problem has been corrected.

If you have a security system installed, you can use it in conjunction with the House Sitter. You can wire a sensor (or the output of some alarms, including Heath's SS-5900 series) directly to the House Sitter, or you can position the unit where it will hear the alarm. A single loud noise—such as the breaking of a window—will not set off a sound-level alert. A steady, loud sound, such as that from a burglar or fire alarm, will.

The best feature of the House Sitter is its simplicity. It's easy to install and to use—even for the "low-tech" members of your household, and those who might receive the call. From our point of view, that simplicity is also its worst feature. We'd like to see a way to program the unit from a remote telephone location and for it to recognize busy signals and when a call has been answered. But we're not complaining. After years of trying, our house is finally talking to us!



## Upstairs, Downstairs

**HTS MASTERMIND UNIVERSAL REMOTE CONTROL.** Manufactured by: HTS Corporation, 90 Inverness Circle East, Englewood, CO 80155. Price: \$199.

It's funny how quickly we become spoiled. Do you remember the first remote-controlled TV's? Everybody laughed, "How lazy can you get!" Those early remotes used ultrasonic signals and could perform limited functions. Usually they could control a couple of motors in the TV; one motor controlled the volume, while the other controlled the channel selector—usually in one direction only. Back in those days BC (Before Cable), people didn't mind waiting for the channel selector to move lazily around its thirteen positions. Quite the contrary. They were "wowed" by the technology.

Despite how quickly the electronics industry changes, it took quite some time for remote-control capability to become commonplace. And it took some time for manufacturers to realize that they couldn't all use the same signals to control different functions on various types of equipment. For instance, pressing the volume button on your TV's remote control might also

turn off the power on your VCR. *Those were fun times!*) Now that those problems have been ironed out, we'd be surprised to find anyone reading **GIZMO** who would even consider buying any electronics equipment that didn't offer remote capability.

It didn't take anywhere near as long for consumers, having attained the power to control devices from across the room, to become jaded. We here at **GIZMO** are no exception. Sometimes we complain when we have to sit up so that the remote has a good line of sight over the coffee table. And we've been known to mutter some unkind words under our breath when we pick up the wrong remote and turn the VCR on instead of the TV off. Sometimes, it seems like too much work to have to go into the media room just to change stations on the radio.

Manufacturers have, of course, come up with solutions. Almost five years ago, G-E introduced the Control Central, the first "universal" programmable remote. The idea has been copied by a number of other firms, and some new equipment comes with a remote that can operate other components as well. Those take care of some of our complaints. But they still work from a limited distance, and only in line of sight.

A new remote, the *MasterMind* from HTS addresses just about all of our complaints. It not only "learns" the commands of up to four remote controls, it also

will convert those commands to UHF signals and transmit them even through walls to its base unit in another room, which decodes the UHF signals back to infrared. Those capabilities earned the MasterMind a coveted spot in the "Innovations '90 Design and Engineering Exhibition" at last summer's Consumer Electronics Show. Products were judged, by a panel of consumer-electronics journalists, on the basis of engineering innovation, excellence of physical and functional design, and distinctiveness.

The MasterMind consists of two units: a handheld UHF transmitter, and a base unit transponder. The transmitter will work through walls, around corners, etc., up to 200 feet away from the transponder, which must be placed so that it can "see" your infrared-controlled appliances.

The MasterMind isn't for everyone. We were asked by more than one acquaintance, "Why would I want to change the TV channel if I were in a different room and couldn't see it anyway?" Our answer, in exasperation, was "to drive whoever was watching it crazy!"

There are, of course, plenty of sensible reasons to like the MasterMind, beyond our petty complaints detailed earlier. Indeed, as audio and video systems extend their reach through the house, such a remote becomes almost a necessity. For example, almost all stereo amplifiers sold these days can handle at least two pairs of speakers. Yet that capability is one of the most under-used features. What good is a pair of stereo speakers in the bedroom if you have to walk downstairs to the living room to change stations? The MasterMind also is convenient for those who prefer to keep the clutter of a home-entertainment system behind closed doors—in an armoire, for instance. The transponder can be mounted inside the doors to control the stereo without opening the cabinet. (Of course, you'll still have to open the doors to watch TV!)

The situation that offers the best argument for a radio-frequency remote like the MasterMind is a satellite-TV receiver. Unless you're running a hotel or a Cable TV head end, you're not likely to have more than one dish and receiver. So where do you install the receiver, in the living room or in the bedroom? With the MasterMind, it doesn't really matter. As long as you can run your audio/video or RF cables from one location to the other, you can use the remote to control the receiver from any location.

The MasterMind offers four different modes: TV, VCR, CATV, and AUX. You "teach" it the proper commands by aiming it, and the remote whose commands you want it to learn, at the transponder. You then press the matching keys on each. LED's on the transponder let you know when the command has been learned.

Since there are only 32 function keys on the MasterMind, you're sure to run out of



CIRCLE 54 ON FREE INFORMATION CARD



keys before you've finished programming all of the various functions on your remote. For example, our VCR's remote features 38 keys. And the MasterMind doesn't have any keys labeled "Program" or "Start Time."

Fortunately, you don't have to pay any attention to the labels—you can, for example, program the MasterMind's "Mute" key to control your VCR's tape speed. You can also program the MasterMind's TV mode to control both your TV and the basic functions of your VCR. However, you'll have to find some way to remember what you program. The MasterMind offers no way to re-label its keys, and no convenient way to keep a translation chart or other notes.

Since each of the MasterMind's 32 keys can be programmed for a function in each of the four modes, the remote offers a theoretical limit of 128 different functions. However, some commands require more memory than others, so it's unlikely that you'll be able to program all 128 possible functions.

Another caveat: The MasterMind isn't compatible with all remotes. For example, it's not compatible with Bang and Olufsen equipment, and wasn't compatible with the video printer reviewed elsewhere in this issue of **GIZMO**. Fortunately, the manufacturer offers a full refund if it's not compatible with your equipment.

We found that, even if it wasn't compatible with all of our equipment, the MasterMind was completely compatible with our lifestyle. ■

## PS/1 COMPUTER

(Continued from page 1)

characters. A self-described electro-mechanical klutz, she ordinarily would not even consider hooking up something as complex as a computer (or a telephone) without professional help.

IBM has removed the rigors of computer shopping by narrowing the consumer's choices to the four models described above. Our reviewer was spared from making even that one decision; IBM kindly sent their top-of-the-line PS/1 directly to our offices.

We were a bit leery about leaving her alone with the entire system still in its box (yes, it all comes in one carton), but she gamely agreed to try to hook it up. To everyone's surprise, in less than 15 minutes, it was up and running. The instructions in the "Getting Started" manual were clear and well-illustrated, but the main factor behind her success was that the process was truly simple. There are only four main pieces, all but one of the cables (the telephone cord) are already connected at one end, and no tools are required. That small triumph of man (oops, "woman") over machine also provided our reviewer with a tremendous boost of confidence.

As she began using the PS/1, there was

little to dash her new-found confidence. The opening menu displays four attractively illustrated "quadrants" representing category choices of "Information," "Microsoft Works," "Your Software," and "IBM DOS." The same short-form manual that explained the system hookup (the PS/1 also comes with more detailed books on the PS/1, Microsoft Works, and Prodigy) demonstrates how to select a category using either the mouse or the keyboard, and leads the new user through a simple practice session in each quadrant. That manual ends by introducing the user to the two on-screen tutorials—"Works" and "System"—that can be accessed through the "Information" quadrant. Those tutorials, which pick up where the manual leaves off, are what makes the PS/1 stand out from the crowd.

The Works tutorial menu offers six options: an overview; instructions for the word-processing, database, spreadsheet, and communications programs; and a look at using the tools together. A lot of information is presented; by no means can you simply turn on the computer and be an expert. However, by going through each lesson in order the user can painlessly attain a thorough working knowledge of the integrated software system.

Each of the six options brings up a menu that is a complete, step-by-step course in that area, consisting of individual lessons that use eye-catching graphics and non-threatening, non-technical language. Once again, the emphasis is on building confidence. The lessons are set up in easy-to-digest increments—the approximate (usually exaggerated) time needed to complete a lesson is displayed at the start—and each combines textual and visual instructions and hands-on practice sessions with a large dollop of praise for each successfully completed task. Most practice sessions have the user do a task once by following detailed directions, a second time with only a few prompts, and completely solo on the third go-round.

By finishing the lessons in each subject area, our reviewer quickly put each part of Works through its paces. She had no trouble creating letters, databases, and spreadsheets—and this is a person who once spent the better part of a week trying unsuccessfully to teach herself Lotus 1-2-3. She enjoyed using the PS/1's modem to "call" another computer and "chat" with its operator.

Unfortunately, our reviewer didn't fare quite as well with the "System" tutorial. While it provided a simple overview of the hardware, software, system care, and an index of operations, it lacked the practical you-can-do-it feel of the "Works" lessons. While she came away with "a vague idea" of how the system was put together, what each part did, and what she could use it for, she still had almost no idea how to actually do anything with it.

Beginning with a strictly rudimentary

knowledge of DOS, she found the PS/1's file system—in which graphic file folders represent directories and the folders' contents represent files—confusing, and ended up using trial-and-error to figure out how to copy her own software onto the PS/1. (Granted, she could have tried reading the in-depth references but, for basic functions, we felt she shouldn't have had to resort to those.) We experienced computer operators here at **GIZMO** agreed that IBM could have come up with a more convenient and more intuitive file-management system—perhaps something that took the best features of XTPRO and made it easier to use. Of course, experienced DOS users can always load their own programs—in fact, one of the things we liked most about the PS/1 is that it can bypass the DOS shell and be configured to boot up to just a C: prompt. But this computer's supposed to be for beginners, who don't have that option (or don't know they have that option, or suspect they might have that option but have no idea how to implement it!). Unfortunately, the "Your Software" quadrant really doesn't explain how to get your own software onto the system, either.

For those who do experience difficulty with hardware or software—and who are more technologically curious than our reviewer—IBM provides strong customer support by toll-free telephone and by modem, through the PS/1 Users' Club. Accessible through the Prodigy on-line information service (three month's Prodigy membership comes free with the purchase of a PS/1), the Users' Club provides extensive support 18 hours a day, seven days a week. Questions can be asked in three ways: by accessing "Answer Bank," a database filled with answers to the most commonly asked computer questions; by using the "Info Exchange" bulletin board; or by using "Write to Us" to directly query IBM experts, who respond within 24 hours. Judging from the questions and responses we perused, the advice given is prompt and on-target. "Prodigy" was also popular with our reviewer, who managed to unearth a problem with her American Airlines Frequent Flyer mileage, and to get several restaurant recommendations for the cities she's planning to visit on an upcoming vacation.

We did wonder, however, why a "family" computer with so many built-in attractions would include no games. That gap will be filled, in part, by Promenade, an educational and entertainment on-line service exclusive to PS/1 users. The service was not provided with our test unit, but should be available in the 48 continental states by the time you read this. It will provide live, on-line classes on using the PS/1; a complete on-line encyclopedia; libraries containing more than 7,000 software titles; and multiplayer card and board games that users can play against one another, instead of against the computer.

So, how does the PS/1 rate on ease-of-



use? There's no question that getting started on Works was a fast, painless process for our reviewer. Prodigy offered an easy, intriguing introduction to a different aspect of computing: on-line informational services. Although the "System" tutorial provided only enough information to get around (or to be dangerous?), there were ample sources of additional information provided. The *Users' Reference for PS/1 Computer* offers more details, and technical advice, yet is clearly written with the beginner in mind. The *Microsoft Works Reference* lets the user move well beyond the beginner level, teaching the nuances of the program. The Users' Club proved to be an easy-to-access source of a wealth of helpful tips. And—like icing on a cake—IBM's 48-Hour Service promises to pick up your dysfunctional PS/1, repair it, and return it in working order within two days.

The verdict? Our reviewer was *much* happier to be able to actually *do* things using Works and Prodigy than she was upset by not knowing how the computer worked or how to manage files outside of Works. And, clearly, those who want to learn more have the information they need in easy reach—literally, at their fingertips. Most important, after their initial, positive experiences with the PS/1, not-quite-novice users will have gained confidence in their *ability* to learn more. ■

## CUT! PRINT IT!

(Continued from page 2)

will produce a fax-like image. Di-Tron's "professional" paper will produce a higher quality image. We'd recommend spending the extra money for the professional paper (about \$30 for five 40-foot rolls as compared to about \$25 for ten rolls of the economy "fax" paper). Each 40-foot roll can provide up to 100 prints. The official specifications on the print are: 480 lines, 336 pixels per line, with each pixel one of 16 possible shades of gray.

Using the printer could hardly be easier. Hooking it up is simply a matter of running a video cable (not supplied) between an RCA jack on the back of the printer and the video output of your VCR or TV. Three rear-panel controls are provided for brightness and contrast adjustment, and to switch the input impedance between 75 and 300 ohms. The serial interface port uses a miniature stereo phone jack. The front panel also has three controls: power, reset, and print buttons. A one-button remote control is also provided so that you can start printing without leaving your chair.

With the exception of our software problems, the printer worked exactly as the manufacturer claimed. Now we just have to figure out what to *do* with the thing! ■

## ROCK 'N ROLL STAR

(Continued from page 3)

"heavy metal" genre. If you prefer not to have the full band backing you up, a Select key will let you quiet one backup instrument at a time. And when you get tired of playing, the Finale button will let you wrap things up gracefully.

The built-in speaker hardly offers the volume you'd expect from an electric guitar, although it's certainly superior to our "air guitars" and sufficient for fooling around. An output jack will let you plug the Jaminator into your stereo so you can really make some noise (or use headphones so you can blow out your ears).

Since it is called the Jaminator, you'd expect that there would be some way for a couple of players to get together and jam—and you'd be right. Although we didn't get to try it, an optional cable will allow two players to link up and play everything in synchronization.

We really had fun with the Jaminator. Perhaps we would have gotten tired of it if we were able to keep the unit for more than the week we were allotted. Even so, we'd guess that the Jaminator would have better staying power than most \$100 toys. In the end, however, that's what we decided that the Jaminator was: a toy that makes music, not a musical instrument.

For more information on any product in this section, circle the appropriate number on the Free Information Card.

# ELECTRONICS WISH LIST

### Remote Pause Control

For using a camcorder from a remote position, without disturbing either the camcorder or the subject, or, perhaps, to get yourself in at least *some* of your vacation video scenes, Philips Consumer Electronics Company (One Philips Drive, P.O. Box 14810, Knoxville, TN 37914-1810) has introduced the V8007BK01 remote pause control. Its 16-foot cable allows the user to start and stop the camcorder from across the room. The hand-held unit has a single button that controls the record/pause function and a light that indicates when the camcorder is in the record mode. The remote pause control is compatible with several models of camcorders from many popular manufacturers. Price: \$9.25.

CIRCLE 55 ON FREE INFORMATION CARD

### Remote Video System

Fox Marketing's (1747 Cattlemen Road, Sarasota, FL 34232) Remote Video System allows VCR and cable programming to be transmitted from one part of a house or apartment to another without the use of cables. The Remote Video System transmitter is connected to the audio/video source by cable and can then transmit a signal over the air to its companion receiver (to which is connected a TV set) anywhere within a range of about 250 feet. To ensure a constant signal, the transmitter and receiver have fine-tuning adjustments and include automatic frequency-change circuitry. Price: Not announced.

CIRCLE 56 ON FREE INFORMATION CARD

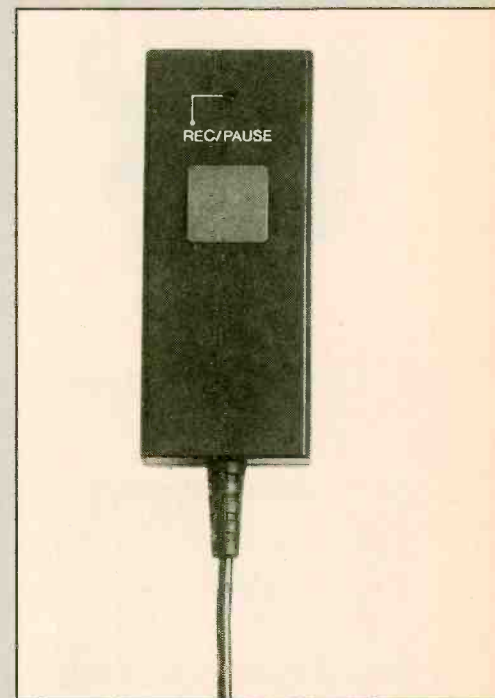

Remote Pause Control

# ELECTRONICS WISH LIST

For more information on any product in this section, circle the appropriate number on the Free Information Card.



"Laptop" Organizer

## "Laptop" Organizer

Bridging the gap between portable electronic organizers and laptop computers, the B100P from *Bondwell Industrial Corp.* (47485 Seabridge Drive, Fremont, CA 95438) has a full-size QWERTY keyboard and a large LCD readout—yet it weighs only slightly more than five pounds, is less than 1¼ inches thick, and runs off standard alkaline or NiCd "C" batteries. Based on a 9.83-MHz V30 CPU, the B100P is faster and has more memory than the usual personal organizer—2MB RAM (640K user RAM and 1.4M RAM disk) is standard. The RAM disk, or "Silicon Hard Disk," lets users store applications software and data files being downloaded from PC's and, at the same time, serves as a disk drive. Built-in software includes DR. DOS; PC Tools; Desktop management software; FastLynx for file transfers; and Bondwell's Travelnet, which provides travelers with convenient information such as phone numbers for major hotels, airlines, and credit-card companies. The B100P also has a 2400-bps Hayes-compatible modem, a standard RS-232 port, a parallel port, a real-time calendar/clock, and an AC power adaptor. A briefcase-style carrying case and RS232C and printer cables are optional. Price: \$999.

CIRCLE 57 ON FREE INFORMATION CARD



Videophile Satellite Receiver

## Videophile Satellite Receiver

*Toshiba* (Video Communications Group, 1010 Johnson Drive, Buffalo Grove, IL 60089) has introduced the TRX-2000, the first integrated receiver/descrambler (IRD) with a Super-Video (S-Video) output for "videophile" picture quality. The S-Video output provides separate luminance and chrominance signals that can be fed to Super-VHS VCR's or monitors equipped with S-Video inputs. In addition to improved picture quality, the TRX-2000 boasts category-driven program selection. More than 100 channels are factory-programmed into memory in 12 different categories, such as movies or sports: easy-to-use subject menus further simplify program selection. A built-in UHF remote allows users to control all major functions from any location in the home. This top-of-the-line IRD also features dual A/V outputs, dual source switching, a built-in VideoCipher II Plus descrambler module, C- and Ku-band capability, multi-color on-screen display, and an eight-event, one-year timer. Price: \$1,949.

CIRCLE 58 ON FREE INFORMATION CARD



Cordless Headphones

## Cordless Headphones

With the abundance of audio/video components and the huge selection of programming available today, it's not unusual for family members to disagree on what they want to hear, play, or watch. Headsets can help keep the peace. For use with both television and audio systems, the IR-500 *Infrasound* headset system from *Arkon Resources* (11627 Clark Street, Suite 101, Arcadia, CA 91006) includes an improved microphone adapter for use with older television sets that don't have an audio-output/headphone jack. The IR-500 consists of a comfortable, 6-ounce, Euro-style headset/receiver and an infrared transmitter that doubles as a headset stand. Designed for convenience, the system does not require the user to adjust the transmitter's volume output for optimal reception. The headset features an on/off volume control, and runs on two "AAA" batteries. Price: \$99.95.

CIRCLE 59 ON FREE INFORMATION CARD



Japanese/English Translator

## Japanese/English Translator

Executives, students, and travelers will appreciate *Seiko Instruments* (2990 West Lomita Boulevard, Torrance, CA 90505) model TR-1700 Japanese/English translator. Users simply punch in a word on the keypad and press the "translation" key. Using direct-access search capability, the unit locates the correct translation and displays it on an easy-to-read, 16-character dot-matrix screen. If the original word is misspelled, the TR-1700 takes a guess and adds a question mark next to the translation. Multiple meanings or synonyms are indicated by a comma. The word search function can be used to locate a word or to learn new words by scrolling through the memory. A calculator and a currency exchanger are built in, and two batteries and a carrying wallet are included. Price: \$89.99.

CIRCLE 60 ON FREE INFORMATION CARD



For more information on any product in this section, circle the appropriate number on the Free Information Card.

# ELECTRONICS WISH LIST

## Fax Organizer

If you've found the convenience of your fax machine to be somewhat offset by the mess of papers and supplies surrounding the unit, *FaxRax* is for you. The modular system, from *Lightwave Technologies Incorporated* (306 North Fiore Parkway, Vernon Hills, IL 60061), makes it easy to keep organized incoming and outgoing faxes, cover sheets, logs, directories, and paper rolls. The desktop fax set consists of two pieces—a fax stand and a paper basket—and is available in two finishes. The "Platinum" (FRX003) FaxRax includes a taupe, injection-molded, plastic ABS stand, and a basket made of vinyl-coated steel wire. FaxRax "Gold" (FRW006) is constructed entirely of wood stained in a light-oak tone. Additional paper baskets are available as options for each style, to accommodate as much of a mess as you can generate. Price: \$34.99 (Platinum); \$59.99 (Gold).

CIRCLE 61 ON FREE INFORMATION CARD

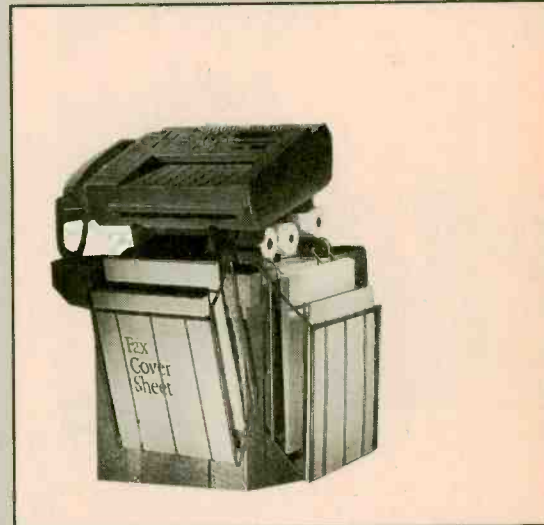

Fax Organizer

## Around the Bend

Remote control is becoming even more so, thanks to devices like *Sonance's* (961 Calle Negocio, San Clemente, CA 92672) infrared repeater system, which permits remote control of multi-room audio systems even where a direct line of sight for infrared remote control is impractical. Dubbed *ROAR*, for remote optical amplified repeater, the system consists of four modules—an infrared sensor, an infrared splitter, an infrared emitter, and a remote power supply. The sensor and emitter are designed for wall mounting in standard light-switch junction boxes. The emitter module transmits a signal three times stronger ("brighter") than that of standard IR remote controls. The splitter and power supply can be mounted in unobtrusive locations. The splitter can handle up to four connections, and as many as ten units can be "ganged" together and operated from one power supply and sensor. Price: Not available.

CIRCLE 62 ON FREE INFORMATION CARD

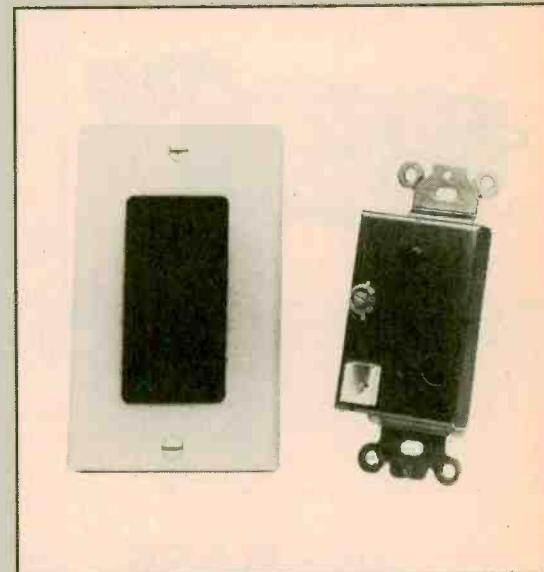

Infrared Repeater

## Pure Preamp

*Perraux* (26864 Mandelieu Drive, Murrieta, CA 92362) has long been a respected name in luxury handcrafted audio equipment, and its *EP Stereo Pre-amplifier* continues the tradition. The unit keeps circuit paths to a minimum by virtually eliminating all off-board wiring; there is just a main circuit board, with a sub-board to which are attached directly the volume and balance controls. To avoid interactions, all signal traces on the circuit board are isolated from each other by ground traces. Front-panel input-selection and tape-select switching are accomplished by switching voltages conveyed to the appropriate board; that, says Perraux, is the sonically more acceptable method. The EP has no tone controls or other switches that might induce extra noise and distortion. Price: \$799.

CIRCLE 63 ON FREE INFORMATION CARD

## Ultra-Compact Camcorder

The latest in the "less-is-more" category might be *Sony's* (Corporate Communications Department, Sony Drive, Park Ridge, NJ 07656) *CCD-TR4*. Billed as the world's smallest camcorder, it measures only  $4\frac{3}{8} \times 4\frac{1}{8} \times 6\frac{3}{8}$  inches and weighs well under two pounds (without tape and battery). The tiny 8mm unit doesn't skimp on recording or editing features however. Its  $6\times$  variable-speed power-zoom lens (f/7, 42mm) with macrofocusing makes it easy to take wide-angle or close-up shots. With a 5-lux minimum illumination rating, the *CCD-TR5* performs well in low-light situations, and a high-sensitivity CCD image sensor ensures sharp, clear images. Automatic functions include autofocus, auto iris, and auto white balance. The one-page digital superimposer lets users add titles or graphic elements, and the flying erase head allows clean transitions between scenes. Other features include a linear time counter, a quick-start recording mechanism, and edit-search and record-review functions to allow playback while the unit is in camera mode. Using its switchable audio/video input/output terminals, the *CCD-TR4* can easily be connected to a TV for playback or a VCR for editing and dubbing. Price: \$1,100.

CIRCLE 64 ON FREE INFORMATION CARD



Ultra-Compact Camcorder

# ELECTRONICS WISH LIST

For more information on any product in this section, circle the appropriate number on the Free Information Card.



Anti-Car-Theft Card

## Anti-Car-Theft Card

Magnetic-striped cards have been seen around banks for years—and now they're showing up in automobiles. The *Batron* integrated anti-theft/alarm system, from *Batron, Inc.* (10999 Reed Hartman Highway, Suite 336, Cincinnati, OH 45242) consists of a microprocessor that is installed directly into the vehicle's electric system, a piercing alarm, a uniquely coded magnetic-striped card, and a small card reader that can be placed on the dashboard or console. Before starting the engine, the driver must run the card through the reader to disarm the system. If the properly coded card is not recognized, the microprocessor sounds the alarm and shuts down the vehicle's four major operating components: the starter, the electronic ignition/coil, the fuel system, and the main ignition switch. The alarm is also triggered by attempted entry, abnormal movement, or broken glass. The system activates automatically when the ignition key is removed. A time delay gives the driver sufficient time to enter or exit the car—and since the card attaches directly to a key chain, no time will be wasted searching through a purse or wallet for it. A series of LED indicator lights lets the driver monitor the status of each of the anti-theft and alarm modes. Now, if we can just figure a way to make it give cash. Price: \$445.00.

CIRCLE 65 ON FREE INFORMATION CARD

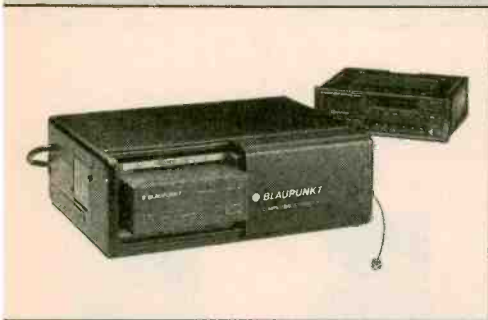

Fiber-Optic Car Stereo Link

## Fiber-Optic Car Stereo Link

The *Blaupunkt* (Mobile Communications Division, 2800 South 25th Avenue, Broadview, IL 60153) *CDC M1* compact-disc changer uses a fiber-optic cable to send digital audio and program data from the CD changer, which is usually mounted in the car's trunk, to an under-dash interface module that converts the data to analog audio. The operating controls and a display are provided by the *Blaupunkt Washington SQR 49* AM/FM cassette player/receiver. The complete system lets users enjoy the radio, audio tapes, and CD's with a single in-dash component—and provides the benefits of fiber optics, including immunity from electrical noise, total electrical isolation to eliminate ground loops, and lighter and thinner cables. The 10-disc, single-magazine CD changer has a three-beam laser pickup with sophisticated error-correction and digital-processing circuits. The digital outputs of those circuits are converted into light pulses that travel through a 15-foot optical cable to the interface module, where the light is converted into electrical digital data and the audio is separated from the program data. A 16-bit D/A converter changes the audio data to stereo audio signals, which pass through a short, heavily shielded cable to the cassette/receiver's CD input. The program data is linked, via an I<sup>2</sup>S (Inter-IC Signal) bus to the cassette/receiver, and back to the CD changer, with a conventional wire cable. The top-of-the-line *Washington SQR 49* displays a readout of the current disc and track number and the CD scan function, along with the usual radio and tape information. It has a full array of performance, convenience, and anti-theft features, and can be installed permanently or as a removable unit. Price: \$899.95 (*CDC M1*); \$649.95 (*Washington SQR 49*).

CIRCLE 66 ON FREE INFORMATION CARD



6 1/2-Hour Videocassette

## 6 1/2-Hour Videocassette

Following the philosophy that a product that offers something extra will be successful, *BASF* (35 Crosby Drive, Bedford, MA 01730) has introduced a 6 1/2-hour videocassette tape. At slow speed (EP or SLP) the *T 130* provides 30 minutes more recording time than standard tapes, and at the fastest speed (SP), an extra ten minutes. The extra recording time provided by the tape could mean the difference between catching and missing the end of a movie or sports event that runs longer than two hours (or is delayed). Price: Not available.

CIRCLE 67 ON FREE INFORMATION CARD



For more information on any product in this section, circle the appropriate number on the Free Information Card.

# ELECTRONICS WISH LIST

## Surround-Sound "Concert" System

The "Designer Series" of audio rack systems from *Yamaha Electronics Corporation, USA* (6722 Orangethorpe Avenue, Buena Park, CA 90620) allows fashion-conscious buyers a choice of three different finishes on cabinets that house identical components. The CS-740 golden-oak veneer, CS-742 bleached-oak veneer, and the CS-745 high-gloss black cabinets (pictured here) each hold Yamaha's Concert System—the AV-75 surround-sound amplifier with Dolby Pro Logic, the K-65 dual-cassette deck, the T-60 AM/FM stereo tuner, the CDC-60 5-disc CD changer, the EQ-70 10-band graphic equalizer, and the P-31 fully automatic belt-drive turntable with cartridge. In addition, each system includes four speakers finished to match the cabinet: a pair of 3-way speakers with a 12-inch polypropylene woofer, 5-inch midrange, and 1-inch high-definition dome tweeter; and compact surround-sound speakers. Rounding out the Concert System is a pre-programmed, learning-capable remote control. Price: \$2,299 in your choice of finish.

CIRCLE 68 ON FREE INFORMATION CARD



Surround-Sound "Concert" System

## Talking Thesaurus

*Franklin Electronic Publishers* (122 Burrs Road, Mt. Holly, NJ 08060) uses state-of-the-art voice technology to create the *Speaking Wordmaster (WM-1500)*. The Speaking Wordmaster is a hand-held electronic thesaurus, phonetic spelling corrector, and word-game player that has the ability to pronounce, out loud, more than 80,000 words from its Merriam-Webster dictionary and thesaurus. Hard-to-pronounce or unfamiliar words are clearly pronounced at the touch of a key. The unit can even distinguish and properly pronounce homographs—words that are spelled the same but have more than one pronunciation and meaning (for example, "attribute"). More than 487,000 synonyms and 76,000 thesaurus definitions are provided. A unique feature, called "Sound-Alikes," will display two more than one word that sounds the same, and will include all definitions. For instance, typing in "rain" will call up two "sound-alikes": "rein:harness" and "reign:rule." A personal word list stores up to 50 of the user's own words; it's a handy place to store important words that aren't listed in a standard dictionary, like the correct spelling of your boss' wife's name. The games include flashcards, Hangman, anagrams, and jumbles. The Speaking Wordmaster comes with a built-in speaker, adjustable volume control, a headphone jack, a 16-character dot-matrix display with adjustable contrast, a QWERTY-style keypad, and automatic power shutoff. Price: \$149.95.

CIRCLE 69 ON FREE INFORMATION CARD



Talking Thesaurus

## Personal Copier

Every part of the *PC-11* personal copier that possibly could wear out or run out is contained in its user-replaceable PC mini-cartridge, making it virtually maintenance free. *Canon U.S.A.'s* (Home Office Products Division, One Canon Plaza, Lake Success, NY 11042) PC-11 includes a convenient paper holder on its space-saving stationary platen, a fast (10-copies-per-minute) copying speed, and both selectable and preset zoom ratios. Ratios between 70% and 122% can be chosen in 1% increments, or users can opt for preset ratios of 70%, 78%, 86%, or 122%. The machine makes copies from business-card size to legal size. Manual feed allows users to make copies on materials other than plain paper, and automatic exposure with manual override provides clean copies from materials such as newspapers and half-tone originals. The automatic paper-feed system can feed up to 100 sheets. For colorful printing, the replaceable PC mini-cartridges are available in black, brown, blue, red, and green. Price: \$1,795 (PC-11); \$149.95 (black PC mini-cartridge); \$99.95 (color mini-cartridge).

CIRCLE 70 ON FREE INFORMATION CARD

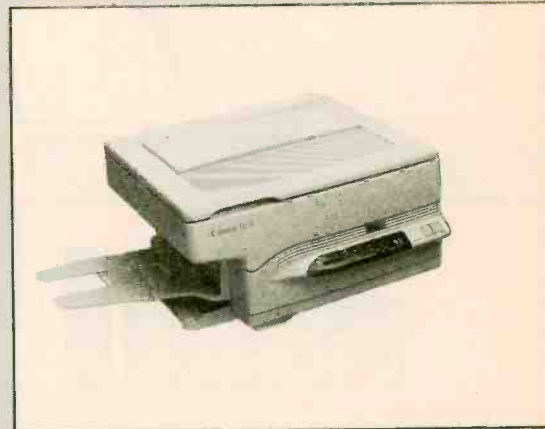

Personal Copier

# ELECTRONICS WISH LIST

For more information on any product in this section, circle the appropriate number on the Free Information Card.



Portable Answering/Dictation System

## Portable Answering/Dictation System

*Cobra* (Dynascan Corporation, 6500 West Cortland Street, Chicago, IL 60635) calls its model *An-8450 Traveler* "a totally new concept in business communications." For use while traveling and in hotel rooms, as well as at home and in the office, the *Traveler* combines a portable answering machine with a dictation recorder, and throws in a dual-time-zone alarm to boot. The device, which is about the size of a portable cassette player, includes a fully featured beeperless answering system with one-touch operation and auto reset. A digital voice chip contains the outgoing announcement, and a multifunction LCD read-out indicates the number of messages and the time each was recorded. The dictation system uses standard microcassettes. Price: \$229.95.

CIRCLE 71 ON FREE INFORMATION CARD



Cordless Phone

## Cordless Telephone

Boasting "corded quality," *Uniden America Corporation's* (4700 Amon Carter Boulevard, Ft. Worth, TX 76155) model *CT 785* cordless phone also has a speakerphone, two-way page, and automatic intercom. The dual-keypad phone also features two-channel select, 10-number memory, "DialCode" digital security, and last-number redial. The batteries can be easily replaced by the consumer, and the phone can be wall or desk mounted. Price: \$219.95.

CIRCLE 72 ON FREE INFORMATION CARD



Portable Vacuum/Flashlight

## Portable Vacuum/Flashlight

A handy item to keep in your car or boat—or around the house—the *PC5L Vaclite* from *Sanyo Fisher (USA) Corp.* (21350 Lassen Street, Chatsworth, CA 91311-2329) combines a hand-held vacuum cleaner with a searchlight. The cordless device can quickly handle a wide variety of smaller cleaning jobs, and doubles in an emergency as a flashlight. The wide-mouth intake speeds up normal vacuuming, and the crevice attachment gets into hard-to-reach spots. The *Vaclite* includes a charging bracket to recharge *Sanyo Cadnica* batteries during storage. A power indicator lights up when the unit is in use or being recharged, and goes off to signal the need for recharging. Price: \$34.95.

CIRCLE 73 ON FREE INFORMATION CARD



High-Performance A/V Amplifier

## High-Performance A/V Amplifier

With "6-channel bridgeable amplifier topology," *Denon's* (222 New Road, Parsippany, NJ 07054) *AVC-1000* makes it easy to use an advanced Dolby Pro Logic A/V surround-sound system. The amplifier delivers 210 watts of total power: two 55-watt front channels are complemented by two 25-watt rear channels and two 25-watt center channels. The use of two center-channel amplifiers allows users to create a convincing stage for on-screen dialog, sound effects, and music. With the rear-panel bridging switch, the six amplifiers can be bridged to four channels to connect an existing high-power amplifier for the front channels. Then, the 55-watt front channels can be used to drive the rear speakers, and the rear amps can be bridged to make two 55-watt center channel amps. The *AVC-1000's* four Pro Logic and three surround modes adapt it to just about any size room and speaker configuration. A "Cinema" switch compensates for the sound mixes of programs intended to be shown mainly in theaters, and helps to keep the dialog sounding natural. In addition, the "Audio Visual Sound Effect Circuit" adds energy to the lowest registers to enhance video music and effects. The amplifier also offers five video and five audio inputs, including four S-video inputs, and a separate mono output for driving a powered subwoofer. The 62-key programmable remote control, which has built-in commands for controlling other *Denon* components, can be programmed to activate sequences of commands at the push of a button. Price: \$700.

CIRCLE 74 ON FREE INFORMATION CARD



# The Long Island

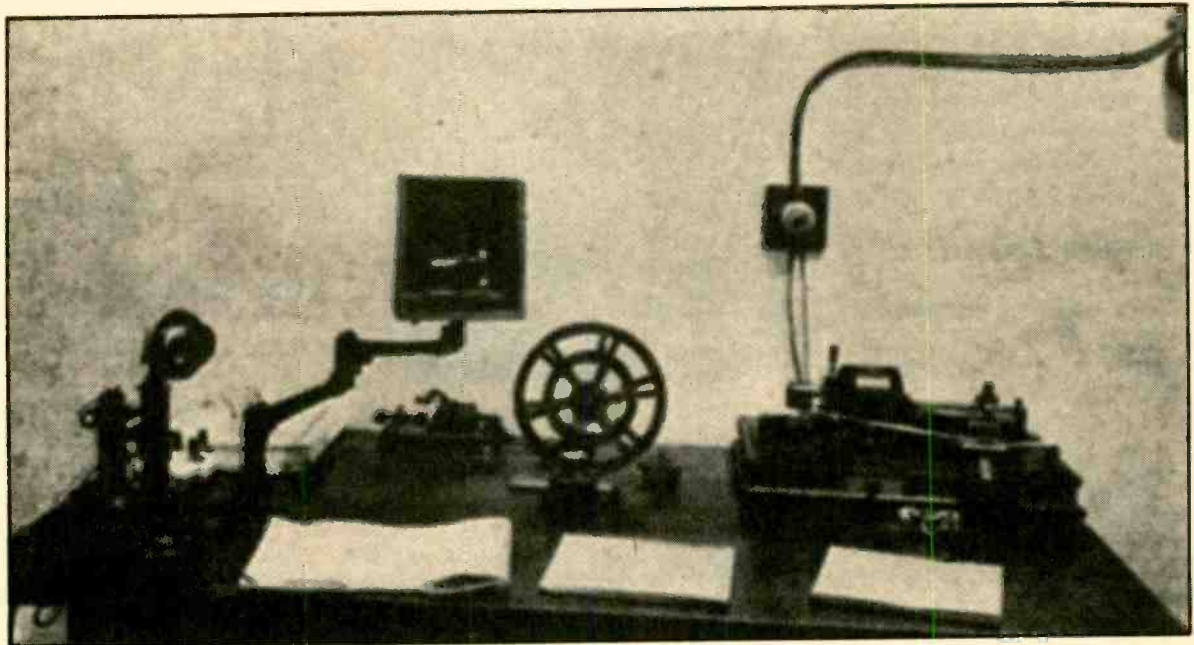

## Spy Station

*Read a true tale of espionage that would have made Ian Fleming proud, and how a ham-radio operator provided the clue that exposed the spies.*

BY ROBERT ANGUS

trained in Sayville, Long Island, New York on the night of Monday, July 5, 1915 and Howard Ballard was not pleased. Ballard, a bachelor in his 20's, listened to it ping on his pup tent, staked out in an open field beside the Long Island Railroad tracks. On the other side of the tracks, he could see the three giant transmission towers of the Atlantic Communication Company, and under them, men frantically loading cartons onto the back of a truck.

Ballard secretly wished that he could be anywhere else—at Kennedy's Cafe in downtown Sayville, for example—but he was on duty. His paper, the *Brooklyn Eagle*, had assigned him the task of breaching the security of the station, the only commercial communications link with Europe following the severing of the Transatlantic Cable at the outbreak of World War I. Earlier in the day, Ballard had been repelled by five gun-

toting guards, and had retreated to the relative safety of the field across the tracks. He knew that on the following day, the U.S. Navy, suspecting espionage, would seize the radio station.

So, apparently, did the Atlantic Communication staff, who were busy whisking away anything that might prove incriminating as well as any high-tech equipment that otherwise would fall into U.S. Government hands.

**A Twisted Tale.** The Sayville story starts just over a year earlier, when workmen arrived one morning to start work on a little white building. Within days, it sported a large sign reading Telefunken. Before the month was out, there was a 500-foot tower. Since Congress had passed a Communications Act in 1913 limiting ownership of broadcast facilities to American citizens, the *New York Times* wanted to know how a foreign

company could build a radio station on U.S. soil. A spokesman at Telefunken's office on lower Broadway told the *Times*, "We have no interest in the station. It has been purchased by U.S. interests."

The new owner was the Atlantic Communication Company of 90 West Street, which claimed that its business was transmitting and receiving commercial messages with a similar station in Nauen, Germany. Its president was Herman Metz, then just finishing his first term in Congress after a business career as importer and manufacturer of dyestuffs and drugs. Most of his business contacts were in Germany, and he represented such German companies in the U.S. as I.G. Farben, BASF, and Agfa. The company's general manager, A.E. Debec, told the *Times* reporter that Metz was unavailable, but assured him that Atlantic was owned by American

stockholders who had purchased the Sayville site "with some German capital."

That proved to be not entirely true; subsequent events showed that much of the equipment had been provided by the Imperial German Navy, and the transmitter was under the command of Captain Karl Zenneck. In fact, Metz was the only American to own stock in Atlantic. Dr. Karl George Frank, a German national, was the nominal secretary-treasurer and actual head of the firm.

**The Lusitania.** What triggered all the attention was the sinking of the Cunard liner *Lusitania* on May 7. It had left New York several days earlier with a number of prominent Americans aboard. And, if German propaganda was to be believed, a cargo of war supplies destined for Britain. Carl Schurz Jr., the son of a New York congressman, and the New York representative for a number of German interests, told the *New York World* that the German submarine fleet had been alerted by wireless to the presence of munitions on the liner. Since Sayville was the only telecommunications link with Europe, and since radio amateurs had reported strange transmissions coming from it, suspicion naturally fell on the Atlantic Communication transmitter.

After establishing contact with Nauen, the Sayville operator would begin



*This large concrete and brick anchorage was one of six that supported the structure via thick cables. Note the large glass insulators.*

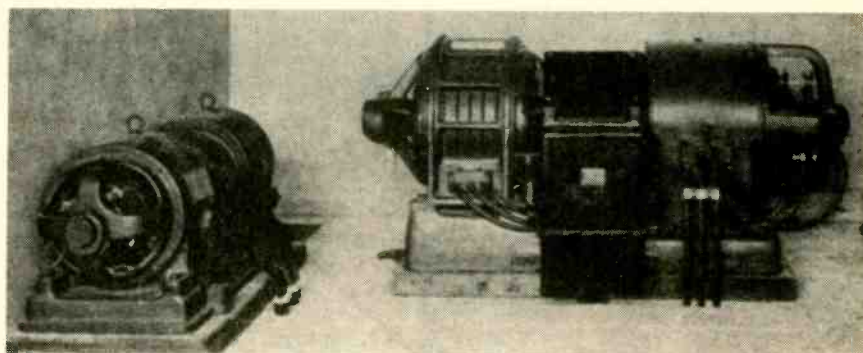

*The main motor-generator set was made by General Electric. The unit at right consists of an induction motor driving a 220-volt DC generator, which in turn charged a 600-amp storage battery, which in turn powered the station.*



*The main Sayville tower was the first in North America to substitute a ball-and-socket joint base for the more common "Eiffel Tower" design in which the structure supports itself. Most AM radio towers today use the Sayville design. The building at the base of the tower is the operations and transmitter building.*

tip that the sensors were frequently not on duty, but more likely to be found at Kennedy's bar, the *Brooklyn Eagle* had dispatched young Ballard to the scene. When he arrived that fateful Monday, he reported, the armed guards shooed him away, telling him that none of the sensors were in. When he asked for one of them by name, the guard replied that he was not in the operations building, "but must be somewhere around the grounds." The guard made no move to relay Ballard's request to see him.

**A Ham Helps Out.** Unbeknownst to Ballard, to the *Providence Journal's* telegrapher, or even to the otherwise well-informed staff at Sayville, a ham-radio operator in Westfield, NJ, had been recording the transmissions on an Edison dictating machine he'd specially modified for the purpose. Charles

sending so fast that the message became unintelligible. But not all transmissions fell into this category. Between 11 PM and 5 AM, Sayville sent a full schedule of noncommercial messages at normal speed. The *Providence Journal* (whose editor later proved to be a British Intelligence agent) stationed a crack telegrapher at its experimental radio station at Point Judith, RI, with instructions to transcribe every word sent out by Sayville.

**Suspicion Grows.** By the end of June, Navy Secretary Josephus Daniels ordered three lieutenants into Sayville as censors with instructions to hold up every message they couldn't understand. The censors did stop a number of what appeared to be commercial messages using code words or referring to British or German ships, but reported nothing else wrong. Acting on a

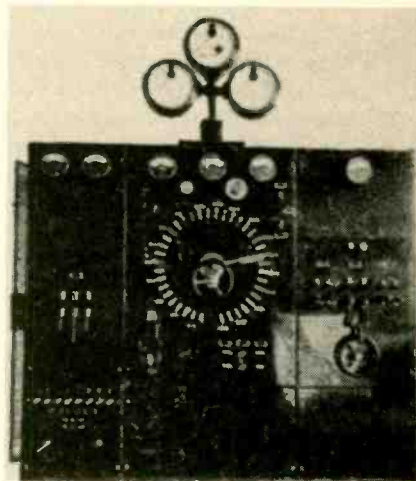

*This odd device actually is a portion of the central switchboard panel.*

E. Apgar, a car salesman by day became a secret agent at night. At first, the transmissions made no sense to him, either. But one evening, the Edison



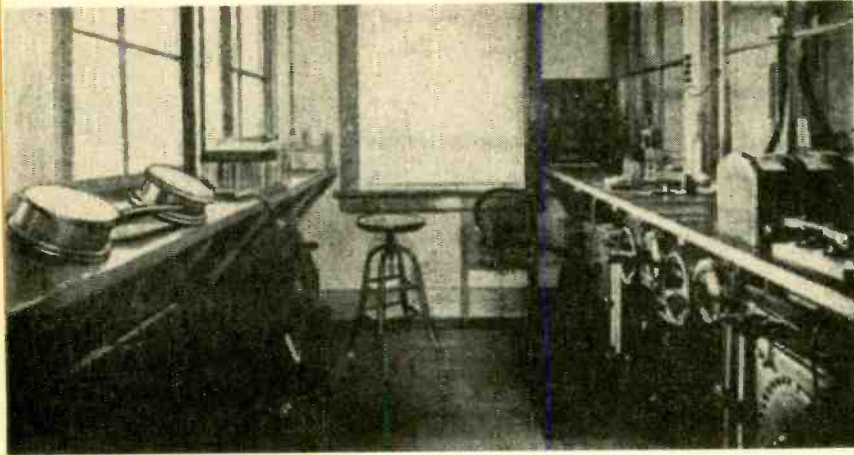

*This small control room's windows (left and right) allow the electrician in charge to see both the generating and transmitting equipment while controlling the system. A system of small signal lamps and a speaking tube and call gong provide communications between the control and operating rooms.*

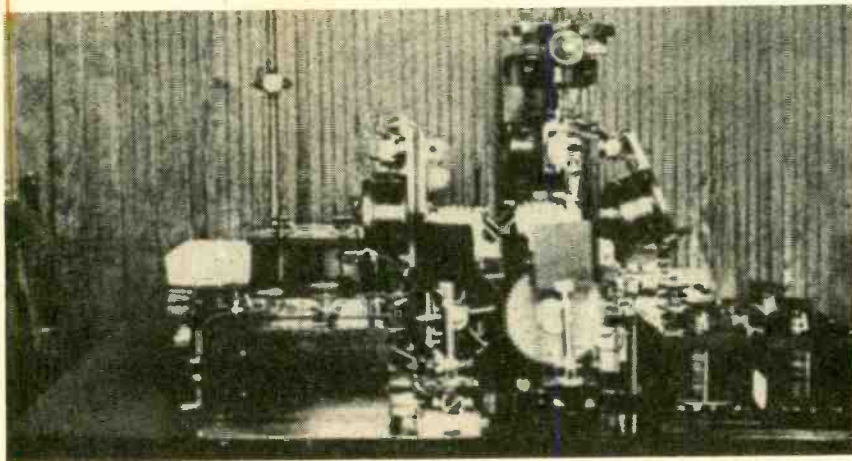

*Telefunken's sound intensifier, an amplifying device sensitive only to sounds on a given frequency and capable of making them audible "over considerable distances."*

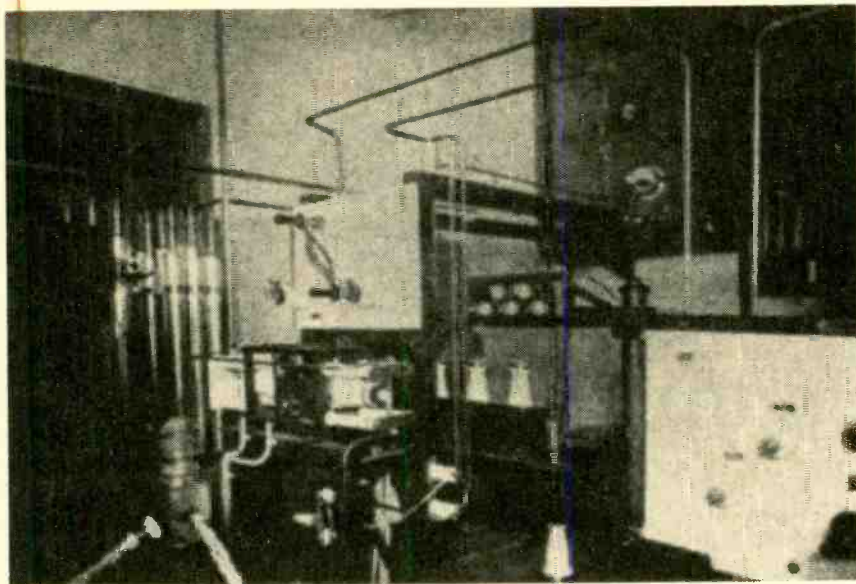

*In the transmitting room, an automatic antenna switch operated by pressure of the operator's foot switches the antenna from receiving to transmission mode, or vice versa.*

machine began to slow down while playing a cylinder. Apgar listened intently as the high-pitched drone resolved itself into dots and dashes. He wrote down what he heard, then got a German-English dictionary.

What he found sent him hurrying the next morning to the offices of L.R. Krumm, the chief radio inspector of the Bureau of Navigation's New York office. Apgar showed him the messages and played a few of the cylinders. Krumm was not easily alarmed, but he sent promptly for William J. Flynn, head of the U.S. Secret Service. Together the three listened as Apgar tried to slow down his machine.

It wasn't until after the war that anyone disclosed what Apgar had recorded. Even then, no one was providing complete texts. As an example, however, a government spokesman cited what appeared to be a commercial message reporting that a cargo of sugar had been shipped on a particular vessel and bills of lading were going forward by hand. Another message announced the birth of a baby, the date and the fact that the child had been christened Mercedes. The Secret Service determined that there was no sugar aboard the ship. But when it docked in Liverpool, there was a passenger named Mercedes aboard. She was met by two men. British police arrested all three and confiscated the documents (bills of lading) the woman was carrying.

**The Raid on Sayville.** On the afternoon of July 6, the weather had cleared and as reporter Ballard watched, U.S. Navy Captain W.H.G. Bullard arrived to carry out Secretary Daniels' order to seize the station. Nobody was more surprised than the three Navy censors who were on duty at the time. Wrote Ballard, "It is said that the Government authorities taking over the station will not find themselves in possession of the exact equipment used by the Atlantic Communication Company when the *Eagle* representative first came on the spot." For a few days, Atlantic Communication continued to send commercial messages to non-belligerents only, and then Captain Bullard clamped a lid of secrecy on the entire operation. Following the entry of the U.S. into the War in 1917, the Navy used the station. With the coming of peace, it became part of Long Island's air traffic communications system.

*(Continued on page 97)*



Most of us have encountered thermistors, either in devices we've built or repaired or maybe just in reading. They appear in applications as diverse as medical thermometers, auto-temperature gauges, and heat-pump controls. You may know how they're used or how to troubleshoot them, but do you know how to design thermistor circuits? Most designers and even experienced engineers see them as strange, nonlinear, and unfamiliar devices, so they steer away from using them. That's a shame, because they may be missing the best, simplest, and least-expensive solution to their needs. Not only are they straightforward but, once you know how, they're also easy to use and even to linearize!

What is a thermistor? The name says it all: *thermal resistor*, a device whose resistance changes with temperature. There are several types, but we're going to limit this discussion to the most common, NTC (Negative Temperature Coefficient) thermistors. They are called NTC thermistors because they decrease in resistance as their temperatures increase.

They are formed from mixtures of powdered metal oxides (usually nickel and manganese oxides), sometimes with other oxides or dopants added. The oxides are mixed with water and various binders to form a clay-like slurry, which is pressed or otherwise formed into the desired shape and sintered (fired) at temperatures above 1000°C (1832°F) to form a semiconducting, ceramic-like structure. Then one of several techniques is used to add leads.

Finished thermistors may be dip-coated with epoxy or glass, assembled into probes or glass envelopes, or left unenclosed. The photos illustrate the wide variety of thermistors available, including discs and washers from under 0.1- to 1-inch diameter, glass-coated beads down to 0.06-inch diameter, rods, and probes.

**Thermistor Behavior.** NTC thermistors are narrow-range, highly sensitive, and nonlinear. Figure 1 shows a typical resistance vs. temperature (R-T) characteristic curve, for a common ambient-temperature thermistor (useful for -80 to 150°C, or -112 to 302°F). Typical sensitivities are 3 to

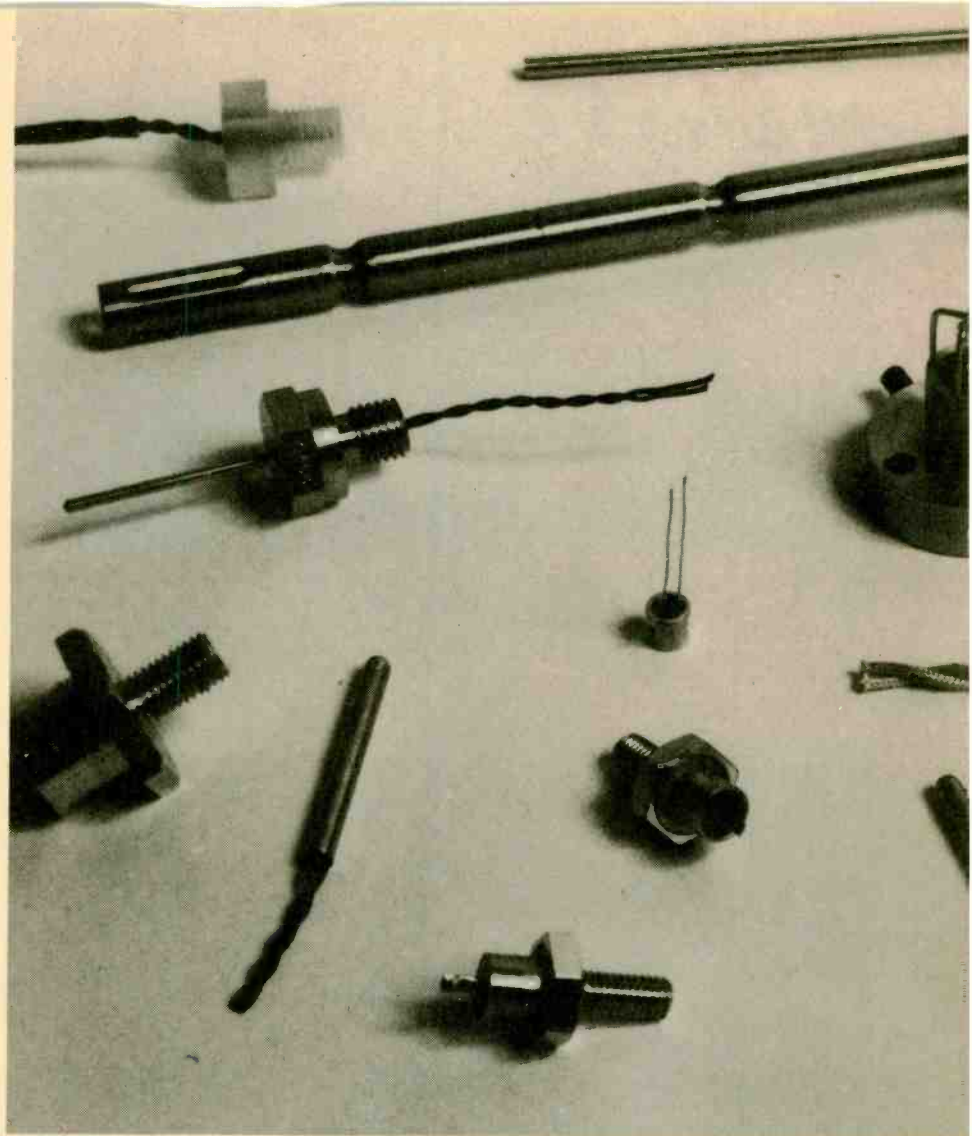

# ALL ABOUT THERMISTORS

5%/°C (1°C = 1.8°F). Thermistors are specified by their resistance at 25°C, which can run from below ten ohms to one megohm and beyond. With such a wide variety of thermistors to choose from, resistance changes from tens of ohms to tens of kilohms per °C are possible. Table 1 lists some typical specifications.

Inexpensive thermistors usually have fairly loose tolerances, ±5% to 10% (at 25°C) for discs, 20% for beads, and greater at higher and lower temperatures. This is not as bad as it sounds, though, because at 4%/°C a 10% tolerance translates to about 2.5°C (4.5°F). Tight-tolerance thermistors, costing about \$2.00 and up, provide ac-

curacies from 0.2 to 0.05°C. Tight tolerance thermistors (especially glass-coated ones) provide superior long-term stability at high temperatures.

Even though a thermistor may operate from -80 to 150°C or beyond, it's usually not practical to use it over its entire range, since its resistance may change by 10,000 or 20,000 to one. You can imagine the difficulty of trying to design a circuit to accurately handle both ends of the range (unless you use range switching). A high-temperature glass bead having a useful resistance at 400°C will be multi-megohms at 25°C.

Because thermistors are resistors, any current passing through them will gen-



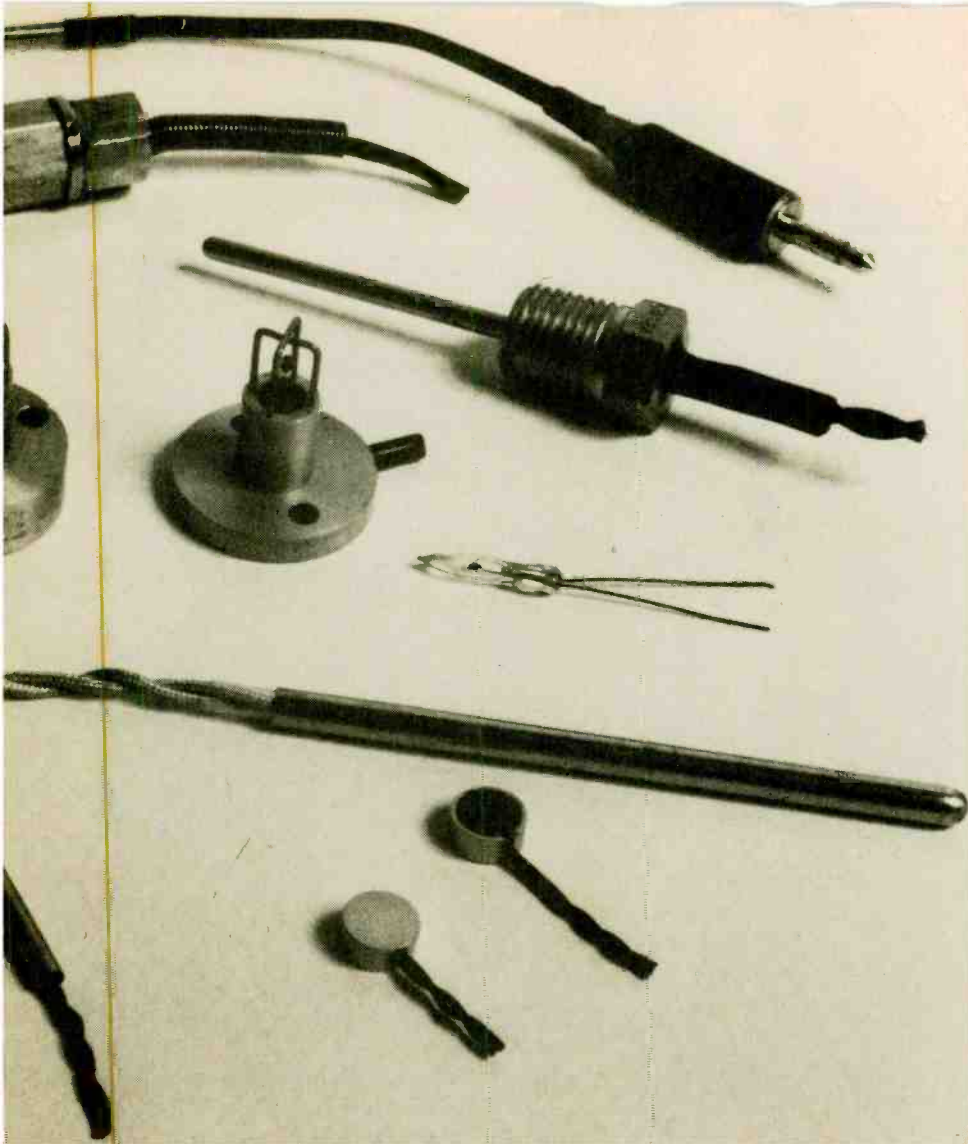

*Gain a full understanding of how thermistors work, what they can do, and right way to use them in your circuits and designs.*

erate heat and produce measurement errors. Small epoxy-coated disc thermistors, for example, have dissipation constants around one milliwatt per °C in still air, or 8 mw/°C in stirred oil. In other words, one milliwatt of power will raise the thermistor's internal temperature by 1°C in still air, two milliwatts will raise it 2°C, etc. Large thermistors such as one-inch discs or washers can dissipate up to 20 or 30 milliwatts per °C in still air.

**Thermistor Equations.** Before we get to practical designs, let's take a look at some simple thermistor equations. Manufacturers usually provide resistance-versus-temperature tables or graphs, so it's not necessary to use

equations. However, it's best to know something about them, and they'll help us understand terms such as "alpha," "beta," and "ratio."

There is no such thing as an exact equation for thermistors, but an exponential equation gives us a reasonable approximation over limited temperature ranges. A thermistor's resistance decreases almost exponentially as temperature increases, as shown by the equation:

$$R_{T2} = R_{T1} e^{\beta(1/T2 - 1/T1)}$$

where T1 and T2 are absolute temperature in degrees Kelvin (°C + 273.15); R<sub>T1</sub> and R<sub>T2</sub> are the thermistor's resistances at temperatures T1 and T2; and β (beta)

is a constant (typically 3000 to 5000). If beta and R<sub>T1</sub> are known, the equation can be rearranged and used to calculate temperature based on its resistance:

$$1/T2 = 1/T1 + (1/\beta) \ln(R_{T2}/R_{T1})$$

Manufacturers often give values of beta based on the resistances at two temperatures such as 0°C and 50°C, or 25°C and 75°C. The exact value of beta depends on the temperatures chosen. The equations are accurate to ± 1°C or better over spans to 100°C, but should not be trusted very far beyond that for a given value of beta.

Alpha is simply the slope of the R-T curve—the sensitivity—at some particular temperature, usually 25°C. Typical values run between 3 and 6%/°C. Like beta, alpha depends on the temperature at which it is measured. Its value decreases somewhat at higher temperatures.

A thermistor's "ratio" is simply the ratio of the resistance at one temperature to the resistance at a second, higher temperature. Common 0°C/50°C ratios range from 9 to 13, 25°C/125°C ratios from 30 to 50. Some thermistors' ratios fall outside these limits.

**Thermistor Bridge Circuits.** If we connect an NTC thermistor in a Wheatstone bridge (Fig. 2), we can generate a voltage that increases with temperature. The output-versus-temperature curve (Fig. 3) is S-shaped, approaching—but never reaching—the supply voltage at high temperatures (low thermistor resistance). Notice that the mid-range portion of the curve is fairly linear.

While you cannot change the basic shape of this curve, you can choose RA and RB (which should be equal) so that the center of your temperature range is in the most linear (center) portion of the curve. For narrow temperature ranges (not more than about 20°C or 36°F) you can do quite well by making them equal to the thermistor's resistance at the center of the temperature range. Linearity becomes poorer as the temperature range gets wider.

Actually, the best value for RA and RB correspond to a temperature just a bit higher than the midrange value. You can find a better value if you're willing to do a bit of math. A quick-and-easy approach is to add 10% of the temper-

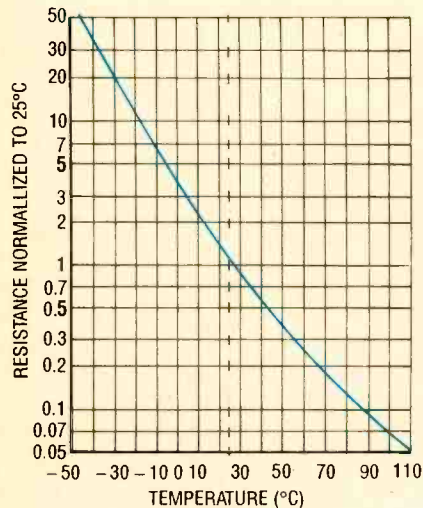

Fig. 1. Thermistors are not linear devices. However, they can be useful in hobbyist-level projects.

ature range to the midrange value. For example, if your temperature range is 25 to 125°F go to the midrange temperature (75°F) and add 10% of the 100-degree-wide range (10°F). The result is 85°F, so set RA and RB equal to the thermistor's resistance at that temperature.

Best possible linearity occurs when RA and RB are chosen so the "ideal" straight line crosses the actual curve at the low end, midrange, and full-scale temperatures T1, T2, and T3. We won't go through the mathematical derivation, but this value of RA (and thus RB) may be calculated using:

$$RA = \frac{R_{T1}R_{T2} + R_{T2}R_{T3} - 2R_{T1}R_{T3}}{(R_{T1} + R_{T3} - 2R_{T2})}$$

If you know the thermistor's resistance ( $R_{T1}$ ,  $R_{T2}$ , and  $R_{T3}$ ) at temperatures T1, T2, and T3, simply substitute them in this equation to find the optimum value of RA and RB. The thermistor's values may be taken from the manufacturer's data or by measurement at the three temperatures.

Whichever method you use, complete the bridge by choosing RC equal to the thermistor's resistance at the temperature where you want the bridge to be balanced (zero output). You may want to make RC adjustable for calibration purposes.

The supply voltage, V, determines the bridge sensitivity (millivolts per degree). You may need to do some trial-and-error calculations here. Choose a reasonable value—say, one volt—and calculate the bridge output at T1 and T3 to find the sensitivity. You can lower the sensitivity by either lowering the voltage or tapping off equal portions of RA and

TABLE 1—RESISTANCE-TEMPERATURE CHARACTERISTICS OF TYPICAL NTC THERMISTORS

Temperature	THERMISTORS:			
	100Ω @ 25°C	1K @ 25°C	10K @ 25°C	1MEG @ 25°C
-80°C (-112°F)	14.47kΩ	278.80kΩ	3558kΩ	
-70°C (-94°F)	7475Ω	132.60kΩ	1694kΩ	
-60°C (-76°F)	4066Ω	66.78kΩ	845.9kΩ	
-50°C (-58°F)	2315Ω	35.39kΩ	441.3kΩ	
-40°C (-40°C)	1374Ω	19.64kΩ	239.8kΩ	
-30°C (-22°F)	846.0Ω	11.35kΩ	135.2kΩ	
-20°C (-4°F)	538.9Ω	6815Ω	78.91kΩ	
-10°C (14°F)	354.1Ω	4232Ω	47.54kΩ	
0°C (32°F)	239.2Ω	2710Ω	29.49kΩ	3966kΩ
10°C (50°F)	165.9Ω	1785Ω	18.79kΩ	2238kΩ
20°C (68°F)	117.7Ω	1206Ω	12.26kΩ	1299kΩ
30°C (86°C)	85.4Ω	834.0Ω	8194Ω	774.5kΩ
40°C (104°F)	63.1Ω	589.5Ω	5592Ω	473.2kΩ
50°F (122°F)	47.5Ω	424.8Ω	3893Ω	295.9kΩ
60°C (140°F)	36.4Ω	311.9Ω	2760Ω	189.1kΩ
70°C (158°F)	28.3Ω	233.0Ω	1990Ω	123.3kΩ
80°C (176°F)	22.3Ω	176.9Ω	1458Ω	81.98kΩ
90°C (194°F)	17.8Ω	136.2Ω	1084Ω	55.48kΩ
100°C (212°F)	14.3Ω	106.4Ω	816.8Ω	38.20kΩ
110°C (230°F)			623.5Ω	26.76kΩ
120°C (248°F)			481.8Ω	19.03kΩ
130°C (266°F)			376.4Ω	13.74kΩ
140°C (284°F)			297.2Ω	10.05kΩ
150°C (302°F)			237.0Ω	7447Ω

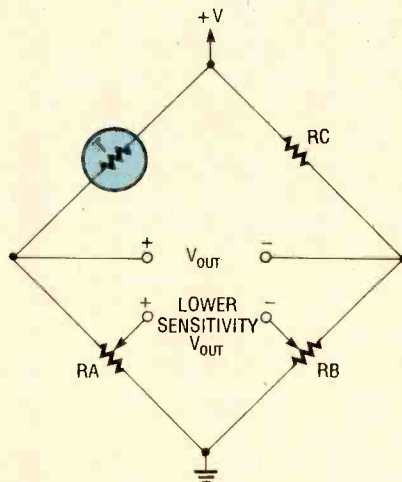

Fig. 2. A simple wheatstone bridge can be used to interface a thermistor to a circuit. You can adjust the sensitivity by tapping off of RA and RB closer to ground.

RB. Increasing the voltage will raise sensitivity, but remember that you will want to keep the a small thermistor's power dissipation under one milliwatt to avoid the self-heating problems mentioned earlier.

Table 2 lists calculated design values for three temperature ranges, each one having a sensitivity of 10 mV/°C using a precision interchangeable thermistor. A circuit like that can be used with a DVM to measure temperature in the laboratory. You will probably need to create series/parallel resistor combinations to obtain the calculated

resistor values. Since the thermistor's sensitivity is about 4%/°C, a resistor or supply error of 1% causes a temperature measurement error of only 0.25°C. The thermistor itself is precise to 0.2°C or better.

Notice that linearity gets worse as the measurement range widens. This can be a problem using digital readouts, but when analog (moving pointer) meters are used, nonlinear scales can be printed to match the output.

**Temperature Control.** Adding an op-amp and a relay to the thermistor bridge creates a low-cost on-off temperature controller (see Fig. 4). The relay will switch when the thermistor's resistance equals R2 plus R3 (i.e. RC) which occurs at the bridge's null point. Since

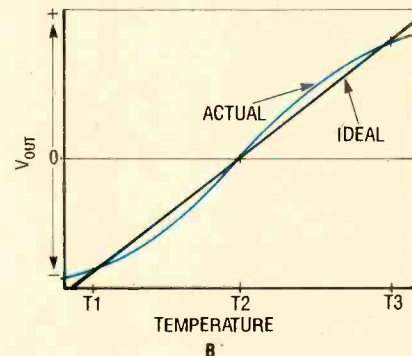

Fig. 3. This gives you an idea of the kind of behavior a thermistor exhibits over its useful range in a bridge circuit.



TABLE 2—EXAMPLES OF BRIDGE DESIGNS

Temperature Range	10 to 30°C	0 to 50°C	0 to 70°C
Temperature for Zero Output	10°C	0°C	0°C
Sensitivity	10 mV/°C	10 mV/°C	10 mV/°C
Bridge Supply (V)	916.2 mV	1017.3 mV	1147.0 mV
R1	2,168 ohms	1,763 ohms	1,164 ohms
R2	4,482 ohms	7,355 ohms	7,355 ohms
Maximum Nonlinearity	+0.07, -0.06°C	+0.85, -0.95°C	+2.0, -2.3°C

Thermistor: Precision interchangeable thermistor, 2,252 ohms at 25°C. YSI 44004 or 400-Series probe, Fenwal 192-222-LET-A01 or Thermometrics DC95F232W.

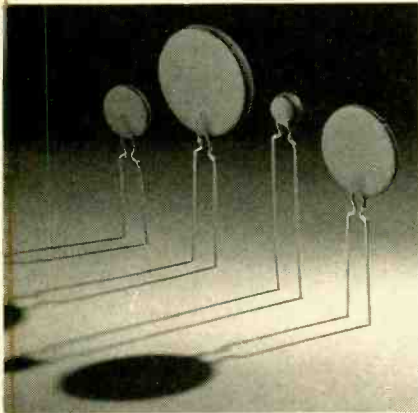

Some thermistors look like capacitors. They can be placed right on a circuit board for circuit protection or linearization purposes.

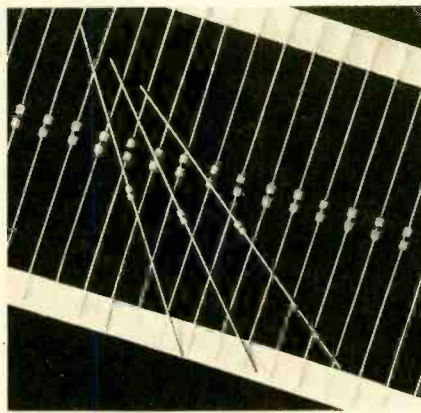

Glass encapsulated capacitors are often used for high-temperature environments. They display greatest linearity in the high-temperature ranges.

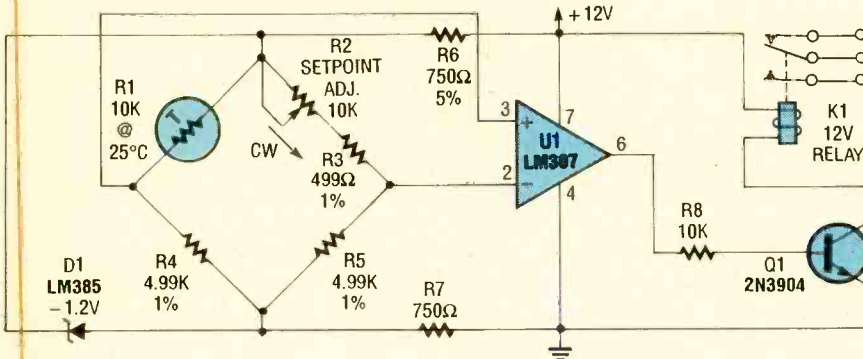

Fig. 4. By using a bridge circuit in between, a thermistor can provide input to a comparator to yield on-off operation of a device.

we are concerned only with the null point, linearity is not important.

The circuit values shown cover the range 25°C–100°C. You can create a dial for potentiometer R2 by marking the points where its resistance corresponds to specific temperatures. Almost any 10k thermistor can be used, as long as the dial for R2 is calibrated to its R-T curve.

If you wish to use a completely different thermistor, simply choose the resistor values as mentioned previously keeping in mind that:

$$RA = RB = R4 = R5$$

$$RC = R2 + R3$$

### Measuring Differential Temperature.

Temperature-difference measurements are useful in applications such as monitoring the efficiency of heat exchangers and making humidity (wet-bulb depression) measurements. As an example, consider the circuit shown in Fig. 5; that circuit uses two identical thermistors in a differential bridge. RA and RB should be calculated for best linearity as described earlier, but a portion of their resistances should be in the balance control potentiometer. The control (R5) should be set for zero output when both thermistors are at the same temperature.

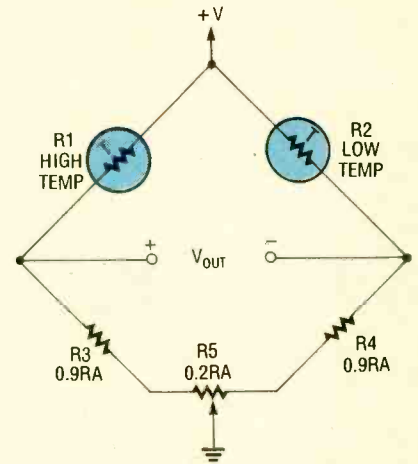

Fig. 5. A differential circuit can be made by modifying a bridge. This bridge is sensitive to the temperature differences between the two thermistors.

**Wide-Range Linearization.** You can measure temperature linearly over a much wider range by using a two-thermistor network. Figure 6 shows one such circuit that's linear to within  $\pm 0.22^\circ\text{C}$  from 0°C to 100°C (32°F to 212°F).

At the low end of the temperature range, the resistance of thermistor R5-b is so high (95k at 0°C) that it has very little effect on the circuit. The circuit behaves much like a 6k thermistor in series with 9.45k fixed resistance, linear from zero to about 30°C. Near 100°C the opposite occurs, with R5-a becoming so small (408 ohms at 100°C) that R5-b takes over. In between, both thermistors contribute to the response.

Selecting components for fraction-of-a-degree linearity is not easy. Trial-and-error calculations, best done on a computer or a programmable calculator, are needed to find the best

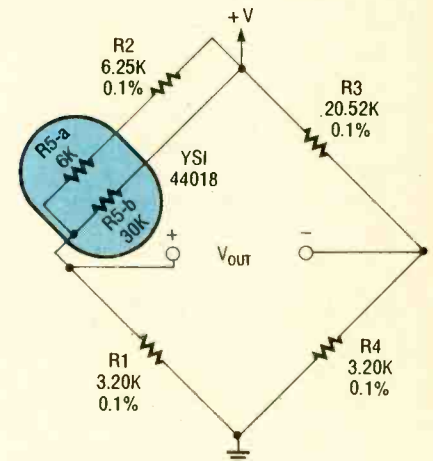
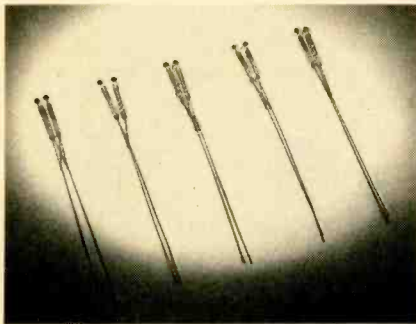

Fig. 6. A wide-range temperature-sensitive bridge can be built by using two different thermistors in the same leg of a bridge.



Cryogenic thermistors are paired for the wide temperature-range measurements necessary.

resistance values. The thermistors themselves are a precision pair, packaged as a single three-lead epoxy-encapsulated component (part no. 44018). Both YSI and Fenwal offer such components along with preselected resistor sets. (YSI and Fenwal thermistors are available from Newark Electronics.)

You may want to do your own experimentation, especially if you don't want or need high-cost, high-precision component sets. All you need is the patience to do lots of voltage-divider calculations. Pick two thermistors, making R5-b several times larger than R5-a. Start with R2 equal to R5-b somewhere in the upper end of your temperature range, and R1 + R2 equal to R5-a near the low end. For temperatures at the low and high end and several points between, substitute the thermistor resistances and calculate V. See how linear the voltage-versus-temperature relationship is, then keep trying different values for R1 and R2 to find the optimum values.

**Linear Resistance Changes.** It is often useful to create a network whose resistance changes linearly with temperature. An NTC thermistor may be linearized by simply connecting a resistor in parallel; in fact, the best resistance turns out to be exactly the same value used earlier to linearize a thermistor bridge.

Figure 7 shows a common applica-

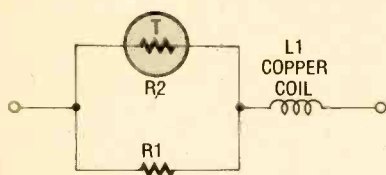

Fig. 7. Thermistors can be useful in overcoming the temperature-dependent resistance changes in coils. As the temperature increases, the coil's resistance increases, but the thermistor's resistance decreases.

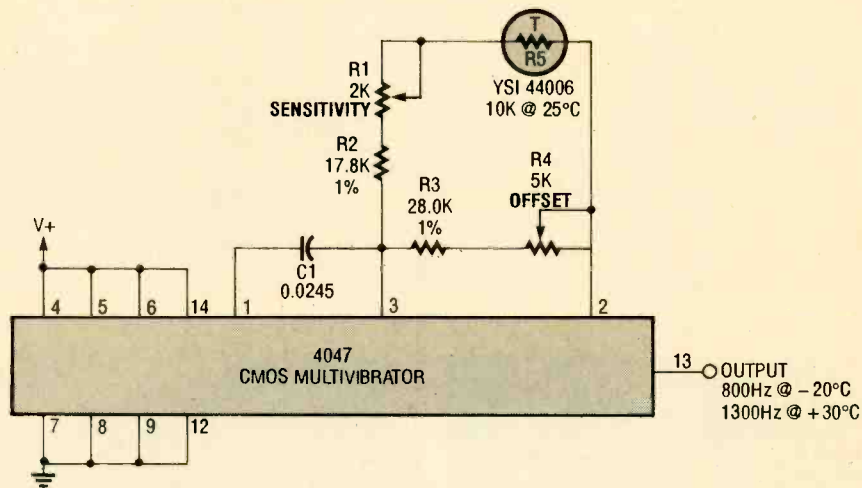

Fig. 8. Temperature-to-frequency conversion is also possible with a thermistor. That is useful for telemetry applications in particular.

tion: compensating the resistance change of copper coils such as meter movements or TV deflection coils. Sensitivity (in ohms per degree) will be roughly  $\frac{1}{4}$  the thermistor's mid-scale sensitivity. Of course, the thermistor resistance will decrease as temperature rises opposing changes in the copper coil which increases by  $0.39\%/^{\circ}\text{C}$ . Again, use trial-and-error calculations to zero-in on the best values.

### Temperature-to-Frequency Converter.

Temperature-to-frequency conversion is useful in telemetry applications such as RF telephone, or optical transmission where DC transmission is impossible. Figure 8 shows a circuit built around a precision 10k thermistor (YSI 44006) and a 4047 CMOS multivibrator. The 4047's output frequency (pin 13) is given by  $f = 1/(2.2RC)$ . In this circuit, that becomes:

$$f = \{1/(R1 + R2 + R5) + 1/(R3 + R4)\}/2.2C1$$

The combination of R1, R2, and C1 set the circuit's sensitivity, while R3 and R4 affect only the frequency offset. Use parallel combinations of capacitors to get the value of C1 you need. High-resistance thermistors are preferred to minimize measurement errors due to power dissipation in the thermistor. Properly calibrated, that circuit produces 800 to 1300 Hz between  $-20^{\circ}\text{C}$  and  $+30^{\circ}\text{C}$  ( $-4^{\circ}\text{C}$  and  $+86^{\circ}\text{F}$ ) for a sensitivity of 10 Hz/ $^{\circ}\text{C}$ . Adjust R4 at the low end ( $R5 = 78.91\text{k}$ ) and R1 at the high end ( $R5 = 8.194\text{k}$ ) until both frequencies are correct. Maximum non-linearity will be  $\pm 1^{\circ}\text{C}$ .

**Other Applications.** So far we've focused on temperature measurement

and compensation. By passing enough current through thermistors to heat them we can create a whole new series of applications. For instance, by using a lower-resistance thermistor and a higher bridge voltage in the circuit of Fig. 4, we can create a liquid-level sensor. Recall that earlier we mentioned that a small thermistor's dissipation constant is about  $1 \text{ mW}/^{\circ}\text{C}$  in still air,  $8 \text{ mW}/^{\circ}\text{C}$  in liquid. By dissipating, say, 50 mW, the thermistor's temperature will rise  $50^{\circ}\text{C}$  in air but only  $6^{\circ}\text{C}$  in liquid. If the thermistor is suspended at the desired level, its temperature will drop when it is touched by the liquid. By setting the potentiometer in Fig. 4 midway between the temperature extremes the relay can be used to open or close a valve as needed to control the level.

An anemometer (wind-speed gauge) can be similarly created using the circuit of Fig. 5. Increase power dissipation, expose one thermistor to the wind and shield the other. As the wind speed picks up the exposed thermistor's temperature will drop, unbalancing the bridge and creating an output voltage. The balance control should be adjusted for zero output with both thermistors shielded. Calibration is nonlinear and strictly experimental: you will need a calibrated wind gauge, or perhaps a friend to drive you at a steady speed on a still day while you hold the device out the car window and take measurements.

Despite being nonlinear and often unfamiliar, thermistors are not all that difficult to apply. They are highly sensitive, versatile, and available in a wide range of precisions, styles, and costs. Now that you know how, you can use them in your next project.



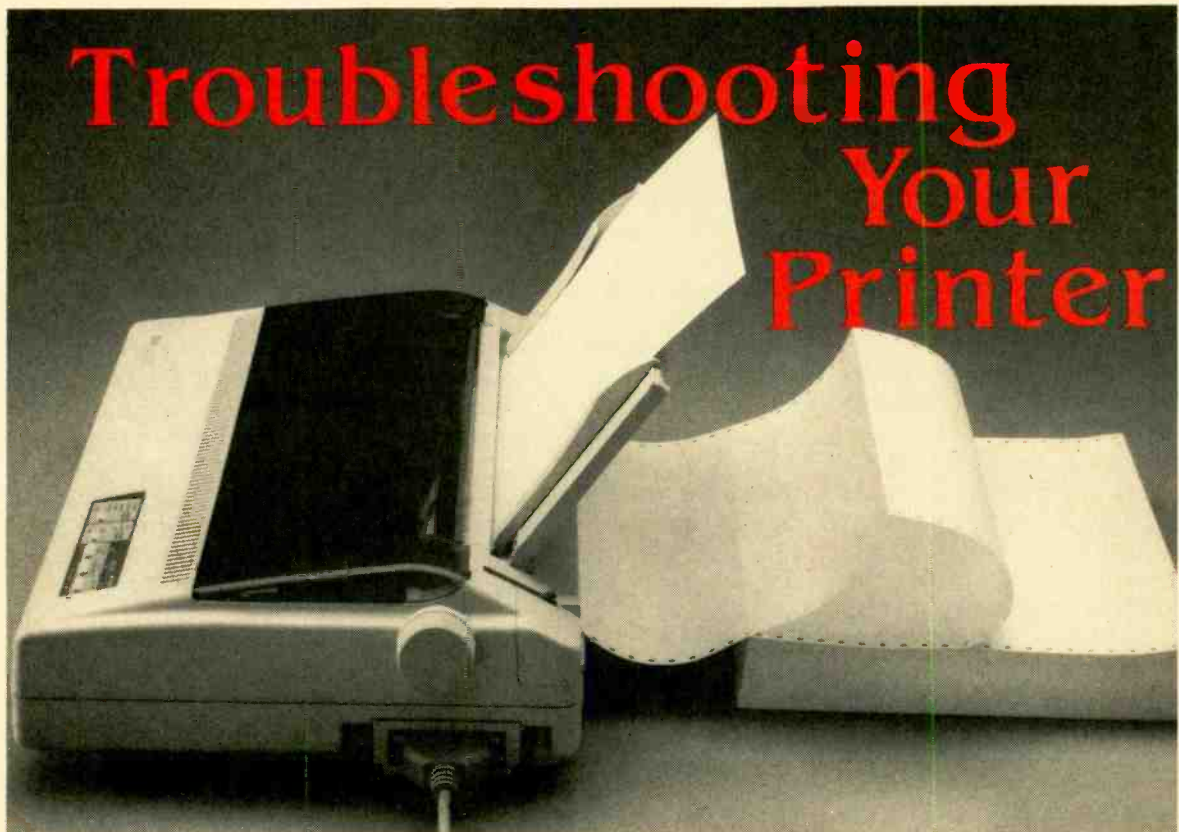

BY STEPHEN J. BIGELOW

*Don't needlessly spend money on a printer repair that you may be able to do yourself. As we'll show you, sometimes a simple fix or a little adjustment is all that's needed*

**B**roken type, wrinkled paper, erratic print, smearing letters. You may have seen one or more of those clear signs of printer failure before. In spite of their overall reliability, computer printers are intricate electromechanical devices. Eventually, they will all need some sort of adjustment or repair. But before you pack up that old workhorse and ship it off to be repaired, take a moment to consider the problem. If your printer is not still under warranty, you may well be able to service that cranky printer yourself and save a lot of time and money in the process.

This article will introduce some of the basic guidelines for printer troubleshooting, then explain the most common problems and solutions for impact (both wheel-type and dot-matrix), thermal, and ink-jet printers.

**Troubleshooting Tools.** Before you roll up your sleeves and plunge right into that repair job yourself, take some time to prepare yourself for the task at hand. First, clear off a comfortable, well-lit workspace for yourself. The re-

pair may take some time, so try to find a space where your work will not be disturbed. Make sure that you have the right tools for the job. A standard Phillips and a flat-blade screwdriver may not be enough. Manufacturers often use the more exotic Allen, spline, or Torx type of screws. They do this to prevent inexperienced individuals from tampering with the equipment. Those special tools can be found in most big hardware stores. Needle-nose pliers and diagonal cutters are also good to have on hand. Get a low-power (25 to 30 watt) soldering iron with a fine tip for any soldering that might be needed. Use only 60/40 rosin-core solder. You may also need some instruments to help you troubleshoot. A good, general-purpose VOM (volt/ohm meter) is probably the most valuable tool to have. Either a digital or an analog VOM is fine. If you plan to perform more sophisticated electronic work, you may need a digital logic probe and an oscilloscope.

**Locating Problems.** The trou-

bleshooting process begins by clearly identifying the printer's problem. To do so, ask yourself these two important questions: What exactly is happening? What could be causing those symptoms?

To aid you in answering the second question read through your printer's documentation. You should have a set of schematics for it, or a user's manual with mechanical drawings and views. Good documentation will be an invaluable aid in locating problems and replacing parts.

Use all of your senses to help you troubleshoot. When electronic parts fail, they can get very hot. They can produce smoke and an awful smell. When that happens, you can smell a burning component and see smoke, maybe even hear the component sizzle or pop. You may see linkages bent, missing, broken, or wires shorted. You may be able to hear unusual noises as the printer runs. Make the most of your senses.

Begin with what you can see. Check all of the obvious external things before

taking the printer apart. Inspect the AC power cord to be sure that it is installed correctly. Look at the interface cable that connects the computer to the printer. Be sure that it is tight and secure. If you are not sure about the interface cable, replace it with a different one, or use a VOM (on the low-ohm scale) to verify the continuity of each pin. Refer to your documentation to find the specific pin-to-pin connections of the suspected cable.

If the power and signal cables are correct, consider the computer's software set-up, especially if you're using new software or a new printer. Configuration commands tell the computer how and where to talk to the printer. If the computer is not configured properly, it may not operate the printer at all.

Once you are confident that the trouble does, in fact, lie within the printer, it is time to begin the process of disassembly and troubleshooting.

**Soldering Precautions.** Soldering is one of the most important skills in electronic troubleshooting and repair. Soldering must be done correctly at all times to prevent damage to electronic components and printed-circuit boards. When working with soldering irons, there are a number of precautions to follow.

The first that comes to mind is to avoid excessive heating. Electronic components, especially semiconductors, are very sensitive to heat. Printed-circuit boards are also easily damaged by excessive heat. Heat can separate copper traces from the board. Heat the component leads and the circuit board contacts only long enough to allow solder to flow well. Several seconds should be plenty of time.

Second, be gentle with the tip of the

soldering iron. A lot of force can tear up a printed-circuit trace or break a component lead.

Last, never pull a component lead out of a circuit-board hole. It will almost always tear the printed-circuit trace. Either remove all the solder from the hole, or heat the component lead with the soldering iron and withdraw the lead with needle nose pliers. If you are unfamiliar with soldering and de-soldering techniques, get some practice first on a piece of discarded electronic equipment (*i.e.* an old TV or radio that you are going to throw away.)

**Electrical Guidelines.** Use caution when working with printer electronics. There are some guidelines to keep in mind that can simplify the process of electrical work.

If during the course of tracking down a problem you must apply power to the printer after removing its cover, be extremely careful not to touch sources of AC line voltage inside the printer. That voltage exists at the input of the printer's power supply. Under the right conditions, it can present a dangerous—sometimes deadly—shock hazard. On a similar note, once you're sure you know what the problem is, remove AC power before correcting it.

A second shock hazard that you should be aware of are the large filter capacitors of the power supply. Essentially, a capacitor is an energy-storage device that can develop a serious charge across its leads. It can hold that charge long after the AC line voltage is removed. Be sure that any electrolytic capacitors are fully discharged before beginning work in the power supply.

In the midst of troubleshooting, be careful not to short circuit any part of the electronics. Paper clips, snips of

wire, solder drops, and bent leads can all cause problems further down the line. Further, never leave any wiring exposed—insulate any splices and replace all covers and shields.

If you must replace a component, be sure to get a proper replacement part, not a rough equivalent. The part should have the same value and ratings as the original if not better. For example, if a 2000-ohm, 1-watt, 5% resistor must be replaced, install another resistor of the same value, size, and tolerance. If a 0.1- $\mu$ F, 10-volt Tantalum capacitor fails, replace it with another 0.1- $\mu$ F, Tantalum capacitor that can handle at least 10 volts. Although the printer circuit may work with a slightly different value, it may cause unexpected (and unwanted) results during operation.

Very large scale integration (VLSI) circuits such as microprocessors, memory chips, UART (Universal Asynchronous Receiver/Transmitter) communication chips, or other advanced integrated circuits are very sensitive to static electricity. Many such circuits can be instantly destroyed after being zapped with a static charge. That can be a serious problem when working with the interface and logic circuitry of the printer. To help avoid any hazard, ground yourself on a cold water pipe, or earth-grounded printer chassis. Also handle IC's by the ends—try not to touch the leads.

Finally, soldering and de-soldering IC's can be a tough process. Not only is there a risk of damaging the new IC, but the printed-circuit board will probably not withstand more than one or two IC replacements. Clearance permitting, install an IC socket in the circuit board if an IC must be changed, then plug the new IC into the socket. If the same IC must be replaced in the future, you just have to pry out the old one and plug in the new one—no soldering will be needed.

**Mechanical Guidelines.** It's very important in printer repair (or any other type of repair) to keep good notes. Unless you have a photographic memory, it is surprisingly easy to lose track of what part goes where. Make careful diagrams and mark each major part. The investment of time and effort are more than worthwhile for a smooth, easy re-assembly.

Keep the hardware for each part of the mechanical assembly separate. An egg carton or a divided box is excellent for that. Of course you should use all of

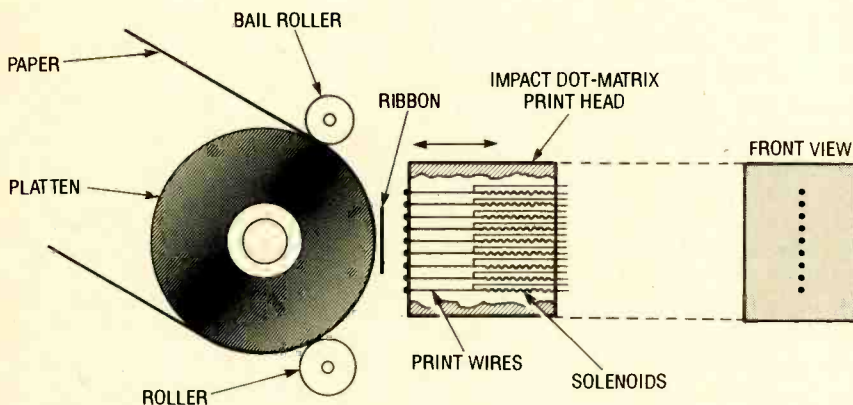

Fig. 1. This is the layout of a standard 9-pin impact dot-matrix print-head assembly. The print wires are fired in sequence to form the letters.



**TABLE 1—IMPACT DOT MATRIX PRINT HEAD TROUBLESHOOTING CHART**

Symptom	Possible Solution								
	Check Wiring to Print Head	Check Driver Solenoids At Print Head	Check Print Wires	Check Linkages in Print Head	Check Power Supply	Check Driver Circuits	Check Communication Logic	Check Ribbon and Ribbon Advance	Check Print Head Alignment
No Print	•	•	•			•			
Intermittent Print	•		•	•	•		•		
Prints Faintly								•	•
Black Smudged Lines in Print	•		•	•					
White Missing Lines in Print	•		•	•					

the parts that you remove when it comes time to re-assemble the printer. If you wind up with too many or too few parts, do not just "let it go." Go back and check your work again.

Use the appropriate lubricants on the mechanical parts. A light, general-purpose oil is normally acceptable, but double-check the user's manual or any other service documentation just to be sure. Avoid heavy oils and greases that can attract dust and dirt or come in contact with the printer paper.

**Impact Dot-Matrix Printing Heads.**

Impact-type, dot-matrix heads use hard, polished print wires that are fired in sequence to form the desired characters (see Fig. 1). Print-head data is sent from the printer's control logic to drive solenoids that push the print wires out against the paper, then draw them back in very quickly. That happens continuously as the carriage moves back and forth across the paper. Most heads are polished and curved to some extent so that the wires will make an even impression on the paper. As a result, the print wires themselves are generally not interchangeable.

Print wires can be driven by external solenoids via a series of linkages, or by solenoids built right into the head that force the print wires directly. Either way, the print head is an intricate and delicate assembly.

Table 1 lists some of the more common troubles that arise in impact dot matrix heads. In many cases, the carriage will carry the head back and forth properly, but the head will not produce characters, or will print characters incorrectly. Always suspect print-head

wiring when characters are missing, intermittent, or formed incorrectly. Wiring that is flexed back and forth continuously can eventually break, or become intermittent or shorted. Missing dots can also suggest stuck or failed print wires. After long periods of continuous use, print wires can become sticky and worn, or clogged with ribbon oils and paper dust.

Keep printer power off when checking the continuity of head wiring and solenoids. A good solenoid will have some measurable resistance (anywhere from 5 to 500 ohms). If the solenoid is shorted (about 0 ohms, or much less than its rated resistance), it may have to be replaced. If the solenoids are an integral part of the print head, the entire head may have to be replaced.

Checking the logic and drive circuits that supply data to the print head is a

much more involved process. In a later section of this article, we'll discuss interface and logic troubleshooting in more detail.

Faint printing almost always pinpoints the ribbon or head alignment. If the ribbon is fresh and advancing properly, find out if the head can be adjusted for better contact with the ribbon.

**Wheel Type.** Wheel printers, as the name implies, work in much the same way as conventional typewriters—characters are pre-molded onto a support structure to form what is called a die. When a character is to be printed, logic signals to a motor will move the desired character die into place. Then, a firing signal from the controlling logic will trigger a solenoid (or hammer) that will push the die forward against an inked ribbon to form an impression on the paper (see Fig. 2). There are several different types of dies used by wheel printers, but the three most typical are the daisy wheel, the ball type, and the thimble wheel.

Table 2 lists common problems and solutions for wheel printers. Many problems in wheel printers are similar to those encountered in dot-matrix impact printers. Wiring to the head is often at fault when the printer will not print, or prints intermittently. Be certain to inspect the die carefully when only certain characters will not print, or are tilted or uneven—those dies may be bent or broken. Faint characters usually point directly to a worn ribbon or broken ribbon advance, but do not rule out a possible problem in the hammer. It may be shorted, or the firing pulse from the interface and control logic may be failing.

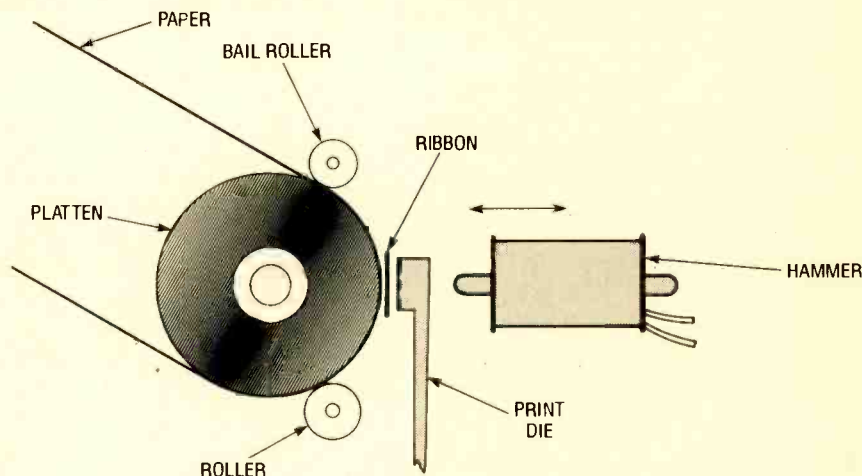

Fig. 2. This is a typical wheel-type print head assembly. The print die is a daisy-wheel type.

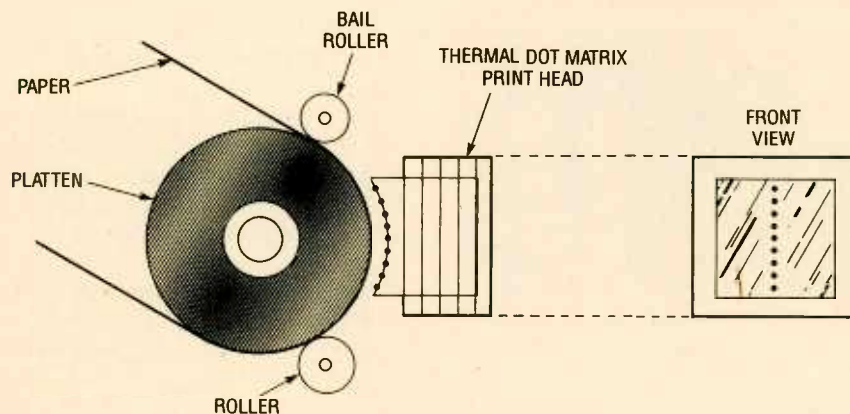

Fig. 3. A thermal dot-matrix print head must come in close contact with the paper to be effective. That's why it has a curved shape.

**Thermal Dot-Matrix.** Essentially, thermal dot-matrix printers work with the same control principles as impact dot-matrix printers. The major exception lies in the head itself. A thermal head uses an array of pin-point heating elements to form the necessary dot sequences on a special heat-sensitive paper (see Fig. 3). Controlling logic will activate the pin heaters which are so small that they can be heated and cooled again almost instantly. That allows very clear characters and graphics to be formed as the head moves across the paper. Thermal printers can be made very small, quiet, and light. That makes them popular in portable instrumentation.

To make a thermal print head reliable and rugged, the pin heaters are potted with hard, high-temperature epoxy right into its face. That prevents accidental damage and tampering, but it also prevents any chance of repair. If an element in the thermal print head itself should fail, the entire print head will have to be replaced.

Table 3 shows the troubleshooting chart for thermal dot-matrix printers. Like most conventional printers, the continuous flexing of wires at the print head can eventually raise havoc by opening or shorting. Such a circuit failure can cause smudged or missing lines in the print.

Beware of your thermal paper's quality and position. It should be fresh and inserted with the heat-sensitive side facing the print head. If the paper is not heat-sensitive or loaded properly, the printer will not generate any characters.

**Ink-Jet Dot-Matrix.** Ink-jet print heads literally paint dot-matrix text and graphic characters onto a page surface (see Fig. 4). The ink comes from a

reservoir and squirts out a nozzle. Vertical- and horizontal-deflection plates exert forces on the ink, which is ionized,

that will direct the droplets to the desired spots on the page. That "draws" the characters as the carriage moves the head across the page.

A continuous-flow ink-jet head circulates ionized ink out of the nozzle constantly, regardless of whether or not a character is actually being formed. A trough captures any unused ink flowing from the nozzle, such as when the print head is between characters or idling. The idle ink is filtered and re-circulated back to the print head.

The more popular drop-on-demand ink-jet head uses piezo-electric crystals to force out ink droplets only when a character is being formed. Vertical- and horizontal-deflection signals direct the droplets as needed based on information from the control circuitry.

Ink-jet heads are much fussier than

TABLE 2—WHEEL-TYPE IMPACT PRINT HEAD TROUBLESHOOTING CHART

Symptom	Possible Solution	Check Wiring to Print Head	Check Hammer and Hammer Drive Circuit	Check Other Driver Circuits	Check Die For Broken, Bent, or Missing Characters	Check Power Supply	Check Communication Logic	Check Ribbon and Ribbon Advance
No Print		•	•	•	•			
Certain Characters Do Not Print, or Print Incorrectly				•	•			
Intermittent Print		•			•	•	•	
Prints OK, But Faintly			•					•

TABLE 3—THERMAL DOT MATRIX PRINT HEAD TROUBLESHOOTING CHART

Symptom	Possible Solution	Check Wiring to Print Head	Check Pin Heaters on the Print Head	Check Driver Circuits	Check for Proper Paper	Check Print Head Spacing and Alignment	Check Power Supply	Check Communication Logic
No Print		•	•	•	•	•		•
Intermittent Print		•		•			•	•
Faint Print					•	•	•	
Black Smudged Lines in Print		•	•	•				
White Missing Lines in Print		•	•	•				



other dot-matrix heads. A fresh supply of liquid ink is needed at all times, and the nozzle in the head can dry out and clog if left unattended for a long period of time. The ink must also be right for the particular print surface—an ink used on paper may not work well on metals, plastics, or other types of paper, and vice versa. Faint or smudged print can result.

Table 4 lists some common problems and solutions for ink jet printers. Faulty or intermittent print can often be traced to wiring problems at the head. A short or open connection can interfere with nozzle control pulses or deflection signals. Failures in the driving circuitry or power supply can easily distort characters or misfire the ink jet causing smudged lettering.

**Power Supplies.** Power supplies are used to convert an AC line voltage into one or more DC voltages needed by the logic and driving circuits of the printer, as well as electromagnets, solenoids, and motors that perform the printer's mechanical functions.

The power supply is often one of the most neglected sections of any electronic system. Never underestimate the importance of a power supply. Trouble there may effect every other aspect of a printer's operation. In some cases, a supply fault can even cause damage to other portions of the printer.

Regardless of the size and power capacity of the supply, or the number of voltages levels it provides, all supplies can usually be broken down into 4 important sections: the transformer, the rectifier, the filter, and the regulator.

Transformers convert the AC line voltage that enters the printer into a lower AC voltage. The rectifier network changes the low-voltage AC into a very coarse form of DC called "pulsating DC"—unusable by most circuits. A filter is then used to smooth out the extreme variations in the pulsating DC. The "filtered DC" will still have some minute variations in it (called "ripple"), but it is suitable for rugged electrical parts such as motors and solenoids. Filtered DC is sent through a regulator that fixes the filtered DC at a stable, constant, ripple-free voltage. The "regulated DC" powers most logic and controlling circuitry.

The troubleshooting chart in Table 5 covers some familiar problems and solutions for power supplies. A total failure in the supply usually suggests an AC-line voltage problem. Check your AC

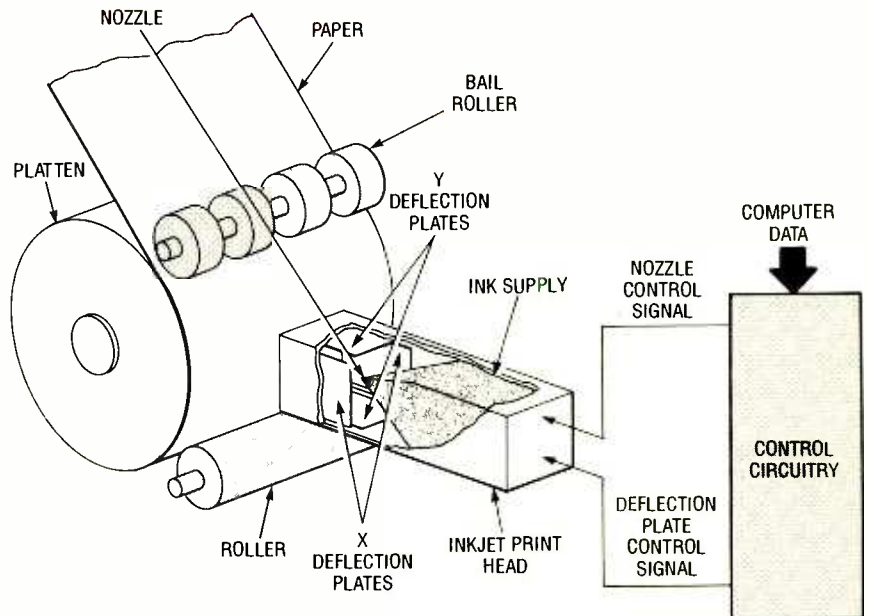

Fig. 4. An ink-jet print head squirts ink on paper under the direction of controlling logic circuitry.

TABLE 4—INK JET DOT MATRIX PRINT HEAD TROUBLESHOOTING CHART

Symptom	Possible Solution								
	Check Writing to Print Head	Check Nozzle Control Signals	Check Deflection Plate Signals	Check Ink Supply	Check Jet Nozzle. Inspect for Clogged Ink.	Check Power Supply	Check Controlling Circuitry	Check for Ink Compatibility with Printing Surface	Check Print Head Alignment and Spacing
No Print	•	•	•	•					
Intermittent Print	•	•				•	•		
Characters Faint or Smudged			•		•			•	•
Black Smudged Lines in Print	•		•				•		
White Missing Lines in Print	•		•		•		•		

connections and fuse. If both are good, check for the correct DC-voltage level(s) at the supply output and inspect the circuit board for shorts or intermittent connections.

Be cautious around the regulators in the supply. Under normal operation, they will become warm from providing current to the rest of the printer.

Many supplies have fan-driven ventilation to reduce stress on components that warm up. Make sure that the fan is working, and that all vents are clear. Otherwise, the supply can overheat and damage the regulators. A failing transformer can also become surprisingly hot and cause overheating problems. Let your senses be your

guide. Power-component failures can often be heard, seen, or smelled.

**Interface and Control Logic.**

Interface and control logic form the "brain" of every modern printer. It is that circuitry that manages and directs every operation of the printer. Logic circuits not only direct the flow of data in the printer, it processes that data and converts it into character and command information. The logic is also responsible for driving the various motors, solenoids, and linkages. Most modern printers use a built-in microprocessor to form a "remote computer" within the printer itself.

Although the theories and principles

of digital circuits, memories, and microprocessors are too voluminous to cover here, it is possible to break down the interface and control logic into five key sections: the microprocessor, the RAM, the ROM, the communications logic, and the input/output logic and drivers (see Fig. 5).

The microprocessor is the key to the interface and control circuit. It must look at the status of every other portion of the circuit, process the information, and send new commands and data as required. Read-only memory (ROM) is a permanent storage area where instructions for the microprocessor are stored. The ROM provides the instructions for power-up, initialization, and self-testing. It also holds the dot sequences (or font styles) for dot-matrix printers, or the character-position information for wheel printers. The RAM (random-access memory) is a temporary storage area that acts as a buffer to store characters and commands coming from the computer. It also acts as a "scratch pad" for the microprocessor's calculations and processing.

The communications logic organizes and maintains the flow of data and synchronization signals between the printer and computer. It also places transferred data into the RAM buffer.

Finally, I/O (input/output) logic directs

the mechanical activities of the printer. It contains drivers for the panel indicators, the print head, the carriage, and paper advance mechanism, as well as reads panel controls and sensors.

Logic troubleshooting can become an involved, time-consuming process that may require more sophisticated instruments (like a digital-logic probe and oscilloscope) to tackle the complex, intertwined maze of IC chips and

printed-circuit traces. Experience is certainly helpful. Table 6 covers some typical problems and solutions.

Before you warm up the oscilloscope, be sure that you have a complete set of schematic diagrams for your specific printer. Schematics are the road maps that will show the pathways through the circuits. Trying to trace logic circuits without schematics is rarely fruitful.

When a printer fails to initialize, just about any part of the logic can be responsible. A printer will normally initialize with a self-test sequence when it is first turned on. Since all portions of the logic ultimately report to the microprocessor, a failure in any one of the logic areas may create an error condition and cause the printer to hang up.

Start with obvious things: Check your computer's software configuration, as well as the communications cable. At that point, investigate the on-board microprocessor and its associated clock-pulse generator. Consider memory chips next. Find out if the RAM and ROM are intact. Finally, check the more discrete logic in the communications and I/O sections.

If the printer appears to initialize, but will not print, consider the communication cable and software set-up again. Check the computer's communications logic to be sure that data is moving into the printer. Check the memory in the printer's data buffer to be sure that it is storing data. If the carriage moves and the paper advances normally, but there is no print, inspect the print-head wiring.

(Continued on page 98)

TABLE 5—POWER-SUPPLY TROUBLESHOOTING CHART

Symptom	Possible Solution				
	Check AC Line Voltage at Supply Input	Check AC Fuse	Check DC Regulator(s)	Check Wiring and Circuit Board for Shorted/Intermittent Connections	Check for Proper Ventilation
No Power. Supply Totally Dead	•	•	•	•	
Intermittent Power	•		•	•	
Higher Than Expected DC Voltages on Outputs			•	•	
Excessive Heating	•				•
Lower Than Expect DC Voltages on Outputs	•				•

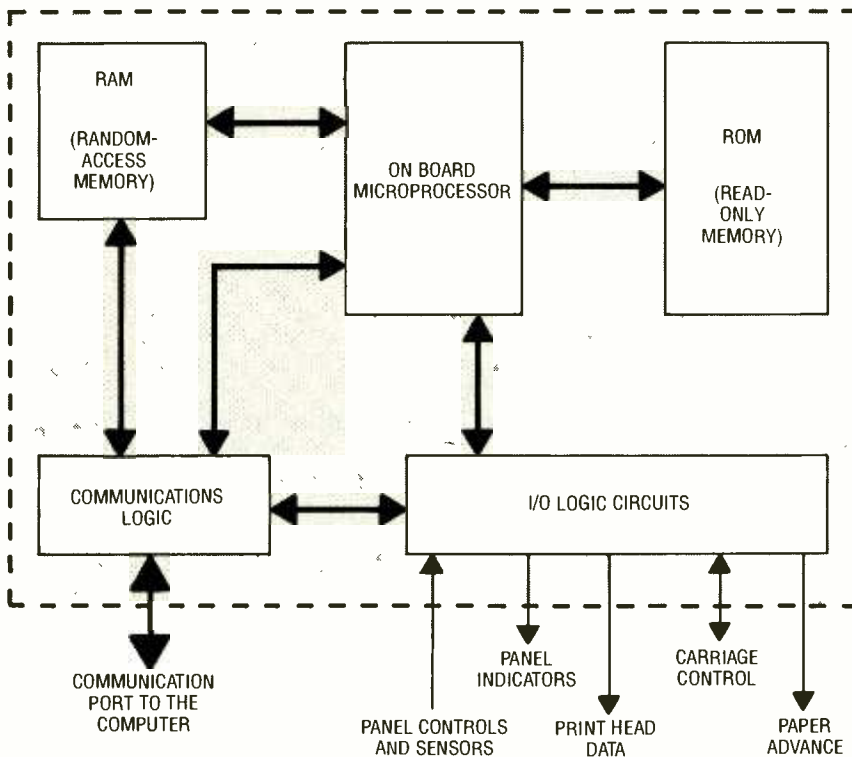

Fig. 5. This is a block diagram of a typical interface and control circuit for a printer. There is a lot of "intelligence" under the hood of a printer.



# THE DIGITAL ELECTRONICS COURSE

## AN INTRODUCTION TO LATCHES

Latches can be considered as data “traffic cops;” they are often used to temporarily halt the flow of data until it’s safe to proceed.

BY ROBERT A. YOUNG

Combinational-logic circuits are often connected to form what’re known as a latches. A latch can be used as a temporary storage device, such as an address latch or an input/output (data) latch in a microprocessor system. In latching operations, a signal must be applied to a specific input (the latching-signal input) to cause the device to respond to its other inputs. Continued application of that signal has no affect on the circuit; e.g., the device is latched in its present state, and will not respond to a new input until it receives another latching signal.

The 74LS374 is an octal D-type flip-flop that can be used for latching applications. A pinout/functional block diagram of the 74LS374 is shown in Fig. 1. The 74LS374 contains eight edge-triggered flip-flops. Information presented to the eight D inputs is transferred to eight Q outputs during the positive-going (low-to-high) transition of the clock pulse. While the clock is high, the latch is said to be transparent, allowing data to pass through unchecked. When the clock input signal makes the high-to-low transition, the output states are latched (jocked) at their present states,

\*Our gratitude is extended to the EIA/CEG for the creation of this course, especially to the consultants who brought it to fruition: Dr. William Mast, Appalachian State University; Mr. Joseph Sloop, Surry Community College; Dr. Elmer Poe, Eastern Kentucky University,

The Digital Microprocessor Course is reprinted here with the permission of the Electronic Industries Association/Consumer Electronic Group (EIA/CEG). The complete parts kit is available from EIA/CEG. For further information, contact EIA/CEG Product Services Department, 1722 Eye Street, NW, Suite 200, Washington, DC 20006; or call 202/457-4986.

and will remain that way until the clock goes high again.

**Demonstration Circuit.** Figure 2 shows a counter circuit in which a 74LS374 octal D-type latch has been placed to form a pseudo random-number generator. You’ll recognize that circuit as a modified version of the circuit used in the decade-counter exercise. As before, the 7490 decade counter has been connected to provide a conventional binary-coded decimal or BCD (8-4-2-1) output signal (the CP1 clock-input terminal is connected to the  $\bar{Q}_0$  input) and the clocking signal is applied to the device’s CP0 input.

When a clock signal is applied to the clock input of the 7490, it counts the incoming pulses and provides a BCD output as usual. The output of the counter is then fed to the latch (the 74LS374 D-type flip-flop). The output of the 7490 is then either passed through the 74LS374 to the 7448 BCD-to-7-segment decoder/driver, or the count is stopped

at its present position, depending upon the logic level at the clock input of the 74LS374.

Let’s say that the decimal number seven (1011) is applied to the data inputs (D1 through D4) of the 74LS374 on the rising edge of the clock signal. That number would be passed through to the Q1 through Q4 outputs. Now if the clock input should go low, the present data (in this case the BCD equivalent of seven) is said to be latched. The data latched into the 74LS374 can thereafter be changed only when the clock signal again swings positive. Thus the circuit becomes a form of random-number generator, with the latch acting as a temporary storage device.

**Latch Exercise.** Assemble the circuit shown in Fig. 2 on your breadboard. If you have not disassembled the circuit from the 1-1/2-Digit Counter exercise, all you’ll have to do is modify the circuit by removing the 7476 flip-flop and DISP2 from the circuit, and then connecting a 74374 between the 7490 decade counter and the 7448 7-segment common-cathode decoder/driver. Once you’ve wired up the circuit apply power and, using your logic pulser, apply a pulse to the clock input of the 7490. Observe the inputs and outputs of the 74LS374 with a logic probe. Record the results (repeat once or twice).

Again using your logic pulser, apply a  
(Continued on page 102)

# PRODUCT TEST REPORTS

By Len Feldman

## Onkyo TX-SV90PRO Audio/Video Receiver

The Onkyo (200 Williams Dr., Ramsey, NJ 07446) TX-SV90PRO Audio/Video Receiver provides all the audio amplification and audio/video switching facilities that you would need for a complete home-theater system. Unlike some AV receivers that provide only minimal power in the surround-sound mode for the rear and center channels, this unit delivers more than 30-watts-per-channel to both the rear and the center-front speakers, and 100-watts-per-channel to the

quality component tuners and offers stereo separation that is better than that found on most tuners or competing receivers.

The TX-SV90PRO incorporates full Dolby Pro Logic decoding, including an additional center-channel amplifier for complete realization of Pro Logic's spatial benefits. The unit also provides hall and matrix surround-sound modes. A step-adjustable, digital time delay, accessible in Dolby and hall modes, allows modification of the per-

use with a camcorder, and video-dubbing capabilities are also provided. Audio inputs include two tape circuits that also have dubbing capability. Pre-amp-out/main-amp-in connections are associated with the front channels and facilitate bi-amplification (the addition of a separate amplifier) and the use of a subwoofer. Preamplifier-output jacks for the rear and center channels allow easy substitution of high-powered external amplifiers if you decide that your rear and center-channel speakers require more power than is provided by the receiver's own rear and center channels. Up to 20 AM and FM presets can be set for the tuner section, so that your favorite radio stations can be accessed at the touch of a button on the front panel or via the programmable, supplied remote control. The remote can be "taught" command codes of audio and video products made by other manufacturers.

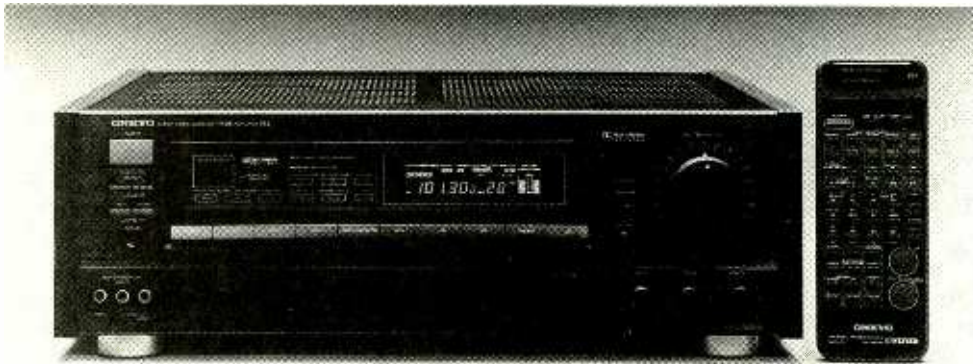

CIRCLE 120 ON FREE INFORMATION CARD

The Onkyo TX-SV90PRO audio/video receiver.

two main front speakers. When used as a conventional stereo receiver, the amplifier section delivers 110-watts-per-channel.

As an audio-only receiver, this Onkyo product can handle both analog-phono and high-level inputs with excellent signal-to-noise ratios and accurate, flat frequency response. Onkyo is noted particularly for excellent FM-tuner designs, and the FM-tuner section incorporated in this receiver is as sensitive as most better-

ceived acoustical environment. The receiver also features a user-programmable mode that allows "phantom" synthesis of center-channel information when the original sound source lacks specific directional information.

All five audio-amplifier channels in this receiver feature discrete output devices. Three of the four video inputs feature supplementary "S-video" connectors. The receiver has a front-panel input for

### CONTROLS

For all its flexibility and control features, the front panel of the Onkyo receiver retains a reasonably uncluttered look thanks to a hinged panel along its lower section that hides the controls that are used least often. A power switch, four speaker-selector switches, and a stereo-headphone jack are at the extreme left. A display area occupies a major section of the panel and has indicators for just about every function of the



receiver, including level indicators for center and rear channels. Ten pushbuttons arranged in a row below the display area are used to select audio- or video-program sources. To the right of the display area are a loudness-control switch, an input-channel balance-control knob, and a master volume-control knob. An illuminated indicator on the volume knob itself lets you see where the control is set even if you are sitting at a distance from the receiver.

Bass, treble, and channel-balance controls are at the lower right of the panel, while the extra set of audio and video inputs mentioned earlier (for quick connection of a camcorder) are at the lower left end of the panel. When the hinged panel is lowered, additional controls associated with the surround-sound and Dolby Pro Logic functions are revealed, along with preset number buttons; "up" and "down" tuning buttons; an FM-mode button (mono/stereo); an FM-mute button; a "memory" button, used when storing frequencies for preset stations; a stereo-simulation button; and a "bass expander" button designed to add a fixed amount of bass boost to the front-channel outputs regardless of the volume-control settings.

As you might expect, judging by the number of available inputs and outputs, there's practically no empty area on the rear panel of this versatile receiver. Nevertheless, all inputs, tape outputs, and speaker terminals are logically arranged and clearly labeled, so that even if you refuse to refer to the owner's manual (something we don't recommend) you could probably hook up the receiver to your other components and speakers without too much trouble.

## TEST RESULTS

We tested the FM-tuner section of the receiver first. Figure 1 shows that the frequency response, though not quite "flat," deviates by no more than  $\pm 1.0$  dB from 20 Hz to 15 kHz. Figure 2 shows how the FM signal-to-noise ratio varied as a function of input signal strength. With strong signals, mono S/N measured a very acceptable 76.5 dB while stereo S/N under the same conditions measured just over 70 dB; 50 dB quieting was reached with signal strengths of 19 dBf (dB's referred to 1 femtowatt; a femtowatt is  $10^{-10}$  watt) in mono and 42 dBf in stereo. Figure 3 shows how dis-

ortion plus noise varied with signal levels. For strong signals, distortion plus noise in mono was only 0.1%, referred to 100% modulation levels, while stereo THD (total harmonic distortion) plus noise was just over 0.2%. From those measurements we were also able to determine the so-called usable sensitivity of this tuner section, which was 17 dBf for mono and 23 dBf for stereo.

Stereo separation was excellent. Not only was the separation 40 dB or better at mid-frequencies, but that separation held true for almost the entire audio spectrum, as shown in Fig. 4. The upper, solid trace

represents the output from the desired channel, while the lower, dashed-line trace shows how much crosstalk appeared at the output of the unmodulated channel in the stereo mode. The AM-suppression ratio measured 53 dB as against 50 dB claimed by Onkyo, while the capture ratio measured exactly 1.5 dB, as claimed by the manufacturer. IF rejection was 95 dB, while alternate-channel selectivity was a bit higher than the 65 dB claimed. The muting level was 20 dBf.

As for the AM-tuner section of this receiver, the less said the better. For all the efforts recently made to convince both broadcasters and receiver manufacturers to improve AM transmission and reception, Onkyo seems to have done little to implement such improvement in this particular receiver. Figure 5 shows, believe it or not, the frequency response of the AM-tuner section. The  $-6$ -dB cutoff points occur at 50 Hz and 3.0 kHz—providing fidelity that's not much better than what you might expect when music is played over a telephone! The poor fidelity of the AM tuner is no great surprise, however. Most high-fidelity receiver and tuner manufacturers devote very little attention to the AM-tuner sections of their products because they feel that music lovers are not likely to use AM as a source of high-fidelity music programming.

Next, we measured the performance of the amplifier channels. The frequency response of the front channels when the receiver is operated in stereo mode is shown in the plots of Fig 6. A slight channel imbalance between left and right outputs was noted (generally less than 1 dB), which could be easily corrected by means of either the input-balance control

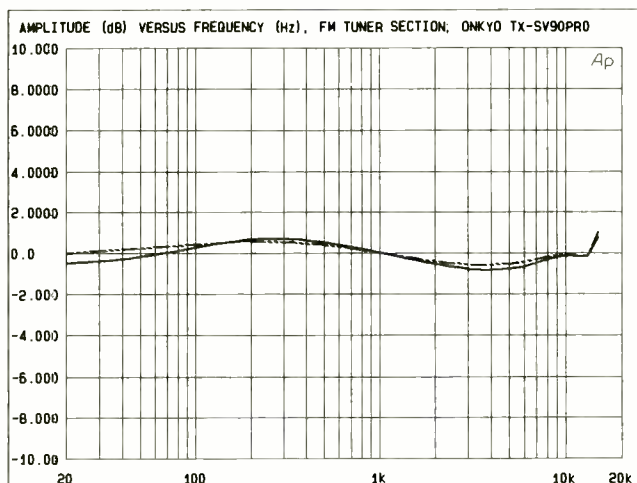

Fig. 1. While the frequency response was not quite "flat," it deviated by no more than  $\pm 1.0$  dB from 20 Hz to 15 kHz.

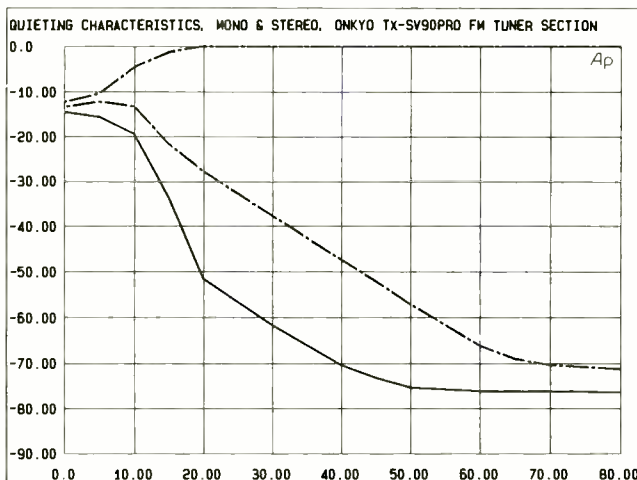

Fig. 2. At strong signal levels, mono S/N (solid trace) measured a very acceptable 76.5 dB, while stereo S/N (lower dashed trace) under the same conditions measured just over 70 dB. The upper dashed trace is the audio reference level.

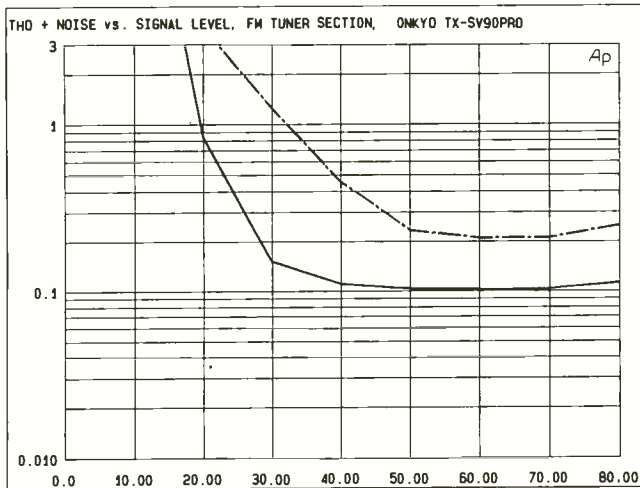

Fig. 3. For strong signals, distortion plus noise in mono (solid trace) was only 0.1%, referred to 100% modulation levels, while in stereo (dashed trace), THD plus noise was just over 0.2%.

or the regular channel-balance control.

Attempting to measure the frequency response of the rear channel amplifiers in any of the surround-sound modes proved difficult, since various amounts of time delay are automatically introduced by the circuitry. For example, examine the plots shown in Fig. 7. The solid-line plot is simply a repeat of the front-channel frequency response and is shown for reference. The dashed-line plot seems to have a series of peaks and nulls, but they were caused by the inability of the tracking filters in our test equipment to compensate for the time delays introduced into the rear channels. If you mentally "average out" those peaks and valleys you will see that in the surround-sound mode roll-off of the rear-channel response begins at around 5 or 6 kHz, as it should. (In surround-sound systems, rear-channel response should not extend all the way to 20 kHz, since in a concert hall environment, high-frequency reverberant sound is absorbed by wall surfaces.)

We next measured the harmonic distortion plus noise of the front amplifiers, operating in stereo mode,

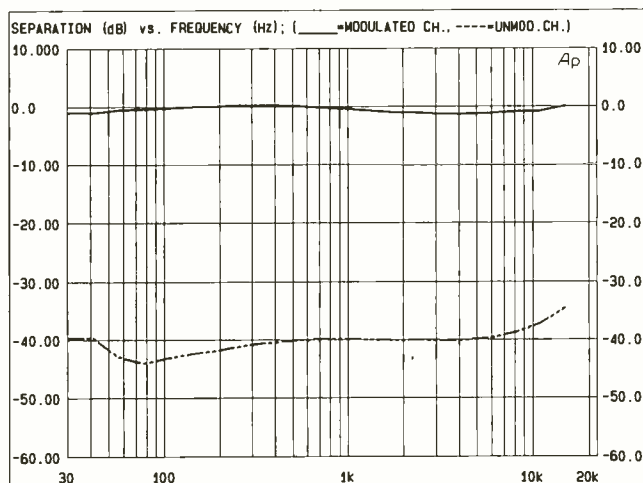

Fig. 4. Stereo separation was 40 dB for almost the entire audio spectrum. The upper, solid trace represents the output from the desired channel, while the lower, dashed-line trace shows how much crosstalk appeared at the output of the unmodulated channel in the stereo mode.

as a function of power-output level per channel. The amplifier easily produced its rated 110 watts per channel both at mid-frequencies (middle trace in Fig. 8) and at the frequency extremes of 20 Hz and 20 kHz (lower and upper plots of Fig. 8). The distortion plus noise at the rated output ranged between 0.005% and 0.02%, depending upon the test frequency. Onkyo specifies a THD of 0.04% at the rated output using 8-ohm loads.

The power-output capability of the rear channels was also measured. The rear-channel

and center-channel amplifiers easily produced the rated 30-watts/channel at far less than the rated THD level of 0.08%, even while the front channels were delivering their rated power output of 100-watts-per-channel in the surround-sound mode.

The amplifier A-weighted signal-to-noise ratio for the high-level (CD, AUX, etc.) inputs was a satisfactory 76.2 dB below 1 watt, referred to a 0.5-volt input. As is usual, phono signal-to-noise ratio was a bit lower, reading 73.1 dB below 1-watt output, referred to 5

millivolts of input. Input sensitivity of the high-level inputs was 15 millivolts for a 1 watt output, while 0.25 millivolts were required to produce 1 watt of output via the phono inputs. Phono equalization was accurate to within 1.0 dB of the prescribed RIAA playback-equalization curve.

Since the video circuitry of the Onkyo TX-SV90PRO receiver is essentially switching and control circuitry, we simply confirmed the fact that both luminance (brightness) signal and chroma (color signal) video signal-to-noise ratios were far better than the S/N ratios of video products that were likely to be connected to and controlled by the receiver.

## HANDS-ON TESTS

We hooked up the Onkyo TX-SV90PRO receiver in our home-theater surround-sound system, substituting it for some five components that had been required to provide pretty much the same control flexibility and amplification channels as this single component. Watching and listening to a Dolby-encoded videotape or video disc of a motion picture provides the viewer/listener with a sense of in-

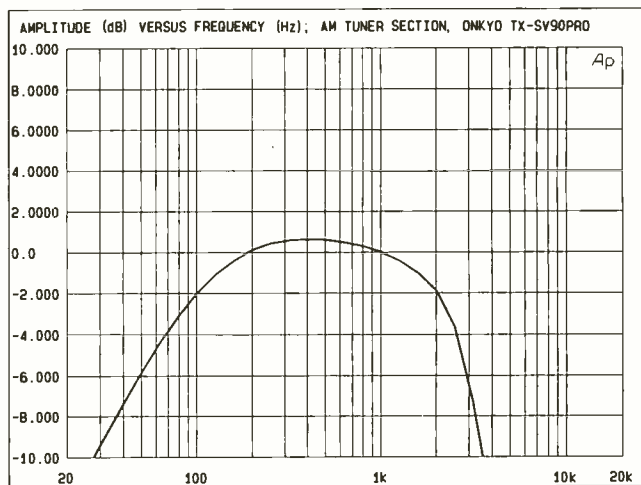

Fig. 5. This plot shows the frequency response of the AM-tuner section. The -6-dB cutoff points occur at 50 Hz and 3.0 kHz, providing fidelity that's not much better than what you might expect from a telephone.



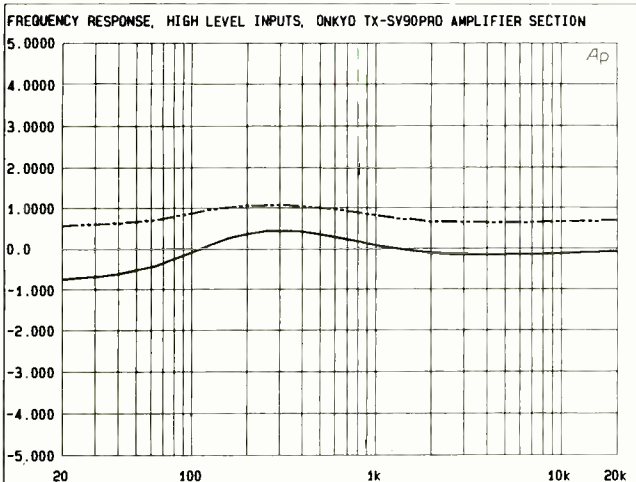

Fig. 6. The frequency response of the front channels when the receiver is operated in stereo mode is shown here. The slight imbalance between left and right outputs can be easily corrected by means of either the input-balance control or the regular channel-balance control.

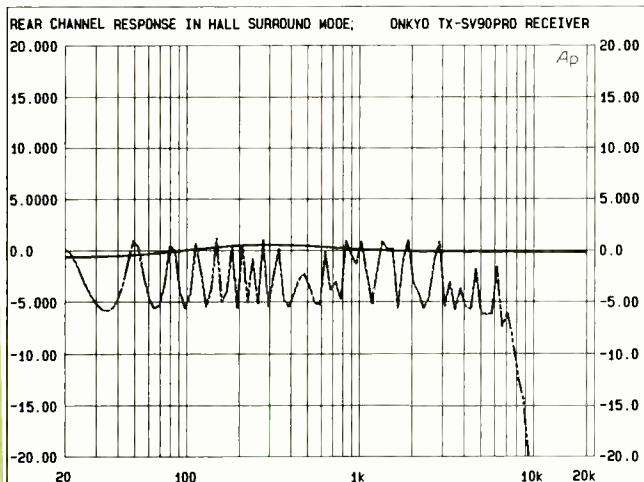

Fig. 7. The peaks and nulls in this plot of the rear-channel frequency response (dashed trace) were caused by the inability of the tracking filters in our test equipment to compensate for the time delays introduced into the rear channels.

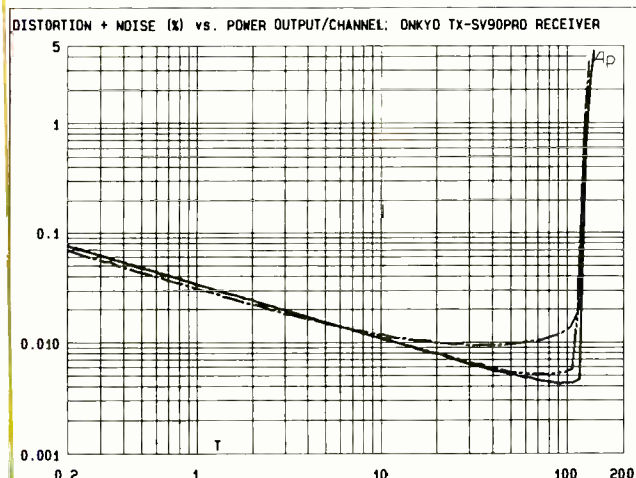

Fig. 8. The amplifier easily produced its rated 110 watts per channel both at mid-frequencies (middle trace) and at the frequency extremes of 20 Hz (lower trace) and 20 kHz (upper trace). The distortion plus noise at the rated output ranged between 0.005% and 0.02%, depending upon the test frequency.

## TEST RESULTS—ONKYO TX-SV90 PRO A/V RECEIVER

Specification	Amplifier Section	PE Measured
Power Output		
Stereo Mode		116 W/channel
Surround Mode, Front		105 W/channel
Surround Mode, Rear & Center		45 W/channel
Distortion		
Front Channels		0.02%
Rear Channels		0.017%
Input Sensitivity (for 1W output)		
High Level Inputs		15 mV
Phono		0.25 mV
Signal-to-Noise Ratios		
High Level (re: 1W, 0.5V input)		76.2 dB
Phono (re: 1W, 5.0mV input)		73.1 dB
Tone Control Range		
Bass, at 100Hz		± 9 dB
Treble, at 10 kHz		+ 8, - 9 dB
Phono Overload		120 mV
RIAA Deviation		± 0.8 dB
Phono Overload		120 mV
Frequency response		
Front Channels, 20 Hz to 20 kHz		+ 0.3/ - 0.8 dB
Rear Channels, 30 Hz to 7.0 kHz		+ 0, - 3.0 dB
Muting Level		- 20 dB
<b>FM Tuner Section</b>		
Usable Sensitivity, Mono/Stereo		17/23 dBf
50 dB Quieting, Mono/Stereo		19/42 dBf
Signal-to-Noise Ratio, Mono/Stereo		76.5/70 dB
Harmonic Distortion, Mono/Stereo (1 kHz)		0.1/0.2%
Stereo Separation, 1 kHz		40 dB
Capture Radio		1.5 dB
AM Suppression Ratio		53 dB
IF Rejection		95 dB
Alternate Channel Rejection		65 dB
Frequency response		30 Hz to 15 kHz, ± 1.0 dB
<b>AM Tuner Section</b>		
Frequency Response		50 Hz to 3 kHz, - 6 dB
Usable Sensitivity		30µV
Signal-to-Noise Ratio		40 dB
Image Rejection Ratio		40 dB

### General Specifications

Dimension (W × H × D, inches)	18 $\frac{1}{16}$ × 6 $\frac{1}{4}$ × 17
Weight	32.3 lbs
Suggested Retail Price: \$1100.00	

involvement in the action on screen that just cannot be duplicated with a two-channel stereo system. Spatial localization of sounds was truly impressive in the Dolby Surround mode, while the hall and matrix modes, though not as effective on ordinary stereo programming, nevertheless made our rather small listening room seem much larger and acoustically better than it actually was.

Controls were easy to use once we familiarized ourselves with them, and the owners manual provides all the tips you'll need to take

full advantage of the flexibility and versatility of the receiver. Considering the splendid features of this do-it-all audio/video receiver, its suggested retail price represents a real bargain. If you had to assemble a group of separate components capable of doing the same job as the Onkyo TX-SV90PRO you might well end up spending at least twice as much, if not even a bit more.

For more information on the Onkyo TX-SV90PRO, contact the manufacturer, or circle no. 120 on the Free Information Card.



# INDIVIDUAL TRAINING FOR LOTUS 1-2-3

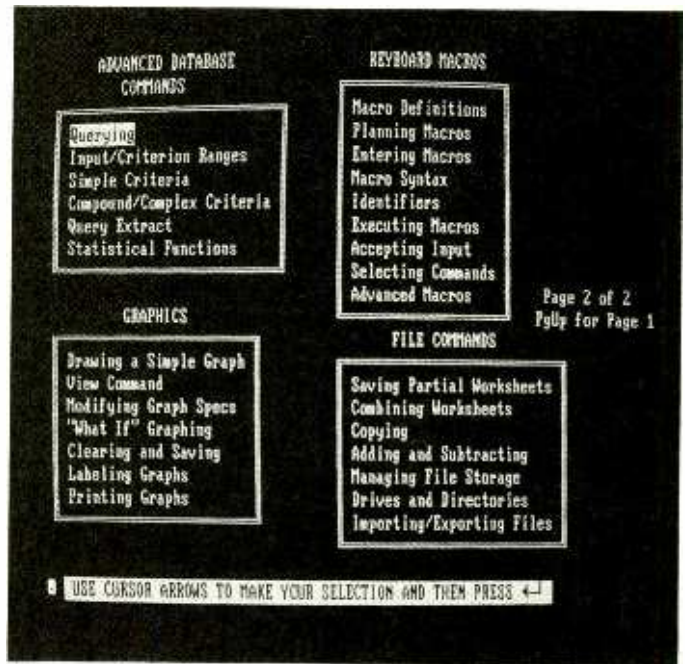

CIRCLE 119 ON FREE INFORMATION CARD

*Step-by-step instructions with interactive practice sessions let you master Lotus 1-2-3 before you actually use it. It includes coverage of macro commands, too.*



*This screen display describes how to insert or delete a column in an existing spreadsheet. The display above the window is what you would see in an actual Lotus 1-2-3 session.*

Everyone should become familiar with Lotus 1-2-3 because it is one of the most popular programs used by accountants, businessmen, and other professionals. Soon after its release in 1983, Lotus 1-2-3 vaulted to the top slot of the computer software best-seller list. The program package combines an electronic worksheet for performing extremely fast calculations; graphics, for providing visual presentations of the results; and database management, for managing lists of related information.

However, Lotus 1-2-3 can be a problem because, like so many other humungus programs, it is so extensive

that a user who doesn't use the program frequently is sure to forget much about running it. To many casual users, each Lotus 1-2-3 session becomes a refresher course. Additionally, the Lotus 1-2-3 manual requires extensive reading time and it is complex. The manual is not the ideal text for either learning how to use Lotus from scratch or for relearning what you've forgotten.

**How Sweet It Is.** Individual Training for Lotus 1-2-3 software by Individual Software, Inc. (ISI) is designed for beginners and experts, alike. The software provides an interactive introduction to the basics of Lotus 1-2-3 as well as in-depth coverage of database man-



*Lotus users can run one or more windows while working on a spreadsheet. This screen trains the user on how to clear (delete) unwanted windows.*

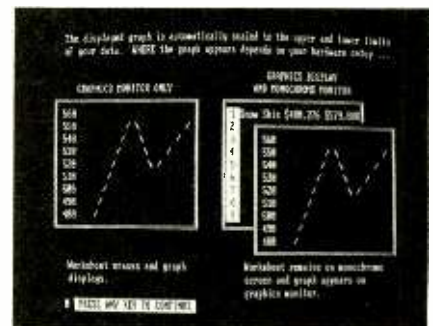

*Lotus is capable of several types of graphic displays. A sample line chart is seen on the training screen.*

agement, spreadsheet analysis, and graphing operations. It presents comprehensive lessons on user defined keys called "macros," an overall view of various functions available in Lotus 1-2-3, plus interactive lessons covering "what-if" analysis using data-table commands. That's a lot of interactive training for one educational software package.

The manual consists of 11 pages, and that is a credit to ISI's training-program philosophy. After the brief program discription, license agreement, and copyright protection are discussed, the user is informed of how to either run the program from two copied floppy disks, or from a subdirectory from the system's hard disk. Once the program is running,

*(Continued on page 97)*



# Give a Friend a Year of Electronics Fun this Christmas. . .

Does fighting the crowds at Christmas short-circuit your holiday fun? Don't blow a fuse this year. . .for the friend who shares your love of project-oriented electronics — or a youngster who may need only a spark to ignite a life-long interest — give a gift subscription to Popular Electronics.

. . . Because when you give him Popular Electronics, you're giving month after month of challenging construction projects — including complete plans for testing equipment, electronic worksavers for home and car, add-ons and modifications for hi-fi, computers, radio and TV.

He'll get the how-to he needs to build exciting, useful projects like these. . .a touch light dimmer. . .a traveler's theft alarm. . .an economy NiCd battery charger. . .a voice synthesizer. . .a wave form generator. . .the ultimate burglar alarm. . .a stereo graphic equalizer. . .and many, many more!

PLUS. . .testbench tips and techniques. . .circuit design. . .electronics fundamentals. . .book reviews and new product news including our 12-page "Gizmo" section. . .regular columns on computers, scanners, dx'ing, ham and antique radio. . .the list goes on and on!

**SAVE MONEY.** . .A great gift to receive, Popular Electronics is also a great gift for *you* to give! The Special Holiday Rate saves you \$11.00 off the newsstand price on each gift. You can save another \$11.00 when you start or extend your own subscription at the same time. It's our "thank-you" for sharing Popular Electronics with a friend this Christmas.

Send no money, unless you prefer. We'll be glad to bill you in January, Next Year. Just take a brief moment to go over your gift list and make sure you haven't forgotten anyone who might appreciate the many benefits of Popular Electronics. Then write the names on the attached Gift Certificate and mail it back in the postage-paid reply envelope. . .we'll take it from there!

Your friends will receive a handsome gift announcement card signed with your name just before Christmas. And all through the new year they'll remember and appreciate your thoughtful gift!

So don't blow a fuse. . .take it easy and enjoy the holidays. Give Christmas gifts of Popular Electronics!

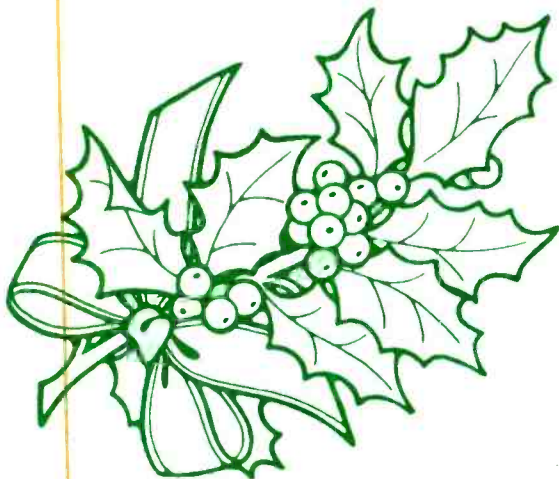

# ANTIQUE RADIO

By Marc Ellis

## Tube Testing Power!

In September and October, we started talking about some basic tube-tester circuits. By the end of the October column, we had built up a schematic diagram that could be used as a model for putting together a practical unit for testing early tubes. But, at the time, I cautioned you against attempting to build

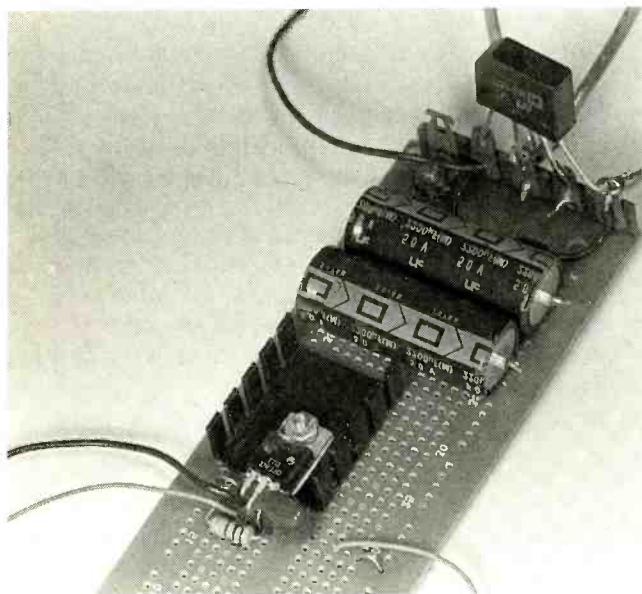

A close shot of the circuit board shows the major regulator components. Note the bridge rectifier installed at the rear.

from that schematic because it was *only* a model and there were still a few details to be worked out. Some of the most important of those details involve the methods for providing and controlling power to the tube under test.

### POWER CONTROL THE OLD WAY

Early testers typically used either a rheostat or a tapped-transformer secondary to adjust the filament voltage to the correct value. Plate voltage usually came from direct connection to the AC

power line. It wasn't necessary to convert to DC because the tube being tested acted as a rectifier, providing its own direct-current supply. Sometimes a rheostat was also provided to adjust plate voltage to a standard value; sometimes not.

Rheostats really aren't a very good solution because the degree of voltage control they exert (governed by Ohm's inexorable law) depends not only on their resistance value, but also on the current running through them. Sometimes two different values of filament rheostat had to be provided: one for tubes with low-current filaments (such as the 12 or the 99), the other for tubes with higher-current filaments, or heaters (such as the 80 or the 27).

Using a rheostat, it wasn't possible to set filament voltage in advance of plugging the tube into the tester. With no tube in the socket, no current would flow through the rheostat. Hence, no control was possible and the filament-voltage meter would simply read the total output of the transformer supplying the circuit. You had to remember to turn the rheostat to its maximum resistance position before plugging in a new tube type. Once the tube was in place, you could then ease the voltage up to the correct value.

The plate currents involved in tube tests are relatively small, often on the order of a few milliamperes. Thus, rheostat control of plate voltage presented an even greater problem. One early-day schematic I looked at showed a 25-

watt lamp (which doubled as a kind of pilot light) connected across the output of such a rheostat to provide enough current flow for adequate voltage control. Of course, if plate voltage was going to be supplied directly from the AC line, the shaft of the rheostat could easily be 110 volts hot to ground. But the ancients didn't seem to worry as much about those things as we do now.

In any case, even if I wanted to stick with the old way of doing things, the parts would be difficult to come by now. The necessary rheostats and/or tapped-secondary filament transformers are definitely not available at the average electronics supply store. You'd probably have to obtain them by scrounging through hamfest flea markets or surplus catalogues. And my plan is to come up with a unit that could be put together almost exclusively from Radio Shack parts.

### SEMICONDUCTORS TO THE RESCUE

An excellent solution to the filament-voltage-control problem is offered by a remarkable, and readily obtainable, integrated circuit—the LM317T voltage regulator. Its thumbnail-sized package contains a couple dozen each of transistors and resistors, not to mention several capacitors and Zener diodes. Requiring only a handful of external parts, this simple-looking, but highly sophisticated, unit can provide an adjustable regulated output of from 1.2 (depending on input voltage) to 37 volts—at currents in excess of 1.5



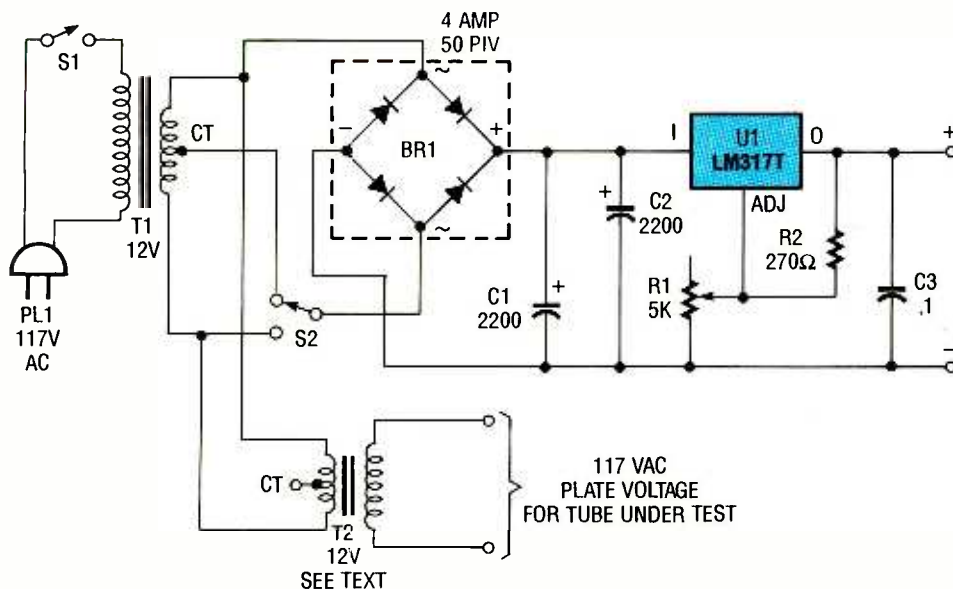

### PARTS LIST FOR THE REGULATOR CIRCUIT

- U1—LM317T adjustable regulator, integrated circuit
- BR1—4-amp, 50-PIV bridge rectifier
- R1—5000-ohm, linear-taper potentiometer
- R2—270-ohm, 1/2-watt resistor
- C1, C2—2200-μF, 50-WVDC, electrolytic capacitor
- C3—0.1-μF, 50-WVDC, ceramic-disc capacitor
- T1, T2—12-volt CT, 3-amp transformer
- S1—SPST switch
- S2—SPDT switch

Fig. 1. Schematic of the regulator circuit. (T2 is not part of regulator—see text.)

amps. Those specifications satisfy the filament-voltage and current requirements of most of the tubes we'd be interested in testing.

The fact that the LM317T is basically a DC device is no problem. All of the tubes to be tested are designed for either DC or AC operation, and the DC input for the regulator can be obtained from a \$1.39 bridge rectifier. The LM317T itself is currently available for the princely sum of \$1.99. Correctly wired up to its few external components (including the small carbon potentiometer used as a voltage control), the little regulator will deliver, and hold, any selected voltage within its range.

The LM317T also contains its own on-board current-limiting and thermal-overload circuitry. If you try to overload it, the regulator shuts itself down, reducing current flow to a minimum.

#### THE CIRCUIT

Figure 1 shows an LM317T regulator circuit suitable for use as a filament/heater power supply in our tube tester. Regular readers will recall seeing an almost identical circuit in August, where it was mentioned as an example of a power supply that could be used

for tube rejuvenation. At that time, it was presented only as an idea; but in this column I've put together and tested a practical version. The circuit and component values came directly from Radio Shack literature and, as of this writing, all parts are available at Radio Shack.

Transformer T1 is rated at 12 volts (center-tapped), 3 amperes. Though a 25-volt transformer is recommended at T1 when constructing a general-purpose power supply, the 12-volt unit is more than adequate for putting out the relatively low voltages we need for testing tubes. In fact, using switch S2, we can make use of the transformer's center-tap, converting it into a 6-volt source.

The lower voltage will be suitable for many, if not most, of the tube types we'll be testing, and will put less strain on the LM317T regulator when high currents must be drawn from it. For example, some tubes (such as the type 27) will draw a little more current than the regulator's 1.5-amp rated output. And though the tough little '317T seems happy to provide the extra current without shutting down, it's important to

"baby" it as much as possible. The 3-amp rating suggested for transformer T1 is adequate to handle the current drawn by any of the tubes to be tested plus the power dissipated as heat within the regulator.

Bridge BR1 rectifies the AC output of the transformer, changing it to DC suitable for processing by the regulator. Capacitors C1 and C2 filter the pulsating DC output of the rectifier—converting it to relatively hum-free steady DC suitable for powering a variety of electronic circuits.

I went along with the 2000-microfarad value suggested for C1 and C2, even though such heavy filtering isn't necessary for our present purpose. The relatively small extra expense is justified because it makes the power supply more versatile—allowing it to be used in situations where well-filtered DC is essential. For example (though I haven't tried it yet) this little supply should serve well as an "A"-battery eliminator for firing up radios with tubes having DC filaments. It should be able to handle five or six 01-A's without complaining a bit.

Integrated circuit U1 is the LM317T regulator and, in spite of its internal complex-

ity, has only three terminals for connection to outside components. Potentiometer R1 and resistor R2 form a voltage-divider network that provides an adjustable bias for the regulator's voltage-control terminal. Capacitor C3 is a small bypass unit that is necessary for stable operation of the regulator circuitry.

Transformer T2 is identical to T1, and its 12-volt secondary is connected to the matching one on T1. With T2 connected "backwards" in that way, the equivalent of the AC line voltage will appear on its primary. However, this "back-to-back" hookup effectively isolates the primary from the AC line, making it a safe 117-volt source. This will be the source of plate voltage for the tubes under test, and will be discussed further in the next column.

#### CONSTRUCTION

I assembled the regulated power supply on a Radio Shack predrilled board (Cat. #276-170). That particular board was chosen because it was set up with some convenient bus lines (a bus is series of holes connected together electrically by the board foil) suitable for the plus and minus sides of the regulator circuit. The circuit used up only a little more than half the space on the

board, which was fine with me. I wanted to keep a little extra board space available for unforeseen needs during development of this project. Time will tell whether I need it or not.

**Note:** Since this project is being developed as we go along, please don't begin building the regulated supply until the entire tube tester has been assembled and checked. That will give me an opportunity to make circuit additions and changes, as necessary, without inconveniencing you. It will also allow me to thoroughly evaluate the completed tester so that I can report on its capabilities and limitations. Then you can make an intelligent decision about whether you'd like to build a duplicate.

When you're ready to build this unit, you can use whatever construction layout or technique you'd like, including "ugly" point-to-point wiring using wire leads. Just try to keep the leads reasonably short to ensure the effective bypassing necessary for stable operation of the regulator.

One point that is highly critical, however, is the adequate heat sinking of the LM317T. There can be no compromise here because the regulator is being operated at the limit of its current rating, and even a little beyond. I used the Radio Shack 276-1363 heat sink, designed for PC-board mounting of the TO-220-style case used for this particular integrated circuit. That is an anodized-aluminum unit carrying several fins for rapid dissipation of the heat absorbed from the case.

I did *not* use the 376-1373 mounting-hardware kit, which includes a mica insulator for electrically isolating the mounting plate of the TO-220 case from the surface to which

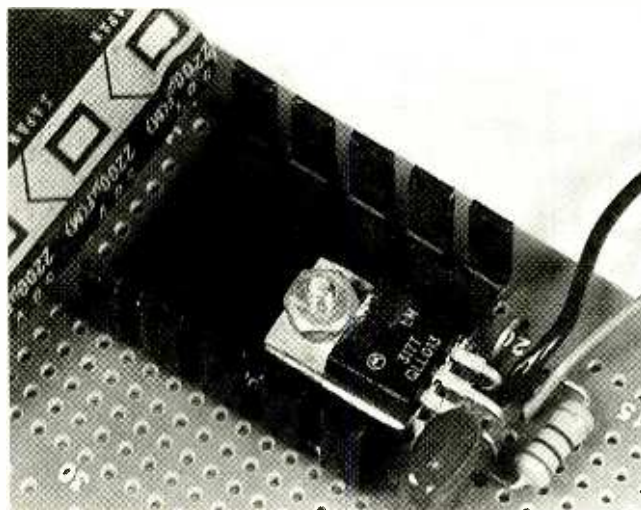

*An extreme close-up of the heat-sink assembly shows the LM317T securely mounted at center. Capacitor C3 and resistor R1 can be seen at lower right.*

it's attached. To get the maximum heat dissipation, I wanted the plate to be in direct contact with the heat sink. The plate happens to be electrically connected to the regulator's output terminal, which thus makes the heat sink "hot" to ground. But that's not particularly important as long as you understand the situation and mount the board in such a way that the heat sink could never be accidentally grounded.

Before placing the regulator mounting plate on the heat sink, smear it well with heat-sink grease (Radio Shack 276-1372). That ensures the most effective transfer of heat between plate and heat sink. Then be sure to get the mounting screw good and tight so that plate and heat sink are in the most intimate possible contact.

A couple of final points on construction: You'll notice from studying the pictures that bridge rectifier BR1 is not mounted directly on the circuit board. Its leads are too big to fit through the holes in the board, and drilling out the holes to fit the leads wouldn't leave enough foil on the board to make a decent electrical connection. Accordingly, I simply

mounted BR1 on a separate terminal strip attached to one end of the board and made wire connections between the terminals and the appropriate holes. You'll also notice that the transformer and voltage-control potentiometer are not mounted on the board, but simply connected to it with wire leads. Those components will be mounted independently of the board when all of the parts are assembled in a common enclosure.

## TESTING THE REGULATOR

With the regulator board assembled and wired, I hooked it up temporarily to the transformer and connected a voltmeter across the output. The unit seemed to work perfectly, with potentiometer R1 providing smooth control of the output voltage all the way down to the 1.2-volt value given in the LM317T's specifications.

Next, using clip-lead connections, I wired the regulator's output to the filament connections of a 4-prong tube socket. Adjusting the voltage to the correct value each time, I successively tried firing up a type 12, 01-A, 71-A, and 26 tube. All went well, with the

regulator delivering the required voltage and current for each tube.

Now I was ready for the ultimate test. Switching over to a 5-prong tube socket, I plugged in a type-27 tube. The type 27 pulls 1.75 amperes, or a quarter of an amp more than the LM317T's maximum rating. Yet the regulator didn't shut itself down, delivering the needed current without a hitch. I left the tube powered up for several minutes to invite failure. But, though the heat sink was hotter than the proverbial two-bit pistol, no failure came.

You may wonder why I didn't choose a power-supply design with slightly higher current ratings—at least enough to power 1.75-amp tubes without overload. The answer: To obtain regulated outputs rated at more than 1.5 amps, one must go to a more sophisticated style of supply using at least a few harder-to-find parts.

The simpler arrangement discussed here seems to do the job quite well. And keep in mind that tubes are powered up in a tester for not more than a couple of minutes at a time. That does a lot to minimize burn-out due to overload.

Next time, we'll be back with further progress on the tube tester project. Until then, remember that that I'm looking for your help with background information for some columns I'm going to devote to the RCA Theremin—an electronic musical instrument produced in the late 1920's. Writers of the best letters mailed to me *before Thanksgiving* will receive reprints of the fascinating 1924 Gernsback publication *100 Radio Hookups*. Contact me *c/o Antique Radio, Popular Electronics*, 500-B Bi-County Blvd., Farmingdale, NY 11735.



# CIRCUIT CIRCUS

By Charles D. Rakes

## More Generator Circuits

This month we're going to continue where we left off last month by experimenting with several more waveform-generator circuits.

### STAIRCASE GENERATOR

Our first entry is a 10-step staircase generator (see Fig. 1). Staircase generators are circuits that produce an increasing or decreasing stepped voltage or current.

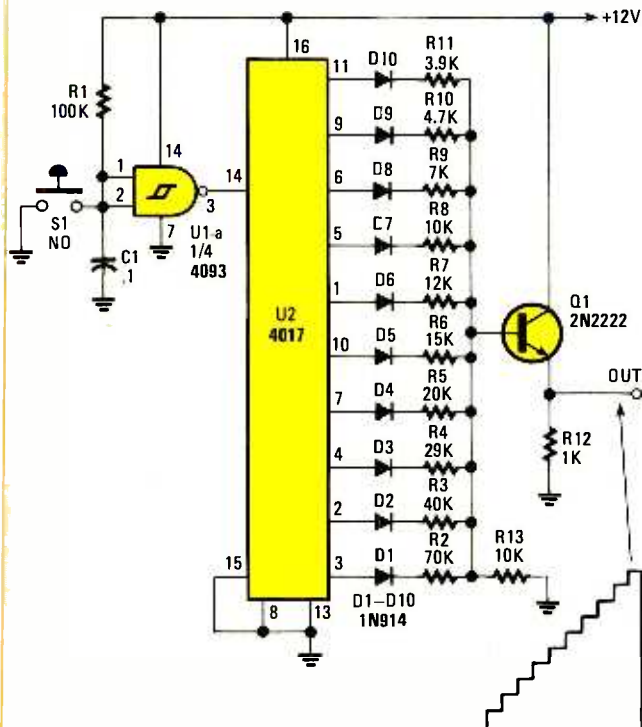

Fig. 1. This 10-step staircase generator is a manually operated circuit built around a 4017 decade counter/divider and one fourth of a 4093 2-input NAND Schmitt trigger, which is used as a switch-debouncing circuit.

Such generators are very useful in many applications such as semiconductor curve tracers, for example. The stepped waveform generator is also found in a variety of video circuits, test instruments, and specialized test set ups, as well

as facsimile or fax machines and gray-scale generators.

The stepping generator in Fig. 1 is a manually operated circuit built around a 4017 decade counter/divider, U2. One fourth of a 4093 2-input NAND Schmitt trigger (U1-a) is used as a switch-debouncing circuit; its job is to ensure that one and only one clock pulse is applied to pin 14 of U2 each time S1 is closed. The values of C1 and R1 are selected to give a time constant that's longer than the closing transition time of S1. The values specified work well with most available switches. However, if you happen to select a really noisy switch, the values of C1 and/or R1 can be increased to extend the time period to cover for S1's poor performance.

The circuit is designed to convert each closure of S1 into an increasing output voltage at the base Q1, causing it to conduct harder. As Q1 conducts harder, the circuit's output voltage at the emitter of Q1 increases by about 0.5-volt per step. That produces an uphill staircase output beginning at near ground level and peaking at about 5 volts. Once the peak has been reached, the next switch closure resets U2, beginning the cycle anew. The inputs of the three unused gates in U1 must be tied to ground or the +V bus.

The upward direction of the staircase can be reversed (producing a downhill staircase) by reversing the positions of R2 through R11. That is, placing R2 (a 70k unit) at pin 11, R3 (a 40k unit) at pin 9, R4 (a

29k unit) at pin 6, and so on.

The staircase generator can easily be converted into a self-generating circuit by reconfiguring U1-a to conform to the schematic diagram shown in Fig. 2, and then feeding its output to pin 14 of U2 in Fig. 1. Simply remove S1 and R1 from the circuit and series connect a 10k fixed resistor and 1-megohm potentiometer in the feedback loop as shown.

The generator's repetition rate can be varied from a low of about 3 Hz to over 300 Hz with the component values shown. If you want to pick up the tempo, all that's required is to reduce the value of C1; or if a speed reduction is desired, increase the value of C1.

The simple circuit in Fig. 3 adds yet another dimension to the staircase-generator circuit in Fig. 1; this one allows any or all of the output steps to be increased in length (time duration). Transistor Q1 (a 2N3904 general-purpose NPN unit) operates as a switch. When Q1 turns on placing C1 in Fig. 3 in parallel with C1 in Fig. 2, the higher capacitance created (remember capacitors in parallel add like resistors in series), lowers the oscillator circuit's normal operating frequency.

The step-stretcher circuit is activated by connecting any one of the inputs in Fig. 3 to the appropriate output pin on the 4017 for the desired step. Output pin 3 is the bottom step, pin 2 is the second, pin 4 is the third, pin 7 is the fourth, pin 10 is the fifth, pin 1 is the sixth, pin 5 is the seventh, pin 6 is the

## PARTS LIST FOR FIG. 1

### SEMICONDUCTORS

U1—4093B quad 2-input NAND Schmitt trigger, integrated circuit  
 U2—4017 decade counter/divider, integrated circuit  
 Q1—2N2222 general-purpose, NPN silicon transistor  
 D1—D10—1N914 small-signal silicon diode

### RESISTORS

(All resistors are 1/4-watt, 5% units.)

R1—100,000-ohm  
 R2—70,000-ohm  
 R3—40,000-ohm  
 R4—29,000-ohm  
 R5—20,000-ohm  
 R6—15,000-ohm  
 R7—12,000-ohm  
 R8, R13—10,000-ohm  
 R9—7000-ohm  
 R10—4700-ohm  
 R11—3900-ohm  
 R12—1000-ohm

### ADDITIONAL PARTS AND MATERIALS

C1—0.1- $\mu$ F ceramic-disc capacitor  
 Perfboard materials, 9-12-volt power source, wire, solder, hardware, etc.

eighth, pin 9 is the ninth, and pin 11 is the top step.

Only six input diodes are shown in Fig. 3, but any number can be added as needed to match the number of steps to be stretched. The length of the step can be doubled by making C1 of Fig. 3 a 0.1- $\mu$ F capacitor. For a longer stretch, make C1 larger, and for less make it smaller. The Fig. 3 circuit allows only the selected steps to be stretched; each step is

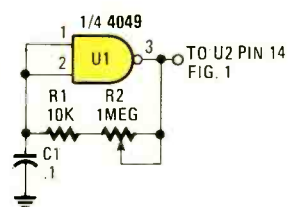

Fig. 2. The staircase generator can easily be converted into a self-generating circuit by reconfiguring U1-a to conform to this schematic diagram, and then feeding its output to pin 14 of U2 in Fig. 1.

## PARTS LIST FOR FIG. 2

U1—4093B quad 2-input NAND Schmitt trigger, integrated circuit  
 R1—10,000-ohm, 1/4-watt, 5% resistor  
 R2—1-megohm potentiometer  
 C1—0.1- $\mu$ F ceramic-disc capacitor  
 Perfboard materials, wire, solder, hardware, etc.

stretched by equal amounts.

More than one stretch-time period can be provided by adding a second circuit like that in Fig. 3, and selecting the value of C1 for the desired time period. In fact, you can add a stage for each step and have all 10 steps controlled individually. Experiment with the circuit to obtain the right timing combination.

The staircase-generator circuit may also be used to drive a VCO to produce a sequentially stepped output. That arrangement can be used to generate a string of musical notes, doorbell chimes, sequential encoder tones, or to fill some special circuit requirement. Each step of the generator's output may be made variable by replacing R2 through R11 with 100k

potentiometers. With such an arrangement each step can be individually set to whatever duration is desired or required.

## SAWTOOTH GENERATOR

The sawtooth generator just might be the most prolific waveform-generator circuit in use today. Everywhere you look there's a TV set or a computer monitor that contains at least one sawtooth sweep-generator circuit. Oscilloscopes; spectrum analyzers; and AF, RF, and IF sweep generators are a few of the test instruments that rely heavily on

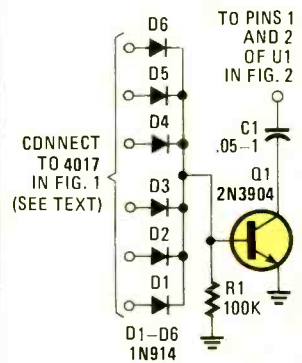

Fig. 3. When added to the staircase generator circuit in Fig. 1, this simple circuit allows any or all of the output steps to be increased in length (time duration). Only those outputs selected will have their durations increased.

## PARTS LIST FOR FIG. 3

Q1—2N3904 general-purpose, NPN silicon transistor  
 D1—D6—1N914 general-purpose, small signal silicon diode  
 R1—100,000-ohm, 1/4-watt, 5% resistor  
 R2—10,000-ohm, 1/4-watt, 5% resistor  
 C1—0.05- $\mu$ F ceramic-disc capacitor (see text)  
 Perfboard materials, wire, solder, hardware, etc.

the sawtooth generator.

Refer to Fig. 4. In the sawtooth generator circuit, Q1, D1—D3, R1, R2, and R7 form a simple constant-current generator circuit that charges C1 at a constant rate. That steady charging

current produces a linear rising voltage across C1. Transistors Q2 and Q3 are wired in a Darlington configuration to transfer the voltage across C1 to the output without loading or distorting. When the volt-

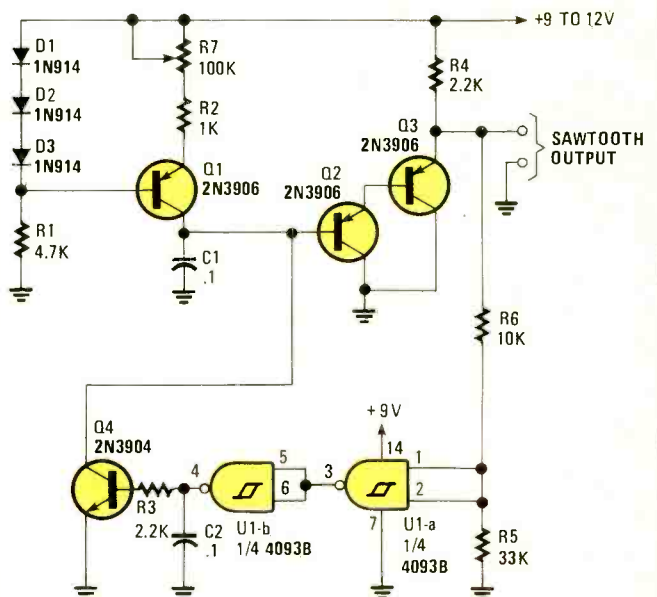

Fig. 4. The Sawtooth Generator's output frequency is controlled by R7, which provides a low end frequency of about 30 Hz and an upper end frequency of close to 3.3 kHz.



## PARTS LIST FOR FIG. 4

### SEMICONDUCTORS

U1—4093B quad 2-input NAND Schmitt-trigger, integrated circuit  
 Q1-Q3—2N3906 general-purpose, PNP silicon transistor  
 Q4—2N3904 general-purpose, NPN silicon transistor  
 D1-D3—1N914 general-purpose, small-signal silicon diode

### RESISTORS

(All fixed resistors are 1/4-watt, 5% units.)

R1—4700-ohm  
 R2—1000-ohm  
 R3, R4—2200-ohm  
 R5—33,000-ohm  
 R6—10,000-ohm  
 R7—100,000-ohm potentiometer

### ADDITIONAL PARTS AND MATERIALS

C1, C2—0.1- $\mu$ F, ceramic-disc capacitor  
 Perfboard materials, 9-12 power source, wire, solder, hardware, etc.

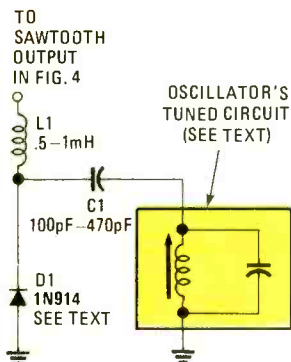

Fig. 5. The sawtooth generator can be used to vary the frequency of an RF oscillator, thereby turning a transistor-based RF oscillator into a usable narrow-band sweep generator.

age across C1 increases to about 70% of the supply voltage, U1-a (1/4 of a quad NAND Schmitt trigger) turns on, causing the output of U1-b to go high and momentarily turn on Q4; Q4 is held on as C1 discharges. That completes one cycle and starts the next.

The circuit's output frequency is controlled by R7, which provides a low-end frequency of about 30 Hz and an upper-end frequency of close to 3.3 kHz. The frequency range can be increased by lowering the value of C1 and decreased by increasing the capacitor's value. To keep Q4's

peak discharge current in check, C1 should be no larger than 0.27- $\mu$ F.

The sawtooth generator can be a very handy test item to have around the shack, and it's well worth the small cost in time and funds to build. The circuit isn't critical and any suitable construction scheme will do.

The circuit in Fig. 5 illustrates one way that the sawtooth generator can be used to vary the frequency of an RF oscillator. That simple approach can turn a transistor-based RF oscillator into a usable narrow-band sweep generator.

When the input to the circuit in Fig. 5 is tied to the circuit in Fig. 4, the sawtooth signal is fed through an RF choke (L1), across the cathode of D1, and on to the RF oscillator's tuned circuit through coupling capacitor C1 (an NPO ceramic disc). As the reverse voltage increases across the diode, its internal capacitance decreases, causing the oscillator's frequency to climb until the cycle is completed.

Looks like we've used up all of our space for this time. See you here again next month with more fun circuitry. Good luck and so long until then.

# ISCET VCR Cross Reference

VCR Model Number Cross Reference  
and VCR Parts Cross Reference

**UPDATED** - Feb. 1990. 272-page reference guide. \$35 plus \$3 shipping.

**DISC** - IBM-compatible disc with expandable data base. \$99 plus \$1 shipping.

**COMBO OFFER:** Book and disc for only \$125 plus \$3 shipping.

**MORE INFO?** Contact ISCET,  
2708 West Berry St.  
Fort Worth TX 76109  
(817) 921-9101

Allow 4-6 weeks delivery when using personal checks or VISA and MasterCard. Money orders and cashiers checks processed immediately.

Amount \_\_\_\_\_ VISA  MasterCard   
 Card No. \_\_\_\_\_ Exp. \_\_\_\_\_  
 Name \_\_\_\_\_  
 Business \_\_\_\_\_  
 Address \_\_\_\_\_  
 City \_\_\_\_\_ State \_\_\_\_\_ Zip \_\_\_\_\_  
 Phone \_\_\_\_\_ Member:  ISCET;  NESDA  
 Texas residents multiply dollar value x 7% for taxes.  
 Foreign shipments please add International postage.  
 Send to: ISCET, 2708 W. Berry St., Ft. Worth TX 76109

## SUPER LONG PLAY TAPE RECORDERS

12 Hour Model —  
USES 120 TAPE

\$119.00\*

Modified Panasonic Slimline, high quality AC-DC provide 6 continuous hours of quality recording & playback on each side of cassette for 12 hours total. Includes • Voice level control • Digital counter, etc. TDK - 120 Cassette Furnished.



## PHONE RECORDING ADAPTER

Records calls automatically. All Solid state connects to your telephone jack and tape recorder. Starts recording when phone is lifted. Stops when you hang up. \$28.50\* FCC APPROVED



## VOX VOICE ACTIVATED CONTROL SWITCH

Solid state. Self contained. Adjustable sensitivity. Voices or other sounds automatically activate and control recorder. Uses either recorder or remote mike. \$28.50\*  
 \*Add for ship & hdg. Phone Adapter & Vox \$1.50 ea. Records \$4.00 ea. Cal. Res. add tax. Mail order. VISA, M/C, COD's OK. Money Back Guarantee. Qty. disc. avail., Dealer Inquiries Invited. Free data.  
**AMC SALES INC.** Dept. B 9335 Lybec St.  
 Box 928 Downey, CA 90241  
 Phone (213) 869-8519  
 FAX (213) 923-1478



CIRCLE 6 ON FREE INFORMATION CARD

# COMPUTER BITS

By Jeff Holtzman

## Fun With Windows

Ever since Microsoft released Windows 3.0 in May of this year, computer-industry analysts have bored us to tears about why Windows will be a successful product, who will buy it, when they'll buy it, how much of it they'll buy, what they'll use it for, whether it will really increase productivity, etc. (I should also confess that I've been guilty of some of that type of crystal-ball gazing as well.)

All pontificating aside, the real reason I think Windows

screen icons for the default values. The Paintbrush program that comes with Windows allows you to create your own patterns; you can also scan in artwork, or obtain commercial or shareware images. I've also seen several commercial and shareware icon packs. The ability to change the look of the environment is one thing that puts a lot of the "personal" back into personal computing.

Windows is also fun because it contains a set of

of analysis is ignorant of what Windows is all about, however: providing a complete environment in which the user can make himself feel at home. When the user is comfortable, productivity increases. When the user has to fight several programs, each with a different look and feel, different keystrokes, and different commands—it's no wonder most DOS users learn only one or two applications. Macintosh users, by contrast, are often adept at five or six.

One intriguing (and infuriating!) aspect of Windows 3.0 is its chameleon-like ability to run on 8088, 80286, and 80386 systems. Speed naturally increases with the more modern and faster processors. But capabilities also increase, and in subtle yet powerful ways. The result is that people with less-powerful systems can get started with Windows and see how they like it. If they do like it, they're going to find themselves thinking about upgrades—more memory, more disk space, a faster CPU. In that sense, Windows probably will help the industry get out of its current slump.

### FIRSTAPPS

A company called hDC has been selling Windows utilities for several years. The current offerings include Windows Express, which allows you to create your own menu system for organizing your programs, and FirstApps, a set of nine utility programs that lists for about \$100. Several of the utilities are extremely useful, and nearly all are fun. You install FirstApps from two 1.2MB or

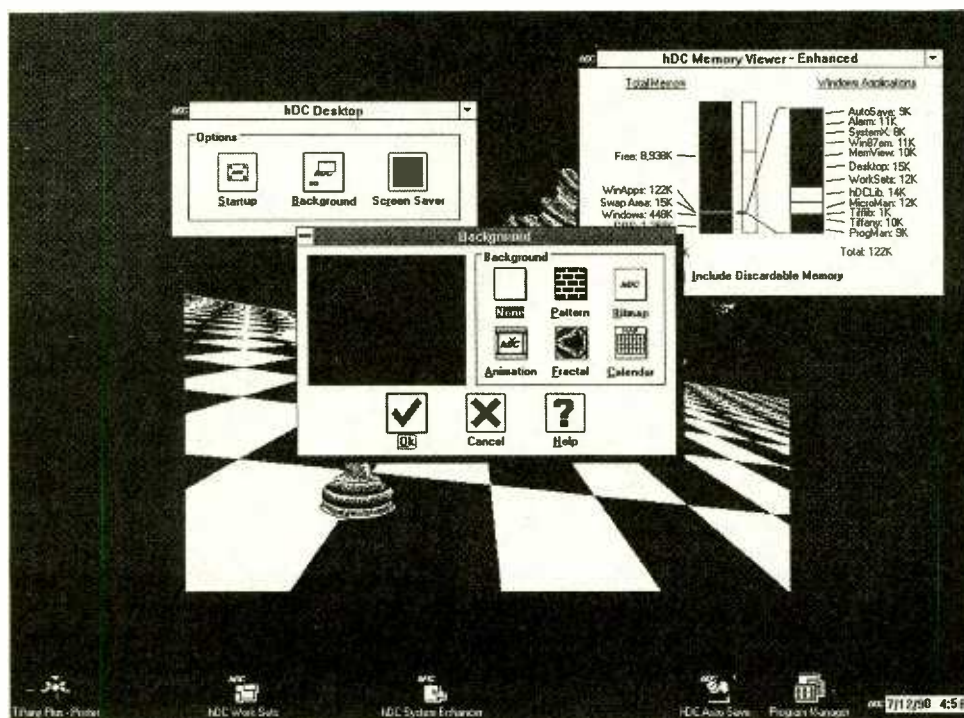

The FirstApps software package contains a group of programs called Work Sets, along with additional utilities such as Memory Viewer, Alarm Clock, Desktop, Art Gallery, and a game called Rocks.

is going to transform the world is that it's fun. And one of the main reasons it's fun is that it's customizable. That means that you can change its look at will, substituting different background patterns and

basic tools that are truly functional. By itself, any one of the applications could and probably will be ripped to shreds in comparison with full-blown everything-but-the-kitchen-sink applications. That type



three 720K diskettes. If you install all the utilities, you'll have to give up about 2.1MB of space.

You can get to FirstApps in one of two ways. You can replace the control bar, which normally appears in the upper left corner of every application window, with hDC's own control menu. (The control menu allows you to move and size windows, close applications, etc.) Or you can set things up so that a single icon allows you access to FirstApps. Using the first method provides access to FirstApps from any application window, but subtly alters standard Windows procedures; using the sec-

### Programs and Vendors

Windows 3.0 (\$149)  
Microsoft Corp.  
16011 NE 36th Way  
Box 97017  
Redmond, WA 98073-9717  
Tel. 206-882-8080

Windows Express (\$99.95)  
FirstApps (\$99.95)  
hDC Computer Corporation  
6742 185th Avenue NE  
Redmond, WA 98052  
Tel. 206-885-5550

ond keeps the Windows environment similar to what you're used to.

One huge time saver is called Work Sets. A work set consists of a group of programs, along with their screen positions and open documents. hDC's trick is to let you save that environment and reload it later, putting each window back on the screen in its original position, with the same document loaded. You can even set things up so that everything loads for you automatically whenever you start Windows. You can also have different work sets for different groups of applications.

Several other programs are extremely useful: A Memory Viewer displays a

bargraph that shows how much memory is in the system and how it is being used, taking account of the type of CPU, mode of operation, and memory available to the system. When reduced to an icon, the memory viewer maintains a display of the amount of free memory.

The Alarm Clock displays a small clock with time, date, or both; you can also program any number of alarms, and be notified with a message or one of several tunes—reveille, charge, etc. You can also link alarms to appointments entered in Windows' own Calendar program.

Desktop is another fun program. It allows you even greater power than Windows in choosing the desktop background. You can define a "startup" image that displays briefly when FirstApps is loaded. You can set up the background that displays during normal operation as a functional calendar, or as an animated series of images, or as a fractal that actually runs in the background while you're working on other applications. Several sample animations are included; you can also create your own.

Art gallery provides the equivalent of an electronic scrapbook, allowing you to catalog, locate, and use your electronic drawings. It includes several "galleries" of its own (Christmas, Birthdays, etc), each containing several images.

FirstApps has a help system that uses Windows' built-in hypertext help display engine. Even so, you'll probably want to skim the manual once to get an idea of what's going on. FirstApps has become indispensable to me in just a few hours. If you're going to take the Windows plunge, check out FirstApps—you won't be disappointed.

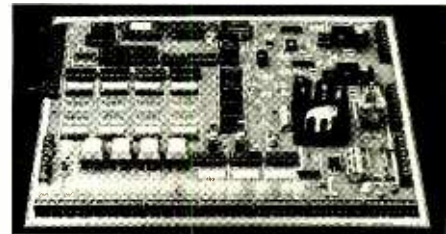

### Knight Patrol™

#### Talking Home Alarm Kit

A high end alarm system at an affordable price!

Features include:

- ◆ State of the art PCF 8200 Speech Synthesizer
- ◆ 21 Sensor Zones, 2 Arming Circuits
- ◆ 2 Five Watt Audio Amplifiers
- ◆ Auxiliary Alarm
- ◆ Real Time 24 Hr. Clock
- ◆ A 10A & 3A Relay Circuit for Sirens, etc.
- ◆ Alert/Sleep Monitoring Modes (verbal status)
- ◆ Trigger Memory (verbal status)
- ◆ Self Diagnostics & Performance Monitoring
- ◆ Microprocessor Controlled
- ◆ Pleasant Female Voice
- ◆ Expandibility & so much MORE!

Available as a kit or pre-assembled. Send for our FREE catalog! A complete line of peripherals is also available. Complete Circuit Board kit \$220 plus \$10.50 S&H. (Ca residents add 6.75% tax).

### Paladin Electronics

19425 B Soledad Lynn Rd  
Suite 333 Dept. PE  
Canyon Country, CA 91351

"We protect your castle"



CIRCLE 7 ON FREE INFORMATION CARD

## AMAZING NEW Pocket Reference

480 pages of tables, maps, formulas, and conversions and it fits in your shirt pocket (3.2" x 5.4" x 0.6")!

**\$9.95\***



\* Plus \$2.00 shipping & handling. Colorado residents add 56¢ tax.

### Small sample of contents

Air Tool CFM vs PSI	Radio Alphabet
Battery Charging	TEN Radio Codes
Tire Manufacturer Codes	Telephone Area Codes
Lumber Sizes & Grades	Lost Credit Card Phones
Concrete & Mortar	Sound Intensities
Element Tables	Wind Chill Factors
Computer ASCII Codes	Frequency Spectrum
IBM® PC Error Codes	Geology Mineral Tables
IBM® Interrupts-I/O Map	Glues and Solvents
80286 Hard Disk Types	Bolt Torque Tables
Printer Control Codes	Wood Screw/Nail Sizes
Electric Wire Size vs Load	Math Formulas & Tables
NEMA Motor Frames	Plane/Solid Geometry
Wire & Sheet Gauges	Copper/Steel/PVC Pipe
Resistor/Capacitor Colors	Rope, Cable and Chain
Pilot Lamp Specs	Tap-Die-Drill Sizes
Fuse & Battery Specs	Sand Paper & Abrasives
RF Coil Winding Data	Weld Electrode & Solder
Wire Size vs Turns/Inch	3200 Conversion Factors

Money Back Guarantee - If not completely satisfied, return book postage prepaid, in mint condition for a 100% refund!

Sequoia Publishing Inc.  
Dept 915, P.O. Box 620820  
Littleton, CO 80162

CIRCLE 8 ON FREE INFORMATION CARD

# FUN SOFTWARE

By Fred Blechman

## A "Risky" Landing

This month you'll sweat out landing "JetFighter" on a carrier and take a "RISK" to conquer the world.

### JETFIGHTER: THE ADVENTURE

*(Velocity Development Corporation, Distributed by Broderbund through software dealers. Available for IBM PC/XT/AT/386/PS/2, and Tandy 1000, 3000. Requires 512K RAM, CGA, EGA or*



Try your skill at an aircraft-carrier landing in *JetFighter: The Adventure*.

VGA. Joystick recommended. Suggested Price: \$49.95.)

"Wheels down, flaps down, speed brakes down, hook down. Thrust at 40%. Airspeed 140 knots. Meatball looks good. I'm right on the centerline and the three-degree glide slope. I might make a three-wire trap for a change. Oops! Slipping a bit to port. Correcting with a little right stick and rudder. There! Must be some crosswind. I wonder if I'll ever get used to the ship's wake streaming back 12 degrees off the slant-deck centerline.

"I'll bet my RIO is worried. We can both see the Constellation's deck pitching and rolling. Looks like the ramp is steady for the moment. My hook should be about twenty feet above the rounddown. The LSO will be giving me a cut in a few seconds, so I better be ready to slam on the power in case I miss the four-wire and have to bolter. Or I might get a waveoff. Whoops! My nose is low and airspeed a little too high. Pull back very slightly...."

Those might be your thoughts as you approach a real carrier in an F-14 Tomcat. But even if you've never flown even a Piper cub, you can "make believe" with *JetFighter: The Adventure*, which provides a remarkably good simulation of a carrier landing on the U.S.S. Constellation (CV-64) off the coast of California near Los Angeles.

This simulation provides most of the elements mentioned, even the RIO (Radar Intercept Officer) in the back seat. The deck doesn't pitch, roll or yaw, so the "ramp" (the back end, also called the "rounddown" or the "fantail") stays steady. The latest program upgrade even has a "meatball" (light landing device) as well as a "wave-off" (go around again) display light. You can "trap" (catch) any of the four deck arresting cables, or "bolter" (put on power and go around again.)

JetFighter's graphics, control, and simulations are excellent. Making a good carrier landing with JetFighter is really tough—just like the real thing. You must make four good landings

(or sixteen attempts) before you can advance to the over-thirty combat missions offered. Also, in addition to the F-14, you can fly an F/A-18 Hornet or an F-16 Falcon. You are not limited to flying from the Constellation, since five land-based airfields, all in California, are available.

The graphics in JetFighter are exceptional. Once you select your takeoff location, the program zooms in from a satellite view right down into the cockpit! You can even select the time of day from seven choices, including nighttime with stars.

There are five types of training missions (Flight Maneuvers, Drone Intercept, Precision Bombing, Practice Dogfight, and Carrier Landings), with several scenarios for each. The flight maneuvers include various aerobatics detailed and illustrated in the 64-page manual. In the dogfight practice you tangle with a tough instructor.

Your aircraft control response is surprisingly good with the keyboard, but even better with a joystick. But be careful; you can stall out in some maneuvers if you don't provide sufficient thrust to hold your speed.

You can look around outside of the cockpit in different directions, or put yourself outside the aircraft in any position. It's just like flying formation, since you can zoom in or out and move around the aircraft in any direction. You can see when your wheels and hook are down, and if you're in an F-14, you can even watch your swing-wing move to and from the delta position.

You can also put yourself



in the control tower or "vulture's row" on the carrier bridge, and watch the aircraft respond to your commands while flying toward or away from you, also with zoom capability.

All activity takes place in California or off the coast. The detail is surprising, since towers, bridges, roads, buildings, and piers show up, and some objects, like radar antennas, actually move.

JetFighter in its initial release required at least an EGA display, with 16 colors available, and that's the version I reviewed on a 10-MHz IBM AT, but the latest upgrade allows the use of CGA. The instruments and scenery are clear and colorful, using solid (not wire-frame) graphics. The display animation is relatively smooth, unlike some simulations that have very choppy screen updates.

Everything considered, JetFighter is an outstanding program that can keep you challenged for many, many hours, yet lets you "win" often enough to prevent getting discouraged.

**CIRCLE 131 ON FREE INFORMATION CARD**

## RISK

(Virgin Mastertronic, 18001 Cowan, Suite A, Irvine, CA 92714. Order phone: 714-833-8710. VISA or MC accepted. Price: \$39.99 for IBM PC—specify 5¼ or 3½-inch disk, Atari ST, Apple II+ / IIe / IIc, Macintosh, Amiga; \$29.99 for Commodore 64/128. Shipping and CA tax added to order.)

Ever since 1959, one of the more popular board games has been Parker Brothers' *RISK*, a game of world conquest. That game has now been faithfully reproduced for personal computers.

In this classic game of military strategy, you battle to conquer the world. To



The computer version of *RISK* is a faithful reproduction of the popular board game.

wir., you must launch daring attacks, defend yourself on all fronts, and sweep across vast continents with boldness and cunning. Then, just as the world is in your grasp, an opponent might strike and take it all away! Although luck certainly plays a part in individual battles, which depend upon the throw of the dice, better strategy and tactics will overwhelm the enemy.

If you are familiar with the *RISK* board game, you know there are a lot of rules and variations permitted. This takes some study initially, but becomes easy after a few games. A big advantage of the computer version is that it does a lot of the work you have to do yourself in the board game.

The computer version also allows more game variations, and includes options played on both United States (U.S.) and United Kingdom (U.K.) board games. If you like the board game, you'll like the computer version even more, since some of the grunt-work of counting and calculating is done for you.

From two to six players can be selected as humans or computers. If you select computers for all players, the game plays almost completely automatically, and you can learn by watching—although some of the battles are over in seconds. You can pit yourself, as a human, up against as many as five computer opponents, each of which can be easy, average or tough. It's sometimes fas-

inating to see how the computer "thinks."

A colorful map of the world is displayed, and armies are placed in 42 global territories on six continents by human players, or automatically by computer opponents. Battles are fought, and invasions succeed or fail on the random throw of dice. It's all fairly complicated to explain, but the computer interprets the results of each action and appropriately moves on and replaces armies based on the game rules.

Although the program runs well even on a slow 4.77-MHz PC/XT, it requires at least CGA or Tandy graphics capability. If you have a Hercules display, you can exchange your disk for a Hercules version free within 30 days of purchase (or \$5 if after 30 days). CGA shows only four colors, but checkered patterns allow easy discrimination be-

tween territories occupied by each of the six players. The only real penalty of CGA is that the entire world map can't be shown at once, and you must scroll the map around the screen. With EGA you see the whole world at once in finer resolution, and in many colors.

You have your choice of using either a mouse, joystick, or keyboard as a control device. I preferred the mouse first, keyboard second. The joystick needed to constantly be pushed off center, but joysticks have springs to center them, so I found myself fighting the joystick.

I strongly suggest reading through the 34-page manual completely before trying to use the program. It won't take long, but then you'll be prepared to conquer the world!

**CIRCLE 132 ON FREE INFORMATION CARD**

## Be an FCC LICENSED ELECTRONIC TECHNICIAN!



**Earn up to \$30 an hour and more!**

Learn at home in spare time.  
No previous experience needed!

No costly school. No commuting to class. The Original Home-Study course prepares you for the "FCC Commercial Radiotelephone License." This valuable license is your professional "ticket" to thousands of exciting jobs in Communications, Radio-TV, Microwave, Maritime, Radar, Avionics and more...even start your own business! You don't need a college degree to qualify, but you do need an FCC License.

**No Need to Quit Your Job or Go To School**  
This proven course is easy, fast and low cost! **GUARANTEED PASS**—You get your FCC License or money refunded. **Send for FREE facts now. MAIL COUPON TODAY!**

**COMMAND PRODUCTIONS**  
 FCC LICENSE TRAINING, Dept. 100  
 P.O. Box 2824, San Francisco, CA 94126  
 Please rush FREE details immediately!

NAME \_\_\_\_\_  
 ADDRESS \_\_\_\_\_  
 CITY \_\_\_\_\_ STATE \_\_\_\_\_ ZIP \_\_\_\_\_

# DX LISTENING

By Don Jensen

## Two-Hundred Years of Mozart!

**N**ot long ago, Mozart Year might have passed with only dyed-in-the-wool classical music buffs paying much attention. But the success of the highly successful film, "Amadeus," changed that.

A year-long musical celebration begins in Vienna this month, marking the

200th anniversary of the death of Wolfgang Amadeus Mozart on December 6, 1791. All Austrians and an expected two million foreign visitors will pay tribute to the composer-genius who lived so fully and died so tragically in this beautiful and cultured city.

The city's prolonged and lavish celebration will include nearly daily concerts and musical events at Vienna's two opera houses, concert halls, and churches. The city Mozart once called "the finest place in the world for me to get on with my work" will be a showcase of the young maestro's talents.

For those lucky enough to visit Austria in 1991, there will be much more to catch their attention, from the beautiful, though not-so-blue, Danube to Schonbrunn Palace, where the Hapsburg emperors played, from cozy old world coffee houses to the Cathedral of St. Stephen, built seven centuries ago.

Those of us who must stay home, though, can catch some of the flavor by doing our traveling—as DX'ers have done for years—by shortwave radio. Shortwave listeners surely can expect *Radio Austria International*, the foreign service of *Osterreichischer Rundfunk* (ORF), to do its part to bring the bicentennial of Mozart's death to life for its overseas audiences. Follow the highlights of "Mozart Year-1991" on Radio Austria International's English programming. It's not a difficult shortwave catch, with at least some

of its broadcasts to North America relayed by *Radio Canada International's* facilities in a time-swapping arrangement.

Look for RAI English programs at 0130, 0530, and 1200 UTC. As of this writing, the frequencies to try were 9,875/13,730, 6,015, and 21,475 kHz, respectively. For more information on the on-air festivities, you can write to Radio Austria International (A-1136 Vienna, Austria) for their free program schedule.

### FEEDBACK

Whether you call it your DX shack, your listening post, or your monitoring den, every SWL has that special corner of his or her living room, den, bedroom, or basement where he or she can lean back in a comfortable chair, slip the headphones over his or her ears, and tune in the world. Some are elaborate set-ups with multiple SW receivers and assorted electronic accessories. But I've seen some simple yet attractive arrangements that are absolute gems of efficiency.

What does yours look like? Why not send me a photo of you and your listening station? I'll use as many as I can in *DX Listening* in the coming months. Be sure to include a note identifying the receiver or receivers and other gear in the photograph. Get somebody else to take the picture so we all can see what you look like, too! This is your chance to, shall we say, strut your stuff. Send your photos, letters with your questions, comments, and SW logging

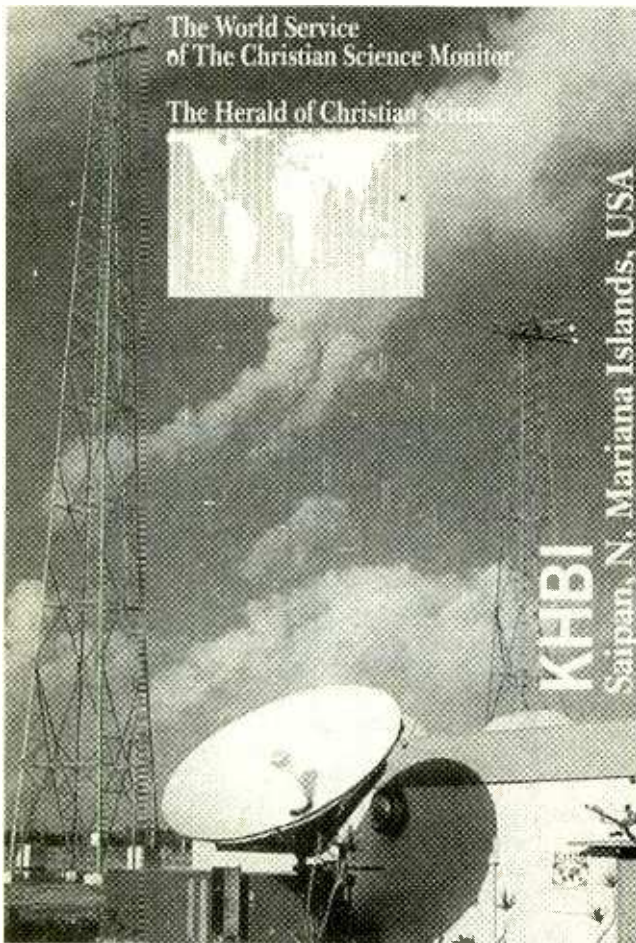

*The World Service of the Christian Science Monitor, which has three stations (WCSN, WSHB, and KHBI) will now verify reports with QSL cards. You can obtain blank cards by writing—to World Service/Herald, P.O. Box 860, Boston MA 02123—for their program guide and asking for QSL's. When you hear the station, fill in the card with details and mail it back. It will be signed, validated and returned to you. Here is the current KHBI card.*

\*CREDITS: Brian Alexander, PA; Robert Ross, Ont.; Richard D'Angelo, PA; Rufus Jordan, PA; Bob Rydzewski, CA; North American SW Association, 45 Wildflower Road, Levittown, PA 19057)



tips to *DX Listening*, **Popular Electronics**, 500-B Bi-County Blvd., Farmingdale NY 11735. I'm looking forward to hearing from you!

And now, to the mail-bag. This month's first letter comes from Larry D. Byers of Torrance, CA, who has a problem. Thus writes Larry: "I just bought a Sangean ATS-803A receiver. I live only two miles from KNX, which transmits on 1070 kHz. The problem is that I pick up signals from that station all over the place. The signals show up in many bands as interference. I think that maybe a filter would help, but I don't know what type to use."

The solution, Larry, may be a wavetraps—a simple-to-build device that radio amateurs have used for decades to solve just the sort of problem that's plaguing you. Wavetraps consist of a simple coil and a small variable capacitor connected between your antenna and receiver. When the trap circuit is tuned to the frequency of the interfering station, little of the unwanted signal reaches the receiver.

For details on wavetraps, check out one of the amateur-radio reference books at your public library. My old edition of *The Radio Handbook*, by Bill Orr, W6SAI, has a useful explanation. Or to help you solve this and other noise problems, Tiare Publications (PO Box 493, Lake Geneva WI 53147) has a paperback reference called *Radio/TV Interference: Sources and Solutions*.

Next we hear from Jim Wilson, Columbia, SC, who writes: "I've been reading your *DX Listening* column from time to time and recently started looking for stations to diversify my listening. I used to be a

radio specialist in the US Air Force and it feels good to be digging out some signals again."

Among the stations Jim enjoys, he says, is *Spanish National Radio* from Madrid, which he heard on 11,880 kHz from 0000 to 0100 UTC, with a program of news and sports, followed by features on the "Many Faces of Spain," and "DX Tips." Jim also says he's trying to especially focus on Australia and New Zealand and listens, from time to time, to *Radio Australia* on 21,740 kHz at 0200 UTC.

Jose A. Delgado, a US Navy avionics technician currently stationed at Rota, Spain, writes: "It's good to see an SWL column in **Popular Electronics**. I really enjoy this section of your magazine. I have been an SWL for over 12 years. Five years ago, while in college, I became an amateur-radio operator, too. Overseas, SWL'ing has a different meaning. News from home is a lot more accessible on shortwave from the BBC or *Radio Nederland* than from the local AFRTS (*American Forces Radio/TV Service*) FM outlet."

#### DOWN THE DIAL

In this month's list of what's being heard on the shortwave bands, let's try something a bit different, focusing on just one corner of the world: Central America. If you like this arrangement, let me know, and we can zero in on other areas in future columns.

**Costa Rica**—7,375 kHz. *Radio For Peace International* is an American privately sponsored station that promotes the worldwide cause that its name suggests. It transmits in the upper-sideband mode. Look for it here at

around 0045 UTC with a United Nations news program.

**Guatemala**—3,370 kHz. *Radio Tezulutlan*, broadcasts in Spanish, but as is the case with other Central American SW'ers, you'll also hear programming in local Indian languages as well. Try tuning this station at around 0230 UTC. The marimba rhythms should be a tip off. The station also operates in parallel on 4,835 kHz.

**Guatemala**—4,800 kHz. *Radio Buenas Nuevas* (or "good news" in Spanish) is a religious SW outlet. It has been logged with easy-listening instrumental music and Spanish announcements during the evening hours, until sign off at about 0330 UTC.

**Honduras**—3,250 kHz. *Radio Luz y Vida* (Spanish for "light and life") is a Protestant religious station.

It has some English programming as well as Spanish. Try tuning this one at around 0330 until sign off, just after 0400 UTC.

**Honduras**—4,910 kHz. *La Voz de la Mosquitua* is yet another religious station, this one broadcasting from a Baptist mission near Puerto Lempira. It has some English programming, as well as programming in Spanish and the local Miskito language. Try for this broadcaster at around 0215–0300 UTC.

**Mexico**—6,115 kHz. *Radio Universidad de Sonora* is one of a series of shortwave stations operated by some Mexican colleges and universities. This one, broadcasting in Spanish, has been logged at morning sign on at 1300 UTC, with the Mexican national anthem, identifications, and music.

Make the most of your general coverage transceiver with *Monitoring Times!*

Every month *Monitoring Times* brings everything you need to make the most of your general coverage transceiver: the latest information on international broadcasting schedules, frequency listings, international DX reports, propagation charts, and tips on how to hear the rare stations. *Monitoring Times* also keeps you up to date on government, military, police and fire networks, as well as tips on monitoring everything from air-to-ground and ship-to-shore signals to radioteletype, facsimile and space communications.

**ORDER YOUR SUBSCRIPTION TODAY** before another issue goes by. In the U.S., 1 year, \$18; foreign and Canada, 1 year, \$26. For a sample issue, send \$2 (foreign, send 5 IRCs). For MC/VISA orders (\$15 minimum), call 1-704-837-9200.

### MONITORING TIMES

Your authoritative source, every month.

P.O. Box 98  
Brasstown, N.C. 28902

# SCANNER SCENE

By Marc Saxon

## A Gift That Keeps On Giving

This is the time of year for gifts—not only those you give to others, but also those for yourself. (Santa won't mind.) For scanner enthusiasts, great gifts include frequency directories, accessories, and more scanners.

For those who enjoy scanning, the ability to introduce a child, parent,

transportation, and VHF/UHF ham bands.

The Bearcat 145XL scans at 15 channels per second, and offers such features as priority channel, three-second scan delay, channel lockouts, direct channel access, instant weather-channel access, and an LED readout. It comes with a telescoping antenna, and also with a connector for an external antenna for extended reception. It's ready to operate on 117 VAC.

This scanner is available for about \$100 if you shop around, and that puts it in the realm of reasonably priced gifts. Also, while it is a fine, easy-to-operate scanner that's well suited to a beginner, it has sufficient capabilities and features to be genuinely serviceable for monitoring.

Take a look at the Bearcat 145XL at any of the many dealers who sell the Bearcat line of scanners.

easily converted into a reasonably good VHF/UHF scanning receiver in addition to being a fine transceiver for the two ham bands for which it was designed. Of course, a ham license would be required to transmit within the ham bands.

To unlock the receiving capabilities of the ICOM IC-24AT, turn the set off. Then, turn it on again. Next, simultaneously press the "B" button, the "#" button, and the "light" button.

With those three buttons still pressed, turn off the set, then turn it on again. Let go of the three buttons, and you have now unlocked the receiver. Be aware, however, that all ham and other frequencies that were previously programmed into the unit will have to be reprogrammed from scratch, as you will have wiped the slate clean.



*If there's someone you'd like to introduce to scanning, you might consider giving them a Uniden Bearcat 145XL this holiday season!*

grandparent, other relative, or close friend to this exciting and rewarding hobby is like giving a double gift: the gift of the scanner itself and the gift of a new and fascinating interest. Moreover, it's a gift that lasts long after the tinsel and multicolored, twinkling tree lights have been packed away.

A fine choice for such giving would be the Uniden Bearcat 145XL, a 16-channel programmable radio that covers 29–54, 136–174, and 406–512 MHz. That takes in the most popular public-safety, federal, business, industrial,

### FREQUENCY TRICKS

Inasmuch as our readers like frequency-expansion tricks and modifications, and since we have had specific inquiries about the ICOM IC-24AT, let's look at some of the possibilities.

The ICOM IC-24AT is a ham transceiver for the 144- and 440-MHz bands, plus receive-only from 138 to 174 MHz. With almost no effort at all (and without even opening up the case), the unit can be "taught" to receive from 75 to 195 MHz, and 740 to 960 MHz. It will not transmit on all of those frequencies, but it can be

### MEET MY "AUNT ENNA"

Mobile monitoring is getting very popular, and lots of new products are becoming available to accommodate those who pursue that activity. We liked the new *Antenna Specialists' MON-53* all-band mobile-scanner whip for roof or deck mounting, since it was designed to include reception in the 800-MHz band.

This antenna comes supplied with 17 feet of coaxial cable and an installed pin plug. For more information, contact The Antenna Specialists Co., 30500 Bruce Industrial Parkway, Cleveland, OH 44139-3996.



## FREQUENCY FINDER

Thomas Griff, of Blue Springs, MO, asks for the security frequency at the Independence Center Shopping Mall in Independence, MO. Program 154.515 MHz into your scanner, Tom, and hear it all.

Numerous readers from various locations have asked for the frequency used by Brinks, Inc. for communicating with their armored trucks. Generally speaking, the most often used Brinks frequencies (in most areas) are 159.495 for dispatching, plus 467.8125 for handhelds. In Richmond, VA, listen on 461.40 MHz. Several areas use the VHF low band. For instance, 44.20 MHz is used around Beaumont and San Antonio, TX, and also in the areas of Indio, Running Springs, and Sacramento, CA. Monitors in Columbus, OH and around Bethesda, MD can try 44.44 MHz for those communications.

Del Steinberg, of Amsterdam, NY, observes that at many federal buildings there are armed, uniformed security personnel. He wonders if we can offer any thoughts on the frequencies used, since they have hand-held transceivers.

Those guards are security personnel of the General Services Administration. According to the latest (7th) edition of the *Top Secret Registry*, the most commonly used frequencies around the nation are 415.20 and 417.20 MHz, although other frequencies are listed for some specific installations.

And, for the several readers who wanted to know what frequencies to monitor at the National Air Races in Reno, NV, we would suggest tuning in 118.5, 126.4, 126.7, 128.1, 151.625, 151.685, 151.805, 151.925, and 152.36 MHz. That should give you an inside ear on everything from the

flights to the communications between the race officials, and plenty more.

## SHARP-EARED SCANNER OWNER

A scanner owner in Albany County, NY contacted the New York State Police to report turning on his scanner and overhearing several persons discussing plans for a jewelry-store burglary. The scanner owner provided the police with the name of the store and also the frequency on which the conversation was monitored.

When the police showed up at the store, they found that the burglary process had already begun. Several holes had been cut in the store's roof, but nothing had been taken from the store; nor were the suspects in sight. However, from their own monitoring of the suspects' frequency, they realized that they were still in the area.

An intensive search located the suspects' van hidden in a wooded area, loaded with burglary tools. By then, the police had been able to determine the suspects' identities and release their descriptions.

Soon enough, an anonymous caller reported that he had spotted the suspects at a local diner and had directed them to a nearby motel. When the police showed up at the motel, the suspects weren't there, so a surveillance operation was established. The suspects soon appeared and, after a struggle, were subdued and put under arrest.

They probably never realized that someone with a scanner could put an end to their careers.

Send any questions, photos, or comments related to scanners to *Scanner Scene*, Popular Electronics, 500-B Bi-County Blvd., Farmingdale, NY 11735.

# ATTENTION! ELECTRONICS TECHNICIANS



## EARN YOUR B.S.E.E. DEGREE THROUGH HOME STUDY

Our New and Highly Effective Advanced-Placement Program for experienced Electronic Technicians grants credit for previous Schooling and Professional Experience, and can greatly reduce the time required to complete Program and reach graduation. No residence schooling required for qualified Electronic Technicians. Through this Special Program you can pull all of the loose ends of your electronics background together and earn your B.S.E.E. Degree. Upgrade your status and pay to the Engineering Level. Advance Rapidly! Many finish in 12 months or less. Students and graduates in all 50 States and throughout the World. Established Over 40 Years! Write for free Descriptive Literature

### COOK'S INSTITUTE OF ELECTRONICS ENGINEERING

 4251 CYPRESS DRIVE  
JACKSON, MISSISSIPPI 39212

**CIRCLE 14 ON FREE INFORMATION CARD**

## New AOR Receiver

### 400 Channels. 100KHz to 2036MHz



**AR3000**  
Total Price: Freight Prepaid  
(Express Shipping Optional)  
**\$995**

- Continuous coverage
- AM FM wide band FM LSB USB CW modes
- 4 Scan Banks
- Programmable Attenuation
- Tuning increments as low as 50Hz
- Search with lock out
- 15 front end filters
- RS232 port built in
- 25 Day Satisfaction Guarantee Full refund if not Satisfied
- Includes AC/DC power cord Telescope Antenna
- Size 3 1/7" H x 5 2/5" W x 7 7/8" D Wt 2lb. 10oz

**ACE**  
COMMUNICATIONS  
10701 E. 106th St. Indpls., IN 46256  
Toll Free 800-445-7717  
Visa and Mastercard (COD slightly higher)  
FAX (317) 849-8794 

**CIRCLE 16 ON FREE INFORMATION CARD**

# HAM RADIO

By Joseph J. Carr, K4IPV

## Choosing The Right Transmission Line

**T**ransmission lines are used to carry RF power from the transmitter to the antenna, or alternatively, received signals from the antenna to the receiver. Of course, on a transceiver the same line handles both chores. The type of line used most often by hams is coaxial cable. That form of line, see Fig. 1, consists of two cylindrical conductors sharing the same axis (hence, co-axial) and separated by an insulating dielectric.

For low frequencies (in flexible cables), the dielectric may be polyethylene or polyethylene foam, but at higher frequencies Teflon and other materials are used. Also used in some applications are dry-air and dry-nitrogen dielectrics, which are used in the broadcasting industry.

There are several forms of coaxial line available. Flexible coaxial cable (see Fig. 2A) is perhaps the most common form used in ham radio. The outer conductor in such cable is made of either braid or foil. Down-leads or cable systems are two places where you might find such outer conductors.

Another form of flexible or semi-flexible coaxial line is helical line (illustrated in Fig. 2B), in which the outer conductor is spiral wound. Hardline is coaxial cable that uses a thin-wall pipe as the outer conductor (see Fig. 2C). Some hardline coax used at microwave frequencies uses a rigid outer conductor, and a solid dielectric.

Gas-filled line is a special case of hardline which is hollow (as illustrated in Fig.

2D), the center conductor being supported by a series of thin ceramic or Teflon insulators. The dielectric is either anhydrous (*i.e.*, dry) nitrogen, air, or some other inert gas.

Some forms of flexible microwave coaxial cable use a solid "air-articulated" dielectric (Fig. 2E), in which the inner insulator is not continuous around the center conductor, but rather is ridged. That type of conductor reduces dielectric losses, increasing the usefulness of the cable at higher frequencies. Double-shielded coaxial cable (Fig. 2F) provides an extra measure of protection against radiation from the line, and EMI from outside sources from getting into the system.

### VELOCITY FACTOR

It is important to note that the velocity of a wave or signal in a transmission line is less than its free-space velocity; *i.e.*, less than the speed of light. Further, the velocity is related to the dielectric constant of the insulating material that separates the conductors in the transmission line.

The *velocity factor*,  $vf$ , is defined as the ratio be-

tween the velocity of a wave in a transmission line to that of a wave in free space. Velocity factor is usually expressed as a decimal fraction (or percentage) of the speed of light,  $c$ , in meters per second ( $3 \times 10^8$  m/s). For example, RG-58/U solid-dielectric coaxial cable has a velocity factor of .66; thus the velocity of the wave in such cable is 0.66 $c$ , or  $(0.66)(3 \times 10^8 \text{ m/s}) = 1.98 \times 10^8 \text{ m/s}$ .

The velocity factor becomes important when designing things like transmission-line transformers, or any other device in which the length of the line is important. In most cases, the transmission line length is specified in terms of electrical length, which can be either an angular measurement (*e.g.*, 180 degrees or  $\pi$  radians), or a relative measure keyed to wavelength (*e.g.*, one-half wavelength, which is the same as 180 degrees). The physical length of the line is longer than the equivalent electrical length.

A rule of thumb tells us that the length of a wave ( $\lambda$ ), in meters, in free-space is:

$$\lambda = 300/f$$

where  $f$  is frequency expressed in megahertz, and  $\lambda$  is wavelength expressed in meters. Therefore, a half-wavelength line is  $150/f$ . At 10 MHz, the line must be 150 meters/10 MHz, or 15 meters. If the velocity factor is 0.80, then the physical length of the transmission line that will achieve the desired electrical length is:  $[(150 \text{ meters})(vf)]/f = [(150 \text{ meters})(0.80)]/10 \text{ MHz} = 12 \text{ meters}$ . Alternatively, if you

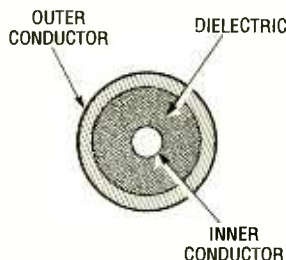

*Fig. 1. Coaxial cable (the choice of most hams) consists of two cylindrical conductors sharing the same axis and separated by an insulating dielectric (as shown here).*



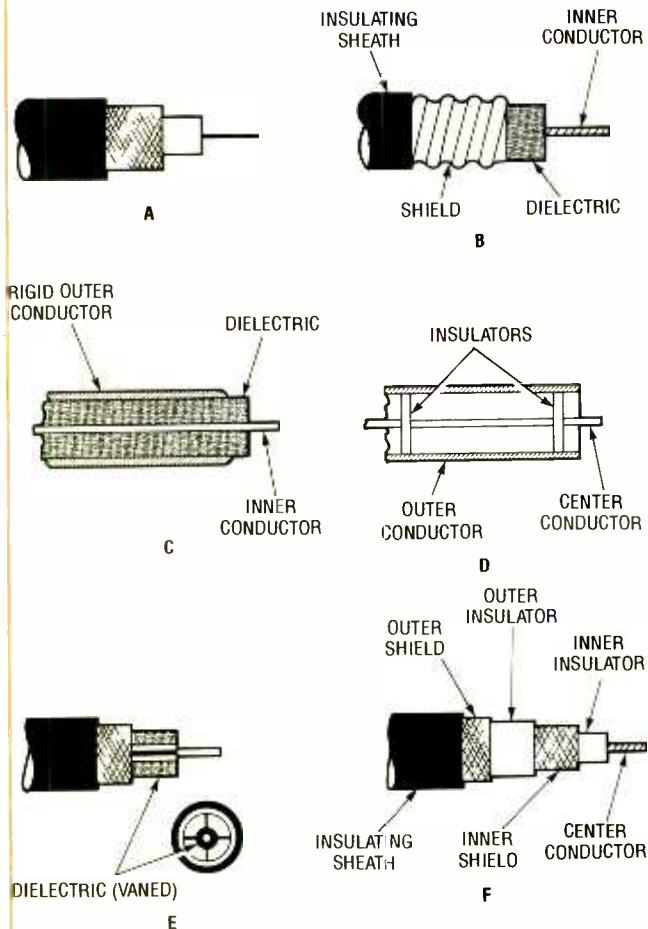

Fig. 2 Shown here are several coaxial cable types: A shows regular flexible coaxial cable; B is helical coax; rigid coaxial line is shown in C; D is gas-filled line; E is articulated air coaxial line; and F is double-shielded coaxial cable.

prefer English units:  $\lambda_{FEET} = 492v/f$ .

There are certain practical considerations regarding velocity factor that result from the fact that the physical and electrical lengths are not equal. For example, in a certain type of phased-array antenna design radiating elements are spaced a half-wavelength apart, and must be fed 180 degrees (half-wave) out of phase with each other. The simplest interconnection scheme is to

use a half-wave transmission line between the 0-degree element and the 180-degree element.

According to the standard wisdom, the transmission line will create the 180-degree phase delay required for the correct operation of the antenna. Unfortunately, because of the velocity factor, the physical length for a one-half electrical wavelength cable is shorter than the free-space half-wave distance between elements. In other words, the cable will be too short to reach between radiating elements by the amount of the velocity factor!

Clearly, velocity factor is a topic that must be understood before transmission lines can be used in prac-

tical situations. Table 1 shows the velocity factors for several types of popular transmission line.

### HOW LONG A TRANSMISSION LINE?

There is a lot of mythology out there regarding the required length of a transmission line, which is spurred on by the fact that trimming a transmission line appears to affect VSWR. That, however, is not true—VSWR is never affected by the length of a normal transmission line. It only appears to be affected because the meters frequently used to measure VSWR are not very sophisticated.

The only things that affect VSWR are antenna tuning and impedance matching. The guidelines for antenna transmission-line length are simple.

- If you are connecting a coaxial line between a transmitter and a matched antenna (e.g., a 50-ohm output transmitter to a 50-ohm coaxial cable connected to an antenna with a 50-ohm feedpoint impedance), and only want to carry RF power to the antenna, then the line can be any length.
- If you need some impedance transformation, then a specific length line may be required. For more information on this, check the standard texts for discussions on quarter-wave matching sections, coaxial impedance transformers, etc.
- If you want your VSWR meter, impedance bridge, or other antenna instrumentation to be accurate, then make the antenna transmission line either exactly one-half wavelength long (electrically), or an integral multiple of a half wavelength.

Use the formula above along with the velocity factor to find the physical

length that equates to an electrical half wavelength (the practice that I prefer). All of my transmission lines are integral multiples of a half wavelength at mid-band on the lowest band of operation. That practice can be taken too far, but it is useful.

### TRANSMISSION-LINE NOISE?

Transmission lines are capable of generating noise and spurious voltages that are seen by the system as valid signals. Several such sources exist. One source is coupling between noise currents flowing in the outer and inner conductors. Such currents are induced by nearby electromagnetic interference and other sources. Although coaxial design reduces noise pickup compared with parallel line, the potential for EMI exists. Selecting high-grade line with good shielding reduces the problem.

Another source of noise is thermal noises in the resistances and conductances. That type of noise is proportional to resistance and temperature.

There is also noise created by mechanical movement of the cable. One type of mechanical noise results from movement of the dielectric against the two conductors, while a second type of mechanically generated noise is piezoelectricity in the dielectric. Both types can be reduced or eliminated by proper mounting of the cable.

My new antenna book, "Practical Antenna Handbook" (catalog no. 3270) is now out. You can get it from TAB Books (Blue Ridge Summit, PA, 17294-0850) for \$21.95. An IBM-PC diskette of some BASIC computer programs on antennas is available from me directly. For more information, contact me at PO Box 1099, Falls Church, VA 22041.

TABLE 1

Cable Type	Velocity Factor
Regular Polyethylene	0.66
Polyfoam	0.80
Teflon	0.70





## LOTUS 1-2-3

(Continued from page 76)

the user need only refer to page 8 in the manual for specific control-key inputs—seven control keys to be exact—that make the program totally flexible.

The program introduces the user to spreadsheet concepts and terminology. There is a help function that is at first very useful, but is made obsolete with the acquisition of knowledge. There's much more, but we'll leave that as a bonus for the first-time user.

Photographs of a few monitor screens are presented in this article to show the reader what the software user sees.

Unlike many other programs it can be stopped in the middle and you can return to within one or two frames from where you left by using the menu's "Sub-menu." The program lets you learn Lotus 1-2-3 at your own pace—just tap the space bar when you finish a screen's worth of information, and the



Lotus lets you figure out loan-interest costs before you go to the bank. That and many other interesting features are covered in Individual Training for Lotus 1-2-3.



The expanded contents for the course comes in two windows. Position the highlight area on the subject matter of interest and the program jumps to it immediately. This feature is valuable for quick refreshers or for returning to the course later.

program advances to the next screen. If you want to jump to a particular portion of the course, say "Creating Windows," it is possible to do so with ease.

**Running the Software.** To run ISI's training program all you need is a basic IBM PC, or equivalent, with 128 kilobytes of Ram, DOS 2.0 or better, one diskette drive and a monochrome monitor (color is supported). In fact, you don't need the Lotus 1-2-3 software loaded at all! The ISI training program simulates all the Lotus windows and its activities while you are learning, and eliminates the need for referencing a manual.

If you have a hard disk, then make a subdirectory called LEARN123 (using MD \LEARN123) on the hard disk you wish to use. Then move to the new directory (using CD \LEARN123). Then insert Disk 1 into the A: drive and type:

COPY A:\*.\*

and press ENTER. Now you are ready to "setup" the software. Type:

SETUP

and answer the questions on the screen. Your answers will direct the training program to respond to your individual needs.

Now you can run Individual Training for Lotus 1-2-3 by typing:

INSTRUCT

and the software will be up and running.

Individual Training for Lotus 1-2-3 is available from leading hardware and software retailers in North America and overseas. For more information and suppliers of the software, contact Individual Software, Inc., 125 Shoreway Road, Suite 3000, San Carlos, CA 94070-2704; Tel. 1-800-331-3313 (Nationwide) or 415-595-8855 (California), or circle No. 119 on the Free Information Card. The suggested retail price is \$69.95 and the software comes in both 5¼- and 3½-inch formats. ■



## SPY STATION

(Continued from page 59)

**Inside the Spy Station.** But what about the high-speed transmissions that drew the attention of ham-radio operators and the newspapers in the first place? The *Providence Journal's* operator testified that "no human fist could possibly transmit as fast as that." The answer lay in two unusual (at least for that time and place) pieces of equipment—a wire recorder and a similar device that used a perforated paper strip as the recording medium. In both cases, recordings of Morse Code messages made at normal transmission speed could be speeded up during transmission to squeeze more messages into a given amount of transmission time. At the other end, a comparable device would record the incoming signals at high speed so that an operator, at his convenience, could slow the tape or wire down for transcription. Transmission and reception could take place automatically without the need for an operator's attention.

The paper recorder consisted of a perforator, which punched small holes in a paper strip moving at a fixed speed, and a transmitter. The distance between the holes represented the dots or dashes produced by an ordinary telegraph key. The transmitter used spring contacts that opened and closed the transmitting circuit as the holes in the tape passed by.

Much more ingenious was the wire recorder or Telegraphone, a product of a factory in Springfield, MA. Forerunner of the Compact Cassette recorder, it utilized a spool of piano wire that could be run past an electromagnet at a choice of speeds. As the wire passed through the magnetic field, it picked up magnetic impulses which, on replay, reproduced the original sounds. An invention of Danish telephone engineer Valdemar Poulsen, its two upright spools made the device look like a spinning jenny (a machine used for spinning wool).

For more than 50 years, the secrets of Sayville lay locked away in the vaults of the National Archives in Washington. Today, Archives visitors can rummage among the cables sent by Sayville and try to figure out for themselves what they meant. Or, if you'd like to hear what an Apgar cylinder sounded like and you happen to be in the vicinity of the Antique Wireless Association museum in East Bloomfield, NY, stop in for a listen.

## TROUBLESHOOTING

(Continued from page 70)

**Mechanical Systems.** Printers use a variety of solenoids, gears, motors, belts, and pulleys to transport the print head, advance the paper, and move the ribbon. Those mechanical systems are driven by power semiconductor components in the I/O logic portion of the controlling circuitry. Although electronic problems may cause a failure in those systems, never rule out the possibility of a mechanical problem. Table 7 is a troubleshooting chart for the three major mechanical systems.

Impact printers require an inked ribbon to transfer the character image to

TABLE 6—INTERFACE AND CONTROL LOGIC TROUBLESHOOTING CHART

Symptom	Possible Solution						
	Check Microprocess or Microcontroller	Check Clock Generator(s)	Check Memory Chips	Check Communications Logic	Check I/O Logic and Drivers	Check Discrete Logic	Check Print Head Wiring and Position Sensors
Printer Does Not Initialize	•	•	•		•	•	
Printer Initializes DK. No Print			•	•	•	•	•
Prints Unintelligibly			•	•	•	•	•

TABLE 7—MECHANICAL TROUBLESHOOTING CHART

Symptom	Possible Solution													
	Check Ribbon Motor	Check Paper Advance Motor	Check Carriage Motor	Check Ribbon System Wiring	Check Paper Advance System Wiring	Check Carriage System Wiring	Check Ribbon System Gears and Linkages	Check Paper Advance System Gears and Linkages	Check Carriage System Gears and Linkages	Check Ribbon Itself (Broken/Jammed)	Check Power Supply	Check Paper Rollers	Check Position Sensors or Optical Encoder(s)	Check "Home" Signal(s) at Carriage
Ribbon Does Not Advance	•			•			•			•	•			
Ribbon Advances Intermittently				•			•			•	•			
Ribbon Does Not Reverse				•			•			•				
Paper Does Not Feed		•			•			•						
Paper Feeds Intermittently					•			•			•			
Paper Jams												•		
Print Head Does Not Move			•			•			•		•			
Head Moves Intermittently						•			•					
Head Rams the Carriage Frame								•					•	•
Bad Character Spacing						•							•	•

the surface of the paper. Like a typewriter, the ribbon must be advanced regularly in order to keep a fresh area of ink in front of the print head. Some printers reverse the direction of the ribbon automatically to make it last longer. Any trouble in moving the ribbon should point to the motor, gears, and linkages that drive it. Also check for power and the wiring in the ribbon transport system.

The paper is normally fed by a motor, which drives a gear assembly. When paper does not feed correctly, check the alignment and condition of the motor, gears, and any linkages. Check

the wiring and power to the paper-advance system. A consistent paper jam almost always suggests trouble with roller alignment or poor roller condition. Typewriter supply stores sell solvents to clean the roller rubber.

The carriage must actually move the print head back and forth across the page. That is probably one of the most important processes in the printer; if the carriage does not move, or moves only intermittently, check the wiring and power to the carriage motor, then check the carriage gears, pulleys, and linkages. Incorrect carriage movement or spacing, especially at either end of

the carriage, may indicate a problem with the position sensors or optical encoders in the carriage system. If the printer can not determine the position of the head, it may print the right characters, but in the wrong places.

**Conclusion.** Troubleshooting a printer is a precise, painstaking process that combines intuition with logic, and senses with instrumentation. Take your time, be thorough, use care, and document each step of your work. With some experience and persistence, printer troubleshooting will become an easier process.



# ELECTRONICS MARKET PLACE

## FOR SALE

**DESCRAMBLERS.** All brands. Special: Combo Jerrold 400 and SB3 \$165. Complete cable descrambler kit \$39.00. Complete satellite descrambler kit \$45.00. Free catalog. **MJH INDUSTRY**, Box 531, Bronx, NY 10461-0208.

**CABLE descrambler liquidation.** Major makes and models available. Industry pricing! (Example: Hamlin Combo's, \$44 each... Minimum 10 orders). Call **WEST COAST ELECTRONICS**, 1 (800) 628-9656.

**FREE catalog.** Interfaces for IBM compatibles. Digital I/O and Analog input. Control relays, motors, lights, measure temperature, voltage. **JOHN BELL ENGINEERING, INC.**, 400 Oxford Way, Belmont, CA 94002. (415) 592-8411.

**CABLE descramblers (Jerrold)** from \$40.00. Tocom VIP test chip. Fully activates unit. Also Zenith test board. Fully activates Z-Tacs. \$50.00. Call (213) 867-0081.

## CABLE TV DESCRAMBLERS! BARGAIN HEADQUARTERS!



- JERROLD™ •TOCOM •HAMLIN
- OAK •ZENITH
- SCIENTIFIC ATLANTA

6 month warranty! We ship C.O.D.!  
Lowest retail/wholesale prices!

FREE CATALOG:  
Global Cable Network  
1032 Irving St. Suite 109  
S.F., CA 94122  
NO CALIFORNIA SALES!!!

**ORDER TODAY! 800-327-8544**

**PRINTED** circuit boards etched & drilled. Free delivery. **K & F ELECTRONICS, INC.**, 33041 Groesbeck, Fraser, MI 48026. (313) 294-8720.

**HUGE** 88 page communications catalog of short-wave, amateur and scanner equipment. Antennas, books and accessories too. Send \$1.00 to: **UNIVERSAL RADIO**, 1280 Aida Drive, Dept. PE, Reynoldsburg, OH 43068.

**LASERS** 1mW to 2kW, world's largest selection of new & used surplus. Free catalog. **MWK INDUSTRIES**, 1269 Pomona Road, Corona, CA 91720. (714) 278-0563.

## CB RADIO OWNERS!

We specialize in a wide variety of technical information, parts and services for CB radios. 10-Meter and FM conversion kits, repair books, plans, high-performance accessories. Thousands of satisfied customers since 1976! Catalog \$2.

o **CBC INTERNATIONAL**  
P.O. BOX 31500PE, PHOENIX, AZ 85046

**ELECTRONIC** muscle stimulator! Grow your muscles quickly and effortlessly or resale for huge profits. Complete kit - \$69.95; assembled and tested - \$98.00. **TECHNIX**, Box 55249, Bridgeport, CT 06610.

**FREE IBM** shareware catalog, 1 (800) 842-6819, **OFFSHORE SOFTWARE**, 2941 Pretty Branch Drive, Mobile, AL 36618.

**FORMATTED** 3-1/2" 1.44 MB HD disks only \$1.00 each plus 10% postage. Minimum purchase 12. See our other ad for computers this issue. **BEACH RADIO**, PO Box 548, Boston, MA 02112-0548.

**ELECTRONIC** parts, kits, software. No minimum orders. Free catalog. **WELSH ELECTRONICS**, 620 Olive Lane, Ambridge, PA 15003-2458.

**MOVIES!** Rare and unusual science-fiction and horror classics on VHS. Send \$2.00 for 16 page illustrated catalog. **SAFE-AIR VIDEO**, 162 East Chestnut, Canton, IL 61520.

## CLASSIFIED AD ORDER FORM

To run your own classified ad, put one word on each of the lines below and send this form along with your check to:

**Popular Electronics Classified Ads**, 500-B Bi-County Boulevard, Farmingdale, N.Y. 11735

**PLEASE INDICATE** in which category of classified advertising you wish your ad to appear. For special headings, there is a surcharge of \$11.00.

( ) Plans/Kits ( ) Business Opportunities ( ) For Sale  
( ) Education/Instruction ( ) Wanted ( ) Satellite Television  
( ) \_\_\_\_\_

Special Category: \$11.00

### PLEASE PRINT EACH WORD SEPARATELY, IN BLOCK LETTERS.

(No refunds or credits for typesetting errors can be made unless you clearly print or type your copy.) Rates indicated are for standard style classified ads only. See below for additional charges for special ads. **Minimum: 15 words.**

1	2	3	4	5
6	7	8	9	10
11	12	13	14	15 (\$23.25)
16 (\$24.80)	17 (\$26.35)	18 (\$27.90)	19 (\$29.45)	20 (\$31.00)
21 (\$32.55)	22 (\$34.10)	23 (\$35.65)	24 (\$37.20)	25 (\$38.75)
26 (\$40.30)	27 (\$41.85)	28 (\$43.40)	29 (\$44.95)	30 (\$46.50)
31 (\$48.05)	32 (\$49.60)	33 (\$51.15)	34 (\$52.70)	35 (\$54.25)

We accept MasterCard and Visa for payment of orders. If you wish to use your credit card to pay for your ad fill in the following additional information (Sorry, no telephone orders can be accepted.):

Card Number \_\_\_\_\_

Expiration Date \_\_\_\_\_

PRINT NAME \_\_\_\_\_

SIGNATURE \_\_\_\_\_

**IF YOU USE A BOX NUMBER YOU MUST INCLUDE YOUR PERMANENT ADDRESS AND PHONE NUMBER FOR OUR FILES. ADS SUBMITTED WITHOUT THIS INFORMATION WILL NOT BE ACCEPTED.**

**CLASSIFIED COMMERCIAL RATE:** (for firms or individuals offering commercial products or services) \$1.55 per word prepaid (no charge for ZIP code)...**MINIMUM 15 WORDS.** 5% discount for same ad in 6 issues within one year; 10% discount for 12 issues within one year if prepaid. **NON-COMMERCIAL RATE:** (for individuals who want to buy or sell a personal item) \$1.25 per word, prepaid...no minimum. **ONLY FIRST WORD AND NAME** set in bold caps at no extra charge. Additional bold face (not available as all caps) 30c per word additional. Entire ad in boldface, \$1.85 per word. **TINT SCREEN BEHIND ENTIRE AD:** \$1.90 per word. **TINT SCREEN BEHIND ENTIRE AD PLUS ALL BOLD FACE AD:** \$2.25 per word. **EXPANDED TYPE AD:** \$2.05 per word prepaid. Entire ad in boldface, \$2.45 per word. **TINT SCREEN BEHIND ENTIRE EXPANDED TYPE AD:** \$2.55 per word. **TINT SCREEN BEHIND ENTIRE EXPANDED TYPE AD PLUS ALL BOLD FACE AD:** \$2.95 per word. **DISPLAY ADS:** 1" x 2 1/4" - \$205.00; 2" x 2 1/4" - \$410.00; 3" x 2 1/4" - \$615.00. General information: Frequency rates and prepayment discounts are available. **ALL COPY SUBJECT TO PUBLISHERS APPROVAL. ADVERTISEMENTS USING P.O. BOX ADDRESS WILL NOT BE ACCEPTED UNTIL ADVERTISER SUPPLIES PUBLISHER WITH PERMANENT ADDRESS AND PHONE NUMBER.** Copy to be in our hands on the 15th of the fourth month preceding the date of issue (i.e.; Sept. issue copy must be received by May 15th). When normal closing date falls on Saturday, Sunday or Holiday, issue closes on preceding work day. Send for the classified brochure. Circle Number 49 on the Free Information Card.

## FREE CATALOG

FAMOUS "FIRESTIK" BRAND CB ANTENNAS AND ACCESSORIES. QUALITY PRODUCTS FOR THE SERIOUS CB'er. SINCE 1962  
**FIRESTIK ANTENNA COMPANY**  
 2614 EAST ADAMS  
 PHOENIX, ARIZONA 85034

**SECRET Scanner Frequencies:** Directories list federal, police, surveillance, bugging, channels. Big free catalog. CRB, Box 56-PE, Commack, NY 11725.

IS it true jeeps for \$44.00 through the US gov't? Call for facts! (504) 649-5745 ext. 5-5730.

**TV VCR repair tips** send \$39.95 to **JOE MASARO**, 1041 Revere Ave., Trenton, NJ 08629.

**FREE Catalog:** Save hundreds on sought after electronic, electro mechanical, and computer related hardware and components — including hard-to-find items. Call toll free: 1 (800) 776-3700. **AMERICAN DESIGN COMPONENTS/Dept.** 114-120, 815 Fairview Avenue, Fairview, NJ 07022.

★★★★★ PRESENTING ★★★★★

### CABLE TV DESCRAMBLERS

★★★★★ STARRING ★★★★★

#### JERROLD, HAMLIN, OAK

AND OTHER FAMOUS MANUFACTURERS

- FINEST WARRANTY PROGRAM AVAILABLE
- LOWEST RETAIL/WHOLESALE PRICES IN U.S.
- ORDERS SHIPPED FROM STOCK WITHIN 24 HOURS

FOR FREE CATALOG ONLY **1-800-345-8927**  
 FOR ALL INFORMATION **1-818-709-9937**

---

**PACIFIC CABLE CO., INC.**  
 7325 1/2 Reseda Blvd., Dept. 1000  
 Reseda, CA 91335

**FREE Programs! Free Disks!** Choose game, utility or business then you will get an IBM compatible program on 5-1/4" 360K disk free! You choose category. We choose program. Also receive our electronics surplus/closeouts catalog and rental/commercial disk catalog on another disk free. Just enclose \$2.00 (refundable) for shipping! **BEACH RADIO**, PO Box 548, Boston, MA 02112-0548.

**\$1.99 software** for IBM Compatibles. Quality at affordable prices! Huge selection: business, games, graphics, utilities database, spreadsheets. Free catalog. **AULT**, 1556 Halford Avenue, #242, Santa Clara, CA 95051.

### PLANS & KITS

**CATALOG: hobby/broadcasting/HAM/CB:** Cable TV, transmitters, amplifiers, surveillance devices, computers, more! **PANAXIS**, Box 130-H12, Paradise, CA 95967.

**BUILD** — five-digit, ohms, capacitance, frequency, pulse, multimeter. Board, and instructions \$9.95. **BAGNALL ELECTRONICS**, 179 May, Fairfield, CT 06430.

### REMOTE CONTROL KEYCHAIN



Complete w/mini-transmitter and +5 vdc RF receiver. Fully assembled including plans to build your own auto alarm. Quantity discounts available.

Check, Visa or M/C  
Add \$3 shipping

\$24.95

VISITECT INC./Dept. P (415) 872-0128  
 PO BOX 5442, SO. SAN FRAN., CA 94080

**RECEIVER** plans, kits. Simple to sophisticated. Thorough explanations included. All bands. Catalog and sample schematics \$3.00. **PREMIER ENTERPRISES**, 3850 Plymouth Blvd, Suite 104, Plymouth, MN 55446.

**SURVEILLANCE transmitter kits!** Four models of each; telephone, room, combination telephone/room transmitters tune from 65 to 305 MHz. Catalog with **Popular Communications'** and **Popular Electronics** book reviews of "Electronic Eavesdropping Equipment Design," \$1.00. **SHEFFIELD ELECTRONICS**, 7223A Stony Island Ave., Chicago, IL 60649-2806.

**VIDEOCIPHER II manuals.** Volume 1 — Hardware. Volume 2 — Software — either \$34.95. Volume 3 — Projects/Software, Volume 5 — Documentation or Volume 6 — Experimentation \$44.95 each. Volume 7 — 032-Hacking \$54.95. Volume 4 — repair — \$99.95. **Cable Hacker's Bible** — \$34.95. **Clone Hacker's Bible** — \$34.95. Catalog-\$3.00. CODs: (602) 782-2316. **TELECODE**, PO Box 6426-PE, Yuma, AZ 85366-6426.

**MINIATURE FM transmitters!** Tracking transmitters! Voice disguisers! Bug detectors! Phone devices! More! Available as kits or assembled and tested! Catalog \$2.00 (refundable). **XANDI ELECTRONICS**, Box 25647, 32YU, Tempe, AZ 85285-5647.

### SURVEILLANCE TELEPHONE

This is a normal functioning telephone! EXCEPT it has a secret built in monitor. Only YOU can call and monitor ALL conversations, using a secret code, and never be detected! Range Unlimited.

\$175.00 - 6 month Warranty Catalog \$3.00  
 LISTEN ELECTRONICS, 603 Elgin, Muskogee, OK 74401

ALARMS 1-800-633-8277 SECURITY EQUIP.



**SHORTWAVE** — 1933. One-tube. Plug-in coils. DX radio. Free plans. **BOB RYAN**, PO Box 3039, Anaheim, CA 92803.

**SURVEILLANCE** — countermeasures! Guaranteed lowest prices! Huge catalog \$5.00 (refundable). **PROTECTOR**, PO Box 520294-E, Salt Lake City, Utah 84152.

**KITS** — alarms, games and test equipment. Send \$1.00 for catalog. **RAKJAB**, PO Box 1875, Apopka, FL 32704.

### LASERS

New Laser Tubes \$15

New Visible Diode Modules

Helium-Neon Laser Tubes from \$25

FREE CATALOG CALL OR WRITE TODAY!

COMPLETE HELIUM-NEON LASERS FROM \$110\*\*

MEREDITH INSTRUMENTS P.O. Box 1724/Glendale, AZ 85311/(602)934-9387

**UNIQUE** projects. Build an infrared motion detector, ultrasonic distance meter, digital rain gauge. Complete plans, PCB layout, \$4.00 each. Others available. **K. KEMP**, 13772 Goldenwest St., #549 Westminster, CA 92683.

**TALK** to your PC! Build a voice interface for your IBM computer. Detailed instruction booklet \$8.00. **PANG ENTERPRISES**, 45 Park Home, Willowdale, Ontario, Canada M2N 1W7.

**LASER** lighting entertainment systems. Create your own 3-dimensional laser light shows with these professional secrets! Detailed mechanical and electrical schematics, designs for any budget! \$20.00 **MILLENIUM**, 229 McAfee, Thousand Oaks, CA 91360.

**DAZER II** Personal protection device! Plans \$8.00. Dazers! Supersonics! Transmitters! Gravity! Tesla! Detectors! More! Catalog \$2.00. **QUANTUM RESEARCH**, 17919 77 Avenue, Edmonton, Alberta T5T 2S1.

**BUILD** six band shortwave superhet, covers 1.8 — 30 M.C., R.F. amp, product detector, variable B.F.O., bandspread tuning, crystal calibrator, send \$12.50 to **RANDY EPPINETTE**, Rt. 2, Box 621, Camden, AR 71701.

**BUILD** this electronic roach hotel. Simple plans and directions to attract & kill roaches — \$5.00. **D. LETERSKY**, PO Box 795, Abilene, TX 79604.

## CABLE TV "BOXES"

Converters — Descramblers  
 Remote Controls — Accessories

- ★ Guaranteed Best Prices ★
- ★ 1 Year Warranty — C.O.D.'s ★
- ★ Immediate Shipping ★
- ★ FREE CATALOG ★

Call or Write

**TRANS-WORLD CABLE CO.**

12062 Southwest 117th Court, Suite 126

Miami, Florida 33156

1-800-442-9333



### T.V. FILTERS

T.V. notch filters, surveillance equipment, brochure \$1.00. **D.K. VIDEO**, Box 63/6025, Margate, FL 33063. (305) 752-9202.

### EDUCATION/INSTRUCTION

**MAGIC!** Four illustrated lessons plus inside information shows you how. We provide almost 50 tricks including equipment for four professional effects. You get a binder to keep the materials in, and a one-year membership in the International Performing Magicians with a plastic membership card that has your name gold-embossed. You get a one-year subscription to our quarterly newsletter, "IT'S MAGIC!" Order now! \$29.95 for each course + \$3.50 postage and handling. (New York residents add applicable state and local sales tax). **The Magic Course**, 500-B BiCounty Blvd., Farmingdale, NY 11735.

**LEARN** IBM PC assembly language. 80 programs. Disk \$5. Book \$18. **ZIPFAST**, Box 12238, Lexington, KY 40581-2238.

**ECONOMY Homestudy Courses** Micro computer development system, C programming and CET exam preparation. Send **SASE H. FRANCISCO**, 8332 Peggy St., Tampa, FL 33615.

## BEST BY MAIL

Rates: Box 5, Sarasota, FL 34230

### COMPUTERS

**HUNDREDS OF IBM** programs \$3.00 each. Free catalog on disk. **BAC Marketing**, 279 South Beverly Drive, Suite 1142, Beverly Hills, CA 90212-3898.

### MONEYMAKING OPPORTUNITIES

**EARN 1000'S STUFFING** envelopes at home. Free details. **CPSL**, Box 231121-(K), Harahan, LA 70183.

**MAKE MONEY, MAIL** Order Easily, Cheaply - Smarter, Not harder. \$29.95 to: **WMS Enterprises Special Report**, 3145 Geary Blvd., S.F., CA 94118.

**\$330 + WEEKLY ASSEMBLING** products from home. Guaranteed! Amazing recorded message! 24 hours. (316)292-2091, Extension 133.

### CABLE EQUIPMENT

**CABLE TV** secrets — the outlaw publication the cable companies tried to ban. HBO, Movie Channel, Showtime, descramblers, converters, etc. Suppliers list included. \$9.95. **CABLE FACTS**, Box 711-H, Pataskala, OH 43061.

### ZENITH DESCRAMBLERS

**ZENITH ZTACS** will work where others have failed, fully warranted with remote. \$175.00 call (213) 478-2506.

### TEST EQUIPMENT

**FACTORY** direct test equipment. Function generators, frequency counters microprocessor development systems and security systems. Call for free brochure. **APPLIED ELECTRONIC RESEARCH**, Hollywood, Florida, (305) 987-9785.



## Cable TV Descramblers

If you find a better deal, we'll better our deal.

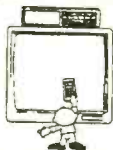

\*Jerrold \*Tocom \*Hamlin \*Oak  
\*Scientific Atlanta \*Zenith

Ask about our extended warranty program.

COD, Visa, M/C welcome.

Free Call - Free Catalog.

Video Tech **800-562-6884**

2702 S. Virginia St., Ste. 160-304  
Reno, NV 89502.

## BUSINESS OPPORTUNITIES

**YOUR** own radio station! AM, FM, TV, cable. Licensed/unlicensed. **BROADCASTING**, Box 130-112, Paradise, CA 95967.

**EASY** work! Excellent Pay! Assemble products at home. Call for information. (504) 641-8003 Ext. 5730.

**MAKE** \$50/hr working evenings or weekends in your own electronics business. Send for free facts. **MJPI INDUSTRY**, Box 531, Bronx, NY 10461.

**UP** to \$7,000 month using your VCR. USA, Canada, info \$1.00 cash, US funds. **RANDALL**, Box 2168-E, Van Nuys, CA 91404.

**MAKE** \$2000.00/week - reclaiming pure gold from scrap computers. Free report! (worth \$25.00) 1 (900) 246-2323 (\$2.00 min.).

**LET** the government finance your small business. Grants/loans to \$500,000. Free recorded message: (707) 448-0270. (KJ8)

**YOUTH** oriented mini-business earns \$60.00 an hour. Details \$6.00. **DIPAC ASSOCIATES**, PO Box 1882, Greenville, TX 75401.

## CABLE DESCRAMBLERS OAK M35B COMBO \$39.95

Jerrold, Zenith, Hamlin, Sci. Atlanta, Pioneer & MORE! OUR PRICES ARE BELOW WHOLESALE!

### CABLE+PLUS

14417 Chase St. # Panorama City, CA 91402  
1-800-822-9955 • Other Info. 1-818-785-4500  
NO CALIF. SALES - DEALERS WANTED

## SATELLITE TV

**FREE** catalog - Do-it-yourself save 40-60% lowest prices world wide, systems, upgrades, parts, all major brands factory fresh and warranted. **SKY-VISION INC.**, 2008 Collegeway, Fergus Falls, MN 56537. 1 (800) 334-6455.

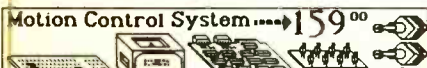

**Motion Control System** \$159.00  
Includes Computer, Monitor, Keyboard, Power supply, 4 Motors, and Software.  
Call or Send for **Free Robotics Catalog**

Silicon Valley Surplus 4222 E. 12th St. Serving you since 1983  
415 261-4506 Oakland Ca. 94601 8 am to 4 pm PST

## ANTIQUE RADIO CLASSIFIED

Free Sample!

Antique Radio's

Largest Circulation Monthly. Articles, Ads & Classifieds.

6-Month Trial: \$13. 1-Yr: \$24 (\$36-1st Class).  
A.R.C., P.O. Box 802-L5, Carlisle, MA 01741

## CABLE T.V. CONVERTERS WHY PAY A HIGH MONTHLY FEE?

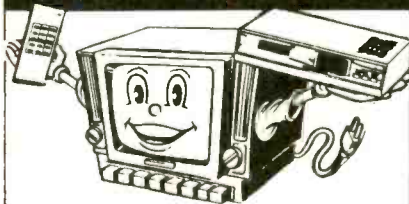

All Jerrold, Oak, Hamlin, Zenith, Scientific Atlanta, Magnavox and all specialized cable equipment available for shipment within 24 hours. For fast service MC / VISA or C.O.D. telephone orders accepted (800) 648-3030 60 Day Guarantee (Quantity Discounts) 8 A.M. to 5 P.M. C.S.T. **CLOSED WEEK-ENDS.** Send self-addressed Stamped envelope (60¢ postage) for Catalog.

**MIDWEST ELECTRONICS INC.**

P.O. Box 5000  
Suite 311 (PE)  
Carpentersville, IL 60110

No Illinois Orders Accepted.

## WANTED

**INVENTORS!** Call **IMPAC** - we submit ideas to manufacturers! For free information package call in US/Canada 1 (800) 225-5800.

**HAVE a new idea? Invention?** Call **THE "CONCEPT NETWORK"** for free confidential kit at 1 (800) 835-2246 ext. 197 US/Canada 24 Hrs. day.

**100'S** of Silicon Valley companies hiring technical professionals. For current listings send \$15.00 to **EXCEL SERVICES**, PO Box 36046, San Jose, CA 95158.

**KELVIN 200**  
AC/DC VOLTAGE  
AC/DC CURRENT  
RESISTANCE DIODE TEST  
LOW BATTERY Warning  
ACCURACY ±0.5%  
CONTINUITY TEST BUZZER  
TRANSISTOR CHECKER  
CAPACITANCE CHECKER

**\$39.95**  
Stock No. 990091

**KELVIN Electronics M/C**  
7 Fairchild Ave., Plainview, NY 11803  
(516) 349-7620 1(800) 645-9212

## FREE CATALOG!

**1-800-648-7938**

For all information 1-702-362-9026

**JERROLD HAMLIN OAK ETC.**

## CABLE TV DESCRAMBLERS

• Compare our low Low Retail Prices!

• Guaranteed Prices & Warranties!

• Orders Shipped Immediately!

**REPUBLIC CABLE PRODUCTS INC.**

4080 Paradise Rd. #15 Dept. PE-90

Las Vegas, NV 89109

## TUBES - 2000 TYPES DISCOUNT PRICES!

Early, hard-to-find, and modern tubes. Also transformers, capacitors and parts for tube equipment. Send \$2.00 for 28 page wholesale catalog.

**ANTIQUE ELECTRONIC SUPPLY**

6221 S. Maple Ave. • Tempe, AZ 85283 • 602-820-5411

## NAS CABLE BOXES FREE CATALOG 1-800-848-3997

Jerrold • Scientific Atlanta  
Many Others

1 Year Warranty • COD's



THE AMERICAN HEART  
ASSOCIATION  
MEMORIAL PROGRAM



American Heart Association

This space provided as a public service.

## ADVERTISING SALES OFFICE

**Gernsback Publications, Inc.**  
500-B Bi-County Blvd.  
Farmingdale, NY 11735  
1-(516) 293-3000

President: **Larry Steckler**

Vice President: **Cathy Steckler**

**For Advertising ONLY**  
516-293-3000  
Fax 1-516-293-3115

**Larry Steckler**  
publisher

**Arline Fishman**  
advertising director

**Denise Haven**  
advertising assistant

**Christina Estrada**  
advertising associate

**Kelly McQuade**  
credit manager

**Customer Service/Order Entry**  
1-800-435-0715  
1-800-892-0753  
7:30 AM - 8:30 PM EST

## SALES OFFICES

### EAST/SOUTHEAST

**Becky Akers**  
Pattis/3M  
310 Madison Ave., Suite 1804  
New York, NY 10017  
1-212-953-2121  
Fax 1-212-953-2128

### MIDWEST/Texas/Arkansas/Okla.

**Ralph Bergen**  
540 Frontage Road—Suite 339  
Northfield, IL 60093  
1-708-446-1444  
Fax 1-708-446-8451

### PACIFIC COAST/Mountain States

**Marvin Green**  
5430 Van Nuys Blvd., Suite 316  
Van Nuys, CA 91401  
1-818-986-2001  
Fax 1-818-986-2009

# ADVERTISING INDEX

POPULAR ELECTRONICS magazine does not assume any responsibility for errors that may appear in the index below.

Free Information No.		Page
6	AMC Sales	83
16	Ace Communications	91
5	All Electronics	25
—	Amazing Concepts	12
—	Antique Electronics Supply	101
17	C & S Sales	7
—	CB City	99
—	CIE	21
—	Cable Plus	101
—	Command Productions	87
22	Communications Electronics	CV4
12	Contact East	27
14	Cook's Institute	91
—	Damark International	3
—	Electronic Tech. Today	CV3
13	Electronics Book Club	5
—	Electronics & Engineers B.C.	26
—	Firestik II	100
—	Global Cable Network	99
—	Grantham College	16
18	Heathkit	13
—	ISCET	83
—	Kelvin	101
—	Listen Electronics	100
—	Lindsay Publications	15
—	Meredith Instruments	100
—	Midwest Electronics	101
—	Monitoring Times	89
21	Mouser	12
—	NRI Schools	11
—	North American Services	101
10	Protel Technology	27
—	Pacific Cable	100
7	Paladin Electronics	85
19	Parts Express	17
11	People's College	23
20	Radio Shack	CV2
—	Republic Cable	101
8	Sequoia Publishing	85
—	Silicon Valley Surplus	101
—	Trans World	100
15	U.S. Cable	24
—	Video Tech	101
9	Viejo Publications	24
—	Visitec	100

## DIGITAL COURSE

(Continued from page 71)

pulse to the clock<sub>2</sub> input of the 74LS374. Monitor the status of the inputs and outputs of the 74LS374. The  $Q$  outputs

should be at the same logic levels as the  $D$  inputs. (Were they?)

Remove power from the circuit, and connect a 555 oscillator/timer (configured as an astable multivibrator) in the circuit with the output of the oscillator (pin 3) feeding the clock input of the

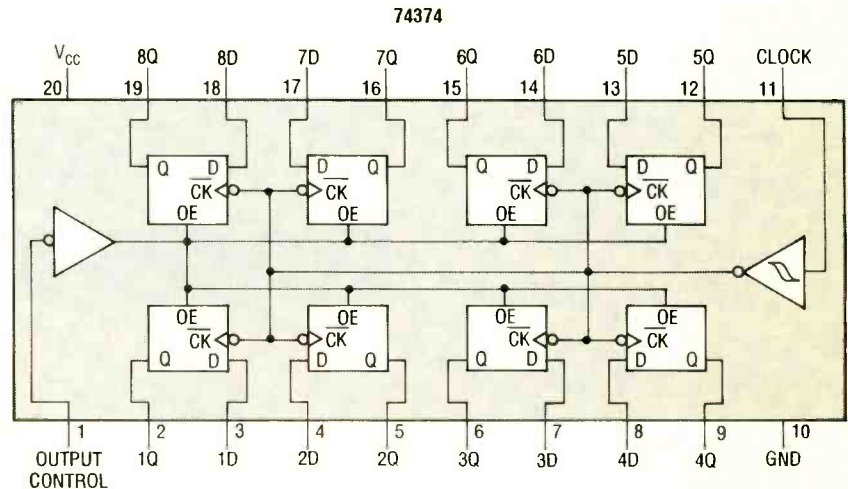

Fig. 1. This pinout/functional-block diagram shows that the 74LS374 octal D-type latch consists of eight edge-triggered flip-flops.

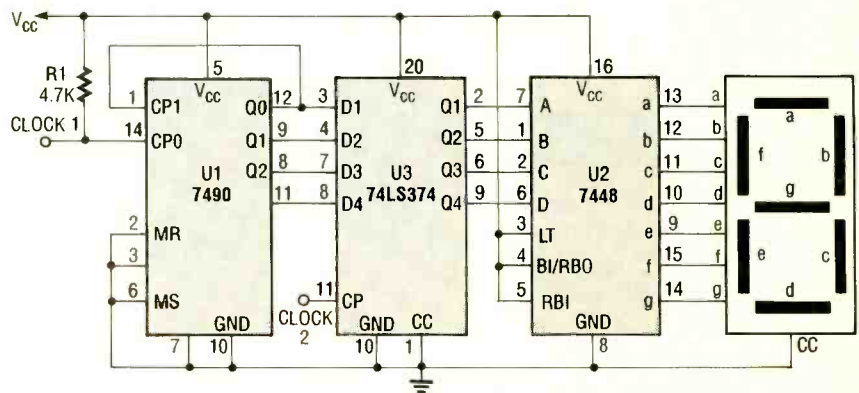

Fig. 2. Here the 74LS374 is placed in a counter circuit to form a pseudo random-number generator. The 7490 decade counter has been connected to provide a conventional BCD (8-4-2-1) output signal.

### PARTS LIST FOR THE 1-1/2-DIGIT COUNTER EXERCISE

- U1—7490 decade counter, integrated circuit
  - U2—7448 BCD to 7-segment common-cathode, decoder/driver, integrated circuit
  - U3—74LS374 octal D-type flip-flop, integrated circuit
  - DISP1—7-segment, common-cathode LED display
  - R1—4700-ohm, 1/4-watt, 5% resistor
- Breadboard materials, 5-volt power source, wire, etc.

7490; 555-oscillator circuit should still be on your breadboard from the previous exercise. Reapply power to the circuit. Using your logic probe, monitor the output of the 555 to make sure that it is oscillating. Once you've established that the circuit is oscillating, apply a pulse (once again using your logic pulser) to the clock input of the 74LS374. What is the result?

Inject several pulses to the clock input of the 74LS374. If your circuit is functioning properly, you should observe a stream of random numbers from "0" to "9" on the display. Can you explain why the numbers appear random rather than repetitive?



# Electronics Paperback Books

GREAT PAPERBACKS AT SPECIAL PRICES

**BP248—TEST EQUIPMENT CONSTRUCTION** ..... \$5.95. Details construction of simple, inexpensive, but extremely useful test equipment. AF Gen, Test Bench Ampl, Audio Millivoltmeter, Transistor Tester and six more.



**BP267—HOW TO USE OSCILLOSCOPES AND OTHER TEST EQUIPMENT** ..... \$6.95. Mastering the oscilloscope is not really too difficult. This book explains all the standard controls and functions. Other equipment is also described.



**BP265—MORE ADVANCED USES OF THE MULTIMETER** ..... \$5.95. Use these techniques to test and analyze the performance of a variety of components. Also see how to build add-ons to extend multimeter capabilities.

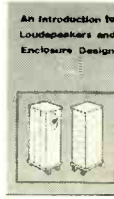

**BP256—INTRO TO LOUDSPEAKERS AND ENCLOSURE DESIGN** ..... \$5.95. We explore the variety of enclosure and speaker designs in use today so the reader can understand the principles involved.

**BP263—A CONCISE INTRO TO dBASE** ..... \$6.95. The dBASE series of programs are probably the best known database programs for microcomputers. This book is designed to help you get started working with them.



**BP260—CONCISE INTRO TO OS/2** ..... \$5.95. If you are a multitasking PC user and want to get the most out of your computer, then you must learn its OS/2 operating system. This book shows you just how to do that, quickly and easily.



**BP249—MORE ADVANCED TEST EQUIPMENT CONSTRUCTION** ..... \$6.95. Eleven more test equipment construction projects. They include a digital voltmeter, capacitance meter, current tracer and more.



Digital Audio Projects



**BP245—DIGITAL AUDIO PROJECTS** ..... \$5.95. Practical circuits to build and experiment with. Includes A/D converter, input amplifier, digital delay line, compander, echo effect and more.

**BP247—MORE ADVANCED MIDI PROJECTS** ..... \$5.95. Circuits included are a MIDI indicator, THRU box, merge unit, code generator, pedal, programmer, channelizer, and analyzer.



**BP257—INTRO TO AMATEUR RADIO** ..... \$6.95. Amateur is a unique and fascinating hobby. This book gives the newcomer a comprehensive and easy to understand guide to the subject.



**PCP102—INTRODUCING DIGITAL AUDIO** ..... \$9.95. Covers all kinds of digital recording methods—CD, DAT and Sampling. Bridges the gap between the technician and the enthusiast. Principles and methods are explained.

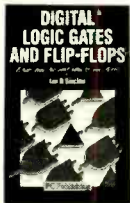

**PCP107—DIGITAL LOGIC GATES AND FLIP FLOPS** ..... \$10.00. Thorough treatment of gates and flip-flops for enthusiasts, student and technicians. Only a basic knowledge of electronics is needed.

**BP251—COMPUTER HOBBYISTS HANDBOOK** ..... \$8.95. A wrapup of everything the computer hobbyist needs to know in one easy to use volume. Provides a range of useful reference material in a single source.

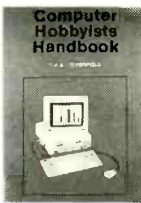

**PCP108—COMPUTERS AND MUSIC** ..... \$9.95. Explains the basics of computers and music with no previous knowledge of computers needed. Covers types of music software and explains how to set up your own computer music studio.

- BP195—INTRODUCTION TO SATELLITE TV**..... \$9.95. A definitive introduction to the subject written for the professional engineer, electronics enthusiast, or others who want to know more before they buy. 8 x 10 in.
- BP190—ADVANCED ELECTRONIC SECURITY PROJECTS**.....\$5.95. Includes a passive infra-red detector, a fiber-optic loop alarm, computer-based alarms and an unusual form of ultrasonic intruder detector.
- BP235—POWER SELECTOR GUIDE**.....\$10.00. Complete guide to semiconductor power devices. More than 1000 power handling devices are included. They are tabulated in alpha-numeric sequence, by technical specs. Includes power diodes, Thyristors, Triacs, Power Transistors and FET's.
- BP234—TRANSISTOR SELECTOR GUIDE**.....\$10.00. Companion volume to BP235. Book covers more than 1400 JEDEC, JIS, and brand-specific devices. Also contains listing by case type, and electronic parameters. Includes Darlingtons, transistors, high-voltage devices, high-current devices, high power devices.
- BP99—MINI-MATRIX BOARD PROJECTS**.....\$5.50. Here are 20 useful circuits that can be built on a mini-matrix board that is just 24 holes by ten copper-foil strips.
- BP82—ELECTRONIC PROJECTS USING SOLAR CELLS**.....\$5.50. Circuits with applications around the home that are powered by the energy of the sun. Everything from radio receivers, to a bicycle speedometer, to timers, audio projects and more.
- BP117—PRACTICAL ELECTRONIC BUILDING BLOCKS—Book 1**.....\$5.75. Oscillators, Timers, Noise Generators, Rectifiers, Comparators, Triggers and more.
- BP184—INTRO TO 68000 ASSEMBLY LANGUAGE**.....\$6.95. The 68000 is a great new breed of microprocessor. Programming in assembly language increases the running speed of your programs. Here's what you need to know.
- BP179—ELECTRONIC CIRCUITS FOR THE COMPUTER CONTROL OF ROBOTS** ..... \$7.50. Data and circuits for interfacing the computer to the robot's motors and sensors.

- BP239—GETTING THE MOST FROM YOUR MULTIMETER**..... \$5.95. Covers basics of analog and digital meters. Methods of component testing includes transistors, thyristors, resistors, capacitors and other active and passive devices.
- BP97—IC PROJECTS FOR BEGINNERS**.....\$5.50. Power supplies, radio and audio circuits, oscillators, timers, switches, and more. If you can use a soldering iron you can build these devices.
- BP37—50 PROJECTS USING RELAYS, SCR'S & TRIACS**.....\$5.50. Build priority indicators, light modulators, warning devices, light dimmers and more.
- RADIO—100 RADIO HOOKUPS**.....\$3.00. Reprint of 1924 booklet presents radio circuits of the era including regenerative, neutrodyne, reflex & more.
- BP42—SIMPLE LED CIRCUITS**..... \$5.50. A large selection of simple applications for this simple electronic component.
- BP127—HOW TO DESIGN ELECTRONIC PROJECTS**.....\$5.75. Helps the reader to put projects together from standard circuit blocks with a minimum of trial and error.
- BP122—AUDIO AMPLIFIER CONSTRUCTION**.....\$5.75. Construction details for preamps and power amplifiers up through a 100-watt DC-coupled FED amplifier.
- BP92—CRYSTAL SET CONSTRUCTION**.....\$5.50. Everything you need to know about building crystal radio receivers.
- BP45—PROJECTS IN OPTOELECTRONICS**.....\$5.50. Includes infra-red detectors, transmitters, modulated light transmission and photographic applications.

**BP185—ELECTRONIC SYNTHESIZER CONSTRUCTION** ..... \$5.95. Use this book to learn how to build a reasonably low cost, yet worthwhile monophonic synthesizer and learn a lot about electronic music synthesis in the process.

## CHECK OFF THE BOOKS YOU WANT

**ELECTRONIC TECHNOLOGY TODAY INC.**  
P.O. Box 240, Massapequa Park, NY 11762-0240

**SHIPPING CHARGES IN USA AND CANADA**

\$0.01 to \$5.00	.. \$1.25
\$5.01 to 10.00	.. \$2.00
\$10.01 to \$20.00	.. \$3.00
\$20.01 to \$30.00	.. \$4.00
\$30.01 to \$40.00	.. \$5.00
\$40.01 to \$50.00	.. \$6.00
\$50.01 and above	.. \$7.50

**SORRY No orders accepted outside of USA & Canada**

Number of books ordered

Name \_\_\_\_\_  
Address \_\_\_\_\_  
City \_\_\_\_\_ State \_\_\_\_\_ Zip \_\_\_\_\_

Total price of merchandise ..... \$ \_\_\_\_\_  
Sales Tax (New York State Residents only) ..... \$ \_\_\_\_\_  
Shipping (see chart) ..... \$ \_\_\_\_\_

**All payments must be in U.S. funds**

Total Enclosed .. \$ \_\_\_\_\_

P-1290



# uniden®

## \$12,000,000 Scanner Sale

Uniden Corporation of America has purchased the consumer products line of Regency Electronics Inc. for \$12,000,000. To celebrate this purchase, we're having our largest scanner sale in history! Use the coupon in this ad for big savings. Hurry...offer ends January 31, 1991.

### ★ ★ ★ MONEY SAVING COUPON ★ ★ ★

Get special savings on the scanners listed in this coupon. This coupon must be included with your prepaid order. Credit cards, personal checks and quantity discounts are excluded from this offer. Offer valid only on prepaid orders mailed directly to Communications Electronics Inc., P.O. Box 1045 - Dept. UN14, Ann Arbor, Michigan 48106-1045 U.S.A. Coupon expires January 31, 1991. Coupon may not be used in conjunction with any other offer from CEI. Coupon may be photocopied. Add \$12.00 for shipping in the continental U.S.A.

- RELM RH606B-A ..... \$419.95
- RELM RH256B-A ..... \$294.95
- Bearcat 800XLT-A ..... \$229.95
- Bearcat 200XLT-A ..... \$229.95
- Bearcat 100XLT-A ..... \$179.95
- Bearcat 70XLT-A ..... \$139.95
- Bearcat 55XLT-A ..... \$99.95
- Bearcat 210XLT-A ..... \$164.95
- Uniden CARD-A1 ..... \$144.95
- Uniden RD3XL-A1 ..... \$144.95
- Uniden RD9XL-A ..... \$119.95

### ★ ★ ★ VALUABLE COUPON ★ ★ ★

## Bearcat® 760XLT-A

List price \$499.95/CE price \$254.95/SPECIAL 12-Band, 100 Channel • Crystalless • AC/DC Frequency range: 29-54, 118-174, 406-512, 806-956 MHz. Excludes 823.9875-849.0125 and 868.9875-894.0125 MHz. The Bearcat 760XLT has 100 programmable channels organized as five channel banks for easy use, and 12 bands of coverage including the 800 MHz band. The Bearcat 760XLT mounts neatly under the dash and connects directly to fuse block or battery. The unit also has an AC adaptor, flip down stand and telescopic antenna for desk top use. 6-5/16" W x 1-1/2" H x 7-3/4" D. Model BC590XLT-A1 is a similar version without the 800 MHz band for a new low price of only \$194.95. Order today.

## NEW! Uniden® Telephones

- AM470D-A Uniden answering machine ..... \$69.95
- AM464-A Uniden answering machine ..... \$49.95
- AM468V-A Uniden answering machine ..... \$49.95
- AM460-A Uniden answering machine ..... \$49.95
- AM480-A Uniden answering machine ..... \$69.95
- FP300-A Uniden feature phone ..... \$34.95
- FP302-A Uniden feature phone ..... \$49.95
- FP320S-A Uniden feature speakerphone ..... \$49.95
- FP322S-A Uniden feature speakerphone ..... \$59.95
- XE570-A Uniden cordless phone ..... \$74.95
- XE422S-A Uniden cordless speakerphone ..... \$109.95
- BE777S-A Uniden cordless speakerphone ..... \$109.95
- BT100-A Uniden Trimstyle phone ..... \$17.95
- KT280-A Uniden Family phone with 911 feature ..... \$29.95
- FF150-A Uniden Executive phone ..... \$39.95

## RELM® RH256B-A

List price \$587.50/CE price \$299.95/SPECIAL 16 Channel • 25 Watt Transceiver • Priority The RELM RH256B is a sixteen-channel VHF land mobile transceiver designed to cover any frequency between 150 to 162 MHz. Since this radio is synthesized, no expensive crystals are needed to store up to 16 frequencies without battery backup. All radios come with CTCSS tone and scanning capabilities. A monitor and night/day switch is also standard. This transceiver even has a priority function. The RH256 makes an ideal radio for any police or fire department volunteer because of its low cost and high performance. A 60 Watt VHF 150-162 MHz version called the RH606B-A is available for \$429.95. A UHF 15 watt, 16 channel version of this radio called the RU156B-A is also available and covers 450-482 MHz. but the cost is \$454.95.

### ★ ★ ★ Uniden CB Radios ★ ★ ★

The Uniden line of Citizens Band Radio transceivers is styled to compliment other mobile audio equipment. Uniden CB radios are so reliable that they have a two year limited warranty. From the feature packed PRO 810E to the 310E handheld, there is no better Citizens Band radio on the market today.

- PRO310E-A Uniden 40 Ch. Portable/Mobile CB ..... \$83.95
- PRO330E-A Uniden 40 Ch. Remote mount CB ..... \$104.95
- ER100-A Uniden Emergency CB Mobile ..... \$49.95
- GRANT-A Uniden 40 channel SSB CB mobile ..... \$166.95
- PC122-A Uniden 40 channel SSB CB mobile ..... \$119.95
- PRO510XL-A Uniden 40 channel CB Mobile ..... \$38.95
- PRO510AXL-A Uniden CB Mobile with antenna ..... \$49.95
- PRO520XL-A Uniden 40 channel CB Mobile ..... \$56.95
- PRO640E-A Uniden 40 channel SSB CB Mobile ..... \$137.95
- PRO810E-A Uniden 40 channel SSB CB Base ..... \$174.95

### ★ ★ ★ Uniden Radar Detectors ★ ★ ★

Buy the finest Uniden radar detectors from CEI today. RD3XL-A Uniden 3 band radar detector ..... \$159.95 RD8-A Uniden visor mount radar detector ..... \$89.95 RD9GTL-A1 Uniden "Passport" size radar detector ..... \$99.95 RD9XL-A1 Uniden "micro" size radar detector ..... \$124.95 RD27-A Uniden visor mount radar detector ..... \$54.95 RD99GT-A Uniden remote mount radar detector ..... \$119.95 CARD-A1 Uniden credit card size radar detector ..... \$159.95

## Bearcat® 200XLT-A

List price \$509.95/CE price \$239.95/SPECIAL 12-Band, 200 Channel • 800 MHz. Handheld Search • Limit • Hold • Priority • Lockout Frequency range: 29-54, 118-174, 406-512, 806-956 MHz. Excludes 823.9875-849.0125 and 868.9875-894.0125 MHz. The Bearcat 200XLT sets a new standard for handheld scanners in performance and dependability. This full featured unit has 200 programmable channels with 10 scanning banks and 12 band coverage. If you want a very similar model without the 800 MHz band and 100 channels, order the BC 100XLT-A for only \$189.95. Includes antenna, carrying case with belt loop, ni-cad battery pack, AC adapter and earphone. Order your scanner now.

## Bearcat® 800XLT-A

List price \$549.95/CE price \$239.95/SPECIAL 12-Band, 40 Channel • No-crystal scanner Priority control • Search/Scan • AC/DC Bands: 29-54, 118-174, 406-512, 806-912 MHz. Now...nothing excluded in the 806-912 MHz band. The Uniden 800XLT receives 40 channels in two banks. Scans 15 channels per second. Size 9 1/4" x 4 1/2" x 1 1/2". With nothing excluded in the 806-912 MHz band, this scanner is an excellent choice for law enforcement agencies. If you do not need the 800 MHz band, a similar model called the BC 210XLT-A is available for \$178.95.

## NEW! Bearcat® 147XL-A

List price \$189.95/CE price \$94.95/SPECIAL 10-Band, 16 Channel • No-crystal scanner Priority control • Weather search • AC/DC Bands: 29-54, 136-174, 406-512 MHz. The Bearcat 147XL is a 16 channel, programmable scanner covering ten frequency bands. The unit features a built-in delay function that adds a three second delay on all channels to prevent missed transmissions. A mobile version called the BC560XLT-A featuring priority, weather search, channel lockout and more is available for \$94.95. CEI's package price includes mobile mounting bracket and mobile power cord.

## NEW! Ranger® RC12950-A

List price \$549.95/CE price \$249.95/SPECIAL 10 Meter Mobile Transceiver • Digital VFO Full Band Coverage • All-Mode Operation Backlit liquid crystal display • Auto Squelch RIT • 10 Programmable Memory Positions Frequency Coverage: 28.0000 MHz to 29.6999 MHz. The Ranger RC12950 Mobile 10 Meter Transceiver by Ranger, has everything you need for amateur radio communications. The RF Power control feature in the RC12950 allows you to adjust the RF output power continuously from 1 watt through a full 25 watts output on USB, LSB and CW modes. The RC12950 also features a noise blanker, roger beep, PA mode and more. The Mic Gain Control adjusts the gain in transmit and PA modes to maximize talk power. Digital VFO. Built-in S/R/F/ MOD/SWR meter. Frequency selections may be made from a switch on the microphone or the front panel. There is even a repeater split switch for repeater offsets. The RC12950 lets you operate AM, FM, USB, LSB or CW for full mode operation. The digitally synthesized frequency control gives you maximum stability. There's also RIT (Receiver Incremental Tuning) to give you perfectly tuned signals. With memory channel scanning, you can scan ten pre set frequencies to keep track of all the action. An optional CTCSS tone board is available (order # RTONE) for \$59.95. For technical questions, call Ranger at 714-858-4419. Order your Ranger RC12950 from CEI today.



BC760XLT 800 MHz. mobile scanner SPECIAL!

### ★ ★ ★ Extended Service Contract ★ ★ ★

If you purchase a scanner, CB, radar detector or cordless phone from any store in the U.S. or Canada within the last 30 days, you can get up to four years of extended service contract from Warrantech. This service extension plan begins after the manufacturer's warranty expires. Warrantech will perform all necessary labor and will not charge for return shipping. Extended service contracts are not refundable and apply only to the original purchaser. Warrantech does not have an extended warranty plan for handheld scanners. For mobile or base scanners, CB radios or radar detectors a 1 year extended warranty is \$19.99, two years is \$39.99 and four years is \$59.99. Order your service contract today.

### OTHER RADIOS AND ACCESSORIES

- BC55XLT-A Bearcat 10 channel scanner ..... \$114.95
  - AD100-A Plug in wall charger for BC55XLT ..... \$14.95
  - PS001-A Cigarette lighter cable for BC55XLT ..... \$14.95
  - VC001-A Carrying case for BC55XLT ..... \$14.95
  - BC70XLT-A Bearcat 20 channel scanner ..... \$159.95
  - BC172XL-A Bearcat 20 channel scanner ..... \$134.95
  - BC1-A1 Bearcat Information scanner with CB ..... \$119.95
  - BC310A-A Bearcat Information Radio ..... \$79.95
  - BC330A-A Bearcat Information Radio ..... \$104.95
  - UC102-A Regency VHF 2 ch. 1 Watt transceiver ..... \$114.95
  - UC202-A Regency VHF 2 ch. 2 Watt transceiver ..... \$149.95
  - VM200XL-A Uniden Video monitoring system ..... \$179.95
  - BP205-A Ni-Cad batt. pack for BC200/BC100XLT ..... \$39.95
  - FBE-A Frequency Directory for Eastern U.S.A. .... \$14.95
  - FBW-A Frequency Directory for Western U.S.A. .... \$14.95
  - RFD1-A MI, IL, IN, KY, OH, WI, Regency Directory ..... \$14.95
  - RFD2-A CT, ME, MA, NH, RI, VT Directory ..... \$14.95
  - RFD3-A DE, DC, MD, NJ, NY, PA, VA, WV Dir. .... \$14.95
  - RFD4-A AL, AR, FL, GA, LA, MS, NC, PR, SC, TN, VI. .... \$14.95
  - RFD5-A AK, ID, IA, MN, MT, NE, ND, OR, SD, WA, WY. .... \$14.95
  - RFD6-A CA, NV, UT, AZ, HI, GU Freq. Directory ..... \$14.95
  - RFD7-A CO, KS, MO, NM, OK, TX Freq. Directory ..... \$14.95
  - SMH-A Scanner Modification Handbook ..... \$14.95
  - ASD-A Airplane Scanner Directory ..... \$14.95
  - SRA-A Survival Radio Frequency Directory ..... \$14.95
  - TSG-A "Top Secret" Registry of U.S. Govt. Freq. .... \$14.95
  - TTC-A Tune in on telephone calls ..... \$14.95
  - CBH-A Big CB Handbook/AM/FM/Freeband ..... \$14.95
  - TIC-A Techniques for Intercepting Communications ..... \$14.95
  - RRF-A Railroad frequency directory ..... \$14.95
  - EEC-A Embassy & Espionage Communications ..... \$14.95
  - CIE-A Covert Intelligence, Elect. Eavesdropping ..... \$14.95
  - MFF-A Midwest Federal Frequency directory ..... \$14.95
  - A60-A Magnet mount mobile scanner antenna ..... \$34.95
  - A70-A Base station scanner antenna ..... \$34.95
  - USAMM-A Mag mount VHF ant. w/ 12' cable ..... \$39.95
  - USAK-A 1/4" hole mount VHF ant. w/ 17' cable ..... \$34.95
- Add \$4.00 shipping for all accessories ordered at the same time. Add \$12.00 shipping per radio and \$4.00 per antenna.

### BUY WITH CONFIDENCE

To get the fastest delivery from CEI of any scanner, send or phone your order directly to our Scanner Distribution Center. Michigan residents please add 4% sales tax or supply your tax I.D. number. Written purchase orders are accepted from approved government agencies and most well rated firms at a 10% surcharge for net 10 billing. All sales are subject to availability, acceptance and verification. On all credit card orders, the ship to address must exactly match the credit card billing address. If the billing address is a P.O. Box or a P.O. Box Zip Code, UPS can not deliver to that address. When this occurs, the order must be shipped by mail at a higher cost to you. To avoid this extra charge, you may mail us a check with your order. Prices, terms and specifications are subject to change without notice. All prices are in U.S. dollars. Out of stock items will be placed on backorder automatically or equivalent product substituted unless CEI is instructed differently. A \$5.00 additional handling fee will be charged for all orders with a merchandise total under \$50.00. Shipments are F.O.B. CEI warehouse in Ann Arbor, Michigan. No COD's. Most items listed have a manufacturer's warranty. Free copies of warranties on these products are available by writing to CEI. Non-certified checks require clearance. Not responsible for typographical errors.

Mail orders to: Communications Electronics®, Box 1045, Ann Arbor, Michigan 48106 U.S.A. Add \$12.00 per scanner for U.P.S. ground shipping and handling in the continental U.S.A. For Canada, Puerto Rico, Hawaii, Alaska, or APO/FPO delivery, shipping charges are two times continental U.S. rates. If you have a Discover, Visa, American Express or MasterCard, you may call and place a credit card order. 5% surcharge for billing to American Express. Order toll-free in the U.S. Dial 800-USA-SCAN. In Canada, dial 800-221-3475. FAX anytime, dial 313-971-6000. If you are outside the U.S. or in Michigan dial 313-973-8888. Order from CEI today. Scanner Distribution Center™ and CEI logos are trademarks of Communications Electronics Inc. Sale dates 7/15/90 - 1/31/91 AD #071590-A Copyright © 1990 Communications Electronics Inc.

For credit card orders call 1-800-USA-SCAN

**COMMUNICATIONS ELECTRONICS INC.**

Consumer Products Division  
P.O. Box 1045 □ Ann Arbor, Michigan 48106-1045 U.S.A.  
For orders call 313-973-8888 or FAX 313-971-6000