

# Popular Electronics

NOVEMBER 1990

## Build the Digital Entry Switch

Throw away your keys with this programmable entry guard

## The Hobbyist's Guide to CCTV

How to set-up your own closed-circuit television system

## The Universal 3-Terminal Power Supply

Here's the answer for virtually all of your power-supply needs

## Surface Mount Technology

It's moving from the leading edge of industry to your workbench



## Build the Radfax Decoder

Receive and display weather maps and other radio-facsimile transmissions with this low-cost circuit. Use it to decode RTTY and Morse-code, too.



A GERNSBACK PUBLICATION

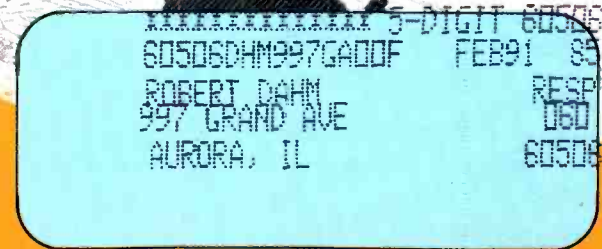
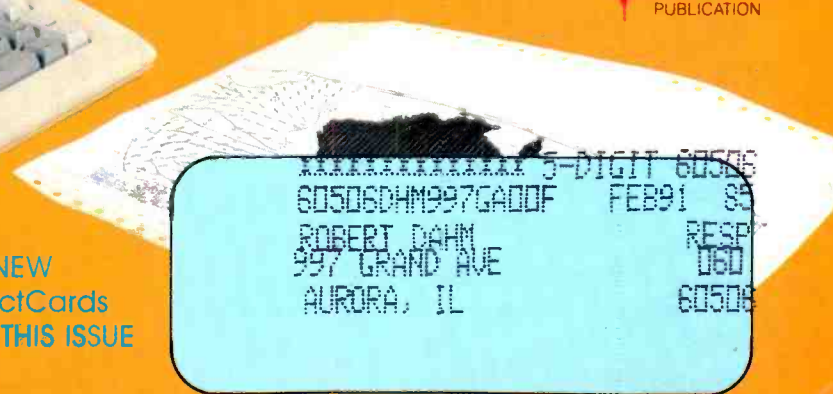

\$2.50 U.S.  
\$2.95 CANADA

3 NEW  
FactCards  
IN THIS ISSUE

# DAMARK

INTERNATIONAL, INC.

THE "GREAT DEAL" CATALOG  
**1-800-729-9000**  
**ORDER TODAY!**



## 386SX LAPTOP COMPUTER w/ 40 MB HARD DRIVE

- 80386SX microprocessor operating at 8/16MHz, zero wait state
- 100% IBM compatible
- One MB RAM, expandable to four MB on motherboard
- 40 MB hard disk drive
- 1.44MB 3.5" floppy disk drive
- Desktop expansion module; converts laptop into desktop computer.



Converts from laptop to desktop!

- 2400 bps Hayes compatible modem with two phone jack connectors
- Two 16-bit AT expansion slots & one XT slot
- Two RS232C serial ports
- 1 centronics parallel port
- Detachable LCD display & 101 key keyboard
- VGA graphics, resolution: 640x480
- MS-DOS 4.0
- Includes Nicad batteries and battery charger
- 80387SX-16 match co-processor socket
- Dim.: 14"W x 11.5"D x 3"H.

• One Year Mfr. Warranty!  
**DAMARK \$2499<sup>99</sup>**  
 PRICE  
 Item No. B-2350-146969  
 Insured Ship/Hand.: \$29.00

## FAMOUS MAKER

### 286 AT COMPUTER WITH 14" HIGH RESOLUTION VGA COLOR MONITOR w/ 30MB HARD DRIVE

- 80286 microprocessor, 12.5/6.25MHz switchable
- One MB RAM on motherboard, expandable to four MB
- 30 MB hard drive
- One 5.25" 1.22MB floppy drive
- High resolution VGA monitor: 640 x 480
- Socket for 80287 math co-processor
- 16-bit VGA card; 800 X 600 resolution
- IBM compatible



• 3 expansion slots—two 16-bit and one 8-bit
- 1 serial port
- 1 parallel port
- PS/2 compatible 6-pin mouse port
- Phoenix 286 ROM BIOS
- Includes MS-DOS 4.01 with DOS Shell utilities and GW BASIC™
- PC dim.: 4-1/4"H x 15"W x 15-1/2"D
- Monitor dim.: 13.9"W x 14.7"D x 14.1"H

Mfr. Sugg. Retail: **\$2,094.00**  
 • One Year Mfr. Warranty!  
**DAMARK \$999<sup>99</sup>**  
 PRICE  
 Item No. B-2350-149047  
 Insured Ship/Hand.: \$49.00



## PROFESSIONAL FAX/PHONE COPIER MACHINE

- 9600 baud fax machine, full-featured telephone and photo-copier
- Automatic paper cutter crops incoming faxes to proper length
- 15-page auto document feeder
- 16-level grayscale
- Voice/fax switch
- Answering machine connection
- 50-number autodialer
- 164 ft. paper roll
- Send faxes after hours with delayed dialing command
- Advanced polling
- Voice prompt
- Auto/manual answer
- Normal, fine and superfine transmission
- Full-featured telephone
- Convenient copier
- Remote diagnostics and repair—Murata fixes most problems over the phone line
- Compatibility: CCITT Group 3 and Group 2
- English/Spanish operation
- Dim.: 16.1" x 12.6"D x 7.3"H
- Model #: M1850
- Weight: 16.7 lbs.



Mfr. Sugg. Retail: **\$1,499.00**  
 • 90 Day On-Site Manufacturer's Warranty!  
**DAMARK \$699<sup>99</sup>**  
 PRICE  
 Item No. B-2350-149203  
 Insured Ship/Hand.: \$29.00



## 24 PIN DOT MATRIX PRINTER

- 24-pin letter quality printer
- Print speed: 216 CPS draft; 72 CPS letter quality
- 32K buffer
- Includes: 12 Multi-Strike Ribbons PLUS 2 Font Cards—because of this great low price, no choice on font cards received.
- Built-in rear tractor
- Friction feed
- Auto loading, single sheet guide for letterhead and cut sheets and friction feed
- Front panel LCD display includes: type fonts, pitch, emulation, lines per inch, quiet mode and page length
- 360x360 graphics
- IBM emulation
- Tractor feed and tear bar for continuous forms
- Single or continuous feed paper loading
- Parallel/serial interfaces included
- Model #: P321SL
- Dim.: 16.3"W x 9"H x 15"D



• One Year Limited Manufacturer's Warranty!  
 Mfr. Sugg. Retail: **\$1,019.00**  
**DAMARK \$299<sup>99</sup>**  
 PRICE  
 Item No. B-2350-149468  
 Insured Ship/Hand.: \$29.00



## TRACKBALL

- Smooth moving Trackball mouse
- 100% IBM compatible
- Variable resolution up to 1150 D.P.I.
- Complete one-handed control
- Easy to install: just insert disk and follow step-by-step menu driven instructions
- Includes one 5-1/4" disk and one 3-1/2" disk
- Includes Telepoint™ software with two 5-1/4" disks
- Microsoft compatible
- Software driver included
- System requirements: IBM or compatible PC, DOS 2.0 or higher
- Includes 9 to 25 adapter cable for installation on any RS232 serial port
- Includes Telepoint™ Software
- Five Year Limited Mfr. Warranty!
- Factory New!
- Factory Perfect!



Mfr. Sugg. Retail: **\$169.90**  
**DAMARK \$59<sup>99</sup>**  
 PRICE  
 Item No. B-2350-148684  
 Insured Ship/Hand.: \$6.00



## Fax/Phone Auto Switch

- No need for a dedicated fax line
- Fax/phone auto switch allows your new fax to share existing phone line
- Works on all Group 3 fax machines
- Single switch to lock out either voice or fax calls
- Front panel status lights indicate modes of operation
- SmartMax handles power outages by automatically switching to phone-only mode
- Allows manual override so you can send a fax to the person you're talking to on the phone



- 24-Hour customer service line
- Easy installation
- U.L. listed
- FCC certified
- Dim.: 4" X 7" X 1-1/2"
- Wt.: 2-1/2" lbs.
- Model #: MX 1030
- Two Year Mfr. Warranty!
- Factory New & Perfect!

Mfr. Sugg. Retail: **\$245.00**  
**DAMARK \$99<sup>99</sup>**  
 PRICE  
 Item No. B-2350-128934  
 Insured Ship/Hand.: \$7.50

**FOR FASTEST SERVICE CALL TOLL FREE**  
**1-800-729-9000**

CUSTOMER SERVICE: 1-612-531-0082

NAME \_\_\_\_\_  
 ADDRESS \_\_\_\_\_  
 CITY \_\_\_\_\_ ST \_\_\_\_\_ ZIP \_\_\_\_\_  
 PHONE \_\_\_\_\_

Check/Money Order  VISA SIGNATURE \_\_\_\_\_  
 MasterCard  Discover CARD NO. \_\_\_\_\_ EXP. DATE \_\_\_\_\_

QTY	DESCRIPTION	ITEM #	S/H/I	PRICE

DELIVERY TO 48 U.S. CONTINENTAL STATES ONLY

SUB TOTAL \_\_\_\_\_  
 in MN add 6% Sales Tax \_\_\_\_\_  
 Total S/H/I \_\_\_\_\_  
**GRAND TOTAL** \_\_\_\_\_



B-2350

Send To: DAMARK INTERNATIONAL, INC., 7101 Winnetka Ave. N., Minneapolis, MN 55428-1619

Copyright 1990, DAMARK International, Inc. All rights reserved.



# Popular Electronics®

THE MAGAZINE FOR THE ELECTRONICS ACTIVIST!

## CONSTRUCTION ARTICLES

<b>BUILD THE RADFAX DECODER</b> .....	John Clarke	29
<i>Plot weather maps, capture news photos, and decode radioteletype and Morse code with this simple circuit</i>		
<b>THE UNIVERSAL THREE-TERMINAL POWER SUPPLY</b> .....	James Melton	53
<i>One printed-circuit layout can take care of all your low-voltage power needs</i>		
<b>DIGITAL ENTRY SWITCH</b> .....	Fred Blechman	61
<i>This simple digital combination lock provides security and convenience</i>		
<b>SIGNAL GENERATOR CIRCUITS THAT YOU CAN BUILD</b> .....	Joseph J. Carr	67
<i>Read a cookbook of signal generators and never be without input again</i>		

## FEATURE ARTICLES

<b>SURFACE MOUNT TECHNOLOGY</b> .....	Dave Hollander	35
<i>Surface-mount components have moved from industry to your workbench</i>		
<b>STAYING ALIVE</b> .....	David C. Toalson	40
<i>Ground-fault electrical shock and how to prevent it</i>		
<b>UPDATE YOUR PC OR XT</b> .....	Don Stewart	55
<i>Increase your computer's productivity the low-cost way</i>		
<b>A GUIDE TO CCTV</b> .....	Isaac Szlechter	58
<i>Closed-circuit TV systems are easy to install; the trick is knowing what's needed</i>		
<b>CLASSIC HAM RECEIVERS</b> .....	Larry Lisle	64
<i>Yesterday's workhorses can still fill the bill today</i>		
<b>THE DIGITAL ELECTRONICS COURSE</b> .....	Robert A. Young	71
<i>An introduction to IC counter circuits</i>		

## PRODUCT REVIEWS

<b>GIZMO</b> .....		43
<i>Including: Heathkit AD-2550 Surround Sound Processor, Sony STR-D2010 Stereo Receiver, and much more</i>		
<b>HANDS-ON REPORT</b> .....		72
<i>Elenco Digital Trainer</i>		
<b>PRODUCT TEST REPORT</b> .....	Len Feldman	73
<i>Hitachi VT-S730A Videocassette Recorder</i>		

## COLUMNS

<b>THINK TANK</b> .....	Byron G. Wels	22
<i>Protecting your idea</i>		
<b>CIRCUIT CIRCUS</b> .....	Charles D. Rakes	75
<i>Simple circuits with practical applications</i>		
<b>COMPUTER BITS</b> .....	Jeff Holtzman	78
<i>On-line information</i>		
<b>FUN SOFTWARE</b> .....	Fred Blechman	80
<i>The fun side of computers</i>		
<b>ANTIQUE RADIO</b> .....	Marc Ellis	82
<i>Bits and pieces</i>		
<b>DX LISTENING</b> .....	Don Jensen	84
<i>Genghis Khan returns</i>		
<b>HAM RADIO</b> .....	Joseph J. Carr	86
<i>Receiving SSTV and fax photos on your ham rig</i>		
<b>SCANNER SCENE</b> .....	Marc Saxon	88
<i>The dynasty continues</i>		

## DEPARTMENTS

<b>EDITORIAL</b> .....	Carl Laron	2
<b>LETTERS</b> .....		4
<b>ELECTRONICS LIBRARY</b> .....		6
<b>NEW PRODUCTS</b> .....		14
<b>ADVERTISERS INDEX</b> .....		102

Popular Electronics (ISSN 1042-170X) Published monthly by Gernsback Publications, Inc., 500-B Bi-County Boulevard, Farmingdale, NY 11735. Second-Class postage paid at Farmingdale, NY and at additional mailing offices. One-year, twelve issues, subscription rate U.S. and possessions \$21.95. Canada \$26.95, all other countries \$29.45. Subscription orders payable in U.S. funds only. International Postal Money Order, or check drawn on a U.S. bank. U.S. single copy price \$2.50. © 1990 by Gernsback Publications, Inc. All rights reserved. Hands-on Electronics and Gizmo trademarks are registered in U.S. and Canada by Gernsback Publications, Inc. Popular Electronics trademark is registered in U.S. and Canada by Electronics Technology Today, Inc. and is licensed to Gernsback Publications. Printed in U.S.A.

Postmaster: Please send address changes to Popular Electronics, Subscription Dept., P.O. Box 338, Mount Morris, IL 61054-9932.

A stamped self-addressed envelope must accompany all submitted manuscripts and/or artwork or photographs if their return is desired should they be rejected. We disclaim any responsibility for the loss or damage of manuscripts and/or artwork or photographs while in our possession or otherwise.

As a service to readers, Popular Electronics publishes available plans or information relating to newsworthy products, techniques, and scientific and technological developments. Because of possible variances in the quality and condition of materials and workmanship used by readers, Popular Electronics disclaims any responsibility for the safe and proper functioning of reader-built projects based upon or from plans or information published in this magazine.

**Larry Steckler**

*EHF, CET*

*Editor-In-Chief and Publisher*

---

## EDITORIAL DEPARTMENT

**Carl Laron**

*Editor*

**Robert A. Young**

*Associate Editor*

**John J. Yacono**

*Associate Editor*

**Byron G. Wels, K2AVB**

*Associate Editor*

**Teri Scaduto**

*Assistant Editor*

**Kathy Terenzi**

*Editorial Assistant*

**Marc Spiwak**

*Editorial Associate*

**Joseph J. Carr, K4IPV**

**Marc Ellis**

**Len Feldman**

**Jeffrey K. Holtzman**

**Don Jensen**

**Charles D. Rakes**

**Marc Saxon**

*Contributing Editors*

---

## PRODUCTION DEPARTMENT

**Ruby M. Yee**

*Production Director*

**Karen S. Tucker**

*Production Manager*

**Marcella Amoroso**

*Production Assistant*

**Janice Box**

*Editorial Production*

---

## ART DEPARTMENT

**Andre Duzant**

*Art Director*

**Russell C. Truelson**

*Technical Illustrator*

**Injae Lee**

*Assistant Illustrator*

**Jacqueline P. Cheeseboro**

*Circulation Director*

**Michele Torrillo**

*P-E Bookstore*

---

## BUSINESS AND EDITORIAL OFFICES

Gernsback Publications, Inc.

500-B Bi-County Blvd.

Farmingdale, NY 11735

1-516-293-3000

Fax: 1-516-293-3115

President: **Larry Steckler**

Vice President: **Cathy Steckler**

**Customer Service/Order Entry**

1-800-435-0715

In IL 1-800-892-0753

7:30 AM – 8:30 PM EST

---

Advertising Sales offices listed on page 101

Cover photo courtesy of  
Silicon Chip, Australia

Composition by  
Mates Graphics



The publisher has no knowledge of any proprietary rights which will be violated by the making or using of any items disclosed in this issue.

## A NEW LOOK

As you turn the pages of this issue of **Popular Electronics**, those of you who are regular readers will notice that something looks a little different. You're right! We've updated the look of most of our regular columns.

There are several reasons behind this change. They mostly relate to the logistics of putting together the magazine. But the most important reason is that we thought that the new design looks great. We hope you agree!

And, yes, there is yet another change in this issue. We've added a new column written by veteran author Fred Blechman. Those of you who regularly read this magazine, and others in the electronics and computer fields, probably are familiar with Fred's work. His column, called *Fun Software*, will explore the less serious side of computing. Each month, Fred will report on the entertainment-software scene, providing hands-on reviews of game and simulation programs, news about hardware that will, or will not, help you pile up the points, and more.

But while this issue is full of changes, our mission is the same as always—to bring you the best in hobby electronics. Whether your interest is in radio, video, communications, high-voltage electronics, robotics, antique radio, digital electronics, computers, consumer gear, or any other facet of our wonderful hobby, you're sure to find something just for you in the pages of **Popular Electronics**.

Thanks to everyone for your continued support, and we hope you like our new look as much as we do.

Carl Laron  
Editor



# SELECT 5 BOOKS for only \$4<sup>95</sup>

(values to \$125.70)  
and get a **FREE Gift!**

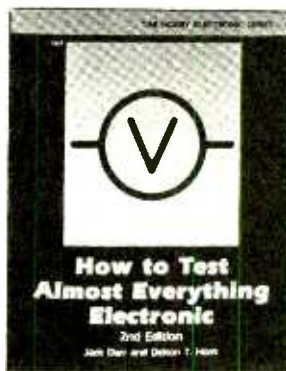
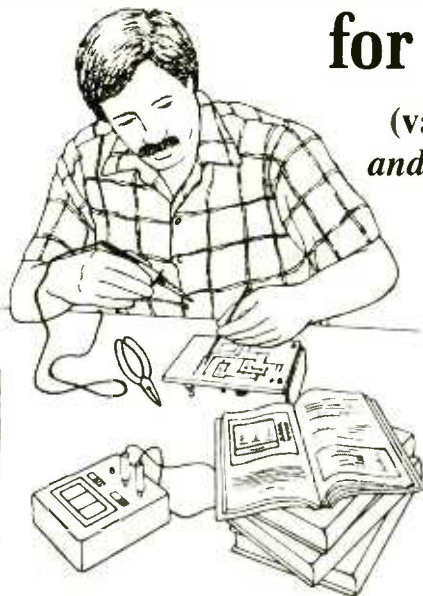

2925P \$9.95

For over 25 years, your most complete source for electronics books.

**Membership Benefits • Big Savings.** In addition to this introductory offer, you keep saving substantially with members' prices of up to 50% off the publishers' prices. • **Bonus Books.** Starting immediately, you will be eligible for our Bonus Book Plan, with savings of up to 80% off publishers' prices. • **Club News Bulletins.** 15 times per year you will receive the Book Club News, describing all the current selections—mains, alternates, extras—plus bonus offers and special sales, with scores of titles to choose from. • **Automatic Order.** If you want the Main Selection, do nothing and it will be sent to you automatically. If you prefer another selection, or no book at all, simply indicate your choice on the reply form provided. You will have at least 10 days to decide. As a member, you agree to purchase at least 3 books within the next 12 months and may resign at any time thereafter. • **Ironclad No-Risk Guarantee.** If not satisfied with your books, return them within 10 days without obligation! • **Exceptional Quality.** All books are quality publishers' editions especially selected by our Editorial Board.

(Publishers' Prices Shown)

## FREE when you join!

### 15 Easy Electronic Projects From Delton T. Horn

Projects you can build—some unique, some old favorites—from the author's vast treasury of electronics know-how.



2826P \$16.95



1367P \$24.95



283-P \$15.95



2867P \$18.95

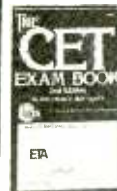

2950 \$21.95



1536P \$11.95

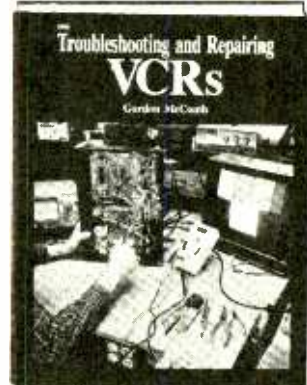

2960 \$27.95  
Counts as 2

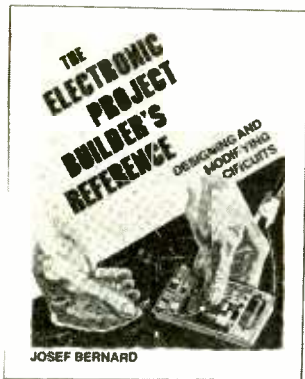

3260 \$22.95



3219 \$27.95  
Counts as 2



3044P \$11.95

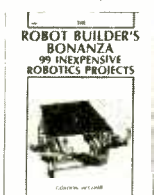

2800P \$16.95

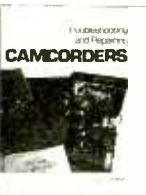

3337 \$35.95  
Counts as 2



1897P \$14.95



1604P \$17.95



1625P \$22.95



3145 \$19.95



2883P \$17.95



2198P \$15.95

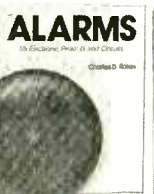

2996P \$13.95



3258 \$27.95  
Counts as 2

All books are hardcover unless number is followed by a "P" for paperback

**ELECTRONICS BOOK CLUB<sup>SM</sup>**  
Blue Ridge Summit, PA 17294-0810

Please accept my membership in the Electronics Book Club and send the 5 volumes listed below, plus my FREE copy of *Delton T. Horn's All-Time Favorite Electronic Projects* (3105P), billing me \$4.95. If not satisfied, I may return the books within ten days without obligation and have my membership cancelled. I agree to purchase at least 3 books at regular Club prices during the next 12 months and may resign any time thereafter. A shipping/handling charge and sales tax will be added to all orders.

Name \_\_\_\_\_  
Address \_\_\_\_\_  
City \_\_\_\_\_  
State \_\_\_\_\_ Zip \_\_\_\_\_ Phone \_\_\_\_\_

Valid for new members only. Foreign applicants will receive special ordering instructions. Canada must remit in U.S. currency. This order subject to acceptance by the Electronics Book Club. PE 1190



2707 \$26.95  
Counts as 2



2613P \$17.95



2809 \$29.95  
Counts as 2



1532P \$14.95

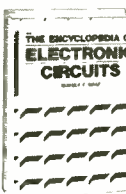

1938 \$60.00  
Counts as 3



3374 \$24.95

1990 ELECTRONICS BOOK CLUB  
Blue Ridge Summit, PA 17294-0810

# LETTERS

## "ANTIQUÉ" RECHARGEABLE

The article "All About Batteries" prompted me to write this letter. A few days ago, while browsing through the goodies stacked on my workbench, I discovered an old and dead Eveready alkaline battery that was very clearly marked, on two sides, that it was rechargeable! Although I don't intend to recharge it, I will definitely keep it as a collector's item (someday it might be worth a fortune).

Back in the days when "D" cells sold for a nickel (and five cents was hard to come by), I used to invigorate dead cells by poking nail holes through the zinc cases and then placing them overnight in a dish of vinegar. It worked, but what a mess! And the renewed life was short.

In the early days of automobiles, when electric headlights were introduced, my father was a professional battery rebuilder. I can still recall the acid odor and the white corrosive fluff that mysteriously showed up on nearby metal, and the blue glow and hum of the Tungar bulb chargers that were then used at the battery area (off to one side of the repair shop).

So much for batteries—now on to meters! In the *Letters* section of the August issue of **Popular Electronics**, someone goofed in "Measuring Meters." With S1 open, you would either twist the knob off R2 or wear it to a nub with no effect on M2 or M1. Could you have meant R1? I went back to Mr. Rakes' article in the June issue and I am quite satisfied that he knows what he wrote about. (I could nitpick the part about a shunt on a meter allowing the *meter* to handle more current, but I won't, because I know what he means—although I worry about those who don't.)

I enjoy **Popular Electronics**, and the familiar name of Gernsback tastefully displayed. I built radios using diagrams and information from Gernsback magazines way back when all tubes were 01's, no matter what numbers or letters they had on them. (Hope you don't "git" the idea that I'm old—hey, I ain't even mature yet!) The only reason I have time to write letters is

that the TV is broken. Been that way since *Kukla, Fran, & Ollie* left, so there's no incentive to fix it!

E.J.C.  
Los Alamitos, CA

## REMOTE-CONTROL FAX SWITCH

After reading the article entitled "Remote-Control Fax Switch" in the August issue of **Popular Electronics**, I felt compelled to write. As a service manager for an office-product wholesaler, I've seen many fax switches come and go.

The one presented in the article has one major setback in that, unless you build as many transmitters as you have phones, you are only able to transfer the incoming fax call from the phone that has the transmitter.

One possible solution that I've come up with is to change the frequency of the tone decoder to one of the more unused frequencies of the phone keypad: the \* and # keys. The frequencies associated with those keys are 2150 and 268 Hz and 2418 and 536 Hz. (If you are unfamiliar with how those frequencies were derived, refer to the August article.) By using one of those keys and their respective frequencies, you would be able to transfer the message from any phone. So, all that really need be done is to make a simple frequency modification to the tone-decoder circuit of the receiver.

The RC time constant, which consists of C8 and R9, is the part of the circuit that must be modified. Depending on which key and frequency that you choose, the following values should get you close:

For the \* key: at 2150 Hz, use 47K ohms and 0.01  $\mu$ F = 2128 Hz; at 268 Hz, use 36K ohms and 0.1  $\mu$ F = 277 Hz. For the # key: at 2418 Hz use 39K ohms and 0.01  $\mu$ F = 2564 Hz; at 536 Hz, use 18K ohms and 0.1  $\mu$ F = 555 Hz. Those calculations

were derived using  $F = 1/RC$  where F is in hertz, R is in ohms, and C is in farads. After choosing a key and a frequency and changing the associated parts, the alignment procedure should remain the same.

I hope this modification to the circuit will make the remote-control fax transfer switch a more convenient device.

T.M.  
Winner, SD

## SHORTWAVE ADAPTER

I really had a lot of fun building and installing the little CW/SSB adapter circuit for my shortwave radio ("Add CW and SSB to your Shortwave Receiver," **Popular Electronics**, May, 1990). It worked right away—I didn't even have to adjust the IF transformer. To test the adapter, I attached the secondary output of the IF transformer directly to the antenna. Thus the incoming SW signal combines with the 455-kHz signal. It sure worked for me.

Your magazine is the best. Keep those awesome circuits coming!

C.H.  
Nipawin, Sask., Canada

## ELECTRONICS IN MEDICINE

I enjoyed the article on "Keeping Pace with Pacemakers" in the July 1990 issue of **Popular Electronics**. While slightly light on electronic specifics for an article in an electronics magazine, it did make its principle points clear. My main interest is R&D, so the hobbyist approach usually taken in **Popular Electronics** is fine with me.

I think there is always room for improvement in electronics in medicine—especially when it comes to electronic measurement, monitoring, and instrumentation. Because I am seriously ill at the present time, I am well aware of the plethora of medical devices available. And, because I am ever hopeful of better treatment, I appreciate the need for improvement of any sort. On the other hand,

medical research is very sensitive and dangerous—two points that the article handled well. Obviously, complete replacement of organs using electronic organs is a whole other area—but considering the complexity of the mechanical heart, it is easy to see people's eyes glaze over.

Everything considered, it was a good article!

N.L.  
Brooklyn, NY

## HAVES AND NEEDS

I need schematics and construction notes on both a Heathkit model ER-81 and a Realistic Science Fair Globe Patrol (Cat. No. 28-205). Both are four-band regenerative sets, and both were sold as kits. I also would like to get in touch with someone who has copies of the ballast-tube manuals. I'll cover the costs of copies and postage. Thanks.

Tony Evans  
823 Jane Drive  
Jacksonville, AR 72076

I am in need of a schematic diagram for a Zenith Transatlantic all-waveband radio, model #3000-1. Any help in this matter will be greatly appreciated. I am willing to bear any reasonable costs involved.

John Apsitis  
750 Durham Road East  
Durham, Ont.  
Canada N0G 1R0

I'm trying to locate the schematic for a Totevision model CT-6000 five-inch color TV set. A letter to Totevision Corporation at 1422 Seneca St., Seattle WA was returned marked "Moved, Unable to Forward." Sams Photofacts does not publish schematics for Totevision equipment, and phone calls to the Korean Trade Association in New York (it is a Korean TV set) provided no additional help. I'll gladly pay any copying costs involved—please help!

Jeffrey Lawrence  
1839 East 28th Street  
Brooklyn, NY 11229 ■



# Countersurveillance

*Never before has so much professional information on the art of detecting and eliminating electronic snooping devices—and how to defend against experienced information thieves—been placed in one VHS video. If you are a Fortune 500 CEO, an executive in any hi-tech industry, or a novice seeking entry into an honorable, rewarding field of work in countersurveillance, you must view this video presentation again and again.*

**ORDER LINE—1-800-522-6260**

*Wake up!* You may be the victim of stolen words—precious ideas that would have made you very wealthy! Yes, professionals, even rank amateurs, may be listening to your most private conversations.

*Wake up!* If you are not the victim, then you are surrounded by countless victims who need your help if you know how to discover telephone taps, locate bugs, or “sweep” a room clean.

There is a thriving professional service steeped in high-tech techniques that you can become a part of! But first, you must know and understand Countersurveillance Technology. Your very first insight into this highly rewarding field is made possible by a video VHS presentation that you cannot view on broadcast television, satellite, or cable. It presents an informative program prepared by professionals in the field who know their industry, its techniques, kinks and loopholes. Men who can tell you more in 45 minutes in a straightforward, exclusive talk than was ever attempted before.

## Foiling Information Thieves

Discover the targets professional snoopers seek out! The prey are stock brokers, arbitrage firms, manufacturers, high-tech companies, any competitive industry, or even small businesses in the same community. The valuable information they filch may be marketing strategies, customer lists, product formulas, manufacturing techniques, even advertising plans. Information thieves eavesdrop on court decisions, bidding information, financial data. The list is unlimited in the mind of man—especially if he is a thief!

You know that the Russians secretly installed countless microphones in the concrete work of the American Embassy building in Moscow. They converted what was to be an embassy and private residence into the most sophisticated recording studio the world had ever

known. The building had to be torn down in order to remove all the bugs.

## Stolen Information

The open taps from where the information pours out may be from FAX's, computer communications, telephone calls, and everyday business meetings and lunchtime encounters. Businessmen need counselling on how to eliminate this information drain. Basic telephone use coupled with the user's understanding that someone may be listening or recording vital data and information greatly reduces the opportunity for others to purloin meaningful information.

The professional discussions seen on the TV screen in your home reveals how to detect and disable wiretaps, midget radio-frequency transmitters, and other bugs, plus when to use disinformation to confuse the unwanted listener, and the technique of voice scrambling telephone communications. In fact, do you know how to look for a bug, where to look for a bug, and what to do when you find it?

Bugs of a very small size are easy to build and they can be placed quickly in a matter of seconds, in any object or room. Today you may have used a telephone handset that was bugged. It probably contained three bugs. One was a phony bug to fool you into believing you found a bug and secured the telephone. The second bug placates the investigator when he finds the real thing! And the third bug is found only by the professional, who continued to search just in case there were more bugs.

The professional is not without his tools. Special equipment has been designed so that the professional can sweep a room so that he can detect voice-activated (VOX) and remote-activated bugs. Some of this equipment can be operated by novices, others require a trained countersurveillance professional.

The professionals viewed on your television screen reveal information on the latest technological advances like laser-beam snoopers that are installed hundreds of feet away from the room they snoop on. The professionals disclose that computers yield information too easily.

This advertisement was not written by a countersurveillance professional, but by a beginner whose only experience came from viewing the video tape in the privacy of his home. After you review the video carefully and understand its contents, you have taken the first important step in either acquiring professional help with your surveillance problems, or you may very well consider a career as a countersurveillance professional.

## The Dollars You Save

To obtain the information contained in the video VHS cassette, you would attend a professional seminar costing \$350-750 and possibly pay hundreds of dollars more if you had to travel to a distant city to attend. Now, for only \$49.95 (plus \$4.00 P&H) you can view *Countersurveillance Techniques* at home and take refresher views often. To obtain your copy, complete the coupon below.

<b>RADIO-ELECTRONICS VIDEO OFFER</b>	<b>PE</b>
500-B Bi-County Blvd. Farmingdale, NY 11735	
Please rush my copy of the Countersurveillance Techniques Video VHS Cassette for \$49.95 plus \$4.00 for postage and handling.	
No. of Cassettes ordered _____	
Amount of payment \$ _____	
Bill my <input type="checkbox"/> VISA <input type="checkbox"/> MasterCard	
Card No. _____	
Expire Date _____ / _____	
Signature _____	
Name _____	
Address _____	
City _____ State _____ ZIP _____	
All payments in U.S.A. funds. Canadians add \$4.00 per VHS cassette. No foreign orders. New York State residents add applicable sales tax.	

**CALL TODAY TO ORDER 1-800-522-6260**

# ELECTRONICS LIBRARY

## Designing, Building And Testing Your Own Speaker System: Third Edition

by David B. Weems

If your wallet doesn't quite match your taste in audio components, or if you simply enjoy honing your electronics-construction skills by building practical projects, you'll appreciate this book. Featuring custom designs that use easily accessible Radio Shack components, it describes how to build a durable, inexpensive speaker system that can hold its own with even the most expensive commercially available units.

The third edition has been updated to reflect the latest trends in audio technology,

placing speakers for superior acoustics, and proper level- and tone-control settings. Straightforward advice on speaker maintenance, protection, testing, and troubleshooting is also included. Step-by-step instructions are accompanied by dozens of illustrations, tables, charts, and parts lists. A glossary of speaker terms and appendices of useful formulas, computer programs, and wire data for home-made coils round out the text.

*Designing, Building, and Testing Your Own Speaker System: Third Edition* is available for \$16.95 from TAB Books Inc., Blue Ridge Summit, PA 17294-0850; Tel. 1-800-233-1128.

CIRCLE 98 ON FREE INFORMATION CARD

## COMPUTER PROFESSIONALS EMPLOYMENT DIRECTORY

from Alexander Scott Associates, Inc.

If you're a professional in the computer field, or a student planning a career in the field, this innovative directory could simplify your job hunting in the New England area. The Research Division of Alexander Scott Associates, an engineering recruiting firm, compiled lists of more than 4000 hiring managers, divided by their areas of specialization. The customized report uses "skillcodes" corresponding to software, hardware, and communications engineering; MIS; quality assurance; technical support; and sales. Using the skillcodes system—based on information provided by applicants when ordering the directory—the customized directory will provide the names of hiring managers in the applicant's areas of interest. The

report contains the historical as well as current hiring activities of managers, and states precisely where and to whose attention resumes should be sent. The directory, which is updated at a rate of 600 records per month, assists people in finding jobs with companies that do not use agencies or recruiters.

*The Computer Professionals Employment Directory* is available at prices starting at \$49.95 for students and \$69.95 for professionals from Alexander Scott Associates, Inc., Thames Street, Box 719, Newport, RI 02840; Tel. 800-876-8369 or 401-849-1812.

CIRCLE 93 ON FREE INFORMATION CARD

## BASICS OF ELECTRICAL POWER TRANSMISSION

by Anthony J. Pansini

Providing basic information for those just entering the field, as well as a thorough review for those with more experience, this book uses non-technical language to present the information needed to plan, design, build, run, and maintain problem-free electrical-power transmission lines. The materials and equipment that

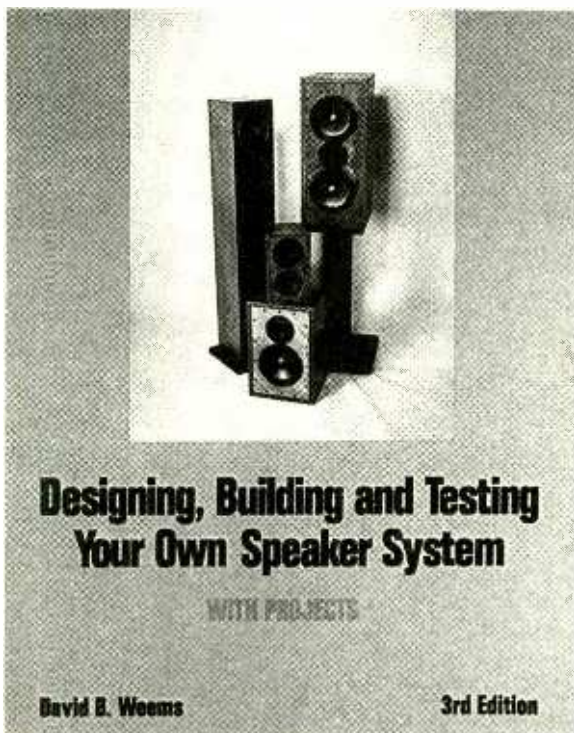

while retaining the previous editions' clear coverage of basic speaker theory, types and functions of speaker enclosures, crossover networks and filters, and closed-box and ported-box speaker construction. In addition, it provides information on selecting speaker equipment,

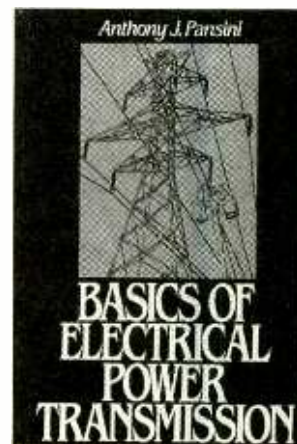



comprise transmission lines are described, and the function and make-up of transmission facilities are explained. Practical considerations, including safety, reliability, and economic aspects, are covered, and day-to-day operations are described. The book explains how to determine optimum voltage and costs, protect against lightning damage, increase the capacity of existing lines, and handle legal and financial matters concerning transmission lines. This edition has been updated to reflect technological progress and expanded to provide chapters on basic electricity and extra-high-voltage and direct-current transmission. Appendices have been added that include an examination of the environmental considerations of power transmission, a step-by-step guide for operating transmission lines, and a metric conversion chart. The amply illustrated book contains helpful diagrams, charts and tables, as well as dozens of typical examples.

*Basics of Electrical Power*

*Transmission is available for \$38.00 from Prentice Hall, Englewood Cliffs, NJ 07632.*

**CIRCLE 99 ON FREE INFORMATION CARD**

**VELLEMAN HIGH-Q KIT**  
*from Taptoc Corporation*

Anyone who enjoys building general electronic, electronic music, industrial, or computer projects from kits, should find something of interest in this catalog. More than 30 new electronic kits are featured in its 32 pages. Highlighted are several newly introduced audio kits, including a graphic equalizer, and a 6- and 12-channel professional mixer. Also featured are car accessories, communications devices, computer interfaces, measuring devices, membrane keyboards, sensors, counters, timers, power supplies, dimmers, alarms, and gadgets. A color photograph accompanies the description of each kit.

*Velleman High-Q Kit catalog is available from Taptoc Corpora-*

*tion, P.O. Box 44247, Denver, CO 80201; Tel. 303-295-7704; Fax 303-295-7708.*

**CIRCLE 92 ON FREE INFORMATION CARD**

**INDUSTRIAL ELECTRONICS FOR TECHNICIANS**

*by Sam Wilson*

Besides providing an effective overview of the topics covered in the Industrial Electronics Certified Electronics Technician (CET) exam, this book is a valuable reference on industrial electronics in general. Written as a "workbench companion," the book puts vital information at the reader's fingertips. It covers the theory and application of industrial hardware from the technician's perspective, explaining every area in which understanding is necessary to qualify for CET accreditation. Some of the topics examined are passive and active transducers; electronic amplifying components, including diodes;

thyristors, relays, switches, and ladder diagrams; digital logic gates; power supplies, motors, and generators; and robotics.

*Industrial Electronics for Technicians is available for \$16.95 from TAB Books Inc., Blue Ridge Summit, PA 17294-0850; Tel. 1-800-233-1128.*

**CIRCLE 98 ON FREE INFORMATION CARD**

**SIMPLIFIED PRACTICAL FILTER DESIGN**

*by Irving M. Gottlieb*

For engineers, technicians, and hobbyists, this "back-to-basics" guide to designing and building electronic filters provides the hands-on experience needed to be able to quickly put together a working filter. The essentials of fundamental analog-circuit design—often neglected in this age of digital circuitry—are the focus of this book. Using simple mathematics and straightforward procedures, the book aims to promote a thorough under-



**2-1/2" SANYO TWEETER**

Paper cone with gold tone dust cap. 8 oz. magnet. 8 ohm. 1/2" ferro fluid voice coil. Power handling: 50W RMS, 70W max. Frequency response: 3K-20KHz.



#PM-271-020 **\$1<sup>95</sup> \$1<sup>75</sup> 95c**  
(1-9) (10-59) (60-up)

**SUPER HORN TWEETER**

Original piezo tweeter made by Motorola. SPL=94 dB 2.83V/1M. Response: 4KHz-27KHz. Handles approximately 50 watts.



#PM-270-010 **\$5<sup>30</sup> \$4<sup>50</sup> \$3<sup>95</sup>**  
(1-9) (10-79) (80-up)

**2" DOME MIDRANGE**

Textile dome midrange made by Philips. 8 ohm. SPL=90 dB 1W/1M. 30W RMS, 40W max. Response: 550-5KHz.



#PM-280-210 **\$27<sup>30</sup> \$25<sup>70</sup>**  
(1-3) (4-up)

**15" SUBWOOFER**



Dual voice coil. 40 oz. magnet. 6 ohm imp. 100W RMS, 140W max. Response: 20-1.2KHz. Resonant frequency: 21Hz. SPL=93 dB 1W/1M.

**PIONEER**  
#PM-290-190 **\$54<sup>50</sup> \$49<sup>90</sup>**  
(1-3) (4-up)

**SUBWOOFER XOVER**



200W RMS crossover designed specifically for use with dual voice coil subwoofers. 12 dB per octave roll-off at 150Hz.

#PM-260-220 **\$28<sup>80</sup> \$24<sup>40</sup>**

**10" POLY WOOFER**

Medium duty. 60W RMS, 80W max. 14 oz. magnet. Response: 25-2.5KHz. fs=28Hz.



#PM-290-096 **\$18<sup>50</sup> \$16<sup>90</sup>**  
(1-3) (4-up)

**TITANIUM COMPOSITE TWEETER**

The advantages of both hard and soft dome technologies. 8 ohm. Ferro fluid cooled voice coil. SPL=90 dB 1W/1M. 50W RMS, 70W max. 4" round. Polydax #DTW100T125



**Polydax**  
#PM-270-047 **\$27<sup>50</sup> \$24<sup>90</sup>**  
(1-9) (10-up)

**SPEAKER BUILDING BOOK**

Revised edition of David Weems' best selling book. Learn to build low cost speakers that rival the high priced models.



#PM-500-021 **\$16<sup>95</sup>**

**12" CAST FRAME WOOFER**



**EMINENCE**

12" woofer made in the USA by Eminence. Paper cone and dust cap with treated cloth surround. 80 oz. magnet. 2-1/2" vented voice coil. 8 ohm. 170W RMS, 235W max. 40-4.5KHz response.

#PM-290-147 **\$72<sup>90</sup> \$69<sup>50</sup>**  
(1-3) (4-up)

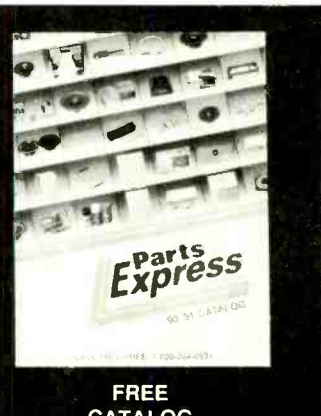

**Parts Express**  
340 E. First St., Dayton, Ohio 45402  
Local: 1-513-222-0173  
FAX: 513-222-4644

\* 15 day money back guarantee • \$15.00 minimum order • We accept Mastercard, Visa, Discover, and C.O.D. orders. • 24 hour shipping • Shipping charge = UPS chart rate + \$1.00 (\$3.00 minimum charge) • Hours 8:30 am-7:00 pm EST. Monday-Friday • Mail order customers, please call for shipping estimate on orders exceeding 5 lbs. Foreign customers please send \$5.00 U.S. funds for catalog postage.

**CALL TOLL FREE**  
**1-800-338-0531**

**FREE CATALOG**

**CIRCLE 7 ON FREE INFORMATION CARD**

standing of filter components, including how their exact values are determined and how they are properly connected. Common techniques for laying out and assembling low-pass, bandpass, M-derived, crystal, high-pass, band-rejection, and composite filters, and crossover networks, are included.

Throughout the book, an emphasis is placed on the differences between real-world and "textbook" filters—in particular, why heavily mathematical texts often work against designers, and how readers can avoid falling into the same trap. The simple designs presented in this book—whose real-world practicality surpasses their "mathematical elegance"—are accessible to anyone with reasonable proficiency in arithmetic and basic algebra.

*Simplified Practical Filter Design* is available for \$16.95 from TAB Books Inc., Blue Ridge Summit, PA 17294-0850; Tel. 1-800-233-1128.

**CIRCLE 98 ON FREE INFORMATION CARD**

## SMART ANALOG DATA BOOK

from Crystal Semiconductor Corporation

Information on the full range of SMART Analog data-acquisition IC's is available in this 848-page data book. Using detailed product descriptions, along with in-depth discussions of operations and applications, the book provides a comprehensive overview of price and performance. It contains full data sheets for 26 products, including ten new products.

The catalog presents the product line divided into six cat-



egories: analog-to-digital converters, digital-to-analog converters, sample-and-hold amplifiers, filters, voltage references, and power monitors. Product information includes features and specifications, block diagrams, theories of operation, application notes, evaluation-board information, schematics, and packaging and grading information.

*SMART Analog Data Book* is available from Crystal Semiconductor Corporation, 4210 South Industrial Drive, Austin, TX 78744; Tel. 512-445-7222.

**CIRCLE 91 ON FREE INFORMATION CARD**

## TELEVISION AND VIDEO SYSTEMS: OPERATION, MAINTENANCE, TROUBLESHOOTING, AND REPAIR

by Charles G. Buscombe

Intended as a training guide for future technicians and as a tool to make life easier for technicians who are working in the field, this book covers the most popular group of consumer-electronic products—TV/monitors, projection sets, and VCR's. With an equal emphasis on theory and troubleshooting, it provides a well-rounded, in-depth course for students and technicians alike. It covers the basics along with the latest technological developments—HDTV, MTS stereo, digital electronics, and VCR's—and takes a practical approach to all.

Beginning with a general introduction to TV as a system, including both broadcast stations and receivers, the book explains precisely how each part of the system works. It describes all types of test equipment and provides an introduction to electronic troubleshooting and repair. Examinations of power supplies, CRT's, receivers, basic VHF and UHF tuners, and various television circuits and components are included. Also covered are vertical and horizontal sweep, sync stages and noise-immunity systems, video-amplifier stages, chroma-signal processing stages, and the TV circuits that process and reproduce sound. Several chapters are devoted to VCR's,

digital television, and projection TV. Numerous troubleshooting flow charts clearly illustrate virtually all possible breakdowns and failures, their common causes, and corrective procedures.

*Television and Video Systems: Operation, Maintenance, Troubleshooting, and Repair* is available in hardcover for \$45.80 from Prentice Hall, Englewood Cliffs, NJ 07632.

**CIRCLE 99 ON FREE INFORMATION CARD**

## HIGH RELIABILITY ELECTRONICS COMPONENTS D.A.T.A. DIGEST 1990

from D.A.T.A. Business Publishing

A time-saver for component engineers, this one-stop volume provides cross-reference data on more than 13,500 discrete semiconductors and 17,000 integrated circuits. It includes concise, logically arranged information on device functions, current QPL status, military part-number equivalents, package outlines and availability,

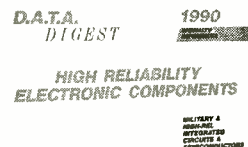

military-to-commercial cross reference, and manufacturers' addresses and phone numbers. Each D.A.T.A. Digest subscription includes periodic updates to keep the information presented to the user as current as possible.

*The High Reliability D.A.T.A. Digest 1990 with updates* costs \$175 plus shipping from D.A.T.A. Business Publishing, 8977 Activity Road, San Diego, CA 92126; Tel. 800-447-4666; Fax 619-530-0637.

**CIRCLE 90 ON FREE INFORMATION CARD**

## 49 EASY ELECTRONIC PROJECTS FOR TRANSCONDUCTANCE & NORTON OP AMPS

by Delton T. Horn

Used in thousands of different circuits, the operational amplifier is one of the most versatile and popular IC's available today. Many hobbyists, however, are unfamiliar with some powerful variations on the basic op amp. This book, by focusing on two important op-amp variants, strives to remedy that situation.

The transconductance op amp, or OTA, and the Norton op amp are subtly but significantly different from the conventional op amp. While all three types can be used in many of the same applications, the special features of the OTA and the Norton op amp make them suitable for some extra uses. Filling the gap in hobby-oriented information, the book discusses theory of operation and presents details of popular IC's of both types.

In addition, the book contains 49 practical projects that illustrate many of the possible applications and give the reader hands-on experience at the same time. Some of those projects are AC and DC amplifiers, square-wave generators, temperature sensors, filters, sample-and-hold circuits, signal generators, voltage and current switches, voltage regulators, modulators, Schmitt triggers, and constant current sources. Each of the projects is designed to be easily built in one evening for no more than \$15.00.

*49 Easy Electronic Projects for Transconductance & Norton Op Amps* is available for \$16.95 from TAB Books Inc., Blue Ridge Summit, PA 17294-0850; Tel. 1-800-233-1128.

**CIRCLE 98 ON FREE INFORMATION CARD**

## PCS MADE EASY

by James L. Turley

Written for all newcomers to the world of personal computing—particularly those "who have no technical background and do not wish to start now"—this book is intended to help anyone who finds himself confronted with a PC at work or at home. The up-to-date guide covers all



# No other training—in school, on the job, anywhere—shows you how to troubleshoot and service computers like NRI

## DIGITAL MULTIMETER

Professional test instrument for quick and easy measurements.

## LESSONS

Clearcut, illustrated texts build your understanding of computers step by step.

## SOFTWARE

Including MS-DOS, GW BASIC, word processing, database and spreadsheet programs.

## HARD DISK

20 megabyte hard disk drive you install internally for greater data storage capacity and data access speed.

## NEW! AT-COMPATIBLE COMPUTER

High-speed 80286 CPU (12 MHz clock, 0 wait states), 1 meg RAM, 1.2 meg, 5 1/4" high-density floppy disk drive.

## MONITOR

High-resolution, non-glare, 12" TTL monochrome monitor with tilt and swivel base.

## TECHNICAL MANUALS

With professional programs and complete specs on your computer.

## DIGITAL LOGIC PROBE

Simplifies analyzing digital circuit operation.

## DISCOVERY LAB

Complete breadboarding system to let you design and modify circuits, diagnose and repair faults.

Only NRI walks you through the step-by-step assembly of a powerful AT-compatible computer system you keep—giving you the hands-on experience you need to work with, troubleshoot, and service all of today's most widely used computer systems. You get all it takes to start a money-making career, even a business of your own in computer service.

No doubt about it: The best way to learn to service computers is to actually build a state-of-the-art computer from the keyboard on up. As you put the machine together, performing key tests and demonstrations at each stage of assembly, you see for yourself how each part of it works, what can go wrong, and how you can fix it.

Only NRI—the leader in career-building, at-home electronics training for more than 75 years—gives you such practical, real-world computer servicing experience. Indeed, no other training—in school, on the job, *anywhere*—shows you how to troubleshoot and service computers like NRI.

**You get in-demand computer servicing skills as you train with your own AT-compatible system—now with 20 meg hard drive**

With NRI's exclusive hands-on training, you actually build and keep the powerful new AT-compatible West Coast 1010 ES computer, complete with 1 meg RAM and 20 meg hard disk drive.

You start by assembling and testing the 101-key "intelligent" keyboard, move on to test the circuitry on the main logic board, install the power supply and 1.2 meg 5 1/4" floppy disk drive, then interface your high-resolution monitor. But that's not all.

**Only NRI gives you a top-rated micro with complete training built into the assembly process**

Your NRI hands-on training continues as you install the powerful 20 megabyte hard disk drive—today's most wanted computer peripheral—included in your course to dramatically increase your computer's storage capacity while giving you lightning-quick data access.

Having fully assembled your West Coast 1010 ES, you take it through a complete series of diagnostic tests, mastering professional computer servicing techniques as you take command of the full power of your computer's high-speed 80286 microprocessor.

In no time at all, you have the confidence and the know-how to work with, troubleshoot, and service every computer on the market today. Indeed you have what it takes to step into a full-time, money-making career as an industry technician, even start a computer service business of your own.

**No experience needed, NRI builds it in**

You need no previous experience in computers or electronics to succeed with NRI. You start with the basics, following easy-to-read instructions and diagrams, quickly

moving from the fundamentals to sophisticated computer servicing techniques. Step by easy step, you get the kind of practical hands-on experience that makes you uniquely prepared to take advantage of every opportunity in today's top-growth field of computer service.

What's more—you learn at your own pace in your own home. No classroom pressures, no night school, no need to quit your present job until you're ready to make your move. And all throughout your training, you have the full support of your personal NRI instructor and the NRI technical staff always ready to answer your questions and give you help whenever you need it.

## Your FREE NRI catalog tells more

Send today for your free full-color catalog describing every aspect of NRI's innovative computer training, as well as hands-on training in robotics, video/ audio servicing, electronic music technology, security electronics, telecommunications, and other growing high-tech career fields.

If the coupon is missing, write to NRI School of Electronics, McGraw-Hill Continuing Education Center, 4401 Connecticut Avenue, Washington, DC 20008.

AT is a registered trademark of International Business Machines Corporation

**NRI School of Electronics**



For career courses approved under GI bill  
 check for details

McGraw-Hill Continuing Education Center  
4401 Connecticut Avenue, Washington, DC 20008

Check one FREE catalog only

- |  |  |
|--|--|
| <input type="checkbox"/> Computers and Microprocessors | <input type="checkbox"/> Security Electronics        |
| <input type="checkbox"/> Robotics                      | <input type="checkbox"/> Electronic Music Technology |
| <input type="checkbox"/> TV/Video/Audio Servicing      | <input type="checkbox"/> Basic Electronics           |
| <input type="checkbox"/> Computer Programming          | <input type="checkbox"/> Telecommunications          |

Name \_\_\_\_\_ (please print) Age \_\_\_\_\_

Address \_\_\_\_\_

City/State/Zip \_\_\_\_\_ Accredited Member, National Home Study Council 18-110

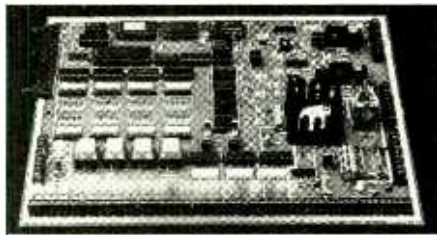

### Knight Patrol™

#### Talking Home Alarm Kit

A high end alarm system at an affordable price!

Features include:

- ◆ State of the art PCF 8200 Speech Synthesizer
- ◆ 21 Sensor Zones, 2 Arming Circuits
- ◆ 2 Five Watt Audio Amplifiers
- ◆ Auxiliary Alarm
- ◆ Real Time 24 Hr. Clock
- ◆ A 10A & 3A Relay Circuit for Sirens, etc.
- ◆ Alert/Sleep Monitoring Modes (verbal status)
- ◆ Trigger Memory (verbal status)
- ◆ Self Diagnostics & Performance Monitoring
- ◆ Microprocessor Controlled
- ◆ Pleasant Female Voice
- ◆ Expandibility & so much MORE!

Available as a kit or pre-assembled. Send for our FREE catalog! A complete line of peripherals is also available. Complete Circuit Board kit \$220 plus \$10.50 S&H. (Ca. residents add 6.75% tax)

#### Paladin Electronics

19425 B Soledad Cyn Rd  
Suite 333 Dept. R.E.S.  
Canyon Country, CA 91351

"We protect your castle"



CIRCLE 12 ON FREE INFORMATION CARD

## SUPER LONG PLAY TAPE RECORDERS

**12 Hour Model — USES D-120 TAPE**  
**\$119.00\***

Modified Panasonic Slimline, high quality AC-DC provide 6 continuous hours of quality recording & playback on each side of cassette for 12 hours total. Includes • Voice level control • Digital counter, etc. TDK D-120 Cassette Furnished.

**PHONE RECORDING ADAPTER**

Records calls automatically. All Solid state connects to your telephone jack and tape recorder. Starts recording when phone is lifted. Stops when you hang up. **\$28.50\*** FCC APPROVED

**VOX VOICE ACTIVATED CONTROL SWITCH**

Solid state. Self contained. Adjustable sensitivity. Voices or other sounds automatically activate and control recorder. Uses either recorder or remote mike. **\$28.50\***

\*Add for ship & hdg. Phone Adapter & Vox \$1.50 ea. Records \$4.00 ea. Cal. Res. add tax. Mail order, VISA, M/C, COD's OK. Money Back Guarantee. Qty. disc. avail. Dealer Inquiries invited. Free data.

**AMC SALES INC.** Dept. B 9335 Lubec St.  
Box 928 Downey, CA. 90241  
Phone (213) 869-8519  
FAX (213) 923-1478





CIRCLE 11 ON FREE INFORMATION CARD

PC's, including IBM's and compatibles, the Apple, Macintosh, and others. Designed to help new users get their PC's up and running as quickly and painlessly as possible, the book provides a thorough but simple introduction to the world of microcomputers. It explains, without resorting to jargon, what PC's are, what they can do, and how to make them do it. The



chapters are generally set up so that each one answers a single basic question about PC's, and so that the information is presented in a logical progression. Readers can either tackle the book from start to finish, or turn to a particular chapter to quickly find the answer to a specific question. To aid in understanding, the book contains dozens of illustrations. Time-saving tips about traps to avoid are also provided.

PC's Made Easy is available for \$18.95 from Osborne McGraw-Hill, 2600 Tenth Street, Berkeley, CA 94710.

CIRCLE 89 ON FREE INFORMATION CARD

### 1990 ELECTRICAL INDEPENDENCE GUIDEBOOK AND CATALOG

from Integral Energy Systems

More than simply a catalog of products, this unique book provides an introduction to "the world of energy alternatives." With traditional power sources becoming increasingly expensive—and hazardous to the environment—there is a re-

newed interest in alternate power sources. The latest information regarding those sources can be found in the 105 pages of this guidebook. It covers photovoltaics, small hydropower, wind-electric, and other home power systems, along with batteries, inverters, low-voltage lighting, propane appliances, composting toilets, energy-saving products, books, and solar toys. In addition, there are several pages of charts, diagrams, tables, and instructions that explain in plain English how to design, size, select, and install a solar-electric system.

The 1990 Electrical Independence Guidebook and Catalog is available for \$4.00 from Integral Energy Systems, 105 Argall Way, Nevada City, CA 95959; Tel. 800-735-6790 (orders) or 916-265-8441 (technical information); Fax 916-265-6151.

CIRCLE 88 ON FREE INFORMATION CARD

### 1990 NEW PRODUCTS UPDATE

from Contact East

This supplement to the Contact East general catalog serves as a reference guide for engineers, managers, and technicians. It offers a wide range of reliable, brand-name products for testing, repairing, and assembling electronic equipment. The update highlights new products in several categories, including linear power supplies, analog and

### contact east

New Products Update



digital oscilloscopes, inspection products, soldering/desoldering equipment, temperature and humidity chart recorders, and static-protection products. Also included are DMM's, adhesives, test equipment, precision hand tools, and an exclusive line of tool kits. All products are de-



scribed in detail with specifications, full-color photographs, and discounted pricing.

The 1990 New Products Update is free upon request from Contact East, 335 Willow Street South, North Andover, MA 01845; Tel. 508-682-2000.

CIRCLE 87 ON FREE INFORMATION CARD

## PORTABLE TEST-EQUIPMENT CATALOG

from A.W. Sperry Instruments

This 35-page catalog features A.W. Sperry's complete line of portable electrical and electronic test equipment. A selection of inexpensive new electrical testers and indicating devices have been added to this issue. Those include a 4-way voltage tester, two continuity testers, a battery tester, a 3-wire circuit analyzer, and two electrical testers. The catalog includes all specifications, and accessories are offered as well.

Catalog MC-600, Issue D is free upon request from A.W. Sperry Instruments, Inc., 245 Marcus Boulevard, Hauppauge, NY 11788; Tel. 800-645-5398 (in NY and AK, 516-231-7050).

CIRCLE 86 ON FREE INFORMATION CARD

## 1990 AMATEUR RADIO/SWL ACCESSORIES CATALOG

from MFJ Enterprises

This 16-page catalog includes everything needed for amateur-radio hobbyists. A sampling of items includes antenna tuners, portable transmitting antennas, SWR/wattmeters, coax switches, clocks, keys and memory keys, antenna bridges, RFI-free choke kits, and multiple DC power outlets. Handheld accessories include speaker/mics and antennas, and SWL accessories include tuners, indoor and outdoor active antennas, and preamplifiers. The catalog also features ham software for IBM, Macintosh, Commodore, and compatible computers; packet radio units, a multi-mode data controller, and a "Picture Perfect" video digitizer.

The 1990 Amateur Radio/SWL Accessories catalog is

free upon request from MFJ Enterprises, Inc., P.O. Box 494, Mississippi State, MS 39762; Tel. 800-647-1800.

CIRCLE 85 ON FREE INFORMATION CARD

## ELECTRONIC AND COMPUTER PARTS CATALOG

from American Design Components

Geared to meet the needs of hobbyists, computer buffs,

small manufacturers, large OEM's, universities, and R&D facilities, this 40-page catalog features electronic, electromechanical, and computer-related parts and components at below-factory-outlet prices. Included in the catalog are components and peripherals such as IC's, switches and connectors, power supplies, rechargeable batteries, fans, and blowers. The fully-illustrated booklet also contains a large assortment of computer prod-

ucts, such as monitors, disk drives, add-on boards, mice, modems, and complete computer systems. All items that are contained in the catalog are available for "off-the-shelf" delivery.

The Electronic and Computer Parts Catalog is available at no charge from American Design Components, 815 Fairview Avenue, Fairview, NJ 07022; Tel. 800-776-3800.

CIRCLE 84 ON FREE INFORMATION CARD

# ELENCO & HITACHI PRODUCTS AT DISCOUNT PRICES

**NEW!** RSOs (Real-Time & Storage Oscilloscopes) From HITACHI **NEW!**

The RSO - its the new solution  
View, Acquire, Test, Transfer and Document Your Waveform Data

Model	Introductory Price
4-Channel, 100MS/s Model	
100MS/s (25MS/s on 4 channels simultaneously), 100MHz, 4kw x 1ch., 2kw x 2ch., 1kw x 4ch.	VC-6145 \$4,695.00
<b>Compact, Full Feature Models</b>	
40MS/s, 100MHz, 4kw x 1ch., 2kw x 2ch.	VC-6045 \$3,049.00
20MS/s, 50MHz, 2kw x 2ch.	VC-6025 \$2,295.00
<b>Low Cost/High Value Models</b>	
20MS/s, 50MHz, 2kw x 2ch.	VC-6024 \$2,049.00
20MS/s, 20MHz, 2kw x 2ch.	VC-6023 \$1,749.00

RSOs from Hitachi feature such functions as roll mode, averaging, save memory, smoothing, interpolation, pretriggering, cursor measurements, plotter interface, and RS-232C interface. With the comfort of analog and the power of digital.



**V-212**  
Hitachi Portable Scopes  
DC to 50MHz, 2-Channel, DC offset function, Alternate magnifier function

V-212 DC to 20MHz Dual Channel \$435  
V-525 CRT Readout, Cursor Meas. \$1,025  
V-523 Delayed Sweep \$995  
V-522 Basic Model \$995

**FREE DMM**  
with purchase of ANY SCOPE

**SCOPE PROBES**  
P-1 65MHz, 1x, 10x \$19.95  
P-2 100MHz, 1x, 10x \$23.95



**20MHz Elenco Oscilloscope**  
MO-1251 \$375

- Dual Trace
- Component Tester
- 8" CRT
- X-Y Operation
- TV Sync
- 2 p-1 Probes

**Compact Series Scopes**



Delayed Sweep  
Lightweight (13lbs)  
2mV Sens  
3 Yr. Warranty  
Model V-106S

This series provides many new functions such as CRT Readout, Cursor measurements (V-108S/108S/66S), Frequency Ctr (V-108S), Sweeptime Autoringing and Trigger Lock using a 6-inch CRT. You don't feel the compactness in terms of performance and operation.

V-660	60MHz Dual Trace	\$1,195
V-665	60MHz Dual Trace w/Cursor	\$1,345
V-106S	100MHz Dual Trace	\$1,425
V-106S	100MHz Dual Trace w/Cursor	\$1,695
V-108S	100MHz Quad Trace w/Cursor	\$2,045
V-1100A	100MHz Quad Trace w/Cursor	\$2,295
V-1150	150MHz Quad Trace w/Cursor	\$2,775



**Elenco 35MHz Dual Trace**  
Good to 50MHz  
MO-1252 \$495

- High luminance 6" CRT
- 1mV Sensitivity
- 5KV Acceleration Voltage
- 10ms Rise Time
- X-Y Operation - 2 Axis
- Delayed Triggering Sweep
- Includes 2 P-1 Probes

All scopes include probes, schematics, operators manual, and 3 year (2 yrs for Elenco scopes) world wide warranty on parts & labor. Many accessories available for all Hitachi scopes. Call or write for complete specifications on these and many other fine oscilloscopes.

**WE NOW CARRY COMPLETE LINE OF FLUKE MULTIMETERS**

Models

21F 83  
23F 85  
25F 87  
27F 8050A  
73 8060A  
75 8062A  
77F + More

CALL FOR SPECIAL PRICING

**True RMS 4 1/2 Digit Multimeter M-7000**

\$135

.05% DC Accuracy  
.1% Resistance with Freq. Counter and deluxe case

**10 Function Multimeter CM-365**

\$65

AC + DC Voltage & Amps  
Resistance to 2000MΩ  
Diode, Logic, & Trans test  
Capacitance to 200µF

**Digital Capacitance Meter CM-1550**

\$58.95

9 Ranges  
.1pF-20,000µF  
5% basic acc  
Zero control  
with case

**Digital LCR Meter LC-1801**

\$125

Measures:  
Coils 1µH-200H  
Caps .1pF-200µF  
Res .01-20M

**Function Generator Blox**

\$28.95

Provides sine, triangle, square wave from 10Hz to 1MHz  
AM or FM capability

**Triple Power Supply XP-620**

Assembled \$65  
Kit \$45

2 to 15V at 1A,  
2 to 15V at 1A  
(or 4 to 30V at 1A)  
and 5V at 3A

Contains all the desired features for doing experiments.  
Features short circuit protection, all supplies.

**Wide Band Signal Generators SG-9000**

\$129

RF Freq 100K-450MHz  
AM Modulation of 1KHz  
Variable RF output

**SG-9500 Digital Display and 150MHz built-in Counter**

\$249

**Soldering Station**

Temperature Controlled

SL-30 \$99

Digital display  
Temp range:  
300F-900F  
Grounded tip  
Overheat protect

**Color Convergence Generator SG-200**

\$69.95

Finest in the industry  
10 rock steady patterns

**10MHz Oscilloscope S-3000**

\$275

10MHz DC or AC  
Triggered Sweep  
Calibrated Volt & Hor  
Beats: Volt & Freq

**Temperature Probe M-1100F**

\$29.95

Semiconductor type  
Range  
50F-302F

Files most digital multimeters

**Autorange DMM M-5000**

\$45

9 Functions  
Memory and Data hold  
1/2 % basic acc  
3 1/2 digit LCD

**AC Current Meter ST-1010**

\$69.95

1000 Amps  
Data & Peak hold  
8 Functions  
Deluxe Case

**Decode Blox**

\$96.10 or \$96.20  
\$18.95

#9610 Resistor Blox  
47 ohm to 1M & 100K pot  
#9620 Capacitor Blox  
47pF to 10MFD

**Quad Power Supply XP-580**

\$59.95

2-20V at 2A  
12V at 1A  
5V at 3A  
-5V at 5A

Fully regulated and short circuit protected  
XP-575 without meters \$39.95

**LEARN TO BUILD AND PROGRAM COMPUTERS WITH THIS KIT**

INCLUDES: All Parts, Assembly and Lesson Manual

Model MM-8000 \$129.00

Starting from scratch you build a complete system. Our Micro-Master trainer teaches you to write into RAM, ROM and a 60K5 microprocessor, which uses similar machine language as IBM PC. You will write the initial instructions to tell the 8085 processor to get started and store these instructions in permanent memory in a 2816 EPROM. Teaches you all about input and output ports, computer timers. Build your own keyboard and learn how to scan keyboard and display. No previous computer knowledge required. Simple easy to understand instruction teaches you to write in machine language.

**ROBOTICS KIT FOR ABOVE (MM-8010) \$71.95**

**Digital Triple Power Supply XP-765**

\$249

0-20V at 1A  
0-20V at 1A  
5V at 5A

Fully regulated, Short circuit protected with 2 limit control, 3 separate supplies  
XP-660 with Analog Meters \$175

**GF-8016 Function Generator**

\$249

Sine, Square, Triangle  
Pulse, Ramp, 2 to 2MHz  
Freq Counter, 1 - 10MHz

GF-8015 without Freq. Meter \$179

**WE WILL NOT BE UNDERSOLD!**

UPS Shipping: 48 States 5%  
(\$10 Max) IL Res., 7% Tax

**C & S SALES INC.**  
1245 Rosewood, Deerfield, IL 60015  
(800) 292-7711 (708) 541-0710

**15 Day Money Back Guarantee**  
2 Year Warranty (Prices subject to change)

**WRITE FOR FREE CATALOG**

CIRCLE 5 ON FREE INFORMATION CARD

# NEW PRODUCTS

## Scanner Antenna Boosts Signals

Using only a 36-inch telescoping whip, the *Antenna Plus 3* from *Electron Processing* strengthens signals from weak scanner stations. Reception is "peaked" for scanner frequencies and is further enhanced by a special filter that eliminates interference caused by local AM-broadcast and shortwave transmitters. The unit's 15–20-dB internal amplifier ensures strong signals.

The indoor antenna, which receives 30–2000 MHz, is easy



to install using adapting cables (not included). For connection to virtually any type of receiver, the Antenna Plus-3 comes with a choice of BNC, phono, SO239 (UHF), N, and F connectors. A version that has a built-in antenna splitter and a second output jack is also available.

The Antenna Plus-3 costs \$89.00; the dual-output model costs \$109.95. For a limited time, the standard model is available for a special introductory price of \$79.00. For further information, contact Electron Processing, Inc., P.O. Box 68, Cedar, MI 49621.

**CIRCLE 101 ON FREE INFORMATION CARD**

## MULTI-MODE DATA CONTROLLER

Billed as amateur radio's first multi-mode to have a built-in 2400-baud modem, the *MFJ-1278T Turbo* data control-

ler also works at 1200/300 baud for full compatibility with older TNC's. The faster speed reduces chances for errors during transmission, lessens congestion at busy times and on crowded channels, and allows more efficient use of ham frequencies. The MFJ-1278T transmits and receives in all nine digital modes: packet, Am-tor, RTTY, ASCII, CW, fax, SSTV, Navtex, and contest memory keyer. Other features include a built-in dedicated printer port, Easy Mail personal mailbox, 20-LED precision tuning indicator, 32K RAM, AC power supply, dual radio ports (each HF or VHF), independent transmit-level adjustment for each radio port, random code generator, and a lithium battery backup. In addition, the MFJ-1278T has RS-232 and TTL serial ports, a peripheral I/O port, programmable message memories, a speaker jack that lets users monitor CW sidetone, and automatic-incrementing serial numbering. The data transmitter comes with a one-year unconditional guarantee, a fully integrated instruction manual, and a new "Fast Start" booklet.

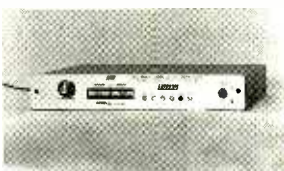

The MFJ-1278T costs \$359.95. The high-speed modem (*MFJ-2400*) and the data transmitter (*MFJ-1278*) are also available separately for \$79.95 and \$279.95, respectively. For more information, contact MFJ Enterprises, Inc., P.O. Box 494, Mississippi State, MS 39762; Tel. 601-323-5869 (800-647-1800 for orders); Fax 601-323-6551.

**CIRCLE 102 ON FREE INFORMATION CARD**

## HAND-HELD RADIO HOLDERS

Two convenient holders from *MFJ* help you make sure your handheld stays where you put it—whether that's in your car or on a crowded desk or table. The *MFJ-24* has a strip of durable plastic that bends to fit snugly over a car door, front seat, or other area in a vehicle. The *MFJ-25* is designed to stand on a table or desktop. Each pro-

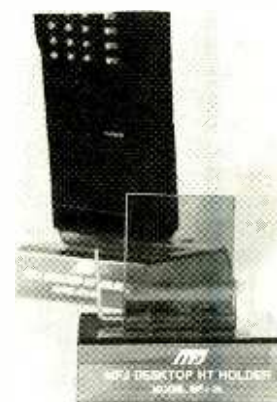

vides an economical way to help guard against dropping your expensive HT radio. Both units provide for both large and small HT's.

The MFJ-24 and MFJ-25 handheld holders cost \$9.95 each. For more information, contact MFJ Enterprises, Inc., P.O. Box 494, Mississippi State, MS 39762; Tel. 610-323-5869 (for orders, 800-647-1800).

**CIRCLE 103 ON FREE INFORMATION CARD**

## AFTER-BLACKOUT SURGE SUPPRESSOR

Designed to protect electronic equipment from "after-blackout" voltage overshoots, which can seriously damage components, *Tripp Lite's Power Pause* features a power-delay switch that waits five seconds before reconnecting plugged-in equipment to the AC power line. That delay allows the voltage overshoots to pass, preventing damage to electronic equipment. The



Power Pause constantly guards against excessive voltages while suppressing every-day spikes and line noise that can damage office machines, stereos, TV's, VCR's, and CD players. It features direct plug-in connection with two protected outlets and an indicator light.

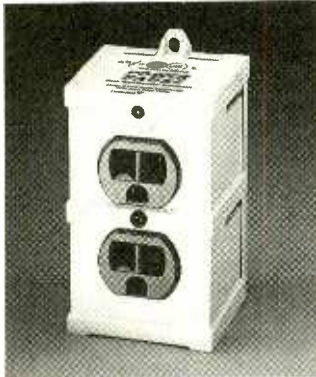

The UL-approved surge protector comes with a full two-year warranty.

The Power Pause surge suppressor has a suggested retail price of \$69.95. For additional information, contact Tripp Lite, 500 North Orleans, Chicago, IL 60610-4188; Tel. 312-329-1777.

**CIRCLE 104 ON FREE INFORMATION CARD**

## WEATHER-MONITOR RADIO

*Weather Max* (model 74-102) is a VHF weather-monitor radio from *Midland International* that delivers up-to-the-minute weather information 24 hours a day from more than 390 locations. It features an Alert Monitor system that automatically receives special warning tones sent by N.O.A.A. stations to notify users of dangerous weather conditions. Three alerting modes are available: siren, voice, or visual. A weather-command button changes the radio

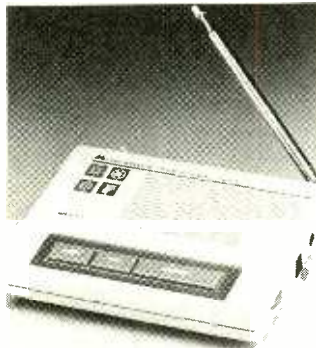

from the alert mode to full-time monitoring. Housed in a high-performance casing with a large top-firing speaker for maximum audio, the *Weather Max* provides a reception of up to 50 miles with its telescopic antenna. The external-antenna jack allows the use of an optional extended-range home antenna or mobile antenna. A UL-approved AC power-supply adapter, model 74-102W is also available as an option.

The *Weather Max* 74-102 has a suggested retail price of \$79.95. For further information, contact *Midland International*, Consumer Communications Division, 1690 North Topping, Kansas City, MO 64120.

**CIRCLE 105 ON FREE INFORMATION CARD**

## LAN-COMPATIBLE UPS

Designed to signal the loss or disruption of commercial power, power restoration, and power-shutdown conditions, two uninterruptible power systems (UPS) from *Perma Power Electronics* are Novell-tested and -approved. The 500-VA model *SPS-500L* and the 1200-VA model *SPS-1200L* are also compatible with other major LAN systems, including 3-Com and Ethernet, and with MS-DOS, UNIX, and XENIX operating systems. The *SPS-500L* is intended for smart nodes and small servers, and the *SPS-1200L* is for larger fileser-

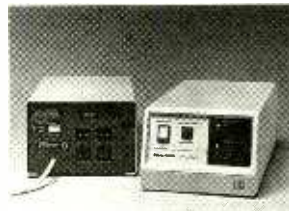

vers and for longer back-up time. Separate interface cables are available to meet the needs of more popular LAN systems.

The LAN-ready systems provide back-up power to the network when power fails, sending a signal to the fileserver to alert users to the status of the power line and that the fileserver is operating on back-up power. The UPS's also include features such as transfer from the AC power line to battery

# Which symbol represents a variable inductor?

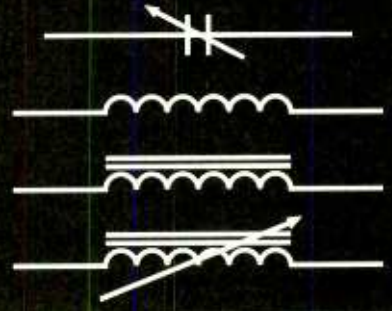

**What is the principle disadvantage of neon lights?**

**What are out-of-phase signals?**

## Heath Video Courses speed your learning curve!

Learn basic electronics at home at your own pace with four, 60-minute video tapes. Know the variable inductor symbol. Recognize a PN junction. Understand oscillator fundamentals. Clearly SEE what most basic electronic books can only describe.

**DC ELECTRONICS.** Covers electron movement to troubleshooting and repairing a simple electronic circuit. **EV-3101-A.**

**AC ELECTRONICS.** Follow-up to DC Electronics. Covers the principles of AC, voltage and electrical measurement. Includes motors, generators and test instrument meter movements. **EV-3102-A.**

**SEMICONDUCTORS.** Complete the DC/AC videos and you're ready to learn how semiconductor devices are made, plus the principles of discrete devices, integrated circuits & optoelectronic devices. **EV-3103-A.**

**ELECTRONIC CIRCUITS.** Complete the basic course with amplifier configurations, biasing, coupling, audio amplifiers, closed-loop vs. open-loop operation and more. **EV-3104-A.**

An activity-filled workbook and explanation of how to solve each problem comes with each tape so you learn three ways — video, workbook and hands-on!

**Order today!**  
**Call Toll free,**  
**24-hours a day.**  
**1-800-253-0570.**

We accept VISA, MasterCard, American Express and Heath Revolving Charge card. Use Order Code 601-026

# Heath®

Benton Harbor, MI

**Call for a FREE catalog 1-800-44HEATH.**

\*Price does not include shipping and handling, or applicable sales tax.

©1990, Heath Company  
Subsidiary of Bull Data Systems, Inc.

**CIRCLE 9 ON FREE INFORMATION CARD**

## Convert your PC into a Brainwave Synthesizer.

By now you have probably read articles, or seen ads for mind machines... devices that can moderate your tense, stressful brainwaves to produce a more relaxed, clearly focused state of mind. Most machines operate on the premise that your state of mind can be correlated to brainwave frequencies, which are measured by EEG (electroencephalogram) patterns. While much remains speculative, what is known is that EEG brainwave patterns tend to "lock on" to an externally controlled source of flashing lights or sounds, and that the frequency of the brainwaves will follow the frequency of the external stimuli. *The implication is that you can influence your state of mind electronically.*

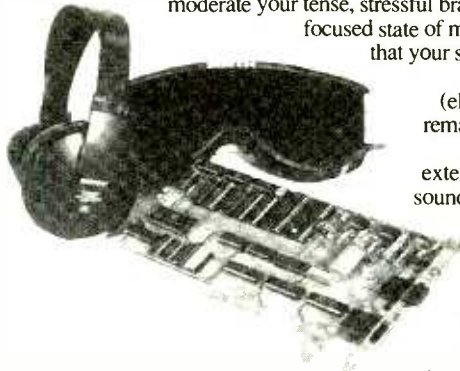

### MINDSEYE SYNERGIZER

SYNERGIZER \$395  
board, lights, software, manual

EXTERNAL CONTROL UNIT \$95  
Software-assignable controls

HEADPHONES \$35

ORDER PHONE  
800-388-6345  
Credit Cards Accepted

© 1990

Information (206) 632-1722 SYNETIC SYSTEMS, INC PO Box 95530 Seattle, Wa 98145

The MindsEye Synergizer™ is a powerful hardware/software combination that allows you to program and experience these shifts of awareness. It turns your IBM PC-XT, AT/386 or clone into a laboratory grade brainwave synthesizer. Synergizer™ sessions may be of almost any length and complexity, with each eye and ear programmed independently if desired; pulses can shift from one rate to another, while different sound frequencies are channeled left and right. Multiple time ramps and sound and light levels may be included within a single programmed session. A stereo synthesizer makes available a variety of waveforms, filters and other sound parameters. The Synergizer™ provides more programmable capabilities than any other available device at a remarkably low price.

Requires DOS 3.0 or above; 512 K of RAM, and a hard drive are recommended.

CIRCLE 18 ON FREE INFORMATION CARD

backup that is undetectable by computers or other connected equipment; surge and spike suppression; RFI/EMI noise reduction; phase-synchronized transfer from battery to line; protection from reverse polarity and inadequate grounding; and a maximum recharge time of 3½ hours.

The models SPS-500L and SPS-1200L have suggested user prices of \$749.00 and \$1249.00, respectively. For further information, contact Perma Power Electronics, Inc., 5601 West Howard Street, Chicago, IL 60648; Tel. 312-763-0763; Fax 312-763-8330.

CIRCLE 106 ON FREE  
INFORMATION CARD

## DIGITAL VIDEO EQUALIZER

Providing at-home video editors with the ability to alter the color of separate elements in a video scene, Videonic's Video Equalizer allows a new level of creative control. The unit's "Digital Paintbrush" lets users target

one element for a change of color—changing, for example, a gray sky to blue, or a brown dog to purple. By positioning on-screen cross hairs over the element to be changed, adjusting the size control, and moving the processor's red, blue, and green slide controls, the user creates the new color.

The Video Equalizer also features a digital video enhancer, digital video processor, split-



screen function, and three-channel audio mixer. The video enhancer/noise reducer lets users sharpen the edges of objects and remove visual "noise"—graininess or snow—from video images. The video processor allows users to independently adjust contrast,

brightness, color, and tint. With the built-in three-channel audio mixer, users can combine a video's existing sound track with additional stereo music, or add narration via the microphone input, and sound from all three sources can be combined and controlled. The split-screen functions lets users monitor and compare before-and-after images.

Other features include Super-VHS and High-Band 8mm compatibility via Y/C (S-Video) connectors, oversized slide potentiometers and switches, and conventional audio and video connectors.

The Video Equalizer has a suggested retail price of \$299.00. For more information, contact Videonics, 1370 Dell Avenue, Campbell, CA 95008-6604; Tel. 408-866-8300; Fax 408-866-4859.

CIRCLE 107 ON FREE  
INFORMATION CARD

## AT-COMPATIBLE PC

Based on the 10-MHz Intel 80286 processor, Tandy's 2500

XL is the company's first 16-bit computer with Tandy's Desk-Mate Graphical User Interface and MS-DOS 3.3 built into ROM for "instant-on" operation. That makes the PC easier to use for novices, and provides added convenience for experienced PC users. As soon as the computer is turned on, the user is greeted with a graphical display of programs. A separate Desk-Mate applications diskette provides a word processor with spell checker; a spreadsheet; a file system; a calendar; an address book; telecommunications; music, sound, and draw programs; and PC-LINK on-line information service.

The small-footprint PC has several integrated features and an innovative "fold-out" internal design with key-lock security. Measuring just 4¼ × 15½ × 15 inches, the 2500 XL includes 16-bit VGA support, a 16-bit "SmartDrive Integrated Drive Electronics" (IDE) connector, a



socket for a math coprocessor, one serial port, one bi-directional parallel port, microphone and headphone jacks, and a mouse port integrated on the main logic board. Industry-standard expansion cards, such as modem or network cards, mount horizontally in the three 16-bit slots. A one-inch high, 1.44MB floppy-disk drive comes standard with the 250 XL, with room to add another 3½-inch and one 5¼-inch device. The SmartDrive permits hard drives with integrated AT-type controllers to plug directly into the system without requiring a separate controller or a card slot.

Expansion is simplified by the "fold-out" internal-case design. Hinged on both sides of the computer, the right side (which contains the power supply and drive bays) swings up and away from the main logic board, allowing easy access to all sides of the drive tower for device



installation and to the main logic board for memory upgrades and math-coprocessor installation. The left side of the case also opens, for separate access to expansion-card slots.

Also standard is one megabyte of RAM, expandable to 4MB on the main logic board and to a maximum of 16MB. The included Tandy Expanded Memory Manager, which emulates the LIM 4.0 expanded-memory specification, enables MS-DOS applications to access memory beyond the traditional 640KB boundary.

The Tandy 2500 XL computer (Cat. No. 25-4074) is available for a suggested retail price of \$1,499.00 at Radio Shack Computer Centers and participating Radio Shack stores and dealers nationwide.

CIRCLE 108 ON FREE INFORMATION CARD

## ELECTRICAL TESTERS

A. W. Sperry has introduced two inexpensive instruments for low-voltage and general-purpose testing: models ET-200A and ET-201A. The ET-200A low-voltage tester checks voltages from 5-50 volts AC/DC, and has alligator clips on the ends of the test leads for user convenience. The ET-201A general-purpose



tester checks AC and DC voltages from 80- to 500-volts, and has heavy-duty test probes on the ends of the test leads for durability.

The ET-200A and ET-201A electrical testers cost \$2.10 and \$1.35, respectively. For further information, contact A. W. Sperry Instruments Inc., 245 Marcus Blvd., Hauppauge, NY 11788; Tel. 516-231-7050.

CIRCLE 109 ON FREE INFORMATION CARD

## ELECTRICAL-INSULATION TESTERS

From *Kyoritsu Electrical Instruments Works*, the analog 3111V and digital 3001B electrical-insulation testers are battery-powered, hand-held instruments made of durable ABS plastic.

Model 3111V features a bright yellow case and an easy-to-read analog display. It measures megohms and low resistance, and indicates voltage. For complete megohm testing, three DC-voltage output ranges of 250, 500, and 1000 VDC are provided, corresponding to 100-, 200-, and 400-megohm ranges, respectively. Those ranges are easily selected from the front panel, and allow the user complete high-voltage high-resistance testing abilities. A

low-resistance range (2-ohms mid scale) is provided for coil measurements and continuity testing. A special live-circuit warning lamp lets the user check for a potentially dangerous live circuit before performing any insulation or low-resistance tests.

Model 3001B features a clear digital display with three auto-ranging insulation-testing ranges (2, 20, and 200 megohms) in two high-voltage DC outputs (500 and 1000

VDC). The instrument automatically selects the correct megohm range to correspond to the user-selected output voltage. Model 3001B also measures low resistance in two ranges (20 and 200 ohms), and indicates the presence of potentially dangerous live voltage with both audible and visual warnings.

Both units feature industry-standard banana terminals, recessed for safety, with shroud-covered banana jacks on the

## If only your broken VCR, Computer or TV...could talk.

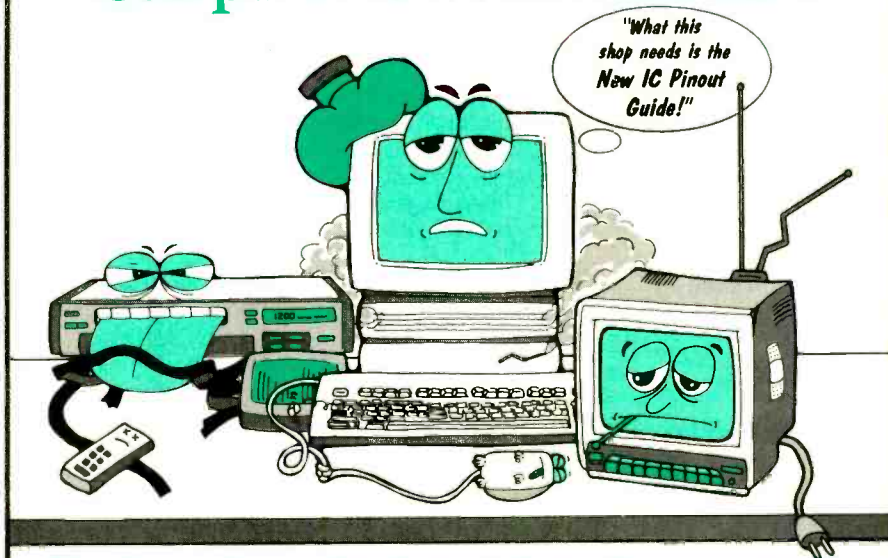

Finally, one book with all the information you need for fast repair jobs. At the very low, introductory price of

**\$99!**

*NEW IC Pinout Guide: Tells you what your broken equipment can't.*

### Complete, Compact, Easy-to-Use

This valuable new repair tool provides • pinout data for over



170,000 ICs currently in use worldwide • package style drawings • IC descriptions • and manufacturer information.

**30-day money-back guarantee.**

### Global Engineering

2805 McGaw Ave., Irvine, CA 92714  
Telephone: **714-261-1455**;  
Toll-free **800-854-7179**

Mail this coupon to: **Global Engineering**,  
2805 McGaw Ave., Irvine, CA 92714

Yes, I want quick answers to my IC replacement questions!  
Send me \_\_\_\_\_ copies of the new IC Pinout Guide!  
*Introductory price applies through November 1990 — ORDER TODAY!*

IC Pinout Guide	List Price	Intro Price	Qty.	Total
	\$149	\$99		
<input type="checkbox"/> Payment enclosed				Subtotal
<input type="checkbox"/> Bill my company				Shipping/Handling (5% of total order)
P.O. No. _____				CA customers add 6.25% tax
				Total

For credit cards, call toll-free 800-854-7179

Company: \_\_\_\_\_  
Name: \_\_\_\_\_  
Title: \_\_\_\_\_ Dept.: \_\_\_\_\_  
Address: \_\_\_\_\_  
City: \_\_\_\_\_ State: \_\_\_\_\_ Zip: \_\_\_\_\_  
Phone: (\_\_\_\_) \_\_\_\_\_  
Signature: \_\_\_\_\_  
*(Required for all orders without purchase order.)* PE110



test leads. Test-lead ends have a large, insulated alligator clip on one and a safety-probe tip on the other. Other features include a lock-down on-off button for continuous insulation testing, automatic discharge of circuit capacitance after insulation testing, a carrying case with neck strap, and 8 "AA" batteries.

Models 3111V and 3001B electrical insulation testers have suggested retail prices of \$199.95 and \$299.95, respectively. For further information, contact Kyoritsu Electrical Instruments Works, Ltd., 62 North Coleman Road, Centereach, NY 11720; Tel. 516-736-0601; Fax 516-732-4650.

**CIRCLE 110 ON FREE INFORMATION CARD**

### MULTI-PLAY CASSETTE DECK

Featuring "CD-deck-synchro" for clean, easy disc-to-tape dubbing, Pioneer's CT-M5R multi-play cassette features Dolby B and C noise reduction and auto-reverse record and playback functions for uninterrupted use. A variety of high-speed functions are also offered: Random play selects tracks from as many as six cassettes, relay play plays up to six tapes consecutively, and cassette scan plays the first 10 seconds of



music on each cassette. In addition, relay recording allows as much as nine hours of material to be recorded from six C-90 cassettes.

CD-deck synchro permits full-function, hands-off recording when used with an equally-equipped Pioneer CD player. When recording from disc to

tape, the CD-deck synchro lets the two units "communicate," causing the tape deck to pause while the CD player searches for the next programmed track. That automatic pause eliminates lengthy gaps between songs and lets users program selections for continuous tapping.

The CT-M5R multi-play cassette deck has a suggested retail price of \$400.00. For more information, contact Pioneer Electronics (USA) Inc., 2265 East 220th Street, P.O. Box 1720, Long Beach, CA 90801-1720; Tel. 213-835-6177.

**CIRCLE 111 ON FREE INFORMATION CARD**

### DUAL-RANGE TEST PROBE

The American-made *Polaris 651* test probe measures both voltage and current. In range one, it measures 40,000 volts DC, and in range two, it measures 0-400 mA DC. The probe is accurate to  $\pm 2\%$  full scale, and has



50- $\mu$ A meter movement. The test probe is 15 inches long and weighs just 12 ounces.

The model 651 dual-range test probe costs \$69.95 plus shipping. For further information, contact Polaris, Division of U.X.L. Corp., 108-02 Otis Avenue, Corona, NY 11368; Tel. 718-271-5200.

**CIRCLE 112 ON FREE INFORMATION CARD**

### FINE-BRAID WITH WATER-SOLUBLE FLUX

*Soder-Wick Fine-Braid* with water-soluble flux, from *Solder Removal Company*, eliminates the need for CFC solvents. The newly-formulated synthetic flux coating, with appropriate pH and holding medium, acts as a

mildly activated flux. Residue is easily removed with de-ionized water and a brush, rather than using CFC solvents.

Fine-Braid is braided with high-purity, fine-gauge strands of pure copper wire in a weave pattern that eliminates waste. It features the lowest possible level of residue impurities on the surface, and no oxides or hydrocarbons are released when heat is applied. Ranging in width from 0.030 inch (Size 1) to



0.210 inch (Size 2), Fine-Braid is available in 5-, 10-, 25-, 50-, 100-, and 500-foot bobbins, with standard or ESD packaging.

Representative prices for Fine-Braid are \$1.80 for a 5-foot bobbin of 0.030-inch braid; \$15.30 for a 50-foot bobbin of 0.080-inch braid, and \$178.00 for a 500-foot bobbin of 0.160-inch braid. For additional information, contact Solder Removal Company, 1077 East Edna Place, Covina, CA 91722; Tel. 800-767-9425; Fax 818-331-9701.

**CIRCLE 113 ON FREE INFORMATION CARD**

### RS-232 COMMERCIAL CONNECTOR KIT

A valuable aid to on-site fabrication and maintenance of RS-232 cable connectors, *Jensen Tools' RS-232 Commercial Connector Kit* can be used to make straight null modem hookups, economical patchcord connections between keyboard and TNC for packet radio, and for many other DB25 patchcord applications. The kit contains 16

plug (male) and 6 receptacle (female) 25-pin connectors, 100 stamped and formed pins and sockets, 50 cable ties, one insertion/extraction tool. Those items are packaged in a compact "Mighty-tuff" plastic storage box. Connector hoods are available separately.

The RS-232 Commercial Connector Kit costs \$69.50. For further information, contact Jensen Tools, Inc., 7815 South 46th Street, Phoenix, AZ 85044; Tel. 602-968-6231.

**CIRCLE 114 ON FREE INFORMATION CARD**

### DIGITAL TROUBLESHOOTING KITS

Designed for field-service and educational use, *Global Specialties' models LTC-6, LTC-7, and LTC-8 TTL- and CMOS-compatible digital logic test kits* each feature the *LM-2A* channel-logic monitor, the *DP-1* logic pulser, the *SQ-1* tone-ohmmeter, and a logic probe. The channel-logic monitor simultaneously displays the static and dynamic states of 16 logic inputs. The pocket-sized DP-1 pulse generator is used to stimulate logic circuits with either a single pulse or a continuous pulse train. The tone-ohmmeter locates bad IC's and circuit



shorts without desoldering parts. Each kit contains a logic probe to find pulses that are too fast even for oscilloscopes: The LTC-6 contains a 10-MHz probe, the LTC-7 has a 35-MHz probe, and the LTC-8 comes with a 100-MHz probe.

The LTC-6, LTC-7, and LTC-8 digital troubleshooting kits range in price from \$299.00 to \$379.00. For more information, contact Global Specialties, 70 Fulton Terrace, New Haven, CT 06512; Tel. 1-800-572-1028. ■

**CIRCLE 115 ON FREE INFORMATION CARD**





# Discover Your Career Potential In The Fast Growing Field Of High-Tech Electronics!

CIE Gives You The Training You Need to *Succeed...*  
At Your Own Pace...& In Your Own Home!

If you're anxious to get ahead...and build a *real* career...you owe it to yourself to find out about the Cleveland Institute of Electronics!

CIE can help you discover *your* career potential in the fast growing field of high-tech electronics. A career that will challenge and excite you every day...reward you with a powerful feeling of personal accomplishment...and deliver a level of financial security you may have only dreamed of before!

As the leading school in home-study electronics, CIE has helped over 150,000 students in the U.S.A. and over 70 foreign countries get started in this exciting field. To find out how CIE could be helping *you*...read on...then send for a CIE catalog TODAY!

## A Growing Need For Trained Professionals!

The career opportunities shown here are only a few of the challenging, high-paying careers you could enjoy as an electronics technician.

You could be the "brains" behind the scenes of an exciting TV broadcast...trouble-shoot life-saving medical equipment...design exotic new aeronautics systems...CIE's job-oriented programs offer you the quickest possible path to the career of your dreams! And CIE also features military and union re-training, to build on what you already know.

## Dozens Of Fascinating Careers To Choose From!

Even if you aren't sure which career is best for you, CIE can get you started with core lessons applicable to *all* areas of electronics. As you advance, CIE makes job opportunities available to you through the bimonthly school paper, *The Electron*.



Data Communications



Automotive Electronics



Avionics

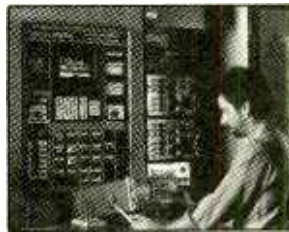

Computer-Assisted Manufacturing



Consumer Electronics



Military Electronics

## Personal Training From A Renowned Faculty.

Unlike the impersonal approach of large classroom study, CIE offers you one-on-one instructional help 6 days a week, toll-free. Each CIE lesson is authored by an independent specialist, backed by CIE instructors who work directly with you to answer your questions and provide technical assistance when you need it.

## Practical Training... At Your Own Pace.

Through CIE, you can train for your new career while you keep your present job. Each course allows a generous completion time, and there are no limitations on how fast you can study. Should you already have some electronics experience, CIE offers several courses which start at the intermediate level.

## "State-Of-The-Art" Facilities & Equipment.

In 1969, CIE pioneered the first electronics laboratory course, and in 1984, the first Microprocessor Laboratory. Today, no other home study school can match CIE's state-of-the-art equipment. And all your laboratory equipment is included in your tuition cost. There is no extra charge—it's yours to use while you study at home and on the job after you complete your course!

## Earn Your Degree To Become A Professional In Electronics!

Every CIE course you take earns you credit towards the completion of your Associate in Applied Science Degree, so you can work towards your degree in stages. And CIE is the only school that awards you for fast study, which can save you thousands of dollars in obtaining the same electronics education found in four-year Bachelor's Degree programs!

## Send For Your Catalog Today!



### CIE World Headquarters

Cleveland Institute of Electronics, Inc.  
1776 East 17th St., Cleveland, Ohio 44114

**YES!** Please send me your independent study catalog (For your convenience, CIE will have a representative contact you—there is no obligation.)

Print Name \_\_\_\_\_

Address \_\_\_\_\_ Apt # \_\_\_\_\_

City/State/Zip \_\_\_\_\_

Age \_\_\_\_\_ Area Code/Phone No. \_\_\_\_\_

Check box for G.I. Bill bulletin on educational benefits:  Veteran  Active Duty

**Mail This Coupon Today!** AHO-156

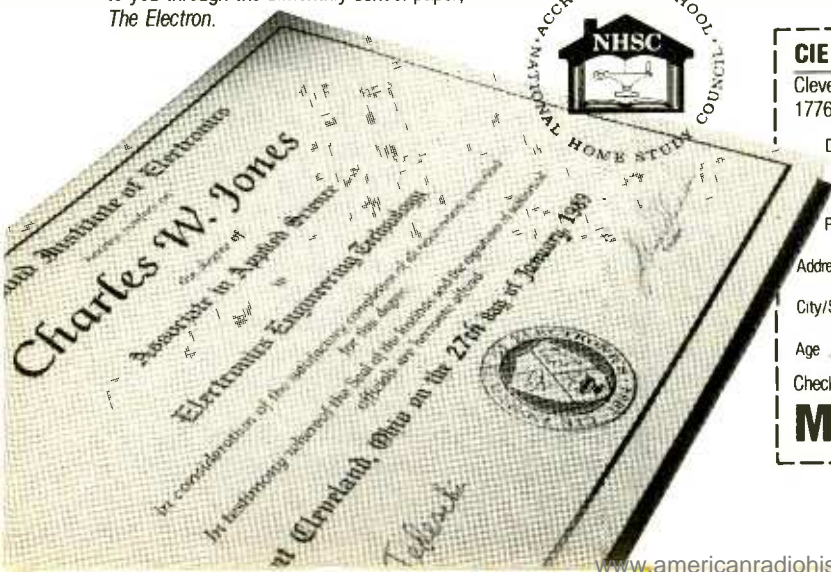

# THINK TANK

By Byron G. Wels, K2AVB

## Protecting Your Idea

From where I sit, I see many new and useful circuits come across my desk, many of which show some promise as marketable items. As most of us know, the circuits could be patented and protected, and introduced to the market to provide some big bucks to the creators. We

printed copy of the magazine away. If anybody tried to steal my idea, I not only had "proof of prior published art"—a very weighty argument in court cases—but the magazine and its contents are copyrighted by the publisher. I'm sure the publisher (who is in the publishing business, not

magazine's copyright. Take another look at your circuit or device. Is it something others might like to have? Should you be advertising it in our classified section? Hey! There's something else, too. If we accept your idea, you'll get a free copy of the Think Tank book!

Those of you who've been reading this column for some time, know that I'm also a magician. I just recently found a piece of magical apparatus that I built and sold many years ago, and I thought that I might share it with you. It's a lot of fun!

It all started when Tony Spina, President of Tannen's Magic Company complained that the price of electronic equipment has sky-rocketed, and the guy who used to build a certain trick for him could no longer afford to do it. It consisted of a black plastic box with three pushbutton switches and a small light bulb on the cover. If you pressed the switches in the right sequence, the lamp would light. Big deal! I took the thing home and studied it. Then I came up with my own version.

I had three switches (connected to nothing!) and a lamp on the cover. I could press the switches in any order and make the lamp light. I'd give the unit to someone, and that person would press whatever switches he or she wanted in whatever order, and nothing would happen. I could make the lamp light by pressing only one switch! Magicians who were familiar with the old unit used to go nuts.

Here's the secret: Inside the box, cemented near

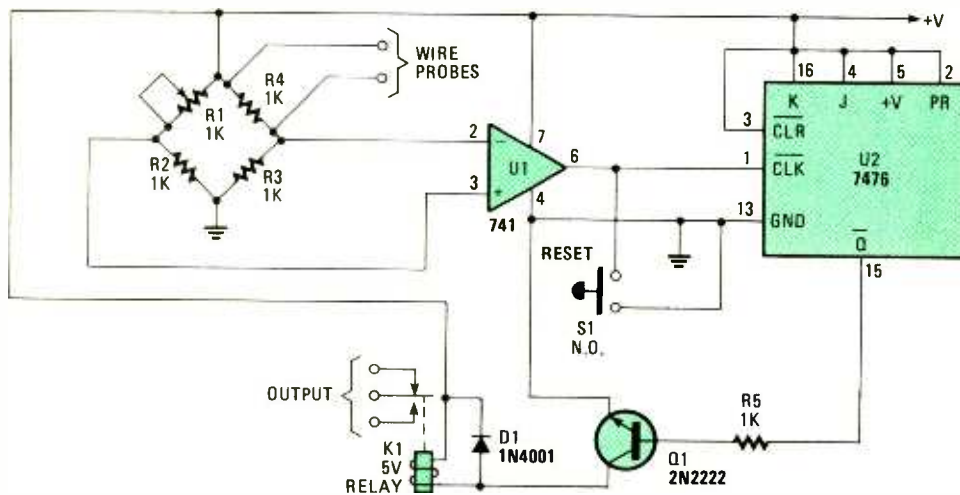

Fig. 1. The Latching Water Sensor is little more than a balanced Wheatstone bridge, feeding a differential amplifier. The amplifier output triggers a JK flip-flop, which in turn forward biases a general-purpose transistor, thereby activating a relay.

also know that obtaining a patent is a long, drawn-out, and very expensive procedure involving lawyers.

A few years ago, the patent office established a method where you could register a new invention without actually going through the entire patent procedure. A date would be established for the registration, and that would provide some measure of protection for your idea.

I've always used a different method: When I came up with a new idea, I'd sell it to an electronics magazine. If it was worthy, they'd publish it, along with schematic diagrams, photos, etc. I'd then store the

manufacturing) would be willing to release the copyright for my own idea back to me for a token fee.

Another idea (again, I don't know what the legal involvements are here) was to write up a description of your idea and mail it to yourself via certified mail, return receipt requested. Save the sealed envelope until it's needed.

Understand that I'm not a patent attorney, and I'm not quite sure about how valid all of this might be. The reason that I'm telling you all of this, is that the next time you send a new circuit to Think Tank, it will give you proof of prior published art, and the protection of the



one edge, was a small magnetic reed switch that was connected to a battery and the lamp. I wore a ring; taped on the palm side of the ring was a small Alnico V magnet. Hold the magnet near the edge with the reed switch, and the lamp would light!

### LATCHING WATER SENSOR

This circuit (see Fig. 1) senses a water level by detecting a change in resistance at the probe tips. Resistors R1-R4 form a balanced Wheatstone bridge. Resistor R1 is used to slightly shift the balance so that the voltage seen on pin 3 of U1 is positive with respect to pin 2. When no conductive liquid is present, the circuit stays in an "idle" condition.

When conductivity takes place in the wire probes, R4's value is effectively re-

duced, causing the voltages to reverse polarity. That causes the differential amplifier (U1) to conduct and a logic 1 is seen at pin 6. That pulse is then sent to pin 3 of U2. A clock to the toggle flip-flop is emitted. The flip-flop toggles and latches the signal, turning on Q1, which in turn activates relay K1.

The outputs of this circuit are the normally closed and normally open outputs of K1, so that pumps, lights, or whatever, can be switched either on or off. This circuit could be used as a fill-level monitor, such as used in a swimming-pool sensor or could be used to activate a sump pump in a basement. My own use for the circuit was to automatically activate my windshield wipers when rain was sensed.

The entire circuit can be build on perfboard, since

component layout isn't critical. The wire probes can be any stranded or solid copper wire that has been stripped and tinned 1 inch, and placed as far apart as needed to accurately sense the moisture. More than one sensor pair can be used in parallel to check on multiple containers. To reset the circuit, just press S1 and release.

Well, that's it. I hope your readers can get some good value out of it!

—Alan Bean, East Ridge, TN

*Alan, that's for sure a handy-dandy! Your Think Tank book is on the way, and I hope you will enjoy it as much as our readers are going to like your offering. Thanks!*

### NEW POWER SUPPLY

I got sick and tired of seeing all those magazine pages wasted on "new

power supplies." The fact of the matter is that if you can afford to buy a new bench supply, please do so. Don't kill yourself trying to build one. If you need a special supply to meet special requirements, don't risk frying your equipment with a home-brew job. And if you need a one amp or less, fixed voltage, use the famous 78xx and 79xx series of regulators.

If you can't afford to purchase a communications-quality unit for that special need, build one using an LM317 regulator. If you need the most economical and smallest fixed or adjustable supply, see Fig. 2. This is simply an emitter-follower circuit using a Darlington-transistor configuration to lower the current flowing into the base that would cause non-linearities in the voltage when applying a load to  $V_{out}$ .

# Train at Home to be an Electronics Technician!

Professional training and equipment can help you qualify for a dynamic, high-paying career in your spare time.

As the demand for computers and microprocessors in business and manufacturing continues to grow, so does the need for qualified technicians. It's not unusual for experienced technicians to earn from \$35,000 to more than \$40,000 a year.\* Now there's a way you can train for this exciting field without interrupting your job or home life.

### Choose From These Programs of Study

- Electronics & Microprocessor Technology
- Industrial Electronics & Microprocessor Technology
- Computer Servicing & Electronics Technology
- Specialized Associate Degree In Electronics Technology

### You Get Professional Equipment For Professional Training

Depending on the program you select, you'll perfect your skills using this advanced equipment, included in the price of tuition:

- IBM-Compatible Personal Computer
- Digital Multimeter
- Digital Logic Probe
- Elenco Oscilloscope

### Exclusive Extras That Enhance Your Training

Peoples College introduces some training firsts to make your learning experience more complete:

- Accelerated Learning System — a scientifically proven study system that lets you learn faster and easier than ever before.
- Optional One-Week Seminar — available with our advanced programs. Conducted on our campus near Orlando, Fla. Not required for graduation, but a valuable opportunity to fine tune your skills with personal guidance.
- Video Tutor Training Tapes — give you a permanent, visual record of informative lectures and close-up demonstrations.
- Experience Labs — professionally designed experiments that give you hands-on "bench" experience.
- Industry Certification Training Guide — provided with three of our programs. Gives you first-hand insight into the examination you may take for your professional license.



For COLOR CATALOG Mail Coupon or Call TOLL FREE

1-800-765-7247

Programs offered only in United States, Canada, Puerto Rico and Virgin Islands. No Obligation. No sales person will call.

Our programs are accredited by the Accrediting Commission of the National Home Study Council

YES! I would like to know more about your training programs. Send a catalog to:

Name \_\_\_\_\_  
 Address \_\_\_\_\_  
 City \_\_\_\_\_  
 State \_\_\_\_\_ Zip \_\_\_\_\_

**PEOPLES COLLEGE**  
 OF INDEPENDENT STUDIES  
 233 Academy Drive • P.O. Box 421768  
 Kissimmee, FL 34742-1768  
Member, D.L. Peoples Group P1190

\* Source: U.S. Bureau of Labor Statistics

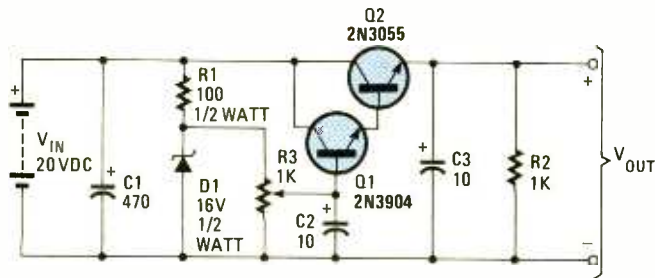

Fig. 2. This power-supply circuit is built around a pair of power transistors connected in a Darlington configuration, with a Zener diode providing a DC reference for potentiometer R3, which varies the Q1's base bias, which in turn varies the circuit's output voltage.

The Zener diode produces a stable DC reference for the potentiometer (R3) that regulates the DC output voltage. ( $V_{out} = V_{ZENER} - 2V_{be}$ ). Make sure to heat sink the 2N3055, and please use a more powerful transistor if the load/input voltage exceeds the maximum-operating parameters for the 2N3055 ( $(V_{in} - V_{out}) \times I_{max} = 115W$  or  $I_{max} = 15A$ ).

Please excuse the rudeness of these lines, but I'd really prefer to see more in the way of new projects than the same old rehash!

—Frank Angelli, Miami, FL

Okay Frank! Your contribution is an excellent one, and I'm inclined to agree with you (partially). We're sending you a Think Tank book, which should satisfy your demand for more variety.

## BACK-UP ALARM

Most home-brew alarms of this type are either too complex, or they have no means to cut the alarm off when not needed. And most start with an audio oscillator feeding some sort of loudspeaker. My version uses just five components (not counting the car) And using a Mallory Sonalert solves the oscillator/speaker problem.

The Sonalerts come in two types: Pulsating or non-pulsating. They operate on 3 to 28 volts, need very little current, are weather proof, are ready to mount, and there are many clones that can save you some additional bucks.

Most people use the back-up light circuit so that whenever the vehicle is put in reverse, the alarm sounds. My solution (see Fig. 3) uses the brake lights to trigger the alarm on and off. If you do not want the alarm to sound, just go forward or put the car in neutral and tap the brake.

Power for the system comes from the back-up lights. Resistor R1 connects to the positive side of the brake lights. With the reverse lights on, the system is ready to go. When you touch the brakes, a positive pulse is passed through R1 to the gate of a low-current SCR, which then turns on the Sonalert. Resistor R2 keeps the gate of the SCR at ground potential until it is triggered by the positive pulse. Resistor R3 applies a

minimum load on the SCR to make sure it conducts. You could also use more than one Sonalert in parallel which would increase the volume.

I built my unit on per-board using point-to-point wiring. The system is best placed in the car's trunk, where all connections are made. You can secure the unit with tape to a convenient wiring bundle so it doesn't flop around.

—R.C. Cable, Austin, TX

Nice circuit R.C. And handy, too. I'm sure that a lot of our readers are going to be putting this one together. We sent a Think Tank book to you today.

## ON/OFF SWITCH

This circuit is really a fancy add-on for other circuits. See Fig. 4. It uses half of a 4013 dual D-type flip-flop and a 2N2222 general-purpose transistor, accompanied by a handful of support components. Capacitor C2 and resistor R4 provide some measure of noise suppression. Pressing switch S1 gives a clock pulse, which applies the data to the output (Q1). Then the  $\bar{Q}$  output is ready to switch the output at the next clock pulse. The  $\bar{Q}$  output turns on Q1, the 2N2222, which causes LED1 to light.

It's not very complex, but the addition of the LED and a pushbutton on-off circuit can really jazz up almost any project. I've used it many times, and it sort of

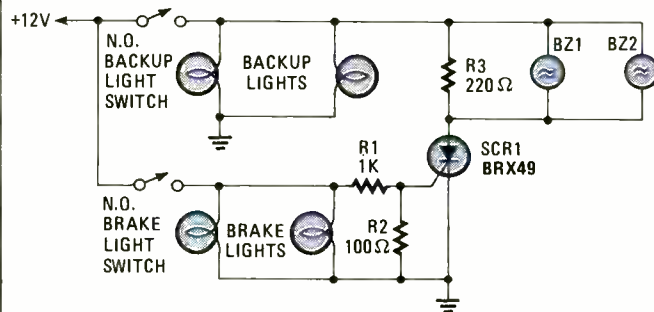

Fig. 3. The Back-Up Alarm uses the brake lights to trigger the alarm on and off.

////// Protel Easytrax®

## Outstanding value in Printed Circuit Board/CAD

Protel Easytrax is a new, low-cost design package for PC and Macintosh users that includes everything required to produce professional quality Printed Circuit Board artwork.

Our easy-to-learn menu-driven design system breaks the 'expert barrier' - you'll be designing in minutes, not hours.

Our comprehensive tutorials guide you through the program's extensive features that take the tedium out of board layout.

When we say professional - we mean through-hole component boards of up to 32 x 32 inches with 6 signal layers plus ground and power planes. A fully independent printplot program is included which supports standard plotters, dot matrix and laser printers, Gerber® photoplotting and NIC drill tapes.

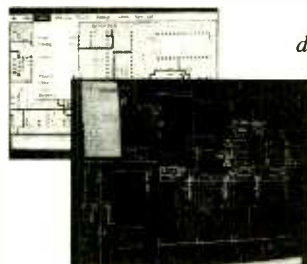

**ONLY \$395**

Easytrax can be run on your PC or Mac!

CALL TOLL FREE (800) 544-4186

for complete specs and FREE evaluation disks.



50 AIRPORT PARKWAY, SAN JOSE, CA 95110, USA (408) 437-7771, FAX (408) 437-4913

CIRCLE 14 ON FREE INFORMATION CARD



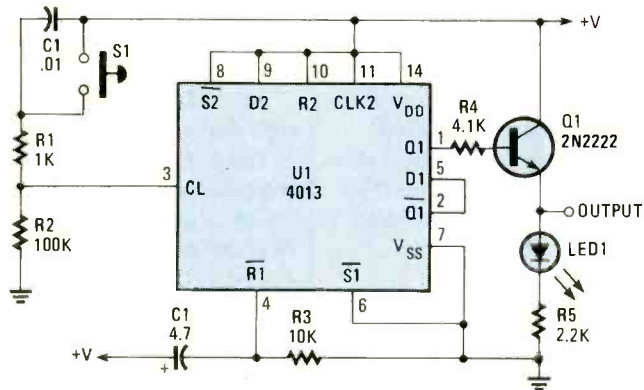

Fig. 4. This simple On/Off Switch consists of a 4013 dual D-type flip-flop and a 2N2222 general-purpose transistor, accompanied by a handful of support components.

adds a nice finishing touch.  
—Rick Holland, Roseburg, OR

Short and sweet, Rick. Readers, make a mental note about this one, and add it to your next project. And Rick, there's a Think Tank book on the way to you now.

### SATELLITE SWITCHER

I wanted to listen to my satellite TV in stereo. I know all of the movie services are in stereo and some channels offer a separate audio mode (SAP) in a second language. It is usually transmitted on 6.8 MHz, which is the frequency used for unscrambled channels.

See Fig. 5. Since my TV set and my satellite receiver

are not ready for receiving stereo or SAP, I took advantage of my satellite descrambler, which is. I also learned that the audio in the scrambled channels is transmitted along with the picture, so when the descrambler descrambles the signal, it also descrambles the audio in stereo. When the channel offers SAP, you'll find it on 6.8 MHz.

The switches are a pair of DPDT switches with the toggle handles tied together. In one position, you hear the audio in stereo and in the other position, you hear the SAP. Just turn down the volume level on the TV and you can connect it to a stereo amplifier and a pair of speakers.

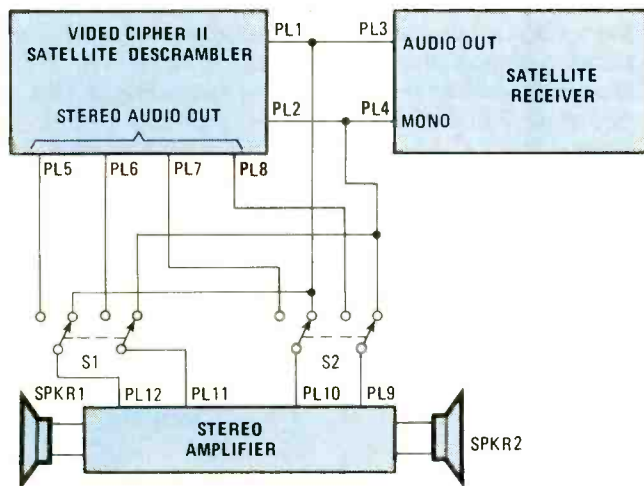

Fig. 5. This simple switching arrangement takes advantage of a satellite descrambler that can decode stereo or SAP to enhance the audio portion of video programming by feeding the audio to a stereo amplifier.

Courteous Service • Discount Prices • Fast Shipping

# ALL ELECTRONICS

P.O. Box 567 • Van Nuys, CA 91408

### 12 Vdc 5 AMP POWER SUPPLY

ACDC Electronics# 12N5 or equiv. Input: 100-240 Vac (wired for 115 Vac) Output: 12 Vdc @ 5 amps. Open frame power supply. 7" X 4 3/4" X 3" high. Regulated. CAT# PS-125 \$37.50 each



### 210 MFD 330 VOLT PHOTOFLASH CAPACITOR

Rubicon CE photoflash capacitor. 0.79" dia. X 1.1" high. These are new capacitors that have been prepped with 1.4" black and red wire leads soldered to the terminals. CAT# PPC-210 \$2.50 each • 10 for \$22.50 • 100 for \$200.00 Large quantities available. Call for pricing.



### FLASHER LED

Diffused L.E.D. with built in flashing unit. PULSE RATE: 3 Hz @ 5 Volt/20 ma. Unit continually flashes when 5 Volts is applied. Operates between 4.5 Volts and 5.5 Volts. T 1 3/4 size.

IDEAL FOR USE AS AN INDICATOR.

RED CAT# LED-4  
GREEN CAT# LED-4G  
YELLOW CAT# LED-4Y  
\$1.00 each • 10 for 9.50 • 100 for \$90.00



### REFLECTIVE OPTO SENSORS

These units have an IR emitter and sensor pair pointing in the same direction. Light from emitter bounces off object to be detected by sensor. Effective range approx. 0.15". Three types available:

TRW/ Optron# OPB5447-2  
Rectangular w/ 28" wire leads  
CAT# OSR-4 2 for \$1.00



TRW/ Optron# OPB703A  
Wedge shape with PC pins.  
CAT# OSR-3 75¢ each

TRW/ Optron# OPB711  
Rectangular with PC pins.  
CAT# OSR-2 75¢ each



Oplek# K-8711  
Wedge shaped device  
CAT# OSR-1 75¢ each

### RG 11/U 75 OHM VIDEO CABLE

Ivory RG 11/U terminated with heavy-duty F connectors.

Also includes a F-61 splicer and a 75 ohm terminator load. New cables manufactured for IBM pc networks. UL listed. Specs: 75 ohm impedance. Cable jacket O.D. 0.405". Dielectric 0.285" dia. Center conductor 0.047" diameter. IBM P/N 1501908 COM/SCOPE. CAT# RG-11-1 100 foot roll \$15.00 CAT# RG-11-2 200 foot roll \$27.50



### TOLL FREE ORDER LINES 1-800-826-5432

CHARGE ORDERS to Visa, MasterCard or Discover

TERMS: Minimum order \$10.00. Shipping and handling for the 48 continental U.S.A. \$3.50 per order. All others including AK, HI, PR or Canada must pay full shipping. All orders delivered in CALIFORNIA must include state sales tax (6 1/4 %, 6 3/4 %, 7 1/4 %). Quantities Limited. NO C.O.D. Prices subject to change without notice.

Call Toll Free, or clip this coupon

FREE 60 Page Catalog  
Containing over 4,000 ITEMS  
**ALL ELECTRONICS CORP.**  
P.O. Box 567 • Van Nuys, CA • 91408

Name \_\_\_\_\_

Address \_\_\_\_\_

City \_\_\_\_\_

State \_\_\_\_\_

Zip \_\_\_\_\_

PE 10/90

CIRCLE 10 ON FREE INFORMATION CARD

Put Professional Knowledge and a  
**COLLEGE DEGREE**  
 in your Technical Career through  
**HOME STUDY**

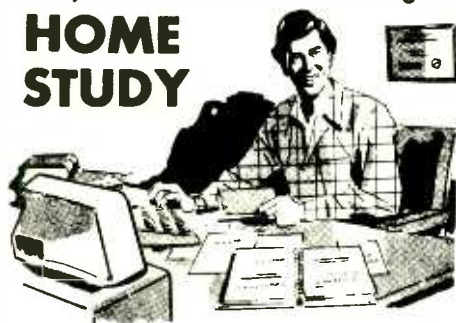

Add prestige and earning power to your technical career by earning your Associate or Bachelor degree through directed home study.

Grantham College of Engineering awards accredited degrees in **electronics and computers.**

An important part of being prepared to *move up* is holding the right college degree, and the absolutely necessary part is knowing your field. Grantham can help you both ways—to learn more and to earn your degree in the process.

Grantham offers two degree programs—one with major emphasis in **electronics**, the other with major emphasis in **computers**. Associate and bachelor degrees are awarded in each program, and both programs are available completely by correspondence.

No commuting to class. Study at your own pace, while continuing on your present job. Learn from easy-to-understand lessons, with help from your Grantham instructors when you need it.

Write for our free catalog (see address below), or phone us at toll-free 1-800-955-2527 (for catalog requests only) and ask for our "degree catalog."

Accredited by  
 the Accrediting Commission of the  
 National Home Study Council

**GRANTHAM**  
 College of Engineering  
 250 Frontage Road  
 Slidell, LA 70460

—Solaummon Romano,  
 Jalisco, Mexico  
 Readers, Solaummon is 15 years old, and has been after a Fips book. Sorry, we're all out of those. I do hope you'll enjoy the Think Tank book, which we sent you instead!

**TELEPHONE PRIVACY**

I live with my parents and to guarantee my phone privacy, I hooked all telephone extensions (except mine) to an extension silencer circuit. My privacy is thereby guaranteed when I'm talking. However, if I pick up my extension when my parents are on the line, they get "silenced" right off the line! To remedy the problem, I designed a phone-line-busy indicator.

See Fig. 6. When all the extensions are on hook, or not in use, there's about +48 volts on the line. (Mine is actually 44.8 volts.) Resistors R1 and R2 divide the voltage to about +8 volts at pin 3 of U1 (a 741 op-amp). Since +8 volts is greater than the +5 volt reference at pin 2 U1, the op-amp goes into positive saturation and conducts, causing the green LED in LED1 to light, indicating "okay to use."

When a phone is off-hook or in use, the phone line voltage drops (depending on your phone's impedance) and the voltage at pin 3 of the 741 drops below the +5-volt reference at pin 2 of the 741. The op-amp goes into

negative saturation and the red LED comes on to indicate an in-use status.

You may have to play with the values of R1 and R2 to adjust for variations in telephone impedance. And oh yes ... one final note. Do NOT use an earth ground on this circuit. Trust me. And have fun!

—Dan Rieskamp, Cincinnati, OH

Interesting, Dan! You've solved a problem-solver's problem. I'm sure that a lot of our readers may have the same problem, and will surely apply your solution. You just cost the company another Think Tank book!

**TWO-WIRE 3-WAY SWITCH**

I guess this is another "Helps & Hints." I lived in a place that had lights along a trail leading to a detached garage. The switches were in the garage and at the top of a flight of outside stairs. I wanted a switch at the bottom of the stairs as well. Unfortunately, the conduit between the two lower switch locations was so full of wires that there was only just enough room for two more! Such circuits usually require three wires, so I devised the circuit shown in Fig. 7, which only needs two wires between the switches to do the job.

The trick here is to take power from two sources, but this is not a problem. Most garages today are furnished with power, the

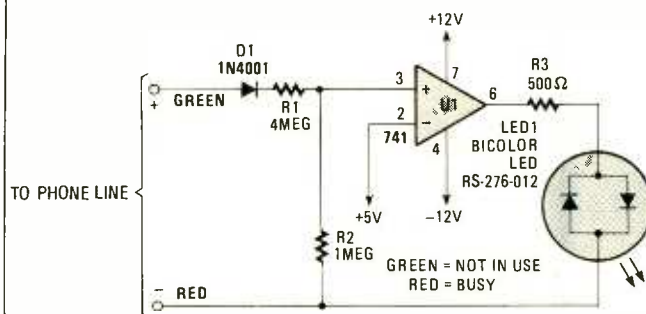

Fig. 6. This extension-silencer circuit light is green when the phone is not in used and red when it is.



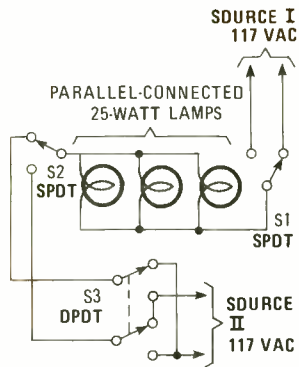

Fig. 7. The Two-Wire 3-Way Switch is a rather unusual approach to a very common problem, wherein two power sources are used to light a single set of lamps.

same as the houses are. Be sure that power source I and II are on the same side of the transformer or there will be times when a switch will toggle between 110 and 220 volts instead of off and on (neither you nor the switches will be happy if that happens). This can be determined by using an AC voltmeter. Switches S1 and S2 are called "3-Way" switches and S3 is a 4-way switch, available at most hardware stores or electrical shops.

—William G. Duggin, Lake Charles, LA

Bill, a lot of readers are going to clip 'n' save this one. It's the kind of thing that you may not need right now, but surely will want some day. Saving this circuit can save a lot of head scratching when the time comes! Hope you enjoy the book.

### ALIGNMENT SCREWDRIVER

Let's finish off for this month with another "Helps 'n' Hints" from one of our faithful readers:

As you probably are aware, sensitive transmitters often require tune up with a plastic screwdriver. Any metal drivers might add hand capacity preventing a proper tuning.

When you buy such a

transmitter, you always get a small (actually teensy-weensy) plastic screwdriver, which always seems to get promptly lost. To replace these screwdrivers, I save the small plastic swords that are served with drinks, usually with a cherry impaled on the blade.

Drink the drink, eat the cherry, and pocket the sword. With a bit of judi-

cious grinding to form a screwdriver tip on the sword, you can use it easily as a tuning tool.

—Mike Giamportone, Yale, MI

Readers, Mike even taped a typical sword to the page with this "Helps 'n' Hints" as a visual aid. No drink, no cherry, just the sword. Okay Mike, you owe me one!

We still need your favorite circuits, but please make sure all component values and part numbers are included. I've got your Think Tank book waiting. Send them as well as your "Hints 'n' Helps," to Think Tank, **Popular Electronics**, 500-B Bi-County Blvd., Farmingdale, NY 11735. We hope to see everyone here again next month. ■

# Lindsay's Electrical Books

## STRANGE BOOKS!

If you haven't received your copy of Lindsay's Electrical Books catalog, you've really missed something! You'll find one of the most bizarre collections of paperbacks, pamphlets, industrial references on incredible plans, lost secrets, forgotten events, and strange theories ever assembled!

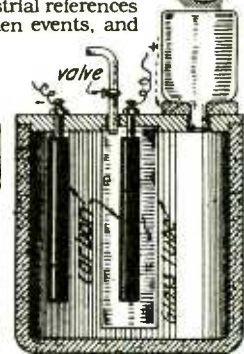
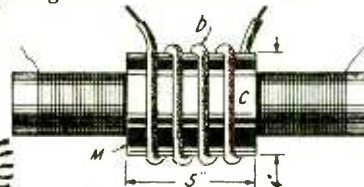
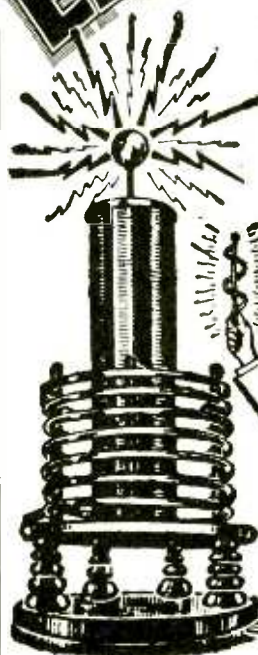

### Fantastic Tesla Books!

Explore one of the finest collections of quality Tesla books available, including both new books and reprints of very old, rare publications. Discover a new booklet on Tesla's lost inventions, a 1904 book on Tesla's experiments with wireless power transmission, rare and unusual books on the construction and use of high voltage Tesla coils, and much more! Highest quality guaranteed!

## Build Lightning Bolt Generators!

Build a Wimshurst, Holtz, or Winter static electric machine! Build condensing electroscopes, Leyden Jars, scintillating tubes, electrical cannons, Cavallo's cylinder machine and much more! Explore the high voltage equipment used in early wireless radio! Build induction coils, spark gaps, and more! Discover the secrets of early high performance shortwave radios, and even the design and construction of motors and generators!

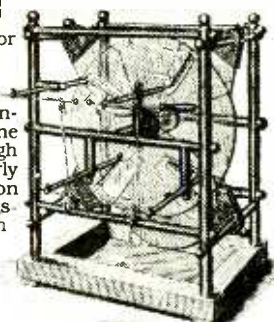

## Strange Science!

You'll even discover a strange collection of books on "Fringe Science" — lost continents, perpetual motion, unusual phenomena recorded throughout the centuries, and much more. Explore the strange world that lies between fact and fiction!

## Write for CATALOG!

Write for your copy of Lindsay's new Electrical Books catalog and see for yourself what you've been missing! Send \$1.00 (US & Canada) or \$3.00 foreign airmail. We'll send your catalog immediately! Write today!



## Lindsay's Electrical Books

PO Box 583-WF9, Manteno IL 60950

Enclosed is \$1.00. Send me a copy of Lindsay's Electrical Books catalog via first class mail!

Name \_\_\_\_\_  
 Address \_\_\_\_\_  
 City \_\_\_\_\_ St \_\_\_\_\_ Zip \_\_\_\_\_

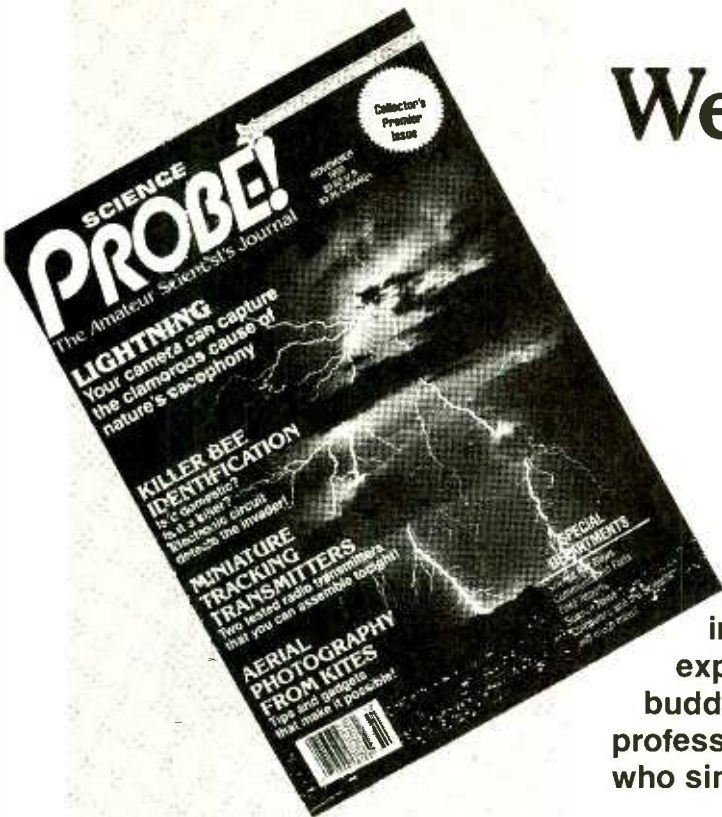

Welcome to. . .

# SCIENCE PROBE!®

The Amateur Scientist's Journal

Embark on an irresistible new journey into the realm of mystery, challenge, and exploration! The perfect magazine for the budding scientist, the serious amateur, the professional who would like to relax, and those who simply want to gaze at the stars.

**SCIENCE PROBE!** — the *only* magazine devoted entirely to Amateur Scientists! If you are fascinated by science in all its many forms . . . if you can't stay away from a microscope, telescope, calipers, or test tube — we invite you to share the wonders in every issue of **SCIENCE PROBE!** You will join a community of Amateur and Student Scientists who enthusiastically seek scientific knowledge or follow scientific pursuits for their own sakes and not merely as a profession.

Obtain your personal *premier* edition of **SCIENCE PROBE!** by visiting a quality Newsstand, Convenience Store, or Supermarket this Fall or by reserving your personal copy through the mail by completing the coupon below.

From the very first issue of **SCIENCE PROBE!** you will be involved in a world of scientific facts, experiments, and studies pursued by amateur scientists who are university students, inventors, academicians, engineers, or office workers, salesmen, farmers—whose *quest* is to probe into the mysteries of science and reveal them to all.

Plan to become a **SCIENCE PROBE!** reader!

Articles to appear in early issues of **SCIENCE PROBE!** are:

- LIGHTNING—CAPTURE IT ON FILM**
- MONITORING ULTRAVIOLET FROM THE SUN**
- MOBILE-MOUNT EXPERIMENTAL WIND TUNNEL**
- CHECKING OUT ACID RAIN**
- AERIAL PHOTOGRAPHY FROM KITES AND BALLOONS**
- MINIATURE TRACKING TRANSMITTER**
- KILLER BEE IDENTIFICATION**
- HOW TO OBTAIN ANIMAL EYESHINE PHOTOGRAPHS**

If you're fascinated by science in all its many forms, if you are compelled to experiment and explore, then **SCIENCE PROBE!** is your kind of magazine!

<b>SCIENCE PROBE!</b>	<b>7PEL7</b>
500-B Bi-County Boulevard Farmingdale, NY 11735	
Please forward my Premier Edition of <b>SCIENCE PROBE!</b> as soon as it comes off the press. I am enclosing \$3.50-U.S.A. (\$3.95-Canada) plus \$1.00 for shipping and handling. Better still, please enroll me as a charter-member subscriber and send the next four (4) quarterly issues of <i>Science Probe</i> . I am enclosing \$9.95-U.S.A. (Canada: \$14.95 U.S.A. Funds)	
<input type="checkbox"/> Premier Edition only <input type="checkbox"/> First Four Issues (1 Year)	
Offers valid in the U.S.A. and Canada only. No foreign orders.	
Name _____	
Address _____	
City _____ State _____ ZIP _____	
All Orders payable in U.S.A. Funds only.	

**ON SALE AT QUALITY NEWSSTANDS, CONVENIENCE STORES AND SUPERMARKETS  
STARTING SEPTEMBER 13, 1990 — \$3.50-U.S.A. — \$3.95-Canada**



If you have an IBM PC or PC-compatible computer and a shortwave radio, you can plug into the intriguing world of non-voice transmissions on the shortwave bands. Those transmissions include radioteletype (RTTY), Morse code, and perhaps the most interesting of the lot, facsimile (fax). Of the fax transmissions, weather maps are the most interesting and useful, particularly if you are in a remote rural area or at sea. Facsimile is also how news-gathering agencies around the world send photos to their clients. Seeing the photos that will appear on tomorrow's front pages in "real time" can be breathtaking.

Weather faxes can take many different forms. We have plotted maps giving the conventional isobars with lows and highs, just as shown on nightly TV news programs. We have also received cloud maps (nephanalysis), also as seen on TV weather reports, as well as charts of wind wave and swell height, which are not shown on TV, and could be very useful if you were at sea in a small boat!

Regardless of whether maps are shown on TV or not, the attraction of being able to decode your own is that you get them as soon as they are transmitted. And of course, the Radfax lets you decode RTTY and Morse transmissions as well.

**FSK Transmissions.** Both fax and RTTY transmissions use the FSK principle. FSK stands for "frequency-shift keying" and refers to a system whereby the modulation on a radio transmission is continually switched or "keyed" between two frequencies such as 2400 Hz and 1200 Hz. The rate of switching sets the "baud," which is an old telegraphic term that means bits/second.

Typical nominal rates for RTTY are around 75 baud (bits/sec.) while typical rates for fax transmissions are 1200, 600, and 300 baud. As for Morse—well, Morse is pretty slow. Decoding FSK transmissions does not take a lot of circuitry but it does require some software to allow the computer to turn the decoded dig-

*Got a computer and a shortwave receiver? Why not link the two together and get up-to-the-minute weather charts, read overseas radioteletype, or eavesdrop on Morse transmissions*

BY JOHN CLARKE

# Build The RADFAX Decoder

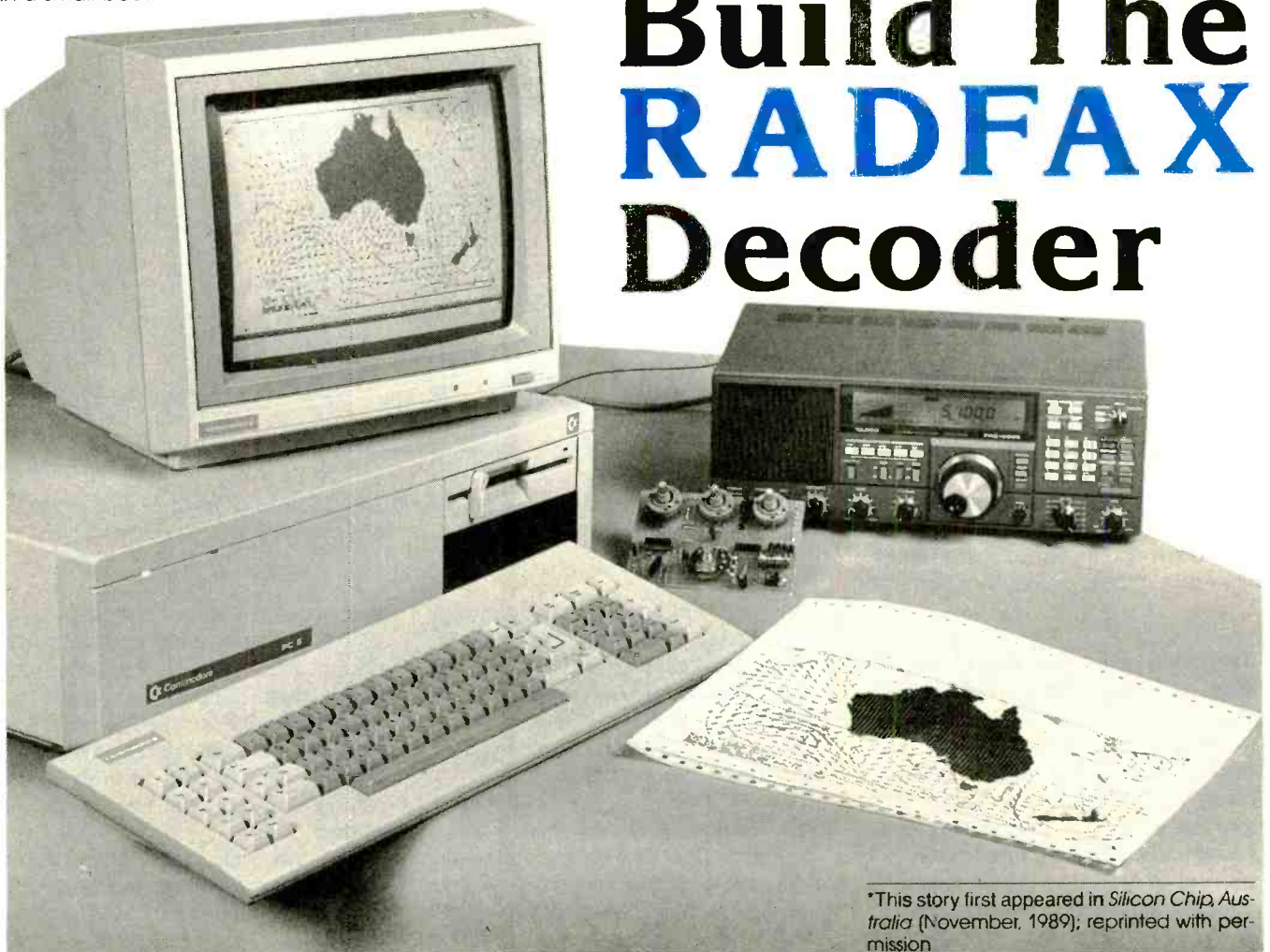

\*This story first appeared in *Silicon Chip, Australia* (November, 1989); reprinted with permission



Here is how the fax transmission appears on screen. Once the transmission has been completed, the picture can be saved to disk, and printed out on an IBM or Epson compatible printer.

ital data into something intelligible that can be displayed on the screen or printed out on a dot matrix printer.

We have designed the Radfax Decoder to take advantage of a commercial software package called *Radfax 2*, written by Michael Delahunty. Although the software is only available directly from the author, it is reasonably priced and easy to use; see the Parts List for ordering information.

**The Hardware.** Okay, let's be specific about the hardware you need if you want to get into the world of fax and RTTY. First, as already stated, you need an IBM PC XT or compatible computer with a CGA or EGA monitor. There is also a version of the software designed to work with a monochrome Hercules Graphics card. The program requires at least 256K of RAM and it will not work if you attempt to use it in conjunction with memory resident programs such as Sidekick. That's easily fixed by booting up the computer just with *Radfax 2*.

If you want to print out weather maps and other information received via fax or RTTY transmissions, you'll need an IBM- or Epson-compatible printer. The *Radfax 2* software is rather clever in that it allows you to print out faxes sideways. That not only gives larger printouts, but provides much more detail than is possible with smaller printouts or from the screen.

**The Shortwave Receiver.** The FSK tones for fax and RTTY can only properly be received on a radio that's designed for picking up SSB (single sideband) transmissions. That means that you need a good quality shortwave radio that has either a BFO (beat-frequency oscillator, which is normally used for picking up Morse) or an SSB switch for selecting USB (upper sideband) or LSB (lower sideband).

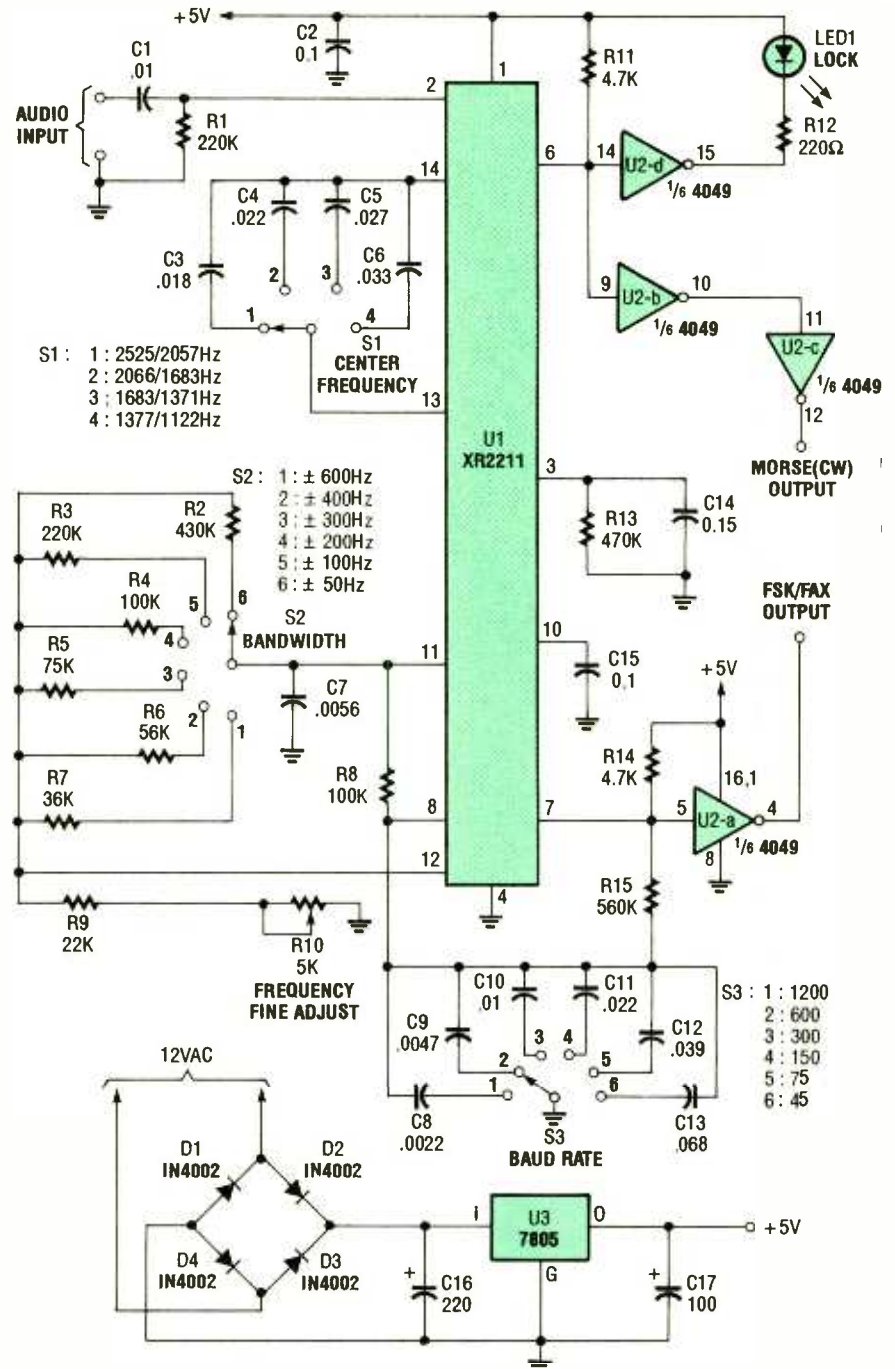

Fig. 1. The Radfax Decoder is based on an XR2211 FSK demodulator/tone decoder (U1), which is used to generate a high or low error signal, depending on the incoming tone frequency.

You will also need a good outdoor antenna for your shortwave radio, although we have successfully picked up some transmissions using nothing more than a whip antenna. For best results though, you need an outdoor antenna—the bigger, the better.

**The Radfax Decoder.** Next, there is the Radfax Decoder, which connects to the audio output of your shortwave receiver. A schematic diagram of the Radfax Decoder is shown in Fig. 1. The

output of the decoder connects to the RS-232 (serial) or to the parallel printer port on your computer. If your computer has an RS-232 port, we suggest that you use it for the Radfax Decoder input, leaving the parallel port for the printer. That way, you can print out faxes without having to disconnect the Radfax Decoder.

Now let's have a look at the circuit. There is not a lot to it, just two integrated circuits, a 3-terminal regulator, and a handful of support components.



## PARTS LIST FOR THE RADFAX DECODER

### SEMICONDUCTORS

U1—XR2211 FSK demodulator, integrated circuit  
 U2—4049 or 4009 hex inverter, integrated circuit  
 U3—7805 5-volt, 1-amp, voltage-regulator, integrated circuit  
 D1—D4—1N4002 1-amp, 100-PIV, rectifier diode  
 LED1—Jumbo light-emitting diode (any color)

### RESISTORS

(All resistors are 1/4-watt, 5% units, unless otherwise noted.)  
 R1, R3—220,000-ohm  
 R2—430,000-ohm  
 R4, R8—100,000-ohm  
 R5—75,000-ohm  
 R6—56,000-ohm  
 R7—36,000-ohm  
 R9—22,000-ohm  
 R10—5000-ohm linear potentiometer  
 R11, R14—4700-ohm  
 R12—220-ohm  
 R13—470,000-ohm  
 R15—560,000-ohm

### CAPACITORS

C1, C10—0.01- $\mu$ F, metallized-polyester  
 C2, C15—0.1- $\mu$ F, monolithic  
 C3—0.018- $\mu$ F, metallized-polyester  
 C4—0.022- $\mu$ F, metallized-polyester  
 C5—0.027- $\mu$ F, metallized-polyester  
 C6—0.033- $\mu$ F, metallized-polyester  
 C7—0.0056- $\mu$ F, metallized-polyester  
 C8—0.0022- $\mu$ F, metallized-polyester  
 C9—0.0047- $\mu$ F, metallized-polyester

C11—0.022- $\mu$ F, metallized-polyester  
 C12—0.039- $\mu$ F, metallized-polyester  
 C13—0.068- $\mu$ F, metallized-polyester  
 C14—0.15- $\mu$ F, metallized-polyester  
 C16—220- $\mu$ F, 16-WVDC, axial-lead electrolytic  
 C17—100- $\mu$ F, 16-WVDC, radial-lead electrolytic

### ADDITIONAL PARTS AND MATERIALS

S1—S3—Single-pole 12-position PC-mounting rotary switch (Jaycar catalog number SR-1210, see below)  
 Printed-circuit board materials, enclosure, knobs, RCA panel socket, DB-25 plug to suit IBM serial or parallel port, PC pins, 12-volt AC source, wire, solder, hardware, etc.

**Note:** The Radfax 2 software on 5 1/4- or 3 1/2-inch disk with instruction manual is available from Michael Delahunty (42 Villiers Street, New Farm, Queensland, Australia 4005), for \$35 (in US funds). Payment by check or money order only. Price includes airmail to the U.S. Specify CGA, EGA, or Hercules Graphics version, and disk type.

A complete kit of parts for the Radfax Decoder is available from Jaycar Pty Ltd (PO Box 185, Concord, NSW, Australia 2137) for \$60 (US), including shipping by writing to the company, or faxing them on 02-744-0767, and quoting an America Express, Visa, or Master Card number.

**Phase-Locked Loop.** The heart of the Radfax is U1, an XR2211 FSK demodulator/tone decoder. As its name suggests, it is designed especially for decoding FSK signals. The XR2211 is basically a phase-locked loop that generates a high or a low error signal, depending on whether the tone at its input is high, say 2400 Hz or low, say in the neighborhood of 1200 Hz.

The error signal at pin 7 of U1 is buffered by inverter U2-a and then fed to the computer input (either the RS-232 port or the parallel printer-port can be used; more on that later). Switch S1 and the associated four capacitors provide four separate, switch-selectable, free-running frequencies for the phase-locked loop. The 5k potentiometer (R10) allows the frequency to be adjusted within the limits shown for S1.

For example, setting S1 to position 2, allows you to set U1's center frequency anywhere between 1683 Hz and 2066 Hz via R10. That's the setting that we used most of the time; but depending on the nature of the transmission, you'll need the facility provided by S1. For example, when receiving Morse or RTTY, you may want to use setting 4 (1377–1122 Hz) of that switch.

**Bandwidth and Baud.** Switch S2 sets the operating bandwidth for which U1 will generate high and low error signals. In general, use a wide bandwidth when receiving fax (i.e.,  $\pm 600$  Hz) and a narrow bandwidth for Morse and RTTY. Using a narrow bandwidth reduces data errors due to noise; but if the bandwidth selected is greater than the difference between the two FSK tones, the circuit will not work.

Switch S3 gives the optimum filtering to suit the various data rates. In general, a smaller filter capacitor is used for the higher data rates. For example, at the 1200 baud setting, the filter capacitor is .0022  $\mu$ F.

**Morse Output.** Since Morse is transmitted by switching the carrier frequency on and off, U1 will respond to a Morse transmission by switching its lock-indication output, pin 6, on and off. To provide a visual indication of that, inverter U2-d drives LED1. Inverters U2-b and U2-c provide buffering of the lock indication output before it is fed to the computer port. LED1 lights continually when the Radfax Decoder is correctly picking up fax or RTTY signals and flickers on and off in time with a Morse signal.

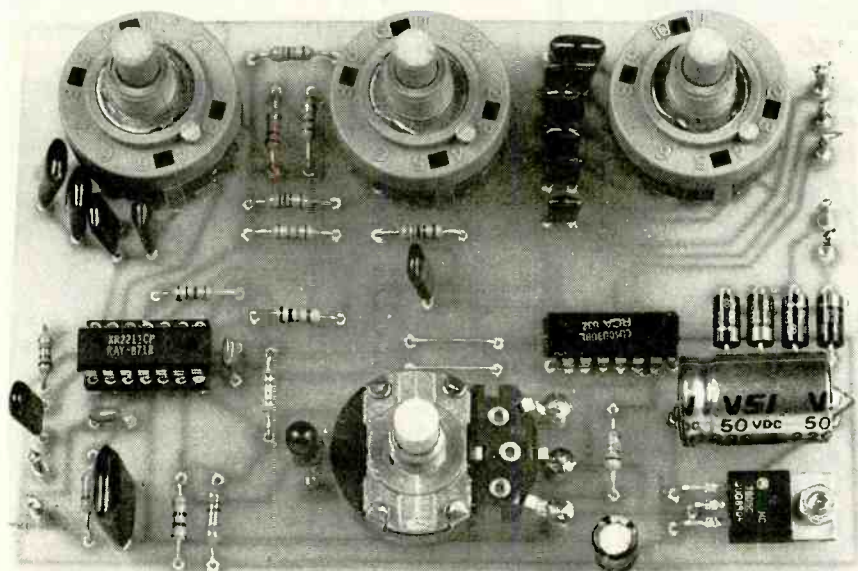

Potentiometer R10 was mounted on the board by soldering its terminals to three PC stakes. Note that C16 is an axial-lead unit—if radial-lead type were used, it is doubtful that it would fit the space once the board and enclosure lid are fitted together.

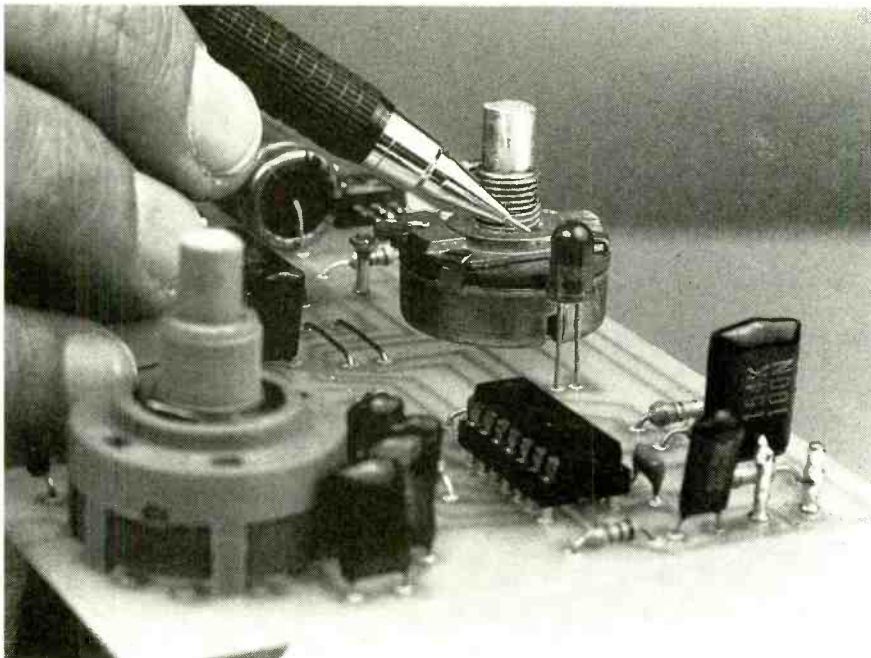

*LED1 is mounted so that it's suspended about 1/2-inch above the board. The LED lights continuously when picking up a fax or RTTY signal and flickers on and off in time with a Morse signal.*

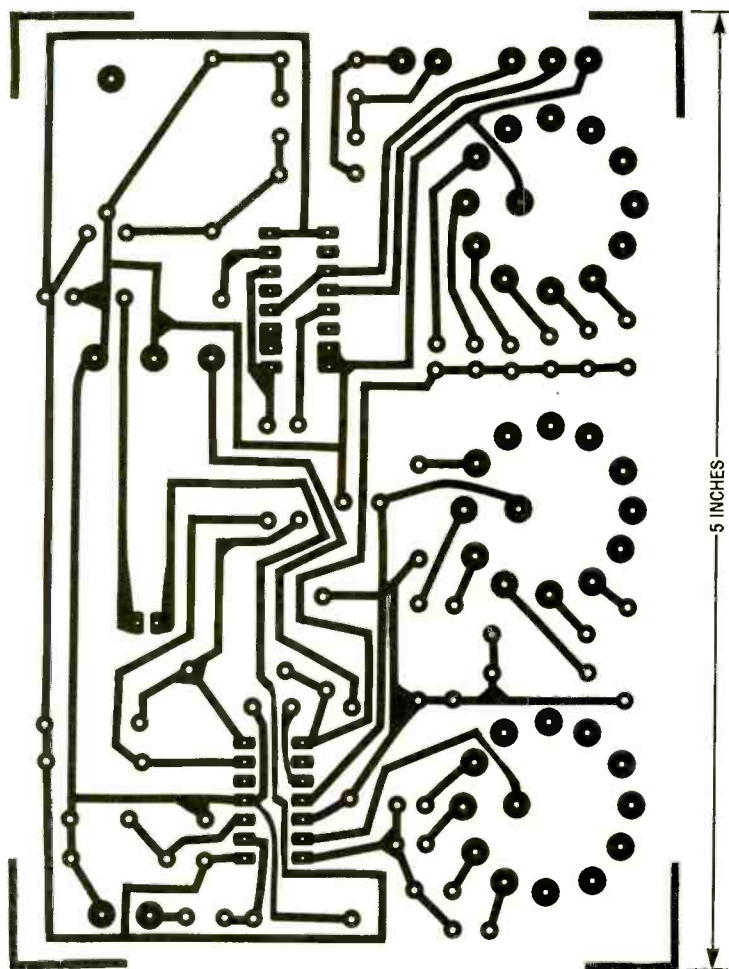

*Fig. 2. The author's prototype of the Radfax Decoder was assembled on a printed-circuit board, the foil pattern for which is shown here full size. Inspect the copper traces carefully after etching and correct any defects before mounting any of the parts.*

**Power.** The Radfax Decoder is powered from an external wall-plug transformer of 9–12 volts (nominal). Diodes D1 to D4 are connected in a bridge so that an AC or DC source can be used (without regard to polarity in a DC source). The output of the bridge is fed across a 220- $\mu$ F capacitor (C16) to the input of a 3-terminal 5-volt regulator. Further filtering of the 5-volt output is provided by a 100- $\mu$ F capacitor (C17).

The total current drain is quite modest and should be around 20 milliamperes.

**Construction.** We housed our prototype Radfax Decoder in a standard plastic enclosure, measuring about 6 1/4 x 3 3/4 x 2 inches. All the components, including the switches and potentiometer, are mounted on a printed-circuit board measuring 5 x 3 1/2 inches. Since the rotary switches are soldered directly to the circuit board, the board does not attach to the case but hangs off the front panel via the switch bushings.

Figure 2 shows the foil pattern for the Radfax Decoder's printed-circuit board. Assembling the decoder board is a fairly straightforward matter although, it's best to install all PC pins, jumper connections, resistors, and other small components before mounting the three rotary switches.

The board pattern is designed specifically to suit the rotary switches called for in the Parts List (Jaycar catalog number SR-1210). Other suitable switches can be used, but the pattern must be altered or the switches must be mounted off board and the connections made with short jumpers.

If the switches specified are used, they should be adjusted to give the required number of switch positions before installation. For example, S1 is adjusted to four positions and S2 and S3 to six positions. That's done by removing the nut from the switch bushing and lifting out the lock washer to reveal the stop ring. You then reposition the stop ring tab in the hole marked "4" for a 4-position switch and in "6" for a 6-position switch. Check that each switch will give the required number of positions before installing it on the board.

Assemble Radfax's printed-circuit board guided by the parts-placement diagram shown in Fig. 3. The 3-terminal regulator is laid flat onto the board and its tab anchored with a screw and nut. LED1 is installed so that it is suspended about 1/2 inch above the board surface so that it protrudes through the front



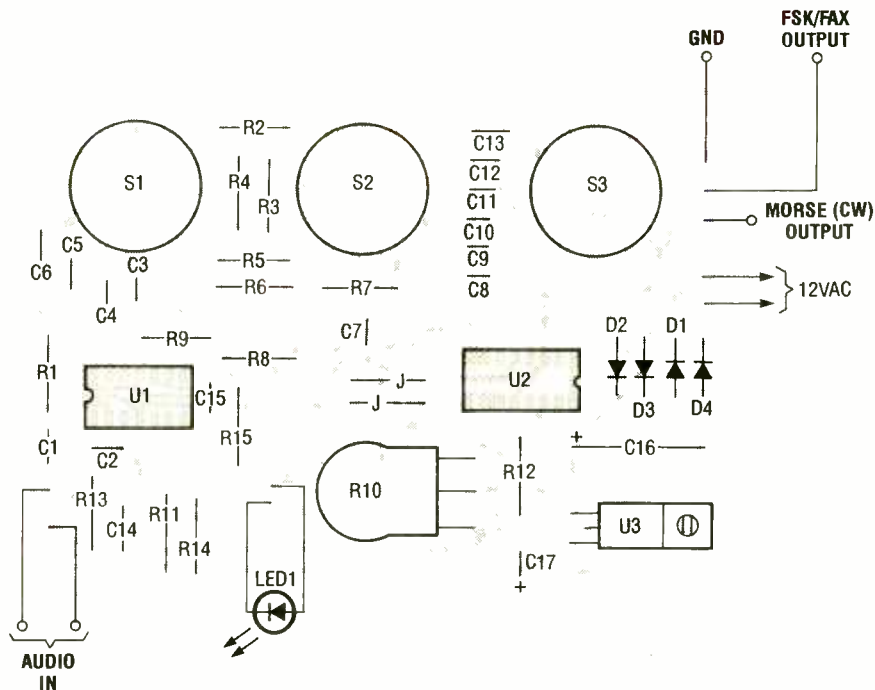

Fig. 3. When assembling the Radfax Decoder's printed-circuit board, be sure to adjust each switch for the correct number of positions before installing it on the board (see text). Note: The 3-terminal regulator (U3) is mounted flat to the board and secured using a screw and nut.

panel (when it is fitted). You might also consider panel-mounting the LED and then connecting it to the board through short lengths of hook-up wire. The potentiometer is installed by soldering its three terminals to the three PC pads on the board. Note that the 220- $\mu$ F power-supply filter capacitor (C16) is an axial-lead type.

When all components are on the board, check your work carefully, and correct any construction errors that you find. When you are reasonably sure that the circuit has been correctly assembled, apply power to the circuit and check that +5 volts DC is present at the output of U3, at pin 1 of U1, and at pins 1 and 16 of U2.

If that's okay, put the board aside and start work on the case and lid. Any enclosure of suitable size can be used. The case itself requires two holes of about 3/16-inch in diameter for the power supply and output leads and another hole to suit the RCA panel jack. When drilling holes for the front-panel controls, it is best to drill slightly small (about 3/8-inch diameter for the switches) then open them up slightly with a tapered reamer, if necessary. Drill a hole to suit the LED. You can now label the front panel.

When that is done, attach the various input, output, and supply leads to the circuit board, then fit the lid over the switch and potentiometer shafts, and install the locking nuts. Attach knobs to

the switches and potentiometer, screw the lid to the case, and you are almost in business.

The final wiring task involves connecting the Radfax Decoder output wires to a DB-25 male or female plug to suit the RS-232 or parallel printer-port on your computer. As noted above, if you have an RS-232 port, we suggest that you use it for the input to the Radfax Decoder. That way you don't have to bother with connecting and disconnecting the printer each time you want to print out a fax or RTTY page.

If you are using the RS-232 port, the connections are as follows:

Radfax Decoder	RS-232 Port
RTTY/Fax output	pin 5
Morse output	pin 6
GND	pin 7

If you are using the parallel port, the connections are as follows:

Radfax Decoder	Parallel Port
RTTY/Fax	pin 13
Morse output	pin 12
GND	pins 18-25

Now connect your shortwave receiver to the Radfax Decoder and the Decoder output cable to the computer. Boot up your *Radfax 2* software disk. The main menu should come up; at that point you can enter a sample fax chart from the files directory.

Having displayed a fax on the screen, you will know that the software is working okay. You now have to check that the software knows which port you are using for the Radfax Decoder input. To do that, you call up the "Settings Menu" by typing "S" (when the main menu is displayed). If you are using a serial port, the address is 02FE Hex (Com2) or 03FE Hex (Com1). For the parallel port, the address is 279 Hex (LPT2) or 379 Hex (LPT1). You call up the correct port address by using the juggle command until the right value is displayed (type "J").

**What to Look For.** It is now simply a matter of tuning in a good fax signal. Here are a few tips to get you started:

- Use a decent shortwave receiver (e.g., Yaesu FRG-8800, Kenwood R-2000, or similar). Forget about using one of the popular portable receivers that are around today—they don't have sufficient bandwidth or a good

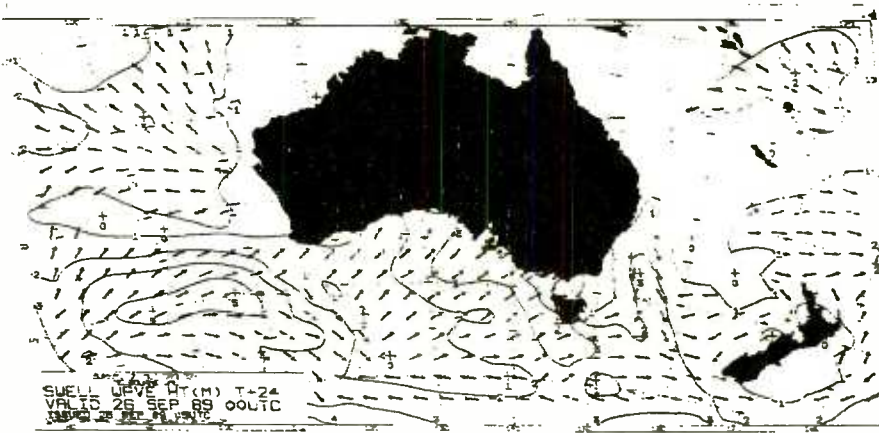

A printout has much better resolution than an on-screen picture. This printout was made in the conventional fashion, but the software also allows you to print out faxes sideways for even greater detail.

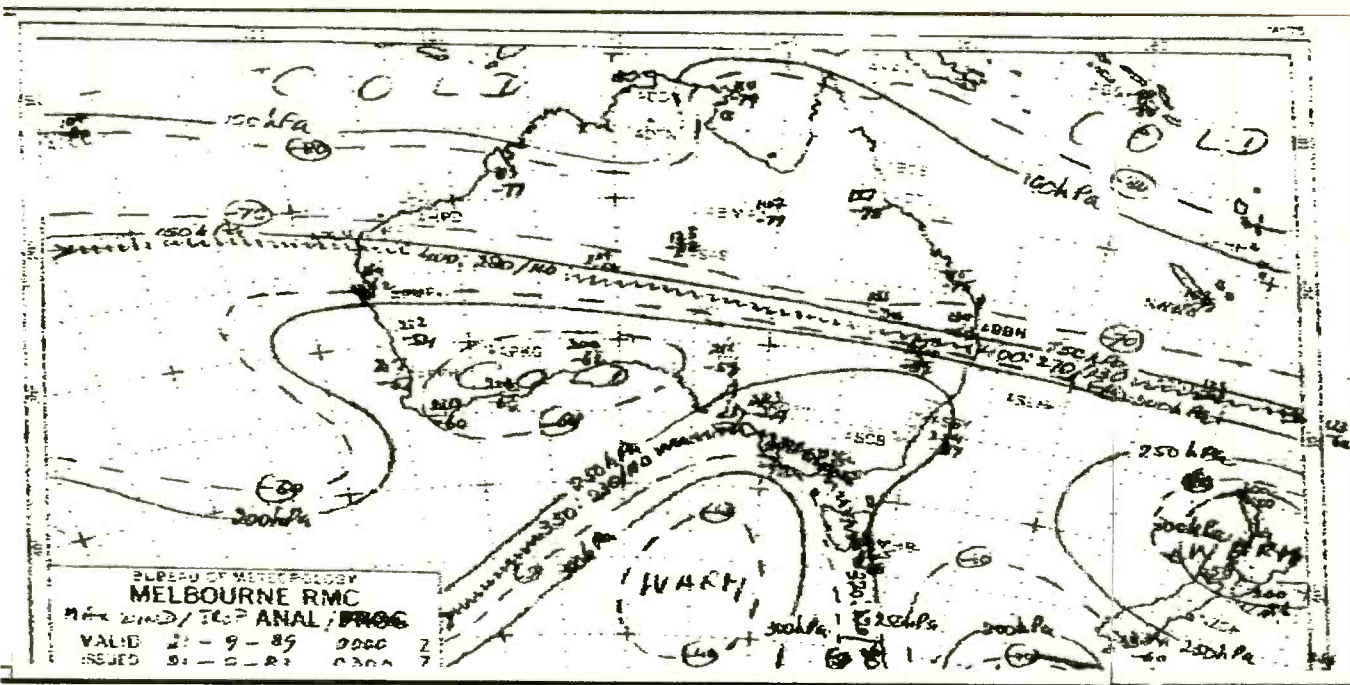

A typical weather map as transmitted by the Bureau of Meteorology in Canberra, Australia. Note that this particular map is leaning slightly to the left. That is easily corrected by altering a value in the software.

enough signal-to-noise (S/N) ratio.

- Use the headphone socket of the receiver to ensure adequate signal level to drive the Radfax Decoder. You can increase the sensitivity by increasing the value of R1 (the 220k resistor connected to pin 2 of U1). But doing so will also make the unit more susceptible to interference.
- Be patient and be prepared to experiment with the software settings.

- Facsimile signals have a very unique (and somewhat nasty) sound, making them easy to find on shortwave. Perhaps the strongest fax signal in North America emanates from U.S. Naval Station NAM in Norfolk, VA. Their fax signal can be heard 24 hours a day on 8080, 3357, or 10863 kHz. Tune any of those on your shortwave radio to hear what fax sounds like. The signal sounds like a scratchy phonograph record stuck at

the end. Other fax stations to try are listed in Table 1.

- For RTTY stations, try 7542 kHz and 10,730 kHz (France), 9968 kHz and 10,552 kHz (Germany), 7695 kHz and

TABLE 1—  
FACSIMILE FREQUENCIES

Frequency (kHz)	Station	Type	Frequency (kHz)	Station	Type
3357	NAM Norfolk, VA	Weath.	9395	NPM Pearl Harbor, HI	Weath.
4296	NOJ Kodiak, AK	Weath.	9438	JMJ3 Tokyo, Japan	Weath.
4704	AOK Rota, Spain	Weath.	10535	CFH Halifax, NS	Weath.
4853	NPM Pearl Harbor, HI	Weath.	10677	Unknown (AP)	Press
5768	JBK3 Tokyo, Japan	Press	10863	NAM Norfolk, VA	Weath.
5878	Unknown	Press	12728	USN Point Reyes, CA	Weath.
6330	CFH Halifax, NS	Weath.	13454	Hong Kong (Reuters)	Press
6850	WLO Mobile, AL	Weath.	13751	London, England	Press
6872	LRB79 B. Aires, Arg.	Press	14828	NPM Pearl Harbor, HI	Weath.
6944	CKN Vancouver, BC	Weath.	16410	NAM Norfolk, VA	Weath.
7993	NPM Pearl Harbor, HI	Weath.	17069	JJC Tokyo, Japan	Press
7710	VFF Frobisher, Bay	Weath.	17151	NMC San Fran., CA	Weath.
8080	NAM Norfolk, VA	Weath.	17405	WWD LaJolla, CA	Weath.
8185	FPI88 Paris, France	Weath.	17585	AOK Rota, Spain	Weath.
8459	NOJ Kodiak, AK	Weath.	17670	LQZ67 B. Aires, Arg.	Press
8467	Tokyo, Japan	Press	18093	LRO84 B. Aires, Arg.	Weath.
8492	NPM Pearl Harbor, HI	Weath.	18130	JMJ5 Tokyo, Japan	Weath.
8617	JJC Tokyo, Japan	Press	18413	Unknown (Reuters)	Press
8646	WWD LaJolla, CA	Weath.	18431	B. Aires, Arg. (Reuters)	Press
8682	NMC San Fran., CA	Weath.	20736	LSA600 B. Aires, Arg.	Press
9157	WLO Mobile, AL	Weath.	21037	NPM Pearl Harbor, HI	Weath.
9383	NPN Apra, Guam	Weath.	22542	Tokyo, Japan	Press

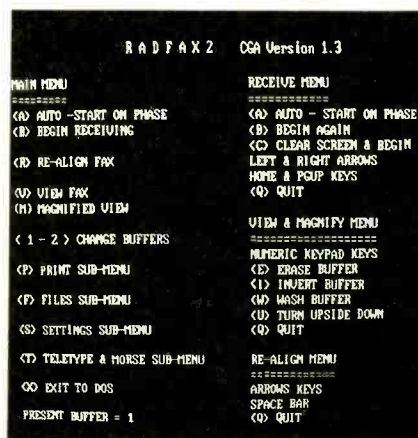

The Radfax decoder is designed to use a commercial program called Radfax 2. Here's that program's main menu.

13,563 kHz (Taiwan), 13,780 kHz (Korea), 6845 kHz, 9120 kHz, 10,960 kHz, and 14,514 kHz (Reuters); and 9985 kHz, 16,232 kHz and 19,520 kHz (UPI).

- For more on the world of fax reception, see "Guide to Facsimile Stations," by J. Klingenfuss. That and other books on non-voice radio, as well as reception equipment, are available from Universal Radio (1280 Aida Dr., Reynoldsburg, OH 43068; Tel. 800-431-3939).



**E**lectronic equipment continues to get smaller and smaller, with miniaturization being the name of the game. Today, the electronic industries' present direction is to use fully automated assembly methods, utilize both sides of the PCB, reduce size and weight, and offer more functions and features without increasing product size.

Wrist-watch televisions, pocket scanners, tiny radar detectors, or a miniature HF amateur-radio transceiver whose equivalent twenty years ago would have occupied an entire desk, have all become a reality in the last decade. What is behind this miniaturization and how has it come about? Surface-mount technology (SMT) is the answer. In the 1970's, electronic manufacturers began to mount miniaturized components directly on the surface of printed-circuit boards—an automated technique that evolved from thick-film hybrids (*i.e.* circuitry etched onto a circuit board). Today SMT can meet the electronic industries' demand for boards that are smaller, cheaper, and more reliable.

Surface mounting has changed many aspects of the electronics industry. For example, the electronic-component industry has had to create whole new families of tiny active, passive, and electromechanical components to meet the demand for surface-mountable devices (SMD's). New kinds of automatic assembly and soldering machines, currently used on production lines, place and attach components at fantastic rates. This automated assembly equipment is also constantly being improved.

Despite all the high-tech surrounding (and supporting) SMT, hobbyists can get in on the fun, too. In this article we'll present some easy "hands-on" methods of assembling SMT projects of your own. Obtaining parts for such projects is also relatively easy because many mail-order parts suppliers carry SMD's. To name but a few, Mouser (2401 Highway 287, North Mansfield, TX; Tel. 1-800-346-6873), DigiKey (701 Brooks Ave. South, PO. Box 677, Thief River Falls, MN 56701-0677; Tel. 1-800-DIGIKEY), Communication Specialists (426 West Taft Ave., Orange, CA 92665-4296; Tel. 1-800-854-0547), Newark (4801 N. Ravenswood, Chicago, IL 60640; call oper-

\*Dave Hollander is the Strategic Marketing Manager for Motorola's Discrete and Special Technologies Group.

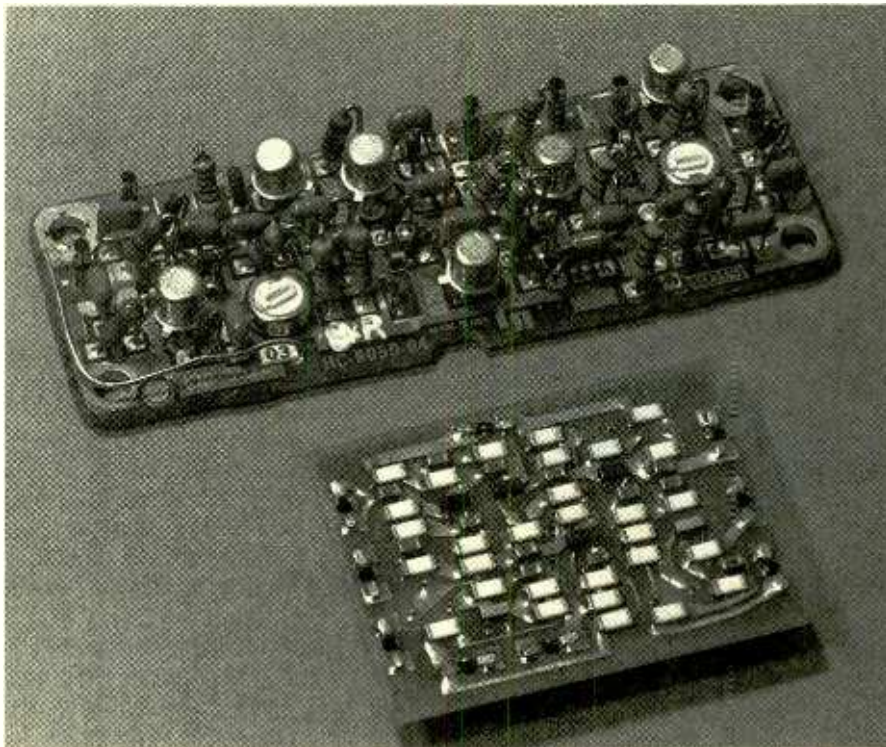

# SURFACE MOUNT TECHNOLOGY

BY DAVE HOLLANDER\*

*Surface-mount components have become so popular among product manufacturers that they are now available at reasonable prices for hobbyists.*

ator for local number), and Allied Electronics (401 East 8th St., Fort Worth, TX 76102; Tel. 1-800-435-5700) all do.

**The Advantages of Surface Mounting?** Surface Mounting involves a component being soldered directly to a "footprint" rather than inserting the leads into holes (called "thru-holes") on a printed-circuit board (PCB). The footprint is a series of solder pads that conform to the lead layout of the surface-mount component (see Fig. 1).

Surface mounting has several advantages over the insertion method. For example, the smaller leadless components and the elimination of through-holes can triple board density. Surface-mount components can be placed on both sides of a PC board,

which also reduces board size. The use of chip capacitors, resistors, and semi-conductors could, in theory, give those boards packaging densities equal to those of hybrids. Looking at the photographs, the size reduction becomes very obvious.

Smaller boards have smaller runs between components. The shorter runs reduce parasitic inductance and capacitance, thus improving overall circuit performance. Of course, a smaller board with fewer layers dramatically cuts costs as well. It can also be shown that approximately 65% of the system costs are related to component size. Some of the system parameters affected by the size of components are:

- The number of printed-circuit boards
- Cabinet size

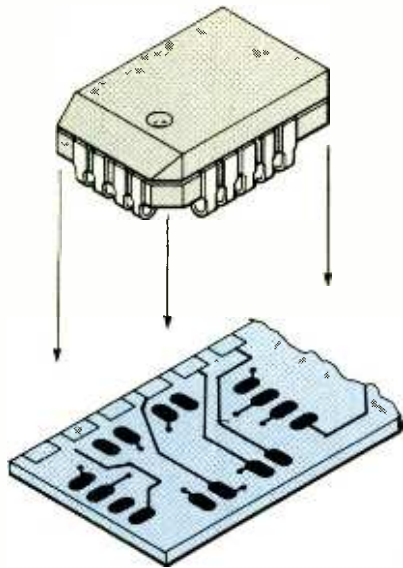

Fig. 1. This is a typical surface mount footprint suitable for a J-leaded component. Note that there are pins on all four sides of the chip.

- Connectors and cabling
- Cooling requirements

Because consumer electronics' and retail prices seem to be inversely proportional to worldwide inflation, cost reductions are paramount.

Some of the benefits that can be achieved by designing a board to utilize SMT are summarized in Table 1.

### The Manufacturers' Assembly Process.

Prior to mounting, the leads of a surface-mount device (SMD) should be tinned to provide a better solder joint. That is often done by the device's manufacturer. In addition to improved solderability, the tinning provides a small amount of extra clearance between the package and the board that might be desirable in some assemblies.

Pre-tinned printed-circuit boards (provided by most PCB manufacturers) make a clean connection to SMD's since both the mechanical and electrical attachment are made at the footprint pad by just reflowing solder.

However, extra solder is needed to finish the joint, therefore the next step is to "print" solder paste onto the pads. That is normally done by a screen printer. The paste provides the necessary solder to form the joint fillets that are so important to making good electrical and mechanical connections. The component is then placed on the fresh solder paste and soldered by a "vapor-phase" reflow-soldering process that melts the solder and bonds the SMD to the PCB. After the soldering

TABLE 1—ASSEMBLY TECHNIQUE COMPARISON

	Through-hole	Surface Mount	%Reduction
Board Size	11" x 14" (154 sq. in.)	6.5" x 9.6" (64 sq. in.)	56%
No. of Layers	6	4	33%
Board Cost	\$150	\$75	50%

operation, the board is cleaned with a solvent and it is then ready to be tested.

All surface-mountable devices come packaged in tape and reel, sleeves (also known as rails), and in vials. Without the need to pre-form component leads, automation is straightforward. Figure 2 shows how automation is used in assembling a surface-mount board. Assembly lines for automated surface mounting take up about 50% less factory space than "auto-insert" lines do.

### Some Ideas for Hand Assembly.

If one wants to build a project with surface-mount components, here are some hand-assembly techniques: To start, some sort of magnifying glass will be needed as most of the components are extremely small.

It is highly recommended you use a PC board (in fact its almost impossible to do without one). Of course, the board must be laid out with the appropriate SMD footprints. Recommended footprints for surface-mount devices can be found in most manufacturer's databooks, data sheets, or surface-mount guides. The techniques for laying out and etching a board are the same as for thru-hole boards except no holes will be necessary for the surface-

mount components. Such techniques can be found in the *Radio Amateur's Handbook*. It is recommended that all of the pads be tinned using a low-power pencil-type soldering iron (30 watts or less).

Either the board should be marked with component locations or a parts placement diagram should be drawn; once a component is soldered to the board it will be difficult to remove.

Before placing components on the board, the board should be anchored down where it will be free from vibration and/or possible bumping as this will move the components and you will have to start over. With the same thought in mind, try not to sneeze on the board before a component is secure; You will have a difficult time finding the missing component due to their small size.

When the component locations have been determined, one can proceed with mounting the components. For handling them, tweezers are recommended (several different sizes might come in handy), preferably the type that are normally closed as they will retain the component easier than standard tweezers.

You can slip a rubber band around

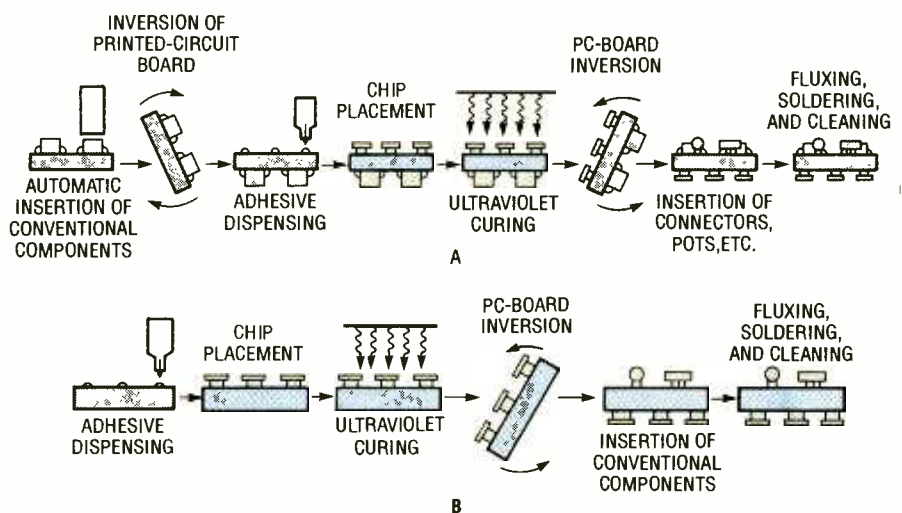

Fig. 2. The surface-mounting process is particularly suitable for automation assembly. Two processes for SMD assembly are shown here. The first (A) shows how conventional and SM components are mounted on the same board. The second process is for SMD's and larger control components (potentiometers, etc.).



regular tweezers to get the same effect. Rolling the rubber band up and down, the tweezers will open and close its jaws. You might also wish to try slipping flexible tubing (like heat shrink that hasn't been shrunk) onto the tweezers. If it's the right size, slipping it down on the tweezers should close the jaws, and moving it back should release them.

There are two possible ways of mounting and soldering the components to the printed-circuit board. The first is to glue all the components to the the board with an adhesive, and then solder them in place. Try to use some type of super glue that can be dissolved with acetone (i.e. nail-polish remover) if a component is incorrectly placed. Once again, do not sneeze or bump the board before the glue has set.

Another method is a crude version of the reflow-solder method of surface-mount assembly. That involves the use of a hot plate and solder paste. A small amount of solder paste is dispensed onto the solder pads using a syringe. The components are then placed on their appropriate pads on the board. The paste will act as an adhesive to hold the components in place. The board is then placed on the hotplate and the solder paste will then flow, soldering all of the components at the same time.

There are two nice features to this method: All of the components are soldered in place at the same time, and the surface tension of the molten solder will pull the components into alignment with their solder pads.

However, this method can only be used if one is building a single-sided board. Also, it is imperative that there is some way of accurately monitoring the temperature of the hot plate. Most surface-mount semiconductors and many other passive surface-mount components can not withstand more than 260°C for 10 seconds. Exceeding that temperature can reflow the solder within the device and damage it. The temperature must be brought up close to 260° gradually with the hot plate to avoid thermal shock to the components.

After soldering, the board should be cleaned of all flux. The board should then be inspected with a magnifying glass for solder bridges, cracks, cold solder joints, and missing solder. Too little solder results in a weak joint and can cause reliability problems later. Another precaution: use as little heat as possible

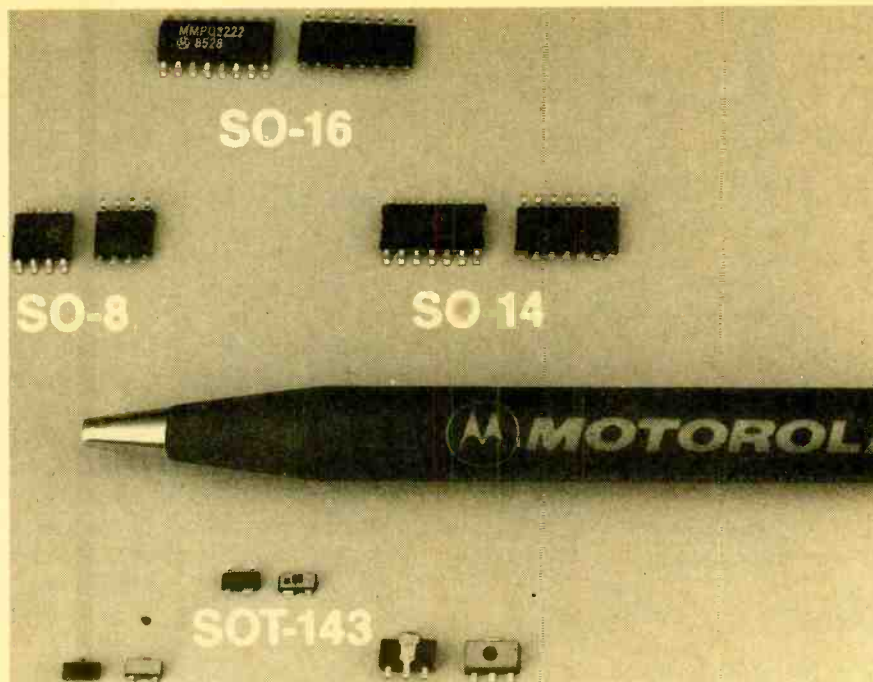

*These are typical low-power surface-mount packages. They are used for IC's, semiconductor-component arrays, and discrete components, all requiring little heat dissipation.*

on components with metalized ends (chip capacitors, diodes, etc.) as too much heat can cause the metalization to leach off, which will render the component unusable. To remove a misplaced or defective component from the board, you will need some kind of solder wick for solder removal, and an adhesive remover such as acetone (this should be dispensed with a syringe to keep the liquid confined to the component to be removed) for components that have been glued in place.

These are just a few ideas for hand assembly of a surface mount board. Incidentally, there is no rule that says that insertion-mount components cannot be mixed with SMD's. If you are using the hotplate method, the insertion-mount components should be placed on the board and soldered after the surface-mount devices. That is done in the industry when a particular component is not available in surface-mount format. That will probably be necessary on certain projects as some of the SMD's may not be obtainable. And on that note, now that you know how to proceed you'll need a better idea of what's out there.

**Surface Mount Components.** The present family of surface-mount components includes chip resistors and capacitors, inductors, integrated circuits, discrete semiconductors, switches, crystals, relays, transformers, and con-

nectors, with new surface mount components becoming available all the time.

The current industry trend is to make as much of the standard leaded products available in surface mount form as possible. That allows designers to create complete surface-mount assemblies as opposed to boards containing both SMD and feed-through devices.

**Passive Components.** A typical chip resistor and its construction is shown in Fig. 3. The pre-tinned ends are suitable for reflow or other soldering techniques. The resistance element (see cut-away view of Fig. 3B) is a glass-passivated thick-film element on a high-purity alumina substrate so the result is a highly reliable and precise component. Chip-resistor values range from 10 ohms to 2.2 megohms with tolerances of either 5% or 10%. Power dissipation is one-eighth of a watt.

Figure 4 shows a typical chip capacitor. Chip capacitors have monolithic construction with a totally encapsulated electrode system and metalized terminations. The electrodes are deposited in the ceramic chip using an interleaved pattern with two electrodes forming a single capacitive layer. The layers are stacked to increase capacitance. Chip-capacitor values range from the low picofarad range to the microfarad range.

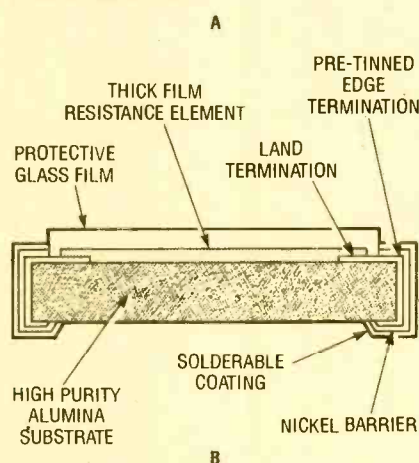
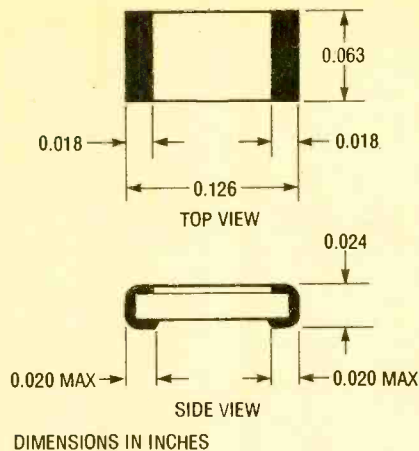

Fig. 3. These two sided (A) and cut-away views of a chip resistor's construction reveal just how simple they are.

**Gull Wings and J-Bends.** An important characteristic to consider when choosing an active surface-mount component is its lead configuration. Their are gull-wings (Fig. 5A) and "J" bends (Fig. 5B). There are advantages and disadvantages to both. Gull-winged leads can be easily probed by test leads and their packages are more easily handled by automated pick-up and place equipment.

Packages with J-bend leads have smaller footprints and take up less real estate on the printed-circuit board, however their solder joints are not easily inspected and test points must be provided to access the leads.

**Multi-Purpose Semiconductor Packages.** There are a number of standard case styles available for use in surface-mount designs. Refer to the photos throughout this discussion to see what they look like. Some of the low-power types are the SOT-23, SOT-143, SOT-223, SO-8, SO-14, and the SO-16.

The SOT-23 (or TO-236) shown in Fig. 6 can dissipate up to 200 mW in free air or up to 350 mW when attached to a ce-

ramic substrate. There are a number of different products in the SOT-23 package. They include small-signal transistors (both bipolar and FET), tuning and switching diodes, Zener diodes, and SCR's.

Low-voltage quad transistor arrays and diode arrays can be found in the SO-16 and SO-14 packages, respectively. We'll discuss discrete diodes some more a little later.

For RF applications, there are two packages: the SOT-143 and a special type of SO-8 modified for RF operation. The SOT-143 is very similar to the SOT-23 with the exception of having four leads. The extra lead lowers the package inductance, improving high-frequency operation. The RF-capable SO-8 has a power dissipation of 1.5 watts in free air. Transistors operating as fast as 870 MHz are available in this package.

For applications where a little more power dissipation is needed, there is

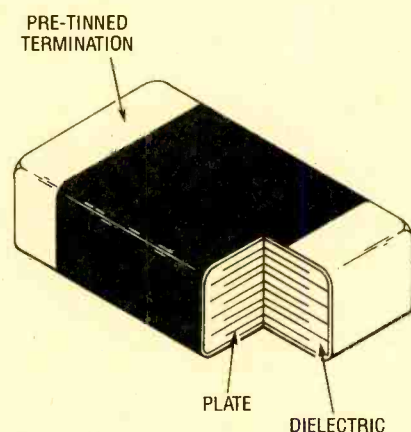

Fig. 4. Surface-mount chip-capacitor construction is fairly simple. Multiple plates inside the component are sandwiched around the electrolyte and terminated with pre-tinned ends.

the SOT-223. The package can dissipate one watt in free air and greater than 2 watts when mounted on an alumina substrate.

**Diodes.** Discrete, two-terminal diodes come in leadless cylindrical glass packages referred to as MELF's (metallized-electrode face) and mini-MELF's. There are a wide variety of rectifiers and Zener diodes in MELF packages. The devices generally contain the same diode as their leaded counterparts, but in DO-35 and CO-41 cases. In the rectifier category, one will find 0.5-amp and 1-amp devices such as the 1N4001 family, in addition to Schottky and ultra-fast rectifiers.

There are also plastic diode packages denoted SMB and SMC. They resemble "SO"-type integrated packages with the exception of wide leads bent in a J-lead configuration (explained later in the article). The packages come with 1-watt and 3-watt ratings and can fit the same footprints as their equivalent MELF brothers.

**Power Devices.** High-power SMD's have only become available in the last five years. For power applications, there are two options; the DPAK and the D<sup>2</sup>PAK. The DPAK resembles a miniature TO-220. It has a power-dissipation rating of 25 watts at 25°C in free air, and 1.75 watts when mounted to a glass epoxy printed-circuit board. Components available in this package include power MOSFET's, bipolar power transistors, thyristors, rectifiers, and three-terminal voltage regulators.

For applications requiring a higher power rating but a lower saturation voltage or on resistance, there is the D<sup>2</sup>PAK. It is a new package introduced by Motorola. The new unit resembles a conventional TO-220 without its heat-sink mounting tab. The case can hold much larger devices than the DPAK, its maximum size being 175- x 220-mils (a mil is 1/1000-inch) where the DPAK is limited to 112- x 112-mils maximum. The D<sup>2</sup>PAK does take up considerably more "real estate" on the printed-circuit board. The devices have a maximum junction temperature of 175°C. Total power dissipation is 3.5 watts, with a

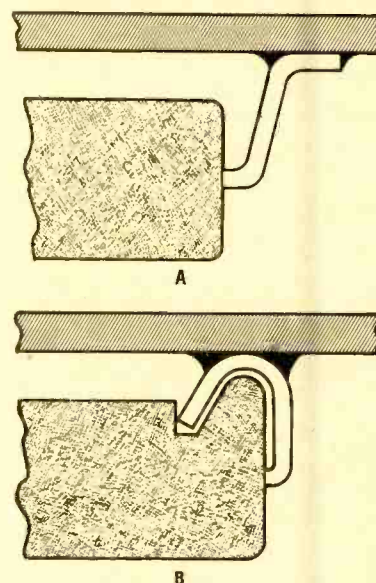
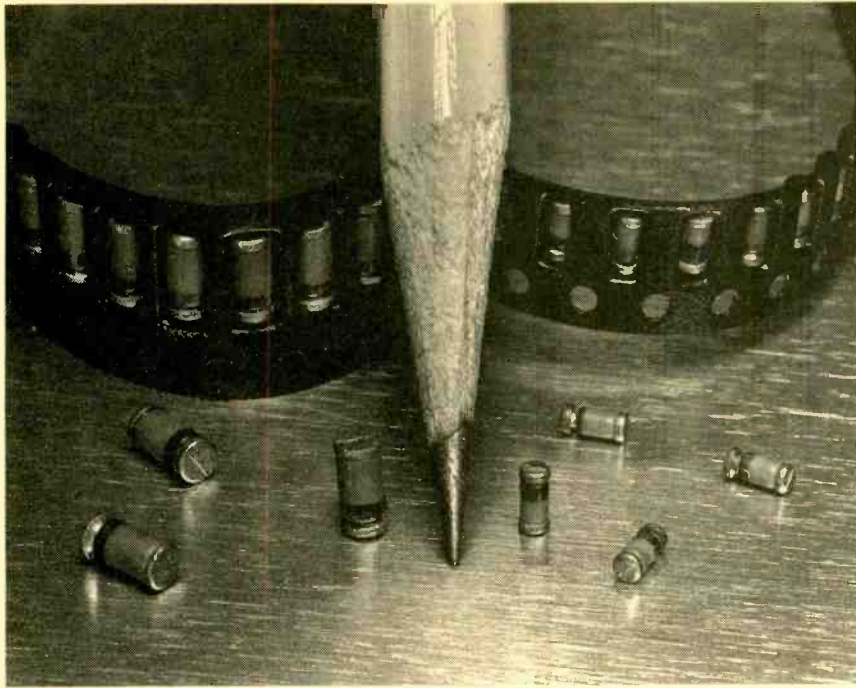

Fig. 5. These are the gull-wing (A) and J-lead (B) SMD contact configurations. (Note: the IC's are shown beneath the boards).





These are diodes cloaked in MELF and mini-MELF packages. Despite their unusual appearance, they are identical to their leaded versions.

maximum ambient temperature of 25°C when mounted on a glass-epoxy printed-circuit board with the minimum recommended footprint. D<sup>2</sup>PAK products include TMOS power MOSFETs, bipolar power transistors, and rectifiers.

**Integrated Circuit Packages.** IC's come primarily in three styles; the SOIC (standard outline integrated circuit), the PLCC (plastic leaded chip carrier), and the DPAK. The packages come in a variety of different pin counts. All SOIC packages are of the "gull-wing" config-

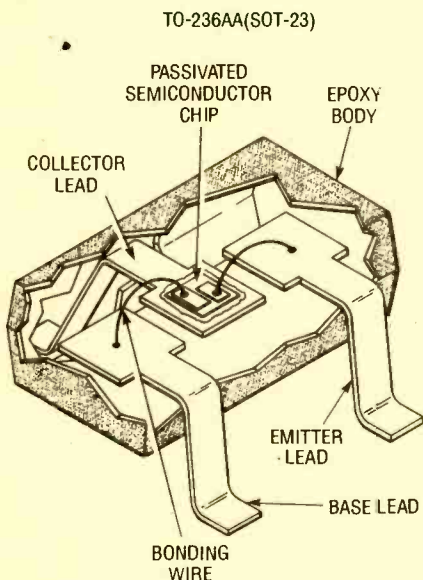

Fig. 6. The SOT-23 package is a tight low-profile case usually used for transistors.



These case styles are used for power applications (power-transistors, regulators, high-amperage diodes, and such).

uration (see Fig. 7). SOIC and PLCC constitute the bulk of the products while the DPAK is used for three-terminal regulators.

PLCC's offer the flexibility of high pin count in a smaller package than their leaded equivalent—they take up approximately 1/3 the board space. They all have J-lead terminals.

A wide variety of products are available in surface-mount packages. In the digital family, MOS products available include LSI, CMOS standard logic, and high-speed logic. Bipolar logic is also available. Products in this family include LS TTL, fast TTL, and MECL. MPI's, MCU's, and peripherals are also available in PLCC packages.

Among the linear IC's, all of the major bipolar analog families are also avail-

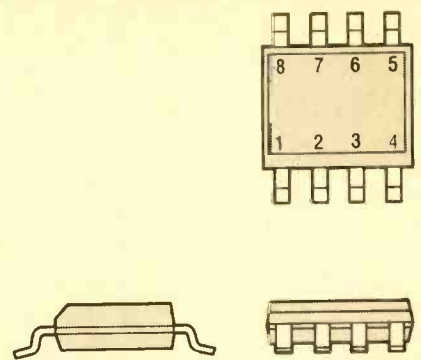

Fig. 7. This is a standard SOIC package. It is the surface-mount equivalent of a DIP, so it's used for IC's.

able in surface-mount packaging. One will find op-amps; regulators; interface; data-converters; and consumer, telecom, and automotive products in surface-mount packages.

**Summary.** With the growing availability of surface mount components, the task of designing total surface

mount assemblies is becoming easier. Using surface-mount designs will allow both size and cost reductions as well as increasing the ease of achieving fully automated assembly.

Additionally, suppliers of electronic components are putting forth a major effort to develop new packages compatible with surface-mount assembly technology, and are making most of their standard products available in surface-mount form. Surface-mount technology has revolutionized the way industry builds the products we use every day. And while hand assembling an SMT circuit can be challenging, now that the technology has become readily available to hobbyists, it may soon change the way we build circuits at home.

# STAYING ALIVE:

BY DAVID C. TOALSON

## Ground Fault Electric Shock and How to prevent it



**H**ave you ever been “bitten” by some kind of electronic hardware you were testing by inadvertently coming in contact with just one side of the line, or maybe only the chassis? Have you puzzled over why the shock occurred, and what you could have done to prevent it? If so, read on...

There are two common kinds of electric shock from household AC: one caused by simultaneous contact with two “live” conductors (called hot and neutral), and the second by contact with only one conductor while the body is in contact with ground. As you may know, the second kind occurs because one side of the household AC supply is grounded, and current will flow through a circuit connected between the “hot” conductor and a ground. That can result in a shock called a “ground-fault electric shock,” perhaps the most dangerous kind, partly because it is elusive.

In this article, we will review utility-grounding practices to understand why we are occasionally surprised by this dangerous and unpleasant electrical phenomenon, and then identify several ways to minimize or eliminate it.

**Utility Grounding.** Within a few hundred feet of your home is a utility transformer designed to reduce the utility distribution voltage to 120 and 240 VAC. The actual voltages you receive in your house can vary over a wide range, but referring to the power lines as 120- and 240-VAC lines is standard usage, so we’ll

stick with it. (Note: in some areas three-phase 120/208 VAC is common. Although three-phase systems won’t be discussed, the grounding principles and precautions are the same as for single phase).

Figure 1 shows a simplified typical connection between the utility distribution transformer and a 120-VAC receptacle. Power is distributed in most parts of the country through high-voltage power mains at 7,200 or 12,200 VAC.

The utility transformer is in reality a large power transformer. Its fused primary receives the high voltage power, and a center-tapped secondary rated at 240 VAC (*i.e.*, 120 volts on each winding) distributes it. The center tap is grounded at the pole or pad, usually via a buried copper plate and heavy, bare, solid-copper wire.

There are a number of reasons for grounding the transformer secondary,

**WARNING!!** This article deals with and involves subject matter and the use of materials and substances that may be hazardous to health and life. Do not attempt to implement or use the information contained herein unless you are experienced and skilled with respect to such subject matter, materials and substances. Neither the publisher nor the author make any representations as to the accuracy of the information contained herein and disclaim any liability for damages or injuries, whether caused by or resulting from inaccuracies of the information, misinterpretation of the directions, misapplication of the information or otherwise.

but the most important is to provide a low-impedance ground path for the high voltage in case the transformer develops a short circuit between the primary and secondary windings. If a short occurs, the primary fuse will simply blow and shut the transformer down. Although such failures are rare, without the grounded secondary, a transformer short could result in 12,000 VAC appearing on your house wiring!

Three heavy-duty “service-entrance” conductors carry the transformer secondary voltage to the utility watt-hour meter (not shown) and then through the main “service disconnect” switch to the distribution panel. The center tap or “Neutral” line is grounded again in the distribution panel, usually to a copper-plated ground rod driven into the earth. Any 240-VAC circuits in the house are connected between Hot1 and Hot2, and 120-VAC circuits run between either Hot1 or Hot2, and Neutral (as shown).

**Cause of the Shock.** Obviously, anything between either HOT1 or HOT2 and any ground will complete a 120-VAC circuit, and current will flow in accordance with Ohm’s Law. Unfortunately, “R” in the equation for Ohm’s Law can be the resistance of the human body.

Ground-fault electric shock can occur in a number of ways. One may inadvertently touch the hot conductor in a frayed cord while in contact with ground. A faulty component can short



the hot conductor to the ungrounded chassis of a piece of equipment. Or you may brush against a hot conductor while engrossed in troubleshooting some portion of the circuitry.

In the heyday of American consumer electronics, it was relatively common for manufacturers to actually connect one side of the line cord directly to the chassis of "AC/DC" radio receivers and, later on, many cheap television receivers. The receivers were furnished with two-prong, non-polarized plugs (see Fig. 2A), so that when the plug was inserted one way in the receptacle, the chassis was at ground potential. But when the plug was reversed, the chassis was at 120 VAC with respect to ground. The operator was protected from a possible hazard only by a plastic case and knobs.

It was standard practice in most electronics service shops in those days to hook up a VTVM (vacuum-tube voltmeter) between the chassis and ground and reverse the plug if required to get the chassis at ground potential before servicing. Scores of technicians were rumored to be electrocuted by failing to observe that precaution when repairing such dangerous equipment. Some equipment was supplied with a polarized plug (see Fig. 2B) to prevent such fatalities.

As time passed more equipment was supplied with a three-wire grounded cord and plug (Fig. 2C). That type of plug has a dedicated ground conductor that is used to ground the device's chassis. Unfortunately, many buildings are still equipped with old-style two-wire receptacles, and that important safety feature is lost.

Unfortunately, many items of electronic hardware still come with two-wire cord sets, although at least most modern two-wire plugs are polarized so they will only fit the receptacle one way. On such devices, the chassis is not connected to either side of the line, but it is still fairly common to see the AC line bypassed to the chassis with a .05- or 0.1- $\mu$ F capacitor. That can cause an uncomfortable stinging sensation if you touch the chassis.

**Electric-Shock Physiology.** The internal resistance of the human body is quite low, and most of the body's electrical resistance is concentrated in the skin. While the resistance of dry, intact skin as measured with a VOM may be as high as several megohms, moisture, particularly perspiration, can lower that

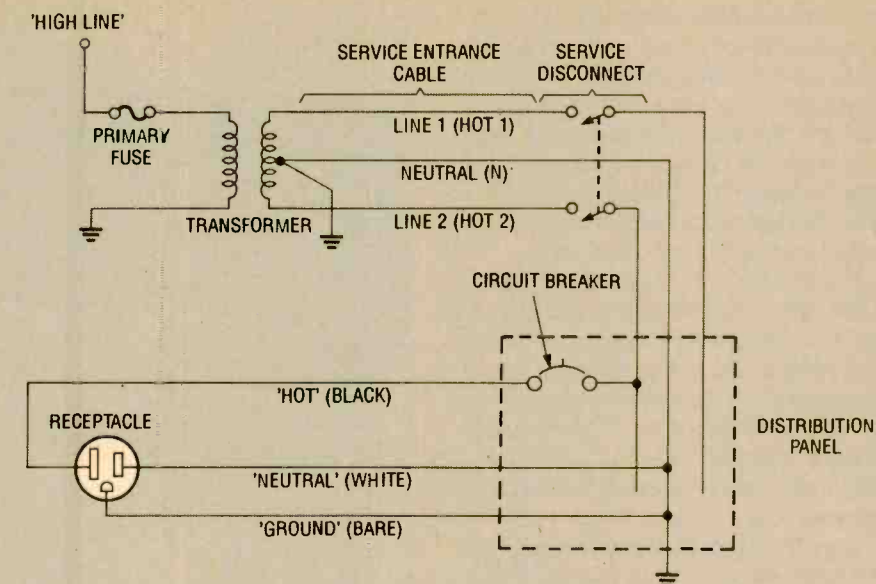

Fig. 1. This is the standard circuit for connecting power mains to a household junction box. Absent from the drawing is the connection of a 240-VAC socket that would simply run between the two hot lines.

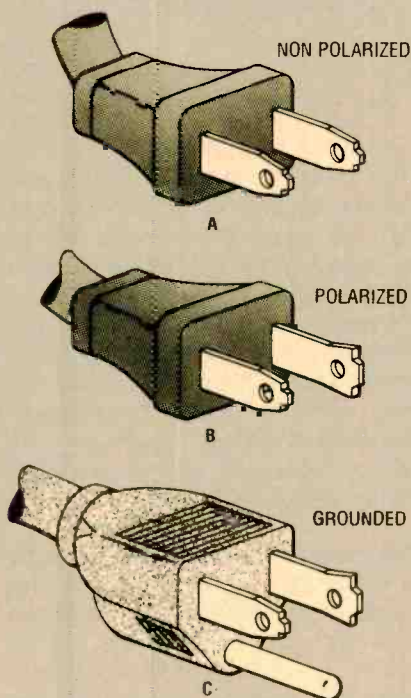

Fig. 2. These are plugs used on American electrical devices. Note the top plug (A) is non-polarized and goes against current standards. The polarized plug (B) is somewhat safer, while the grounded, polarized plug (C) is the safest.

to a few hundred ohms.

It is recognized that low-frequency alternating current has much more serious physiological consequences than direct current. DC tends to cause muscle contractions resulting in pulling away from the source of the shock. AC, on the other hand, is much more likely

to produce muscle "tetany"—spasms causing one to grip onto the source of current.

The "threshold of perception" for AC current is well below 10 mA. The highest AC current at which it is possible to let go of the source of current, may be as low as 15 mA.

Various studies over the years have determined that only 60 to 100 mA of AC through the chest for a fraction of a second are sufficient to cause unsynchronized, chaotic spasms of the heart called "ventricular fibrillation," which might result in death. Since most shock incidents occur when one or both hands are touching a hot lead while another part of the body is grounded, the chest is the most common path for ground-fault current.

However, the muscle convulsions are the most common cause of fatal injury as a result of electrical shock. They cause people to fall off ladders, strike walls, or impale themselves on nearby objects.

**An Ounce of Prevention.** Apart from caution and good judgement, there are several mechanical and electrical means for preventing or limiting the severity of ground-fault electric shock.

To begin, whenever working on a piece of electrical or line-powered electronic gear, certain precautions are in order. If the item has a three-wire cord, use an ohmmeter to check that the plug's ground pin is connected to the metal chassis of the unit. **Never use an adapter to defeat the grounding**

**feature of a three-wire cord.** If the unit is equipped with a two-wire cord and plug, check between each blade of the plug and the chassis for infinite resistance. If the resistance is measurable, check for the presence of an AC voltage between the chassis and ground after plugging the item in to the wall outlet and *before you touch it.*

If your shop is in a garage or basement with a concrete floor, you should be especially careful because when concrete is wet, it is a relatively good conductor, and it is generally in direct contact with the ground. Concrete can absorb moisture from the underlying soil. It also tends to "sweat" when the temperature changes.

One of the best shock prevention measures for a concrete floor is to install rubber or plastic matting over the entire area where you normally work. The matting insulates you from the grounded concrete, and is also much more comfortable to work on for long periods. It is available from many department stores in various widths and lengths, and is relatively inexpensive.

The last several years have seen an increase in the use of ground-fault circuit-interrupting devices, or GFCI's. In a good AC electrical circuit current flows from the line (Hot1 or Hot2), through the load to the Neutral, and vice versa. There should be no current flow though the ground conductor. GFCI's operate on the principle that the currents in the line and neutral conductors must be equal in magnitude, although flowing in opposite directions. The vector sum of the two currents should therefore be zero. Any detectable net current indicates a ground fault, and the device trips, disconnecting the circuit.

The National Electric Code now mandates those devices for all kitchen, bathroom, and outdoor receptacles, as do many local building codes. They come in two basic configurations. The preferred device is a circuit breaker installed in the main distribution panel, and thus protects all downstream receptacles connected to the circuit.

A variation is a duplex receptacle with the GFCI components built in that can be installed in place of an ordinary three-wire receptacle. Although the second type is also capable of protecting downstream receptacles, it is seldom installed in that fashion.

GFCI's are easy to recognize in the distribution panel or wall by their "Push to Test" button. If you do not have those devices installed, it would be worth-



*Some isolation transformers, like the unit shown here, allow you to vary the amount of voltage delivered to a device. That feature is very useful in troubleshooting faulty gear.*

while to consider them, at least for your shop circuit. Cost ranges from \$30 to \$80 each plus installation. It is recommended that the devices be installed only by a licensed electrician.

Although GFCI's are very reliable and effective, and have doubtless saved many lives, they are mechanical devices, which take time to operate, at least several cycles. They cannot prevent a ground-fault electric shock, but can only limit its duration.

**The Isolation Transformer.** One way to eliminate ground-fault electric shocks is to eliminate the connection between ground and neutral. That requires a second power transformer called an "isolation transformer" (see Fig. 3) between the equipment you're working on and the utility. The secondary leads of the isolation transformer

are not grounded, so if you accidentally touch one of them and ground, there is no complete circuit path.

You can purchase an isolation transformer from several sources. A fairly typical one is the Allied Transformer, type 6K181VCP. Rated at 150 VA, it comes with both a three-conductor plug and receptacle built in. To use it, simply plug the transformer into the wall, and the equipment you are working on into the transformer. The 150-watt rating should be sufficient for most electronics-shop applications. It may be purchased from Allied Electronics (401 East 8th St., Fort Worth, TX; Tel. 800-433-5700).

**Summary.** Electric shocks are very serious and can cause severe injury or fatality. Ground-fault shocks are especially dangerous because the current usually flows through the chest and they are somewhat unexpected.

The devices and techniques described in this article can help to prevent ground-fault type electric shocks, but nothing can protect you from shocks caused by simultaneous contact with both sides of the line. **When working near line connections, it is a good practice to make sure the power is off at the junction box.** The best safety measures you can observe are care and good cautious judgement. ■

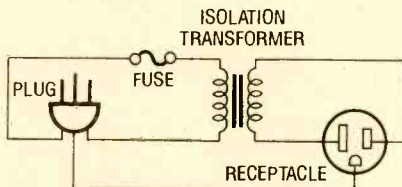

*Fig. 3. The isolation transformer provides total ground-fault protection. However, it cannot prevent shock from direct contact with the transformer leads.*



# GIZMO

NOVEMBER, 1990

VOLUME 3,  
NUMBER 11

A CHRONICLE OF CONSUMER ELECTRONICS

## A Farewell to Analog

**SONY STR-D2010 AM/FM STEREO RECEIVER WITH DSP.** Manufactured by: Sony Corporation of America, One Sony Drive, Park Ridge, NJ 07656. Price: \$1100.

Digital signal processing, or DSP, is going to be a very important factor in the evolution of consumer-electronics equipment in the 1990's. While DSP's potential is sure to be abused by some designers and manufacturers, and overlooked by others, many will leap to take advantage of its power. Until things settle down we will undoubtedly see a lot of strange and unusual—and largely useless—things done in the name of DSP, but we will also be treated to many exciting new processes and applications made possible by this high-speed digital technology.

Sony has long been committed to the digital realm, and one of the first DSP units on the market is its *STR-D2010* AM/FM stereo receiver. Since our space here is limited, you'll have to take our simple word for it that as a receiver and amplifier the unit performs acceptably (output, by the way, is rated at 195-watts-per-channel into eight ohms from the front two channels, and at 15-watts-per-channel from the two surround-amp ones). What we'll concentrate on here is the receiver's DSP section.

If you're new to it, here's some background on DSP. (It's really quite simple, at least conceptually.) To begin with, the analog signal is converted into digital form. If a signal already in digital form is applied to the Sony receiver's digital inputs, switchable sampling frequencies of 32, 44.1, and 48 kHz are available. Otherwise, the unit uses 16-bit A-to-D conversion at a fixed sampling rate. (The switchable sampling rate depends on the equipment and system used in preparing and playing back a recording; CD's use a rate of 44.1 kHz. Switching, by the way, is automatic, so this information is presented solely for your information; you needn't concern yourself with it.



CIRCLE 50 ON FREE INFORMATION CARD

Now, once the analog signal has been converted into a string of binary numbers the fun begins. It is a (relatively) simple matter to manipulate those numbers in any way you desire, and the things you can do, and the results you can obtain by that number crunching can be spectacular. By operating on only certain numbers, to give a simple example, you can enhance signal response at a few frequencies, or provide digital equalization across the band. Doing things that way does away with awkward analog filters (hardly used anymore, anyway), whether they are plain old R-C types or more sophisticated op-amp ones. Digital filtering eliminates most sources of imprecision and gives a much greater measure of control.

At a slightly more advanced level, by passing the digital signal through a (digital) delay line, and then adding it back to the original signal stream, you can achieve any sort of echo or reverberative effect you like.

After digital processing has been performed, the transformed digital numbers are converted back to analog form (Sony uses a proprietary chip incorporating an 18-bit digital filter with 8x oversampling in that process, and dual 18-bit D-to-A converters) and can be reproduced conventionally. Sorry, no digital speakers yet.

Now, what does Sony do with all that digital power? There's so much, at least for

those of us being confronted for the first time with DSP, that Sony has built into the *STR-D2010* a program to demonstrate all the receiver's capabilities. By pressing the button on the front panel marked "display/demo" until the word "Demo" appears on the display, you can get the receiver to put itself through its paces. As it cycles through the modes you get a demonstration of: the digital parametric equalizer, the digital surround processor, the DDS (digital dynamic sound), the display (real-time spectrum analyzer, peak level meter, equalization-curve display), and a feature called "Index Tuning" that lets you group radio-frequency presets according to the type of program material the stations feature. Note that in describing the demo mode we have just demo'd for you a large number of the receiver's DSP capabilities, and then some. The display, and especially Index Tuning, are not directly related to signal processing.

The parametric-equalizer section of the *STR-D2010* is a good example of what can be done with DSP, and replaces the conventional bass and treble controls. A parametric equalizer differs from the more conventional sort (commonly known as a "graphic equalizer") in that you change not the device's response in different frequency bands (hence "n-band graphic equalizer"), but the way the audio spec-

*(Continued on page 5)*

TURN PAGE FOR CONTENTS



# This month in GIZMO

Sony STR-D2010 Stereo Receiver.....	pg. 1
Omnispeaker Outdoor Speaker.....	pg. 2
Heathkit AD-2550 Surround Sound Processor.....	pg. 3
Personal Office Desktop Organizer.....	pg. 4
Casio Pocket Color TV.....	pg. 6
Pioneer Integrated Amplifier.....	pg. 6
Telecommand Home Controller.....	pg. 6
Winegard Satellite Dish.....	pg. 6
Automatic Fax Switch.....	pg. 7
Behavior Modifier.....	pg. 7
Motion Activated Alarms.....	pg. 7
Remote Control Extender.....	pg. 7
Answering Machine Stopper.....	pg. 8
Elexis Sun Monitor Watch.....	pg. 8
Game Boy Screen Light.....	pg. 8
Sound-System Accessory Light.....	pg. 8
Telephone Call Controller.....	pg. 8
Competition Joystick.....	pg. 9
Hitachi Video Printer.....	pg. 9
Mini Hi-Fi.....	pg. 9
Personal Paper Shredder.....	pg. 9
Auto-Sound Processor.....	pg. 10
E-mu Piano Simulator.....	pg. 10
Talking Translator.....	pg. 10
Tiny DC Changer.....	pg. 10

Gizmo is published by Gernsback Publications, Inc., 500-B Bi-County Blvd., Farmingdale, NY 11735. Senior Writer: Josef Bernard. Contributing to this issue: Fred Blechman, Marc Spiwak. ©Copyright 1990 by Gernsback Publications. Gizmo is a registered trademark. All rights reserved.



CIRCLE 51 ON FREE INFORMATION CARD

## Sound in the Ground ... Can You Dig it, Man?

**OMNISPEAKER OUTDOOR SPEAKER.**  
Manufactured and Distributed by: Tripod International Co., 15224 East Stafford Street, City of Industry, CA 91744-4418. Price: \$129.99/pair.

Somebody made a mistake. When we requested the *Omnispeaker* outdoor speakers for review from *Tripod International*, we thought they were going to send us a pair of speakers-in-plant-pots ... an interesting concept in speaker enclosures. The idea behind those is that you can situate them just like the hanging planters they are, anywhere indoors or out, disguising the source of sound by blending it in with your living room or patio decor.

Well, when we unpacked what we got, we discovered that we couldn't plant anything *in* our speakers; we had to plant *them!* Yes, the Omnispeaker is made to be buried outdoors in your garden or patio, or near your pool, to provide what might be the ultimate in camouflaged listening. (The speakers arrived here in January; this review is late because we had to wait for the ground to thaw out.)

The Omnispeaker is a two-way design in a green plastic housing. Inside is a two-inch tweeter, together with an eight-inch driver for the mid- and low-frequency ranges. The system is rated to handle 100

watts of continuous power. (If it starts running hot, you can always hose it down ... it's waterproof.) A green plastic cap with a screen—which you leave sticking out of the ground, five inches above the surface—protects the system from the direct onslaught of the elements, and prevents dirt, leaves, and other debris from accumulating within it. You can also use the cap as a ground-level tabletop for snacks or drinks as you lounge alongside it by the pool. Don't worry too much about spills. The Omnispeaker is supplied with 50 feet of heavily insulated 18-gauge cable that's intended to be buried in a shallow (4-6-inches-deep) trench you dig between the speaker location and your amplifier or switch box.

The ground around here is pretty hard, but fortunately we have a patch that we use for growing tomatoes, and which is pretty well dug up already. Before putting in the tomato plants for the season, we planted the Omnispeakers. The instructions tell you to dig a hole 16 inches square, and 10 inches deep. Doesn't sound like much ... until you start digging. To plant the Omnispeakers you have to remove something more than a twentieth of a cubic yard of dirt. Again, that doesn't sound like much ... until you see it piled up.

Anyway, we dug the holes and buried the speakers up to their necks, leaving the requisite five inches of enclosure sticking out to let the sound escape. Then we connected the cable (in all honesty, we didn't bother to dig the trench for it since we knew we were going to have to unearth the speakers, hose them off, and return them after the review) and turned on the music.

The sound was about what you'd expect  
(Continued on page 5)



## You're Surrounded

**HEATHKIT AD-2550 SURROUND SOUND PROCESSOR.** Manufactured by: Heath Company, Benton Harbor, MI 49022. Price: \$199.95.

Nowadays, surround-sound processors can cost a pretty penny, and some of them, quite frankly, don't surround you in all that much sound. However, the *Heathkit AD-2550* happens to be a true Dolby Surround Sound processor, and it's available as a kit for under \$200. And its performance is excellent.

For those of you who are unfamiliar with surround sound, here's a brief explanation of how the process works: Basically, true Dolby Surround Sound, better known as Dolby Stereo, is the same sound that you hear in a movie theater. When seated in a movie theater you will hear left-front, center, right-front, and surround (or rear) audio channels—four channels in all. That adds up to one magnificent audio-visual experience that is designed to make you feel as if you're in the midst of the action.

Any Dolby-Surround program material that's been properly transferred to any stereo format (VHS stereo, Beta Hi-Fi, VHS Hi-Fi, LaserDisc, MTS stereo, etc.) is encoded with the same four audio channels. So it is possible to accurately reproduce the intended sound effects if you're using a true Dolby Surround Sound decoder, like the AD-2550. Of course, the effects will be most dramatic with any of the Hi-Fi formats including LaserDiscs. That's because those formats offer you the best frequency response, signal-to-noise ratio, and stereo separation.

The AD-2550's features include left- and right-audio inputs, and left-front, center, right-front, sub-woofer, and two surround outputs. The left- and right-front outputs are obvious—they simply connect to a stereo TV or an extra input on your home-stereo amplifier. The center output is used to keep the actor's voices "on screen" if your left- and right-front speakers are more than ten feet apart—it is unnecessary otherwise. That output must be connected to a separate mono amplifier, and the speaker should be located just below the screen. The sub-woofer output, which is also optional, can provide you with room-shaking bass if you connect it to a separate amplifier and sub-woofer.

The two surround outputs are actually the same channel. So, to achieve the surround effect, you really have to connect only one amplifier and speaker (although two—one in each rear corner of the room—are more effective). At least, that's what you need to do with many lower-cost

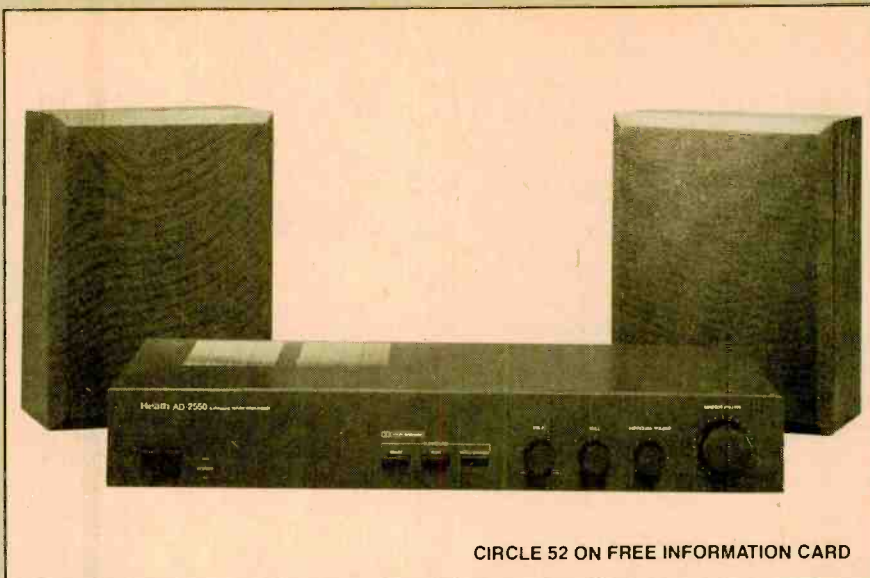

CIRCLE 52 ON FREE INFORMATION CARD

processors. The AD-2550 includes a built-in 20-watt amp that makes putting the system to work a bit easier for those on a tight budget. What's more, Heath throws in two 4-inch speakers (in ported, black-vinyl finished enclosures) with each unit.

But for those with the money, and the space, a full-blown Surround-Sound system, including the center and subwoofer channels, is a joy to experience—especially when coupled with a large-screen monitor. Don't be too surprised, however, if your friends and neighbors start dropping by a little more often.

The AD-2550's front-panel includes a time-delay control, null control, surround volume, and master volume. The time delay is used to vary the timing between the front and rear speakers to add ambience, or "roominess," to any room. The null control balances the inputs to achieve the best surround sound possible. The surround-sound volume control allows you to vary the 20-watt speaker outputs, and the master volume control varies all outputs simultaneously. All of those controls allow you to tailor the sound to a particular room according to its size and the speaker placement.

The AD-2550 can be used in any one of three modes: Dolby Surround, Music Surround, and Mono-Enhance Surround. Dolby Surround, what we've been talking about, is used for surround-sound effects on Dolby-stereo encoded material. Music Surround adds depth to any stereo-audio source, regardless of whether or not it is Dolby encoded. Material such as records, cassettes, and CD's fit that bill. The Mono-Enhance mode simulates stereo surround from a mono signal. Although it doesn't exactly duplicate stereo, it does provide a somewhat fuller sound from a mono source. Automatic Dolby-B noise reduction is also included, to properly bias such material.

There's only one hitch to getting such

great surround sound for under \$200: As you might have guessed, the AD-2550 is available only as a kit. But if you have pretty good assembly skills (basically soldering), you shouldn't have any trouble getting the unit together and, of course, getting it to work. I assembled mine in ten leisurely hours that included several trips to the kitchen, and other places.

However, Heath does not recommend this project for inexperienced builders. Those with no construction background should try their hand at a few simpler tasks first, or at least enlist the aid of someone who's more familiar with these sorts of things.

The instruction manual is very easy to understand, and each step is completely explained; that should come as no surprise to anyone familiar with Heathkit's reputation. The instructions even include resistor color codes for each resistor, as well as all possible capacitor-identification markings.

If you don't have a lot of test instruments, don't worry; the only required alignment procedure involves adjusting one potentiometer—basically in the center of its adjustment range, and you tweak it by ear. A multimeter is required for a few precautionary last-minute checks of the power-supply wiring.

Assuming that you do a good job in following the instructions, the odds are good that the unit will work the first time you plug it in. And, if you do have any trouble, there's a complete troubleshooting section in the manual; Heath also offers technical assistance by telephone if you really get bogged down.

The finished unit gives no hint that it started out life as a kit. The black, all metal cabinet is attractive, and measures 2¾ inches high, 17 inches wide, and 8½ inches deep. The processor weighs about 12 pounds.

(Continued on page 5)



# Office on a Desktop

**PERSONAL OFFICE DESKTOP ORGANIZER.** Produced by: Top Ten Software, 40308 Greenwood Way, P.O. Box 1450, Oakhurst, CA 93644. Price: \$79.95.

*Personal Office* is an integrated software package designed for small-business and home users. It includes a desktop organizer, word processor, database manager, spreadsheet, label printer, and communications modules. Pull-down menus and help screens make each of the modules easy to use.

This is not a new program, but was designed in Great Britain, and claims 400,000 satisfied users worldwide. The latest version, 3.01, is now being marketed in the United States by *Top Ten Software*.

The desktop organizer and communication modules set *Personal Office* apart from other integrated packages, including those priced much higher. The organizer includes an address/telephone book, a calendar, an appointment book, an expense-report generator, a U.S. postage-rate calculator, a U.S. and metric weights and measures converter, a foreign-currency converter, a distance calculator, and a U.S./world-time clock.

*Personal Office* is designed for IBM PC/Tandy and compatible computers with at least 512K of RAM, and using DOS 3.0 or greater. The package contains four 360K 5.25-inch and two 720K 3.5-inch diskettes, so it can be run from all currently popular floppy drives. You can get by with one floppy drive (two floppies are no advantage), but a hard drive offers the smoothest operation.

Extensive printer support is provided, and you can easily modify the built-in printer drivers to use all the features and type styles of your printer.

I used *Personal Office* on four machines—a Toshiba T1000 laptop with one floppy drive, an IBM PC/XT with two floppy drives and a CGA monitor, a 286 AT clone with a hard drive and VGA graphics, and a 286 AT laptop. My printer was an Epson LX-810, which responded to the Epson FX program driver.

You'll need some kind of graphic display—Hercules, CGA, EGA, or VGA: laptop LCD displays may be troublesome, however. On my Toshiba T1000, the reverse-video menu selection bars were not visible on some screens, though perfectly visible on an external monitor plugged into the T1000. On the 286 AT laptop, some "colors" and the cursor were often a very light hard-to-see shade of gray. No problem with VGA on my other AT, or Hercules monochrome on my XT.

The 5.5-inch by 8.5-inch perfect-bound

Working at home has never been this easy!

**PERSONAL OFFICE™**

**CompuServe**

The package includes:  
 ■ a **FREE** membership  
 ■ **\$15 Usage Credit**  
 to the world's largest personal information service.

DESKTOP ORGANIZER  
 WORD PROCESSOR  
 DATABASE  
 SPREADSHEET  
 LABEL PRINTER  
 COMMUNICATIONS

IBM PC/TANDY 512K and Compatibles  
 Supports HGA, CGA, EGA or VGA graphics  
 Requires DOS 3.0 or greater  
 CONTAINS BOTH  
 4x5 5.25" Disks and 3.5" Disks

3.5" Disk Also Included!

MEMBER  
**TOP TEN**  
 SOFTWARE GROUP

CIRCLE 53 ON FREE INFORMATION CARD

212-page manual is especially well done. The printing is clear and there are numerous screen illustrations, especially in the communications section. Both the Table of Contents and Index are finely detailed.

Throughout the manual, it seems pain has been taken to insure beginner success, and yet allow power users to access the many advanced features built into the various modules. For example, the discussion and detailed connection diagrams describing direct wiring between two computers for hard-wire data transfer is the most complete and best I've seen in any program manual. There is also significant discussion of different communication protocols.

Although the manual seems large, almost half of it is devoted to the subject of communications, since *Personal Office* offers relatively sophisticated capabilities in this area, especially for an integrated package.

About the only documentation improvement I could suggest would be to make the manual spiral bound for ease in handling,

and to include program-file limitations (how big can the spreadsheet be? how many records can you put in the database?)

If you use *Personal Office* with a hard drive, you'll first need to install the four 5.25-inch or two 3.5-inch floppies onto your hard drive from the A drive. This works quickly and easily with an **INSTALL** program, and is definitely the way to go.

If you don't have a hard drive, plan on doing everything from one floppy, not two. The program can be run with two drives, but you must constantly change the drive path whenever you would normally just swap a disk. Believe me, it's easier to use one drive, and far better to use a hard drive.

Once in memory, the program runs very comfortably, and is almost seamless with a hard drive. From the Main Menu you can select any of the principal modules. If you're operating from a hard drive, the selected module pops up very quickly, but if you're using floppies you may have to change disks. (Unfortunately, the program



only displays a message saying the program has not been found, and does not tell you to change disks.) It seems the real intention of the programmers was to have you use a hard drive.

Using the various modules within Personal Office takes some practice. Most of the programs are quite powerful, and have many features and hot keys that will take you time to learn. An excellent step-by-step tutorial gives you hands-on experience with each of the main modules. You write and print a letter, create a spreadsheet and database, print labels, merge names and addresses into a form letter, and ends up by logging into Top Ten Software's Customer Support Service bulletin board.

The word processor has all the conventional functions, but I could not find a way to number pages other than starting with Page 1. It allows you to save your document in its own format, or in ASCII with carriage returns at the end of each line, or just at the end of paragraphs—a very handy feature.

The spreadsheet has all the expected features, including many arithmetic, logic, trigonometric, logarithmic, and numeric functions that allow very powerful "what if" inspection.

I couldn't find the maximum spreadsheet size in the manual. Scrolling to the limits shows 52 cells across and 200 down. Not enough to keep a corporate power-user happy, but certainly enough (10,400 cells) to do most jobs.

Similarly, the manual does not indicate any limit of records for the database, so it may be limited only by disk space. That could be important if you're working with floppies.

The communication module is by far the most complex part of the package. It offers a complete script language (50 pages of the manual are devoted to this language alone!) as well as two different text editors and seven different transfer protocols. That does not mean it can't be used for simple communication, but if your needs are modest, it might be like driving a Mack truck to the store for a loaf of bread!

The desktop accessories listed earlier are very easy to use, and could be very handy in an office environment. The postage-rate calculator and foreign-currency conversion portions can be updated as rates and currency equivalents change.

The package does not include any book-keeping, payroll, invoice, or accounting functions other than the expense-account generator. It is, however, a very complete and well integrated combination of the most-used program requirements of a small office or home-based business—word processing, database, spreadsheet and communications, together with neat features like label printing, mail-merge and desktop organizers. ■

## SONY RECEIVER

(Continued from page 1)

trum itself is divided into bands, and the way the audio signal is processed in each of those bands. You adjust the equalizer's parameters, hence the name. A parametric equalizer is a very powerful sound-shaping tool.

Another interesting, although less useful, of the DSP features, termed "digital dynamic sound," takes the place of a loudness control. DDS, through the magic of high-speed number crunching, provides a compression effect, increasing the level of low-level signals—and thus the average signal level—without changing the maximum signal level. That, says Sony somewhat confusingly, allows you to enjoy "...dynamic sound even at small output levels." While we will not deny that signal compression does add to the "punch" of a signal, musical or otherwise—it is, in fact, already much used and overused in the recording and broadcasting industries—it does *not* add to the dynamics of a piece of music, but rather reduces them.

We would much rather have seen that feature implemented in reverse—as a dynamic-range expander—to restore some of the dynamics lost in the compression processing introduced at various stages between the time of the recording session and the time the music is reproduced by your speakers. Be that as it may, DDS is a very good example of what can be accomplished by digital signal processing, and of the sort of thing we can expect to see in the next few years. We're sure someone (if not Sony, then another manufacturer) will use a process such as it to provide dynamic-range expansion.

The STR-D2010 also includes several other features that deserve mention. There's Dolby Surround processing (which is accomplished digitally) as well as several other ambience effects made possible by recirculating signals through RAM at various intervals. As a fringe benefit of DSP, the receiver can link any of seven different equalization curves (see above) to a particular radio station. For example, if you find that one of your favorite stations consistently requires a high-end boost to make it come alive, you can store an EQ curve to do just that and, with a feature that Sony calls "EQ Link," recall those settings whenever that station is tuned in.

For use with CD players and DAT decks—when they get here—there are digital inputs—one each, coaxial and optical. There are plenty of analog inputs and outputs, too, including two pairs of S-video inputs and outputs and a set of up-front RCA jacks for quick and convenient connection of video equipment.

Of course, the STR-D2010 comes with a remote control: 66 buttons and three slide switches. One of the switches selects

"Sony standard" or "user standard" infrared-control codes, and a good portion of the remote is trainable to operate your other A/V system equipment. Not *every* function is labeled for you, but there are certainly enough of them to permit you a large degree of control of your system from the one remote unit.

If you are eager to plunge headfirst into the DSP revolution, the Sony STR-D2010 deserves your attention. It has a number of noteworthy features that make good use of that new technology. However, bear in mind that this is just the beginning. As the technology matures there will be lots of new developments and we predict that DSP will be at the top of the list of attractions at (at least) the next few Consumer Electronics Shows. If you can't wait, though, try this one. ■

## SOUND IN THE GROUND

(Continued from page 2)

from an outdoor speaker. Not great, but adequate. We found it a little on the thin side unless we were right nearby, but that is understandable given the fact that it really takes a lot of energy to produce a usable sound level outdoors where there are no nearby reflecting surfaces to contain the energy. The bass content of the system's sound also seemed to increase as we put our ears closer to the ground. The ants and earthworms probably loved it, and the moles are now being fitted for hearing aids.

The sound produced by the in-earth Omnispeakers is not spectacular, but you most likely would not use them for serious listening, anyway. They do an adequate job for the sort of material you probably would want in your garden or by your pool, though—quiet, unobtrusive, easy-listening background music. For that they're just fine.

PS: After all this, it turns out that Tripod International *does* manufacture several planter-speaker combinations. Maybe next year ... ■

## YOU'RE SURROUNDED

(Continued from page 3)

The final truth, of course, is not in the unit's appearance, but in its performance—and the results were superb right off the bat. As a comparison, the pictured unit replaced an old pseudo-surround-sound decoder (not true Dolby) that I had been using for some time, and the difference between the two was incredible. The AD-2550 is quite selective in what is heard in the rear channel, while the pseudo unit's rear channel was pretty much on all the time with the exception of a loud spot here and there. The AD-2550 really delivers what surround sound is all about: sound that surrounds you. ■



# ELECTRONICS WISH LIST

For more information on any product in this section, circle the appropriate number on the Free Information Card.

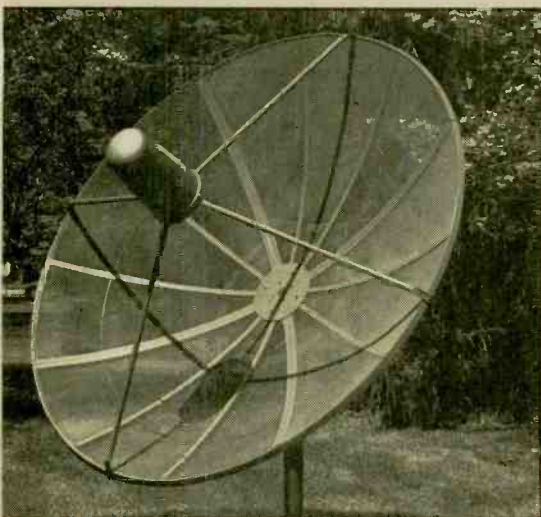

Winegard Satellite Dish

## Mini Satellite Dish

High price and highly visible (read eyesore) receiving antennas have kept many potential buyers from experiencing the benefits of satellite TV. Now, Winegard (P.O. Box 1007, Burlington, IA 52601-1007) has introduced a new dish antenna, the 7.5-foot *QuadStar Model QD-0750*, that they hope can overcome both obstacles. With all the features of its 10-foot cousin, one of the industry's most popular low-cost antennas, the dish was made possible by today's higher power satellites and improved receiving electronics. Designed for fast, easy assembly, the mesh petals are positioned in aircraft-grade aluminum ribs that are formed in an accurate curve for a clean appearance. Price: \$350

CIRCLE 54 ON FREE INFORMATION CARD



Telecommand Home Controller

## Telephone Home Controller

The *TeleCommand System 100* from *JDS Technologies* (17471 Plaza Otcal, San Diego, CA 92128) is a telephone-controlled home-automation system that lets you take command of virtually any device in your home from any convenient telephone, either in the house or world-wide. Simple two-digit command codes allow you to do anything from turning on lights to controlling home heating and cooling systems. To use the TeleCommand, just plug the unit into any AC outlet and telephone jack. Devices to be controlled can be connected directly to the unit, or plugged into a remote module (sold separately). Features include local and remote programmability, two remote-access codes, programmable restrictions, programmable momentary control, programmable AC outlet and relay terminal for hardwired applications (computers, security systems, etc.), and discrete confirmation tones for on, off, and momentary commands. The system is X-10 compatible, and is compatible with most powerline-carrier control systems. Price: \$499.

CIRCLE 55 ON FREE INFORMATION CARD

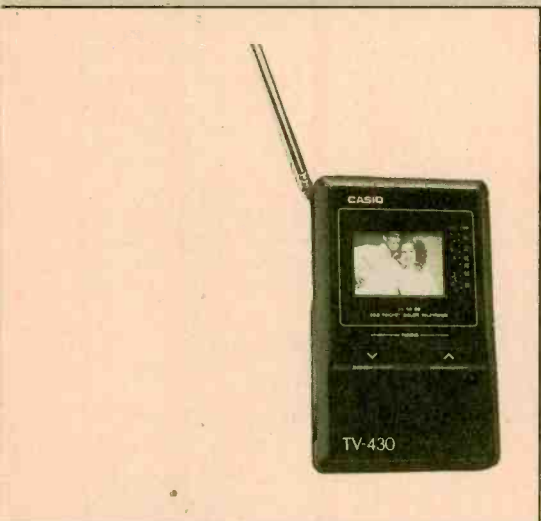

Casio Pocket Color TV

## Tiny TV

For those who like to catch their TV on the run, *Casio* (570 Mt. Pleasant Ave., P.O. Box 7000, Dover, NJ 07801) has introduced the latest member of their line of pocket-sized TV sets. The *TV-430* features Casio's HQ-M2 passive-matrix, high-resolution, color liquid-crystal display. A high luminance, fluorescent material is used for backlighting to provide the clearest and brightest possible picture. The unit measures just  $5\frac{1}{8} \times 3\frac{3}{8} \times 1\frac{1}{4}$ -inches and weighs 8.5 ounces. It can be powered by four "AA" batteries, via an optional AC adaptor, or via an optional car-adaptor line. A soft carrying case as well as a telescoping VHF/UHF antenna are included. And for those who don't like a lot of company when watching TV at home, there's an external antenna input for hook-up to an outdoor antenna or cable system. Price: \$299.

CIRCLE 56 ON FREE INFORMATION CARD

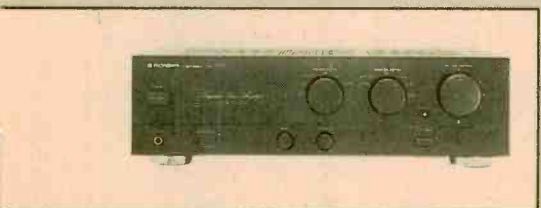

Pioneer Integrated Amplifier

## Low-Priced Amplifier

Those searching for a decent amplifier to complete a surround-sound system or a moderately powered stereo system will want to check into *Pioneer's* (2265 E. 220th St., P.O. Box 1720, Long Beach, CA 90801-1720) latest offering. The *A-337* integrated amplifier is designed to appeal to "cost-conscious" consumers with more modest power requirements. Still, at 40-watts-per-channel (into 8 ohms), it is ideal for those looking for a small amp to power the effects channel during surround sound or digital-sound-field processing. The unit features "direct-connection" circuitry that allows the signal to follow the shortest path from input to output, and provides connections for two pairs of speakers, which can be driven independently or simultaneously. Price: \$250.

CIRCLE 57 ON FREE INFORMATION CARD



For more information on any product in this section, circle the appropriate number on the Free Information Card.

# ELECTRONICS WISH LIST

## Simple Security System

Unfortunately, one of the facts of life in the latter part of the 20th Century is that no matter what you own, there's always someone out there ready to take it if they can. That's the reason for the tremendous growth in the security industry. Modern security systems can set you back a bundle, but there is a more modest solution for those in a more modest situation. New from *Teiko* (26611 Cabot Road, Laguna Hills, CA 92653) are two low-cost security alarms. The *S001* and *S002* are one-piece motion-activated units. Each uses a passive IR motion sensor to trigger a built in 110-dB alarm. Powered by a 9-volt battery, the units are wall mountable and provide a horizontal detection area of 110 degrees at 60 feet. A vertical detection control allows the alarm to coexist with pets. The *S001* provides an on/off keylock; the *S002* features an alphanumeric keypad and a user-selected security code. Price: \$29.99 and \$39.99, respectively.

CIRCLE 58 ON FREE INFORMATION CARD

## Better Lives for Couch Potatoes

You can improve your life and mind even as you're watching Monday night football or *Roseanne* on TV. Hard to believe, isn't it! Well, *MindVision*, a product of *Gateways Institute* (P.O. Box 41, Ojai, CA 93023), claims to be able to help you do this, without your even being aware that it's happening. The *MindVision* system uses specially prepared tapes that you play on your VCR while watching off-the-air or cable programming (or even tapes, if you have a second VCR). The tapes contain messages such as "I lose weight easily," "I see myself thin," or "I am a non-smoker" that are mixed with the ordinary program material you are watching and are flashed so briefly on the screen that they are invisible to the eye. (However, a control on the unit allows you to turn up the messages so you can read them if you want to make sure you're getting the right one.) The messages, which appear about 5000 times in the course of an ordinary sitcom, do register on the mind subliminally, however, and some say that method really works in modifying behaviors. It has been estimated that by the time a child reaches 18 years of age, he has spent over 18,000 hours in front of the TV set ... compared to only about 12,000 in school! If you have a message for him, this may be the way to get it across. Price: To be announced.

CIRCLE 59 ON FREE INFORMATION CARD

## Remote Control Extender

Ushering in the dawn of "designer electronics"—at least in the eyes of their Swiss distributor, *Sicommerce* (in the U.S. contact Ken Brown Associates, 256 Commerce Dr., Suite 471, Peachtree City, GA 30269)—comes the *Remex Cy-Klön* remote-control extender. The two piece system uses an RF link to allow you complete command of your gear from anywhere in, or near, your house. The system consists of a converter that translates the IR signals from a conventional remote to an RF signal, and a receiver that is located near the gear to be operated. The system can run from either batteries or an AC adapter. The unusual looking units may not be your cup of tea, but at least your guests can ask: Is it art, or is it *Remex*? Price: \$89.

CIRCLE 60 ON FREE INFORMATION CARD

## Automatic Fax Switch

All of the "conveniences" offered by your telephone, answering machine, computer modem, and fax can really get to be a nuisance sometimes. To the rescue comes the *ASAP TF 555* automatic fax switch from *Command Communications, Inc.* (10800 E. Bethany Dr., Suite 300, Aurora, CO 80014). Acting as a mini switchboard, the unit "reads" the incoming call and automatically transfers it to the appropriate equipment. The automatic functions can be overridden by picking up another phone on the line. The user can then carry on a normal telephone conversation or direct a voice call with tones or pulses to an answering machine for voice mail, a manual fax call to the fax, or transfer the caller to an auxiliary port, which can be a PC modem. Among the switch's user-programmable features are port security codes, phantom ring-back options, nighttime fax handling, line-clear notifications, and fax junk-mail screening. Price: \$199.95.

CIRCLE 61 ON FREE INFORMATION CARD

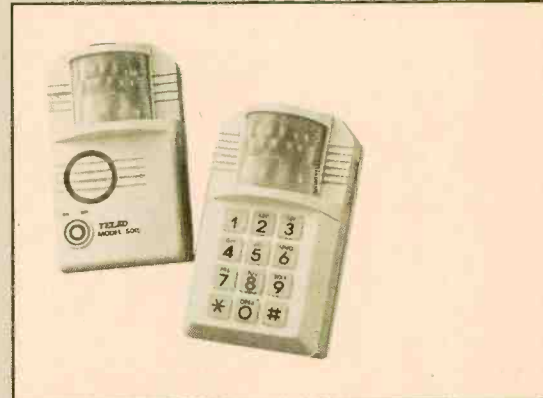

Motion Activated Alarms

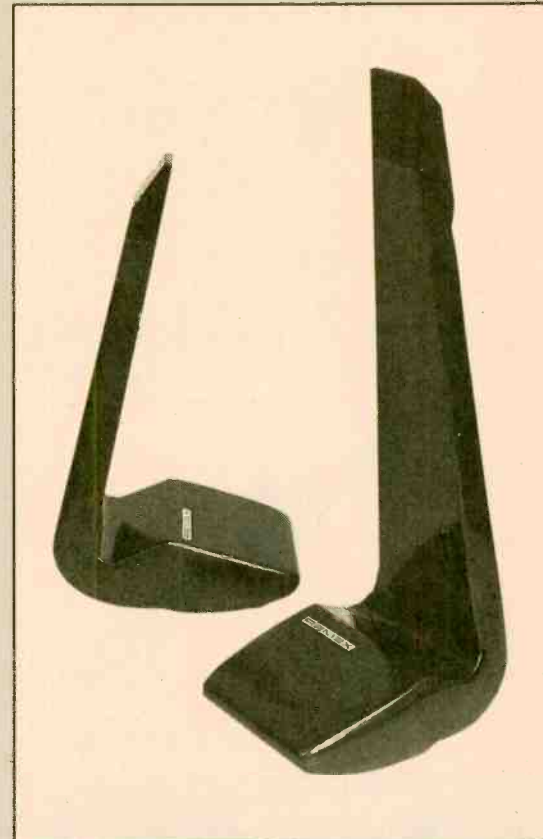

Remote Control Extender



Automatic Fax Switch

# ELECTRONICS WISH LIST

For more information on any product in this section, circle the appropriate number on the Free Information Card.

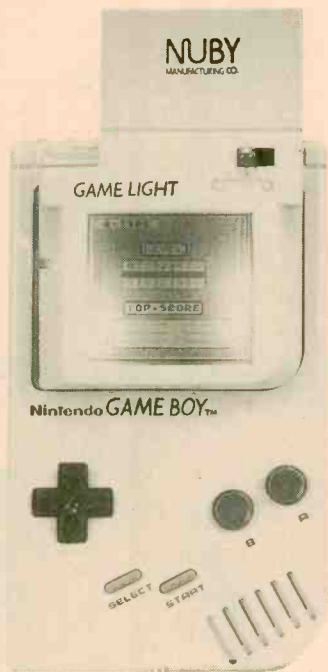

Game Boy Screen Light

## Game Boy Light

There're never enough hours in the day to play with your Nintendo Game Boy. At least that's what *Nuby Manufacturing* (30 Fitzgerald Drive, Jaffery, NH 03452) seems to think. Their answer? The *Nuby Game Light*. Designed to let users play their Game Boy in dark or dim areas (like under the covers after bedtime), the Game Light uses a unique frame of light to improve viewing contrast and visibility. The unit is powered by 4 AA batteries (not included) and snaps directly to the Game Boy. Price: \$9.95.

CIRCLE 62 ON FREE INFORMATION CARD

## Leitmotif Music Light

*LightWave*, from *Marantz* (PO Box 2066, Aurora, IL 60507) is an accessory light for high-fidelity music systems. It consists of a clear tube, measuring about 15 inches long and half an inch in diameter, filled with miniature "grain-of-wheat" type incandescent light bulbs. The tube fits in a metal housing that can be attached underneath a slide-out turntable shelf or under the top (or any shelf) of a music system equipment cabinet. When plugged into the "switched" AC outlet of a receiver or amplifier, the unit illuminates the components of a system with a gentle light whenever they are turned on. An accessory AC receptacle on the *LightWave's* plug replaces the switched outlet used to power it. Price: \$24.95.

CIRCLE 63 ON FREE INFORMATION CARD

## Answering Machine Stopper

One of the more annoying things in life is hearing your phone ring and then just missing picking it up before your answering machine can get to it and lock you out (until, as soon as it's finished delivering its message, you get your chance and shout, "Wait, wait... I'm really here!"). The *Message Stopper* is an inexpensive little product from *Design Tech International* (7401 Fullerton Road, Springfield, VA 22153) that allows you to cut in on your machine if it tries to lock you out. You simply plug the *Message Stopper* into a modular phone jack, plug the answering machine into its green jack and the phone that was plugged into the answering machine into its red one, and you're back in control. Should a call then come in and you get to it just a "tad" too late, picking up any phone will override the answering machine's lockout and put you on the line live. Price: \$14.95.

CIRCLE 64 ON FREE INFORMATION CARD

## Sunburn Alert

Hey dudes, worried that you've been catching too many rays? Well, a new watch from *Elexis* can help you chill out. Seriously, overexposure to the sun can lead to skin cancer. To help those who work outdoors, or who simply enjoy sunbathing, the *Sundial* wristwatch features an electronic monitor that warns you when it is time to get out of the sun. The users simply programs their skin type and the protection factor of the suntan lotion being used. The monitor then calculates how long the user can stay outside without being burned and sounds an alarm when the time is up. Oh, yes, it also works as a normal digital watch with time, date, and stopwatch functions. Price: Approximately \$39.95.

CIRCLE 65 ON FREE INFORMATION CARD

## Telephone Watchdog

With all of the "entertainment" telephone services around now, it's harder than ever for businesses and households to keep control over telephone costs. If you find yourself in that situation, electronic help is available in the form of the *Callbuster* from *Telcontrol Incorporated* (1489 Chain Bridge Rd., Suite 300, McLean, VA 22101). The *Callbuster* can be programmed—even from remote locations—to deny access to unnecessary calls. With it, you can control outgoing calls by area code, exchange, or number. Once restrictions are in place, they can be overridden only by a programmable 4-digit code. One *Callbuster* will control all devices on the line, and offers speed dialing for up to 90 numbers, redial, and a programmable emergency number that can be dialed even when the phone is off hook. Price: \$149.

CIRCLE 66 ON FREE INFORMATION CARD



Elexis Sun Monitor Watch

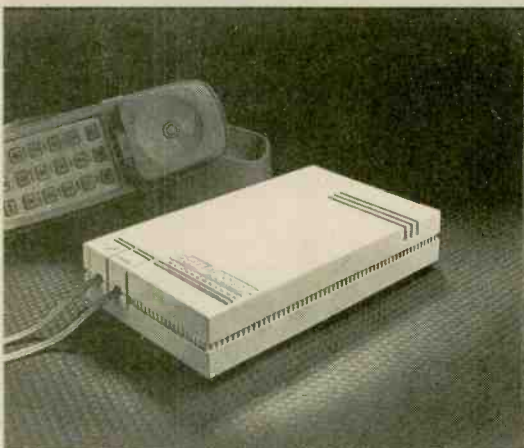

Telephone Call Controller



For more information on any product in this section, circle the appropriate number on the Free Information Card.

# ELECTRONICS WISH LIST

## Mini Hi-Fi

After an apparent failure in the marketplace a few years ago, mini components seem to be making a comeback. The *NXS-800* from *Aiwa* (35 Oxford Dr., Moonachie, NJ 07074) is a complete home stereo system in mini format. Included are a CD player and Dolby B double cassette deck—whose operations can be synchronized for recording from one to the other—but no turntable; they're passe. The system, which measures  $11\frac{1}{16} \times 9\frac{1}{16} \times 11\frac{1}{16}$  inches, includes a 55-watts-per-channel stereo amplifier with three-band graphic equalizer and a sound-processing feature called "BBE." A PLL synthesized tuner allows ten AM and ten FM presets and includes a timer and 46-key wireless remote control (that operates the entire system). Output is through a two-way bass-reflex speaker system with  $5\frac{1}{8}$ -inch woofers and  $2\frac{3}{8}$ -inch tweeters offering a response from 40 to 20,000 Hz. A "super T-bass" circuit in the amplifier is said to improve the system's bass response and imaging. Price: \$1100.

CIRCLE 67 ON FREE INFORMATION CARD

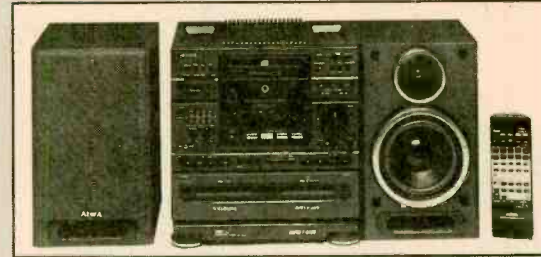

Aiwa Mini-Hi-Fi

## Competition Joysticks

If zapping invaders is your passion, you'll want to check out the line of chrome-handled, arcade-quality joysticks from *Happ Controls* (106 Garlich Dr., Elk Grove, IL 60007). *Competition Pro* models are available for the Atari/Commodore/Amiga/Amstrad, NEC PC, Nintendo, Sega Genesis, and for the IBM PC/XT/AT. Each model has specific features to provide precise control. Each features extra-large microswitch buttons, a steel shaft with spring return, chrome handles, and an unusual translucent blue base. A three-way slide switch selects special features such as rapid fire, slow motion, and neutral mode. An extra long cord and quality connector round out the package. Price: \$49.95 IBM; \$19.95 all other models.

CIRCLE 68 ON FREE INFORMATION CARD



Competition Joystick

## Color Video Printer

Video camera's have supplanted the conventional still camera in many households. Still, there's something special about leafing through a stack of snapshots that videotape just can't duplicate—until now. *Hitachi* (401 W. Artesia Blvd., Compton, CA 90220) has introduced a color video printer for the home market that is capable of producing standard-sized prints from various video sources. The new *VY-15A* printer can capture images from any TV, VCR, or camcorder, including S-VHS units, and produces crystal-clear,  $3\frac{1}{2} \times 5$ -inch photos in about 100 seconds. Printed on special thermal paper, the prints resist curling, are long-lasting, and are comparable in quality to 35mm prints. Dates, titles, illustrations, or messages in eight selectable colors can be superimposed on any video frame. Price: \$999.95.

CIRCLE 69 ON FREE INFORMATION CARD

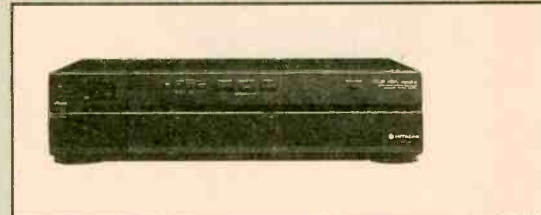

Hitachi Video Printer

## Personal Shredder

Perfect for the paranoid executive, the *AEG Olympia* (3140 Route 22, Box 22, Somerville, NJ 08876-0022) *Redi-Shred* is a personal shredder designed for a home or corporate office. Self-activating on the insertion of paper, it shreds documents into  $\frac{1}{8}$ -inch strips at an average rate of 6 sheets per second. Its opening is large enough to accommodate 6-8 sheets per pass. It also has a stop feature and a reverse switch to eliminate paper jams and overflow. At 16-inches tall, it fits conveniently under a desk. With its compact size and neutral pearl-gray color, it's the perfect alternative to a conventional wastebasket for those who handle sensitive materials. Remember, just because you're paranoid, it doesn't mean that they're not out to get you. Price: \$349.

CIRCLE 70 ON FREE INFORMATION CARD

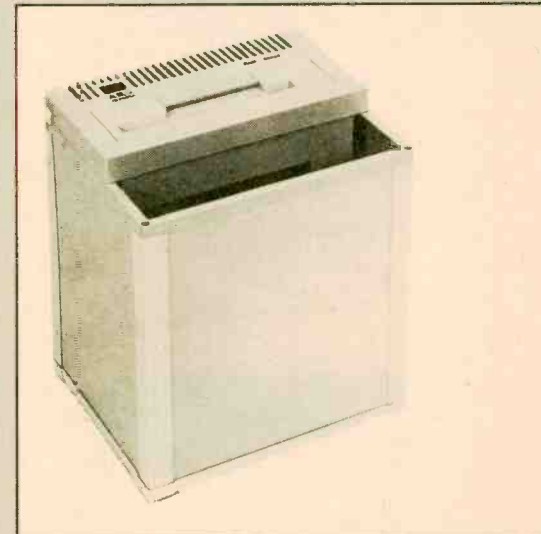

Personal Paper Shredder

# ELECTRONICS WISH LIST

For more information on any product in this section, circle the appropriate number on the Free Information Card.



Talking Translator

## Talking Translator

The *Matrix Design Interpreter*, distributed by *British Boston Marketing* (38 Newbury St., Boston, MA 02116) is a pocket translator that goes a bit beyond the norm—it actually *speaks* in 5 different European languages. It features a vocabulary of over 10,000 words and 67,000 phrases in English, Italian, French, Spanish, and German. It uses a digitized human voice (with male/female) options that speaks with perfect pronunciation and a realistic accent in each language. In addition, it offers a phrase-building feature that allows the user to type in a word via the built-in keyboard, and the Interpreter will create useful phrases related to the word. Commonly used phrases are arranged in 5 categories (money, eating, assistance, courtesy, and socializing) for easy access. A teach mode allows the user to speak and learn random words in any of the languages. Price: \$249.

CIRCLE 71 ON FREE INFORMATION CARD

## World's Smallest CD Changer

Alpine (P.O. Box 2859, Torrance, CA 90509) says that its *CD Shuttle 5952S* autosound CD changer is the world's smallest. Measuring just  $11 \times 2\frac{3}{16} \times 6\frac{1}{8}$  inches, the six-disc unit can be stashed just about anywhere—between the seats or in the trunk—either horizontally or vertically ( $\pm 30^\circ$ ). The unit, which features  $8 \times$  oversampling, two 16-bit D-to-A converters, and a second-order Butterworth analog filter, weighs only  $5\frac{1}{2}$  pounds, and includes a silicon-damped suspension and balanced servo drive to improve playability when the going gets rough. The RCA-type output jacks are gold plated, and sixteen-foot RCA and DIN cables are included with the changer. A wide variety of controllers are available. Price: \$600.

CIRCLE 72 ON FREE INFORMATION CARD

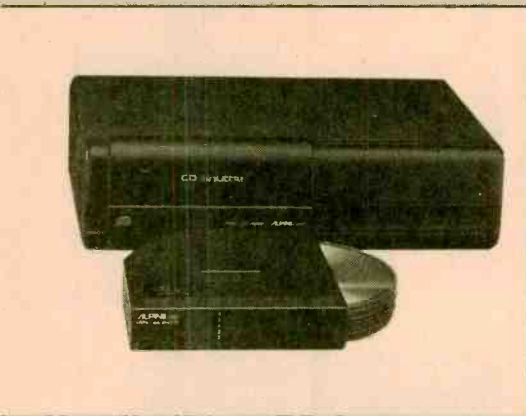

Alpine CD Changer

## Auto-sound Processor

What is said to be the first and (so far) only DSP (Digital Signal-Processing) sound processor for car-audio systems, the *EQS-1000*, has been introduced by Eclipse (Division of Fujitsu Ten Corp. of America, 19600 So. Vermont Avenue, Torrance, CA 90502). With the DSP device in the circuit, an auto-sound system can emulate one of four preset acoustical environments (*jazz club, concert hall, cathedral, and stadium rock concert*), making voices and instruments appear to move in space anywhere from 20 to 200 feet away from the listener. A function setting also lets users program four of their own listening preferences by changing the parameters for early reflection, late reflection, and subwoofer balance. A defeat control disengages the DSP unit—useful when listening to newscasts, spoken voice recordings, sports events, etc. At the heart of the DSP system is a 24-bit processor capable of performing 13 million computations per second. The minimum recommended configuration for the system calls for six speakers, including a rear subwoofer and a "center fill" speaker for the front of the vehicle. The "center-fill" speaker, which is driven by a ten-watt amplifier built into the processor, is required for all systems not already using something similar, and is available separately as an accessory (*ESG-3000*). Price: \$999.95 (*EQS-1000*), \$159.95 (*ESG-3000*).

CIRCLE 73 ON FREE INFORMATION CARD



Auto-Sound Processor

## Grand Piano in a Box

It may not be as majestic looking as a grand piano, but *E-mu Systems'* (1600 Green Hills Rd., Scotts Valley, CA 95066) *Performance/1* stereo module certainly takes up less space in your ballroom. Billed by the manufacturer as a "Grand Piano in a Box," the *Performance/1* uses digitally recorded and stored piano passages to recreate a variety of piano sounds. Among the 15 presets are classic, rock, jazz, honky-tonk blues, and more. To use the unit, users simply plug in and play any MIDI-standard electronic keyboard. The output of the *Performance/1* is fed to any high-quality stereo system to reproduce all the sonic qualities and spatial resonances that define the sound of a classic piano. The module measures just  $8\frac{1}{2} \times 8\frac{1}{2} \times 1\frac{3}{4}$ -inches and weighs  $1\frac{3}{4}$  pounds. Price: \$499.

CIRCLE 74 ON FREE INFORMATION CARD



E-mu Piano Simulator



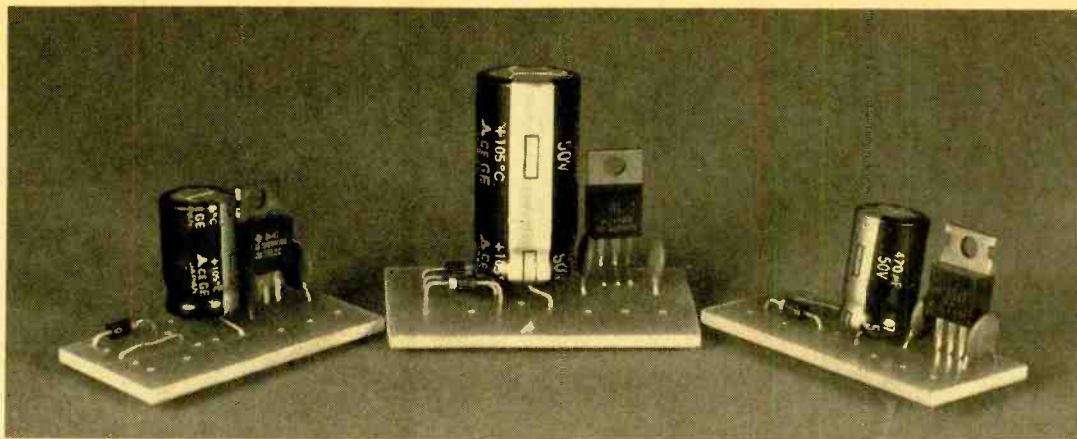

# THE UNIVERSAL THREE-TERMINAL POWER SUPPLY

*Are you tired of designing power-supply circuits for each and every electronics project that you build? With this circuit, that task will soon be a distant memory*

BY JAMES MELTON

**W**hen you design or build a project, what is your least favorite part? My least favorite part is the power supply. For the majority of electronic projects, the power supply is as exciting as a bowl of oatmeal. Since practically all electronic projects require one, I decided to sit down and eliminate at least 90% of the hassle and boredom associated with building them. That led to the birth of the *Universal 3-Terminal Power Supply*.

**About the Circuit.** Figure 1 is a schematic diagram of the Universal 3-Terminal Power Supply. Essentially, it's a printed-circuit board design that can be configured to provide either positive or negative supply voltages; it lets you select full-wave, full-wave bridge, or half-wave rectification; and can be fed from a single-winding, dual-winding, or center-tapped transformer. The circuit can handle most low-voltage power-supply needs, and can be fitted into a 1- x 2-inch space!

The Universal Power Supply uses the LM78xx/79xx series of 3-terminal regulators in the TO-220 plastic package. The LM78xx/79xx series of regulators in-

corporate thermal shutdown, so that external output protection was deemed unnecessary. In fact, about the only way to permanently damage those regulators is to hit the input with a voltage that exceeds 40 volts.

**The Regulator.** The LM78xx/79xx series of regulators takes all the pain out of small power-supply design. With the ability to regulate from 5 to 24 volts, with any output up to 1.5 amps, they are a tinkerer's dream come true. At higher currents, you should be aware that the regulator will require a heat sink. If you mount the package on the printed-circuit board with plenty of lead length left above the board, you can bend the entire package enough to mount the tab of its TO-220 case directly to the project case, thus providing a very large heat-sinking surface. As a rule of thumb, the tab is at ground potential for positive supplies and at the negative supply voltage for the negative regulators.

The output-voltage point for both positive and negative supplies is the same point, J6, but the point where you obtain a ground is different. Output J7

(labeled +) is the ground for the positive supply and output J5 (labeled -) is the ground for the negative supply. Sorry about that, but I still cannot think of a better way to label it!

**Construction.** The first step in your quest for power-supply independence is to make a few of the boards. Figure 2 is a foil pattern for the power supply's printed-circuit board. In order to use that design with the most efficiency, it will be necessary for you to get a few copies of the board design printed at a print shop. I keep about 10 around so that whenever I make a board for a project, I can cut the raw circuit-board material big enough to include a few of the supplies around the perimeter of the desired board.

The traces and pads on the board are big enough that extremely critical exposure or alignment is not necessary, thus, you should be able to use it on any board design you may contemplate making. You may even decide to print the design with the circuit board you are making and leaving it there, thus eliminating the need to mount a separate supply somewhere else.

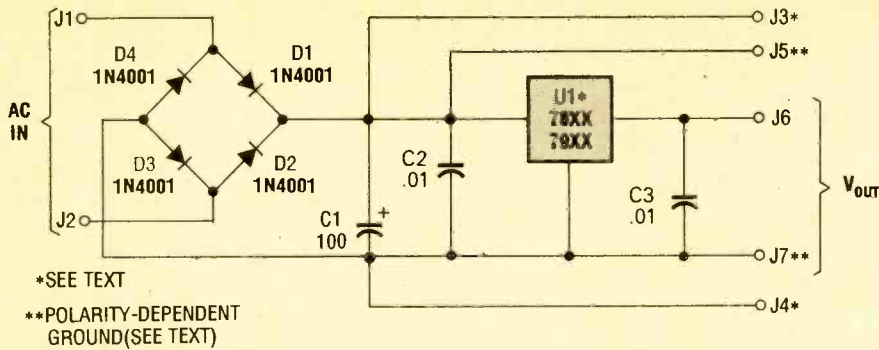

Fig. 1. The Universal 3-Terminal Power Supply is essentially a printed-circuit board design that can be configured to provide either positive or negative supply voltages; lets you select full-wave, full-wave bridge, or half-wave rectification; and can be fed from a single- or dual-winding, center-tapped or non-center-tapped transformer.

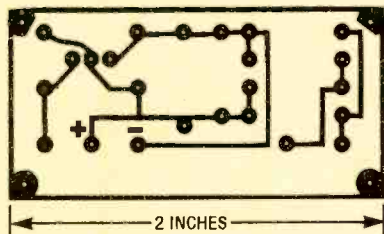
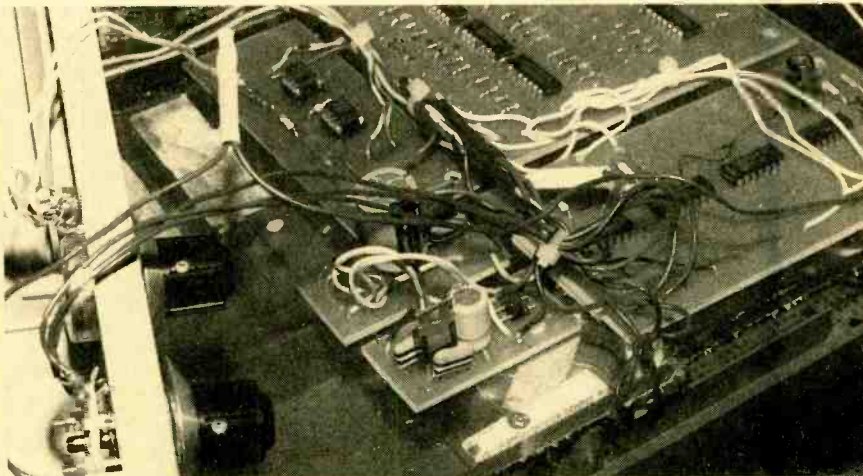

Fig. 2. Here's the foil pattern for the Universal 3-Terminal Power Supply's printed-circuit board.

After etching the boards and cutting them from the circuit board stock, drill all holes with a #65 drill bit and true up the edges by sanding. Stuffing the board with components should wait until the need to use one arises, since



The Universal 3-Terminal Power-Supply is easily fitted into the enclosure of an existing project.

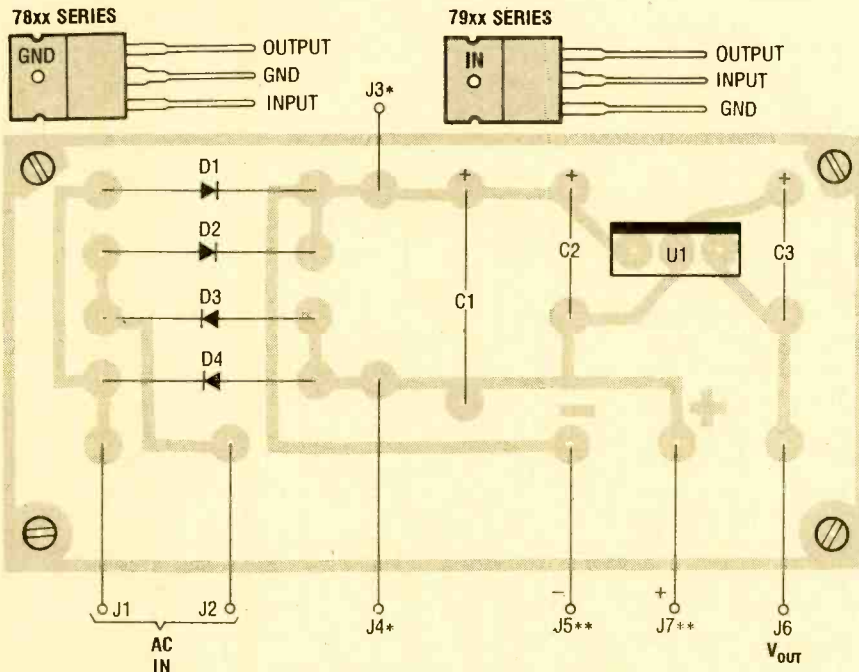

Fig. 3. This parts-placement diagram shows the position and orientation of all the parts. But, before you go stuffing parts on the board, you must consider the power-supply configuration needed.

### PARTS LIST FOR THE UNIVERSAL 3-TERMINAL POWER SUPPLY

- U1—Three-terminal voltage regulator (78xx/79xx series, TO-220 package) integrated circuit, see text
  - D1–D4—1N4001 1-amp, 50-PIV, rectifier diode
  - C1—100–2200- $\mu$ F, 50-WVDC, electrolytic capacitor, see text
  - C2, C3—0.01–0.56- $\mu$ F, ceramic-disc capacitor (see text)
  - J1–J7—See text
- Printed-circuit materials, wire, solder, hardware, etc.

you will not know what to stuff it with until then. Figure 3 is a parts-placement diagram showing the position and orientation of all the parts. Remember, you have to configure the board for type of supply needed.

**Configuring the Board.** As mentioned previously, the board was designed with an eye toward using it in as many places as possible. Consequently, the markings on the etched side can be somewhat confusing. I will attempt to clarify the markings so that you will be able to understand why I labelled them as I did.

Let's start with J1 and J2 (the AC input to the circuit), which will connect to the transformer. Those positions are always used no matter what configuration (positive or negative, half wave, full wave, or full-wave bridge) of the circuit you choose to assemble or the type of transformer (single or dual winding, center tapped or non-center-tapped) selected. If you want to use a center-tapped transformer in a positive full-

(Continued on page 96)



**W**ell, my trusty friend is finally beginning to wear my patience a little thin! My XT clone has been my workhorse for years. But, lately, I have been getting really irritated at having to wait for the trusted dinosaur to process the more complex jobs that have found their way to my "In" basket.

The solution (as I'm constantly reminded through ads and editorials) is to step-up to a high-performance AT or AT-grade computer. That's great but, like most little-business owners, I'm struggling to make ends meet. The price tags on some of those guys are steeper than I can handle now.

The dilemma was resolved for me when I read about a special motherboard that would cost me under \$200, and allow me all of the performance of an AT-class compatible, without having to throw away any of my existing (read that "costly") XT hardware. Soon after that, I found myself looking around the office here for a spare piece of equipment that I could sell in order to buy that great problem-solving motherboard.

Magically (as it sometimes happens) up surfaced an unloved printer, which brought me enough to order an inexpensive 286 motherboard from D.P. Computers (see the boxed text entitled "Sources" for ordering info.)

I promptly received (and that's always nice) a well-packaged motherboard, and a super technical reference manual that describes the installation, requirements and procedure,

as well as more technical information than most folks would ever want to know.

If you are hesitant about tackling a PC or XT upgrade, there's a VHS video available from Friendly Videos that covers all you need to know for the conversion (see the box entitled

*Take your PC or XT and  
turn it into an  
up-to-date 286 AT  
powerstation with very  
little cash and very  
little effort.*

BY DON STEWART

# UPDATE YOUR PC OR XT

"Sources" elsewhere in this issue for ordering info for that tape).

**Requirements.** Okay, let's find out what you need to know to upgrade your PC or XT computer to an AT compatible for under \$200: First off, before you order your motherboard, you will have to determine the answers to some questions about your system.

The low-cost motherboard (called the Bullet 286) was designed to fit an eight-slot chassis only. That means that your computer cabinet should have vertical cutouts in the rear panel that can accommodate eight expansion boards (like your display graphics adapter, or disk controller).

Don't despair if you have one of the older five-slot chassis, there are a couple of solutions.

One solution is to pick-up a brand-new eight-slot XT-type case for about \$25 at your local clone-parts supplier. All of your own PC or XT equipment will fit in the new case (except, of course, your old motherboard). Another solution is to purchase a motherboard designed for a five-slot chassis. However, most of those are a bit more expensive.

My old XT eight-slot case used brass standoffs to support the motherboard inside. One of the standoffs caused a short and destroyed one of my motherboards awhile back. So during this conversion, I decided to replace my chassis with a brand spanking new case that has the more common plastic standoffs.

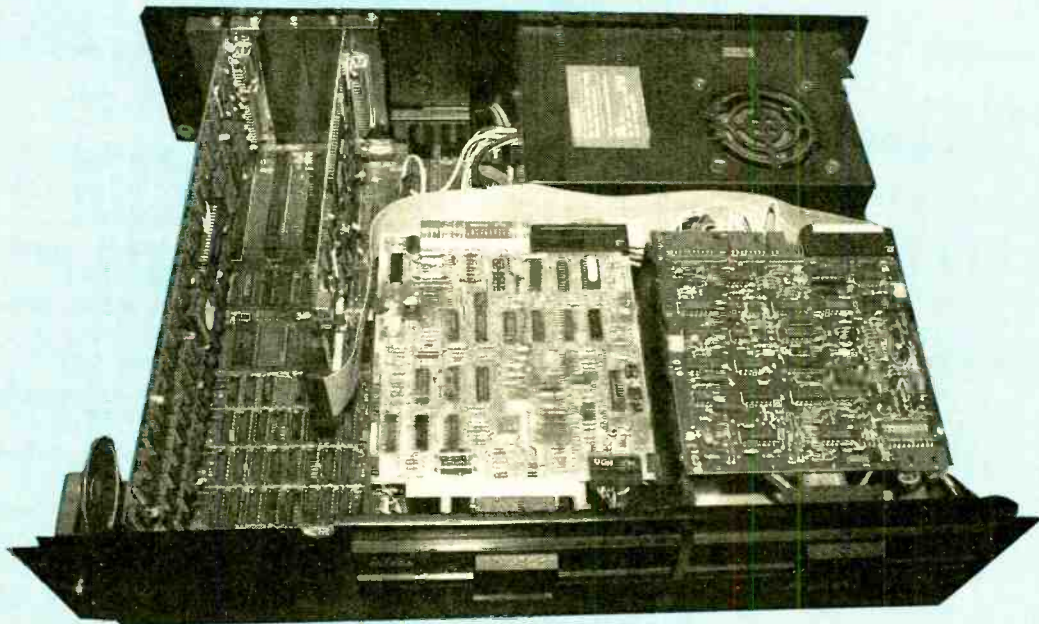



The next hurdle is to determine the size of your power supply. To get that information, you are going to have to open your computer (heaven forbid!) if the information isn't in its owners manual. That isn't tough. Make sure your system is off and unplug the power cable just to be sure.

Locate and remove the five (count 'em: 5) phillips-head screws that hold the cover to the rear panel in most units. One screw is located at each of the four corners, and one is located at the top center of the rear panel.

With the screws out, slide the cover off the chassis. The power supply is the big silver thing located in the right rear of the chassis, as viewed from the front of the computer.

You're looking for a label on the power supply that will indicate its power rating. Some of the possibilities are 85, 100, 110, 135, and 150 watts.

The Bullet 286 motherboard folks suggest a power supply of at least 135 watts. Since a typical minimal system might consume anywhere in the neighborhood of 110 watts, any later expansion might tax the meager reserves of a 135-watt power supply. So it makes a lot of sense (but it is not mandatory) that you install a power supply of 150 watts, or greater.

If the power supply in your existing system is smaller than 135 watts, you will have to purchase a replacement. Again, the cost is relatively small (but money *is* money), and shopping around should get you what you need for well under \$50.

Third on our list of minimum requirements is to check out the speed of the

**TABLE 1—  
RAM CHIP 'DASH' NUMBER VS. SPEED**

Dash No.	Speed
- 8	80 ns (fastest part)
- 10	100 ns
- 12	120 ns
- 15	150 ns (You need this for the Bullet 286)
- 18	180 ns
- 20	200 ns (slowest part)

RAM (random-access memory) that resides on your old motherboard. You see, the way you save a big hunk of money with this conversion is to take the memory chips from your old motherboard, and install them onto the 286 motherboard. The motherboard, however, expects memory chips of a certain speed.

Look at your old motherboard for four similar rows (banks) of integrated circuits with nine RAM chips packed close together in each row. As shown in Fig. 1, the RAM area is located on the motherboard close to the front of the computer, on the left side near the speaker.

The 7.2-MHz and 8-MHz Bullet 286 motherboards need RAM chips of 150 ns, or faster. The speed of a memory chip is sometimes called the chip's dash number, because the speed is usually printed on the top of a RAM chip following a dash (hyphen). Look for the part numbers on your memory chips, and mark down the dash numbers. See Table 1 to help you determine their speed.

Note that the dash number on the part, when appended with a zero, becomes the speed of the chip. The larger the dash number, the slower the part.

If the dash numbers don't seem to follow the pattern in the table, the manufacturer of your RAM chips may be using a special coding scheme of his own. Your motherboard supplier should be able to help.

Now that we're on a roll, let's check out the size (or capacity) of your existing memory system. There are only two sizes of memory chips that can populate your old motherboard: 64-kilobit chips, and 256-kilobit chips (where a kilobit is 1024 bits). You can tell which is which because, again, somewhere in the part number (before the dash number) either a "64" or a "256" will appear to indicate the capacity. Once again, if you have a set of really old

chips, the coding scheme may be non-standard. If possible, talk to your old motherboard's supplier for help.

Your PC or XT may have 128, 256, 512, or 640 kilobytes of RAM on the motherboard, depending on the mix of 256- and 64-kilobit chips (see Table 2). The 640-kilobyte RAM configuration consists of 2 rows of 9 chips per row, with each chip being a 256-kilobit device, and 2 rows of 9 chips per row, with each chip being a 64 kilobit device. Again, that totals 36 chips in all.

RAM is configured somewhat differently on 286 motherboards. Instead of four banks of 9 chips (as in a PC or XT), there are only two banks of 18 chips. The total chip count is still the same (36), only the way that the banks are numbered is different.

The Bullet 286 motherboard requires a minimum of 640 kilobytes of memory on the motherboard in order to operate. It can, however, support as much as 1 megabyte of RAM, configured as 2 banks of 18 chips, with each chip being a 256 kilobit part.

If you are thinking of expanding the memory of your old system to 1 megabyte, you will have to add or replace some of the memory chips.

If you wish to purchase additional memory to augment your existing memory, remember to purchase memory chips of at least 150 ns or faster (80 ns, 100 ns, or 120 ns units are okay).

**DOS and Drives.** If you're going to add either a hard drive or 3.5-in. floppy drive that wasn't in your old system, then it will be necessary for you to know which version of the operating system is running on your computer. That's not at all tough to determine. At the DOS prompt, type:

VER <ENTERKEY>

and DOS will respond with your present version number.

If you are going to add a hard drive to your system, you will have to use DOS version 2.1 or newer. Very often it's possible, when you purchase your new hard drive and drive controller board, to negotiate with your supplier to format (physically and logically) the hard drive, and load the appropriate operating system, all for one discount price (somewhere around \$250 for an XT controller and 20 megabyte drive).

If you are going to be adding one of the new 3.5-in. floppy drives, you will need to upgrade your DOS version. DOS version 3.2 and your old floppy

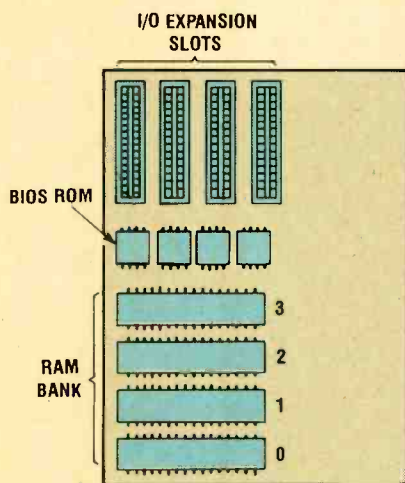

Fig. 1. This is the general layout of a standard PC/XT. Take note of the position of the RAM banks because you'll need those chips for your up-grade.



TABLE 2-RAM

	PC, XT, or AT				AT Only
Bank 3		64k		64k	256k
Bank 2		64k		64k	256k
Bank 1	64k	64k	256k	256k	256k
Bank 0	64k	64k	256k	256k	256k
Total	128k	256k	512k	640k	1 meg

controller will work fine if you are installing a 720-kilobyte (low-capacity) drive. However, a high-density 1.44-mega-byte drive requires a special high-speed controller, and at least DOS version 3.3. Not to get too far off the subject, but there are some software packages available that allow the high-speed hardware to operate with any DOS version. Friendly Videos also puts out videos that cover installing hard drives, and installing 3.5-in. floppy drives if you feel uncomfortable with the task.

Now with all this information (power-supply rating, memory speed, memory capacity, and DOS version number), it's time to order the motherboard as well as any additional hardware that you'll want to install in your new system.

**Preparation.** Clear a work area for the conversion that will remain unmolested for the duration (a couple of evenings during the week at most) and lay out all of the hardware you've purchased. Make room for your computer cabinet, too.

Open your computer as detailed previously. Be sure that the power switch is off and the power cable is disconnected from both the wall outlet and the back of the computer. Disconnect all the cables for your external peripheral equipment such as your monitor, modem, and/or mouse from your computer and set them aside.

The time has come to actually remove the old, antiquated motherboard from your chassis. That isn't difficult, just follow the next steps one-by-one:

First, make a note of the positions of each of the daughter boards (i.e. which slot holds which board). If you reinstall them in the new motherboard in the same order, there is less chance of having to reroute the interconnecting cables.

Locate and remove the bracket-retaining screw for each expansion board. Those screws are accessible

from the top of the machine at the rear of the computer. There is one screw for each board.

Remove each expansion board by unplugging it from the motherboard socket in which it seats. Try not to disconnect any of the ribbon cables. Just lay the board out of the way of the motherboard. To be safe, you might want to mark the ribbon cables with a felt tip marker to indicate which cable goes with which board, and the orientation of the ribbon-cable connectors (which side connects to pin 1 on the expansion board for instance).

Locate the two side-by-side connectors that connect the power supply's wire harness to the motherboard. Make a note of their orientation. Note especially that, when connected correctly to the motherboard, the black wires of each of the two connectors are next to each other. Mark the connectors to indicate which is closer to the rear panel, and which is closer to the front of the computer. Each of those connects to the Bullet 286 motherboard in the same manner, and can be inadvertently swapped if you don't pay attention.

Now grasp the two connectors (not the wires!) and firmly (but *gently*) pull them out of their sockets. If they are stubborn, gently rock them along their length until they spring free.

At this point, you will have encountered one of two possible motherboard-mounting styles in your case: One involves plastic standoffs that mount to the motherboard, and then engage slots in the chassis floor; The other option involves metal standoffs mounted to the chassis onto which the motherboard is attached.

The plastic-standoff option can be identified by the presence of only two screws holding the motherboard to the chassis. The metal-standoff option is identifiable by the use of nine (or so) screws.

Let's first discuss removing a motherboard held with plastic standoffs. Lo-

cate and remove the two motherboard-mounting screws. One will be located at the center front edge of the motherboard. The other will be located at the rear edge of the motherboard near the power supply.

Slide the motherboard to the left until all of the plastic standoffs are free, then lift out the motherboard. Remove each standoff from the motherboard by carefully pinching its plastic ears from the top of the motherboard with a pair of needle-nose pliers. Then, once released, pull the standoff out of its hole from the bottom of the motherboard. Save the standoffs, you'll need them later.

If your motherboard is held down with nine screws, then remove all nine screws, and lift out the motherboard. Remember, I mentioned that metal standoffs had given me serious trouble, and was cause enough for me to replace my old case. You might want to consider doing the same. Either way, you will be mounting your new motherboard in exactly the same manner that the old one was mounted.

Place your old motherboard flat down on some kind of conductive surface, like a sheet of aluminum foil, on top of a folded terry-cloth towel or newspaper. Place your new motherboard on the conductive surface right next to the old motherboard. Press each motherboard *gently* into the conductive surface so that the pins on the backside make good contact.

Now with an IC-extraction tool (available from electronics or computer stores) remove each of the RAM chips from their sockets in each of the four banks (rows) on the old motherboard. Place each chip, as it is removed from the motherboard, onto the conductive surface in such a way as to keep track of which is which.

Note that a notch, or some other mark, on the memory chip indicates the end of the memory chip that is to be aligned with a corresponding notch in the socket. All socket notches face the same direction in the motherboard RAM area. Therefore, all RAM chips will be facing the same direction when installed correctly (this is called a sanity check).

Pick up a chip with an IC-insertion tool, check it for bent or missing pins and if all is well then install it in the RAM socket on the new motherboard, aligning the socket notch with the mark on the memory chip.

(Continued on page 98)

**C**ameras! Cameras! Seems that just about every place you go these days you come under the gaze of a closed-circuit television (CCTV) camera. They peer at you in airports, hospitals, and department stores. Name the company, large or small, and chances are that they are using a camera for security reasons.

Although many might think setting up a CCTV system is complicated and expensive, it is not. In recent years, great strides have been made in designing CCTV equipment that is simple to use, inexpensive, and highly reliable. In fact, using CCTV equipment is much like using your home-video camera and TV set. A complete system consists of just three components: a television camera, a video monitor, and a coaxial cable. Installation is simple, too. Just mount the camera and monitor, plug them in standard electrical outlets and connect the camera and monitor with the coaxial cable. Last, just turn the camera and monitor on, and the installation is complete. However, there is some information about CCTV systems and their installation and maintenance that you should be aware before you start. This article will present that information.

**Hardware.** There are three main pieces of electronic hardware in any CCTV system: the camera, the cable, and the monitor. Starting with the camera, the ultimate measure of a video camera is the quality of the image it delivers. Obviously there are many other criteria that can influence your choice of camera. One application may require a feature that can only be found on a camera with only moderate picture quality, or perhaps price may be more important. However, the essence of video is seeing a picture, so picture quality will always rank at least near the top of the list of camera-selection criteria.

The two most common characteristics used to judge performance are sensitivity and resolution. Sensitivity tells you the minimum amount of light required for the camera to generate a picture, and resolution indicates how sharp the image is.

# A GUIDE TO CCTV

BY ISAAC SZLECHTER



*A closed-circuit TV system is pretty easy to install. All you need is a knowledge of what to buy and some important tips on setting it up and maintaining it.*

Next in line of important hardware is the video monitor. To view the images, always use a closed-circuit monitor, not a TV. Home TV sets do not have the capability and resolution to give as clear and stable a picture as a CCTV monitor. The best camera made can not improve the picture displayed by a poor-quality screen.

A nine-inch monitor is ideal for most applications. When the monitor is going to be viewed from more than ten feet away, then use a larger monitor. In a store a large monitor can serve to warn would-be shoplifters that their actions are under surveillance.

In CCTV installations, the most common way of conducting a video signal from one piece of equipment to another is coaxial cable (or simply coax). Coax has some basic characteristics you should be aware of. Namely: impedance, placement (indoor vs. outdoor), and center-conductor type (solid vs. stranded).

With regard to impedance, video coaxial cable is designed to transmit the maximum signal power from a 75-ohm source to a 75-ohm load. Of course, cameras and monitors have a 75-ohm impedance as a rule. Excessive signal loss and reflection occurs if you use cable of a different rating.

Use only high-quality cable, and use indoor stock indoors and outdoor cable outdoors. A solid bare-copper center conductor is best for video applications, but in situations where the cable will be flexed often, use cable with a stranded-wire core.

**Camera Types.** Until recently the tube-type camera was the only camera available for CCTV use, but developments in solid-state electronics have produced a new type of camera that replaces the vacuum pickup tube with a small solid-state image sensor. Various designs have appeared, but the type that has had the most success in CCTV cameras to date is called the charge-coupled device or CCD.

Cameras based on the CCD image sensor have several advantages over tube-type cameras: Such cameras can be made smaller because the CCD chip is replacing a much larger vac-



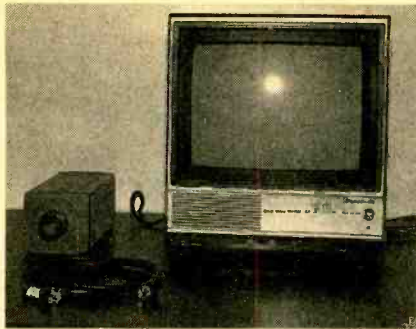

A camera, monitor, and coaxial cable are the heart of any CCTV system. This is really all you need to get started.

uum pickup tube. Also, there is no need for deflection coils and their support components, further contributing to smaller size. There is no filament to burn out in the chip, so the camera has a virtually unlimited lifetime and does not require an expensive periodic tube replacement. Such cameras are available in 1/2-inch and 2/3-inch formats.

**Lens.** As odd as it might seem, cameras seldom come with a lens. In a way, you could consider them a "fourth" piece of hardware to concern yourself with.

A variety of lenses can be used on CCTV cameras. Most lenses have adjustable irises. A faster (lower *f*-stop number) lens should be used to allow more light to pass through the lens aperture for viewing a dimly lit area.

All television pictures have a width-to-height ratio of 4 to 3, regardless of the type of lens or the size monitor used. Therefore, a televised picture of an area 20 feet wide will allow a height of 15 feet. That area is called the "field of vision."

Which brings us to another important criteria for selecting a lens: its focal length (denoted by *f*, but not to be confused with *f*-stop). As we proceed to discuss it look at Fig. 1 to get a feel for the relationship between focal length and the field of vision. Also, keep in mind that the height of the picture will always be 3/4 of the width.

In surveillance installations, wide-angle lenses are frequently used. However, a picture that covers a greater area will contain less detail and definition. For instance, to see an area that is about 1/2 as wide as the distance from the camera to the subject, use a standard 16-mm focal length lens. A camera with such a lens 40 feet from the subject will view an area 20 feet wide and 15 feet high.

However, to see an area that is about

as wide as the distance from the camera to the subject, use a wide-angle lens of 8.5-mm focal length or equivalent.

For more moderate use, to see an area that is about 1/4 as wide, or less, as the distance from the camera to the subject, use a telephoto lens of 50-mm or longer focal length.

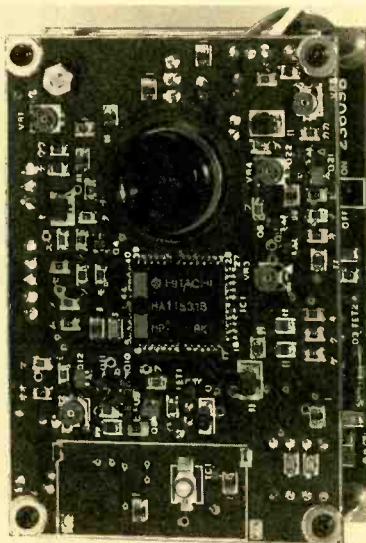

Advances in technology have allowed the industry to produce much smaller CCTV cameras, like this Chinon unit. The use of CCD (charge-coupled device) image capturing and surface-mount technology are primarily responsible.

**Lighting.** No matter what hardware you use, to get the best picture possible there must be good lighting on the scene. You will get the best picture in a well-lit, evenly-lit area, like the conditions found in an average office. Unfortunately, lighting conditions for CCTV use can vary greatly: from dimly lit hallways, to shadow-filled parking lots.

However, to broaden the possible applications for CCTV systems, some cameras are designed to operate from near darkness to bright light, and to compensate automatically and quickly for changes in brightness. With such hardware you can obtain a good picture in less than three footcandles of light—barely enough to read a newspaper with.

But keep in mind that all cameras tend to retain images for a split second. A bright image will tend to erase a prior image quicker, so even with cameras that work well in dim light, scene luminance is important. Conversely, you don't want the scene so bright that dark shadows form. Shadows appear much more distinct on a monitor and can obscure the image.

To optimize the picture, be sure to adjust the brightness and contrast controls on the monitor to suit the lighting. Also, it's a good idea to locate the monitor so that direct light does not fall on the screen. That tends to wash-out the picture.

**Camera Handling.** As with any electronic equipment, you must take some care in handling, installing, and maintaining CCTV equipment. Direct bright light can permanently damage a sensitive camera element, so never point the camera out a window, or allow sunlight or other bright light to enter the lens directly. Watch out for reflections of the sun, too.

When handling or storing the camera never carry or place it with the lens pointing directly downward. That would be particularly dangerous for tube-bearing cameras as a shock may damage the tube in that position. Do

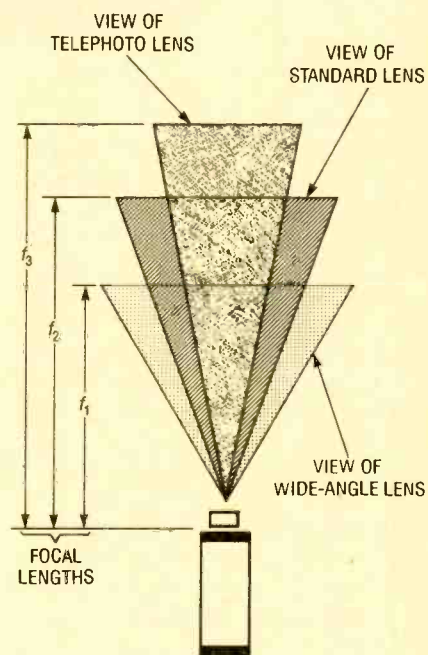
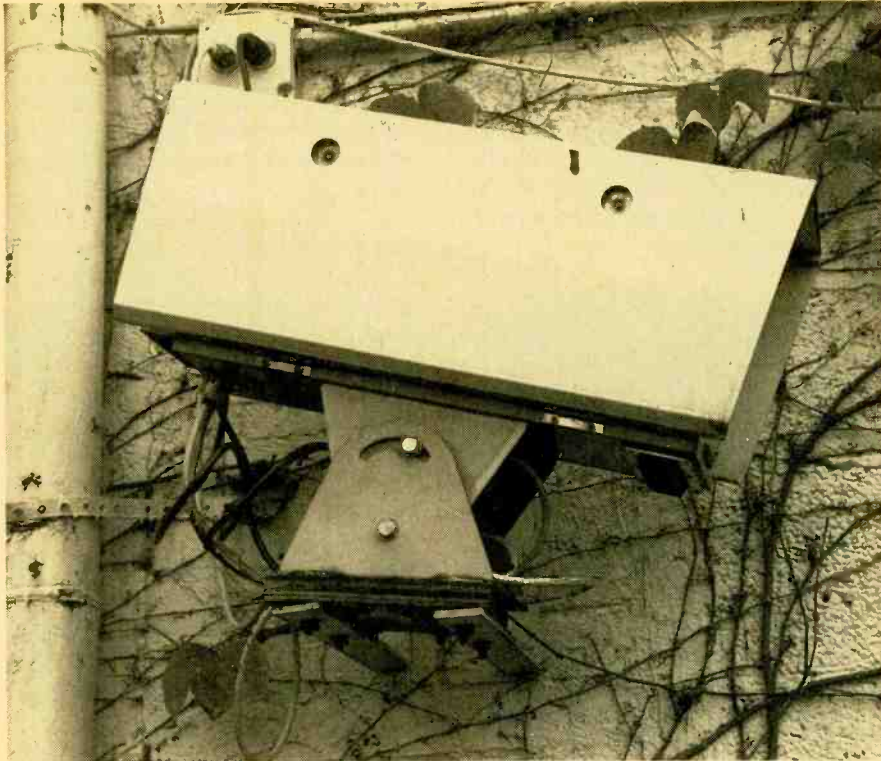

Fig. 1. To change the field of view seen by a CCTV camera, various lenses are available. Use a wide-angle lens to see a wider picture. Use a telephoto lens to get a close up view of a subject. Also available are zoom lenses, which combine wide-angle, standard, and telephoto capability into one lens.

not let the camera run for long periods without enough lighting on the scene. Doing so will put excess strain on the components, and, in tube-type cameras, shortens tube life in particular.

The camera should be mounted securely to a vibration-free surface. Use a





*To place a camera outdoors, use a special weatherproof housing with built-in heating and cooling devices.*

bracket designed especially for it and place the camera as high as possible, looking down on the scene. Avoid having the lights in the room in the camera's field of view.

All CCTV cameras require a proper operating environment. If you need to place a camera in an extremely dusty location, use a special housing to protect the camera and the lens. If necessary, you can purchase a tamper-proof housing to prevent damage or theft. When cameras are placed outdoors, special weatherproof housings, which also have heaters and cooling devices, are frequently used. Avoid mounting the camera in extremely hot or cold areas without such protection.

**Installation & Maintenance.** When installing a camera, keep a monitor at the camera location to save time in checking the televised picture.

Regardless of the type of cable you select, you must take certain precautions when working with coaxial cable. To prevent long-term signal degradation, do not stretch the cable or subject it to sharp bends (even with a stranded center conductor). Keep the cable out of contact with hot pipes or other heat sources. Even if there is not enough heat to cause obvious damage to the cable, transmission characteristics will be affected.

Do not use a standard staple gun to install coaxial cable. The staple may crush the dielectric foam in the cable, causing the main conductor to pick up interference. Use only round-crown staples or special hangers for 1/4-inch coax. Do not run the cable near large-capacity transformers, magnets, and high-voltage lines, or lay the cable parallel with or directly across typical AC lines.

Most video products are equipped with either a polarized 2-conductor AC-line plug—a plug having one blade wider than the other—or a 3-conductor grounding-type plug. Both plugs fit into a power outlet only one way for safety. If you are unable to insert the plug into the outlet, replace the obsolete outlet, but do not defeat the purpose of the plug.

The lens and monitor screen should be cleaned periodically with lens tissue or very soft cloth to remove dust. Do not use solvents.

As the camera ages, you'll have to adjust it. You can do this fairly easy procedure with a screwdriver. To get maximum life from the tube in tube-type cameras, turn off the camera or unplug it when not in use.

**Additional Equipment.** Although the camera (with lens), monitor, and cable are the heart of any CCTV system, a

number of accessories are available that provide some extra features.

To view several locations on one video monitor, you can connect multiple cameras to a video switcher. A switcher allows you to select a scene from any camera in a multi-camera installation and display it on one monitor. The video switcher may be either manual or automatic. An automatic unit switches from camera to camera at predetermined intervals. The switcher saves money since it allows one monitor and one person to service as many as 10 cameras.

To view the output of a camera on more than one monitor, additional monitors are simply added on to the system. That allows several persons located in different places to watch the same scene. That procedure is known as "looping" and may be used as long as the total length of cable between all monitors and the camera is less than 1000 feet. For further distances, in-line amplifiers must be used.

When you must move the camera up and down as well as sideways to home-in on a specific subject, you can get a remotely controlled pan-and-tilt unit. A motorized zoom lens can be used with a pan-and-tilt device to allow close-up focusing on a small section of the picture. Those units are used in more complex CCTV systems, where the ability to view detail in any one spot of the total field of view is necessary.

When not enough coverage is given by a wide-angle lens, the camera can be mounted on an automatic scanning device called an autoscanner. The autoscanner rotates the camera back and forth over a predetermined arc and is especially useful in retail situations for shoplifter-deterrent systems.

When you want to record what the camera is viewing, you can connect a video time-lapse recorder to the system, and you will have a permanent record. Most machines record continuously up to 120 hours on one tape. The whole time-lapse recording can be played back in just two-hours.

These and many other technical advances have produced today's expanding market in security for video surveillance equipment. Overall, even though CCTV systems have been designed for a highly segmented market, the trend is toward user-friendly components, and the prices are going down. In the future, it is likely that you'll come in contact with CCTV cameras everywhere you go, not just in stores. ■



**W**hat started out as a simple keyless switch to operate an electric garage door has ended up as a *Digital Entry Switch* with various uses. By entering a preset four-digit code, it can be used to open and close your automatic garage door, driveway gate, or any other electrically-operated device. In addition, if used with an external latching circuit, it can be configured to prevent unauthorized use of electrical or electronic equipment—including your computer or car!

**Background.** I needed my remote-controlled garage door to be opened by a delivery service when no one was home. The normal operation was with a remote-control transmitter, or an inside pushbutton switch. Obviously, I could have added a key switch to the setup, but that would have meant carrying around another key, and furnishing a duplicate key to the delivery service.

In addition, it was often necessary to enter the garage from outside, and short of lugging around the remote-control unit, there was no way to gain access to the garage from the outside. Then it dawned on me that a digital switch might be the answer to my dilemma. With a digital switch, I could enter the garage by punching in the appropriate code, and I could inform the bonded delivery service of the entry code.

The original solution was to buy a ready-made digital garage-door opener. The commercial unit worked fine, until a passing thunderstorm zapped it. When an identical replacement suffered the same fate a few weeks later, I abandoned that device.

I found a circuit that would do the same job, but by the time I added a keypad and relay, my homebrew digital switch became a real Rube Goldberg. It worked, but became more and more unreliable with time—partly because my door mechanism was getting old and sluggish. So I replaced the door mechanism with a universal garage-door keyless entry system, which came complete with a membrane keyboard and a flat ribbon cable that plugs into a connector on the controller's circuit board. The installation was simple: You merely screw the keypad on the outside of the garage and feed the cable to the control circuit inside.

Once installed, I thought to myself, this is really a first-class product. But the

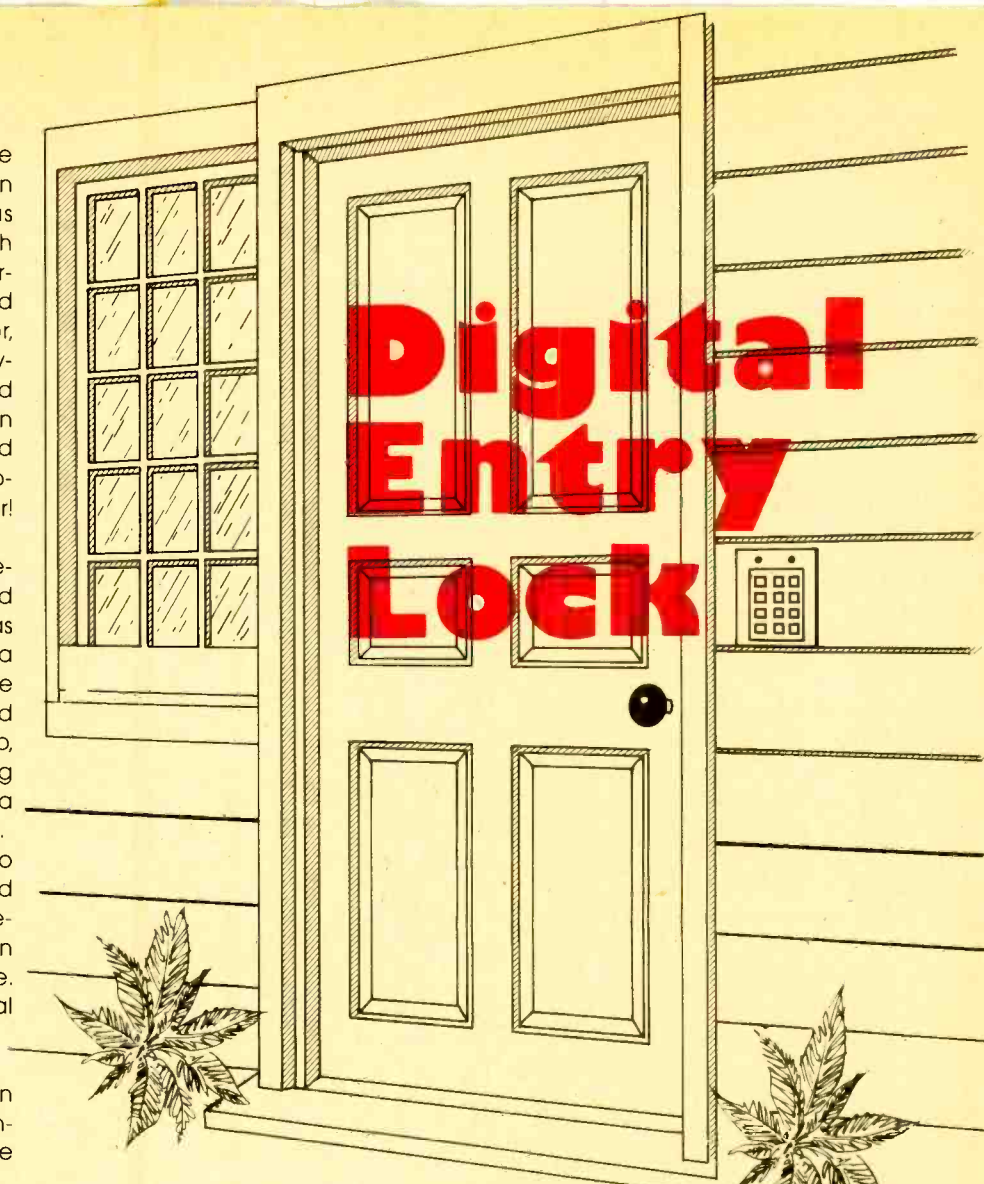

*With this digital, combination-lock circuit you may not be able to throw away your keys, but at least they won't have to be your constant companions*

**BY FRED BLECHMAN**

darn thing didn't work! My automatic garage-door opener was "tired." It required that the remote or manual switch be held down for about one second to assure operation, and the universal garage-door keyless entry system only provided about a half-second closure of its internal relay. The door would start to move, but never completed its mission.

After a lot of head-scratching and experimenting, I made several phone calls to the manufacturer. I was told that the system was not intended for old, beat-up garage doors like mine, and the half-second closure works perfectly with any normally-operating garage door.

Not long afterward, I stumbled on a

special-purpose IC, the LS7220 keyless-lock IC, that, with just a little effort on my part, could be made to handle the task quite well. A block pinout diagram of the LS7220 keyless-lock IC is shown in Fig. 1. Normally that unit is used to accept a four-digit code to enable and lock an output "on."

However, the specification sheet showed a very simple circuit for a time-adjustable momentary output—just what I wanted! All that was needed with the LS7220 was a keyboard, a capacitor, and a relay (with a few support components). I thought to myself, how simple can you get? I put together a sample circuit and it worked like a charm, even with my old and sluggish door opener!

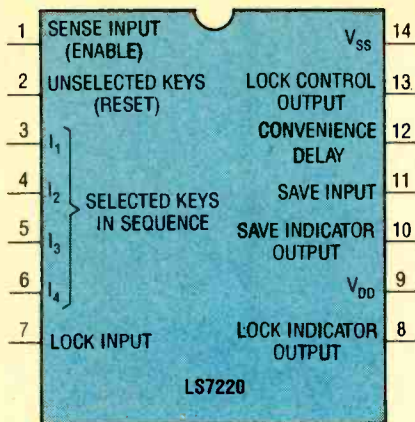

Fig. 1. The LS7220 keyless lock (a pinout of which is shown here) is a special-purpose IC designed to accept a four-digit code.

**Circuit Description.** Figure 2 shows a schematic diagram of the *Digital Entry Lock*. The circuit can be powered from a 6- to 12-volt DC, wall-plug transformer or you can design your own power-supply circuit. Standby current is very small (about 15 microamperes), and operating current is about 40 milliamperes (depending on the operating voltage). Capacitor C1 assures minimum ripple from the DC supply.

The keypad must be one that provides each key with a contact to a common connection. In this case, the common connection goes to the positive supply rail, so that when a key is pressed, a positive voltage is passed through to the wire associated with that key. Each of the twelve keys are brought out to separate wires, and each wire is connected to a different pin of a 24-pin socket (SO1).

To activate (unlock) the circuit, a pre-programmed four-digit access code must be entered in the proper sequence. The four-digit access code is programmed into the circuit by connecting jumpers between terminals of a 24-pin plug-in header. (More on that later.)

When the correct access code is entered (in the proper sequence), positive voltages appear at pins 3, 4, 5, and 6 of U1. That causes U1 to output a positive voltage at pin 13, which is fed through resistor R2 to the base of Q1, causing it to conduct. With Q1 conducting, its collector is pulled to ground potential, energizing relay K1. The normally-open relay contacts close, switching on any external device.

Capacitor C2 controls the total time that the output of U1 at pin 13 is positive after the release of the first key. With a

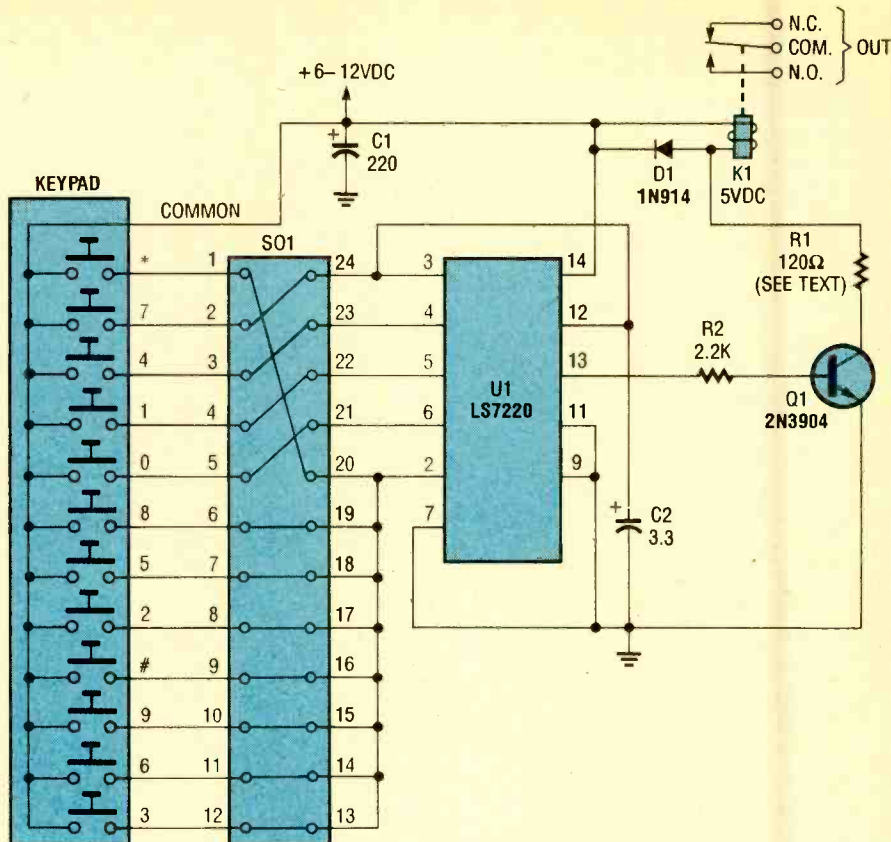

Fig. 2. The operation of the *Digital Entry Lock* is simple; when a four-digit access code is entered (in the proper sequence), the device connected to K1's normally-open contacts is activated. Any incorrectly entered (including the right digits in the wrong sequence) digit immediately resets the lock.

value of 3.3  $\mu$ F for C2, active time after release of the first key is about two seconds, assuming a 6-volt supply or four seconds with a 12-volt supply. Therefore, if you push the subsequent keys too slowly, the relay may not close at all! To increase the time allotted for code entry, you will have to increase the capacitance value of C2.

Incidentally, resistor R1, which is in series with the relay coil, is not required if you

are using a power supply of less than about 9 volts. The resistor must be used for higher voltages; it is intended to provide a voltage drop, so you don't burn out the relay coil.

**Construction.** There's nothing critical about building the *Digital Entry Lock*. A pre-drilled printed-circuit board is available from the supplier listed in the Parts List. But for those who prefer to

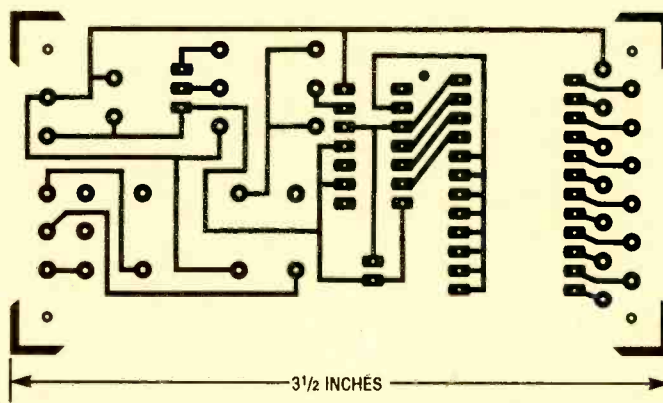

Fig. 3. There's nothing critical about building the *Digital Entry Lock*. Shown here is the simple foil pattern used to etch the author's printed-circuit board. For those not wishing to roll their own, the board (as well as a complete kit of parts, and selected individual components) can be ordered from the supplier listed in the Parts List.



## PARTS LIST FOR THE DIGITAL ENTRY LOCK

### SEMICONDUCTORS

U1—LS7220 keyless lock, integrated circuit (see supplier below)

Q1—2N3904 general-purpose NPN silicon transistor

D1—1N914 or equivalent small-signal silicon diode

### ADDITIONAL PARTS AND MATERIALS

R1—120-ohm, 1/4-watt, 5% resistor (see text)

R2—2200-ohm, 1/4-watt, 5% resistor

C1—220- $\mu$ F, 16-WVDC, electrolytic capacitor

C2—3.3- $\mu$ F, 16-WVDC, electrolytic capacitor

K1—5-volt DC SPDT relay (Arrow NF 2E-5V or equivalent)

S01—24-pin DIP socket

Printed-circuit board materials, 12-key keypad, 24-pin header, enclosure, 6-12-volt power source, wire, solder, hardware, etc.

**Note:** The following items are available from EKI, Inc., 16631 Noyes Ave., Irvine, CA 92714; Tel. 714-833-8711. A complete kit of parts for the Digital Entry Lock (#2-1051), including all parts and a circuit board for \$22.95; A partial kit (#2-2851), containing the electronic components only for \$19.95; the printed-circuit board only (#2-2751) for \$3.95; Arrow NF 2E-5V relay only (#4-1010) for \$3.95; Keypad only with special connector board (#4-1011) for \$7.95; LS7220 (EKI-7220) digital lock IC only (#4-1012) IC \$6.95. Please add \$3.00 per order for shipping and handling. California residents please add local sales tax. No foreign orders accepted.

"roll" their own, a foil pattern for the printed-circuit board is shown in Fig. 3. You could even use point-to-point wiring on a perforated board, but that would mean risking all sorts of construction errors that tend to creep into electronics construction projects—so that's not recommended.

If you opt to go the printed-circuit route (using the pattern in Fig. 3), Fig. 4 shows the location and orientation of all the board-mounted and off-board parts. Once the printed-circuit board has been assembled and your work checked for the usual construction defects—cold solder joints, solder bridges, misplaced and misoriented components—it's time to consider the enclosure that will house your creation.

The circuit board could be mounted

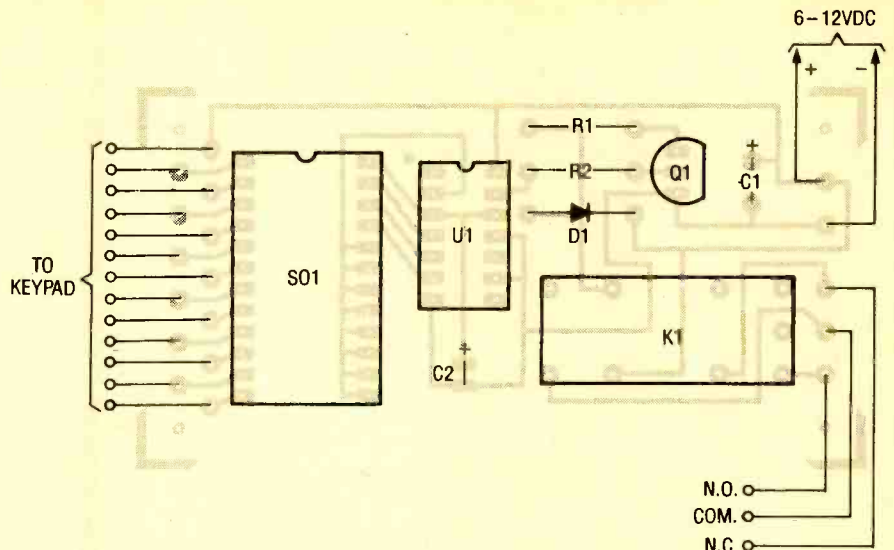

Fig. 4. Assemble the Digital Entry-Lock's printed-circuit board guided by this parts-placement diagram. Once assembled, check your work for the usual construction defects—cold solder joints, solder bridges, misplaced and misoriented components, etc.

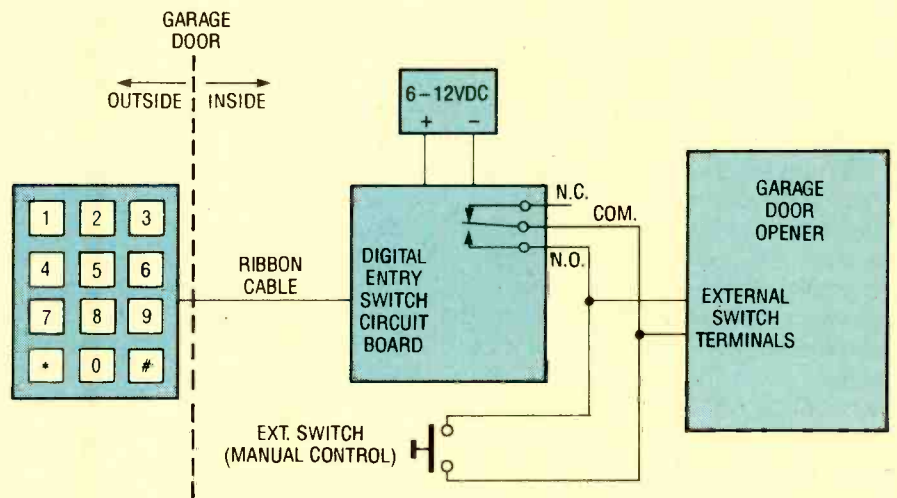

Fig. 5. In the author's application, the Digital Entry Lock was connected in parallel with the existing manual control switch for an automatic garage-door opener. That installation allowed the garage door to be opened by entering a four-digit access code, while leaving manual control of the garage door intact.

in a small case outfitted with a jack for a plug-in power supply and binding posts for the relay contacts. The interconnections between the keypad and the printed-circuit board are best handled through a length of flat ribbon cable. The ribbon cable will have to be cut to a length suitable for your installation. The keyboard, of course, is mounted near the entry point.

**Programming the Lock.** In order to activate the output of this switch, a positive voltage must be applied to pins 3, 4, 5, and 6 of U1 in that order. Any other sequence will not open the lock. Also, putting a positive voltage on pin 2

of U1 resets it to look for the first digit of the code.

The circuit can be programmed to respond to almost any four-digit access code desired—repeated digits are not allowed; for example, 1020, 9668, 7647, etc., are not allowed. When programming the circuit for a specific access code, the first digit of the code must be jumpered to pin 3 of U1, the second to pin 4, the third to pin 5, and the fourth digit to pin 6 via a 24-pin header.

Now place jumpers on the 24-pin header so that the first key wire on the left side of the jumper goes to pin 24 of the header, the second key wire to pin  
(Continued on page 96)

*Amateur radios have a lineage that's just as interesting to electronics hobbyists as antique cars are to the automobile enthusiast. Come with us as we take a look at the sets that for many made ham radio a life-long hobby.*

BY LARRY LISLE, K9KZT



## CLASSIC HAM

**T**he receiver has always been the heart of a hamshack. But, as the old amateur-radio saying goes, "You can't work them if you can't hear them." In this article I'd like to rummage through the corridors of ham history and take a look at some of the receivers amateurs have used in the past, and see how they can still be of service today.

You might say that ham radio really began with the invention of the crystal set in 1906. There had been receivers before then of course, but the crystal set could be built by anyone and thousands of people were introduced to wireless by plans of them printed in magazines and newspapers.

The triode vacuum tube was invented in the same year but seldom used because the early ones were expensive, short-lived, and only slightly more sensitive than their crystal counterparts. The discovery of regeneration in 1912 and the publication of that phenomenon in 1915 changed all that.

**Regenerative Receivers.** The earliest regenerative receivers used variable-coil tuning, a carry-over from crystal sets. The circuits of the time are a wonder to behold—coils all over the place!

Variable-capacitor tuning started to become popular after 1923 and circuits began to take on a look more

familiar to modern hams. Bandspread tuning came into vogue in 1925, and was the last major development for the regenerative detector.

The superheterodyne receiver was invented in 1918, but didn't begin to displace the "regen" for decades. The reasons aren't hard to understand: the regenerative detector was more sensitive (with the components then available), it required fewer tubes (an important consideration when power was supplied by batteries), and it was much easier to build.

It was the need for more selectivity that made the superheterodyne receiver popular. In 1929 the amateur bands were drastically narrowed by international treaty. That, coupled with the boom in amateur radio during the

depression (from 16,829 operators in 1919, to 46,390 in 1934), made interference a serious problem.

Those numbers don't seem great considering that we have millions of hams around the world today, but remember, in the thirties most were active on only the lowest bands, signals were often broad, and the regenerative receiver overloaded easily on strong signals.

The invention of the crystal filter in 1932 made razor-sharp selectivity possible using a super heterodyne receiver. A regenerative receiver would respond with equal volume to signals from 5000 to 10,000 Hz. The "nose" of the selectivity curve of a crystal filter might be only 1000 Hz wide! The difference was astounding. Even today, a crystal filter will do a fine job for code work.

The crystal filter also marked the beginning of the decline of home-brew receivers. Most hams could build a regenerative receiver in a few evenings. If it didn't work right, you could rip it apart and start again with little cost since they were usually built breadboard style with only the panel being metal.

The superheterodyne receiver required extensive metal shielding throughout the receiver, and if the IF amplifiers oscillated instead of amplifying, or if the signal slipped through the filter instead of passing through it, it was a long and expensive job to start over



*The Hallcrafters S-19R Sky Buddy was a budget six-tube receiver introduced in 1939. It will still do good work on the lower bands if backed with a good audio filter.*



Mansbury Train Dispatch



the 40-meter band. Using a 50-year old receiver is always a good conversation starter! The receiver still works very well for code reception on the lower bands, though it requires an hour or so of warm-up to control the drift. It will pull in weak signals on those bands just as well as more modern sets, and the crystal filter is adequate for all but the worst interference.

The transparent covers for the dials have darkened and the dial cords are getting worn, but it's still a good receiver. It's always a pleasure to use something that skilled craftsmen have built to the best of their ability, regardless of when it was made.

# RECEIVERS

again. It just took more time and money than most hams wanted to put into a hobby.

Thus, from the late thirties onward much emphasis was placed on commercially manufactured ham receivers. Many, if not most of the companies that became famous among the amateur community were started by technically minded hams, such as Art Collins, Bill Halligan, and Bob Drake. I think few really made money from their ham divisions, but they served their fellow amateurs, and incidentally kept their company's name in front of the procurement officers for government and industry—many of whom were also hams. To describe every commercial ham receiver would take volumes, so let's concentrate on a few of the most popular ones.

**The Sky Series.** The *Hallicrafters SX-16 Super Skyrider* was introduced in 1937 for \$111—quite a price in the depression, but it was quite a receiver. The SX-16 was one of the first commercial receivers with a crystal filter. The stage line-up included an RF amplifier, a mixer, two IF amplifiers, a diode detector a first audio amplifier, and a push-pull audio-output amplifier. There were also separate oscillators for high-frequency mixing and BFO operation, an S-meter amplifier, and a rectifier. As a measure of how new that type of receiver was,

the BFO injection voltage was adjustable from the front panel—a sure sign that the engineers weren't altogether sure what it should be. The output impedance was either 500 or 5000 ohms to match the headphones and speakers of the day. Its tubes were the then new metal octals.

The main tuning dial was a metal disk on the front of the receiver. The frequency was indicated by a pointer that was mechanically linked to the band-switch and pointed to the correct scale when the band was changed.

A dial was provided on the right side of the front panel for bandspread; it was calibrated with an arbitrary 1 to 1000 scale. The dial was gear-driven by a knob on the panel.

A Super Skyrider I have has been used for many enjoyable contacts on



*Brady McGhee, KA9VDE can work the world from his bedroom with a Heath DX-40 and RME-45. The RME was typical of the better receivers built after the war but used a mechanical bandspread system.*

The S-19R Sky Buddy was a receiver produced for the budget minded. First sold in 1939 for \$29.50, it had no RF stage, only one IF stage, and no S-meter or filter.

The receiver covered 540 kHz to 46 MHz in four bands, and used a cursor instead of a moving pointer. The Sky Buddy also had a built-in speaker; for some reason the better receivers seldom had them.

The S-20R Sky Champion was also introduced that year, but selling for \$49.50. The S-20R had nine tubes compared to six for the S-19R, and the tuning dial was enclosed within the receiver.

After World War II, Hallicrafters updated the S-20 and called it the S-40. The styling was changed and so was the price—\$79.50—but essentially it was the same receiver.

I've included those last three receivers, not because they were the best

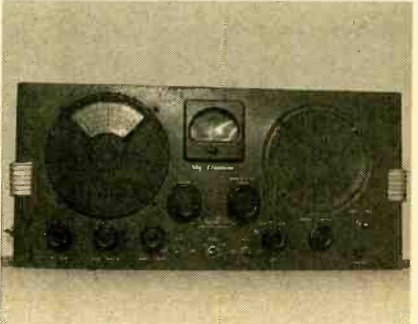

*The S-20R Sky Champion, by Hallicrafters was a medium-quality nine-tube radio. It sold for \$49.50 in 1939.*





*This SX-101 is my personal all-time favorite Hallicrafters receiver. It weighs 80 pounds and has a dial that seems a yard wide. It cost \$395 in 1957, but I bought this one for around \$60 at a hamfest.*

available at the time, but because they were good workhorse radios at reasonable prices. Many beginners probably started with them.

I've used all three of the receivers on the air and have had a great time. With a modern audio filter backing them up, they are entirely adequate for making contacts on the 80- and 40-meter code bands or for listening to short-wave-broadcast stations. They are easy to use and don't overwhelm the newcomer.

**Post-War Units.** The receivers of the early post-war period followed the design trends established before the war. One of the best and most popular of those was the *Hammarlund HQ-129X* which sold for \$177. The HQ-129X used eleven tubes and included a third IF stage and a voltage regulator that improved stability greatly.

The HQ-129X, like the receivers already discussed, used two dials, a main tuning dial on the left and a bandspread dial on the right calibrated for the ham bands. To set the dials, you'd adjust the bandspread to the frequency of one of the crystals, key the transmitter, and turn the main tuning knob until the signal was heard. After that you'd leave the main tuning knob alone and use the bandspread control to cover the band. It was a good system because it gave almost all of the advantages of both a general-coverage receiver and the convenience of a ham-band only model.

The dials of the Hammarlund receivers were circular, like those we've already discussed, but Hammarlund eliminated the dial cord by connecting tuning knobs to the edge of the dial with a friction drive. I've always been partial to the Hammarlunds for that reason; replacing the dial cords of old

radios is about as much fun as undergoing gum surgery.

The Hammarlund crystal filter was one of the best ever. It could be switched out entirely or adjusted to any of five different degrees of selectivity, the last being very tight indeed.

The Hammarlunds were very well built receivers. The wiring was always neat, and they didn't hesitate to add the little touches that make a difference in the long run.

Another interesting receiver of the period was the *RME-45* by Radio Manufacturing Engineers. The RME-45 used a mechanical bandspread system instead of separate tuning dials and capacitors. The outer knob would move the pointer quickly across the band and the inner knob moved it five times more slowly. It was a good system but probably expensive to manufacture.

**The Shift to Voice.** In the 1950's, hams turned in greater numbers to voice communication—at first AM and later SSB—and more began moving to the higher frequency bands. Receiver manufacturers took a long hard look at their wares and decided some changes were in order. The crystal filter was good for code work, but caused distortion with audio. One solution was to go to a lower final-IF frequency of 50 to 60 kHz where a series of IF transformers could give a flat-topped selectivity curve with steep sides that could be adjusted in width for voice or code. To avoid image problems, double, and even triple IF conversion was used with the higher frequency oscillator sometimes crystal controlled for stability.

My personal favorite Hallicrafter re-

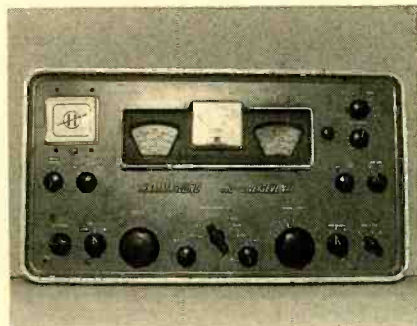

*The HQ-170 was a classic Hammarlund. A ham-band only receiver introduced in 1958, it sold for \$359. Unlike most manufacturers, Hammarlund kept the external appearance of their receivers pretty much the same through the years. The improvements were all on the inside—they kept getting better and better, and the 170 was one of the best.*



*Few people would argue that the Collins 75A-4 isn't one of the best receivers ever made. It had Collins mechanical filters, the Collins super-stable tuning system, a bunch of other features and a price tag of \$695.*

ceiver is the *SX-101*, which sold in 1957 for a mere \$395. (They sell at hamfests for \$50 to \$75 today.)

In the 101, an incoming signal is first converted to 1650 kHz and then to 50.5 kHz. Selectivity can be varied from 500 Hz to 5 kHz and can be changed from upper to lower sideband with a flip of a switch. There's also a notch filter to take out interfering signals that might slip through its built-in crystal calibrator, and many other features. Perhaps the most striking things about the 14-tube set are its dial (it seems a yard wide) and its weight of 80 pounds!

The following year Hammarlund introduced the classic *HQ-170* for \$359. Though it retained the traditional two-dial look of other Hammarlunds, it was a ham-band only receiver, with the lower bands logged on the left dial and the upper bands on the right. The two were connected by a steel dial cord. What would appear to be the bandspread tuning knob on the right is really an electrical fine-tuning knob that can move the receiver frequency up or down 3 kHz without disturbing the main tuning. I like that feature when I call CQ because I can tune around a little for a reply without moving the dials.

The 170 has so many other features that it's hard to list them all. It's a triple-conversion radio, taking an incoming signal and changing it first to 3035 kHz, then to 455 kHz, and finally to 60 kHz. It has a notch filter, adjustable noise limiter, variable-speed automatic volume control—even the audio system is automatically selective. You could even get a clock timer so the receiver would be warmed up and ready to go when you got home! Today they sell at hamfests for around \$60.

The HQ-180 is very similar but designed for general coverage. It's still  
(Continued on page 102)



# Signal Generator Circuits that you can Build

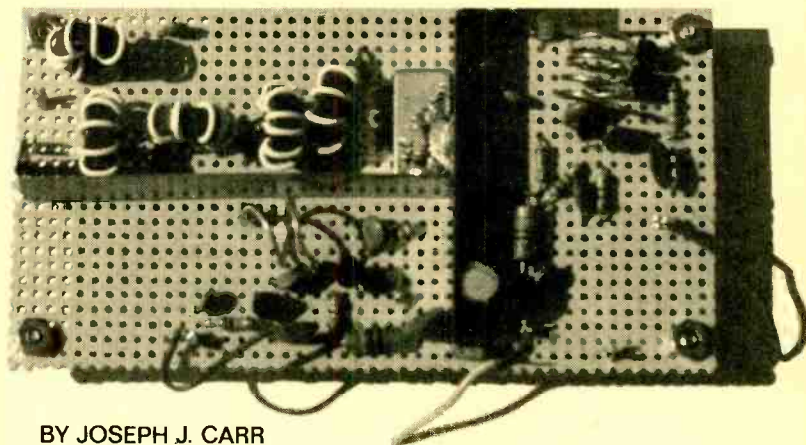

BY JOSEPH J. CARR

*Read our cookbook of  
signal generators and never be  
without input again.*

**A**lthough the subject of designing top-notch RF signal generators can be quite deep, we'll skip a lot of the design theory and limit ourselves to a small number of circuits for times when your needs are less severe. The circuits we will look at can be used in a wide variety of applications. Let's first take a look at the generic types of oscillator circuits that you'll probably encounter.

**Types of Oscillator Circuits.** There are two major categories of oscillators: relaxation oscillators and feedback oscillators. A relaxation oscillator uses some sort of voltage-breakdown device such as a neon bulb or unijunction transistor. A feedback oscillator uses an amplifier circuit and a feedback network to start and sustain oscillations of a particular frequency. Most of the oscillators that are useful for sinewave-signal generation are of the feedback-oscillator class.

The requirements for sustained oscillation, called Nyquist's criteria, are: The overall circuit gain, even with feedback network losses taken into account, must be greater than or equal to one at the frequency of oscillation; and the feedback signal must be in-phase with the input signal at the frequency of oscillation. The second of the criteria means that the feedback signal must

be phase shifted some multiple of 360-degrees. Usually, 180-degrees of shift is obtained from the inversion of the amplifier and another 180 degrees is provided by the frequency-selective feedback network.

Feedback oscillators can be classified according to the nature of their feedback network. Among RF oscillators, there are three basic types (and many variations on them): Armstrong, Colpitts or Clapp, and Hartley. There are other forms of feedback networks used at audio frequencies, but let's stick to RF oscillators. You can distinguish the different types by looking at their feedback networks (see Fig. 1).

The Armstrong oscillator (see Fig. 1A) uses a separate tickler coil (L2) to provide feedback to the main tuning coil (L1). The coils are usually wound on the same coil form with each other. The Colpitts oscillator (in Fig. 1B) uses a parallel, resonant-tuned circuit and (this is the key) a tapped-capacitor voltage divider (C1 and C2) to provide feedback. The voltage divider may or may not be a direct part of the resonant circuit. The Clapp oscillator (not shown) is a variant of the Colpitts circuit in which a series resonant-tuning circuit is used. Finally, the Hartley oscillator uses a tapped-inductor voltage divider (Fig. 1C) for the feedback network.

The resonating portion of the oscillator may be either an inductor/capacitor (LC) tuned circuit, as shown in Fig. 1, or a piezoelectric-crystal resonator. The latter are more stable than LC tuned circuits.

## **1- to 20-MHz Crystal Oscillator.**

Figure 2 shows a simple, nearly universal signal generator that can accommodate crystal frequencies between 1 and 20 MHz. It operates in the "fundamental mode," so the marked frequency of the crystal is the actual frequency that it operates on (as opposed to units with "overtone crystals" that operate on harmonics of the fundamental frequency). When specifying the crystal, if you are given a choice, ask for a crystal that operates into 32 pF of capacitance. Otherwise, the actual operating frequency may be a little different than the specified frequency.

The amplifier device is simply a bipolar NPN transistor. The transistor selected is not critical, but the 2N3904 and 2N2222 devices have been used by the author on numerous occasions in the circuit. Obviously, whatever transistor is selected, it must operate as an oscillator in the frequency range of interest. If you want to use a similarly rated PNP transistor (e.g. 2N3906), then simply reverse the polarity of the DC power supply.

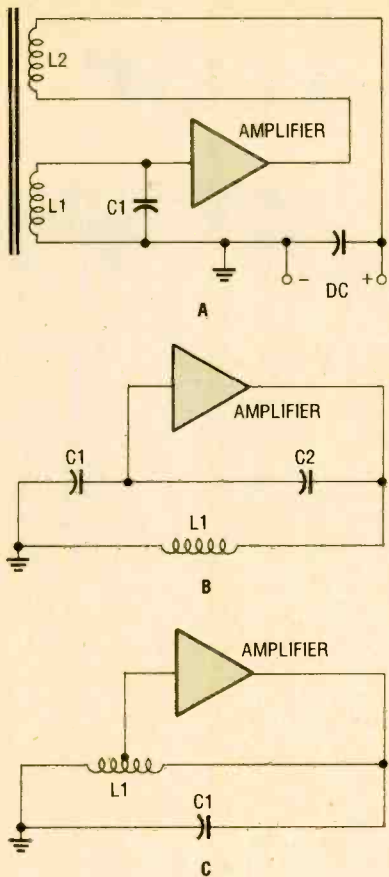

Fig. 1. These are the three main forms of RF feedback oscillators: Armstrong (A), Colpitts (B), and Hartley (C).

The circuit has the simplest form of DC-bias network for the transistor—R1 is directly connected between the transistor's collector and its base. The output signal is passed through a DC-blocking capacitor (C5), which is across the emitter resistor (R2). Bypass-capacitor C4 (valued from .01 to 0.1  $\mu\text{F}$ ) is con-

nected between the collector and ground. The capacitor sets the collector at ground potential for AC signals to keep it at the rated 9- to 12-volts DC power-supply potential.

The feedback network consists of capacitors C1 and C2. The ratio of their values is selected to achieve a reasonable tradeoff of output-voltage level and stability. Those capacitors and capacitor C3 should be either silvered-mica or (preferably) NPO ceramic-disc capacitors. Use of those types will prevent drift of the oscillator frequency due to temperature.

The circuit as shown in Fig. 2 operates at a single frequency because it is crystal controlled. While one would like to think that the crystal always operates on the specified frequency, it is likely that differences in circuit capacitance will make it oscillate at different fre-

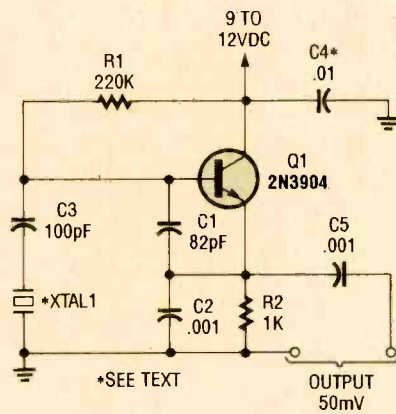

Fig. 2. This is a simple Colpitts crystal oscillator for 1–20 MHz, can be easily made from junk-box parts (provided there's a crystal handy).

quencies. If the exact frequency is important, then replace C3 with a variable capacitor for tuning. Alternatively, connect a 50-pF variable capacitor in parallel across the crystal.

The circuit is popular with people who have to troubleshoot FM receivers. Figure 3 shows a signal generator that can be used to align and test common FM receivers. The basic circuit is the same as the one in Fig. 2, but the crystal is replaced with a SPDT switch and a pair of crystals. The 10.7-MHz crystal is used to test the FM IF-amplifier stages (because 10.7 MHz is the standard FM IF). The 9-MHz crystal is used to test the front-end and tuning-dial accuracy of the receiver.

A 9-MHz crystal will output sufficient harmonics at 90, 99, and 108 MHz to check the calibration of the low-end, middle, and high-end of the dial, respectively. Note that the signal generator does not produce an audio tone in the output of the receiver, but rather it quiets the receiver and can be detected by an increase in the strength-meter reading.

**HF/VHF Buffer Amplifier.** A buffer amplifier is used to isolate the output of the oscillator from circuits that follow it along the signal path. Variations in the load of an oscillator can shift its frequency, so a buffer is used to prevent that problem. Figure 4 shows a circuit for a buffer amplifier that can be used in the low-frequency (LF), high-frequency (HF), and lower end of the VHF ranges.

The actual "amplifier" in that buffer amplifier is a 40673 dual-gate MOSFET (or NTE-222, which is a standard re-

### PARTS LIST FOR THE COLPITTS CRYSTAL OSCILLATOR

#### CAPACITORS

- C1—82-pF, silvered mica or NPO ceramic-disc
- C2—.001- $\mu\text{F}$ , silvered mica or NPO ceramic-disc
- C3—100-pF, silvered mica or NPO ceramic-disc
- C4—.01–0.1- $\mu\text{F}$ , ceramic-disc
- C5—.001- $\mu\text{F}$ , ceramic-disc

#### ADDITIONAL PARTS AND MATERIALS

- Q1—2N3904, small-signal NPN transistor
- R1—220,000-ohm, 1/4-watt, 5% resistor
- R2—1000-ohm, 1/4-watt, 5% resistor
- XTAL1—1–20 MHz crystal (see text)

### PARTS LIST FOR THE SWITCHABLE COLPITTS CRYSTAL OSCILLATOR

#### CAPACITORS

- C1—82-pF, NPO ceramic-disc
- C2—.001- $\mu\text{F}$ , NPO ceramic-disc
- C3—100-pF, NPO ceramic-disc
- C4, C5—50-pF, variable
- C6—0.1- $\mu\text{F}$ , ceramic-disc
- C7—.001- $\mu\text{F}$ , ceramic-disc

#### ADDITIONAL PARTS AND MATERIALS

- Q1—2N3904, small-signal NPN transistor
- R1—220,000-ohm, 1/4-watt, 5% resistor
- R2—1000-ohm, 1/4-watt, 5% resistor
- XTAL1—10.7-MHz crystal
- XTAL2—9-MHz crystal
- SI—SPDT switch

### PARTS LIST FOR THE VHF/UHF BUFFER AMPLIFIER

#### RESISTORS

- (All resistors are 1/4-watt, 5% units.)
- R1—220,000-ohm
  - R2—100-ohm
  - R3—270-ohm
  - R4—10,000-ohm
  - R5—56,000-ohm

#### CAPACITORS

- C1—100-pF, ceramic-disc
- C2, C4–C6—0.1- $\mu\text{F}$ , ceramic-disc
- C3—.001- $\mu\text{F}$ , ceramic-disc

#### ADDITIONAL PARTS AND MATERIALS

- Q1—40673 dual-gate MOSFET
- L1—1000- $\mu\text{H}$  choke



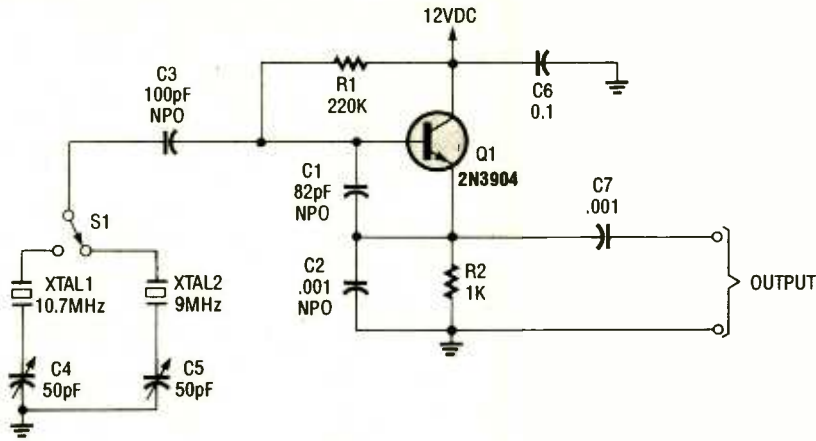

Fig. 3. Here's a two-frequency Colpitts crystal oscillator for testing FM receivers. It's just a variation of the unit in Fig. 2 to show how versatile a multi-throw switch can make such circuits.

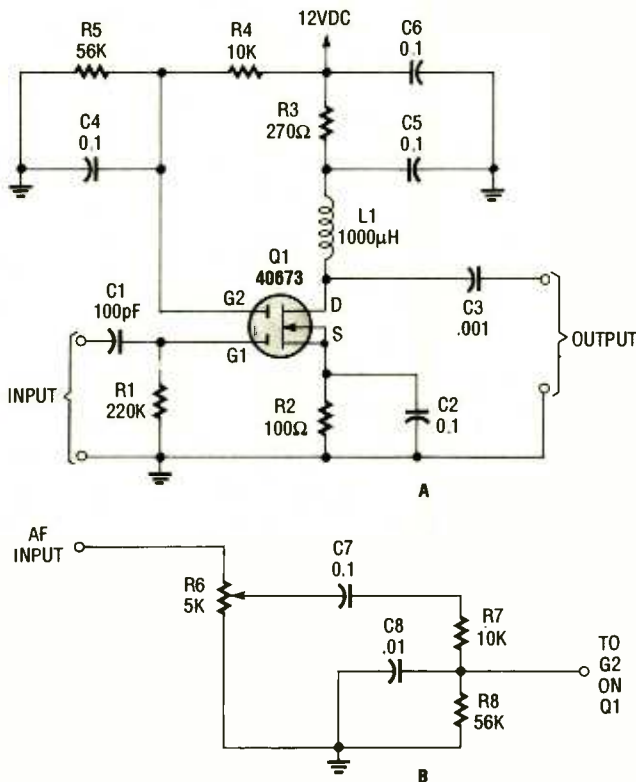

Fig. 4. The gain of the buffer-amplifier circuit in A can be amplitude modulated by replacing the components going to gate 2 with the circuit in B.

placement part for it). The MOSFET is connected in the standard "grounded-source" configuration. A small source bias is provided by the 100-ohm resistor (R2) from source to ground. A 0.1-µF capacitor shunted across R2 keeps the source resistor at ground potential for RF signals, while also keeping it at a small, positive, DC potential caused by the voltage drop across it.

The positive DC operating potential on the drain (D) is supplied through a 270-ohm drain-load resistor (R3) and a

1000-µH radio-frequency choke (L1). The choke has an inductive reactance that increases linearly with frequency, so the combination of R3 and L1 provides a load impedance that increases with frequency, overcoming the tendency of the transistor to offer less gain at higher frequencies. That DC drain-load network (R3/L1) is decoupled by a pair of 0.1-µF bypass capacitors. You can use ceramic disc, polyester, or any other capacitor that can work as a bypass at the low-VHF region.

Input is applied through a DC-blocking capacitor (C1), across a gate resistor (R1), to MOSFET gate G1. The output signal is taken from the drain (D) through a .001-µF DC-blocking capacitor (C3).

The second gate (G2) of the 40673 MOSFET is biased to a DC potential of about 10 volts, which is set by the voltage divider made of R4 and R5. The G2 terminal is set to AC ground by a bypass capacitor (C4) selected to have a low capacitive reactance at the minimum operating frequency, relative to R5. In practical terms, that means that the impedance of C4 must be less than a tenth of the resistance of R5.

A variation on the theme can be built by connecting the voltage-divider network (R4/R5) to a potentiometer or other variable-voltage source instead of the power supply (as shown). The variable voltage can then be used as an output-level control. In some signal generators, the G2 terminal of the

**PARTS LIST FOR THE BUFFER-AMPLIFIER MODULATOR**

- R6—5000-ohm, ¼-watt, 5% resistor
- R7—10,000-ohm, ¼-watt, 5% resistor
- R8—56,000-ohm, ¼-watt, 5% resistor
- C7—0.1-µF, ceramic-disc capacitor
- C8—.01-µF, ceramic-disc capacitor

MOSFET buffer amplifier is connected to an automatic gain control (AGC) to stabilize the output-signal level.

Another use for the G2 terminal is to amplitude modulate the output-signal level. A potentiometer and capacitor (see Fig. 4B) is used to connect the G2 circuit to an audio-sinewave source. Make sure that the sinewave amplitude is high enough to make the amplifier nonlinear (otherwise modulation will not result), but not so much that the output waveform plateaus and bottoms-out from being overdriven.

**455-kHz AM IF-Amplifier Test/Alignment Oscillator.** A modern superheterodyne AM radio uses a 455-kHz IF amplifier (262.5 kHz is used on AM car radios). Figure 5 shows a simple signal-generator circuit that can be used to test, troubleshoot, or align an AM IF stage in common radios. The active element is an MPF-102 (or NTE-312) junction field-effect transistor (JFET).

As you can see by comparing Fig. 5 to Fig. 1C, this circuit is of the basic Hartley-oscillator class because it uses

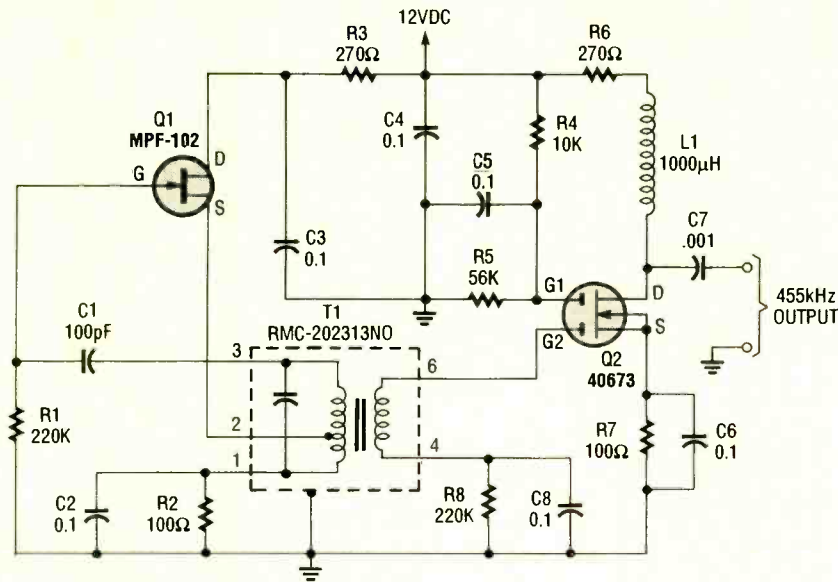

Fig. 5. This 455-kHz AM IF signal-generator circuit relies on transformer T1 for its frequency stability.

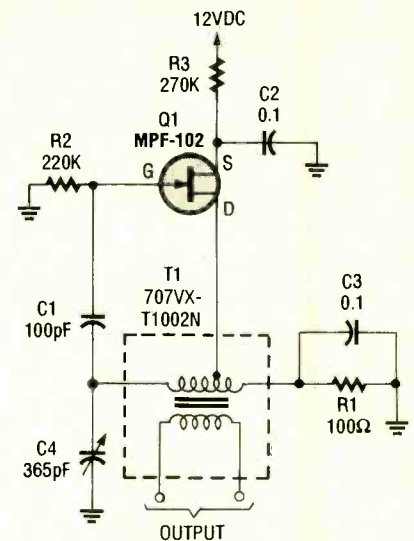

Fig. 6. The frequency of this AM and shortwave-band RF signal-generator circuit is tuned by using variable capacitor, C4. It covers both bands as is.

### PARTS LIST FOR THE 455kHz-IF TEST/ALIGNMENT OSCILLATOR

#### RESISTORS

(All resistors are 1/4-watt, 5% units.)  
 R1, R8—220,000-ohm  
 R2, R7—100-ohm  
 R3, R6—270-ohm  
 R4—10,000-ohm  
 R5—56,000-ohm

#### CAPACITORS

C1—100-pF, ceramic-disc  
 C2—C6, C8—0.1-μF, ceramic-disc  
 C7—.001-μF, ceramic-disc

#### ADDITIONAL PARTS AND MATERIALS

Q1—MPF-102 JFET  
 Q2—40673 dual-gate MOSFET  
 L1—1000-μH choke  
 T1—.64-mH, 455kHz Toko-coil transformer RMC-202313NO (Digi-Key Part No. TK-1301, or equivalent)

a tapped inductor (T1) in its feedback network. The transformer used for this purpose is a standard 455-kHz IF transformer. The transformer has a tapped primary that is used to match the low collector impedance of bipolar- (PNP or NPN) transistor amplifiers, but we can press that tapped LC-tank circuit into service as a Hartley oscillator. The secondary of the transformer forms a handy output port to pass the 455-kHz signal to the buffer stage (see Fig. 4 and discussion above for a description of that portion of the circuit).

### Signal Generator for the AM and Shortwave Bands.

The same general type of circuit can be used for the AM band (530 kHz to 1610 kHz), or for the shortwave bands (1610 kHz to 30 MHz). The version shown in Fig. 6 uses a standard transformer that has a 217-μH inductance in the primary winding. Our particular example uses a Toko coil, T1, in conjunction with a 365-pF variable capacitor to cover the AM broadcast band. For other frequencies use:

$$f = 1/6.28\sqrt{LC}$$

or, if  $f$  is known but  $C$  is unknown:

$$C = 1/39.5f^2L$$

or, if  $f$  is known but  $L$  is unknown:

$$L = 1/39.5f^2C$$

In all three cases above,  $f$  is in hertz,  $C$  is in farads, and  $L$  is in henries.

A VHF voltage-tuned oscillator circuit is shown in Fig. 7. I've used that circuit at frequencies from 20 MHz to 150 MHz. The circuit uses a feedback capacitor (C2) across the collector-emitter circuit of the transistor. This capacitor is critical, and the circuit probably won't oscillate without it. The tuning network consists of inductor L1, DC-blocking capacitor C1, and the varactor (D1). Varactors are voltage-controlled, variable-capacitance diodes. The inductor can be wound on an air form about 3/8-inch in diameter. If #20 or thicker solid wire is used for L1, then the coil will be self-supporting after it is removed from the coil form. To determine the number of turns of wire you will need use:

### PARTS LIST FOR THE AM-BAND OSCILLATOR

#### RESISTORS

(All resistors are 1/4-watt, 5% units.)  
 R1—100-ohm  
 R2—220,000-ohm  
 R3—270,000-ohm

#### CAPACITORS

C1—100-pF, ceramic-disc  
 C2, C3—0.1-μF, ceramic-disc  
 C4—365-pF, variable

#### ADDITIONAL PARTS AND MATERIALS

Q1—MPF-102 JFET  
 T1—217-μH, 100kHz, Toko-coil transformer 707VX-T1002N (Digi-Key Part No. TK-1903)

$$n = \sqrt{L(9a + 10b)/a^2}$$

where  $n$  is the number of turns,  $L$  is the desired inductance in microhenries,  $a$  is the coil radius in inches, and  $b$  is the coil length also in inches. The inductor need not be close wound so its a good idea to add an extra turn or two and open and squeeze the coil to tune it.

The VHF oscillator of Fig. 7 is tuned with a DC voltage ( $V_d$ ) applied through a 150k resistor (R4). That voltage is positive in order to reverse-bias D1. A problem with the circuit is that the frequency is a non-linear function of voltage because of the characteristics of D1. A somewhat more linear circuit can be achieved by replacing the DC-blocking capacitor C1 with a second  
 (Continued on page 102)



# THE DIGITAL ELECTRONICS COURSE

## AN INTRODUCTION TO IC COUNTER CIRCUITS

Learn how counters count, and how to use those IC's in your circuits.

BY ROBERT A. YOUNG

In a previous exercise we demonstrated how discrete JK flip-flops might be combined to form a ripple counter. Such counters are available in IC form, thereby reducing the number of components committed to that application in a given circuit. One such counter is the 7490 decade counter. Its pinout diagram is shown in Fig. 1.

The 7490 is a monolithic counter that contains four master-slave flip-flops and additional gating to provide divide-by-two counting and a three-stage divide-by-five counter for which the count cycle is divide-by-ten. Each counter section has a separate clock input ( $CP_0$  and  $CP_1$ ), which is triggered on the high-to-low transition of the input clock pulse.

The counter can be connected to provide a conventional BCD output signal, or it can be connected to provide a square-wave output with a 50% duty cycle. To configure the 7490 for BCD operation, the  $CP_1$  clock input terminal is connected to the A output. The clocking signal is then applied to the device's  $CP_0$  input.

In the BCD mode, a high logic level applied to both of the MS inputs (pins 6 and 7) sets the outputs of the 7490 to

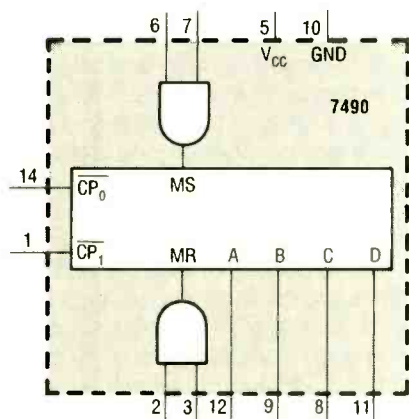

Fig. 1. The 7490 contains four master-slave flip-flops and additional gating to provide a divide-by-two counter and a three-stage divide-by-five counter, which combine to form a divide-by-ten or decade counter.

BCD 9 (1001). A high logic level applied to both MR inputs (pins 2 and 3) forces a 7490's outputs to go to BCD 0 (0000).

A 7490 is shown configured for BCD operation in Fig. 2. Clock pulses applied to the  $CP_0$  input terminal of the 7490 are counted and output in BCD form at the A, B, C, and D outputs (pins 12, 9, 8, and 11, respectively). The output of the 7490 is then applied to the A, B, C, and D inputs of the 7448 7-segment display decoder/driver. The 7448, upon receiving the BCD signal, decodes the input data, and activates (in this case, toggles high) the appropriate segments of the display.

Now recall (from a previous exercise) that a common-cathode display has the cathodes of all the segments tied to ground. So, whenever a segment output of the 7448 goes high, the corresponding display segment lights. Now let's assume that a single clock pulse is applied to the  $CP_0$  input of the 7490.

The 7490 then interprets the input signal and outputs the corresponding value in BCD form (0001). The BCD value of the input is then fed to the 7448, which in turn interprets the input signal, causing the appropriate segment outputs to go high. Note that in order to display the number 1, only the "b" and "c" segments are activated. Had the input to the 7490 counter been 6 pulses, the process would have been the same, except that instead of lighting the "b" and "c" segments only, the "c," "d," "e," "f," and "g" segments of the display would be activated.

**Decade Counter Exercise.** Breadboard the circuit shown in Fig. 2. If you left the circuit from last time, you'll just have to remove some components.

Apply power to the circuit and, using your logic pulser, inject a pulse to the  $CP_0$  (pin 14) clock input. Did the count (as shown on the 7-segment display) advance? The count should have advanced one digit for each pulse fed to the  $CP_0$  input. Did the count advance on the positive- or negative-going tran-

(Continued on page 97)

\*Our gratitude is extended to the EIA/CEG for the creation of this course, especially to the consultants who brought it to fruition: Dr. William Mast, Appalachian State University; Mr. Joseph Sloop, Surry Community College; Dr. Elmer Poe, Eastern Kentucky University.



# ELENCO XK-220 DIGITAL TRAINER



CIRCLE 119 ON FREE INFORMATION CARD

*The Elenco XK-220 Digital Trainer makes testing logic circuits as simple as possible.*

**N**owadays, it's relatively easy to design a circuit, especially if you're using IC's; they can perform functions that, in the past, would have required a large number of discrete components to implement. One IC can replace literally thousands of discrete components. And, every day, more and more specialized IC's are being put on the market that can do things that engineers of the past only dreamed about.

The only problem with IC's is that, in order to test a new circuit idea, you need a protoboard to make all of the connections to the IC pins. And even if you've already got a protoboard, you still need various power supplies, test instruments, and switches to get any circuit to work.

That's why the XK-220 Digital Trainer (from Elenco Electronics, 150 W. Carpenter Avenue, Wheeling, IL 60090; Tel. 312/541-3800) is a good addition to any workbench. The XK-220's features include +5-, +12-, and -12-volt power supplies; 1-Hz, 1-kHz, and 100 kHz clock outputs; eight LED logic indicators; eight data switches; two no-bounce logic switches; a 590-pin protoboard; and a 100-pin output board for all of the accessories. So, basically, the XK-220 provides you with virtually everything you'll need to test a digital circuit in one neat package.

The XK-220 is housed in a sturdy plastic case with a silkscreened front panel, and space is provided inside the case

for storing the line cord. It even includes a storage box for your test components that mounts on the lid of the case. The XK-220 is priced right for most budgets: it is available fully assembled for \$150, and as a kit for \$110. The kit includes everything you need to complete the unit, and it provides good building practice for beginners. One can gain valuable experience soldering PC boards, mounting and wiring controls, assembling cabinets, and so on. It's also good for the experienced hobbyist who needs "something to do."

The XK-220 kit comes with a well-thought-out assembly/operating manual, that has checkboxes for each assembly step, as well as tips on good construction techniques. It contains clear assembly diagrams, and also covers the testing and troubleshooting of the unit—although there's very little chance of having any trouble with it.

**A Closer Look.** The AC transformer and line cord that are included with the unit are used to power the three internal power supplies. There's a master power switch on the control panel, and a "Power-On" LED indicator. The +5-volt supply provides up to 0.5 amps, and the two 12-volt supplies can deliver 150 mA each. The unit has a fuse and regulators with built-in thermal cutoff to protect against short circuits.

The front panel includes eight single-pole double-throw data switches. One side of each switch is connected to +5

volts, the other side is connected to ground, and the poles are connected to sockets on an output protoboard (five sockets for each switch). The switches are useful for providing up to eight different signal inputs for a logic circuit that is under test.

Also on the front panel are two bounce-free "logic switches." The word "bounce" can be taken quite literally in this case; when you throw the lever on a mechanical switch, the contacts actually jump up and down a few times before coming to rest. Now that might not make a difference in an analog circuit, where things happen very slowly with respect to the amount of time that switch contacts will bounce. However, in a logic circuit, where things happen at extremely high speeds, each bounce of a switch will be seen as a separate pulse—and that's unacceptable. Therefore, the two logic switches contain no-bounce circuitry to eliminate the problem.

A 555-timer IC is used to generate clock pulses at three different rates (the 1-Hz, 1-kHz, and 100-kHz signals mentioned before). All clock pulses are 5-volts peak-to-peak, with 220 ohms output impedance. A 60-Hz pulse that is derived from the AC line voltage is also available on the front panel.

The unit also has eight LED logic indicators. Each LED will turn on when its input is over 2.8 volts, and shut off when it drops below 1 volt. The logic indica-

*(Continued on page 97)*



# PRODUCT TEST REPORTS

By Len Feldman

## Hitachi VT-S730A Videocassette Recorder

The most obvious difference between the Hitachi VT-S730A and the VCR that most people own is that this one is Super-VHS (S-VHS) compatible. For those still unfamiliar with that system, S-VHS is capable of recording and playing back pictures that have better resolution or picture detail than can be obtained from over-the-air broadcast TV—400 lines of horizontal resolution or better, as opposed to a maximum of 330 lines from regular broadcast TV. But that's not where the dif-

fer- dio tracks right on the same area of tape where the video signals are recorded. That seemingly impossible juxtaposition is accomplished without interference between the two types of signals by means of a clever system called depth-multiplexing, and through the use of different azimuth angles for the audio and video recording heads.

The VCR features an eight-event, one-year timer. Programming is made easy by displaying the program steps on your TV screen. You can also enter the record-

own to let you know the status of the VCR. The remote control can also be used to control most TV sets—even those not made by Hitachi. Up to 12 series of "codes" have been programmed into the remote and, by experimenting, you can find the code that works with your brand of TV. As Hitachi points out in their manual, however, there may be some brands of TV sets that will not respond to any of the codes.

Getting to some of the more interesting features found on this VCR, there is a built-in video titler. Three character sizes are available for titling, and once a title is stored it can be brought up at any time and superimposed on what you happen to be recording at that time.

Another innovation is the ability to connect a video printer to the VCR, via a rear panel terminal. By the time you read this, such printers will be available in this country. I saw several being offered in Tokyo recently, when I visited the famous Akihabara section of that city, also known as Electric City because of its more than 400 consumer-electronics shops crowded into just a few square blocks. The VCR is also able to perform sophisticated editing operations when hooked up to another VCR.

Among the more common features found on this VCR are automatic power turn-on when a cassette is inserted, automatic start of play when a cassette that has its record protection

CIRCLE 120 ON FREE INFORMATION CARD



The Hitachi VT-S730A videocassette recorder.

ferences end.

To match the improved picture quality, there is, of course, an MTS (stereo and secondary audio program) decoder built into the VCR, so that you can record and view programs with two-channel stereo audio sound tracks. Furthermore, audio tracks can be recorded both conventionally and using the VHS HiFi system, which superimposes a pair of high-fidelity FM au-

ing mode instantly, without full timer programming, either for the recording to start immediately or for the recording to start at any time within the next 24 hours. Most of the more sophisticated functions and features of this VCR, as well as the more usual tape-transport and simple record functions, can be operated via the supplied remote control, which even has a large display area of its

tab removed is inserted, and automatic rewind at the end of play. Other features of this recorder will be apparent as we examine its control panel.

## CONTROLS

The only controls visible when the hinged panels on the front of the unit are closed are a jog dial and a shuttle ring. The shuttle ring is used to speed up or slow down playback at a smooth variable rate for everything from slow motion to fast picture search. During still-frame viewing, the jog dial moves the tape forward one frame at a time.

When you swing down the hinged panel, the cassette slot is exposed, as are several controls directly beneath it. Included there are a pair of audio record-level slide controls, an audio-mix switch, an edit switch, a switch that enhances bass response during playback, a color control (operative only during playback), a picture-sharpness control, and a stereo-headphone jack and its associated level control.

Many additional buttons and controls are also found on the back side of the hinged panel. There we find the usual tape-transport buttons, the power on/off button, the TV-tuner programming buttons that store only those channels received in your area for subsequent TV-channel access, and an S-VHS switch (the VCR will record in standard VHS mode if you wish and will, of course, play back tapes made on conventional VHS machines). Also there are an input-selector button (including a setting for simulcast recording of a TV picture with sound supplied from an FM tuner), various buttons used during editing, tracking-control buttons, a tape-speed selector, a title but-

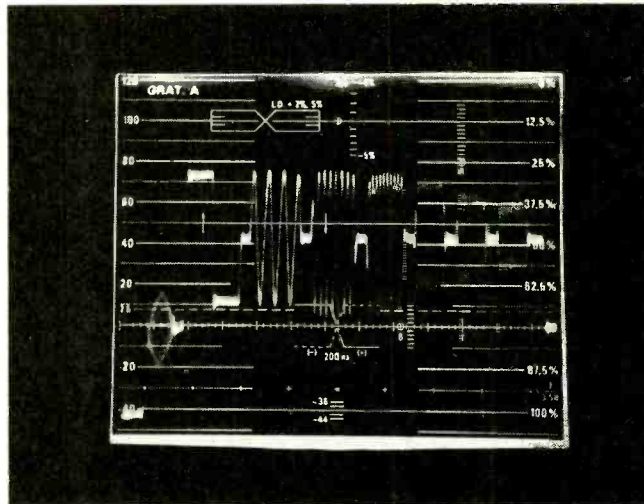

*This S-VHS VCR boasts frequency response that far surpasses that of conventional VHS VCR's. As shown in this photo, which shows video response to burst signals of ascending frequencies, there was a significant amount of video signal present even at 5 MHz.*

ton (pushed when creating titles), counter-reset and memory-rewind buttons, a level-meter on/off button, channel up and down selector buttons, audio and video dubbing buttons, a VCR/TV selector button, and a "go to" button that uses the linear time counter to move so many minutes forward or backward from the current tape position.

Beneath the main swing-down panel, at the very bottom edge of the VCR, is

another smaller swing-down panel. Behind it are microphone and stereo-audio input jacks, a video-input jack, an S-video input jack (that is used to feed separate luminance and color signals from any other S-VHS or high-resolution product), and a synchro-in jack that can accept a pause signal from a video camera or from another VCR for synchro editing.

Besides duplicating most of the control functions of

the VCR itself, the supplied remote control offers additional buttons and controls used to activate still more features. For example, number buttons permit you to access TV channels directly, instead of having to scan up and down. A skip button fast-forwards the tape during playback for about 30 seconds worth of actual recording time. This feature is a boon for commercial "zappers." Programming buttons, clock setting buttons, parental channel lockout, index setting, blank-tape searching, mono and SAP (secondary audio program) buttons, a repeat-play button, and even a button for activating a connected video printer are among the many additional controls found on the remote control, which even duplicates the jog and shuttle rings found on the main unit.

The rear panel of this VCR is equipped with video input and output jacks, audio-input jacks, and two sets of audio-output jacks. Audio level for the second set of audio-out jacks is controlled by the headphone-level jack up front. An S-video output terminal is also found here, as are the usual antenna and RF jacks, a channel 3/4-switch, and a synchro-out switch for connection to a second VCR when doing synchro editing.

## THE TEST RESULTS

As in our previous video-product test reports, all lab measurements were made by the Advanced Product Evaluation Laboratory (APEL). Results of their measurements, along with the sample actually tested, were then sent to my lab for further subjective testing and hands-on use of the product.

This VCR records at two speeds: SP and EP, but it will  
(Continued on page 92)

### TEST RESULTS—HITACHI VT-S730A VCR

Specification	APL Measured
Video Frequency Response	
At 3.0 MHz	-1.34 dB
At 4.2 MHz	-4.86 dB
Video Signal-to-Noise Ratios	
Chroma, AM	49.3 dB
Chroma, PM	44.6 dB
Luminance, 100 IRE	41.4 dB
Luminance, 50 IRE	41.3 dB
Luminance, 10 IRE	42.0 dB
HiFi Audio Reference Level for 0.77% THD	2.9 volts
HiFi Audio Signal-to-Noise Ratio	87.5 dB
HiFi Frequency Response (-3 dB)	20 Hz to 20 kHz
Regular Audio Reference Level	0.35 volts
Regular Audio Signal-to-Noise Ratio	50.5 dB
Regular Audio Frequency Response (-3 dB)	110 Hz to 15 kHz
Stereo TV Signal-to-Noise Ratio	62 dB
Stereo TV Distortion @ -20 dB	0.20%
Mono Signal-to-Noise (via Stereo Decoder)	64.7 dB
Mono Distortion (via Stereo Decoder)	0.40%
Power Requirement	32 watts
Fast Forward/Rewind Time	4 min. 10 sec.
Dimensions (H x W x D, inches)	4 x 17 1/2 x 15 1/2
Weight	16 1/2 lbs.
Suggested Retail Price: \$1199.95	



# CIRCUIT CIRCUS

By Charles D. Rakes

## Simple Circuits With Practical Applications

This month we are going to take a look at a number of unrelated circuits that can be used as is, or modified to fit some specific application. Even if you don't have a project in mind, it can be a lot of fun building and experimenting with a new circuit just to see how it operates.

### PROXIMITY SWITCH

Our first circuit (see Fig. 1) came about when we were working on a project that required a proximity switch in which RF could not be used as the sensing medium. In addition, the sensor's pick-up plate had to be mounted in a location

application; reflected IR radiation striking the detector triggered the circuit. At the heart of the circuit in Fig. 1 is a single 567 tone decoder IC (U1) which, in this circuit, performs a dual function: it operates both as a basic IR-transmitter driver and as a receiver. Capacitor C1 and resistor R2 are used to set U1's internal-oscillator frequency to about 1 kHz.

The square-wave output of U1 at pin 5 is fed to the base of Q1. Transistor Q1 (a 2N2222 general-purpose unit) is configured as an emitter-follower amplifier, which applies a 20-mA pulse to the anode of LED2 (an infrared-emitting diode, that's half of an IR-emitter/detector pair). Transistor Q3 (the other half of the IR-emitter/detector pair) detects the IR output of LED2 and sends the signal on to Q2 for additional amplification.

After amplification by Q2, the signal is fed back to the input of U1 at pin 3, causing pin 8 to go low, biasing LED1 on. If desired, LED1 can be replaced with an optocoupler to control just about any AC-operated circuit.

Since the circuit is so simple, just about any construction scheme will do. The IR emitter (LED1) and the phototransistor (Q3) should be placed about 1/2-inch apart in a side-by-side position and aimed in the same direction.

You'll need to experiment with the spacing and mounting angle of the two IR devices to determine the best location for a given distance between the detector and the emitter. As a

guideline, a 1/2-inch spacing between the IR-emitter/detector pair allows the proximity circuit to detect an object about 1/2 to 1-inch away. Lighter colored objects reflect better and will work at greater distances than those made of darker materials.

The optocoupler-based, Triac-driver circuit shown in Fig. 2 can be added to the proximity switch in Fig. 1 to control a small AC motor. As long as the proximity sensor detects an IR signal, the controlled circuit remains activated, and when the signal disappears the output turns off.

### GAIN CONTROLLER

Our next entry places a 4066 quad bilateral switch in a remote gain-control circuit to illustrate the IC's basic function in a simple application. The 4066 contains four independently controlled, normally open, single-pole single-throw (SPST) switches in a single plastic package. Each SPST switch can be viewed as (essentially) a micro-powered Triac, since, like the Triac (which is also called a bilateral switch), they are capable of conducting current in either direction.

Each normally open switch has its own control input; when a positive logic signal is applied to a switch's control input, the switch closes, tying any devices connected to it to each other. The switch contacts are opened by applying a negative logic signal to the control input.

All input/output circuitry is internally protected against damage from high static voltages or electrical fields,

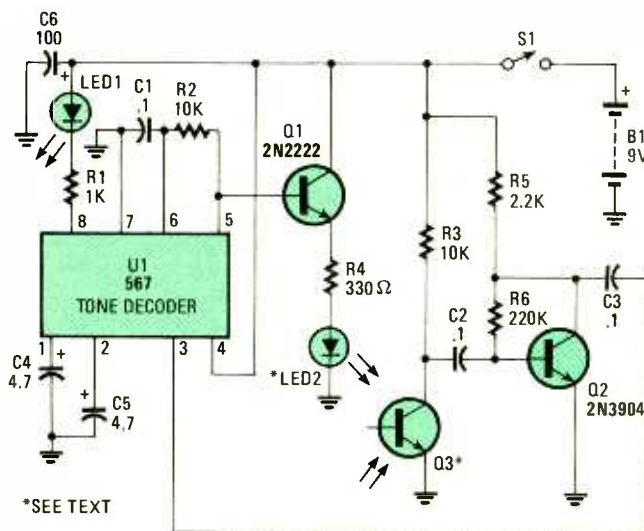

Fig. 1. The unusual thing about our Proximity Switch is that it is not triggered by direct IR radiation, but instead is triggered by a reflected IR signal.

where it could not be touched or bridged to activate. Those restrictions resulted in some real head scratching that, after a time, produced an IR-triggered, proximity-detector circuit.

The unusual thing about the circuit is that it is not triggered by direct IR radiation in its original

## PARTS LIST FOR THE PROXIMITY SWITCH

### SEMICONDUCTORS

- U1—567 tone decoder, integrated circuit  
 Q1—2N2222 general-purpose NPN silicon transistor  
 Q2—2N3904 general-purpose NPN silicon transistor  
 Q3—IR detector transistor (from matched emitter/detector pair, RS 276-142 or similar)  
 LED1—Jumbo light-emitting diode (any color)  
 LED2—IR emitter (from matched emitter/detector pair, RS 276-142 or similar)

### RESISTORS

(All resistors are 1/4-watt, 5% units.)

- R1—1000-ohm  
 R2, R3—10,000-ohm  
 R4—330-ohm  
 R5—2200-ohm  
 R6—220,000-ohm

### CAPACITORS

- C1—C3—0.1- $\mu$ F, ceramic-disc  
 C4, C5—4.7- $\mu$ F, 25-WVDC, electrolytic  
 C6—100- $\mu$ F, 16-WVDC, electrolytic

### ADDITIONAL PARTS AND MATERIALS

- B1—9-volt transistor-radio battery  
 S1—SPST switch  
 Perfboard materials, enclosure, AC molded power plug with line cord, battery(ies), battery holder and connector, wire, solder, hardware, etc.

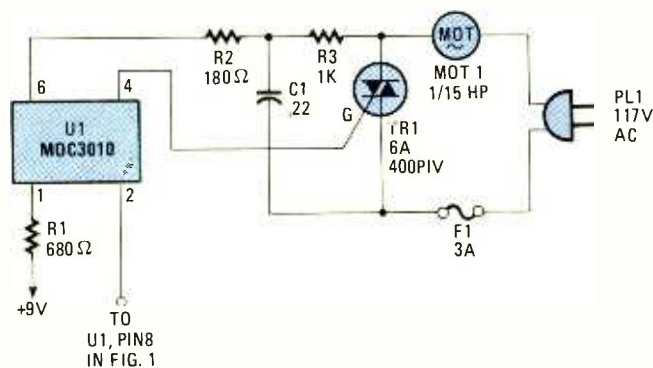

Fig. 2. The Triac Driver can be added to the proximity switch to control a small AC motor.

## PARTS LIST FOR THE TRIAC DRIVER

### RESISTORS

(All resistors are 1/4-watt, 5% units.)

- R1—680-ohm  
 R2—180-ohm  
 R3—1000-ohm

### ADDITIONAL PARTS AND MATERIALS

- TR1—6-amp, 400-PIV Triac  
 U1—MOC3010 optoisolator/coupler (Triac driver), integrated circuit  
 C1—0.22- $\mu$ F, ceramic-disc capacitor  
 F1—3-amp fuse  
 Perfboard materials, enclosure, AC molded power plug with line cord, battery(ies), battery holder and connector, wire, solder, hardware, etc.

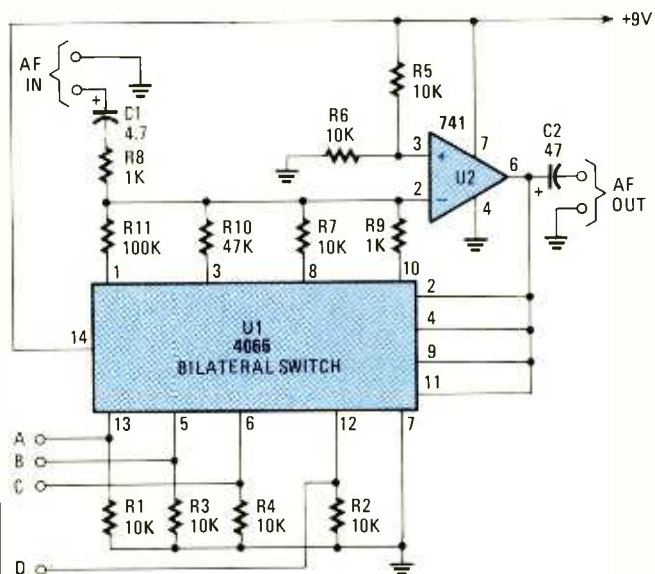

Fig. 3. The Gain Controller uses a 4066 quad bilateral switch to electronically select a feedback resistor for the 741 op-amp. One or more switches can be turned on at the same time to produce a stepped, variable-gain range of from less than 1 to 100.

## PARTS LIST FOR THE GAIN CONTROLLER

### RESISTORS

(All resistors are 1/4-watt, 5% units.)

- R1—R7—10,000-ohm  
 R8, R9—1000-ohm  
 R10—47,000-ohm  
 R11—100,000-ohm

### ADDITIONAL PARTS AND MATERIALS

- U1—4066 quad bilateral-switch, integrated circuit  
 U2—741 general-purpose op-amp, integrated circuit  
 C1—4.7- $\mu$ F, 16-WVDC, electrolytic capacitor  
 C2—47- $\mu$ F, 16-WVDC, electrolytic capacitor  
 Perfboard materials, enclosure, AC molded power plug with line cord, battery(ies), battery holder and connector, wire, solder, hardware, etc.

but to be on the safe side, don't let any of the input/output pins go above the IC's supply voltage. The 4066 IC performs admirably in modulator/demodulator, signal-gating, attenuator, gain-control, commutating-switching, multiplexing, analog-to-digital and digital-to-analog conversion, and other circuits.

The 4066 in Fig. 3 switches four gain-setting resistors in and out of a single-stage AF amplifier (built around a 741 op-amp) to obtain up to 12 different gain settings. When the control input of

U1 at pin 13 is tied high, R11 (a 100k resistor) is connected in U2's feedback loop. With the 100k value of R11 (and ignoring the switch's resistance), U2 has a voltage gain of 100; the gain is found by dividing the feedback resistor's value by the input resistor's value ( $R_{11}/R_8 = 100k/1k = 100$ ).

When pin 5 of U1 is tied high, R10 (a 47k resistor) is connected in the op-amp's feedback loop, and the op-amp's gain drops to 47; when pin 6 is tied high, R7 (a 10k resistor) is connected in the op-amp's feedback



loop, giving it a gain of 10; and with pin 12 tied high, R9 is connected in the feedback loop, providing a gain of 1 (unity). One or more switches can be turned on at the same time to produce a stepped, variable-gain range of from less than 1 to 100. The values of R7 through R11 can be selected to produce the desired gain for each activated switch, or the combination of two or more activated switches.

The control inputs (labeled A-D) can be remotely operated through either a wire cable or a wireless system to control the amplifier's gain. By changing the values of the feedback resistors, the circuit can be changed into a remote-controlled attenuator. Additional gain or attenuator steps can be added by using more than one 4066 IC and additional gain-setting resistors.

## WAVEFORM GENERATOR

Figure 4 shows another application of the 4066 quad bilateral switch. In that circuit, the 4066 (U1) is used to perform sequential switching to produce a symmetrical stepped waveform; see Fig. 5. As shown, the generator's waveform is made up of 3-up and 3-down steps in 1-volt increments. Switch triggering for the 4066 is controlled by a 4017 decade counter/divider (U2); a 567 tone decoder configured as a square-wave generator supplies the clock pulses for the 4017.

The 4017 is programmed to count from 0 to 5 (0-1-2-3-4-5) sequentially and reset on the leading edge of the seventh step by tying pin 5 (output 6) of U2 to pin 15 (reset). When output 6 (pin 5 of U2) goes high, the reset terminal of U2 forces output 0 (pin 3) to toggle from low to high,

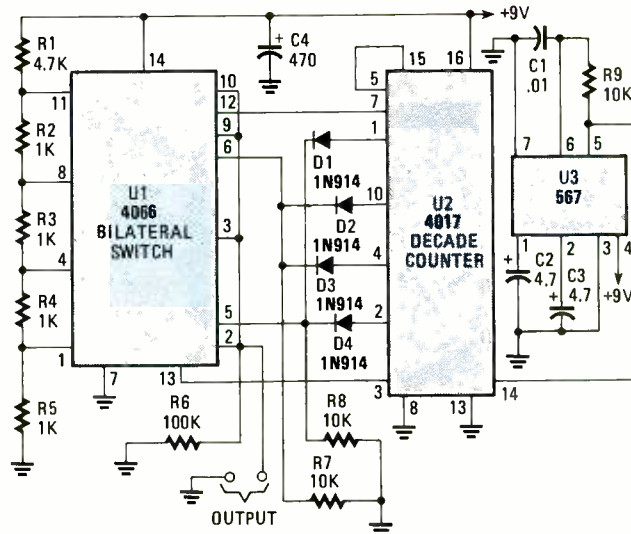

Fig. 4. In the Waveform Generator, the 4066 (U1) is used to perform sequential switching to produce a symmetrical stepped waveform.

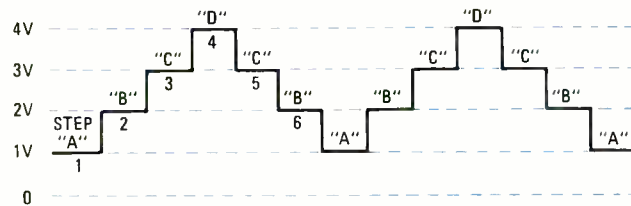

Fig. 5. The output of the stepped waveform generator is made up of 3-up and 3-down steps in 1-volt increments (much like the output of a digital-to-analog converter). Switch triggering for the 4066 is controlled by a 4017 decade counter/divider (U2), which is clocked by a square-wave generator built around a 567 PLL (phase-locked loop).

## PARTS LIST FOR THE STEPPED WAVEFORM GENERATOR

### SEMICONDUCTORS

- U1—4066 quad bilateral-switch, integrated circuit
- U2—4017 decade counter/divider, integrated circuit
- U3—567 tone decoder, integrated circuit
- D1-D4—1N914 small signal silicon diode

### RESISTORS

- (All resistors are 1/4-watt, 5% units.)
- R1—4700-ohm
  - R2-R5—1000-ohm
  - R6—100,000-ohm
  - R7-R9—10,000-ohm

### CAPACITORS

- C1—0.01- $\mu$ F, ceramic-disc
- C2, C3—4.7- $\mu$ F, 16-WVDC, electrolytic
- C4—470- $\mu$ F, 16-WVDC, electrolytic

### ADDITIONAL PARTS AND MATERIALS

- Perfboard materials, enclosure, 9-volt power source, IC sockets, wire, solder, hardware, etc.

beginning the sequence anew. The high pin-3 output (output 0) of U2 is fed to the control terminal of the first

switch in U1, turning it on and thereby bridging the junction of R4 and R5 to the output bus.

That sets the first step at a one-volt level. On the next clock pulse from the 567, the 4017 produces a high output at pin 2, which is fed through D4 to the next switch control at pin 5, turning it on. That connects the junction of R3 and R4 to the output bus. The second step produces a 2-volt output. On the next pulse received from U3, pin 4 of U2 goes high, causing the third switch (in U1) to conduct, which in turn produces a 3-volt output for step 3. The fourth pulse from U3 causes pin 7 to go high, turning on the final switch, and thereby producing a 4-volt output for step 4.

The fifth pulse applies a high to pin 10 of U2, which passes through D4 to the control input of the third switch, turning it on (for a second time) and giving a 3-volt output for the fifth step. On the next clock pulse, the switch connected to pin 6 of U1 is again triggered, producing a 2-volt output for step 6. After step six is completed the counter resets and starts over by turning on the first switch for step 1.

There are a number of applications for this circuit. The stepping waveform generator can be used to supply a number of progressive voltages for testing the on/off switching points of various CMOS devices. Each step on the waveform can be set for any voltage from zero to full supply voltage by using individual voltage dividers for each step. Also, the generator's output can be buffered to supply sufficient voltage and current outputs to serve as an increasing voltage or current source for a semiconductor curve tracer.

Looks like we've run out of room for this month, but let's meet here again same time next month. In the meantime, may the flow be with you. ■

# COMPUTER BITS

By Jeff Holtzman

## On-Line Information

I have stacks and stacks and stacks of old magazines and trade journals (just ask my wife). And there's lots of good information buried there—it's just hard to find. This month I'm going to look at two different solutions to the problem of finding buried data. The two take radically different approaches, provide different types of information, and differ greatly in how they are priced.

One, Computer Database Plus, is an on-line service accessible through CompuServe; the other—PC-Index—puts its database right on your PC.



*PC-Index indexes more than a dozen PC-oriented publications going back to 1987. Although rough around the edges, the program is a cost-effective solution to finding important information.*

### PC-INDEX

For a couple of years I have subscribed to a database provided by Information Services; the company indexes most major personal-computer publications (see Table 1), and provides quarterly updates in dBASE format. Indexes for some magazines go back as far as 1987, but some of the mag-

azines have been added only recently.

Information Services used to provide a copy of PC-File and let you do your own searches. This year, however, the company is supplying its own front-end (a compiled dBASE program) that makes all databases accessible through one menu, simplifies the search process, provides several useful built-in reports, but reduces overall flexibility.

PC-Index requires from 3.5 to 7 megabytes of space on your hard disk, depending on how far back your database goes; the data comes in compressed format, so installation and indexing takes about 20 minutes. You can access the database through one of two groups of information. One covers product reviews; the other covers all other types of articles.

PC-Index locks your searches into a predefined set of keywords, which makes finding information difficult. For example, suppose you want to buy a new hard disk, and can't decide which type. You've heard a lot about SCSI and ESDI drives, and wonder whether you should go with one of them, or with a standard ST-506 type. You'd like to bone up on some technical articles, and read some product reviews.

Under the Product Review section, you bring up the hardware keywords, and select hard disk. Sub-keywords for hard disk include SCSI, but not ESDI, so you can't search for what you want directly. You can search without the sub-keyword (i.e., for all articles on

TABLE 1—  
MAGAZINES INDEXED  
BY PC-INDEX

Business Software  
Byte  
Computer Language  
Data Base Advisor  
Dr. Dobbs Journal  
InfoWorld  
Latus  
PC Computing  
PC Week  
PC Magazine  
Personal Computing  
PC Resource  
PC World  
PC Tech Journal

hard disks), but then you've got many possible candidates, and little way to distinguish among them.

Under the General section, hard disk is again a keyword, but neither SCSI nor ESDI appears as a sub-keyword, so the situation is even worse. PC-Index lacks a number of ease-of-use features. One of the most frustrating is that after every search, the program takes you all the way back out to the main menu, so if you want to perform a variation on a search, you have to enter the same search parameters again.

Overall, it seems arbitrary to divide articles into re-

TABLE 2—  
COMPUTER DATABASE PLUS  
SEARCH METHODS

Key Words (words occurring in article titles, subject headings, company names, or product names)  
Any Words (words occurring anywhere in articles)  
Subject Headings  
Company Names  
Product Names  
Publication Names  
Publication Dates  
Article Types  
Article Reference Numbers



## PROGRAMS AND VENDORS

PC-Index (\$59.95)  
Information Services  
949 Villa Gran Way  
Fenton, MO 63026  
Tel. 314-576-9295

Computer Database Plus  
(Rates vary)  
Information Access Company  
362 Lakeside Drive  
Foster City, CA 94404  
Tel. 1-800-227-8431  
415-378-5000

CompuServe  
P.O. Box 20212  
Columbus, OH 43220-9922  
Tel. 1-800-848-8199  
Operator 20

views and "other." If I was researching SCSI and ESDI hard disks, I might want to find all occurrences of either term, and gradually limit the search to reviews, technical articles, and installation tips.

You can't search for all occurrences anywhere of an item. Another complaint is that the General section lists the author of each article, but the reviews section doesn't. I would greatly prefer to see authors listed, because over the long haul, some reviewers prove more reliable than others.

### COMPUTER DATABASE PLUS

If PC-Index is a small fishing boat, Computer Database Plus is an ocean liner. CDP indexes hundreds of magazines, including virtually all popular personal-computer publications, technical journals from the IEEE and the ACM; vendor journals from IBM, DEC, and others; the New York Times, the Wall Street Journal, and more. And the full text of many articles is available as well.

Of course, all that doesn't come free. You have to pay CompuServe's basic charge, \$12.50 per hour; CDP adds a \$24 per hour surcharge. In addition, it costs \$1 for each article

summary, or \$2.50 for the abstract and complete text (if available). That makes a basic rate of \$36.50 per hour, plus article charges. Obviously, CDP is not a system for casual browsing. On the other hand, after becoming familiar with the system, you can usually perform a search and download an article in ten or fifteen minutes; viewed in that way, an article costs about \$10 or \$15, a small price to pay in a professional setting.

You access CDP via CompuServe. (To join CompuServe, call 800-346-3247 with your

### TABLE 3— COMPUTER DATABASE PLUS ARTICLE TYPES

Bibliography  
Buyers guide  
Column  
Company profile  
Directory  
Editorial  
Evaluation  
Glossary  
Hardware review  
Illustration  
Interview  
Letter to the editor  
Obituary  
Panel discussion  
Product announcement  
Software review  
Technical  
Transcript  
Tutorial

modem to find a local access number. To enter Computer Database Plus, type GO COMPLIB at any CompuServe prompt.

CDP provides a menu-driven interface that is awkward to use, but powerful nonetheless. It allows you to create simple and complex searches, and to narrow and broaden the scope of the search until you've got just what you want, at which point you can download abstracts or full-text.

You can search by any combination of the items shown in Table 2. For exam-  
*(Continued on page 92)*

## LEARN VCR CLEANING/MAINTENANCE/REPAIR

EARN UP TO \$1000 A WEEK, WORKING  
PART TIME FROM YOUR OWN HOME!



Secrets  
Revealed!

NO Special  
Tools or  
Equipment  
Needed.

EARN UP TO \$60  
AN HOUR AND  
MORE!

### THE MONEY MAKING OPPORTUNITY OF THE 1990'S

IF you are able to work with common small hand tools, and are familiar with basic electronics (i.e. able to use voltmeter, understand DC electronics) . . . .

IF you possess average mechanical ability, and have a VCR on which to practice and learn . . . then we can teach YOU VCR maintenance and repair!

**FACT:** up to 90% of ALL VCR malfunctions are due to simple MECHANICAL or ELECTRO-MECHANICAL breakdowns!

**FACT:** over 77 million VCRs in use today nationwide! Average VCR needs service or repair every 12 to 18 months!

Viejo's 400 PAGE TRAINING MANUAL (over 500 photos and illustrations) and AWARD-WINNING VIDEO TRAINING TAPE reveals the SECRETS of VCR maintenance and repair—"real world" information that is NOT available elsewhere!

Also includes all the info you'll need regarding the BUSINESS-SIDE of running a successful service operation!

**FREE INFORMATION**  
CALL TOLL-FREE 1-800-537-0589  
Or write to: Viejo Publications Inc.  
5329 Fountain Ave  
Los Angeles, CA 90029 Dept. PE

CIRCLE 13 ON FREE INFORMATION CARD

## AMAZING NEW Pocket Reference

480 pages of tables, maps, formulas, and conversions and it fits in your shirt pocket ( 3.2" x 5.4" x 0.6" )!

**\$9.95\***



\* Plus \$2.00 shipping & handling.  
Colorado residents add 56¢ tax.

### Small sample of contents

Air Tool CFM vs PSI	Radio Alphabet
Battery Charging	TEN Radio Codes
Tire Manufacturer Codes	Telephone Area Codes
Lumber Sizes & Grades	Lost Credit Card Phones
Concrete & Mortar	Sound Intensities
Element Tables	Wind Chill Factors
Computer ASCII Codes	Frequency Spectrum
IBM® PC Error Codes	Geology Mineral Tables
IBM® Interrupts-IO Map	Glues and Solvents
80286 Hard Disk Types	Bolt Torque Tables
Printer Control Codes	Wood Screw/Nail Sizes
Electric Wire Size vs Load	Math Formulas & Tables
NEMA Motor Frames	Plane/Solid Geometry
Wire & Sheet Gauges	Copper/Steel/PVC Pipe
Resistor/Capacitor Colors	Rope, Cable and Chain
Pilot Lamp Specs	Tap-Die-Drill Sizes
Fuse & Battery Specs	Sand Paper & Abrasives
RF Coil Winding Data	Weld Electrode & Solder
Wire Size vs Turns/Inch	3200 Conversion Factors

**Money Back Guarantee** - If not completely satisfied, return book postage prepaid, in mint condition for a 100% refund!

Sequoia Publishing Inc.  
Dept 914, P.O. Box 620820  
Littleton, CO 80162

CIRCLE 25 ON FREE INFORMATION CARD

# FUN SOFTWARE

By Fred Blechman

## The Fun Side of Computing

The Computer Bits column that appears in **Popular Electronics** is aimed at the serious side of computing. But since "All work and no play makes Jack a dull boy," we decided it was time to loosen up and look at the flip-side of computing—the fun side.

In this column I'll be reviewing some of the great computer games and simulators for the IBM PC. Many of these programs are also available in versions for

different flight simulators for the IBM PC). For example, in this column I'll review *Electronic Arts' F-16 Combat Pilot*, an excellent flight simulator, but I'll also review *Spectrum HoloByte's Welltris*, a really addictive flat 3-D version of their award-winning Tetris game.

### F-16 COMBAT PILOT

*(Electronic Arts, 1820 Gateway Drive San Mateo, CA 94404, Tel. orders 800-245-4525 (VISA or Mas-*

be promoted to Squadron Commander. But before you undertake your first command mission, you must qualify by mastering five different basic missions. Once you achieve command status, there are ten missions you can command. You advance in rank and responsibility as you complete each command mission. Each promotion becomes more difficult, since each command mission requires more skill to survive.

Before you go on any real missions, you go through flight training. Here you can select mock missions with relative impunity from enemy weapons (although you can still crash and get "killed.")

There are enough scenarios and options to keep you busy, without repeating specific actions, for years. As an added feature, you can hook up two computers by direct cable or through modems and have head-to-head combat with a live adversary.

F-16 Combat Pilot is available for the IBM, Tandy, and compatibles, and also for the Atari ST. The IBM/Tandy version (the version I tested) requires DOS 2.0 or better, at least 512K RAM, and CGA, EGA, or Tandy 16-color. Although Hercules monochrome graphics is supported, forget it. The same applies to an LCD screen, unless it has at least four shades of gray.

I ran F-16 on a venerable PC/XT with a 4.77-MHz clock speed and a CGA video card, using PC-DOS 2.10. My favorite joystick, a Gravis Mark VI, provided very smooth flight control. I also ran F-16 on a 12-MHz 80286

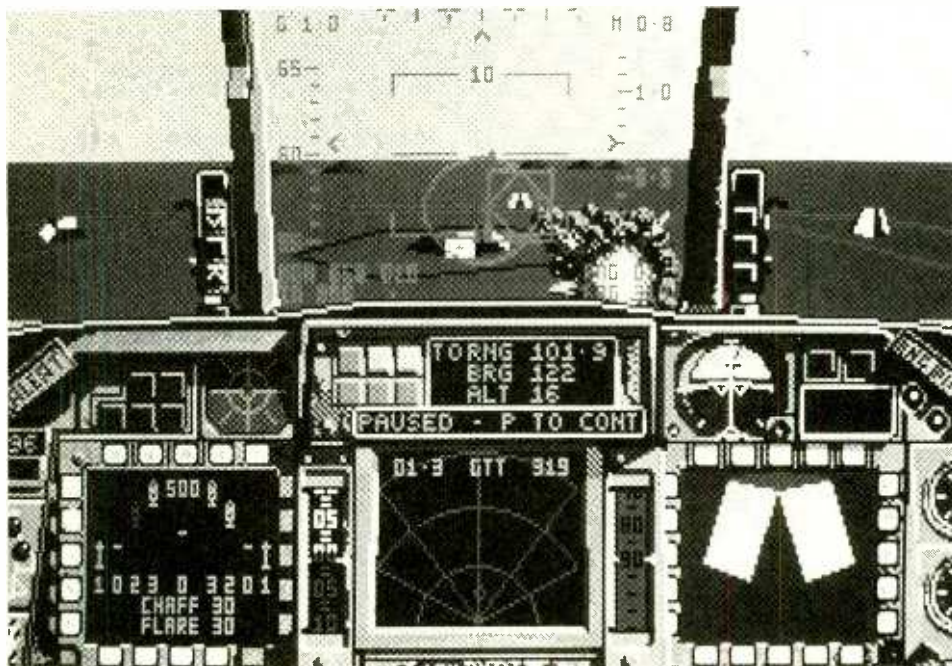

*Electronic Arts F-16 Combat Pilot*

other machines, such as the Apple, Commodore, Atari, and Amiga. In addition to software, I'll occasionally cover hardware, such as sound boards and controllers, that can make game playing more enjoyable.

As an ex-Navy carrier-based fighter pilot with a commercial pilot's license, my passion is flight simulators, but I won't limit my scope to those alone (although I have over 30

*ter Charge*). Price for IBM PC or Atari ST version: \$49.95 + \$3 S/H. CA residents add \$3.50 sales tax.)

Despite its sophistication, F-16 Combat Pilot runs respectably using CGA on a plain-vanilla 4.77-MHz PC/XT without a hard drive. If you have an EGA 12-MHz machine with a hard drive, so much the better.

This is the first fighter simulation that allows you to



AT with a hard drive and EGA, using keyboard control.

The program is supplied on three 360K 5¼-inch floppy diskettes; a 720K 3½-inch microdiskette is available for \$7.50 extra if you can't make your own. The disks are not copy-protected, but you need a randomly-selected code word from the manual to get started.

Two pieces of documentation are provided, and you need them both. The manual is generic, intended for use with both the IBM and Atari versions. A separate 12-page Pilot Kneepad is provided with specific keyboard commands and screen descriptions for the version you're using.

Trust me: Don't try to fly this simulator before reading the manual and learning the game controls. There are many, many instruments and lights to interpret, as well as weapons management, targeting modes, and flight parameters. This is no Piper Cub!

From the main screen (a picture of a ready room) you move a cursor to choose "demonstration" (sample flight and landing), "quickstart" (airborne), "controls" (sets keyboard, joystick, or mouse as controller), "aircraft data" (F-16 and Russian aircraft views and specifications), "weapon data" (lots of them!), "pilot's log" (your personal record), or "missions" (training, five missions, or two-player dogfight.)

Once airborne, I was amazed at the smooth and sensitive control of the aircraft with the slow PC/XT, even while landing. Some simulators suffer badly in screen-update speed and controllability as they show more graphic detail while nearing the ground. This did not seem to happen with F-16.

I was highly pleased with the acrobatic capability, instrument response, and stability of this simulator. Although there was certainly some small control response delay, and screen animation was not completely smooth when using CGA and a 4.77-MHz clock speed, I found the flight characteristics completely acceptable. On the 12-MHz AT, using a hard drive and EGA, the animation was even faster and smoother.

On the XT I found a joystick much more comfortable than keyboard control, but found keyboard control very adequate. On the other hand, mouse control, for me, was very unnatural and overly sensitive.

On the AT, I couldn't get either the joystick or the mouse to operate properly at all! Electronic Arts will probably have corrected that by now.

Screens changed instantly when commanded. You can look to the left, right, or behind instantly, but only from inside the cockpit. There are no views from outside the aircraft.

The most up-to-date weapons are available. LANTIRN- (low altitude navigation and targeting infrared for night) guided Maverick missiles can destroy enemy tanks in a single pass. Iron bombs and Durandals destroy airfields and radar stations. ATARS (advanced tactical reconnaissance system) pods take pictures of enemy installations. AMRAAM's (advanced medium-range air-to-air missiles) clear MiG's out of the sky. More than 1000 fixed and mobile targets, including airbases, early warning radars, factories and power plants, are spread over thousands of square miles. Amazingly, you can select up to five specific targets of any type before a mission, and your

inertial navigation computer will guide you to each one!

Everything considered, I found F-16 Combat Pilot to be an outstanding flight simulator, entirely acceptable even on modest equipment. Just don't plan on becoming a squadron commander without m-a-n-y combat hours!

**CIRCLE 117 ON FREE INFORMATION CARD**

## WELLTRIS

*(Spectrum HoloByte, 2061 Challenger Drive, Alameda, CA 94501. Tel. 415-522-3587. Retail Price: \$34.95.)*

"CAUTION! Play this game at your own risk. It may cost you many hours of otherwise productive time, and is considered addictive."

That's the warning that the Federal Trade Commission should consider placing on every package of Welltris, the successor to the award-winning Tetris, and by the same author (Alexey Pajitnov, Soviet mathematician, designer, and programmer).

Welltris challenges the player to manipulate randomly falling pieces, consisting of various configurations of squares, into solid lines. The pieces fall down one of four walls of a well—hence the name Welltris—to a grid-like bottom. As the piece hits the bottom, it skids along until it hits another piece, or the opposite wall.

You can rotate the falling piece (made up of from one to five squares) and move it along the walls until it hits the bottom. As solid vertical or horizontal lines of squares are formed at the bottom, they disappear and adjacent squares move into the gap. The faster you go, and the more solid lines you form, the higher your score. The top ten scorers are recorded for posterity.

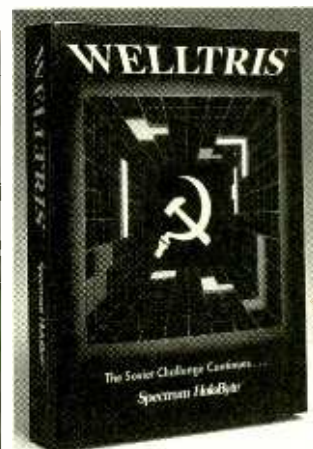

*Spectrum HoloByte Welltris*

Three levels of difficulty and five speeds provide fun for everyone from the first-time player to the veteran Tetris addict. It is very easy to learn, but challenging to play.

I reviewed the IBM PC version of Welltris. By the time you read this, versions are promised for the Apple Macintosh and the Commodore Amiga.

You don't need a very exotic IBM PC system to play Welltris. It will operate on any PC/XT/AT or reasonably close compatible (including the Tandy 1000) with 256K RAM and some kind of graphics capability (Tandy 16-color mode requires 348K RAM). A hard drive is not required.

I ran Welltris on a plain-vanilla PC/XT running CGA and Hercules at 4.77-MHz without the use of a hard disk, and had no complaints. I also ran Welltris on my Toshiba T1000 laptop using the LCD screen and an external composite monochrome monitor.

Although the distribution disks are not copy-protected, you won't be able to run the program until you type in requested information about a country flag that appears on the screen and is illustrated in the excellent 16-page Player's Guide.

*(Continued on page 87)*

# ANTIQUÉ RADIO

By Marc Ellis

## Bits And Pieces

In the last issue, I mentioned that this month would bring a continuation of our ongoing tube-tester project. Serves me right for making definite promises. Other demands on my time, including some business travel, kept me a bit too busy to do the required testing and experimentation. Instead, I'm going to take the opportunity to review a couple of interesting books that recently came in the mail and to discuss a few other items that I've been saving to share with you.

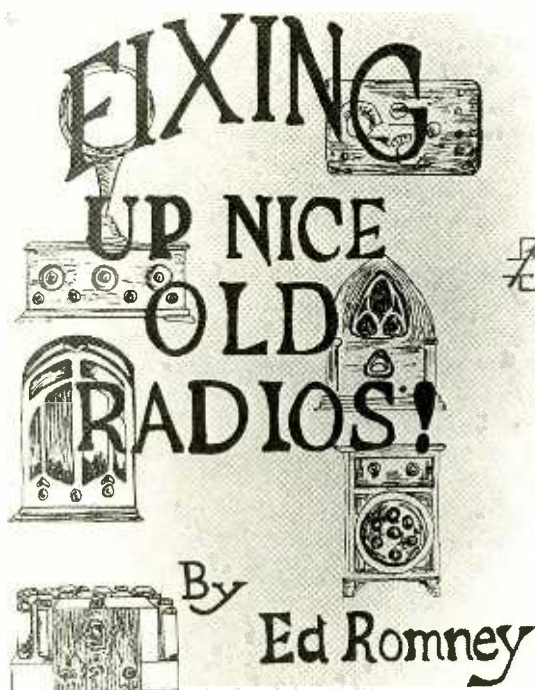

*Serious study of Ed Romney's easy-to-read radio fix-up book will make it possible for even beginners to tackle ambitious repair jobs.*

### AN "ELMER" FOR YOUR BOOKSHELF

In amateur radio parlance, an "Elmer" is an experienced operator making a special effort to help a beginner get started. Almost any radio ham, no matter how accomplished

he or she may now be, can look back into the past and fondly remember an Elmer—a person who helped smooth out the hurdles of studying for the license exam, putting together a workable station, and/or making that first, tension-filled Morse-code contact.

Though a would-be or neophyte radio ham can often find an Elmer, the beginning antique-radio restorer is usually on his/her own. That's what makes Ed Romney's book, *Fixing Up Nice Old Radios*, so valuable. The book is written in such a friendly, chatty style that going through it is almost like having an Elmer at your side. Ed's style is easygoing, and he has a knack for presenting difficult technical concepts in layman's terms. Even if you're a beginner, serious study of this book should soon put you in a position to troubleshoot and repair antique sets.

The theory is presented in easy-to-assimilate doses throughout the book as Ed progresses from the crystal sets and one-tube regenerative radios of the early 1920's to the complex multi-tube luxury sets of the 1930's and 1940's. There are even chapters covering vintage communications and hi-fi gear. Using a case-history approach, the theory is applied to the repair of specific radios typical of the various eras. Ed's "example" radios are well chosen, including many desirable and well-loved sets.

*Fixing Up Nice Old Radios* is spiral-bound and contains 188 pages. It's also very well illustrated—with over 300 drawings, sche-

matics and close-up photos. At this writing (June, 1990), the book was being sold at an introductory price of \$19.00—but scheduled to increase to \$25.00 in August. Antique Electronic Supply (P.O. Box 1810, Tempe, AZ 85280) lists the book at \$19.00 in its just-released *1990 Catalog Supplement #2*. You can also buy directly from Ed by phone (412-867-0314), using Visa or MasterCard.

### BALLAST BACKGROUND

Tony Jacobi's definitive reference books on ballast tubes came to my attention as a result of a misconception about ballast identification codes that appeared in the July, 1990 issue of this column. More about the books and the error in a moment. But first, some background material on ballasts based on information contained in the introduction to Tony's *The Ballast Tube Handbook*.

A "ballast" is a specialized resistor for stabilizing and/or controlling the flow of current. When the current passing through it is low, it presents a relatively low resistance. But should the current begin to rise, its resistance increases and—in accordance with the dictates of Ohm's law—so does the voltage drop across it. The increased voltage drop impedes the current flow through the circuit, minimizing the current rise. Should the current begin to drop, the ballast's resistance decreases, allowing current flow to increase. So a ballast resistor acts as an automatic regulator, smoothing out current fluctuations in a circuit.



necessity for its use.

## Grid Leak Drip Pan

Image)

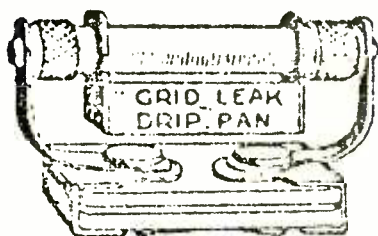

Autom. Contr. (Perh.)

A grid-leak drip pan was introduced in the September 1927 Radio News. See the text for details!

Some of the earliest ballasts employed in radio circuits were used to control filament voltage in battery sets. For example, as long as a means of filament voltage control was present, it was handy to operate tubes with 2-volt filaments from a 3-volt battery source (such as a couple of dry cells wired in series).

When the control was a manually-operated rheostat (as was very common), it could be adjusted to present a relatively high resistance to current flow while the batteries were fresh. The resistance could be gradually reduced as the batteries aged and their voltage dropped. But substituting a properly-designed ballast for the rheostat made operator intervention unnecessary; through its ability to adjust its resistance in response to current changes, the ballast automatically applied proper compensation.

Later, after radios were commonly being operated from house current, ballasts were often used to stabilize power supplies against the line-voltage fluctuations that were common in power lines. Used in series with the primary of a set's power transformer, the proper ballast could smooth out the variations, providing a relatively stable input voltage.



Brother Pat (left) and I study a display panel during my recent visit to his world-class museum of vacuum tubes.

But the use of ballasts most familiar to radio collectors today is in the AC-DC, or "transformer-less" receivers of the 1930's. With the elimination of the power transformer (a cost-cutting measure that helped to make inexpensive radios that could be sold during the Depression years), there came a need for finding an alternate method to light up tube heaters. Those required a low voltage formerly supplied by one or more of the transformer's secondary windings.

The solution was to operate the heaters directly from the AC line. But because the (nominal) 115 volts supplied by the line was much higher than the voltage required by any of the tube heaters, some ad-

justments had to be made. A few new tube types were developed that had higher voltage heaters (the 25Z5 rectifier—with a 25-volt heater—was one example), and the heaters were wired in series so that the required supply voltage would equal the sum of the individual heater voltages.

But the voltage needed by that series string was still much less than the line voltage. The difference (which varied with the tube types used, but was typically on

of heat, which created undesirably high temperatures in the unventilated under-chassis space. Then someone invented the familiar *line-cord resistor*, which was bundled into the line cord along with the radio's power leads. That worked well, but was difficult to replace—and tended to overheat if the cord was rolled up.

The next improvement in voltage-dropping resistors was the so-called "ballast tube." The first ballast tubes were perforated metal cylinders, or standard glass-tube envelopes, containing the necessary resistance elements. Fitted with tube-type bases, they plugged in alongside the set's regular vacuum tubes. They were easy to replace, and their above-chassis location provided decent ventilation.

Later, when octal-based metal tubes began to replace the old tall glass styles, the new-type metal shells and bases were pressed into service for ballast use. But by about 1941, a more complete range of

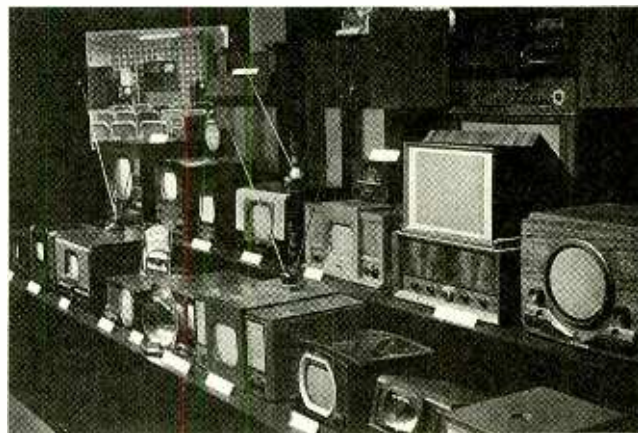

Snapped at the Smithsonian's National Museum of American History was this comprehensive exhibit of late '30's and mid-to-late '40's television receivers.

the order of 50 volts) had to be absorbed by using a resistor connected in series with the string.

The first such resistors were conventional power units mounted under the chassis. They radiated a lot

tubes with higher-voltage heaters was developed for the little AC-DC sets. It was now possible to design a radio whose combined heater requirement totaled 115 volts, making all forms  
(Continued on page 90)

# DX LISTENING

By Don Jensen

## Genghis Khan Returns?

In Mongolia, these days, the popular slogan could well be "Khan do." Genghis is making a comeback! Two of the hottest popular songs in Ulan Bator, the Mongolian capital, are about the 13th Century warlord whose empire once stretched from the Yangtze to the Danube. Genghis Khan, despite his western reputation as a ruthless conqueror whose Mongol hoards scared the pants off of European monarchs some 700 years ago, is something of a national hero.

The rebirth of nationalism among Mongolia's two million inhabitants, and certain

Genghis' comeback may, at least in part, be calculated, part of a budding interest in promoting tourism. Mongolian historians, for example, reportedly have been searching for the tomb of the Great Khan, who died in 1227. The reason? To build a museum there. And in Ulan Bator there's a new hotel named after Genghis. Even a Mongolian-distilled vodka now bears his name!

Tourists in Mongolia? With western travelers already bicycling along China's Great Wall and trekking through Tibet's forbidden city of Lhasa, why not? If that, indeed, is Mongolia's intent, if the Khan's kin have begun to scan the sandy horizon for the first signs of an invasion of suitcase-toting tourists, what will that mean for *Radio Ulan Bator*—Mongolia's foreign-broadcasting service?

Surely its shortwave operations cannot compare with those, say, of Beijing or Moscow. The station broadcasts in only two western languages, English and French, for a half hour each, repeated four times daily. Radio Ulan Bator does not have many shortwave transmitters, only three, but they include a world-ranging 250-kilowatt transmitter and a pair of 100-kilowatt units.

Will Radio Ulan Bator begin promoting Genghis Khan's homeland as an inexpensive, fascinating, and off-the-beaten-path vacation getaway for the adventurous traveler? Other world-band broadcasters have played that sort of public relations game for years.

Because of its limited

schedule, the fact that programs are not beamed directly to North America, and interference from other stations, Radio Ulan Bator can be quite a challenge to tune, but be persistent. The best time to try is during the early morning, 1200 to 1230 UTC—except Tuesdays and Fridays—on 12,025 kHz.

### FEEDBACK

There were lots of letters in the mailbox this month, and that's the way I like it. Before I get to them, though, a reminder that this section of "DX Listening" belongs to you. This is the place where you can ask your questions about shortwave listening, let other DX'ers know about the stations you're hearing or would like to hear. Here's the place for your comments and observations about SWL'ing, the programs you're tuning on your receiver, and your suggestions for this column.

Do you want more basic information about the DX'ing hobby? Do you want tips on stations that are tougher to tune, countries you haven't yet managed to pull in? Or do you want more information on programming from the easier-to-hear stations? The trick for me is to try to balance this column with information for both the beginning listener and the more experienced SWL. Where that balance is struck will depend on the feedback I get from you readers. Send your correspondences to DX Listening, **Popular Electronics**, 500-B Bi-County Blvd., Farmingdale, NY 11735.

The first letter asks about some of the basics. H.B.,



This drawing of the windswept Divi Divi tree, characteristic of the island of Bonaire, is featured on the QSL card currently being received by listeners who send their reception reports to Trans World Radio, Bonaire, Netherlands Antilles.

inclinations to distance themselves from the influence of Moscow, have been credited for some of the past year's changes. For an astonishing 70 years, Mongolia was governed by a Communist regime that was little more than a puppet of the Soviet Union. That is now changing.

But looking a bit closer, there are also hints that

\*Credits: James Streitmatter, IN; Guy Atkins, WA; Jerry Klinck, NY; Wallace Treibel, WA; Rufus Jordan, PA; North American SW Association (45 Wildflower Road, Levittown, PA 19057)



who writes from Pittsburgh, says he's been listening to shortwave for a few months and recently picked up a copy of **Popular Electronics** and "stumbled across the column."

"I know that shortwave broadcasters mostly are grouped in bands of frequencies," says H.B., "but I don't know much about those bands and where I should be tuning. When I go fishing, it helps to know where they're biting."

A good question, H.B. While some SW broadcasters do operate "out of band," most do concentrate on specific frequency ranges that have been established over the years by international agreement. Generally, those SW bands are known by their wavelengths. For many years, there were 12 such bands. Not long ago, during an international frequency conference, a 13th was allocated and several others are to be expanded in size to help ease interference problems.

Although the expansion frequencies haven't been officially added to the list yet, some stations already are using them, so I'll list them with the rest in Table 1.

**TABLE 1—SHORTWAVE BAND FREQUENCIES**

Band	Frequency (kHz)
120 METERS	2,300 - 2,495
90 METERS	3,200 - 3,400
75 METERS	3,900 - 4,000
60 METERS	4,750 - 5,060
49 METERS	5,950 - 6,200
41 METERS	7,100 - 7,300
31 METERS	9,500 - 9,775 9,775 - 9,900*
25 METERS	11,650 - 11,700* 11,700 - 11,975 11,975 - 12,050*
22 METERS	13,600 - 13,800*
19 METERS	15,100 - 15,450 15,450 - 15,600*
16 METERS	17,550 - 17,700* 17,700 - 17,975
13 METERS	21,450 - 21,750 21,750 - 21,850*
11 METERS	25,600 - 26,100

\*See Text

and mark them with an asterisk.

A letter from Albert Jelinek, Neptune City, NJ, passes along word on a broadcasting cutback. "I've just received a letter from the *South African Broadcasting Corporation* regarding *Radio South Africa* (RSA). The letter signed by the head of External Radio Services says: I regret having to inform you that the overseas transmissions of RSA ceased on April 30, 1990. The authorities decided that henceforth RSA will only broadcast to Africa."

That's too bad, since SWLs always hate to see reductions in SW programming. The foreign service of South Africa's RSA was quite popular with SWLs, especially its English programs beamed to North America from 0200 to 0300 UTC. The station also had beams to Latin America in Spanish and Portuguese; to Europe in Danish, Dutch, English, French, German, and Portuguese; and to India and Pakistan in English.

I expect SWLs will still be able to hear RSA's English programming to African listeners, probably during the morning hours.

### DOWN THE DIAL

Here are some shortwave tips, what you may be able to hear, and when and where to tune. The times are, as always, given in Coordinated Universal Time (UTC).

**Cyprus**—7,205 kHz. The *Cyprus Broadcasting Corp.* has been logged with programming in Greek at around 2200 UTC.

**Malaysia**—5,005 kHz. Sarawak, part of the country of Malaysia on the island of Borneo, is a shortwave target for listeners in western Canada and the U.S. at around 1430 UTC. There may be interference from *Radio Nepal* on the same frequency.

# AMAZING SCIENTIFIC & ELECTRONIC PRODUCTS

PLANS IN STOCK		
GRA1	ANTI GRAVITY GENERATOR	\$10.00
LC7	40 WATT BURNING CUTTING LASER	\$20.00
RUB4	HI POWER PULSED DRILLING LASER	\$20.00
BTC5	1 MILLION VOLT TESLA COIL	\$20.00
MCP1	HI VELOCITY COIL GUN	\$15.00
LLS1	LASER LIGHT SHOW 3 METHODS	\$20.00
EH1	ELECTRONIC HYPNOTISM TECHNIQUES	\$8.00
EML1	LOWER POWERED COIL GUN LAUNCHER	\$8.00
JL3	JACOB LADDER 3 MODELS	\$10.00
SD5	SEE IN THE DARK	\$10.00
LEV1	LEVITATION DEVICE	\$10.00

ASSISTANCE KITS PROGRAM AVAILABLE		
FMV1K	3 MILE FM VOICE TRANSMITTER	\$34.50
PFS1K	HAND CONTROLLED PLASMA FIRE SABER	\$49.50
NIG7K	HI FLUX NEGATIVE ION GENERATOR	\$34.50
PG5K	PLASMA LIGHTNING GLOBE	\$49.50
LHC2K	VISIBLE SIMULATED 3 COLOR LASER	\$44.50
HOD1K	HOMING/TRACKING BEEPER TRANSMITTER	\$44.50
LGU6K	2.5 MW HAND-HELD VISIBLE LASER GUN	\$249.50
BTC3K	250,000 VOLT TABLE TOP TESLA COIL	\$249.50
IOG2K	ION RAY GUN, project energy without wires	\$129.95
TKE1K	TELEKINETIC ENHANCER/ELECTRIC MAN	\$79.50
VWPM7K	3 MILE AUTO TELEPHONE TRANSMITTER	\$49.50

ASSEMBLED IN OUR LABS		
LIST10	INFINITY XMTR Listen in via phone lines	\$199.50
IPG70	INVISIBLE PAIN FIELD BLAST WAVE GENERATOR	\$74.50
ITM10	100,000 VOLT INTIMIDATOR UP TO 20'	\$99.50
TAT30	AUTOMATIC TELEPHONE RECORDING DEVICE	\$24.50
PSP40	PHASOR SONIC BLAST WAVE PISTOL	\$89.50
DNE10	ALL NEW 26" VIVID COLORED NEON STICK	\$74.50
LGU20	5 TO 1MW VISIBLE RED HENGE LASER GUN	\$199.50
BLS10	100.00 WATT BLASTER DEFENSE WAND	\$89.50

EASY ORDERING PROCEDURE - TOLL FREE 1-800-221-1705 or 24 HRS ON 1-603-673-4730 or FAX IT TO 1-603-672-5406  
VISA, MC, CHECK, MO IN US FUNDS, INCLUDE 10% SHIPPING. ORDERS \$100.00 & UP ONLY ADD \$10.00. CATALOG \$1.00 OR FREE WITH ORDER.

## INFORMATION UNLIMITED

P.O. BOX 716, DEPT. P N, AMHERST, NH 03031

# Be an FCC LICENSED ELECTRONIC TECHNICIAN!



No costly school. No commuting to class. The Original Home-Study course prepares you for the "FCC Commercial Radio-telephone License." This valuable license is your professional "ticket" to thousands of exciting jobs in Communications, Radio-TV, Microwave, Maritime, Radar, Avionics and more... even start your own business! You don't need a college degree to qualify, but you do need an FCC License.

**No Need to Quit Your Job or Go To School** This proven course is easy, fast and low cost! **GUARANTEED PASS**—You get your FCC License or money refunded. **Send for FREE facts now. MAIL COUPON TODAY!**

### COMMAND PRODUCTIONS

FCC LICENSE TRAINING, Dept. 100  
P.O. Box 2824, San Francisco, CA 94126  
Please rush FREE details immediately!

NAME \_\_\_\_\_  
ADDRESS \_\_\_\_\_  
CITY \_\_\_\_\_ STATE \_\_\_\_\_ ZIP \_\_\_\_\_

# HAM RADIO

By Joseph J. Carr, K4IPV

## Receiving SSTV Ham, WeFAX And Photos On Your Ham Rig

**A**lthough for most hams, our hobby consists of chit-chatting on SSB, working DX, or doing the dah-dit bit on CW, there are some of us who branch out into other areas of the radio hobby. One of our topics this month is a piece of hardware—the MFJ-1278—and some software to go with it that's offered by MFJ Enterprises, Inc. (PO Box 494, Mississippi State, MS, 39762; Tel. 601-323-5869 or 1-800-647-1800).

The MFJ-1278 is an advanced digital terminal that allows you to operate in any of several modes: Packet radio, AMTOR, RTTY (radioteletype), ASCII digital, CW, FAX, and SSTV (slow-scan TV). It is basically a high-class digital radio-modem. The MFJ-1278 has a built-in printer port that allows it to drive an Epson or IBM compatible printer. The price of the MFJ-1278 is \$279.95.

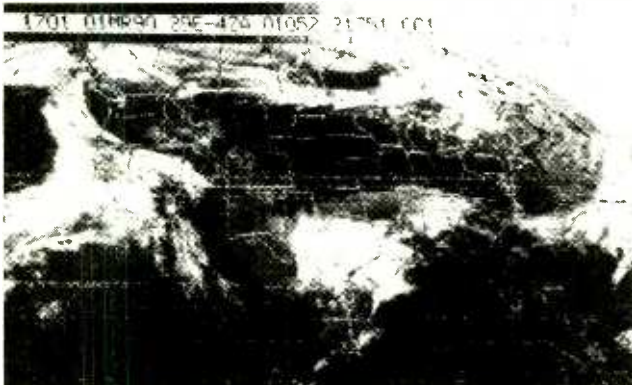

This WeFAX weather photo (taken on 16.41 MHz) was produced using MFJ-1289 MultiCom software with the MFJ-1278 Multi-Gray Level modem.

The mode of the MFJ-1278 that we are interested in is multi-gray level modem. It will transmit and receive multi-gray-level signals over high-frequency (HF) radio. That feature makes it possible to receive

ham generated slow-scan television signals, WeFAX weather photographs, and wire-service news photos.

MFJ Enterprises, Inc. now offers their MFJ-1289 load-and-use IBM-PC compatible software for the MFJ-1278 multi-gray level modem. And best of all, the software is priced at only \$59.95. According to the MFJ news release, the MFJ-1289 MultiCom software is able to transmit full-color packet pictures. The software includes extensive on-screen help functions.

The MFJ-1289 MultiCom also gives the amateur 80 one-key macros that let a single keystroke do the work of many. By combining multiple keystrokes into a single button, you get quick multi-mode operation. You also get MFJ Call-Alert that sounds an alarm when an alphanumeric character sequence (such as the call sign of a rare DX station or the call sign of your friend who has a schedule with you) is received by the MFJ-1278.

That feature allows the operator to maintain a watch for specific call signs, stations, message or call areas, even when you are

not at the computer screen. That means that you're free to do other things while the radio keeps a lookout for the rare ones.

MFJ Auto-Set lets you instantly switch modem modes without having to retype command parameters. You can store entire sets of command parameters for quick access when you need them. MFJ Auto-Router allows you to store digipeater node routes for instant digipeating. MFJ Packet Multi-Plex lets you send and receive packet-radio messages during a binary data-file transfer. You can exchange programs without your QSO being QRT'ed.

There is also a simple word processor (MFJ Multi-Word) included in the MFJ-1289 software package. The word processor is specially designed for multi-mode communications applications. You can bring up a text file from within MFJ MultiCom and instantly transmit any portion directly from that file. It is so powerful and advanced, according to MFJ, that you can also use it for ordinary word processing.

The word processor ca-



The MFJ-1289 MultiCom software and MFJ-1278 Multi-Gray Level modem combination was used to pick up this AP news photo on 20.738 MHz.



pability allows you to create Auto-Router and Auto-Set files. A single key-stroke brings it up on the screen. MFJ MultiCom lets you integrate with another company product, the MFJ-1292 Picture Perfect Video Digitizer, so that you can shoot and transmit a video picture by SSTV, FAX, or Packet.

The software also gives you menu control for your entire disk and disk utilities for graphics-screen capture and conversion to Packet picture format. A disk of sample pictures is included. To make the MFJ-1278/MFJ-1289 hardware and software combination work, you will need an IBM-XT or AT (or fully compatible) that is equipped with 512K of RAM. The MFJ-1289 software supports CGA, EGA, and VGA graphics monitors; picture quality depends on the system used (VGA has the best resolution).

MFJ normally supplies the software on three 5.25-inch, 360K diskettes, but they can also provide the software on 3.5-inch disks if desired (order MFJ-1289M).

#### TECHNICAL NOTE

Believe it or not, I got a ham gram not long ago! Although I was once involved in traffic handling on CW, it has been a long time, and I'd forgotten all about that aspect of ham radio. The ham gram asked me two questions, which I'll answer for everyone here. First, what is "dBm?" Second, "how do you convert dBm to power and voltage readings?"

First things first. The notation dBm refers to decibels with respect to a standard power level of one milliwatt (1 mW or 0.001 W) dissipated in a 50-ohm resistive load. In other words, 0 dBm is 1 mW into 50 ohms. The voltage level represented by 1 mW in a 50 ohm load is;

$$V = \sqrt{PR}$$

$$= \sqrt{(0.001)(50)}$$

$$= 0.2236 \text{ volts}$$

The dBm system is often used to specify signal-generator outputs, receiver sensitivities, amplifier inputs, and so forth. The dBm rating for any given power level is found from the following equation:

$$\text{dBm} = 10 \log (P/0.001) \quad (1)$$

where dBm is the decibel expression of the ratio and P is the power level in watts. For example, 1.2 watts expressed in dBm is:

$$\text{dBm} = 10 \log (P/0.001)$$

$$= 10 \log (1.2/0.001)$$

$$= 30.8 \text{ dBm}$$

A negative dBm rating (e.g. -12 dBm) indicates that power is less than 0.001 watts. Converting dBm to voltage and power levels simply use the inverse of Eq. 1. The first job is to convert to a power ratio. Solving Eq. 1 for P gives:

$$P = (0.001) 10^{\text{dBm}/10} \quad (2)$$

For example, what is the lower level represented by -12 dBm? The calculation is:

$$P = (0.001)(10^{\text{dBm}/10})$$

$$= (0.001)(10^{(-12/10)})$$

$$= (0.001)(0.063)$$

$$= 0.0000631 \text{ watts}$$

$$= 0.0631 \text{ mW}$$

To check the result, use Eq. 1 to find out if the answer is correct. In other words, does 0.0000631 watts translate to -12 dBm? It does.

The dBm notation is often used in designing and building circuits such as frequency mixers and other circuits where signal level is important. Devices such as prepackaged double-balanced mixers have RF and oscillator input impedances of 50 ohms (unless designed for TV applications, in which case 75 ohms is the standard impedance). The oscillator-injection levels are specified in dBm. For example, one popular

brand calls for an oscillator-injection level of +7 dBm (0.005 watts) and an RF-injection level of 1 dBm (0.0013 watts) or less.

#### WINTERING UP

Well, winter is right around the corner. While that means little or nothing to amateurs in the south, southwest, or those with W6 or KH6 callsigns, those of us who haven't fled to the sunbelt still have to worry about snow, sleet, and freezing rain.

Despite that, winter is one of my favorite seasons (when the weather is not too bad) because a big guy like me finds it a whole lot easier to dress to keep warm than to keep cool. Hamming is also a lot better for me during the winter. That's because propagation is better on the HF DX bands.

And have you ever noticed that distances are longer during the winter on 2-meters and up? It seems that all that foliage absorbs VHF/UHF radio signals, so mobiles don't get out quite as far in heavy foliage. For you people who don't understand changes of seasons, let's point out that shortly after those gorgeous northeast forest colors fade, the leaves hit the ground...to be raked up (I know, I know).

Are there any things that ought to be done for winter? Yep! I would take a closer look at the antenna and make sure that it enters winter in sound shape. Winter icing conditions stress antennas considerably, and can bring them down in quick order if preventative measures are not taken. Wire antennas ought to be counterweighted, or otherwise designed to prevent stresses from wind or ice breaking the wire. Aluminum tubing antennas should be checked for loose fasteners, bad mountings, or loose guy wires. ■

#### FUN SOFTWARE

*(Continued from page 81)*

You can select difficulty level, game speed, sound on/off, move mode, next-piece display, scoreboard, credits, and whether you would like to save these options for future games. This may sound confusing, but it all becomes obvious once you start playing the game.

The left side of the screen shows the four-sided well and the bottom grid. At the top you'll see the Level number, Speed number, current score, the number of lines completed, and the shape of the next piece to fall.

The sound is very well done, mostly because there is not much of it. Leave it on. It is not intrusive, but it lets you know when a wall is blocked, when you try to move into a blocked wall, when you complete a line, when pieces move into a removed line—and when you've blown the game!

"Cornering" can give you extra points if used properly. That is, if a piece is wrapped around a corner when it hits bottom, the squares split off in two directions. Sometimes that can fill two lines with one piece.

You get a higher score if you press the space bar to let the object free-fall instead of moving at the programmed rate. Once you can see a piece is headed where you want, hit the space bar and watch those points add up.

Be prepared to be captivated, fascinated, enchanted, enthralled, and eventually enslaved with Welltris. Is this a devious Soviet plot to decimate the productivity of America's proletariat computer owners? ■

**CIRCLE 118 ON FREE INFORMATION CARD**

# SCANNER SCENE

By Marc Saxon

## The Dynasty Continues

A shudder of fear went through scanner fans when Radio Shack cut short the *Realistic PRO-2005's* somewhat abbreviated life-span. The PRO-2005 had been the heir apparent to the venerable *PRO-2004*, but when the plug was yanked on the PRO-2004, there was fear that the dynasty of that family of high-tech super-scanners had ended.

Those fears were allayed when Radio Shack suddenly announced a *Realistic PRO-2006*. Externally, the PRO-2006 looks practically identical to the PRO-2005. From design and performance standpoints, the

lowing frequency ranges: 25–520 MHz, 760–824 MHz, 851–869 MHz, and 896–1300 MHz. That means everything from 25 to 1300 MHz, with the exception of the UHF-TV and cellular frequencies, is covered. As this column is being written, the jury is giving “thumbs up” on the possibilities of unblocking the excluded 800-MHz segments.

The unit will search in steps of 5 kHz, 12.5 kHz, and 50 kHz, the same as its predecessor. It is in the search/scan and scanning areas, however, that we find the major functional differences between the PRO-2006 and the earlier models. The PRO-2004 and PRO-2005 could search and scan at two speeds—“slow” (16 cps) and “slower” (8 cps)—although Bill Cheek's *Scanner Modification Handbook* (CRB Research Books, Inc., P.O. Box 56, Commack, NY 11725) explains how to easily increase that to 20 cps and 10 cps, or 30 cps and 15 cps with slightly more effort. The new PRO-2006 comes out of its carton ready to operate at 26 cps and 13 cps, an ability that Radio Shack calls “Hyperscan.”

At this point, it appears that the PRO-2006 is priced the same as was the PRO-2005—\$419.00. And the latest version in this series is worth every single cent. It is a really fine piece of hardware.

### SINCE YOU ASKED...

Carson McDonald, of Paris, KY, reports that the

two-meter ham band (144 to 148 MHz) is loaded with repeaters. That made him wonder how repeaters work.

Repeaters aren't limited to ham communications. Most two-way communications between 406 and 894 MHz, as well as many between 152 and 174 MHz, are via repeaters. Generally speaking, a repeater is a completely automatic receiving and transmitting station that has been located with its antennas on a high tower, mountain top, or tall building. The combination of antenna gain, antenna height above ground, and transmitter power allows the system to be designed to be operational over a wide area.

Mobile units, handhelds, and sometimes even the base stations in the system all transmit on the repeater's receive (input) frequency, and receive on the repeater's transmit (output) frequency. That effectively gives the relatively low-powered mobiles and portables the ability to communicate with other units over a far wider area than would be possible without the repeater (direct communications). Scanner owners need to monitor only the repeater's output frequency to hear everything. Naturally, there are many variations on how repeater systems may be designed, including those where several different users can share the same repeater, those where the base station itself has repeater capabilities, etc.



A worthy successor to the *Realistic PRO-2004* and *PRO-2005*, the new *PRO-2006* adds “Hyperscan,” which allows you to search and scan at two impressive speeds: 26 and 13 cps.

PRO-2004, PRO-2005, and PRO-2006 are similar—and, in many respects, they are identical (although the price increased when the model number went from PRO-2004 to PRO-2005).

The *Realistic PRO-2006* is a 400-channel scanner that offers AM-, NFM-, and WFM-mode coverage in the fol-



Carson also asked if we could list some of the frequencies used by medical beepers. Listen on 35.64, 35.68, 43.68, 152.0075, 157.45, 163.25, 453.025, 453.075, 453.125, and 453.175 MHz. Those frequencies are exclusively designated for paging, although some paging is also permitted on a secondary basis on certain two-way frequencies used by medical services.

Letters continue to arrive on a regular basis from readers who are interested in monitoring federal agencies. You can discover a lot of exciting communications from military services and civilian federal agencies by

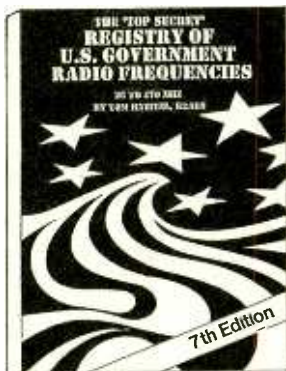

*If you're interested in monitoring federal agencies, this book will provide all the information you need.*

searching 163 to 174 MHz, 225 to 400 MHz, and 406 to 420 MHz, although other frequencies are used as well.

For all federal monitoring enthusiasts, there's the brand-new, 240-page, 7th edition of the "Top Secret" *Registry of U.S. Government Radio Frequencies*. This series is the standard reference source for scanner owners, the news media, law-enforcement agencies, the communications industry, and federal agencies.

It contains frequencies, call signs, tactical ID's, locations, aircraft rosters, and other information. About 80

agencies are covered, including all military services, FBI, Secret Service, ATF, Treasury, DEA, Customs Service, U.S. Marshal, FCC, State Department, Border Patrol, Immigration, FAA, NORAD, NRC, national parks, federal prisons, NASA, and Coast Guard, plus selected government aerospace and defense contractors, UHF aeronautic band (225 to 400 MHz) listing, agents' lingo, frequencies used for bugs and body mikes, and much more. In addition, there's information on Canadian government frequencies. It is a useful book for all scanner users, especially when you consider that more than half the communications space between 25 and 470 MHz is reserved for federal stations. The book includes plenty of 2-25-MHz listings, too.

The newly expanded 7th edition is \$19.95, plus \$2.00 postage, from CRB Research Books, Inc., P.O. Box 56, Commack, NY 11725. Residents of New York please add \$1.50 sales tax.

#### WHAT LICENSE?

Jim Lougherty of Boise, ID, wrote to tell us that most auto-supply stores, as well as stores that cater to campers and hunters, seem to sell VHF transceivers set up to operate on one of three available frequencies. He asked if we can list which frequencies are used for that type of equipment.

Well, Jim, those sets are being sold nationally in all sorts of retail outlets catering to everyone from RV owners to private investigators. Zillions must be in use, and most of them have probably not been licensed by the FCC (as required). They are sold with "Channel A" as 151.625 MHz, "Channel B" as 154.57 MHz, and "Channel C" set up on 154.60 MHz. I always keep those frequencies going in my scanner. ■

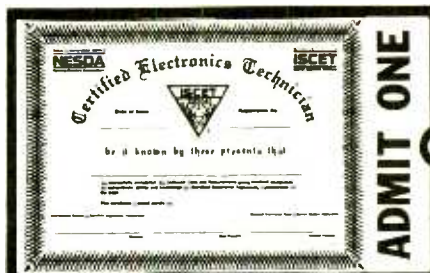

## Your Ticket To SUCCESS

Over 25,000 technicians have gained admittance worldwide as certified professionals. Let your ticket start opening doors for you.

ISCET offers Journeyman certification in Consumer Electronics, Industrial, Medical, Communications, MATV, Radar, Computer, and Video. For more information, contact the International Society of Certified Electronics Technicians, 2708 West Berry St., Fort Worth, TX 76109 • (817) 921-9101.

Name \_\_\_\_\_  
Address \_\_\_\_\_  
City \_\_\_\_\_  
State \_\_\_\_\_ Zip \_\_\_\_\_

Send material about ISCET and becoming certified.

Send one "Study Guide for the Associate Level CET Test." Enclosed is \$10 (inc. postage).

## New AOR Receiver

**400 Channels.  
100KHz to 2036MHz**



**AR3000**

Total Price Freight Prepaid  
(Express Shipping Optional)

**\$995**

- Continuous coverage
- AM FM wide band FM LSB USB CW modes
- 4 Scan Banks Programmable Attenuation
- Tuning increments as low as 50Hz
- Search with lock out
- 15 front end filters
- RS232 port built in
- 25 Day Satisfaction Guarantee Full refund if not Satisfied
- Includes AC/DC power cord Telescope Antenna
- Size: 3 1/7" H x 5 2/5" W x 7 7/8" D Wt. 2lb 10oz

**ACE**  
COMMUNICATIONS

10701 E. 106th St. Indpls., IN 46256  
Toll Free 800-445-7717

Visa and Mastercard  
(COD slightly higher)  
FAX (317) 849-8794



CIRCLE 6 ON FREE INFORMATION CARD

## ANTIQUE RADIO

(Continued from page 83)

of ballast resistance obsolete.

### THE TONY JACOBI BALLAST BOOKS

Now back to the misleading information that appeared in the July column. I had stated (quoting an old P.R. Mallory technical manual's explanation of the RMA standard ballast code) that if a designation began with the letter "B," then that ballast contained a pilot-light connection.

Along with his letter of correction, and copies of his very impressive ballast reference books, Tony included a photocopy of the ballast chapter from Ghirardi's *Radio Trouble-Shooter's Manual*. Reading Ghirardi's chapter, I now see that the statement needs a bit of refinement.

Though we may call a plug-in power resistor a "ballast," it doesn't necessarily contain a true ballast resistance (that is, a resistance that varies in accordance with the current passing through it). In fact, the dropping resistor used in the tube-heater circuit usually *wasn't* a ballast, but a conventional power resistor. But the ballast enclosure generally also contained resistance networks designed to provide voltage for the pilot lamp(s). In order to function properly, some of those networks had to provide true ballast action.

That brings us to the real meaning of a "B" prefix in a ballast tube's RMA (Radio Manufacturer's Association) code. The prefix is *not* used to indicate the presence of a pilot-lamp connection; that's shown elsewhere in the code. But if there *is* such a connection, the "B" shows that true ballast action is provided.

Though information on

radio tubes is readily available, ballast-tube data has been quite rare. Tony Jacobi has remedied that situation with his two reference books: *The Ballast Tube Handbook* (72 pages—photocopied, stapled) and *The Ballast Tube Substitution Guide* (56 pages—photocopied, stapled).

The handbook gives schematics and technical data for over 3,600 American and European types, including universal replacement types. If a ballast is associated with a particular radio, the set is listed along with its Rider's Manual volume and page. Also covered is the standard RMA ballast-coding system (which I touched on in the July column), as well as non-standard codes.

The substitution guide lists equivalents for about 2700 ballast-tube types. It also includes the same data on coding systems and universal replacement units found in the handbook.

No serious antique-radio restorer should be without these two information-packed references. Order them directly from Anthony Jacobi, 8053 Maywood St., Ralston, NE 68127. The handbook is \$8.00 postpaid; the substitution guide is \$7.00 postpaid. Those prices will probably have to go up at the end of the year to cover increased postage rates.

### GRID-LEAK DRIP PAN

I've been saving this gem in my "Nice-Items-To-Use-Someday" file for well over a year. The "grid-leak drip pan" (see photo) originally appeared in the September, 1927 issue of *Radio News*. The little illustration, with accompanying article, was sent to me by reader Paul R. Flaughter (Cincinnati, Ohio).

At last, I've found an appropriate spot for the "drip

pan," because what it really does is convert an ordinary grid leak into a kind of ballast resistor. (Before I get too much further, let me assure those of you who may be worrying about me that this is *entirely* facetious!)

Back in the 1920's, it was considered great sport to monkey with the value of the grid-leak resistor that was part of almost every radio receiver's detector stage. If the resistor had been a wired-in component, people wouldn't have paid much attention to it and simply would have accepted the unit that came installed by the factory. However, as most of you know, 1920's grid leaks looked something like small glass fuses and were easily snapped in and out of their spring holders. Folks were always concerned about whether they had just the right size, and some manufacturers even marketed continuously variable grid leaks that allowed you to try almost any desired resistance.

According to the article that Paul sent along, the drip pan was an accessory item that hung below the grid leak and served as a reservoir for extra megohms. It could also sense the ideal value for the grid leak under any conceivable operating condition. If the grid leak needed an extra megohm or two for optimum operation, the pan would deliver them. If the grid leak needed to shed a few megohms, they'd automatically drip out into the pan, where they would be stored for future use!!

### SEEN IN MY TRAVELS

In last month's column, I mentioned that I'd had an opportunity to meet Brother Patrick Dowd (also see the February, 1990 column) in person and to visit his in-

credible vacuum-tube museum located at New York City's Manhattan College. I'd corresponded with Pat in detail about the museum while preparing the February column, and thought I had a pretty good idea about what to expect. But I was still bowled over by what I saw.

The exhibit includes beautifully displayed samples of virtually every vacuum tube—whether receiving, transmitting, industrial, or special purpose—that was ever used in this country. If you're in the New York City area don't miss it! See the February issue for details on how to arrange a visit, or call the Manhattan College Engineering Library at 212-920-0165.

The recent business trip that prevented me from continuing, this month, with the tube-tester project, took me to Washington, D.C. While there, I was able to find a little time to visit the Smithsonian's National Museum of American History. If you're interested in early TV sets, and happen to find yourself in D.C., be sure to visit the "A Nation Of Nations" exhibit on the second floor of that museum. It contains a really extensive collection of late 1939 and mid-to-late 1940's sets, representing the dawn of serious TV broadcasting in this country.

### BYE FOR NOW

But don't forget that I need your help with background information about the RCA Theremin—an electronic musical instrument produced in the late 1920's. Reprints of the fascinating 1924 Gernsback publication *100 Radio Hookups* will be sent to the writers of the best letters. Contact me *c/o Antique Radio, Popular Electronics*, 500-B Bi-County Blvd., Farmingdale, NY 11735. ■





# Select 5 Books for only \$4<sup>95</sup> when you join The Computer Book Club<sup>SM</sup> (Values to \$146.75)

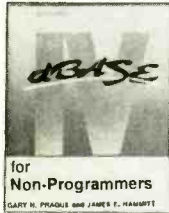
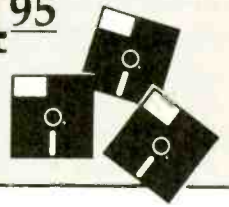

3570P \$22.95  
Counts as 2



3417P \$24.95  
Counts as 2

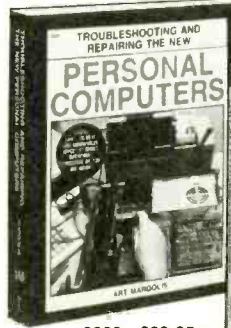

2809 \$29.95



3239 \$29.95



3382P \$29.95

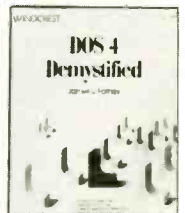

3563P \$22.95  
Counts as 2



3359P \$16.95

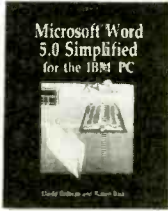

3318P \$19.95  
Counts as 2

When it's new and important in business or personal computing, The Computer Book Club<sup>SM</sup> has the information you need . . . at savings of up to 50% off publishers' prices!



3341 \$16.95



3280 \$31.95  
Counts as 2



15019P \$21.95



3616 \$27.95  
Counts as 2



9309P \$28.95  
Counts as 2



3578P \$16.95



9262 \$39.95  
Counts as 2



15014P \$19.95

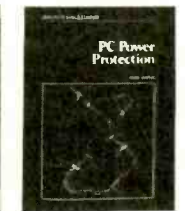

9250P \$19.95

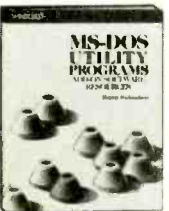

3278 \$34.95  
Counts as 2



3176P \$16.95

**Membership Benefits • Big Savings.** In addition to this introductory offer, you keep saving substantially with members' prices of up to 50% off the publishers' prices. • **Bonus Books.** Starting immediately, you will be eligible for our Bonus Book Plan, with savings of up to 80% off publishers' prices. • **Club News Bulletins.** 15 times per year you will receive the Book Club News, describing all the current selections—mains, alternates, extras—plus bonus offers and special sales, with scores of titles to choose from. • **Automatic Order.** If you want the Main Selection, do nothing and it will be sent to you automatically. If you prefer another selection, or no book at all, simply indicate your choice on the reply form provided. You will have at least 10 days to decide. As a member, you agree to purchase at least 3 books within the next 2 years and may resign at any time thereafter. • **Ironclad No-Risk Guarantee.** If not satisfied with your books, return them within 10 days without obligation! • **Exceptional Quality.** All books are quality publishers' editions especially selected by our Editorial Board. (Publishers' Prices Shown)



3204P \$21.95



3146P \$17.95



3131 \$26.95

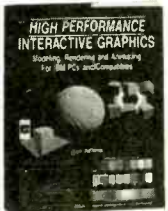

2879P \$22.95



2959 \$29.95



3101P \$19.95



3006P \$29.95  
Counts as 2



2870P \$16.95

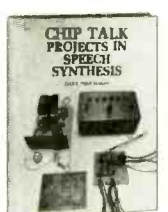

2812P \$14.95

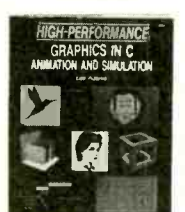

3049 \$37.95  
Counts as 2

All books are hardcover unless number is followed by a "P" for paperback.

## The Computer Book Club<sup>SM</sup> Blue Ridge Summit, PA 17294-0820

Please accept my membership in The Computer Book Club and send the 5 volumes listed below, billing me \$4.95. If not satisfied, I may return the books within ten days without obligation and have my membership cancelled. I agree to purchase at least 3 books at regular Club prices during the next 2 years and may resign any time thereafter. A shipping/handling charge and sales tax will be added to all orders.

Name _____					
Address _____					
City _____		State _____		Zip _____	
Phone _____			Signature _____		

Valid for new members only. Foreign applicants will receive special ordering instructions. Canada must remit in U.S. currency. This order subject to acceptance by The Computer Book Club. PPI1C190

CIRCLE 15 ON FREE INFORMATION CARD

©1990 THE COMPUTER BOOK CLUB  
Blue Ridge Summit, PA 17294-0820

## HITACHI VCR

(Continued from page 74)

also play back recordings made on other VCR's at the intermediate LP speed. In any event, all APEL's measurements were made at the faster SP speed, which invariably yields best picture performance.

If you have read some of our previous VCR test reports, you will recall that conventional VHS VCR's have video-frequency response that rarely extends much beyond 2.0 MHz. It is that limitation that also limits the sharpness of picture that can be obtained during playback of recordings. By contrast, S-VHS VCR's such as this Hitachi model boast frequency responses extending well out beyond that limit—often to 4 MHz or beyond. In fact, this sample's video response at 4.2 MHz was down only 4.86 dB and even at 5.0 MHz there was still a significant amount of video output signal present.

Video signal-to-noise ratios are measured in two ways: chroma (color) AM and PM (amplitude and phase modulation) noise is measured relative to a solid red field, while noise with respect to the brightness (luminance) portion of the signal is measured with respect to three reference luminance levels: 100, 50 and 10 IRE. Chroma AM and PM signal-to-noise ratios measured 49.3 and 44.6 dB, respectively. These results are somewhat better than what we expect to see from conventional VHS machines. Signal-to-noise ratios with respect to the luminance signals ranged between 41.3 dB and 42 dB, or about average for this type of VCR.

Using the VHS HiFi recording mode, audio output for a distortion level of 0.77% at 1 kHz was 2.9 volts, while signal-to-noise ratio in this

audio-recording mode was an excellent 87.5 dB. Frequency response was virtually flat from 20 Hz to 20,000 Hz when audio was recorded using VHS HiFi. By contrast, using the conventional audio tracks, not only was the output much lower and the signal-to-noise much poorer (0.35 volts at 1.7% distortion and a signal-to-noise ratio of only 50.5 dB), but frequency response extended only from 110 Hz to 15 kHz for the -3 dB cut-off points. While the high-frequency limit of this recording mode was quite good—well above average for this type of VCR audio recording—bear in mind that the measurement was made at the fastest tape speed. At the slower EP tape speed, high-frequency response will be much poorer. In fact, the only reason to ever use the conventional audio recording tracks with a machine such as this is if you want to have two audio programs accompanying your video; for example, background music could be recorded onto the hi-fi tracks when editing from another VCR, while voice narration could be added later on the conventional audio tracks.

The stereo decoder section of this VCR performed adequately, yielding good overall frequency response from recovered stereo transmissions and stereo separation just short of 20 dB at mid-frequencies. Stereo signal-to-noise ratios using the stereo decoder circuitry measured 62 dB, while in the mono mode of the decoder signal-to-noise ratio was 64.7 dB. Distortion was low under both listening conditions. A summary of all of the measurements can be found elsewhere in this report.

## HANDS-ON TESTS

Some 57 pages of an owner's manual are

needed to describe all of the features and functions of this elaborate VCR. Even though I consider myself an experienced user of this type of product, I had to refer to the manual more than once to exercise the many features offered by this S-VHS recorder. I was especially pleased with the remote control; other than having to load the tape into the machine, I was able to operate all of the other functions and features of this VCR from the comfort of my viewing chair.

The on-screen menus and programming information were clear and easy to understand, and the ability to do an on-screen review of the programming that I had done to insure against possible programming errors is a welcome feature. All of us, experienced or otherwise, have had the misfortune of setting up a VCR for timer recording only to discover after the program took place that we made a "small" error (such as setting the start time as A.M. when we really meant P.M.) and therefore failed to capture that once-in-a-lifetime program on tape.

As for the basics, pictures were extremely sharp—in most cases as sharp or sharper than broadcast TV—and colors were natural during playback without having to readjust the color control on the TV monitor/receiver to which the VCR was connected. To get the full advantage of the sharp pictures you would do well to connect this VCR to a TV set that's also equipped with an S-Video connector. Short of that, at least use a TV set that has separate video and audio inputs.

For more information on the VT-S730A, contact Hitachi (401 W. Artesia Blvd., Compton, CA 90220), or Circle No. 120 on the Free Information Card. ■

## COMPUTER BITS

(Continued from page 79)

ple, you could search for all articles in either PC Magazine or Byte that mentioned either ESDI or SCSI disks. You could further limit the scope of the search by date and article type. Table 3 lists valid article types; PC-Index should take that list to heart!

## CONCLUSIONS

The lack of integration, consistency, and flexibility in PC-Index is frustrating, but I keep renewing my subscription. The low cost and the convenience of having the database on my PC outweighs the problems. And Information Services does seem intent on improving things. The company is gradually adding more magazines and improving the user interface. Let's hope they keep up the good work.

However, for professional work, there's no question that Computer Database Plus is a winner. It may take you a while to get used to its search method, but it is logical; on-line search specialists will have no trouble at all. ■

## MEDIATION

Another way to reunite children with their families.

1-800  
A-WAY-OUT



The Mediation Program offers free, confidential help to parents and families involved in the missing children problem.

The goal of the program is to return parentally abducted children to a stable, legal environment.



**CHILD FIND  
OF AMERICA INC.®**

Post Office Box 277  
New Paltz, New York 12561-9277



# WATCH <sup>FOR THIS</sup> ISSUE ON SALE OCTOBER 2, 1990

**Radio  
Electronics®**  
TECHNOLOGY - VIDEO - STEREO - COMPUTERS - SERVICE

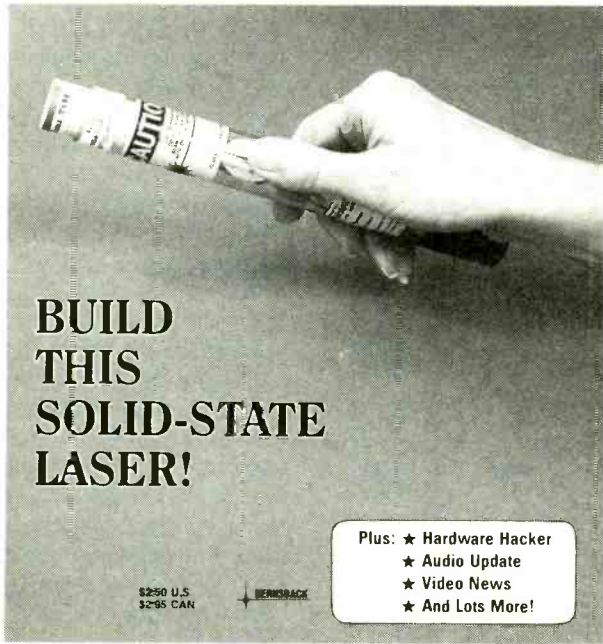

**BUILD  
THIS  
SOLID-STATE  
LASER!**

Plus: ★ Hardware Hacker  
★ Audio Update  
★ Video News  
★ And Lots More!

\$250 U.S.  
\$295 CAN

BENCHMARK

## OUR NOVEMBER ISSUE FEATURES:

### BUILD A SOLID-STATE LASER

*Experiment with a state-of-the-art laser diode!*

### BUILD A TELEPHONE CALL SCREENER

*Stop wasting time on junk calls and wrong numbers.*

### BUILD A PORTABLE QUAD ANTENNA

*An easy-to-build high-gain antenna for the 2-meter band.*

### WHAT'S IN STORE FOR SATELLITE TV?

*A look at some of the latest proposal for direct-broadcast satellites.*

### SPICE

*Analog circuit simulation for your PC.*

**PLUS: Hardware Hacker  
Audio Update  
Drawing Board**

**Video News  
Hardware Reviews  
And lots more!**

The **LOW COST, EASY** Way  
To Learn About Computers

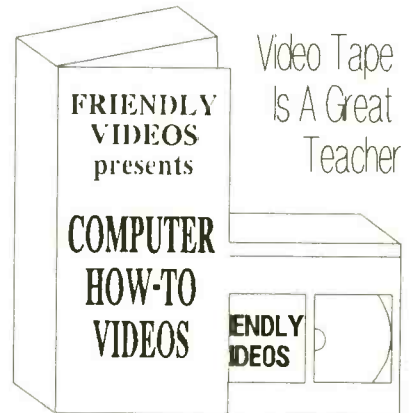

\*HOW TO BUILD YOUR OWN IBM 286/386 CLONE\*  
\$39.95 + SHIPPING AND SALES TAX  
\*SHAKE HANDS WITH YOUR IBM PC/XT/AT COMPUTER\*  
\$29.95 + SHIPPING AND SALES TAX  
\*UPGRADE YOUR PC TO A 286-AT FOR UNDER \$150\*  
\$24.95 + SHIPPING AND SALES TAX  
\*HOW LASER PRINTERS WORK\*  
\$39.95 + SHIPPING AND SALES TAX

**ORDER NOW!**



Friendly Videos



PO Box 5684

Garden Grove, CA 92645

(714) 898-4055



**H**old a piece of tape up to your eyes, dim the lights and try to fill out your taxes.

**Now you're seeing things from her point of view.**

Almost everybody has to file taxes, but not everyone can do it on their own. Volunteer and help make someone's taxes less taxing. Call 1 800 424-1040.

A Public Service of  
This Publication &



Internal  
Revenue  
Service



NOVEMBER 1990

## DIGITAL LOCK

(Continued from page 63)

23, the third key wire to pin 22, and the fourth key wire to pin 21. As an example, consider the jumper arrangement shown in Fig. 2; that arrangement gives an access code of 7410. Notice that all other key wires are connected to U1's reset terminal at pin 2 through jumpers. Therefore, if a "wrong" key is pressed, U1 is reset awaiting the first digit of the code. That helps ensure that random key pressing will not open the lock.

By using a socket and header for the jumpers, you can change the code by just unplugging and replacing the header. You can have different codes for different purposes, or different times of the day, by just inserting a header programmed with different jumpers.

equipped with a solenoid-operated strike mechanism.

The relay supplied with the Digital Entry Lock Kit (see Parts List) has both normally-open and normally-closed contacts, which can be coupled to an external circuit or external latching relay for any number of applications requiring security-protected operation, not necessarily momentary.

For example, suppose you wanted to keep your computer (or other AC operated device) from being used by unauthorized parties. Just have the Digital Entry Lock's relay contacts close an external latching circuit, as shown in Fig. 6. Plug what you want protected into the switched socket. To unlatch (power off), press the normally-closed pushbutton. Be sure the contacts of the external relay in the latching circuit can handle

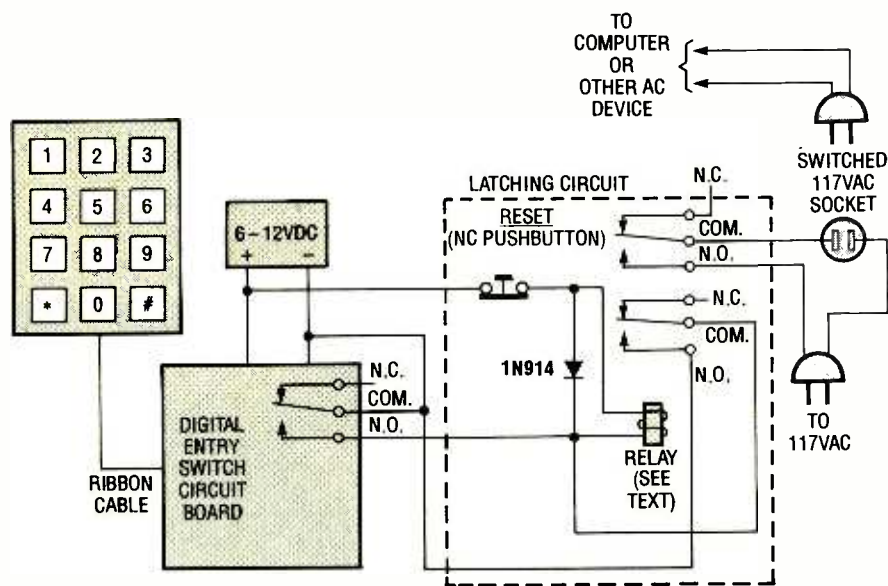

Fig. 6. The Digital Entry Lock can also be used to prevent unauthorized use of equipment, such as a computer (as shown here), or it can just as easily be used to keep someone from shutting down a device during some critical operation.

**Applications.** My application, as previously mentioned, was to control my garage-door opener. A block diagram of that set up is shown in Fig. 5. In most cases, all that is required is that the normally-open relay contacts of the Digital Entry Lock be connected in parallel with the existing "manual" door switch.

When the relay closes it's the same as if you pressed the manual switch. If your door opener needs more time to properly operate, increase the value of C2, or press and hold the first digit after hitting the fourth digit.

Obviously, the Digital Entry Lock could be used for an electric gate, or a door

the AC current of the controlled device.

The circuit works equally well at preventing equipment from being shut down by unauthorized parties; that's done by wiring one terminal of the 117-volt AC socket to the normally-closed contact of the latching circuit instead of the normally-open contact. In that case, pressing the reset button would turn the device on.

A momentary-closure, switching format can be used to arm and disarm many alarm systems. With a little imagination you'll find the Digital Entry Lock can be used for a variety of applications. How many can you think of? ■

## POWER SUPPLY

(Continued from page 54)

wave rectified power supply, connect the center-tap terminal of the transformer to J4, and install rectifier diodes in the D1 and D2 positions. Conversely, if a half-wave rectified, negative power supply is desired, you'd connect the center tap to J2 and install rectifier diodes in D3 and D4.

If you are using a non-center-tapped transformer for your AC source and a full-wave bridge (either negative or positive) is desired, tie the secondary of the transformer to J1 and J2 and install four diodes at the positions labeled D1, D2, D3, and D4. If, on the other hand, only half-wave rectification is needed, install a diode at the position labeled D1 and a jumper in the D3 position for positive; or a jumper in the D1 position and a diode in the D3 position for a negative supply.

The next item on the board is the main filter capacitor (C1). That unit will have to be sized according to the transformer, the diodes, and the load. Ample space is provided for anything from 100  $\mu$ F to about 4700  $\mu$ F. And don't forget to watch the DC voltage rating (WVDC) of the unit. When selecting a voltage rating for the capacitor, choose one that is twice the maximum anticipated voltage (although one and one-half is the norm). For instance, say that you are using a 12-volt transformer; the closest common capacitor-voltage rating is 16-volts. That's not sufficient "head-room" to protect the circuit against large surge (transient) voltages. A much better choice would be a unit rated for 25-WVDC.

The bypass capacitors, C2 and C3, can range in value from around .01 to about .56  $\mu$ F and should always be included.

**Mounting the Supply.** Since the supply is so small, it can be mounted using only two of the mounting holes that are marked, and I have used several by mounting them directly to a base of an enclosure using 1/8-inch double-sided foam tape. If you do that, however, remember to cut the protruding leads as short as possible.

I hope that you will use this supply in your future designs. It is really an easy-to-build and useful device that will make your projects come to fruition much quicker by freeing you from the drudgery of designing the same or similar circuit over and over again. ■



**DIGITAL ELECTRONICS COURSE**  
(Continued from page 71)

**PARTS LIST FOR THE  
DECADE COUNTER EXERCISE**

- U1—7490 decade counter, integrated circuit
- U2—7448 BCD to 7-segment common-cathode, decoder/driver, integrated circuit
- DISP1—7-segment, common-cathode LED display
- R1—4700-ohm, ¼-watt, 5% resistor
- Protoboard materials, logic pulser, 555 oscillator, 5-volt power source, wire, etc.

sition of the clock pulse? Inject a stream of pulses until the display goes through a count of from "0" to "9."

Now disconnect R1 from the  $\overline{CP}_0$  input, and connect the output of the 555 astable oscillator (from last month)

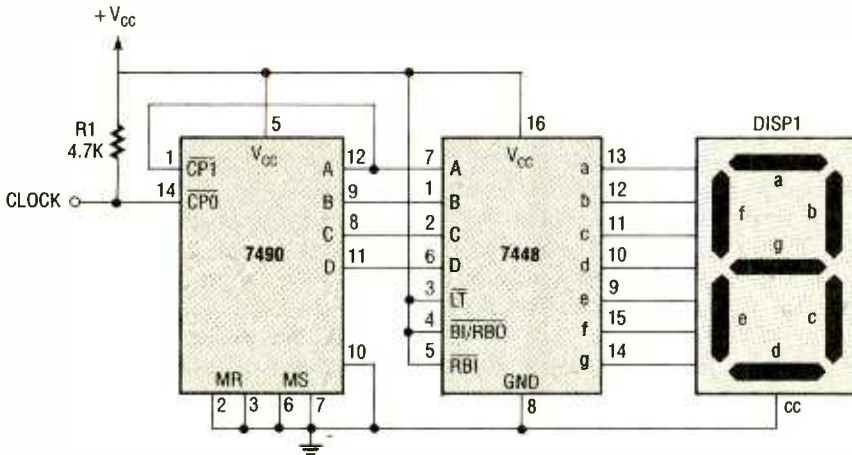

Fig. 2. To configure the 7490 for BCD operation, the A output of the 7490 is fed back to the  $\overline{CP}_1$  clock input terminal. The clocking signal is then applied to the device's  $\overline{CP}_0$  input, and output at pins 8, 9, 11, and 12 in BCD form.

to the  $\overline{CP}_0$  input of the 7490, and adjust the oscillator for a 1 Hz output. Did the counter count through its sequence when clocked by the 555?

Tie both MS inputs (pins 6 and 7) of the 7490 high, but leave the two MR inputs (pins 2 and 3) connected to

The Digital Microprocessor Course is reprinted here with the permission of the Electronic Industries Association/Consumer Electronic Group (EIA/CEG). The complete parts kit is available from EIA/CEG. For further information, contact EIA/CEG Product Services Department, 1722 Eye Street, NW, Suite 200, Washington, DC 20006; or call 202/457-4986.

ground. The display should change to "9." Did it? Reconnect pins 6 and 7 to ground, and tie the two MR inputs (pins 2 and 3) high. The display should now be "0." Is it? Did the clock pulses from the 555 have any effect on the output display when either the MS or MR inputs (pins 6 and 7, and pins 2 and 3, respectively) were tied high?

Have someone cross an output line from the counter to the decoder—for example, the A output to the B input, or the B output to the C input, etc.—while not allowing you to see which one. Then proceed to troubleshoot the circuit. Start by noting the symptoms displayed by the circuit. Check the essential signals (inputs and outputs) and power-supply lines, noting whether each IC is operating properly.

Make a diagnosis, and then determine if your diagnosis is confirmed by your tests. Start by determining if the signal inputs and outputs necessary for operation of that section are present, and whether they are correct. If so,

move on to the next section down the chain of subassemblies (in this case, the IC's) until you find the faulty subassembly. Once you've found the malfunctioning subassembly, check all inputs and outputs to determine the cause of the problem. Once you have found the problem and corrected it, verify the proper operation of the circuit.

Now, disconnect one line from the counter. How does the decoder respond to the now-floating input line? Try another, and another. What conclusion can be drawn?

Remove power from the circuit, but do not disassemble the circuit; it will be used in further exercises.

**DIGITAL TRAINER**  
(Continued from page 72)

tors have a minimum of 100k input impedance.

Inside the XK-220 are two PC boards containing all of the components for the power supplies, the clock-pulse outputs, the logic-indicators, the no-bounce switches, etc.

The 590-pin protoboard on the front panel can accommodate enough IC's for moderately complicated circuits. The 590 pins (sockets actually) are made from 118 individual clips, each running to 5 sockets. So, if you plug an IC into the board, up to four leads can be attached to each pin—more if you jump one of the four to an unused clip.

So, with an XK-220 by your side, testing new circuit designs is as simple as can be. For those who need the utility offered by the XK-220 in a hurry, the assembled version can be put to work as soon as it is uncrated. But for those on a tight budget, or who want to get additional construction experience, putting together the kit is an enjoyable pastime. Either way, the XK-220 Digital Trainer is a worthwhile investment.

**ATTENTION!  
ELECTRONICS  
TECHNICIANS**

**EARN YOUR  
B.S.E.E.  
DEGREE**

**THROUGH HOME STUDY**

Our New and Highly Effective Advanced-Placement Program for experienced Electronic Technicians grants credit for previous Schooling and Professional Experience, and can greatly reduce the time required to complete Program and reach graduation. No residence schooling required for qualified Electronic Technicians. Through this Special Program you can pull all of the loose ends of your electronics background together and earn your B.S.E.E. Degree. Upgrade your status and pay to the Engineering Level. Advance Rapidly! Many finish in 12 months or less. Students and graduates in all 50 States and throughout the World. Established Over 40 Years! Write for free Descriptive Literature.

**COOK'S INSTITUTE  
OF ELECTRONICS ENGINEERING**

**CI** 4251 CYPRESS DRIVE  
JACKSON, MISSISSIPPI 39212

**CIRCLE 17 ON FREE INFORMATION CARD**

## PC UPDATE

(Continued from page 57)

All that you have to pay attention for here is that the chips from banks 0, 1, 2, and 3 of the old motherboard must end up in the sockets of their respective banks 0, and 1 on the new motherboard.

The bank numbers (0-3) will be silk-screened somewhere on your old motherboard near the memory-chip sockets. The *Bullet* technical-reference manual will identify the socket numbers (also silk-screened onto the motherboard) corresponding to the banks into which your memory chips are to be installed.

Memory chips with broken or missing pins (which you'll almost never see) must be replaced. Chips with bent pins can be straightened by careful use of needle-nose pliers. If a bent pin becomes a broken pin a new memory chip will have to be purchased, so be careful.

Locate the plastic standoffs (if present) that you removed earlier from the old motherboard. Install a standoff into each of the new motherboard-mounting holes from the bottom. Do not install a standoff in either of the holes used for the two mounting screws. The standoffs should press-fit from the bottom of the motherboard with just a little pressure, but they should all be fully seated against the bottom of the motherboard before you continue.

**Putting it All Back Together.** Okay, let's get this puppy back together and turn the power on. Pick up the 286 motherboard and clear off any foreign material that may have attached itself to the back (pin) side of the motherboard. (Caution, these pins can be very sharp!)

Position the new motherboard in the chassis, and engage the standoffs in the slots in the chassis floor if present. Slide the motherboard to the right, making certain that each standoff has engaged its chassis slot. If you miss one, the motherboard won't sit level and may even crack when the mounting screws are tightened. Look carefully.

At this point, frustration can be your biggest enemy. Keep cool when trying to get that motherboard aligned in the chassis. Even the most experienced builders have to try a couple of times before they get it positioned just right!

Line-up the two motherboard-

mounting holes with their respective holes in the chassis. Insert and tighten the two screws to secure the motherboard to the chassis.

Now get your notes out regarding the power supply connectors. Grab the two connectors and carefully align the black power leads next to each other (Remember?). Now push the two connectors into the appropriate sockets on the motherboard. No gargantuan effort is required here, just a firm, steady push.

If you encounter unusual resistance, check that the motherboard sockets have been keyed to match the little bumps on the connectors in your hands.

If the keying is different, then recheck your drawings because you probably have erred. However, if no keying exists (that is, none of the little bridges on the sockets on the motherboard have been snipped out to accommodate the bumps on the connectors you have in your hands), then you'll have to key the sockets yourself.

First, be absolutely certain of the orientation of the two connectors (black leads next to each other when the connectors are held side by side). Then, with a pair of diagonal cutters, snip away the bridge of plastic between the appropriate motherboard socket pins to match the pattern of bumps on the connectors. You should only need to cut one bridge on each motherboard power socket. Double check your notes before making the cuts.

If you have installed a new power supply, and the power supply connectors need to be keyed, the process is similar, except that you will be snip-

ping away all but one bump on each connector. The remaining bump must align with the missing bridge on the matching motherboard socket.

Now try the power supply connectors again. *Voilà!* They slip in smooth as silk.

Again, refer to your notes, and install each of the expansion boards into their respective sockets in the motherboard. Start with the board closest to the left (outboard) side of the motherboard. It should seat fully, and comfortably, and the bracket-retaining screw hole should line up with the hole in the shoulder on the rear panel.

If the board does not line up, loosen the two motherboard-mounting screws, and shift the motherboard to promote a good fit. Continuing problems with fit are almost always sheet-metal-chassis caused, and are seldom due to the motherboard. When everything is okay, retighten the motherboard-mounting screws. Finish installing the rest of the boards, and their retaining screws.

Reinstall any of the ribbon cables which you had to remove from the interface boards, referring to your notes. Remember to route the ribbon cables close to the motherboard and/or chassis so as to present a low profile to the flange on the top cover, which usually tries to hook something inside the machine as it comes sliding by.

Reinstall the cover. Locate and install the five cover-retaining screws, and tighten securely. Reconnect your peripherals, the keyboard, and the power cable to the rear of your new AT-compatible computer. Now plug the power cable into the wall outlet, and throw the computer's power switch.

I have to tell you that my system was up and running the very first time. I guess that this isn't too surprising since, except for the motherboard, everything inside the chassis has been running fine for quite awhile! I expect no less performance from your new AT. ■

### Sources

#### The Mother Board:

A *Bullet* 286 7.2-MHz 8-slot motherboard can be purchased for \$169.00 plus shipping and tax (if applicable) from D.P. Computers, 735 South 400 W, Salt Lake City, UT 84101; Tel. 1-801-532-1004, FAX 1-801-596-1520. They accept MasterCard, VISA, COD, and checks.

Several higher-speed versions (8 MHz, 10 MHz, 12.5 MHz, and 16 MHz) designed for a 5- or 8-slot chassis are available at a little higher cost (call D.P. computer for more information).

#### The Video:

The PC/XT to AT conversion video, costing \$25 (the shipping is free, but add sales tax if you live in CA), is available from Friendly Videos, P.O. Box 5684, Garden Grove, CA 92645; Tel. 1-714-898-4055. Mastercard and Visa are accepted. ■

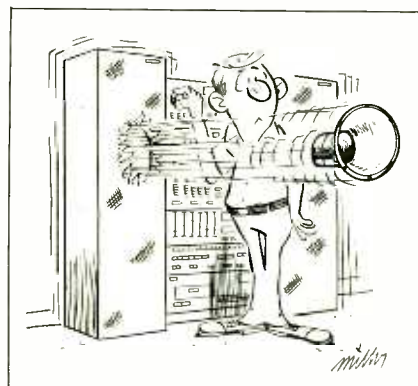



# ELECTRONICS MARKET PLACE

## FOR SALE

**DESCRAMBLERS.** All brands. Special: Combo Jerrold 400 and SB3 \$165. Complete cable descrambler kit \$39.00. Complete satellite descrambler kit \$45.00. Free catalog. **MJH INDUSTRY**, Box 531, Bronx, NY 10461-0208.

**CABLE descrambler liquidation.** Major makes and models available. Industry pricing! (Example: Hamlin Combo's, \$44 each... Minimum 10 orders). Call **WEST COAST ELECTRONICS**, 1 (800) 628-9656.

## CABLE TV DESCRAMBLERS! BARGAIN HEADQUARTERS!



•JERROLD™ •TOCOM •HAMLIN  
•OAK •ZENITH  
•SCIENTIFIC ATLANTA

6 month warranty! We ship C.O.D.!  
Lowest retail/wholesale prices!

FREE CATALOG:  
Global Cable Network  
1032 Irving St. Suite 109  
S.F., CA 94122

NO CALIFORNIA SALES!!!

**ORDER TODAY! 800-327-8544**

**FREE catalog.** Interfaces for IBM compatibles. Digital I/O and Analog input. Control relays, motors, lights, measure temperature, voltage. **JOHN BELL ENGINEERING, INC.**, 400 Oxford Way, Belmont, CA 94002. (415) 592-8411.

**CABLE** descramblers (Jerrold) from \$40.00. Tocom VIP test chip. Fully activates unit. Also Zenith test board. Fully activates Z-Tacs. \$50.00. Call (213) 867-0081.

**PRINTED** circuit boards etched & drilled. Free delivery. **K & F ELECTRONICS, INC.**, 33041 Groesbeck, Fraser, MI 48026. (313) 294-8720.

## FREE CATALOG

**FAMOUS "FIRESTIK" BRAND CB ANTENNAS AND ACCESSORIES. QUALITY PRODUCTS FOR THE SERIOUS CB'er. SINCE 1962**

**FIRESTIK ANTENNA COMPANY**  
2614 EAST ADAMS  
PHOENIX, ARIZONA 85034

**JERROLD** 450 turn-on boards, plug-in, no modifications. \$40.00 for kit, \$50.00 assembled, quantity discounts available. Send check or money order to **DIVERSIFIED WHOLESALE**, 7014 E. Gofflinks, Suite 141, Tucson, AZ 85730.

**BOOKS!** Catalog of most exciting electronic and science books, **free!** Box 596-H, Logan, Utah 84321. 1 (800) 359-0466.

**SABOTEUR/surveillance handbook** \$12.00. Quality blueprints. Catalog \$4.00, refunded. **RAYCON**, Box 2049, Bartlesville, OK 74005-2049.

**TRANSISTORS**, diodes, resistors, capacitors, MOVs, new, up to 60% off. Catalog. **MINUTEMAN SYSTEMS**, Box 1427, Concord, MA 01742.

**HUGE** 88 page communications catalog of short-wave, amateur and scanner equipment. Antennas, books and accessories too. Send \$1.00 to: **UNIVERSAL RADIO**, 1280 Aida Drive, Dept. PE, Reynoldsburg, OH 43068.

**ELECTRONIC** parts, kits, software. No minimum orders. Free catalog. **WELSH ELECTRONICS**, 620 Olive Lane, Ambridge, PA 15003-2458.

**\$1.99 software** for IBM Compatibles. Quality at affordable prices! Huge selection: business, games, graphics, utilities, database, spreadsheets. **Free** catalog. **AULT**, 1556 Halford Avenue, #242, Santa Clara, CA 95051.

**FREE IBM** shareware catalog, 1 (800) 842-6819. **OFFSHORE SOFTWARE**, 2941 Pretty Branch Drive, Mobile, AL 36618.

## CLASSIFIED AD ORDER FORM

To run your own classified ad, put one word on each of the lines below and send this form along with your check to:

**Popular Electronics Classified Ads**, 500-B Bi-County Boulevard, Farmingdale, N.Y. 11735

**PLEASE INDICATE** in which category of classified advertising you wish your ad to appear. For special headings, there is a surcharge of **\$11.00**.

( ) Plans/Kits ( ) Business Opportunities ( ) For Sale  
( ) Education/Instruction ( ) Wanted ( ) Satellite Television  
( )

Special Category: \$11.00

### PLEASE PRINT EACH WORD SEPARATELY, IN BLOCK LETTERS.

(No refunds or credits for typesetting errors can be made unless you clearly print or type your copy.) Rates indicated are for standard style classified ads only. See below for additional charges for special ads. **Minimum: 15 words.**

1	2	3	4	5
6	7	8	9	10
11	12	13	14	15 (\$23.25)
16 (\$24.80)	17 (\$26.35)	18 (\$27.90)	19 (\$29.45)	20 (\$31.00)
21 (\$32.55)	22 (\$34.10)	23 (\$35.65)	24 (\$37.20)	25 (\$38.75)
26 (\$40.30)	27 (\$41.85)	28 (\$43.40)	29 (\$44.95)	30 (\$46.50)
31 (\$48.05)	32 (\$49.60)	33 (\$51.15)	34 (\$52.70)	35 (\$54.25)

We accept MasterCard and Visa for payment of orders. If you wish to use your credit card to pay for your ad fill in the following additional information (Sorry, no telephone orders can be accepted):

Card Number

Expiration Date

PRINT NAME

SIGNATURE

**IF YOU USE A BOX NUMBER YOU MUST INCLUDE YOUR PERMANENT ADDRESS AND PHONE NUMBER FOR OUR FILES. ADS SUBMITTED WITHOUT THIS INFORMATION WILL NOT BE ACCEPTED.**

**CLASSIFIED COMMERCIAL RATE:** (for firms or individuals offering commercial products or services) \$1.55 per word prepaid (no charge for ZIP code)...**MINIMUM 15 WORDS.** 5% discount for same ad in 6 issues within one year; 10% discount for 12 issues within one year if prepaid. **NON-COMMERCIAL RATE:** (for individuals who want to buy or sell a personal item) \$1.25 per word, prepaid...no minimum. **ONLY FIRST WORD AND NAME** set in bold caps at no extra charge. Additional bold face (not available as all caps) **30¢ per word additional.** Entire ad in boldface, \$1.85 per word. **TINT SCREEN BEHIND ENTIRE AD:** \$1.90 per word. **TINT SCREEN BEHIND ENTIRE AD PLUS ALL BOLD FACE AD:** \$2.25 per word. **EXPANDED TYPE AD:** \$2.05 per word prepaid. Entire ad in boldface, \$2.45 per word. **TINT SCREEN BEHIND ENTIRE EXPANDED TYPE AD:** \$2.55 per word. **TINT SCREEN BEHIND ENTIRE EXPANDED TYPE AD PLUS ALL BOLD FACE AD:** \$2.95 per word. **DISPLAY ADS:** 1" x 2 1/4"—\$205.00; 2" x 2 1/4"—\$410.00; 3" x 2 1/4"—\$615.00. **General Information:** Frequency rates and prepayment discounts are available. **ALL COPY SUBJECT TO PUBLISHERS APPROVAL. ADVERTISEMENTS USING P.O. BOX ADDRESS WILL NOT BE ACCEPTED UNTIL ADVERTISER SUPPLIES PUBLISHER WITH PERMANENT ADDRESS AND PHONE NUMBER.** Copy to be in our hands on the 15th of the fourth month preceding the date of issue (i.e.; Sept. issue copy must be received by May 15th). When normal closing date falls on Saturday, Sunday or Holiday, issue closes on preceding work day. Send for the classified brochure. **Circle Number 49 on the Free Information Card.**

## CB RADIO OWNERS!

We specialize in a wide variety of technical information, parts and services for CB radios. 10-Meter and FM conversion kits, repair books, plans, high-performance accessories. Thousands of satisfied customers since 1976! Catalog \$2.

### CBC INTERNATIONAL

P.O. BOX 31500PE, PHOENIX, AZ 85046

**ELECTRONIC** muscle stimulator! Grow your muscles quickly and effortlessly or resale for huge profits. Complete kit — \$69.95; assembled and tested — \$98.00. **TECHNIX**, Box 55249, Bridgeport, CT 06610.

**LASERS** 1mW to 2kW, world's largest selection of new & used surplus. Free catalog. **MWK INDUSTRIES**, 1269 Pomona Road, Corona, CA 91720. (714) 278-0563.

## WIRELESS CABLE RECEIVERS 1.9 TO 2.7 Ghz



30 CH PARABOLIC DISH SYSTEM \$173.90  
30 CH ROD ANTENNA SYSTEM \$193.90  
30 CH CRYSTAL CONTROLLED SYSTEM \$294.95  
SUN MICROWAVE INT'L. INC. SEND \$1.00 FOR P.O. BOX #34522 CATALOG ON THESE PHOENIX, AZ, 85067 AND OTHER FINE (602) 230-0640 VIDEO PRODUCTS QUANTITY DISCOUNTS LIFETIME WARRANTY MEMBER OF THE BETTER BUSINESS BUREAU

## PLANS & KITS

**CATALOG: hobby/broadcasting/HAM/CB: Cable TV, transmitters, amplifiers, surveillance devices, computers, more!** **PANAXIS**, Box 130-H11, Paradise, CA 95967.

**BUILD** this five-digit panel meter and square wave generator including an ohms, capacitance and frequency meter. Detailed instructions \$2.50. **BAGNALL ELECTRONICS**, 179 May, Fairfield, CT 06430.

**SURVEILLANCE transmitter kits!** Four models of each; telephone, room, combination telephone/room transmitters tune from 65 to 305 MHz. Catalog with **Popular Communications'** and **Popular Electronics** book reviews of "Electronic Eavesdropping Equipment Design," \$1.00. **SHEFFIELD ELECTRONICS**, 7223A Stony Island Ave., Chicago, IL 60649-2806.

## NEW HE NE LASER TUBES \$35

Dealer Inquiries Invited.  
Free Catalog!

**MEREDITH INSTRUMENTS:** 6403 N. 59th Ave. Glendale, AZ 85301 • (602) 934-9387  
"The Source for Laser Surplus"

**VIDEOCIPHER II** manuals. **Volume 1** — Hardware, **Volume 2** — Software — either \$34.95. **Volume 3** — Projects/Software, **Volume 5** — Documentation or **Volume 6** — Experimentation \$44.95 each. **Volume 7** — 032/Hacking \$54.95. **Volume 4** — repair — \$99.95. **Cable Hacker's Bible** — \$34.95. **Clone Hacker's Bible** — \$34.95. Catalog \$3.00. CODs: (602) 782-2316. **TELECODE**, PO Box 6426-PE, Yuma, AZ 85366-6426.

**MINIATURE FM transmitters!** Tracking transmitters! Voice disguisers! Bug detectors! Phone devices! More! Available as kits or assembled and tested! Catalog \$2.00 (refundable): **XANDI ELECTRONICS**, Box 25647, 32XX, Tempe, AZ 85285-5647.

**RECEIVER** plans, kits. Simple to sophisticated. Thorough explanations included. All bands. Catalog and sample schematics \$3.00. **PREMIER ENTERPRISES**, 3850 Plymouth Blvd, Suite 104, Plymouth, MN 55446.

**SURVEILLANCE** — audio/video equipment — debugging. Industrial or private. 500 item catalog \$7.00. **SECURITY SYSTEMS**, 3017F Hudson, New Orleans, LA 70131.

**SHORTWAVE** — 1933. One-tube. Plug-in coils. DX radio. Free plans. **BOB RYAN**, PO Box 3039, Anaheim, CA 92803.

**STRANGE stuff.** Get the advantage! Laser listener, surveillance, descrambling, underground information. Plans, kits, complete items. Informational package \$3.00 refundable. **DIRIJO/BOND**, Box 212, Lowell, NC 28098.

**ETCH** your own printed circuit boards using the photographic method. The only inexpensive step-by-step process that guarantees professional results. A book that every serious electronics hobbyist should have. Send \$12.95 to **ETCHING INFO**, PO Box 8064, Westfield, MA 01086-8064.

## REMOTE CONTROL KEYCHAIN



Complete w/mini-transmitter and 45 vdc RF receiver Fully assembled including plans to build your own auto alarm Quantity discounts available  
\$24.95 Check, Visa or M/C Add \$3 shipping

**VISITECT INC.** /Dept. P' (415) 872-0128  
PO BOX 5442, SO. SAN FRAN., CA 94080

**SURVEILLANCE — countermeasures!** Guaranteed lowest prices! Huge catalog \$5.00 (refundable). **PROTECTOR**, PO Box 520294-E, Salt Lake City, Utah 84152.

**AIRCRAFT:** complete plans available for master switch warning system. Circuit warns pilot when master electrical switch is inadvertently left on. For additional information, please send \$2.00 to: **PO BOX 12282**, Hauppauge, NY 11788.

**KITS** — alarms, games and test equipment. Send \$1.00 for catalog. **RAKJAB**, PO Box 1875, Apopka, FL 32704.

**MIND reading and psychic abilities!** Train your mind with electronics! Anyone can! Send \$5.00. **THE DIRECT COMPANY**, 5627 Clippert, Dearborn Hts., MI 48125.

## SURVEILLANCE TELEPHONE



This is a normal functioning telephone! EXCEPT it has a secret built in monitor Only YOU can call and monitor ALL conversations, using a secret code, and never be detected! Range Unlimited.  
\$175.00 - 6 month Warranty Catalog \$3.00 LISTEN ELECTRONICS, 809 Eglon, Muskogee, OK 74401  
ALARMS 1-800-633-8277 SECURITY EQUIP.

**PROJECTION TV** Convert your TV to project 7 foot picture... Easy!... Results comparable to \$2,500 projectors... **Plans and 8" lens \$27.95...** Professional systems available... Illustrated catalog free. **MACROCOMA**, 15HC Main Street, Washington Crossing, PA 18977. Creditcard orders 24 hrs. (215) 736-3979.

**TALK** to your PC! Build a voice interface for your IBM computer. Detailed instruction booklet \$8.00. **PANG ENTERPRISES**, 45 Park Home, Willowdale, Ontario, Canada M2N 1W7.

**PROTECT** your computer and data with surge suppressors and uninterruptible power assembled by you. Plans and parts sources for \$2.00 and SASE to **JULIAN PEREZ**, 5307 Neville Court, Alexandria, VA 22310.

**UNIQUE** car alarm that thieves don't know about. For instructions send \$2.00 to **INNOVATIVE THINK TANK**, PO Box 750543, Houston, TX 77275-PE11.

## FREE CATALOG! 1-800-648-7938

For all information 1-702-362-9026

**JERROLD HAMLIN OAK ETC.**

## CABLE TV DESCRAMBLERS

• Compare our low Low Retail Prices!  
• Guaranteed Prices & Warranties!  
• Orders Shipped Immediately!  
**REPUBLIC CABLE PRODUCTS INC.**

4080 Paradise Rd. #15 Dept. PE-90  
Las Vegas, NV 89109

## \*\*\*\*\*PRESENTING\*\*\*\*\*

## CABLE TV DESCRAMBLERS

\*\*\*\*\* STARRING \*\*\*\*\*  
**JERROLD, HAMLIN, OAK**  
AND OTHER FAMOUS MANUFACTURERS

• FINEST WARRANTY PROGRAM AVAILABLE  
• LOWEST RETAIL/WHOLESALE PRICES IN U.S.  
• ORDERS SHIPPED FROM STOCK WITHIN 24 HOURS

FOR FREE CATALOG ONLY 1-800-345-8927  
FOR ALL INFORMATION 1-818-709-9937

**PACIFIC CABLE CO., INC.**  
7325½ Reseda Blvd., Dept. 1000  
Reseda, CA 91335

**UNIQUE** projects. Build an infrared motion detector, ultrasonic distance meter, digital rain gauge. Complete plans, PCB layout. \$4.00 each. Others available. **K. KEMP**, 13772 Goldenwest St., #549 Westminster, CA 92683.

\$.45 stamp brings you our new catalog of kits, odd parts, hv capacitors. **TWO FOX**, POB 721, Pawling, NY 12564-0721.

## CABLE TV "BOXES"

Converters — Descramblers  
Remote Controls — Accessories

• Guaranteed Best Prices •  
• 1 Year Warranty — C.O.D.s •  
• Immediate Shipping •  
• FREE CATALOG •

Call or Write

**TRANS-WORLD CABLE CO.**

12062 Southwest 117th Court, Suite 126

Miami, Florida 33186

1-800-442-9333



**PLANS** for three different bench top power supplies. Three levels of difficulty, plans were tested and are guaranteed to work. Send \$5.50 and SASE to **R.C.S.G.**, PO Box 486, Clarcona, FL 32710.

**RADIATION detector-alarm**, Send \$3.00 for detailed instructions & parts list: **CAMPIONE**, 32 Jones Street, NYC, NY 10014.

## EDUCATION/INSTRUCTION

**MAGIC!** Four illustrated lessons plus inside information shows you how. We provide almost 50 tricks including equipment for four professional effects. You get a binder to keep the materials in, and a one-year membership in the International Performing Magicians with a plastic membership card that has your name gold-embossed. You get a one-year subscription to our quarterly newsletter, "IT'S MAGIC!" Order now! \$29.95 for each course + \$3.50 postage and handling. (New York residents add applicable state and local sales tax). **The Magic Course**, 500-B BiCounty Blvd., Farmingdale, NY 11735.

**LEARN IBM** PC assembly language. 80 programs. Disk \$5. Book \$18. **ZIPFAST**, Box 12238, Lexington, KY 40581-2238.

**TURN** your love into a living! The professional video industry needs qualified technicians. Institute of Audio Research, the world leader in audio education, announces the **Video Technology Program** for people like you. In under a year turn your flair for electronics into highly marketable skills. Grads work in broadcast television, production companies, manufacturers, corporate communications, etc. Financial aid available if qualified. HS Diploma or GED required. **INSTITUTE OF AUDIO RESEARCH**, 64 University Place, New York, NY 10003. 1 (800) 544-2501. NY, NJ, CT (212) 777-8550.



**Motion Control System** → \$59.00



Includes Computer, Monitor, Keyboard, Power supply, 4 Motors, and Software.  
Call or send for **Free Robotics Catalog**

**Silicon Valley Surplus** 4222 E. 12th St. Serving you since 1983  
415 261-4506 Oakland, Ca 94601 8 am to 4 pm PST

**BECOME Doctor of Philosophy.** Earn prestigious European style Doctorate by nonresident research rather than "coursework." Send resume. **EURYTECHNICAL RESEARCH UNIVERSITY**, Box 516-W, Hilo, HI 96721.

**SUPERNATURAL cloud** - Earth rotation displacement nuclear warfare \$1.00, **NIEDER**, PO Box 5162, San Antonio, TX 78201.

## Cable TV Descramblers

If you find a better deal, we'll better our deal.

*\*Jerrold \*Tocom \*Hamlin \*Oak  
\*Scientific Atlanta \*Zenith*  
Ask about our extended warranty program.

COD, Visa, M/C welcome.  
Free Call - Free Catalog.

Video Tech **800-562-6884**

2702 S. Virginia St., Ste. 160-304  
Reno, NV 89502.

## BUSINESS OPPORTUNITIES

**YOUR own radio station!** AM, FM, TV, cable. Licensed/unlicensed. **BROADCASTING**, Box 130-H11, Paradise, CA 95967.

**EASY work!** Excellent Pay! Assemble products at home. Call for information. (504) 641-8003 Ext. 5730.

**MAKE \$50/hr** working evenings or weekends in your own electronics business. Send for free facts. **MJPI INDUSTRY**, Box 531, Bronx, NY 10461.

**UP to \$7,000 month** using your VCR. USA, Canada, info \$1.00 cash, US funds. **RANDALL**, Box 2168-E, Van Nuys, CA 91404.

**MAKE \$2000.00/week** - reclaiming pure gold from scrap computers. Free report! (worth \$25.00) 1 (900) 246-2323 (\$2.00 min.).

**LET the government finance** your small business. Grants/loans to \$500,000. Free recorded message: (707) 448-0270. (KJ8)

**WHY rent?** Homes for \$1.00, repos. Gov't give away programs! For information (504) 649-0670 Ext. R-5730.

**YOUTH oriented mini-business** earns \$60.00 an hour. Details \$6.00. **DIPAC ASSOCIATES**, PO Box 1882, Greenville, TX 75401.

## CABLE DESCRAMBLERS OAK M35B COMBO \$39.95

Jerrold, Zenith, Hamlin, Sci. Atlanta, Pioneer & MORE! OUR PRICES ARE BELOW WHOLESALE!

### CABLE+PLUS

14417 Chase St. #481-B Panorama City, CA 91402  
1-800-822-9955 • Other info. 1-818-785-4500  
NO CALIF. SALES - DEALERS WANTED

## CABLE EQUIPMENT

**CABLE TV secrets** - the outlaw publication the cable companies tried to ban. HBO, Movie Channel, Showtime, descramblers, converters, etc. Suppliers list included. \$9.95. **CABLE FACTS**, Box 711-H, Pataskala, OH 43062.

## WANTED

**INVENTORS!** Call **IMPAC** - we submit ideas to manufacturers! For free information package call in US/Canada 1 (800) 225-5800.

**LM3795** dual audio amp 1-1000 call Rick. 1 (800) 873-3729. **RESOURCE SYSTEMS**, 2475-F Meadowbrook Parkway, Duluth, GA 30136.

**HAVE a new idea? Invention?** Call **THE "CONCEPT NETWORK"** for free confidential kit at 1 (800) 835-2246 ext. 197 US/Canada 24 Hrs. day.

**INVENTOR** seeks competent person/electronics engineer capable drawing device schematic. **BOX 141265, S.I., NY 10314.**

**EXPERIENCED technician needed** in Beaumont, Texas. Must be certified for Matsushita products. Excellent pay. (409) 769-0235.

**AC/DC VOLTAGE** **KELVIN 200** **RESISTANCE** **DIODE TEST** **LOW BATTERY Warning** **ACCURACY +/- 0.5%** **CONTINUITY TEST/BUZZER** **TRANSISTOR CHECKER** **CAPACITANCE CHECKER**

**\$39.95**

Stock No 990091 VISA M/C

**KELVIN Electronics**

7 Fairchild Ave., Plainville, NY 11803  
(516) 349-7620 1(800) 645-9212



## BEST BY MAIL

Rates: Write National, Box 5, Sarasota, FL 34230

### OF INTEREST TO ALL

**BASIC ELECTRICITY HOME study course.** Free info, send SASE to: Box 9, Flushing, MI 48433.

### BUSINESS OPPORTUNITIES

**BUMPERSTICKER PRINTER.** Cheap, simple, portable. Free details. Bumper, POB 22719(PE), Tampa, FL 33622.

### MONEYMAKING OPPORTUNITIES

**EARN \$240-\$315.45 Weekly** assembling at home. 1-800-752-5489, Ext. 27.

**\$50,000 IN 3 Months: Only 3 pieces of paper, no membership or company start up fees.** Our whole program cost you just \$3.00, send to: TSCOA, POB 670(PE), Lewiston, NY 14092.

### BOOKS/CATALOGS/MAGAZINES

**FREE CATALOG - DESIGNER Clothing.** OMEGA, 101(PE) Clematis, Pensacola, FL 32503-2834.

**50,000 + CATALOG LISTING!** \$5.95: Catalogs, Box 92452GT, Atlanta, GA 30314.

## CABLE BOXES

### FREE CATALOG

**1-800-848-3997**

Jerrold • Scientific Atlanta

Many Others

1 Year Warranty • COD's

## NAS CABLE

## SATELLITE TV

**FREE catalog** - Do-it-yourself save 40-60% lowest prices world wide, systems, upgrades, parts, all major brands factory fresh and warrantied. **SKY-VISION INC.**, 2008 Collegeway, Fergus Falls, MN 56537. 1 (800) 334-6455.

## T.V. FILTERS

T.V. notch filters, surveillance equipment, brochure \$1.00. **D.K. VIDEO**, Box 63/6025, Margate, FL 33063. (305) 752-9202.

## CABLE TV. CONVERTERS

WHY PAY A HIGH MONTHLY FEE?



All Jerrold, Oak, Hamlin, Zenith, Scientific Atlanta, Magnavox and all specialized cable equipment available for shipment within 24 hours. For fast service MC / VISA or C.O.D telephone orders accepted (800) 648-3030 60 Day Guarantee (Quantity Discounts) 8 A.M. to 5 P.M. C.S.T. **CLOSED WEEK-ENDS.** Send self-addressed Stamped envelope (60¢ postage) for Catalog.

**MIDWEST ELECTRONICS INC.**

P.O. Box 5000  
Suite 311 (PE)  
Carpentersville, IL 60110

No Illinois Orders Accepted

## ZENITH DESCRAMBLERS

**ZENITH ZTACS** will work where others have failed, fully warranted with remote. \$175.00 call (213) 478-2506.

## ADVERTISING SALES OFFICE

**Gernsback Publications, Inc.**  
**500-B Bi-County Blvd.**  
**Farmingdale, NY 11735**  
**1-(516) 293-3000**

President: **Larry Steckler**

Vice President: **Cathy Steckler**

**For Advertising ONLY**  
**516-293-3000**  
**Fax 1-516-293-3115**

**Larry Steckler**  
publisher

**Arline Fishman**  
advertising director

**Denise Haven**  
advertising assistant

**Christina Estrada**  
advertising associate

**Kelly McQuade**  
credit manager

**Customer Service/Order Entry**  
1-800-435-0715  
1-800-892-0753  
7:30 AM - 8:30 PM EST

**SALES OFFICES**  
**EAST/SOUTHEAST**  
**Becky Akers**

Pattis/3M  
310 Madison Ave., Suite 1804  
New York, NY 10017  
1-212-953-2121  
Fax 1-212-953-2128

**MIDWEST/Texas/Arkansas/Okla.**

**Ralph Bergen**  
540 Frontage Road—Suite 339  
Northfield, IL 60093  
1-708-446-1444  
Fax 1-708-446-8451

**PACIFIC COAST/Mountain States**  
**Marvin Green**  
5430 Van Nuys Blvd., Suite 316  
Van Nuys, CA 91401  
1-818-986-2001  
Fax 1-818-986-2009

## ADVERTISING INDEX

POPULAR ELECTRONICS magazine does not assume any responsibility for errors that may appear in the index below.

Free Information No.		Page
11	AMC Sales	12
6	Ace Communications	89
10	All Electronics	25
—	Amazing Concepts	85
5	C & S Sales	13
—	CB City	100
—	CIE	21
—	Cable Plus	101
—	Command Productions	85
15	Computer Book Club	91
17	Cook's Institute	97
—	Damark International	CV2
—	Electronic Tech. Today	CV3
—	Electronics Book Club	3
—	Firestik II	99
—	Friendly Videos	95
—	Global Cable Network	99
—	Global Engineering	5
—	Grantham College	26
9	Heathkit	15
—	ISCET	89
—	Kelvin	101
—	Listen Electronics	100
—	Lindsay Publications	17
—	Meredith Instruments	100
—	Midwest Electronics	101
—	NRI Schools	11
—	North American Services	101
14	Protel Technology	27
—	Pacific Cable	100
12	Paladin Electronics	12
7	Parts Express	7
16	People's College	23
8	Radio Shack	CV4
—	Republic Cable	100
25	Sequoia Publishing	79
—	Silicon Valley Surplus	100
—	Sun Microwave International	100
18	Synetic Systems, Inc.	16
—	Trans World	100
—	Video Tech	101
13	Viejo Publications	79
—	Visitect	100

## SIGNAL GENERATORS

(Continued from page 70)

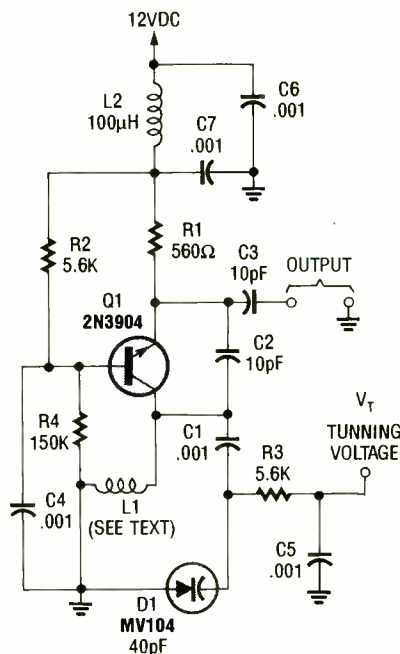

Fig. 7. This is a voltage-tuned VHF oscillator circuit. The tuning voltage determines the resonant frequency of the tank circuit (composed of D1, C1 and L1).

### PARTS LIST FOR THE VOLTAGE-TUNED OSCILLATOR

#### RESISTORS

(All resistors are 1/4-watt, 5% units.)

- R1—560-ohm
- R2, R3—5600-ohm
- R4—150,000-ohm

#### CAPACITORS

- C1, C4-C7—.001-µF, ceramic-disc
- C2, C3—10-pF, ceramic-disc

#### ADDITIONAL PARTS AND MATERIALS

- D1—MV104 40-pF varactor diode (NTE-614 is suitable)
- Q1—2N3904 small-signal transistor
- L1—open wound coil, (see text)
- L2—100-µH choke

varactor diode identical to the first. The total capacitance of the combination is half the capacitance of one diode, but the voltage-vs.-frequency characteristic is more linear.

With or without that modification the circuit can be either fixed-frequency tuned with a DC voltage, variable-frequency tuned through a potentiometer, or swept across a band of frequencies with a 10- to 60-Hz sawtooth signal. ■

## HAM RECEIVERS

(Continued from page 66)

considered one of the top receivers by shortwave listeners.

**Last but Not Least.** Finally, we come to one of the best receivers ever built: the Collins 75A4. The A-4 used the famous Collins plug-in mechanical filters that allowed excellent selectivity at 455 kHz and simplified the receiver's design. You could buy filters narrow enough for code or wide enough for phone and switch to the one you wanted from the front panel.

The A-4 was famous for its stability; you really had to pay attention to detect any frequency drift at all. Its dial was calibrated in 1-kHz divisions, and this is one radio where the dial markings meant what they said—each radio's dial was calibrated *by hand* at the factory.

The Collins was a better receiver than most hams ever needed, but we all wanted one! At \$695, I couldn't begin to afford one when they were new, but I picked up one for \$100 last year and considered myself lucky.

I apologize for leaving out so many good receivers. Many hams fondly remember those radios made by National, Drake, Heath, Allied, Gonset and others. They all made good, dependable receivers at various levels of performance and price.

If you're a beginner setting up your first station you might want to consider getting an old receiver. Many radios that were top of the line 25 years ago can be had for well under \$100. If you're really on a budget you can usually find a medium-quality set that's still more than adequate for low-band code work for around \$25. Buy or build an audio filter to go with it, and you'll be ready to work the world. Ham radio doesn't have to be expensive to be a lot of fun!

And don't think you'll be at a big disadvantage using some of yesterday's classics. I recently had occasion to operate an SX-101 next to a popular transceiver of just a few years ago. Signals that couldn't be heard on the new transceiver were clear copy on the 101 on ten meters, and the 75A-4 will hang right in with anything.

The best reason for using old amateur-radio gear though is that it's so much fun. And that's what ham radio is really all about. ■



# Electronics Paperback Books

GREAT PAPERBACKS AT SPECIAL PRICES

**BP248—TEST EQUIPMENT CONSTRUCTION** ..... \$5.95. Details construction of simple, inexpensive, but extremely useful test equipment. AF Gen, Test Bench Ampl, Audio Millivoltmeter, Transistor Tester and six more.

Test Equipment Construction



**BP267—HOW TO USE OSCILLOSCOPES AND OTHER TEST EQUIPMENT** ..... \$6.95. Mastering the oscilloscope is not really too difficult. This book explains all the standard controls and functions. Other equipment is also described.

How to Use Oscilloscopes and Other Test Equipment



**BP265—MORE ADVANCED USES OF THE MULTIMETER** ..... \$5.95. Use these techniques to test and analyze the performance of a variety of components. Also see how to build add-ons to extend multimeter capabilities.

More Advanced Uses of the Multimeter



An Introduction to Loudspeakers and Enclosure Design

**BP256—INTRO TO LOUDSPEAKERS AND ENCLOSURE DESIGN** ..... \$5.95. We explore the variety of enclosure and speaker designs in use today so the reader can understand the principles involved.



**BP263—A CONCISE INTRO TO dBASE** ..... \$6.95. The dBASE series of programs are probably the best known database programs for microcomputers. This book is designed to help you get started working with them.

A Concise Introduction to dBASE

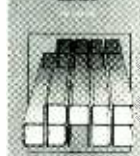

**BP260—CONCISE INTRO TO OS/2** ..... \$5.95. If you are a multitasking PC user and want to get the most out of your computer, then you must learn its OS/2 operating system. This book shows you just how to do that, quickly and easily.

A Concise Introduction to OS/2



**BP249—MORE ADVANCED TEST EQUIPMENT CONSTRUCTION** ..... \$6.95. Eleven more test equipment construction projects. They include a digital voltmeter, capacitance meter, current tracer and more.

More Advanced Test Equipment Construction



Digital Audio Projects

**BP245—DIGITAL AUDIO PROJECTS** ..... \$5.95. Practical circuits to build and experiment with. Includes A/D converter, input amplifier, digital delay line, compander, echo effect and more.



**BP247—MORE ADVANCED MIDI PROJECTS** ..... \$5.95. Circuits included are a MIDI indicator, THRU box, merge unit, code generator, pedal, programmer, channelizer, and analyzer.



An Introduction to Amateur Radio

**BP257—INTRO TO AMATEUR RADIO** ..... \$6.95. Amateur radio is a unique and fascinating hobby. This book gives the newcomer a comprehensive and easy to understand guide to the subject.



Introducing Digital Audio

**PCP102—INTRODUCING DIGITAL AUDIO** ..... \$9.95. Covers all kinds of digital recording methods—CD, DAT and Sampling. Bridges the gap between the technician and the enthusiast. Principles and methods are explained.

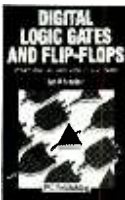

**PCP107—DIGITAL LOGIC GATES AND FLIP FLOPS** ..... \$10.00. Thorough treatment of gates and flip-flops for enthusiasts, student and technicians. Only a basic knowledge of electronics is needed.

**BP251—COMPUTER HOBBYISTS HANDBOOK** ..... \$8.95. A wrapup of everything the computer hobbyist needs to know in one easy to use volume. Provides a range of useful reference material in a single source.



**PCP108—COMPUTERS AND MUSIC** ..... \$9.95. Explains the basics of computers and music with no previous knowledge of computers needed. Covers types of music software and explains how to set up your own computer music studio.

- BP195—INTRODUCTION TO SATELLITE TV**..... \$9.95. A definitive introduction to the subject written for the professional engineer, electronics enthusiast, or others who want to know more before they buy. 8 x 10 in.
- BP190—ADVANCED ELECTRONIC SECURITY PROJECTS**.....\$5.95. Includes a passive infra-red detector, a fiber-optic loop alarm, computer-based alarms and an unusual form of ultrasonic intruder detector.
- BP235—POWER SELECTOR GUIDE**.....\$10.00. Complete guide to semiconductor power devices. More than 1000 power handling devices are included. They are tabulated in alpha-numeric sequence, by technical specs. Includes power diodes, Thyristors, Triacs, Power Transistors and FET's.
- BP234—TRANSISTOR SELECTOR GUIDE**.....\$10.00. Companion volume to BP235. Book covers more than 1400 JEDEC, JIS, and brand-specific devices. Also contains listing by case type, and electronic parameters. Includes Darlingtion transistors, high-voltage devices, high-current devices, high power devices.
- BP99—MINI-MATRIX BOARD PROJECTS**.....\$5.50. Here are 20 useful circuits that can be built on a mini-matrix board that is just 24 holes by ten copper-foil strips.
- BP82—ELECTRONIC PROJECTS USING SOLAR CELLS**.....\$5.50. Circuits with applications around the home that are powered by the energy of the sun. Everything from radio receivers, to a bicycle speedometer, to timers, audio projects and more.
- BP117—PRACTICAL ELECTRONIC BUILDING BLOCKS—Book 1**.....\$5.75. Oscillators, Timers, Noise Generators, Rectifiers, Comparators, Triggers and more.
- BP184—INTRO TO 68000 ASSEMBLY LANGUAGE**..... \$6.95. The 68000 is a great new breed of microprocessor. Programming in assembly language increases the running speed of your programs. Here's what you need to know.

- BP239—GETTING THE MOST FROM YOUR MULTIMETER**..... \$5.95. Covers basics of analog and digital meters. Methods of component testing includes transistors, thyristors, resistors, capacitors and other active and passive devices.
- BP97—IC PROJECTS FOR BEGINNERS**.....\$5.50. Power supplies, radio and audio circuits, oscillators, timers, switches, and more. If you can use a soldering iron you can build these devices.
- BP37—50 PROJECTS USING RELAYS, SCR'S & TRIACS**.....\$5.50. Build priority indicators, light modulators, warning devices, light dimmers and more.
- RADIO—100 RADIO HOOKUPS**.....\$3.00. Reprint of 1924 booklet presents radio circuits of the era including regenerative, neutrodyne, reflex & more.
- BP42—SIMPLE LED CIRCUITS**..... \$5.50. A large selection of simple applications for this simple electronic component.
- BP127—HOW TO DESIGN ELECTRONIC PROJECTS**.....\$5.75. Helps the reader to put projects together from standard circuit blocks with a minimum of trial and error.
- BP122—AUDIO AMPLIFIER CONSTRUCTION**.....\$5.75. Construction details for preamps and power amplifiers up through a 100-watt DC-coupled FED amplifier.
- BP92—CRYSTAL SET CONSTRUCTION**.....\$5.50. Everything you need to know about building crystal radio receivers.
- BP45—PROJECTS IN OPTOELECTRONICS**..... \$5.50. Includes infra-red detectors, transmitters, modulated light transmission and photographic applications.

**BP179—ELECTRONIC CIRCUITS FOR THE COMPUTER CONTROL OF ROBOTS** ..... \$7.50. Data and circuits for interfacing the computer to the robot's motors and sensors.

**BP185—ELECTRONIC SYNTHESIZER CONSTRUCTION** ..... \$5.95. Use this book to learn how to build a reasonably low cost, yet worthwhile monophonic synthesizer and learn a lot about electronic music synthesis in the process

## CHECK OFF THE BOOKS YOU WANT

**ELECTRONIC TECHNOLOGY TODAY INC.**  
P.O. Box 240, Massapequa Park, NY 11762-0240

SHIPPING CHARGES IN USA AND CANADA

**SORRY No orders accepted outside of USA & Canada**

Number of books ordered

Name \_\_\_\_\_  
Address \_\_\_\_\_  
City \_\_\_\_\_ State \_\_\_\_\_ Zip \_\_\_\_\_

\$0.01 to \$5.00	... \$1.25
\$5.01 to 10.00	... \$2.00
\$10.01 to \$20.00	... \$3.00
\$20.01 to \$30.00	... \$4.00
\$30.01 to \$40.00	... \$5.00
\$40.01 to \$50.00	... \$6.00
\$50.01 and above	... \$7.50

Total price of merchandise ..... \$ \_\_\_\_\_  
Sales Tax (New York State Residents only) ..... \$ \_\_\_\_\_  
Shipping (see chart) ..... \$ \_\_\_\_\_

All payments must be in U.S. funds

Total Enclosed .. \$ \_\_\_\_\_

P-1190

# RADIO SHACK PARTS PLACE™

**YOUR NEIGHBORHOOD SOURCE FOR HOBBY AND REPAIR ELECTRONICS  
OVER 7000 LOCATIONS IN THE USA—NOBODY COMPARES!**

## Special-Order Parts "Hotline" Service



Radio Shack has a huge selection of popular electronic components. Plus, we can special-order 10,000 items from our main warehouse—ICs, semiconductors, tubes, phono cartridges and styli, even SAMS manuals. Service is fast and there's no minimum order or postage charge.

## Special-Order the Batteries You Need

In addition to our large in-store stock, we can now supply almost any currently manufactured consumer-type battery—for cordless phones, computer memory, camcorders, transceivers, pagers and more. Service is fast and there are no postage charges.



## Test Equipment

- (1) **Extra-Feature LCD VOM.** Has capacitance and transistor-gain ranges. #22-194 ... 79.95
- (2) **Digital Logic Probe.** LED and tone. #22-303 ... 16.95



## Regulated Supply

- Rated 12VDC at 2.5 amps. Circuit breaker. UL listed AC. #22-120 ... 39.95

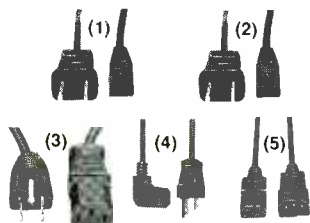

## UL Listed AC Cords

- (1) **Recorder/Radio.** 6 ft. Fits many portables. #278-1254. 2.49
- (2) **Recorder/Radio Version Two.** 6 ft. #278-1256 ... 1.99
- Computer/Business Machine Cords.** 6 ft.
- (3) **With Straight Connector.** #278-1257 ... 3.99
- (4) **Right-Angle Connector.** #278-1260 ... 5.99
- (5) **Extension.** Ideal for monitors. #278-1259 ... 4.99

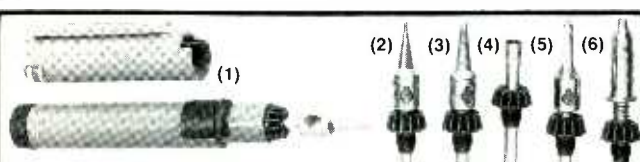

- (1) **4-in-1 Soldering Tool.** Gas-powered so you can solder anywhere, even when you're miles from an AC outlet. Operates continuously up to 60 minutes. And it refills in seconds with standard butane lighter fuel. #64-2161 ... 29.95
- (2) **2.4 mm Replacement Tip.** #64-2162 ... 9.95
- (3) **1.0 mm Replacement Tip.** #64-2163 ... 9.95
- (4) **Blow Torch,** #64-2168, (5) **Heat Blower,** #64-2169, and (6) **Hot Knife Tip,** #64-2170 available on special order (CMC) ... Each 9.95

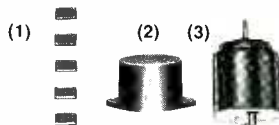

## Hobby Corner

- (1) **Surface-Mount Resistors.** 200 pieces! 5% tolerance. #271-313 ... 4.99
- (2) **"Ding-Dong" Chime.** #273-071 ... 8.99
- (3) **DC Motor.** 1½ to 3VDC. #273-223 ... 99c



## AC Voltage Sensor

Indicates presence of AC voltages from 70 to 440—without direct electrical connection. Use it to find broken connections, blown fuses, burned-out lamps, defective grounds and more. With instructions and replaceable battery. #22-103 ... 9.95

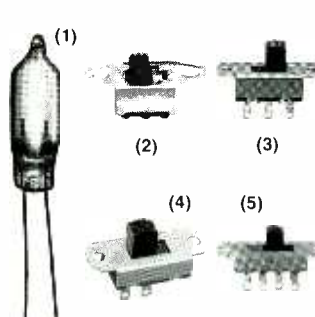

## Switch Values

- (1) **Mercury Bulb.** 5 amps at 125VAC. Style may vary. #275-027 ... 1.29
- (2) **SPDT Micromini Slides.** 3 amps at 125VAC. #275-409 ... Pkg. of 2/1.19
- (3) **SPST Submini.** Rated 0.3A at 125VAC. #275-406 ... 2/79c DPDT. #275-407 ... 2/89c
- (4) **SPST Heavy-Duty.** Rated 3A at 125VAC. #275-401, 2/1.19 DPDT. #275-403 ... 2/1.39
- (5) **Kit.** 0.5A/125VAC. SPDT, DPST, two DPDT. #275-327 ... Set of 6/1.99

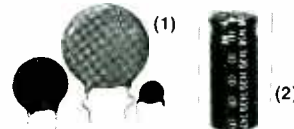

## Cap Assortments

- (1) **Ceramic Discs.** Wide variety of styles and values. #272-801 ... Set of 100/1.98
- (2) **Electrolytic Capacitors.** #272-802 ... Set of 20/1.98



## Bridge Rectifiers

- Rated 4 amps.

PIV	Cat. No.	Each
50	276-1146	1.39
100	276-1171	1.59
400	276-1173	1.99



## Semi "Sub" Book

- New 1991 edition lists over 95,000 types. #276-4014. 3.99



## TV Transistor

- 2SC1308. NPN. Horizontal output. #276-2055 ... 6.95



## Power MOSFET

- IRF-511. For switching supplies, experimental designs. 60VDC, 3 amps. #276-2072 ... 1.99

Since 1921 Radio Shack has been the place to obtain up-to-date electronic parts as well as quality tools, test equipment and accessories. Today, with our big in-store selection and convenient special-order service, Radio Shack continues its tradition of supplying high-tech products at competitive prices. We're America's Technology Store with over 7000 locations—NOBODY COMPARES

Prices apply at participating Radio Shack stores and dealers. Radio Shack is a division of Tandy Corporation

**Radio Shack®**  
**AMERICA'S**  
**TECHNOLOGY**  
**STORE™**

CIRCLE 8 ON FREE INFORMATION CARD