

# Popular Electronics

MAY 1990

THE MAGAZINE FOR THE ELECTRONICS ACTIVIST!

## BUILD A BUDGET FREQUENCY/EVENTS COUNTER

Build our expandable, adaptable counter for professional performance at a hobbyist price

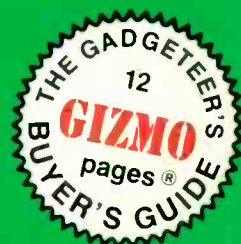

## AN EASY UPGRADE FOR SHORTWAVE RECEIVERS

This simple circuit adds single-sideband and Morse-code reception to any inexpensive shortwave radio

## TROUBLESHOOTING COMPUTER DRIVES

Knowing how and why your computer's disk drives fail can save you a bundle of money when they do



## BUILD A 30-WATT AUDIO AMPLIFIER

High-fidelity, high-performance, and low cost



## PRECISION TEMPERATURE CONTROLLER

Build it and use it for any application from etching PC boards to controlling room temperature

**PRODUCT TEST REPORT**

- RCA 20-Inch Monitor/ Receiver With MTS Sound



\$2.50 U.S.  
\$2.95 CANADA

3 NEW  
FactCards  
IN THIS ISSUE

# Electronics Paperback Books

GREAT PAPERBACKS AT SPECIAL PRICES

**BP248—TEST EQUIPMENT CONSTRUCTION** ..... \$5.95. Details construction of simple, inexpensive, but extremely useful test equipment. AF Gen, Test Bench Ampl, Audio Millivoltmeter, Transistor Tester and six more.



**BP267—HOW TO USE OSCILLOSCOPES AND OTHER TEST EQUIPMENT** ..... \$6.95. Mastering the oscilloscope is not really too difficult. This book explains all the standard controls and functions. Other equipment is also described.

**BP265—MORE ADVANCED USES OF THE MULTIMETER** ..... \$5.95. Use these techniques to test and analyze the performance of a variety of components. Also see how to build add-ons to extend multimeter capabilities.



**BP256—INTRO TO LOUDSPEAKERS AND ENCLOSURE DESIGN** ..... \$5.95. We explore the variety of enclosure and speaker designs in use today so the reader can understand the principles involved.

**BP263—A CONCISE INTRO TO dBASE** ..... \$6.95. The dBASE series of programs are probably the best known database programs for microcomputers. This book is designed to help you get started working with them.

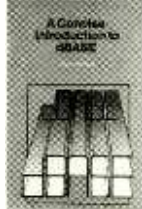

**BP260—CONCISE INTRO TO OS/2** ..... \$5.95. If you are a multitasking PC user and want to get the most out of your computer, then you must learn its OS/2 operating system. This book shows you just how to do that, quickly and easily.



**BP249—MORE ADVANCED TEST EQUIPMENT CONSTRUCTION** ..... \$6.95. Eleven more test equipment construction projects. They include a digital voltmeter, capacitance meter, current tracer and more.



Digital Audio Projects



**BP245—DIGITAL AUDIO PROJECTS** ..... \$5.95. Practical circuits to build and experiment with. Includes A/D converter, input amplifier, digital delay line, compander, echo effect and more.

**BP247—MORE ADVANCED MIDI PROJECTS** ..... \$5.95. Circuits included are a MIDI indicator, THRU box, merge unit, code generator, pedal, programmer, channelizer, and analyzer.



**BP257—INTRO TO AMATEUR RADIO** ..... \$6.95. Amateur is a unique and fascinating hobby. This book gives the newcomer a comprehensive and easy to understand guide to the subject.



**PCP102—INTRODUCING DIGITAL AUDIO** ..... \$9.95. Covers all kinds of digital recording methods—CD, DAT and Sampling. Bridges the gap between the technician and the enthusiast. Principles and methods are explained.

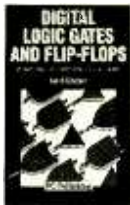

**PCP107—DIGITAL LOGIC GATES AND FLIP-FLOPS** ..... \$10.00. Thorough treatment of gates and flip-flops for enthusiasts, student and technicians. Only a basic knowledge of electronics is needed.

**BP251—COMPUTER HOBBYISTS HANDBOOK** ..... \$8.95. A wrapup of everything the computer hobbyist needs to know in one easy to use volume. Provides a range of useful reference material in a single source.



**PCP108—COMPUTERS AND MUSIC** ..... \$9.95. Explains the basics of computers and music with no previous knowledge of computers needed. Covers types of music software and explains how to set up your own computer music studio.

- BP195—INTRODUCTION TO SATELLITE TV**..... \$9.95. A definitive introduction to the subject written for the professional engineer, electronics enthusiast, or others who want to know more before they buy. 8 x 10 in.
- BP190—ADVANCED ELECTRONIC SECURITY PROJECTS**.....\$5.95. Includes a passive infra-red detector, a fiber-optic loop alarm, computer-based alarms and an unusual form of ultrasonic intruder detector.
- BP235—POWER SELECTOR GUIDE**.....\$10.00. Complete guide to semiconductor power devices. More than 1000 power handling devices are included. They are tabulated in alpha-numeric sequence, by technical specs. Includes power diodes, Thyristors, Triacs, Power Transistors and FETs.
- BP234—TRANSISTOR SELECTOR GUIDE**.....\$10.00. Companion volume to BP235. Book covers more than 1400 JEDEC, JIS, and brand-specific devices. Also contains listing by case type, and electronic parameters. Includes Darlingtons transistors, high-voltage devices, high-current devices, high power devices.
- BP99—MINI-MATRIX BOARD PROJECTS**.....\$5.50. Here are 20 useful circuits that can be built on a mini-matrix board that is just 24 holes by ten copper-foil strips.
- BP82—ELECTRONIC PROJECTS USING SOLAR CELLS**.....\$5.50. Circuits with applications around the home that are powered by the energy of the sun. Everything from radio receivers, to a bicycle speedometer, to timers, audio projects and more.
- BP117—PRACTICAL ELECTRONIC BUILDING BLOCKS—Book 1**.....\$5.75. Oscillators, Timers, Noise Generators, Rectifiers, Comparators, Triggers and more.
- BP184—INTRO TO 68000 ASSEMBLY LANGUAGE**.....\$6.95. The 68000 is a great new breed of microprocessor. Programming in assembly language increases the running speed of your programs. Here's what you need to know.
- BP179—ELECTRONIC CIRCUITS FOR THE COMPUTER CONTROL OF ROBOTS** ..... \$7.50. Data and circuits for interfacing the computer to the robot's motors and sensors.

- BP239—GETTING THE MOST FROM YOUR MULTIMETER**..... \$5.95. Covers basics of analog and digital meters. Methods of component testing includes transistors, thyristors, resistors, capacitors and other active and passive devices.
- BP97—IC PROJECTS FOR BEGINNERS**.....\$5.50. Power supplies, radio and audio circuits, oscillators, timers, switches, and more. If you can use a soldering iron you can build these devices.
- BP37—50 PROJECTS USING RELAYS, SCR'S & TRIACS**.....\$5.50. Build priority indicators, light modulators, warning devices, light dimmers and more.
- RADIO—100 RADIO HOOKUPS**.....\$3.00. Reprint of 1924 booklet presents radio circuits of the era including regenerative, neutrodyne, reflex & more.
- BP42—SIMPLE LED CIRCUITS**.....\$5.50. A large selection of simple applications for this simple electronic component.
- BP127—HOW TO DESIGN ELECTRONIC PROJECTS**.....\$5.75. Helps the reader to put projects together from standard circuit blocks with a minimum of trial and error.
- BP122—AUDIO AMPLIFIER CONSTRUCTION**.....\$5.75. Construction details for preamps and power amplifiers up through a 100-watt DC-coupled FED amplifier.
- BP92—CRYSTAL SET CONSTRUCTION**.....\$5.50. Everything you need to know about building crystal radio receivers.
- BP45—PROJECTS IN OPTOELECTRONICS**.....\$5.50. Includes infra-red detectors, transmitters, modulated light transmission and photographic applications.

**BP185—ELECTRONIC SYNTHESIZER CONSTRUCTION** ..... \$5.95. Use this book to learn how to build a reasonably low cost, yet worthwhile monophonic synthesizer and learn a lot about electronic music synthesis in the process

## CHECK OFF THE BOOKS YOU WANT

**ELECTRONIC TECHNOLOGY TODAY INC.**  
P.O. Box 240, Massapequa Park, NY 11762-0240

**SHIPPING CHARGES IN USA AND CANADA**

**SORRY No orders accepted outside of USA & Canada**

Number of books ordered

Name \_\_\_\_\_  
Address \_\_\_\_\_  
City \_\_\_\_\_ State \_\_\_\_\_ Zip \_\_\_\_\_

\$0.01 to \$5.00 ... \$1.25  
\$5.01 to 10.00 ... \$2.00  
\$10.01 to \$20.00 ... \$3.00  
\$20.01 to \$30.00 ... \$4.00  
\$30.01 to \$40.00 ... \$5.00  
\$40.01 to \$50.00 ... \$6.00  
\$50.01 and above ... \$7.50

Total price of merchandise ..... \$ \_\_\_\_\_  
Sales Tax (New York State Residents only) ..... \$ \_\_\_\_\_  
Shipping (see chart) ..... \$ \_\_\_\_\_

**All payments must be in U.S. funds**

Total Enclosed .. \$ \_\_\_\_\_

P-590



# Popular Electronics®

THE MAGAZINE FOR THE ELECTRONICS ACTIVIST!

## CONSTRUCTION ARTICLES

<b>BUILD A FREQUENCY/EVENTS COUNTER</b> .....	John Wannamaker	33
<i>A precision counter that grows with your needs</i>		
<b>PRECISION TEMPERATURE CONTROLLER</b> .....	Joseph Giannelli	38
<i>Get rock-steady temperatures for any application</i>		
<b>ADD CW AND SSB TO YOUR SHORTWAVE RECEIVER</b> .....	Michael Covington	41
<i>An inexpensive way to refresh your Morse-code skills, and more</i>		
<b>BUILD A 30-WATT AUDIO AMPLIFIER</b> .....	Marc Spiwak	61
<i>Give those low-power audio signals the boost they need</i>		

## FEATURE ARTICLES

<b>EARLY RADIO TRANSMITTERS</b> .....	Joseph J. Carr	43
<i>The history of radio is chock full of colorful stories</i>		
<b>TROUBLESHOOTING COMPUTER DISK DRIVES</b> .....	Isaac Szlechter	63
<i>Learn why disk drives fail and how to get them back on track when they do</i>		
<b>GAMES AND THE AMAZING AMIGA</b> .....	Karl T. Thurber Jr.	67
<i>Dynamite sound and graphics capabilities make the Amiga a game-player's dream come true</i>		
<b>TUNE IN TO SATELLITE RADIO</b> .....	Robert Angus	71
<i>Unlock the secret potential of your satellite receiving system</i>		
<b>CHOOSING AND USING THREE-TERMINAL VOLTAGE REGULATORS</b> .....	Joseph J. Carr	72
<i>Pick the right regulator for your power-supply circuit</i>		
<b>THE DIGITAL ELECTRONICS COURSE</b> .....	Robert A. Young	76
<i>Using the 555 oscillator in digital circuits</i>		

## PRODUCT REVIEWS

<b>GIZMO</b> .....		49
<i>Including: Sharp Optonica VC-G980 Voice-Coach VCR; Terk pi<sup>2</sup> Active Indoor FM Antenna; CopyCam 601 Enhancer; and more!</i>		
<b>PRODUCT TEST REPORT</b> .....	Len Feldman	78
<i>RCA X20343WN 20-inch TV Monitor/Receiver</i>		
<b>HANDS-ON REPORT</b> .....		80
<i>Analog Devices Component Selection Software</i>		

## COLUMNS

<b>THINK TANK</b> .....	Byron G. Wels	22
<i>Go with the flow</i>		
<b>ANTIQUE RADIO</b> .....	Marc Ellis	82
<i>The Super Wasp plays again</i>		
<b>CIRCUIT CIRCUS</b> .....	Charles D. Rakes	84
<i>Solid-state equivalents of yesteryear's radio circuits</i>		
<b>COMPUTER BITS</b> .....	Jeff Holtzman	86
<i>Blues for Sandy</i>		
<b>DX LISTENING</b> .....	Don Jensen	88
<i>Steam radio</i>		
<b>HAM RADIO</b> .....	Joseph J. Carr	90
<i>Keeping your antenna system in shape</i>		
<b>SCANNER SCENE</b> .....	Marc Saxon	92
<i>Taking it on the road</i>		

## DEPARTMENTS

<b>LETTERS</b> .....		2
<b>ELECTRONICS LIBRARY</b> .....		4
<b>NEW PRODUCTS</b> .....		12
<b>FACTCARDS</b> .....		47
<b>FREE INFORMATION CARD</b> .....		65
<b>ADVERTISER'S INDEX</b> .....		107

Popular Electronics (ISSN 1042-170X) Published monthly by Gernsback Publications, Inc., 500-B Bi-County Boulevard, Farmingdale, NY 11735. Second-Class postage paid at Farmingdale, NY and at additional mailing offices. One-year, twelve issues, subscription rate U.S. and possessions \$21.95, Canada \$26.95, all other countries \$29.45. Subscription orders payable in U.S. funds only. International Postal Money Order or check drawn on a U.S. bank. U.S. single copy price \$2.50. © 1990 by Gernsback Publications, Inc. All rights reserved. Hands-on Electronics and Gizmo trademarks are registered in U.S. and Canada by Gernsback Publications, Inc. Popular Electronics trademark is registered in U.S. and Canada by Electronics Technology Today, Inc. and is licensed to Gernsback Publications. Printed in U.S.A.

Postmaster: Please send address changes to Popular Electronics, Subscription Dept., P.O. Box 338, Mount Morris, IL 61054-9932.

A stamped self-addressed envelope must accompany all submitted manuscripts and/or artwork or photographs if their return is desired should they be rejected. We disclaim any responsibility for the loss or damage of manuscripts and/or artwork or photographs while in our possession or otherwise.

As a service to readers, Popular Electronics publishes available plans or information relating to newsworthy products, techniques and scientific and technological developments. Because of possible variances in the quality and condition of materials and workmanship used by readers, Popular Electronics disclaims any responsibility for the safe and proper functioning of reader-built projects based upon or from plans or information published in this magazine.

Larry Steckler  
EHF, CET  
Editor-In-Chief and Publisher

## EDITORIAL DEPARTMENT

Carl Laron  
Managing Editor

Robert A. Young  
Associate Editor

John J. Yacono  
Associate Editor

Byron G. Wels, K2AVB  
Associate Editor

Teri Scaduto  
Assistant Editor

Kathy Terenzi  
Editorial Assistant

Robert A. W. Lowndes  
Editorial Associate

Marc Spiwak  
Editorial Associate

Joseph J. Carr, K4IPV  
Marc Ellis  
Jeffrey K. Holtzman  
Don Jensen  
Charles D. Rakes  
Marc Saxon  
Contributing Editors

## PRODUCTION DEPARTMENT

Ruby M. Yee  
Production Director

Karen S. Tucker  
Production Manager

Marcella Amoroso  
Production Assistant

## ART DEPARTMENT

Andre Duzant  
Art Director

Russell C. Truelson  
Technical Illustrator

Injae Lee  
Assistant Illustrator

Jaqueline P. Cheeseboro  
Circulation Director

Michele Torrillo  
P-E Bookstore

## BUSINESS AND EDITORIAL OFFICES

Gernsback Publications, Inc.  
500-B Bi-County Blvd.  
Farmingdale, NY 11735  
1-516-293-3000  
Fax: 1-516-293-3115  
President: Larry Steckler  
Vice President: Cathy Steckler

## Advertising Sales Offices listed on page 105

Cover photography by  
Diversified Photo Services

Composition by  
Mates Graphics  
and  
Magtype



The  
Audit  
Bureau  
of Circulation



The publisher has no knowledge of any proprietary rights which will be violated by the making or using of any items disclosed in this issue.

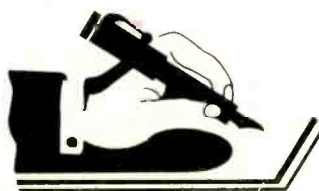

# Letters

## DYNAMITE DIMMER SWITCH

I really enjoyed the "Touch Control Dimmer Switch" project by Mike Giamportone (**Popular Electronics**, November 1989). I have built two units so far, and they work so well that I am assembling parts for two more. I am a hobbyist whose interest in electronics started in the amateur-radio arena in the mid-1930's. Since then, with the exception of a 20-year period between 1965 and 1985, I have derived a great deal of satisfaction from building anything and everything electronic!

That article was excellently written, sufficiently broad in scope to cover all pertinent bases, and supported by descriptive commentary to give the builder all the aid he may require. I found the switch to be easy to construct and, so far, reliable in its performance. I'm looking forward to seeing more articles by Mike Giamportone.

C.J.P.  
Vancouver, WA

## OZONE WARNING

I notice that quite a few articles featuring high voltages have appeared recently in **Popular Electronics** and other publications. While those articles caution readers about electrical dangers, they omit an important caveat. February 1990's "Custom Plasma Display" and "Violet Ray Generator" (and all similar projects) produce ozone. Experiments of that sort should be brief, and should be conducted in well-ventilated areas. The gas that lends the shack and the rainy pine forest that "electrifying" scent of freshness is toxic, carcinogenic, and mutagenic.

It's getting difficult to keep up awareness about ozone since the emergence of an "alternative treatment" called "Ozone Therapy"—the perfect oxymoron, since neither word is accurate.

L.P.D.  
Middle Village, NY

## CHATTER-CHANNEL RESTRICTIONS

In the January 1990 *Scanner Scene* column, Marc Saxon noted that the "chatter channel" for airline pilots over the Continental U.S. is 123.45 MHz. You might be interested to know that the FCC has been citing airlines and private aircraft for using that frequency for such chit-chat.

Both 123.4 and 123.45 MHz are *exclusively* reserved for the test and development of aircraft and aircraft components. Type certification testers, for tests of aircraft and instrumentation, use those channels for both voice and data communications.

Radio Systems Technology is licensed on those frequencies, and we use them quite frequently for antenna-pattern tests and the like. (We were privileged to have designed most of the antennas for almost all "plastic" home-built aircraft in this country, including one "Voyager" round-the-world aircraft, using those two test frequencies.) You have no idea how much fun it is to be at the end of a four-hour flight test and then get clobbered by "Red Baron calling Uncle Snoopy!"

Jim Weir  
Vice President, Engineering  
Radio Systems Technology  
Grass Valley, CA

## SWEEP/BURST GENERATOR

Several errors crept into the illustrations that accompanied the "Sweep/Burst Generator" article that appeared in the February, 1990 issue of **Popular Electronics**. First, in the schematic diagram, there is a dot missing from the C7 ground bus where that line crosses the one coming from U1-a, pin 1. Also, LED1, is reversed. Its anode should be tied to the top of R14. In addition, the feedback resistor connected to U4 is not identified; that unit is R21 and has a value of 10k. Finally, J2 is shown wired backwards, with the center conductor going to ground. The center conductor should be connected to the output of U7-b, and the outer conductor should go to ground.

There were also two errors in the parts-placement diagram: Integrated circuit U7 is shown backwards and switch S4's x 1 and pole contacts have been interchanged; hook up that switch as shown in the schematic.—  
Editor

## HAVES & NEEDS

I'm looking for information on a Hallicrafters S-108 communications receiver. I bought the rig at a junk store, and it's missing all the usual stuff—operator's manual, schematics, and service manual. Can anyone help?

Darell A. Larose  
2-101 Western Avenue  
Ottawa, Ontario  
Canada, K1Y 0L9

Do any **Popular Electronics** readers know where I might obtain the schematic for a Realistic 8-track tape deck, model 14-928? I would appreciate any help and would pay for any copying and postage costs.

Tim Karle  
Rt. 8, Lot #9, Sitton Dr.  
Greenville, SC 29611 ■



# Radio Shack<sup>SM</sup> Parts Place

## YOUR ONE-STOP STORE FOR BIG ELECTRONIC VALUES

Build with the Best—Over 1000 Components in Stock!

**Parts "Hotline" Service!**  
Thousands of Items Available

Your Radio Shack store manager can special-order a huge variety of parts and accessories direct from our electronics warehouse—Realistic® Long-Life tubes, linear and digital ICs, microprocessors, support chips, phono cartridges and styli, crystals, special-purpose batteries, diodes, selected modules for TVs and audio equipment, autosound wiring harnesses, accessories, even SAMS Photofacts®. No handling charge, no shipping charge—just speedy delivery to the Radio Shack near you!

**Amateur Radio License Guides**

**495 to 1995**

Home Study Courses  
For FCC License Tests

Novice Voice Class License  
Prep Course. With cassettes.  
#62-2402 ..... 19.95  
Technician Class Manual.  
#62-2403 ..... 4.95  
General Class FCC License  
Course. #62-2404 ..... 19.95



### Brushless Fan



**16<sup>95</sup>**

Operates  
On 12VDC

Tiny, tough and efficient! Rated 150 mA. 1 1/16" x 1 9/16" x 1 3/16". #273-244

### IR Detector

**349**

Module operates on 5VDC, board mountable. 5/8" x 1/2" x 1 9/32". With data. #276-137

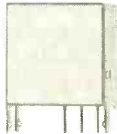

Simplifies  
IR Design

### IC Tool Set

**6<sup>95</sup>**  
Set

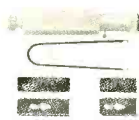

Install and remove 6-pin to 40-pin DIPs without damage. Works with LSI, MSI, and DIP devices. Both tools are groundable. #276-1581

### Motor and Chime



(1) 1.5-3V DC Motor. For robotics, projects. 1 1/2" x 1 5/16" dia. #273-223  
(2) Doorbell Chime. IC/mini-speaker combo. 6-18VDC. 5" leads. #273-071

### Diode Rectifiers



3-Amp "Barrel" Type Diodes  
200-Amp Surge

Type	Peak Inverse Voltage	Cat. No.	Pkg. of 2
1N5400	50	276-1141	99
1N5402	200	276-1143	1.19
1N5404	400	276-1144	1.29

### Speaker Stuff

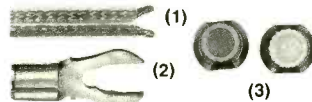

(1) MEGACABLE™. Hi-wattage, 12-gauge. #278-1268 ... Per Foot 99c  
(2) Gold Terminals for MEGACABLE. #64-401 ... Set of 8/4.99  
(3) Terminal Knobs. Screw-down large cable. #274-619 ... Set 5.95

### Dress It Up



(1) Classy Two-Piece Enclosure. Accepts PC board and 9V battery. 5 5/8" x 2 1/4" x 1 1/16". #270-257 ... 4.99  
(2) Project Labels. Four 7 7/8" x 3" sheets of rub-on letters and symbols. #270-201 ..... Set 2.99

### Halogen Lamps

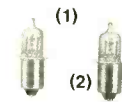

**3<sup>95</sup>**  
Each

(1) HPR50. For 4-cell flashlights and 6-volt lanterns. #272-1189  
(2) HPR52. For 2-cell flashlights and 3-volt lanterns. #272-1190

### Gold-Plated Plugs and Jacks



(1) Phono Plug. #274-850 ... 2.49  
(2) Chassis-Mount Phono Jack. #274-852 ... 2-pk./2.49  
(3) Straight Inline Phono Jack. #274-854 ... 2.99  
(4) 2-Conductor 1/4" Phone Plug. Monaural. #274-855 ... 3.49  
(5) Three-Conductor (Stereo) 1/4" Phone Plug. #274-856 ... 3.99  
(6) 1/8" Plug. #274-857 ... 2.79  
(7) 3-Conductor 1/8" Phone Plug. Stereo. #274-858 ... 3.49  
(8) 3-Conductor 1/4" Inline Phone Jack. #274-859 ... 3.99

### Wire Connectors & Accessories



Fig.	Pos.	Type	Amps	Cat. No.	Each
1	2	Male	20	274-151	99
	6	Male	15	274-152	1.69
	12	Male	12	274-153	1.99
2	2	Female	20	274-154	99
	6	Female	15	274-155	1.69
	12	Female	12	274-156	1.99

(3) 2-Row Strip. #274-670 ... 1.99  
(4) Jumper. 8-pos. #274-650, 1.59  
(5) 45° T-Lugs. #274-645 ... 4/79c  
(6) Dual Solder-Lug Adapters. #274-644 ..... Pkg. of 4/79c  
(7) Heavy-Duty Bonded Wire. 25 ft., 2 x 18-gauge. #278-1250 ... 3.99

### Engineering Calculator



**3<sup>995</sup>**

Uses Standard  
Electronic Symbols

EC-4035 makes design math a snap! Has 110 functions, memory. With case and batteries. #65-983

### 30-Range Multimeter



**7<sup>995</sup>**

Tests Capacitors  
and Transistors

A great value! Measures to 1000VDC and 750VAC. With 0.5" digital display. Battery extra. #22-194

### Panel-Mount Counter

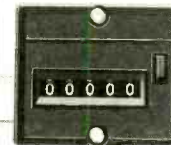

**14<sup>95</sup>**

Electromechanical — Counts to 99,999

One count per 12VDC pulse, pushbutton reset. Mounts in 1 1/16" x 1" hole. Depth: 1 1/16". With leads and data. #277-222

Over 1000 items in stock! Binding Posts, Books, Breadboards, Buzzers, Capacitors, Chokes, Clips, Coax, Connectors, Fuses, Hardware, ICs, Jacks, Knobs, Lamps, Multimeters, PC Boards, Plugs, Rectifiers, Resistors, Switches, Tools, Transformers, Transistors, Wire, Zeners, More!

Prices apply at participating Radio Shack stores and dealers

CIRCLE 8 ON FREE INFORMATION CARD

**Radio Shack**  
**AMERICA'S**  
**TECHNOLOGY**  
**STORE**  
A DIVISION OF TANDY CORPORATION

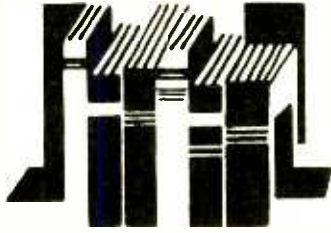

## Electronics Library

To obtain additional information on the books and publications covered in this section from the publisher, please circle the item's code number on the Free Information Card

### HOW TO INSTALL, CONNECT AND EXPAND TVs, VCRs, TELEPHONES, AUDIO SYSTEMS AND OTHER CONSUMER ELECTRONIC PRODUCTS

from the Electronics Industries Association

Arranged in a "question-and-answer" format, this 52-page booklet provides the answers to dozens of commonly asked questions concerning consumer-electronics connections. Part of the EIA/Consumer Electronics Group's "Consumers Should Know..." series, this one is written for consumers with little or no knowledge of electronics. It not only tells readers precisely what type of connector is needed for each of dozens of different applications, but goes on to describe that connector in detail, accompanied by a photo or line drawing. The basic cable categories are described and illustrated, as well as jacks, adapters, antenna leads, etc. Drawings of the backs of the components, showing locations of inputs and outputs, also help reduce confusion. A glossary of terms is also included.

How to Install, Connect and Expand TVs,

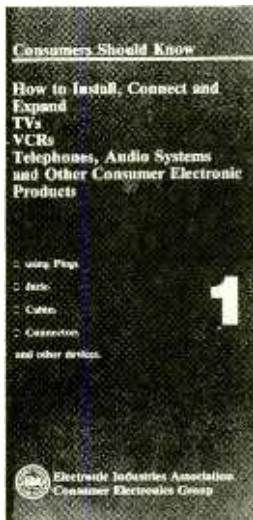

VCRs, Telephones, Audio Systems and Other Consumer Electronic Products is available by sending a 65-cent SASE to the Electronics Industries Association/Consumer Electronics Group, Installation Products, P.O. Box 19100, Washington, DC 20036.

CIRCLE 81 ON FREE INFORMATION CARD

### GETTING THE MOST OUT OF DESKMATE 3

by Michael A. Banks

For novices as well as advanced users of DeskMate 3 integrated software, this 300-page reference guide offers helpful information on both installation and use. Designed around Tandy's DeskMate Graphical User Interface, DeskMate 3 features pull-down menus and pop-up dialogue boxes that allow users to access any program directly from the DeskMate Desktop. It includes applications for writing letters, budgeting, filing, scheduling appointments, drawing, and more.

The book provides advanced tips and techniques for the effective use of DeskMate's application and accessory programs. Using a step-by-step approach to customizing the program—designed to meet the computing and work needs of each reader—the book describes ways to save disk space, import and export data, access DOS commands, and run other programs from DeskMate.

Getting the Most Out of DeskMate 3 has a suggested retail price of \$21.95. It is available at local Radio Shack stores and Radio Shack Computer Centers.

CIRCLE 82 ON FREE INFORMATION CARD

### THE HANDBOOK OF MICROCOMPUTER INTERFACING: Second Edition

by Steve Leibson

There are so many devices to be connected to today's microcomputers—printers, plotters, terminals, tape readers, and keyboards, to name just a few—that when it comes to interfacing, confusion abounds. This introduction to microcomputer/microprocessor-interfacing technology provides the information needed to get everything hooked up and running quickly and easily.

Practical insights on each aspect of interfacing, including hardware and software, as well as history and theory, provide not only the "hows" of interfacing but also the "whys." The book describes dozens of new applications for your computer, and explains how to attach peripherals from any manufacturer—and even home-brewed ones—to your computer, and how to use your computer to control everything from household appliances to amateur-radio equipment. Con-

struction details for a variety of practical circuits are provided. The second edition has been updated to include discussions on topics such as the difference between Motorola and Intel bus interfaces, details on the IEEE-488 interface, and why the

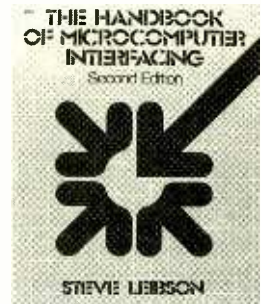

RS-232 isn't quite a "standard" and how you can make RS-232 devices work together properly.

The Handbook of Microcomputer Interfacing: Second Edition costs \$19.95. It is available from TAB Books Inc., Blue Ridge Summit, PA 17294-0850; Tel. 1-800-233-1128.

CIRCLE 98 ON FREE INFORMATION CARD

### FUNDAMENTAL DC/AC CIRCUITS: Concepts and Experimentation

by Fredrick W. Hughes

The first book in a series that is designed to provide the reader with the essential skills required to become an electronics technician, this book places an emphasis on student involvement and self-learning, and can be used by individuals or as a classroom text. Exercises and experiments provide practical experience using test instruments, and demonstrate the exact skills required of a beginning electronics technician.

Through its self-teaching format, the book aims to teach the reader to apply basic atomic theory and electrical principles to practical electrical circuits. Lessons define basic electrical terms and teach the reader how to select proper wire sizes; to explain the effects of electrical resistance; to identify and label discrete electrical components; and to demonstrate the use of resistors, capacitors, inductors, and transformers in electrical circuits. The book explains how to use Ohm's law, how to calculate the power dissipated by electrical components and circuits, and how to solve for the parameters of complex circuits. Lessons and exercises demonstrate how to build electrical circuits, read schematic diagrams, troubleshoot circuits, and connect test equipment to circuits and obtain accurate readings. Readers are taught to describe the





## Electronics Library

counting into existing business systems, providing all the information necessary to computerize a company's financial records.

For those who are just starting to learn Peachtree, the book describes what hardware and software are needed, how to install and operate the system, and how to make a smooth transition from ledger books to a PC. More experienced users will appreciate the step-by-step examination of the entire automated-accounting process, including real-life examples that demonstrate exactly how Peachtree handles inventory, accounts receivable and payable, and payroll.

*Peachtree Complete II: Accounting Made Easy* is available for \$19.95 from Windcrest, Division of TAB Books, Blue Ridge Summit, PA 17294-0850.

**CIRCLE 98 ON FREE INFORMATION CARD**

## FIBER OPTICS HANDBOOK: For Engineers and Scientists

edited by Frederick C. Allard

Containing the comparative data required for solving specific fiber-optics problems, this book is a highly practical reference on today's systems, components, test methods, and applications. Eleven specialists in the fiber-optics field have contributed material on their areas of expertise, explaining the key aspects involved in the selection, specification, and application of fiber optics. It takes the reader from basic fiber properties, through systems and test procedures, to design parameters.

The book provides the basis for applying fiber optics to problems in information transfer. It includes definitions, operational principles, and comparative performance information on candidate components for fiber-optics systems. The functional relationships among the elements of the system are described and illustrated with examples that relate to the transfer of digital and analog data, and of other information, such as from sensors. Some of the topics examined are splices, connectors, and couplers; fiber-optic cables; systems design; suggestions on selecting optical fibers for special applications; and optical-fiber sensors. In addition, the book offers expert advice and applications data for modulation, optical sources, test methods, and optical detectors.

*Fiber Optics Handbook: For Engineers and Scientists* is available for \$69.50 from McGraw-Hill Publishing Company, 11 West 19th Street, New York, NY 10011; Tel. 1-800-2-MCGRAW.

**CIRCLE 96 ON FREE INFORMATION CARD**

## COMPUTERS AND MUSIC: An Introduction

by R.A. Penfold

The fields of music and computers are becoming increasingly entwined, and computerized music has entered the mainstream. Today's prices have become more reasonable, and the latest equipment has enormous potential. This book is designed to show those who are tempted into the unfamiliar territory of computerized music how to tap that potential.

The book explains the basics of computing, with the aim of setting up and using a computer-based music system. It shows how to run applications programs, wire up

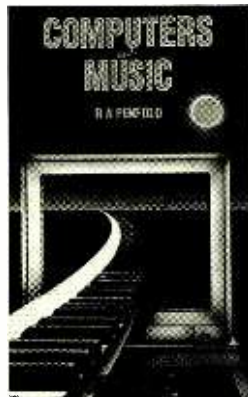

a MIDI system, and use it properly. It explores how to choose the right components for a system that meets your particular needs—and how to get the most out of that system. The currently available types of music software are described. Illustrations and a glossary of terms help clarify the text. Absolutely no prior knowledge of computers is needed to read and understand the book.

*Computers and Music: An Introduction* costs \$11.95, including shipping. It is available from *Electronics Technology Today, Inc.*, P.O. Box 240, Massapequa Park, NY 11762-0240.

**CIRCLE 97 ON FREE INFORMATION CARD**

## COMPONENTS CATALOG

from Jim-Pak

This fold-out flyer is filled with items for the electronics technician or enthusiast. Its pages list more than 560 items ranging from resistors and capacitors to microprocessors. Some of the product categories include diodes, crystals, connectors, switches, LED's, potentiometers, and heat sinks. Besides components, Jim-Pak offers kits, enclosures, data books, solderless breadboards, computer cables and accessories, and soldering stations and tools. For convenience,



pin-out charts for various components are included, as are a list of the more than 350 distributors that carry the items described in the brochure.

The 1990 Catalog is free from Jim-Pak Electronic Components, 1355 Shoreway Road, Belmont, CA 94002.

**CIRCLE 83 ON FREE INFORMATION CARD**

## THE EQUIPMENT DIRECTORY OF AUDIO-VISUAL, COMPUTER, AND VIDEO PRODUCTS

from the International Communications  
Industries Association

This 35th edition of the comprehensive directory to communications products has been updated to include descriptions and photographs of more electronics equipment than any previous edition. The International Communications Industries Association (ICIA), a well-known and -respected non-profit trade association, assembled the information directly from the manufacturers, and carefully verified it before publication.

Putting complete details on state-of-the-art equipment at the readers' fingertips, the book is a vital reference source for anyone involved in the communications industries. It includes descriptions of nearly 3000 products in more than 200 categories, and represents more than 400 manufacturers and 800 dealers. Each product listing in the illustrated section of the directory provides uniform, detailed specifications including suggested list price, model number, weight capacity, features, applications, accessories, and other technical details. Recently added categories include computer interfaces for overheads, slide-, filmstrip-, and film-to-video systems, and a complete section on video products.

(Continued on page 8)





2809 \$29.95  
Counts as 2



3118 \$23.95



3165 \$17.95



2613P \$15.95



2883P \$17.95



2867P \$18.95



3002 \$49.50



2925P \$9.95



2826P \$15.95



1536P \$9.95

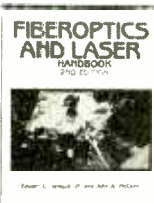

2981P \$16.95



3155 \$19.95

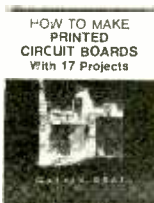

2898 \$23.95

# SELECT 5 BOOKS for only \$4.95

(values to \$150.25)  
and get a **FREE Gift!**

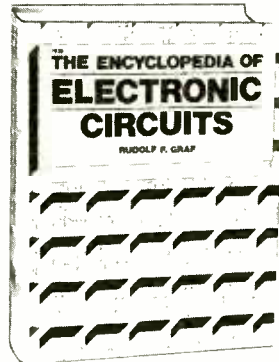

1938P \$29.95  
Counts as 2



1897P \$14.95



3219 \$27.95  
Counts as 2



1425P \$22.95



3195 \$28.95  
Counts as 2

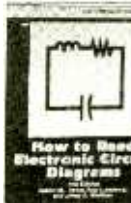

2880P \$14.95



3031P \$16.95

For 25 years, your most complete source for electronics books.

**Membership Benefits • Big Savings.** In addition to this introductory offer, you keep saving substantially with members' prices of up to 50% off the publishers' prices. • **Bonus Books.** Starting immediately, you will be eligible for our Bonus Book Plan, with savings of up to 80% off publishers' prices. • **Club News Bulletins.** 14 times per year you will receive the Book Club News, describing all the current selections—mains, alternates, extras—plus bonus offers and special sales, with scores of titles to choose from. • **Automatic Order.** If you want the Main Selection, do nothing and it will be sent to you automatically. If you prefer another selection, or no book at all, simply indicate your choice on the reply form provided. You will always have at least 10 days to decide. As a member, you agree to purchase at least 3 books within the next 12 months and may resign at any time thereafter. • **Ironclad No-Risk Guarantee.** If not satisfied with your books, return them within 10 days without obligation! • **Exceptional Quality.** All books are quality publishers' editions especially selected by our Editorial Board.

(Publishers' Prices Shown)

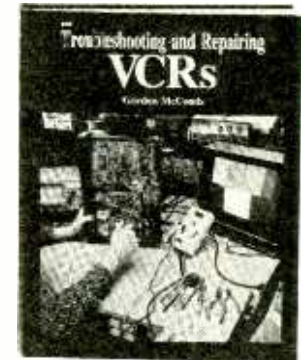

2960 \$27.95  
Counts as 2

**FREE when you join!**

**15 Easy Electronic Projects From Delton T. Horn**

Projects you can build—some unique, some old favorites—from the author's vast treasury of electronics know-how.



Delton T. Horn's  
All-Time Favorite  
Electronic Projects



**ELECTRONICS BOOK CLUB<sup>SM</sup>**

Blue Ridge Summit, PA 17294-0810

Please accept my membership in the Electronics Book Club and send the 5 volumes listed below, plus my FREE copy of Delton T. Horn's All-Time Favorite Electronic Projects (3105P), billing me \$4.95 plus shipping and handling charges. If not satisfied, I may return the books within ten days without obligation and have my membership cancelled. I agree to purchase at least 3 books at regular Club prices (plus shipping/handling) during the next 12 months and may resign any time thereafter.

\_\_\_\_\_

**50% MONEY-SAVING OPTION:** I also wish to order my first Club Selection at 50% off the Publishers' price (plus shipping/handling). I then need to purchase only 2 or more books within the next 12 months.

Name \_\_\_\_\_

Address \_\_\_\_\_

City \_\_\_\_\_

State \_\_\_\_\_ Zip \_\_\_\_\_ Phone \_\_\_\_\_

Signature \_\_\_\_\_

Valid for new members only. Foreign applicants will receive special ordering instructions. Canada must remit in U.S. currency. This order subject to acceptance by the Electronics Book Club. PE590

**Call Toll-Free 1-800-233-1128 to join Now!**



2707 \$26.95  
Counts as 2

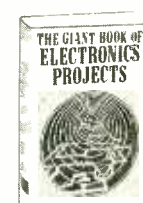

1367P \$24.95



2980F \$19.95



2800P \$15.95



3241 \$24.95  
Counts as 2



2912P \$14.95

All books are hardcover unless number is followed by an "P" for paperback.

www.americanradiohistory.com

## Electronics Library

(Continued from page 6)

*The Equipment Directory of Audio-Visual, Computer, and Video Products: 35th Edition costs \$35.00 pre-paid for ICIA members (\$40.00 if billed) and \$40.00 pre-paid for non-members. (For shipment to Canada and Mexico, add \$10.00; Virginia residents add 4.5% sales tax.) It can be ordered from ICIA, 3150 Spring Street, Fairfax, VA 22031-2399; Tel. 703-273-7200.*

**CIRCLE 84 ON FREE INFORMATION CARD**

## PREVIEW EDITION CATALOG

from HMC

Don't be surprised if this catalog stands out from the crowd in terms of design, text, concept, and customer service—it won first place in American Catalog Awards' "New Catalog" category. The fully-illustrated buying guide of tools, test equipment, and supplies for the manufacture, assembly, and



repair of electronics features large photos, concise copy, and easy-to-understand comparison tables. Included are test instruments, tool kits, soldering/desoldering systems, lamps, magnifiers, anti-static products, and precision hand tools.

*The Preview Edition is free upon request from Hub Material Company, 33 Springdale Avenue, Canton, MA 02021; Tel. 617-821-1870.*

**CIRCLE 85 ON FREE INFORMATION CARD**

## INTRODUCTIONARY OPERATIONAL AMPLIFIERS AND LINEAR ICs: Theory and Experimentation

by Robert F. Coughlin and Robert S. Villanucci

The op amp is a versatile and powerful tool for solving many practical problems, with a wide array of general-purpose and specialized devices—and even those designed to be incorporated into more complex linear integrated circuits—readily available. This

book aims to show the simplest, fastest, and most modern techniques for using op amps and linear IC's in practical and useful circuits.

The book is clearly designed as a teaching aid: Each chapter opens with a list of learning objectives and closes with a formal laboratory exercise. The exercises give step-by-step procedures to help bridge the gap between reading about a task and actually doing it. Dozens of circuits are included. All have been tested, and each one demonstrates a principle of operation or a solution for a class of practical problems. Pin numbers and component values are included on every circuit drawing, and all op amps and IC's are clearly identified. The book shows how to use op amps and linear IC's to make active filters, precision timers, square- and triangle-wave generators, and many other devices.

*Introductionary Operational Amplifiers and Linear ICs: Theory and Experimentation is available for \$37.00 from Prentice Hall, Englewood Cliffs, NJ 07632.*

**CIRCLE 99 ON FREE INFORMATION CARD**

## THE WHITE BROCHURE/DISKETTES

from Best Power Technology

Filled with charts, graphs, and explanatory material, this 36-page catalog details Best's uninterruptible-power products and services. It explores power problems including outages, brown-outs, spikes, sags, surges, frequency variation, and noise, and explains how Best's line of ferrups and micro-ferrups units, ranging from 350 VA to 15 KVA, can protect equipment and data from damage. The information is also available on 5 1/4 or 3 1/2-inch diskettes that use character graphics and will run on any IBM PC or compatible computer. Anyone who requests the catalog or diskette will be added to the subscriber list of *Horizons*, a monthly newsletter that deals with uninterruptible-power systems.

*The White Brochure or diskette is available at no charge from Best Power Technology, Inc., P.O. Box 380, Necedah, WI 54646; Tel. 1-800-356-5794.*

**CIRCLE 86 ON FREE INFORMATION CARD**

## ELECTROLUMINESCENT DISPLAYS

from Cherry Electrical Products

This full-color 8-page brochure describes the process behind DC technology as well as specific product information on DC electroluminescent, lightweight, flat-panel, matrix displays. The emissive, thick-film display features low-cost, low power consumption, and fast response time for jitter-free

graphics. It is compatible with standard display signals and several commercially available interface boards and chip-sets. The display has applications in hospital radiology labs, machine-tool controllers, laptop computers, and on brightly lit factory floors.

*Cherry Electroluminescent Displays (Brochure No. CE-3700) is available at no charge from Cherry Electrical Products, 3600 Sunset Avenue, Waukegan, IL 60087; Tel. 708-360-3522.*

**CIRCLE 87 ON FREE INFORMATION CARD**

## PARTS CATALOG

from All Electronics Corp.

The *Winter 1989/90 Catalog* from All Electronics provides 60 pages filled with everything for the electronics hobbyist or professional. The fully illustrated brochure includes wide selections of capacitors, switches, sockets, resistors, relays, connectors, and IC's. Also featured are accessories for phones and televisions, test equipment, optoelectronic devices, PC-board materials, batteries and chargers, and hundreds of other handy items.

*The Winter 1989/90 Catalog is free upon request from All Electronics Corporation, P.O. Box 567, Van Nuys, CA 91408; 1-800-826-5432.*

**CIRCLE 88 ON FREE INFORMATION CARD**

## NEW & RECONDITIONED TEST EQUIPMENT CATALOG

from RAG Electronics

The 16-page *Test & Measurement Instrumentation* catalog from RAG Electronics contains both reconditioned and new equipment from 15 top manufacturers, including Hewlett-Packard, Tektronix, and Fluke. A wide variety of oscilloscopes, spectrum analyzers, digital multimeters, power supplies, signal sources and environmental chambers are featured. All reconditioned equipment is calibrated by RAG's NIST-traceable lab for performance to the manufacturers' original specifications, with a six-month parts and labor warranty. A postage-free response card, included with the catalog, allows the reader to obtain additional product information and automatic entry into a contest to win a Fluke 87 digital multimeter.

*Test & Measurement Instrumentation Catalog 18 is free from RAG Electronics Inc., 21418 Parthenia St., Canoga Park, CA 91304-1597; Tel. 1-800-732-3457 (in CA, 1-800-272-4225).*

**CIRCLE 89 ON FREE INFORMATION CARD**



# How to build a high-paying career, even a business of your own, in computer programming.

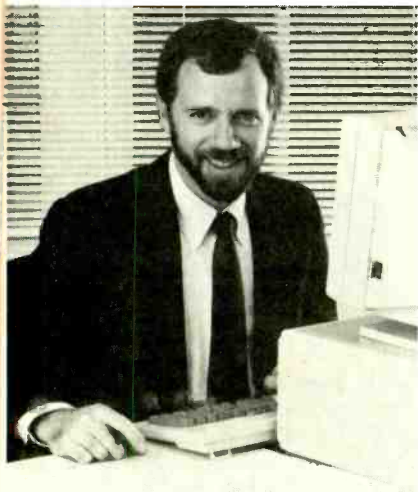

**RICK BRUSH,**  
NRI PROGRAMMER/ANALYST

**Start with training that gives you hands-on programming experience—at home and at your own pace. Training that begins with BASIC, then continues with Pascal, C, and COBOL—today's hottest computer languages. Training that even includes a powerful IBM-compatible computer, modem, and programming software you keep.**

**Start with real-world training. The kind of training only NRI provides.**

Now with NRI's new at-home training in Computer Programming, you can be one of today's highly paid, creative team of computer wizards who give computers the power to carry out an astonishing range of business, professional, and personal applications. Now, with NRI, you can be a computer programmer, ready to build a high-paying career—even a business of your own—making computers do anything you want them to do.

**The only programming course that includes a powerful computer system and software you keep.**

Unlike any other school, NRI gives you hands-on programming experience with a powerful IBM compatible West Coast computer system, including 2400

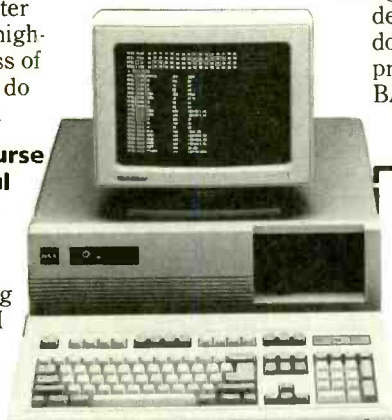

**Only NRI gives you an IBM-compatible computer with modem, 640K RAM, disk drive, monitor, and software—BASIC, Pascal, C, and COBOL—all yours to keep!**

baud internal modem, 640K RAM, disk drive, monitor, and invaluable programming software—BASIC, Pascal, C, and COBOL—all yours to keep.

You get the experience and the know-how, the computer and the software to get to the heart of every programming problem, design imaginative solutions, then use your choice of four key computer languages to build original, working programs.

**No matter what your background, NRI gives you everything you need to succeed in programming, today's top-growth computer career field.**

You need no previous experience to build a successful programming career with NRI training. Indeed, your NRI lessons start by walking you step by step through the fundamentals, giving you an expert understanding of the programming design techniques used every day by successful micro and mainframe programmers. And then the fun really begins.



**You master today's hottest computer languages, gaining the skills you need to build programs for a wide variety of real-world applications.**

With your personal NRI instructor on call and ready to help, you use your computer and software to actually design, code, run, debug, and document programs in BASIC, Pascal,

C, and COBOL. Then, rounding out your training, you use your modem to "talk" to your instructor, meet other NRI students, even download programs through NRI's exclusive programmers network, PRONET.

**Your career in computer programming begins with your FREE catalog from NRI.**

For all the details about NRI's at-home training in Computer Programming, send the coupon today. Soon you'll receive NRI's fascinating, information-packed, full-color catalog.

Open it up and you'll find vivid descriptions of every aspect of your NRI training. You'll see the computer system included in your course up close in a special, poster-sized foldout section. And, best of all, you'll find out how your NRI training will make it easy for you to build that high-paying career—even a business of your own—in computer programming.

**Send for your NRI catalog today. It's yours, free.**

If the coupon is missing, write to us at the NRI School of Computer Programming, McGraw-Hill Continuing Education Center, 4401 Connecticut Avenue, NW, Washington, DC 20008.

IBM is a Registered Trademark of the IBM Corporation

**NRI School of Computer Programming**

McGraw-Hill Continuing Education Center  
4401 Connecticut Avenue, NW  
Washington, DC 20008



**YES! Please rush me my FREE catalog describing NRI's at-home training in Computer Programming.**

NAME (please print) AGE

ADDRESS

CITY/STATE/ZIP 5413-050

Accredited Member National Home Study Council



## New Products

To obtain additional information on new products covered in this section from the manufacturer, please circle the item's code number on the Free Information Card

### INFRARED DETECTOR PEN

The first battery-operated infrared detector pen, dubbed the *B.I.R.D.* by *Parts Express*, should come in quite handy for technicians in the consumer-electronics-repair industry. The small device provides instant confirmation of the operation of infrared-emitting devices—including alarm-system infrared detectors, remote-control units, and VCR tape-stop circuits. An LED in the top



of the device indicates the presence of infrared signals in normal light conditions. The *B.I.R.D.*'s slim, pen-like design makes it easy to reach IR emitters on crowded VCR circuit boards.

The *B.I.R.D.* battery-operated infrared detector pen costs \$55.00. For additional information, contact *Parts Express International, Inc.*, 340 East First Street, Dayton, OH 45402; Tel. 800-338-0531.

**CIRCLE 100 ON FREE INFORMATION CARD**

### DIGITAL STORAGE/ANALOG SCOPE

Even for first-time digital-storage scope users, *B&K's* model 2522 is easy to use. Its simplified instructions demonstrate how to use the digital-storage capability in just minutes.

The portable digital-storage/analog oscilloscope is fast, offering 10-ms/s real-time sampling on each channel, and 20-ms/s repetitive sampling. It permits display of single-shot events to 1-ms/s equivalent time sampling. The model 2522 also provides full 20-MHz dual-trace analog-scope operation at the touch of a button. Features include up to 1-mV-per-division vertical sensitivity and V-mode for viewing

two signals that are unrelated in frequency. In the analog mode, the user can choose from 20 calibrated sweep-time ranges with full variable adjustment between ranges. A  $\times 10$  magnifier allows closer examination of analog waveforms while maintaining display calibration.

In the digital mode, the user can freeze a waveform to closely examine it, which is useful when viewing transients, one-shot events, low repetition-rate signals, and events that occurred before or after the trigger signal. Dual channels make signal comparisons easy. Several  $\times 100$  time/division ranges extend sampling time to as much as 20 seconds per division (200 seconds per screen), allowing slow events to be viewed. Stored waveforms can be expanded for closer examination.

Additional features include front-panel x-y operation, z-axis input (TTL compatible), channel-1 and channel-2 outputs on the



rear panel for driving an analog plotter, and an  $8 \times 10$ -cm CRT. The scope comes with two 10:1 probes, instruction manual, and schematic diagram.

The model 2522 digital-storage/analog oscilloscope has a suggested user price of \$1495.00. For further information, contact *B&K-PRECISION*, Maxtec International Corporation, 6470 West Cortland Street, Chicago, IL 60635.

**CIRCLE 101 ON FREE INFORMATION CARD**

### IN-DASH AM/FM/CD-PLAYER

A full-featured, in-dash AM/FM compact-disc player, *Cooustic's* *CD-3*, has built-in high power, DIN-E chassis with locking handle, and slide-in/out mounting capability. For safety and convenience, the system automatically mutes when incoming cellular-phone calls are detected. The front panel illumination can be dimmed, and the user can switch between amber and green to match other dashboard controls.

The CD player has a 16-bit D/A converter with  $4 \times$  oversampling, and a 3-beam laser to provide the tracking accuracy needed in mobile applications. The CD player has a programmable memory that allows the individual sequencing of as many as 16 selections; CD memory scan lets the listener quickly review those selections at any time,

and shuffle play randomly sequences the selections. Other features include 3- and 5-inch-disc compatibility, anti-skip floating suspension, forward and reverse track advance, intro scan with LCD indication, and forward and reverse search.

The tuner section uses *Cooustic's* exclusive "Optimizer V" flat-pack, one-chip LSI circuitry. Its one-touch auto memory stores up to 18 stations; another 12 of the most powerful stations in the area can also be



programmed and stored. Station memory is backed up by a lithium battery with an expected life of 15 years. The tuner also features mono/stereo selection and local/distance switching, both with LCD indicator; automatic seek, scan, and preset scan; and power-antenna lead.

The amplifier provides 15 watts per channel at 1% THD. A double-function fader control lets the user control front and rear speakers simultaneously or separately. The amp also has gold-plated RCA-type jacks, special active bass and treble controls that incorporate a buffer, and a 36-detent volume control.

The *CD-3* in-dash CD player has a suggested retail price of \$599.95. For additional information, contact *Cooustic*, Concept Enterprises, Inc., 4260 Charter Street, Vernon, CA 90058-2596; Tel. 800-227-8879.

**CIRCLE 102 ON FREE INFORMATION CARD**

### MOBILE PREAMP/EQUALIZER

A car-audio preamplifier/equalizer combination from *Alphasonik*, the model *P-2*, features five adjustable EQ controls—allowing the unit to operate like a parametric equalizer. Each equalization band has switches that allow for 12 different center frequencies, all in  $1/3$  octaves for customized sound. A switching power supply isolates the chassis ground from the audio ground and improves headroom by permitting the use of high voltage power supplies.

The *P-2's* pre-amp section has front/rear fader, balance, and volume controls. The volume control doubles as a power switch for the entire mobile audio system. The front





panel has backlit rotary controls, with backlighting adjustable from amber to green. Tape and CD inputs each have adjustable sensitivity controls. The 1 x 7 x 6-inch, 1/2-DIN P-2 is designed to be rugged and reliable.

The P-2 preamp/equalizer combination has a suggested retail price of \$300.00. For more information, contact Alphasonik, Inc., 701 Heinz Avenue, Berkeley, CA 94710.

CIRCLE 107 ON FREE INFORMATION CARD

### SWEEP FUNCTION GENERATOR

Designed as a tool for bench-top engineers, field technicians, R&D personnel, and hobbyists, Beckman's model FG3A 2-MHz sweep/function generator features versatile performance in a small package. The instrument has seven frequency ranges, covering 0.2 Hz through 2 MHz, and a wide array of signal outputs, including sine wave, triangle wave, and square wave; and both TTL and CMOS compatibility. It can add logarithmic or linear sweep to any of the selected signal outputs, and can perform either AM or FM modulation with internal or external signals.

Because the FG3A has a built-in 5-digit



frequency counter, there is no need to connect an external counter to get an accurate frequency setting. With the voltage-controlled frequency jack at the front of the unit, the user can vary frequency as a function of the input he chooses, with a 0-10-volt input causing a 1000:1 change in frequency. A switchable 20-dB output attenuator comes in handy where low signal levels are needed. The frequency counter can also be used as a stand-alone unit.

The sweep/function generator can be used for response testing of audio components including speakers, crossovers, amplifiers, and microphones; vibration testing; exercising servo systems; AM-radio alignment; ultrasonics testing; and a variety of applications calling for CMOS and/or TTL pulses. Other applications are as a signal

source for troubleshooting and repair and for debugging prototypes.

The FG3A sweep/function generator has a suggested list price of \$475.00. For further information, contact Beckman Industrial Corporation, Instrumentation Products Division, 3883 Ruffin Road, San Diego, CA 92123-1898.

CIRCLE 111 ON FREE INFORMATION CARD

### OMNIDIRECTIONAL ANTENNA

Designed particularly for attic installations in areas where zoning won't permit rooftop antenna installations, Windgard's MetroStar MS-3000 is also weather resistant and attractive enough to be mounted outside where permitted. The omnidirectional antenna provides clear reception in metropolitan and suburban areas, in houses, condos, townhouses, mobile homes, or apartments. Measuring just 21 inches in diameter, the MetroStar is quick and easy to install, even in crowded attics. It receives good VHF/UHF/FM signals without a rotator, and has an integrated low-noise amplifier that strengthens weak signals to maximize reception. The package includes the antenna with amplifier and power supply, some co-



EMINENCE



MOTOROLA

Polydax

1-800-338-0531

PIONEER

### 3-WAY 100W CROSSOVER

12 dB/octave rolloff. 800Hz, 5000Hz crossover points. 8 ohm. 100 watts RMS.



#260-210 \$12.50 (1-9) \$9.95 (10-up)

### SPEAKER CONTROL PANEL

Panel with 50 watt L-pads for tweeter and midrange and built-in LED power meter. 5 x 2 1/2" 100 watt version available



#260-235 \$14.50 (1-5) \$12.90 (6-up)

### 12" POLY WOOFER

Super duty, 40 oz. magnet. 100 watts RMS, 145 watts max. 4 and 8 ohm compatible (6 ohm). 2" voice coil. fs = 25 Hz. QTS = .166, VAS = 10.8 cu ft. Response: 25-1500 Hz. Net weight: 9 lbs. Pioneer #A30GU40-51D



#290-125 \$36.80 (1-3) \$34.50 (4-up)

### WALNUT SPEAKER CABINET KIT

Super quality, genuine walnut veneer cabinet. Kit includes: routed and mitred top, sides, and bottom in unfinished 3/4" walnut veneer. Cut your own custom holes in the front and rear to match your drivers. 15" x 24" x 11". Volume: 1.9 cubic feet.



#260-350 \$22.50 (1-3) \$19.95 (4-up)

### PIONEER HORN TWEETER

Mylar dome. 2.93 oz. barium ferrite magnet. 8 ohm. Response: 1800-20000 Hz. 35W RMS. 50W max. fs = 2000 Hz, SPL = 106 dB. Pioneer #AHE60-51F



#270-050 \$6.50 (1-9) \$5.90 (10-up)

### 12" SUB WOOFER

Dual voice coil sub woofer. 30 oz. magnet, 2" voice coils. 100 watts RMS, 145 watts max. fs = 25 Hz. 6 ohm (4 and 8 ohm compatible). SPL = 89 dB 1W/1M. Response: 25-700 Hz. QTS = .31, VAS = 10.3 cu. ft. Pioneer #A30GU30-55D. Net weight: 6 lbs.



#290-145 \$39.80 (1-3) \$36.80 (4-up)

### 15" THRUSTER WOOFER

Thruster by Eminence. Made in USA. Poly foam surround, 56 oz. magnet. 2-1/2", 2 layer voice coil. 150 watts RMS, 210 watts max. 4 ohm. fs = 23.5 Hz, QTS = .33, VAS = 17.9 cu ft. SPL = 94.8 dB 1W/1M. Net weight: 15 lbs.



#290-180 \$43.50 (1-3) \$39.80 (4-up)

### GRILL FRAME KIT

With this kit you can make speaker grill frames up to 30" x 40". Kit includes 4 corner pieces, 2 T brackets, and 7 frame bars. Grill mounting kit included.



#260-333 \$8.50 (1-9) \$7.80 (10-up)

### 18" EMINENCE WOOFER

MADE IN USA  
100 oz. magnet, 3" voice coil. 250 watts RMS, 350 watts max. 8 ohm. 30 Hz resonant frequency. 22-2700 Hz response. Efficiency: 95 dB 1W/1M. Paper cone, treated accordion surround. Net weight: 29 lbs.



#290-200 \$98.90 (1-3) \$89.50 (4-up)

### TITANIUM COMPOSITE TWEETER

Titanium is deposited on a polymer dome to combine the advantages of both hard and soft dome technologies. 8 ohm. Ferro fluid cooled voice coil. fs = 1200 Hz. SPL = 90 dB 1W/1M. 50 watts RMS, 70 watts max. 4" round. Polydax part #DTW100T125.



#270-047 \$27.50 (1-9) \$24.80 (10-up)

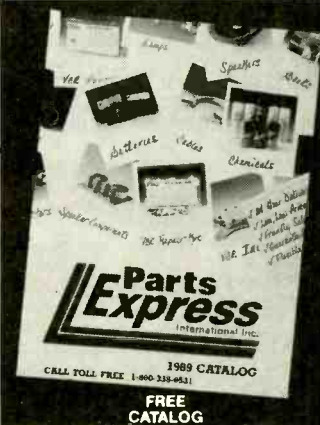

340 E. First St., Dayton, Ohio 45402  
Local: 1-513-222-0173  
FAX: 513-222-4644

\* 15 day money back guarantee \* \$15.00 minimum order \* We accept Mastercard, Visa, Discover, and C.O.D. orders \* 24 hour shipping \* Shipping charge = UPS chart rate + \$1.00 (\$3.00 minimum charge) \* Hours: 8:30 am - 6:00 pm EST, Monday - Friday \* Mail order customers. Please call for shipping estimate on orders exceeding 5 lbs.

CIRCLE 6 ON FREE INFORMATION CARD

www.americanradiohistory.com

## NEW FROM ETT



□ **TELE—THE INVENTION OF TELEVISION** ..... \$9.95. How television came to be. Packed with history. 36-pages of photos and illustrations of early equipment. A collector's delight.

□ **PCP105—MAKE MONEY FROM HOME RECORDING** ..... \$10.00. Now that you've spent a fortune on all that recording gear, MIDI and all, wouldn't you like to get some of it back? This book shows you how.



□ **PCP106—SYNTHESIZERS FOR MUSICIANS** ..... \$10.00. All current popular forms of synthesis explained. LA, additive, phase distortion, FM and sampling. Get the sounds you want.

□ **BP182—MIDI PROJECTS** ..... \$6.95. How to interface popular home computers with MIDI systems. Also covers interfacing MIDI gear to analog and percussion synthesizers.

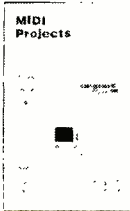

□ **BP255—INTERNATIONAL RADIO STATIONS GUIDE** ..... \$8.95. Essential reference work for the casual listener, amateur radio DXer and the professional radio monitor.

□ **BP85—INTERNATIONAL TRANSISTOR EQUIVALENTS GUIDE** ..... \$7.50. Find possible substitutions for a popular user-oriented selection of modern transistors made by more than 100 manufacturers.



MAIL TO: **Electronic Technology Today, Inc.**  
P.O. Box 240  
Massapequa Park, NY 11762-0240

### SHIPPING CHARGES IN USA AND CANADA

\$0.01 to \$5.00	... \$1.25	\$30.01 to \$40.00	\$5.00
\$5.01 to 10.00	... \$2.00	\$40.01 to \$50.00	\$6.00
\$10.01 to \$20.00	\$3.00	\$50.01 and above	\$7.50
\$20.01 to \$30.00	\$4.00		

**SORRY, No orders accepted outside of USA and Canada**

Total price of merchandise	..... \$	_____
Shipping (see chart)	..... \$	_____
Subtotal	..... \$	_____
Sales Tax (NYS only)	..... \$	_____
Total Enclosed	..... \$	_____

Name \_\_\_\_\_  
Address \_\_\_\_\_  
City \_\_\_\_\_ State \_\_\_\_\_ Zip \_\_\_\_\_

## New Products

axial cable with connectors, a VHF/UHF-band separator with cable, and a mounting bracket with hardware.

The MetroStar MS-3000 omnidirectional-antenna package has a suggested retail



price of \$144.95. For additional information, contact Winegard Company, P.O. Box 1007, Burlington, IA 52601-1007.

**CIRCLE 103 ON FREE INFORMATION CARD**

## MINI WIRE STRIPPER

Paladin's PA 1115 Mini-Stripax strips and cuts 30- to 16-gauge solid and stranded wires in a single motion. The miniature wire stripper completely removes the insulation from multiple conductors without touching or nicking the internal wires. The tool's compact size makes it easy to maneuver in spaces too tight for standard-sized wire strip-



pers, and its lightweight trigger-like design requires minimal force for precision cutting and stripping.

A built-in wire cutter, stainless-steel blades rated for up to 20,000 strips, front feed for close-in work, and fiberglass-reinforced nylon construction are standard on the Mini-Stripax. The tool is insulated to 600 volts to protect users from accidental contact with live wires.

The PA 1115 Mini-Stripax wire stripper has a list price of \$59.95. For additional information, contact Paladin Corporation, 3543 Old Conejo Road, Suite 102, Newbury Park, CA 91320.

**CIRCLE 105 ON FREE INFORMATION CARD**

## WIDE-DOCUMENT FAX MACHINE

To solve the problems inherent in receiving oversized documents via facsimile machines, Ricoh has come up with the FAX105, which permits full 11-inch-wide printouts and automatically selects the proper size paper from its two paper-roll compartments. Ideal for receiving computer printouts and engineering drawings, its 11-inch-wide output eliminates the need to reduce incoming documents to fit on 10.1- or 8.5-inch-wide paper.

The FAX105 is designed to serve as the hub unit in fax networks or for use in other high-volume applications. The table-top unit



offers high-performance features including a 133-station autodialer, a 30-page automatic document feeder, 64 shades of gray, an error-correction mode, and seven-page (128-kilobyte) memory. Optional memory upgrades to one or two megabytes provide broadcasting, confidential reception, and programmed forwarding to another location; a 20-megabyte upgrade will be available in the future. The FAX105 has a built-in, full-featured phone.

The FAX105 dual paper-roll facsimile has a suggested retail price of \$3,695.00. For more information, contact Ricoh Corporation, Office Products Business, 5 Dedrick Place, West Caldwell, NJ 07006; Tel. 1-800-63-RICOH.

**CIRCLE 104 ON FREE INFORMATION CARD**

## VOICE ADD-ON

For use in multi-media presentations, education, entertainment, language training, voice mail—or just for fun—the Voice Master II from Covox can record and play back speech and other sounds through the parallel printer port found on virtually all IBM PC, PS/2, and compatible computers, including portables and laptops. A powerful graphics editor allows speech to be manipulated in many ways, and long speech files are possible. Speech can be introduced into applications programs written in a variety of languages, including C, compiled Basic, and GWBasic. Sound files made with the Voice Master II will play back through the Covox Speech Thing.



Word-recognition software is included with the Voice Master II. The software can be combined with popular applications programs in business and for game-playing. Individual words can be made to act like a sequence of hundreds of keyboard strokes. Special utility programs, which are included, support third-party software such as IBM's talking educational titles.

The Voice Master II is housed in a vinyl-clad steel case that has speaker, volume, and tone controls; connectors and panel



switches provide versatility. The unit includes a connecting cable, AC adapter, headset microphone, manual, and extensive software on both 5 1/4 and 3 1/2-inch disks. Its use does not affect normal printer operation; the printer is simply hooked up to a second connector on the unit, using a standard printer cable.

The Voice Master II has a list price of \$219.95. For additional information, contact Covox, Inc., 675 Conger Street, Eugene, OR 97402; Tel. 502-342-1271.

CIRCLE 108 ON FREE INFORMATION CARD

### BOOKSHELF-SPEAKER SYSTEM

Offering stereo imaging from anywhere in the listening room, the three-piece ADC Soundshaper 3025 is acoustically designed to provide big-speaker sound from a bookshelf-sized system. The system's crossfire-imaging driver configuration is engineered to provide smooth, balanced sound over a wide listening area. The Soundshaper 3025 offers 150-watts peak-power handling, a 45-Hz frequency response to over 20-kHz  $\pm 3$  dB, 6-ohms nominal impedance. The speakers' frequency response is 85 Hz - 20 kHz  $\pm 3$  dB. The woofer module features an 8-inch high-flux subwoofer and a frequency range of 165 Hz down to 45 Hz. The cross-



over frequencies are 100 Hz, 150 Hz, and 5 kHz. The subwoofer's first-order cross-over directs all signals at the maximum frequency of 100 Hz and above to the speakers, which become the source of midrange and high frequencies.

The compact, omnidirectional subwoofer module and a pair of 2-way imaging satellite speakers can be purchased separately or as a complete system. All three components are designed to be unobtrusive—the charcoal-black subwoofer can be placed out of sight and the diminutive speakers,

available in black or white, can be wall-mounted or placed on a shelf.

The ADC Soundshaper 3025 three-piece system (in black) has a suggested retail price of \$499.95. The satellite speaker pair (model 3010 in black or model 3016 in white) and the subwoofer module (model 3015, in black only) have suggested retail prices of \$269.95 and \$229.95, respectively. For additional information, contact ADC, 707 East Evelyn Avenue, Sunnyvale, CA 94086.

CIRCLE 114 ON FREE INFORMATION CARD  
(Continued on page 16)

## HITACHI SCOPES AT DISCOUNT PRICES

### Digital Storage Scopes

VC-6025 20MS/S  
50MHz BW with  
2K Word Memory  
Capacity  
**\$2349.00**

Advanced storage functions create new dimensions in scopes such as one shot observation, flicker free display, bright display for even high speed event, trace observation for low speed event, hard copy by plotter and data output to computer.

VC-6045 100MHz 40MS/S 4K Word Memory cap. (Call)

All Hitachi scopes include probes, schematics, and Hitachi's 3 year worldwide warranty on parts and labor. Many accessories available for all scopes.

V-212  
**\$435**  
List \$595  
Save \$160  
DC to 20MHz  
Dual Channel

V-1060  
**\$1,359**  
List \$1595

Model	Frequency	Features	List Price	Price	Save
V-422	40MHz	D.T., 1mV sens, DC Offset, Vert Mode Trigger, All Mag	\$940	\$740	\$200
V-423	40MHz	D.T., 1mV sens, Delayed Sweep, DC Offset, All Mag	\$1,025	\$825	\$200
V-425	40MHz	D.T., 1mV sens, DC Offset, CRT Readout, Cursor Meas	\$1,070	\$849	\$221
V-560	60MHz	D.T., 2mV sens, Delayed Sweep, CRT Readout	\$1,295	\$1,145	\$150
V-1085	100MHz	D.T., 2mV sens, Delayed Sweep, CRT Readout, Cursor Meas	\$1,895	\$1,670	\$225
V-1100A	100MHz	Q.T., 1mV sens, Delayed Sweep, CRT Readout, DVM, Counter	\$2,450	\$2,095	\$355
V-1150	150MHz	Q.T., 1mV sens, Delayed Sweep, Cursor Meas, DVM, Counter	\$3,100	\$2,875	\$425

## ELENCO PRODUCTS AT DISCOUNT PRICES

### 20MHz Dual Trace Oscilloscope

**\$375**  
MO-1251  
• 8" CRT  
• Built-in component tester  
• TV Sync

Top quality scopes at a very reasonable price. Contains all desired features. Two 1x, 10x probes, diagrams and manual. Two year guarantee.

### FREE DMM

with purchase of ANY SCOPE

SCOPE PROBES  
P-1 65MHz, 1x, 10x \$19.95  
P-2 100MHz, 1x, 10x \$23.95

### 35MHz Dual Trace Oscilloscope

**\$495**  
MO-1252  
• High luminance 6" CRT  
• 1mV Sensitivity  
• 6KV Acceleration Voltage  
• 10ns Rise Time  
• X-Y Operation • Z Axis  
• Delayed Triggering Sweep

### PRICE BREAKTHRU

on Auto Ranging DMMs

3 to choose from:  
MDM-1180 **\$24.95**  
MDM-1181 **\$27.95**  
MDM-1182 **\$29.95**

• 3 1/2 LCD Display  
• 27 Functions  
• Auto Manual Ranges  
• Audible Continuity  
• Data Hold (MDM-1182)  
• 1% Accuracy (MDM-1181)

### True RMS 4 1/2 Digit Multimeter

**\$135**  
M-7000  
• 0.5% DC Accuracy  
• 1% Resistance with Freq, Counter and deluxe case

Bench DMMs  
M-3500 **\$125** 3 1/2 digit  
M-4500 **\$175** 4 1/2 digit  
0.5% ac/cy

### Multimeter with Capacitance and Transistor Tester

**\$55** CM-1500  
Reads Volts, Ohms, Current, Capacitors, Transistors and Diodes with case

AC Current Meter ST-1010  
**\$69.95**  
1000 Amps Data/Peak Hold 8 Functions Deluxe Case

### Digital Capacitance Meter

**\$58.95** CM-1550  
9 Ranges  
1pf-20,000ufd  
5% basic acc  
Zero control with case

Solderless Breadboards  
9430 1,100 pins **\$15**  
9434 2,170 pins **\$25**  
9436 2,860 pins **\$35**  
All have color coded posts  
9436 SHOWN

### Digital LCR Meter

**\$125** LC-1801  
Measures Coils 1uH-200H  
Caps. 1pf-200uf  
Res. 0.1-20M

AC Clamp-On Current Adapter ST-265 **\$25.00**  
0-1000A AC Works with most DMM

### Soldering Station

Temperature Controlled SL-30 **\$99**  
Digital display Temp range 300F-900F Grounded tip Overheat protect

### Color Convergence Generator

SG-200 **\$69.95**  
Finest in the industry 10 rock steady patterns

### 10MHz Oscilloscope

S-3000 **\$275**  
10MHz DC or AC Triggered Sweep Calibrated Vert & Hor Reads Volt & Freq

### Temperature Probe

M-110CF **\$29.95**  
Semiconductor type Range 58F-322F Fits most digital multimeters

### Autorangeing DMM

M-5000 **\$45**  
9 Functions Memory and Data hold 1/2 % basic acc 3 1/2 digit LCD

### Wide Band Signal Generators

SG-9000 **\$129**  
RF Freq 100K-450MHz AM Modulation of 1KHz Variable RF output  
SG-9500 with Digital Display and 150MHz built-in Freq Ctr **\$249**

### TRIPLE POWER SUPPLY XP-620

Assembled **\$65**  
Kit **\$45**  
2 to 15V at 1A  
2 to 15V at 1A  
5V at 3A  
5V at 3A

### Function Generator

Blox **\$96.00**  
Provides sine, tri, sq wave from 1Hz to 1MHz AM or FM capability  
\$28.95

### Decade Blox

**\$96.10** or **\$96.20**  
\$18.95  
#9610 Resistor Blox 47 ohm to 1M & 100K pot  
#9620 Capacitor Blox 47pf to 10MFD

### Digital Triple Power Supply

XP-765 **\$249**  
0-20V at 1A  
0-20V at 1A  
5V at 5A  
Fully Regulated, Short circuit protected with 2 Limit Cont., 3 Separate supplies  
XP-660 with Analog Meters **\$175**

### Quad Power Supply

XP-580 **\$59.95**  
2-20V at 2A  
12V at 1A  
5V at 3A  
-5V at 5A  
Fully regulated and short circuit protected  
XP-575 without meters **\$39.95**

### LEARN TO BUILD AND PROGRAM COMPUTERS WITH THIS KIT!

INCLUDES: All Parts, Assembly and Lesson Manual  
MODEL MM-8000 **\$129.00**

### Four-Function Frequency Counters

F-100 120MHz **\$179**  
F-1000 1.2GHz **\$259**  
Frequency, Period, Totalize, Self Check with High Stabilized Crystal Oven Oscillator, 8 digit LED display

### GF-8016 Function Generator with Freq. Counter

**\$249**  
Sine, Square, Triangle Pulse, Ramp, 2 to 2MHz Freq Counter, 1 - 10MHz  
GF-8015 without Freq. Meter **\$179**

WE WILL NOT BE UNDERSOLD!  
UPS Shipping: 48 States 5%  
(\$10 Max) IL Res., 7% Tax

**C & S SALES INC.**  
1245 Rosewood, Deerfield, IL 60015  
(800) 292-7711 (708) 541-0710

15 Day Money Back Guarantee  
2 Year Warranty  
WRITE FOR FREE CATALOG

CIRCLE 9 ON FREE INFORMATION CARD

## New Products

(Continued from page 15)

### ELECTROMAGNETIC RADIATION MONITOR

For measuring the potentially hazardous, low-level electromagnetic radiation that is generated by power lines, TV's, VDT's, appliances, and other equipment, *Walker Scientific* has introduced the *ELF-50* field monitor. The hand-held instrument makes it easy to measure the extra-low-frequency (ELF) electromagnetic radiation generated from any 60-Hz AC device. When the unit is switched on and placed in a suspect area,



its 10-segment LED will illuminate to indicate the level of radiation present.

The *ELF-50* features two switch-selectable measurement ranges: The low range covers from 1 – 512 milliGauss and the high covers up to 512 Gauss. It is powered by two 1.5-volt AAA batteries and has a built-in low-battery indicator light.

The *ELF-50* electromagnetic radiation monitor has a list price of \$179.95. For further information, contact Walker Scientific, Inc., Rockdale Street, Worcester, MA 01606.

**CIRCLE 115 ON FREE INFORMATION CARD**

### TELEPHONE DIALER

Part of *Texas Instruments'* "Pocket Solutions" line of products, the *TI-3200 Pro Dialer*, features five functions in addition to telephone dialing. The pocket-sized unit serves as a memo file, telephone directory, appointment schedule, clock/alarm, and calculator. Nine individual memo files allow the user to type in short notes and retrieve them at will. As a phone directory, the unit can accommodate 400 entries averaging 24 characters each, which can be read on the 12-character display by scrolling left and right. Sensitive entries can be coded with a password. Information concerning appointments can be stored by date

in chronological order; the alarm feature can be set as a reminder. The *Pro Dialer's* calculator has a ten-digit display and performs basic mathematical functions.

With 8 kilobytes of memory, the *TI-3200* can store, retrieve, and dial as many as 400 numbers. Designed for use with Touch-



Tone phones or phones on Touch-Tone lines, the unit provides one-handed dialing. A "joined" dialing function that links several numbers is particularly handy when placing long-distance calls with credit-card access numbers.

The *TI-3200 Pro Dialer* has a suggested retail price of \$85.00, and will be available this summer. For additional information, contact Texas Instruments, Consumer Relations, P.O. Box 53, Lubbock, TX 79408; Tel. 806-747-1882.

**CIRCLE 116 ON FREE INFORMATION CARD**

### FIBER-OPTIC KITS

Available in either simplex or duplex versions for single- or bi-directional data communications, Sintec's fiber-optic kits require no previous experience or training. They include all the components needed to build a ten-meter data link that can be extended to 60 meters with extension kits. The data link operates off a single +5-volt power supply, and interfaces to all TTL/CMOS logic.

The basic *Simplex* and *Duplex* kits contain fiber-optic emitter(s) and detector(s), all the necessary electronic components,

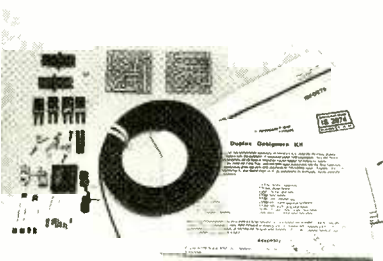

and 10 meters of simplex or duplex cable. The fiber-optic connections for interfacing to the emitter and the detector, two bulkheads, and a fiber-optic splice are also included. All the fiber-optic connections have a dry, non-polish interface that requires no special tools. Completing the kit, which is packaged in an impact-resistant plastic box, are assembly and fiber-termination instructions.

The *Simplex*, and 25-meter and 50-meter *Duplex*, fiber-optic kits cost \$59.95, \$44.95, and \$89.95, respectively. For additional information, contact Sintec Company, 28 8th Street, P.O. Box 410, Frenchtown, NJ 08825.

**CIRCLE 117 ON FREE INFORMATION CARD**

### PORTABLE SOUND SYSTEM

A compact sound-system-to-go, *Samsung's PCD-800* includes a detachable, full-feature, stereo radio/cassette player and a compact-disc player. The portable unit also has a dynamic, two-way, 4-speaker system and a 3-band graphic equalizer. The double cassette deck allows high-speed dubbing, tape selection (Nor/CrO<sub>2</sub>/metal), and synchro-record, and has a continuous-play mechanism. The CD player has 3-beam



laser pickup, 16-track random memory access, and plays either 3- or 5-inch discs. Dolby B noise reduction, "Super Bass" sound, and a stereo-headphone jack round out the system.

The *PCD-800* portable sound system has a suggested retail price of \$389.95. For additional information, contact Samsung Electronics America, Inc., 301 Mayhill Street, Saddle Brook, NJ 07662; Tel. 201-587-9600.

**CIRCLE 118 ON FREE INFORMATION CARD**

### TEMPERATURE-CONTROLLED SOLDERING IRON

A totally self-contained, temperature-controlled soldering iron, *M.M Newman's Antex TCS*, is designed for use in electronic assembly or field-service operations that require 110-VAC or 24-volt operation. An adjustment screw on the handle is used to regulate temperatures from 392° to 842°.



The soldering iron has zero-voltage switching and comes in two models—one for 110 VAC and the other for use with all 24-volt power sources. The Antex TCS heats up to 665° in just 60 seconds, and provides rapid recovery times. Its plastic handle is

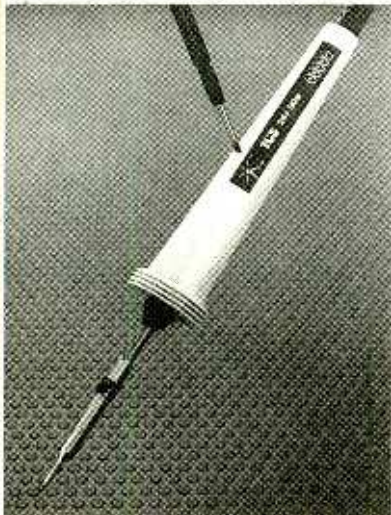

molded to fit comfortably in the hand. For optimum thermal efficiency, the heating element is located under the tip. Various slide-on tips are offered.

The Antex TCS temperature-controlled soldering iron has a list price of \$84.95. For more information, contact M.M. Newman Corporation, 24 Tioga Way, P.O. Box 615, Marblehead, MA 01945; Tel. 617-631-7100.

**CIRCLE 112 ON FREE INFORMATION CARD**

#### AUDIO/VIDEO PROCESSOR

At 5 MHz, the top-of-the-line *Vivanco 4044* audio/video processor delivers 400-line VHS picture definition when used with top-quality VCRs—a significant improvement over the usual 3-MHz units with 250-line definition. The 4044 can be used to enhance color and sharpness, correct white-light balance, add fades and wipes, create special effects, and add or change colors.

Audiophiles will appreciate the unit's sound capabilities. The 4044 delivers a very linear 20-Hz to 20-kHz frequency range



# M O R E T H A N LOGIC

## 286 SupersPort Laptop by Heathkit®



Your logical source for quality computer and electronic product needs, the **FREE Heathkit Catalog** is your key to a fun and exciting hobby. The Heathkit Catalog contains powerful kit laptop and desktop computers, test instruments, weather equipment, and home theater components, plus self-study electronics courses. Order your **FREE Heathkit Catalog** today! It's the logical thing to do!

**1-800-44-HEATH**  
(1-800-444-3284)

Send to: Heath Company, Dept. 107-894  
Benton Harbor, Michigan 49022

Name \_\_\_\_\_

Address \_\_\_\_\_

City \_\_\_\_\_

State \_\_\_\_\_

Zip \_\_\_\_\_

**CIRCLE 18 ON FREE INFORMATION CARD**

and 70-dB signal-to-noise ratio. Three independent audio channels are available to control an original sound track, narration (using the microphone hookup), and music. A master audio control permits fades of all three together.

The audio/video processor comes with a VHS-format instructional videotape, as well as an operator's manual and video-control planning charts. The unit features sleek European styling, with easy-to-use knobs, levers, and switches on logically arranged control panels.

The *Vivanco 4044* audio/video processor (pictured at the front of the photograph) has a suggested list price of \$1,335.00. For additional information, contact the U.S. distributor: *GMI Photographic, Inc.*, 1776 New Highway, P.O. Drawer U, Farmingdale, NY 11735; Tel. 516-752-0053.

**CIRCLE 109 ON FREE INFORMATION CARD**

#### CAR-STEREO SUBWOOFERS

A new subwoofer from *Phase Linear*, the *PLS1200*, is designed to handle enormous power, produce deep sub-bass sound, and be extremely efficient. The 12-inch graphite subwoofer has a peak power-handling capacity of 500 watts with 165-watt continuous power handling. Its usable frequency



response is 20 Hz – 2.5 kHz, its efficiency is 93 dB (1 watt, 1 meter), and its impedance is 4 ohms. The *PLS1200* can accommodate crossover settings up to 200 Hz. The subwoofer features a hefty 40-ounce magnet with a bottom-load mounting depth of 148 mm and a top-load mounting depth of 135 mm.

When used in conjunction with other *Phase Linear* car-audio components—including their "Separates Kit," high-powered amplifiers, and car-speaker systems—the subwoofer's power, performance, and versatility is further enhanced.

The *PLS1200* car-stereo subwoofer has a suggested retail price of \$145.00. For further information, contact *Phase Linear*, 4134 North United Parkway, Schiller Park, IL 60176. ■

**CIRCLE 110 ON FREE INFORMATION CARD**

# Join the Electronics and Control Engineers' Book Club®

**TROUBLESHOOTING ELECTRONIC EQUIPMENT WITHOUT SERVICE DATA, Second Edition.** By R.G. Middleton. 320 pp., illus. This indispensable new edition features all the information that made the first edition so successful, plus the latest developments in digital testing, phase checks, IC troubleshooting, and repair of VCRs, stereos, TVs, tape recorders, and much, much more.  
585092-3 Pub. Pr., \$30.00 Club Pr., \$22.50

**PRINTED CIRCUITS HANDBOOK, Third Edition.** By C.F. Coombs, Jr. 960 pp., 556 illus. Here in one handy volume is all the information you need to design, manufacture, test, and repair printed wiring boards and assemblies. This new edition features ten all-new chapters, including three on SMT.  
126/097 Pub. Pr., \$64.95 Club Pr., \$45.50

**SOUND SYSTEM ENGINEERING, Second Edition.** By D. Davis and C. Davis. 665 pp., illus. The definitive source for all professionals responsible for audio system design, covering everything from concert halls to virtually every oscillator in use today. Packed with proven strategies for solving design and engineering problems and cutting your clients' costs.  
584657-8 Pub. Pr., \$39.95 Club Pr., \$31.50

**MCGRAW-HILL ENCYCLOPEDIA OF ELECTRONICS AND COMPUTERS, Second Edition.** S. Parker, Editor-in-Chief. 1,047 pp., 1,250 illus. Featuring 160 new and revised articles, this new edition treats the entire spectrum of applications, devices, systems, and theory in areas ranging from the flow of electricity to hardware, software, robotics, and IC fabrication.  
454/99X Pub. Pr., \$79.50 Club Pr., \$54.95

**COMMUNICATIONS RECEIVERS: Principles and Design.** By Ulrich L. Rohde and T.T.N. Bucher. 608 pp., 402 illus. Everything you need to know if you design or work with communications receivers, from theory to practical design approaches. Coverage includes all types of receivers: shortwave, broadcast, radar, military, marine, aeronautical, and more.  
535/701 Pub. Pr., \$64.95 Club Pr., \$44.50

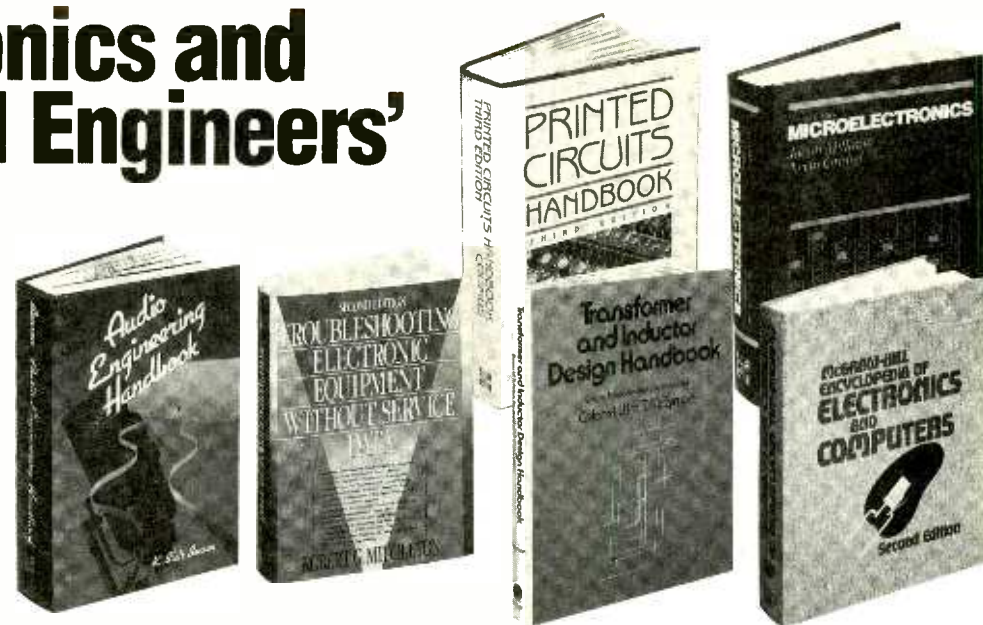

- your one source for engineering books from over 100 different publishers
- the latest and best information in your field
- discounts of up to 40% off publishers' list prices

New Members!  
Take any one of these great professional books for only **\$289** as a premium with your first selection!

Spectacular values up to **\$199.50**

**ENGINEERING FUNDAMENTALS FOR THE PROFESSIONAL ENGINEERS' EXAM, Third Ed.** By L. M. Polentz. 432 pp., 170 illus. Features worked-out solutions and full explanations for all sample problems so you can learn how to solve them. It's a dependable way to prepare for the exam or a perfect on-the-job reference.  
503/931 Pub. Pr., \$39.50 Club Pr., \$27.95

**AUTOMATIC CONTROL SYSTEMS, Fifth Ed.** By B. C. Kuo. 736 pp., illus. Provides an overview of automatic control systems, including in-depth coverage of classical control techniques, optimal control theory, and analog and digital control system design. This up-dated edition discusses the latest ideas on the use of computers to design control systems and as components of such systems.  
583706-4 Pub. Pr., \$57.40 Club Pr., \$43.50

**CIARCIA'S CIRCUIT CELLAR, Volume VII.** By S. Ciarcia. 256 pp., 100 illus., softcover. More do-it-yourself circuits from the master—Steve Ciarcia. Step-by-step guidance on projects ranging from a gray-scale video digitizer and the Circuit Cellar AT Computer to parallel interfacing and the Neighborhood Strategic Defense Initiative.  
109/699 Pub. Pr., \$19.95 Club Pr., \$15.95

**THE COMPACT DISC: A Handbook of Theory and Use.** By K. C. Pohlmann. 288 pp., illus. softcover. The most readable and comprehensive guide to CD technology offers clear descriptions of disc design and manufacturing . . . player circuitry . . . and comparisons of different types of players—all without complicated theoretical or mathematical discussions.  
585096-6 Pub. Pr., \$29.95 Club Pr. \$22.50

**MOBILE CELLULAR TELECOMMUNICATIONS SYSTEMS.** By W.C.Y. Lee. 442 pp., 215 illus. A to Z coverage of state-of-the-art cellular systems, from design to implementation and troubleshooting. Clearly explains spectrum efficiency, propagation models and prediction, interference treatment, and more.  
370/303 Pub. Pr., \$62.95 Club Pr., \$44.50

**TRANSFORMER AND INDUCTOR DESIGN HANDBOOK, Second Edition.** By Col. W.T. McLyman. 440 pp., illus. All the information you need to design today's lighter, smaller transformers and inductors, without relying on out-moded approximation methods. In ready-reference tabular format, this new edition covers the latest equations in transformer and gapped design applications.  
584646-2 Pub. Pr., \$55.00 Club Pr., \$38.50

**MICROCOMPUTER TROUBLESHOOTING AND REPAIR.** By J. G. Stephenson and B. Cahill. 354 pp., illus., softcover. This nuts-and-bolts guide provides expert tips, troubleshooting tools and shortcuts, and practical help on deciding if you really do have to bring it in to the shop. It also explains techniques for anticipating and defending against most common computer problems.  
585106-7 Pub. Pr., \$24.95 Club Pr., \$18.95

**MICROELECTRONICS, Second Ed.** By J. Millman and A. Grabel. 1,001 pp., 646 illus. Takes you from the basics of semiconductor properties to an understanding of the operation of solid-state devices, and then to more advanced topics. Its up-to-date coverage, real-life examples, and practical data make this an ideal reference for the working engineer.  
423/30X Pub. Pr., \$56.95 Club Pr., \$41.50

**ENGINEERING MATHEMATICS HANDBOOK, Third Ed.** By J. J. Tuma. 512 pp., illus. This best-selling handbook gives you the essential mathematical tools—formulas, definitions, theorems, tables, and models for computer programming—that you need for your day-to-day engineering calculations.  
654/433 Pub. Pr., \$52.50 Club Pr., \$34.50

PORTABLE ELECTRONICS DATA BOOK

360 pp., 6 x 9, illus., softcover 585390-6

A-to-Z coverage of all the essential facts, figures, and formulas you need, in a format that's easy to use and easy to carry. John Douglas-Jong has filled this handy on-the-job companion with equations, algorithms, calculus formulas, and BASIC programs in areas ranging from alternating current and amplifiers to transducers and waveguides . . . and they're all yours ABSOLUTELY FREE!

A \$19.95 Value — Yours ABSOLUTELY FREE when you join!



**BASIC TELEVISION AND VIDEO SYSTEMS, Fifth Ed.** By B. Grob. 592 pp., illus. Provides the clearest picture of how television and video systems work, and what to do when they don't. Covers television receivers, VCR's, video cameras, and cable systems — all in readable, practical detail.

249/334 Pub. Pr., \$39.95 Club Pr., \$24.95

**BUILD YOUR OWN UNIVERSAL COMPUTER INTERFACE.** By B. Chubb. 309 pp., illus., softcover. Guiding you from theory to step-by-step assembly instructions, this lively manual shows you how to construct a computer interface and hook it up to virtually any IBM or IBM compatible personal computer, including the XT, XT-286, AT, and System/2 Model 30.

585080-X Pub. Pr., \$19.95 Club Pr., \$15.95

**HANDBOOK OF ELECTRICAL NOISE MEASUREMENT AND TECHNOLOGY, Second Ed.** By C. A. Vergers. 440 pp. 213 illus. Provides answers to all your questions about noise origins, causes, effects. Also shows you how to predict and measure noise, and how to design low-noise circuits.

583947-4 Pub. Pr., \$39.95 Club Pr., \$29.95

**SWITCHGEAR AND CONTROL HANDBOOK, Second Ed.** Edited by R. W. Smeaton. 1,056 pp., 789 illus. The only handbook that treats all aspects of switchgear control, including design, applications, safety, and maintenance. Updated to reflect the changes brought about by the use of computers, solid-state devices, and programmable controls.

584/494 Pub. Pr., \$83.00 Club Pr., \$56.95

**ANTENNA APPLICATIONS REFERENCE GUIDE.** Edited by R. C. Johnson and H. Jasik. 496 pp., 368 illus. and tables. Covers the major applications of antenna technology in all areas of communications and their design methods. Emphasizes important new applications such as earth station, satellite, seeker, aircraft, and microwave-relay antennas.

322/848 Pub. Pr., \$59.95 Club Pr., \$42.50

**RADIO HANDBOOK, Twenty-Third Ed.** Edited by W. I. Orr. 667 pp., 1,073 illus. and tables. The latest edition of the most complete, current resource on radio technology and its applications. Expert contributors show you how to select, design, build, test and operate all kinds of equipment.

584638-1 Pub. Pr., \$29.95 Club Pr., \$23.95

**AUDIO ENGINEERING HANDBOOK.** Edited by K. B. Benson. 1056 pp., 722 illus. The ideal on-the-job reference for professionals who design, operate, and service audio equipment. It's a one-volume source of fundamental audio acoustics engineering information and practical how-to source book covering generation, transmission, storage, and reproduction of the audio signal.

047/774 Pub. Pr., \$83.50 Club Pr., \$59.95

**Be sure to consider these important titles as well!**

**BUCHSBAUM'S COMPLETE HANDBOOK OF PRACTICAL ELECTRONIC REFERENCE DATA, Third Ed.** By W. H. Buchsbaum. 583880-X Pub. Pr., \$34.95 Club Pr., \$26.50

**ON-LINE ELECTRICAL TROUBLESHOOTING.** By L. Lundquist. 391/106 Pub. Pr., \$34.50 Club Pr., \$26.50

**ESSENTIAL CIRCUITS REFERENCE GUIDE.** By J. Markus & C. Weston. 404/623 Pub. Pr., \$59.95 Club Pr., \$47.50

**INTRODUCING PC-DOS AND MS-DOS, Second Ed.** By T. Sheldon. 565/651 Pub. Pr., \$28.95 Club Pr., \$19.95

**HANDBOOK OF ELECTRONICS CALCULATIONS FOR ENGINEERS AND TECHNICIANS, Second Ed.** Edited by M. Kaufman & A. H. Seidman. 335/281 Pub. Pr., \$49.95 Club Pr., \$37.50

**INTRODUCTION TO DIGITAL SIGNAL PROCESSING.** By J. G. Proakis and D. G. Manolakis. 584954-2 Pub. Pr., \$50.00 Club Pr., \$37.50

**CIRCUIT DESIGN FOR ELECTRONIC INSTRUMENTATION: Analog and Digital Devices from Sensor to Display, Second Ed.** By D. Wobschall. 712/31X Pub. Pr., \$52.95 Club Pr., \$36.95

**BOB MIDDLETON'S HANDBOOK OF ELECTRONIC TIME-SAVERS AND SHORTCUTS.** By R. G. Middleton. 583865-6 Pub. Pr., \$29.95 Club Pr., \$22.50

**DIGITAL AND MICROPROCESSOR TECHNOLOGY, Second Ed.** By P. J. O'Connor. 585184-9 Pub. Pr., \$42.00 Club Pr., \$33.50

**OP-AMP HANDBOOK, Second Ed.** By F.W. Hughes. 583651-3 Pub. Pr., \$39.00 Club Pr., \$27.50



**FOR FASTER SERVICE IN ENROLLING CALL TOLL-FREE 1-800-2-MCGRAW**

**MAIL THIS COUPON TODAY**

**McGraw-Hill Book Clubs  
Electronics and Control Engineers'  
Book Club®**  
P.O. Box 582, Hightstown, NJ 08520-9959

Please enroll me as a member and send me the two books indicated, plus the PORTABLE ELECTRONICS DATA BOOK. I am to receive one book for just \$2.89, the other at the discounted member's price, plus local tax, shipping and handling charges. I agree to purchase a minimum of one additional book during my first year of membership as outlined under the Club plan described in this ad. I understand that a shipping and handling charge is added to all shipments.

Your FREE Data Book	
585390-6	
Write Code No. of the \$2.89 selection here	Write Code No. for the First selection here
<input type="text"/>	<input type="text"/>

Signature \_\_\_\_\_

Name \_\_\_\_\_

Address/Apt. # \_\_\_\_\_

City \_\_\_\_\_

State \_\_\_\_\_ Zip \_\_\_\_\_

This order subject to acceptance by McGraw-Hill. All prices subject to change without notice. Offer good only to new members. Foreign member acceptance subject to special conditions.

ECGB-032

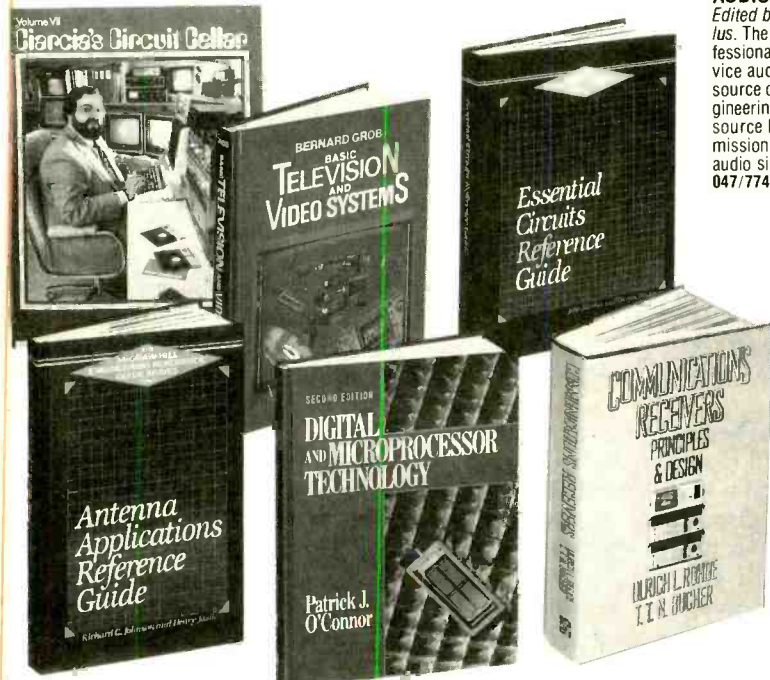

## Here's how the Club works to serve YOU:

- IMPORTANT INFORMATION... WE MAKE IT EASY TO GET!**  
In our rapidly changing world, those who perform best are those who are best informed. Designed exclusively for the practicing engineer, the Electronics and Control Engineers' Book Club provides you with information that is relevant, reliable, and specific enough to meet your needs. Each Club bulletin comes your way 14-16 times a year and offers you more than 30 books to choose from — the best and newest books from all publishers!
- DEPENDABLE SERVICE... WE'RE HERE TO HELP!**  
Whether you want information about a book or have a question about your membership, our qualified staff is here to help. Just call us toll-free or write to our Customer Service. We also make sure you get only the books you want. All you do is simply tell us your choice on the Reply Card and return it to us by the specified date. If you want the Main Selection, do nothing — it will be sent to you automatically. (A small shipping and handling charge is added to each shipment.)
- CLUB CONVENIENCE... WE DO THE WORK!**  
Beyond the benefit of timely information, Club membership offers many other benefits. For example, you get a wide choice of books that cannot be matched by any bookstore — anywhere. And all your books are conveniently delivered right to your door. You also get the luxury of 10 full days to decide whether you want the Main Selection. If you should ever receive a Main Selection you don't want because the Club bulletin came late, just return it for credit at our expense.
- SUBSTANTIAL SAVINGS... AND A BONUS PROGRAM TOO!**  
In keeping with our goal to provide you with the best information at the greatest possible savings, you will enjoy substantial discounts — up to 40%! — on every book you buy. Plus, you're automatically eligible for our Bonus Book Plan which allows you savings up to 70% on a wide selection of books.
- EASY MEMBERSHIP TERMS... IT'S WORTHWHILE TO BELONG!**  
Your only obligation is to purchase one more book — at a handsome discount — during the next 12 months, after which you enjoy the benefits of membership with no further obligation. Either you or the Club may cancel membership anytime thereafter.

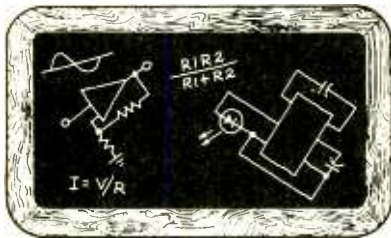

# Think Tank

By Byron G. Wels, K2AVB

## GO WITH THE FLOW!

**A**lrigh, I'll tell you Tom Allston's answer: You've got to ask the right question... Where are *all* the dollars? The hotel has \$25. Each man has \$1.00, and the bellhop has \$2.00. \$25 + \$3.00 + \$2.00 equals \$30.00. And next year, they'll make reservations!

Now you've got to understand that I was never into spectator sports. I don't even know the batting averages of any of the players in the NFL. I don't know how they score a touchdown in a baseball game!

As you probably already know, the Japanese are avid baseball fans, but when the game was first introduced over there, there was also a lot of confusion. All the players wore chest protectors, and each wore a catcher's mitt on his left hand, a fielder's glove on his right. Right-handed players ran the bases properly, but left handed batters ran the bases in the opposite direction. It made for a very-interesting game.

All of that is leading up to this month's question: In the very-early days of radio, engineers and technicians had deep discussions about the "flow" of current and voltage. Some said current flowed from negative to positive and voltage flowed from positive to negative. Today, we mostly accept that current in a closed circuit will flow from negative to positive, and that voltage provides the "push," but does not *flow*.

So assume that you've got a circuit consisting of a battery, a switch, and a load—perhaps a small lamp. You close the switch, and current flows, lighting the lamp, okay? But *where* in that circuit does current actually flow from *positive* to *negative*? Believe me, it does, and I'll tell you where next month. Now if you've figured it out, write to me and let me know. And by the way, I answer all letters that come in.

Russell Fontenot, of Hemphil, TX threw us a cute one: "Is it more correct to say 'Six sheep and three sheep *IS* eight sheep,' or 'Six sheep and three sheep *ARE* eight sheep?' Actually, Russ, the

best way to say it, is "Six sheep and three sheep are *NINE* sheep!"

We're now offering "Think Tank II." If you don't have your own copy yet, do send for it. It makes a mighty reference work and one that belongs on your bookshelf. And to answer your next question, yes, there are still some copies of the original "Think Tank" book available. Make sure to write for your copies today. Tomorrow may be too late.

Talking about letters, let's see what you've been busy with this month...

**Phone Flasher.** Here's a circuit that you can put together for about \$7.00 that will flash a light when your phone rings. It's great for the hearing impaired, or for noisy environments. See Fig. 1. Components TR1, D1, and R1 form a voltage-triggered switch. When the telephone is on-hook, there is about 52 volts between tip and ring. That's enough voltage to keep the triac conducting.

When the phone is taken off-hook, phone-line voltage drops to about 12 volts, which causes the triac to stop conducting. That section of the circuit serves to guard against dialing pulses on rotary phones, making the relay flash in time. Capacitor C1 blocks the 52-volt DC telephone line voltage normally present.

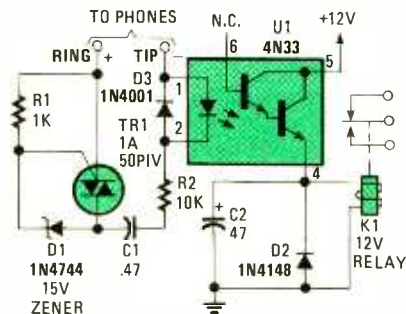

Fig. 1. The Phone-Flasher is a rather simple circuit (built around a triac, an optoisolator/coupler, and a relay) designed to give a visual indication of an incoming call.

When the phone rings, 90 volts AC is sent to the phone. Capacitor C1 allows the AC ring voltage to pass. Resistor R2 reduces the AC to a level that the internal LED of the optoisolator can handle. Diode D3 converts the AC voltage to a DC voltage, which is necessary for the LED to work.

U1 is a 4N33 optoisolator, which consists of an internal infrared LED and a photo-Darlington transistor. When DC voltage is presented to pins 1 and 2, U1's internal LED lights, causing the photo-Darlington to conduct, feeding a DC voltage to the relay. Capacitor C2 filters the voltage to the relay. Without it, the relay will oscillate at the frequency of the ring pulse—approximately 400 Hz.

Diode D2 clips the high-voltage pulse caused by K1's collapsing field. Relay K1 is a 12-volt, with 125-volt, 2-amp contacts. With that contact rating, it will accommodate a 100-watt lamp with no problem.

All parts for this circuit are available from Digi-Key Corp. (701 Brooks Ave. So., P.O. Box 677, Thief River Falls, MN 56701-0677).

I hope this gets me a book Byron!  
—Sam Kaplin, Minneapolis, MN

*It's on the way, Sam. And I'd advise our readers to carefully complete this circuit and house it all in a small plastic case. You've got some high voltages running around in there!*

**Metal Detector.** Byron, have you ever noticed that most metal-detector circuits call for some pretty-bizarre components? You have to hunt for rare transistors and some pretty-nightmarish coils with odd taps. The simpler metal detectors also have to be coupled with an AM radio, which is another iffy proposition.

Here's a metal detector that uses only standard components (see Fig. 2). It uses a 2N2222 transistor and a pair of 741s. Even the coil is a breeze! Just put 8 turns of 22-gauge enameled wire on a nine-inch diameter form. (I used some sort of baking pan that I found in the kitchen closet.) After winding, secure the coil with tape or glue and slide it off the form.

Transistor Q1 (a 2N2222 general-purpose unit) serves as the heart of a Colpitts oscillator. Diode D1 rectifies the wave to a slightly varying DC. Op-amp U1 serves as a difference amplifier to zero the varying DC, and U2 amplifies the signal for the 200- $\mu$ A meter.

To operate, adjust the potentiometer until M1 is at midscale. When metal ob-



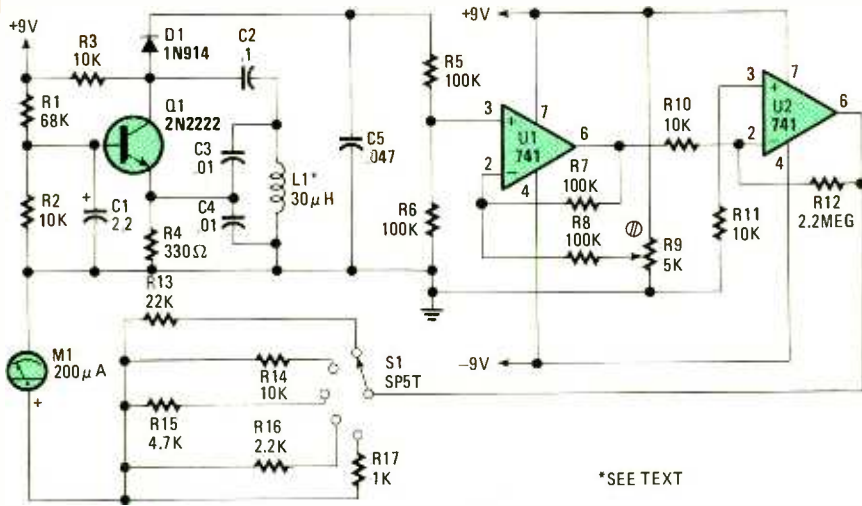

Fig. 2. This Metal-Detector circuit, with Q1 serving as the heart of a Colpitts oscillator, is easy to build and contains no exotic parts.

jects (gold bars, tooth fillings, etc.) get near the coil's field, slight changes in wave amplitude cause meter reading changes. Switch S1 is an attenuation or sensitivity select. By the way, you're also going to require a 9-volt split supply. And Byron, I've already got a Fips Book. Do you have anything else to reward me with?

—Nick Cinquino, Chicago, IL

Good circuit, Nick. Hey listen! Put that Fips Book away and leave it in trust for your kids. It's going to be very valuable one day. I'm sending you one of our "Think Tank" books. Enjoy.

### Variable 10-AMP AC/DC Supply.

Used 10-amp standard power transformers are getting harder to find...and new ones cost a fortune. Using a triac to build a low-cost, transformerless, variable power supply is a cost-effective alternative for some applications.

The circuit in Fig. 3 is designed as a "universal" 1.5 hp AC or DC motor-

speed controller and can also be used as an unregulated AC or DC power supply for those applications requiring minimal filtering. In the AC mode, the circuit can power loads up to 1000 watts (for things like dimming multiple incandescent lamps). In the DC mode, the circuit's 0–10-amp, 15–140-volt capability can provide 0.1C (10% of capacity) series charging of multiple NiCd, auto or golf-cart batteries.

The design extends the range of motor-speed control from full power to very-low conduction angles by the use of a double time-constant circuit. In the DC mode, that improvement also results in a smooth 0–10-amp DC output with minimal filtering at DC voltages as low as about 10–15 volts rather than the 30–40-volt low-end output associated with a standard triac control circuit. The 10-amp 4PDT switch allows a standard 20-amp female receptacle (SO1) to provide either AC or DC outputs. Once completed, the circuit can be fitted

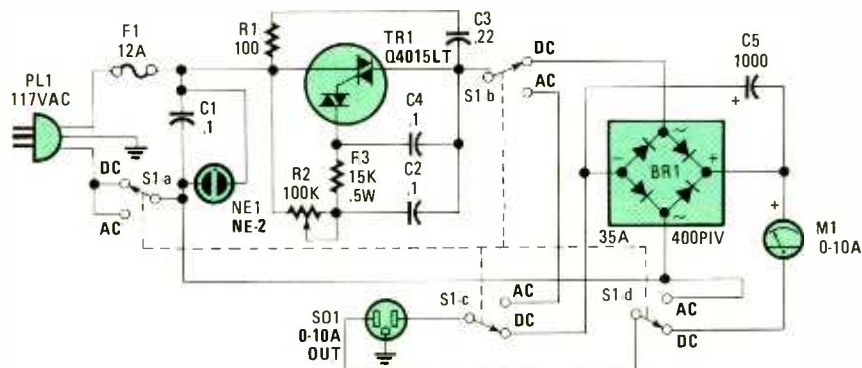
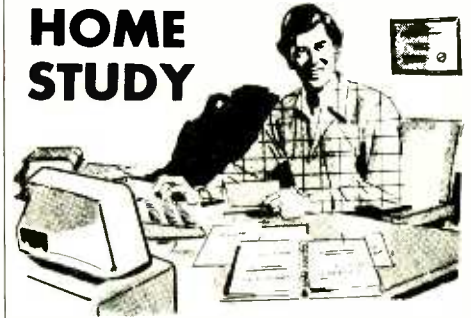

Fig. 3. The Variable 10-AMP AC/DC Supply can be viewed as nothing more than a light-dimmer circuit with a full-wave bridge rectifier (BR1) connected across its output to provide a variable DC voltage. AC power is available when S1 is flipped to the AC position, effectively removing BR1 from the circuit.

## Put Professional Knowledge and a COLLEGE DEGREE in your Technical Career through HOME STUDY



Add prestige and earning power to your technical career by earning your Associate or Bachelor degree through directed home study.

Grantham College of Engineering awards accredited degrees in **electronics and computers.**

An important part of being prepared to *move up* is holding the right college degree, and the absolutely necessary part is knowing your field. Grantham can help you both ways—to learn more and to earn your degree in the process.

Grantham offers two degree programs—one with major emphasis in **electronics**, the other with major emphasis in **computers**. Associate and bachelor degrees are awarded in each program, and both programs are available completely by correspondence.

No commuting to class. Study at your own pace, while continuing on your present job. Learn from easy-to-understand lessons, with help from your Grantham instructors when you need it.

Write for our free catalog (see address below), or phone us at toll-free 1-800-955-2527 (for catalog requests only) and ask for our "degree catalog."

Accredited by the Accrediting Commission of the National Home Study Council

**GRANTHAM**  
College of Engineering  
10570 Humbolt Street  
Los Alamitos, CA 90720

**NEW SUPER LONG PLAY TAPE RECORDERS**  
**12 Hour Model — \$119.00\***  
 Modified Panasonic Slimline, high quality, AC-DC Recorders provide 6 continuous hours of quality recording & playback on each side of cassette for a total of 12 hours.  
 Built-in features include:  
 • Voice level control, • Digital counter, etc. TDK DC 120 Cassette Furnished

**PHONE RECORDING ADAPTER**  
 Records calls automatically. All Solid state connects to your telephone jack and tape recorder. Starts recording when phone is lifted. Stops when you hang up. **\$28.50\***  
 FCC APPROVED

**VOX VOICE ACTIVATED CONTROL SWITCH**  
 Solid state self contained. Adjustable sensitivity. Voices or other sounds automatically activate and control recorder. Uses either remote or remote mike. **\$28.50\***

\*Add for ship & hdlg Phone Adapter & Vox \$1.50 ea. Recorders \$4.00 ea. Cal. Res. add tax. Mail order, VISA, MIC. COD's OK. Money Back Guarantee. Qty. disc. avail. Dealer inquiries invited. Free data.

**AMC SALES INC.** Dept B 9335 Lubec St., Box 928, Downey, CA 90241 Phone (213) 869-8519

CIRCLE 12 ON FREE INFORMATION CARD

**AMAZING NEW Pocket Reference**

**480 pages of tables, maps, formulas, and conversions and it fits in your shirt pocket (3.2" x 5.4" x 0.6")!**

**\$9.95\***

\* Plus \$2.00 shipping & handling. Colorado residents add 56¢ tax.

**Small sample of contents**

Air Tool CFM vs PSI	Radio Alphabet
Battery Charging	TEN Radio Codes
Tire Manufacturer Codes	Telephone Area Codes
Lumber Sizes & Grades	Lost Credit Card Phones
Concrete & Mortar	Sound Intensities
Element Tables	Wind Chill Factors
Computer ASCII Codes	Frequency Spectrum
IBM® PC Error Codes	Geology Mineral Tables
IBM® Interrupts-IO Map	Glues and Solvents
80286 Hard Disk Types	Bolt Torque Tables
Printer Control Codes	Wood Screw/Nail Sizes
Electric Wire Size vs Load	Math Formulas & Tables
NEMA Motor Frames	Plane/Solid Geometry
Wire & Sheet Gauges	Copper/Steel/PVC Pipe
Resistor/Capacitor Colors	Rope, Cable and Chain
Pilot Lamp Specs	Tap-Die-Drill Sizes
Fuse & Battery Specs	Sand Paper & Abrasives
RF Coil Winding Data	Weld Electrode & Solder
Wire Size vs Turns/Inch	3200 Conversion Factors

**Money Back Guarantee**— If not completely satisfied, return book postage prepaid, in mint condition for a 100% refund!

**Sequoia Publishing Inc.**  
 Dept 905, P.O. Box 620820  
 Littleton, CO 80162

CIRCLE 15 ON FREE INFORMATION CARD

**THINK TANK**

into a 5/4- x 3- x 2-inch aluminum box.

The components for the circuit can be obtained from the following sources: 15-amp, 400-PIV quadrac (internally triggered triac) is available from Digi-Key Corp. for \$2.60 (part no. Q4015LT); a 35-amp/400-PIV bridge rectifier (part no. MB354) is available from Circuit Specialists for \$2.45; and a 10-amp DC edgewise ammeter (part no. 698-3205) from Allied Electronics.

Okay Byron, there you have an easy, handy, and inexpensive supply. Worth a book?

—Len Rider, Kalispell, MT

Yes Len, and a fine piece of work it is! This is the kind of thing that has so many applications, I'm certain our readers are going to be building this one. And the book is on the way.

**CMOS Square-wave/Pulse Generator**

This circuit uses two TLC 555 (Radio Shack 276-1718) devices for their higher speed potential. (See Fig. 4.) Nothing is really critical here. Mount U1 and U2 in a single 16-pin DIP socket and bypass U1's supply terminals as shown with a 0.1-µF ceramic-disc capacitor and add 1-µF Tantalum unit at the supply terminals. Keep the capacitors' lead lengths as short as possible.

Short lead lengths and good quality capacitors for C1 and C2 are necessary for good high-frequency waveforms but are not mandatory. The C1/R1 and C2/R2 combinations can easily be tailored to your desired ranges, and logarithmic taper potentiometers make adjustments much simpler.

The first 555 (U1) generates the squarewave with Q1 supplying charging current equal to the discharge current of C1 through U1—an easy way to get a squarewave. The output frequency of U1 can range up to 2 MHz. The output of U1 is fed to the trigger input of U2, which is set up in a standard monostable configuration, which gives a nice, clean pulse to better than 0.5 µs. With the values shown in the schematic, R1 sets the frequency of the squarewave and thus, the repetition rate of the pulses, from 100 Hz to 100 kHz. Resistor R2 sets the width of the pulses from 1 ms to 1 µs. A nine-volt battery makes a great supply for this project.

—Skip Campisi, So. Bound Brook, NJ

Okay, Skip. You've earned yourself a book with this one. I'm sure that this will result in a sell-out of 555's.

**Smart Continuity Tester.**

Occasionally, you require a continuity test between two points in an electronic circuit. Unfortunately, most continuity testers available today are prone to lie. They don't do it deliberately, but if they see a small resistance, they'll still tell you that you have continuity. They just don't know any better.

This unit is different. If you have continuity, it will tell you so. And if you're reading even a low resistance through a component, the unit will tell you that as well.

See Fig. 5. The unit uses two 741 op-amps. It offers a short-circuit test current of less than 200 µA. It detects resistance values of less than 10 ohms. Nicest of all, it will not break down a PN junction. The device has come in handy in my own shop for debugging electronic circuits.

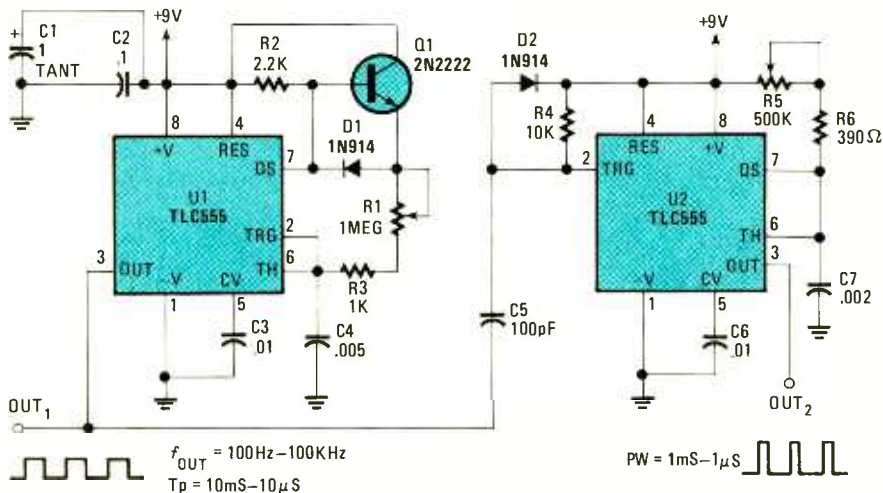

Fig. 4. The CMOS Square-wave/Pulse Generator is essentially two 555 oscillator/timer IC's (one gating the other). The output frequency of the first 555 and the output pulse rate of the second 555 are variable via R1 and R5, respectively.



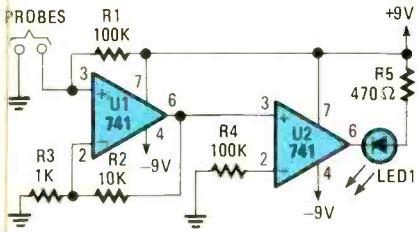

Fig. 5. The Smart Continuity Tester, as its name implies, will not only tell you when you have continuity, but will also tell you if you're reading even a low resistance through a component as well.

In building the unit, use good electronic practice, mounting the 741s in suitable sockets mounted on perf-board. While there's nothing critical here, keep the work neat, and leads nice and short. After completing the unit, I mounted my own in a small plastic box. A small dab of silicon cement holds the nine-volt battery to the bottom of the case, and a small hole with a grommet in it keeps the leads together. Another hole with a grommet holds the LED where it is plainly visible, atop the box. Putting it together makes a nice one-evening project. Is this worth one of your books?

—Ruben Garcia, Friendswood, TX  
Let me tell you about that Ruben; According to the mail that we receive here, test-equipment projects seem to attract most of our readers. Your project falls into that category, and yes, your book is on the way!

**Wall Finder.** Byron, one of my problems is that I walk around at night with the lights out. I have no trouble finding the walls of the room. I find 'em with my big toe, with my nose, you get the picture. The circuit I submitted (see Fig. 6) not only solved the problem, it attracted a good deal of attention from engineering-type friends.

The circuit uses only passive components. There are no transistors, SCR's, vacuum tubes, etc. And the circuit is actually an oscillator!

The AC line voltage, rectified by diode D1, slowly charges capacitor C1 through a 470k resistor (R1). Initially, NE1 (an NE-2 neon lamp) represents an "infinite" impedance. At a point, the firing voltage of NE1 is reached. That causes



Fig. 6. The Wall Finder is nothing more than a flashing line-fed neon lamp.

the lamp to fire. Once fired, the lamp will actually continue to glow for a bit even after the voltage drops below the firing voltage.

The afterglow, of course, means that a tiny current is being drawn through the 10k resistor (R2), which soon discharges C1 to a point where the voltage across NE1 is insufficient to keep it lit. At that point, NE1 again becomes an infinite impedance and the process starts again.

With the circuit values shown, you should get a flash rate of a bit more

than 1 Hz. Making the value of R2 less than 10k may cause enough current to get to the lamp to destroy it or at least, shorten its life considerably. The sum of the two resistors should not go lower than say, 47k for the same reason. Lowering the value of R1 will increase the flash rate until it equals or exceeds the 60 Hz line frequency, but in no case should R1 be lower than 33k.

I potted one of these in a clear polymer with a pair of brass line-cord blades emerging from one side. It's (Continued on page 27)

★QUALITY PARTS ★DISCOUNT PRICES ★FAST SHIPPING

# ALL ELECTRONICS CORP.

<p><b>12-VOLT DC MINI FAN</b> Howard Industrial 3-15-810. Operates on 12 Vdc. 0.10 amp. 1.0 watt. Compact plastic housing. 2.35" square X 1.275" thick. 3 blade fan. Two 9" digital leads. CAT# CF-121 \$9.00 each</p>	<p><b>LED CHASER KIT</b> Build this variable speed led chaser. 10 leads flash sequentially at whatever speed you set them for. Easy to build kit includes pc board, parts and instructions. Ideal for special lighting effects, costumes, etc. Operates on 3 to 9 volts. PC board is 5" X 2.25". A great one hour project. CAT# AEC \$5.50 each</p>	<p><b>STEPPER MOTOR</b> Airpax# A82743 M4 Brand new 12 volt dc stepper motor. 35 ohm coil. 7.5 degrees per step. 2.25" diameter. 0.93" long excluding shaft. 0.22" dia. shaft is 0.75" long. 2 hole mounting flange. 2.675" mounting centers. 6 wire leads. CAT# SMT-5 \$10.00 each</p>	<p><b>RECHARGEABLE BATTERY PACK (USED)</b> Four AA nickel cadmium batteries connected in series to make a 4.8 volt pack. Batteries are in a 2 X 2 configuration with a 2 pin connector attached. The four batteries can be separated into single AA size solder tab nickel cadmium batteries or resoldered into other configurations. SPECIAL SALE PRICE NOW \$3.00 per pack - 10 packs for \$25.00 CAT# NCB-41AA</p>
<p><b>115 VAC COOLING FAN</b> STANDARD SIZE COOLING FAN Features die cast metal housing for strength and durability. IMPEDANCE PROTECTED 4 1/16" square X 1 1/2" deep. Factory new 120 VAC fans. CF1-N \$9.50 each</p>	<p><b>TIL-18 PHOTO TRANSISTOR</b> TO-18 case with window. For wide angle viewing applications. Spectrally and mechanically compatible with TL-318. CAT# TL-18 \$1.00 each - 10 for \$9.00</p>	<p><b>0-30 MINUTE AUTO-SHUTOFF TIMER</b> Sanjyo Seika Mfg # TMCF35MYB9 120 Vac 60 Hz. 10 amp contacts. U.S. made. Turn shaft to turn on lights or other electrical devices. Bell rings or circuit breaks after specified amount of time. Ideal for any device that needs to shut off automatically. 2.32" X 1.17" X 2.54" beveled face plate. 1/4" tall round shaft. CAT# TMC-30 \$3.00 each</p>	<p><b>LED'S</b> STANDARD JUMBO DIFFUSED 1/4" size RED CAT# LED-1 10 for \$1.50 - 100 for \$13.00 GREEN CAT# LED-2 10 for \$2.00 - 100 for \$17.00 YELLOW CAT# LED-3 10 for \$2.00 - 100 for \$17.00 FLASHING LED with built in flashing circuit. Operates on 5 volts. RED \$1.00 each CAT# LED-4 10 for \$9.50 GREEN \$1.00 each CAT# LED-40 10 for \$9.50 BI-POLAR LED Light RED one direction, GREEN in the other. Two leads. CAT# LED-4 2 for \$1.70 LED HOLDER Two piece holder. CAT# HLED 10 for \$6.00</p>
<p><b>TIL-318 PHOTO DIODE</b> TO-18 case with window Infrared emitting photo diode. CAT# TL-318 \$1.00 each - 10 for \$9.50</p>	<p><b>NICKEL-CAD BATTERIES (RECHARGEABLE)</b> AAA SIZE \$1.50 each 1.2 volts 180 mAh CAT# NCB-AAA AA SIZE \$2.00 each 1.25 volts 300 mAh CAT# NCB-AA AA SIZE \$2.30 each WITH BOLDER TABS CAT# NCB-BAA C SIZE \$4.25 each 1.2 volts 1200 mAh CAT# NCB-C D SIZE \$4.50 each 1.2 volts 1200 mAh CAT# NCB-D</p>	<p><b>PHOTO FLASH CAPACITOR</b> Rubicone F10X 200 mfd. 350 volts 0.797" diameter X 1.11" high Solder loop terminals CAT# PPC-200 \$3.25 each 10 for \$30.00 - 100 for \$275.00</p>	<p><b>LOOK WHAT \$1.00 WILL BUY</b> 200 ASSORTED 1/4 WATT RESISTORS Bare leads, carbon comp and carbon film. CAT# GREB \$1.00 per assortment 200 ASSORTED 1/2 WATT RESISTORS Bare leads, carbon comp and film. CAT# GRABR \$1.00 per assortment 50 ASSORTED DISC CAPACITORS Most are cut (i.e. leads). Some to 500 volts. CAT# GRABDC \$1.00 per assortment 15 VALUES OF ELECTROLYTICS Contains both axial and radial styles from 1 millid. CAT# GRABCP \$1.00 per assortment</p>
<p><b>SWITCHES</b> ITT PUSH BUTTON ITT Model 344 X 1/2" grey rectangular key cap. S.P.S.T. N.O. Push to close. RATED 1/2 amp switching, 0.25 amp carry current. P.C. mount. CAT# PB-18 \$56 each - 10 for \$5.00 100 for \$50.00</p>	<p><b>XENON TUBE</b> 1" long fluoresce with 3 1/2" red and base leads. Ideal for electronic flash or strobe projects. CAT# FLT-3 \$2.81 each</p>	<p><b>22/44 PIN CONNECTOR</b> .156" pin spacing, 0.200" between double rows, gold contacts, P.C. mounting. SPECIAL Same as AMP# 2-500655-6. CAT# EBC-1G \$1.00 each - 10 for \$8.00</p>	<p><b>LOOK WHAT \$2.00 WILL BUY</b> 18 AMP SNAP-ACTION SWITCH 8 pieces of a 18 amp 125,250 Vdc normally open switch. Body is 3/4" X 3/4" X 3/8". Button extends 3/16" above switch body. CAT# GRABRS \$2.00 per package</p>
<p><b>SPDT PUSHBUTTON</b> Marquart 1843 Rated 8 amps @ 125/250 Vdc. Black plastic pushbutton. Switch body .52" X .34" X .86". CAT# PB-18 \$1.65 each - 10 for \$15.00 ea.</p>	<p><b>RELAYS</b> 5-8 VDC SIP REED RELAY Electro "Blue Boy" BB1-K0510-11 5-4 Vdc, 500 ohm coil. S.P.S.T. normally open reed relay. 0.5 amp contacts. SIP configuration. 1" X 3/8" X 3/4". CAT# RRLY-5RPS \$1.10 each - 10 for \$10.00</p>	<p><b>ELECTRONIC GAME BOARD</b> The inner workings of an electronic Scrabble game. Operates on 6 Vdc. 8 digit alpha-numeric readout. 45 button keypad. 14 transistors, 2 I.C.'s, 1 photo element and other goodies. Top and bottom rows of keypad buttons are function keys, middle 3 rows are alphabetic. No instructions available. P# 8 457. CAT# ST-4 \$1.75 each 10 for \$15.00</p>	<p><b>OPTO SENSOR</b> U shaped package with mounting ears. 1/8" mounting hole. 24" mounting wire. CAT# OSU-4 \$0.40 each - 10 for \$4.50 - 100 for \$40.00</p>
<p><b>PUSHBUTTON SWITCH</b> GPH/Thomson 35-420 S.P.S.T. normally open momentary pushbutton switch. Dielectric actuator 0.57" diameter. Chrome bezel 0.88" diameter. Threaded mounting in .50" diameter hole. Rated 3 amp @ 250Vdc. Solder loop terminals. CAT# PB-20 \$1.00 each</p>	<p><b>WALL TRANSFORMERS</b> ALL PLUG DIRECTLY INTO 120 VAC OUTLET 12 Vdc @ 500 mA CAT# DCTX-12B \$4.50 8 Vdc @ 200 mA CAT# DCTX-400 \$2.25 9 Vdc @ 1 amp CAT# DCTX-461 \$5.00 24 Vdc @ 825 mA CAT# ACTX-2462 \$3.25</p>	<p><b>TELEPHONE COUPLING TRANSFORMER</b> Muz. Products International ATNH-101 Primary 600 ohm Secondary 800/200 ohm 0.77" X 0.41" X 0.67" high 6.0 cc. pins on 0.187" centers. Primary inductance 300 mH at 1 kHz, 1 volt. CAT# TCTX-1 \$1.25 each - 10 for \$11.00</p>	<p><b>A.C. LINE CORDS</b> Back end .182, SPT-2 NON POLARIZED PLUG CAT# LCAAC 2 for \$1.00 100 for \$45.00 POLARIZED PLUG CAT# LCP-1 \$0.40 each 100 for \$50.00</p>
<p><b>SERVO MOTOR</b> 1/3" servo with potentiometer Ideal for robotics or remote control applications. Precision. Rotates approx. 140 degrees. For connected to motor wires from either 500 to 3000 ohms. 1.57" X 0.88" X 1.48". 0.87" diameter rubber wheel attached to motor shaft can be used as a capacitor or can be easily removed. Prepped with capacitors, chassis and wire leads. CAT# SVO-2 2 for \$1.00</p>	<p><b>12 VOLT D.C. COIL S.P.D.T.</b> Omron G2E-12AP 8 amp contacts. 250 ohm coil. Super cube size 3/8" X 4/8" X 1/4" high. P.C. mount with pins on DIP. CAT# RLY-787 \$1.50 each</p>	<p><b>AC LINE CORDS</b> Back end .182, SPT-2 NON POLARIZED PLUG CAT# LCAAC 2 for \$1.00 100 for \$45.00 POLARIZED PLUG CAT# LCP-1 \$0.40 each 100 for \$50.00</p>	<p><b>TO-92 TRANSISTORS</b> 20 assorted TO-92 plastic case transistors. Various styles of NPN and PNP. Some have common emitter markings. CAT# GTRIN \$2.00 per assortment</p>

**CALL OR WRITE FOR OUR FREE 60 PAGE CATALOG OVER 4000 PARTS!**

OUTSIDE THE U.S.A. SEND \$2.00 POSTAGE FOR A CATALOG!

**ORDER TOLL FREE 1-800-826-5432**

MAIL ORDERS TO: ALL ELECTRONICS, P.O. BOX 567, VAN NUYS, CA 91408

INFO: (818)904-0524 FAX: (818)781-2653  
MINIMUM ORDER \$10.00  
QUANTITIES LIMITED  
CALIF. ADD SALES TAX  
USA: \$3.50 SHIPPING  
FOREIGN ORDERS INCLUDE SUFFICIENT SHIPPING. NO C.O.D.

CIRCLE 11 ON FREE INFORMATION CARD



# “Where can I turn for help?”



There is a way to get help when you need it. The American Home Satellite Association. An organization created exclusively to protect and enhance your enjoyment of your satellite TV system.

Take our toll free “Helpline,” for example. From locating satellite signals to locating a reputable dealer, help is just a phone call away. AHSA provides educational videotapes and informative books, too. At very special member prices.

Plus, 10 times a year, AHSA’s official newsletter, *Sky Report*, will bring you the latest word on products, legislation, programming, and more. Not to mention reviews of new products and services. And that’s not all AHSA has in store for you.

## Programming shouldn’t cost a fortune.

With AHSA’s group buying power, you can save on premium services, superstations and basic programming services. Enjoy savings on accessories, equipment, and programming guides, too.

## You’re not alone anymore!

With your voice behind us, AHSA is promoting legislation to guarantee fair access at reasonable prices. Addressing zoning and piracy issues. Even sending expert witnesses to Congressional hearings. Join other dish owners around the nation, and become a force to be reckoned with.

### Rush my free information kit.

Name \_\_\_\_\_

Address \_\_\_\_\_

City \_\_\_\_\_ State \_\_\_\_\_ Zip \_\_\_\_\_

### Sign me up right away and send my complete membership kit.

Check enclosed for \$36 (made out to AHSA)

Bill my  VISA  MasterCard

Card # \_\_\_\_\_

Exp. Date \_\_\_\_\_

Authorized Signature \_\_\_\_\_

X \_\_\_\_\_

30-day Money Back Guarantee



**American Home  
Satellite Association**  
CA

Return completed coupon to:  
American Home  
Satellite Association, Inc.,  
Suite 800, 500 108th Ave. NE,  
Bellevue, WA 98004-5560  
Or call Toll Free  
1-800-321-AHSA (2472).  
CA



## THINK TANK

(Continued from page 25)

been functioning for 24 hours a day for over 15 years now and it's still going the way it did when the polymer hardened. Will this mean I get a Fips Book?

—Jan Rowland, Houston, TX

No Jan, we're pushing the Think Tank I Books now, and that's what I sent you! Readers, Jan signed his letter as a "retired Geriatric Incessant tinkerer and a heinous and unsavory rapsacallion!" I doubt that, but believe me, I plan to build one of these as soon as possible. Nobody believes me when I say I walked into a wall!

**Cycler.** I must admit that using rechargeable batteries in my Walkman has saved me a small fortune. But the infamous memory effect has proven to be a headache. I call this circuit (See Fig. 7) a "cycler" instead of a charger, because it first discharges the batteries and then automatically recharges them, thereby wiping out the memory. With the components shown in the schematic diagram, the cycler charges four "AA" batteries in series.

When S1 is pressed, the relay closes. One set of contacts lights the appropriate LED, and the other set connects the batteries to the base of Q1. Transistor Q1 then holds the relay closed until the batteries are virtually depleted. Resistor R4 acts as a load for the batteries, and R3 limits the current applied to the base of Q1.

When the batteries are discharged and release the relay, the batteries begin to recharge through R1 and D1. The value of R1 can be changed to whatever value might be necessary to trickle

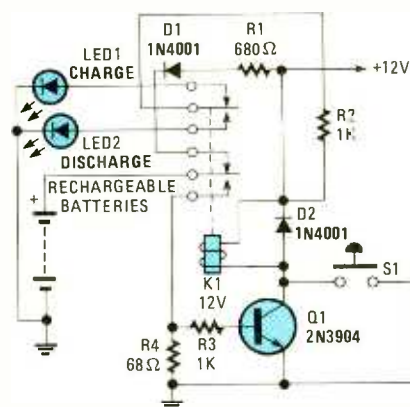

Fig. 7. The Cycler is basically a battery-charging circuit that completely discharges the battery before charge, thereby eradicating the infamous memory effect of rechargeable batteries.

charge whatever number of batteries you wish. Diode D2 shunts any inductive kick from the relay coil and R2 limits current to the LED.

I already have a Fips Book, and think I could use a Think Tank book. What do you think?

—Keith Rawlinson, Berea, OH

I think so Keith...I think so. And one is already in the mail. This is really a project and a half. If you're using a Walkman (or any other small battery-operated device) change over to rechargeables, build this unit, and spend the money you save for your next Popular Electronics subscription!

**Missile Controller.** Well, actually, it's a relay controller but before I retired as an engineer, we used to energize and deenergize relays with this sort of device. And it was used in missile control, back in the early days of missiles!

See Fig. 8. When the ON switch (S1) is momentarily depressed, the relay energizes and is held in the on state by the holding (latching) contact. Momentarily closing the OFF switch (S2) de-energizes the relay by placing the same potential on both terminals of the relay coil. With no potential difference be-

## AMAZING SCIENTIFIC & ELECTRONIC PRODUCTS

PARTS ARE IN STOCK	PLANS	PRICE
GRA1 — ANTI GRAVITY GENERATOR		\$10.00
LC7 — 40 WATT BURNING CUTTING LASER		\$20.00
RUB4 — HI POWER PULSED DRILLING LASER		\$20.00
BTC5 — 1 MILLION VOLT TESLA COIL		\$20.00
MCP1 — HI VELOCITY COIL GUN		\$15.00
LLS1 — LASER LIGHT SHOW 3 METHODS		\$20.00
EHI — ELECTRONIC HYPNOTISM TECHNIQUES		\$8.00
EML1 — LOWER POWERED COIL GUN LAUNCHER		\$8.00
JL3 — JACOB LADDER 3 MODELS		\$10.00
SD5 — SEE IN THE DARK		\$10.00
LEV1 — LEVITATION DEVICE		\$10.00

KITS PROGRAM AVAILABLE	PRICE
FMV1K — 3 MILE FM VOICE TRANSMITTER	\$34.50
PFS1K — HAND CONTROLLED PLASMA FIRE SABER	\$49.50
NIG7K — HI FLUX NEGATIVE ION GENERATOR	\$34.50
PG5K — PLASMA LIGHTNING GLOBE	\$49.50
LHC2K — VISIBLE SIMULATED 3 COLOR LASER	\$44.50
HOD1K — HOMING/TRACKING BEEPER TRANSMITTER	\$44.50
LGU6K — 2.5 MW HAND-HELD VISIBLE LASER GUN	\$249.50
BTC3K — 250,000 VOLT TABLE TOP TESLA COIL	\$249.50
IQG2K — ION RAY GUN, project energy without wires	\$129.95
TKE1K — TELEKINETIC ENHANCER/ELECTRIC MAN	\$79.50
VWPM7K — 3 MILE AUTO TELEPHONE TRANSMITTER	\$49.50

ASSEMBLED IN OUR LABS	PRICE
LIST10 — INFINITY XMTR Listen in via phone lines	\$199.50
IPG70 — INVISIBLE PAIN FIELD BLAST WAVE GENERATOR	\$74.50
ITM10 — 100,000 VOLT INTIMIDATOR UP TO 20'	\$99.50
JAT30 — AUTOMATIC TELEPHONE RECORDING DEVICE	\$24.50
PSP40 — PHASOR SONIC BLAST WAVE PISTOL	\$89.50
DNE10 — ALL NEW 26" VIVID COLORED NEON STICK	\$74.50
LGU20 — 5 TO 1MW VISIBLE RED HeNe LASER GUN	\$199.50
BLS10 — 100,000 WATT BLASTER DEFENSE WAND	\$89.50

EASY ORDERING PROCEDURE - TOLL FREE 1-800-221-1705 or 24 HRS ON 1-603-673-4730 or FAX IT TO 1-603-672-5406  
VISA, MC, CHECK, MO IN US FUNDS. INCLUDE 10% SHIPPING. ORDERS \$100.00 & UP ONLY ADD \$10.00. CATALOG \$1.00 OR FREE WITH ORDER.

**INFORMATION UNLIMITED**  
P.O. BOX 716, DEPT. P N, AMHERST, NH 03031

## You got it to work? Good!



## NOW MAKE IT LOOK GOOD

Let DATAK be your designing partner. Use our dry transfer title sets to put that finishing touch to your custom project. Over 2200 titles plus alphabets and numbers insure that you'll have the words you need. Switch markings and dial plate arcs are in a companion set. Use DATAKOAT spray for complete protection. Sprays are not available.

- 948 Blk (949 Wht) 10 pt. 105" Electronic Titles (24 sheets) . . . . . \$12.50
- 9581 Blk (9591 Wht) 12 pt. 125" Electronic Titles (24 sheets) . . . . . 12.95
- 968 Blk, Wht, Red asst. Meter dial & Switch Markings (12 sheets) . . . . . 12.95
- 04177 DATAKOAT Gloss Spray (12 oz) . . . . . 5.75
- 04178 DATAKOAT Matte Spray (12 oz) . . . . . 5.75

Minimum order: \$20.00 (add 7% shipping. NJ and CA also add sales tax)  
**WRITE FOR A FULL CATALOG AND SAMPLES TODAY**  
DATAK Corp. • 3117 Paterson Plank Rd. • N. Bergen, NJ 07047

CIRCLE 16 ON FREE INFORMATION CARD

## Employers

Willing workers available now at as little as 1/2 your usual cost. This is your chance to get help you've needed, but thought you couldn't afford. No business too large or too small. Call your private industry council or write National Alliance of Business, P.O. Box 7207, Washington, D.C. 20044



## THINK TANK

tween the two ends of the relay coil, no current flows through the coil, and therefore the relay is de-energized.

In most cases, R2 is not needed. It is only required if the relay has residual magnetism that holds it energized when S2 switch is pressed. Resistor R1, connected in the relay's ground circuit, should be selected for a value of about half the resistance of the relay's coil.

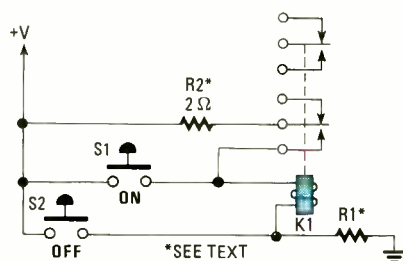

Fig. 8. The Missile-Controller, to put it quite simply, is a double-pole, double-throw relay wired for latching operation.

Resistor R1 could be replaced by an automobile lamp if 12 volts is the supply source.

It seems, Byron, that modern-day technicians tend to do things the "hard" way, making circuits far-more complicated than they really have to be. My own experience with military contract work regularly pointed up that fact!

—William J. Rottman, Roswell, NM

Be patient, Bill! I can remember building about ten-times as much circuit as I really needed. Electronics has come a long, long way. And the road hasn't always been easy, either.

**Door Monitor.** If you live in an apartment at the top of a stairway and want to know if somebody enters the downstairs door, check out this circuit. That was a problem for a friend of mine, and this device seemed to be the perfect answer.

See Fig. 9. In that circuit one gate from a 4049 hex inverter, U1, is configured as an astable multivibrator. Gates U1-b–U1-d are paralleled to provide additional drive current to the output stages. Components R1 and C1 set the primary frequency of the system, while R2 also adjusts the frequency and sensitivity of the device.

When the protected door is opened, the magnetic door switch closes, allowing current from the 9-volt battery to drive the base of Q1 (a 2N2222 NPN general-purpose transistor). With Q1

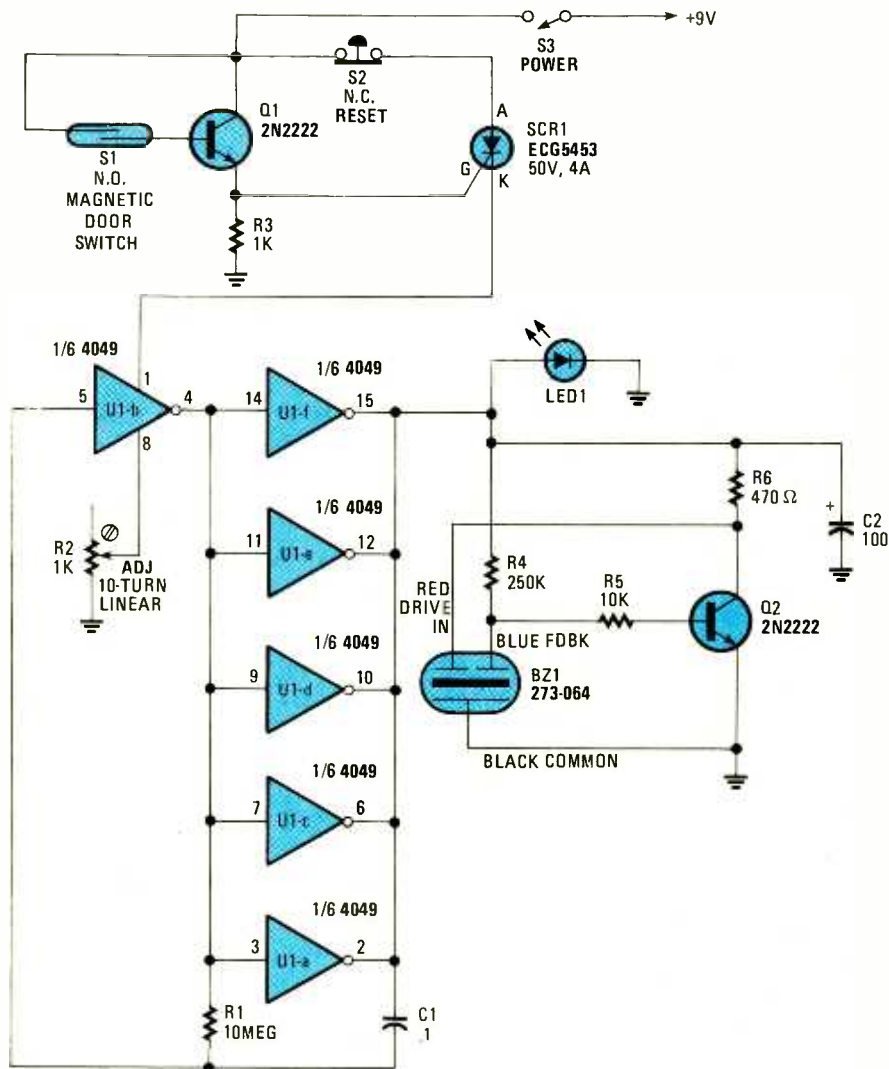

Fig. 9. In the Door Monitor circuit, one gate from a 4049 hex inverter is configured as an astable multivibrator, while the other gates in that package are paralleled to provide additional drive current to the output stages.

turned on, a trigger voltage (about 8.5 volts) is fed to the gate of SCR1, causing it to turn on. As SCR1 conducts, it provides power to the oscillator (U1, R1, R2, and C1).

The pulses from the clock circuit then drive LED1 and the associated components for the alarm circuit (BZ1, R4, R5, R6, and Q2). Capacitor C2 was added to provide stability and prevent false triggering of the system.

One of the better features of this alarm is that when the door is opened, the alarm will remain on (even if the door is closed again) until RESET-switch S2 is opened, starving current from SCR1. Since the circuit is dormant until activated, battery life can be anticipated to be equal to the shelf life of the battery. Good enough for a Book., Byron?

John C. Grise, Dractut, MA

More than good enough, John!

Well that's about all the space allotted to us for this month, but before I close out this month's column, let me suggest that when you send in your solutions to the monthly problem, you make your postage do double duty! Send along a circuit for this column as well. Who knows? You might even win yourself a free book as a reward! Send all solutions and submissions to *Think Tank*, **Popular Electronics**, 500-B Bi-County Blvd., Farmingdale, NY 11735. See you next month guys!

# BUY BONDS



# Discover Your Career Potential In The Fast Growing Field Of High-Tech Electronics!

CIE Gives You The Training You Need to *Succeed...*  
At Your Own Pace...& In Your Own Home!

If you're anxious to get ahead...and build a *real* career...you owe it to yourself to find out about the Cleveland Institute of Electronics!

CIE can help you discover *your* career potential in the fast growing field of high-tech electronics. A career that will challenge and excite you every day...reward you with a powerful feeling of personal accomplishment...and deliver a level of financial security you may have only dreamed of before!

As the leading school in home-study electronics, CIE has helped over 150,000 students in the U.S.A. and over 70 foreign countries get started in this exciting field. To find out how CIE could be helping *you*...read on...then send for a CIE catalog TODAY!

## A Growing Need For Trained Professionals!

The career opportunities shown here are only a few of the challenging, high-paying careers you could enjoy as an electronics technician.

You could be the "brains" behind the scenes of an exciting TV broadcast...trouble-shoot life-saving medical equipment...design exotic new aeronautics systems...CIE's job-oriented programs offer you the quickest possible path to the career of your dreams! And CIE also features military and union re-training, to build on what you already know.

## Dozens Of Fascinating Careers To Choose From!

Even if you aren't sure which career is best for you, CIE can get you started with core lessons applicable to *all* areas of electronics. As you advance, CIE makes job opportunities available to you through the bimonthly school paper, *The Electron*.



Data Communications



Automotive Electronics



Avionics

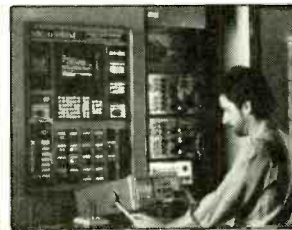

Computer-Assisted Manufacturing



Consumer Electronics



Military Electronics

## Personal Training From A Renowned Faculty.

Unlike the impersonal approach of large classroom study, CIE offers you one-on-one instructional help 6 days a week, toll-free. Each CIE lesson is authored by an independent specialist, backed by CIE instructors who work directly with you to answer your questions and provide technical assistance when you need it.

## Practical Training... At Your Own Pace.

Through CIE, you can train for your new career while you keep your present job. Each course allows a generous completion time, and there are no limitations on how fast you can study. Should you already have some electronics experience, CIE offers several courses which start at the intermediate level.

## "State-Of-The-Art" Facilities & Equipment.

In 1969, CIE pioneered the first electronics laboratory course, and in 1984, the first Microprocessor Laboratory. Today, no other home study school can match CIE's state-of-the-art equipment. And all your laboratory equipment is included in your tuition cost. There is no extra charge—it's yours to use while you study at home and on the job after you complete your course!

## Earn Your Degree To Become A Professional In Electronics!

Every CIE course you take earns you credit towards the completion of your Associate in Applied Science Degree, so you can work towards your degree in stages. And CIE is the only school that awards you for fast study, which can save you thousands of dollars in obtaining the same electronics education found in four-year Bachelor's Degree programs!

## Send For Your Catalog Today!

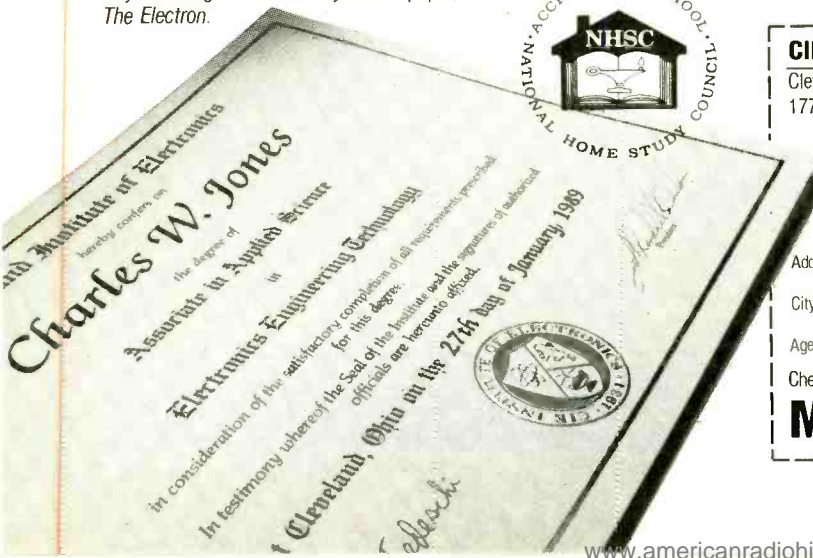

### CIE World Headquarters

Cleveland Institute of Electronics, Inc.  
1776 East 17th St., Cleveland, Ohio 44114

AH0-147

**YES!** Please send me your independent study catalog (For your convenience, CIE will have a representative contact you—there is no obligation.)

Print Name \_\_\_\_\_

Address \_\_\_\_\_ Apt # \_\_\_\_\_

City/State/Zip \_\_\_\_\_

Age \_\_\_\_\_ Area Code/Phone No. \_\_\_\_\_

Check box for G.I. Bill bulletin on educational benefits:  Veteran  Active Duty

## Mail This Coupon Today!



# 1-800-334-4539

AMERICAN RADIO CORPORATION AK, Puerto Rico, Tel 216-681-6674 FAX - 216-681-3380 TWX - 910350892 DIGI KEY CORP

INTEGRATED CIRCUITS				INTEGRATED CIRCUITS				SILICON TRANSISTORS				PANASONIC SU SERIES				DISC CAPACITORS						
7400 TTL	74LS258N	54	80C95N	45	451880N	48	LM747CN	72	AN79M05	83	PN4355	37	PA100	10	PE210	1.62	P4129	1200V 1K	2.25	P4307	047 1/2	75
7400N	74LS258N	54	80C95N	45	452080N	48	LM747CN	72	AN79M06	83	PN4888	58	PA101	10	PE211	1.62	P4130	1800V 1K	2.25	P4410	1000 50	79
7401N	74LS259N	54	80C95N	45	452080N	48	LM747CN	72	AN79M07	83	PN4889	58	PA102	10	PE212	1.62	P4131	2200V 1K	2.93	P4419	1500 25	75
7401N	74LS259N	54	80C95N	45	452080N	48	LM747CN	72	AN79M08	83	PN4890	58	PA103	10	PE213	1.62	P4132	2200V 1K	2.93	P4420	2200 25	75
7401N	74LS259N	54	80C95N	45	452080N	48	LM747CN	72	AN79M09	83	PN4891	58	PA104	10	PE214	1.62	P4133	2200V 1K	2.93	P4421	3000 25	75
7401N	74LS259N	54	80C95N	45	452080N	48	LM747CN	72	AN79M10	83	PN4892	58	PA105	10	PE215	1.62	P4134	2800V 1K	3.30	P4422	4700 25	75
7401N	74LS259N	54	80C95N	45	452080N	48	LM747CN	72	AN79M11	83	PN4893	58	PA106	10	PE216	1.62	P4135	3800V 1K	3.67	P4423	4700 25	75
7401N	74LS259N	54	80C95N	45	452080N	48	LM747CN	72	AN79M12	83	PN4894	58	PA107	10	PE217	1.62	P4136	4700V 1K	3.67	P4424	4700 25	75
7401N	74LS259N	54	80C95N	45	452080N	48	LM747CN	72	AN79M13	83	PN4895	58	PA108	10	PE218	1.62	P4137	5600V 1K	3.67	P4425	10000 25	83
7401N	74LS259N	54	80C95N	45	452080N	48	LM747CN	72	AN79M14	83	PN4896	58	PA109	10	PE219	1.62	P4138	8000V 1K	4.44	P4426	15000 25	83
7401N	74LS259N	54	80C95N	45	452080N	48	LM747CN	72	AN79M15	83	PN4897	58	PA110	10	PE220	1.62	P4139	8000V 1K	4.44	P4427	22000 25	83
7401N	74LS259N	54	80C95N	45	452080N	48	LM747CN	72	AN79M16	83	PN4898	58	PA111	10	PE221	1.62	P4140	8000V 1K	4.44	P4428	22000 25	83
7401N	74LS259N	54	80C95N	45	452080N	48	LM747CN	72	AN79M17	83	PN4899	58	PA112	10	PE222	1.62	P4141	8000V 1K	4.44	P4429	22000 25	83
7401N	74LS259N	54	80C95N	45	452080N	48	LM747CN	72	AN79M18	83	PN4900	58	PA113	10	PE223	1.62	P4142	8000V 1K	4.44	P4430	22000 25	83
7401N	74LS259N	54	80C95N	45	452080N	48	LM747CN	72	AN79M19	83	PN4901	58	PA114	10	PE224	1.62	P4143	8000V 1K	4.44	P4431	22000 25	83
7401N	74LS259N	54	80C95N	45	452080N	48	LM747CN	72	AN79M20	83	PN4902	58	PA115	10	PE225	1.62	P4144	8000V 1K	4.44	P4432	22000 25	83
7401N	74LS259N	54	80C95N	45	452080N	48	LM747CN	72	AN79M21	83	PN4903	58	PA116	10	PE226	1.62	P4145	8000V 1K	4.44	P4433	22000 25	83
7401N	74LS259N	54	80C95N	45	452080N	48	LM747CN	72	AN79M22	83	PN4904	58	PA117	10	PE227	1.62	P4146	8000V 1K	4.44	P4434	22000 25	83
7401N	74LS259N	54	80C95N	45	452080N	48	LM747CN	72	AN79M23	83	PN4905	58	PA118	10	PE228	1.62	P4147	8000V 1K	4.44	P4435	22000 25	83
7401N	74LS259N	54	80C95N	45	452080N	48	LM747CN	72	AN79M24	83	PN4906	58	PA119	10	PE229	1.62	P4148	8000V 1K	4.44	P4436	22000 25	83
7401N	74LS259N	54	80C95N	45	452080N	48	LM747CN	72	AN79M25	83	PN4907	58	PA120	10	PE230	1.62	P4149	8000V 1K	4.44	P4437	22000 25	83
7401N	74LS259N	54	80C95N	45	452080N	48	LM747CN	72	AN79M26	83	PN4908	58	PA121	10	PE231	1.62	P4150	8000V 1K	4.44	P4438	22000 25	83
7401N	74LS259N	54	80C95N	45	452080N	48	LM747CN	72	AN79M27	83	PN4909	58	PA122	10	PE232	1.62	P4151	8000V 1K	4.44	P4439	22000 25	83
7401N	74LS259N	54	80C95N	45	452080N	48	LM747CN	72	AN79M28	83	PN4910	58	PA123	10	PE233	1.62	P4152	8000V 1K	4.44	P4440	22000 25	83
7401N	74LS259N	54	80C95N	45	452080N	48	LM747CN	72	AN79M29	83	PN4911	58	PA124	10	PE234	1.62	P4153	8000V 1K	4.44	P4441	22000 25	83
7401N	74LS259N	54	80C95N	45	452080N	48	LM747CN	72	AN79M30	83	PN4912	58	PA125	10	PE235	1.62	P4154	8000V 1K	4.44	P4442	22000 25	83
7401N	74LS259N	54	80C95N	45	452080N	48	LM747CN	72	AN79M31	83	PN4913	58	PA126	10	PE236	1.62	P4155	8000V 1K	4.44	P4443	22000 25	83
7401N	74LS259N	54	80C95N	45	452080N	48	LM747CN	72	AN79M32	83	PN4914	58	PA127	10	PE237	1.62	P4156	8000V 1K	4.44	P4444	22000 25	83
7401N	74LS259N	54	80C95N	45	452080N	48	LM747CN	72	AN79M33	83	PN4915	58	PA128	10	PE238	1.62	P4157	8000V 1K	4.44	P4445	22000 25	83
7401N	74LS259N	54	80C95N	45	452080N	48	LM747CN	72	AN79M34	83	PN4916	58	PA129	10	PE239	1.62	P4158	8000V 1K	4.44	P4446	22000 25	83
7401N	74LS259N	54	80C95N	45	452080N	48	LM747CN	72	AN79M35	83	PN4917	58	PA130	10	PE240	1.62	P4159	8000V 1K	4.44	P4447	22000 25	83
7401N	74LS259N	54	80C95N	45	452080N	48	LM747CN	72	AN79M36	83	PN4918	58	PA131	10	PE241	1.62	P4160	8000V 1K	4.44	P4448	22000 25	83
7401N	74LS259N	54	80C95N	45	452080N	48	LM747CN	72	AN79M37	83	PN4919	58	PA132	10	PE242	1.62	P4161	8000V 1K	4.44	P4449	22000 25	83
7401N	74LS259N	54	80C95N	45	452080N	48	LM747CN	72	AN79M38	83	PN4920	58	PA133	10	PE243	1.62	P4162	8000V 1K	4.44	P4450	22000 25	83
7401N	74LS259N	54	80C95N	45	452080N	48	LM747CN	72	AN79M39	83	PN4921	58	PA134	10	PE244	1.62	P4163	8000V 1K	4.44	P4451	22000 25	83
7401N	74LS259N	54	80C95N	45	452080N	48	LM747CN	72	AN79M40	83	PN4922	58	PA135	10	PE245	1.62	P4164	8000V 1K	4.44	P4452	22000 25	83
7401N	74LS259N	54	80C95N	45	452080N	48	LM747CN	72	AN79M41	83	PN4923	58	PA136	10	PE246	1.62	P4165	8000V 1K	4.44	P4453	22000 25	83
7401N	74LS259N	54	80C95N	45	452080N	48	LM747CN	72	AN79M42	83	PN4924	58	PA137	10	PE247	1.62	P4166	8000V 1K	4.44	P4454	22000 25	83
7401N	74LS259N	54	80C95N	45	452080N	48	LM747CN	72	AN79M43	83	PN4925	58	PA138	10	PE248	1.62	P4167	8000V 1K	4.44	P4455	22000 25	83
7401N	74LS259N	54	80C95N	45	452080N	48	LM747CN	72	AN79M44	83	PN4926	58	PA139	10	PE249	1.62	P4168	8000V 1K	4.44	P4456	22000 25	83
7401N	74LS259N	54	80C95N	45	452080N	48	LM747CN	72	AN79M45	83	PN4927	58	PA140	10	PE250	1.62	P4169	8000V 1K	4.44	P4457	22000 25	83
7401N	74LS259N	54	80C95N	45	452080N	48	LM747CN	72	AN79M46	83	PN4928	58	PA141	10	PE251	1.62	P4170	8000V 1K	4.44	P4458	22000 25	83
7401N	74LS259N	54	80C95N	45	452080N	48	LM747CN	72	AN79M47	83	PN4929	58	PA142	10	PE252	1.62	P4171	8000V 1K	4.44	P4459	22000 25	83
7401N	74LS259N	54	80C95N	45	452080N	48	LM747CN	72	AN79M48	83	PN4930	58	PA143	10	PE253	1.62	P4172	8000V 1K	4.44	P4460	22000 25	83
7401N	74LS259N	54	80C95N	45	452080N	48	LM747CN	72	AN79M49	83	PN4931	58	PA144	10	PE254	1.62	P4173	8000V 1K	4.44	P4461	22000 25	83
7401N	74LS259N	54	80C95N	45	452080N	48	LM747CN	72	AN79M50	83	PN4932	58	PA145	10	PE255	1.62	P4174	8000V 1K	4.44	P4462	22000 25	83
7401N	74LS259N	54	80C95N	45	452080N	48	LM747CN	72	AN79M51	83	PN4933	58	PA146	10	PE256	1.62	P4175	8000V 1K	4.44	P4463	22000 25	83
7401N	74LS259N	54	80C95N	45	452080N	48	LM747CN	72	AN79M52	83	PN4934	58	PA147	10	PE257	1.62	P4176	8000V 1K	4.44	P4464	22000 25	83
7401N	74LS259N	54	80C95N	45	452080N	48	LM747CN	72	AN79M53	83	PN4935	58	PA148	10	PE258	1.62	P4177	8000V 1K	4.44	P4465	22000 25	83
7401N	74LS259N	54	80C95N	45	452080N	48	LM747CN	72	AN79M54	83	PN4936	58	PA149	10	PE259	1.62	P4178	8000V 1K	4.44	P4466	22000 25	83
7401N	74LS259																					



# Build a Budget Frequency/Events Counter

BY JOHN WANNAMAHER

**Y**ou're saving until you can afford a really good frequency counter, right? If most of your needs are for frequencies below 100 kHz, this *Budget Frequency/Events Counter* can fill the bill at a cost of between \$58.00 and \$80.00 (plus enclosure), depending on the options that you want.

You can build a stripped-down version of the counter—which would make a fantastic addition to an audio-signal generator—or add an events (totalizing) mode. There is also an optional photo-Darlington input that allows the Budget Frequency/Events Counter to be used as a tachometer, or you can add your own special triggering signal to count random happenings per hour, per week, or whatever.

Power-source flexibility is also provided: The counter can be built for battery-only operation, AC-only operation, or you can make the circuit capable of operating from either source. The more options, the more switches—and the higher the cost.

**Description.** The frequency response of the Budget Frequency/Events Counter is from 1 Hz to 175 kHz with a 100 mV peak-to-peak (p-p) input (35 mV rms),

when powered from a DC supply of 5 to 6 volts. Even when the battery voltage drops to 3.3 volts, the response is good to beyond 100 kHz. The photo input (when the counter is in the EVENTS mode) has a frequency response to well over 5 kHz, which corresponds to a motor speed of 300,000 rpm. The photo input is used in conjunction with an appropriate light source. When the light striking the circuit's photo detector is broken, a count is entered. The light source should be operated from DC so that there is no chance of a false count due to AC flicker.

In the FREQUENCY mode, there are three front-panel selectable sampling rates: 0.1, 1.0, and 10 seconds. With 0.1-second sampling rate, a decimal lights between the two middle digits to indicate a reading in kilohertz; with a 10-second rate, a decimal lights to the left of the first digit to indicate a readout to the nearest tenth of a hertz. For all ranges, the basic accuracy of the counter is  $\pm 0.01$  percent or better. Unfortunately, there is no leading-zero suppression.

In the EVENTS mode, sampling is continuous and incoming counts are accumulated or totalized. A front-panel RESET switch allows you to hold the unit at all-

zeros until ready to count, or to wipe out any old count before starting a new one. An event will be counted on any clean 1-Hz or greater signal with an amplitude of at least 200-mV p-p, or on a 0.5-volt positive pulse with a duration of 0.5 microseconds or greater. The repetition rate for pulses with moderately fast rise and fall times has no lower limit, and in that sense, the low frequency response is practically 0 Hz.

When using the photo input, the unit may be operated in either the EVENTS or FREQUENCY mode and on any range. The input impedance when in the FREQUENCY mode is about 10k, a value selected to minimize any false inputs from the counter's multiplexing signals.

While one false input every five minutes or so is insignificant in the FREQUENCY mode, it might be disastrous in the events mode. For that reason, a 1.5k resistor is added in parallel with the other input resistances to bring false triggering to a halt in reasonably noise-free environments. Transients on the AC line, caused by contact arcing, are usually the source of false inputs. Battery operation should eliminate much of the false triggering unless there is a lot of radiated noise.



*Do your electronics endeavors suffer because you can't afford expensive commercially available test equipment? If so, perhaps this little counter should be the next project you tackle.*



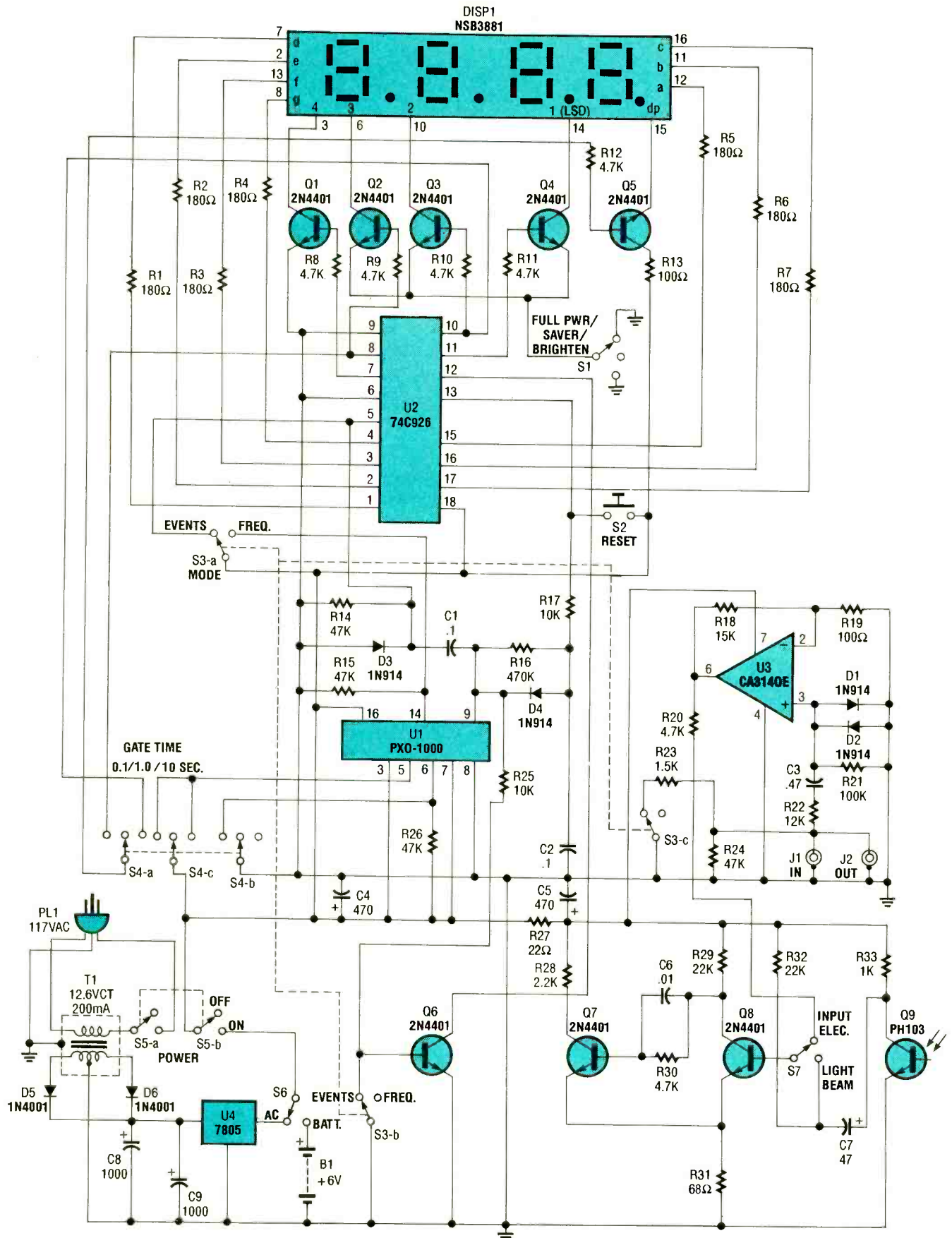

Fig. 1. The Budget Frequency/Event Counter is built around a PXO-1000 1-MHz precision oscillator (U1), a 4-digit counter with multiplexed outputs (U2), and a CA3140E Bi-MOS op-amp (U3). The PXO-1000 (U1) has its own on-board 1-MHz crystal and may be programmed via pins 2 through 7 to produce more than 50 output frequencies.



A battery SAVER switch is also included to extend battery life by cutting off the three least-significant digits of the display. The leftmost digit remains lit to act as a pilot light. No information is lost when the unit is in the SAVER mode. The missing data may be seen by flipping the SAVER switch to one of two positions: When flipped to the FULL POWER position, the display is continually illuminated. When in the BRIGHTEN position, the momentary action of the switch allows the display to remain fully illuminated only as long as the switch is held in that position; the three least-significant digits turn off again when the switch lever is released.

In the SAVER position, current consumption is about one-third of that consumed when the counter is set for continuous (full-power) display. Four alkaline AA cells will operate the unit in the FREQUENCY mode for more than 60 hours. The photo input requires additional current, and would reduce battery life by about 25%.

Dual jacks on the front panel allow the signal to be fed into and out of the unit so that it may serve as an in-line counter.

**Theory of Operation.** Figure 1 is a schematic diagram of the Budget Frequency/Event Counter. The circuit is built around a Statek (512 N. Main St., Orange, CA 92688, Tel. 714-639-7810) PXO-1000 1-MHz precision crystal oscillator (U1), a 4-digit counter with multiplexed outputs (U2), and a CA3140E BiMOS op-amp (U3). The PXO-1000 (U1) has its own internal 1-MHz crystal and may be programmed via pins 2 through 7 to produce more than 50 output frequencies.

Pins 2, 3, 4, and 7 of U1 are hard-wired internally to pull-down unless wired high. Pins 5 and 6 of U1 are switched via GATE switches S4-b and S4-c to produce square-wave outputs of 5, 0.5, and .05 Hz to provide gating times of 0.1, 1.0, and 10 seconds, respectively. The square-wave output of U1 at pin 9 is differentiated by components C1 and R14 to produce a spike-like update or store pulse, which is applied to U2 at pin 5. The same output is integrated by C2 and R16 to provide a delayed reset pulse that is then applied to U2 at pin 13.

The amplitude of the input signal (applied to J1) is limited by diodes D1 and D2, and then fed to op-amp U3, which only amplifies the positive alternation of the sinewave input. The out-

put of U3 is applied through INPUT selector switch S7 (when in the ELEC. position) to the base of Q8 (which along with Q7 forms a Schmitt trigger). The Schmitt trigger produces an output pulse train at the collector of Q7 that coincides with the frequency of the input signal.

The output of the Schmitt trigger is gated off and on by the shorting/non-shortening action of Q6, which is driven by the precision gating pulse from U1. When S7 is in the light-beam position, the input to the base of Q8 is derived from the collector of Q9 (a PH103 photo-Darlington). The value of capacitor C7 determines the circuit's slowest response to a change in light.

In the EVENTS mode, the gating action of Q6 is disabled by S3-b, which keeps Q6 from turning on and shorting out the Schmitt trigger's pulses. Switch S3-a applies a constant high to the counter's update (store) input, while S3-c connects a 1.5k resistor directly across the input jack to provide added noise immunity to prevent false counts.

The counter, U2, has built-in multiplexing and supplies transistors Q1 through Q4 with the proper switching signals to energize the appropriate digit of DISP1 (an NSB3881 four-digit display). The decimal must also be multiplexed and its position is selected by S4-a.

The power SAVER switch, S1, is an SPDT unit with on/off/momentary-on con-

tacts. The current requirements at 5 volts DC are 100 mA when S1 is in the FULL POWER or BRIGHTEN positions, and 35 mA in the SAVER (display off) position. Proper use of the LIGHT BEAM feature draws an additional 5 milliamperes.

Power for the circuit can be derived from either of two sources—from a battery pack or from the AC line—and should not exceed 6 volts. Four AA cells provide sufficient power for portable operation. The AC derived power supply consists of T1, D5, D6, C8, C9, and U4. In that subassembly, AC line voltage is stepped down to 12 volts by T1 and fed to D5 and D6 for full-wave rectification, and filtered by C8 and C9. The filtered 12-volt DC output of the rectifier is then regulated to 5 volts by U4 (a 7805 5-volt, 1-amp voltage regulator). A medium-power regulator could be used but the 7805 is much easier to locate.

**Construction.** The Budget Frequency/Events Counter was built on a printed-circuit board, a template for which is shown in Fig. 2. (For those not inclined to etch their own board, an etched, drilled, and plated printed-circuit board is available, along with a list of sources for hard-to-find parts and a layout template for the front panel, from the supplier listed in the Parts List.)

After you've obtained the parts and the printed-circuit board, assembly can begin. Start by installing IC sockets at

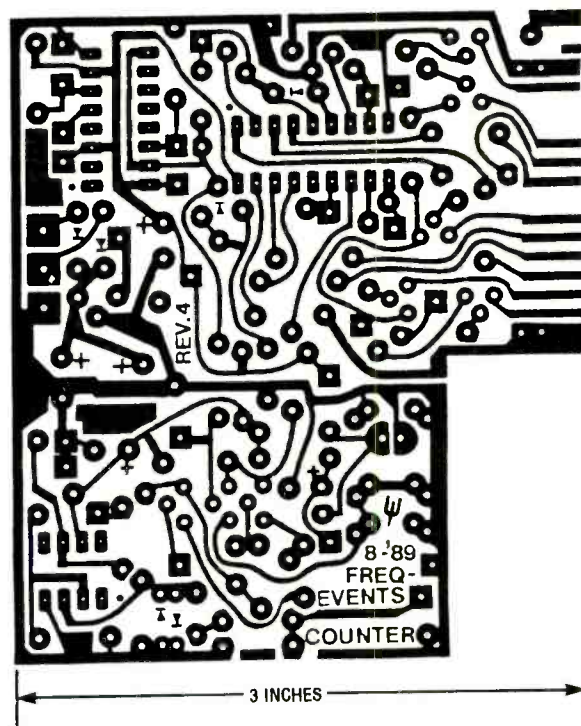

Fig. 2. The Budget Frequency/Events Counter was built on a printed-circuit board; shown here is a template for that board.



the positions indicated for U1, U2, and U3, using Fig. 3 as a guide. Then install the jumper connections and passive components (resistors, capacitors, etc.) followed by the semiconductor devices (diodes, transistors, but not the IC's).

Because Q9 is sensitive to light coming from any direction, it must be inserted into a light-tight housing. In the author's prototype, a 6.3 mm O.D. coaxial power plug (Radio Shack 274-1572) was used as a housing for Q9. All the guts were removed, the hole for the wire lead was plugged with a duct-sealing compound and two 1/16 inch holes were drilled near the plugged end of the housing so that the leads of Q9 could be connected to the board. There are 12 foil pads (only four are used in Fig. 3) in the area where the plug housing is to be located so that wire straps can be formed around the plug housing and soldered in place to hold the housing firmly against the printed-circuit board.

Next we come to the display. The display mates directly to the foil fingers on the printed-circuit board. Two of those fingers have provisions for a length of hookup wire to be threaded through a couple of holes for mechanical stability. After threading the wires through the holes, press them flat against the foil

and let them extend no more than 1/16 inch beyond the board's edge. Solder along the length of the foil fingers and use the protruding wires as indexing pins; they are to be inserted into holes 2 and 16 of the display board. Hold the

display tight against the printed-circuit board at a 90-degree angle as you tack solder the two wires. Once you're sure the angle is correct, form solder bridges between all other board/display connections.

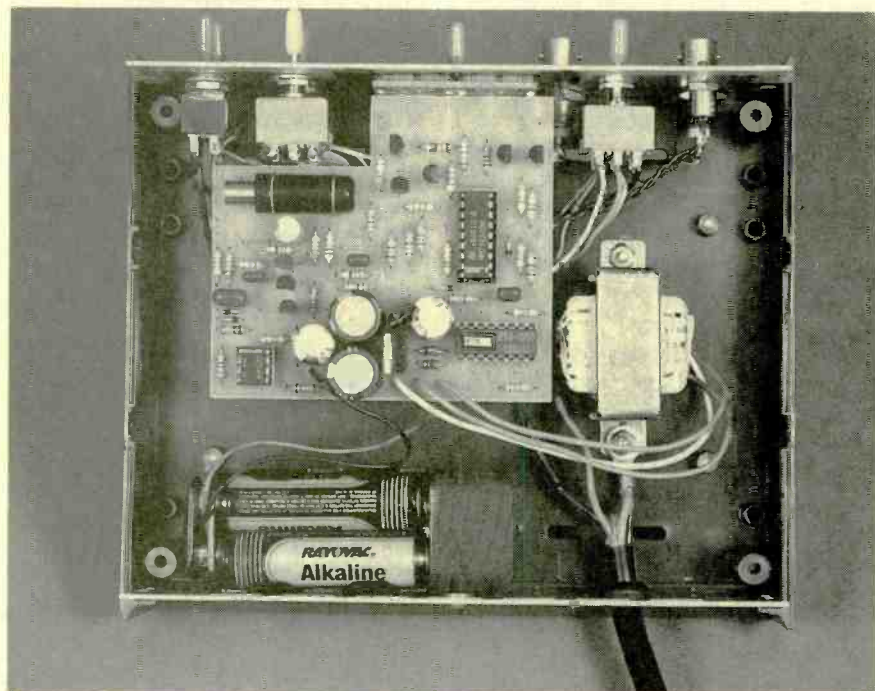

As can be seen from the open-cabinet view of the project, the orientation and positioning of the board and the off-board components plays a big part in determining the size of the cabinet used to house the project.

### PARTS LIST FOR THE BUDGET FREQUENCY/EVENTS COUNTER

#### SEMICONDUCTORS

- U1—PXO-1000 1-MHz precision crystal oscillator, integrated circuit (Statek)
- U2—74C926 4-digit counter with multiplexed 7-segment outputs, integrated circuit
- U3—CA3140E Bi-MOS op-amp, integrated circuit
- U4—7805 5-volt, 1-amp, voltage regulator
- Q1—Q8—2N4401 general-purpose NPN transistor
- Q9—PH103 photo-Darlington transistor
- D1—D4—1N914 general-purpose, small-signal diode
- D5, D6—1N4001 general-purpose rectifier diode
- DISP1—NSB3881 (or TSB3001) 4-digit common-cathode multiplexed display

#### RESISTORS

- (All resistors are 1/4-watt, 5% units.)
- R1—R7—180-ohm
  - R8—R12, R20, R30—4700-ohm
  - R13, R19—100 ohms
  - R14, R15, R24, R26—47,000-ohm
  - R16—470,000-ohm
  - R17, R25—10,000-ohm
  - R18—15,000-ohm
  - R21—100,000-ohm

- R22—12,000-ohm
- R23—1500-ohm
- R27—22-ohm
- R28—2200-ohm
- R29, R32—22,000-ohm
- R31—68-ohm
- R33—1000-ohm

#### CAPACITORS

- C1, C2—0.1- $\mu$ F, polyester
- C3—0.47- $\mu$ F, polyester
- C4, C5—470- $\mu$ F, 16-WVDC, radial-lead electrolytic
- C6—0.01- $\mu$ F, polyester
- C7—47- $\mu$ F, 16-WVDC, radial-lead electrolytic
- C8, C9—1000- $\mu$ F, 16-WVDC, radial-lead electrolytic

#### SWITCHES

- S1—SPDT on/off/momentary-contact toggle switch
- S2—Normally-open, momentary-contact, pushbutton switch
- S3—3PDT toggle switch
- S4—3PDT on/off/on toggle
- S5—DPST toggle switch
- S6, S7—SPDT toggle switch

#### ADDITIONAL PARTS AND MATERIALS

- B1—6-volt DC battery pack, see text

- J1, J2—Chassis-mount, female BNC connector
- T1—12.6-volt, center-tapped, 200-mA transformer
- Printed-circuit board materials, enclosure (Dick Smith Electronics, 173 E. Broadway, Greenwood, IN 46142, part DS RXRE2G), AC molded power plug with line cord, IC sockets, wire, solder, hardware, etc.

**Note:** The PXO-1000 precision crystal oscillator is available from Repron Electronics, Inc., 3040 Business Park Dr., Suite H, Norcross, GA 30071. Tel. 404-446-1300 and 5954-A Six Forks Rd., Raleigh, NC 27609, Tel. 919-870-5189. Contact them directly for price, shipping charges, etc.

A printed-circuit board for the Budget Frequency/Events Counter is available from John Wannamaker, RT. 4, Box 550, Orangeburg, SC 29115, for \$12.95 ppd; payable by money order only. South Carolina residents, please add 5% sales tax. A free parts-source list is also available by sending a SASE (self-addressed, stamped envelope) to the author.



Once all the on-board components have been installed, check your work for the common construction errors—solder bridges, cold solder joints, misplaced or misoriented components, etc. If you find any problems with the assembly, correct them before going any further. If all checks out, put the printed-circuit assembly to the side while you prepare the enclosure that will house the project.

The author's prototype was housed in a plastic enclosure (with metal front and rear panels) measuring about  $6\frac{7}{8}$  by  $5\frac{1}{16}$  by  $2\frac{1}{4}$  inches, but any plastic enclosure of sufficient size will do. Begin preparing the enclosure by drilling nine holes of appropriate size in the front panel to accommodate the front-panel controls and jacks. Next it will be necessary to make a cutout (about  $1\frac{5}{8}$  by  $\frac{1}{2}$  inches) in the front panel for the four-digit display (DISP1).

It will also be necessary to drill three holes in the rear panel of the enclosure: one through which the AC line cord will pass and the other two to hold the battery holder in place. (Two flat dual AA cell holders would be the easiest to mount on the bottom shell of the enclosure near the rear. But since such holders don't appear to be common, you may have to improvise with whatever you can locate.) Two additional holes are needed, and are drilled in the floor of the enclosure to mount transformer T1 in place. Transformer T1 is mounted to the left of the printed-circuit board; there's room for a larger transformer if you happen to have one on hand.

Once all the necessary holes and the cutout have been made, attach the off-board components to the enclosure. Solder a 1500-ohm resistor from the center contact of J1 to a center contact of S3-c, as shown in Fig. 3. Connect the off-board components to the printed-circuit board with lengths of wire. The signal wires between the jacks and the printed-circuit board should be oriented away from the counter section to minimize radiation pickup. As an additional safeguard, it's a good idea to use shielded wire. You'll find it more convenient to make connections to the panel controls by routing the wiring directly to the foil side of the board. The square take-off pads are easy to spot there.

Connect one hot lead of the line cord to T1's primary, and the other to switch S5. The ground (third) lead of the 3-wire line cord is then connected to

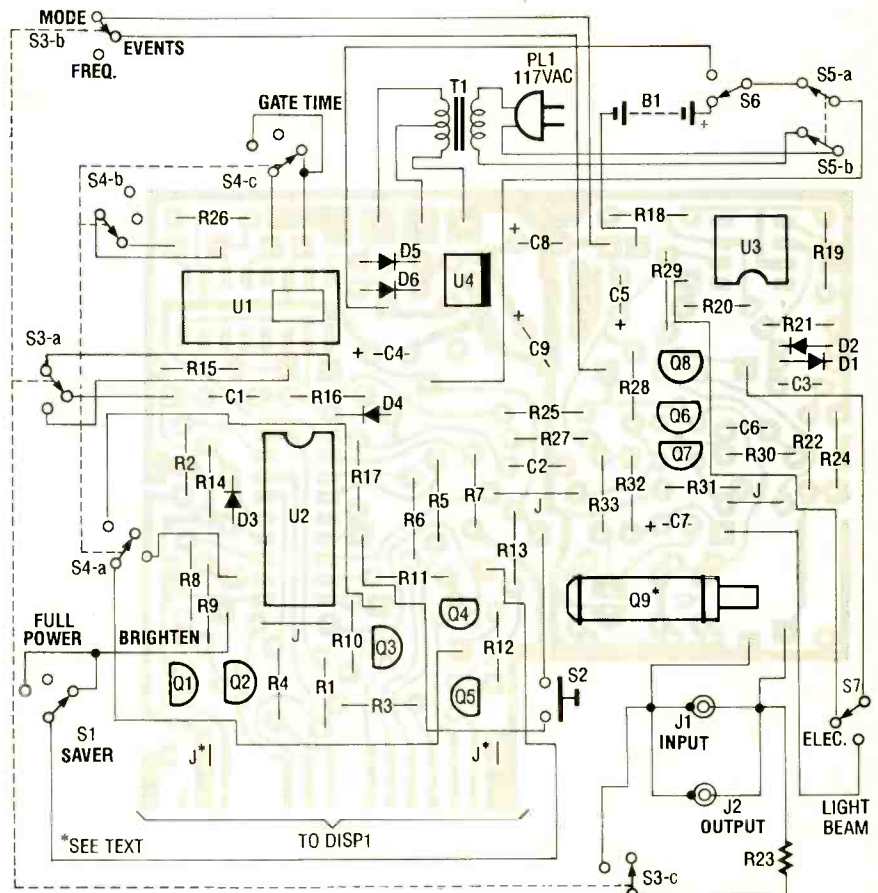

Fig. 3. When assembling the counter, first install IC sockets at the positions indicated for U1, U2, and U3, then the jumper connections and passive components (resistors, capacitors, etc.), followed by the semiconductor devices (diodes, transistors); do not install the IC's until the initial checkout has been performed.

the shell (casing) of T1. That reduces the chance of random triggering (counts) when the counter is in the EVENTS mode. Once all the wiring has been completed, check your work for errors.

If all seems okay, mount the board in its enclosure. There are three mounting holes in the printed-circuit board. The prototype has a bracket formed of .062 aluminum with one end attached around the INPUT switch bushing. The other end is attached to the board with a 4-40 machine screw through a hole near the voltage regulator.

With the LED display fitting snugly into a front-panel cutout, everything is held together reasonably secure. Insulate the display's foil from the metal panel.

A small hole must be cut in the right side of the enclosure for the light to enter. Save that task for last when everything is securely in place. Drill a small pilot hole where you think it should be after doing your best measuring and adjust for any error in placement as you enlarge the hole to one-eighth inch.

**Checkout.** Before inserting the IC's in

their sockets, check for the proper AC-derived DC voltage at the input and output of the voltage regulator, U4. There should be no noticeable ripple if checked with an oscilloscope. After several minutes of operation, the tab of the regulator should merely be warm to the touch. If the DC voltage at the output of the regulator is reasonably ripple-free, turn off the power, discharge the filter capacitors, and install the IC's. Pin 1 of the PXO-1000 oscillator is at the end where there is a window for the crystal.

Once all the IC's have been installed, power up the circuit. With all the IC's in place and the power on, the display should indicate "0000" if the power SAVER switch is set to the FULL POWER position. There will be a decimal point among the zeros if the 0.1 or 10 second gate time is selected. If any count is displayed, pressing the RESET button should clear it, but it will not be apparent until updating occurs when the counter is in the FREQUENCY mode.

When using the LIGHT BEAM input in the  
(Continued on page 104)

# PRECISION

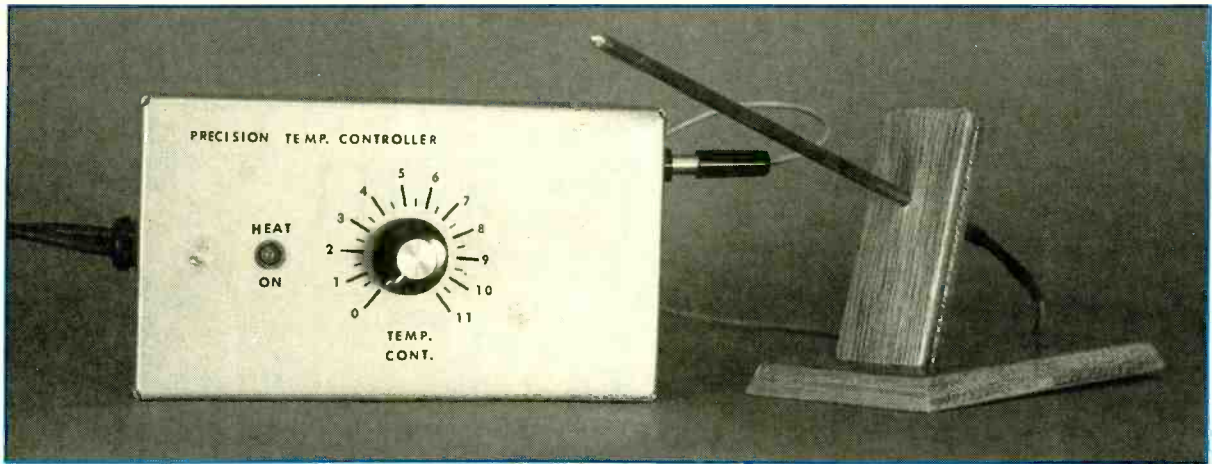

## TEMPERATURE CONTROLLER

*Need precise temperature control for photographic work, making PC boards, or any other application? Here's a circuit that can give you rock-steady temperatures to within 0.5°F.*

BY JOSEPH GIANNELLI

**H**ere is a device you can use for those tight temperature requirements, such as developing and printing black and white or color photographs, or even baking the "resist" on a printed-circuit board. You can even use it to control an electric space heater. Other applications are limited only by your imagination.

With the *Precision Temperature Controller*, temperature regulation to within 0.5°F is easily obtained by a unique method of "phase control" rather than "on" and "off" switching. Heating starts with full line voltage to the heater; as the desired temperature is approached, the voltage to the heater gradually drops until temperature equilibrium is reached at some very low voltage. The controller's range is 68–250°F.

**Circuit Description.** The circuit is designed around U1, an LM3524 pulse-width modulator (see Fig. 1). That IC is normally used in switching power-supply circuits, but it is versatile enough to be used in a number of other applications, including temperature control. Among the IC's features are an internal 5-volt regulator capable of supplying up to 50 mA to external circuitry and a programmable internal oscillator that can output up to 100 kHz.

In this circuit, a negative temperature-coefficient thermistor is used as a temperature sensor and is connected in series with the non-inverting (+) input of U1's internal error amplifier (pin 2). A reference voltage is fed to the inverting (-) input of that amp (pin 1). The error amp's output is then compared with a sawtooth generated by the IC's oscillator. The result of the comparison is a variable duty-cycle pulse train that is available at pin 11; the duty cycle will be between 0 and 45%, depending on the inputs at pins 1 and 2 (more on that in a moment).

The output of the IC's error amplifier is available at the compensation terminal (pin 9). The amp's gain can be controlled by loading that pin, or by feeding it back to pin 1. To cut the gain from 80 dB to 38 dB and avoid excessive

loading at pins 1 and 9, both types of gain control are used.

The internal oscillator frequency is set by C1 and R4. With the values shown, the output pulse train (at pin 11) will have a frequency of 150 Hz. Capacitor C2 rolls off the error-amp well below that frequency. Resistor R3 was added in series with the thermistor probe to satisfy the IC's "common-mode" input specification of 1.8–3.4 volts for the full temperature range.

The pin-11 output is fed to an optoisolator. The balance of the circuit, to the right of the optoisolator, may look somewhat familiar to you. It is pretty much a classic light-dimmer circuit with the role of the control potentiometer being filled by the optoisolator.

Temperature control is achieved by varying the "setting" of the "potentiometer" (the optoisolator) by varying the on-time of that device's light element. And, of course, that is done by varying the duty cycle of U1's output. Maximum duty cycle (45%) is achieved when the pin-1 voltage is much lower than the voltage at pin 2. As warming increases, the thermistor's resistance decreases, decreasing the voltage at pin 2. As the pin-2 voltage approaches the pin-1 voltage, the output's duty cycle decreases, reducing the amount of power delivered to the heating element.



*Here's one of the author's applications for the controller—a home-made oven used to dry PC-boards in less than one-half hour.*



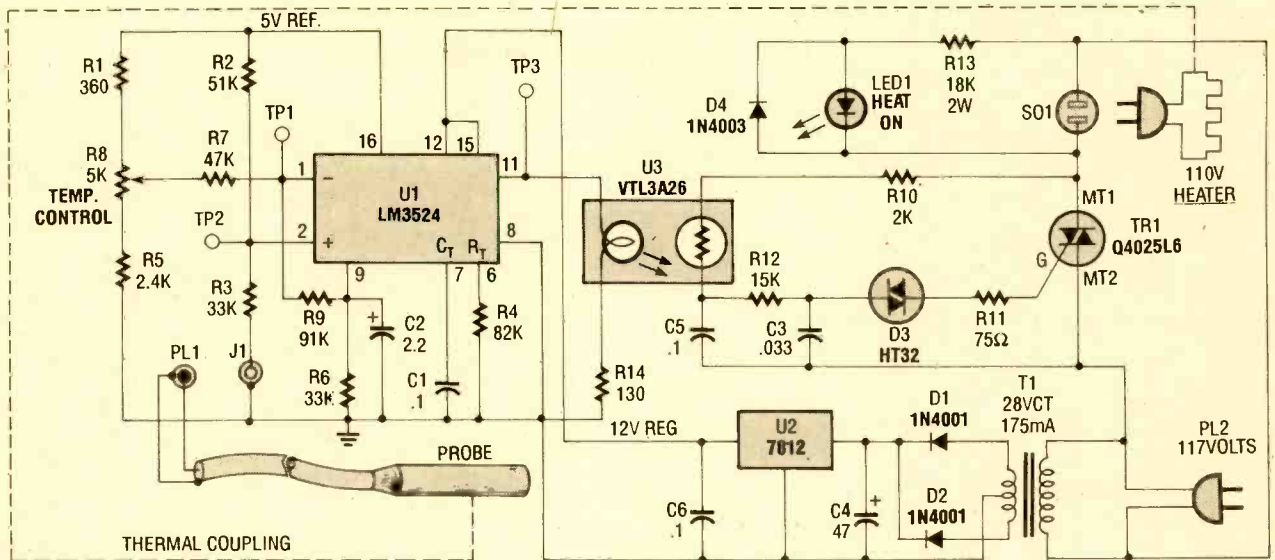

Fig. 1. The heart of the Precision Temperature Controller is U1, an LM3524 pulse-width modulator. That IC is normally used in switching power supplies, but is versatile enough that it can be used in many other applications, including this one.

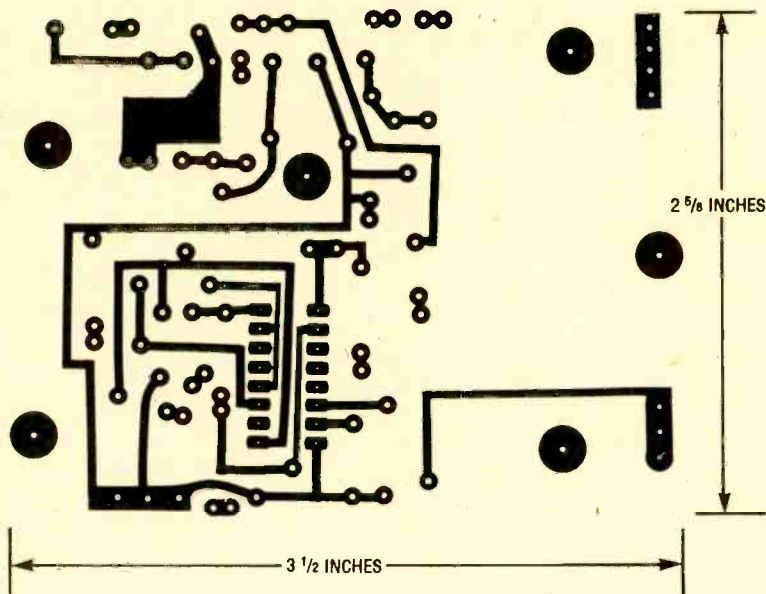

Fig. 2. While any construction technique can be used, the author elected to use a printed-circuit board. If you choose to do the same, here's a PC pattern that you can use.

The heating element is connected to the circuit via SO1. An LED is connected across SO1 to serve as a heating indicator. Its brightness will vary with the amount of power delivered to that socket.

**Construction.** While any construction technique can be used, the author elected to use a printed-circuit board. A template of the author's PC board is shown in Fig. 2. As shown in the parts-placement diagram (see Fig. 3), all parts except TR1, J1, SO1, R8, LED1, and, of course, the probe assembly mount on the board.

Except for the Triac, the off-board

components mount to the front panel of the project's enclosure. The Triac (TR1) is mounted on a 2 × 2 × 1/8-inch heat sink mounted above the PC board on 5/8-inch standoffs. The voltage regulator (U2) should also be heat sunk. The author found that a small (3/4 × 1 3/4-inch) piece of scrap aluminum worked well for that.

Use any enclosure that's large enough to accommodate the project comfortably. The PC board should be mounted on 1/4-inch standoffs on the bottom of the enclosure.

The next step is to assemble the thermistor probe. Details for that task are shown in Fig. 4. Start with about a two-

foot length of miniature (small-diameter) coaxial cable. Wire the thermistor across the end of the cable as shown and then thread the cable through a 6-inch length of 1/8-inch I.D. brass tubing. Place a small amount of heat-sink compound over the thermistor and then push it into the tube until only about a 1/8-inch pigtail extends beyond the end. Crimp that end of the tube and solder to seal it closed. Use a piece of heat-shrink tubing on the other end of the tube to provide a more finished look and to supply a degree of strain relief. Waterproof the probe with a good-quality silicon sealant for applications where it is likely to be placed in liquid. Finish up by placing a line-mounted jack on the free end of the cable.

**Using the Controller.** The Temperature Controller must be calibrated for use in any particular application. When warming a liquid, for instance, place the probe in the liquid and plug the heat source—such as a submersible heater or a hot plate—into SO1. Begin with potentiometer R8 set fully counterclockwise and apply power.

Monitor the temperature with a good quality thermometer. Advance temperature control R8 until the LED just begins to glow. Each time the LED goes out, advance the temperature control as before until the LED just begins to glow again. Repeat the process until the desired temperature is reached as indicated on the thermometer. Note the position and you are done.

Calibrating the controller for warming corrosive chemicals such as PC

## PARTS LIST FOR THE PRECISION TEMPERATURE CONTROLLER

### SEMICONDUCTORS

- U1—LM3524 regulating pulse-width modulator, integrated circuit  
 U2—7812 12-volt, 1-amp voltage regulator, integrated circuit  
 U3—VTL3A26 optoisolator/coupler, integrated circuit (Allied Electronics 890-0226)  
 TR1—Q4025L6, 25-amp, 400-PIV. Triac  
 D1, D2—1N4001, 1-amp, 50-PIV, rectifier diode  
 D3—HT32 Diac  
 D4—1N4003 1-amp, 200-PIV, rectifier diode  
 LED1—Jumbo light-emitting diode

### RESISTORS

(All resistors are 1/4-watt, 5% units, unless otherwise noted.)

- R1—360-ohm  
 R2—51,000-ohm  
 R3, R6—33,000-ohm  
 R4—82,000-ohm  
 R5—2400-ohm  
 R7—47,000-ohm  
 R8—5000-ohm potentiometer, linear taper  
 R9—91,000-ohm  
 R10—2000-ohm  
 R11—75-ohm  
 R12—15,000-ohm  
 R13—18,000-ohm, 2-watt  
 R14—130-ohm

### CAPACITORS

- C1, C5, C6—0.1- $\mu$ F, polyester  
 C2—2.2- $\mu$ F, 35-WVDC, tantalum  
 C3—0.033- $\mu$ F, polyester  
 C4—47- $\mu$ F, 25-WVDC, electrolytic

### ADDITIONAL PARTS AND MATERIALS

- T1—28-volt CT, 175-mA, transformer (Allied 928-4101 or equivalent)  
 J1—Miniature phone jack (Radio Shack 274-1565 or equivalent)  
 PL1—Miniature phone plug (Radio Shack 274-1567 or equivalent)  
 PL2—117-volt AC molded power plug with line cord  
 SO1—AC socket  
 Thermistor (negative temperature coefficient, Keystone AL03006-58.2K-97-G1 or equivalent, Allied 837-5210), printed-circuit board materials, enclosure, brass tubing for probe, miniature coaxial cable (Radio Shack 278-752 or equivalent), LED holder (Radio Shack 276-079 or equivalent), wire, solder, hardware, etc.

Note: Many of the components used in this project are available from Allied Electronics, 401 East 8th St., Ft. Worth, TX 76102, Tel. 800-433-5700. Allied also has stores nationwide; contact them directly for the one nearest you.

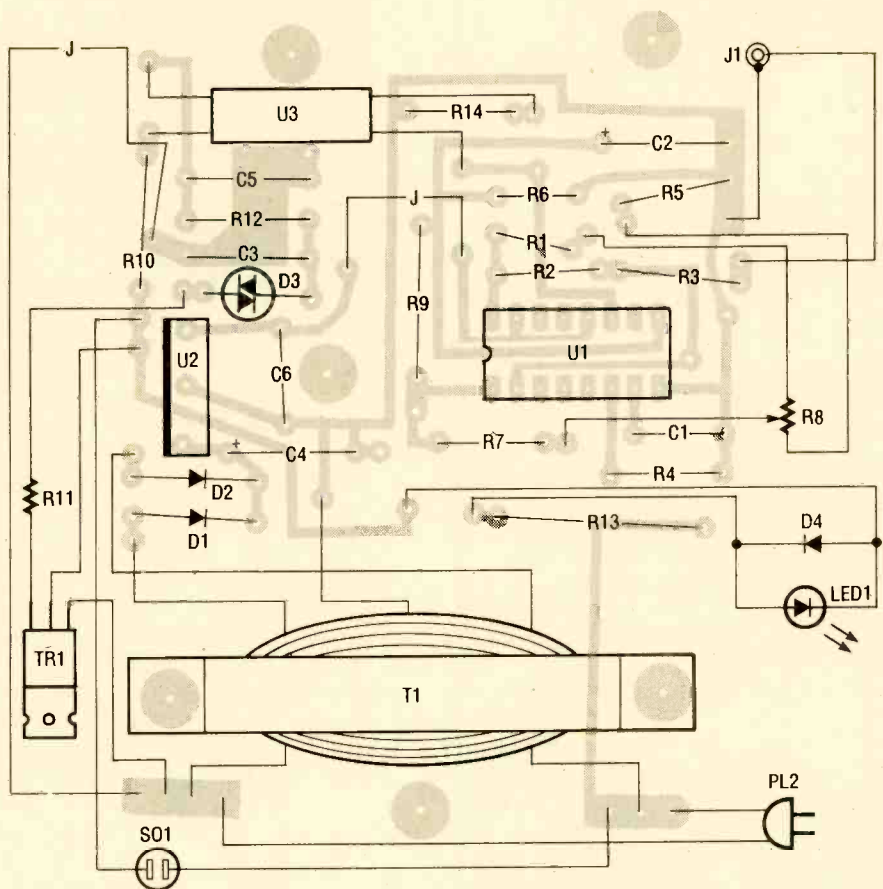

Fig. 3. Most of the parts mount on the board, as shown here. The Triac (TR1) requires a hefty heat sink, so it is mounted above the board on standoffs.

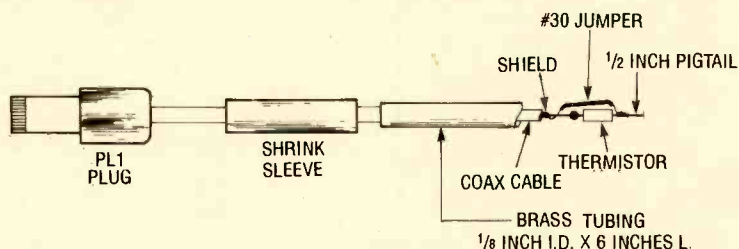

Fig. 4. A negative temperature coefficient thermistor is used as a temperature sensor. It is mounted in a temperature probe using the technique illustrated above.

etchant or photographic developer requires a slightly different procedure to protect the probe. Place the container containing the liquid on a buffet-type warming tray and place the probe on the warming tray itself. Increase the setting of R8 as before, monitoring the liquid's temperature with a thermometer until the desired temperature is reached. Note the setting to complete the procedure. Note: Be sure to use a warming plate, not a conventional hot plate for this. A hot plate generates too much heat too quickly and will likely damage the probe.

There are many other applications for the Temperature Controller. For instance, the author used it to speed the baking of resist onto a PC-board blank. The "oven" can be made from a cookie

tin. Holes should be punched in the bottom of the tin for mounting and 1-inch standoffs to create a platform for the board. Corrugate the top edge of the tin to allow for ventilation while preventing light from getting inside. Add thermal insulation by wrapping the tin with layers of cloth (taped in place) and adding a layer of corrugated cardboard to the top of the lid. To insert a thermometer for the one-time calibration procedure, drill a 1/4-inch hole one-inch from the bottom of the tin. As shown in the photo, use a buffet-type warming tray as the heat source and place the Temperature Controller's probe directly on that tray. By raising the temperature in the oven to 120-150°F, drying time can be reduced from overnight to 1/2 hour. ■



# Add CW and SSB to any Shortwave Receiver



*Whether you're thinking of getting your ham operator's license, or just have a yen to eavesdrop on CW and SSB communications, this inexpensive circuit can help you reach your goal.*

MICHAEL A. COVINGTON, N4TMI

It's easy to add CW and SSB capability to a low-cost shortwave radio. When you do, you'll be able to hear not only CW transmissions in Morse code, but also single-sideband (SSB) voice communications from hams, aircraft pilots, and the military. That's accomplished by adding a beat-frequency oscillator (BFO) to the radio circuit; the output of the BFO mixes with the incoming signal. The circuit, which we will henceforth refer to as the CW/SSB Adapter, replaces the missing carrier in an SSB signal, and it converts a CW signal into an audible tone.

The CW/SSB Adapter can be used with a portable transistor receiver or the car radio that you use with our High-Performance Shortwave Converter (*Popular Electronics*, October 1989). All that's required is that the receiver have a 455-kHz intermediate frequency (IF). Practically all do, but it's a good idea to check the IF before modifying the receiver.

**How it Works.** A schematic diagram of the CW/SSB Adapter is shown in Fig. 1. The circuit—consisting of a 455-kHz IF transformer, a 2N2222 general-purpose transistor, and three support components, is little more than a simple Hartley-type, beat-frequency oscillator (BFO) designed to put out a clear 455-kHz sinewave.

For the technically minded, here's how it works. Suppose power has just been turned on. Resistor R1 feeds a small amount of current into the base of Q1, which makes Q1 conduct. With Q1

conducting, a surge of current is sent from the emitter of Q1 through T1. The primary of T1 has a capacitor across it, forming a tuned circuit, which imme-

diately converts the surge of current into an oscillation, rather like the way a bell rings when hit sharply. Left alone, the oscillation would die out, but Q1 amplifies it and keeps it going.

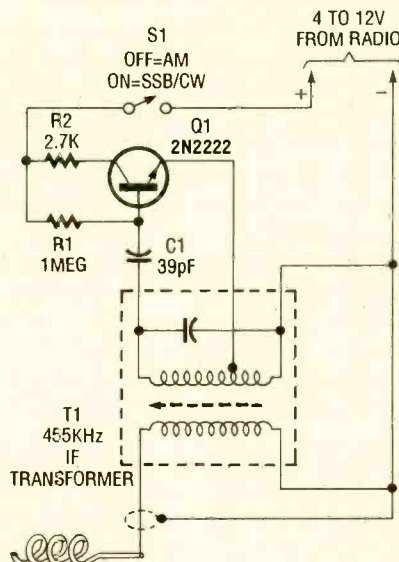

PLACE NEAR OR AROUND DETECTOR DIODE

Fig. 1. The CW/SSB Adapter is made up of very few components, and none of them are critical.

**Construction.** This circuit is designed to be built from salvaged parts, so check your junkbox before shopping for parts. Transformer T1, a 455-kHz IF transformer, can be taken from any discarded AM radio. Given a choice, use the first or second IF transformer, usually color-coded yellow or white. If the radio is AM/FM, be sure you don't get a 10.7-MHz transformer from the FM section (usually orange, blue, or green).

Transistor Q1 is likewise a junkbox item. Almost any general-purpose NPN silicon transistor will do; the 2N2222 (used in Fig. 1) and 2N3904 are good examples. A junked radio will probably contain at least one C945 (a general-purpose amplifier transistor), which will also do just fine.

The author's prototype of the CW/SSB Adapter was built on a small piece of perfboard, the layout of which is not critical. The output of the CW/SSB Adapter should go into a shielded ca-



ble, as shown in Fig. 1. You can get pieces of small-diameter shielded cable from junked tape recorders, record players, or microphones.

**Tuning Up.** After you've assembled the CW/SSB Adaptor, but before installing it in the radio, take a moment to adjust it. Remove the shield (but not the insulation) from the final inch or two of the CW/SSB Adapter output cable and place the unshielded part near the radio's detector diode. If you don't know where the detector is located, just put it close to the radio's IF transformers.

Next, turn on the radio and tune in a shortwave broadcast station that has a fairly strong signal. Then apply power to the CW/SSB Adapter. Adjust the transformer's tuning slug until you get a nice loud whine in the receiver. If the transformer was taken from a correctly aligned radio, you'll probably have to turn the slug counterclockwise two or three turns. There may be more than one position that gives a whine; select the loudest one. Don't be disappointed if the whine is not especially loud.

**Troubleshooting.** If you don't hear a

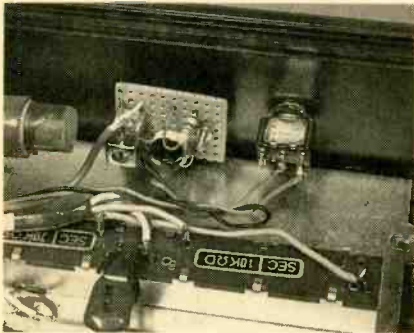

The CW/SSB Adapter is easily installed inside of an inexpensive receiver such as this Realistic DX-40 AM/FM/SW unit.



Once switch S1 is in place, it's a good idea to label the switch positions on the outside of the receiver's enclosure. Removing power from the circuit, by flipping S1 to the AM position, effectively disconnects the Adapter from the receiver's detector diode.

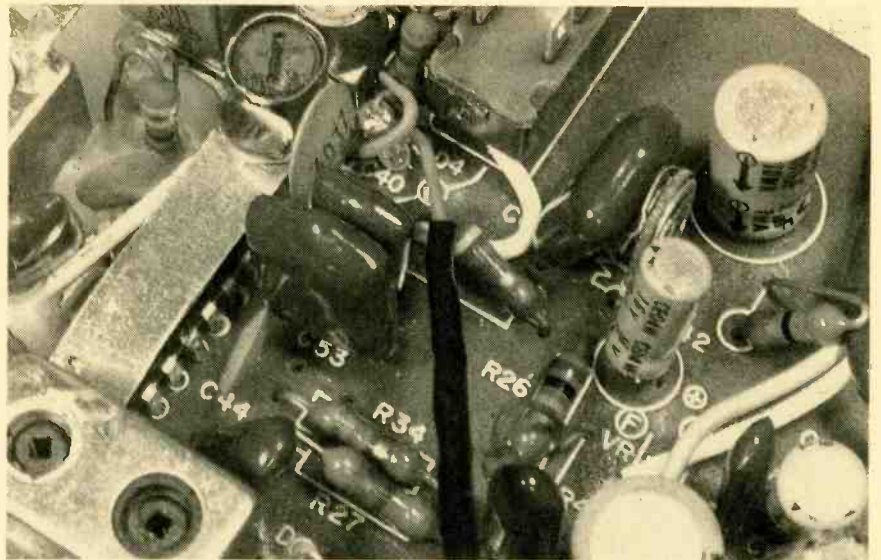

The installation of the CW/SSB Adapter does not require that any wire connections be broken. Instead, the circuit is coupled to the receiver's detector diode through shielded wire.

#### PARTS LIST FOR THE CW/SSB ADAPTER

- Q1—2N2222, 2N3904, or similar general-purpose NPN silicon transistor
  - R1—1-megohm, 1/8-watt, 5% resistor
  - R2—2700-ohms, 1/8-watt, 5% resistor
  - C1—39-pF polyester or ceramic-disc capacitor
  - T1—455-kHz IF transformer (see text)
  - S1—SPST toggle switch
- Printed-circuit or perfboard materials, shielded cable, hook-up wire, solder, hardware, etc.

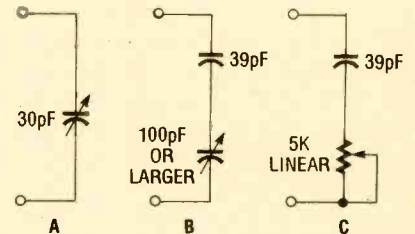

Fig. 2. Any of these sub-circuits can be added to the CW/SSB Adapter to make it tunable, and there is no instance in which one is preferred over the others. Which one you use is determined by what you happen to have on hand.

whine coming from the shortwave set, try coupling the CW/SSB Adapter more closely to your receiver by actually wrapping the output lead around the detector diode. An alternative to that would be to put the shortwave set aside and test the CW/SSB Adapter with an inexpensive AM radio that doesn't have much shielding.

If you still can't get a whine, the CW/SSB Adapter is probably not oscillating. Check your wiring carefully and try using a lower value for R1 (perhaps 330k or even 100k). Also try swapping the ends of the tapped side of T1.

**Installation.** Mount the CW/SSB Adapter circuit board and power switch wherever it's convenient inside the radio. Be sure to tap into the radio's power supply after the main on/off switch so that the CW/SSB Adapter can't drain the battery if it's accidentally left on. The balance of the installation is simple since there is no direct connection from the CW/SSB Adapter output to

the radio. Instead, you'll rely on coupling as you did when tuning up.

Your job is to find the best place to couple the circuit. The Adapter's signal should be kept out of the antenna so that it doesn't get into other receivers, and out of the AVC (automatic voltage control) system so that the receiver doesn't mistake it for a strong incoming signal and reduce its gain. Usually, wrapping a few turns of wire around the detector diode is sufficient.

Test the coupling by tuning to a shortwave broadcaster and turning on the CW/SSB Adapter. If you don't get a loud whine, the coupling is too weak; but if the received signal disappears when the CW/SSB Adapter is turned on, the coupling is too strong. Adjust the position and the amount of coupling (number of turns) as necessary. Above all, be sure not to make a direct electrical connection.

**How to Tune CW and SSB.** You'll find  
(Continued on page 108)



In the early years, a wide variety of transmitters were designed and used, although none of them reached the level of sophistication that even inexpensive CB units have today. The history of radio transmitters (and of course receivers) is one of constant growth.

The earliest transmitters were spark-gap models. While modern radiotelegraph operators are used to hearing the singsong "beep beep beep" of undamped continuous-wave transmitters, early wireless operators heard a raucous "zzzt zzzt zif" sound from damp-

ed spark-gap transmitters that were then the norm. Despite their simplicity, they weren't banned by the FCC until 1938.

Radio stations were also different than today's stations. In the pre-World War I era, only the low frequencies (less than 1000 kHz) were used, and waves of those frequencies have very long wavelengths. Because antenna size is a function of wavelength, very tall towers were common.

Radio Arlington (also called NAA), the Navy's primary radio station at one time, had two 400-foot towers and one

600-foot tower. Radio Arlington was located in Arlington, VA, across the Potomac River from Washington, DC. People traveling north on Washington Blvd. today can see the two buildings (shown in the photo that appears on this page) still standing a few blocks past Columbia Pike. The towers themselves, however, were torn down sometime in the early 1940's to make air room for National Airport, and are survived only by a historical marker sign and their bases (which are now called "parking lots"). The old NAA station was decommissioned in 1956.

# EARLY RADIO TRANSMITTERS

*The history of radio is chock full of colorful stories, and there's a lot that we can learn from them even today.*

BY JOSEPH J. CARR

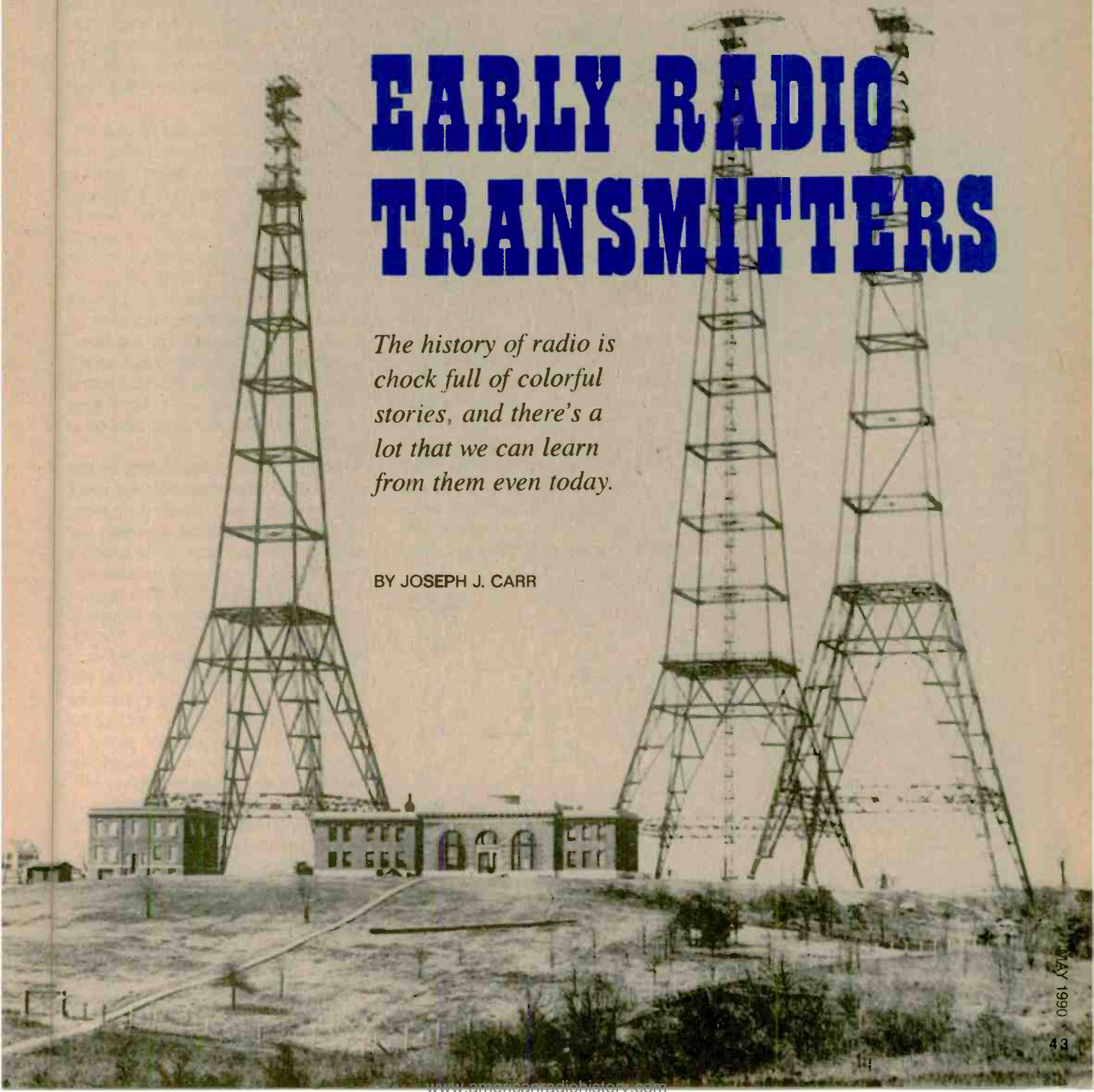

**Hertz's Contribution.** When the air between two points becomes ionized, its electrical resistance breaks down and current flows in the form of a high-voltage spark through the normally insulating air. The most spectacular example of that phenomena is natural lightning. As any AM band or shortwave listener will attest, lightning generates RF signals across a wide swath of the radio spectrum. The RF is generated, in part, because the spark or lightning "bolt" is actually a large number of oscillating bolts. The electrical current rapidly oscillates back and forth between the two poles. Early radio pioneers discovered that spark energy

could be tapped and used in radio transmitters.

Heinrich Hertz discovered in 1887 that electromagnetic waves could be generated with a spark-gap apparatus. The transmitter consisted of an induction coil that generated high voltage from an interrupted-DC source (a battery) and a pair of copper plates that were used for the antenna. The receiver was a resonant length of wire wound to form a coil with its ends terminated in a spark gap. When the transmitter was keyed, a spark jumped across the receiver-coil spark gap.

Hertz conducted his experiments on frequencies from 31.3 to 1250 MHz (wavelengths of 960 cm to 24 cm). It is interesting to note that those frequencies are in what we now call the VHF/UHF and lower microwave regions. Although Hertz conducted his experiments in that range, it would be nearly fifty years before those wavelengths were commercially viable. The early practical success of radio depended on using much longer wavelengths. Marconi, for example, used a wavelength of 960-meters (313-kHz) in his famous experiments and public demonstrations.

Hertz's apparatus was exceedingly crude, but it worked over the short distances he needed to demonstrate his experiments and prove his theories. With such a simple set-up, Heinrich Hertz verified Maxwell's equations for electromagnetic waves (previously used to explain visible light and infrared radiation), demonstrated that electromagnetic waves with wavelengths longer than infrared actually exist, and

measured the approximate wavelengths of such radiation. Perhaps the most important contribution of Hertz was that he initiated the search for practical wireless telegraphy.

**Spark Gap Transmitters.** The very earliest spark-gap transmitters used a simple high-voltage spark gap coupled to a helical coil. Energy for the spark gap was stored in a Leyden-jar capacitor that was charged by an induction coil. It produced a very wide-band signal that caused tremendous interference with nearby stations. Later, the spark-gap transmitters used an oscillatory coil in place of the helical coil. Those devices reduced the bandwidth required, and so permitted more stations to operate in the same segment of the spectrum.

One of the earliest practical spark-gap transmitters used by experimenters and amateur-radio operators was the spark-coil design (see Fig. 1). Spark coils are high-voltage transformers, usually encased in wood or some other insulating material, that incorporate a vibrator or interrupter switch in their primary circuit. When DC is applied to the primary of the transformer, the vibrator chops it to allow it to pass through the transformer like AC. If a telegraph key is wired in series with the DC input to the primary circuit, as shown in Fig. 1, then the high voltage will turn on and off in step with the key.

The high-voltage secondary of the spark coil is connected across a spark gap. When the key is pressed, an electrical spark will oscillate between the points of the spark gap. Some tuning is provided by the variable series-resonant tank circuit (C1/L1) that is connected across the spark gap. Coupling to the antenna is provided by a variable inductor, L2, which is wound as a transformer secondary with L1 as the primary coil. Typical tuning instructions called for adjustment of L1 and L2 for maximum antenna current. Either a hot-wire RF ammeter or an incandescent light bulb in series with the antenna line was used as the indicator.

The design was very popular among radio experimenters and amateur radio operators. Some such designs were published in Hugo Gernsback's early radio magazines. Spark coils could be bought from radio-supply houses (local and mail-order), scientific-apparatus companies, and auto-parts stores. The latter source was viable because a vibrator spark coil was the source of

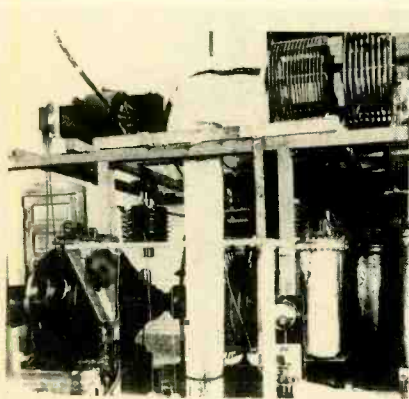

*This was the most powerful rotary spark-gap transmitter of its time. Installed at a Navy radio station, it produced 100 kW on a frequency of 113 kHz. In the lower portion of the picture are the motor and rotary spark gap. To the lower right are the compressed-air high-voltage capacitors, and on top of the platform you can see the oscillation transformer.*

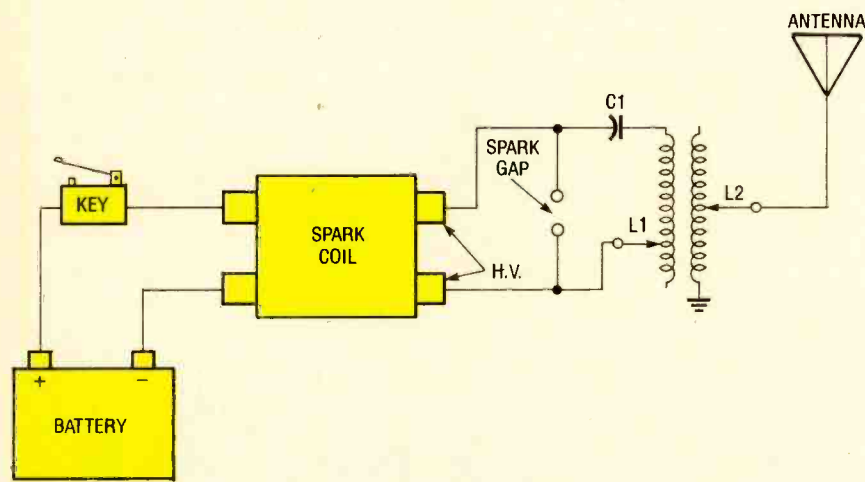

*Fig. 1. One of the earliest practical spark-gap transmitters used by experimenters and amateur-radio operators was this spark-coil design. Spark coils are high-voltage transformers, usually encased in wood or some other insulating material, that incorporate a vibrator or interrupter switch in the primary circuit.*



high voltage for the spark plugs in the Ford Model-T and other cars of the era. The introduction of the Kettering ignition system, which was used for 50 years until the invention of all-electronic ignitions, deprived hams of readily available "transmitters." Many radio amateurs used spark coils purloined from the family "tin lizzy" for their transmitter! I suppose that there were frequent arguments over which took priority: a trip to town or good DX.

An AC version of the spark-coil transmitter is shown in Fig. 2. The spark coil is replaced with a high-voltage 60-Hz transformer. The key was wired into the primary circuit as shown. In most cases, the "key" was either totally enclosed and insulated, or it was actually an electromechanical relay that was, in turn, operated by an actual telegraph key. Those arrangements were safer than straight keying a live, high-power, 117-VAC circuit.

Although banned for transmission purposes in the late 1930's, that same spark-gap circuit was used in medical devices called "electrosurgery generators" (or "Bovies," after the inventor, in medical jargon). During the 1930's, surgeons discovered that RF power would not only cut tissue cleanly, but also cauterized and nearly sterilized the tissue as it cut. The spark-gap ES generator reduced bleeding (hemostasis) from the surgical cut, and was considered superior to using the old scalpel-and-clamps method. Although solid-state ES generators began to replace the old spark-gap types in the early 1970's, "brand new" spark machines (which internally looked like the models sold in the 1930's) were sold as late as the early 1980's. Some surgeons claimed that the spark-gap models offered superior hemostasis over the new solid-state models. Although only in my thirties in 1979, I had worked on spark-gap RF generators for several years—which no one in my radio club quite believed.

Another form of spark-gap transmitter depended on a DC-driven motor/generator that produced the AC required to operate the high-voltage transformer. Beyond that change, the circuit is similar to the other spark-gap transmitters presented in this section.

Still another form of spark-gap transmitter was the rotary spark gap shown in Fig. 3. Although conceptually similar to the fixed spark gap, an electrical motor was used to spin a rotor-style electrode for the spark gap. Keying was accomplished by interrupting the cur-

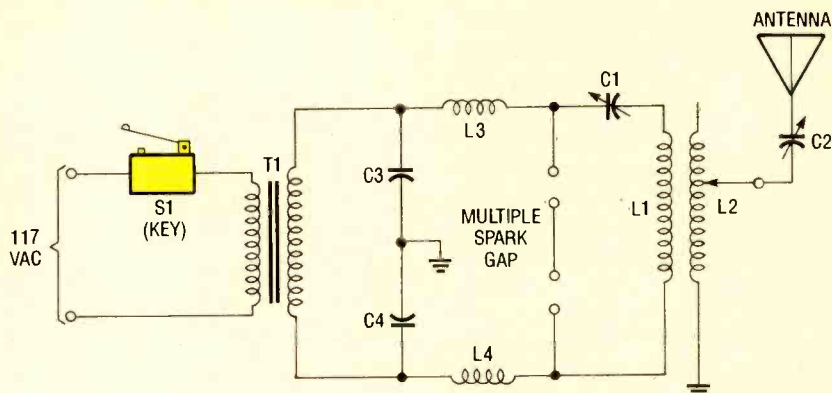

Fig. 2. This is an AC version of the spark-coil transmitter. The spark coil is replaced with a high-voltage 60-Hz AC transformer. That same spark-gap circuit was used in medical devices called electrosurgery "machines."

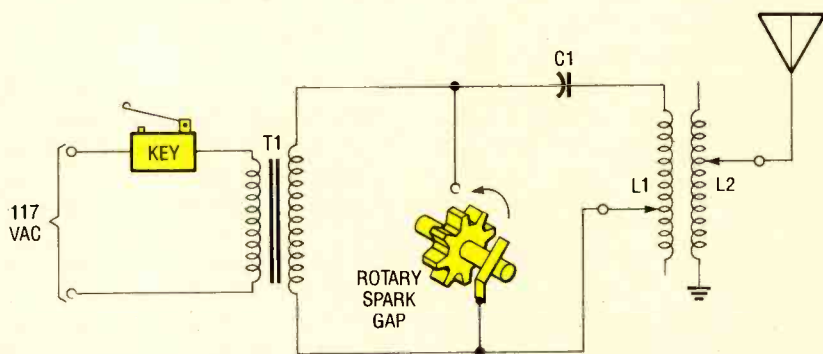
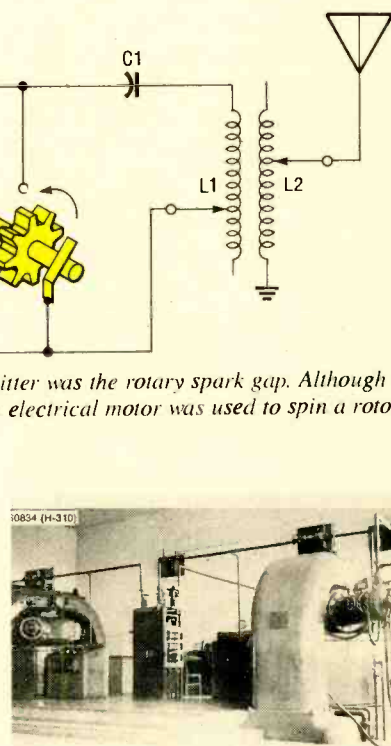

Fig. 3. Still another form of spark-gap transmitter was the rotary spark gap. Although conceptually similar to the fixed spark gap, an electrical motor was used to spin a rotor-style electrode half of the spark gap.

rent to the primary of the transformer. One of the photos shows the most powerful rotary spark gap transmitter of its time, which was installed at Navy radio station NAA in Arlington, VA. It produced 100 kW at a frequency of 113 kHz. In the lower portion of the picture are the motor and rotary spark gap. To the lower right are the compressed-air, high-voltage capacitors, and on top of the platform you can see the oscillation transformer.

The design of spark-gap transmitters changed in two major ways between the turn of the century and World War I. First, the helical coil was outlawed and replaced with the oscillation transformer. That helped reduce the bandwidth of the signal, although by modern standards they were still very broad. Next, the introduction of quenched spark gaps limited the damping and provided a signal with yet a smaller bandwidth.

**Arc Transmitters.** The arc transmitter was invented in 1903 by Valdemar Poulsen. According to its inventor, it consisted of a "...resonant circuit containing a direct-current arc between carbon-



THE HIGHEST POWER ARC GENERATORS IN THE UNITED STATES

This 500-kw, 17.5-kHz arc generator was installed in 1918 at the U.S. Navy radio station at Annapolis, MD, and was the highest power arc transmitter in the United States.

copper electrodes in a magnetic field and a hydrogen atmosphere." The U.S. Navy first procured arc transmitters in 1907. In tests, an undamped continuous wave (or CW) 30-kw arc transmitter outperformed a 100-kw, damped spark-gap transmitter.

Another attempt at producing undamped CW signals was the Alexanderson Alternator, invented by Dr Ernst Alexanderson of General Electric. The alternator was similar in concept to the alternators that generate alternating

current for power distribution (of which, GE was a primary source). The frequency of the AC produced by those generators is a function of the rotational speed and the number of poles in the generator's stator. The power generator produces 60-Hz AC, while the alternator in your car produces a much higher frequency AC (which is rectified inside the alternator to produce DC for the car battery). You can hear the car-alternator frequency change with engine speed if your radio suffers from alternator interference. The Alexanderson alternators produced high-power CW signals in the 20-kHz region.

**Vacuum-Tube Transmitters.** The earliest vacuum tubes could only operate at audio and the lowest RF frequencies, were low powered, and were very unreliable. They were also terribly expensive and tended to be fragile. The



This Navy 5-kW shipboard arc transmitter/receiver station operated on a frequency from 100 to 250 kHz.

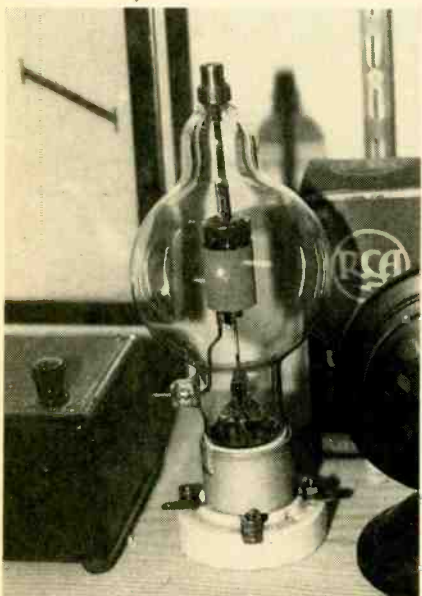

The 250TH E-M tube was a triode that used a plate cap for the anode (on top) and a side electrode for the grid.

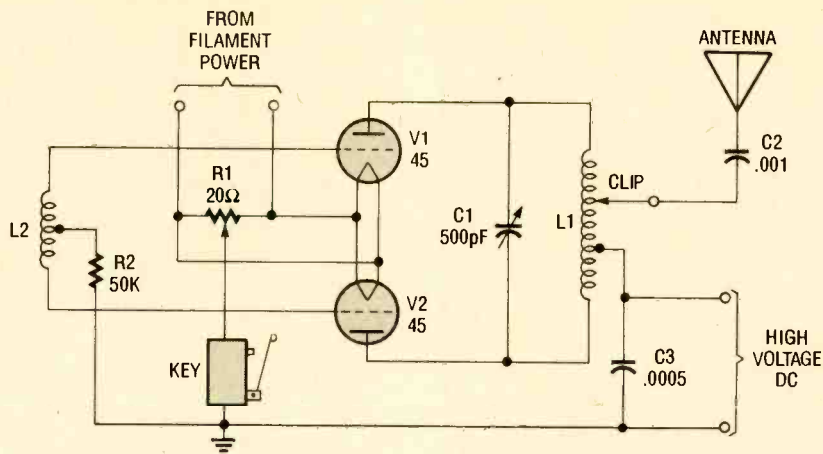

Fig. 4. Perhaps one of the most common forms of amateur tube transmitters was this "pair of 45's in push-pull." The oscillator circuit was tuned in the plates and untuned in the grids.

low-power problem was eventually overcome, but not until relatively late. In 1915, the U.S. Navy radio station at Arlington, VA had installed a radiotelephone transmitter with 2.5-kW output on a frequency of about 120-kHz, but it required 550 vacuum tubes in the final amplifier to output it!

Two basic forms of transmitter design emerged in the early vacuum-tube era. First was the simple oscillator-type transmitter. In those models, an RF oscillator was coupled to the antenna without any intervening stages. Perhaps one of the most common forms of that type of transmitter in amateur circles was the famous "pair of 45's in push-pull" shown in Fig. 4. The name came from the configuration of the circuit: The type-45 triodes were connected as a "push-pull" oscillator. Keying was accomplished by grounding the directly heated cathodes through a cathode-bias resistor. Coupling to the antenna was through a DC-blocking capacitor (C2) and a tap on the plate tank coil.

The 45 oscillator served as a low-power shortwave transmitter for amateur-band operation for several years. Although older hams fondly remember the reddish glow of the tube plates, those oscillators were unstable and tended to have a high vacuum-tube casualty rate. Because the tubes were expensive, and often came from the family broadcast-radio receiver, some older magazines reported family friction over those transmitters.

The oscillator-type transmitter was the simplest vacuum tube design that could be accommodated, and schematics and information on it appeared in amateur-radio construction literature until the early 1960's.

However, in most transmitters the oscillator gave way in the 1930's to the master-oscillator power-amplifier (MOPA) design. Those transmitters isolated the sensitive and low-powered oscillator from the load and the problems that the varying load caused by using an RF-power amplifier. The RF-power amplifier also served to boost the power levels to a much higher wattage than an oscillator could handle by itself. In some transmitters, there was also an intermediate power stage between the oscillator and the power amplifier called a buffer amplifier. Those are, however, still classed as MOPA transmitters.

World War II spawned a lot of electronic developments, and indeed was the first "electronic war" in history. The power levels of vacuum tubes had already been increasing in the late 1930's, but with World War II pushing their development, a lot of kilowatt and higher power-level tubes were invented by Eitel-McCullough, RCA, and other manufacturers.

As examples, the 250TH Eitel-McCullough tube was a triode that used a plate cap for the anode (on top) and a side electrode for the grid. The 304TL and 304TH tubes were designed with essentially four parallel triodes inside the same envelope.

Those tubes were intended mostly for HF service in grounded-grid power amplifiers. RF power tubes finally came of age with the invention of high-power tetrodes, such as the 4-400, 4-1000, and high-power pentodes, such as the 813. The invention of those tubes, and others of the same class, forever changed the look of radio transmitters—without a doubt for the better.



# GIZMO

MAY 1990

A CHRONICLE OF CONSUMER ELECTRONICS

VOLUME 3,  
NUMBER 5

## Terk-ish Delight

**TERK pi<sup>2</sup> ACTIVE INDOOR FM ANTENNA.** Manufactured by: **Terk Technologies Corporation, 56 Harrison Street, New Rochelle, NY 10801.** Price: **\$79.95.**

For those of you unfamiliar with it, the term "active antenna" does not refer to a piece of wire that moves around a lot. Rather, an active antenna is one that incorporates a built-in amplifier to improve reception. It is an active, as opposed to a passive, device; hence the name. *Terk Technologies* has been manufacturing active antennas for a few years now and the *Terk pi<sup>2</sup>*, its latest model, incorporates a new twist that may prove beneficial to quite a few listeners.

The pi<sup>2</sup> is a little antenna intended for unobtrusive indoor use. It is encased in a disk-shaped molded plastic housing about five inches in diameter and can stand upright on an integral base or be laid flat so as to require only about an inch of headroom. We'll have more to say on the subject of positioning later on. A wall-plug-type DC supply provides the power to drive the antenna's amplifier. There's no power switch (although there is a green power-on indicator), but since the amplifier consumes only about half a watt, it won't hurt you to leave it plugged in all the time. If the half-watt is of great concern to you, plug the transformer into one of your receiver's switched outlets so it is on only when the receiver itself is on.

We wanted to open the pi<sup>2</sup> to see what was inside, but the sealed "hockey puck" case precluded that. We surmise, though, from the shape of the case, that the antenna is a simple loop. A blurb on the box—which, by the way, you should keep since it contains more information about the antenna than do the instructions!—more or less confirms that: it refers to the antenna as a "gamma loop" design (U.S. Patent 4,801,944). We advise you to take what's on the package with a grain or two of salt though, since it has a tendency to doubletalk and hyperbole.

As we got ready to put it into action, we searched in vain for adequate information on positioning the antenna. You can use the pi<sup>2</sup> in either of two basic positions:



CIRCLE 50 ON FREE INFORMATION CARD

horizontal or vertical. In its horizontal position, which allows it to be set nearly unnoticed atop a tuner or to fit into tight shelf space, the antenna works omnidirectionally. That is, it picks up signals equally well from all directions, a characteristic you might find useful if you listen to several stations broadcasting from different cities. When it stands up vertically, the pi<sup>2</sup> becomes directional, says the box, allowing it to "pick up specific stations and eliminate multipath distortion" and noise. However, neither the box nor the scanty instructions within tell you which way to turn the antenna to get the best results—do

you turn it broadside to the station you want, or edge on? And, if the answer is "broadside," does it matter whether the front or the back of the antenna is facing the transmitter?

Our experience with conventional loop antennas tells us that the loop should be broadside to the station, and that it will receive equally well from the front or the back. Our limited testing of the Terk, however, seemed to indicate that it favored stations coming in off its edge. In the end, we guess, you'll just have to wave the antenna around the room until you get the

*(Continued on page 8)*

TURN PAGE FOR CONTENTS



# This month in GIZMO

Terk pi <sup>2</sup> Active Indoor FM Antenna .....	pg. 1
Sharp Optonica VC-G980 Voice-Coach VCR .....	pg. 2
Soundesign ACR-550 Air Purifier/Ionizer/Clock Radio .....	pg. 3
CopyCam 601 Enhancer .....	pg. 4
Seiko Voice Station Talking Translator .....	pg. 5
XTreePro Gold Disk Manager .....	pg. 7
FM Tuner .....	pg. 9
Hi-Fi VCR .....	pg. 9
Tower Speaker .....	pg. 9
TV-Mode Camera .....	pg. 9
CD Changer .....	pg. 10
CD Lens Cleaner .....	pg. 10
Remote Control .....	pg. 10
Videocassette Player .....	pg. 10
Automotive CD Player .....	pg. 11
Home Audio Controller .....	pg. 11
Videotapes .....	pg. 11
Voice Recorder .....	pg. 11
Built-in Speakers .....	pg. 12
Mitsubishi Fax .....	pg. 12
Northgate Computer .....	pg. 12
Reference CD Player .....	pg. 12

Gizmo is published by Gernsback Publications, Inc., 500-B Bi-County Blvd., Farmingdale, NY 11735. Senior Writer: Josef Bernard. Contributor to this issue: Tricia Kelley. © Copyright 1990 by Gernsback Publications. Gizmo is a registered trademark. All rights reserved.

## The Young Lady Who Lived in a ROM

OPTONICA VC-G980 VCR WITH VOICE COACH REMOTE CONTROL. Manufactured by: Sharp Electronics Corp., Sharp Plaza, Mahwah, NJ 07430. Price: \$649.95.

We have heard that there are lots of people out there—none of them GIZMO readers, naturally—who still sit in front of their VCR's with the digits of the clocks flashing in their faces; they haven't yet figured out how to set the time. And when those people attempt to program their machines, they consider themselves lucky if they get them to record anything at all—on any channel, at any time. Just turning the VCR on is an accomplishment!

We thought you'd be interested in knowing what one company, at least, is doing to combat VCR illiteracy. For people who won't read the manual that comes with its *Optonica VC-G980* VHS VCR, *Sharp Electronics* supplies with it a remote control that talks them through the programming procedure. Yes, folks, there's a lady in there who, at the push of a button, tells you which button to push next! We'll come back to her in a little while.

First, the VCR itself. Although it lacks the "frills" that a megabyte or so of digital memory would give it, the VC-G980 does offer most of the basic ones: MTS stereo with VHS Hi-Fi sound, HQ picture system, index search, four heads, on-screen display, etc. There are also a couple of unusual features that one doesn't normally find included as "standard" on a VCR.

For example, there's a button marked "tamper proof" on the remote. When you push it, the VCR will refuse to respond to any commands that follow. That feature may come in handy for situations where you don't want other people messing with settings you've made. The recorder can be unlocked by pressing the tamper-proof button again. If you lose the remote, you can also release the function by pressing the all-clear button on the VCR, which may also be the route taken in desperation by those who want to use the unit when you've locked it up and taken the remote with you. Unfortunately, pressing all clear not only releases the tamper-proof mechanism, it also erases *all* the VCR's programming, even to the extent of resetting the clock!

The VC-G980 also has a "video squelch" circuit that Sharp calls "Blue Screen." If a noisy signal—or no signal at all—is being received by the unit's tuner, or if a tape is noisy or contains blank spaces, instead of a screen full of snow



CIRCLE 51 ON FREE INFORMATION CARD

(and a hiss from your speakers) you get a screen full of blue and no sound at all—equivalent to the interstation muting (squelch) on most FM receivers. Fortunately for those of us who like to be aware of what's going through our equipment at all times, there's a switch that allows you to defeat the "blue screen" feature and so see and hear what it is that the VCR would otherwise prevent us from knowing about.

Now for the Voice Coach: It is more than a gimmick—we suspect that it's a sincere effort by Sharp to help people to program their VCR's and to set their clocks. Actually, the more we think of it, the more it seems that the *entire* remote control, and not just the speech system, was very carefully thought out with the concept of user-friendliness (a term we cannot abide) in mind. The remote has a large LCD that shows the time and serves to confirm programming information. There are only a few buttons on the unit—just enough for programming, channel selection, and basic operating control (play, fast forward, pause, etc.) of the VCR. Those are exactly the ones that a first-time or infrequent VCR user would want. Nothing threatening, just the basic functions.

To get at the controls for more compli-  
(Continued on page 6)



## Negative Ions?

**SOUNDESIGN MODEL ACR-550 AIR PURIFIER/IONIZER WITH CLOCK RADIO.** Manufactured by: Soundesign Corporation, Harborside Financial Center, 400 Plaza Two, Jersey City, NJ 07311. Price \$149.95.

Soundesign Corporation has several product lines: low-price hi-fi combos, telephones, clock radios, air purifiers, and a few others. One of the "games" the company seems to enjoy playing is "let's see how many products we can combine in one, and how many different ways we can do it." To that end, Soundesign has come up with such items as a clock radio with a built-in cassette player, a clock radio with a built-in telephone, a clock radio with a built-in night light and, now, the ACR-550 clock radio with a built-in air purifier/negative-ion generator.

We'd always wanted to see what a negative-ion generator would do for us, and having one that would not only do it in the bedroom, but put us to sleep and wake us up as well, was irresistible. So we got one.

The ACR-550 is a cube about seven inches on a side, which makes it larger than most clock radios. That probably results from the size of the fan and air filters it has to contain. Still, the unit fit pretty well on our night table beside the bed. As an AM/FM radio the ACR-550 performed fairly well, with a sound quality about what you would expect from its three-inch speaker. A built-in AM antenna and several feet of insulated wire that serve as an indoor FM antenna are provided. There is no provision for external antennas, and you are cautioned against connecting the FM wire-antenna to anything.

While the radio's dial markings are not illuminated, a small red LED built into the dial pointer makes tuning more convenient than it would otherwise be by bedroom lighting. The radio also has an earphone jack that outputs in mono. You supply the earphone.

The clock uses a large (0.6-inch), 12-hour-format, four-digit, red LED display, with an LED PM indicator (and another LED to indicate that the alarm is set). A user-supplied 9-volt battery can keep the clock running—without the display—for about 30 hours in the event of a power failure. We did not find the backup time-keeping function to be terribly accurate, however.

There's no way of dimming the clock display, but it isn't overly bright and did not keep us awake with its glow. Both the clock and alarm were easy to set using buttons on top of the case. The time-adjust and alarm-adjust buttons that must be depressed along with those used to advance the hour or minute count prevent you from



CIRCLE 52 ON FREE INFORMATION CARD

inadvertently changing the settings. A sleep-timer button starts the radio playing for 59 minutes (you can also set the timer for shorter periods) while you work on getting to sleep.

The only alarm function this clock radio provides is to turn on the radio (and fan, if desired) at the time you select. There's no buzzer or beeper. If you like to fall asleep to quiet music, a dose of the same may not be enough to wake you in the morning—although if you set things so the fan turns on, too, maybe that will awaken you. A snooze button gives you the option of nine minutes or so more sleep after the radio has turned itself on. After its "alarm" goes off, the radio will continue to play for two hours unless you reset it, which sets it up for the next morning's alarm.

Now for the other part of the ACR-550, the part that's supposed to clean up the air. There are two blower speeds: high (50 cfm) and low (20 cfm). At neither speed could the blower sound be termed "unobtrusive," and the slow speed was not too much quieter than the high one, but we suppose you could learn to ignore the noise if you left the blower on all the time. Room air is taken in through the rear and right sides of the cube, passes through a set of filters, and is exhausted through the top of the unit. The exhaust-vent louvers can be reversed to direct air toward either the front or the rear.

The filter inside the intake louvers consists of two layers of material. The first is impregnated with activated carbon, and is

intended to trap larger pieces of airborne particulate matter and to help control odors. Inside that is a white cottony electret filter (an electret is a material with a permanent electric charge built into it—this electret material seems to be positively charged) that Soundesign says attracts and captures small and sub-micron-size particles. We presume that the positive electret material attracts stuff in the air that is negatively charged. Soundesign also says that "... the Electret filter does not lose efficiency as its fibers collect dirt. It continues to perform at a high level of efficiency until its resistance to air becomes too great ..." You figure that one out. It's recommended that the filters, which are not reusable and which cost about ten dollars a set, be replaced every three months.

At the bottom of the ACR-550 cube is a small compartment that holds the clock-backup battery and a small box with a perforated cover. Into that box you can, if you desire, pour scented pellets, whose aroma is picked up by the circulated air and spread throughout the room. You can select the degree to which air passes through this chamber, and that determines how fragrant your room air will be. Our unit came with a pack of "green apple" pellets. Contrary to our expectations, they did smell rather apple-like, but even with the air flow adjusted to its minimum, the effect in our bedroom was rather overwhelming. There's no way to shut off the scent generator without removing the pel-



let box. Other fragrances available from Soundesign include "baby powder" and a "medicated menthol eucalyptus." They cost \$1.95 a packet, or you can obtain a sampler with all six available scents plus the menthol-eucalyptus one for \$10.

Finally, inside the air chamber is a small, needle-shaped electrode whose purpose it is to emit lots and lots of electrons. As air passes the needle, it supposedly acquires a negative charge which, some claim, induces good health and a sense of well being. (It also promotes the attraction of negatively-charged particulate matter by the electret filter.)

Our long-awaited venture into sleeping in negative-ion filled air came to an abrupt

standstill when we discovered that there was no way to run the radio and the ion generator (although we could run the radio and the blower) at the same time, or even to run the ion generator by itself from the sleep timer. In other words, anything involving the clock radio and the negative-ion generator were mutually exclusive. Our guess is that you're supposed to generate negative ions during the daytime, when you're not using the bedroom, and listen to the radio at night and in the morning, when you are. We made a half-hearted effort to fill the room with negative ions in the hour or so before bedtime, but noted no salubrious effect. Nor, come to think of it, did being in a room all day with the gener-

ator going seem to do anything for us. Maybe all this negative-ion business is just part of a plot contrived by someone with a surplus of electrons.

As far as its working as an air cleaner and purifier, the ACR-550 didn't fare too much better. The unit may have helped to ameliorate the effects of an attack of mold spores, but we can't be sure. And one cool morning, we having built a fire in our wood-burning stove to take off a bit of the chill, the house started to fill with smoke, as sometimes happens with those things. We fired up the ACR-550 in the bedroom and shut the door, but hours later the scent of burning oak still lingered. Maybe if we had used the green apples ...



CIRCLE 53 ON FREE INFORMATION CARD

## Details, Details

**COPYCAM CAMCORDER ENHANCER MODEL 601.** Manufactured by: Videolink (Division of Xantech Corporation), 12950 Bradley Avenue, Sylmar, CA 91342. Price: \$59.95.

Back in the days when we traveled a lot, instead of writing letters we sometimes made and sent audio cassettes. We'd try to include a little local color—the cries of sea birds on a deserted beach in New Zealand, weather noises such as the approach of a violent thunderstorm across the harbor in Hong Kong, crowd noises at a New York street fair, and so on. One of our better-remembered efforts included as background the making of a batch of tuna salad, with all the chopping and slicing noises involved. Now, in the age of camcorders, we occasionally create the video equivalent of those audio epistles.

One of the problems we sometimes encounter in the production of those tapes is loss of quality through the "generations" of tapes used. Depending on the equipment on hand at the time, material may be recorded in regular-VHS, S-VHS, or 8mm formats. In preparing the final video edit and "mixdown," material from tape in one format may be transferred to tape using another, and perhaps to still another

tape if we get involved in laying down a separate narrative or musical soundtrack. And, as each transfer is made, there is a concomitant loss of image quality. With formats such as S-VHS, where there is a lot of video information to begin with, that loss does not become immediately apparent. If we're working with material that was recorded at the slow (EP) VHS speed, the difference between the original tape and even a first-generation dub can be quite noticeable.

Camcorder and VCR manufacturers have of late become conscious of the quality losses incurred during dubbing, and often include on their equipment a switch marked edit. The edit switch brings into play a "peaking" circuit that boosts the level of the higher-frequency-parts of a video signal, the parts that are usually attenuated during the copying process. The result of that peaking is better edge definition, meaning a greater apparent sharpness (and less loss of picture quality) in the dub.

The CopyCam Model 601 is a little device manufactured by Videolink that can be connected between a camcorder and VCR, or between two VCR's for that matter, to provide the peaking function. In addition, it allows you some control over the audio information as well. The CopyCam is not fancy, but neither is its price, about \$60.

The palm-of-the-hand-size unit is powered by another one of those wall-plug DC supplies (boy, we wish we had a nickel for every one of those that was around!). This one provides nine volts at 200 mA and plugs into an earphone-type jack at the rear.

Also at the rear of the unit are five RCA-style jacks. Two of those are for getting the video in and out, and the other three are for audio: one input and two outputs. The presence of two audio output jacks does not imply stereo—the CopyCam works only in mono—but is a convenience added for those making dubs to stereo equipment. The mono signal is split inside the enhancer into two; that built-in signal splitter and the two rear-apron jacks make it unnecessary for the user of the CopyCam with stereo equipment to come up with his own apparatus to do the job. All he needs is an extra cable (Videolink supplies one audio and one video cable with the CopyCam unit) and he can have audio (albeit it only monophonic) in both his stereo channels.

While we're on the subject of audio, one of the two controls on the CopyCam's front panel is labeled audio zoom. That is the level control for an audio amplifier that allows you to boost incoming audio levels by up to 20 dB, a feature you may find useful if the original audio level is a bit on the low side. You have to watch out, though—that feature also boosts background noise (and the level of anything else recorded on the tape) and makes tape hiss more noticeable.

The video portion of the CopyCam is similar to that found in the perhaps-better-known Detailer line of equipment. Indeed, Videolink recently struck a deal with the Detailer people, Vidicraft, to purchase their "Detailer" trademark. Furthermore, the CopyCam 610 was designed by a former Vidicraft engineer to contain refinements of the Detailer circuitry. Take all that for what you will.

As we noted above, the device performs its enhancement by peaking, or amplifying

*(Continued on page 6)*



## Now, Repeat After Me ...

SEIKO INSTRUMENTS VOICE STATION TALKING TRANSLATOR. Produced by: Seiko Instruments U.S.A., Inc., 2990 West Lomita Boulevard, Torrance, CA 90505. Price: \$129.95.

The "character" C3-PO in George Lucas' *Star Wars* films was, before he got snaffled up into battling the Empire, a protocol droid. One of his jobs in that capacity was that of translator, and he spoke several thousand languages (including, of course, R2-D2's beeps, hoots, and whistles). We recently had a chance to spend some time with what just might be C3-PO's great-great grandfather.

In principle, *Seiko Instruments* had a good idea when they conceived of their *Voice Station Talking Translator*—a playing-card-size device, with speech stored in ROM, that would whisper in your ear the words you needed in a foreign language. All you had to do would be to repeat what you heard and you would be understood perfectly. What better way to get around in a foreign land and to learn its language than this? And, hearing and repeating the words you needed would certainly be a lot more intelligible to the listener than your taking a stab at turning "ES-tay ah-SYEN-toh es-TAH OH-koo-PAH-doh" ("*Este asiento esta ocupado*;" "This seat is occupied") into something that would be understood by the fat lady from Barcelona about to sit down next to you. The reality of the situation leaves a lot to be desired. There are some good points to the Voice Station, but just how well it does its advertised job of providing repeatable speech is debatable.

The translator is small—about half the size of the operation-manual/phrase book that accompanies it, and not much thicker (about  $\frac{3}{16}$  inch). It's powered by four lithium button cells that give it a working life of about 20 hours (if left to its own devices, the device shuts itself off after about a minute). The 301 phrases of digitized speech it contains are stored in four internal ROM's, and speech is reproduced through a single bud-type earphone; that leaves the other ear free, we suppose, to listen for replies or oncoming traffic.

On the front of the translator are several membrane switches. There are two marked on and off, and another labeled "AC," which stands for "all clear." The AC switch is used to reset the device after the batteries are replaced or should it just decide to lock up all by itself (which, fortunately, did not happen to us). Two more switches are marked play and replay. Those are the ones that you press to listen to the recorded speech, and they are used



CIRCLE 54 ON FREE INFORMATION CARD

in conjunction with a small LCD display that shows a number between 1 and 301 corresponding to a phrase in the little soft-cover phrasebook. Finally, two other membrane switches provide single-step, and fast-forward and -reverse, functions to get you quickly to the number of the phrase you need.

Now here is the first of the Voice Station's several quirks. You're supposed to use the device by finding the phrase you need in the phrase book—phrases are arranged into six categories dealing with such things as aircraft and airports, restaurants, hotels, and the usual tourist and business-traveler stuff—and get the LCD to display the same number as the one printed along with the phrase in the book. Having done that, you'd think you would then press the play button ... but you don't. You press the replay button. If you press play, the counter advances to the number that follows the one you want, and plays the phrase associated with it. You use replay to hear the phrase that goes with the number on the LCD—for the first time, and then again if you want it repeated. The play button seems to be useful only for stepping through the phrases one by one while listening to each. That may be handy if such phrases are alternate sides of a conversation (which is indicated by a diminutive "A" or "B" in the LCD window) or simply for browsing. If you don't understand the way the buttons work, though, you could conceivably wind up in an embarrassing situation.

The Voice Station is currently available in French and Spanish versions—we had the Spanish one and can vouch for the fact that the little man inside sounded authen-

tically Spanish. He was definitely not from South or Central America, but probably from a city such as Madrid in Spain. We don't know what the French version sounds like, but presumably it is Parisian.

However genuine the accent is, though, what you hear through the earphone is of dubious value if you are going to try to repeat it exactly. The first problem comes with the way the speech seems to be stored. It's no easy task to squeeze 301 multiword phrases into a few little ROM's, and the method Seiko used seems to involve reusing a number of the individual words. That is to say, if the word "*disculpe*" ("excuse me") is required in several phrases, the same digitized recording of the word is used each time. That involves a lot of pointing at memory locations and jumping around to get things accomplished, but it does save a lot of valuable memory space. Unfortunately, that method requires that the words be recorded without inflection, since it is not known whether they are going to appear as part of a simple statement, a question, an exclamation, or be inflected to express a particular emotion. The characterless nature of the translator's vocabulary makes its phrases take on a computer-like quality—sort of what R2-D2 might sound like if he were to have undergone a pre-frontal lobotomy. If Seiko expects you to learn the correct way to enunciate a phrase, it had better do better than this. The individual words aren't too badly reproduced, but the translator does not do a good job of putting them together.

Our Voice Station also suffered from what sounded like switching noise at the beginning and end of most phrases. For



instance, "I can't get over the itching" comes out as "Click. *No me puedo recuperar de esta picazon.* Click." The initial click sometimes tends to obscure the first syllable of the first word of a phrase. If you were to mimic the Voice Station exactly, you would undoubtedly be taken to have a strange and exotic new type of speech impediment. Finally, at least one glitch seems to have crept into the Voice Station's ROM's. In enunciating one particular phrase, we found the unit's voice so garbled that it was nearly impossible to make out—the result, we think, of some sort of clocking problem in recording or maybe just a bad bit or two in a ROM.

We had thought of connecting our Voice Station to a little battery-powered amplifier, and perching a small speaker on our shoulder like Long John Silver's parrot. We could have then let the gadget do all our talking for us directly. That scheme seemed a bit too impractical, though, so we abandoned it. Despite all that, we have to admit that the Voice Station is more than a gimmick. Even with its clicks, sometimes marginal intelligibility, and lack of expression, the quality of pronunciation you can get from this translator is much, much better than anything you could expect from phrasebook transliterations. If your needs fit in with its vocabulary, you may be able to learn something from Seiko's little contrivance. ■

## OPTONICA VCR

(Continued from page 2)

cated operations—those for index search, for example, and for setting the counter memory) you have to flip up a panel on the face of the remote control. That panel also contains several of the large buttons used for programming. In fact, you'll get quite a surprise when you see that the button marked clock set depresses search mode, and the one marked prog set uses both the slow and f-adv buttons beneath it. Close scrutiny reveals a tiny pin on the underside of the flip-up button-panel that pushes in a tiny switch beneath it when the panel is closed. That switch, it turns out, allows the control to assign different functions to the same keys on the remote, depending on whether it is closed or not. Very clever. Sharp!

Alright, back to Ms. Optonica. She lives in a ROM inside the remote, and her job is to lead you through the procedures involved in setting the clocks built into the remote and VCR, and to assist you in programming them.

To give you an idea of how the system works, here's how the programming routine goes when you press the prog/set button. Ms. Optonica's voice is heard fairly distinctly through a tiny speaker on the face of the remote. Each paragraph that follows begins with the assumption that you have just pressed the program/set but-

ton on the unit, as called for in the previous step:

*"Here's how to set the program timer. Set the desired channel by using the numbered keypad. Then press the program/set button.*

*"Select either AM or PM by using the AM/PM button, and set the hour and minute of the program start time by using the numbered keypad. Then press the program/set button.*

*"Set the month of the year by using the numbered keypad. Then press the program/set button.*

*"Set the day of the month by using the numbered keypad. Then press the program/set button.*

*"Select either AM or PM by using the AM/PM button, and set the hour and minute of the program end time by using the numbered keypad. Then press the program/set button.*

*"Select the recording speed by using the SP/LP/EP button. Then press the program/set button.*

*"The VCR timer is programmed to record. (Here Ms. Optonica confirms the programming information you've entered.) Press the transfer button."*

The transfer button sends the program from the remote to the VCR. The remote beeps to indicate it is sending the program, and the VCR beeps to tell you it is receiving it. If there's a problem, the VCR beeps at you in a different way, but you're left on your own to find the source of the difficulty.

A routine similar to that, but shorter, helps you to set the clock and the alarm that, at the predetermined time (say 8:00), announces, "Beep. Beep. Beep. It's 8:00." Ms. Optonica will also tell you the current time when you press the clock button, and can inform you of a programming error. A button marked reset causes her to repeat her last instruction in case you forget what you're supposed to be doing halfway through.

An inconvenience arises if you make a mistake or change your mind about programming after you've started. In the case of a programming error, Ms. Optonica forces you to go back to the beginning and do everything over again, whether or not you got the preceding steps right the first time. Also, there's no way that we could find to get out of a programming mode—that's not what the reset button does—once you're in it without running all the way to the end of that particular sequence. We did discover, though, that if you just put the remote down and leave it for a while it resorts to its usual non-programming state, so maybe that's the only answer.

Finally, there's no way to shut up Ms. Optonica. You can, however, turn the volume all the way down and proceed at your own pace without her once you've learned the ropes. You can also interrupt her while

she's speaking if you know what you want to do, by doing it. As soon as you press program/set she jumps to instructions for the next step.

The Voice Coach system used on the VC-G980 is not the ultimate answer to conquering fear of programming, but it can make your VCR seem less intimidating, and maybe even ensure that you set the start and stop times correctly. And if you have to resort to the manual to find out how to work the Voice Coach feature, so much the better. Maybe you'll learn how to use the rest of your VCR the old-fashioned way.

## COPYCAM ENHANCER

(Continued from page 4)

ing, the higher frequencies of the video signal, which contain the detail. If those frequencies are attenuated, as they are through lossy cables (you're not using audio cables for your video, are you?) or simply due to the nature of the copying process itself, that detail tends to disappear in a sort of video smear. Boosting the high-frequency end of the video signal ensures that as much detail as possible is preserved.

If your TV set or monitor has a sharpness control, you are undoubtedly familiar with the effect of video peaking, as well as with what happens when too great a degree of boost is applied to the high-frequency signal. Too much sharpness, like too much salt, is not always a good thing. Video noise and "sparklies" that may be undetectable in the original material (those types of problems are especially prevalent at slower speeds on standard VHS tapes) get peaked right along with the picture information, and if those defects are present, they can make a processed tape harder to watch than an unprocessed one. The video-sharpness control on the front of the CopyCam unit allows you reach your own compromise between sharpness and distracting interference, which is one of the reasons you might choose to use it rather than your camcorder's or VCR's edit switch.

We tried the CopyCam both in copying tapes and as an enhancer for off-the-air material through our VCR's tuner (if your cable service is marginal, the processor might restore some lost quality there as well). We noticed what seemed to be an improvement in picture quality and something of a sense of greater detail there, although turning the video-sharpness control beyond its two-o'clock position introduced too much noise for our comfort. If you do a fair amount of dubbing—possibly from your camcorder to your bigger deck for reasons of convenience—but have no call for the facilities of a fancy editing console, the compensation for loss of detail, both visible and audible, that the CopyCam provides might make it worth using.



## *XTree Revisited: Silver Threads Among the Gold*

**XTREEPRO GOLD DISK MANAGER FOR MS-DOS.** Produced by: XTree Company (A Division of Executive Systems, Inc.), 4330 Santa Fe Road, San Luis Obispo, CA 93401. Price: \$129.

If you've been around personal computers for a while you've probably encountered a program called XTree. XTree provides you with a way to manipulate—copy, move, rename, erase, etc.—the files on your MS-DOS hard disk much more conveniently than DOS permits you to, and makes available to you many functions that DOS does not even include. This rather unsophisticated description of XTree's capabilities applies most properly to the first version of XTree, which did just that (the program's name derives from the ease with which it permitted you to move around the limbs and branches—directories and subdirectories—of the directory tree structure) and not too much more.

The program was later improved upon and became XTreePro, and has also shown up in a version for Apple's Macintosh called XTreeMac. The latest version of this program from XTree Company is *XTreePro Gold*. We would not normally comment on such a mundane occurrence as a simple program upgrade, but this product has added so much, and impressed us so greatly, that we felt it deserved another mention.

The original XTree was great. If you have ever had to copy some, but not all, of the files from a directory on your hard disk to a floppy, or wanted to get rid of a motley assortment of outdated data, you can appreciate what that program had to offer. All you had to do was "tag" the particular files you wanted to copy or delete or move (from a directory list presented by XTree), and off you went. If there was a question of how many files would fit on the floppy before you ran out of space, all you had to do was keep an eye on the right side of the XTree screen as you tagged the files on which you wanted to operate—it showed a running total of the size of the tagged files (and presented you with lots of other useful information as well). XTree also routinely displayed things such as hidden and system files, which DOS did not show. Things of that nature made operating selectively on files a nearly painless procedure.

The original program was superseded by XTreePro, which added such refinements as a WordStar-like text editor called "IWord" and some "point-and-shoot" techniques to facilitate moving things

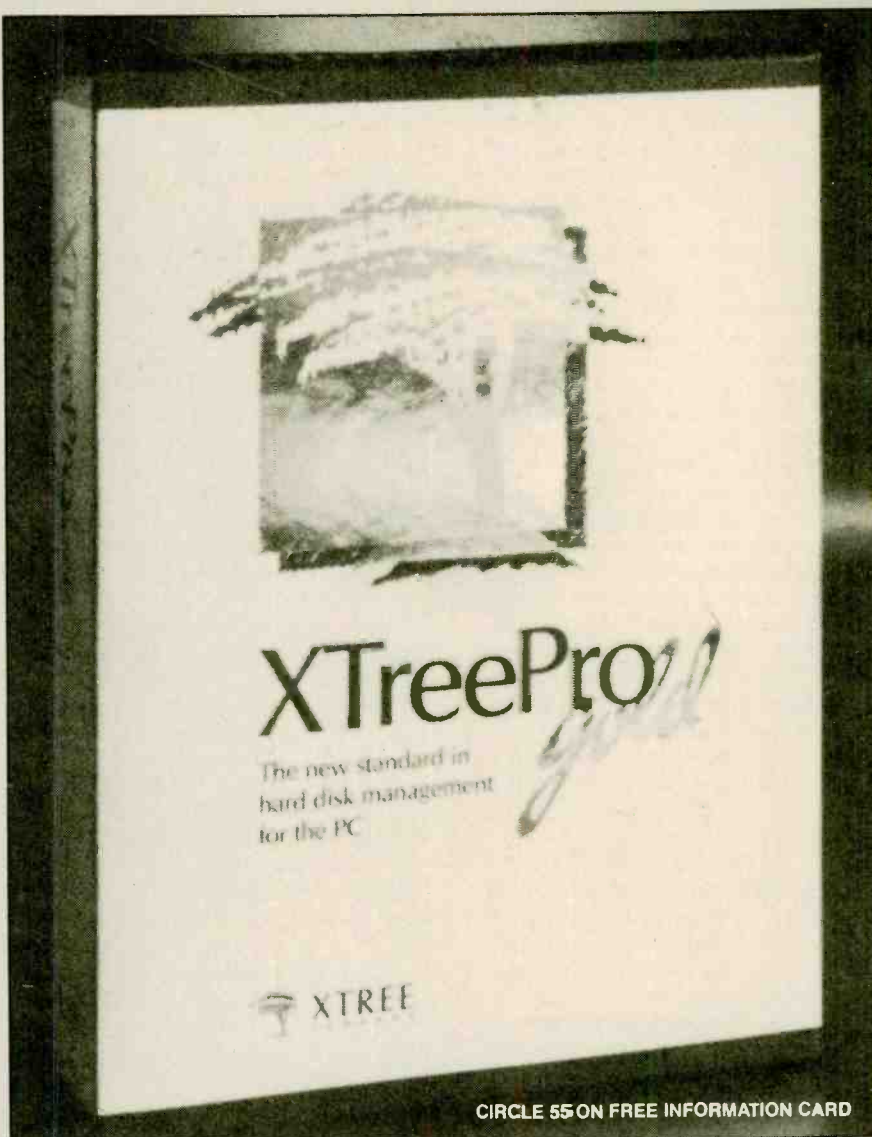

around from directory to directory. While all those new features are nice, they can't hold a candle to what's been added now in XTreePro Gold.

The current program includes all the old functions, of course, but several new ones add considerably to its usefulness and convenience. For example, you can still use IWord for editing text files if you like, but you can now specify another editor if you prefer as your editor of choice, say XyWrite or Microsoft Word, and pop into that one automatically whenever you invoke the edit function. And, while you have always been able to display the contents of files in hexadecimal or ASCII format, that was not especially convenient for formatted files such as those from dBase or Lotus 1-2-3, or from word processors that relied heavily on special formatting codes. With XTreePro Gold you can view your files in one of the old ways if you wish, or you can use a "Formatted" option to see them as they would be displayed from within the word processor or other program. There is also an (albeit somewhat rudimentary) edit

function within the view function that makes it possible for you to change files containing material other than text— .COM or .EXE files, for instance—and write them back to disk after modification.

Another of XTreePro Gold's new features provides split windows, permitting you, in effect, to run two Xtrees simultaneously. You can work on one side of the screen, switch over to work on the other side for a while, and then switch back again.

If you're one of those people who can remember what you said, but not when or where, another helpful feature in this version of XTree gives you the ability to search through your entire disk, or just through selected files, for the occurrence of a specific string of characters. And if your memory isn't even that good, there's an autoview function that gives you a directory listing in a window on one side of the screen and shows the contents of the file whose name is currently highlighted on the other. It's great for browsers, too.

XTreePro Gold requires MS-DOS Ver-



sion 3.1 or higher and a system containing at least 256K. The program itself uses about 70K of RAM, but can be configured to collapse itself to about 7K when it is not being used. Which brings to mind the fact that the original XTree, although primarily a file-management utility, had provision to run also as a primitive DOS shell. XTreePro Gold becomes a case of the tail starting to wag the dog. It makes getting at DOS functions a lot easier without your having to exit the program at all, and begins to approach real "shell-dom." There's an intrinsic format command, for instance, in case you find out in the middle of things that you're running out of space on the floppy you're copying to; and an open command, using a series of short batch files you create, allows you to select a file (document, spreadsheet, database) and access it from the program that originally created it—in other words, you select only the output file, and XTree launches you into the application by itself. Neat. Finally, there's an Application Menu that gives you a way to perform simple or multiple-command functions, which you have previously scripted in batch-type files, with a single command or click of a mouse button. Once you get it working, you may never see DOS again if you don't want to.

All our glowing praise—and we really are impressed by this version of the program—does not come without at least a little criticism. One of XTree's major shortcomings over the years has been the quality of its documentation. And, although this upgrade contains a greatly expanded (over 100K of overlays) on-line help feature, it is still no easy task to find your way around in the program, or even to get assistance from the user's manual. When we tried to find out how to "launch" (a word used in XTree's promotional material) a program as described in the previous paragraph, we searched in vain for that term in the manual's skimpy index. It was only through serendipity that we came across the term "Open" and then tracked it through the pages of the book. (Incidentally, the batch files required by that function seem to have to reside in the XTree directory, not in the root directory as we had at first supposed. That fact, which set us back by about 15 minutes, is not in the manual. Nor is the term "Window" indexed.)

The help screens are somewhat confusing to page through: your keyboard's up- and down-arrow and PgUp and PdDn keys have no effect. You use the right- and left-arrow keys to move a highlight to the paging function you want, and even that can prove confusing since the label that should read "Previous Page" reads "Last Page." You can, however, alternately select a function by pressing the key representing its first letter ("L" for "Last Page" and so on), or you can just use a mouse.

You have to watch out when you return to XTree from an application started using the Application Menu or the open command. The XTree directory will not show new files created by an application, nor will it reflect changes in the size of existing files, until you cause it to relog the drive. If you don't bear this in mind you can get into trouble, or at least start wondering what happened to all the work you just did!

We also missed the presence of a "hot key" that could get us back to XTree instantly from an application and then allow us to return again to it if we needed to. There's no backward equivalent of "Open."

Returning to compliments, space does not allow us to praise many of the other new XTreePro Gold features such as the addition of mouse support (at which we've hinted here and there in this review), a 43-line expanded display mode for EGA and VGA (also not indexed in the manual, by the way), and a keystroke history file that keeps track of your last 13 command entries should you want to review them or just repeat complex ones. There's lots more, too, that can endear this program to you and make it a useful part of your software library. While we intend to use XTreePro Gold primarily for the same purpose as the older versions of XTree—file manipulation—we know that its many extra features will come in very handy from time to time. ■

## ACTIVE ANTENNA

(Continued from page 1)

best indication from whatever passes for a signal-strength meter on your FM tuner or receiver.

The pi<sup>2</sup> instructions, skimpy as they are, do contain a useful bit of information: namely, that (at the frequencies for which it is designed—88-108 MHz) some locations may exhibit "null" or "dead" spots, where reception becomes difficult or even impossible. Terk suggests that, should you encounter such a situation, you move the antenna around a bit until you find a spot where reception improves. To this we'd like to add that you should try moving it not only in the horizontal plane, but in the vertical as well. A change in height of just a foot or two up or down can sometimes make all the difference.

While we're on the subject of orientation, we should mention that the pi<sup>2</sup> is not hard to set up. All you need do is attach the push-on "F" connector at the end of the antenna cable to your receiver's 75-ohm antenna input. If the receiver has only a 300-ohm (twin-lead) input, you use the matching transformer supplied with the antenna between the "F" connector and the antenna terminals. The cable from the plug-in power supply is fitted with a small plug that goes into a jack in the "F" connector: power then flows up the antenna

cable to the amplifier in the antenna housing. As we noted earlier, leaving the amplifier power on all the time should not cause a problem.

What sets the pi<sup>2</sup> antenna apart from other active antennas in the Terk line is the design of its amplifier, which includes a variable gain control. Not only can gain be varied continuously from 0 dB (no amplification) up to 38 dB (an amplification factor of over 4000), but it can also be adjusted *downward*, to reduce signal levels at a receiver's antenna terminals to about 1/500 their original strength.

Strange as it may seem, there are several reasons why you might want to do that—decrease rather than increase the antenna's gain. The reason is most obvious, perhaps, to those listeners who are situated very close to an FM transmitter or transmitters—perhaps in some infamous "Intermod Alley," such as the areas around New York's Empire State Building or Chicago's John Hancock Building, where most or all of those cities' FM transmitters are located. Reducing the antenna's gain can prevent the strong (to put it mildly!) signals found in such locations from overloading a receiver's front end and causing distortion in both the strong signal and in others on the band.

A second reason has to do with eliminating the interference caused by multipath reflections—signals from the same source that arrive at an antenna at slightly different times because of the different routes they take getting to it. Those reflected signals can arise from steel-frame buildings in cities, and from natural features such as mountains in more rural areas. On television you see multipath interference as "ghosts;" on radio it induces a subtle, but sometimes quite noticeable, distortion in the audio. By adjusting the gain of the antenna downward (and perhaps relocating or reorienting the unit) you can sometimes eliminate most or all of the multipath signals while still receiving the original one clearly.

The Terk pi<sup>2</sup> antenna—despite the paucity of information provided with it—performed very well for us. It certainly worked much better than a pair of indoor rabbit ears, or one of those "tack-up" twin-lead dipoles supplied with many FM receivers. And it even outperformed an (albeit makeshift, we must admit) outdoor antenna we were using. We also noted with the Terk little of the whistling interference we've sometimes picked up here and there when using a separate signal amplifier with the outdoor antenna. We would recommend this antenna to city dwellers suffering from FM signal problems and a lack of space. Just ignore the nonsense on the box and move the antenna around until it works best for you.

PS: Terk cautions you that the pi<sup>2</sup> functions only for FM—not for AM or television signals. They're right. We tried.



For more information on any product in this section, circle the appropriate number on the Free Information Card.

# ELECTRONICS WISH LIST

## TV-Mode Camera

What makes the Ricoh (155 Passaic Avenue, Fairfield, NJ 07006) *Shotmaster Zoom* 35mm camera of particular interest to **GIZMO** readers is its special TV MODE setting. Ordinarily, photographing a TV screen is a chore, and an uncertain one at that. Unless you set everything just right—and with today's automatic cameras holding the reins, you frequently don't have the degree of control you require—you can easily wind up with one of those bright diagonal bars across the picture. That results from the camera's shutter speed not being exactly the  $\frac{1}{30}$ - or  $\frac{1}{60}$ -second required to match the NTSC scan rate. The same blemish can mar pictures taken of computer screens. Putting the Shotmaster Zoom into its TV MODE setting causes the camera to synchronize its shutter automatically with the scan rate of the video device, banishing that difficulty. The motorized camera, which has an  $f/3.5$ , 38-76mm zoom lens, has a number of other interesting features as well. Those include an INTERVAL mode that exposes a frame every 60 seconds, provision for making multiple exposures on a single frame, and a NIGHT/PANORAMA setting that permits you to override the automatic flash normally used in low-light situations. Price: \$425.

CIRCLE 56 ON FREE INFORMATION CARD

## Tower Speaker

With powered woofers driven by their own high-current amplifier, *Mission's* (18303 8th Avenue, Seattle, WA 98148) model 767 speaker system is claimed to provide accurate phasing, pinpoint imaging, and faithful sound reproduction across the entire audio spectrum from 30 Hz to 20 kHz. The 55-inch-high tower unit gains at least part of its imaging power from the positioning of its drivers: One 8 $\frac{1}{4}$ -inch woofer is at the bottom of the cabinet and another at the top. The system's tweeter is located in the middle of the column, with one 6 $\frac{3}{4}$ -inch midrange driver above it and another below it. The tweeter's dual-chamber, impedance-transforming design prevents dome distortion—which leads to audio breakup—at high power. The cabinet is visco-elastic damped and includes heavy-duty floor-mounting cones to eliminate cabinet vibrations. The system can easily be adapted for bi-amping or bi-wiring, and features a level control to adjust the rolloff point over a range of 15 Hz (from 20 to 35 Hz) and a contour control to alter the shape of the rolloff curve by about three dB. The Mission 767 has a power-handling capacity of 200 watts. Price: \$3999 per pair.

CIRCLE 57 ON FREE INFORMATION CARD

## Tuner

*Nikko Audio Products'* (5830 South Triangle Dr., Commerce, CA 90040) new high-end G-400 AM/FM stereo tuner has no STEREO-MONO switch. It doesn't need one because it incorporates a variable HIGH BLEND control that, at its uppermost position, "squeezes" high frequencies so there is virtually no stereo separation; at its lowest position stereo separation is maximized. That control allows a listener effectively to increase the tuner's S/N ratio and sensitivity, albeit at the expense of stereo separation. In addition, the tuner allows ten FM and ten AM presets, has a MEMORY SCAN feature that previews each preset station for five seconds before moving on to the next, and uses a 220,000-microfarad capacitor to keep station memories alive for four days should the unit be unplugged or a power failure occur. Other features include interstation muting and a NARROW/WIDE IF selector. Price: \$440.

CIRCLE 58 ON FREE INFORMATION CARD

## Hi-Fi VCR

*Aiwa America* (35 Oxford Drive, Moonachie, NJ 07074), long known for its audio products, has now entered the video market. One of its initial offerings is the HV-90 Hi-Fi stereo VHS VCR. The four-head deck features MTS sound, index-search system, linear-time tape counter, peak-hold sound-level meters, and 6-event/14-day programming. An on-screen-display function provides instant confirmation of programming selections. The deck, which is housed in a black-finish case, comes with an LCD remote control. Price: \$699.

CIRCLE 59 ON FREE INFORMATION CARD



Ricoh TV-Mode Camera

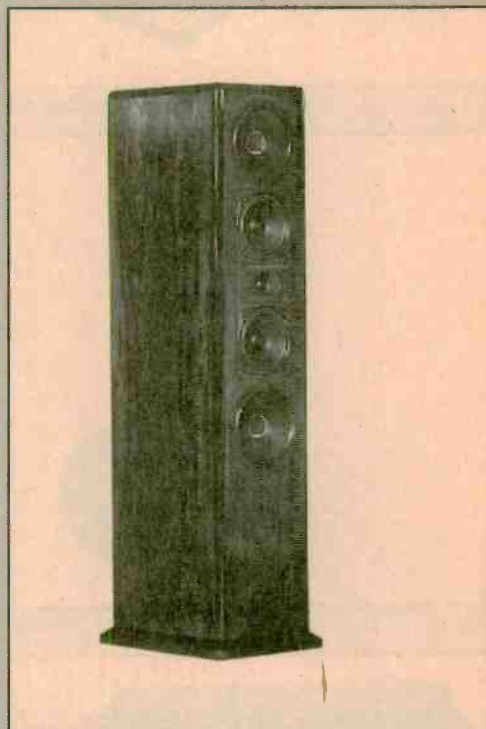

Mission Tower Speaker



Nikko AM/FM Stereo Tuner



Aiwa VCR



# ELECTRONICS WISH LIST

For more information on any product in this section, circle the appropriate number on the Free Information Card.

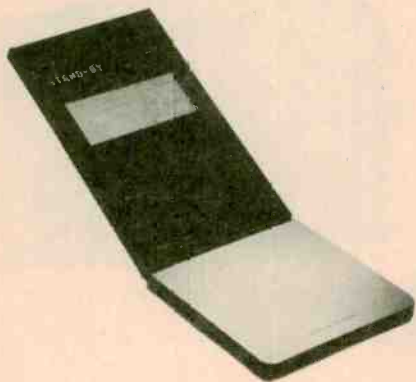

Bang & Olufsen Remote Control



AudioSource CD Lens Cleaner



Goldstar Videocassette Player



Marantz CD Changer

## Remote Control Chameleon

The *Beolink 7000* is an intelligent two-way infrared controller for use with several of *Bang & Olufsen's* (1150 Feehanville Drive, Mt. Prospect, IL 60056) audio and video systems. The stylish remote can automatically configure its controls and displays to match the source being used at the moment. When not in use, no controls are visible, but a finger touch on the unit's metal surface "wakes up" the controller, and backlit status displays appear through its glass surface. Basic command "keys," which are actually touch-sensitive areas on the glass, also light up; ten more touch-sensitive keys are defined by an illuminated blue LCD screen that serves, in addition, to provide user prompts and other text messages. Approximately 200 different legends are available for the configurable liquid-crystal keys, whose functions and labels change to match the device being controlled. Power is provided by rechargeable nickel-cadmium batteries, and the operating panel is motorized, automatically able to tilt itself up to a predetermined position. The *Beolink 7000* provides two-way interactive operation with the *Beosystem 4500* and *6500* music systems and *Beocenter 9500* music center, and one-way control of other recent B&O audio and video products. With optional accessory units, the *Beolink 7000* can even control room lighting, and has the ability to store several different lighting "scenes" with the ability to change among them according to a programmed schedule. Price: \$1000.

CIRCLE 60 ON FREE INFORMATION CARD

## CD Lens Cleaner

Frequently, the reason a CD refuses to play properly lies not with the disc, but with the lens in the player through which the player's laser beam passes. Dust, dirt, smoke, and other airborne contaminants deposit themselves there (that process is accelerated by the large static charges that can build up as a result of the rapidly spinning plastic disc) and eventually interfere with the passage of the laser beam that reads the disc information. *AudioSource* (1327 North Carolan Avenue, Burlingame, CA 94010) offers a remedy for that ailment in its *LLC-1* laser lens cleaner. The device consists of a digitally encoded compact disc with a built-in laboratory-grade brush. When inserted into the player the disc/cleaner inaudibly issues instructions to the player to align the brush with the laser's lens, and a digital "self test" is read by the laser as cleaning proceeds. When the lens passes the test, the *LLC-1* stops spinning and the process is complete. The operation takes about ten seconds. Price: \$29.95.

CIRCLE 61 ON FREE INFORMATION CARD

## Videocassette Player

*Goldstar's* (1050 Wall Street West, Lyndhurst, NJ 07071) *VCP-4200M* VHS videocassette player has an AC power cord and a 12-volt DC car cord, making it suitable for both indoor and outdoor use. The unit, which comes with a wireless remote control, features power-assisted front loading, auto repeat play, auto power, play, and eject functions, and automatically selects the proper playing speed (SP, LP, or EP) for the tape inserted. The *VCP-4200M* measures 11.4 x 3.5 x 12.9 inches, and weighs 11.5 pounds. Price: \$349.95.

CIRCLE 62 ON FREE INFORMATION CARD

## Top-Loading CD Player

A top-loading carousel-type CD player from *Marantz* (P.O. Box 2066, Aurora, IL 60507) is said to offer several advantages over conventional drawer-type rotary players. Looking a bit like a phonograph turntable with its hinged cover, the *DC-3587 Gyrodisc Five* provides easy access to the discs loaded into it, even when it is playing. Since the feed tray moves only rotationally—not laterally as it does in drawer- or magazine-type changers, the top-loading design also permits the use of a very stable laser-head mechanism. The 16-bit, 4x-oversampling player has a 20-track program memory, four-mode repeat system (track, disc, program, and continuous), and can play three- or five-inch discs without the need for an adapter. It comes with a 27-key wireless remote control. Price: \$380.

CIRCLE 63 ON FREE INFORMATION CARD



For more information on any product in this section, circle the appropriate number on the Free Information Card.

# ELECTRONICS WISH LIST

## Videotapes

Konika's (440 Sylvan Avenue, Englewood Cliffs, NJ 07632) *Super SR* and *Super HG* videotapes feature a newly developed Super HP binder that is toughened for higher durability in repeated recording and playback. The tape uses a specially treated base surface that holds tightly to the binder, lessening the load on the tape caused by still, slow, and high-speed search. The tape's surface formulation consists of ultra-fine, high-density cobalt/ferric-oxide magnetic particles, resulting in sharp resolution and rich color. The black-plastic housing includes a molded rib that prevents tape sticking resulting from static electricity, and an anti-static leader tape cuts down on dust and dirt accumulation for a low dropout rate. Price: Unavailable.

CIRCLE 64 ON FREE INFORMATION CARD

## Automotive CD Changer

The first automotive CD changer from *Blaupunkt* (2800 South 25th Avenue, Broadview, IL 60153) offers users a number of conveniences. The *CDC 01 Compact Disc Changer*, which is intended to be used with *Blaupunkt's CDC 01 Commander* control head unit, holds two six-disc magazines for almost 15 hours of uninterrupted music (if you can drive that long without a break). The 16-bit, 4x-oversampling player is carefully isolated to make it resistant to vibration and road shock, and uses a sophisticated monitor circuit that allows the laser to recover its position almost instantaneously after very severe—pothole-type, for example—shocks. The *CDC 01 Commander* can be dash mounted in a standard radio slot or mounted almost anywhere with Velcro, permitting it to be removed and hidden when not in use. This control-head unit allows you to operate and program the changer, as well as to adjust volume, balance, bass, and treble. A brief tap on the *Commander's* on/att(enuate) button mutes audio output by 20 dB for toll booths, cellular phone calls, conversation, etc. The cartridges used by the *CDC 01* are interchangeable with those used in the home changers made by several other manufacturers. Price: *CDC 01 Compact Disc Changer*, \$629.95; *CDC 01 Commander*, \$249.95.

CIRCLE 65 ON FREE INFORMATION CARD

## Multi-Room Audio Controller

The *Component Commander* is a computer-controlled system from *Niles Audio Corporation* (12331 SW 130th St., Miami, FL 33186) that lets users select and control from two to six home-entertainment sources simultaneously, from as many as sixty rooms. The *Component Commander's* infrared remote provides control of source selection, volume, balance, and tone, as well as of transport functions and station selection, through wall-mounted receivers that are located in each room. Configuration is accomplished through plug-in cards housed in a metal control box, and card racks can be cascaded should expansion beyond the capabilities of a single one be required. Price: Approximately \$1000 per room, plus labor.

CIRCLE 66 ON FREE INFORMATION CARD

## High-Tech Memo Pad

You can use the *Voice Memo 60* to capture your thoughts and ideas on the spot, without resorting to awkward pen and paper. The little recorder, a product of *Plus U.S.A. Corporation* (3 Reuten Drive, Closter, NJ 07624), contains a 60-second endless-loop of magnetic tape ready to hold your gems of wisdom and insight until you can transcribe them in a more permanent form. The palm-sized unit has an integral microphone, volume control, 60-second alarm, message lock, and message-waiting indicator. Suggested alternate applications—after you've exhausted your creativity for the day—include making the recorder a family message center, and using it as a medium for transporting the names and phone numbers you find on your answering machine over to the phone when you go to return calls. Price: \$44.95.

CIRCLE 67 ON FREE INFORMATION CARD

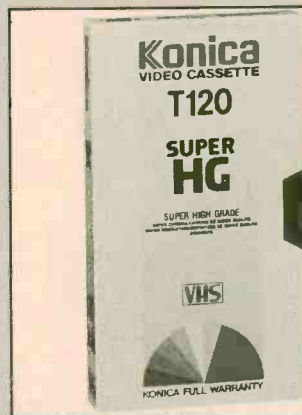

Konika Videotapes

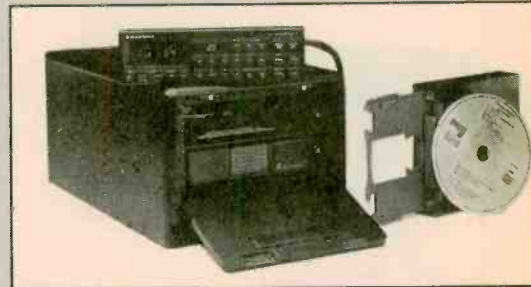

Blaupunkt Automotive CD Player

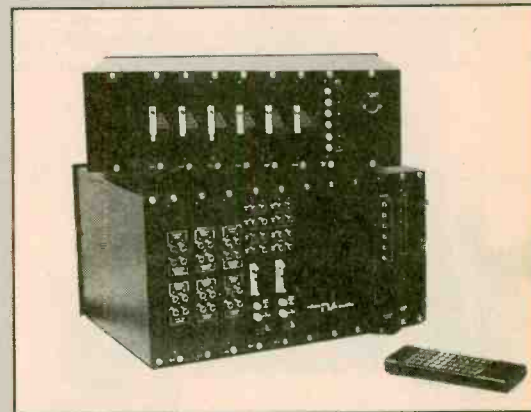

Niles Home Audio Controller



Plus Voice Recorder



# ELECTRONICS WISH LIST

For more information on any product in this section, circle the appropriate number on the Free Information Card.



Northgate Computer

## Small '386 Computer

What it says is the world's smallest 386/20 desktop computer, the *MicroStation 320*, has been introduced by *Northgate Computer Systems* (P.O. Box 41000, Plymouth, MN, 55441). The computer, which stands just three inches tall, includes the following as standard: one megabyte of 32-bit DRAM (expandable to eight megabytes); two serial ports; one parallel port; a socket for an 80387-20 or Weitek 3167-20 coprocessor; two half-length 8-bit slots and three full-length 16-bit slots; a 40-megabyte, 28-ms IDE hard-disk drive (the on-board controller will handle hard disks with capacities up to 200 megabytes, in addition to two floppy drives); a 1.2-megabyte 5.25-inch or 1.44-megabyte 3.5-inch floppy-disk drive; AMI BIOS; 800 × 600 pixel 16-bit VGA interface with 256K of video RAM; a 12-inch high-resolution monochrome VGA monitor with base; and Northgate's OmniKey/101 keyboard. Also included is MS-DOS 4.01 or, upon request, MS-DOS 3.30a. The *MicroStation 320*, which contains an Intel Double Sigma 80386-20 microprocessor, uses a pipeline page-mode memory-management system that provides speed and performance approaching and often exceeding that of cache memory systems. Price: \$2399.

CIRCLE 68 ON FREE INFORMATION CARD



Mitsubishi Fax

## Top Fax

*Mitsubishi's* top-of-the-line *FA-980* facsimile transceiver is designed as the hub unit of a corporate-level facsimile network. The fax has a sequential-program transmission feature with four timers, allowing documents stored in its 60-page (one megabyte) internal memory to be sent automatically to as many as 16 different locations at different preprogrammed times. Transmission takes place at the rate of nine seconds per page. A "broadcast" function also gives users the ability to send documents to up to four groups of 100 destinations each for speedy distribution, and a speed-dialing feature can be programmed with 132 numbers. The unit includes a 50-page document feeder, automatic redial, a fax/voice detection circuit with automatic switching, and sequential polling. For security, documents can be transmitted directly to the device's memory, accessible only by password. A 64-level gray-scale capability provides faithful reproduction of photographs and graphics, and an image-separation feature distinguishes between text- and gray-scale material to ensure optimum reproduction of each. Price: Unannounced.

CIRCLE 69 ON FREE INFORMATION CARD

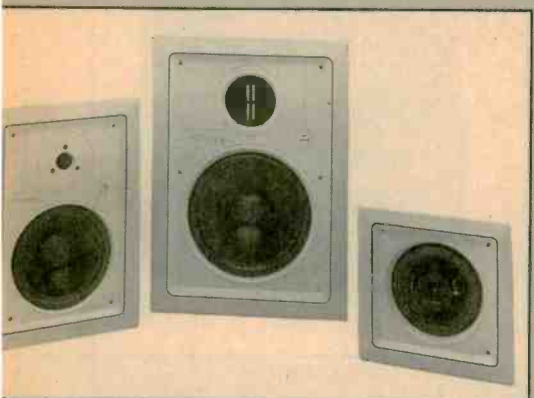

Infinity Built-In Speakers

## Environmental Speakers

Despite their name, the *Environmental Reference Standard* flush-mount speakers from *Infinity* (9409 Owensmouth Ave., Chatsworth, CA 91311) have nothing to do with clean air or water. Rather, these three systems—the *ERS 800*, *ERS 600*, and *ERS 500*—are intended to be built into your *listening* environment. The systems employ shallow, minimum-diffraction baffles to reduce the potential detrimental effect of in-wall mounting. The *ERS 800* uses an eight-inch long-throw woofer with a rotatable tweeter for optimizing frequency response and sound dispersion; the *ERS 600* has a long-throw 6½-inch woofer and ¾-inch dome tweeter, and the *ERS 500* is a coaxial system featuring a 5¼-inch woofer with a concentrically mounted dome tweeter. Both the *ERS 800* and *ERS 600* have tweeter-level controls to compensate for speaker placement and room acoustics. Mounting-bracket kits are sold separately. Price: \$552/pair (*ERS 800*), \$306/pair (*ERS 600*), \$235/pair (*ERS 500*).

CIRCLE 70 ON FREE INFORMATION CARD

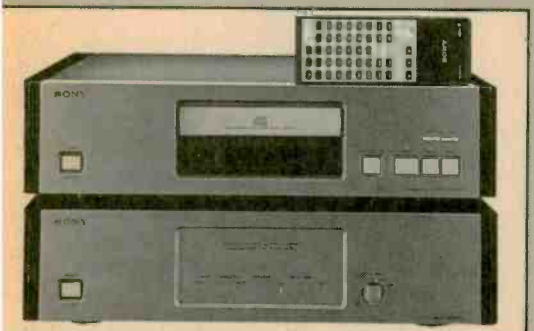

Sony CD Player

## Reference CD Player

Designed by *Sony* (One Sony Drive, Park Ridge, NJ 07656) as an industry-reference unit, the two-piece *CDP-R1/DAS-R1* CD player contains what is claimed to be the industry's most sophisticated digital filter, a unique staggered architecture in its converter stage, and a proprietary dual-link data-transfer system that reduces jitter by a substantial amount. Finished in champagne-color brushed aluminum with Tamo ash-wood side panels, the *R1* is available at select *Sony ES* dealers. Price: \$8000.

CIRCLE 71 ON FREE INFORMATION CARD



# Build a 30-Watt Audio Amplifier

BY MARC SPIWAK,  
EDITORIAL ASSOCIATE

*Are you looking for a high-quality, low-cost audio amplifier? Then why not try this one—it's simple, it's inexpensive, and it's ideal for just about any application!*



**A**mplifiers are one of the most commonly used circuits that you will find in electronics. The chances are good that you'll need an amplifier for one of your projects at some time or another. The problem is that it's not always easy to design your own amplifier circuit, even if you are using an integrated circuit that does the hard part for you. Well, if you have a need for an amplifier, then consider the TSM 11 30-watt Monophonic Amplifier described in this article; it might just be exactly what you want. It's inexpensive and will work for most amplifier applications.

It can be used for such things as an intercom, a PA system, or, most likely, a plain old audio amplifier. You will of course, need two of them for stereo audio, but at \$15.50 apiece (if you buy the kit from the source mentioned in the Parts List), the cost shouldn't be a problem. The amplifier is designed around the TDA2004 audio-amplifier IC, which in the configuration shown in Fig. 1, provides 30-watts peak, 15-watts RMS, and it can drive 4–8-ohm speakers. You'll also need a 12-volt DC, 2-amp power supply. The one shown in Fig. 2 will do just fine.

**Construction.** As far as construction goes, you probably could etch and drill

your own PC board (using the pattern shown in Fig. 3), track down all of the resistors, capacitors, potentiometers, etc., and buy the TDA2004 from some supplier. Or you can buy the TSM-11 kit from the source mentioned in the Parts List and save yourself from a few of life's unnecessary headaches. The choice is up to you.

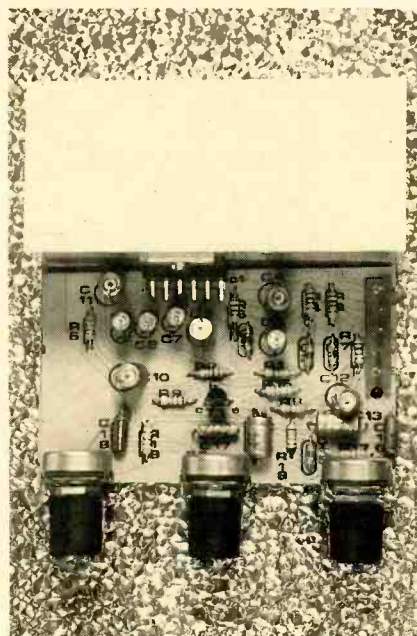

*If assembled properly, the finished board should be neat and compact. Here's the author's unit ready for use.*

However you decide to get your parts, solder them to the PC board (or hardwire them on perfboard) as shown in the parts-placement diagram in Fig. 4. You should install them in the order that they're shown in the parts list (except for the potentiometers—install them last), and there are several reasons for that. To begin with, it gives you an easy way to check off each part as it's installed on the board. You'll also be installing the components in size order, making it easier to fit each part onto the board. And last (but not least important), the semiconductors should receive the least amount of handling.

The resistors can all be mounted flush against the board, but some of the axial electrolytic capacitors included in the kit must be mounted on end. (Axial capacitors have a lead coming out of each end, much like a resistor, while radial capacitors have two leads coming out of one end.) If you are putting your amplifier together from scratch, it might be a better idea to use radial capacitors where they will fit (see PC-board hole spacing for the capacitors). But if your kit includes axial capacitors, or if you want to use them because you have the ones of the right value lying around, then it's best to put the positive end directly against the board, with the negative lead bent down around the

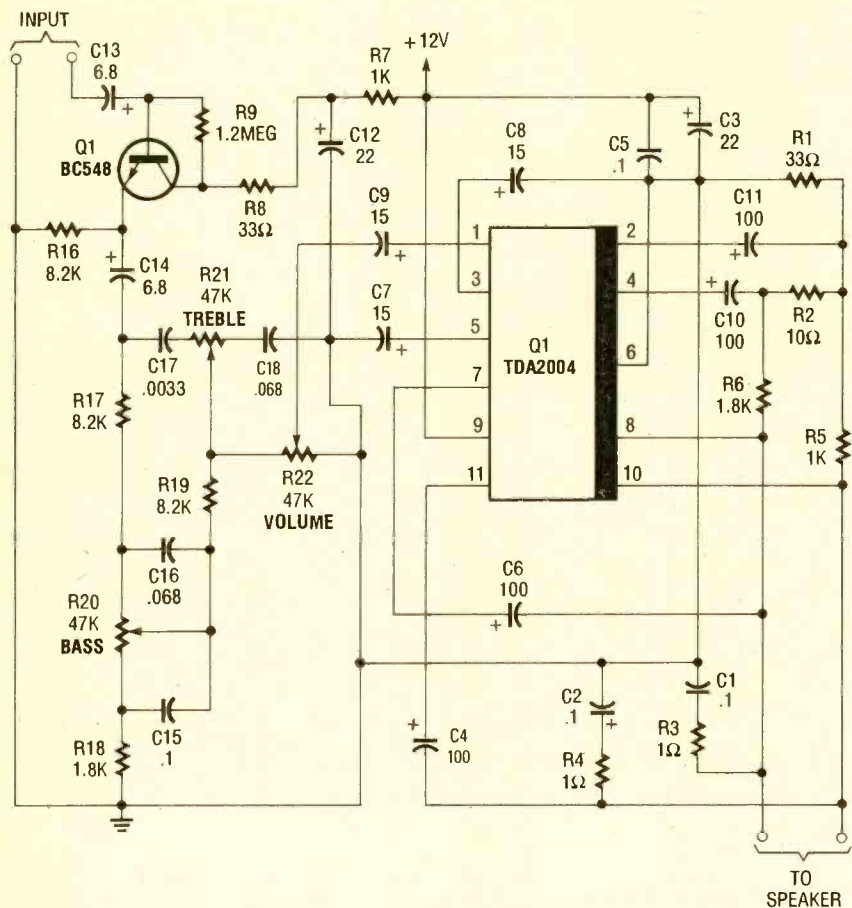

Fig. 1. The amplifier is designed around the TDA2004 audio-amplifier IC, which provides 30 watts of power in this monaural configuration.

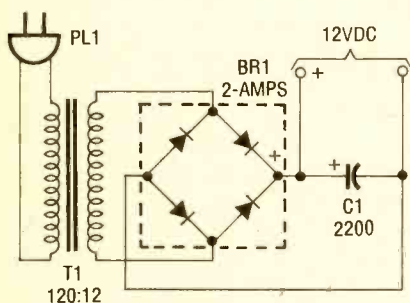

Fig. 2. The amplifier requires a 12-volt DC, 2-amp power supply, such as this one.

side. That way it's harder to accidentally short something out.

Besides observing the polarity on all of the electrolytic capacitors and the transistor, you must pay special attention to U1, the TDA2004. It would be difficult to install it incorrectly on the PC board, as it has two rows of pins, with 5 in one, and 6 in the other. But before you do that, you should first attach the heatsink to the circuit board. Then push the pins of U1 through the holes in the board, attach it to the heatsink, and solder the pins (see Fig. 5). Use this procedure because the pre-drilled hole in

the heatsink is at a fixed height, and if you solder U1 too low or too high, its hole probably won't line-up with the one on the heatsink.

Proper soldering technique is a must. Always use a good iron, with a good properly tinned tip. If your soldering-iron tip is in bad shape, then it must be replaced and tinned before use. Anti-seize compound must be put on the end of the heating element before putting on the new tip, or else it might not come off when it's time to replace it. Then you must tin the new tip. That involves allowing the tip to reach maximum temperature, and then melting a lot of fresh solder onto it. Let it sit for a few moments, and then wipe off the solder. Repeat that once or twice.

Always use the right amount of solder; if your joints are bulging, then you've used too much, and if they're incomplete, then you've used too little. Also, to avoid putting too much solder where you don't want it, and to remove any crud build up, clean the hot tip on a damp sponge from time to time during assembly—you don't want crud to become part of your amplifier.

After the board is finished, carefully inspect it for any solder shorts, opens, cold-soldered leads, and heavy flux build-ups. A cold solder joint will have a really dull appearance, and it won't make a good electrical connection. Poor soldering can really hinder the performance of any circuit, because a bad joint will have a higher resistance

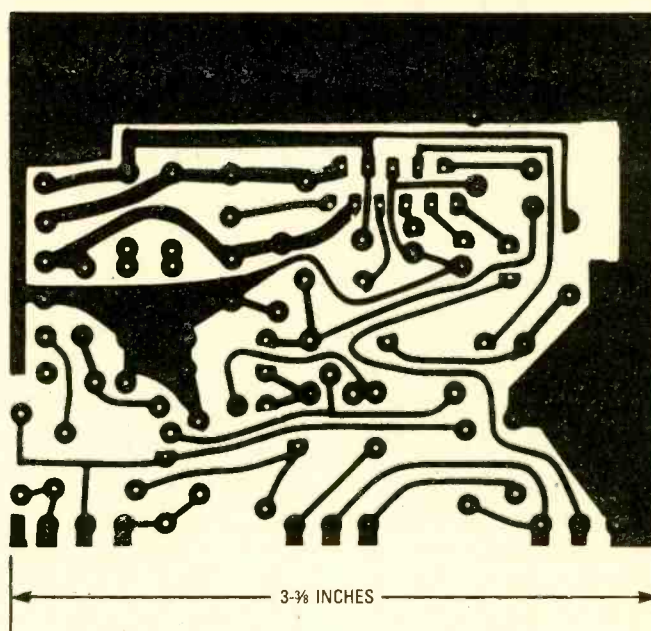

Fig. 3. This foil pattern, for use if you want to make your own PC board, is shown actual size.

than a good one. So check the board thoroughly, and correct any soldering errors you may find.

(Continued on page 98)



# TROUBLESHOOTING COMPUTER DISK DRIVES

BY ISAAC SZLECHTER

*When a disk drive fails the problem is not always fatal. You can diagnose those correctable malfunctions by using our step-by-step procedure.*

**C**oincidental as it may be, when I sat down at my computer to write this article my disk drive didn't respond when I booted it. The busy light didn't even come on. So before I could write this article on how to diagnose and repair disk drives, I had to diagnose and repair my own.

Despite the reliability of a PC, every user at some time will go to boot up a disk and get a data error, seek error, or some other such annoying message in return. Disk-drive failure is really a major cause of computer downtime.

But you don't have to be a trained technician to find the source of a malfunction. If you can operate your PC, you can diagnose it, and most of the time you can fix it yourself, saving you both time and money.

**The POST Procedure.** A system-checking procedure called POST (for power-on self test), is automatically performed every time an IBM or compatible personal computer is turned on. The POST procedure tests various components in a PC and if it discovers a problem, a message is issued to the user. That message might take the form of text on your screen, a series of beeps from your speaker (see Table 1), or both.

If POST confirms that the trouble area is the drive, the first step is to determine the actual source of the problem, which may be in one of the following three categories:

- 1. Software**—One or more problem-causing files on the diskette are defective, incompatible, or perhaps just write-protected.
- 2. The diskette itself**—The diskette might be physically damaged, improperly formatted, incompatible with the drive, etc.
- 3. Hardware**—The drive or its adapter card is actually defective.

It is not possible to predict all the

things that can go wrong at the software or diskette level. However, some of the most obvious diskette-related problems are summarized in Table 2.

The safest way to end all suspicion of a diskette-based problem is to simply remove the diskette that was in use at the time the problem occurred. Reboot the system using another DOS diskette, and run a few programs from another diskette that you know to be good, using the "almost suspect" drive.

**Mixing and Matching.** If the problem persists, then the drive system is indeed at fault. As a rule, you can trace most drive problems to one of three areas: the drive adapter; the system-board slot where the adapter is placed; or the drive itself.

To localize the problem, insert the adapter in any other slot on the system board. If that clears up the problem, put the adapter back in the original slot to make sure that the problem wasn't due to an improperly seated adapter. Also make sure that the contact fingers of the adapter are clean.

Temporarily swapping drives A and B will help you determine if a drive is defective. One flat multiconductor cable leaves from the drive adapter to drive B

TABLE 1—AUDIO ERROR SIGNALS

Audio (beeps)	Video Display	Problem Area
•	DOS prompt	Normal startup
•	PC BASIC screen	
• —	None	Display Display
••	Incorrect, or blank	
••	Error code	Refer to DOS manual
None	None	
None	Cursor only	
None	DOS prompt	Power Defective speaker

(•) short beep; (—) long beep



**TABLE 2—DISKETTE-RELATED ERROR MESSAGES**

Error Message	Possible Causes
Access denied	Trying to erase a write-protected file, or read nonexistent file
Disk error reading drive x	Trying to read absolute sectors on network drive.
Disk full. Edit lost	An End Edit command ended because disk is full.
Drive not ready	Drive door is open.
Error loading operating system	A disk error occurred while attempting to load your operating system from fixed drive.
Error reading fixed disk	The FDISK program was unable to read the startup record of current fixed disk after five tries.
Error writing fixed disk	The FDISK program was unable to write the startup record of the current fixed disk after five tries.
File creation error	Unformatted diskette, or read only file with name exists on target diskette
General failure error	Unformatted or incompatible diskette.

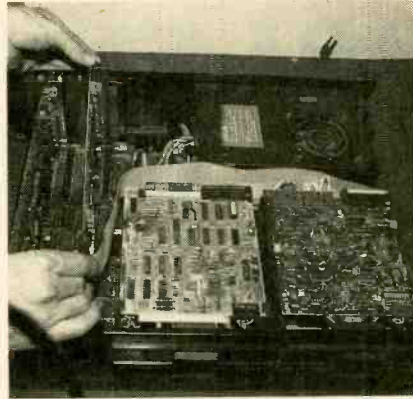

*To localize the problem, remove the adapter board and insert it in any other slot on the system board.*



*To remove the diskette drive, unscrew the two mounting fasteners, either on the left side of drive A or on the right side of drive B. To remove the drive A screws, you will have to remove the nearby adapter cards first.*



*The actual position of the cable connectors may vary from one PC to another, but they are easy to identify if you take note of where they terminate.*

and then continues on to drive A. The connector used by a drive determines its identity (*i.e.* a drive plugged into the end connector becomes drive B). Connectors may be labeled to show their

proper drive, or may have an uninformative label instead. To swap drives, start by swapping their drive connectors. Note that each drive connector on the cable is keyed so it

cannot be attached to a drive in the wrong direction. If your PC has two piggybacked, half-height drives, you will have to physically swap the drives also.

You should look for a 16-pin (14-pin on AT drives) terminating resistor network on one, and only one, of the diskette or hard-disk drives. You'll find it installed on the printed-circuit card on the top of the drive. The equivalent sockets on the other drives must be empty, which should make identifying the right chip easy. When you've located the resistor network and made sure it's the only one, move it to the new drive A.

Some drives might use an 8-position switch-block termination network instead of the resistor chip. If so, turn all drive A switches on and all drive B switches off. Of course drives with termination switches may be used interchangeably with other drives using a removable resistor. Just make sure that on drive B the switches are off or the resistor is removed.

If drive A was the cause of the fault, the swap will restore normal DOS operation. If drive B was defective, then the system will go into cassette-BASIC mode when power is again turned on. If the swap has no effect on the problem, then the problem is not located in the drives.

Since a functioning drive A is required for any operation other than cassette BASIC, make sure the drive you leave attached as drive A is the good one. That will allow you to use your computer while you are waiting for a new drive.

**Reconfiguration.** After removal and replacement procedures, remember to verify the system configuration using the diagnostic program diskette supplied with every IBM PC. When it is used with a non-IBM PC, the diskette may or may not work, depending on the computer's level of compatibility. As an alternative, non-IBM diagnostic diskettes are commercially available for testing PC's with varying degrees of compatibility.

When an additional diskette drive is installed, or an old one is removed and not immediately replaced, the system will have to be reconfigured. If a single-sided diskette drive is replaced by a double-sided drive of the same diskette size, system reconfiguration is not required.

In the PC and XT, switches on the system board are used to reconfigure the system. In the AT, system reconfiguration

*(Continued on page 103)*



# GAMES

AND

# THE AMAZING AMIGA

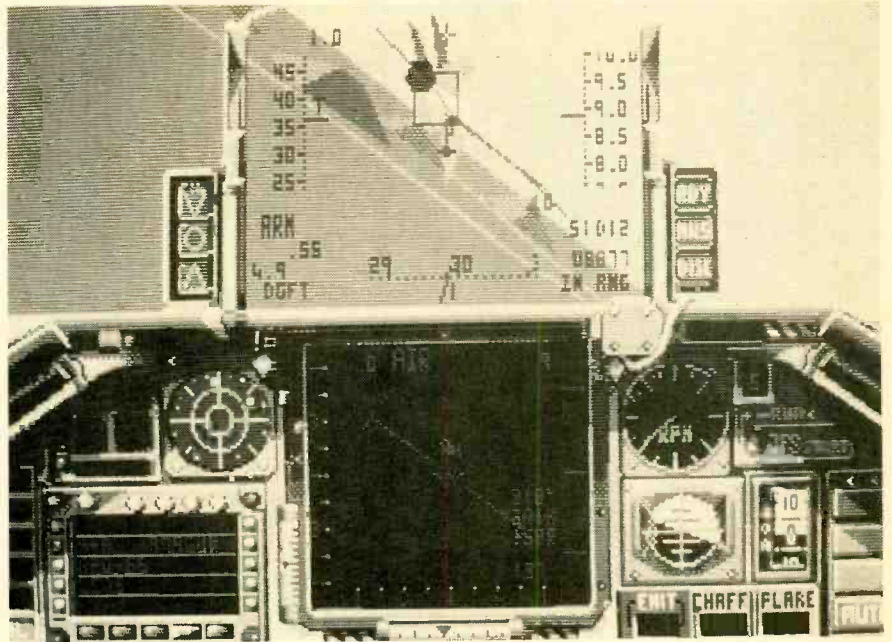

*Here are the game-playing facts on a versatile computer made by the same folks who brought us the Commodore 64.*

BY KARL T. THURBER, JR. W8FX

**T**outed by Commodore (1200 Wilson Dr. West Chester, PA 19380) as the "ultimate" home computer, the under-\$800 Amiga has some formidable capabilities. With its 16-bit central processor, the Amiga has lots of number-crunching power. But the machine really excels at any and all applications involving graphics and sound. All of those features add up to excellent game-playing and entertainment capabilities that you can capitalize on.

In this article, we'll take a close look at the Amiga's advantages and disadvantages as the premier game machine of the 1990's. We'll also survey the world of Amiga game software, looking at several different types of games and some top-notch five-star games. We'll also suggest some ways to get the most-out

of your Amiga as a hi-tech amusement vehicle.

We'll focus on the popularly-priced Amiga 500. What we say about the A500 still goes if you happen to own one of the memory-rich, expandable, and IBM-adaptable Amiga 2000 series. They both can handle the same Amiga games.

**The Hardware.** Icon-driven menus and pull-down windows contribute to the Amiga's performance and user-friendliness. The Amiga 500, which uses a graphic "window/icon/mouse/menu/pointer" system and the "Intuition"-based Workbench visual interface, has all of the features of the older Amiga 1000, and then some. It uses the Motorola 68000 CPU and runs at a clock speed of 7.16 MHz. The A500 comes with 512K of RAM though it may be expanded up to 1 MB (or more) internally, or up to 8 MB externally. There are even some emulators for the Amiga that let you play many Commodore 64 games, though most emulators are slow and quirky in operation.

The Amiga 500 includes three custom VLSI (very large scale integration) chips that provide the computer with unique capabilities for animation, graphics, and sound. Key features include arcade-quality 4,096-color graphics, two mouse/joystick ports,

four-voice digital stereo sound, and multitasking capability—you could conceivably play two games on the Amiga at once. There are also left and right audio outputs for driving a stereo sound system, making the Amiga especially well suited to playing games with special sound effects.

Unlike the Commodore 64 and the older A1000, there's no composite color-video output for a VCR, and no RF output for hookup to a television set. You can, with an external adapter and a TV modulator, use a conventional TV as a display monitor, though results are likely to be disappointing. (Commodore will sell you the Amiga 520 Video Adapter for \$49 that lets you connect your Amiga to a standard composite-color monitor, VCR, or TV).

You'll soon tire of the continual disk-swapping that's required by many complex games with the Amiga's single internal drive. After bringing your computer's memory up to 1 MB, you should consider adding an external 3.5-inch 880K disk drive. Commodore's own A1010 drive is one choice, though many excellent and reliable third-party external drives are available.

Overall, you'll likely find the Amiga to be a more practical and inexpensive computer on which to play games than, say, the IBM PC. Some IBM PC games, for example, require an AT-class



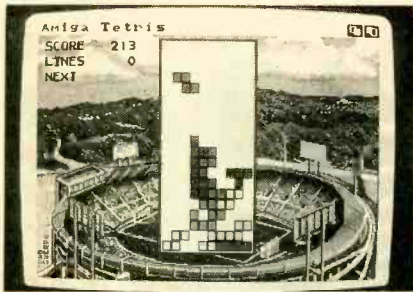

*Tetris, by 30-year-old Soviet programmer Aleksei Pazhitnov and 18-year-old student Vadim Gerasimov, is the first Soviet computer game to emerge on the international scene. It is a complex Rubik's Cube-type puzzle played against highly graphic Soviet backgrounds. Ten difficulty levels, with increasingly fast-paced action, make this one a real challenge. (Photo courtesy Spectrum HoloByte).*

machine with an EGA (Enhanced Graphics Adapter) and special sound card to run properly, thus involving much more than a casual investment for the sake of a gaming capability.

**Adventure for the Asking.** There are a lot of games on the market for the Amiga, being the game machine that it is, and most of them take good advantage of the Amiga's capabilities. Let's survey what's available starting with fantasy and role-playing games.

Such diversions are among the most popular on the Amiga, offering exciting story plots, excellent graphics, and high quality sound. Most have you assume a fantasy role (detective, adventurer, space hero, etc.) with the game presenting you with a series of challenges to overcome. Most accept sentence-like commands; some are text-only, while others have coordinated on-screen graphics. Many of the newer games allow you to customize your character, permitting you to arm your character with special weapons, abilities, etc.

Among the better-executed examples is the fascinating and beautiful interactive graphics/text adventure, *Twilight's Ransom* (Paragon/MicroProse), in which you must rescue your pretty Salvadoran-immigrant girlfriend from her kidnappers. Another game called *Defender of the Crown* (Cinemaware), is an adventure set in medieval England where you lead the Saxon knights against the Norman invaders. Still another is called *Shadowgate* (Mindscape), a graphic adventure in which you're the only one left with enough power to destroy the evil Warlock Lord

before he summons the titan Behemoth to destroy the world.

There's also the snappy martial-arts adventure *Master Ninja* (Paragon/MicroProse), in which you're challenged to recover the katana, a precious magical sword that has been stolen by an evil warlord. *Hybris* (Discovery) is a fast-paced action-adventure in which you're the commander of a missile cruiser flying over enemy territory—with 11 cruisers to pilot and up to 24 ships attacking at one time. The top-rated adventure, *Dungeon Master* (FTL), with its 14 levels of dungeons to explore and conquer, is said to be the game for those who consider themselves to be first-class adventurers.



*In The Hunt For Red October, you are Captain First-Rank Marko Ramius, Commander of the Red October, the latest Soviet nuclear ballistic-missile submarine. Your goal is to reach the United States in order to defect, but the Soviet Red Banner fleet is pursuing you as you try to rendezvous with the U.S. Navy. (Photo courtesy DataSoft/Electronic Arts).*

**Arcade-Action Games.** Arcade amusements are big sellers on the Amiga. These graphics-oriented games are typified by the shoot-'em-ups featured at coin-operated arcade galleries, though there are plenty of innovative and hybrid types available for the Amiga.

Some arcade favorites include the classic coin-operated diversion *Arkanoid* (Discovery), a mesmerizing 66-level game of skill that tests your reflexes and ability to make split-second decisions; *Bubble Ghost* (Accolade), in which you navigate a bubble-blowing ghost through 36 chambers chock full of hazards and monsters; *Fire Power* (Microillusions), a superb tank battle game in which you can compete against the computer or with another player with split-screen action; *Marble Madness* (Electronic Arts), a 3-D game in which one or two players race to get their marbles through the raceways and over the goal line; and the fast-

paced and addictive trio of arcade classics, *Arcadia's Awesome Arcade Pack Volume I* (Arcadia/Electronic Arts).

Gambling, card, and board games are finding their way into arcades also. In the Amiga world, such games run the full spectrum of gambling as well as competitive parlor game endeavors. One excellent and sophisticated computerized card game is *Solitaire Royale* (Spectrum HoloByte), with its eight different versions of solitaire and tournament-play options placed at your disposal. The dramatic and challenging chess encounter, *Battle Chess* (Interplay/Mediagenic), places the entire medieval world at war on a checkered field in 3D, and yes the pieces actually fight one another. There is even a computerized version of the crossword game *Scrabble* (Leisure Genius/Electronic Arts), which—with its 23,000-word vocabulary—allows you to match wits with the computer and build your own and your children's vocabulary and gaming skills.

### Sports, Space, and Simulations.

Sports games let you get a couch-potato version of "exercise". Some of the more popular Amiga sports simulations include the action-packed *Earl Weaver Baseball* (Electronic Arts), which allows you to experience many different aspects of the game from playing ball to building a stadium. The arcade-action TV Sports Football (Cinemaware), offers you more than 28 teams and a 16-game schedule with post-season play-offs. *GBA Championship Basketball Two-on-Two* (Gamestar/Mediagenic) lets you control two men in basketball competition, the players being based on real pro basketball players. In *Gridiron* (Bethesda Softworks) you can take the part of a football coach and create your own plays. *World Tour Golf* (Electronic Arts) is a game that allows you to play golf on more than 12 of the world's greatest courses or design your own "soon-to-be" classics. Lastly, *Final Assault* (Epyx), is a 3-D mountain-climbing simulation, where you practice scaling some of the world's most formidable peaks from the comfort of your den.

Space and science-fiction games, on the other hand, typically combine strategy, vehicle simulations, adventure scenarios, and arcade games in a futuristic, space-based setting.

Some of the top games of this genre include *Reach for the Stars* (Strategic Studies Group/Electronic Arts), a challenging epic of space conquest, explo-



ration, and domination of the galaxy and Carrier Command (Rainbird/Mediagenic), a challenging game which takes you to the year 2166 and presents you with a mission to populate a series of volcanic islands in the Southern Ocean that enemy terrorists are destroying one by one.



*World Tour Golf* affords realistic golf action, with random conditions such as wind, green dampness, and pin placement factored-in to help ensure a new game each time. You can play golf on more than 12 of the world's greatest courses; once you've mastered the best, you can design your own. (Photo courtesy Electronic Arts).

Not to be overlooked are favorites such as the interactive movie *Rocket Ranger* (Cinemaware) that offers many of the thrills and chills of a Saturday-morning serial, where scientists of the 21st century return to 1940 to alert the hero that the Nazis will win World War II unless something is done; the 3-D *Starglider II* (Rainbird/Mediagenic), in which you defend the colonists and destroy the multitudinous aliens and their patrol craft; *Skyfox II: The Cygnus Conflict* (Electronic Arts), an entertaining sequel to *Skyfox* in which you again get to use the warp-speed space fighter to fight for the Federation in the deep, dark space of the Cygnus Constellation; and *Empire* (Interstel), the space strategy game that combines combat, exploration, and artificial intelligence with the objective of controlling the galaxy.

On a similar front, vehicle simulations cover a great deal of air, ground, and sea action. Games in this challenging class include such hi-tech favorites as *Falcon* (Spectrum HoloByte), an incredibly realistic F-16A fighter simulator that lets you engage enemy aircraft with the most advanced aeronautics and electronic displays available on a personal computer, and which may even give the unsuspecting player a case of vertigo; *Gunship* (MicroProse), in which you take control of the U.S. Army's AH-64 Apache attack helicopter to conduct



*Commodore's Amiga 500 is a highly versatile and sophisticated PC that is widely considered to be the world's best game-playing machine. A multitasking and graphics-oriented computer, it's also a serious contender for video, business, and home-productivity applications.* (Photo courtesy Commodore Business Machines).

seven rescue, search-and-destroy, and covert missions; *Test Drive* (Accolade), a grueling driving simulation that has you test-drive a variety of high-performance cars, including Ferraris, Lamborghinis, and Porsches; *F/A-18 Simulator* (Electronic Arts), in which you turn your Amiga into a \$1-million air-combat simulator to command an advanced interceptor and lead combat missions to down enemy aircraft and defend Air Force One; and the classic *World War II* submarine simulation, *Silent Service* (MicroProse), that genuinely recreates the tension and exhilaration of underwater warfare.

There's also *The Hunt For Red October* (DataSoft/Electronic Arts), another first-class combat simulation in which you assume the role of a Soviet submarine captain who wants to defect to the "good guys" and turn over his submarine; and *SkyChase* (Maxis/Broderbund), a snappy dogfight simulation that lets you choose from among seven different fighter models to experience white-knuckle flying thrills on your airborne Amiga.

In various war games you can array yourself against the most brilliant military minds in history, participate in the world's "all-time greatest wars," and even design your own customized futuristic conflicts.

Some popular Amiga war-fighting titles include *Gettysburg: The Turning Point* (Strategic Simulations), in which the three days of bloody fighting at Gettysburg in 1863 are realistically reenacted; *S.D.I.* (Cinemaware), in which two lovers—an officer with the United State's Strategic Defense Initiative forces and a Russian commander—are

the only ones who can protect the human race from destruction; *Blitzkrieg at the Ardennes* (Command Simulations), a one-megabyte enhancement with many new features that depicts the Battle of the Bulge of World War II fame; and *The Universal Military Simulator* (Rainbird/Mediagenic), an all-purpose, custom wargame with digitized sound, in which five historical battles can be reenacted on a 3-D grid and what-if scenarios can be tested.

**Education and Beyond.** The Amiga 500 is an excellent educational resource; its formidable capabilities combine to make it an ideal teacher of the language arts, math, and social studies—or anything else.

Right now, though, there aren't as many educational games available for the Amiga as we'd like to see. One novel "learning game" lets you create and print out prehistoric giants chosen from a museum of dinosaur bones in *Designasaurus* (Britannica Software). Most of the others are from a single company, MicroEd. (The latter company has an extensive catalog available and also offers a complementary "Demo Picture Loop Disk" that's designed to let you sample their educational software through the display of some of their digitized screens.)

As Amiga games become more sophisticated and complex, pushing graphics, sound, and memory capabilities to their limits, progressive designers have produced games that don't fit neatly into any of the categories we've mentioned. Entirely new categories have been devised that integrate elements of arcade and

graphic adventure games with lifelike three-dimensional images. Typically, those games make use of speech synthesis, let you personalize and customize the game to your heart's content, and have a sophisticated interactive capacity that adapts to your style and skill.

Some innovative and impressive titles in this hard-to-define area, include: *The Three Stooges* (Cinemaware), a movie-like slapstick romp in which you maneuver Moe, Larry, and Curly through prizefighting, pie-throwing, and medical madness; *SimCity* (Maxis/Broderbund), a singular "city development" simulation that lets you design your own cities from scratch or choose from an array of familiar predesigned metropolises such as Rio de Janeiro, Tokyo, San Francisco, and Boston; and *Tetris* (Spectrum HoloByte), an addictive and challenging implementation of Aleksei Pazhitnov's and Vadim Gerasimov's dy-

namic, puzzle-like game of skill, said to be the first U.S. taste of Soviet computer gaming.

**Keep These Things in Mind.** The "golden rule" of gaming is "Know your game specs." Your best protection against a game software purchase going bad is to make sure you know the game's specific hardware requirements before purchase. Make sure the software is actually available for the Amiga, and double-check memory (some Amiga games now require 1 MB), disk drive, and joystick requirements, before ordering or plunking down hard cash in your local software emporium.

There's really little risk in buying game software by mail, and you can usually obtain the titles you're interested in at a lower price than at the local computer shop. However, if you do have a problem, you'll have all the usual hassles of obtaining an exchange—refunds are



*The Amiga's made-for-games ancestor is the 8-bit Commodore 64. It's shown here in its latest incarnation, the C64C, which has been around since 1982 and is probably the most successful home computer ever built. It's aging, however, and rumors abound that Commodore will soon downplay its 8-bit line in favor of the 16-bit Amiga series. (Photo courtesy Commodore Business Machines).*

almost unheard of for game software. Keep that in mind if you choose to seek out mail-order good deals.

Also beware of copy-protection schemes. Disk copy protection is, fortunately, slowly fading away, at least for productivity software. Unfortunately, many game manufacturers still protect their wares. They figure that if a game disk owned by a registered owner goes bad, nothing but his time is lost in securing a replacement.

If you own a hard disk (HD), you'll find that installing copy protected games on the HD requires special procedures. Be sure to follow the instructions carefully; if you don't you may wind up with an inoperative game. To avoid such hassles, many Amiga HD users just won't buy copy-protected games at all.

Fortunately, more and more game manufacturers are deleting the more onerous forms of on-disk copy protection and going to "off-disk" protection. In such schemes, you may be furnished with a complex decoder wheel or have to look up numbers on a special chart, or perform some similar task, for the game to work properly. Or the game may be so complicated that you must have a copy of the instructions to productively use the game.

### **The Bottom Line on Amiga Gaming.**

If you thought that playing computer games was fun on the aging Commodore 64, the hot Nintendo or Sega, or even on an IBM "big blue," hold onto your socks—Ya ain't seen nothin' yet! If you haven't been converted to the Amiga yet, playing that first game may just do the trick.

### **Manufacturers and Distributors.**

#### **Accolade, Inc.**

550 S. Winchester Blvd. #200  
San Jose, CA 95128

CIRCLE 40 ON FREE INFORMATION CARD

#### **Bethesda Softworks**

15235 Shady Grove Road, Suite 100  
Rockville, MD 20850

CIRCLE 41 ON FREE INFORMATION CARD

#### **Britannica Software**

345 Fourth Street  
San Francisco, CA 94107

CIRCLE 42 ON FREE INFORMATION CARD

#### **Broderbund Software, Inc.**

17 Paul Drive  
San Rafael, CA 94903-2101

CIRCLE 43 ON FREE INFORMATION CARD

#### **Cinemaware Corp.**

4165 Thousand Oaks Boulevard  
Westlake Village, CA 91362

CIRCLE 44 ON FREE INFORMATION CARD

#### **Command Simulations**

Bldg. 3, 297 North Street  
Hyannis, MA 02601

CIRCLE 45 ON FREE INFORMATION CARD

#### **Discovery Software International**

163 Conduit Street  
Annapolis, MD 21401

CIRCLE 46 ON FREE INFORMATION CARD

#### **Electronic Arts**

1821 Gateway Drive  
San Mateo, CA 94404

CIRCLE 47 ON FREE INFORMATION CARD

#### **Epyx**

600 Galveston Drive  
Redwood City, CA 94063

CIRCLE 48 ON FREE INFORMATION CARD

#### **FTL Games**

6160 Lusk Blvd. C-206  
San Diego, CA 92121

CIRCLE 121 ON FREE INFORMATION CARD

#### **Interstel**

Box 57825  
Webster, TX 77598

CIRCLE 122 ON FREE INFORMATION CARD

#### **Mediagenic**

3885 Bohannon Drive  
Menlo Park, CA 94025

CIRCLE 123 ON FREE INFORMATION CARD

#### **MicroEd, Inc.**

PO Box 24750  
Edina, MN 55424

CIRCLE 124 ON FREE INFORMATION CARD

#### **MicroIllusions**

1748 Chatsworth Street  
Grenada Hills, CA 91344

CIRCLE 125 ON FREE INFORMATION CARD

#### **MicroProse Software**

180 Lakefront Drive  
HuntValley, MD 21030

CIRCLE 126 ON FREE INFORMATION CARD

#### **Mindscape**

3444 Dundee Road  
Northbrook, IL 60062

CIRCLE 127 ON FREE INFORMATION CARD

#### **Spectrum HoloByte**

2061 Challenger Drive  
Alameda, CA 94501

CIRCLE 128 ON FREE INFORMATION CARD

#### **Strategic Simulations**

1046 N. Rengstroff Avenue  
Mountain View, CA 94043

CIRCLE 129 ON FREE INFORMATION CARD



# TUNE IN TO

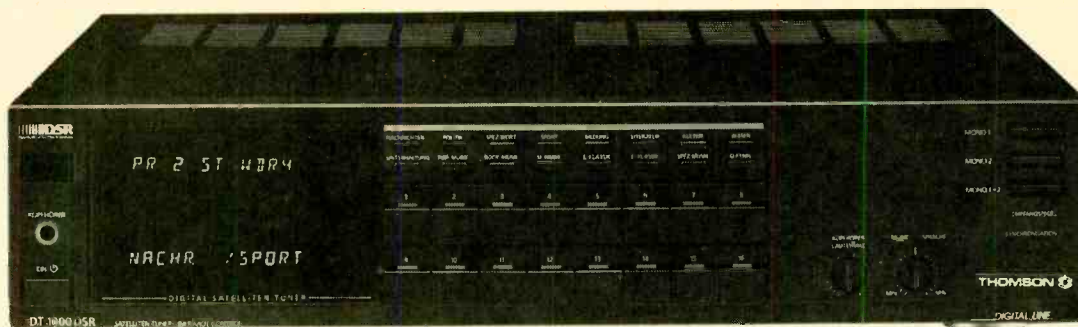

## SATELLITE RADIO

*If you've got a satellite-broadcast receiving system then you could be listening to the best audio programming technology has to offer. Read on and learn how to unlock the secret potential of your receiver.*

BY ROBERT ANGUS

**D**id you know that, along with the 200-plus video channels your satellite receiver pulls in, there are more than 120 audio programs as well, ranging from Chicago's Fine Arts music station to talking books for the blind? That doesn't count 300 or more SCPC (single-channel-per-carrier) audio programs—more on those later—for which you'll need a special tuner, nor the 50 to 60 channels of compact-disc-quality stereo that will be available by subscription early in the 1990's.

Satellite audio, in fact, is to the ear what satellite video is to the eye—a diversity of programming even cable can't rival and much more diverse and cosmopolitan than any metropolitan area can offer in terms of off-air signals. And while it's left something to be desired in sonic quality until recently, satellite seems sure to beat over-the-air programmers to the punch as a delivery system for digital stereo sound.

**Audio Subcarriers.** If your satellite receiver is less than seven years old, chances are that it has facilities for tuning in audio subcarriers (some older receivers do as well, and many recent-vintage models also have the ability to store favorite audio as well as video channels in memory). To see whether yours does, dig out the instruction manual and look under the "audio tuning"

and "audio-video connections" section. If you've lost the instruction book, virtually any satellite receiver that allows you to tune stereo sound for video channels also has audio-tuning capability.

If fact, most of the audio channels available on subcarriers actually are discrete stereo, with separate frequencies for left and right channels. While it may not make much difference when it comes to the CNN Radio Network (which broadcasts in single-frequency mono), it makes all the difference when it comes to the various music formats, particularly those with pretensions to high-quality audio.

Your satellite program guide lists most, if not all, of the sideband audio signals together with their satellite and transponder locations and the frequency of left and right channels. Unfortunately, there's no standardization when it comes to satellite audio, particularly with regard to the left and right channels. Generally, the higher frequency is the right channel, but this practice is by no means universal. If you're in doubt, listen carefully before finalizing your hookup to be sure that the instruments that belong on the left are on the left. If you've got it wrong the first time, resist the temptation to reverse the audio output cables connecting your satellite receiver to your audio sys-

tem and instead reprogram the subcarriers.

Audiophiles will realize immediately that satellite-delivered FM stations generally don't sound as good as local FM signals pulled in with the aid of a component-quality FM tuner. That's because of distortion inherent in satellite receivers that can be as much as 100 times that found in a good hi-fi system.

But that's not the only reason. Another is the use of narrowband audio for most subcarrier audio, a process that enables uplinkers to cram in as many as half a dozen stereo audio programs onto a transponder along with a full-frequency TV channel. In order to fit that much information onto the transponder, it's necessary to limit frequency response to as little as 5–6 kHz, or slightly less than that of AM radio.

Because the signal is being compressed, there's also a marked increase in background noise, or hiss. That handicap is most noticeable on low-powered transponders.

Fortunately, some "satcasters" use wideband transmission, which drives down the level of background noise and improves high-frequency response. If you're not sure whether the audio program you want to listen to is being broadcast narrowband or wideband, switch your receiver to the latter.

*(Continued on page 95)*

# CHOOSING & USING THREE-TERMINAL

*Learn how three-terminal voltage regulators work, how they are used, and how to select the right one for your next project.*

It would be great if the output voltage of a DC power supply were nice and constant—free of ripple and other problems. Indeed, some circuits and projects will not work properly unless the DC power supply is relatively stable and clean. However, in real “rectifier-plus-filter” DC power supplies, the output voltage is not stable, instead it may vary considerably over time and contain ripple components that are difficult to effectively filter out with capacitors alone.

There are two main sources of output-voltage variation in that type of DC power supply. First, there is always a certain fluctuation of the AC input voltage. Ordinary commercial power lines vary from 105 to 120 volts AC (rms), and may droop to less than 95 volts during local power “brownouts” (sometimes seen during summer when high air-conditioner usage places a burden on the power company).

The second source of variation is created by load variation (see Fig. 1). The problem is caused by the fact that real DC power supplies are not ideal. The ideal textbook power supply has zero ohms internal resistance, while real power supplies have a certain amount of internal resistance (represented by  $R_S$  in Fig. 1). When output current ( $I_O$ ) is drawn from the power supply, there is a voltage drop ( $V_1$ ) across the internal

resistance, and that voltage is thus subtracted from the available voltage ( $V$ ). In an ideal power supply, output voltage  $V_O$  is the same as  $V$  but in real supplies  $V_O$  is equal to  $(V - V_1)$ . Because  $V_1$  varies with changes in the load current,  $I_O$ , the output voltage will also vary with changes in current demand.

The “goodness” or “badness” of a power supply can be gauged in terms of its “percentage of regulation.” That specification is a measure of how much the voltage changes due to changes of load current, and is found from:

$$\%REG = 100\% \times (V - V_O)/V$$

where  $V$  is the open-terminal output voltage (i.e., the voltage you would get without drawing current),  $V_O$  is the output voltage under full load current, and %REG is the percentage of regulation.

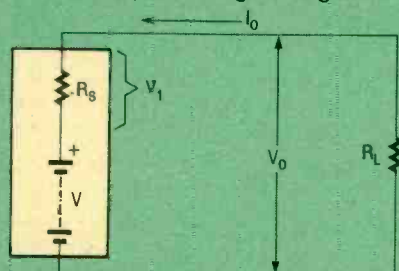

*Fig. 1. The main cause of voltage changes with variations in load current is the internal resistance of the DC power supply. The voltage drop across it ( $V_1$ ) varies with load current.*

Many electronic circuits do not work properly under varying supply-voltage conditions. Oscillators and some waveform generators, for example, tend to change frequency if the power-supply voltage changes. Obviously, some means must be provided to stabilize the DC voltage. While, in the past, Zener diodes were used to regulate the voltage, those devices are a bit limited in their application. A better solution is the low-cost, three-terminal voltage regulator IC's that are now available.

The other reason for using a voltage regulator in your projects is to prevent ripple on the output voltage. A rectifier does not actually convert AC to DC, but rather it converts AC to a unidirectional form of pseudo-DC called “pulsating DC.” The filter capacitor in the power supply is used to mask the pulsations. However, unless a very large capacitor is used, it is unlikely that the best regulation would be obtained without a regulator. The next time you hear a power-supply manufacturer touting a product as having “...the equivalent of 1-farad of output capacitance,” regulation is probably how they achieved it! That claim means that the regulator reduces the ripple the same amount as a 1-farad filter capacitor.

**Three-Terminal Voltage Regulators.**  
Regulated power supplies for low cur-



# VOLTAGE

# REGULATORS

BY JOSEPH J. CARR

rent levels (up to 5 amperes) are reasonably easy to build now that simple three-terminal regulators are available. A common circuit using positive three-terminal regulators is shown in Fig. 2. Capacitor C1 is the usual power-supply ripple filter, and should have a value of 1000- $\mu$ F-per-ampere of load current (although some authorities insist on 2000- $\mu$ F/ampere). Capacitor C4 is used to improve the response to sudden increases in current demand (something that happens in digital circuits). Capacitor C4 should have a value of approximately 100- $\mu$ F/ampere of load current. Capacitors C2 and C3 are used to improve the immunity of the voltage regulator to transient noise. Those capacitors are usually 0.1- $\mu$ F to 1- $\mu$ F units, and are to be mounted as close as possible to the body of the voltage regulator, U1.

The transformer used in the circuit reduces the AC line voltage (nominally 117 VAC) to a level that is compatible with the regulator. If the voltage regulator is to work properly, the input voltage to that device must be greater than the rated output voltage by 2.5 volts or more, so scale the transformer accordingly. Given that the output of the rectifier will be approximately 90 percent of the peak AC voltage (which is  $1.414V_{rms}$ ), we can calculate the required minimum voltage rating of the

transformer secondary winding ( $V_{rms}$ ) according to a simple rule:

$$V_{rms} = (V_o + 2.5)/1.28$$

The current rating of the transformer secondary must be set according to the load current expected. You can theoretically get away with scaling the transformer current rating to the same current as the maximum load, but that is not the best practice for long-term reliability. The secondary's current rating should be at least 1.5 times the expected current load. Keep in mind that a center-tapped transformer has its current rating specified for a standard two-diode fullwave rectifier, not a

bridge rectifier. The current rating required in the later case will be at least twice the load current. Check the volt-ampere (VA) rating of the transformer to find out whether or not that is a problem for your application.

**Diodes and Bridges.** The bridge rectifier used in a circuit must have a forward-current rating at least as high as the load current, and again add a 50-percent margin for reliability. In other words, if you plan to make a 1-ampere DC power supply, and will run it continuously at or near the full rated output current, then select a 1.5-ampere or higher bridge rectifier.

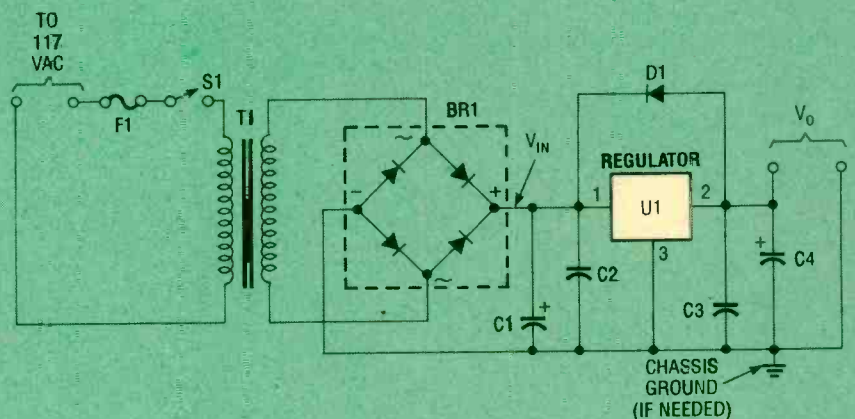

Fig. 2. This is a standard circuit for using a three-terminal voltage regulator. Note that D1 will dissipate the charge on C4 when the supply is shut down.



The peak inverse voltage (PIV) rating, also called the peak reverse voltage (PRV) in some data books, is the maximum reverse-bias voltage that can be applied to the diode without causing permanent damage due to heavy reverse current flow. The PIV rating of the rectifier must be at least 2.83 times the rms secondary voltage of the transformer. That criteria is rarely a problem when designing and building very low voltage power supplies (e.g., 5 VDC), but as the voltage rises, the selection of rectifier PIV becomes critical. Standard PIV values include 50, 100, 200, 400, 600, and 1000-volts. I personally prefer to use the 1000-volt PIV diodes and bridges for the sake of the safety margin they provide.

Diode D1 is used in a lot of circuits, but is especially recommended for applications where C4 is present. If the diode is missing, then the charge stored in C4 would be dumped back into the regulator when the circuit is turned off.

That current has been implicated as troublesome, causing poor regulator reliability. The mechanism of the failure is that the normally reverse-biased PN junction formed by the regulator IC's substrate and the circuitry is forward bi-



Fig. 4. This is the negative-voltage regulator symbol (note that the pin-outs are different with respect to positive regulators).

ased by the capacitor discharge. That allows a destructive current to flow.

The diode should be a 1-ampere type for small power-supply currents, and up to at least 2 amperes for larger current levels. For most low voltage, 1-ampere or less supplies, a 1N400x is sufficient.

**Packaging.** A few three-terminal voltage-regulator packages are shown in Fig. 3. The "H" package (two views of which are shown in Fig. 3A) is used at currents up to 100 mA. The TO-3 "K" package (Fig. 3B) can handle currents to 1 ampere. The TO-220 "T" package (Fig. 3C), you'll find, is good for currents up to 750 mA.

There are two general families of IC regulator. One is designated "78xx", for which the "xx" is replaced with the fixed output voltage rating. So, a 7805 is a 5-volt regulator, while a 7812 is a 12-volt regulator. There's also an LM340y-xx series. The "y" is the package style (H, K, or T) while the "xx" is the voltage. Thus, an LM340K-05 is a 1-ampere, 5-volt regulator in a type-K package; an

LM340T-12 is a 12-volt, 750-mA regulator in a plastic TO-220 power-transistor type of package.

There are also a lot of plastic versions of the "H" package on the market. Those devices are rated at 100 mA, and are likely to have an "L" in the type number. Thus, a 78L05 is a 5-volt, 100-mA regulator in the plastic "H" package; similarly, a 78L12 is a 12-volt, 100-mA regulator. Those devices are used extensively in small projects to provide a small amount of regulated current. In some cases, it can be used to power a critical circuit, such as an oscillator.

Negative-polarity versions of those regulators are available under the "79xx" and "LM320y-xx" designations. They are used in applications requiring a negative output voltage. Figure 4 shows their typical circuit symbol. Note that the pinouts on the negative regulator device are different from those of the positive regulator.

The power dissipation is proportional to the voltage difference between the input potential and the rated output potential (which should be at least 2.5 volts, as we mentioned). For a 1-ampere regulator, therefore, the power dissipation will be at least 2.5 watts (2.5 volts times 1 ampere).

### Dual-Polarity DC Power Supplies.

Figure 5 shows a dual-polarity DC power supply such as might be used in operational-amplifier circuits, some microcomputers, and many other ap-

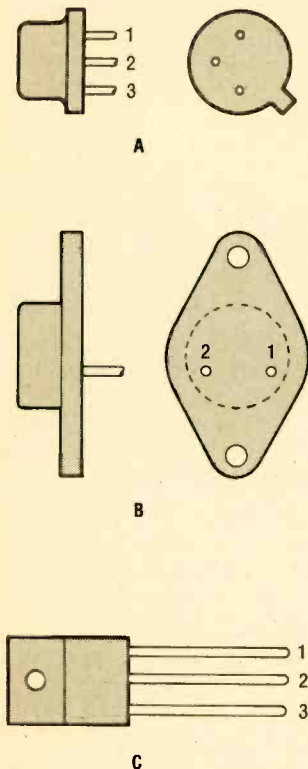

Fig. 3. Here are the most common package styles for voltage regulators. From top to bottom they are: (A) the "H" package (for up to 100 mA); (B) the "K" package (for 1 ampere maximum); and (C) the "T" package (to provide 750 mA).

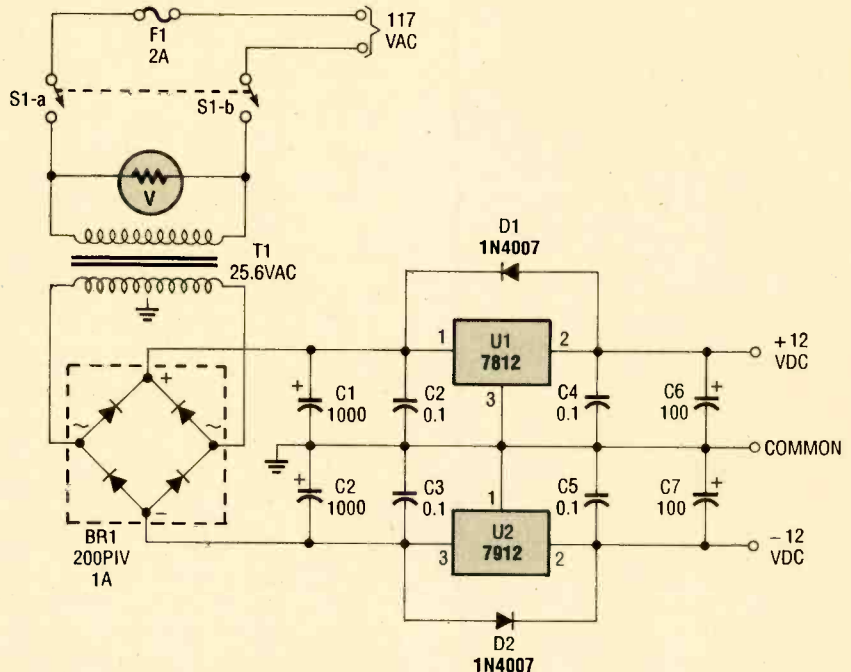

Fig. 5. This dual polarity 1-ampere DC power supply requires only one bridge rectifier, but must have a center-tapped transformer.



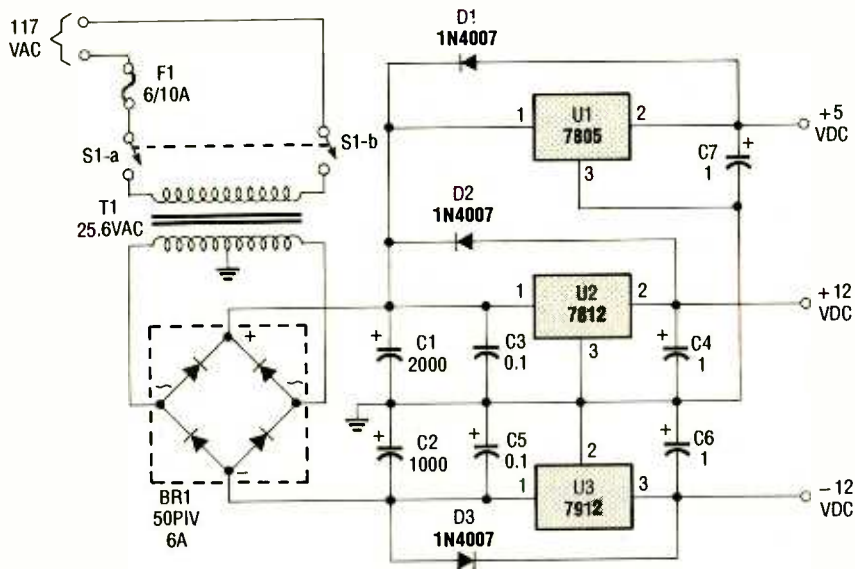

Fig. 6. This bench-top power supply can output +12, -12, and +5 VDC, all at 1 ampere.

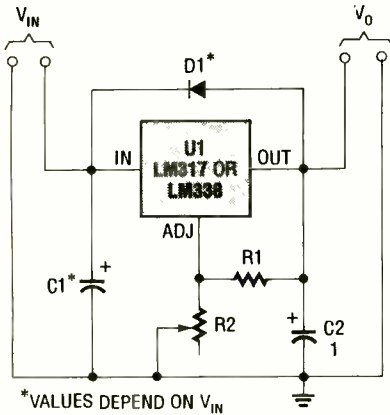

Fig. 7. This circuit, used for the LM317 and LM338 variable-voltage three-terminal regulators, can provide excellent regulation over a range of voltages.

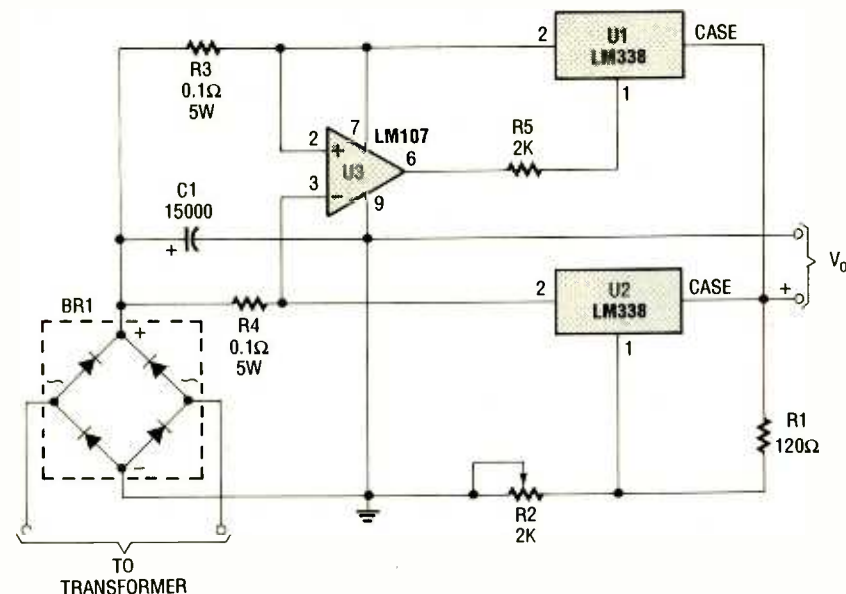

Fig. 8. This is a variable-voltage, 10-ampere DC power supply. The operation of the two LM338's is controlled by the op-amp to ensure that they each work equally as hard.

mined in the same manner as discussed above, so they will not be discussed further here.

Figure 6 shows a three-voltage DC power supply that can be used in microcomputer projects, or on the workbench. I use that power supply on my own workbench to supply the three most common DC voltage levels used in testing projects and circuits for this magazine. The power supply of Fig. 6 is capable of delivering  $\pm 12$  VDC at 1 ampere each, and +5 VDC at 1 ampere. The 7805 requires a heatsink because the input voltage is on the order of 17.5 volts, so the input-output differential is 12.5-volts. At a current of 1-ampere, that means 12.5 watts of power dissipation.

**Adjustable Voltage Regulators.** The IC voltage regulators discussed so far are fixed output-voltage types. They offer an output voltage that is predetermined and unchangeable without extraordinary effort that will probably result in the deterioration of regulation. A variable-output three-terminal voltage regulator, on the other hand, can be programmed to any voltage within its range by using two resistors. Those devices can be used for either variable DC power supplies, or to supply custom output voltages other than those allowed by standard fixed-voltage regulators. Two similar models are considered here as examples.

The LM317 and LM338 devices are variable DC-voltage regulators that are capable of delivering up to 1.5 amperes and 5 amperes, respectively, at voltages up to +32-volts DC. Figure 7 shows a typical circuit for those regulators. The input voltage must be 3 volts higher than the maximum output voltage. The output voltage is set by the ratio of two resistors, R1 and R2, according to the equation:

$$V_O = (1.25 \text{ volts})(R_2/R_1 + 1)$$

An example from the National Semiconductor, Incorporated Linear Databook shows 120 ohms for R1, and a 5k potentiometer for R2. That combination produces a variable output voltage of 1.2 to 25 VDC when  $V_{in}$  is 28 VDC or greater. Diode D1 can be any of the series 1N4002 through 1N4007 for LM317 regulators, and any 3-ampere type for LM338 regulators.

Figure 8 shows a pair of LM338 devices used in parallel to produce a variable-voltage, 10-ampere, DC power supply. (Continued on page 98)

# THE DIGITAL ELECTRONICS COURSE

## 555 OSCILLATOR CIRCUITS

Learn about another application for the versatile 555—generating fixed-frequency pulses for use as timing signals in digital circuits.

BY ROBERT A. YOUNG

In a previous discussion, we looked at how the 555 oscillator/timer IC operates in the monostable mode, and we described (in some detail) some variations on that theme. However a far more common application of the 555 is as an astable multivibrator (commonly referred to as an oscillator).

When the 555 is configured as an astable multivibrator, it can be used in digital circuits to provide a timing signal, thus it is often referred to as a clock. Rather than providing an output for a preset time and turning off (as was the case with the monostable), the astable multivibrator provides a steady stream of pulses of fixed duration, at the repetition rate (frequency) that is determined by two resistors and a capacitor.

**Astable Multivibrator.** Figure 1 shows the basic 555 astable circuit. At start up, the voltage across C1 is low, which causes the 555 to be triggered via pin 2. That forces the output of the 555 high, which in turn causes the 555's internal discharge transistor to turn off, causing C1 to begin charging toward  $V_{CC}$  via R2 and R3.

When the charge across C1 reaches about  $\frac{2}{3}V_{CC}$  (the internally set upper

threshold level), the output of the 555 is forced low. At that point, the charge on C1 is bled off via R3. When the charge across C1 reaches about  $\frac{1}{3}V_{CC}$  (the internally set lower threshold level), U1 is retriggered beginning a new cycle. That process—oscillating between  $\frac{1}{3}V_{CC}$  and  $\frac{2}{3}V_{CC}$ —continues as long as power is applied to the circuit.

The operating restrictions on the 555 in the astable mode are few and are similar to those imposed when the device is operated in the monostable mode (see the March, 1990 issue of **Popular Electronics**). While there is no theoretical limit on the 555's low frequency operation—other than those imposed by limitations on the R2/R3/C1

combination—its upper frequency limit for reliable operation is about 100 kHz.

The limits on C1 in the astable mode are the same as those specified for the monostable mode (.001 to 100  $\mu\text{F}$ ); the maximum value for R2 + R3 in the astable circuit is the same as the maximum value for R1 in the monostable circuit: 14 megohms.

Many applications demand a specific duty cycle, which can be pre-set (within limits) by the values of R2 and R3:

$$\text{Duty Cycle} = R3 / (R2 + 2R3)$$

As R3 becomes large with respect to R2, the duty cycle approaches 50%. If R2 is to be a very small fraction of R3, it should be made no lower than 1k. A note of caution: at some point, pin 7 goes to ground potential, therefore the value of R2 must be maintained at some reasonable value to prevent loading  $V_{CC}$ .

The frequency of the astable circuit is determined by R2, R3, and C1, and is calculated from:

$$f = 1.46 / (R2 + 2R3)C1$$

**Extended Range Astable.** The timing range of the astable multivibrator can be extended far beyond that of the basic 555 astable by the use of a buffer amplifier in the timing network, as shown in Fig. 2. In the circuit, the input bias limitation of the 555 is replaced by those of the op-amp. The low bias cur-

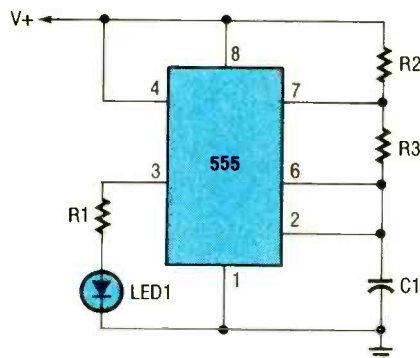

Fig. 1. When operated in the astable mode, the voltage on C1 oscillates between  $\frac{1}{3}V_{CC}$  (the internally set upper threshold level) and  $\frac{2}{3}V_{CC}$  (the internally set lower threshold level) as long as power is applied to the circuit.



## PARTS LIST FOR THE ASTABLE 555 EXERCISE

- U1—555 oscillator/timer, integrated circuit
- LED1—Jumbo light-emitting diode
- R1—270-ohm ¼-watt, 5% resistor
- R2—1000-ohm ¼-watt, 5% resistor
- R3—10,000-ohm ¼-watt, 5% resistor; 100,000-ohm trimmer potentiometer (see text)
- C1—10-µF, 15-WVDC, electrolytic capacitor
- Breadboard, +5-volt power source, oscilloscope, etc.

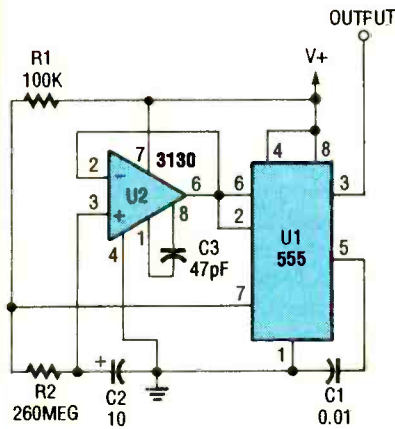

Fig. 2. The timing range of the astable multivibrator can be extended by the use of a buffer amplifier in the timing network. In this circuit, the input-bias limitations of the 555 are replaced by those of the op-amp.

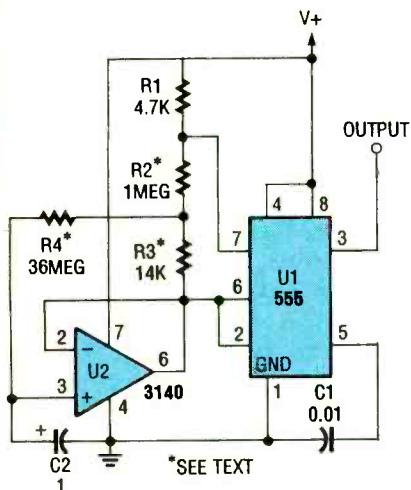

Fig. 3. In this circuit, the op-amp is used as a buffer stage for the timing network, while additional circuitry effectively multiplies the values of the timing components.

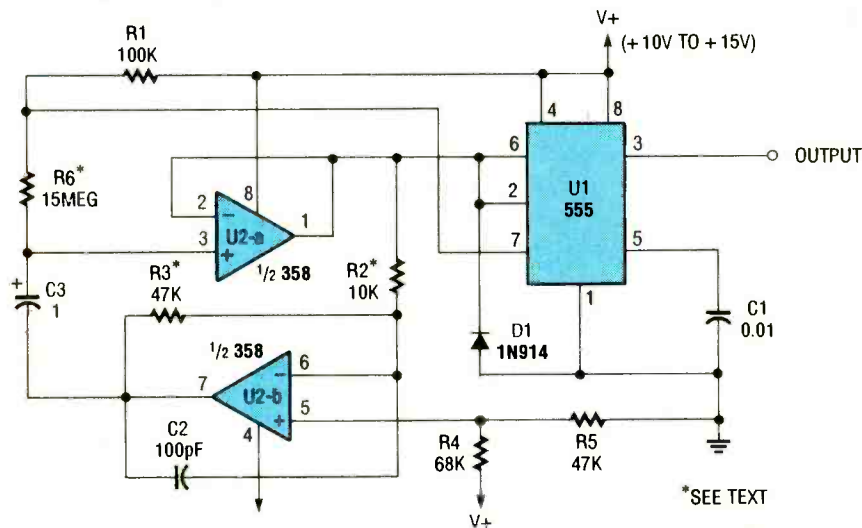

Fig. 4. This circuit multiplies the timing capacitance rather than the timing resistance. Note that in the circuit, the timing capacitance (C3) is not tied to ground, but instead to the output of the second op-amp (U1-b), which functions as a capacitance multiplier.

currents. That allows timing resistances of up to hundreds of megohms to be used.

The circuit in Fig. 3 uses an op-amp also. In that case the op-amp is used as a buffer stage for the timing network, while additional circuitry effectively multiplies the values of the timing components. The circuit in Fig. 3 is similar to that in Fig. 2. The difference is that pin 7 of the 555 switches the voltage applied to the timing network between the positive supply rail and ground, whereas in Fig. 2, pin 7 is connected directly to the timing resistor.

In Fig. 3, the voltage that appears across the timing resistor (R4) is scaled down by a voltage-divider network, consisting of R1 through R3. Connection of R3 as shown (tied to the output of the op-amp), the value of the timing resistance (R4) is effectively multiplied by the ratio of R2 to R3. The ratio of R2 to R3 can be varied over a wide range, as long as the voltage appearing at pin 6 of U1, and hence across R3, is 50 mV or more.

If desired, R3 can be used to trim the timing period, and the output waveform will remain essentially square as long as R2 is kept much larger than R1.

A variation of the extension theme is shown in Fig. 4, where the timing capacitance is multiplied. Note that the timing capacitance (C3) is not tied to ground, but instead to the output of the second op-amp (U1-b), which functions as a capacitance multiplier. The output of U1-a is amplified by a factor deter-

mining the ratio of R3 to R2 (R3/R2), non-inverting input of U1-a. That increases the effective capacitance of C3 by a factor equal to the gain of U1-b. Since the gain of U1-b is 4.7 (R3/R2), capacitor C3 has an effective value of 4.7 microfarads.

**Astable Exercise.** In this exercise, we examine the operation of an astable circuit. Begin by breadboarding the circuit shown in Fig. 1 using the parts values given in the Parts List. If you have not dismantled the monostable circuit from the last installment of this course, you will merely have to modify the circuit by rearranging a few components. With the values given for the components, calculate the expected frequency and duty cycle of the output waveform.

To gain the most benefit from this exercise an oscilloscope is needed. If you do not have access to a scope, simply skip the portions of the experiment that require one. Note: The frequency of the output can be measured using a frequency counter (if one is available).

Apply power to the circuit; LED1 should begin to pulse on and off. Connect an oscilloscope to the output of the circuit and observe the output waveform. Determine the circuit's output frequency from the scope's screen display. Also estimate the duty cycle of the output waveform from the ratio of logic-high output to the period. How does your estimate compare to the calculated duty cycle?

Remove power from the circuit and remove the 10k resistor specified for R3 and replace it with a 100k potentiometer. Apply power to the circuit, and observe the output waveform with an oscilloscope. Vary the resistance of R3, while keeping an eye on the oscilloscope trace.

Note the changes in frequency and duty cycle of the output waveform.

What is the lowest output frequency observed?

(Continued on page 108)

rent of the op-amp virtually removes all restrictions on timing errors due to bias

mined by the ratio of R3 to R2 (R3/R2) and fed through U1-b and C3 to the

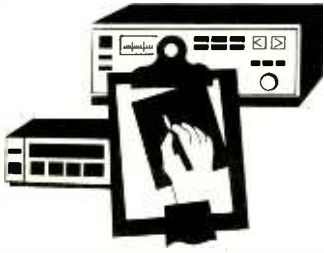

# Product Test Reports

Len Feldman

## RCA MODEL X20343WN TV MONITOR/RECEIVER

It's been said that a relatively small TV picture seems bigger when it's accompanied by "big" sound, or by the spread of stereo sound. That may be why the RCA X20343WN TV monitor/receiver, which is equipped with a built-in MTS (stereo) decoder, offers a picture that seems bigger than its nominal 20-inch (diagonally measured) designation would suggest. Then again, maybe the reason is RCA's square-cornered "Combined Optimum Tube and Yoke" (COTY, for short) picture tube that produces a sharp picture with very good color accuracy. The square-corner screen delivers a noticeably larger viewing area than a conventional round-cornered tube.

A 147-channel, cable-compatible, quartz-synthesized tuner is incorporated in this set. The set's hand-held wireless remote offers direct push-button access of channels, scanning through channels that have been programmed into the set's "memory," or instant recall of the last channel view-

ed. Audio-system controls on the remote raise or lower the volume level, or mute and restore sound levels.

Special on-screen displays are accessed via a special "Setup" button and allow you to adjust various picture and sound settings either at the TV set itself or via the remote control. Other features include auto-programming (setting up and memorizing only the useful channels in your area), automatic and instant switching from cable to off-the-air broadcast mode (a feature that operates during the auto-programming procedure), and automatic contrast and color tracking (once the picture is set to your preference, the contrast/color-tracking circuitry balances contrast, color, and overall brightness with a single contrast adjustment). The set also features a BlackLock Contrast circuit, which enhances the picture by preserving detail, controlling distortion, and preventing dark areas from fading to shades of grey when the picture is very bright.

CIRCLE 119 ON FREE INFORMATION CARD



The RCA X20343WN 20-inch TV monitor/receiver with MTS stereo sound.

**The Controls.** There are actually very few controls found on the front of the set, and their location depends upon the particular version or model of this family of sets you select. In our particular sample, the controls were all at the upper right of the cabinet and included Power, Audio and Video, Setup (used during channel programming or when adding or deleting channels from memory), Channel Up and Down, and Volume + and -.

The volume controls, in conjunction with the Video button, are also used to adjust other video functions. For example, if you press the Video button repeatedly, you will see displays appearing on the screen, in sequence, for color, tint, contrast, brightness, and sharpness adjustment, and for resetting picture controls to the original factory setting. When the desired display appears, pressing either the + or - button alters that particular adjustment. That system may sound a bit cumbersome, but it sure cuts down on the number of controls that might otherwise clutter the front of the TV set or the remote control.

Pressing the Audio button alternately selects mono or stereo reception. Normally, the stereo setting can be used all the time. However, if you encounter a weak signal, sound quality can often be improved by switching to the mono mode.

The supplied remote control duplicates the control functions found on the set itself, and adds a keypad for direct channel access and a Mute button that instantly reduces sound levels. The remote control also has a button labeled PC, which allows you to switch back and forth between the current channel and the one last tuned.

**The Test Results.** Once again we have worked together with APEL (Advanced Product Evaluation Labs), whose director, Mr. Frank Barr, was in charge of measuring the performance of the TV receiver. A summary of all of his audio and video measurements will be found elsewhere in this report. Some comments concerning those results and our own reaction to the receiver are in order.

The maximum usable luminance of 150 foot-lamberts, as reported by APEL, means that the picture you get from this set can be made bright enough, without CRT "blooming," to be comfortably viewed even in a well illuminated room. Horizontal resolution, or picture detail,



while falling short of the maximum that can be received from standard TV broadcasts (330 lines), was nevertheless better than average, and, combined with the vertical resolution of 400 lines, made for a very good, well detailed picture.

While the interlace fell short of perfect (which is 50/50), it was good enough for a picture of these dimensions; when seated at normal viewing distances (generally considered to be a distance equal to seven times the height of the picture tube), the scanning lines pretty much disappear.

Transient response was good, though both APEL and we noticed a slight amount of what's called "pre-shoot,"—an effect that sometimes mars the sharp borders of large objects in a scene.

The perfect black-level retention observed by APEL made for reception of pictures having excellent contrast. Color quality was very good and the amount of overscan reported by APEL is not considered to be a problem, as only a very small amount of the picture is lost along the left and right edges of the picture tube. (Some manufacturers use large amounts of overscan to compensate for low power-line voltages that occur during summer brown-outs. Under such conditions, sets having poorly regulated power supplies will have pictures that shrink. Large amounts of overscan mean the picture will still fill the screen even under those conditions. Absence of overscan suggests that the manufacturer uses a well regulated supply.)

The TV tuner section of this receiver was excellent, and exhibited very good sensitivity as you can see by examining Figs. 1 and 2. For the photo in Fig. 1, which was taken directly from the screen of the set, APEL "transmitted" a standard still-life photo with a signal strength of 1000 microvolts, equivalent to strong signal reception. For Fig. 2, signal strength was reduced to only 100 microvolts, which is equivalent to fringe-area reception. As you can see, there is very little difference between the quality of the photos and only a very slight increase in background noise can be noted.

We wish we could be as enthusiastic about the sound system of this TV set as we are about its picture. The built-in amplifier outputs about 1.5 watts-per-channel at reasonably low levels of distortion and at signal-to-noise ratios that are acceptable when you consider the

## TEST RESULTS—RCAX20343WN TV MONITOR/RECEIVER

Unlike the case with audio products, video products seldom have many meaningful published specifications associated with them. Thus, APEL's results are tabulated without any reference to manufacturer's specifications, simply because few of APEL's measurements are normally reported by this or any other manufacturer. As Popular Electronics publishes more and more reports, you will be able to make meaningful comparisons between competing products.

### SPECIFICATION

Maximum Usable Luminance  
Resolution (Vertical/Horizontal)  
Interlace  
Transient Response  
Black Level Retention  
Color Quality  
Overscan

0-dB Reference Level (1 kHz)  
Distortion at Reference Level  
Distortion at -10 dB (1 kHz)  
Signal-to-Noise Ratio  
Stereo Separation (100%/ -20 dB  
re: 100% Modulation)  
100 Hz  
1 kHz  
10 kHz

Distortion at -10 dB (1 kHz)  
Signal-to-Noise Ratio

Power Requirements  
Picture Size  
Weight (lbs.)  
Dimensions (inches)  
Suggested Price: \$369.00.

### APEL MEASURED VIDEO SECTION

150 Foot-Lamberts  
400/280 Lines  
60/40  
Good/Some Pre-shoot  
100%  
Very Good  
2.2% Horizontal

### STEREO TV (AUDIO) SECTION

1.5 watts/channel  
3%  
0.6%  
43.4 dB  
9.0 dB/6.0 dB  
3.0 dB/1.0 dB  
1.5 dB/2.0 dB

### MONO TV (AUDIO) SECTION

0.39%  
35.2 dB

### ADDITIONAL DATA

70 Watts  
20-inches (diagonal)  
45  
17 $\frac{3}{8}$  H x 24 $\frac{1}{4}$  W x 19D.



Fig. 1. At a signal strength of 1000 $\mu$ V, the receiver displayed a top-quality picture



Fig. 2. Even at fringe-area signal levels (100 $\mu$ V), only a slight increase in background noise is evident.

type of speakers being used. The real problem with the set is its stereo-decoder circuitry. It became clear to APEL right from the start that the circuitry was improperly aligned. There was virtually no stereo separation at middle and upper audio frequencies, and even at low frequencies of 100 Hz, only 9 dB of separation was measured at maximum modulation. That separation decreased to a mere 6 dB at levels of modulation that were 20 dB below maximum.

We feel fairly certain that if the stereo decoder circuitry had been properly aligned, much better stereo separation would have been measured and we would have sensed a far greater stereo sound stage than we did with this sample. We have no reason to suspect that the low level of separation observed in this one sample represents a design flaw, so if you do plan to consider owning this model, we would urge you to check out the stereo effect for yourself  
(Continued on page 108)



# ANALOG DEVICES COMPONENT- SELECTION SOFTWARE



CIRCLE 120 ON FREE INFORMATION CARD

*A software package that can tell you what chip fits your needs is nice to have. When that software is free, it's impossible to do without.*

One of the biggest problems facing hobbyists who design their own projects is choosing components to provide optimum performance. After all, once you know what you want a circuit to do, you want to start stuffing your project with the parts to do it—and all, of course, with the least expense possible. Imagine (if you must) being on the threshold of total “gadgethood,” only to be thwarted by an insidious data book full of chips.

“But aren’t data books supposed to be full of chips?” you might ask. Well, yeah; but when several chips can all do the same job, but have subtle yet important differences, you better get real comfortable—you and your data books are going to stay home tonight. Perhaps there are some noble individuals more than happy to risk confusion and paper cuts to bring their projects to life, but I can’t be counted among them. In fact, it’s enough to make me want to scream “Data base!”

**An Answer.** If you’re like me, then fear not; Analog Devices, Inc., offers a solution that’s easy-to-use for the product-proliferation blues: the Component Selection Guide software package. The guide helps project designers choose

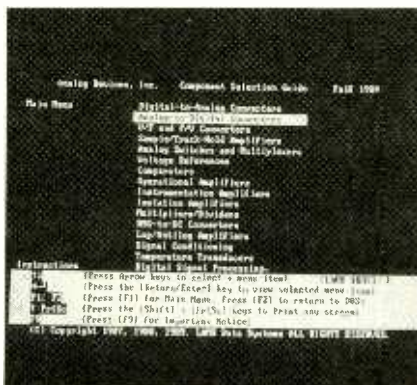

*This photo of the software's main menu should give you a good idea of how large the Analog Devices' product line is. There are over 1600 products supported in all.*

the most suitable component, and provides them with the confidence that they’ve made the best choice after reviewing the alternatives and trade-offs.

The company boasts of having “the industry’s broadest-ranging catalog including analog- and digital-signal processing components and data converters....” I must admit, their product line up is impressive. The software is capable of helping the user choose between various converters (namely digital-to-analog, analog-to-digital, frequency-to-voltage, voltage-to-fre-

quency, and RMS-to-DC types), a variety of amplifiers (including the operational, sample/track-hold, instrumentation, isolation, and log/antilog families), and other components such as analog switches and multiplexers, voltage references, comparators, multiplier/dividers, signal conditioners, digital-signal processors, and even temperature transducers.

Used with any IBM PC or PC compatible, the designer simply enters the minimum and maximum specifications allowable for key design parameters.



*Certain parts come in so many different “flavors” that a sub-menu is provided to allow you to further specify what you wish to investigate.*







# Antique Radio

## THE SUPER-WASP PLAYS AGAIN!

By Marc Ellis

This month brings good news for those of you who've been waiting for the other shoe to drop on the *Pilot A.C. Super-Wasp* story. As you know, I originally covered this classic 1929-era BC-SW receiver in the July through November, 1989 issues. By November, we'd examined every square inch of the Wasp, made repairs where necessary, and were ready to try the set out.

However, one crucial component was still missing. The A.C. Super-Wasp was designed to operate from a separate, outboard AC power supply, and I didn't have one available. Accordingly, I set out to construct one that would be similar to the the K-111 power pack sold as an accessory by Pilot.

**Murphy Strikes!** In the January 1990 issue, we talked about the design of both the K-111 and of the more modern adaptation I planned to construct. And when it was time for me to start putting together the March column, the new power pack was virtually complete. But before I could finish it and power up the Wasp, I became a victim of Murphy's Law. Through an accidental stroke of a file, I ruined the wire-wound power resistor to be used as the power supply's bleeder resistor/voltage divider.

Attempts to locate a replacement through surplus channels proved fruit-

less, so I eventually had to bite the bullet and come up with the \$25.00 minimum order required to obtain a new unit. The friendly UPS driver dropped it off a week or so ago, and I lost no time getting the Wasp project back on track.

Once the resistor was installed and the wiring completed, I turned on the supply (which was not yet connected to the radio) and verified that it was functioning properly. Next, I set the four adjustable taps on the voltage divider/bleeder resistor to deliver the voltages required by the Super-Wasp (180, 135, 90, and 45).

The four taps would have to be reset later, after the supply was actually delivering power to the receiver. That's because the additional current flow through the bleeder would increase the voltage drops across it, lowering the values available at the taps. However, this preliminary adjustment would at least provide voltages that were in the right ballpark—and that were on the low side rather than of a damaging high value.

**The Anemic Heater Problem.** Next, I wired the power cable from the supply to the receiver's binding posts. Removing the rectifier tube to temporarily suppress the high voltage, I switched on the supply and watched the Super-Wasp's tubes light up. They seemed a little dim, as did the pilot lamps illuminating the set's twin tuning dials. A voltmeter check confirmed what my eyes had told me: The heater-circuit voltage was too low, measuring about 1.9 instead of the required 2.5.

At first I was concerned that a partial short circuit somewhere in the receiver was overloading the filament transformer. But inserting an AC ammeter in series with one of the heater-circuit leads showed that the supply was putting out only about six and a half amps—well within the rating of the 10-amp filament transformer and actually

a little low for the four 1.75-amp-heater tubes being powered.

Then I realized what was probably the source of the problem: It was almost certainly the beautifully-laced, 4-foot-long, 7-lead power cable I had acquired along with the receiver. The wires didn't look heavy enough to carry more than six amperes that far without a significant voltage drop, and another voltmeter check confirmed my suspicions. The filament transformer was delivering almost three volts to the power-supply end of the cable.

I could have reduced the voltage drop in the cable by taking it apart and substituting heavier wires for the two heater leads. But, being basically lazy and not wanting to redo the beautiful lacing job, I opted for the less drastic alternative of cutting the cable in half and discarding the far end. Reconnecting the cable to the receiver, I now measured the voltage delivered to the heater circuit at just a bit under 2.5. I could live with that.

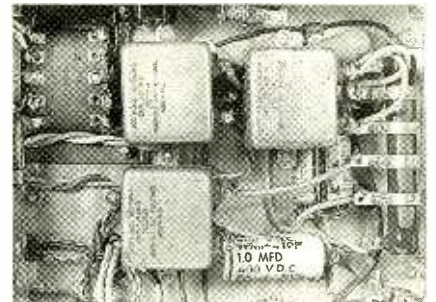

Here's a look beneath the power-supply chassis. The large tubular capacitor and the three big square units are bypasses. A wire-wound bleeder/voltage-divider resistor is at the right.

**The Moment of Truth.** With the broadcast-band coils installed, an antenna and ground connected, a pair of headphones plugged into the front-panel jack, and the tubes still lit up, the Super-Wasp was ready for the acid test. I inserted the type-80 rectifier tube into its socket and awaited the results. Warm-up was quick. As a matter of fact, the set happened to be tuned fairly close to a station, and I heard music coming from the headphones before I had a chance to pick them up! It looked like all of the careful preparatory work was going to pay off.

But when I tried to check other stations in the band, I ran into some trouble: No amount of dial twisting would change the tuning of the set; the original station continued to come in with unvarying intensity!

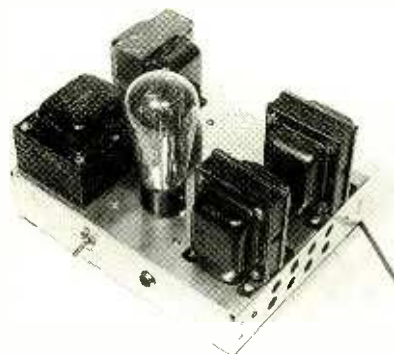

Here's the Super-Wasp power supply completed and ready for use. Pear-shaped type-80 rectifier gives it a vintage look.





Here's the power supply and receiver hooked up and ready for testing.

My concern changed to amusement, however, when I realized what was going on. Though the tuning dials were turning, the tuning capacitors were not! I'd forgotten to tighten the set screws on the dial bushings after reassembling the radio. It took only a few moments to adjust and tighten the bushings, and after that the Wasp tuned as expected.

Though I was in my basement workshop and using only about a 20-foot antenna (most of which was inside), I was able to pick up broadcast stations over the set's entire tuning range. In fact, stations of even moderate strength came in super-loud, overloading the phones and all but blasting them off my head. Designed in an era when broadcast stations were weak and widely scattered, this highly sensitive little set wasn't even equipped with a volume control! About the only way I could reduce volume to a listenable level was to slightly detune the station.

**Switching to Shortwave.** Though doubtful about how much I'd hear with my short workshop antenna, I decided to try a shortwave band. Since it was daytime (New Year's Eve morning, in fact), I thought propagation might be better on the higher frequencies, so I replaced the broadcast-band coils with the pair covering the Wasp's highest frequency range (14.2–28 meters, or approximately 11–21 MHz). The static crashes coming through the headphones told me that the set was, at least, functioning—and I began tuning around.

Not having a calibration chart (the Wasp's dials carry only 0-100 reference scales), I had no idea where in the band I was tuning—but there were



Here are two of the Wasp's five coil sets. The original box for the antenna (RF amplifier) coils is in the background.

places that were alive with signals. I was able to hear snatches of BBC and Voice Of America broadcasts, American and Canadian time-and-frequency-standard stations, innumerable religious broadcasters (it being a Sunday morning), various stations from Latin America, and a number using languages I didn't recognize.

On that band, there was no problem with too-strong signals overloading the headphones. In fact, some of the more tantalizing stations were barely strong enough to hear, and managed to fade out before I could learn the country of origin.

As might be expected with an early regenerative set, selectivity was far from perfect, and I often found myself hearing two stations at once. Trying to listen to one station while mentally rejecting another is quite a strain on the brain—even if the interfering broadcast is in a language you don't understand!

**Interacting Adjustments.** But the real challenge in exploring the shortwave bands with a sensitive regenerative receiver is coping with the tuning. The Super-Wasp has four tuning controls: RF amplifier and detector tuning (controlled by the two illuminated dials with 0–100 scales), regeneration (controlled by a front-panel knob with-

out a scale) and an antenna trimmer (controlled by a knob located inside the set on the RF-amplifier shield can). In theory, the RF-amplifier and detector controls are used to actually tune in the station; the regeneration control is adjusted for maximum sensitivity (it's usually kept set so that the detector is almost—but not quite—on the point of oscillation); the RF trimmer is adjusted for best performance (within a given frequency range) from the antenna you are using.

In practice, however, I found that changing the positions of the regeneration control and/or antenna trimmer would also affect the tuning of the set (stations would change when I moved them). Also, as might be expected, adjusting either of the main tuning controls required a re-optimization of the regeneration control. Finally, the set sometimes would refuse to oscillate (and therefore pick up stations) even with dial adjustments that had been successful not five minutes before.

**Restoration Completed!** I think I can say, at last, that the Pilot A.C. Super-Wasp restoration has been successfully completed. The set works well with its new AC-derived power supply, pulling in both broadcast and shortwave stations with decent tonal quality and a minimum of hum. The supply itself, being overdesigned for its job, loafs along without even getting warm (except for the bleeder resistor, of course).

Though shortwave tuning was touchy, regenerative receivers are legendary for exhibiting such difficulties. And my makeshift antenna system and inexperience in working with this type of radio didn't help matters.

While the restoration is complete, I don't think we've quite seen the end of the Wasp in this column. After hooking up the radio to a decent antenna and ground, and gaining a little experience in operating it, I plan to spend a solid evening of DX-ing. I'll log in all of the exotic stations I've been able to pick up and report on the results.

I'd also like to try the set with a speaker of appropriate vintage. And I'd like to test, once and for all, Pilot Radio's claim that, because of innovations in the design of the heater, Pilotron type-27 tubes make more sensitive, quieter detectors.

So far, my attempts to get hold of a Pilotron type-27 for testing have been

*(Continued on page 97)*

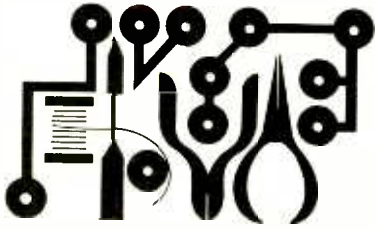

# Circuit Circus

By Charles D. Rakes

## YESTERYEAR'S CIRCUITS SHOW THE WAY

The circuits I'm sharing with you this month are very similar to the ones that got your's truly into the electronic game many years ago. As a youngster growing up before TV's were common household items and portable tape recorders were contained in suit cases, radio was still the mysterious wonder that needed exploring.

For me the romance started with the successful operation of my first primitive home-built, "orange-crate special" (a one-tube radio) and has never ceased since that day. Over the years I've seen numerous neophytes get caught up in the wonders of electronics, and go on to become engineers, technicians, and lifetime hobbyists from such a meager beginning.

So this month's circuit trilogy is especially dedicated to the first time builder and experimenter as a catalyst, hopefully, to spark that special interest that could turn out to be the beginning of a lifelong odyssey into the field of electronics.

There are two basic types of receiver circuits that we can build. The simplest of the two is the non-powered receiver that takes the available RF energy and converts it to audio by simple diode rectification. That type of popular passive receiver is best known as the crystal set or diode radio.

The majority of simple crystal radios suffer in selectivity and audio output. To improve both, the RF level must be increased without amplification. The solution is to increase the efficiency of the antenna by raising it higher above the ground and making it longer in length, or to move the receiver closer to the RF source. Normally neither solution is too practical. But if we opt to go the active route in building a receiver just about anything that can be done to the signal electronically is fair game.

The RF can be amplified before detection, or converted to a new frequency (IF) to be amplified again before detection. In fact several popular com-

munication receivers convert the RF three times before the modulation information is converted to audio and sent on for audio-frequency (AF), amplification. All three of our receiver circuits fit nicely in the active class.

**Tunable/Amplified Receiver.** Our first receiver circuit (see Fig. 1) goes two steps beyond the popular crystal radio by adding a tuned RF amplifier stage before the signal is demodulated and an audio amplifier stage after. The RF energy from the antenna is fed through a small trimmer capacitor, C2, to the tuned circuit made up of L1 and C1. The desired broadcast signal is selected via C1 (a 365-pF variable capacitor). Inductor L2 feeds the tuned RF signal to the input of the RF amplifier, consisting of Q1 (an MPF102 N-channel, junction field-effect transistor or JFET), which boosts the RF signal many times before sending it on to the detector stage.

Two 1N34A germanium diodes (D1 and D2) are connected in a voltage-doubler/detector circuit that adds even more output signal to drive the audio-amplifier circuit. The RF portion of the signal, after detection, is filtered out by C5, R3, and C6 leaving the audio portion of the signal at the top of the volume control, R5. A 2N3904 NPN transistor, set up in a common-emitter configuration, increases the AF signal to a

level sufficient to drive headphones or, on strong local stations, to drive a speaker with the addition of an impedance-matching transformer.

I was able to receive several stations when an 18-inch clip lead was connected to the antenna terminal and six stations were received with a 20-foot length of hookup wire hanging from the shop's ceiling. That's not too shabby when you consider our most powerful station, a 5-KW daytimer, is over five miles away, and all other local stations are of lower power.

Operating power for the receiver is supplied by a single 9-volt transistor-radio battery. Since the current drain is only a few milliamperes, the battery should last several months under normal use.

As for assembling a similar unit, it can be built for mounting on a piece of hardwood measuring 11 x 11 x 1 inches. The size of the wood base need not adhere to our dimensions, but should be large enough so component crowding is unnecessary. A 2 x 4-inch section of perfboard with push-pins holds the small components and is mounted to the wood base with wood screws and spacers.

The tuning capacitor should be mounted so that it faces one edge of the board for ease of operation, with L1 and L2 located close behind. The volume control potentiometer and phone jack are mounted on an "L" bracket formed from a strip of scrap aluminum and attached to the breadboard so that it faces in the same direction as the tuning capacitor.

Inductors L1 and L2 were produced by winding No. 20 enamel-covered copper wire on a 2½-inch length of 4-inch diameter plastic pipe. Just about any good plumbing shop should have a scrap piece of that popular size pipe—possibly free for the asking. Or if

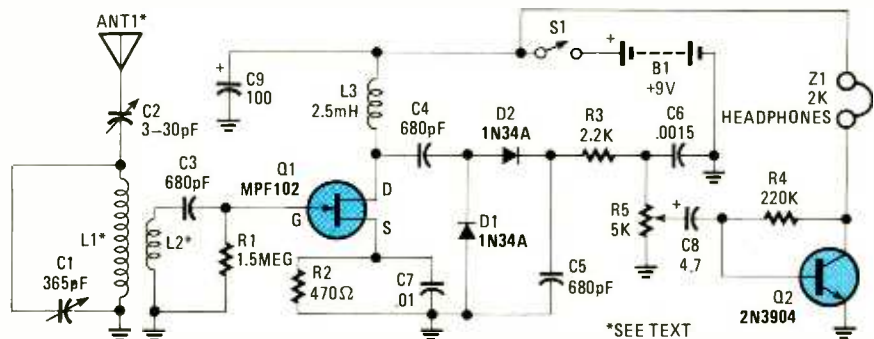

Fig. 1. The Tunable/Amplified Receiver goes two steps beyond the conventional crystal radio by adding a tuned RF amplifier and an audio-amplifier stage.



## PARTS LIST FOR THE TUNABLE/AMPLIFIED RECEIVER

### SEMICONDUCTORS

Q1—MPF102 general-purpose, N-channel JFET  
 Q2—2N3904 general-purpose, NPN silicon transistor  
 D1, D2—1N34A general-purpose, germanium diode

### RESISTORS

(All resistors are 1/2-watt, 5% units, unless otherwise noted.)

R1—1.5-megohm  
 R2—470-ohm  
 R3—2200-ohm  
 R4—220,000-ohm  
 R5—5000-ohm potentiometer

### CAPACITORS

C1—365-pF, tuning  
 C2—3-30-pF, trimmer  
 C3—C5—680-pF, ceramic-disc  
 C6—0.0015- $\mu$ F, Mylar  
 C7—0.01- $\mu$ F, ceramic-disc  
 C8—4.7- $\mu$ F, 25-WVDC, electrolytic  
 C9—100- $\mu$ F, 16-WVDC, electrolytic

### ADDITIONAL PARTS AND MATERIALS

L1, L2—See text  
 L3—2.5-mH choke  
 Z1—2000-ohm headphones  
 B1—9-volt transistor-radio battery  
 S1—SPST switch (any type)  
 Perfboard materials, enclosure, battery holder and connector, #20 enamel-coated wire, plastic pipe (see text), wire, solder, hardware, etc.

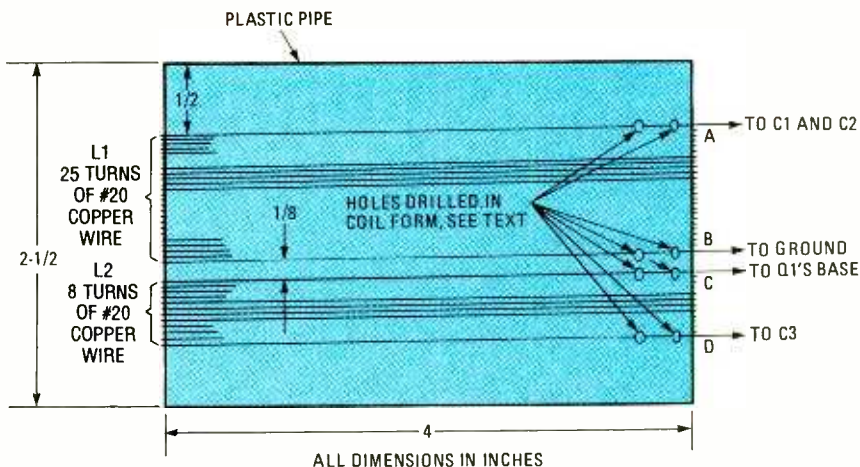

Fig. 2. Inductors L1 and L2 in the Tunable/Amplified Receiver are easily fabricated from a 2½ length of 4-inch diameter plastic pipe (which is used as the coil form) and 22-gauge enamel-coated wire (25 turns for L1 and 8 turns for L2).

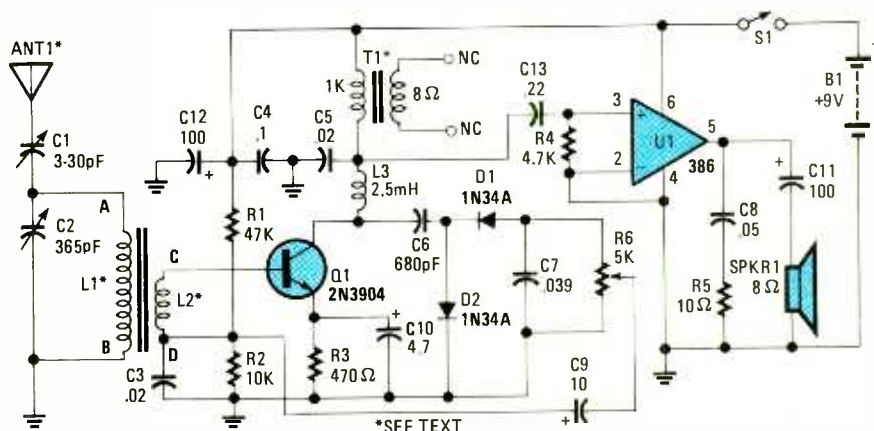

Fig. 3. Our solid-state version the Reflex Receiver is based on a popular circuit of the 1920's.

a scrap piece can't be found a 10-foot section should set you back no more than 5 bucks.

Figure 2 illustrates how the two inductors are to be wound. Starting with the 2½-inch length of plastic pipe, drop down about a ½ inch from the top of the coil form and drill two small holes through the form to hold the start end of L1. Weave the wire through the two holes to make a 6-inch pigtail to connect to C1. Close wind, in a solenoid fashion, 25 turns to complete L1.

Then temporarily tape the loose end of the winding to the form, drill two more small holes in the form, and thread the wire through the holes to hold the completed winding in place. Also leave about 6-inches of wire at the finish end of L1 to connect to C1 and circuit ground. Drop down about an ⅛ inch from L1 and drill two more holes in the form for the start end of L2. Leave a 6-inch pigtail and close wind a total of 8 turns, in the same direction as L1. Drill

the two remaining holes in the form and secure the ground end of L2 as before, leaving a 6-inch pigtail to connect to circuit ground.

Since there's only one stage of RF gain, the wiring layout isn't critical and any suitable arrangement should do. In any case, keep all leads as short as possible and don't locate the 2.5-mH choke (L3) too close to L1 and L2. To use a speaker with the circuit, connect the primary of an 1 or 2K to 8-ohm audio-output transformer in place of the phones and connect the speaker to the 8-ohm secondary winding.

To use the radio, connect a 9-volt battery to the circuit and apply power. Tune C1 from one end of its rotation to the other and you should at least hear one or more local stations. If so connect a 10- to 20-foot length of wire to C2 and several additional stations should be heard. Set C2 for the best selectivity between stations. If C2 is set at its maximum capacitance with a long anten-

na, the stronger local stations will cover up a number of the weaker stations. So experiment with the setting of C2 for the best overall performance.

**Reflex Receiver.** Our second receiver's design, shown in Fig. 3, is based on a popular radio-reflex circuit of the 1920's. At that time radio was just catching on and home-made sets were being built at a fever pitch among experimenters. Back then, component pricing governed the pace of assembling a receiver; for example, the cost of a single receiving tube could be as much as a good day's wage. So any circuitry magic that would allow the same tube to be used for more than one function in the same circuit was indeed a very favorable choice of the day. The reflex-circuit design lets a single-tube radio perform like a more costly two-tube receiver.

Now let's see how our modern day  
 (Continued on page 96)





# Computer Bits

## BLUES FOR SANDY

By Jeff Holtzman

A friend came to me with an unusual request. She owned an XT compatible with 640K of memory, a 360K floppy, a 20MB hard disk, and a Hercules monochrome video system. Her company was converting over to 286 and 386 machines, and consequently was liquidating its stock of 8088-oriented peripherals, which included several items my friend was interested in. She wanted me to help her pick out the best equipment.

So one Saturday we carried her PC into the office and spent the better part of a day setting it up. The exercise was extremely frustrating for both of us; had I been charging for my time, it wouldn't have been worth her while to do it—she would have been able to buy most of a new system for the cost of the hardware she did buy and what my time would have cost. There are several lessons to be learned from the experience.

In preliminary discussions, Sandy (not

her real name) and I decided that additional memory and an accelerator card would be her best upgrade bets. The company had one memory board with two megabytes of EMS 3.2 memory; several memory boards with 1.25MB of EMS 3.2 memory along with serial and parallel ports, a game adapter, and a clock; and half a dozen different kinds of accelerator cards, including 286 models ranging in speed from 8 to 12 MHz, and one 386SX model running at 16 MHz.

I will refrain from mentioning manufacturers (except for the final system configuration), because most of the equipment we tested worked fine by itself; problems came in the interactions between various components, and those interactions can't really be blamed on individual manufacturers as much as the industry as a whole.

Also, I went through the accelerator-card syndrome a few years ago when they were popular. I guess the passage

of time had erased the memory cells involved; if I had been in my right mind I would have declined her plea or simply bought her a new AT! But I was stuck.

**Speed And Memory.** I figured that the accelerator card would provide the biggest problem. As it turned out, that was not the case; as a group, I had less trouble installing the accelerator cards than the memory boards. First I tried the 386SX board; it worked fine, right out of the box. Installing the card involved removing the 8088 from the system board, re-installing the CPU on the accelerator card, inserting the SX board into an empty slot, running a cable from the card to the now-vacant CPU socket, and then installing the software. Installing the cable takes a fair amount of manual dexterity, and you get better at it after about the 12th time, but I'm sure all that plugging and unplugging doesn't do much for the reliability of the CPU socket! In any case, the next task was to install a memory card.

That particular card had connectors for an optional memory card that the SX processor could address directly; if that card had been available, my Saturday would have been saved, and my friend would have ended up with a much higher performance and a much more versatile system.

Sandy didn't really need I/O ports, so first I tried installing the 2MB card. I did, turned on the machine, and waited. Nothing...nothing...nothing. I took the card out, checked it, re-installed it, powered up, and—you guessed it: Nothing. I figured there was probably some kind of port conflict between the memory card and the accelerator card, so I removed the accelerator card, re-installed the 8088, and removed the memory card. Testing, the machine booted fine. Then I put the memory card back in. No boot. Something deep inside bubbled up and told me to press the Reset switch on the PC. I did, and lo and behold, there was the BIOS sign-on message.

The machine booted fine, so I ran the diagnostic software that came with the board; it seemed to be fine. I went through the entire installation, and the EMS memory seemed to work. Then I installed a disk cache program, re-booted, and soon had completely corrupted the disk. (That wasn't as bad as it sounds; I had told Sandy to prepare TWO backup copies earlier in the week, so all her data was safe.)

Then I took the opportunity to per-

Name	Hex Start	Hex End	Hex Owner	Decimal Length	Text or Interrupt Numbers
DOS & drivers	0973	0F96		25,120	02 08 09 0A 0D 0E 70
COMMAND.COM	0F96	106A	0F97	3,376	22 23 24 2E
	106A	106E	-Avl-	48	
COMMAND.COM	106E	1079	0F97	168	COMSPEC=C:\COMMAND.COM PATH=C:\
SPA.EXE	1079	107F	1000	80	COMSPEC=C:\COMMAND.COM PATH=C:\
SPA.EXE	107F	109E	1000	400	13
P2P.COM	109E	10A5	10A6	96	COMSPEC=C:\COMMAND.COM PATH=C:\
P2P.COM	10A5	1096	10A6	32,512	05 10 1C 21
	1096	109E	-Cur-	112	
	109E	A000	-Cur-	554,512	
High DOS Mem					
Dev=MOVE'EM\$	C400	C45F	C401	1,504	2F 67
Dev=MS\$MOUSE	C45F	C6DE	C460	10,208	33
	C6DE	C7FF	-Avl-	4,608	
RAM or ROM	C7FF	DC00		81,920	41
Dev=SMARTAAR	DC00	DFBD	DC01	15,296	14 17 19
MODE.COM	DFBD	DFD6	DFBE	384	
	DFD6	EFF4	-Avl-	66,000	
MODE.COM	EFF4	F000	DFBE	176	COMSPEC=C:\COMMAND.COM PATH=C:\

C>  
 Move'em is a utility program for 8088- and 80286-based PC's with true EMS 4.0 memory. The program allows you to load device drivers into high memory, thereby increasing usable space in the "lower 640."



form a low-level disk format, reinstalled DOS and a few utility files and went back to work. Needless to say, that memory card was out of contention.

Next I re-installed the 386SX card; it still worked fine by itself. Then I installed one of the 1.25MB cards with I/O. The machine booted without having to press Reset; that was a good sign. However, when I installed the EMS driver, the machine stopped booting. So I took the 386SX back out, put the 8088 back in, re-installed the memory card and software—and it worked fine. It also worked fine with the disk cache program.

At this point we had a machine that would run the accelerator card or the memory card, but not both together. Sandy began to look like she was sorry she ever thought about upgrading; I consoled her, saying that this kind of thing happens all the time.

We took a break for lunch and talked it over. It seemed that the 1.25MB memory board worked fine, and memory was as important to Sandy as a speed enhancement, so we decided to forego the 386SX card and try the others. We tried several of the 286 boards, but simply couldn't get one to work with the memory board. Usually the machine would boot all right, but when the EMS driver was loaded, the machine would hang up.

Near the bottom of the equipment list was Microsoft's *Mach 20* accelerator card. It was near the bottom because, at 8 MHz, it's slower than all the other cards we tried. On the positive side, this particular model happened to come with an optional 1.5MB of fully EMS 4.0-compatible memory, and there's room for another 2MB of RAM. So I de-configured the PC to the base level, verified that it still worked, and then installed the Mach 20. It comes with an excellent installation program that shows how to set all the jumpers and switches. The accelerator portion worked fine, as did the memory portion (with the disk cache).

### Vendor Information

Mach 20  
**Microsoft Corporation**  
16011 NE 36th Way, Box 97017  
Redmond, WA 98073-9717  
Tel. 206-882-8080

Move'em  
**Qualitas, Inc.**  
7101 Wisconsin Avenue, Suite 1386  
Bethesda, MD 20814  
Tel. 301-907-6700

At this point Sandy's options included: (1) a fast 386SX board, but no extra memory; (2) 2.5MB of memory (on two cards), but no accelerator card; or (3) the Mach 20, which gave a moderate performance boost and a fair amount of memory, and also included a mouse that connects directly to a special port on the board. Sandy went for option 3. Then we spent several hours experimenting with options on the Mach 20.

The Mach 20's memory system is 16 bits wide, so I removed all but 256K of the 8-bit memory on Sandy's system board and let the Mach 20 fill in the 384K hole. Tests of access speed surprisingly showed that the lower 256K of 8-bit memory was faster than the upper 384K of 16-bit memory. I figured that the lower memory was being cached by the Mach 20, and the upper memory wasn't. (Cache memory is a small—in this case 16K—block of very fast memory that stores often-used information so that the CPU can get it quicker than from main system memory.) So I replaced the 384K on the system board, but found that the PC wouldn't recognize that memory if caching was enabled.

**Final Configuration.** Sandy ended up with 256K on the system board, a Mach 20 accelerator that gives the raw CPU performance of an 8-MHz AT, and 1.5MB of EMS memory. By my standards (my everyday system is a 10-MHz AT clone, and I use a 386 for demanding work), the setup seems slow.

The only saving grace is the memory system, which provides true EMS 4.0 compatibility. Of the Mach 20 memory, 348K is used to fill out the 640K of conventional memory, about 1MB is used for disk cache (which helps compensate for the 8-bit hard-disk controller and the slow access time of the disk itself), and the remainder is mapped to unused memory segments above the video adapters (D000-DFFF). That block is used to load Sandy's mouse driver, disk cache, etc., saving her about 50K of low memory.

Loading software into high memory is an old trick on 386 machines; just recently, products have become available for 8088 and 80286 machines with EMS 4.0 memory. My favorite 386 memory manager is called *386MAX*; it's made by a company called Qualitas. As you might suspect, Qualitas was first out of the gate with an EMS 4.0 memory manager; it's called *Move'em*, and it is simply wonderful. The company tells

me that 90% of the code for the two products is identical.

If you're thinking about an EMS memory board, make darned sure it's got hardware-mapping registers, which most of the cheap (around \$200) boards definitely don't have. Those registers allow physical blocks of memory (in 16K chunks) to be "mapped" to empty spaces in high memory. The cheap boards claim EMS 4.0 compatibility, but provide it only through software emulation, and without hardware registers they cannot load programs into high memory. The problems that this shortcoming can cause are now painfully clear.

**Conclusion.** In the end, it all really wasn't worth the trouble. Sandy could have bought a 386SX motherboard for \$350-\$400, or a full 386 motherboard for about \$600. If you're in the market for a system or an upgrade, follow these rules:

- Don't buy an 8088.
- Don't even buy a 286.
- Buy an SX or better.

If I'd insisted with Sandy, I wouldn't have this awful headache.

# ATTENTION! ELECTRONICS TECHNICIANS



## EARN YOUR B.S.E.E. DEGREE

### THROUGH HOME STUDY

Our New and Highly Effective Advanced-Placement Program for experienced Electronic Technicians grants credit for previous Schooling and Professional Experience, and can greatly reduce the time required to complete Program and reach graduation. No residence schooling required for qualified Electronic Technicians. Through this Special Program you can pull all of the loose ends of your electronics background together and earn your B.S.E.E. Degree. Upgrade your status and pay to the Engineering Level. Advance Rapidly! Many finish in 12 months or less. Students and graduates in all 50 States and throughout the World. Established Over 40 Years! Write for free Descriptive Literature

## COOK'S INSTITUTE OF ELECTRONICS ENGINEERING

 4251 CYPRESS DRIVE  
JACKSON, MISSISSIPPI 39212

CIRCLE 21 ON FREE INFORMATION CARD



# Ham Radio

By Joseph J. Carr, K4IPV

## KEEPING YOUR ANTENNA SYSTEM IN SHAPE

Okay, you've been working DX all winter, and racked up enough QSO's for DXCC, WAC, WAS, and a score of other prestigious operating awards. The sunspots have been good, and DX signals have been bubbling up all over the HF spectrum from 160 meters to 6 meters. Even the 10-meter novice phone band produced enough contacts to keep your appetite whetted for months to come.

But now it's Spring, and while the bands are not dead (or even sick this year!), they are changing. Pretty soon, summer short-skip will be in, and you will be out for vacations, grass mowing, and taking long walks in the woods. But wait a minute, "ain't" there something you forgot? Everything's working well, isn't it? Maybe, maybe not. Have you taken a look at your antenna recently? What about the rest of your gear? Is it working up to specification?

**Checking the Antenna.** Ham antennas are, for the most part, relatively simple devices made of wire or aluminum tubing, plus a few other parts. Yet they do deteriorate. In most areas of the United States the weather can be quite brutal to mechanical and electrical parts that are kept out of doors—like an antenna. Sun parches the antenna, drying out and cracking plastic, nylon, and other fittings; cold causes other materials to become brittle and crack; rain and snow forces moisture into coax, antenna tuners, and traps; hail beats the stuffings out of the antenna; and the constant transition from cold to hot seen in much of the country stresses mechanical pieces.

**Feedpoint Connections.** On most ham antennas, the RF power from the transmitter is carried to the antenna by way of a coaxial-cable transmission line. On some antennas, the end of the coax is stripped so that the center conductor and shield can be connected to the two screws at the antenna feed-

point. In other models, a coaxial connector is used (normally, an SO-239 female connector is mounted on the antenna, while a male PL-259 is attached to the end of the coaxial cable). In either case, disconnect the coaxial cable from the antenna and

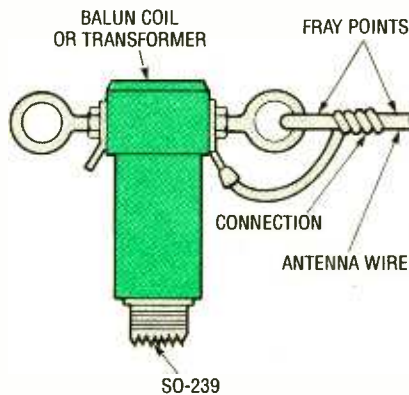
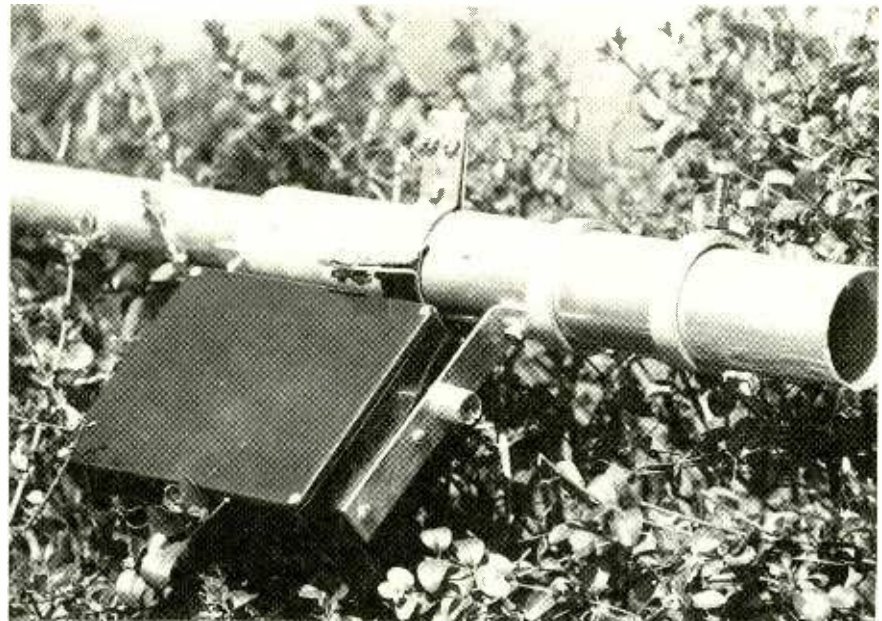

Fig. 1. Dipole antennas often use either a molded, center insulator or balun coil at their feedpoints.



Some antennas have either tuning or impedance-matching networks installed at their bases in a weather-resistant box. Those boxes typically have an SO-239 coaxial connector on one side to receive RF power from the transmitter. The output connection is usually either a single screw-post connector or a beehive insulator. Inspect the tuning and impedance-matching boxes as possible trouble spots.

examine the connections for evidence of corrosion (and if a PL-259 is used, evidence of water penetration as well).

Use sandpaper or some other abrasive material to clean any corrosion off, and make it bright again. Make sure to also clean the connection or connector on the antenna as well as on the coax. When you reconnect the coaxial cable, smear a light coating of silicone grease all over the connections or the coax connector. The grease forms a moisture barrier to prevent water intrusion and corrosion. Silicone grease can be purchased in squeeze tubes from both electronics-parts distributors and ordinary hardware stores.

As an alternative to silicone grease, you might consider using other silicone products such as GE RTV. Those products are caulk-like materials that will perform the functions of the grease (in this case), but is a little harder to work into small spaces. It is also a bit more difficult to remove in the following years. But on the plus side, some people believe that silicone caulks works better than the greases.

**Vertical Antennas.** Vertical antennas have long been popular with amateurs, especially those who have limited space in which to erect antennas. The typical multi-band vertical is a series of aluminum pipe sections separated by LC resonant traps. Verticals for the HF bands tend to be between 18 feet and



25 feet high, and are often mounted on a structure that is 10 to 30 feet high. Because they are thin and mounted high off the ground, a vertical antenna is subject to a lot of whipping around in the wind over the course of a year.

Some vertical antennas have either tuning or impedance-matching networks installed at their bases. Those boxes typically have an SO-239 coaxial connector on one side to receive RF power from the transmitter. The output connection to the antenna is usually either a single screw-post connector or a beehive insulator. Those boxes should be checked to make sure that there are no cracks, holes, or splits in them.

Examine the SO-239 exactly as in the previous cases. Also check the output connector to make sure that it is tight, cannot admit water, and is electrically sound (again, clean any corroded connections). Before finishing the job, check the integrity of the hardware that mounts the tuning unit to the mast.

**Further Up the Antenna.** The next steps will require temporary disassembly of the antenna mounting. Using at least one additional helper (for safety), gently drop the antenna down onto the ground and prepare to inspect the traps, capacity hats, clamps, decoupling elements, etc. Also check the clamps that hold the tubing sections together.

Traps are parallel-resonant LC networks that prevent their resonant frequency from passing. On most commercial antennas, the traps are encapsulated in either an epoxy-like material, or some sort of shrink-fit material. If the traps are cracked or otherwise broken, then contact the antenna manufacturer for replacement traps.

**Dipole Antennas.** The halfwave dipole is a horizontally polarized wire antenna that is popular with a great many amateurs. Over the years such antennas tend to stretch and may eventually break. In addition, they often use either a molded, center insulator, or balun coil (Fig. 1) at the feedpoint. Check the balun or center insulator for cracks and other defects. Also look at the nuts that hold the wire connector to the body of the balun, and make sure they are tight.

Inspect the antenna connections at both the center insulator and the end insulators. Look for corroded connections and especially frayed wires. The most likely point for fraying is immediately before or after the connections.

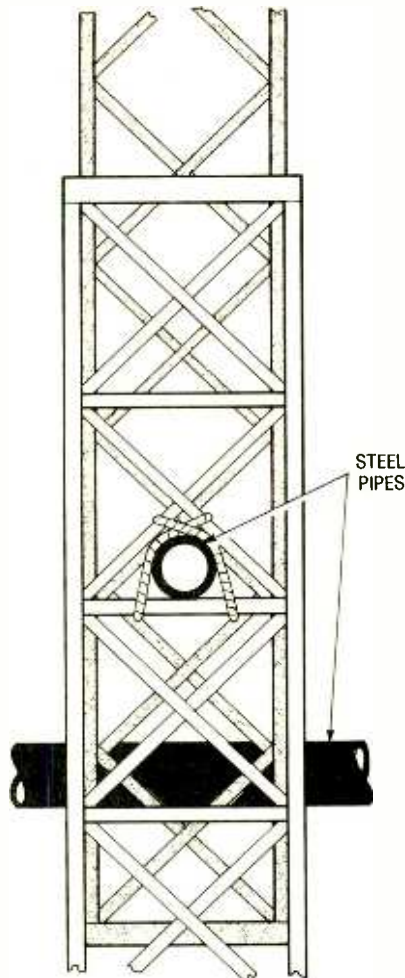
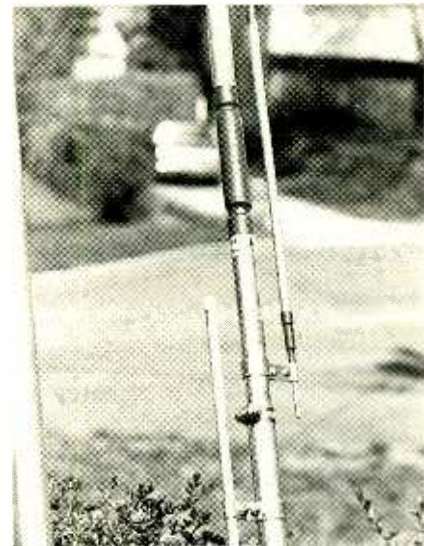

Fig. 2. Antenna towers are made of two or more telescoping sections, and come with locks and fasteners to prevent the sections from separating. For an extra measure of safety, some people use a pair of 1.5- to 2-inch steel pipes placed so that they intersect both inner and outer sections.

However, it is also possible for fraying to exist elsewhere along the antenna, so make a close inspection. Finally, examine the ropes and supports.

**Grounding.** Grounding is used on antennas for two reasons: First, the ground system helps the antenna work better; second, the ground system provides lightning protection. Your antenna should be grounded according to local codes, or with an 8-foot, copper-coated, steel grounding rod. Make sure that the connection between the grounding rod and the antenna system is still good. Disconnect the ground rod, clean up the contact surface, and re-establish the connection.

**Tower Safety Note.** If you use a slip-up tower to support your antenna (usually a beam or quad), then it may be necessary to climb the tower to per-



Temporarily disassemble the antenna mount and inspect the traps, capacity hats, connections, clamps, decoupling elements, stubs, and anything else that hangs off the antenna.

form the maintenance chores. Aside from the normal precaution of using proper footgear and two safety belts (disconnect one at a time to climb), one must also be wary of the guillotine effect. The towers are made of two or more sections, one telescoped inside the other. The tower manufacturer provides locks and fasteners to prevent the tower sections from separating.

If during climbing you added weight breaks a corroded connector or fastener, then the inner section of the tower will come tumbling down causing a shearing action that can take off feet, hands, or other appendages that happen to be in its path. Some people use an extra safety feature in the form of a pair of 1.5- to 2-inch steel pipes placed so that they intersect both inner and outer sections (Fig. 2).

The length of the pipes should be such that they are much longer than the width of the outer section to prevent dropping. The pipes are shown at right angles to each other in Fig. 2, but they could be along the same side. Tie the pipes down securely. If the normal safety catches fail, then the pipes will provide an extra margin of safety for you.

When all of the above inspections have been passed, and/or the damage repaired, remount the antenna and check it out. Run the VSWR curves to make sure that the antenna is both resonant and impedance matched. Once those chores are done, the antenna will be ready for you the next winter when the DX comes rolling in.





# DX Listening

## STEAM RADIO?

**S**team radio may conjure up visions of a bygone era of kerosene lamps, whalebone corsets, and bug-gywhips. But it's just the way South African broadcasters jokingly refer to their shortwave stations.

Radio RSA, the shortwave external service of the South African Broadcasting Corp., has a series of powerful 250- and 500-kilowatt transmitters that are as modern and efficient as any in the world. But they generate, as do all transmitters, great amounts of heat as they pump out shortwave signals in a dozen languages, 216 hours each week. To keep working, those transmitters must be cooled. And that is where the steam comes in.

The cooling is accomplished by what is known as a *vapodyne* system. A relatively small amount of distilled water circulates in a closed cooling system, drawing off heat from the transmitting tubes. As steam, it is condensed by heat exchangers and then returned as water to the transmitter-tube anodes to continue the recirculation process. It is, of course, not unique to the Radio RSA operation, but it works well for the South African broadcasting stations.

Radio RSA began broadcasting to the world in May 1966. Today its beams go out daily to target areas in Africa, Latin America, the U.S., Canada, the United Kingdom, Europe, and the Middle and Far East. Listeners in North America can find Radio RSA in English from 0200 to 0300 UTC on 9,580, 9,615, and 11,935 kHz. The station broadcasts in English to North America, Europe, and Africa at 1400 to 1600 UTC on 11,925, 21,535, 21,590, and 25,790 kHz.

Transmissions are introduced by the Radio RSA interval signal, one of the most attractive on shortwave today. That musical identification combines the proud call of a native South African bird, the Bokmakierie, mixed with the

By Don Jensen

opening bars of an old *Afrikaaner* folk melody, "Ver in die Wereld Kitty," played on a guitar.

Programs, including 57 newscasts daily, originate in studios in the Piet Meyer Building in Auckland Park, a suburb of Johannesburg. Transmissions are relayed to an automatic line-switching unit in the main control, which feeds the transmitters at Bloemendal, outside the capital.

The station's signals can be coupled to any of its 34 high-gain antenna arrays. Radiation for the individual dipole antennas in the curtains multiplies, providing a gain of up to 20 decibels, equal to an amplification factor of 100! The antennas are beamed in seven general directions, three of them serving East Africa and the Middle East, one each for North America and Central Africa, and a final pair for West Africa and Europe.

Among Radio RSA's more interesting programs are "Our Wild Heritage," which introduces listeners to the flora

and fauna of southern Africa; "Sounds of Soweto," featuring traditional black music; and "Conversation Corner" language lessons teaching the Afrikaans language.

Radio RSA has a club-like organization for listeners, called its "Monitoring Panel." It offers a newsletter and handbook to members who regularly report reception of the shortwave station. QSL cards also are sent to listeners who report their loggings.

More information is available by writing to Radio RSA, P.O. Box 4559, Johannesburg, 2000, Republic of South Africa.

Thanks to David Wratten and his column in "Contact," the publication of the World DX Club in England for information about Radio RSA.

**Feedback.** Each month I feature some of your letters in this regular segment of the column. Your questions about shortwave listening and the stations on the air are always welcome, and I will try to answer those having the most general interest.

Also, if you'd like to see yourself and your SWL'ing setup, in these pages, simply send along a clear photo. Please identify the radio receivers and other equipment shown in the pictures. Sorry, but it isn't possible to return photos. You can write me c/o "DX Listening," **Popular Electronics**, 500-B Bi-County Blvd., Farmingdale, NY 11735.

The first note this month is from Paul Peterson, Walnut Creek, CA, who writes:

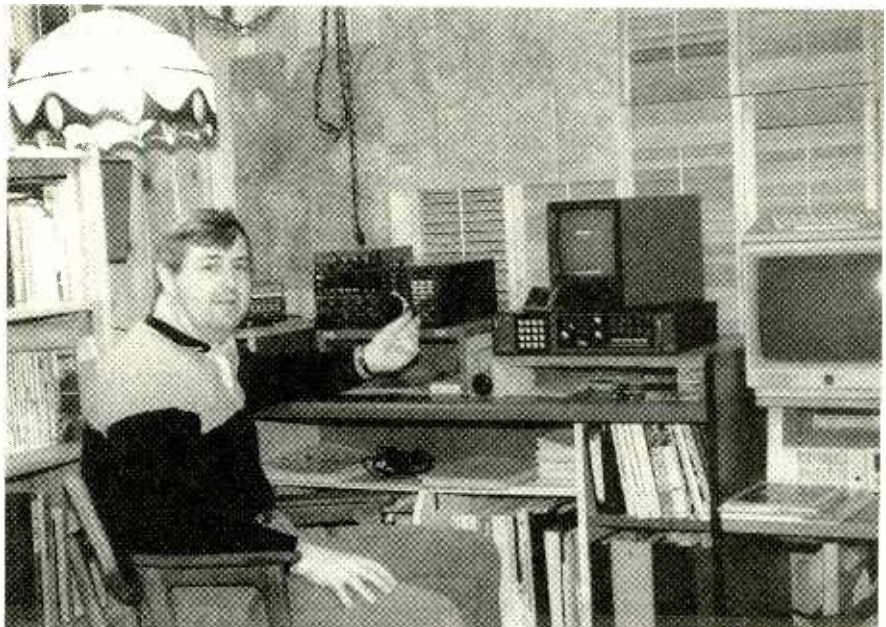

Jim Uerlings, a 37-year-old lawyer and municipal judge in Klamath Falls, OR, got his start in shortwave DX'ing in 1965. Since then he has logged stations in over 200 countries. His monitoring gear includes a Japan Radio Co. NRD-525 receiver, a Sony 2001 receiver, and an Info Tech M-6000 radioteletype monitor with video display.

\*CREDITS—Bob Brown, PA; Paul Peterson, CA; Fred Kohlbrenner, PA; Joseph Kremer, IN; North American SW Association, 45 Wildflower Road, Levittown, PA 19057)



"Thanks for the 4-star column on the shortwave pirates of the airwaves. I haven't heard any of these clandestine transmissions yet, but I like their spirit and I appreciate your open-minded reporting of them."

SWL's should realize, of course, that those unlicensed broadcasters are operating in violation of Federal Communications Commission regulations and U.S. law. If and when they are tracked down by the authorities, these hobby radio "pirates" may be subject to fines totaling hundreds to several thousand dollars. At the same time, however, this column cannot ignore shortwave stations which, legal or not, are on the air and which can be heard by many of our readers.

Surely, the FCC has demonstrated that when it wants to spend the time and money to catch those broadcast violators, it can do so. A number of pirates have been caught and fined. But the FCC, seemingly, will go for long periods of time without cracking down on violators. When enforcement is lax, pirate broadcasting increases.

As of this writing, U.S. pirate broadcasters are quite active. During a recent holiday weekend, at least a dozen different pirate operations were heard, most of them in two spots on the shortwave dial: 7,350-7,450 kHz and 15,025-15,075 kHz.

Some of the pirate broadcasters have been on shortwave—sporadically to be sure—for years. The *Voice of the Purple Pumpkin* announced its 20th anniversary broadcast. The *Voice of Laryngitis*, generally acknowledged to have some of the funniest programming on the shortwave, is another old timer. Others noted include unlicensed operations calling themselves *Radio USA*, *KNBS*, *WXZR*, *Hope Radio 16*, *Voice of the Abnormal*, *East Coast Pirate Radio*, *Secret Mountain Laboratory*, *WBST*, *Tangerine Radio*, and the list goes on and on.

Most transmissions are relatively brief and occur from about 2200 to about 0500 UTC. Some even announce mail drop addresses and promise verifications to listeners who report hearing them.

Next we hear from Joaquin Stuber, a native of Germany who has lived in Venezuela for the last 35 years. Joaquin writes: "This is the first time I'm writing you. I've always been interested in DX listening, unfortunately I haven't kept a record of all the stations I've heard.

"But I have a big question which you

can answer for me. I wonder if there exists in the Caribbean a radio station which transmits weather conditions, thunderstorms, hurricanes, etc. for the islands?"

For routine weather broadcasts, Joaquin, given your Venezuelan location, perhaps your best bet would be to tune in some of the medium-wave AM broadcasters in the Caribbean. ZIZ, St. Kitts on 555 kHz and *NBS Radio*, 610 kHz, Trinidad, are a couple that come to mind. Or, when hurricanes are brewing, you might try some nighttime tuning for the more powerful U.S. southern coastal AM-radio stations, such as *WWL*, New Orleans, LA, on 870 kHz.

On shortwave, before, during, and after major Caribbean storms, it can be interesting to tune in to the amateur-radio hurricane nets and military communications. During last year's Hurricane Hugo, Florida DX'er Terry Krueger noted a lot of ham emergency traffic on 14,325 kHz. Also noted were the otherwise rarely heard islands of St. Barts and Guadeloupe. VP2EHF on Anguilla, VP5LJ on Grand Turk Island, and the United Nations amateur radio station, 4U1UN, were logged with emergency traffic on 3,915 kHz.

**Down The Dial.** Here are some of the stations being heard by SWL's in the U.S. and Canada. What are you hearing?

**Brazil**—2,490 kHz. Not many SWL's tune down to the 120-meter band, but there are a few stations which, occasionally, can be heard. One of them is *Radio 8 de Septiembre*, noted with Brazilian pop music and Portuguese announcements around 2330 to 0030 UTC.

**Ecuador**—6,230 kHz. *HCJB*, the long-time *Voice of the Andes* in Quito is often heard by listeners during the evening hours.

**Solomon Islands**—9,545 kHz. An exotic Pacific-area target station for SWL's is the *Solomon Islands Broadcasting* station, reported with local English news at 0730 UTC.

**South Africa**—11,880 kHz. *Radio Five* is the South-African English-language commercial domestic-radio service. If you tune in shortly before 0600 UTC, you can hear the wakeup program South-African commuters tune in as they get ready to go to work.

**USSR**—7,400 kHz. Moscow's voice isn't the only one broadcasting from the Soviet Union. *Radio Vilnius*, whose English broadcasts originate from the Lithuanian S.S.R., often offers a different viewpoint. Tune this one at 2200 UTC.

## New from AOR

### 2000 Channels 5MHz to 1500MHz



AR2515

- Covers 5MHz to 1500MHz in AM/FM/Wide FM modes Continuous coverage
- 2000 Channel Memory 1984 Scan Frequencies & 16 Search Groups.
- Scan/Search speeds up to 36 channels or increments per second
- Built in RS 232 computer interface
- 25 Day Satisfaction Guarantee Full Refund if not Satisfied
- Size 3 1/2" H x 5 3/4" W x 7 1/4" D Wt. 2 lb 10 oz
- Supplied with AC & DC power cords Telescopic antenna

Total Price, Freight Prepaid (Express Shipping Optional) \*Upgrades of AR2002's to AR2515 specs Available

**\$695.00**

**ACE**  
COMMUNICATIONS

10707 E. 106th St. Indpls., IN 46256

Toll Free 800-445-7717

Visa and MasterCard  
(COD slightly higher)

In Indiana 317-849-2570 Collect FAX (317) 849-8794

CIRCLE 19 ON FREE INFORMATION CARD

## Be an FCC LICENSED ELECTRONIC TECHNICIAN!



No costly School. No commuting to class. The Original Home-Study course prepares you for the "FCC Commercial Radiotelephone License". This valuable license is your "ticket" to thousands of exciting jobs in Communications. Radio-TV. Microwave. Computers. Radar. Avionics and more! You don't need a college degree to qualify, but you do need an FCC License. **No Need to Quit Your Job or Go To School** This proven course is easy, fast and low cost! **GUARANTEED PASS** — You get your FCC License or money refunded. **Send for FREE facts now. MAIL COUPON TODAY!**

**COMMAND PRODUCTIONS**

FCC LICENSE TRAINING, Dept. 203

P.O. Box 2824, San Francisco, CA 94126

Please rush FREE details immediately!

NAME \_\_\_\_\_

ADDRESS \_\_\_\_\_

CITY \_\_\_\_\_ STATE \_\_\_\_\_ ZIP \_\_\_\_\_



# Scanner Scene

## TAKING IT ON THE ROAD

By Marc Saxon

Uniden/Regency's new series of three pre-programmed scanners certainly have stirred up some controversy, with scanner "purists" insisting that any scanner worth its salt should be able to have frequencies added and replaced by the user. But let's not be overly critical. The world of scanning is wide and wonderful, and this series is intended to appeal to a specific segment of that world.

The "top-of-the-line" unit in the series is the model *INF-10*, with a manufacturer's suggested retail price of \$199.95. Like the two other units in the series, it is intended to appeal to long-haul truckers, those who call the interstates home (residents of motor homes and mobile homes), and persons who travel the highways for business.

These scanners save a lot of time and effort for such people, who are mainly interested in keeping an ear open for information on what's happening along the route. All the user need do is switch up the state abbreviation letters on the LED display and the scanner does the rest, checking out all active police frequencies in the 33–511-MHz range. At the touch of a button, it can also pick up NOAA weather broadcasts. This time of the year especially, many people are dusting off those RV's for trips to far away places, and these "in-

formation radios" should have a lot of people interested in what they have to offer.

The *INF-10* zips through the bands at a rate of 60 to 100 channels per second, and the user can opt to hold on a channel of interest, or skip over temporarily unwanted channels. It's really a good introduction to some of the practical benefits of scanning for those not (yet) ready to jump feet first into the hobby of scanner monitoring. My guess is that these sets will win over many who later discover that they want to hear more than they offer, thus adding new members to the hobby.

Uniden/Regency is located at 4700 Amon Carter Blvd., Fort Worth, TX 76156.

**From the Mail Sack.** Lewis Himmelman, from International Falls, MN, observes that his scanner covers 25 through 1300 MHz, and yet there is only one antenna-input jack. He asks if an antenna cut for a particular band will give adequate reception over such a wide expanse of frequencies.

That is an often-asked question, and my advice is to investigate the possibility of using a discone-type antenna. Discones, while not offering much in the way of "gain," provide a lot of frequency coverage. Several models from different manufacturers are now on the

scanner market. Note, however, that the discone coverage of the VHF "low band" (30 to 50 MHz) isn't all that good. To perk up the coverage on that band, several manufacturers have added a vertical whip antenna that sticks up out of the center of the top of the discone. If you are interested in that band, you'll want to keep that in mind.

We receive a lot of mail relating to aeronautical monitoring and would like to offer some general information based on the comments and questions most often contained in our correspondence. The most popular band for monitoring aeronautical communications ranges from 118 to 137 MHz (recently expanded from 136 MHz). Most frequencies in this band are spaced at 25-kHz intervals. Those frequencies are used worldwide for air-traffic control, airline-company air/ground communications, flight instruction, Flight Service Stations and Air Route Traffic Control Centers, and many miscellaneous services at civil and military landing areas.

Although many people don't seem to realize it, a considerable amount of aero-related communications also takes place in the regular 30–50-MHz, 152–174-MHz, 406–512-MHz, and 800-MHz scanner bands, including stations licensed in the business and other radio services. There is also a "UHF aero band" that runs from 225 to 400 MHz and is used exclusively for military purposes.

No matter how remote an area in which someone lives, there's always traffic to be monitored on the aero bands. Not only are some frequencies always busy, but aircraft aloft can be received over considerable distances.

Some frequencies that are usually active, no matter where you are, include 122.2, 122.7, 122.8, 122.9, 122.95 and 123.0 MHz. Helicopter activity can often be monitored on 123.05 MHz. Sometimes you can catch pilots chatting with one another on 122.75 and 123.45 MHz. If your scanner has a search/scan mode, try searching the 128.825–132.0-MHz band for airline operations. Private pilots exchanging weather data with FAA ground stations ("Flight Watch") can be monitored on 122.0 MHz. Those are excellent starter frequencies, but there's an enormous amount of activity to monitor from one end of those bands to the other, including police aircraft, forest-fire aircraft, air ambulances, crop dusters, and so much more.

The most complete directory of aeronautical-communications frequencies



Uniden/Regency's pre-programmed *INF-10* "Information Radio" is targeted at people who spend a lot of time on the road, providing the low-down on highway and weather conditions.



in the USA and Canada is the newly issued, 192-page, fifth edition of *Air-Scan*. This big book, which covers operations in the 118-137-MHz aero band, plus the 30-50-, 152-174-, 406-512-, and 800-MHz bands, takes in every aspect of aeronautical monitoring in considerable detail. The book is \$14.95, plus \$2 postage/handling to addresses in USA/Canada/APO/FPO. Residents of NY State add \$1.13 sales tax. Order from CRB Research Books, Inc., P.O. Box 56-PE, Commack, NY 11725.

Lewis Stone, of Tacoma, WA passed along some of the police channels in his hometown. "F-1" is a car-to-car channel on 460.15 MHz; "F-2" is the dispatcher on 460.05 MHz; "F-3" is another car-to-car frequency at 460.30 MHz; while "F-4," at 460.35 MHz, is for check-in data.

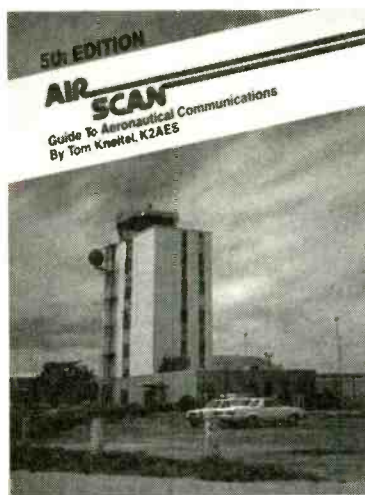

Just about everything you've ever wanted to know about aeronautic communications can be found between the covers of *Air-Scan*.

A few issues back we mentioned that some companies are using short-range transmitters and receivers to permit in-house communications between their computers. That brought in more requests for additional information than we expected. Those units operate on four frequencies in the 900-923-MHz band, transmit with 20 milliwatts, and can handle 38,400 bits per second over each channel. The rated range is 100 to 500 feet, depending upon the installation. They're made by O'Neill Communications, Inc., 100 Thanet Circle, Suite 202, Princeton, NJ 08540.

We are always pleased to hear from our readers with questions and comments, suggestions, and frequency data. Write to us at: *Scanner Scene*, Popular Electronics, 500-B Bi-County Boulevard, Farmingdale, NY 11735.



New solid-state and digital TV sets, stereos, and videorecorders are tougher to repair than old-fashioned tube type sets and require special training for the service technician who works on them.

Only a few states have laws requiring competency tests for licensing technicians who repair consumer electronics, but fifteen years ago the International Society of Certified Electronic Technicians (CET) began its own certification program to qualify these technicians and those in industry. To carry the CET designation, technicians must have four years experience and pass a rigid examination on general electronics and a specific area of expertise such as audio or radio-TV.

Many consumers look for a Certified Electronic Technician in the shop when they need any electronic item repaired.

#### Free Consumer Checklist

A consumer checklist for selecting a service shop is available

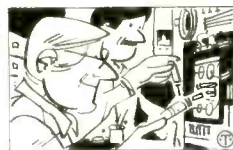

Modern electronic equipment such as digital TVs or stereos should be repaired by specially trained people.

available free by sending a stamped, self-addressed envelope to: Checklist, IS CET, 2708 West Berry, Fort Worth, TX 76109. The list reminds consumers to check such items as "Does the business have the parts for your particular brand?", "Did you get an estimated price?", and "Did you check this company with the Better Business Bureau?"

## Managing to Get Ahead



Test yourself with this sample question:

Which one of the following questions may you ask a prospective employee in a job interview?

- (1) Do you own or rent your home?
- (2) Are you married?
- (3) Are you able to work overtime?
- (4) Have you ever been arrested?
- (5) All of the above?

Now wouldn't you like to test yourself against the real thing?

If you've got the experience and knowledge it takes to get the job done, you can get certified in professional service management. The Certified Service Manager exam is offered through NESDA for owners or service managers with a minimum of 4 years of experience.

For a practice test and more information about CSM Certification, write to NESDA, 2708 W. Berry St., Fort Worth, TX 76109-2356, or phone (817) 921-9061.

(ANSWER: #3)

Make the most of your general coverage transceiver with *Monitoring Times!*

Every month *Monitoring Times* brings everything you need to make the most of your general coverage transceiver: the latest information on international broadcasting schedules, frequency listings, international DX reports, propagation charts, and tips on how to hear the rare stations. *Monitoring Times* also keeps you up to date on government, military, police and fire networks, as well as tips on monitoring everything from air-to-ground and ship-to-shore signals to radioteletype, facsimile and space communications.

**ORDER YOUR SUBSCRIPTION TODAY** before another issue goes by. In the U.S., 1 year, \$18; foreign and Canada, 1 year, \$26. For a sample issue, send \$2 (foreign, send 5 IRCs). For MC/VISA orders (\$15 minimum), call 1-704-837-9200.

### MONITORING TIMES

Your authoritative source, every month.

P.O. Box 98  
Brasstown, N.C. 28902

MAY 1990





## SATELLITE RADIO

(Continued from page 71)

If the level of background noise seems obtrusive, switch to narrowband. That should improve the signal-to-noise ratio of the program, but it may also result in some loss of treble.

Two FM stations that pay a great deal of attention to the audio quality of their signals are the Chicago Fine Arts station, WFMT, and the New York Times station, WQXR, both with classical-music formats. In order to overcome the handicaps of narrowbanding, they use a signal compansion-and-expansion technique developed by Wegener called PANDA. Unfortunately, PANDA companders are professional gear, which means that prices start at several thousand dollars. Consumer expanders like those marketed by dBx and Dolby can approximate the effects of PANDA, but not perfectly. Without signal expansion, the signals tend to suffer from a "squashed" frequency response and dynamic range and a higher-than-normal level of background noise. In fact, to the casual listener, they often sound worse than other uncompanded sub-carrier audio channels.

**Single Carrier Per Channel.** If you've never heard of SCPC or single-carrier-per-channel audio, don't feel badly. Your satellite receiver won't pick it up, and the only company marketing an add-on tuner for consumers is Heil Sound Ltd. (2 Heil Drive, Marissa, IL 62257).

According to SCPC *guru* Bob Heil, there are more than 350 high-quality audio signals on the various C and Ku band satellites ranging from ball games and automated radio, to the World Service programs of the British

Broadcasting Corporation and various other European and Latin American broadcasters.

Because there is only one signal on each channel, the frequency response can rival that of a compact disc (30–20,000 Hz) with distortion of less than 1%, he says. While many signals are mono-only, some stereo is available—but they require separate \$450 tuners for left and right channels.

Not only are SCPC channels not listed in the satellite program guides, Heil says that users move around so frequently that it's probably impossible to keep track of all of their comings and goings—or even to be sure exactly how many channels there are. A single transponder on W4 may hold as many as 80 programs simultaneously. Because the audio quality is superior to that of a subcarrier, Heil points out that SCPC is the preferred audio choice for broadcasters, which explains why so many network and syndicated formats are distributed that way.

If you're an electronics hobbyist, you may be able to convert an all-band portable radio to an SCPC tuner, provided you can feed the 70-MHz signal from your LNB into it. But don't look for audio quality if you do. The \$450 price of an SCPC tuner is money well spent.

**Digital Audio Down the Road.** By the time you read this, European audiophiles who own dishes will be able to tap 16 channels of digital stereo from the Copernicus satellite with the aid of a \$450 tuner being offered by most of the major European electronics manufacturers. Station selection is by push-button and there's a front-panel display showing the format you've selected. If you've selected news and there's none on at the time, the tuner will remain silent until a newscast comes along it

then automatically turns itself on to keep you posted.

Digital audio from satellite is a very real possibility in the United States later this year as well, but don't send a purchase order off to Europe just yet; There are no less than three digital systems under consideration here, none of them compatible with the European standard. Of the three, two—Digital Radio Corporation and ICT—have talked about marketing receivers to consumers as well as renting them through cable operators. The tuner could cost between \$200 to \$450 depending on its features, but an ICT tuner won't receive DRC programs and *vice versa*.

Signals would feed directly into an analog or digital preamp or stereo receiver, then to your existing stereo system. Both companies promise sound quality comparable to that of compact disc, as do the Europeans. That means frequency response of 20–20,000 Hz with virtually unmeasurable distortion and a dynamic range in excess of 90 dB. At that rate, digital audio would win the satellite-audio hi-fi award hands down, but don't look for more than 24 channels from either of the providers, and don't look for anything soon.



Your satellite receiver won't pick up SCPC broadcasts by itself. However, this add-on tuner from Heil Laboratories promises to bring those signals in with a frequency response that can rival CD's.

Get A Complete Course In

## ELECTRONIC ENGINEERING

8 volumes, over 2000 pages, including all necessary math and physics. 29 examinations to help you gauge your personal progress. A truly great learning experience.

Prepare now to take advantage of the growing demand for people able to work at the engineering level.

Ask for our brochure giving complete details of content. Use your free information card number, or write us directly. **\$99.95**, Postage Included. Satisfaction guaranteed or money refunded.

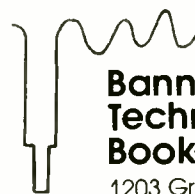

**Banner  
Technical  
Books, Inc.**  
1203 Grant Ave.  
Rockford, IL 61103

CIRCLE 7 ON FREE INFORMATION CARD

## CIRCUIT CIRCUS

(Continued from page 85)

(solid-state) version of the reflex receiver operates. The RF signal is passed from the antenna through C1 to the tuned circuit made up of L1 and C2. One end of L2 feeds the RF signal to the base of Q1 for amplification and the other end ties to the junction of R1 and R2 to supply bias to the transistor. A .02- $\mu$ F capacitor, C3, places the "D" end of L1 at RF ground.

The amplified RF signal is fed through C6 to a two-diode doubler/detector circuit and then on to the volume control, R6. The wiper of R6 feeds the detected audio signal through C9 to the junction of R1, R2, and the "D" end of L2. The "D" end of L2 is at RF ground, but not AF ground, allowing the AF signal to be passed through L2 to the base of Q1 for amplification. The junction of the 2.5-mH choke and T1 is placed at RF ground through C5. The amplified audio is fed from this junction to the input of the 386 audio amplifier, U1, to drive the 4-inch 8-ohm speaker. The single transistor has performed a dual duty by amplifying the RF and AM signals at the same time.

The same construction scheme used in our first receiver can be followed in building the reflex circuit. Inductors L1 and L2 are the same as those used in the previous circuit and can be made by referring to construction details given in Fig. 2. Use an IC socket for the 386 amplifier. When properly assembled, the reflex circuit will out-perform our first receiver by offering greater sensitivity and audio output.

If you are located too close to a powerful station and the tuning seems too broad, try removing two turns from

the "D" end of L2. Doing so should sharpen the selectivity and reduce the interference from the stronger station. The reflex receiver, when tested, picked

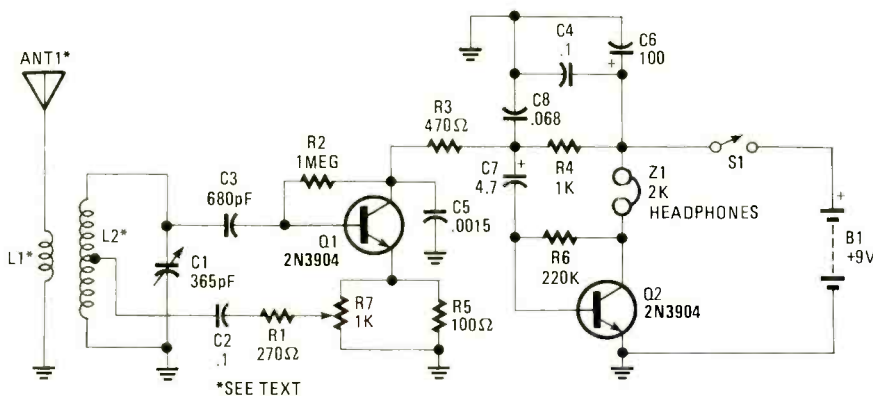

Fig. 4. This Regenerative Receiver is a solid-state version of the extremely popular tube-type receiver built by so many hobbyists over the years. Here we've replaced the tube with a 2N3904 general-purpose NPN transistor for the regeneration stage and have added a second 2N3904 for audio amplification.

## PARTS LIST FOR THE REFLEX RECEIVER

### SEMICONDUCTORS

- U1—LM386 low-power audio amplifier
- Q1—2N3904 general-purpose NPN silicon transistor
- D1, D2—1N34A general-purpose germanium diode

### RESISTORS

(All resistors are 1/4-watt, 5% units, unless otherwise noted.)

- R1—47,000-ohm
- R2—10,000-ohm
- R3—470-ohm
- R4—4700-ohm
- R5—10-ohm
- R6—5000-ohm potentiometer

### CAPACITORS

- C1—3-30-pF, trimmer
- C2—365-pF, tuning
- C3, C5—0.02- $\mu$ F, Mylar

- C4—0.1- $\mu$ F, ceramic-disc
- C6—680-pF, ceramic-disc
- C7—0.039- $\mu$ F, Mylar
- C8—0.05- $\mu$ F, Mylar
- C9—10- $\mu$ F, 25-WVDC, electrolytic
- C10—4.7- $\mu$ F, 25-WVDC, electrolytic
- C11, C12—100- $\mu$ F, 25-WVDC, electrolytic
- C13—0.22- $\mu$ F, Mylar

### ADDITIONAL PARTS AND MATERIALS

- L1, L2—See text
- L3—2.5-mH choke
- T1—1000-ohm to 8-ohm audio output transformer
- SPKR1—8-ohm speaker
- B1—9-volt transistor-radio battery
- S1—SPST switch (any type)
- Perfboard materials, battery holder and connector, wire, solder, hardware, etc.

## PARTS LIST FOR THE REGENERATIVE RECEIVER

### RESISTORS

(All resistors are 1/4-watt, 5% units, unless otherwise noted.)

- R1—270-ohm
- R2—1-megohm
- R3—470-ohm
- R4—1000-ohm
- R5—100-ohm
- R6—220,000-ohm
- R7—1000-ohm, potentiometer

### CAPACITORS

- C1—365-pF, tuning
- C2, C4—0.1- $\mu$ F, ceramic-disc
- C3—680-pF, ceramic-disc

- C5—0.0015- $\mu$ F, ceramic-disc
- C6—100- $\mu$ F, 25-WVDC, electrolytic
- C7—4.7- $\mu$ F, 25-WVDC, electrolytic
- C8—0.068- $\mu$ F, Mylar

### ADDITIONAL PARTS AND MATERIALS

- Q1, Q2—2N3904 general-purpose, NPN silicon transistor
- L1-L2—See text
- B1—9-volt transistor-radio battery
- S1—SPST switch (any type)
- Z1—2000-ohm headphones
- Perfboard materials, knobs, #20 copper wire, coil form, battery holder and connector, wire, solder, hardware, etc.

up four stations with excellent volume without an external antenna. If the coil is mounted horizontally on the wood base the receiver can be rotated to help increase the receiver's audio output and selectivity.

**Regenerative Receiver.** Our third circuit (see Fig. 4) is a solid-state version of the extremely popular tube-type regenerative receiver built by so many set builders over the years. We've replaced the tube with a 2N3904 general-purpose NPN transistor for the regeneration stage and have added a second 2N3904 for audio amplification.

In Fig. 4, Q1 is connected in a modified Hartley regenerative-detector circuit with the RF-feedback level controlled by R7, a 1000-ohm potentiometer. The RF is coupled from L2 to L1 and tuned to the desired frequency using



C1. The R of Q1 th ter thro gain is slightly the ci At sive the poi CF C: fir

Every year isn't cheap; in fact, this fiscal year's product testing program — and test selecting you and your...

the base the emit- mum RF djusted causes ation. as a sen- sition of r. The RF through through is ampli- s. s. sive receiver, scheme can be as used in the first are used again, but d to L1 at the fifth turn end of that coil. That tap carefully removing a small amount of the wire's insulation and then tack soldering a 6-inch piece of hook-up wire to the coil. That lead then connects to C2.

To tune the receiver, turn pontimeter R7's wiper clockwise until a slight pop is heard in the phones, and then tune C1 for a station. Once a station is received, tune R7 for the best signal clarity and volume. On strong stations, R7 will operate like a volume control and should be set well below the point of self-oscillation. ■

### ANTIQUE RADIO (Continued from page 83)

fruitless. In fact, Brother Patrick Dowd (see the February, 1989 issue for a write-up on his outstanding vacuum-tube museum) combed the flea market at the Antique Wireless Association's 1989 conference with no results. He writes that he went through an estimated 300 type 27's without seeing a single Pilotron. If you have, or know of, a Pilotron type-27 that I could acquire for a reasonable price, be sure to write!

**The Original Wasp.** Back in the July, 1989 issue, when I first introduced the Pilot A.C. Super-Wasp, I talked a little bit about the history of the Wasp series of radio receivers. Although I had good information on the A.C. Super-Wasp's immediate predecessor (a battery-operated version called, simply, the Super-Wasp), I couldn't go back much further in time. I knew that there had been a

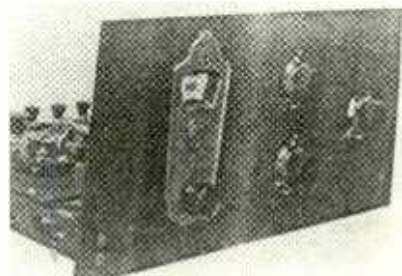

*This photocopy sent by reader Bart Lee gives us a pretty good idea of what the original Pilot Wasp looked like.*

still-earlier model called the Wasp, but couldn't find any mention of it in the references available to me.

A while back, Bart Lee, who edits the *Journal of the California Historical Radio Society*, helped me out on this point. He sent me a very complete article on the Pilot Wasp copied from a 1928 Pilot Co. Publication.

It seems that this ancestral Pilot receiver was similar to both the battery- and AC-operated Super-Wasps in that it had a regenerative detector stage and two stages of audio. But it did not have the tuned screen-grid RF amplifier boasted by the later models. Accordingly, it had just three tubes (all 01-A's) rather than four and used five single plug-in coils, rather than five sets of two, to cover the broadcast and shortwave bands. In 1928, a kit to build the little Pilot Wasp sold for \$21.75 (with coils, but apparently less the tubes).



Support America's colleges. Because college is more than a place where young people are preparing for their future. It's where America — and American business — is preparing for its future.

**Give to the college of your choice.**

## LEARN VCR

### CLEANING/MAINTENANCE/REPAIR

**EARN UP TO \$1000 A WEEK, WORKING PART TIME FROM YOUR OWN HOME!**

**Secrets Revealed!**

**NO Special Tools or Equipment Needed.**

EARN UP TO \$60 AN HOUR AND MORE!

**THE MONEY MAKING OPPORTUNITY OF THE 1990'S**

IF you are able to work with common small hand tools, and are familiar with basic electronics (i.e. able to use voltmeter, understand DC electronics) . . . IF you possess average mechanical ability, and have a VCR on which to practice and learn. . . then we can teach **YOU** VCR maintenance and repair!

**FACT:** up to 90% of ALL VCR malfunctions are due to simple MECHANICAL or ELECTRO-MECHANICAL breakdowns!

**FACT:** over 77 million VCRs in use today nationwide! Average VCR needs service or repair every 12 to 18 months!

Viejo's **400 PAGE TRAINING MANUAL** (over 500 photos and illustrations) and **AWARD-WINNING VIDEO TRAINING TAPE** reveals the **SECRETS** of VCR maintenance and repair—"real world" information that is **NOT** available elsewhere!

Also includes all the info you'll need regarding the **BUSINESS-SIDE** of running a successful service operation!

**FREE INFORMATION**  
**CALL TOLL-FREE 1-800-537-0589**  
 Or write to: Viejo Publications Inc.  
 3540 Wilshire BL. STE. 310  
 Los Angeles, CA 90010 Dept. PE

**CIRCLE 14 ON FREE INFORMATION CARD**

## PROFESSIONAL QUALITY WEATHER STATION NOW AFFORDABLE ENOUGH FOR HOME USE!

The new WeatherPro weather station uses state-of-the-art technology to give you full monitoring capability at an incredibly low price. The WeatherPro includes a weather computer, remote precision wind direction vane, wind speed sensor, external temperature probe, mounting hardware and 40' of cable—all for only \$179!

- WIND SPEED
- WIND GUST
- TEMPERATURE
- WIND CHILL
- WIND DIRECTION
- TIME
- TEMPERATURE HI/LO
- AUTO SCAN
- RAINFALL (OPTIONAL)\*
- 1 YEAR WARRANTY

• 14-DAY MONEY-BACK GUARANTEE

**DIGITAL WEATHERPRO WEATHER STATION: ONLY \$179!**

**ORDER TODAY: 1-800-678-3669, PE M-F 7AM-5:30 PM Pacific Time**

\*Automatic-emplying electronic rain gauge \$49.95 Add \$3.00 for shipping. CA residents add sales tax. Fax 1-415-732-9188 • M/C and VISA

## DIGITAL®

3465 DIABLO AVE, HAYWARD, CA 94545

**CIRCLE 13 ON FREE INFORMATION CARD**

## 30 WATT AUDIO AMP

(Continued from page 62)

**Final Assembly.** The amplifier, as mentioned before, requires a 12-volt DC, 2-amp power supply, like the one shown in Fig. 2. You could use a store-bought 12-volt DC wall adapter, but there aren't many that can supply 2 amps, so if you intend to use one, make sure that it can handle the job. If you are installing the amplifier in a car, just use the car's 12 volts, and put a 2-amp fuse in line with the 12-volt lead. (A fuse is actually a good idea no matter where you plan to use the amplifier.)

As for the speaker, use a good one if your application is anything serious. Don't settle for a real crummy one, because 30 watts is a decent amount of power, and it will damage a poor speaker. Car-stereo speakers are a good choice if you are assembling a one-piece unit, because they are inexpensive, yet have good sound and come with their own grilles. But perhaps you are building a stereo amplifier for your home, in which case a pair of stereo speakers can be used if you supply the proper jacks.

The parts-placement diagram (Fig. 4) shows how to connect the speaker, power supply, and input signal. (A 5-contact steel-pin connector that makes it easy to attach alligator clips to the PC board for testing is supplied with the kit.) When making permanent connections to the board from the amplifier, speakers, and power supply use 18- or 20-gauge stranded wire.

## PARTS LIST FOR THE 30-WATT AMPLIFIER

### SEMICONDUCTORS

U1—TDA2004 audio amplifier IC (SGS)

Q1—BC548 NPN transistor (or equivalent)

### CAPACITORS

C1, C2, C5, C15—0.1- $\mu$ F, ceramic

C3, C12—22- $\mu$ F, 16-WVDC, electrolytic

C4, C6, C10, C11—100- $\mu$ F, 16-WVDC, electrolytic

C7—C9—15- $\mu$ F, 16-WVDC, electrolytic

C13, C14—6.8- $\mu$ F, 16-WVDC, electrolytic

C16, C18—0.068- $\mu$ F, metal film

C17—0.0033- $\mu$ F, metal film

### RESISTORS

(All fixed resistors are 1/4-watt, 5% units.)

R1, R8—33-ohm

R2—10-ohm

R3, R4—1-ohm

R5, R7—1000-ohm

R6, R18—1800-ohm

R9—1.2-megohm

R10—R15—not used

R16, R17, R19—8200-ohm

R20—R22—47,000-ohm, potentiometer

### ADDITIONAL PARTS AND MATERIALS

Aluminum-channel heatsink, 2 screws and nuts, 3 knobs, 5-contact connector, solder, wire, perfboard or printed-circuit materials.

The TSM 11 amplifier kit includes the PC board and everything that mounts on it for \$15.50, plus \$2.50 for postage and handling for the first kit (add an additional \$1 for P/H for each additional one). PA residents must add appropriate sales tax. Contact Prospect Electronics, P.O. Box 9144, Allentown, PA 18105; Tel. 1-215-770-9029.

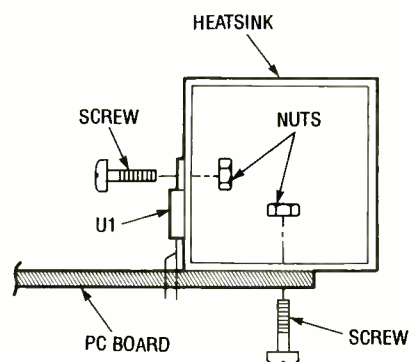

Fig. 5. Before you solder U1 in place, attach the heatsink as shown, so that the pre-drilled hole in the heatsink lines up with the one in U1.

The amplifier should work properly right away, if you assembled it carefully. If you have a problem, go back and check your work to ensure proper parts placement, good solder joints, and that the power supply is putting out 12 volts.

The amplifier exhibited good sound quality when tested with an 8-ohm car-stereo speaker. And, with the bass and treble controls, you can tailor the sound to taste. It should leave you smiling, no matter what your particular application is.

## 3 TERMINAL REGULATORS

(Continued from page 75)

supply. The regulators cannot be simply connected in parallel, but rather require a bit of supporting circuitry to keep things on an even keel. Otherwise, the two regulators would take turns shutting each other down.

The 0.1-ohm, 5-watt resistors used in series with each regulator-input terminal are available in the form of car radio "fusistors" or audio power-amplifier bias resistors. In those circuits they function somewhat as fuses. Here, however, they not only serve as fuses of a sort, but also provide a DC voltage drop to develop a signal for the differential operational amplifier (U3). The amplifier drives the output-voltage setting pin of U1 in response to the differential DC voltage caused by an unbalance in the currents drawn by the two legs of the circuit. Thus, both regulators work approximately as hard as each other. Three-terminal voltage regulators are very inexpensive, are well-behaved, and are easy to use. Because of the tremendous advantages offered by those devices in projects and circuits, you are well-advised to use them wherever you need a stable voltage supply.

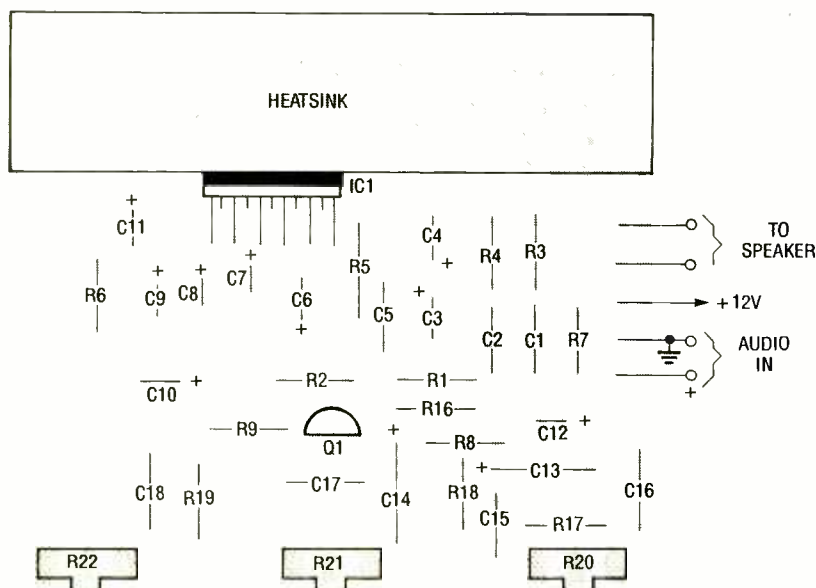

Fig. 4. This is the parts-placement diagram for the 30-watt amplifier. Solder the parts in the order that they're described in the instructions.



# Enter A World Of Excitement with a Subscription to Popular Electronics®

## Get the latest electronic technology and information monthly!

Now you can subscribe to the magazine that plugs you into the exciting world of electronics. With every issue of Popular Electronics you'll find a wide variety of electronics projects you can build and enjoy.

Popular Electronics brings you informative new product and literature listings, feature articles on test equipment and tools—all designed to keep you tuned in to the latest developments in electronics. So if you love to build fascinating electronics, just fill out the subscription form below to subscribe to Popular Electronics... It's a power-house of fun for the electronics enthusiast.

### EXCITING MONTHLY FEATURES LIKE:

- CONSTRUCTION**—Building projects from crystal sets to electronic roulette
- FEATURES**—Educational training on digital electronics, Ohm's Law, Antennas, Communications, Antique Radio, Simplified Theory
- HANDS-ON-REPORTS**—User test comments on new and unusual consumer products
- SPECIAL COLUMNS**—Think Tank, Circuit Circus, Computer Bits, DX Listening, Antique Radio, Amateur, Scanner Scene

### PLUS: ALL OUR GREAT DEPARTMENTS!

You'll get 12 exciting and informative issues of Popular Electronics for only \$18.95. That's a savings of \$11.05 off the regular single copy price. Subscribe to Popular Electronics today! Just fill out the subscription order form below.

FOR FASTER SERVICE CALL TODAY  
**1-800-435-0715**

IN ILLINOIS 1-800-892-0753 (7:30AM-8:30PM)  
EASTERN STANDARD TIME

## Popular Electronics® SUBSCRIPTION ORDER FORM

P.O. Box 338, Mt. Morris IL. 61054

**YES!** I want to subscribe to Popular Electronics for 1 Full year (12 Issues) for only \$18.95. That's a savings of \$11.05 off the newstand price.

Payment Enclosed  Bill me later  
Please charge my:  Visa  Mastercard

Acct. #

Signature \_\_\_\_\_

Exp. Date \_\_\_\_\_

PLEASE PRINT BELOW:

NAME \_\_\_\_\_

ADDRESS \_\_\_\_\_

CITY \_\_\_\_\_

STATE \_\_\_\_\_

ZIP \_\_\_\_\_

Allow 6 to 8 weeks for delivery of first issue. U.S. Funds only.  
In Canada add \$5.00 Postage. All Other Foreign add \$7.50 Postage.

APE-EO

## SELECTION SOFTWARE

(Continued from page 81)

converters come with an internal, external, or both internal and external referencing. Entering either a one, two, or three, for that parameter specifies an internal reference, external reference, or both, respectively. The confusion is that there are two blanks: one for a "minimum" and one for a "maximum."

The thinking is that you would put the capability you absolutely must have in the minimum blank and the capability that would provide the maximum usefulness in the maximum blank. For example, let's set the minimum blank to 1 (internal) and the maximum blank to 3 (both internal and external). Since we've specified 1 for a minimum and 3 for a maximum, the software will look for chips with capabilities 1, 2, or 3 (note that 2 falls between 1 and 3.) If you were to place a 1 in the maximum blank, leaving the minimum blank empty, the software will only hunt for chips with an internal reference. If you were to place a 3 in the minimum blank, leaving the maximum blank empty, the software will only hunt for chips with both refer-

ences. By now you may be wondering how to select only chips with an external reference. You would specify a 2 in both blanks.

When you are through entering the data, a press of the <F10> key will initiate the search for specs. A moment later, you're presented with a list of up to 17 parts that fit your requirements. If the computer has to make some adjustments in your values, it lets you know of the alteration before presenting you with the list of parts.

As mentioned earlier, prices for the items listed are given along with their parameters. The prices are for orders of 100 units, but they can be used to give you a good idea of the relative cost of the devices. Pressing any key while viewing the list will bring you back to the parameter screen. That's very convenient because it gives you a chance to alter some parameters and narrow or expand your scope as needed.

Any screen full of information (including menus) can be printed-out by hitting the standard print screen key on your keyboard.

about the Selection Guide is that it is not copy-protected; there is no licensing or restriction on making additional copies or storing it on hard disk. You can get your copy directly from Analog Devices' Applications Assistance division by contacting Analog Devices, Inc., 181 Ballard St., Willmington, MA; Tel. 1-508-658-9400. You can use that phone number to request help with the software as well.

Any inquiries for additional information on Analog Devices' product line should be addressed to Analog Devices Literature Center, 70 Shawmut Road, Canton, MA 02021, or circle No. 120 on the Free Information Card.



**How Do You Get One?** The best thing

## On Sale April 5

*Projects, hints and tips, technology, and much more—this electronics hobbyist's dream-come-true is packed with the best of the best from the pages of*

**Popular Electronics**

*Don't miss it!*

Pick Up The 1990 **Popular Electronics**  
**ELECTRONICS HOBBYISTS**  
**handbook** At Your Favorite Newsstand,  
Convenience Store, or Supermarket

1990  
**Popular Electronics**  
**ELECTRONICS HOBBYISTS**  
**handbook**™

GERNSBACK SPECIALTY SERIES 49604  
\$3.50 U.S.  
\$3.95 CANADA

**HIGH-VOLTAGE EXCITEMENT**

- The "Square" Tesla Coil
- High-Voltage DC Supply
- Fun With Induction Coils

**TEST EQUIPMENT**

- Dial-Up Resistance Box
- 10-MHz Frequency Counter
- Frequency/Capacitance Meter

**COMPUTERS**

- Printer Spooler Buffer
- Upgrading Your PC

**ANTIQUES**

- Antique Radio Buyer's Guide
- All About Radio Collectibles

**CIRCUITS**

- Personal Pocket Pager
- A Hot Socket
- Holiday Light Sequencer

**TELEPHONE**

- Telephone Monitor
- The Extension Silencer

**HIGH-TECH FUN**

- The Amazing "Antigravity" Machine
- Ultrasonic Receiver
- Executive's Ding-A-Ling

**VIDEO/AUDIO**

- Video/Audio Baseband Switcher
- High Performance Tower Speakers
- Car Stereo Amplifier

**PHOTOGRAPHY**

- Darkroom Timer
- Photoflash Power System

**COMPONENTS**

- How and Where To Buy Parts
- Supplying the Electronics Workshop

**RADIO**

- SCA Adapter
- Active Antenna
- Shortwave Converter

**AUTOMOTIVE**

- Flashing Brake Light
- Lights on Alarm

GERNSBACK SPECIALTY SERIES



## TROUBLESHOOTING

(Continued from page 64)

requires the use of the diagnostic diskette. Follow the instructions given in your computer manual to make any necessary changes.

**Mechanical Failure.** Any disk drive is a hybrid device—part electromechanical and part electronic. The major mechanical parts of a disk drive are the chassis, door mechanism, hub, drive motor, spindle, head-position motor and head assembly, logic board, and servo board. Four major mechanical problems are commonly associated with disk drives: Motor burnout, motor-bearing wear, incorrect spin rate, and drive-belt failure.

A slipping drive belt will also cause irregularities in spin rate. And, of course, a broken belt puts the spin rate at rock-solid zero.

Where possible, check several things at once. For instance, you can easily check the drive motor, the cleanliness of the head, and the cleanliness of the head carriage rails at pretty much the same time. Never use force on anything in a disk drive, except for a frozen drive motor that you've just lubricated. Even so, any force applied should be of a very gentle sort. Lubrication should be applied sparingly to the area where the motor shaft enters the motor housing bushing and to the area where the shaft can be seen on the top of the motor housing.

**Replacement.** You can buy replacement pressure pads, springs, and other odds and ends from companies that specialize in disk-drive sales and repairs. If you cannot get parts, have to pay a premium for them, or have to wait long for them, you are better off by doing what repair shops do: replace the drive. That's what I did.

At that point it's a good idea to comparison shop for disk drives. Don't feel obligated to replace a disk drive with one of the same brand. Keep in mind you'll pay a premium for the IBM logo, beneath which is another manufacturer's disk drive. My recommendation is for the brushless, direct-drive units that are available from discount or mail-order houses for less than \$100. Just make sure that you get the correct size (full height or half height) and that the vendor assures you that the drive is compatible with your computer; fortunately most drives are.

# WATCH FOR THIS ISSUE ON SALE APRIL 3

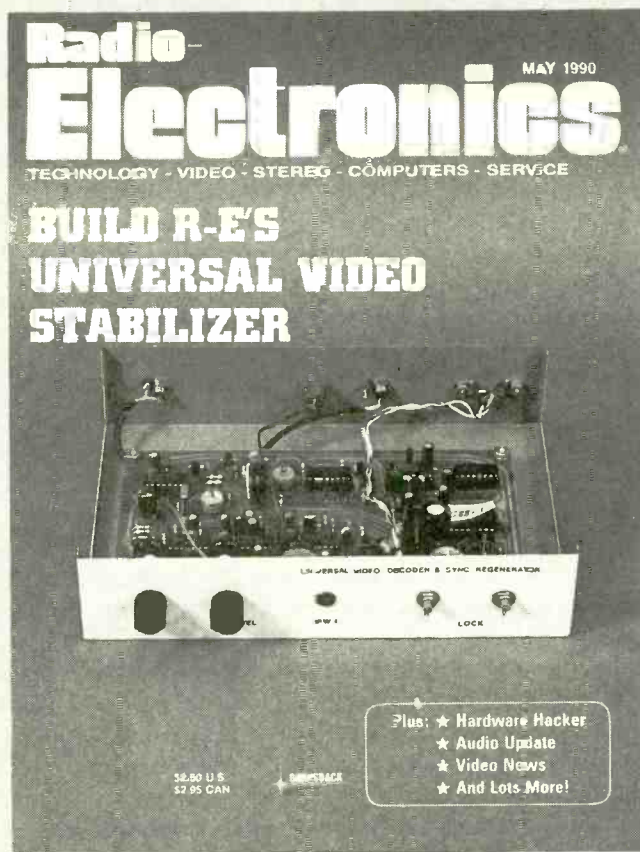

## OUR MAY ISSUE FEATURES:

### BUILD A "UNIVERSAL" DESCRAMBLER

*An education in video synchronization.*

### CROSSTALK-CANCELLING SPEAKER SYSTEM

*An unusual way to use conventional stereo speakers to simulate binaural listening.*

### MORSE/RTTY DETECTOR PART II

*Complete construction details show you how to display morse code and radioteletype communications on your computer.*

### INSIDE THE DIGITAL OSCILLOSCOPE

*A look at how digital storage scopes work and how they're changing the way we look at waveforms.*

### WHY ARE THERE SO MANY TRANSISTORS?

*How to pick the right device for your next design.*

### COMPUTERDIGEST

*The basics of waveform processing using a PC.*

# Popular Electronics REPRINT BOOKSTORE

- |   |   |
|---|---|
| <input type="checkbox"/> 119 Popular Electronics (1989 back issues) <b>\$3.50</b><br>Write in issues desired _____  | <input type="checkbox"/> 106 Radio-Electronics (1986 back issues) <b>.. \$4.25</b><br>Write in issues desired _____                                       |
| <input type="checkbox"/> 118 Hands-On Electronics (1988 back issues) <b>\$3.75</b><br>Write in issues desired _____ | <input type="checkbox"/> 105 Radio-Electronics (1985 back issues) <b>.. \$4.75</b><br>(January, February not available)<br>Write in issues desired _____  |
| <input type="checkbox"/> 117 Hands-On Electronics (1987 back issues) <b>\$4.00</b><br>Write in issues desired _____ | <input type="checkbox"/> 104 Radio-Electronics (1984 back issues) <b>.. \$5.75</b><br>(December, February not available)<br>Write in issues desired _____ |
| <input type="checkbox"/> 116 Hands-On Electronics (1986 back issues) <b>\$4.50</b><br>Write in issues desired _____ |   |
| <input type="checkbox"/> 115A Hands-On Electronics #6 ..... <b>\$5.50</b>   |   |
| <input type="checkbox"/> 115 Hands-On Electronics #5 ..... <b>\$5.50</b>  |   |
| <input type="checkbox"/> 114 Hands-On Electronics #4 ..... <b>\$5.50</b>  |   |
| <input type="checkbox"/> 113 Hands-On Electronics #3 ..... <b>\$5.50</b>  |   |
| <input type="checkbox"/> 112 Hands-On Electronics #2 ..... <b>\$5.50</b>  |   |
| <input type="checkbox"/> 111 Hands-On Electronics #1 ..... <b>\$6.00</b>  |   |
| <input type="checkbox"/> SP10 Special Projects #10 ..... <b>\$6.00</b>  |   |
| <input type="checkbox"/> SP9 Special Projects #9 ..... <b>\$6.00</b>  |   |
| <input type="checkbox"/> SP8 Special Projects #8 ..... <b>\$6.00</b>  |   |
| <input type="checkbox"/> SP6 Special Projects #6 ..... <b>\$6.00</b>  |   |
| <input type="checkbox"/> SP5 Special Projects #5 ..... <b>\$6.00</b>  |   |
| <input type="checkbox"/> SP4 Special Projects #4 ..... <b>\$6.00</b>  |   |
| <input type="checkbox"/> SP1 Special Projects #1 ..... <b>\$7.00</b>  |   |
| <input type="checkbox"/> EH90 Experimenters Handbook (1990) ..... <b>\$4.00</b>                                     |   |
| <input type="checkbox"/> EH88 Experimenters Handbook (1988-89) <b>\$4.50</b>  |   |
| <input type="checkbox"/> EH87 Experimenters Handbook (1987) ..... <b>\$5.00</b>                                     |   |
| <input type="checkbox"/> HH89 Popular Electronics Hobbyist<br>Handbook ..... <b>\$5.00</b>                          |   |
| <input type="checkbox"/> 126 Radio-Electronics Annual 1986 ..... <b>\$6.00</b>                                      |   |
| <input type="checkbox"/> 125 Radio-Electronics Annual 1985 ..... <b>\$6.00</b>                                      |   |
| <input type="checkbox"/> 109 Radio-Electronics (1989 back issues) <b>.. \$3.50</b><br>Write in issues desired _____ |   |
| <input type="checkbox"/> 108 Radio-Electronics (1988 back issues) <b>.. \$3.75</b><br>Write in issues desired _____ |   |
| <input type="checkbox"/> 107 Radio-Electronics (1987 back issues) <b>.. \$4.00</b><br>Write in issues desired _____ |   |

- |  |                 |                 |
|--|-----------------|-----------------|
|  | <b>REPRINTS</b> | <b>REPRINTS</b> |
| <input type="checkbox"/> 169 Think Tank (133 Circuits).....  |                 | <b>\$3.50</b>   |
| <input type="checkbox"/> 169A Think Tank Vol. 2 .....  |                 | <b>\$3.00</b>   |
| <input type="checkbox"/> 168A Fact Cards (#1-33) .....   |                 | <b>\$4.00</b>   |
| <input type="checkbox"/> 168 Fact Cards (#34-66).....  |                 | <b>\$4.00</b>   |
| <input type="checkbox"/> 168C Fact Cards (#67-99).....   |                 | <b>\$3.50</b>   |
| <input type="checkbox"/> 168D Fact Cards (#100-132).....   |                 | <b>\$3.50</b>   |
| <input type="checkbox"/> 167 Designing With IC's .....   |                 | <b>\$4.00</b>   |
| <input type="checkbox"/> 166 Collected Works of Mohammed Ulysses Fips<br>(62 pages, April Fools Collection)..... |                 | <b>\$7.50</b>   |
| <input type="checkbox"/> 165 How to Repair CD Disc Players.....  |                 | <b>\$5.00</b>   |
| <input type="checkbox"/> 164 Modern Electrics (April 1908).....  |                 | <b>\$3.00</b>   |
| <input type="checkbox"/> 163 Receiving Satellite TV .....  |                 | <b>\$5.00</b>   |
| <input type="checkbox"/> 162 Build Your Own Satellite TV Receiver  |                 | <b>\$5.00</b>   |
| <input type="checkbox"/> 161 Descrambling (Feb., 1984) .....   |                 | <b>\$3.00</b>   |
| <input type="checkbox"/> 160 New Ideas - 42 Circuits .....   |                 | <b>\$3.50</b>   |
| <input type="checkbox"/> 159 Low Frequency Receiving Techniques<br>Building and using VLF Antennas.....          |                 | <b>\$5.00</b>   |
| <input type="checkbox"/> 158 Electro Importing Co. Catalog<br>(Circa 1918) .....                                 |                 | <b>\$5.95</b>   |
| <input type="checkbox"/> 157 All About Kits .....  |                 | <b>\$2.00</b>   |
| <input type="checkbox"/> 156 How To Make PC Boards.....  |                 | <b>\$2.00</b>   |
| <input type="checkbox"/> 155 IBM Typewriter To Computer.....   |                 | <b>\$2.00</b>   |
| <input type="checkbox"/> 154 How To Repair VCR's .....   |                 | <b>\$3.50</b>   |
| <input type="checkbox"/> 150 Pay TV Decoder (1981) .....   |                 | <b>\$3.00</b>   |

To order any of the items indicated above, check off the ones you want. Complete the order form below, **include your payment**, check or money order (DO NOT SEND CASH), and mail to **Popular Electronics**, Reprint Department, P.O. Box 4079, Farmingdale, NY 11735. Please allow 4-6 weeks for delivery.

If you need a copy of an article that is in an issue we indicate is unavailable you can order it directly from us. We charge 50¢ per page. Indicate the issue (month & year), pages and article desired. Include payment in full, plus shipping and handling charge. Make checks payable to Gernsback Publications, Inc.

ARTICLE \_\_\_\_\_

PAGES \_\_\_\_\_ MONTH \_\_\_\_\_ YEAR \_\_\_\_\_

TOTAL PAGES \_\_\_\_\_ @ 50¢ each TOTAL PRICE \_\_\_\_\_

MAIL TO: **Popular Electronics**  
Reprint Bookstore, P.O. Box 4079, Farmingdale NY 11735

SHIPPING CHARGES IN USA & CANADA

\$0.01 to \$5.00 ..... \$1.25	\$30.01 to 40.00 ..... \$5.00	<b>ALL payments must be in U.S. funds</b> <b>SORRY</b> — We only ship to USA & Canada
\$5.01 to \$10.00 ..... \$2.00	\$40.01 to 50.00 ..... \$6.00	
\$10.01 to 20.00 ..... \$3.00	\$50.01 and above ..... \$7.50	
\$20.01 to 30.00 ..... \$4.00		

Total price of merchandise ..... \$ \_\_\_\_\_

Sales Tax (New York State Residents only) ..... \$ \_\_\_\_\_

Shipping Charge (see chart) ..... \$ \_\_\_\_\_

Name \_\_\_\_\_ Total Enclosed ..... \$ \_\_\_\_\_

Address \_\_\_\_\_

City \_\_\_\_\_ State \_\_\_\_\_ Zip \_\_\_\_\_ PE590

## FREQUENCY COUNTER

(Continued from page 37)

FREQUENCY mode, a false count of 0001 is normal and it will reappear even after resetting. That should not happen in the EVENTS mode. Any counts other than those that have been indicated mean triggering due to noise. Removing U3 will indicate whether the false counts are due to that circuitry or the Schmitt trigger. Flipping the INPUT switch will enter a few random counts due to switch bounce. A gating pulse with fast rise and fall times should be seen at one end of R16. The duration of the gate should change to reflect the gating time selected.

Now select the EVENTS mode and LIGHT BEAM input. Shine a flashlight into the photo-Darlington housing and wobble it slightly to see that counts are entered each time light strikes the transistor. With the top of the enclosure in place, and if you have the hole for the light beam in the right place, a typical two-cell flashlight should enter counts from more than twenty feet away. The prototype works to forty feet inside a house with average lighting.

With the 0.1-second gate and the counter set to the FREQUENCY mode, the readout may be off by a little more than the timebase accuracy should indicate. If that's objectionable, parallel R25 (10k) with a .01-µF capacitor. Either piggy-back it on top of the board or solder it on the foil side.

**FREE  
VOLUNTEER  
TAX  
ASSISTANCE**

**1-800-  
424-1040**

ASK FOR SITE  
NEAREST YOU.



# ELECTRONICS MARKET PLACE

## FOR SALE

**DESCRAMBLERS.** All brands. Special: Combo Jerrold 400 and SB3 \$165. Complete cable descrambler kit \$39.00. Complete satellite descrambler kit \$45.00. Free catalog. **MJH INDUSTRY**, Box 531, Bronx, NY 10461-0531.

**SURPLUS ELECTRONICS.** New giant wholesale catalog. Hundreds of incredible bargains. \$2. Box 840, Champlain, NY 12919.

**BOOKS, plans, kits; catalog \$2.00 & SASE to NEW WAVE ELECTRONICS**, Suite 1524, 164 N. Elackstone, Fresno, CA 93701. Dep A.

**CABLE TV converters and descramblers discount center!** Jerrold, Tocom, Hamlin, Oak, Scientific Atlanta, Zenith. Quantity discount, order yours today! 1 (300) 962-6836.

**NEURAL network chip** learns reflex actions in real time, \$75.00. **ACCOTECH**, 1126 Apple Valley Road, Accokeek, MD 20607. (301) 292-4124.

## CABLE TV DESCRAMBLERS!



## BARGAIN HEADQUARTERS!

• JERROLD • TOCOM • HAMLIN  
• SCIENTIFIC ATLANTA • ZENITH  
Oak M35B ONLY \$60  
6 month warranty! We ship C.O.D.!  
Lowest retail/wholesale prices!  
FREE CATALOG:  
Global Cable Network  
1032 Irving St. Suite 109  
S.F., CA 94122

**ORDER TODAY! 800-327-8544**

**IBM software.** Large selection of programs. \$3.00 per disk. For free catalog send SASE to: **BY-TEHEAD**, Dept. E, Box 597, Dundee, IL 60118.

**ALARM equipment** wholesale prices call or write for free information. **ALARM CLUB**, 8186 Center, Suite G, LaMesa, CA 92042. (619) 589-2582.

**DESCRAMBLERS** - for free catalog, contact **CABLE CONNECTION**, 1304 E. Chicago Street, Suite 301, Algonquin, IL 60102. (708) 658-2365.

## MICROWAVE TV RECEIVERS 1.9 to 2.7 GHz



2 CH Compact Dish System - \$77.95  
5 CH Dish System - \$93.95  
12 CH Yagi (Rod) System - \$123.95  
30 CH Dish System - \$163.90 Yagi - \$183.90  
**SUN MICROWAVE INT'L. INC.** Send \$1.00 for  
P.O. BOX 34522 catalog on these  
PHOENIX, AZ 85067 and other line  
(602) 230-0640 video products.  
QUANTITY DISCOUNTS LIFETIME WARRANTY

**HANDCRAFTED** crystal sets. Replica 1930's one-tube shortwave radios. Parts. Plans. Tubes. **BOB RYAN**, PO Box 3039, Anaheim, CA 92803.

**DESIGN and build your own computerized product!** New manual makes it easy! Includes introduction to design, choosing the proper CPU, comparison between many CPUs and micro-controllers, component suppliers, sample schematics, programming, debugging, hints, tips, and more! Simple step-by-step details from idea to finished product. \$8.00 complete, satisfaction guaranteed, details free. **TRAVCO**, 107 E Vallette, Suite 1301B, Elmhurst, IL 60126.

**ELECTRONIC test equipment and parts.** Lowest prices. Free catalog. **EF ELECTRONICS**, Box 326, Aurora, IL 60507.

**SURVEILLANCE** - privacy control - debugging - protection. (Kits - assembled). Large new catalog \$5.00. **TRI-TRON**, 2209F Lapaico, Harvey, LA 70058.

**CAPACITORS, resistors and more**, buy any quantity direct from importer. Dealers inquiries welcome. Free details. **WORLD TRADE**, 2 Sproule Drive, Brampton, Ontario, Canada L6V 4B9.

## CLASSIFIED AD ORDER FORM

To run your own classified ad, put one word on each of the lines below and send this form along with your check to:

**Popular Electronics Classified Ads**, 500-B Bi-County Boulevard, Farmingdale, N.Y. 11735

**PLEASE INDICATE** in which category of classified advertising you wish your ad to appear. For special headings, there is a surcharge of \$11.00.

( ) Plans/Kits ( ) Business Opportunities ( ) For Sale  
( ) Education/Instruction ( ) Wanted ( ) Satellite Television  
( )

Special Category: \$11.00

### PLEASE PRINT EACH WORD SEPARATELY, IN BLOCK LETTERS.

(No refunds or credits for typesetting errors can be made unless you clearly print or type your copy.) Rates indicated are for standard style classified ads only. See below for additional charges for special ads. **Minimum: 15 words.**

1	2	3	4	5
6	7	8	9	10
11	12	13	14	15 (\$23.25)
16 (\$24.80)	17 (\$26.35)	18 (\$27.90)	19 (\$29.45)	20 (\$31.00)
21 (\$32.55)	22 (\$34.10)	23 (\$35.65)	24 (\$37.20)	25 (\$38.75)
26 (\$40.30)	27 (\$41.85)	28 (\$43.40)	29 (\$44.95)	30 (\$46.50)
31 (\$48.05)	32 (\$49.60)	33 (\$51.15)	34 (\$52.70)	35 (\$54.25)

We accept MasterCard and Visa for payment of orders. If you wish to use your credit card to pay for your ad fill in the following additional information (Sorry, no telephone orders can be accepted.):

Card Number

Expiration Date

PRINT NAME

SIGNATURE

**IF YOU USE A BOX NUMBER YOU MUST INCLUDE YOUR PERMANENT ADDRESS AND PHONE NUMBER FOR OUR FILES. ADS SUBMITTED WITHOUT THIS INFORMATION WILL NOT BE ACCEPTED.**

**CLASSIFIED COMMERCIAL RATE:** (for firms or individuals offering commercial products or services) \$1.55 per word prepaid (no charge for ZIP code)...**MINIMUM 15 WORDS.** 5% discount for same ad in 6 issues within one year; 10% discount for 12 issues within one year if prepaid. **NON-COMMERCIAL RATE:** (for individuals who want to buy or sell a personal item) \$1.25 per word, prepaid...no minimum. **ONLY FIRST WORD AND NAME** set in bold caps at no extra charge. Additional bold face (not available as all caps) **30¢ per word additional.** Entire ad in boldface, \$1.85 per word. **TINT SCREEN BEHIND ENTIRE AD: \$1.90 per word. TINT SCREEN BEHIND ENTIRE AD PLUS ALL BOLD FACE AD: \$2.25 per word. EXPANDED TYPE AD: \$2.05 per word prepaid.** Entire ad in boldface, \$2.45 per word. **TINT SCREEN BEHIND ENTIRE EXPANDED TYPE AD: \$2.55 per word. TINT SCREEN BEHIND ENTIRE EXPANDED TYPE AD PLUS ALL BOLD FACE AD: \$2.95 per word. DISPLAY ADS: 1" x 2 1/4" - \$205.00; 2" x 2 1/4" - \$410.00; 3" x 2 1/4" - \$615.00. General Information:** Frequency rates and prepayment discounts are available. **ALL COPY SUBJECT TO PUBLISHERS APPROVAL. ADVERTISEMENTS USING P.O. BOX ADDRESS WILL NOT BE ACCEPTED UNTIL ADVERTISER SUPPLIES PUBLISHER WITH PERMANENT ADDRESS AND PHONE NUMBER.** Copy to be in our hands on the 15th of the fourth month preceding the date of issue (i.e.; Sept. issue copy must be received by May 15th). When normal closing date falls on Saturday, Sunday or Holiday, issue closes on preceding work day. Send for the classified brochure. Circle Number 49 on the Free Information Card.

## FREE CATALOG

FAMOUS "FIRESTIK" BRAND CB ANTENNAS AND ACCESSORIES. QUALITY PRODUCTS FOR THE SERIOUS CB'er. SINCE 1962  
**FIRESTIK ANTENNA COMPANY**  
 2614 EAST ADAMS  
 PHOENIX, ARIZONA 85034

**LASER** Listener II, other projects. Surveillance, descramblers, false identification, information. Plans, kits, other strange stuff. Informational package \$3.00 refundable. **DIRIJO/BOND ELECTRONICS**, Box 212, Lowell, NC 28098.

**CABLE descrambler liquidation.** Major makes and models available. Industry pricing! (Example: Hamlin Combo's, \$44 each... Minimum 10 orders). Call **WEST COAST ELECTRONICS**, 1 (800) 628-9656.

## CB RADIO OWNERS!

We specialize in a wide variety of technical information, parts and services for CB radios. 10-Meter and FM conversion kits, repair books, plans, high-performance accessories. Thousands of satisfied customer since 1976! Catalog \$2.

**CBC INTERNATIONAL**  
 P.O. BOX 31500PE, PHOENIX, AZ 85046

## PLANS & KITS

**CATALOG: hobby/broadcasting/HAM/CB: Cable TV, transmitters, amplifiers, surveillance devices, computers, more!** **PANAXIS**, Box 130-H5, Paradise, CA 95967.

**BUILD** this five-digit panel meter and square wave generator including an ohms, capacitance and frequency meter. Detailed instructions \$2.50. **BAGNALL ELECTRONICS**, 179 May, Fairfield, CT 06430.

## REMOTE CONTROL KEYCHAIN

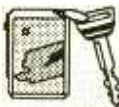

Complete w/mini-transmitter and +5 vdc RF receiver Fully assembled including plans to build your own auto alarm. Quantity discounts available.

**\$24.95** Check, Visa or M/C Add \$3 shipping

VISITECT INC./Dept. P (415) 872-0128  
 PO BOX 5442, SO. SAN FRAN., CA 94080

**VIDEOCIPHER II** manuals. **Volume 1** — hardware, **Volume 2** — software — either \$32.45. **Volume 3** — projects/software — \$42.45. **Volume 4** — repair/software — \$97.45. **Volume 5** — Documentation — \$42.45. **Volume 6** — Experimentation — \$42.45. **Clone Hacker's Bible** — \$32.95. **Cable Hacker's Bible** — \$32.45. CODs: (602) 782-2316. 0100-032 software available. Catalog-\$3.00. **TELECODE**, Box 6426-PE, Yuma, AZ 85366-6426.

**MINIATURE FM transmitters!** Tracking transmitters! Voice disguisers! Bug detectors! Phone devices! More! Available either as kits or assembled and tested! Catalog \$2.00 (refundable): **XANDI ELECTRONICS**, Box 25647, 32NN, Tempe, AZ 85285-5647.

**DETECTION** — Surveillance, debugging, plans, kits, assembled devices. Latest high-tech catalog \$5. **DETECTION SYSTEMS**, 2515 E. Thomas, #16-864J, Phoenix, AZ 85016.

**BUILD** an infrared scanner simulator from common components. Detailed instructions \$2.25. **JONES ELECTRONICS**, PO Box 36, Borden, IN 47106.

**IBM PC** development tools timing software extender boards. **DETROIT DATACOMM**, 1409 West 14 Mile, Mod. Hghts., MI 48071.

**CONTROL** appliances with human voice. Simple circuit will understand several commands. Can be customized. Plans \$8.00. **ALEX WIECEK**, 708 Runningbrook Drive, Mississauga, Ontario, Canada L4Y 2R8.

## CABLE TV. CONVERTERS WHY PAY A HIGH MONTHLY FEE?



All Jerrold, Oak, Hamlin, Zenith, Scientific Atlanta, Magnavox and all specialized cable equipment available for shipment within 24 hours. For fast service MC / VISA or C.O.D. telephone orders accepted (800) 648-3030 60 Day Guarantee (Quantity Discounts) 8 A.M. to 5 P.M. C.S.T. **CLOSED WEEKENDS.** Send self-addressed Stamped envelope (60¢ postage) for Catalog.

**MIDWEST ELECTRONICS INC.** P.O. Box 5000 Suite 311 (PE) Carpentersville, IL 60110

No Illinois Orders Accepted

**STRESSED** out? Relaxation technique easily learned with the aid of a simple electronic device. Not hypnosis! Plans \$9.95. **BLUE CHIP ENGINEERING**, Dept. 42, PO Box 1100, Walnut, CA 91789.

**CONNECT** your IBM/Apple computer to the outside world. Set of manuals for 10 experiments \$16.00. Specify IBM or Apple. **TECH-LINK, INC.**, 520 Lorena SW, North Canton, OH 44720.

**MICROWAVE** antenna plans, PC board layout, \$7.00. **THP**, #302, 5112 MacArthur Blvd. NW, Washington, DC 20016.

## ANTIQUE RADIO CLASSIFIED Free Sample!

Antique Radio's Largest Circulation Monthly Articles, Ads & Classifieds. 6-Month Trial: \$11. 1-Yr: \$20 (\$30-1st Class). A.R.C., P.O. Box 802-L3, Carlisle, MA 01741

**70 WATT** audio amplifier. Simple and easy to build. Plans \$6.00. **T.J.L. ENTERPRISES**, Suite 302PE, 1902 Ridge Road, West Seneca, NY 14224.

**POWERFUL FM transmitter kits:** telephone model, sensitive room model, or homing device. \$19.95 each + \$2.00 shipping. **MKL**, 2385 Brentwood, TN 37024-2385.

**ASSEMBLE** a useful robot for home or resale! And lots of other electronic novelties. Cash—in on your hobbies, details \$2.00. **P.G.P.**, Box 37, Lithonia, GA 30058.

**General Technics**  
 Quality Computer Systems  
**(516) 981-9473**  
 Save hundreds of dollars assembling Your own IBM Compatible Computer  
**Complete AT Computer System \$675**  
 Amber Monitor, 512k Memory, 101 Enhanced Keyboard, 1.2m Floppy Drive 12 mhz 80286 Mother Board, Hard/Floppy Controller Card, Instruction Manual  
**FREE CATALOG**  
 P.O. Box 2676, Lake Ronkonkoma, NY 11779

## BUSINESS OPPORTUNITIES

**YOUR own radio station!** AM, FM, TV, cable. Licensed/unlicensed. **BROADCASTING**, Box 130-H5, Paradise, CA 95967.

**LET** the government finance your small business. Grants/loans to \$500,000. Free recorded message: (707) 448-0270. (KJ8).

**EASY** work! Excellent Pay! Assemble products at home. Call for info. (504) 641-8003 Ext. 5730.

**MAKE \$50/hr** working evenings or weekends in your own electronics business. Send for free facts. **MJPI INDUSTRY**, Box 531, Bronx, NY 10461.

**RECHARGE** toner cartridges used in laser printers and personal copiers. Earn \$50.00+ per hour 1 (800) 221-3516, 62 N. Coleman Road, Centereach, NY 11720.

**EARN \$1000's extra** as a part-time computer dealer. Where to buy products at big discounts. Who to sell to. Financing without cash. Obtaining free software. Exclusive dealer trade shows. Step-by-step check list. Industry inside knowledge. Written by industry pioneer. Order now, only \$19.95 plus \$4.00 shipping/handling, CA residents add \$1.45 sales tax. **CORNERSTONE PUBLICATIONS**, Dept AA, PO Box 5151, San Jose, CA 95150. Allow 2-4 weeks.

## NEW HE NE LASER TUBES \$35

Dealer Inquiries Invited.  
 Free Catalog!

**MEREDITH INSTRUMENTS:** 6403 N. 59th Ave. Glendale, AZ 85301 • (602) 934-9387  
 "The Source for Laser Surplus"

## WANTED

**INVENTORS!** Call **IMPAC** — we submit ideas to manufacturers! For free information package call in US/Canada 1 (800) 225-5800.

## SATELLITE TV

**FREE catalog** — Do-it-yourself save 40—60% **Lowest prices** world wide, systems, upgrades, parts, all major brands factory fresh and warranted. **SKYVISION INC.**, 2008 Collegeway, Fergus Falls, MN 56537. 1 (800) 334-6455.

## CABLE TV "BOXES"

Converters — Descramblers  
 Remote Controls — Accessories

- ★ Guaranteed Best Prices ★
- ★ 1 Year Warranty — C.O.D.s ★
- ★ Immediate Shipping ★
- ★ FREE CATALOG ★

Call or Write  
**TRANS-WORLD CABLE CO.**

12082 Southwest 117th Court, Suite 125  
 Miami, Florida 33186  
 1-800-442-9333



## EDUCATION/INSTRUCTION

**MAGIC!** Four illustrated lessons plus inside information shows you how. We provide almost 50 tricks including equipment for four professional effects. You get a binder to keep the materials in, and a one-year membership in the International Performing Magicians with a plastic membership card that has your name gold-embossed. You get a one-year subscription to our quarterly newsletter, "IT'S MAGIC!" Order now! \$29.95 for each course + \$3.50 postage and handling. (New York residents add applicable state and local sales tax.) **The Magic Course**, 500-B BiCounty Blvd., Farmingdale, NY 11735.

**F.C.C. Commercial General Radiotelephone License.** Electronics home study. Fast, inexpensive! "Free" details. **COMMAND**, D-178, Box 2824, San Francisco, CA 94126.

**OUTSTANDING** educational software for IBMs & compatibles! Wide variety. Rush \$2.00 — (complete information) **D.L.S.**, PO Box 1393, Federal Station, Worcester, MA 01601, #D401.



**Motion Control System** → \$159.00



Includes Computer, Monitor, Keyboard, Power supply, 4 Motors, and Software.  
Call or Send for **Free Robotics Catalog**

**Silicon Valley Surplus**  
415 261-4506

4222 E 12th St. Oakland Ca. 94601  
Serving you since 1983  
8 am to 4 pm PST

**LEARN IBM PC assembly language.** 80 programs. Disk \$5. Book \$15. **ZIPFAST**, Box 12238, Lexington, KY 40581-2238.

**SHORTWAVE** — ham scanner radio books. Catalog \$1.00. **TIARE PUBLICATIONS**, PO Box 493PE, Lake Geneva, WI 53147.

**VCR repair** Save money — make big profits! Learn how from *How to Keep Your VCR Alive*. "This detailed, step-by-step manual enables anyone with no previous knowledge or experience to fix most VCR problems easily, quickly, and inexpensively with a few simple tools." — *Small Press Review*. Highly recommended by *Modern Electronics*, *Popular Electronics*, *Popular Communications* and many other electronics and video magazines. "Far better than Viejo at 1/7 the cost." 400+ page book, with 704 illustrations, plus professional head-cleaning tool, \$24.95. **WORTHINGTON PUBLISHING**, 6907-202H Halifax River Drive, Tampa, FL 33617. Call (813) 988-5751 for C.O.D., Visa, or MC. Money-back satisfaction guarantee!

### SOFTWARE

**FREE** software for IBM and compatibles! Info \$1.00. **BLUE CHIP ENGINEERING**, Dept. 42, PO Box 1100, Walnut, CA 91789.

## BEST BY MAIL

Rates: Write National, Box 5, Sarasota, FL 34230

**NASHVILLE RECORD COMPANY** interviewing Country Singers to record. Call 615-883-5349.

### FINANCIAL

**NEED CREDIT?** \$2,500+ Gold Card. No deposit. No turn-downs. Also MasterCard. 1(602)420-1486.

**FREE DETAILS. LOANS.** Visa/MasterCard. Guaranteed. No credit checks. Jameson, Box 40160(PE), Bakersfield, CA 93384.

## GET OUT OF THE DARK.

The Consumer Information Catalog will enlighten you with helpful consumer information. It's free by writing —

**Consumer Information Center**  
Dept. TD, Pueblo, Colorado 81009

### T.V. FILTERS

T.V. notch filters, surveillance equipment, brochure \$1.00. **D.K. Video**, Box 63/6025, Margate, FL 33063. (305) 752-9202.

### CABLE EQUIPMENT

**CABLE TV** secrets — the outlaw publication the cable companies tried to ban. HBO, Movie Channel, Showtime, descramblers, converters, etc. Suppliers list included. \$8.95. **CABLE FACTS**, Box 711-H, Pataskala, OH 43062.

## FREE CATALOG!

1-800-648-7938

For all information 1-702-362-9026

**JERROLD HAMLIN OAK ETC.**

## CABLE TV DESCRAMBLERS

• Compare our low Low Retail Prices!

• Guaranteed Prices & Warranties!

• Orders Shipped Immediately!

**REPUBLIC CABLE PRODUCTS INC.**

4080 Paradise Rd. #15 Dept. PE-90

Las Vegas, NV 89109

## CABLE TV CONVERTERS IN STOCK

Stocking all types of converters — Panasonic, Jerrold, Tocom, Pioneer, Scientific Atlanta, Zenith, Oak, Hamlin, Eagle, and others brands available.

Call or write for **FREE CATALOG**

10 am - 5:30 pm Eastern, Mon. - Fri.

## VIDEO-LINK Enterprises, Inc.

520 GLENBROOK RD., STE. 202

STAMFORD, CT 06906

Orders 1-800-622-9022

Catalog & info: 203-975-7543

## ADVERTISING INDEX

**POPULAR ELECTRONICS** magazine does not assume any responsibility for errors that may appear in the index below.

Free Information No.	Page		Page
12	AMC Sales	24	—
19	Ace Communications	91	18
11	All Electronics	25	—
—	Amazing Concepts	27	—
—	American Home Sat. Assoc.	26	—
—	Antique Radio Classified	106	—
7	Banner Technical Books	95	—
9	C & S Sales	15	—
—	CB City	106	—
—	CIE	31	6
—	Command Productions	91	8
10	Communications Electronics	CV4	—
21	Cook's Institute	87	15
—	Damark International	108	—
5	Digi Key	32	—
13	Digital	97	16
17	Electronics Book Club	7	—
—	Electronic Tech. Today	CV2, 14	—
—	Firestik II	106	14
—	General Technics	106	—
—	Global Cable Network	105	—
—	Grantham College	23	—
—	Heathkit	17	—
—	McGraw Hill Book Club	18	—
—	Meredith Instruments	106	—
—	Midwest Electronics	106	—
—	Monitoring Times	93	—
—	NESDA	93	—
—	NRI Schools	11	—
—	Pacific Cable	5	—
—	Parts Express	13	—
—	Radio Shack	3	—
—	Republic Cable	107	—
—	Sequoia Publishing	24	—
—	Silicon Valley Surplus	107	—
—	Sun Microwave Int'l	105	—
—	The Datak Corp.	27	—
—	Trans World	106	—
—	Video-Link	107	—
—	Viejo Publications	97	—
—	Visitect	106	—
—	Windjammer	CV3	—

## ADVERTISING SALES OFFICE

**Gernsback Publications, Inc.**  
500-B Bi-County Blvd.  
Farmingdale, NY 11735  
1-(516) 293-3000

President: **Larry Steckler**  
Vice President: **Cathy Steckler**

**For Advertising ONLY**  
516-293-3000  
Fax 1-516-293-3115  
**Larry Steckler**  
publisher

**Arline Fishman**  
advertising director

**Denise Haven**  
advertising assistant

**Christina Estrada**  
advertising associate

**Lisa Strassman**  
credit manager

### SALES OFFICES

#### EAST/SOUTHEAST

**Becky Akers**  
Pattis/3M  
310 Madison Ave., Suite 1804  
New York, NY 10017  
1-212-953-2121  
Fax 1-212-953-2128

#### MIDWEST/Texas/Arkansas/Okla.

**Ralph Bergen**  
540 Frontage Road—Suite 339  
Northfield, IL 60093  
1-312-446-1444  
Fax 1-312-446-8451

#### PACIFIC COAST/Mountain States

**Marvin Green**  
5430 Van Nuys Blvd., Suite 316  
Van Nuys, CA 91401  
1-818-986-2001  
Fax 1-818-986-2009



## DELUXE WIRELESS SECURITY SYSTEM

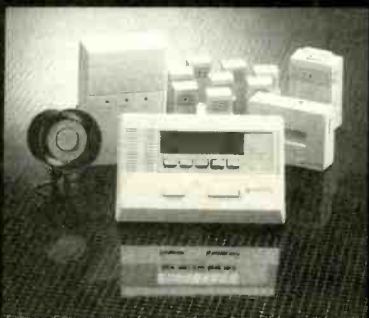

- Intelligent home security system.
- Detects intruder during entry.
- Wireless for easy installation.
- Difficult to defeat because of new, advanced technology.
- Lamp command flashes lamp upon intrusion.
- Signal relay—relays entry sensor intrusion signal from a remote area of your home to controller.
- Tamper resistant.
- 85 decibel alarm on inside siren.
- Piercing 120 decibel outside siren.
- Fail-safe battery back-up.
- Low battery warning.
- **2 Year Warranty!**

### Includes:

- 8 entry sensors, 1 system controller (includes inside siren), 1 signal relay, 1 lamp command, 1 outside siren, 2 window stickers, 1 yard sign, and complete hardware and batteries.

**FACTORY NEW! FACTORY PERFECT!**

Due to a special arrangement, we were able to obtain a large inventory of these wireless security systems. As a result, we can now offer them to you at **HUGE SAVINGS!**

Manufacturer's Suggested Retail  
**\$698.00**

**DAMARK PRICE:**

**\$299<sup>99</sup>**

Item No. B-1935-133389  
Insured Ship/Hand.: \$15.00

**FOR FASTEST SERVICE CALL TOLL FREE**

**1-800-729-9000**



DAMARK INTERNATIONAL, INC.  
6707 Shingle Creek Parkway, Minneapolis, MN 55430  
Customer Service • 612-566-4940

Please rush me:  Black & Decker Security Systems(s) @ \$299.99 each, plus \$15.00 s/h each. Item No. B-1935-133389.  
**MN res. add 6% sales tax.**

Name \_\_\_\_\_  
Address \_\_\_\_\_  
City, State, Zip \_\_\_\_\_  
 Check/MO  VISA  MasterCard  Discover  
Card No. \_\_\_\_\_  
Exp. Date \_\_\_\_\_ Ph. # ( ) \_\_\_\_\_  
Signature \_\_\_\_\_

**DELIVERY TO 48 U.S. STATES ONLY**

## SHORTWAVE RADIO

*(Continued from page 42)*

that you can adjust the pitch of the whine with the radio's main tuning control. That's the key to using a simple CW/SSB Adapter such as this one. To find CW (Morse code) signals, just tune across the band with the CW/SSB Adapter turned on; tune so that you get the desired pitch. You'll find lots of CW in the ham bands, as well as marine and military CW in the 4-5 and 8-9 MHz bands.

SSB is somewhat trickier to pick up than CW. With the CW/SSB Adapter turned off, an SSB signal sounds like a garbled, *Donald Duck*-like voice. Tune in the garbled voice so that the volume is as loud as possible, and then switch on the CW/SSB Adapter and touch up the tuning very carefully. When it's exactly right, the voice will suddenly sound normal.

The direction in which you have to retune depends on whether the signal is upper- or lower-sideband. If you listen to lots of SSB, you may want to build two CW/SSB Adapters and adjust the slugs so that each works best for only one sideband.

**Should BFO's be Tunable?** If you have a hard time tuning your radio precisely, you can add a pitch control to the CW/SSB Adapter. Figure 2 shows several subassemblies that can be added to the CW/SSB Adapter to make the circuit tunable. And regardless of which subassembly choose, it should be connected across the tapped side of T1. A 30-pF variable capacitor (see Fig. 2A) is best, but you can use a larger variable capacitor in series with a small fixed capacitor (Fig. 2B), or a 39-pF fixed capacitor coupled through a variable resistance (Fig. 2C). In each case, you will need to readjust the slug of T1 to make up for the extra capacitance.

A tunable CW/SSB Adapter can even be added to a digital receiver that already has a non-tunable one. An example of such a receiver is the Sony ICF-2010. Because that receiver tunes in 0.1-kHz increments, you can't set the CW/SSB Adapter to a precise pitch, making it hard to use the receiver with an RTTY (radioteletype) demodulator. A second, tunable CW/SSB Adapter, perhaps housed in a separate case, can solve the problem.

In any event, this simple CW/SSB Adapter will inexpensively allow you to tap into the world hidden beyond the capabilities of your present receiver.

## RCA MONITOR

*(Continued from page 79)*

at the dealer's showroom before finalizing your purchase.

**Hands-on Evaluation.** We have pretty much indicated our own reactions to this set, and they correspond almost entirely to those of APEL. In the case of video, measurements reveal a great deal and correlate very well with what an observer sees when viewing a TV picture. Using the remote control makes living with this set a real pleasure, and the auto-programming feature with its variations was easy to use and worked perfectly. So, too, did the on-screen adjustment facilities. So, in summary, this set gets very good grades in the video department, but while it's nice to have built-in stereo in a set that's this compact, our sample's stereo-audio performance fell short.

For more information on the RCA X20343WN 20-inch TV monitor/receiver with MTS sound, contact the manufacturer (Thomson Consumer Electronics, 600 N. Sherman Dr., Indianapolis, IN 46201) directly, or circle No. 119 on the Free Information Card.

## DIGITAL COURSE

*(Continued from page 77)*

The Digital Microprocessor Course is reprinted here with the permission of the Electronic Industries Association/Consumer Electronic Group (EIA/CEG). The complete parts kit is available from EIA/CEG. For further information, contact EIA/CEG Product Services Department, 1722 Eye Street, NW, Suite 200, Washington, DC 20006; or call 202/457-4986.

tunable from the circuit as now set up. What's the highest frequency obtainable? At what frequency, as observed on the oscilloscope, does the output waveform approach a 50% duty cycle.

Remove power from the circuit, alter the values of R2 and C1; R2 can be replaced by another potentiometer. As for C1, start with a lower value of capacitance. Note all changes in duty cycle and frequency. With a lower capacitance value for C1, does the output frequency of the circuit go up or down? What affect does altering the value of C1 have on the duty cycle.

Try making R2 and R3 equal in value and observing the effects on an oscilloscope. What conclusions can be drawn from your observations?



# East of the sun. West of the moon. Windjammer.

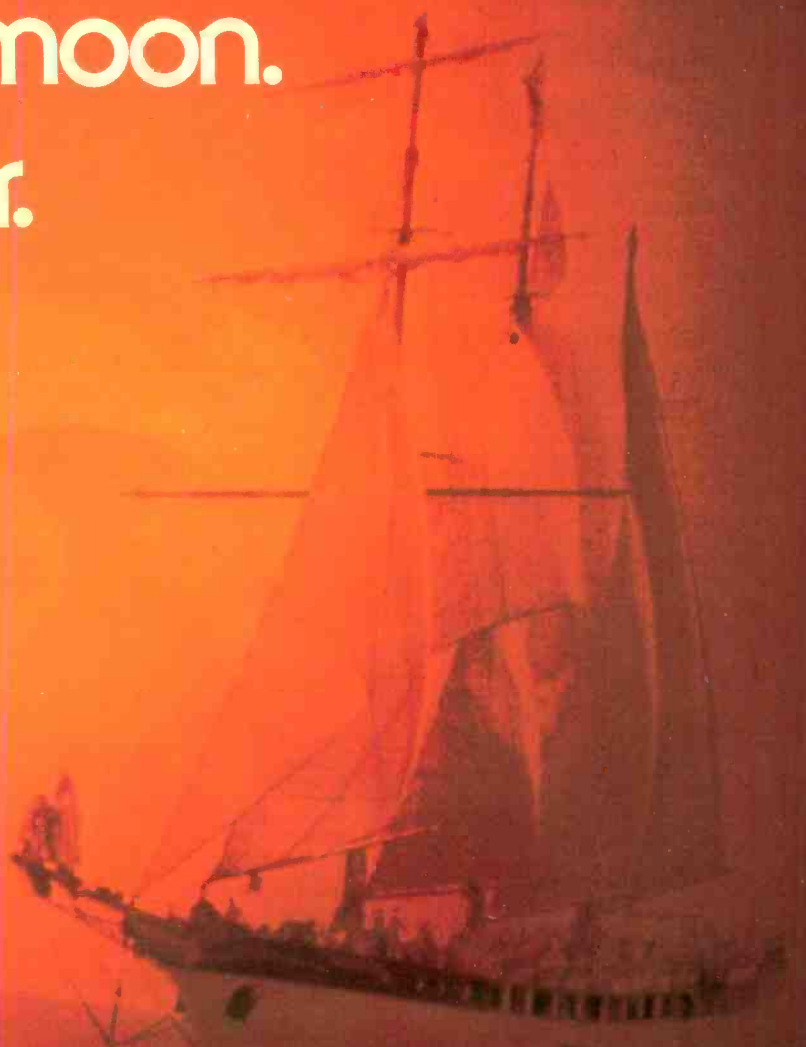

A place to live your fantasies.  
A place to free your soul.

To cozy up to the Caribbean sun.  
To dance among a thousand stars  
to the rhythms of steel drums.  
To play on sparkling white and  
pink sand beaches.  
To discover the underwater  
paradise of the reefs.  
To find a new friend and share the  
intimacies of a sensuous night.

To come alive and live.  
To remember for a lifetime.  
6 days and 6 nights. From \$625.

Reservations toll free  
1-800-327-2600  
In Florida 305/373-2090.

**Windjammer  
Barefoot Cruise**

Post Office Box 120,  
Miami Beach, Florida 33119.



"Cap'n Mike, rush me my free, full color 'Great Adventure' booklet and show  
me the way to Paradise for 6 days and 6 nights from \$625!"  
Windjammer Barefoot Cruises,  
P.O. Box 120, Dept. 1642 Miami Beach, Fla. 33119.

Name \_\_\_\_\_  
Address \_\_\_\_\_  
City \_\_\_\_\_  
State/Zip \_\_\_\_\_



# uniden®

## \$12,000,000 Scanner Sale

Uniden Corporation of America has purchased the consumer products line of Regency Electronics Inc. for \$12,000,000. To celebrate this purchase, we're having our largest scanner sale in history! Use the coupon in this ad for big savings. Hurry...offer ends June 30, 1990.

### ★★★ MONEY SAVING COUPON ★★★

Get special savings on the scanners listed in this coupon. This coupon must be included with your prepaid order. Credit cards, personal checks and quantity discounts are excluded from this offer. Offer valid only on prepaid orders mailed directly to Communications Electronics Inc., P.O. Box 1045 - Dept. UNI3, Ann Arbor, Michigan 48106-1045 U.S.A. Coupon expires June 30, 1990.

Coupon may not be used in conjunction with any other offer from CEI. Coupon may be photocopied. Add \$12.00 for shipping in the continental U.S.A.

- Regency TS2-T ..... \$259.95
- Regency R1600-T ..... \$239.95
- Regency R1099-T ..... \$99.95
- Regency RH606B-T ..... \$419.95
- Regency RH256B-T ..... \$294.95
- Bearcat 200XLT-T2 ..... \$229.95
- Bearcat 100XLT-T ..... \$184.95
- Bearcat 800XLT-T2 ..... \$229.95
- Uniden HR2510-T ..... \$229.95
- Uniden HR2600-T ..... \$274.95
- Uniden PRO500D-T2 ..... \$29.95

### ★★★ VALUABLE COUPON ★★★

#### Bearcat® 760XLT-T

List price \$499.95/CE price \$244.95/SPECIAL 12-Band, 100 Channel • Crystalless • AC/DC Frequency range: 29-54, 118-174, 406-512, 806-956 MHz. Excludes 823.9875-849.0125 and 868.9875-894.0125 MHz. The Bearcat 760XLT has 100 programmable channels organized as five channel banks for easy use, and 12 bands of coverage including the 800 MHz band. The Bearcat 760XLT mounts neatly under the dash and connects directly to fuse block or battery. The unit also has an AC adaptor, flip down stand and telescopic antenna for desk top use. 6-5/16" W x 1 1/4" H x 7 3/4" D. Model BC 590XLT-T is a similar version without the 800 MHz band for only \$194.95. Order your scanner from CEI today.

#### NEW! Regency® Products

- R4030-T Regency 200 ch. handheld scanner ..... \$254.95
- R4020-T Regency 100 ch. handheld scanner ..... \$189.95
- R4010-T Regency 10 channel handheld scanner ..... \$114.95
- R1600-T Regency 100 channel mobile scanner ..... \$244.95
- P200-T Regency 40 channel CB Mobile ..... \$38.95
- P210-T Regency 40 channel CB Mobile ..... \$56.95
- P220-T Regency 40 channel CB Mobile ..... \$79.95
- P300-T Regency 40 channel SSB CB Mobile ..... \$137.95
- P400-T Regency 40 channel SSB CB Base ..... \$174.95
- PR100-T Regency visor mount radar detector ..... \$54.95
- PR120-T Regency "Passport" size radar detector ..... \$114.95
- PR120-T Regency "micro" size radar detector ..... \$144.95
- MP510XLT-T Regency 40 Ch. marine transceiver ..... \$139.95
- MP5510XLT-T Regency 60 Ch. marine transceiver ..... \$159.95
- MP6000XLT-T Regency 60 Ch. marine transceiver ..... \$209.95
- MP2000XLT-T Regency handheld marine trans. .... \$189.95

#### Regency® RH256B-T

List price \$799.95/CE price \$299.95/SPECIAL 16 Channel • 25 Watt Transceiver • Priority The Regency RH256B-T is a sixteen-channel VHF land mobile transceiver designed to cover any frequency between 150 to 162 MHz. Since this radio is synthesized, no expensive crystals are needed to store up to 16 frequencies without battery backup. All radios come with CTCSS tone and scanning capabilities. A monitor and night/day switch is also standard. This transceiver even has a priority function. The RH256 makes an ideal radio for any police or fire department volunteer because of its low cost and high performance. A 60 Watt VHF 150-162 MHz. version called the RH606B-T is available for \$429.95. A UHF 15 watt, 16 channel version of this radio called the RH156B-T is also available and covers 450-482 MHz, but the cost is \$454.95.

### ★★★ Uniden CB Radios ★★★

The Uniden line of Citizens Band Radio transceivers is styled to compliment other mobile audio equipment. Uniden CB radios are so reliable that they have a two year limited warranty. From the feature packed PRO 810E to the 310E handheld, there is no better Citizens Band radio on the market today.

- PRO310E-T Uniden 40 Ch. Portable/Mobile CB ..... \$83.95
- PRO330E-T Uniden 40 Ch. Remote mount CB ..... \$104.95
- PRO500D-T Uniden 40 Channel CB Mobile ..... \$38.95
- KARATE-T Uniden 40 channel rescue radio ..... \$53.95
- GRANT-T Uniden 40 channel SSB CB mobile ..... \$166.95
- MADISON-T Uniden 40 channel SSB CB base ..... \$244.95
- PC122-T Uniden 40 channel SSB CB mobile ..... \$119.95
- PRO510XL-T Uniden 40 channel CB Mobile ..... \$38.95
- PRO520XL-T Uniden 40 channel CB Mobile ..... \$56.95
- PRO530XL-T Uniden 40 channel CB Mobile ..... \$79.95
- PRO540E-T Uniden 40 channel CB Mobile ..... \$97.95
- PRO640E-T Uniden 40 channel SSB CB Mobile ..... \$137.95
- PRO710E-T Uniden 40 channel CB Base ..... \$119.95
- PRO810E-T Uniden 40 channel SSB CB Base ..... \$174.95

### ★★★ Uniden Radar Detectors ★★★

- Buy the finest Uniden radar detectors from CEI today.
- TALKER-T2 Uniden talking radar detector ..... \$144.95
  - RD7-T Uniden visor mount radar detector ..... \$99.95
  - RD9-T Uniden "Passport" size radar detector ..... \$114.95
  - RD9XL-T Uniden "micro" size radar detector ..... \$144.95
  - RD25-T Uniden visor mount radar detector ..... \$54.95
  - RD500-T Uniden visor mount radar detector ..... \$74.95

#### Bearcat® 200XLT-T

List price \$509.95/CE price \$239.95/SPECIAL 12-Band, 200 Channel • 800 MHz. Handheld Search • Limit • Hold • Priority • Lockout Frequency range: 29-54, 118-174, 406-512, 806-956 MHz. Excludes 823.9875-849.0125 and 868.9875-894.0125 MHz. The Bearcat 200XLT sets a new standard for handheld scanners in performance and dependability. This full featured unit has 200 programmable channels with 10 scanning banks and 12 band coverage. If you want a very similar model without the 800 MHz. band and 100 channels, order the BC 100XLT-T for only \$189.95. Includes antenna, carrying case with belt loop, ni-cad battery pack, AC adaptor and earphone. Order your scanner now.

#### Bearcat® 800XLT-T

List price \$549.95/CE price \$239.95/SPECIAL 12-Band, 40 Channel • No-crystal scanner Priority control • Search/Scan • AC/DC Bands: 29-54, 118-174, 406-512, 806-912 MHz. Excludes 823.9875-849.0125 and 868.9875-894.0125 MHz. The Uniden 800XLT receives 40 channels in two banks. Scans 15 channels per second. Size 9 1/4" x 4 1/2" x 12 1/2". If you do not need the 800 MHz. band, a similar model called the BC 210XLT-T is available for \$178.95.

#### Bearcat® 145XL-T

List price \$189.95/CE price \$94.95/SPECIAL 10-Band, 16 Channel • No-crystal scanner Priority control • Weather search • AC/DC Bands: 29-54, 136-174, 406-512 MHz. The Bearcat 145XL is a 16 channel, programmable scanner covering ten frequency bands. The unit features a built-in delay function that adds a three second delay on all channels to prevent missed transmissions. A mobile version called the BC560XLT-T featuring priority, weather search, channel lockout and more is available for \$94.95. CEI's package price includes mobile mounting bracket and mobile power cord.

#### President® HR2510-T

List price \$499.95/CE price \$239.95/SPECIAL 10 Meter Mobile Transceiver • Digital VFO Full Band Coverage • All-Mode Operation Backlit liquid crystal display • Auto Squelch RIT • Preprogrammed 10 KHz. Channels Frequency Coverage: 28.0000 MHz. to 29.6999 MHz. The President HR2510 Mobile 10 Meter Transceiver made by Uniden, has everything you need for amateur radio communications. Up to 25 Watt PEP USB/LSB and 25 Watt CW mode. Noise Blanker. PA mode. Digital VFO. Built-in S/RF/MOD/SWR meter. Channel switch on the microphone, and much more! The HR2510 lets you operate AM, FM, USB, LSB or CW. The digitally synthesized frequency control gives you maximum stability and you may choose either pre-programmed 10 KHz. channel steps, or use the built-in VFO for steps down to 100 Hz. There's also RIT (Receiver Incremental Tuning) to give you perfectly tuned signals. With receive scanning, you can scan 50 channels in any one of four band segments to find out where the action is. Order your HR2510 from CEI today.

#### NEW! President® HR2600-T

List price \$599.95/CE price \$299.95/SPECIAL 10 Meter Mobile Transceiver • New Features The new President HR2600 Mobile 10 Meter Transceiver is similar to the Uniden HR2510 but now has repeater offsets (100 KHz.) and CTCSS encode.



BC760XLT 800 MHz. mobile scanner SPECIAL!

CIRCLE 10 ON FREE INFORMATION CARD

### ★★★ Uniden Cordless Telephones ★★★

- XE750-T Uniden Cordless Phone with speaker ..... \$99.95
- XE550-T Uniden Cordless Phone ..... \$79.95
- XE300-T Uniden Cordless Phone ..... \$69.95

### ★★★ Extended Service Contract ★★★

If you purchase a scanner, CB, radar detector or cordless phone from any store in the U.S. or Canada within the last 30 days, you can get up to three years of extended service contract from Warrantech. This service extension plan begins after the manufacturer's warranty expires. Warrantech will perform all necessary labor and will not charge for return shipping. Extended service contracts are not refundable and apply only to the original purchaser. A two year extended contract on a mobile or base scanner is \$29.99 and three years is \$39.99. For handheld scanners, 2 years is \$59.99 and 3 years is \$79.99. For radar detectors, two years is \$29.99. For CB radios, 2 years is \$39.99. For cordless phones, 3 years is \$34.99. Order your extended service contract today.

### OTHER RADIOS AND ACCESSORIES

- BC55XLT-T Bearcat 10 channel scanner ..... \$114.95
- BC70XLT-T Bearcat 20 channel scanner ..... \$159.95
- BC175XLT-T Bearcat 16 channel scanner ..... \$156.95
- R2066-T Regency 60 channel scanner ..... \$149.95
- R1099-T Regency 45 channel scanner ..... \$109.95
- TS2-T Regency 75 channel scanner ..... \$269.95
- UC102-T Regency VHF 2 ch. 1 Watt transceiver ..... \$114.95
- BP55-T Regency 16 amp reg. power supply ..... \$179.95
- BP205-T1 Ni-Cad batt. pack for BC200/BC100XLT ..... \$39.95
- B8-T 1.2 V AA Ni-Cad batteries (set of eight) ..... \$17.95
- FBE-T Frequency Directory for Eastern U.S.A. .... \$14.95
- FBW-T Frequency Directory for Western U.S.A. .... \$14.95
- RFD1-T Great Lakes Frequency Directory ..... \$14.95
- RFD2-T New England Frequency Directory ..... \$14.95
- RFD3-T Mid Atlantic Frequency Directory ..... \$14.95
- RFD4-T Southeast Frequency Directory ..... \$14.95
- RFD5-T N.W. & Northern Plains Frequency Dir. .... \$14.95
- ASD-T Airplane Scanner Directory ..... \$14.95
- SRF-T Survival Radio Frequency Directory ..... \$14.95
- TSG-T "Top Secret" Registry of U.S. Govt. Freq. .... \$14.95
- TTC-T Tune in on telephone calls ..... \$14.95
- CBH-T Big CB Handbook/AM/FM/Freeband ..... \$14.95
- TIC-T Techniques for Intercepting Communications ... \$14.95
- RRF-T Railroad frequency directory ..... \$14.95
- EEC-T Embassy & Espionage Communications ..... \$14.95
- CIE-T Covert Intelligence, Elect. Eavesdropping ... \$14.95
- MFF-T Midwest Federal Frequency directory ..... \$14.95
- A60-T Magnet mount mobile scanner-antenna ..... \$35.95
- A70-T Base station scanner antenna ..... \$35.95
- A1300-T 25 MHz.-1.3 GHz. Discone antenna ..... \$109.95
- USAMM-T Mag mount VHF ant. w/ 12' cable ..... \$39.95
- USAK-T 3/4" hole mount VHF ant. w/ 17' cable ..... \$35.95
- Add \$4.00 shipping for all accessories ordered at the same time. Add \$12.00 shipping per radio and \$4.00 per antenna.

### BUY WITH CONFIDENCE

To get the fastest delivery from CEI of any scanner, send or phone your order directly to our Scanner Distribution Center. Michigan residents please add 4% sales tax or supply your tax I.D. number. Written purchase orders are accepted from approved government agencies and most well rated firms at a 10% surcharge for net 10 billing. All sales are subject to availability, acceptance and verification. All sales on accessories are final. Prices, terms and specifications are subject to change without notice. All prices are in U.S. dollars. Out of stock items will be placed on backorder automatically unless CEI is instructed differently. A \$5.00 additional handling fee will be charged for all orders with a merchandise total under \$50.00. Shipments are F.O.B. CEI warehouse in Ann Arbor, Michigan. No COD's. Most items listed have a manufacturer's warranty. Free copies of warranties on these products are available by writing to CEI. Non-certified checks require bank clearance. Not responsible for typographical errors.

Mail orders to: Communications Electronics, Box 1045, Ann Arbor, Michigan 48106 U.S.A. Add \$12.00 per scanner for U.P.S. ground shipping and handling in the continental U.S.A. For Canada, Puerto Rico, Hawaii, Alaska, or APO/FPO delivery, shipping charges are two times continental U.S. rates. If you have a Discover, Visa, American Express or Master Card, you may call and place a credit card order. 5% surcharge for billing to American Express. Order toll-free in the U.S. Dial 800-USA-SCAN. In Canada, dial 800-221-3475. FAX anytime, dial 313-971-6000. If you are outside the U.S. or in Michigan dial 313-973-8888. Order today. Scanner Distribution Center and CEI logos are trademarks of Communications Electronics Inc. Sale dates 9/1/89 - 6/30/90 AD #090189-T Copyright © 1989 Communications Electronics Inc.

For credit card orders call 1-800-USA-SCAN



Consumer Products Division P.O. Box 1045 □ Ann Arbor, Michigan 48106-1045 U.S.A. For orders call 313-973-8888 or FAX 313-971-6000