

WORLD'S LARGEST COMPUTER MAGAZINE

# Computers

& ELECTRONICS

APRIL 1984 \$1.75

## HOT NEW NEC NOTEBOOK COMPUTER



\*\*\*\*\*5-DIGIT 60506  
390736 DHM 09976093 PAID SEP84  
MRS EDNA DAHM  
937 GRAND AV  
AURORA IL 0506  
044FD

### per New Business Micro or Laser Printers!

# Introducing the MTX 512

## A World Apart from the Ordinary.

It begins with the sense of touch.

With the sleek black metal housing. Cool to the touch. Cool to the advanced circuitry and components contained within.

And the solid feel of people-sized keys set up in a field that gives you room to work and space in which to think.

But the difference only begins with what you see and feel. Where it ends...well, that's really up to you.

In a very practical sense, the only limits you'll experience with the MTX512 are those you choose to accept.

### 64K To 512K RAM – A Look On The Inside

Take a close look at the MTX512.

We could tell you it offers the greatest performance and versatility of any micro in its price range, but we think you're smart enough to draw your own conclusions.

The design is elegant in its simplicity. Remarkable for the power and complexity it represents. 64K RAM built in, with total expansion to 512K. And that doesn't include 16K of video RAM controlled by its own processor.

Speaking of video, keep in mind this is no ordinary monochromatic, single screen system. The MTX starts off where other micros end up. Delivering vivid screen capabilities with 256 x 192 pixels that crisply define interference-free high resolution graphics. 16 brilliant colors that can be displayed simultaneously. In a format powered by 32 easily movable, user-defined graphics characters. Graphics capabilities you'd find impressive in a system that gives you a single screen to work in. With the MTX, you have eight.

Yes, eight.

Eight definable windows to operate independently or in tandem. And still maintain full screen capabilities. Thus, you can manipulate spread sheets on the MTX and see the impact of changing variables in graphics at the same time. Eight separate windows on the world. We call them Virtual Screens. You'll call them extraordinary.

Far from ordinary as well are the built-in system outputs that come standard on the MTX. The Centronics parallel printer port. The two industry-standard joystick ports. The uncommitted parallel I/O port. The Cassette port with 2400 baud. Separate TV and Video Monitor Ports. The 4-channel sound hifi output. We've even installed a ROM cartridge port for word processing and other dedicated programs.

### Interactive Languages And Routines – A Look At The Way All Micros Will One Day Perform

Forget the way all other micros perform. This is the way they should.

Interactively.

With the MTX, you can create and manipulate programs using four different languages in dynamic interaction, all coordinated through the FRONT PANEL DISPLAY. Interweaving elements as you would in creating a symphony.

And take a serious look at the languages housed in the MTX's 24K ROM. MTX BASIC, a more powerful form of BASIC that allows you to use all standard BASIC programs. MTX GRAPHICS, with straight forward commands, eliminates the tedium and difficulty of creating complex graphics programs. NODDY, an 11-command "easy learn" language that can transform real world programming into a child-friendly activity. And MTX ASSEMBLER, which enables sophisticated programming in assembly language. Something else the advanced programmer will appreciate is our ASSEMBLER/DISASSEMBLER, tied to BASIC, which provides unprecedented display and keyboard access to Z80 CPU storage locations, memory and program.

If you're hungry for more, PASCAL and FORTH are also available as add-on ROM packs.

On the keyboard side of things, you'll find a number of operator-oriented features that speed up and ease up the operation of the MTX. The separate numeric pad with quadri-directional cursor control and full editing functions. The eight dual function keys.





The auto repeat function on all alpha-numeric keys. Add to this such programmer-saving features as the use of abbreviated BASIC commands, a built-in syntax verifier, automatic cursor-honing to errors, auto-line numbering and automatic scrolling, and you begin to see the MTX not only opens a lot of doors that other micros leave closed, but speeds you through them as well.

### The 160 Megabyte Connection – A Look At The System

To build a good system, quality must be designed in at every level. We designed the MTX and its complete line of system peripherals using proven, standard components. Striking a strategic balance between power, versatility and dependability. Our Z80A processor, running at 4MHz, gave us the high performance characteristics we were striving for, plus the ability to expand into the MTX Hard Disc, MTX Silicon and Floppy Disc CP/M operated systems. Systems that could provide up to 160 megabyte storage capacity. More power than you'll probably ever need, unless you take full advantage of the MTX's impressive system capabilities.

Systems hookup is as simple as every other MTX procedure. By merely plugging in the twin RS232C Serial interfaces and the Node software, sold optionally, you're ready to create a disc-driven interactive communications network (OXFORD RING®) that can link up to 255 units.

Software? You'll never worry about software availability with the MTX. Dozens of MTX-dedicated programs have already been created, supplementing the vast landscape of CP/M applications software currently available. And advance word of the MTX's technical capabilities has precipitated an MTX software "push" on the part of many leading software manufacturers.

### Word Processing For \$999 – A Look At A Great Deal

Look first at the capabilities, then at the price. This is word processing the way it should be. Quick. Easy. Professional. A package that includes the MTX512; the powerful New Word™ word processing ROM cartridge; and the Memotech DMX80 correspondence quality printer.\* An exceptional value! And that brings us to the bottom line.



### A Look At The Price

There's a very simple equation that covers the pricing of the MTX512.

The more engineering you put in a system, the less it will cost to produce. As you've already seen, the MTX is a pure product of advanced, innovative engineering.

Which is why we can sell it for \$595.\*\*

And why we can confidently back it up with a full one-year warranty.

Make no mistake. When you turn this page, you'll be returning to a world very different from this one.

A world in which all microcomputers will suddenly seem very different.

Suddenly very ordinary.

For more information about the MTX512, or to find out the location of the MTX dealer nearest you, contact Memotech Corporation, 99 Cabot Street, Needham, MA 02194; or phone (617) 449-6614

# MEMOTECH CORPORATION

CP/M is a trademark of Digital Research, Inc.  
New Word™ is a trademark of New Star Software, Inc.  
\*DMX80 correspondence quality printer suggested retail price \$395.  
\*\*Suggested retail price.



**You're traveling through 140° terrain  
at 300 rpm.**

**Only one disk guarantees safe passage through the torrid zone of drive heat. Maxell.**

A lifetime warranty. And manufacturing standards that make it almost unnecessary.

Consider this: Every time you take your disk for a little spin, you expose it to drive heat that can sidetrack data. Worse, take it to the point of no return. Maxell's unique jacket construction defies heat of 140°F. And keeps your information on track.

And Maxell runs clean. A unique process impregnates lubricants throughout the oxide layer. Extending media and head life. How good is Gold?

Maxell's the disk that many drive manufacturers trust to put new equipment through its paces. It's that bug-free.

So you can drive a bargain. But in accelerated tests, Maxell floppys lead the industry in error-free performance and durability. Proving that if you can't stand the heat you don't stand a chance.



**maxell**®  
IT'S WORTH IT.

Maxell Corporation of America, 60 Oxford Drive, Moonachie, N.J. 07074 201-440-8020

Circle No. 30 on Free Information Card

# Computers & ELECTRONICS

## Features

### THE ROAD TO SUCCESS

Three stories about the software business:

#### 51 Avoiding the Pitfalls

By Michael McCarthy

#### 52 Success Story: Context Management Corp.

By Harvey Berger

#### 54 The Story of a New Venture: Arktronics

By Josef Bernard

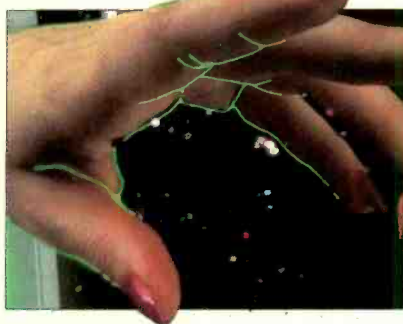

#### 56 Now Let Your Computer Reach Out

By Anita Seelig

Telephone management systems bring new applications to personal computers.

#### 60 High-speed Signal Processors

By Ed Teja

The basis of today's speech recognition and computer vision systems.

#### 62 Sinclair's Newest Bombshell

By Leslie Solomon

The Sinclair QL—a small inexpensive business system.

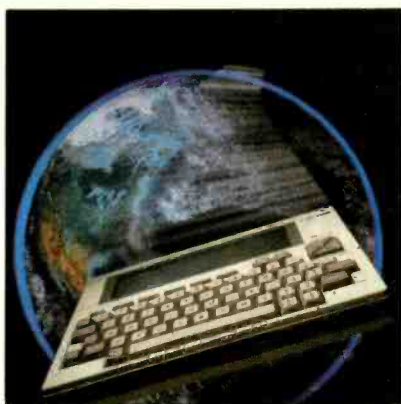

COVER PHOTO BY LIONEL FREEDMAN

#### 64 The Incredible Shrinking Circuits

By Dev Chakravarty

The technology of VLSI circuits and its implications.

#### 68 Bar Codes: Once Over Lightly

By Leslie Solomon

Discover the meaning of those banded patterns.

#### 72 Printing With The Speed Of Light

By Jeff Hecht

Laser printers for personal computers are around the corner.

#### 76 Memories That Don't Forget

By TJ Byers

New technology for preserving the contents of RAM.

## Reviews

#### 36 NEC PC-8201A Lapsize Computer

By Charles P. Rubenstein

#### 44 The ACT Apricot Computer

By William Barden, Jr.

#### 46 DEC 350 Professional Computer

By Henry Collins

#### 48 The Microwriter

By Fred Blechman

Pocketsize word processor stores information while on the run.

## Columns

#### 12 Bits & Bytes

By Sol Libes

#### 16 Les Solomon on Computer Hardware

One More Viewpoint on the Future.

#### 22 The Computer Scientist

By Forrest M. Mims, III

Experimenting with Coleco's Adam.

## Departments

#### 4 Editorial

By Seth R. Alpert

So You Want to Get Rich in the Software Business?

#### 6 Letters

#### 84 New Products

#### 119 Computer Mart/ Electronics Classified

#### 126 Advertiser's Index

COPYRIGHT © 1984 BY ZIFF-DAVIS PUBLISHING COMPANY. All rights reserved. Computers & Electronics (ISSN 0032-4485) April 1984, Volume 22, Number 4. Published monthly by Ziff-Davis Publishing Co., at 3460 Wilshire Blvd., Los Angeles, CA 90010. Richard P. Friese, President; Selwyn Taubman, Treasurer; Bertram A. Abrams, Secretary. One year subscription rate for U.S. and Possessions, \$15.97; Canada, \$20.97; all other countries, \$23.97 (cash orders only, payable in U.S. currency). Second Class postage Paid at Los Angeles, CA 90052 and at additional mailing offices. Authorized as second class mail by the Post Office Dept., Ottawa, Canada, and for payment of postage in cash. POPULAR ELECTRONICS including ELECTRONICS WORLD trademark registered. Indexed in the Reader's Guide to Periodical Literature. Ziff-Davis also publishes Boating, Car and Driver, Cycle, Flying, Popular Photography, Skiing, Stereo Review, Electronic Experimenter's Handbook, and Tape Recording & Buying Guide. POSTMASTER: Send address changes to COMPUTERS & ELECTRONICS, Circulation Dept., P.O. Box 2774, Boulder, CO 80302. Please allow at least eight weeks for change of address, enclosing, if possible, an address label from a recent issue. Permissions: Material in this publication may not be reproduced in any form without permission. Send requests for permission to Elizabeth Amado, Rights and Permissions, Ziff-Davis Publishing Co., One Park Ave., New York, NY 10016.

WILLIAM S. DAVID *Publisher*

SETH R. ALPERT *Editor*

LESLIE SOLOMON *Technical Director*

JOHN R. RIGGS *Managing Editor*

JAMES KIEHLE *Art Director*

A. W. BURAWA *Senior Editor*

JOSEPH DESPOSITO *Technical Editor*

JOSEF BERNARD *Technical Editor*

ANDRE DUZANT *Technical Illustrator*

ROBERT LASCARO *Associate Art Director*

CARMEN VELAZQUEZ *Production Editor*

JEFF NEWMAN *Editorial Assistant*

AMY MADWED *Art Assistant*

**Contributing Editors:** Sol Libes, Forrest M. Mims, III, Barbara E. McMullen, John F. McMullen

**Editorial and Executive Offices**

One Park Avenue, New York, N.Y. 10016.  
212-725-3500

**Advertising Sales Offices**

**New York**

Tom Ballou 212-725-3578/Ken Lipka 212-725-3580

**Midwestern**

Robert Vanek, Suite 1400, 180 N. Michigan Ave.,  
Chicago, IL 60601. 312-346-2600

**Western**

Joe Mesics, J.E.M. Associates, 1905 Pierce St., San  
Francisco, CA 94115. 415-563-3230

**Southeastern**

Mark Browning, PO Box 81306, 2511 Carroll  
Ave., Atlanta, GA 30366. 404-455-3430.

**Representation in Japan**

J.S. Yagi, Iwai Trading Co., Ltd. 603 Ginza Sky  
Heights Bldg., 18-13, Ginza 7-Chome, Tokyo, Jap-  
an 104

**Consumer Computers & Electronics  
Magazine Division**

Larry Sporn *President*

Jeff Hammond *Vice President, Marketing*

Carole Mandel *Vice President, Circulation*

Eileen G. Markowitz *Vice President,*

*General Manager*

Jerry Schneider *Vice President, Licensing & Special Projects*

Jonathan D. Lazarus *Editorial Director*

Peter J. Blank *Creative Director*

**Ziff-Davis Publishing**

**President** Richard P. Friese; **President Consumer Magazine Division** Albert S. Traina; **Executive Vice President, Marketing and Circulation** Paul H. Chook; **Senior Vice President** Phillip T. Heffernan; **Senior Vice President** Sidney Holtz; **Senior Vice President** Edward D. Muhlfield; **Senior Vice President** Philip Sine; **Vice President** Baird Davis; **Vice President** George Morrissey; **Vice President** Rori Parisi; **Vice President** William L. Phillips; **Treasurer** Selwyn Taubman; **Secretary** Bertram A. Abrams

**Editorial correspondence:** COMPUTERS & ELECTRONICS, 1 Park Ave., New York, NY 10016. Editorial contributions must be accompanied by return postage and will be handled with reasonable care; however, publisher assumes no responsibility for return or safety of manuscripts, art work, or models submitted.

The publisher has no knowledge of any proprietary rights which will be violated by the making or using of any items disclosed in this issue.

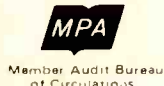

# SETH R. ALPERT EDITORIAL

## SO YOU WANT TO GET RICH IN THE SOFTWARE BUSINESS?

**I**F you have made any real use of a personal computer, you have probably felt a secret temptation. Perhaps it hasn't been more than a subliminal glimmer in the dark recesses of your soul, but nevertheless, it's there. I speak of the urge to develop and market your own software product—one which will certainly become a bestseller and make you indescribably rich and famous.

The seed of this fantasy is sown when you read about the latest 25-year-old multimillionaire who, while he earned a living driving a cab, wrote a package that is selling a zillion copies a month. You think, "Gosh, I'm just as smart as that guy. He simply had the guts to try, and he got lucky."

The seed germinates while you are going nuts trying to get your latest \$195 software acquisition to work properly. It is really pretty good, but you find a bug or two, or note the abysmal quality of the documentation, or think of a couple of good features that the authors forgot. Certainly, had you been the developer, it would have been a better product.

And then you find that you are a rather proficient programmer, and the temptation takes root. But will the fantasy bear fruit?

Software seems to capture our imaginations today in the same way that the movies captured people's imaginations during that industry's formative years. Anyone can dream of becoming a star, just like the ones the media are lionizing. After all, what does it take? No capital investment—\$5000 worth of computer equipment will do. Just some good ideas and a lot of hard work, and you've launched a company.

Thus, dreams are born. It is amazing how common this sort of fantasy is, and how often it goes beyond mere temptation. Industry estimates have it that there are 50,000 microcomputer software products on the market today. The number of people I know personally who are working on one or more such ventures in their spare time quite astounds me. I wish them all well, and hope they remember their dear old friend.

Of course, it's not all that simple. Very, very few products bring their authors any real financial reward. This month, we thought we would edify our readers with a special section called "The Road to Success." Michael McCarthy's article, "Avoiding the Pitfalls," examines what has to go right for a product during the many phases of its life cycle in order for it to make the big time. McCarthy estimates that only half a percent of the products developed will ever become bestsellers.

So that you won't have to consider

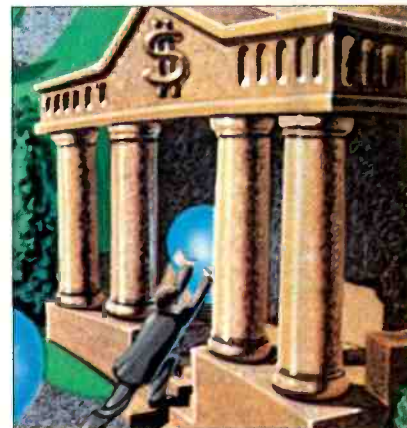

McCarthy's ideas in a vacuum, we have included two real examples: one a success, the other a hopeful. Harvey Berger's article on Context Management Systems, the purveyors of an integrated spreadsheet called Context MBA, is our success story (although their first product did not succeed). Josef Bernard interviews the cochairman of a hopeful, Arktronic. Their product, named Jane, an integrated package for the Apple II family of computers, was scheduled as of this writing to begin shipping by the end of February 1984. We have not included a story about a failure—they are so numerous and the reasons for failure inevitably seem obvious in retrospect.

I hope these articles will give you some food for thought before you mortgage house, wife, and children to seek fame and fortune in software.

By the way, have I told you about the great new spreadsheet I'm writing? ◇

commodore  64

# INDISPENSABLE SOFTWARE

For Your Most Important Computing Needs



**EasyScript 64**  
Displays 764 lines x 240 characters. Prints to 130 columns. Works with EasySpell 64.



**EasySpell 64**  
20,000 word Master Dictionary and automatic spelling checker. Works with EasyScript 64.

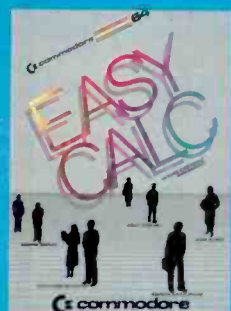

**EasyCalc 64**  
Multiple electronic spreadsheet with color bar graph feature. 63 columns x 254 rows.



**The Manager**  
Sophisticated database system with 4 built-in applications, or design your own. Text, formulas, graphics



**SuperExpander 64**  
21 special commands. Combine text with high resolution graphics. Music and game sounds.



**Easy Finance I—Loan Analysis**  
12 loan functions. Bar graph forecasting as well as calculation.



**Easy Finance II—Basic Investment Analysis**  
16 stock investment functions. Investment bar graph.



**Easy Finance III—Advanced Investment Analysis**  
16 capital investment functions. Bar graphs.



**Easy Finance IV—Business Management**  
21 business management features. Bar graphs.



**Easy Finance V—Statistics and Forecasting**  
Assess present/future sales trends with 9 statistics and forecasting functions.



**Accounts Payable/Checkwriting**  
11 functions. Automatic billing. 50 vendors/disk.

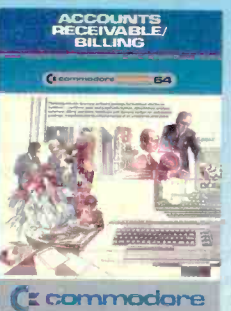

**Accounts Receivable/Billing**  
11 billing functions. Printed statements.

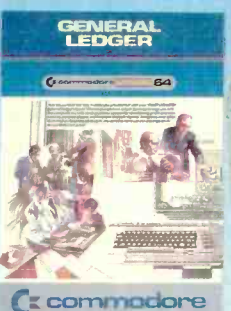

**General Ledger**  
8 general ledger options. Custom income statement, trial balances, reports.

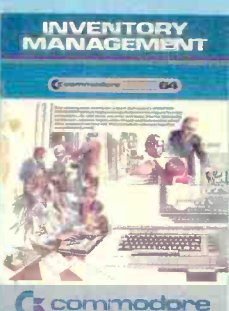

**Inventory Management**  
1000 inventory items. Full reports.



**Payroll**  
24 different payroll functions. Integrated with G/L system.

 **commodore**  
COMPUTERS

**First In Quality Software**

Circle No. 29 on Free Information Card

[www.americanradiohistory.com](http://www.americanradiohistory.com)

# LETTERS

## Minis vs. Micros

I have been accustomed to minicomputer operating system support for file access with symbolic keys since 1977. Also, I am used to variable-length records for keyed files.

So, in recent months, since I have been reading about CP/M and Unix and MS-DOS, it has been a big shock to find that these systems offer very primitive keyed access.

I noticed a book by Douglas Hergert entitled *Doing Business in Pascal*, which showed some code for building a crude ISAM capability into an application. That was an achievement, but what a sorry state of affairs to have to do so. Serious business systems have to be able to access records with symbolic keys like invoice numbers and part number, not relative record numbers. I can't understand why the micros don't have the file access (by now, anyway) that the minis have had for so long. How can this be?

—L. PHEMISTER  
Mt. Vernon, IL

## Which Came First?

It never ceases to amaze me that intelligent people will try and revise history to suit their own needs. Sorry to say, the Altair 8800 was not the first successful microcomputer (per your editorial in your February 1984 issue). Our Mark-8 computer, as published by *Radio Electronics* had the Altair beat by six months.

By the time your article was published, there were several thousand Mark-8 computers built and running. Several small businesses got their start making add-ons for the Mark-8. Sure, the Altair had its place in the scheme of things. It did spawn the S-100 bus, and it did get many people started and interested in computers, but it wasn't the first to do it. Let's not split hairs about the differences between the two, just acknowledge that we were there first.

JONATHAN A. TITUS  
The Blacksburg Group  
Blacksburg, VA

*Of course, the Mark-8 predates the Altair—there was never any question of that. However, the Mark-8 was so complex that most people never were able to get it to work. We stand by our statement that the Altair was the first commercially viable and therefore successful microcomputer.—Ed.*

## The New Format

Some time ago I wrote you a letter in which I expressed my dissatisfaction with the (undoubtedly expensive) multi-colored title pages with which each article seemed to start. I found them childish and confusing.

You must have seen the light, because your new format, starting with the February issue is such an improvement that I have to write again to express my total satisfaction. Gone are the paintings, which I constantly mistook for ads. In addition, the boxed text makes those pages stand out even better. Thank you for a much-improved, professional-looking format.

CEDRIC R. BASTIAANS  
Los Angeles, CA



## Videotex on the Air

Videotex (see "Videotex and You," C&E, February 1984) will not be popular until the broadcast medium is used. At \$1.00 per hour, phone line usage is too expensive. On-line usage of just 5 hours a day adds up to \$1800 annually. That's a lot of money.

BOB McDONNELL  
Cypress, CA

## Flopped Adam

I enjoy your magazine, but I'm afraid your left-handed Adam will cause quite a stir in the market place. I refer to your mirror image of the Coleco Adam on page 43 of your February issue... a slight oversight in your many years of helpful electronics.

WALTER D. MOORE  
Adelanto, CA

*Unfortunately, in our rush to get the information on Adam out as soon as possible, the photo got flopped. The view on the opposite page gives a better idea of how the keyboard really looks.—Ed.*

## No Apple Hard Sectors

Your article "Disks and Drives" in the February issue is excellent. I plan to use it as a reference source in my classes. However, there appears to be one error in the article. It states, "A few (computers) though, like the Apple II family, use hard sector disks..." Such is not the case. The Apple II requires no sector holes at all. The User's Guide says, "The Apple Disk II ignores all timing holes. Its timing is wholly electronic..." You can use either soft sector or hard sector diskettes with the Disk II."

THOMAS F. PRATHER  
Hagerstown, MD

*We stand corrected. Apple has always used soft sector disks. There are a few other systems, though, that do still use the hard sector format.—Ed.*

## About Power!

Thank you for your excellent article about CP/M ("What's New in the CP/M World?" January 1984). As a first-time user of CP/M, I found it very helpful. You showed a photo of a utility called "Power!" Can you tell me where I can get it?

GENE SAILSBURY  
Pittsburg, KS

*Power!, a utility that takes much of the drudgery out of CP/M, is a product of the company, Computing!, 2519 Greenwich, San Francisco, CA 94123. Price is \$169. A version of the program called Menu!, which does not include some of the features of interest primarily to programmers, is available for \$149.—Ed.*

## Philippines User Group

Since the computer industry in the Philippines is still very much in its infancy, there is not much interchange of information among programmers and other computer personnel. Five of us have recently formed a User's Group, however, and we are striving to provide a strong information base for ourselves and others here. Toward this end, we would like to correspond with similar groups in your country. Our exchange could include anything that would be of interest to computer enthusiasts—particularly software utilities and applications.

MARIO F. ARROYO  
14-10 La Salle St.  
Cubao, Quezon City  
Philippines



# To master the computer, master the software

Challenge your ability.  
Take charge of your computer.  
Take pride in the results.

You've invested in the computer. Now invest in yourself. Writing your own software lets you define your own boundaries, broaden your problem-solving resources and puts you in complete command at the keyboard. It's challenging. It's exciting. And now it's easier than ever before with Self-Study Computer Courses from Heathkit/Zenith.

Master today's most powerful contemporary languages including Microsoft BASIC, PASCAL and FORTRAN. And learn the popular CP/M and MS-DOS operating systems, too. When you need to know, we'll take you as far as you want to go.

For more information,  
write: Heath Company,  
Benton Harbor, MI 49022  
Or circle the reader service number.

Circle No. 28 on Free Information Card



**Heathkit®**  
Heathkit/Zenith

# Only NRI Gives You This Kind of Training and Equipment.

## Only NRI Gives You So Much Professional Preparation For a TV/Audio/Video Servicing Career.

Build this 25" Heath/Zenith Color TV with 112 channel tuning system, infrared remote control, advanced sound system, and in-set space phone.

Get complete, thorough instruction in the theory, servicing, and repair of TV, VCR, video disc players, audio equipment, AM/FM receivers, antenna systems, home video cameras, projection TV, and more with 65 easy-to-digest, bite-size lessons.

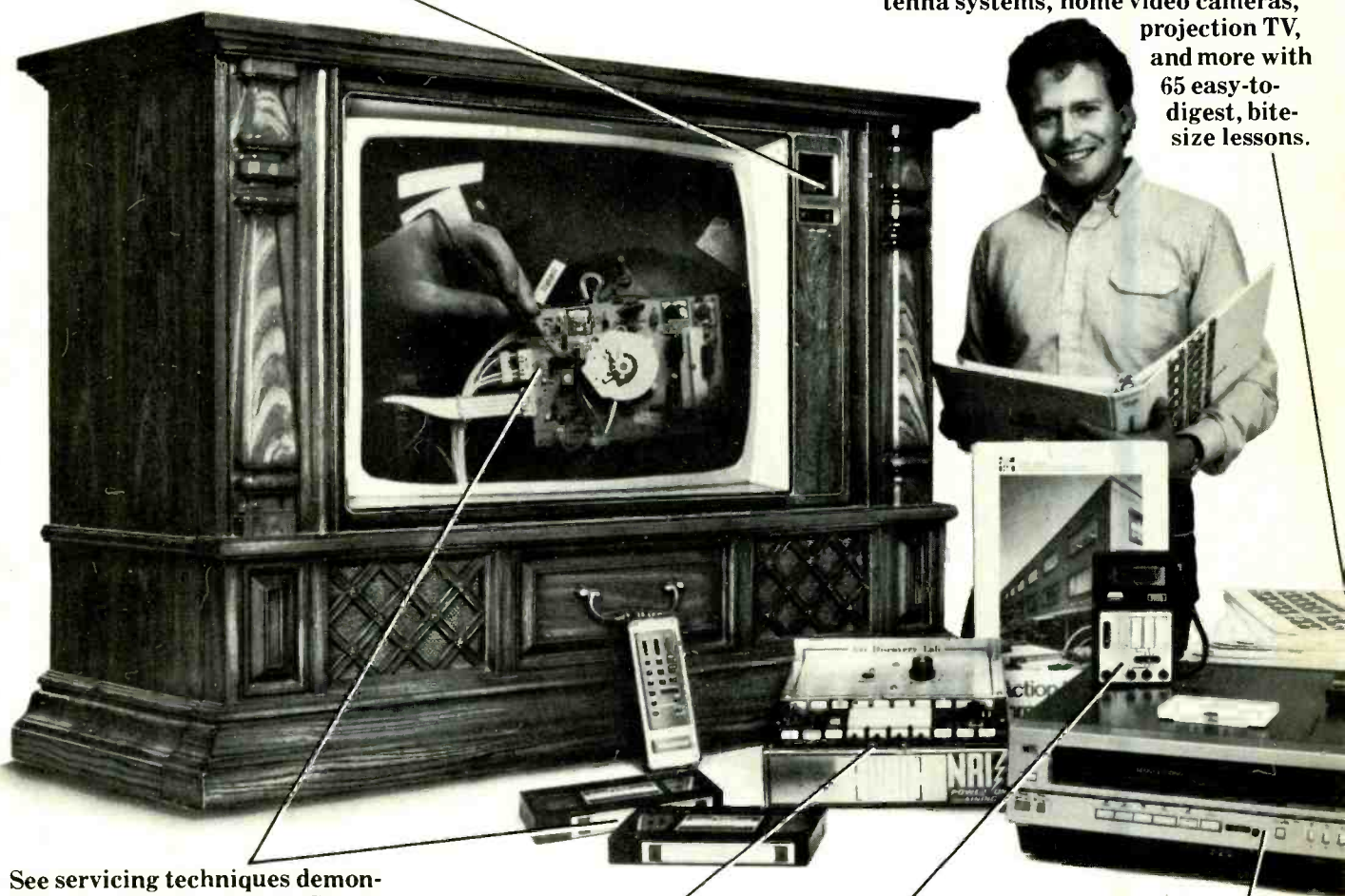

See servicing techniques demonstrated in close-up detail. Graphic presentations make theory and systems come alive on NRI Action Videotapes covering VCRs, disc players, and TVs.

Perform challenging state-of-the-art electronic experiments and demonstrations using your NRI Discovery Lab®.

Learn how to diagnose problems using a professional 3½-digit digital multimeter. Exclusive NRI Action Audio instructions talk you through its complete operation and use.

Learn servicing and adjustment techniques with this 6-hour, remote control videocassette recorder you get as part of your training.

Only NRI gives you so much practical training with equipment you learn on and keep. You learn by doing. That's the way to make it interesting, that's the way to make it enjoyable, that's the way to get the hands-on experience and know-how you need.

## Hands-On Training For Real Bench Experience and Priceless Confidence

You start with experiments and demonstrations on the unique NRI Discovery Lab. You learn basic circuit wiring and soldering techniques, and then quickly move on to more advanced concepts as you come to understand electronic theory, solid-state devices, digital systems, and microprocessors. You learn by actually building and observing the action of circuitry you'll be working with in real-life situations.

## Exclusive NRI Training On Videotape

In addition to profusely illustrated lessons, you get NRI's Action Audio cassette to "talk" you through the use and operation of the professional digital multimeter you receive as part of your equipment. Even more exciting are your NRI Action Videocassettes... videotaped lessons that show you graphic presentations of electronic systems, vivid closeups of servicing techniques and professional "shortcuts" to study and replay as often as you want.

## You Get TV, VCR, DMM and More Equipment To Keep

You also build your own 25" Heath/Zenith color TV, a state-of-the-art unit that includes infrared

remote control, a Time Control Programmer, and the incredible Advanced Space Phone that lets you telephone from your chair. Using the videocassette recorder that's included as part of your training, you learn how to adjust, service and re-

pair these fast-selling units. Your front-loading VCR features up to 6-hour recording capacity, remote control, and programmable touch-button tuning.

The digital multimeter you receive is a truly professional instrument. You use it in the experiments throughout your course and as a key servicing tool on the job. Using the meter along with the NRI Discovery Lab, you'll learn how to measure voltage, current and resistance and how to diagnose all types of servicing problems.

## Advanced Systems Demand Advanced Technicians for Service and Maintenance

The art of TV/Audio/Video servicing has taken quantum leaps into the future. Now, successful technicians must understand advanced concepts like digital control, electronic tuning, laser video discs, microprocessors, and more. NRI gives you the training you need for success... state-of-the-art concepts and practical, hands-on experience working with the kind of equipment you'll encounter on the job.

## 7 Decades of Teaching Electronics Skills At Home

NRI is the oldest, largest, and most successful school of its kind in the world. It has pioneered and refined the teaching techniques that make learning at home the NRI way

one of the most economical and effective methods ever conceived. You learn at your convenience as a class of one, backed by skilled NRI instructors and carefully designed lessons that take you a step at a time toward your goal. No time away from your job, no night school grind, no classroom pressures. Yet your training is thorough and complete, with a foundation of hands-on experience unequalled by any other training organization.



## Send For Free Catalog Covering 12 Electronics Courses

Our 104-page catalog gives you all the details. In it, you'll find a summary description of every lesson, and photos and specifications for every item of equipment included in your course. You'll also learn about other fascinating career opportunities in the world of electronics... Microcomputers, Industrial Electronics including robotics, Communications, and more.

Mail the postage-paid card today for your free copy. See how completely and how thoroughly NRI gets you started on your tomorrow today.



**NRI SCHOOL OF ELECTRONICS**  
McGraw-Hill Continuing Education Center  
3939 Wisconsin Avenue  
Washington, DC 20016

## SOL LIBES

# BITS & BYTES



### Rumors & Gossip

► Sony Corp. is expected to shortly announce a 5-megabyte version of its 3.5" microfloppy drive. The current version stores 1 megabyte. . . Commodore has announced a new \$500 home computer, the 444, with built-in word processor, spreadsheet and graphics software. The system is intended to compete with the Coleco Adam and IBM PCjr. The machine has limited compatibility with the C-64. Also rumored coming soon from Commodore is a new improved version of the VIC-20 to be called the VIC-20-II. . . It is possible that Apple and Computerland are negotiating a renewal of their distribution agreement cancelled last year. . . Look to see the newly divested Bell phone companies retailing personal computers. Nynex (formerly New England Telephone) already is carrying machines in some of its stores. . . Radio Shack is expected to soon discontinue a system to compete directly with the Coleco Adam and discontinue its \$49 Micro-Color Computer made by Kyocera. . . IBM will probably introduce three new PC-based systems this year. First will be a \$10,000 80286-based multi-user system with a Unix-like operating system to replace its current Datamaster/23. Second will be a \$3000 single-user 80286-based system to compete with the Apple Lisa. Last will be a portable with bubble memory.

### Osborne to Reorganize

► Osborne Computer Corp. has filed a bankruptcy reorganization plan that is

expected to put the company back in business. It owes more than \$41 million. The company will get a new president with current President Robert Jaunich and Chairman of the Board Adam Osborne being relegated to Directors. Creditors will be paid in stock and additional financing is being provided by three banks. The company will contract out production and R&D. It intends to concentrate on bringing out 6 products now in development and enhancements for the after-sale market and specific market niches.

### Apple News

► Apple has quietly reduced the price of the IIe by \$150, down to \$1145. Dealer cost is \$895. A dealer in my area was advertising the Apple IIe in a local paper for \$885. (I can't figure how he is staying in business.) Apple is expected to reduce the IIe's price further to compete with the IBM PCjr. and also to introduce a lower-cost version of the IIe.

Apple Computer continues to enforce its Apple II copyrights. Together with the U.S. Customs service, it recently implemented an undercover investigation that led to the seizure of about 400 alleged Apple II copies being sold in California. Apple hired private investigators who posed as large-volume buyers in a "sting" operation. Previously, the Customs service had seized Apples entering the U.S. This is the first time machines have been seized in the domestic market. The seized machines, selling for about one third of the list price of the IIe were copies of the Apple II, which is no longer made by Apple.

Apple says these machines were imported into the U.S. with dummy ROM

chips that did not violate Apple's copyright. The importers then replaced the ROM chips with ROMs that were duplicates of Apple's copyrighted ROMs. Apple Computer currently has about 50 copyright infringement cases pending in 16 countries.

In another action a federal district court has upheld a prohibition by Apple of mail-order sales of Apple computers. The case was brought, in 1981, by six former Apple dealers who charged that it was illegal restraint of trade under the Sherman Act.

Franklin Computer Corp. agreed to pay Apple Computer \$2.5 million for infringing on Apple's software copyright for the Apple II. Franklin agreed to stop using the software. Franklin had sold about 78,000 systems with this software, which according to Apple was a copy of the software provided with the Apple II.

### Software Market Report

► According to a report by Future Computing, a Richardson, TX, market research organization, Microsoft was the largest independent personal computer software publisher last year, with revenues of about \$70 million. FC estimates that IBM and Radio Shack each sold about \$110 million worth of software and Apple close to \$70 million. Second on the list of independents was VisiCorp which sold about \$55 million worth of VisiCalc. Here is how FC projects the ten leading software publishers for last year (in millions of dollars):

IBM	\$110
Radio Shack	\$110
Apple Computer	\$68
Microsoft	\$68
VisiCorp	\$54
MicroPro	\$52
Digital Research	\$46
Lotus Development	\$40
Ashton-Tate	\$35
Peachtree	\$22

The following are the most popular programs, listed by category with the FC estimated monthly shipments (in thousands). The list excludes software bundled with computers.



### Spreadsheets:

Lotus 1-2-3	24
VisiCalc	21
Multiplan	17
SuperCalc	7

### Word Processors:

WordStar	17
Apple Writer	15
Easy Writer	6

### Data Base Managers:

PFS: File	10
dBase II	8
PFS: Report	7

### Accounting:

Home Accountant	13
BPI General Accounting	7
Peachtree General Ledger	4

## The Home Computer Battleground

► Commodore came out on top in last year's home computer battle garnering an estimated 37% of the \$2.4 billion market for under-\$1000 systems, shipping well over 1 million computers. Atari was second at 16%, Texas Instruments, despite its decision to drop out, had an estimated 14% share. Timex was fourth with a 9% share and Tandy was fifth with 8%.

Although the number of retailers about doubled last year, one major retailer, J.C. Penney Co., has stopped selling home computers due to "inadequate profits." JCP had been selling TI, Coleco and Atari computers.

The outlook for 1984 is for sales to increase to about \$3.6 billion with Commodore maintaining its 36% share, Atari about 20%, Tandy about 13%, Timex about 8% and Coleco about 6%. The IBM PCjr is not expected to be a significant factor in the home computer market since virtually all of the units made are expected to sell for well over \$1500.

## Microsoft Announces MSX-DOS

► The Microsoft MSX operating system for home computers has received a less than enthusiastic response by U.S. home computer makers and Japanese companies planning to ship units to the U.S. This is due to the fact that MSX relies on ROM cartridge software rather than disk-based software. Digital Research has introduced the Personal CP/M disk-based operating system for low-cost home computers.

But never fear, Microsoft is not one to give up a market to DRJ and has just announced a disk-based home computer DOS to be called MSX-DOS. Like MSX it will run on a Z80-based 8-bit computer, and Microsoft promises that it will run standard CP/M-80 software, including their Multiplan, Cobol-80, Fortran-80 and MBASIC.

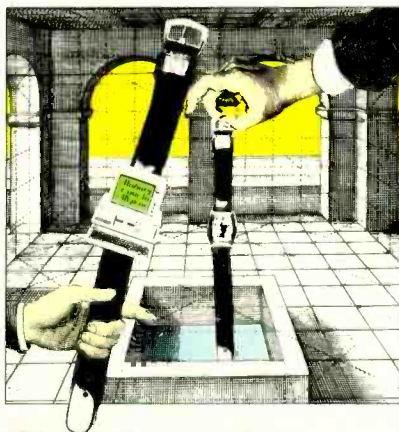

## Wrist Computer Introduced

► Seiko Instruments and Electronics has introduced an LCD wristwatch that can also function as the display for a pocket computer. The latter is an accessory for the watch which communicates with the display via a low-frequency electromagnetic link. Right now the unit is only available in Japan. The display is 4 lines by 10 characters. Two different versions of the computer are available. One version has a Z80-like CMOS processor with 26K of ROM and 4K of RAM, a 71-key keyboard, and compact dot-matrix printer. Interfaces are available to connect to other displays and printers.

## Unix News

► Commodore has confirmed a rumor that appeared in last month's column that it has contracted with Mark Williams Co. to use its Unix-like Coherent operating system on its Z8000-based system. The release of the system is not expected for several months. *Microsystems* magazine reviewed Coherent running on the Intersystems Z8000-based system in its January 1983 issue. Reportedly, Mark Williams furnished Commodore with a set of tapes and Commodore did the actual installation. Coherent is a true multi-user, multi-tasking system.

It is rumored that the system will

have a base price of \$700 and include 128K of RAM and a single drive. It is difficult to imagine how a full-featured Coherent will run on a single-drive, floppy-disk system or even on a system without hard disk. There will be an optional 8088 card.

Western Electric has announced Unix System V Release 2.0, an enhanced version more oriented to the commercial marketplace. It includes enhanced versions of the C compiler and other programming tools, an approximately 10% performance improvement and much better error messages.

## Atari & Activision to Broadcast Software

► Atari and Activision have formed a joint venture to broadcast video game and home computer software via radio. The user would plug an adapter/receiver into his video game console or computer to receive the software with pay-as-you-play charges. Atari is planning a test involving its 2600 video game units.

Control Video Corp., Vienna, VA, is currently transmitting video game and home computer software via telephone and modems. Coleco and AT&T have also announced a telephone-based distribution project. And Romox Inc. is currently offering a system to transmit software via phone to retailers for installation into cartridges.

Further, Playcable, a TV cable distribution company has been furnishing game software for Mattel Intellivision games for three years. However, Mattel is expected to halt its participation shortly.

## Random News Bits

► Zilog Inc., creator of the popular Z80 microprocessor chip, has disclosed that, after nine years of consistent losses, it had a quarter with an operating profit . . . Microsoft has announced that it has licensed its MS-DOS operating system to nearly 100 companies. Digital Research however is still the leader with about 300 companies licensed for CP/M . . . STM Electronics, Menlo Park, CA, has announced the STM-PC, a 17-lb IBM-compatible with a 16 line × 84 character display, 40 column printer, built-in modem, speaker phone, and dual disk drives (1.6 megabytes of storage) for \$3,000.



ANNOUNCING  
A PROUD ADDITION  
TO YOUR FAMILY.

The next addition to your family could be the bright little newcomer in the growing family of IBM® personal computers.

Name: PCjr. Weight: 12 pounds.

Heritage: more than 30 years of computer experience.

"Junior" is a powerful tool for modern times. Yet it's simple enough for a child to enjoy.

---

## BRINGING HOME BABY

---

It's a big day when PCjr comes home.

The surprises begin the moment you open the carton.

Surprise #1 is the IBM "Freeboard"

a keyboard that doesn't need a connecting cord.

The Freeboard frees you to move around and relax.

Then there's the Keyboard Adventure — an instructional exercise for first-time users. It's built into the computer and explained step-by-step in the Guide to Operations. It will help anyone begin learning as soon as PCjr is hooked up to a TV set.

In systems equipped with a diskette drive, there's a program that lets you explore computer fundamentals at your own pace, with PCjr as your teacher.

And to get you off and running from the very first day, a sample diskette with eleven useful mini-programs (ranging from a spreadsheet for monthly expenses to a word game and a recipe file) is also included.

But there are still more surprises.

---

## FAMILY COMPUTING MADE EASY

---

Many IBM software programs written for other IBM personal computers will run on PCjr. And inexpensive new ones written especially for PCjr are being released.

An easy-to-use diskette word processing program, for example, uses pictures as well as words to guide you along. A comprehensive

Circle No. 41 on Free Information Card

The Chaplin character licensed by Bubbles, Inc., S.A.

IBM home budget program makes keeping track of money easier. There's also a selection of educational programs for children at home and at school.

And when the work is finished (or perhaps before), the fun can begin. Just slip in a game cartridge and stand back.

---

## GROWING UP WITH JUNIOR

---

Add a printer. A diskette drive. An internal modem for telecommunications. Increase user memory from 64KB to 128KB. With these and other add-it-yourself options, even the lowest-priced PCjr can grow up *real* fast.

PCjr is a powerful tool for home, school or college. With its optional carrying case, it's a powerful tool anywhere you care to take it.

---

## SEE JUNIOR RUN

---

Junior's starting model includes a 64KB cassette/cartridge unit and Freeboard for about \$700. A 128KB model with diskette drive is about \$1300. (Prices apply at IBM Product Centers. Prices may vary at other stores.)

Your local authorized IBM PCjr dealer proudly invites you to see this bright little addition to the family. For the store nearest you, just call 1-800-IBM-PCJR. In Alaska and Hawaii, 1-800-447-0890.

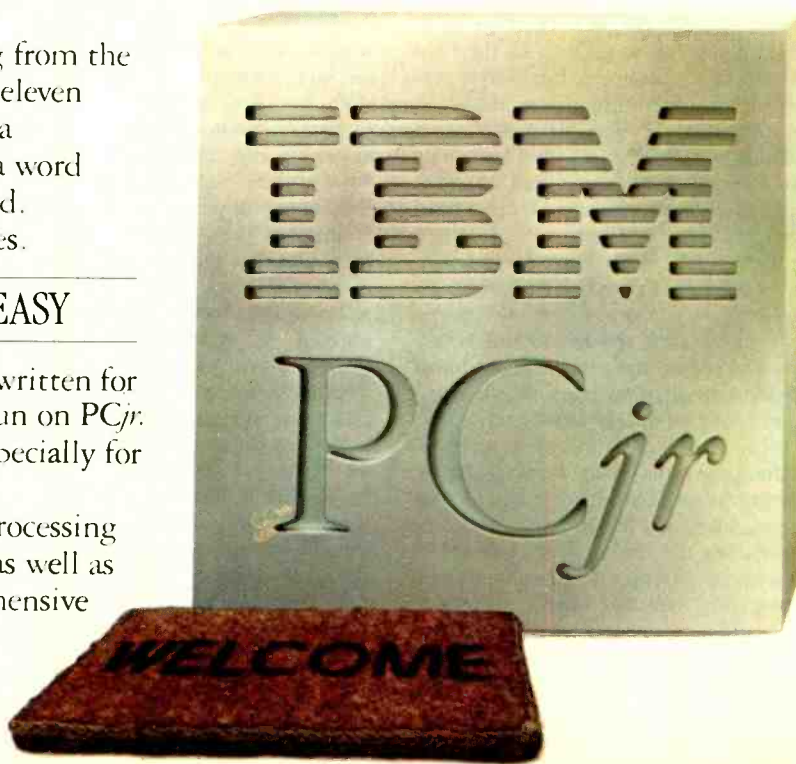

# LES SOLOMON ON COMPUTER HARDWARE

## ONE MORE VIEWPOINT ON THE FUTURE

**C**OMES the dawning of a new year, and my imagination turns to thoughts of what I would like to see in personal computing in the near future. I close my eyes, project myself to the year 1990, and let my imagination take over.

### The Computer

I'm sitting in front of a Mk-1 Model-IV Time Transmogrifier, a product of the late 1980s. My system has a megabyte of RAM, lots of hard-disk storage, a super-high-resolution video display capable of producing really snappy 3-D color graphics, and mice (I am ambidextrous). Absent, however, is a floppy-disk drive.

I turn on my computer and it boots up. When the operating system prompt appears on-screen, I'm asked if I want a menu. Being a conservative but curious sort, I answer "yes" to the query, and up comes the menu. Curiously, though, the hard disk's activity LED never comes on. Aha! The manufacturer has put everything into fast-access ROM. Great!

Since I'm a stranger to this new computer, I tap the HELP key. In the help mode, I snoop around to familiarize myself with the operating system. Buried in one directory, I note, is a file titled "HISTORY.DOC," which I call. The file is many pages long and contains some fascinating reading. Here's a brief synopsis.

### History From the Future

It seems that the home and small-business computer revolution almost fizzled out when ordinary people started reacting adversely to magnetic diskettes in the mid-1980s. They were installing the disks upside-down in drives, getting fingerprints all over the recording medium, and bending and otherwise mutilating the disks. Some companies attempted to solve the problem with reasonably safe microdisks, but there were still far too many complaints about bad software. (Actually, the trouble was due to mishandling of the disks, rather than to bad software.)

Another major complaint was the cost of the software. Computer users objected to paying high prices for the new programs and games they seemed to need in ever-increasing quantities. For a while there, it looked like the personal/home computer would never make it as a fixture in every home.

The situation was saved in the mid-1980s when some enterprising entrepreneurs decided to make software available from a database via telephone lines. Users could simply, and inexpensively, download what they wanted from what

used adjunct to the video image. It was teletext, which occupied only a couple of the 525 scan lines being transmitted.

Up to this time, teletext had been used for little more than closed captioning programs for the hearing impaired. Teletext existed, but it hadn't been capitalized upon, basically because no one knew how to make it into a lucrative venture. Then someone looked into the British Prestel teletext system. This BBC goodie, like its US teletext counterpart, was capable of carrying a couple of hundred thousand "pages" of text



was available on the database. This major step forward worked, but it was slow, working only at 1200 baud.

As the amount of software increased, accessing the database became somewhat slower. Additionally, the greater the number of people accessing the host computers, the slower the system operated. Parallel mainframes became the order of the day, but even this failed to alleviate the problem by any significant amount. It was obvious that some means of downloading huge amounts of data at extremely high baud rates had to be found, and quickly.

A proposal to use an SCA carrier on an existing FM station revealed that bandwidth limitations would still have meant slow baud rates. The SCA scheme had another disadvantage in being a one-way medium that would allow only downloading data from, but not uploading to, the receiver. Just as everything threatened to grind to a halt, someone looked into the specifications for broadcast TV and noticed a little-

and had a bandwidth that would permit a 25,000-baud transfer rate. That was quite a difference from the 300-baud phone rate. The disadvantage of teletext, of course, was that it was one-way only.

The situation might have stagnated but for the fact that almost any operating system, programming language, or applications and games program can be used with teletext. Because of this the teletext system wasn't abandoned altogether and became the motherlode of software! Seen in this light, there really was no need for the system to upload to the transmitter. After all, computers of the day had enough memory to support the operating system, high-level language, and programs, and everything the user wanted could be saved to disk. On top of this, all computer operations could be performed while the family watched its favorite TV programs on the same receiver that did the decoding of the teletext digital data—with no interference! ◇





# The Bearcat® DX1000 makes tuning in London as easy as dialing a phone.

Direct access keyboard tuning brings a new level of simplicity to shortwave radio. With the *Bearcat® DX 1000*, dialing in the BBC in London is as easy as dialing a telephone. And you can switch from the BBC to Peruvian Huayno music from Radio Andina instantly. Without bandswitching.

Featuring the innovative microprocessor digital technology made famous by *Bearcat* scanner radios, the *DX 1000* covers 10 kHz to 30 MHz continuously, with PLL synthesized accuracy. But as easy as it is to tune, it has all the features even the most sophisticated "DXer" could want. 10 memory channels let you store favorite stations for instant recall—or for faster "band-

scanning" during key openings.

The digital display measures frequencies to 1 kHz, or at the touch of a button, doubles as a two time zone, 24-hour digital quartz clock. A built-in timer wakes you to your favorite shortwave station. Or, it can be programmed to activate peripheral equipment like a tape recorder to record up to ten different broadcasts—any frequency, any mode—while you are asleep or at work.

The *DX 1000* also includes independent selectivity selection to help you separate high-powered stations on adjacent

frequencies. Plus a noise blanking system that stops Russian pulse radar interference.

There's never been an easier way to hear what the world has to say. With the *Bearcat DX 1000* shortwave radio, you have direct access to the world.

For the name of your nearest retailer dial toll-free... 1-800-SCANNER.



**Frequency Range:** 10 kHz to 30 MHz continuously. **Tuning:** Direct keyboard entry, selectable 3 or 24 kHz per revolution knob tuning, or manual step tuning in selectable 1-99 kHz steps. **Sensitivity:** 1.0  $\mu$ V AM, 0.5  $\mu$ V CW/SSB/FM, 1.6-30 MHz. **Image and IF Rejection:** 70 dB or more. **Memory:** 10 frequency capacity. **Frequency Stability:** Better than 100 Hz after warm-up. **Modes:** AM/LSB/USB/CW/FM. **AGC:** Selectable Fast/Slow release times. **Filter Bandwidths:** 2.7 kHz, 6 kHz and 12 kHz. **Filter Selection Independent of Mode.**

## Bearcat® DX 1000 shortwave radio.

Direct Access To The World.



Electra Company  
Division of Masco Corp. of Indiana  
300 East County Line Road  
Cumberland, Indiana 46229

# At CIE, you get electronics career training from specialists.



If you're interested in learning how to fix air conditioning, service cars or install heating systems— talk to some other school. But if you're serious about electronics... even earning an Associate Degree... come to CIE —The Electronics Specialists.

## Why trust your education and career future to anything less than a specialist?

You shouldn't. And you certainly don't have to.

If you talked to some of our graduates, chances are you'd find a lot of them shopped around for their training. They pretty much knew what was available. And they picked CIE as number one.

Be sure to shop around. Because, frankly, CIE isn't for everyone.

There are other options for the hobbyist. If you're the ambitious type—with serious career goals in electronics—take a close look at what we've planned for you at CIE. **What you should look for first.**

Part of what makes electronics so interesting is it's based on scientific discoveries—on ideas! So the first thing to look for is a program that starts with ideas and builds on them!

That's what happens with CIE's Auto-Programmed® Lessons. Each lesson takes one or two principles and helps you master them—before you start using them!

### How practical is the training?

This is the next big important question. After all, your career will be built on what you can do—and on how well you do it.

Here are ways some of CIE's career courses help you get your "hands-on" training...

### With CIE's Personal Training Laboratory...

you learn and review the basics—perform dozens of experiments. Plus, you use a 3-in-1 precision Multimeter to learn testing, checking, analyzing!

### When you get your own 5MHz, solid-state

oscilloscope, you take some real professional steps. You use it as a doctor uses an X-ray machine—to "read" waveform patterns...lock them in...study, understand and interpret them!

**When you get your Digital Learning Laboratory, you'll**

be into digital theory—essential training today for anyone who wants to keep pace with the state of the art of electronics. With CIE's Digital Lab, you'll be applying in dozens of fascinating ways the theory you've learned. For example, you'll compare analog and digital devices. You'll learn to make binary to decimal conversions and to work with semiconductor devices and circuits. You'll see how digital equipment is vital to today's exciting, growing fields such as security... where digital theory provides the brains for space-age alarm and protective devices. **You'll build your Microprocessor Training Laboratory,** a working microcomputer—from "scratch." You'll also learn how to program and interface it with displays, memories, switches, and more.

### Earn An Associate Degree from CIE.

One of the best credentials you can have in electronics—or any other career field—is a college degree. That's why CIE gives you the opportunity to earn an Associate in Applied Science

in Electronics Engineering Technology. Any CIE career course can offer you credit toward the degree...more than half of the number needed in some cases.

You can also prepare for the government-administered FCC (Federal Communications Commission) Radiotelephone License, General Class. It can be a real mark in your favor... government-certified proof of your specific knowledge and skills.

### Shop around...but send for CIE's free school catalog first!

Mail the card. If it's gone, cut out and mail the coupon. If you prefer to write, mention the name and date of this magazine. We'll send you a copy of CIE's FREE school catalog—plus a complete package of independent home study information! For your convenience, we'll try to have a representative contact you to

answer your questions.

Mail the card or coupon—

or write: CIE, 1776  
East 17th St.,  
Cleveland,  
OH 44114.

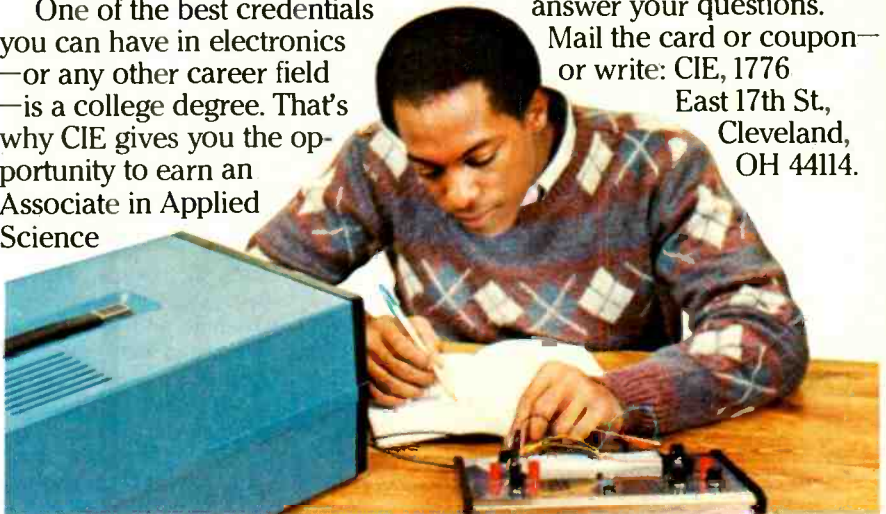

## CIE Cleveland Institute of Electronics, Inc.

1776 East 17th Street, Cleveland, Ohio 44114

Accredited Member National Home Study Council

YES... I'm shopping around for the right kind of career training in electronics—and CIE sounds well worth looking into. Please send me my FREE CIE school catalog—including details about the Associate Degree program—plus my FREE package of home study information!

Print Name \_\_\_\_\_

Address \_\_\_\_\_ Apt. \_\_\_\_\_

City \_\_\_\_\_ State \_\_\_\_\_ Zip \_\_\_\_\_

Age \_\_\_\_\_ Area Code/Phone No. \_\_\_\_\_

Check box for G.I. Bill information:  Veteran  Active Duty

**MAIL TODAY!**

PE-09

FORREST M. MIMS III

# THE COMPUTER SCIENTIST

## EXPERIMENTING WITH COLECO'S ADAM

WHEN Coleco Industries announced its new Adam computer last summer, the press praised the system as a breakthrough in home computing. Indeed, a system complete with keyboard, mass storage unit, and letter quality printer for under \$600 certainly represented a major development.

But Coleco was late in delivering Adam. Worse, when retailers reported higher than expected customer returns and quality control problems with early shipments of the system, the press began to chastise both Coleco and the Adam.

The most devastating blow came when *Consumer Reports* magazine announced in its January 1984 issue that the word-processor portion of its Adam "... wasn't functioning properly within hours after we began using it." The day this item appeared in late December, Coleco's stock lost a fourth of its value! *The Wall Street Journal* added to Adam's image problem by reporting in its December 28, 1983 issue "... *Consumer Reports* magazine said it couldn't rate the Adam because none of the four early production models it bought worked."

While Coleco can certainly be faulted for its decision to hype Adam long before the machine was even in production, some of the press deserves criticism for incomplete and misleading reporting about Adam's alleged problems. For example, the *Consumer Reports* article failed to note that Adam is much more than a word processor. It's also an electronic typewriter. And it's an 80K computer that can be programmed in BASIC and play a wide range of high-resolution, arcade-quality video game cartridges and tapes. (A review of Adam appeared in the February, 1984, issue of this magazine.)

Nor did *Consumer Reports* reveal the nature of the problem with the word-processor mode of the Adams it purchased. If the problem was so serious, why did it take "hours" to discover it?

Fortunately, I bought an Adam before the press ganged up on the ma-

chine. (Would you have bought one after reading items like those in *Consumer Reports* and *The Wall Street Journal*?) The Adam I bought was one of those "customer returns" the press had cited as evidence of machines that failed to work. Actually, it worked just fine—the first owner had returned it because he

PCjr's rubber block keys could learn valuable lessons in effective keyboard design from Adam's keyboard.

The memory console includes one tape drive assembly and room for a second. These tape drives should not be confused with the cassette tape recorders required by some inexpensive com-

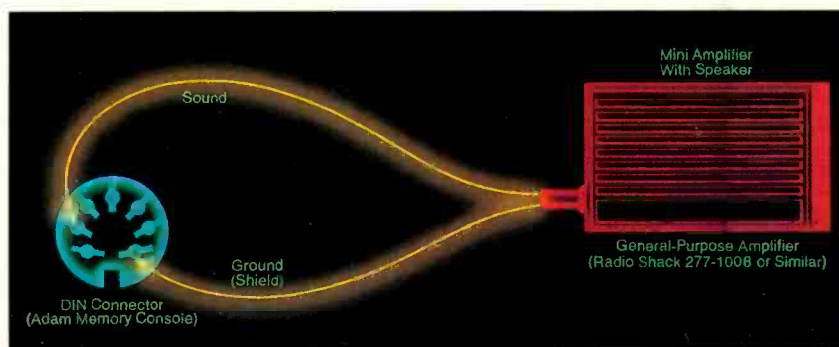

Fig. 1. How to connect an external amplifier to Adam.

needed extra money for a car payment.

Eric R. Mims, my 14-year old son, and I have spent quite some time working with the machine, and we have both become very impressed with Adam's capabilities. Certainly no other "family" computer system comes close to delivering the value for dollar spent that Adam does. In this column I'll report on our observations and describe a couple of Adam add-on projects you may wish to try. Let's begin with a brief review of the hardware.

### Adam's Hardware

Adam consists of three principle system modules: keyboard, printer and a central processor/memory drive unit called the memory console. Also included are a pair of joysticks with built-in 0-9 keypads. Only a television receiver or video monitor is required to place the system in operation.

The superbly designed keyboard has 75 full-travel, stepped and sculptured keys, and is equal in quality to the keyboards of more expensive computers. The people at IBM responsible for the

puters for the storage of programs and text. Their operation is fully automatic and up to sixteen times faster. Moreover, the special high-speed data cassettes used in the memory drive can store up to 250 pages of double-spaced text (about 256K bytes). BASIC programs can also be stored on tape.

On top of the memory console is a slot for inserting Coleco game cartridges; and, on the right side, is a slot for a Coleco Vision expansion module. Inside a user-accessible space behind the tape drive are three card sockets for expansion peripherals. The first of these peripherals, announced at the winter Consumer Electronics Show is a 64K RAM expander that will give Adam 144K of memory.

Inside the sealed portion of the memory console are RAMs and processing circuits, all surrounded by a grounded shield to reduce electromagnetic interference. The machine I purchased was an early production model as revealed by several jumpers plus some bypass capacitors soldered across the power supply pins of several chips.

Adam's letter-quality printer has

# THE TANDY TRS-80® MODEL 2000

The ultra-high performance MS-DOS personal computer that operates at twice the speed of the IBM PC.

## Radio Shack Heralds the Dawn of a New Era in Microcomputer Technology

Our Tandy 2000 delivers much more than other 16-bit MS-DOS based computers. More speed. More disk storage. More expansion. Higher resolution graphics. And a modular design that advances the science of ergonomics.

## Use the Hottest Names In Software

Like dBase II data base management. Microsoft-Multiplan spreadsheet analysis. PFS:File electronic filing. MultiMate word processing. And many more already acclaimed by the entire microcomputer industry.

## Increased Speed, Storage and Expansion

A "next-generation" 16-bit microprocessor makes the Tandy 2000 much faster than other MS-DOS computers, so you get the job done quicker. With 1.4 megabytes of storage, you can set up massive data bases. If you need even more storage, choose our Tandy 2000 HD with a built-in hard disk drive. You can add more memory, high-resolution color and monochrome graphics, our new Digi™-Mouse and more. And you can do most installations yourself.

## Complete Service and Support

The Tandy 2000 is backed with the quality and support that have kept Tandy Corporation in the forefront of the microcomputer industry from the beginning. Come in for a demonstration today.



Tandy 2000 With  
Two Disk Drives

**2750<sup>00</sup>**  
26-5103

Commercial Lease Available  
For Only \$95 Per Month  
(Plus Applicable Use/Sales Tax)

Tandy 2000 HD With  
Built-In 10-Megabyte Hard Disk

**4250<sup>00</sup>**  
26-5104

Commercial Lease Available  
For Only \$150 Per Month  
(Plus Applicable Use/Sales Tax)

Non-interlaced monitor, graphics and Digi-Mouse not included

## Compare the Tandy 2000 to the IBM PC

Price Comparison <sup>1</sup>	Tandy 2000	IBM Personal Computer
Base Unit	\$2750	\$2104
2nd Drive	Included (720K)	\$529 (320K)
Monochrome Monitor	\$249	\$345
Display/Printer Adapter	Included	\$335
128K RAM	Included	\$165
RS-232	Included	\$120
MS-DOS 2.0	Included	\$60
Total Cost*	\$2999	\$3658
Feature Description	Tandy 2000	IBM Personal Computer
Internal Memory	128K Standard	64K Standard
Disk Capacity Per Drive	720K	160K or 320K (optional)
Microprocessor Clock Speed	8 MHz	4.7 MHz
True 16-Bit Microprocessor	Yes (80186)	No (8088)
User-Available Expansion Slots*	4	2
Graphics Options		
Color Resolution	640 x 400	320 x 200
Number of Colors	8	4
Monochrome Resolution	640 x 400	640 x 200

<sup>1</sup>Comparable IBM configuration with monochrome adapter and display, communications adapter, two 320K disk drives and 128K RAM. Manufacturer's pricing as of 9/1/83.

Available at over 1100  
Radio Shack Computer Centers and at  
participating Radio Shack stores and dealers

**Radio Shack®**  
**COMPUTER CENTERS**

A DIVISION OF TANDY CORPORATION

Send me a free Tandy 2000 brochure.

Mail To: Radio Shack, Dept. 84-A-683  
300 One Tandy Center, Fort Worth, Texas 76102

NAME \_\_\_\_\_  
COMPANY \_\_\_\_\_  
ADDRESS \_\_\_\_\_  
CITY \_\_\_\_\_ STATE \_\_\_\_\_ ZIP \_\_\_\_\_  
TELEPHONE \_\_\_\_\_

Prices apply at Radio Shack Computer Centers and participating stores and dealers. IBM is a registered trademark of International Business Machines Corp. PFS is a registered trademark of Software Publishing. MS and Multiplan are trademarks of Microsoft Corp. MultiMate is a trademark of Softword Systems Inc. dBase II is a trademark of Ashton-Tate

# Introducing Macintosh. What makes it tick. And talk.

Well, to begin with, 110 volts of alternating current.

Secondly, some of the hottest hardware to come down the pike in the last 3 years.

*The garden variety 16-bit 8088 microprocessor.*



*Macintosh's 32-bit MC68000 microprocessor.*

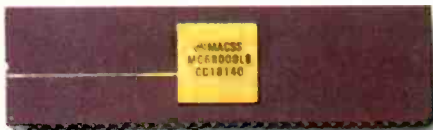

Some hard facts may be in order at this point:

Macintosh's brain is the same blindingly-fast 32-bit microprocessor we gave our other brainchild, the Lisa™ Personal Computer. Far more powerful than the 16-bit 8088 found in current generation computers.

Its heart is the same Lisa Technology of windows, pull-down menus, mouse commands and icons. All of which make that 32-bit power far more useful by making the Macintosh™ Personal Computer far easier to use than current generation computers. In fact, if you can point without hurting yourself, you can use it.

## Now for some small talk.

Thanks to its size, if you can't bring the problem to a Macintosh, you can always

bring a Macintosh to the problem. (It weighs 9 pounds less than the most popular "portable.")

Another miracle of miniaturization is Macintosh's built-in 3½" drive. Its disks store 400K — more than conventional 5¼" floppies. So while they're big enough to hold a desk full of work, they're small enough to fit in a shirt pocket. And, they're totally encased in a rigid plastic so they're totally protected.

## And talk about programming.

There are already plenty of programs to keep a Macintosh busy. Like MacPaint™,



a program that, for the first time, lets a personal computer produce virtually any image the human hand can create. There's more software on the way from developers like Microsoft®, Lotus™ and Software Publishing Corp., to mention a few.

And with Macintosh BASIC, Macintosh Pascal and our Macintosh Toolbox for writing your own mouse-driven programs, you, too, could make big bucks in your spare time.

You can even program Macintosh to talk in other languages, like Yiddish or Serbo-Croatian, because it has a built-in polyphonic sound generator capable of producing high quality speech or music.

*The Mouse itself  
Replaces typed-in  
computer commands with a  
form of communication you  
already understand —  
pointing.*

*Some mice have two  
buttons. Macintosh has  
one. So it's extremely  
difficult to push the  
wrong button.*

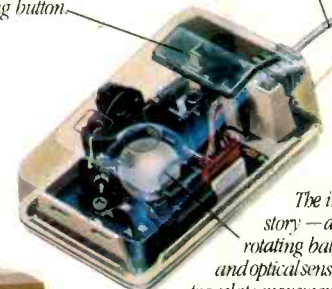

*The inside  
story — a  
rotating ball  
and optical sensors  
translate movements  
of the mouse to Macintosh's screen pointer  
with pin-point accuracy.*

## All the right connections.

On the back of the machine, you'll find built-in RS232 and RS422 AppleBus serial communication ports. Which means you can connect printers, modems and other peripherals without adding \$150 cards. It also means that Macintosh is ready to hook in to a local area network. (With AppleBus, you will be able to interconnect up to 16 different Apple computers and peripherals.)

Should you wish to double Macintosh's storage with an external disk



*Macintosh automatically makes room for your illustrations in the text.*



*MacPaint produces virtually any image the human hand can create.*



*Microsoft's Multiplan for Macintosh.*

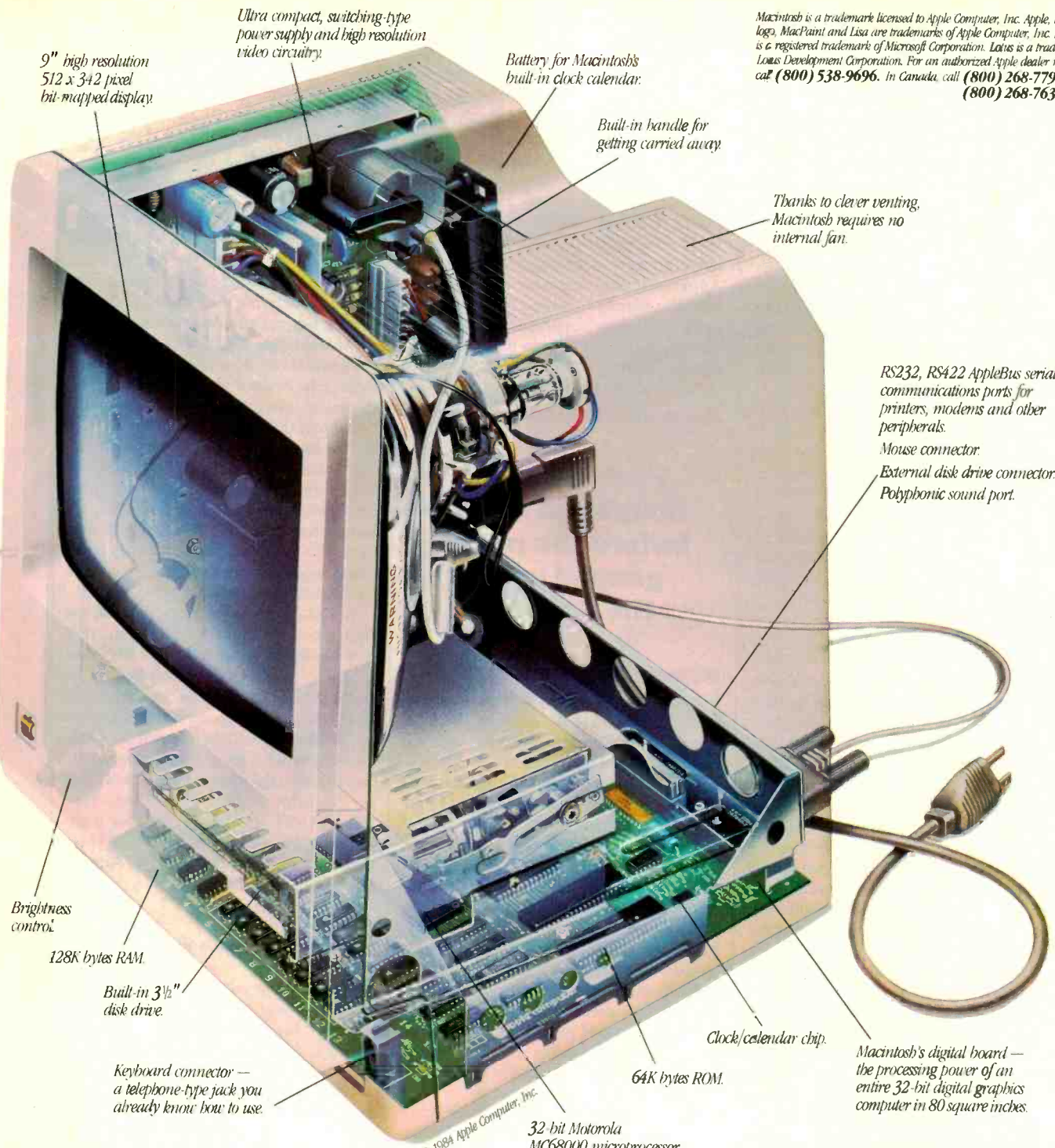

9" high resolution  
512 x 342 pixel  
bit-mapped display

Ultra compact, switching-type  
power supply and high resolution  
video circuitry.

Battery for Macintosh's  
built-in clock/calendar.

Built-in handle for  
getting carried away

Thanks to clever venting,  
Macintosh requires no  
internal fan.

RS232, RS422 AppleBus serial  
communications ports for  
printers, modems and other  
peripherals.

Mouse connector.  
External disk drive connector.  
Polyphonic sound port.

Brightness  
control

128K bytes RAM.

Built-in 3 1/2"  
disk drive.

Keyboard connector —  
a telephone-type jack you  
already know how to use.

64K bytes ROM.

Clock/calendar chip.

Macintosh's digital board —  
the processing power of an  
entire 32-bit digital graphics  
computer in 80 square inches.

© 1984 Apple Computer, Inc.

32-bit Motorola  
MC68000 microprocessor.

drive, you can do so without paying for a disk controller card—that connector's built-in, too.

There's also a built-in connector for Macintosh's mouse, a feature that costs up to \$300 on computers that can't even run mouse-controlled software.

### One last pointer.

Now that you've seen some of the logic, the technology, the engineering genius and the software wizardry that separates

Macintosh from conventional computers, we'd like to point you in the direction of your nearest authorized Apple dealer.

Over 1500 of them are eagerly waiting to put a mouse in your hand. As one point-and-click makes perfectly clear, the real genius of Macintosh isn't

its 32-bit Lisa Technology, or its 3 1/2" floppy disks, or its serial ports, or its software, or its polyphonic sound generator.

The real genius is that you don't have to be a genius to use a Macintosh.

You just have to be smart enough to buy one.

Soon there'll be just two kinds of people.  
Those who use computers. And  
those who use Apples.



## Computer Scientist

generated the most concern among its competitors. The operation of the wheel that turns the platen (roller) of the printer on my Adam is stiff, which slows down the insertion of paper. Nor does the paper release lever allow the paper to slide freely enough across the platen. In operation, the printer is slower (about 120 words per minute) and *much* louder than the more expensive letter-quality printer in my office. The paper advance solenoid is particularly noisy, generating a louder sound than the striking of individual characters.

Its drawbacks notwithstanding, Adam's printer works exceedingly well. It features an interchangeable plastic daisy-wheel printing element and it uses a standard ribbon cartridge. The bidirectional printing mechanism prints 80 columns. The bottom line is the quality of the copy, which is every bit as neat as that generated by some printers costing more than a complete Adam system.

### Adam's Software

Adam plays standard ColecoVision cartridge games plus arcade-quality games stored on high-speed digital data tapes. The arcade-quality games include intermissions and a "hall of fame" that records high scores. After numerous test sessions, Eric is convinced that video game enthusiasts will find little to criticize about Adam's game playing abilities. In his opinion, the sound and high-resolution graphics are excellent.

Adam's word-processing software was apparently responsible for the unfavorable item in *Consumer Reports*. Eric and I have spent considerable time testing the word-processing mode and have managed to identify one software bug.

On some occasions, when the left and right horizontal margin settings are placed, respectively, at their minimum

and maximum settings, Adam's keyboard becomes inoperable. The only way to restore the keyboard to normal operation is to reset the computer. Unfortunately, this erases all the text stored in RAM! We have managed to avoid this problem by always setting the left margin to a value greater than 1. Apparently only early versions of Adam have this word-processing bug. We have just tested a later version of the machine that operates perfectly in its word-processing mode.

Incidentally, Adam's word-process-

## Fortunately, I bought an Adam before the press ganged up on the machine

ing manual is excellent. But chances are you'll rarely need it because the on-screen graphics and prompts are so clear. We have used Adam's word-processor to type, edit, and print considerable practice copy, though neither of us has read the manual.

Adam's BASIC is very similar to Applesoft BASIC. Unfortunately, we have not been able to complete our evaluation of Adam's BASIC since the manual supplied with our machine is very poor. We have, however, found *many* BASIC features and capabilities not even mentioned in the manual. For example, the manual doesn't discuss in detail the editing of programs. Fortunately, Adam's programs can be easily edited simply by moving the cursor and typing in new information.

Nor does the manual mention that Adam has commands for producing sound and special graphics. We discovered some of these special features when a program I wrote went berserk and began displaying on the screen numerous special symbols and functions not listed in the manual. The keyboard then locked-up and we were forced to reset the computer to restore it to normal operation (in the process, losing our program).

Eric wrote the following program that prints the functions of Adam's ASCII codes on the monitor screen.

```
10 REM ADAM CHR$ SEARCH
20 TEXT
```

```
30 FOR A = 0 TO 255
40 PRINT CHR$(A);
50 NEXT A
```

This program revealed that Adam can display five musical notes, various mathematical symbols and a half dozen or so graphics sprites. The machine can also display complete upper- and lower-case alphabets and punctuation symbols in both normal and reverse video.

Incidentally, CHR\$(16) causes Adam's printer to do a rapid series of line feeds. Eric revised his program to avoid this noisy interlude by inserting a conditional test that skips CHR\$(16).

The musical note symbols and Adam's excellent game-playing sound effects imply that the machine has programmable sound effects. Thus far, we have found that a CHR\$(7) produces a beep. We're attempting to identify command sequences that will produce more sophisticated sounds.

A Coleco engineer has informed me that a better Adam BASIC manual is now available. Adam owners can obtain the new manual by calling collect at (800) 842-1225. In the meantime, if you're trying to depend upon the original manual, you'll be pleased to know you can break a program in progress by simultaneously pressing CONTROL and C. To print a program listing, type PR #1:LIST. Hopefully, the new manual will describe in more detail these and many other features of Adam's BASIC.

### Using Adam with a Video Monitor

Like most inexpensive "home" computers, Adam can use a conventional color or black & white television as a display. Adam also has a monitor output that produces excellent results. Games, of course, are more fun when a color monitor is used.

We've found that both monochrome and color monitors work well when Adam is in its word-processing mode. Though a color monitor provides better presentation of the on-screen word-processing prompts and graphics, the monochrome monitor provides better text resolution.

### Adding a Sound Card

The monochrome monitor we used with Adam doesn't have a built in amplifier and speaker. To remedy this problem, I've connected a small commercial amplifier, via a shielded cable, to the sound pin of the DIN connector

Fig. 2. Sound amplifier circuit.

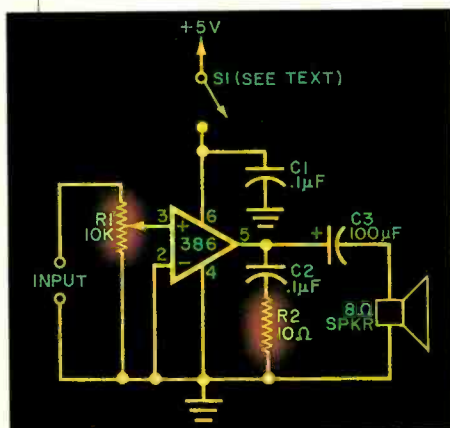





# LAST NIGHT, 39 MUSICIANS HAD A COMPUERVE CONFERENCE, SO DID 31 M.D.S, 49 SPORTS FANS AND 640 APPLE POLISHERS, AND NO ONE HAD TO LEAVE HOME.

## **The Electronic Forum, Cheaper than Long Distance and Much More Rewarding.**

Every night on the CompuServe Information Service, professional and social groups discuss a wide range of subjects. From what's new in medical technology to what's nouvelle in continental cuisine.

And every day more computer owners who share a common interest are discovering this exciting new way to exchange ideas and even transfer hard copy data.

And besides electronic forums, they leave messages for each other on our national bulletin board, "talk" informally on our CB simulator, and communicate via CompuServe's electronic mail.

But best of all, in most cases, CompuServe subscribers get all of these state of the art communications options, plus a world of on-line information and entertainment for the cost of a local phone call plus connect time.

To become part of this flexible communications network, all you

need is a computer, a modem and CompuServe. CompuServe connects with almost any personal computer, terminal, or communicating word processor.

To receive an illustrated guide to CompuServe and learn how you can subscribe, contact or call:

## **CompuServe**

Consumer Information Service, P.O. Box 20212  
5000 Arlington Centre Blvd., Columbus, OH 43220

**800-848-8199**

In Ohio call 614-457-0802

Circle No. 60 on Free Information Card

An H&R Block Company

# In Computer Electronics...

# NTS **INTRONIC**<sup>TM</sup> HOME TRAINING GIVES YOU THE EDGE

**The competition for High-Technology careers is strong, and the rewards are great. Give yourself the edge you need by training with NTS.**

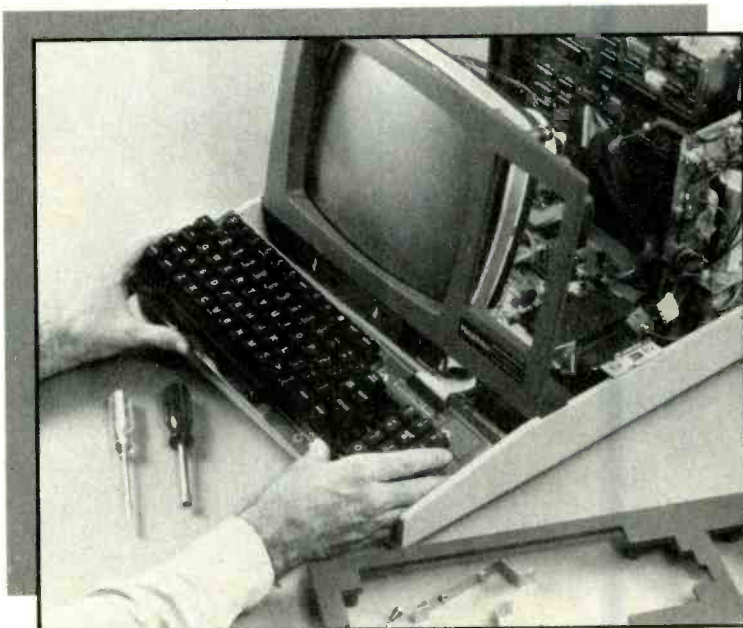

NTS **INTRONIC** home training provides you with a special kind of "Hands-On" experience that prepares you better, develops your skills faster. You advance as quickly as you wish, working with actual circuits, diagrams, schematics, and state-of-the-art hardware. There are a dozen different NTS programs in electronics to help you develop and reach your potential. They range from basics to advanced areas in several fields. And the ALL-NEW NTS course catalog spells it all out. It's free, and does not obligate you in any way. Send for it today.

## **A GROWTH INDUSTRY**

High-Technology is a growth industry. The evidence is clear, and most observers predict a steady expansion due to a relatively strong flow of investment capital into computers, electronics and precision instruments. Sales of computers alone will reach an estimated ten million units this year. This means challenges and new

employment opportunities, especially in servicing and maintenance. Computer servicing skills can best be learned by working directly on field-type equipment. NTS electronic hardware is selected and developed especially for the training program with which it is associated. You learn by doing, by assembling, by performing tests and experiments, covering principles of computer electronics, microprocessor troubleshooting, and circuitry.

## **MICROCOMPUTERS**

NTS offers three programs in computer electronics. You will receive training covering solid-state devices, digital logic circuitry, and the fundamentals of the computer itself. Instruction includes micro-control technology and detailed operation of microcomputers. These courses will prepare you for entry-level in many facets of the computer industry such as field service and customer engineering as well as programming. In addition to written texts your course includes the NTS/HEATH disc-drive computer which you assemble as part of the training process. The assembly and use of the computer will serve to reinforce practical application of principles.

## MICROPROCESSOR TECHNOLOGY

The field of industrial and microprocessor technology encompasses the application of electronic microprocessor control principles. Your course takes you from fundamentals of digital electronics and associated circuitry through the application of the microprocessor as a control device. You will learn how to move and manipulate instructions and information. The microprocessor trainer included in your course is a microcomputer system designed as a practical tool for learning the use of software and hardware techniques utilized in the linking of microprocessors to various systems.

## DIGITAL ELECTRONICS

The NTS Compu-Trainer is a fascinating solid-state device which you will build in order to perform over ninety logic circuit experiments. These experiments serve to emphasize an area of electronics which is essential to the understanding of state-of-the-art control equipment; they are also extremely important to those wanting to pursue a career in computer servicing. Separate courses involving the Compu-Trainer are also available in Microcomputer Servicing and Digital/Analog Electronics.

## ROBOTICS & VIDEO TECHNOLOGY

Other NTS courses cover a wide range of specialization. In Robotics, the NTS/Heath Hero I is included to train you in robotic applications in

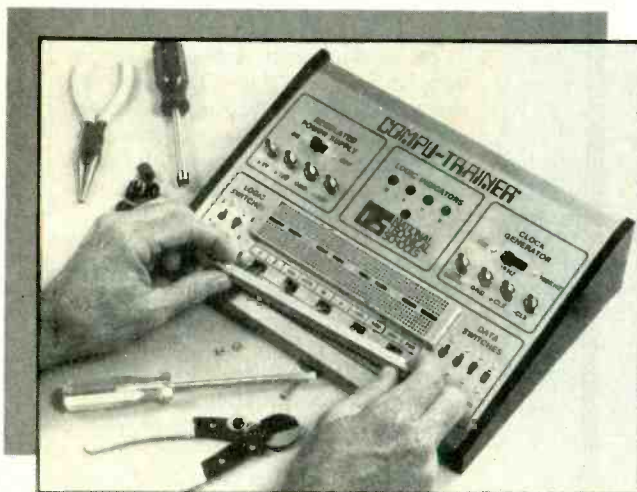

NO OBLIGATION NO SALESMAN WILL CALL

**NTS NATIONAL TECHNICAL SCHOOLS**

TECHNICAL TRADE TRAINING SINCE 1905  
Resident and Home-Study Schools  
4000 So. Figueroa St., Los Angeles, CA 90037

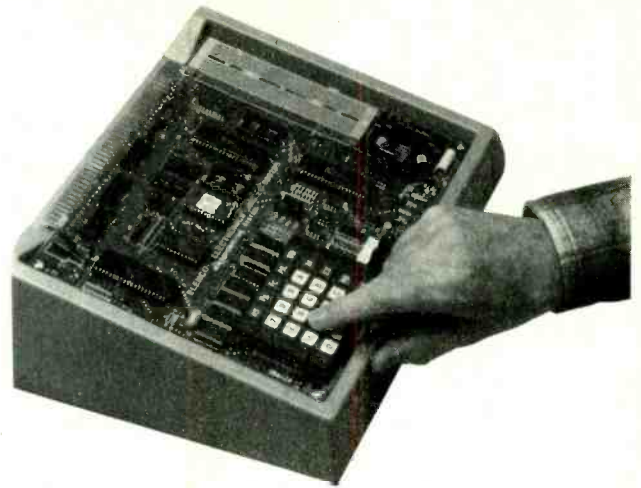

manufacturing processes. In Video technology, a new course features the advanced NTS/Heath Z Chassis "Smart Set" color TV with computer space command remote control and space phone. This is an excellent program for those interested in a career in video servicing with microcomputer basics.

## EARN CEU CREDITS

America's industrial giants are turning more and more frequently to home study as an effective way to upgrade employee skills. You benefit from the experience NTS has gained in its 79 years as a leader in technical training. The skills and experience gained in the building of kits and test equipment provide you with training that cannot be duplicated. And, depending on the program you select, you can earn up to 30 CEU credits for successful completion. Complete details included in the catalog.



Use the mail-in card or fill out and mail the coupon. Indicate the field of your choice. (One, only please.) FREE full color catalog will be sent to you by return mail.

**NATIONAL TECHNICAL SCHOOLS** Dept. 205-044

4000 South Figueroa Street, Los Angeles, CA 90037

Please send FREE color catalog on course checked below:

- |   |   |
|---|---|
| <input type="checkbox"/> Robotics                       | <input type="checkbox"/> Computer Electronics |
| <input type="checkbox"/> Digital Electronics            | <input type="checkbox"/> Video Technology     |
| <input type="checkbox"/> Auto Mechanics                 | <input type="checkbox"/> Home Appliances      |
| <input type="checkbox"/> Air Conditioning/Solar Heating |   |

Name \_\_\_\_\_ Age \_\_\_\_\_

Address \_\_\_\_\_ Apt. \_\_\_\_\_

City \_\_\_\_\_ State \_\_\_\_\_

Zip \_\_\_\_\_ Phone ( ) \_\_\_\_\_

- Check if interested **ONLY** in classroom training in Los Angeles  
 Check if interested in G.I. Bill Information.

## Computer Scientist

on Adam's back panel (Fig. 1).

I've also assembled an amplifier on a small card that plugs into one of Adam's expansion sockets and provides a built-in sound capability. Figure 2 shows the circuit for this amplifier. It works best when Adam is in its game-playing mode. In its computer and word-processing modes, Adam generates a somewhat higher background noise level that, when amplified, produces an annoying hum. For this reason, you might want to add power switch *S1* to disable the sound card when the game mode is not selected.

Figure 3 shows the location of the +5 volt, ground and sound-output pins of the center card socket inside Adam's memory console. You can use a 22-finger (0.1-inch centers), double-sided card for the amplifier. Or you can make your own card by modifying a pre-etched, copper-clad breadboard such as Radio Shack's "Op-Amp IC Experimental Breadboard" (Cat. No. 276-153). Figure 4 shows how to cut a homemade 22-finger card from one of these boards.

Since the Radio Shack board is single-sided, you'll have to provide a ground contact on its unmetallized side. The best solution is to cut a thin strip of copper foil (about 1/16" x 2") and use cyanoacrylate adhesive to cement the foil along the back edge of the card. Be

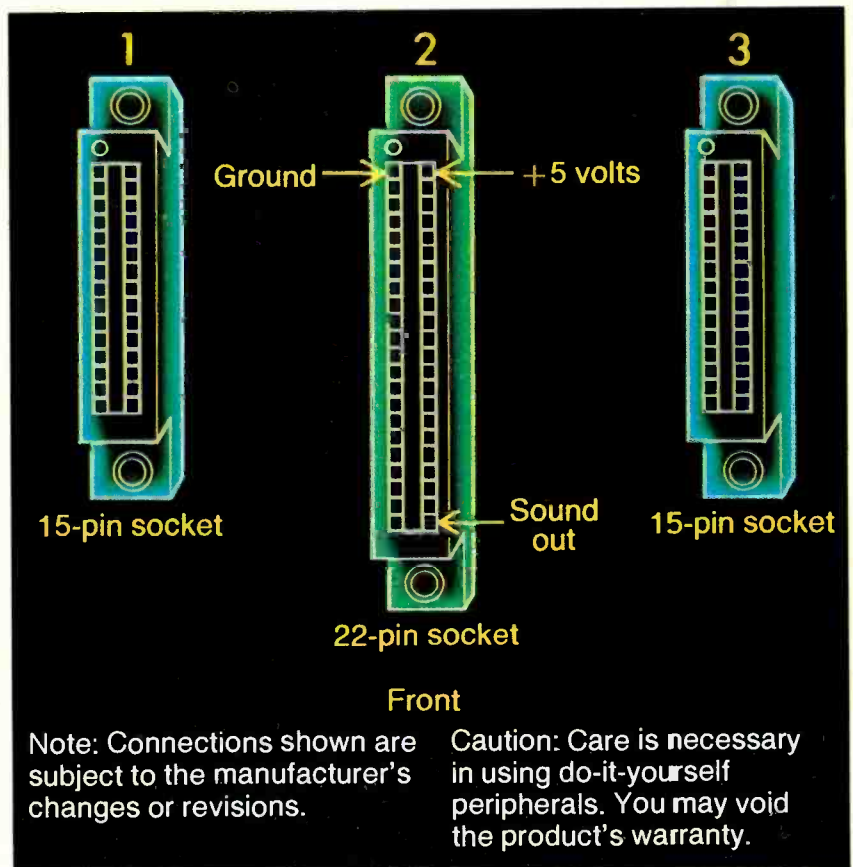

**Fig. 3.** Expansion sockets inside Adam's memory console.

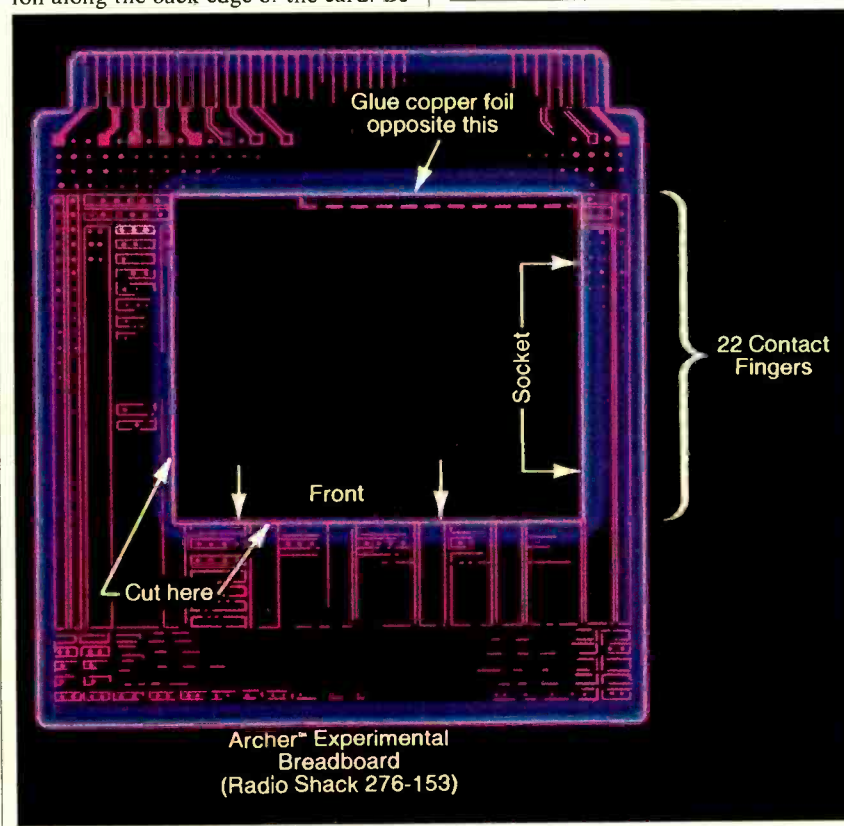

sure the foil strip is directly opposite the contact finger that will carry +5 V.

As for the circuit, install the components on the front side of the board and connect the various leads to one another with short lengths of wrapping wire soldered in place. Screwdriver adjustable trimmer potentiometer *R1* controls the amplifier's volume.

The speaker should be connected to the card by 6" or so of insulated hookup wire. When the card is inserted into its socket, place the speaker on the shelf behind the tape drive.

Incidentally, you *must* exercise particular care when building and using unauthorized computer peripheral cards.

### Using Adam as an Intruder Alarm

Adam's joysticks offer several interesting applications beyond serving as mere cursor, graphics and game-playing controllers. One I've explored is intruder detection.

Joysticks that incorporate a pair of mechanically linked potentiometers form part of an analog-to-digital con-

**Fig. 4.** How to make a 22-pin connector card.

# Tek's best-selling 60 MHz scopes: Now 25 ways better for not a penny more!

Now Tek has improved its 2213/2215 scopes with brighter displays. Greater accuracy. And more sensitive triggering. At no increase in price.

The 60 MHz 2213 and dual time base 2215 have been the most popular scopes in Tektronix history. Now, Tek introduces an "A" Series update with more than 25 specification and feature enhancements — things you have asked for such as single sweep — all included at no added cost.

**A brighter display and new vertical amplifier design provides sharp, crisp traces.**

That makes the 2213A/2215A a prime candidate for tasks like TV troubleshooting and testing, where fast sweeps are typical.

**New features include 10 MHz bandwidth limit switch, separate A/B dual intensity controls (2215A only), and power-on light:** additions customers have suggested for



giving these scopes the final measure of convenience.

**Triggering, sweep accuracy, CMRR and many more major specifications are better than ever.** Check the performance chart: not bad for scopes already considered the leaders in their class!

**The price: still \$1200\* for the 2213A, \$1450\* for the 2215A.** Or, step up to the 100 MHz 2235 for just \$1650\*! You can order, obtain literature, or get expert technical advice, through Tek's National Marketing Center. Direct orders include operator manuals, two 10X probes,

15-day return policy, world-wide service back-up and comprehensive 3-year warranty.

**Talk to our technical experts.  
Call toll-free:  
1-800-426-2200  
Ext. 154.**

In Oregon call collect:  
(503) 627-9000 Ext. 154.

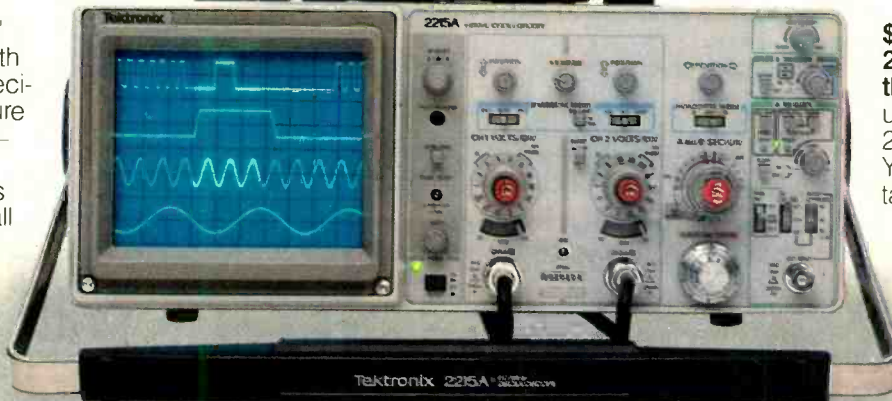

Specification enhancement	2213/2215 "A" Series	2213/2215
CRT brightness	14 kv accel. potential	10 kv accel. potential
Vertical accuracy	3%, 0° to 50°C	3%, +20° to 30°C
Chop rate	500 kHz	250 kHz
Input capacitance	20 pF	30 pF
CMRR	10 to 1 at 25 MHz	10 to 1 at 10 MHz
Channel isolation	100:1 at 25 MHz	Not specified
A Trigger sensitivity (int)	0.3 div at 5 MHz	0.4 div at 2 MHz
TV triggering	1.0 div compos. sync	2.0 div compos. sync
Sweep accuracy (in 10X)	4%, 15° to 35°C	5%, 20° to 30°C
Delay jitter	20,000 to 1 (2215A) 10,000 to 1 (2213A)	10,000 to 1 (2215) 5,000 to 1 (2213)
Holdoff Range	10:1	4:1

\*Price F.O.B. Beaverton, OR.  
All scopes are UL Listed and CSA approved. 3-year warranty includes CRT and applies to 2000 family oscilloscopes purchased after 1/1/83.

## Computer Scientist

version system that causes a computer's cursor to follow the position of the joystick handle. They are called *absolute joysticks*.

Joysticks that incorporate an array of on-off switches are called *rate joysticks*. This type of control causes a computer's cursor to move in the direction the joystick handle is moved. When the handle is returned to center neutral, the cursor stops moving. The system responds to a subsequent joystick handle movement, by moving from its last position in the new direction indicated by the new handle position.

Adam uses rate joysticks, which are better suited for game playing than absolute joysticks. They are also relatively sophisticated, and include a 28-diode matrix that functions as a ROM to encode the signals from the joystick, fire buttons, and keypad.

Figure 5 shows the internal color-coding of the seven leads in Adam's joystick cables. Figure 5 also shows the layout of the four joystick switches. It is these switches that can be used to enable Adam to detect intruders.

Each of the four vector switches in a single joystick can support one or more remotely placed, (in this case) magnet-actuated sensor switches. The remote switches should be designed for *normally open* operation. In other words, each magnet switch should be *open* when the protected door or window is closed.

Wires leading to the remote switches can be soldered directly to the circuit board behind each of the four joystick vector switches (Fig. 5). This permits the joystick to be used to activate the system—and to reset it after a sensor switch is closed.

The program in Fig. 6 shows one way to program Adam as a computerized intruder alarm. When this program is run, Adam's monitor displays for several seconds:

```
INITIALIZE JOYSTICKS TO
100.
THEN PRESS CONTROL-C
AND RUN 99.
```

The monitor then displays two columns of numbers representing the current joystick values. Move the joystick in the appropriate directions to set the numbers in both columns to 100. Then break the program by pressing CONTROL C. You can now activate the alarm by entering RUN 99.

The program will sequentially scan each of the four joystick switches (thus any remote switches connected across them). If all the switches are open, the

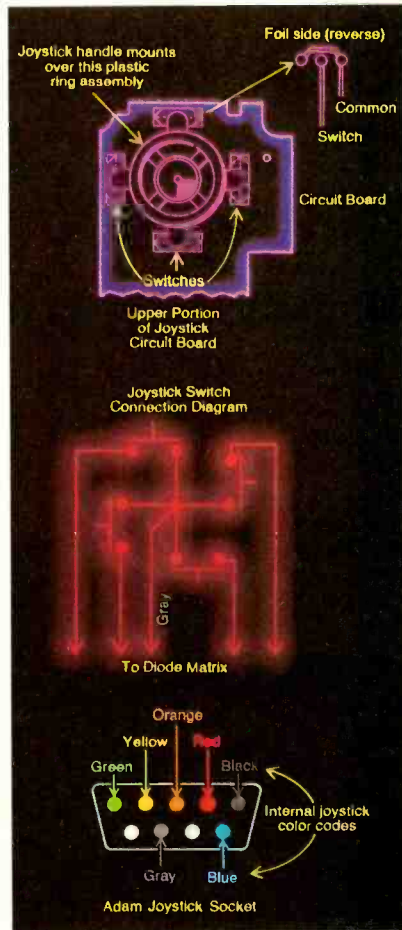

**Fig. 5. Diagrams showing operation of Adam's joystick.**

values of both a and b (line 110, 120) will be 100, and the screen will display ALL SENSORS SECURE following each scan.

If a closed switch is detected, Adam will immediately print on the monitor the location of the tripped switch and emit a continuous series of beeps. The print and beep loop can be stopped only by pressing CONTROL C. The program can then be reinitiated.

This simple intruder detection program can be easily expanded to include more features. For instance, the second joystick can be added to provide an additional four switches. Presumably, all 18 of the switches in a single joystick can be used when a method of accessing them can be determined. One way would be to couple their binary counterparts directly into the joystick sockets. However, this would require external hardware. A better way would be software access via Adam's keyboard.

Incidentally, I learned a valuable lesson about Adam while developing this intruder alarm program. During a test

run, I tried to activate the program by entering RUN 99 while the keyboard CAPS LOCK key was depressed. Nothing happened. Instead, Adam printed on the monitor I/O ERROR and erased the entire program, which I had yet to print out or store on tape! It was necessary to reconstruct the entire program from memory—my memory.

What happened? Eric observed that Adam will run a labeled program whose name is entered *without* the quote marks we're used to using with our other computers (they all use Microsoft BASIC.) Typing RUN 99 in all caps appeared on the screen as RUN (). Therefore, Adam interpreted () as a program label. It then erased the resident program to make room for the nonexistent program labeled (). It printed I/OERROR when its search for () was unsuccessful.

```
10 REM INTRUDER ALARM PROGRAM
15 REM COPYRIGHT 1984, FORREST M.
MIMS, III
20 REM FRONT JOYSTICK SOCKET
SELECTED
30 REM PDL(1) IS UP-DOWN
40 REM PDL(3) IS LEFT-RIGHT
45 TEXT
50 ? "INITIALIZE JOYSTICKS TO
100."
60 ? "THEN PRESS CONTROL-C AND
RUN 99."
70 FOR x=1 TO 5000: NEXT x
80 a=PDL(1): b=PDL(3)
90 ? a, b: GOTO 80
99 a=PDL(1): b=PDL(3)
110 IF a=100 THEN GOSUB 300
120 IF b=100 THEN GOSUB 300
130 IF a<100 THEN ? "INTRUDER AT
FRONT DOOR!": CHR$(7):
GOTO 130
140 IF a>100 THEN ? "INTRUDER AT
BACK DOOR!": CHR$(7): GOTO
140
150 IF b<100 THEN ? "INTRUDER AT
FRONT WINDOW!": CHR$(7):
GOTO 150
160 IF b>100 THEN ? "INTRUDER AT
FRONT WINDOW!": CHR$(7):
GOTO 160
200 GOTO 99
300 ? "ALL SENSORS SECURE.":
RETURN
```

**Fig. 6. Intruder alarm program.**

So, *never* run an Adam program from a specified line number unless the CAPS LOCK key is in the lower-case mode!

### Summing Up

Eric and I have used many different personal computer systems. We've always felt that Radio Shack's Color Computer was vastly underrated by some computer magazines. Now, we feel the same about Adam.

Adam does occasionally do the unexpected, but we've managed to identify, and thereby avoid, most of its quirks. In short, we feel Adam offers excellent value for its ultra-low price. ◇

# Do your skills suffer from half-life crisis?



Five years is the average half-life of technical information. Skill upgrading is critical because, every five years, half of your electronics skills can become outdated. But Heathkit/Zenith Educational Training Systems will put you back in the lead. We've helped thousands keep pace with high-tech self-instruction courses. From fundamentals to state-of-the-art. Learn more about us. We can pull you through the half-life crisis.

## FUNDAMENTAL ELECTRONICS

A complete six-course core curriculum covering DC and AC Electronics, Semiconductors, Electronic Circuits, Electronic Communications and Test Instruments.

## DIGITAL AND MICROPROCESSORS

Six comprehensive courses spanning the spectrum of Microprocessor Technology. From Digital Techniques through Microprocessors to the latest in Voice Synthesis.

## ADVANCED MICROPROCESSING

A valuable course in advanced 16-bit Microprocessor Technology. Course uses a new state-of-the-art trainer that becomes a fully capable 16-bit computer.

## ROBOTICS TECHNOLOGY

A complete, comprehensive education in robotics theory and applications. Train on "HERO 1," a mobile programmable robot with arm, gripper, voice and sensors.

## INDUSTRIAL ARTS

Seven exceptional courses for overview, or beginning training: Soldering, Printed Circuits, Concepts of Electricity or Microprocessors plus Automotive Electronics and Ignition Systems.

## COMPUTER PROGRAMMING/OPERATING SYSTEMS

Eight courses on operating systems and languages: MS-DOS, CP/M, Assembly, BASIC, MBASIC, Pascal, FORTRAN and COBOL.

## ADVANCED ELECTRONICS

Eight advanced courses: Op-Amps, Active Filters, IC Timers, Phase-locked Loops, Opto-Electronics, Fiber Optics, Passive and Transistor Circuit Design. Come up to speed by building actual working circuits.

## NEW VIDEO HIGH TECH COURSES

Send for our brochure of new High Tech Video Training Courses. Fully animated courses demonstrate complex concepts in a step-by-step approach. Can be used with compatible course texts and trainers for hands-on learning. A bold, new approach to technical training!

## TOTAL SUPPORT MATERIAL

Heathkit/Zenith builds its own course-compatible trainers for hands-on learning reinforcement. And we're the only leading education group that manufactures a full line of computers and peripherals.

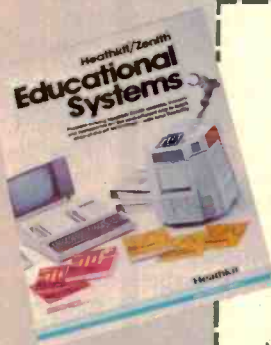

Don't let your technical skills fall behind. Send for our free Education Catalog. Check the boxes that match your needs.

- |  |   |
|--|---|
| <input type="checkbox"/> FUNDAMENTAL ELECTRONICS     | <input type="checkbox"/> ADVANCED ELECTRONICS |
| <input type="checkbox"/> DIGITAL AND MICROPROCESSOR  | <input type="checkbox"/> COMPUTER PROGRAMMING |
| <input type="checkbox"/> ADVANCED MICROPROCESSING    | <input type="checkbox"/> INDUSTRIAL ARTS      |
| <input type="checkbox"/> ROBOTICS TECHNOLOGY         | <input type="checkbox"/> NEW VIDEO COURSES    |
| <input type="checkbox"/> COMPUTERS OR TEST EQUIPMENT | <input type="checkbox"/> ALL COURSES          |

Mail to: Heathkit/Zenith Educational Systems  
Heath Company, Dept. 010-166  
Benton Harbor, MI 49022

Name \_\_\_\_\_

Address \_\_\_\_\_

City \_\_\_\_\_

State \_\_\_\_\_ Zip \_\_\_\_\_

Heathkit/Zenith Educational Systems is a division of  
Heath Company, Benton Harbor, MI 49022

ED-209

**Heathkit®**  
Heathkit/Zenith  
Educational Systems

Circle No. 24 on Free Information Card

# HARDWARE REVIEWS

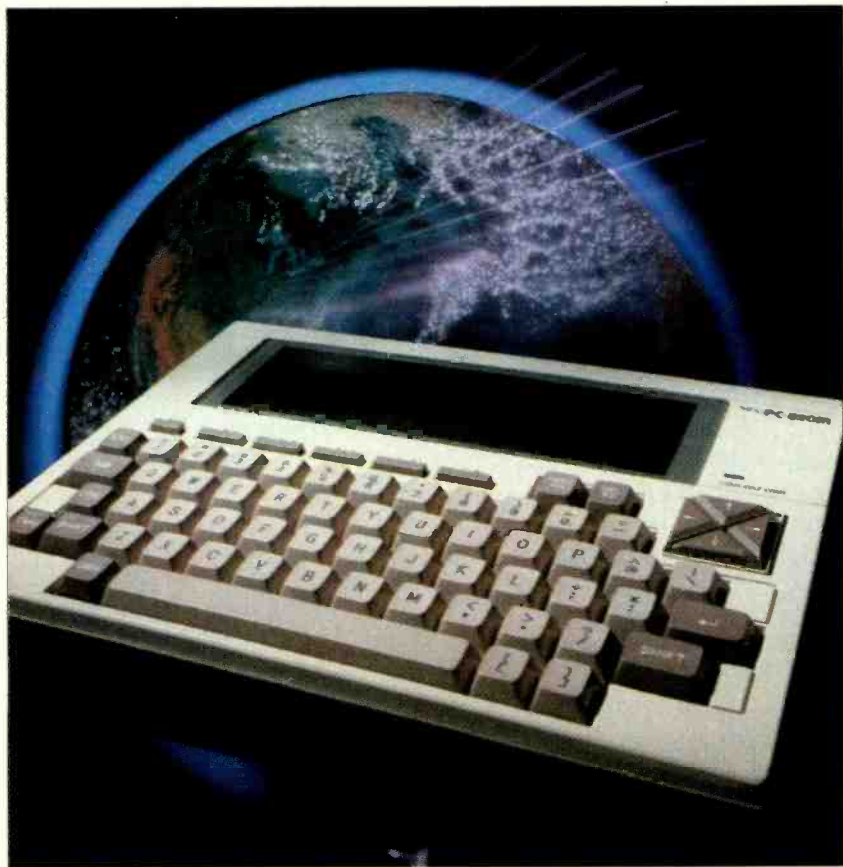

## NEC PC-8201A LAPSIZE COMPUTER

*New portable computer  
for word processing  
on the go*

*By C. P. Rubenstein*

**T**HE appearance of the NEC PC-8201A for review in these pages may give some readers a feeling of *deja vu*. It was about this time a year ago that Radio Shack's Model 100 was reviewed here, and the visual similarity between the two is obvious at first glance. The NEC seems to be just somewhat thicker than the Model 100 with lighter-colored keys and a 15° slope to the front panel. In fact, the systems are

like two peas in a pod—sisters whose “parent,” Kyoto Ceramics (Kyocera Corp.), sold the rights to them to NEC, after which NEC licensed the 100 to Radio Shack, but kept the 8201 for itself. Sibling rivalry notwithstanding, the systems have many similarities (including their \$795 price tag), although there are a few surprise differences in design philosophies, which are obviously being tested in the marketplace.

Common to both units is “continuous” memory (battery-protected RAM memory banks), and a triplet of highly integrated, menu-driven, and function-key controlled programs. The programs appear on a 40-character by 8-line LCD as soon as the battery power is turned on. Simply moving the cursor and pressing RETURN selects a program for TEXT entry, Microsoft BASIC programming, or a variety of telecommunication and peripheral control functions (TELCOM).

Nearly any hardware function you need is supplied, including a cassette port, RS-232 serial port, Centronics compatible parallel port, bar-code read-

er input, and ROM/RAM upgrade and expansion ports. Though not equipped with a built-in modem (like the 100) the NEC includes 16K of RAM standard, a RAM cartridge port, and cassette-based application programs.

### Who Is It For?

The NEC 8201A can justifiably be called a micro-workstation for executives, writers, students, field-service people, and others who need to have telecommunications, text editing, and BASIC programming capabilities in a truly portable system. They have a need to “go-on-the-road” with the unit and communicate via modem and/or RS-232 link to a larger, more-powerful machine for further processing of their data. They need a better-than-scrap-paper method of remembering appointments, phone numbers, and inventory. Some also need the database, stock exchange, and time-sharing access capability on the run.

I have quite easily entered notes for this and other articles with the machine positioned in my lap while riding a commuter train to the office. I found the system increased my throughput of rough copy as I would otherwise have scribbled some notes on paper for later typing into a word-processing system. The Text program is acceptable and allows for a fair amount of manipulation (further comments later).

### CPU, ROM, and RAM

Lurking inside the 8201 is a 2.4-MHz, 80C85 CMOS microprocessor. The unit can hold a maximum of 64K bytes of CMOS ROM and 64K bytes of CMOS RAM (Fig. 1). The memory banks are user-selectable in 32K banks so that there is a maximum of 64K of memory “on-line” at a given time. ROM memory occupies the lower 32K (\$0000-7FFF) and RAM memory the upper 32K (\$8000-FFFF) space (Fig. 2).

The standard 32K ROM includes ASCII character generator tables, a cassette operating system, I/O routines for the display, RS-232 and Centronics ports, and BASIC, Text, and Telcom programs. There is a socket for a later 32K ROM up-grade as well as for a second 32K RAM (with a disk-operating system perhaps or for another set of “built-in” application programs).



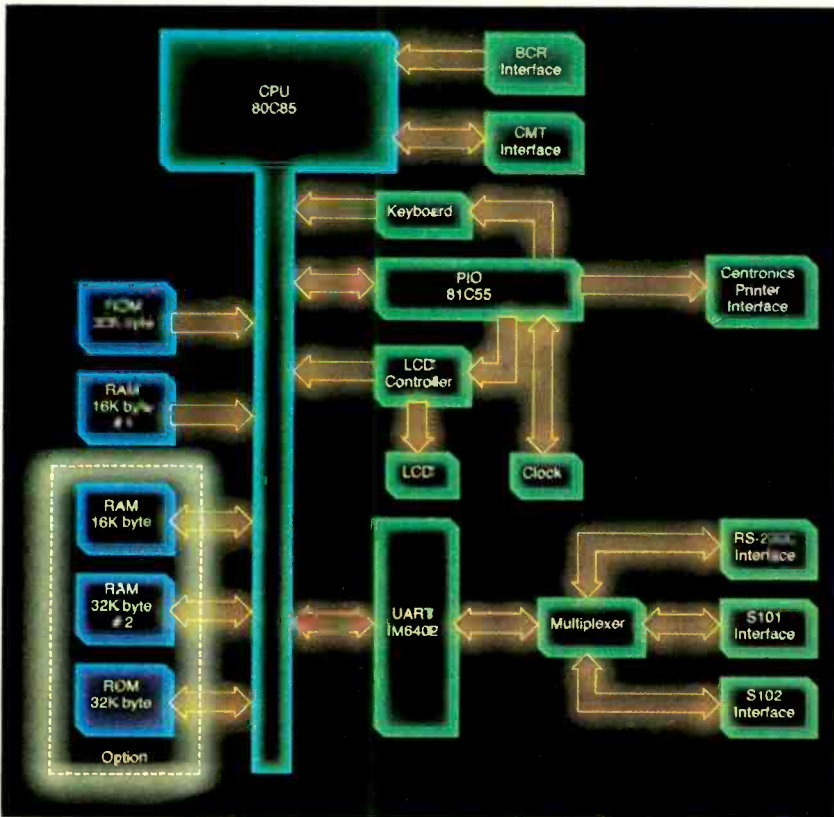

Fig. 1. Internal structure of the NEC PC8201A microcomputer.

The basic unit (\$795) comes with two 8K x 8 RAM modules that allow for an initial 16K Bank (#1). The internal RAM can be upgraded into two separate 32K Banks by inserting 8K RAM modules (\$120 each) into an easily accessed set of sockets on the back of the unit. To increase the RAM storage capabilities even further, a 32K CMOS ex-

only three circuit boards, the 8201 has four: the keyboard, the LCD board, the main computer card, and a board located on top of the main board near the removable power supply. On the underside of the main board, accessible from the back of the unit (by removing three Philips screws), are two sockets for 32K ROMs (the standard one and another), and six sockets for 8K RAM block upgrades.

#### The Keyboard

Across the top of the NEC keyboard are a STOP key, five function keys labeled f-1 through f-5 (keys f-6 through f-10 are obtained using the SHIFT key in combination with the others), and the PAST/INS (paste/insert) and DEL/BS (delete/backspace) keys. A cluster of four cursor keys is positioned just above the keyboard on the right side of the unit. (They're in-line on the 100.) The keys on both machines are full-travel rather than true tactile feedback types. They have a good feel and are not too tinny sounding. Only the function keys are snap-action tactile-feedback keys.

## There are visual similarities to Radio Shack's Model 100, but differences exist

ansion RAM cartridge (\$395) is available, enabling a third RAM bank to be selected. The memory contents of this cartridge are protected by a lithium battery for about a month. It is designed for use in lieu of more expensive bubble memory or floppy-disk storage devices.

Unlike the Model 100, which uses

#### The LCD

The top one-third of both the 8201 and the Model 100 is occupied by a 40-character/line, 8-line LCD that supports both upper- and lower-case characters (with descenders) on a 5 x 8 matrix. Whereas the Model 100's ROM includes a character generator table for nearly 256 unique "characters" for graphics, only 128 standard ASCII and three graphics characters are defined on the NEC. However, 125 more characters and graphics can be defined within BASIC using a supplied applications program. Included in NEC BASIC are commands for direct character placements (LOCATE), and also a full 24 x 64 pixel graphics mode (PRESET,PSET). The viewing angle for the display is adjustable (control along right side of unit) to allow for more pleasing and easier reading. A CRT output is not currently available.

#### Power Supply

The 8201, like the Model 100, can be run for about 20 hours using alkaline (AA) penlight batteries, about 5 hours with an optional NiCd battery pack (\$18), or by using an optional (\$20) ac adapter/NiCd recharger for at-home/office use. In an attempt to conserve battery power, the unit has a built-in, software-controlled, automatic shut-off

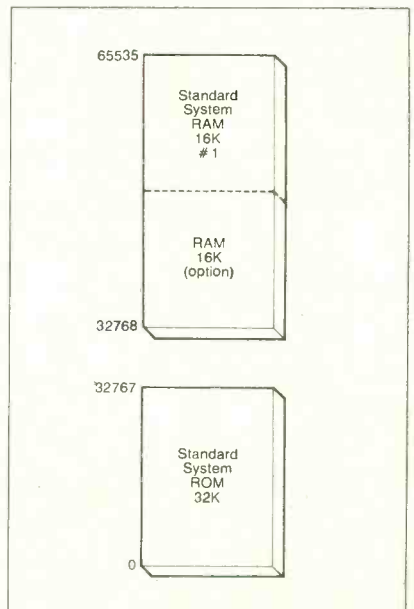

Fig. 2. The 8201A memory map.

# A NEW BREAKTHROUGH FOR YOUR APPLE™...



## Introducing **A+**, the Most Significant Advance in Apple History!

It's here! Big, bold and bursting with page after page of the latest in hardware, software, programming—and more! **A+** is the monthly magazine written exclusively for your Apple microcomputer. Each issue gets you involved with a host of fascinating features, probing updates, unique departments—and reaches to the depths of your imagination to challenge you with daring new strategies and adventures!

### Here's just a sampling of what **A+** is all about:

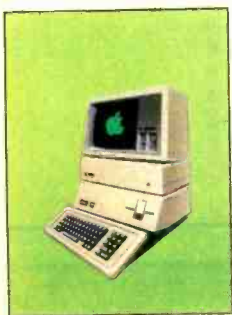

**HARDWARE:** From the latest advances in telecommunications and networking...to new ways to augment memory and access a wider variety of peripherals with greater ease...each issue of **A+** gets you involved.

**SOFTWARE:** What's new on the market and how you can make your system more powerful...plus full reviews and programming information.



**UTILITIES AND DIAGNOSTICS:** In addition to language utilities, **A+** helps you troubleshoot problems... makes you faster and more efficient...with utilities ranging from record processing to data transfer.

**BUSINESS AND FINANCE AIDS:** Software for financial forecasting and analysis...general accounting programs...financial news retrieval services...and business graphics so you can see just where your money is going.

**GAMES:** Take the **A+** challenge—with hoards of innovative brain teasers...from games to help you learn spelling and arithmetic...to games that provide fun and adventure!



**PROGRAMMING TOOLS:** Speed up program development with Apple text editors, testing and debugging aids and data base management systems. Since your Apple can speak many languages—from Cobal to Basic and Pascal—**A+** gives you a wide range of utilities for each language so you can create your own exciting programs.

**HOME/PERSONAL PROGRAMS:** covers it all...from basic processing...to helping you draw with Apple graphics...to speed reading...music theory and composition...even a course on cooking with your Apple...and then how to monitor your diet easily and accurately...along with many educational programs to learn math, science, and geography.

**DATA FILES:** Let **A+** probe new data base management systems so you'll be able to organize, store and retrieve information in ways you never thought possible.

**YOUR TURN:** Speak up with your ideas and innovations and network with other Apple users near and far.

## Plug into Savings of Up to 33% with Our Introductory Offer!

**YES!** I want to subscribe to **A+** for:

- One year (12 issues) only \$19.97—20% off!
- Two years only \$36.97—26% off!
- Three years only \$49.97—33% off!

Savings based on full one-year subscription price of \$24.97.

Name \_\_\_\_\_ 8H211

Address \_\_\_\_\_

City \_\_\_\_\_

State \_\_\_\_\_ Zip \_\_\_\_\_

Check One:  Payment enclosed.  Please bill me.

Please charge my:

MasterCard  VISA  American Express

Card No. \_\_\_\_\_ Exp. Date \_\_\_\_\_

Would you like to receive special offers from qualified users of our mailing list?  YES  NO

MAIL TO: **A+**, P.O. Box 2964, Boulder, CO 80322



## NEC PC-8201A

circuit that will power down the unit after 10 minutes of non-use (variable between 1 and 25 minutes using POWER command in BASIC).

the left side of the unit. This battery-backed device functions as a RAM disk for saving programs and data.

The NEC 8201 can be connected to a

parallel ports, the 8201 includes a DB-9 connector for the future use of bar-code devices. The bar-code reader is available from Radio Shack for \$100. This device reads the product and inventory control codes printed on most of the products that we now purchase. There is also a set of 6-pin and 8-pin telco-type modular plug sockets (similar to those on your home telephone) designed to accommodate 19,200-baud serial transmissions. Several video game computers use this rate for their disk drives. These ports could also be configured by third-party vendors for other control operations.



The NEC has a 40-character by 16-line LCD screen.

A low-battery warning LED is located just above the cursor cluster to the lower right of the display. This LED will turn on to warn the user to shut off the unit to conserve backup power in the event of battery failure. The internal NiCd RAM-backup battery, which trickle charges when the regular power is on, maintains RAM power to protect files for up to a month. Note that the more memory one puts in the system, the greater the power drain on the batteries. A full 64K RAM system will probably get about one-fourth as much operating time from the batteries.

### Input and Output Peripherals

The design of both machines is geared toward the greatest flexibility of peripheral device usage. To effectively save data and programs on a cassette tape, the NEC unit requires a remote-operation cassette recorder. Thus the system's recommended "mass storage" device is a data recorder (\$115) that communicates at 600 baud through an 8-pin DIN plug (supplied). However, I very successfully ran the application program tape on a \$20 cassette recorder that had neither a remote motor input nor a microphone input. (Note: I tried, in vain, to use a NEC tape with the Model 100. I suspect that this means the units are *not* software compatible.)

A 32K RAM cartridge (\$395) called Bank #3 is available for use with the 8201. It plugs into an expansion slot on

printer through the standard Centronics parallel interface (26-pin flat-cable male connector). The Centronics cable is available at about \$40. In the event that you have a serial printer, you can take advantage of the RS-232C serial port. The DB-25 connector and built-in UART electronics allow for various software controlled (TELCOM) protocols and baud rates of 75 to 19,200.

Rather than locking the user into a 300-baud built-in modem as with the Model 100, the NEC does not supply one. It tries to be more universal by allowing *any* baud rate or protocol to be

The 8201 turns on in the menu mode. The display greets you with the day and time, a list of programs stored in Bank #1, the amount of available RAM, and the current operations of the first five of the function keys. With the computer fresh out of the carton, you can dabble in Microsoft's N82-BASIC in the BASIC mode, a built-in word processor in the TEXT mode, or operate the unit as an intelligent terminal in the TELCOM mode.

The BASIC program is always the default selection, but by pressing either the space bar, or one of the cursor control keys, you can select whichever of the programs you want to work on. All command files either have no file type or a ".CO" file type. File names are up to six letters long with either ".DO" or ".BA" for document or BASIC file types respectively. Interestingly, when you select a file, it is executed. Thus if you select a BASIC file that you have written earlier and saved in memory, it

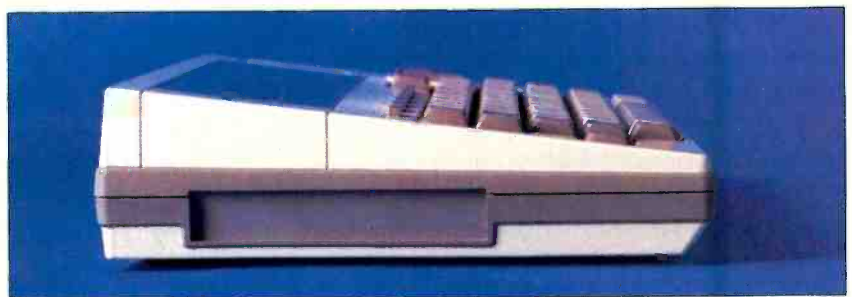

Expansion port for the 32K battery-backed RAM.

user definable. To show its technology wasn't the problem for the internal modem, NEC has introduced a 1.5-oz, 9-V, battery-powered, 300-baud modem add-on (\$79.95) called the "Authentic 300 MD." It is not solely for use on the 8201 but can be used with *any* RS-232 serial port.

In addition to the standard serial and

will be run. A document file will be presented in the TEXT mode, and a command file will be immediately loaded and executed.

In the initial menu mode, the function keys have the operations Load, Save, Name, and List. (There is no f-5 as its space shows the available RAM space.) When in the shift mode, the op-

erations are: SetIPL, CtrIPL (to set or clear the Initial Program Load file that allows one to immediately boot a program on power-up), Kill, and Bank (no f-8). What did you say? You would rather the word processor was called "Words"? No problem! When in the menu mode, select your Text file, press function key f-3 and rename it. These functions cannot all be done from the menu on the Model 100, and some, like Kill require being in BASIC. Name is not available at all on the 100.

## The NEC has 16K RAM standard but is lacking a built-in modem

**BASIC.** The NEC N82-BASIC, although an older version than the one used on the 100, is a better one. It is about 30% faster.

NEC BASIC has other bells and whistles, too. LOCATE is used for direct access to the screen's pixels and RENUM revises the numbers of your program so that you can easily update it. An even larger plus for NEC BASIC is its cursor-controlled screen editing capability.

**TEXT.** Neither the NEC nor the Model 100 has WordStar crammed in its ROM, but their Text programs do a better-than-fair job of word processing. I used the NEC very successfully to create the text for this article. I then invoked the TELCOM program and uploaded the copy into my 8" CP/M system through a null modem (an RS-232 connector with pins 2 and 3 criss-crossed). The Text program is something of an enhanced line editor with some of the search, erase, and move features of a full word processor. As I am used to WordStar, I naturally tried using the CTRL keys for editing. I found that the most common WordStar control characters (CTRL A, S, D, F, E, X, W, Z) have been implemented (similar to the 100). After a few minutes I was able to use the editor with a fair amount of success for text input.

The NEC uses about 4K of RAM space for its display map, stack, and other pointers. Thus, for a 16K RAM machine, we have about 12K or something like 2000 to 2500 words or perhaps 6 to 8 double-space pages of storage. Each 32K RAM bank can hold about 6000 words or 20 pages of text. That is 40 pages internally and another

20 externally for the NEC. Of course, you can always save files onto a cassette. But I found it a simple matter to upload and download files directly to and from the NEC at a variety of baud rates as well as over the standard telephone lines using RS-232, 300-baud acoustic couplers.

**TELCOM.** The ease of use of the TELCOM program is impressive. Decide which protocol to use, press a few keys, and you are up and running. If that is still too difficult, there is a menu-driven application program you can use to set protocols. Use it for standard up-and-downloading, and telecommunications, or go further still and use it as an advanced hardware analyzer and debugger to test your RS-232 and Centronics transmission lines and devices using the STAT routine to change baud rates, word lengths, and protocols. This program alone could easily retail at about \$200 if sold separately.

**Other Software.** The Model 100 (but not the NEC) has a pair of programs, SCHEDL and ADDRSS that are used as a memo book to seek and find ad-

instructions covering the programs on the cassette tape. The manuals in general suffer only from translation from the original Japanese (written in Japanese), and from the proliferation of typographical errors. They have some very good points (such as the use of code symbols for notes, warnings, and returns) and are generally complete and very instructional. The BASIC manual has a program example for nearly every one of the BASIC commands. The only real problem occurs in the applications manual, which has sparse information on some of the 25 varied programs covering finance, memory bank backups, calculations, music, and games. These are supplied "free" with the unit and include a cassette cable (about \$6), a series of six business programs (worth about \$150), seven utility programs (about \$50), and three game/music programs (about \$50) on a cassette tape. Since the standard NEC system has 16K of RAM (which would be 8K or \$135, installed), it might be suggested that the NEC supplies nearly \$400 worth of incentives to buy it over the ubiquitous 100.

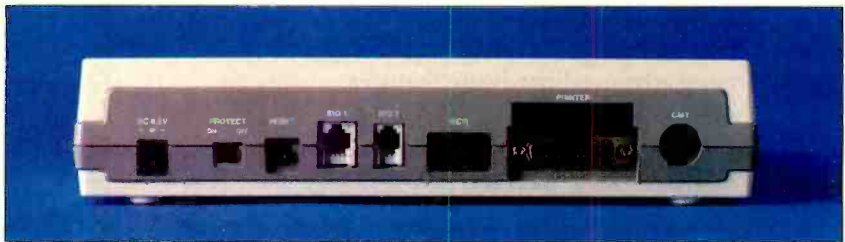

I/O ports and power connectors are accessed on the back of the 8201A.

dresses and appointments. They act like mini-TEXT programs that could easily be implemented with the NEC TEXT program. In taking this route, there is the advantage that you only need the data files for your addresses, etc. On the 100, 2 files and 2 data files take up valuable menu space. However, there is a need for these files for integration with the automatic dialing feature of the modem system in the 100.

To appease those still interested in the schedule functions, the NEC has an application program in "easy to customize to your needs" BASIC. This one even has a little calendar routine with a nice algorithm that you may find helpful elsewhere.

### Application Programs

The 8201 comes with three manuals and a cassette tape. The manuals are the "PC-8201 User's Guide," the "N82-BASIC Reference Manual," and the "Personal Application Kit Guide" of

### All-In-All

The features of the Model 100 and 8201 are very close—too close to call a winner. The difference will be in your application and personal needs. The manufacturer didn't give us a clear choice. When the promised NiCd, battery-powered, double-density, dual-drive, 3.5" floppy disk comes out, it will probably use the 48-pin expansion connector on the NEC. It is expected to store 160K per drive (320K total) and weigh less than 8 lb. I'm sure that a similar device will become available for use with the 48-pin expansion header under the Model 100.

For my needs, I would choose the NEC 8201. Not because it's better, but because I would be happier to have the extra memory capabilities, and there is no problem with sales and service in the New York area. I recommend you do a couple of coin tosses and then try them out at your local computer store. ♦

# *What should you look for in personal*

Before you go looking for personal computer software, you should know what personal computer software looks like.

(You're not alone if you don't already know that software programs come in a package.)

Programs are "pre-recorded" on cartridges, tapes or diskettes. And, although you can't tell by looking at these cartridges, tapes or diskettes, the programs on them can be very different.

## ***What you put in is what you get out.***

What happens when you play a high-quality tape on a high-quality recorder? Superior sound.

This analogy can also hold true with software. The better the program quality, the better the result — be it improved productivity or creativity.

IBM Personal Computer Software is both tested and approved by IBM. And these programs are designed to take advantage of an IBM personal computer's many advanced hardware features.

## ***What the value is.***

What are improved math skills worth? More efficient inventory control? Faster communications? What is accomplishment worth?

Any way you look at it, the value of personal computer software is the value of doing your best.

## ***What compatibility means.***

Many of the same software programs that run on the IBM Personal Computer you use at work will run on other IBM personal computers you use in other places. So you can, for example, continue in your family room what you started in the classroom or boardroom. (Or the other way around.)



The Little Tramp character licensed by Bubbles, Inc., S.A.

# computer software?



communications

Special information services with a single keystroke. Send or receive mail... stock and weather reports... charts or spreadsheets... automatically over standard phone lines.

## *What's available.*

One software program can't satisfy everyone's computing needs. That's why IBM has such an extensive library of programs. You'll find a series for productivity, education, business, entertainment, lifestyle, programming or communications.

With IBM Personal Computer Software, you have a choice.

In word processing, for example, you may want a simple program for memo writing. You'll find that program in the IBM software library. If you want a sophisticated program for report writing, you'll find that in the library as well.

## *What's inside.*

Sometimes learning a program is easy. Sometimes it's not. That's why inside every IBM software package are instructions that are clear and understandable.

## *What you can do right now.*

There's more to look for in personal computer software than what you've read here. To find out more, look no further than your authorized IBM Personal Computer dealer. For one near you, call 800-447-4700. In Alaska or Hawaii, 800-447-0890.

**IBM**<sup>®</sup>

*Personal Computer Software*

Circle No. 2 on Free Information Card

# THE ACT APRICOT COMPUTER

*This British challenger  
to the IBM PC  
has a personality  
all its own*

*By William Barden, Jr.*

**W**ITH 16-bit computers all the rage nowadays, it's not surprising to have another one reach the market. However, it is refreshing to see one that offers something different. This microcomputer is named Apricot and is manufactured in the United Kingdom by Applied Computer technology (which recently opened US operations for marketing the system). The Apricot is an MS-DOS based microcomputer, but with some major and many minor differences compared to such machines as the Texas Instruments Professional, Sanyo MBC-550, Columbia PC 1600, Tandy 2000, Hewlett-Packard 150, and other machines that basically compete with the IBM PC. Some of the factors that make the Apricot interesting are:

- A true 16-bit microprocessor, the Intel 8086
- MS-DOS 2.0 rather than the earlier MS-DOS 1.1 as on some PC compatibles
- Two 3½" Sony micro disk drives
- A *Manager* program that makes it easier for the user to perform basic system operations
- A great deal of software "bundled" in the basic price
- High-resolution 800 × 400-pixel graphics
- A two-line, 80-character LCD display called the "microscreen" above the keyboard
- Touch-sensitive function keys
- A built-in, continuously running clock and calendar circuit
- Compact packaging that allows easy transportability.

## The MS-DOS Mystique

The Apricot is one of the latest in a proliferation of microcomputers running under MS-DOS. Obviously the Apricot is not directly IBM-compatible since it will not load 5¼" diskettes gen-



**The Apricot has a physically small but striking appearance.**

erated on an IBM PC or PC-compatible machine. The operating system and BASIC commands, however, are largely identical with the commands of the IBM PC (the MS-DOS and BASIC software was produced by MicroSoft as with all PC-compatible machines). In addition, the Apricot software includes a utility program that will let you

## **"Why should you buy an MS-DOS system with a 3½-inch rather than 5¼-inch disk drives?"**

download files from an IBM PC or PC-compatible system.

The most relevant question that can be asked of any MS-DOS machine is "Why should I buy this system over an IBM PC or other PC-compatible?". In the case of the Apricot, one must also ask the question "Why should I buy an MS-DOS system with 3½" disk drives rather than the more commonly used 5¼" drives?" I'll try to answer those

two basic questions in this review in addition to highlighting some of the unique features of the Apricot.

## The Apricot System

The Apricot has the appearance of a well-designed microcomputer system. It consists of three components—the main processor unit, the keyboard, and monitor.

The entire package is physically small. The keyboard can even be clipped under the main processor box to make up a single neat 16½" by 12" by 5" unit—about the size of a small suitcase. To carry the analogy a little further, there's a flap that can be pulled down to cover the disk drive openings and a carrying handle that can be pulled out from the main processor box.

A "microscreen" is built into the keyboard and will provide two 40-character lines for display in lieu of the monitor. In fact, just the keyboard and main processor unit alone constitute a complete microcomputer, although this is not the intent of the manufacturer (the microscreen is used as a set of function keys which can be easily relabeled).

Like the rest of the Apricot, the monitor is physically small, about 10" by 10" by 9" and designed with a built-in carry-



ing handle. Although there's no "snap on" packaging for the monitor, the entire microcomputer system can be transported as two small units, even to the extent of being carry-on luggage on a plane. The total weight is about 30 pounds, so you won't be pumping iron while transporting the system, either.

When the three units are operational, the "footprint" of the system is about 300 square inches, quite a bit less than the 450 square inches of the IBM PC, making the Apricot easy to use on any desk or table. The monitor slides across the top of the main processor unit in a recessed area for best viewing. The monitor can also be tilted up or down from its base to change the viewing angle. There is no internal fan to raise the background noise level, an annoying feature on some systems.

### The Apricot Keyboard

The keyboard of the Apricot is a full-sized 90-key unit with full-travel keys.

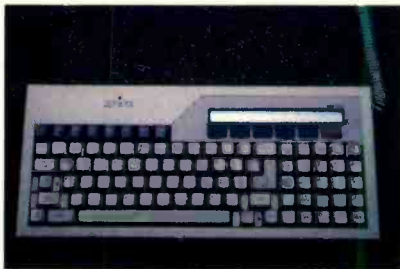

Keyboard with LCD microscreen.

Although it's a subjective thing, I found the touch of the keys to be pleasing and to compare favorably with the keyboard on my IBM PC. One feature that's lacking is some means to adjust the keyboard's tilt as on the PC and other systems.

There are five main areas on the keyboard. The largest area is a QWERTY style keyboard—almost. Some of the keytop markings have British characters. For example, a pound sign is on the 4-key while the dollar sign is on the 6-key (and there are other differences). A second keyboard area consists of a group of function keys located above the main keys. These keys are not general function keys, but are used for single keypresses for the Manager software—keys that invoke a HELP or PRINT function, for example. A third keyboard section is located to the right of the main area and contains editing and cursor control keys. The fourth part of the keyboard is located at the extreme right and is a standard numeric keypad. The fifth and final section of the keyboard is the

microscreen (more details below).

The keyboard has a number of red LED indicator lights which I found helpful. There is an indicator light for CAPS LOCK and STOP (used to stop screen scrolling). I don't know what to say about the red LED used to dot the "i" in the Apricot logo on the keyboard, but it's probably worth the extra money in engineering, tooling, and parts just to impress your friends when you show them the machine!

### The Microscreen

The microscreen deserves special mention. It's located on the upper right of the keyboard and is a liquid crystal display of two lines of 40 characters each. There's a contrast control knob on the right of the keyboard to adjust for various LCD viewing angles. Below the microscreen are six touch-sensitive functions keys, each with a red LED indicating when they are active. The microscreen is used for various system functions. It may be set under software control to echo the last three lines of the screen, allowing you to use the system without the monitor. It is also used to display the current date and time. [I was surprised after unpacking the Apricot and "powering up" to see the current date and (New York) time appear on the microscreen!] Once entered, the date and time are maintained by a built-in calendar/time function powered by a 9-V battery in the keyboard cabinet, even when the main power is turned off. A third, and major, use is to display system options while in the Manager mode—you simply touch a key below a menu item to select a function.

The keyboard is connected to the main processor unit by a flexible cable. You could use the keyboard up to a yard or so away from the main unit, but this would not be a comfortable monitor viewing distance. A reset button is located on the left side of the keyboard, and a connector for an electronic



Apricot is elegantly designed.

"mouse" is located in the rear of the keyboard cabinet.

### The Main Processor Box

The main processor box holds the two Sony disk drives, which are front load-

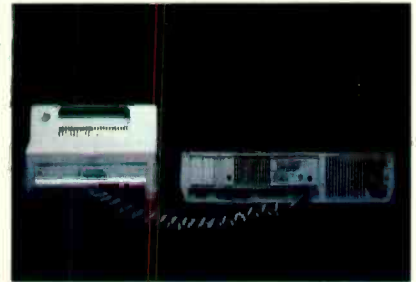

Parallel and serial ports.

ed. There's an indicator LED for each drive that shows when they're in use. System connectors are located in the rear of the cabinet. The monitor and keyboard attach via two DIN-type plugs. There's a power connector, main on/off switch, and fuse holder grouped in the rear left of the cabinet.

The Apricot contains a built-in parallel Centronics compatible interface, and the standard Amphenol connector is located on the rear of the cabinet. (In addition to Centronics compatibility, the Apricot can also be changed under software control so that the printer port is IEEE-bus compatible.) There's also a 25-pin DB-25 connector for RS-232C (serial) operations, such as connection of a modem or serial printer.

### The Monitor

The Apricot uses a monochrome (black and green) high-resolution monitor capable of displaying 800 horizontal by 400 vertical pixels, or picture elements, compared to 640 by 400 on the IBM PC. The monitor face is covered by a nonglare screen. I found the display crisp and very easy on the eyes. About the only complaint that could be made is that the 9" diagonal display is simply smaller than the typical 11" viewing area and a little harder to read. But then again, it's a far cry from the screen/portability compromise made in the Osborne I.

### Hardware Specifications

The Apricot uses an Intel 8086 microprocessor, rather than the 8088 of the IBM PC. The 8086, of course, is a true 16-bit microprocessor, rather than an 8-bit sheep in 16-bit wolf's clothing. Intuitively, one would expect the "throughput" of a computer, or overall

(Continued on page 118)



## DEC 350 PROFESSIONAL COMPUTER

*A high-end personal computer with the power of a mini*

*By Henry Collins*

**W**HEN DEC's (Digital Equipment Corporation) Pro 350 microcomputer—based on that company's well-proven F-11 processor used in much of its other equipment—was introduced a few years ago, it was handicapped by an anemic operating system, a meager software catalog, and a limited selection of add-on hardware options.

The standard system configuration featured 256K of memory, two 5¼" floppy disk drives—offering a total of 800K of storage—a 5-megabyte Winchester disk, a 132-column black-and-white monitor, a low-profile keyboard, and a price tag of \$8595.

Today, for \$8590, you can purchase the Pro 350 with a faster operating sys-

tem and double the memory of the original. Included in the price is your choice of a white-, amber-, or green-phosphor monochrome monitor. (Some people feel the amber is easier on the eyes than green.) An RGB color monitor capable of handling bit-mapped graphics is \$950.

Standard on the new Pro 350 is a floating-point adapter, offering high-precision, high-speed number crunching for scientific and engineering applications. The newly upgraded P/OS (Professional Operating System) Version 1.7, which is optional, comes complete with instructional software, self-testing diagnostics, and Prose—a no-frills text processor.

### Putting It Together

Setting the system up is straightforward and uneventful, thanks to well-written, illustrated documentation. Zero insertion-force (ZIF) connectors and Digital's CTI (Computing Terminal Interconnect) bus simplify the installation of the memory expansion and hard disk controller boards. The Telephone Management Module, consisting of two circuit boards, installs in one option slot on the CTI bus. The other boards, featuring three telephone jacks and a connector for the TMS Voice Unit option, is mounted in a special plug-in

slot located at the rear of the system unit. Also on the rear panel of the unit are connection ports for communications, a serial printer, and the monitor and keyboard. There is also a "NET 1" I/O port for connecting an optional Ethernet device for future local area network communication.

After installation of the slide-in 5-megabyte hard disk is completed, the system unit can be loaded into the optional floor stand and tucked away under a nearby desk. Mounted in the floor stand, the system unit takes up only as much floor space as would a 24" pullman suitcase standing on end—a real space saver when desktop real estate is at a premium.

The monitor is connected to the system unit with a (supplied) multi-conductor cable, and a coiled telephone-type cord is used to complete connections between the detached keyboard and the monitor. Connecting the printer is as simple as plugging a lamp into a wall outlet.

### Software Installation

Shortly after it released the Pro 350 with P/OS Version 1.0, Digital introduced an updated version of the operating system, P/OS Version 1.5. Without a doubt, version 1.5 was an improve-

*(Continued on page 82)*

# THE ONLY COMPUTER THAT MAJORS IN EDUCATION.

It doesn't take an advanced degree to know that teaching computers in a school isn't the same as using a computer in business.

But most computers are designed for businesses or homes, not for schools.

Acorn has designed a computer especially for schools.

It's called The British Broadcasting Corporation Microcomputer System.

Simple to use, it can handle everything from basic applications to creating sophisticated networks. So it won't become obsolete the minute a student becomes advanced. In fact, no other similar sized or priced computer exceeds Acorn's built-in expansion capabilities. But Acorn's BBC Micro is more than a computer. It's a total learning system designed by and for educators. Consisting of educator endorsed software, lesson plans and teacher workbooks. We call it schoolware, because it gives teachers and students everything they need for learning.

You can even learn about Acorn's BBC Micro on our toll-free teacher hotline. And at special Acorn Learning Centers at computer dealers around the country.

Doing our homework has already made Acorn's BBC Micro one of the biggest selling microcomputers in Britain. And led to its selection by the British government for use in its nationwide computer literacy program.

So if you're interested in a computer that will do well in school, take a lesson from the British and learn more about Acorn's BBC Micro.

For more information, write Acorn Computers Corporation, 400 Unicorn Park Drive, Woburn, Massachusetts 01801, or call toll-free 1-800-225-8001.

**ACORN COMPUTER**

© 1983 Acorn Computers Corporation.



# THE MICRO-WRITER

*A pocket-size word processor with 8K of non-volatile memory*

*By Fred Blechman*

**T**HE Microwriter is a portable, self-contained word processor that has a unique six-key entry system, 8K of nonvolatile memory, and a 16-character LCD display. The whole is housed in a compact contrasting tan-and-brown plastic case that measures only 9" high by 4½" wide and weighs less than 2 lb. List price of the device is \$499.

The integrated Microwriter package lets you put your thoughts into electronic memory wherever you happen to be and then dump the contents of memory directly to a printer to obtain hard copy of your work. The device offers powerful text editing and formatting capabilities on its own that obviate the need for a computer altogether, though you *can* use your computer's word processor for additional editing and formatting and to save the text as a disk file. To obtain hard copy from text stored in the Microwriter, without the aid of a computer, text stored in memory is dumped directly to the printer, which then churns out the copy.

What the Microwriter can do, and the mechanics of making it do what it does, may lead to a great deal of controversy on the personal computer scene. My experience with the device convinces me that there *is* a place for the Microwriter, though it won't be a must-have item for all or even the majority of personal computer users.

## General Description

The Microwriter is basically an electronic text generator that can produce the full upper/lower-case alphabet, numbers, and punctuation characters, which are displayed on its scrolling LCD display. Character generation is accomplished with only five main keys and a sixth "command" key. Various



**Microwriter has a unique six-key entry system.**

combinations of keys and key sequences—all operated by your right hand resting over the humped portion of the device's case—make it possible to generate 212 characters and codes!

In addition to storing text in its built-in 8K RAM bank, the Microwriter has powerful text editing and communication facilities. The memory bank itself is sufficiently large to store about 1500 words, or more than five pages of double-spaced text.

Perhaps the most controversial point about the Microwriter is its unique six-key entry system. Such entry devices have been tried in the past, but the products in which they appeared failed to take the marketplace by storm. (Most have been simple alternatives to existing computer keyboards and, following a short introductory fanfare, have died an unmentioned death.) The Microwriter, however, isn't just an alternative to the typewriter keyboard, though it can perform as one. Its combination of keyboard, text-editing capabilities, and memory storage is what makes the

Microwriter unique and completely different from its predecessors.

A standard RS-232C (DB-25) connector is located at the top end of the Microwriter's case. Next to this is a small pushbutton ON/OFF switch and a ¼" miniature phone jack for connection to a cassette deck for saving and loading text. Power can be supplied by an ac adapter/charger, which connects through a standard power jack located on the lower end of the case or independently from the Microwriter's built-in rechargeable nickel-cadmium battery pack. Next to the power jack is a large 37-pin DB-type connector identified, though not defined, in the manual as an "auxiliary socket."

The keys on the Microwriter are square and have concave surfaces for sure "feel" and have very long strokes. To generate most characters and codes requires operation of several keys simultaneously. Keystroke entry to the Microwriter is very forgiving, however, since entries are recorded only when the keys are released.

**An example of the keys to push for four letters.**

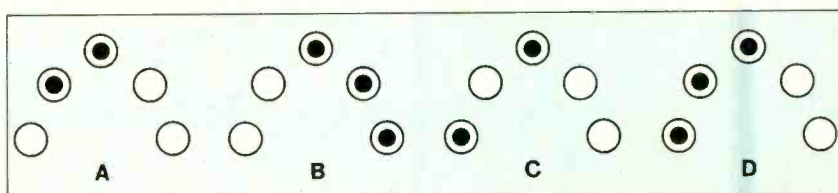

Examples of key combinations are shown in the diagram. The normal mode is used for generating alphabetic characters. Lower-case characters are standard, while upper-case characters are called up with a prestroke. Another prestroke puts the Microwriter in the numbers/punctuation mode. Both upper-case alpha and numeric entry can be "locked" in until the system is told to toggle them off.

It might appear that the Microwriter is skimpy with its single-line, 16-character display. However, through various control codes, the 16-character "window" can be jumped to any location in a document. Scrolling forward and backward one word at a time or at either of two automatic speeds allows you to zero in on the exact portion of the text you want to view. (Mention is made in the manual of a display adaptor, not yet announced for the U.S. market, that will permit display of 16 lines by 64 characters per line on a video monitor.)

Most displayable  $\frac{3}{16}$ "-high characters are formed in the LCD window in a  $5 \times 7$  dot matrix. The descenders for *g, j, p, q,* and *y* occupy a ninth matrix line (there's no eighth line). This gives the characters a unique appearance that makes them hardly recognizable at first.

The internal battery pack is claimed to power the Microwriter for about a week of normal use (about 30 hours) from a full charge. When only about an hour of charge remains, a low-battery indicator appears in the display. A built-in battery-conservation feature automatically powers down the Microwriter if no keyboard activity occurs during an eight-minute or so period.

Recharging the battery from a completely discharged condition takes about 24 hours. However, the Microwriter can still be used during the recharge cycle through the supplied 117-volt ac adaptor.

### Built-In Text Editor

As various key combinations are pressed to enter text, characters appear at the right side of the display window and move one place to the left as each successive one is entered. Two spaces at the extreme right are for status symbols that tell you which of the 10 modes you're in and to warn you when the memory is approaching full. (The only way to find out how much free memory is available is when the system is within 256 characters of being full.)

The procedures for adding and deleting characters from text and moving forward and backward through text in

memory are easily accomplished. Block moves of text, however, are not provided. You can keep as many files as memory will hold. No names are used for files, but each file is separated by a special symbol. You can quickly move to any file, paragraph, line, word, or character with the aid of 17 text-access commands.

Text formatting is accomplished with 12 commands for tabbing, indenting, and setting margins. Page numbering isn't supported, but using the formatting command that jumps to the last line of the page lets you put title and page number there.

You can specify any line length up to 130 characters (more if your printer can handle it), and the last word on a line is automatically wrapped around to the beginning of the next line. Line marker

feature when you have files that exceed the 8K memory capacity of the Microwriter. The save/load procedure is very simple and requires only a standard cable equipped with miniature phone plugs to interconnect Microwriter and cassette deck.

### Manuals and Cards

Two very good manuals and seven colored reference cards are supplied with the Microwriter. One manual contains 52 pages and gives complete step-by-step instructions to make the device very friendly to the first-time user. The other manual contains 30 pages and provides details of the optional settings for special formatting, communications, and RS-232C serial interfacing.



The internal battery pack will run the unit for 30 hours.

symbols permit you to easily identify line ends. Additionally, you can specify carriage returns at any time.

The number of lines per page, form feeds, and other printing instructions can be user specified. With proper programming of "exception codes" (up to three ASCII characters), the extremely versatile Microwriter will let you exercise all the built-in features of your printer, including boldfacing, condensing, expanding, subscripting, superscripting, italicizing, etc.

### Recorder Operation

A cassette recorder can be used to save files stored in the Microwriter and to reload them back into the Microwriter at a later time. This is an especially handy

Most options are set-and-forget but can be easily altered on demand. You'll have to know something about your printer or communications parameters to properly implement the optional settings, however.

The reference cards are extremely useful and summarize the information contained in the manuals. There are so many commands that it's almost impossible for you to memorize all of them, especially since some are infrequently used. The cards cover the alphabet, numbers, punctuation, and a recommended alphabet learning program, as well as commands and menus for formatting, editing, text access, and sending and receiving with tape and RS-232C devices.

(Continued on page 103)



SUCCESS

COMPETITION

ADVERTISING

DEAD END

DEVELOPMENT

DEBUGGING

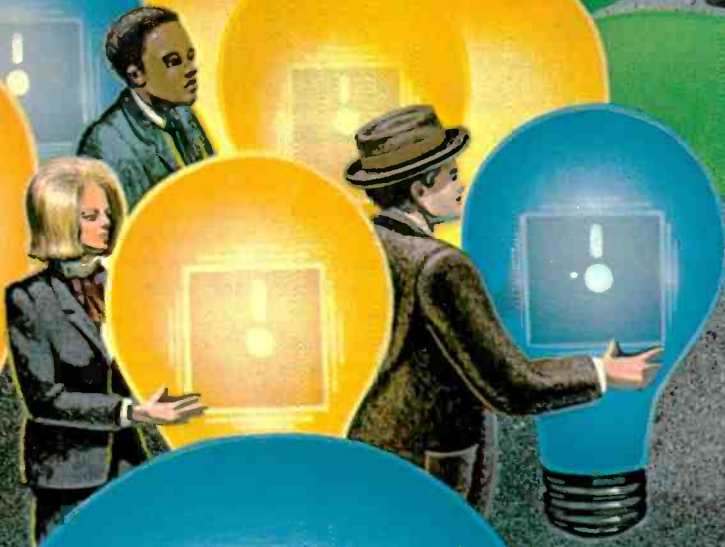

*Handwritten signature or initials in the bottom right corner.*

# THE ROAD TO SUCCESS

*Three articles that give insight into why, out of every 1000 software products, only about 5 will make the big time*

## AVOIDING THE PITFALLS

*By Michael McCarthy*

**W**HERE does the software you use come from? And what is involved in getting a program from the stage where it is just a gleam in some programmer's eye onto the "Top Ten" list? Perhaps you have even entertained the notion of entering this apparently lucrative field yourself. What you read here could well influence the way you go about it. Let's track the fate of a hypothetical group of 1000 similar software products. Along the way we'll look at some of the factors of success and failure and try to form some picture of how the business is changing and where it's headed.

Broadly speaking we can break the life cycle of a software product into three preliminary stages:

- Conception
- Development
- Debugging

They are primarily concerned with bringing the product into being. These "prenatal" stages are followed by:

- Introduction
- Advertising
- Distribution

*Michael McCarthy is a computer consultant and software developer.*

During these stages the product's success or failure becomes apparent. Each stage has its own risks and opportunities. Most products never reach the distribution phase. The successful ones go beyond it, generally passing through two more stages:

- Enhancement
- Obsolescence

What's the lifetime of a successful software product? It depends on the type of software. In the game business, the whole cycle may be collapsed into a period of a year or so, with active marketing lasting only a few months. At the other extreme, certain microcomputer operating systems have been around since the mid-seventies; and, on big computers, there are actively marketed operating systems whose development began twenty years ago.

Let's explore each of the life-cycle stages.

### Conception

Where do product ideas come from? There's no single good answer, but it is generally true that products emerge in response to widely perceived needs. Take microcomputer database managers, for example.

People have been applying computers to business problems since the early fifties, and database management software has existed since the mid-fifties. It is not a new idea.

Similarly, microcomputers have existed in various forms since the early

seventies, and people have wanted to apply them to business all along.

What held back micro business applications and database software was the lack of inexpensive high-speed, high-capacity disk storage. As soon as this became widely available (about three or four years ago), the business market for micros began to explode, and development of micro-based data management tools began in earnest.

This resulted in a wave of database manager product announcements beginning about two years ago, a wave that shows no sign of diminishing.

If you've been involved with micros for even a couple of years, you've already seen several other waves: word processors, command-language "shells," disk utilities, language compilers, speech synthesis devices, etc.

Recent waves include "integrated" software and keyboard macro processors. The latest wave is software with "windows."

In each of these cases, the same product ideas occurred to large numbers of people at roughly the same time. They were triggered either by technological cost breakthroughs (speech synthesis), or by maturation of the marketplace (windows).

There being only one or two basic ways of skinning any particular technical cat, comparable products have comparable lead times, and the early ones hit the market within a few months of each other. Then other folks, enormous numbers of them, see what has been

done and say to themselves, "I can do that too." This results a year or so later in a flood of similar products, all scrambling after the same business.

Sad to say, the battle for life is usually lost at the moment of product conception. The death may be a lingering one, but perhaps 80% of all software is born already suffering the effects of a fatal disease called "competition."

This alone will kill off 800 of our 1000 products.

Their creators don't know that without a massive commitment to advertising there is no way they are going to even budge the leaders, much less displace them. (More about this later.) Eventually they learn, but by then it's too late and they're out of business.

How does such audacity come about? Sometimes it's just ego tripping. ("We can build it better, therefore people are going to buy it from us.") More often, it's short-sightedness—many vendors don't realize that their "new idea" has occurred at the same time to thousands of others, hundreds of whom are going to do something about it, and a few of whom are going to "do it right."

However, once in a while someone

## 80% of all software suffers from the fatal disease called "competition"

has an idea for a product the likes of which have never been seen before. VisiCalc is such a product idea, the notion of a "smart" spreadsheet being entirely without precedent.

If the need for a novel product is both real and widespread, such a product stands a good chance of becoming a classic even if its promotion is relatively weak. The reason, of course, is the lack of competition early in the game.

Incidentally, why didn't VisiCalc happen sooner? Did it serve a new need? No, the need is an old one, computers having been used in business planning since the early 1950s. Furthermore, the technology required—interactive operating systems, low-cost video terminals and low-cost hard-copy printers—had

existed (on minicomputers) since the early 1970s.

The simple fact is, *nobody thought of it before!*

### Development and Debugging

We lost 800 of our 1000 entrants back in the product conception phase, leaving us with 200 potentially viable contenders. Of these 200, probably 150 are going to drop out during development. The reason? They are going to be *late*.

Software projects are notorious for schedule overruns. In turn these lead to sloppy workmanship, no help in a sub-market that may be new but that rapidly becomes competitive.

What causes the overruns? Two things: First, people usually underestimate the magnitude of the work to be done. There's a world of difference between a *program* (which runs in a development environment) and a *product* (used by real customers in the real world). Second, time for product testing is often omitted from development plans, yet testing and reworking can easily account for half or more of the total development effort.

## SUCCESS STORY: CONTEXT MANAGEMENT CORP.

By Harvey Berger

**I**N the wide world of micro-software development, Gib Hoxie and his company Context Management Systems (CMS), have known the thrill of victory as well as the agony of defeat. Since 1981, the Torrence, California-based company has marketed two personal computer business products—Context Connector and Context MBA—with two very different results.

Context Connector and Context MBA, are both communications software products. Connector, introduced in July, 1981, allowed users in large companies to download data from their mainframe computers to their desktop Apple IIs for use with VisiCalc. (The

*Harvey Berger is a Hollywood screen writer and a frequent author of articles about personal computers.*

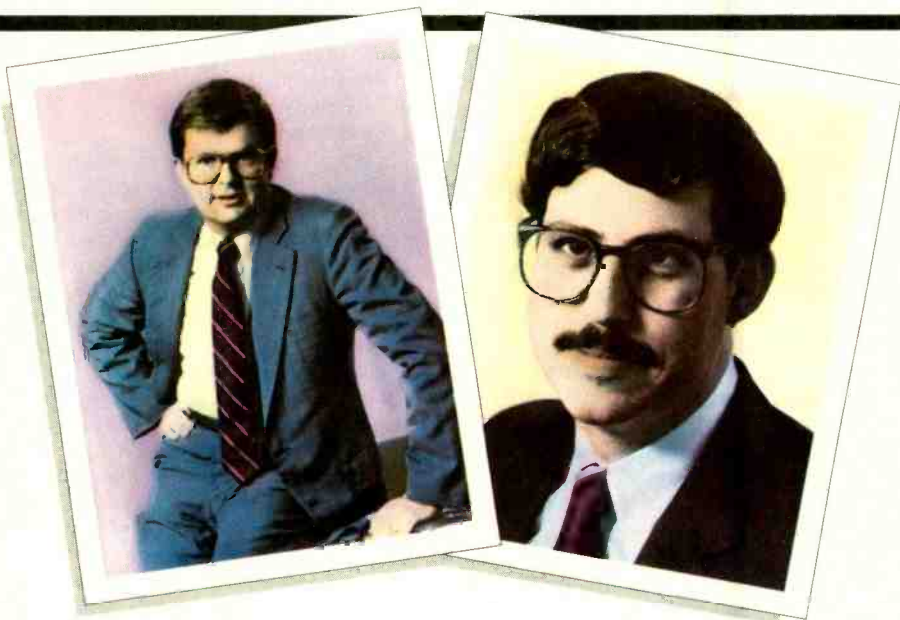

Gib Hoxie (left) and Brian Fischer are succeeding with MBA.

product was taken off the market in January 1982.) MBA went a giant step further, in June 1982, by providing in one program the six major processing functions CMS determined users would need—telecommunications, modeling, electronic spreadsheet, database management, word processing, and graphics.

Although Context MBA was actually the first product designed by the company, Gib Hoxie and his partner Brian Fischer felt it was a little too big a project to get their feet wet on.

"We knew it would be a large and ambitious software product to get going," Gib said. "We also knew that we didn't know very much about marketing mi-



The resulting overruns can be devastating—200 to 300% in dollars and/or time are common, and overruns of 100% are probably the norm. A well-managed effort may experience only 50% overrun . . . maybe.

And of course, it's only the 50 well-managed efforts that will make it to market with any real chance of success. What do these folks do differently from the other 150? They plan ahead . . . and they test, test, and test again. They test the market (if they're really smart they'll have done this earlier). They test the product definition ("Oh, you wanted it with *wheels*?"). They test their design ("What happens if the disk fills up?"). And they test the actual product, both as it is being put together and after it is "finished." It is the rare program that doesn't have its share of "bugs," and the earlier they are located and fixed the sounder the product will be.

In short, those responsible for the program try to make their mistakes *on paper* where possible, as early as possible, and in-house rather than out in customer-land.

They also recognize that, even with in-depth planning, they're not going to

get everything right, and they budget accordingly with respect to dollars, people and time. They're realistic, and they leave themselves plenty of leeway.

How did these 50 people get to be so smart? Well, most of them aren't any smarter than anybody else. They're just more experienced. They made mistakes on previous go-arounds, most likely as part of somebody else's business.

What about the 150 who blew it? Well, if one of their products gets reviews, you're likely to read something like: "I was surprised at the lack of a user manual. However, the developers assure me that . . ." And that's the end of them.

---

### Introduction

---

It's not possible for you to buy a product you've never heard of, right? So when a product is introduced, the objective is to get it noticed—and there are only two ways to go about it.

The first way is through advertising—which costs money, something maybe only 10 or 20 of our 50 survivors have.

The second way is through publicity,

which is free if you have an original and newsworthy idea. But if the idea is less than original, you are going to find yourself competing for the attention of overworked product news editors, who are very busy people.

Remember the 800 products we crossed off at the time of conception? This is the time when their developers find out nobody cares and they've lost the game.

All that work for nothing. Like babies born with some congenital heart defect, the products, unless treated, die just when they ought to be entering the world of adulthood.

At this point we have 20% of our 1000 products surviving the "me too" syndrome, and 25% surviving the "lateness" syndrome. These are independent issues, and any statistician will tell you that the total survivorship is down to 25% of 20%, or just 5%.

Already we have reduced the field of 1000 entrants to 50 or so . . . and success is still not in hand. Because just as people can't buy something they haven't heard of, or that isn't available, they *won't* buy software they haven't seen reviewed. And review editors are busy

crocomputer software products through a retail channel. And so, we said, 'Gee it'd be an awfully smart thing to get some product that was kind of like this out as quickly as we could, so if we had any mistakes to make, we'd make them on that product, learn on that, and do the MBA right.'

And that's exactly what he did. Formerly, with his own management consultant firm, Gib had been working on improving management productivity. It was there that the idea was born that software and personal-computers could solve some of the multiple data-processing problems most corporate managers were facing.

With the objective of developing software for this untapped market, Context Management Systems was formed in 1980. Coincidentally, Gib had already built the basis of Connector as a proprietary program for a client. It seemed the perfect product to launch the new software company.

Securing the marketing rights, CMS modified the program to make it more generic, packaged it, and introduced it at Comdex in June 1981. The company only expected to sell a few hundred units. The idea, right from the start, was to get Connector on the market to learn the ins and outs of how the system of software development worked.

The company was prepared to weather about a year of unprofitable business as part of its growth process. And it's a tribute to Gib's business acumen that it was. In the six months Connector was on the market, CMS sold a total of only about 1000 units. And five major corporations accounted for about 75% of that. "By anybody's objective standards, 1000 units is not a gold record in the microcomputer software business," Gib said. "But we learned a helluva lot."

---

## Selling 1000 units is not a gold record in the software business

---

One of the things they learned was that effective marketing research required a little more than simply telephoning around to find out what percentage of their targeted users had communications hardware on their Apple IIs. CMS failed to determine whether those targeted users could use the

product, or even understand their need for it.

"It's kind of a tool on top of a tool. VisiCalc was the tool. This was a utility to the tool. It's so far removed from the end result that people had a hard time figuring out what the use was." That combined with the fact that many MIS departments weren't very receptive to having their mainframes spilling their guts to a bunch of little Apples.

Lesson #2 was packaging. Connector was dressed in a small box done in a downtoned brown and beige—executive colors—with a "fruit" placed as the first "o" in "Context Connector". There was no information on the box describing the product. More time was spent discussing what the fruit was than on what the product did. (It was an orange, symbolizing California's being citrus country.)

If that wasn't bad enough, there was also a problem understanding the product's name. "Some people expected to open up the box and find alligator clips."

Lesson #3 was about selling. The product was distributed nationally through the only two major retail business outlets at that time—Computerland and Softsel (there was also some direct mail selling at the full retail price of

*(Continued on page 98)*

people too, absolutely drowning in a flood of new products ("Oh brother! Another mouse-driven windowing integrated relational business data management system."). So now the battle is for the attention of the product review editors, and that is tough going for any new product.

Remember that we actually have not 1000 products on the market today, but more nearly 50,000. So when we have 50/1000 surviving, this scales up to 2500 survivors in all.

And how many reviews are printed in a year? Let's be generous and say that, after eliminating multiple reviews of the same product, the most widely read magazines manage to review 1000 different products in a year.

This is 1000/2500, or 40% of our survivors to this point. So where for each 1000 original products we had 50 surviving, of these 50 only  $0.4 \times 50$ —just *twenty*—are going to get reviewed.

That's right! If you subscribe to a lot of computer magazines, and if you read every product review in every issue, you will learn something about 2% of the products introduced in a given year.

### Distribution

Already we've narrowed the field from 1000 products to 20 publicized and reviewed products, and we've barely begun the selling battle—which brings us to the subject of market leadership.

Among our twenty viable contending products there will be maybe two original ideas. The other 18 are going to be "me too" products in two or three market niches—and they will have a tough uphill battle to fight, because they'll have to try to take business away from the leaders.

This is hard to do. Very hard.

Consider this: Take a moment to flip through any computer magazine. Count the number of advertisements for text editors. Look at the beautiful four-color layouts, the skillfully-crafted graphics, the tightly-composed ad copy... the sheer professionalism of it all!

Bet you didn't see a single ad for WordStar! In fact, can you recall when you last saw one? Probably no one else can either, but if you include stolen

copies, WordStar probably enjoys a 60-70% market share.

Another example: Lotus 1-2-3, a very reasonable product, was introduced with a masterful publicity campaign followed by three million dollars of costly startup advertising.

After nearly a year it is doing very well—but at the moment VisiCalc still outsells it two to one. So of the 18 well-built and reviewed "me too" products, how many are actually going to make it? Perhaps three. What will they have done differently from the other 15? They will advertise, heavily.

And of these three, probably only one will go on to become a second-tier leader. (A good example is James Tyson's JRT Pascal. Sure, he's currently in Chapter 11, but he'll be back.) What about the two truly original ideas backed by some advertising? One of the two will probably die for lack of sales, the product just not being needed sufficiently to repay the investment. (But such a death is merely a symptom. The cause of this form of death can be traced back to inadequate market research in

*(Continued on page 98)*

## THE STORY OF A NEW VENTURE: ARKTRONICS

By Josef Bernard

**A**RKTRONICS is a startup software company whose first product, Jane, is a mouse-driven integrated software package for the Apple II and other 8-bit computers. It contains a word processor, spreadsheet program, and list manager, and requires only 64K of RAM. Robert Kotick, a junior at the University of Michigan, Ann Arbor, is co-chairman of Arktronics. What follows are excerpts from an interview with Mr. Kotick.

**C&E:** How did Arktronics get started?

**Kotick:** We (Kotick and his partner, Howard Marks) were roommates at the University of Michigan. Howard had an Apple and an Olivetti typewriter, and we started playing around with them. We didn't really do it for commercial use; we did it for our own purposes and we realized that it might be something that could be successful. But it was the

*(Continued on page 100)*



Howard Marx (left) and Robert Kotick are marketing Jane.

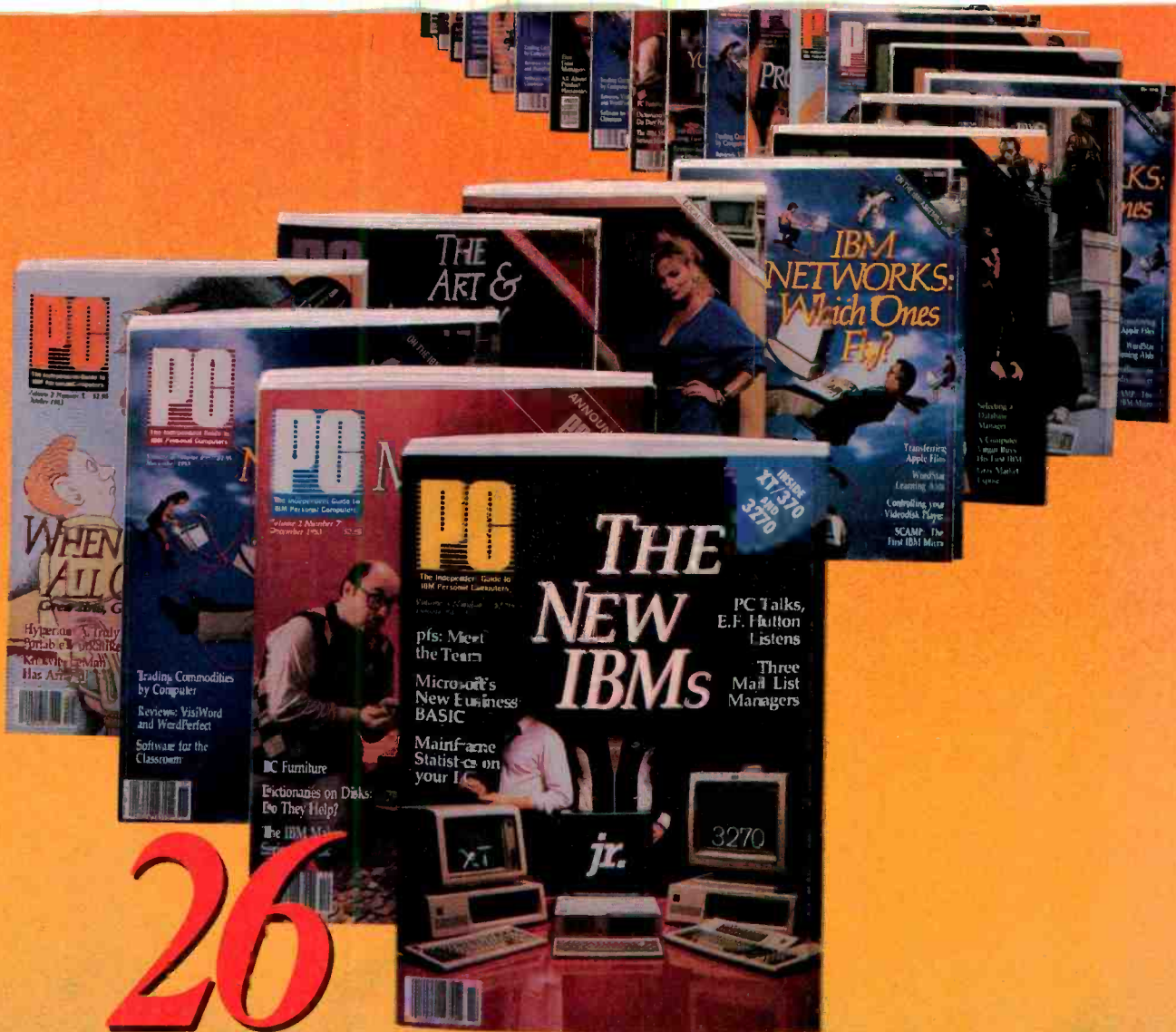

26

# REASONS TO SUBSCRIBE TO

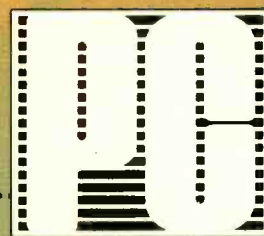

Your subscription will bring you 26 big issues every year of the most up-to-date facts and technological breakthroughs that affect you and your IBM or compatible personal computer. 26 big issues of *PC* delivered to your door AT UNBELIEVABLE SAVINGS!

Every other week you'll get a library of professional insights including latest coverage of newly-released hardware and peripherals. You'll find timely information on innovations in programming, applications and networking. You'll communicate with professionals and users like yourself and get reviews of new software packages, some before they even hit the shelves.

You can subscribe to *PC*, The Independent Guide To IBM Personal Computers for as little as \$1.02 an issue! Use the attached card or the coupon at right TO SUBSCRIBE TODAY!

GET THE MOST UP-TO-DATE INFORMATION FOR YOU AND YOUR PC WITH *PC*, 26 TIMES A YEAR!

26 SUBSCRIBE TO

P.O. BOX 2443 • BOULDER, CO 80322

26

YES, Please enter my subscription to *PC* for:

- 26 issues (one year) for only \$29.97... LESS THAN \$1.16 A COPY!
  - 52 issues for only \$52.97... LESS THAN \$1.02 A COPY!
- Full one-year subscription price \$34.97. Single copy price \$2.50.

Mr./Mrs./Ms. \_\_\_\_\_ please print name in full 8H641

Company \_\_\_\_\_

Address \_\_\_\_\_

City \_\_\_\_\_ State \_\_\_\_\_ Zip \_\_\_\_\_

Check one:  Payment enclosed  Bill me later  
 Charge my:  American Express  Visa  MasterCard

Card No. \_\_\_\_\_ Exp. Date \_\_\_\_\_

Add \$52 a year for postage to Canada and all other foreign countries. Please allow 30 to 60 days for delivery of first issue.

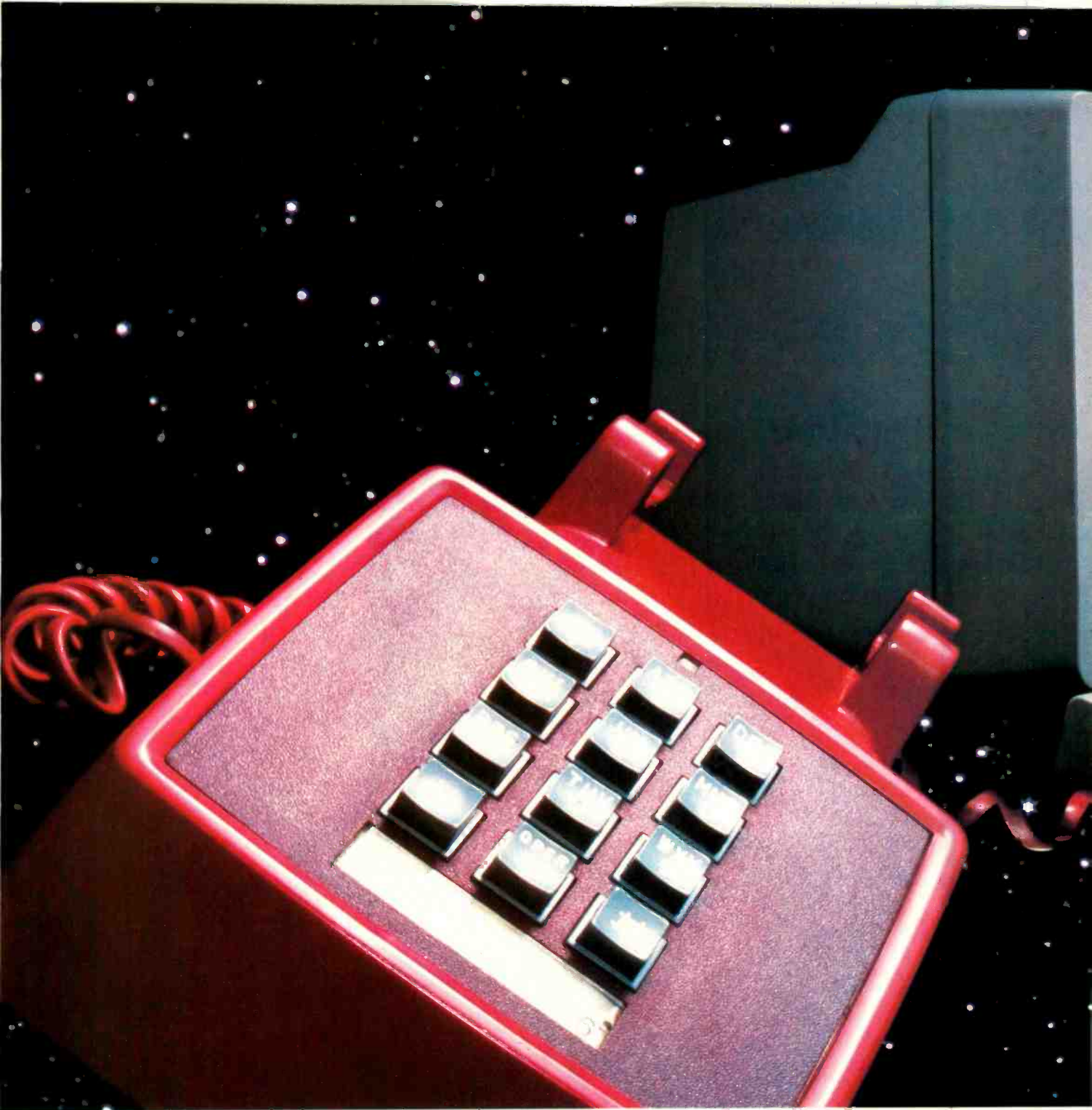

# NOW LET YOUR COMPUTER REACH OUT

*Telephone management systems bring a new  
range of applications to personal computers  
By Anita Seelig*

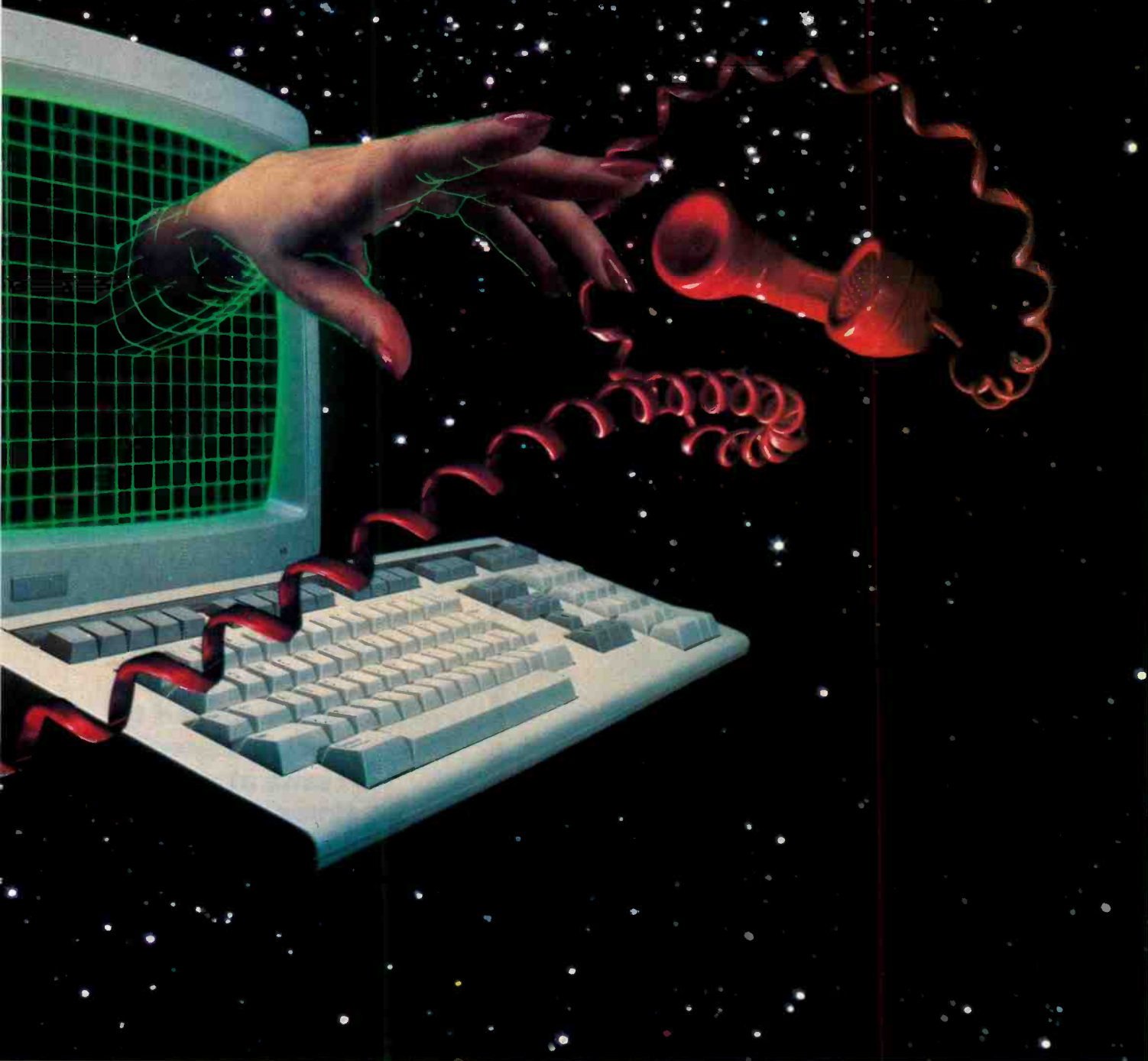

**T**HE telephone has long been one of the most vital pieces of business equipment. Now, with microcomputers edging their way into offices, it's natural for the two machines to shake hands and come out communicating.

To this end, a new kind of product has been developed for various microcomputers. It's called a Telephone Management System (TMS) and its

*Anita Seelig, a former newspaper reporter with a degree in journalism, writes about business and high technology.*

purpose is to link the intelligence and memory capacity of a microcomputer with the communications capability of the telephone.

A TMS uses both voice and data communications. Some of its basic features include automatic dialing, delivering outgoing phone messages, receiving incoming phone messages, and providing playback of recorded messages that can be accessed directly or remotely from a telephone.

Though some of these features may appear to be the same as those found on telephone answering machines, a TMS

has more sophisticated capabilities. In addition to handling both voice and data communications, a TMS can be programmed to perform specific tasks at specific times, and provide password security, among other things.

Some of the current systems available are Texas Instruments *Speech Command System* for the TI Professional Computer, Digital Equipment's *Telephone Management System* for the Pro 350, Intelligent Technologies *PC Express* for the IBM PC, and Tecmar's *ELAN* also for the IBM PC. Prices range from about \$900 to \$3600, though

# Telephone Management

they generally reflect a total office-automation configuration rather than just the TMS package.

## A Day in the Life of a TMS User

The features of individual TMS product vary from system to system. To provide a general overview of the capabilities of a typical TMS product, we set up a scenario of a day with a business executive, from early morning until evening. Later we'll discuss the specific features of each system.

*Early A.M.* New York. You receive a wake-up call from the office computer. Answering, you hear a digitized version

of your own voice—pre-recorded through your TMS the day before—reminding you of your trip to Boston later in the day. In rapid succession, three members of your staff receive similar calls.

After breakfast, you call the computer for voice messages that may have arrived from the West Coast after you left the office last night. (Password protection gives you reasonable reassurance that no one else has access to your messages.) You instruct the computer to store two of the messages by entering appropriate numbers from your telephone keypad.

*Nine A.M. to Noon.* As you enter your

office, you note an illuminated light, which indicates waiting mail. You select the mail menu on your office personal computer with a few quick keystrokes. Three letters have been received.

The TMS gives you the date and time each message was received, along with the person who sent the "letter," and a one-word subject description. Of the three letters, one from a vice president in a branch office is marked "confidential." You enter your password and read it first. To reply, you type and send an answer, which reaches the vice president's PC a few minutes later. The two other messages are sales reports, which you route to the appropriate departments with your comments. You retain a copy of each message on a file on your system.

You then check your calendar on the screen, noting appointments and a reminder to call the accountant. You punch a key that automatically dials the number of the accountant from a database dictionary of names, addresses and telephone numbers. As usual, the line is busy, so your TMS begins redialing

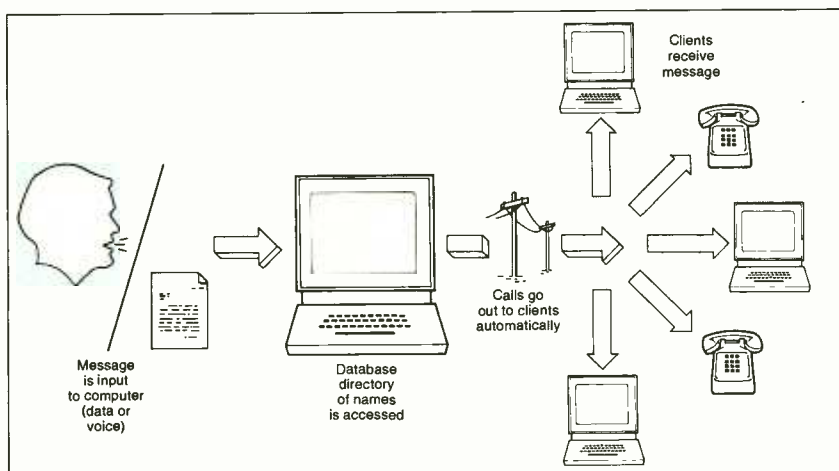

Voice or data can be sent to a number of people.

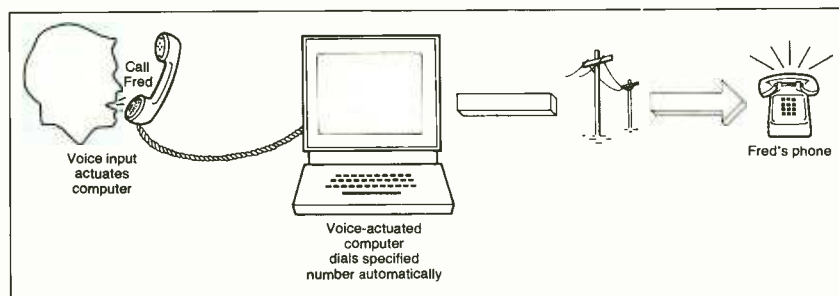

Voice recognition speeds the dialing process.

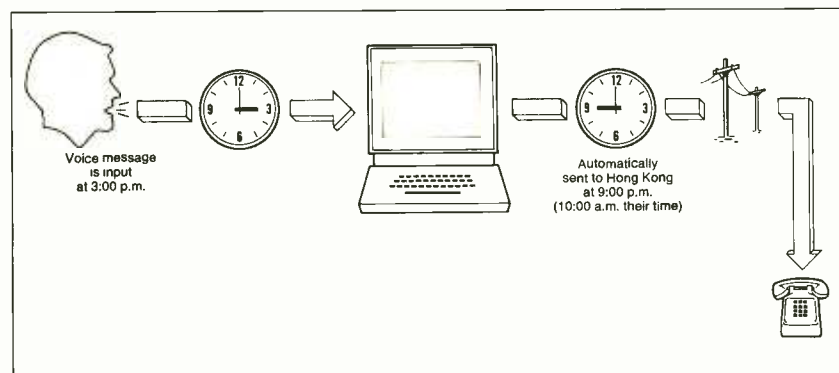

Time-delayed messages can be sent automatically.

## TMS can be programmed to perform specific tasks at specific times and provide password security

while you begin other business. A short time later, you hear the accountant's voice over the speakerphone and you proceed with your conversation. The TMS automatically stores a record of the call by date and time and the length of the call, for administrative purposes.

A while later, you wish to see the marketing forecasts for the coming three- and six-month periods. You load your electronic spreadsheet, call the manager of the marketing department and begin a desk-to-desk teleconference, discussing the forecasts you and the manager are viewing simultaneously. After some discussion, you both agree on changes, and you send him a revised spreadsheet.

The next order of business is to compose a letter to all sales offices. You dictate the letter to the computer, and store your digitized words on a disk. Your secretary "plays" the disk and types the letter into the computer. She instructs the TMS to send a copy to everyone on

your sales distribution list.

*After Lunch.* Before leaving for the airport you want to make a quick check on your stocks. Through stored "login" sequences, the TMS dials your subscriber information service, logs you on to the system, and instructs it to give you a listing of your current day quotes. Satisfied that your investments are in good order, you record a message on the TMS for incoming calls and leave for Boston. One last thing, the Hong Kong office needs some figures. You leave a message containing the appropriate information and instruct the TMS to call Hong Kong at 9:00 p.m., which is just about 10:00 a.m. over there.

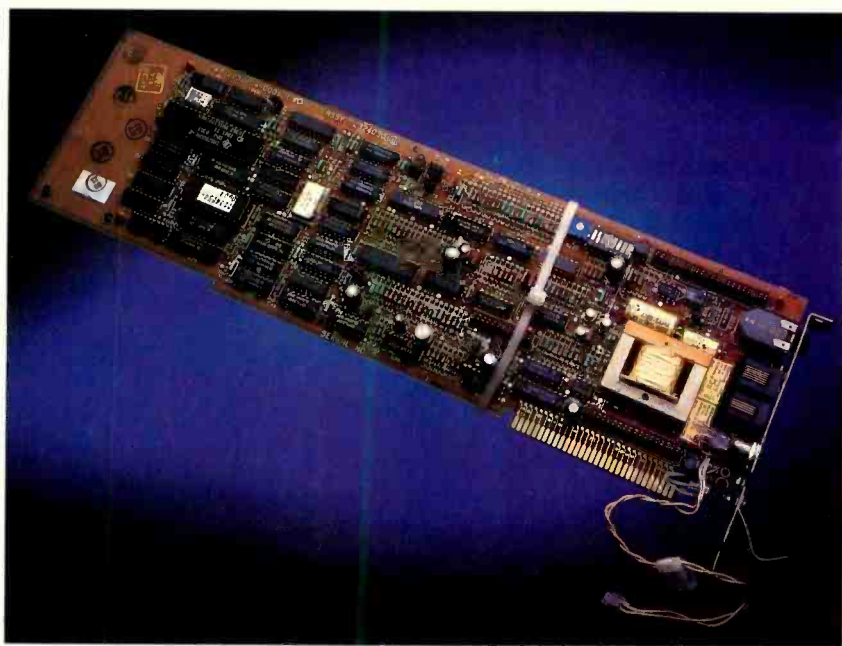

**Plug-in board for TI's Speech Command System.**

*Early Evening.* Boston. After arriving at Logan Airport, you remember that you need information on file in the office. You call the computer. It asks for your password, which you punch in using the touch-tone telephone. You punch in another sequence of numbers that tells the computer what you need, and it gives you the information in its familiar digitized voices. Before hanging up, you punch in another code to check on voice messages you've received since leaving the office. Satisfied that everything is in order, you jump in a cab to make your dinner appointment.

#### **Finale**

As is evident, a TMS adds a great deal of utility to an ordinary office telephone. The functions of a TMS are many but it is usually part of a total of

office-automation package. The overview of currently available products that follows discusses not only the TMS application but other available features as well.

#### **Texas Instruments: Speech Command System**

TMS capability is available from Texas Instruments as part of the Speech Command System (SCS). A turnkey application package, SCS uses voice-recognition and synthesis to enhance both TMS and other software applications. *(Editor's note: The voice-recognition properties of SCS were reviewed in the*

*December, 1983, issue of COMPUTERS & ELECTRONICS.)*

The TMS is used for enhanced telephone dialing, as a calling machine, and as an answering machine. Enhanced dialing includes such features as automatic dialing from a computer phone directory and speed dialing from the telephone keypad. Calling machine features include calling at a specified time of day, playing prerecorded messages when the call is answered, and waiting for a response, if desired (which is recorded for later review). Answering machine features include answering the phone with a prerecorded greeting and then recording the caller's message. Messages can be reviewed directly or remotely from a touch-tone phone. Combining speech recognition with the TMS allows a user to do such things as dial a number by just saying something like

"Call CompuServe," or have the computer respond to voice commands from another phone.

The voice coding feature, which converts human speech into digital values for storage and playback, uses a unique system that stores up to 16 minutes of speech on a standard 320K diskette, up to four hours on a 5M Winchester disk, and eight hours on a 10M Winchester.

Besides TMS functions, SCS can be integrated with any TI Professional Computer MS-DOS software. The Transparent Keyboard feature enables a user to have verbal communication with the computer, in addition to regular keyboard input. One spoken word can replace up to 40 manual keystrokes within a software application.

Other features of SCS are a daily calendar for setting up agendas and scheduling appointments, and a dictation machine. Speech, which is recorded at a rate of 2400 bits per second, is converted to digital data and is available for later playback.

All voice processing uses TI's high-speed TMS320 digital signal processor (see article in this issue) to perform real-time voice analysis and synthesis. The telephone interface is performed with another TI processor chip, the TMS7000.

For the most effective use of SCS, the user's TI Professional Computer should have 256K RAM. Mass storage requirements are flexible, however. The product will perform with a single floppy disk drive, dual drives, or a Winchester and a floppy drive.

The Speech Command package includes two piggyback circuit boards (fit into one slot on the TI-PC), a headset, a user's manual, two software diskettes, an installation/diagnostics guide, a diagnostics diskette, and a telephone cable. The complete kit has a suggested list price of \$2600.

#### **Digital Equipment Corporation: Telephone Management System**

The TMS from Digital Equipment Corporation (DEC) combines the functions of several devices: calculator, computer terminal, telephone, answering machine, dictation machine, Rolodex, speed dialer, and modem. TMS combines voice and data communications with the power of the Professional 300 Series computers and extends that power by providing data communications, voice recording and playback, and telephone call handling.

In data communications, information

*(Continued on page 109)*

# HIGH-SPEED SIGNAL PROCESSORS

*The chips that make today's speech recognition and computer vision systems possible/By Ed Teja*

**S**OME computers, these days, can talk and listen to their operators; and a robot might be able to find a needle in a haystack. However, complex operations such as these require more (and faster) capability than the average general-purpose microprocessor can deliver. To meet this need, a class of specialized devices, called digital signal processors (DSP) has been developed.

Digital signal processors do exactly what the name implies. Digital signals are input to the chip and certain processing is performed. You might want to apply a standard mathematical manipulation, such as a fast Fourier transform (FFT), or you might have some other specialized process in mind (examples will be given later). The TMS320 family of DSP chips from Texas Instruments is a powerful example of currently available chips ideally suited to the handling and processing of digital signals.

The TMS320 lends itself easily to jobs that general-purpose microprocessors would find impossible to perform in a reasonable period of time. For the TMS320's forte is speed. It processes 5-million instructions in a single second and can multiply two 16-bit numbers together in the time it takes to execute a single processor instruction—200 nanoseconds. When it must multiply a series of numbers (doing matrix algebra, for example), the chip performs the multiply operation every 400 ns. The extra 200 ns required for these additional multiplications is used to load the appropriate registers with the two numbers that are to be multiplied together.

## Designing for Speed

Designing a processor that provides high performance in handling numbers (what programmers call number crunching) isn't a matter of chance, but

*Ed Teja is a free-lance technical author and frequent contributor to C&E.*

of careful chip design. Internally, the TMS320 is a 32-bit microprocessor. It automatically performs double-precision arithmetic quickly. But beyond this strong beginning, special architectural features adapt the chip to the task of signal processing.

A conventional microprocessor, regardless of who makes it, is laid out much like the block diagram shown in Fig. 1. This general chip design, known as the Von Neumann architecture, is the

sign plan termed the Harvard architecture, which separates data and program memory. The design provides each of these memory areas with its own independent 16-bit bus, as shown in Fig. 2.

Not all of the programs and data memory need be inside the chip. A 144 by 16-bit RAM that the chip uses for data memory furnishes enough to process a 64-point complex FFT (which it executes in 580  $\mu$ s) and leaves sufficient memory for the chip to perform other

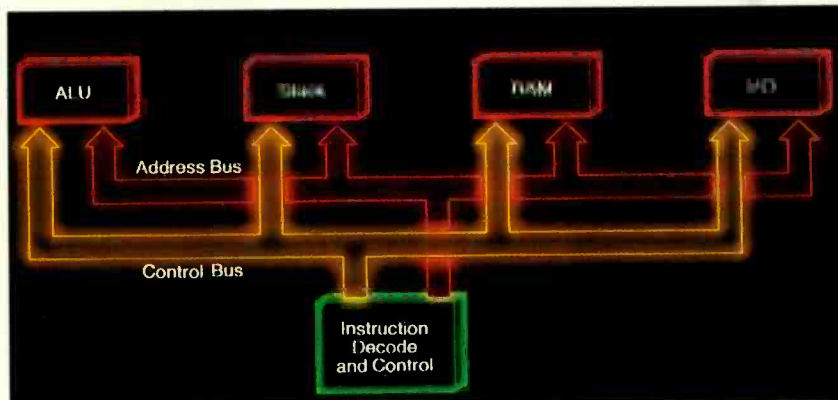

**Fig. 1. Block diagram of a conventional microprocessor.**

standard approach to building computational machines. The differences among general-purpose processors, such as the 8086 and 68000, lie more in how they provide these functions and the format of their instruction sets than in the nature of the functions and capabilities provided.

But the Texas Instruments' DSP chip isn't a general-purpose microprocessor chip; it is an extremely fast number cruncher. Therefore, the designers used an approach unlike that of most processors—they took a page from the books of those who build artificial intelligence systems. A typical Von Neumann microprocessor stores data and programs in a common memory area. Thus, the processor must keep track of where it stores each type of information. The TMS320's designers relied on a de-

functions, too. For instructions, the TMS320M10 version of the chip addresses up to 1536 by 16 bits of on-chip program memory (ROM) and 2560 by 16 bits more of RAM that sits off of the chip. On one version of the chip, the TMS32010, you address 4096 by 16 bits of off-chip memory at full speed; there is no program ROM at all on that chip.

Separating the data and program memories and giving each its own bus increases the processor's operating speed. When the processor fetches an instruction from program memory, it can fetch the data that it needs from data memory at the same time. Each bus operates independently. A conventional processor would have had to use two instruction cycle times for this job—one to fetch the instruction and one to fetch the data. This speed advantage is an in-





**Fig. 2. The Harvard architecture of the TMS320 microprocessor.**

herent feature of the Harvard architecture. But what if you want to mix instructions with data? Some branches in a program are controlled by data.

To take care of these problems, the TMS320 departs a bit from strict Harvard architecture and provides a cross-over feature. The Table Read (TBLR) and Table Write (TBLW) instructions transfer values from data RAM to program memory. It takes three instruction cycles to execute either instruction, however. You can also use the IN and OUT instructions to transfer data from a peripheral to data RAM. These instructions take only two cycles.

A further factor in the high-speed formula of the TMS320 is the use of a special circuit called a hardware multiplier. This circuit is dedicated to the job of multiplying 16-bit numbers and producing a 32-bit result. Carrying out all arithmetic operations to 32 places helps prevent errors from building up as the processor performs a series of calculations. A small error early in the calculations could easily lead to a large mistake later on.

In a general-purpose processor, all of the arithmetic is performed by the arithmetic logic unit (ALU). In addition to the multiplier, the TMS320 also has an ALU that operates on 32-bit data. The ALU performs addition, subtraction and logical operations on data. But, unlike general-purpose processors, the 320's ALU has little to do with multiplication.

Multiplication, to a microprocessor, is actually a series of repeated additions. It can take a processor some time to multiply large numbers because it has to execute an addition program, or algorithm, that adds the numbers enough times to equal the correct answer. The ALU typically multiplies numbers by following the multiplication program (algorithm). This algorithm configures the hardware to act according to the block diagram shown in Fig. 3, and effectively tells the processor that the problem  $2 \times 3 =$ , which the ALU doesn't understand, is the same as  $2 + 2 + 2$ , a problem it can solve easily, given enough time. But the addition, simple as it is, requires several extra instruction cycles. The answer is stored in the accumulator.

A hardware multiplier circuit is specifically designed to multiply the numbers in one instruction cycle. The on-chip hardware does exactly the same thing that the program would do, but it does it with a single processor instruction, and quickly—within 200 ns. In the

*(Continued on page 106)*

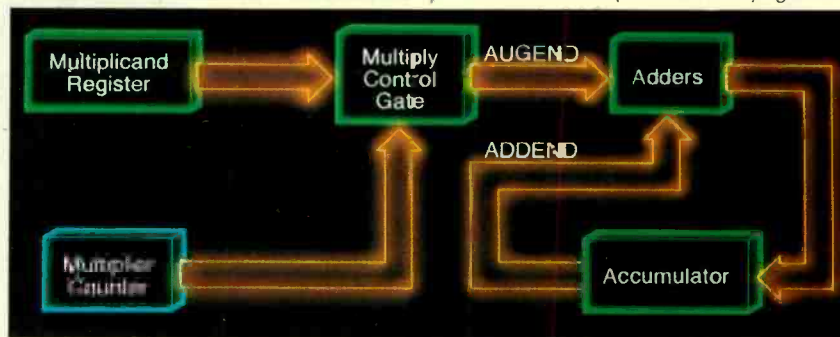

**Fig. 3. The ALU's additive method of multiplication.**

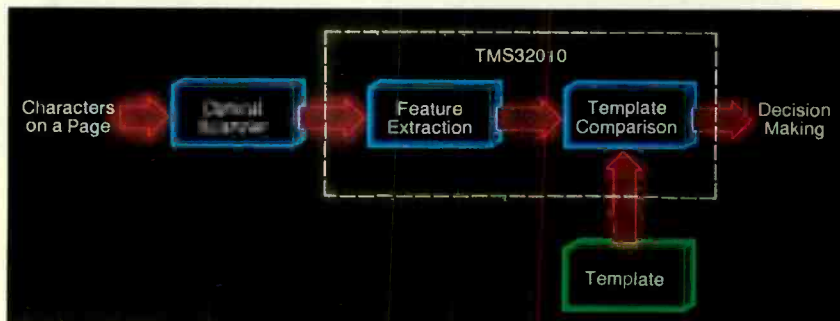

**Fig. 4. The DSP makes optical character recognition easy.**

# SINCLAIR'S NEWEST BOMBSHELL

*The Sinclair QL promises to change the rules of the computer pricing game/By Les Solomon*

**I**N computers, the name Sinclair has always been synonymous with physically small, very-low-cost computer packages like the ZX80 and ZX81. In the United States, these and the latest (until now) Sinclair computer, the TM 2068, have been sold in conjunction with the Timex name.

Now Sinclair has introduced the QL (as Sir Clive Sinclair defines it—the Quantum Leap) computer, its first try at a small business system. A far cry from the small computers that made them famous, the Sinclair QL is priced at \$499—but it offers quite a bit for the money.

When will you see it? Well, it's expected to be available in England by now, and as soon as it has its American design finished and passes the required FCC tests, it will be here. This is esti-

mated to be about the middle of the summer. However, don't look for it under the Timex label, as it is purely a Sinclair venture.

## A Look at the QL

This  $5\frac{3}{8}'' \times 1\frac{3}{4}'' \times 18\frac{3}{4}''$ , 3-lb package features an 16/32-bit Motorola 68008 running at 7.5 MHz as the main CPU with an Intel 8049 handling such housekeeping chores as the keyboard, sound, RS-232C ports, and real-time clock. Since the 68008 can address one megabyte of non-

segmented address space, it can be provided with a wide variety of peripherals and enhancements. Four Sinclair-designed semicustom IC's control memory and display, local-area networking, RS-232C operation, and the microdrive data storage system.

The basic system comes with 128K of RAM expandable to 640K via a RAM pack, and 32K of ROM supporting Sinclair SuperBASIC and Sinclair's new QDOS operating system. The two built-in microcassette drives (similar to those used in previous Sinclair machines) hold 100K each and can be complemented by six external microdrives for a total of up to 800K of data storage. Each microdrive can be write-protected, contains 200' of video-quality tape moving at 30 ips, and has a typical access time of 3.5 seconds (7.5 seconds to make a full pass). Storage is divided into 255 sectors at 512 bytes per sector. There is no cassette I/O port.

The full-size, full-travel, 65-key QWERTY keyboard has five function keys, four independent cursor-control keys, and a normal-size space bar. A membrane under the keyboard protects the electronics from accidental damage



due to liquid spillage over the keys. The keys "click" when fully depressed to indicate that proper contact has been made.

High-resolution color graphics are available at both baseband video and r-f (channels 3/4). There are two modes—512 × 256 pixels with black, white, red, and green; or 256 × 256 pixels with blue, magenta, cyan, and yellow added. The video display uses 32 K of RAM.

*Les Solomon was one of the few U.S. journalists at Sinclair's official unveiling of the QL in London.*

Alphanumerics are software controlled to display 85 characters on 25 lines for suitable video monitors, or 40 characters when a TV receiver is used.

Also provided are two RS-232C serial ports with baud rate selectable between 75 and 19,200 baud, and a local area network that allows up to 64 QL's or Sinclair Spectrum's to intercommunicate at 100K baud. Two joystick ports, and a ROM cartridge connector are available via rear apron connectors.

### Operating System and Basic

The operating system for the Sinclair QL is called QDOS. In addition to conventional DOS commands, QDOS also provides multi-tasking and up to 20 independent "windows" that can be configured as the user desires. These can be "called" by a simple WINDOW statement in Sinclair SuperBASIC, with a selection of parameters and colors. Thus, a number of programs can be running simultaneously with each independently displayed within its own window.

Sinclair SuperBASIC contains the usual BASIC commands and statements, as well as such items as BAUD (rate select), BEEP (with various parameters to create desired sound), window BORDER color, CIRCLE (parameters), SCREEN (set character size), CURSOR x/y (for positioning), DRAW (from/to), EXEC (sequence of programs), FLASH (on/off), REPEAT (if, then), PLOT (at), PAPER (background color), PAN (move current window right or left), MODE (monitor or TV), SBYTES (allows area of memory to be saved), SCALE (of graphics), SCROLL (display up or down so many pixels), TRACE (on/off), UNDER-(line), and others.

### Bundled Software

Bundled with the Sinclair QL are four software packages. All are interactive and take advantage of the color display capabilities. The first bundled package, QL Quill is an interactive word processor and includes all the usual facilities such as insert, erase, copy, move, search, replace, tabs, headers, footnotes, justification, etc. This software will support 40/60/80/132 characters. Like most good word processors, the screen display can be divided to show status, control, and the main writing area. A help menu is provided and color is used to good advantage. Frequently used editing commands can be assigned to a single function key if desired. Data from any of the bundled packages can be transported to any of the others.

QL Quill is a "what you see is what you get" type of word processor. This means that if you perform an action like boldface, you'll see it on the screen. Since the word processor can be used in the 40-column mode with a TV receiver, a "Viewing" feature is available that lets you check for overall layout and format of the page. This feature is also needed (even when a monitor is used) for viewing very wide documents.

The second package, QL Abacus, is the Sinclair version of a spreadsheet. In this utility, there are 256 rows and 64



The QL comes with two 100K microcassette drives

columns. To make calculations easy, the user can tie a "name" onto any row, column, or cell for use in formulas. Calculation accuracy is to 16 significant figures, and two or more spreadsheets can be consolidated or merged.

An important feature of QL Abacus is that it will automatically apply the rules or formulas entered to whole rows, columns, or blocks of cells in a simple manner. For example, "Row = 100" puts 100 in each cell of the current-row, or even more powerfully, one can set up the row "Profit" as "Profit = Sales - Costs" and the formula to subtract the row "Costs" from the row "Sales" is done automatically.

Other features of Abacus are the use of multiple windows, the variation of widths and justification of text, the use of different units including monetary (with arbitrary symbols), integer, percentage, decimal, and exponential form, and the ability to prompt an operator for the input of data as part of the worksheet. The screen can be selected for 40-, 60-, or 80-column widths.

The third piece of software, QL Archive, is a database that can be used for

almost any type of information retrieval with the screen and printout customized as desired. This software does not use SuperBASIC but a derivation of it that is much faster and uses some eighty commands.

Archive commands are arranged in a "Pyramidal" form. That is, the most commonly used commands are immediately available, with layers of secondary commands available via menus. Such features as sorting, searching, and selection of records are provided, along with full string manipulations, operators, and fast arithmetic. Variable length fields and records are used. Several examples are provided that can be modified by the user. Multifile searching and cross reference allows data from the other software to be used in the database.

The last bundled package, QL Easel, is an interactive graphics package that features eight preset formats that can be called with a single keystroke. This allows bar graphs of different colors and styles (stacked or overlapping bars, line graphs, pie charts, and combinations) that can be altered as required. Text or graphics can be placed anywhere on screen and moved as required by the manipulation of a set of "cross hairs." Colors of bars, borders, and backgrounds, can be selected from an array of 17 different ones, plus one color that the user can define himself. In the pie charts, any sector can be lifted out for ease of recognition.

Easel is also designed to handle data entry (via simple formulas), manipulation, display, and printout in a self-contained manner. Easel can retrieve data from Abacus or Archive, or send graphs to Quill for inclusion in a document.

Like the other QL packages, Easel also features three screen areas: status, control, and main areas. And, like the others, these can be changed as desired. Full color is used, with color selection available.

Each QL package comes on its own microcassette. All four packages use 320K of tape storage.

### Comments on the Sinclair QL

We had a chance to get a "hands on" look at the QL for about half an hour. We used it connected to both a TV receiver and an RGB video monitor. Since this took place in England, both the displays were in PAL chroma at 625 lines and 5.5-MHz bandwidth—somewhat better than the 525-line, 4.5-MHz U.S. equivalents. We could not run any

(Continued on page 107)

# THE INCREDIBLE SHRINKING CIRCUITS

*VLSI technology is packing more than 500,000 transistors on a chip and fueling the computer revolution*  
By Dev Chakravarty

**T**HE speed and capacity of computers, from mainframes to desktop personal models, have grown exponentially in recent years. Much of the credit for this growth goes to the advent of devices that utilize very-large-scale integration, or VLSI. This technology makes it possible for extremely complex and highly flexible circuits to be designed into tiny packages that can be relatively inexpensively incorporated into computer products.

VLSI technology is fascinating and understanding it will give you a feeling for the near and medium-term future of computer hardware. But before explaining VLSI, it is useful to recount the history of logic circuits leading up to today's cutting edge of computer technology.

## Five Generations

The first true digital computer, called ENIAC, was built in 1946 in a laboratory at the University of Pennsylvania. This extremely powerful computing device (for its day, of course) contained more than 18,000 vacuum tubes and 1500 relays and performed 500 add or subtract operations per second. Aside from the devices (tubes and relays, considered pretty primitive now) around which it was built, ENIAC differed from today's computers in two very important respects—it could not store programs, and it had to be hand-wired to perform specific computations. The first computer that could store programs in memory was the IAS machine designed by John Von Neumann.

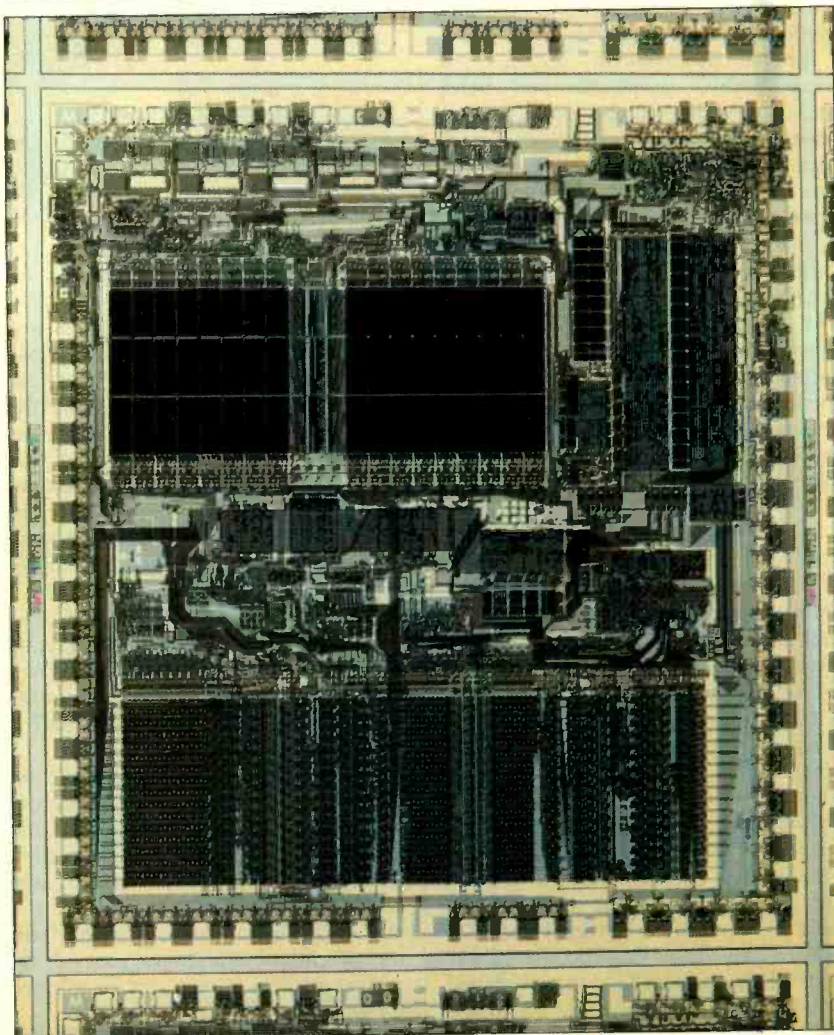

**Fig. 1. The VLSI M68000 contains more than 70,000 transistors.**

PHOTOGRAPHS COURTESY MOTOROLA INC.

However, ENIAC heralded the birth of computers and, as such, represents the first-generation machine. Such vacuum-tube-based computers occupied tens of cubic feet of space, had a host of those flashing lights that science-fiction movies of the 1950s and 1960s were so fond of, and required elaborate air-conditioning environments to remain in operating condition.

While vacuum-tube computer technology was being nursed through its developmental woes, a group of scientists at Bell Laboratories invented a new device in 1948 that was destined to change electronic technology in general and computer technology in particular. The new device was the transistor. It gave birth to such second-generation computers as the Burroughs B5000, IBM S/360, CDC 6600, and PDP-8. They increased computer operating speeds as much as 100 times and reduced cost by a factor of 10 over vacuum-tube computers.

## ENIAC contained 18,000 vacuum tubes and performed 500 additions/second

Discrete-transistor circuits gave way to the third generation of computers with the invention of integrated circuits (ICs). They made it possible for whole circuits consisting of more than one transistor to be fabricated on a flat silicon wafer in a single package. With ICs, circuit complexity, size, and cost dropped dramatically. Among the computers that characterized the third generation were the IBM S/370, PDP-11, CDC STAR, and TI-ASC.

Out of the early days of small- and

medium-scale integration (SSI and MSI) was born a family of large-scale integration (LSI) devices. These complex ICs, containing as many as 10,000 gates (transistor stages) per chip, formed the core of the fourth generation of computers, which included the ICL 2900, HP9845A, and nonstop Tandem. These computers were 100,000 times faster than and just a thousandth of the cost (in terms of computing power) of ENIAC and its contemporaries.

LSI technology had also made possible the microprocessor that heralded the appearance of low-cost microcomputers (also known as personal computers). Some notable microprocessors from this generation are the 4-bit Intel 4004 and the 8-bit Motorola M6800.

Having come through four generations, we arrive at the present, the fifth generation based on very-large-scale integration devices.

### What It Has Wrought

VLSI has made it possible to compress many thousands of logic gates into a single chip, with as many as 100,000 gates per chip. The implications of such a technology are many and far-reaching. Because of reduced distances, interconnect times are lowered and, thus, speeds are substantially increased. Moreover, the cost of manufacturing and using chips has plummeted dramatically.

Manufacturing costs have dropped because a single VLSI chip might replace hundreds of individual SSI and MSI chips, thereby providing a substantial saving on the cost of silicon and other expensive materials. Just as important is the reduced assembly cost for a computer manufacturer who uses VLSI chips in his products, since fewer chips are required and extremely complex circuits can be fabricated on small printed-circuit boards.

The impact of VLSI technology is best illustrated by some of the products that have already made it to the marketplace. The state of the art is represented by the Motorola M68000 microprocessor (Fig. 1), which contains more than 70,000 transistors on a single chip measuring  $246 \times 281$  mil (1 mil = 0.001")—about the size of a fingernail! The M68000 16-bit microprocessor can address up to 4M (4-million) bytes of memory because of its use of 32-bit addresses, giving it the ability to run extremely large programs.

Using 16 bits to store numbers with high degrees of accuracy in number crunching, the M68000 is a very useful



Fig. 2. The 64K-bit RAM was the predecessor of today's 256K RAM.

## Incredible Shrinking Circuits

tool in scientific and technical work. The M68010, an extension of the M68000, permits virtual memory operations that allow limitless amounts of memory to be addressed by the CPU.

To illustrate the power of the M68000, consider that the IBM/370 XT computer uses this device as its central processor. This desktop computer has the power of the huge IBM 370 that not too long ago occupied an entire room.

Another example of the influence of VLSI technology is the evolution of an

### **New applications will probably expand memory needs faster than higher- capacity chips can be made**

entire system onto a single chip. One such system is the RISC (Reduced Instruction Set Chip) computer developed at the University of California, Berkeley. An entire computer, complete with RAM and ROM was created in a single chip whose dimensions are smaller than those of the typical postage stamp. Among the innovations in the RISC's architecture are its hard-wired logic (instead of microprogrammed instructions) and registered window transfers.

Another tribute to the fifth-generation of IC technology is the VAX 11/780 computer, which brought mainframe capabilities to minicomputers and created a new breed of "super-mini" computers. Now VLSI architecture has enabled the Micro VAX chip to capture the computing power of the VAX 11/780 in a personal-size computer. The power of these computers inspired the term "workstation."

Many examples of workstations utilizing VLSI architecture exist. The super-mini Data General Eclipse has been condensed to a workstation with only five VLSI chips. The Apollo workstation uses the M68000 family to bring the power of the mainframe computer to the office desktop. In fact, in the not-too-distant future, parallel processor workstations with 16 to 64 processors will provide capabilities in excess of to-

*Dev Chakravarty is Strategic Marketing Program Manager of Motorola's Semiconductor Products Sector*

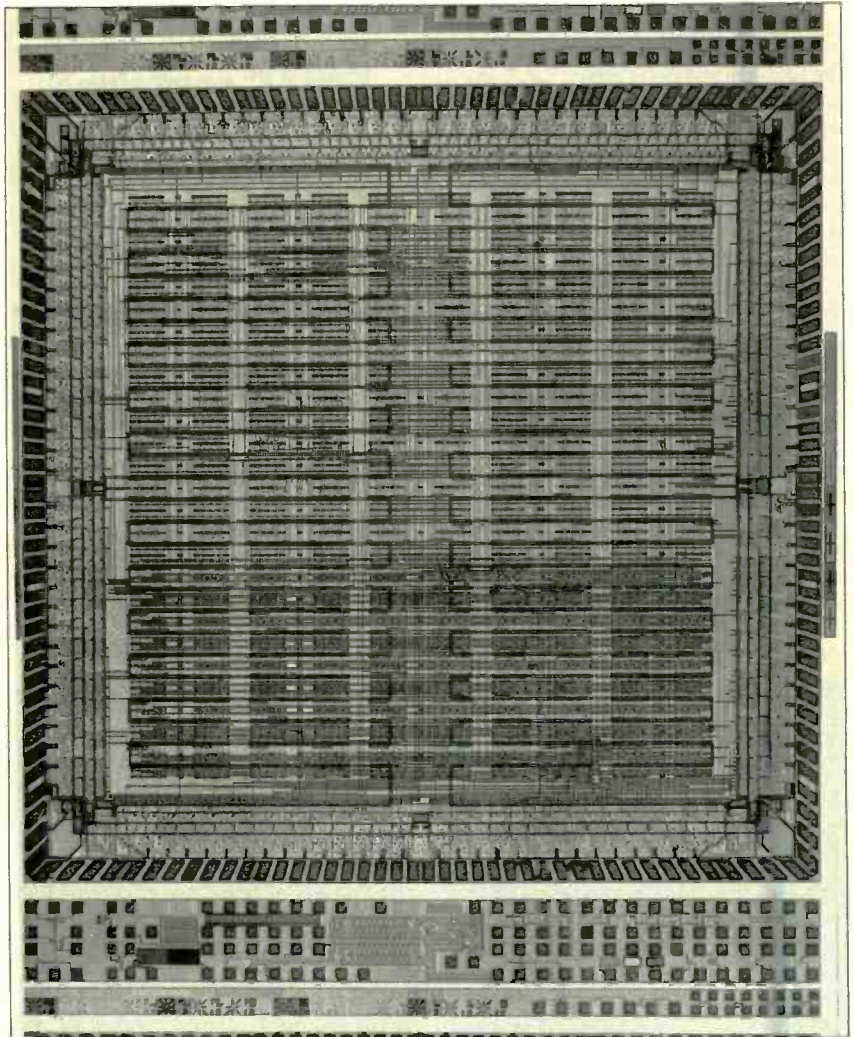
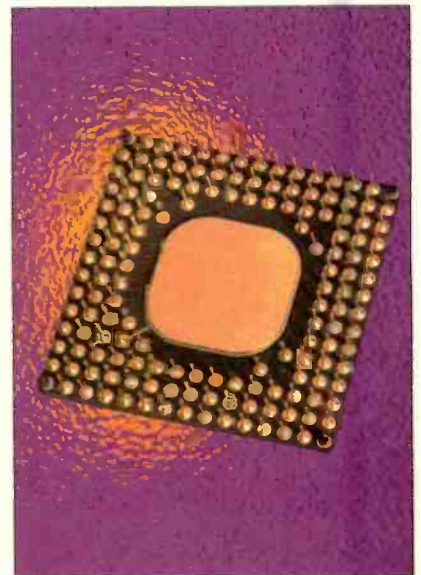

**Fig. 3. Gate arrays are typical of VLSI design tools.**

day's powerful mainframe computers.

The fifth generation of computers has been made possible not only by improved microprocessors, but also by rapid advances in VLSI memory chip technology. Five years ago, the 64K-bit memory chip (Fig. 2) was a novelty. Today, the 256K-bit DRAM is a definite reality. The fact that this chip contains 250,000 transistors in an area smaller than a postage stamp will give you some idea of its complexity and the phenomenal achievement it represents.

Memory evolution does not stop with the 256K-bit DRAM. The 512K-bit DRAM is under test production, and development is under way to produce a 1M-bit DRAM. When will larger memory chips no longer be needed, especially if VLSI technology progresses rapidly enough to permit more and more transistors to be squeezed onto a single chip? The answer is most probably never, since our appetite for more memory



**A multi-pin VLSI package.**

seems boundless. New applications, such as artificial intelligence (AI) and huge databases, will probably expand the need for memory at a rate faster than higher-capacity chips can be produced.

No discussion of VLSI technology would be complete without mention of the cost implications for the industry. VLSI architecture has not only brought about denser logic and faster speeds, it has also significantly reduced both fabrication and user costs. This is exemplified by the enormous decrease in the price of memory devices. Dynamic RAMs (DRAMs) have decreased in price from 5¢ per bit in 1978 to a projected 0.3¢ per bit by 1988. Since memory accounts for a significant portion of a computer's price, this trend has been a major factor in the tumbling prices and increased capacity of all types of computers.

### ASIC

Beyond processors and memory devices, VLSI architecture brings to the computer industry a new breed of integrated circuits, called application-specific integrated circuits, or ASICs for short. These ICs, like traditional ROMs, can be customized by the designer to fill the specific requirements of a particular application. ASICs can be had as programmable logic devices (PLDs), gate arrays (Fig. 3), standard cells, MCU-based macrosystems, and full custom chips.

### VLSI Design

Traditionally, the systems designer familiar with standard logic has at his disposal a vast portfolio of large-scale circuit elements from which he can create ingenious circuits on a breadboard. To convert the breadboarded designs into VLSI products, however, requires a monumental effort. Hand layout of custom circuits by a team of IC designers is very costly. A year or more of effort is required to bring a VLSI device to fruition, depending on complexity and number of transistors per chip.

Two strategies are being used to re-

**Fig. 4. Some of the proposed packaging options for VLSI.**



**A 6" pure silicon ingot, before being cut into wafers for fabrication.**

duce design time and effort. One is the heavy use of the growing portfolio of ASIC products to simplify the design process. The other is automated hierarchical structured design methods, such as "silicon compilers," to build full custom circuits.

The tools in the ASIC portfolio, in increasing order of complexity, are PLDs, gate arrays, and standard cells. The more complex tools provide the benefits of increased silicon efficiency and, consequently, higher logic densities and lower costs (especially for high vol-

umes). Creating system designs with PLDs is a simple procedure. Design time is in minutes, and the hardware "programmers" required to burn the PLD cost only a few thousand dollars. In using a PLD, the designer first defines his logic problem as a truth, or state, table if the circuit is sequential. Using the table, a software program automatically converts the problem into a Boolean equation from which a compiler fuse map is created. The fuse map is then used to "burn" selected fuses in the PLD exactly as specified by the table. Thus, with a minimum of effort, the designer can create a custom IC that is specific to his design requirements.

Designing with gate (or macrocell) arrays is a more difficult problem but permits development of more complex chips. Gate arrays are basically preprocessed wafers with macrocells similar to the familiar standard logic functions. Using an engineering workstation, a designer can call up these macros from a software library. He then draws a schematic layout on the workstation and checks the design using logic simulation.

Engineering workstations, themselves a product of VLSI technology, play a vital role in VLSI design. An engineering workstation typically has a VLSI microprocessor, 1M to 4M bytes of RAM and hard-disk memory, and performance comparable to that of super-mini computers.

In spite of this impressive architecture, the final stages of the gate array design are still largely accomplished with mainframe computers because of the high computing speed and large amounts of memory required. Once this is done, gate arrays are ready to be metallized so that macrocells can be connected to form a customized logic system. To give an idea of their complexity, a typical gate array contains 5000 equivalent gates, compared to the 500 equivalent gates found in a typical PLD. The design effort required to produce gate array devices is more costly than that for PLDs, and estimated time to prototype is 7 to 13 weeks.

Another ASIC device, the standard  
(Continued on page 94)

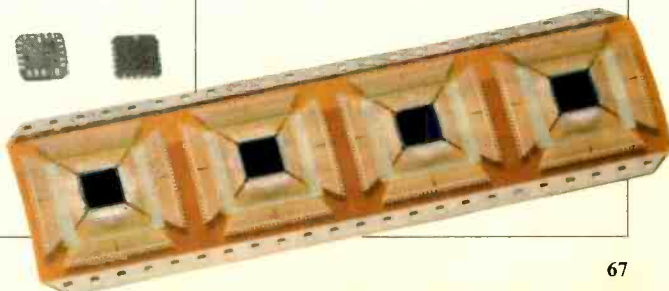
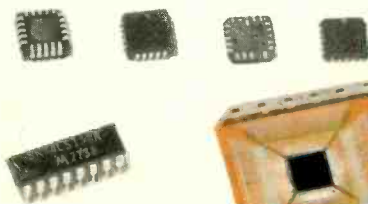

# ONCE OVER LIGHTLY BAR CODES



*What those banded patterns mean,  
and microcomputer products for reading and writing them*  
By Leslie Solomon

**T**HERE is one aspect of computers that has become a part of everyone's life—whether he knows anything about computers or not. This is the bar code that, in the last few years, has been imprinted on practically everything we buy—from magazines and books to packaged foodstuffs. In fact, bar codes are found on just about any item that can be inventoried. There are even magazines and books, publishing mostly computer software, that use bar codes to simplify program entry.

Bar codes are digital messages whose data are encoded as a series of dark bars and light spaces arranged across a simulated sticker. The data provides information on the item to which it is affixed—information required to maintain a complete record of that particular product. This may include its description, its generic identification, its price, its inventory control number, etc.

*Leslie Solomon is Technical Director of  
COMPUTERS & ELECTRONICS*

There is no "standard" bar code, and each of those described here came about with a particular purpose in mind. The only thing that can be considered standard is that each code is composed of a series of wide and narrow dark bars and light spaces (two-level code), in which a wide bar or space represents a binary 1 while a narrow bar or space represents a binary 0—or vice versa. (Although the bars and spaces making up a bar code may *look* familiar to digital enthusiasts, the binary systems used in bar codes are not in the ASCII format.)

Not all bar codes include alphabetic characters, although all of them do include numeric symbols and special control (nonprinting) characters. Many bar codes have a prefix (tag) that is used to define the value of a narrow width. Once this has been decoded, binary values of 1 or 0 are assigned to the other bars and spaces depending on their respective widths.

Some bar codes pass information only via the dark bars while others use

groups of bars and spaces to represent a single coded character. Some use color contrast or changes in reflectivity between the bars and spaces. (For example, a reflective space could be a binary 0 while a nonreflective bar or space would be interpreted as a binary 1.) To keep the data "honest," most codes use some form of parity or checksum check after each character.

## Decoding

Bar-code decoding is similar to data flowing from a modem into the serial port of a computing system. In both cases, the digital data that started out as a series of 1s and 0s have been converted into another form.

In the case of the modem, two discrete tones are used, one for a digital 1 and another for a digital 0. In the case of the bar code, one element of a particular bar code represents a digital 1 while another element represents a digital 0. In both instances, special techniques are



used to convert the codes into binary signals of the required voltage level.

In the basic example shown in Fig. 1, the photosensitive device is connected in series with  $R1$  between the positive voltage and ground. (Note that this circuit is for illustration purposes only. Actual circuits may be quite different.) When the photoresistor is dark, its resistance is maximum, which may be several hundred thousand ohms or more. When the sensitive surface of the photoresistor is illuminated, its resistance drops very low. Thus, as the black-and-white pattern (illuminated by an external light-source) passes in front of the photosensitive device, the output of the amplifier will be high when the dark element is present, and low when the light element is present.

The main element of most bar-code readers is a relatively small, hand-held "wand" that contains a light source, photodetector, and an electronic circuit used to shape the photodetector signal (Fig. 2). In operation, light from the light source is focused at a point slightly in front of the wand-tip opening and is reflected back into the probe where it is focused on the sensitive surface of a photodetector. An amplifier/shaper converts the slow rise-and-fall times of the analog output signal into crisp, sharp-edged signals (at the required voltage levels) for computer entry.

Although two discrete elements are shown in Fig. 2A for the light source and photodetector, at least one company (Hewlett-Packard) has produced a composite unit—the HEDS-1000 High Resolution Reflectance Sensor—that contains the light-emitter, photodetector, and lenses. The cable connecting the wand to the computing system also carries the required power leads.

In a typical wand, the optical sensor can read a bar code having widths as small as 0.3 mm (0.012 inch). This makes it ideal for reading bar codes produced by dot-matrix printers. Most light sources and sensors are designed for black-and-white bar-code displays, but there are some wands that read colored bar codes.

As the decoded data flow into the associated computer system, the software "waits" until a character is complete before entering it into the system.

Since most bar codes are read with a hand-held scanner, the proper reading technique is important. The desired scan trajectory is usually straight across the bars from left to right. However, some codes can be read bidirectionally. The trajectory can be at a slight angle, of course, but it must cut all the bars. The

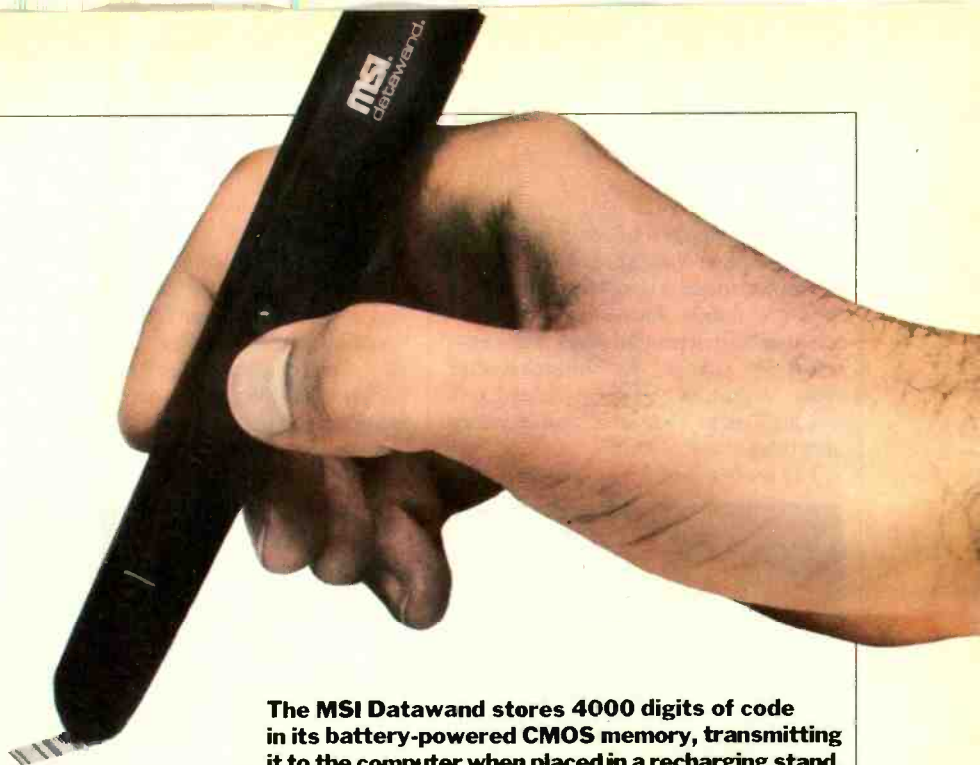

**The MSI Datawand stores 4000 digits of code in its battery-powered CMOS memory, transmitting it to the computer when placed in a recharging stand.**

scanning velocity—how fast the wand tip should pass over the bar code—usually ranges from 3 to 30 inches per second. (Manufacturers of bar code equipment usually specify a range.)

Since both the light source and photodetector within the wand are focused at the tip of the shroud, when reading a bar code, the wand must be angled as close to 90 degrees from the printed material as possible. The H-P HEDS-1000 detector will function properly if it is within 30° from the vertical. Failure to follow this rule may produce a faulty readout.

previously mentioned, there is no standard. Here we will attempt to provide enough information so that the reader will know the essential operation and purpose of each of the bar codes now in use.

*The 2-of-5 Family.* This industrial bar code gets its name from the use of two wide elements per five-element character. There are three members of the family industrial, matrix, and interleaved.

The bar code itself is formed from black bars and white spaces to provide the numeric character set from 0 to 9. In this case, a wide element (two to three times wider than a narrow element) is a binary 1 while a narrow element is a binary 0. Other features include non-character start/stop, bar/space pattern,

### Codes

Several bar codes have been introduced, some better than others. But, as

**Fig. 1. Basic circuit scheme for bar code decoding.**

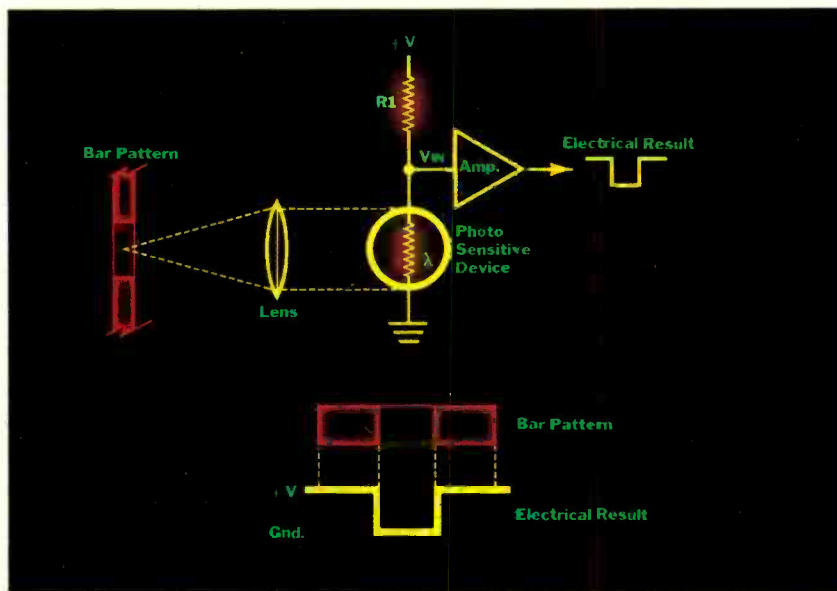

# Bar Codes

even-parity character check, and an optional message checksum character.

The *industrial* is the oldest member of the 2-of-5 family. Each character is represented by five printed black bars separated by spaces. An intercharacter space separates adjacent characters making each character independent (discrete).

The *matrix 2-of-5* approach provides

symbology is in the public domain), this bidirectional *alphanumeric* bar code (Table I) features 36 defined numeric and uppercase alphabetic characters, seven special characters, and a special start/stop character (the \*). This is the bar code that is usually used for representing computer programs.

Each character is represented by 9 elements—five bars and four spaces be-

code enables it to be printed by offset, letterpress, or dot matrix, making it particularly useful in publishing, general printing, point-of-sale, libraries, and postal systems.

To provide for data security, an optional checksum character may be appended to a 3-of-9 message. This checksum digit is the modulus-43 sum of all the character values in a given message and is printed as the last data character. For example, the total numeric value of "ABC123\$" from Table I is 78. When this number is divided by 43 it produces a remainder of 35. Since the alphanumeric associated with 35 is the letter Z, the final code will read ABC123\$Z. (Note that the check digit verifies only the data content of a message, not the order of the characters.)

Code 39 also includes a stop character (\*) that can be used at the end of a message to insure that all data has been captured (in some systems this symbol produces a beeping sound).

To convert Code 39 to an ASCII format (for example, for printing a computer program), the Code 39 data must be passed to a "look-up" table within the computer. In the table, each of the 42 characters is converted into its ASCII value before being entered into the system. Since Code 39 uses 9 data bits, one bit is deleted for use by an 8-bit microprocessor.

*Codabar*. Like Code 39, Codabar is a proprietary approach. This one, from Monarch Marking Systems (a subsidiary of Pitney Bowes), features 10 numeric characters, six control characters, and four start/stop characters.

Each character is represented by seven elements consisting of four dark bars and three light spaces. A wide dark bar or wide light space is a binary 1, while a narrow dark bar or a narrow light space is a binary 0. The bar code can be read bidirectionally and a self-checking feature has been included.

*The 2-of-7 Code*. This bar code provides a character set for encoding nu-  
(Continued on page 104)

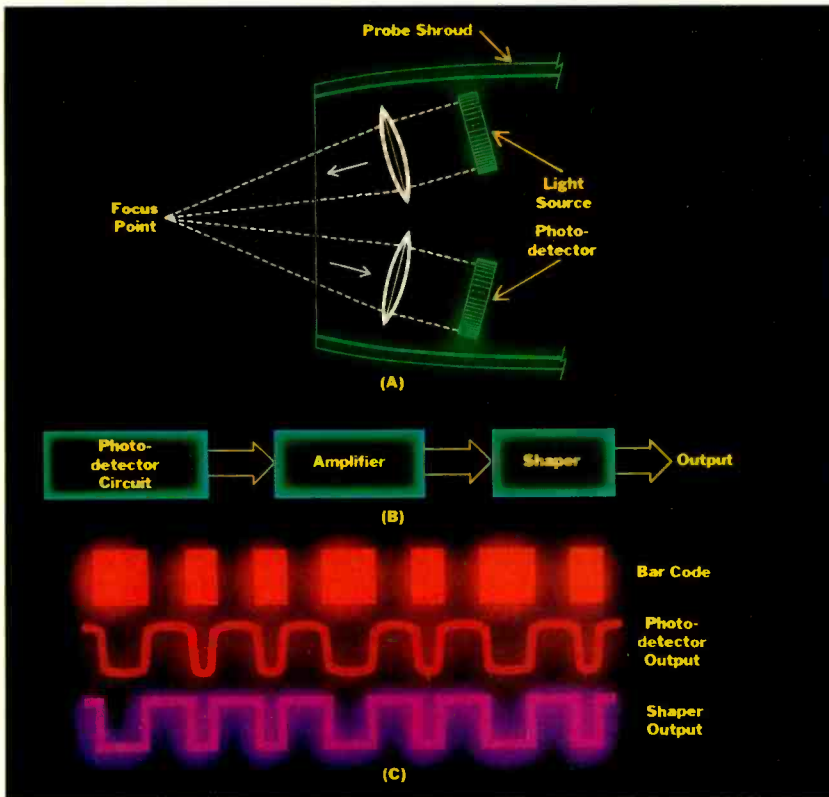

**Fig. 2. Wand operation. Light source and photodetector (A) in wand tip pass output through an amplifier/shaper (B) to produce crisp signals (C) for computer entry.**

a higher information density because information is encoded in both the black bars and the white spaces. This eliminates the interelement spaces used in the industrial approach, resulting in a 30% information-density improvement. Each character includes three black bars and two white spaces, plus one intercharacter space. The use of the intercharacter space classifies this code as discrete.

The *interleaved 2-of-5* code is "continuous," meaning it provides even more information density than the *matrix* version by eliminating the intercharacter space. It is the most complex member of this family to print and decode.

*The 3-of-9 Code*. Also referred to as Code 39 (a registered trademark of Interface Mechanisms Inc., although the

tween the bars (Fig. 3). Three of the elements are wide (binary 1) and six are narrow (binary 0). The spaces between the characters have no value. This code, in which individual characters are separated by an intercharacter space, is classified as discrete. The structure of the

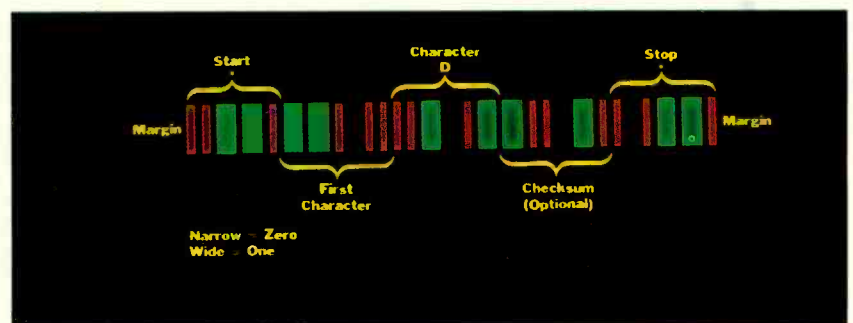

**Fig. 3. In 3-of-9 code, a character has 5 bars and 4 spaces.**

# IS YOUR COLOR FADING AWAY?

## ADD MORE COLOR TO YOUR COLOR COMPUTER WITH



**H**ave you been looking for the magazine to make your Color Computer more colorful... versatile and fun?! It's here... in full color... with bright new ideas, programs and games—The COLOR COMPUTER Magazine, the magazine for TRS-80 Color Computer users and owners! Every issue of The COLOR COMPUTER Magazine brings you a new “users manual” and program guide each month! You'll get:

- Programs for home and business... adults and kids!
- Software and Hardware reviews on the best (and least expensive) ways to upgrade your system!
- Games of skill, chance and luck!
- Sound and music synthesizing tips!

- How-to articles for the “Do-It-Yourselfer”!

You'll also find current listings of new products, directories and compatible peripherals for your Color Computer!

ADD “LIVING COLOR” TO YOUR HOME COMPUTER AND SAVE UP TO 41% WITH The COLOR COMPUTER Magazine!

### YES!



I want to make my Color Computer more versatile! Please enter my subscription to **The COLOR COMPUTER Magazine** for:

- One year for \$17.97. I SAVE 28%!
- Two years for \$31.97. I SAVE 36%!
- Three years for \$43.97. I SAVE 41%!

Savings based on full one-year (12-issue) subscription price of \$24.97.

Mr/Mrs/Ms \_\_\_\_\_ please print name in full 8H013

Company \_\_\_\_\_

Address \_\_\_\_\_

City \_\_\_\_\_ State \_\_\_\_\_ Zip \_\_\_\_\_

**Check one:**  Payment enclosed  Bill me later

Charge my:  American Express  Visa  MasterCard

Card No. \_\_\_\_\_ Exp. Date \_\_\_\_\_

Please allow 30 to 60 days for delivery of first issue.  
Add \$8 per year for Canada and all other foreign countries.

THE COLOR COMPUTER MAGAZINE—P.O. Box 2597—Boulder, CO 80322

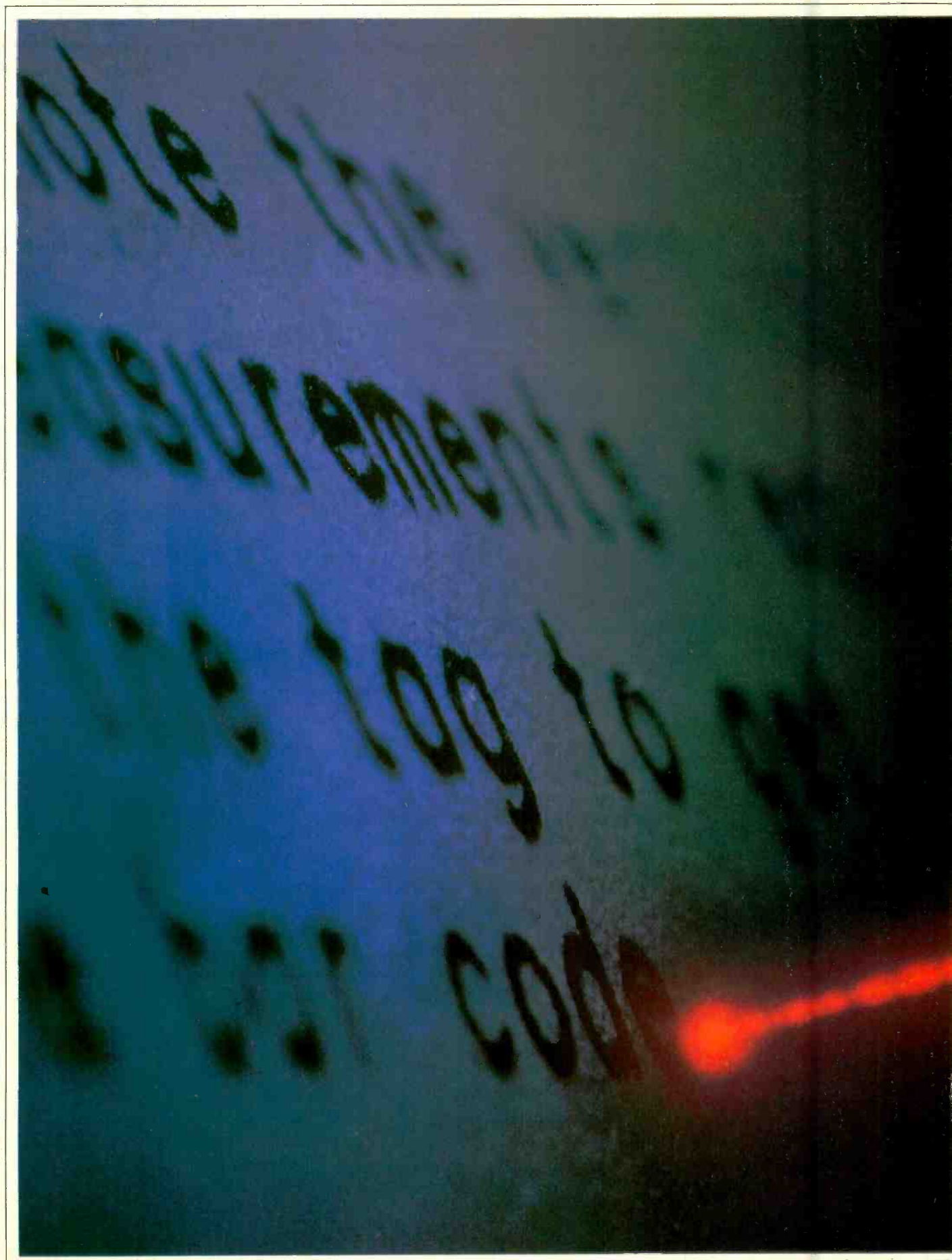

# PRINTING WITH THE SPEED OF LIGHT

*Low-cost versions of laser printers for personal computers are around the corner*  
By Jeff Hecht

**T**HE marriage of laser and photocopier technology will soon offer new printing possibilities to users of personal computers. Laser printers can meet or beat the speed of dot-matrix printers, while producing output comparable in quality to that of much slower letter-quality printers. What's more, laser printers can produce graphics such as line drawings and charts.

New designs and improved technology are bringing the prices of laser printers into the personal computer realm. One Japanese photocopier maker, Canon, has developed a laser printer "engine" that is offered to system makers at previously unheard of prices. Customers can expect to pay around \$3000 and up for complete printers with computer interfaces once they reach the market. The computer industry is very interested; the laser-industry trade magazine *Lasers & Applications* reports that companies such as IBM and Apple plan to buy over 100,000 of the Canon printers in the near future. Meanwhile other companies, including other Japanese copier makers such as Ricoh and Minolta, are working on their own laser printers—pointing to a potential competition that could drive prices even lower.

Laser printers are good news for computer users frustrated by the tradeoffs between dot-matrix and letter-quality printers. Dot-matrix printers are cheap

*Jeff Hecht is a free-lance writer specializing in lasers and their applications.*

and fast, but their text output usually is an invitation to eyestrain. When operated at high resolution, they can produce simple graphics that don't look bad—as long as you don't look too closely, or ask for patterns such as slanted lines, which are hard for them to reproduce.

Letter-quality printers can't generate graphics, but the characters they print are as sharp and clear as those from a typewriter. However, they labor slowly. The 15 characters per second of a cheap \$600 letter-quality printer translates to two minutes for a 30-line, double-spaced page, and twice as long for a single-spaced page. You can get a letter-quality printer that goes three or four times faster, but it will also cost about three times the price. Canon's laser printer can generate eight pages per minute that look almost as good as those from a letter-quality printer, and that speed is obtainable regardless of whether the output is single- or double-spaced, or made up of graphics. Comparing the laser printer with a \$2000 high-speed letter-quality printer, you get single-spaced pages about eight times faster for only about 50% higher printer cost—not bad in the price/performance derby.

## **How Laser Printers Work**

Laser printers are not easy to build, but the basic idea behind them is simple. A laser beam is focused to a tiny spot, which is scanned repeatedly across the length of a cylindrical drum similar to

## Laser Printers

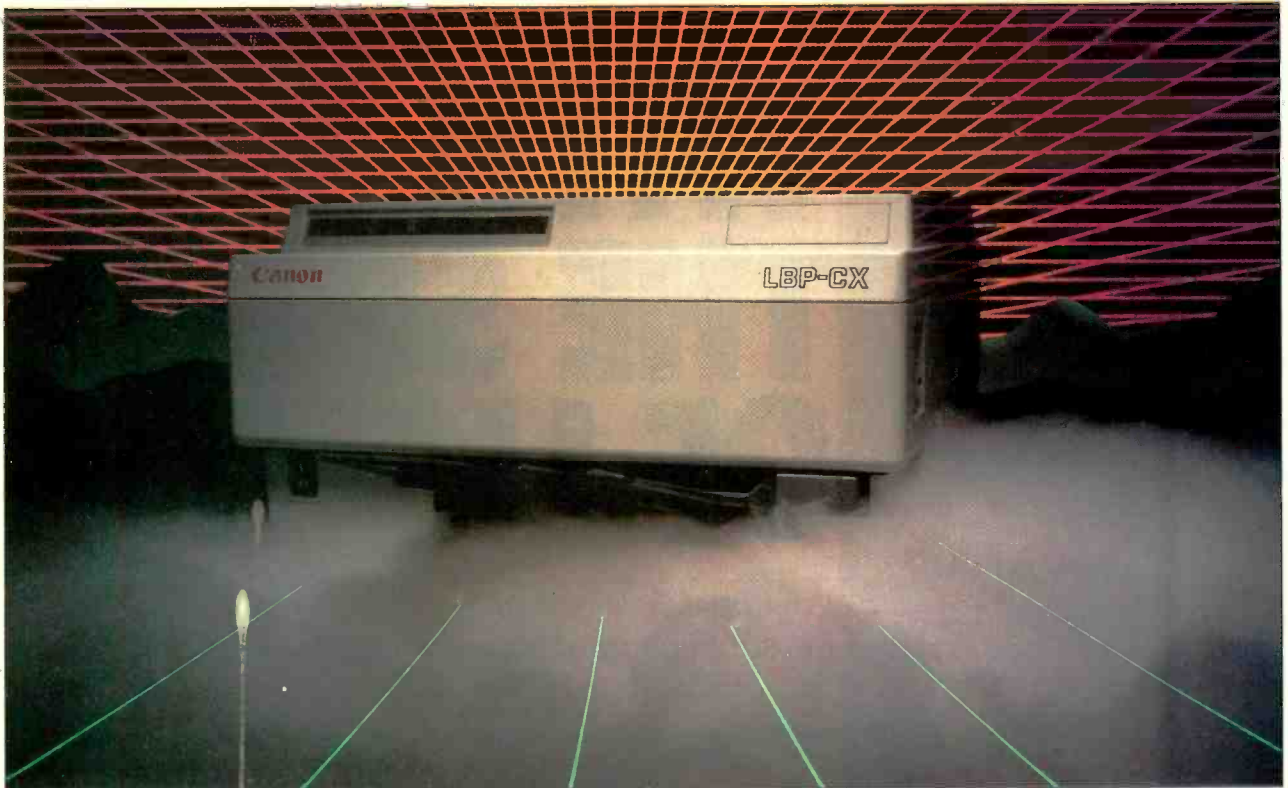

Canon's LBP-CX will serve as the heart of a new generation of low-cost laser printers.

that used in a photocopier. The laser beam is switched off and on as it scans, and the drum revolves so the beam continually scans a fresh surface. The image is created by the same process used in a photocopier. Before it is exposed to the laser beam, the drum is given an electrostatic charge over its entire surface. The laser beam disperses the charge because light makes one of the layers coated on the drum electrically conductive. The remaining charged areas, those which were not exposed by the laser beam, form the actual image. These charged areas attract the toner, which is then transferred to paper to form the printed page in the same way a photocopier image is transferred to paper.

The laser is used not because of its space-age reputation, but because its beam can be focused to a very tiny spot. Small spots are critical because laser printers actually write in dot-matrix format, and the finer the dots, the better the resolution. Mechanical dot-matrix printers generate 50 to 150 dots/in. At the lower densities, the dots are painfully evident. The higher densities produce more legible output, but the characters look boxy, and a close look shows individual dots. Laser printers produce 180 to 480 dots/in. The dots are nearly undetectable at the lower densities, and at the highest densities the output looks

good enough that Canon says its new 480 dot/in. printer can generate "typesetter-quality documents." The high resolution allows laser printers to write in practically any typeface, not just those amenable to coarse dot-matrix reproduction. It also lets them produce excellent graphics.

The simple-sounding jobs of switch-



The LBP-CX's replaceable cartridge.

ing the laser off and on, and of scanning the beam across the light-sensitive drum, turn out to be difficult tasks. Even the least costly laser printers have to scan across the drum several hundred times per second, writing a million or more dots per second.

Scanning is usually done with mirrors. The beam is bounced off a polygonal metal mirror, which rotates rapidly. Each face of the rotating mirror scans the beam across the drum, so the num-

ber of scans per second equals the number of mirror faces multiplied by the number of times the mirror rotates. A typical scanning mirror may have a dozen faces, so the mirror has to rotate dozens of times per second—thousands of revolutions per minute. Industry observers think that manufacturers have done a remarkable job in reducing the price of a scanning mirror and drive motor to a little over \$100, but that's still a significant chunk of Canon's entire printer engine.

There are some alternatives to rotating mirrors. One is to use holographic optical elements, specially made holograms that diffract light in ways that mimic the function of ordinary optics. Such holographic optical elements can focus a beam of light to a point, or, if moved, scan the point across a surface. Advocates say that holographic scanners would be easier to make, lighter (and hence easier to rotate for scanning), and would provide cleaner scans than rotating mirrors. However, all the bugs haven't been ironed out, and only the General Optronics Corp. of Edison, N.J. uses a holographic scanner in its laser printer.

Turning a laser off and on a million times a second or more can also present problems. In most types of lasers, the beam is generated by passing electricity

through a gas-filled tube, thus exciting atoms in the gas, which emit light. It isn't practical to turn gas lasers off and on by switching their power supply. Instead, the beam has to be altered by passing it through an external modulator. Some modulators contain crystals that bend the laser beam when sound waves pass through them; bending the laser beam away from the normal output port effectively turns it off. In other modulators, application of a voltage to a crystal changes the beam polarization, so a separate polarizer can either block the beam or let it pass through. Separate modulators are costly as well as cumbersome; a modulator and the driver it requires together cost much more than a rotating mirror scanner.

To avoid the need for external modulators, designers are turning to semiconductor diode lasers (see box). The light produced by a semiconductor laser depends directly on the drive current passing through it, and this drive current can be changed very rapidly. Semiconductor lasers used in fiber-optic communications research can produce over a billion pulses per second; the few million per second needed for laser printers is easy in comparison.

Semiconductor lasers do present their own problems. While gas lasers produce narrow beams, the beams from semiconductor lasers spread out rapidly. A

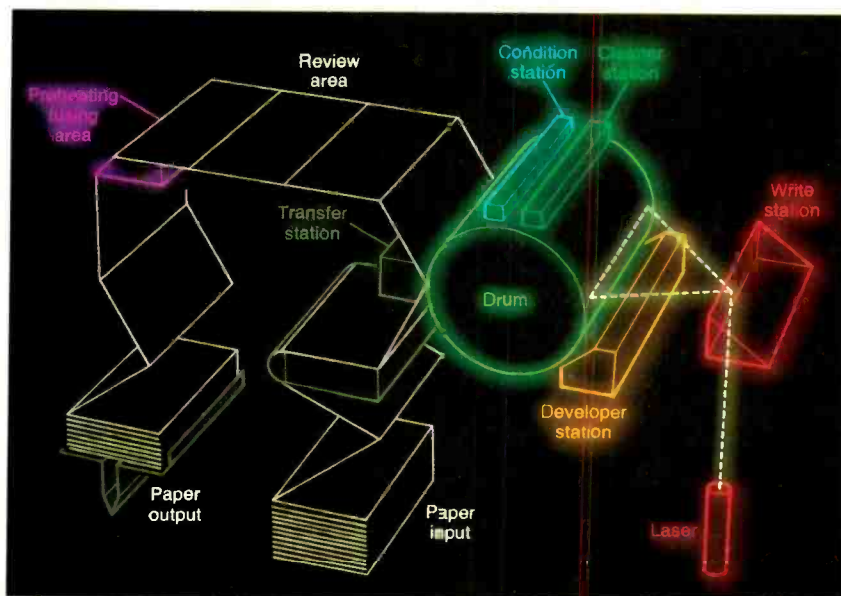

Basic diagram of how a laser printer operates.

semiconductor laser emits light into an angle of 20° to 40°, vast compared with the 0.06° spread of the red beams from the helium-neon lasers used in construction alignment, many laser demonstrations, and supermarket checkout systems. Special optics can solve the beam-divergence problem, but they can't alter the wavelength of semiconductor lasers.

Wavelength is important because the response of the photoconductive materials used in photocopier drums depends on wavelength. The sensitivity of standard materials drops as wavelength increases from the blue part of the visible spectrum to the red, and is even lower at the 800-nanometer infrared wavelength of semiconductor lasers. Early laser printers had to rely on expensive blue lasers, or use higher powers at red wavelengths. The development of new photoconductive selenium alloys has increased sensitivity enough that diode lasers are increasingly common in new laser printers.

### Evolution of Laser Printers

The change in operating wavelength is just one in a series of changes in the design of laser printers. The first laser printers were expensive models that printed at very high speeds and were used with large computers. For example, a model announced by IBM in 1975 used a 25-milliwatt red helium-neon laser beam to print 13,360 lines/min on continuous paper. Relying on a rotating-mirror scanner and an external modulator for the laser, it carried a price tag of \$310,000. Siemens and Xerox announced similar models at about the same time, operating at speeds to 20,000 lines/min (equivalent to over 100 pages per minute), and carrying similarly large price tags.

What justified the high prices of those early printers was their speed—several times faster than the few thousand lines

(Continued on page 102)

### SEMICONDUCTOR AND GAS LASERS

THE emergence of practical, inexpensive semiconductor diode lasers has been one of the most important recent developments in laser technology. Older gas lasers won't go the way of the vacuum tube immediately, but semiconductor diode lasers offer big advantages for many applications.

A semiconductor diode laser is a close relative of the light-emitting diode (LED). As in an LED, passage of a current through a pn semiconductor junction generates light in a diode laser. However, in diode lasers, the light is tightly confined to the active layer, higher currents are used, and the ends of the semiconductor crystal are cut so they reflect some light back into the diode. The result is laser emission—more intense, more coherent and somewhat more tightly focused than LED output.

Diode lasers offer the usual advantages of semiconductor technology: they're compact, durable, and require lower power and lower voltage than gas-filled laser tubes. Laser system designers also like the fact that their output beam intensity can be modulated simply by changing the drive current. Gas lasers, on the other hand, require bulky and expensive external modulators.

Early diode lasers suffered a fatal flaw—they self-destructed in a matter of minutes if operated continuously at room temperature. Developers licked that problem by turning to sophisticated internal structures that reduce device-destroying waste heat. That effort which took many years and millions of dollars, was aimed mainly at building light sources for fiber-optic communications. Once these improved semiconductor lasers came on the market, engineers working on other types of systems began to realize their potential.

Laser printers are not the only computer-related success story for diode lasers. Semiconductor lasers read and write data on special light-sensitive disks in new types of data-storage systems just coming on the market. Although most of these data storage systems cram a billion bytes of data onto a phonograph-record size disk for large computer applications, work is also under way on a smaller version that would store 100 to 360 megabytes on a 4-3/4" (12-cm) disk for desktop computers. Meanwhile, semiconductor lasers are being produced by the hundreds of thousands to play back ultra-pure sound in new digital audio disk players. The players are selling in the \$400 to \$600 range, but the lasers themselves are said to cost as little as \$10 each.

# Memories That Don't Forget

Recent developments in CMOS and battery technology make possible non-volatile static RAMs

By TJ Byers

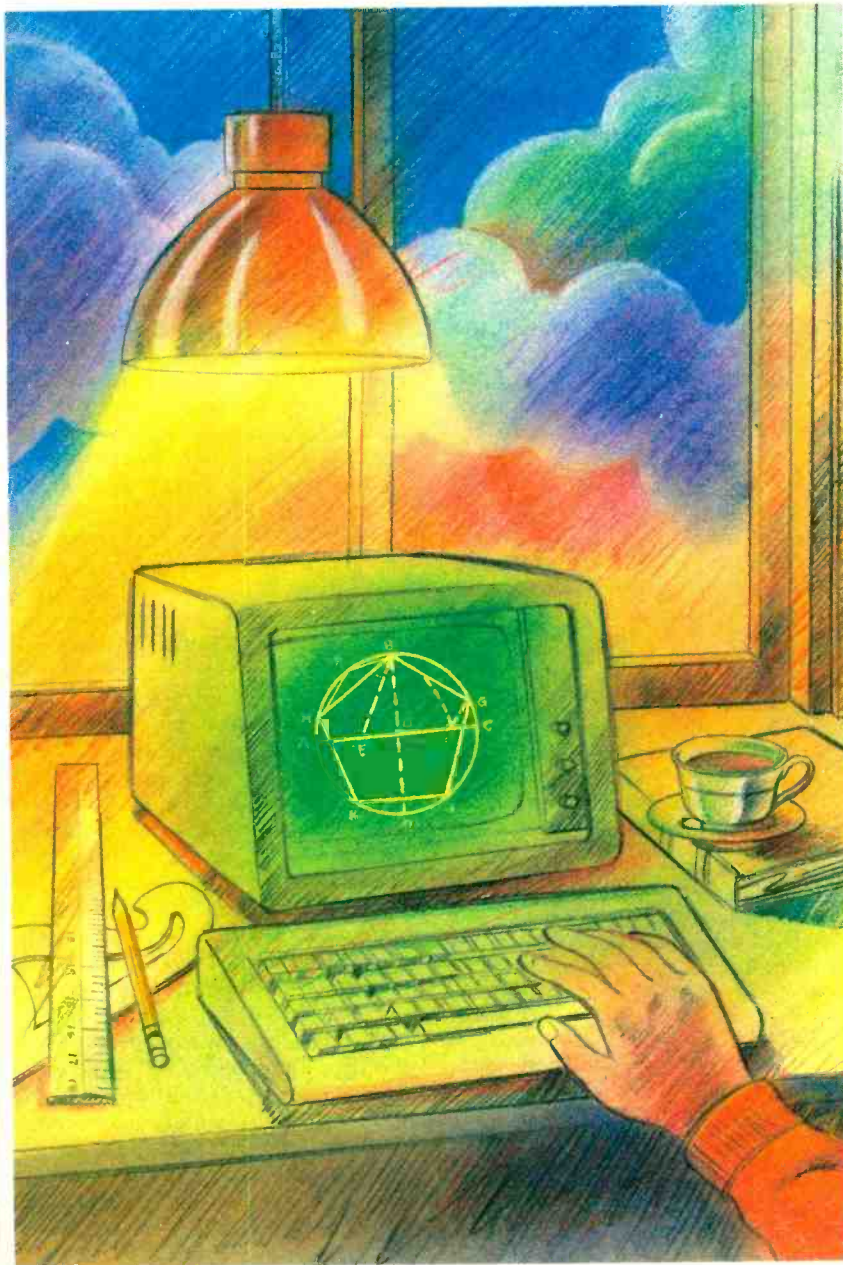

EVERY time you turn your computer off, it forgets. Whatever was stored in its memory, be it a program or data, disappears forever into the "bit bucket" and can only be recovered if the material was previously stored externally using a medium like a floppy disk. This is an irritating fact of life with computers.

This unhappy state of affairs is due to the fact that the semiconductor memory used in today's personal computers is *volatile*. As long as power is applied, the memory will retain whatever was put into it. When power is removed, however, whether intentionally or by accident, everything is lost. The once highly organized and meaningful information is gone, or in the event of a momentary interruption of electrical service, reduced to a random jumble of binary ones and zeros.

Wouldn't it be wonderful if there were a way to keep the contents of memory alive for as long as you wanted?

## Battery Backup

There is. Batteries.

Unlike the memory chips of yore, which frequently required several different dc power supplies (+5 V, +12 V, and -12 V) much of the RAM used in current computers operates from a single positive 5-volt supply. And, the power requirements of today's memories are much lower. You can power a whole IBM PC's memory with what it would have taken for just one 8K RAM board a few years ago. Add to that the fact that modern RAMs offer a standby mode where their voltage and current requirements are substantially less than when the memory is being read from or

*TJ Byers is a professional writer specializing in subjects involving computer-related electronic products.*



written to, and you have met all the conditions required to power—or at least keep alive—your memory with batteries.

Note that this is not the same as using an uninterruptible power supply (UPS). That provides backup power to the entire system—memory, disk drives, and all—should the main supply fail to give you enough time for an orderly shutdown. An alternate power source for RAM keeps only the memory alive; the rest of the system is left to fend for itself.

Battery life depends on how much energy is actually drawn from the

cell(s). So, if we are to maintain any amount of integrity without constantly having to replace dead power cells, we must devise a way of using the main power when it is available, and save the battery power for emergency situations. This can be done with a simple switching circuit.

Basically, the battery (a battery can be a single cell or, more properly, a group of cells) is connected in parallel with the main power supply and maintained in a standby condition. To prevent the battery from being damaged by the power supply during normal operating

conditions, a switching circuit is used to isolate the battery from the system when it isn't needed. Such an arrangement is shown in Fig. 1.

The switch is divided into two sections. The first connects and disconnects the backup battery from the computer's main power bus. Under normal operating conditions, the computer's main power supply furnishes power to the memory chips (and the rest of the computer). The switch disconnects the battery from the circuit.

In the event of a power failure the main power supply, of course, quits. The switch places the standby battery on line so that the information held by the RAM is not lost. The switching action is essentially instantaneous, requiring only a few milliseconds. This brief span of time is not long enough for the electrical charges in the memory chips to dissipate and, when the batteries are switched in and take over, the data in RAM is still intact.

To conserve battery power in the standby mode, the second section of the switch disconnects all of the computer system other than memory from the power bus. That eliminates unnecessary drain on the battery and permits it to support the memory for a longer period. This design is intended to provide sufficient time for a power problem to be resolved, or data salvaged, in the event of a catastrophic power failure. And it

## Floppy disks may be replaced with their solid-state equivalents

does. In some cases, memory will last for years before the battery power fails.

In general, memory chips don't require their full 5-volt operating voltage to retain their stored data. Most 5-volt chips can retain their contents with a supply voltage as low as 3 volts, while drawing a current sometimes of only a few nanoamperes—a few *billionths* of an ampere. This is particularly true for the newer CMOS (Complementary Metal Oxide Semiconductor) RAM designs.

Non-volatile RAM can be used for more than program and data protection in the event of power failure. It can also be used as a time-saving tool.

Let's consider a situation where you use your computer for access to a database. Normally, the first thing you do is

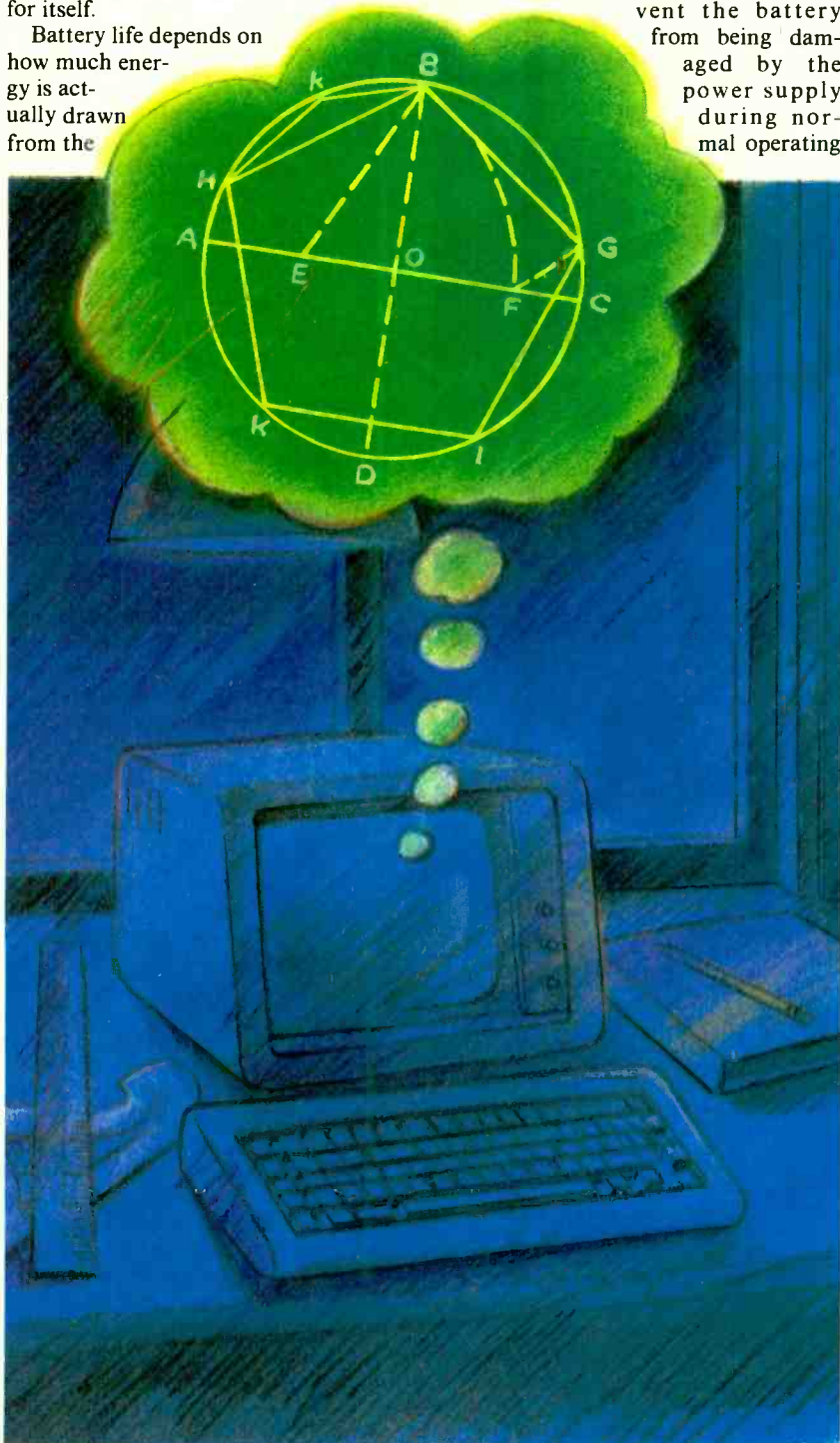

## Memories

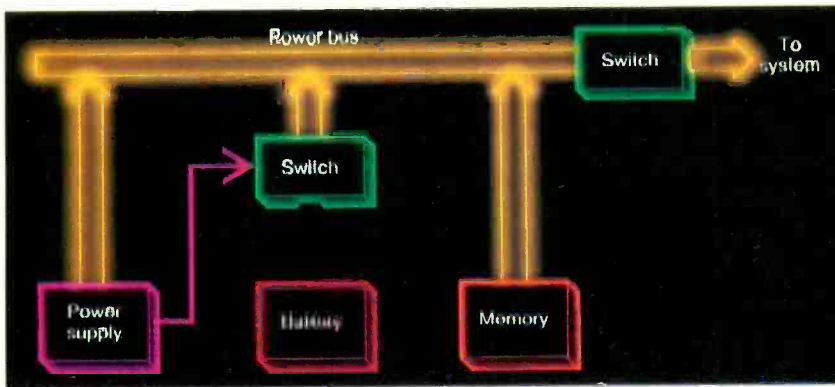

**Fig. 1. Switching arrangement for a backup power supply.**

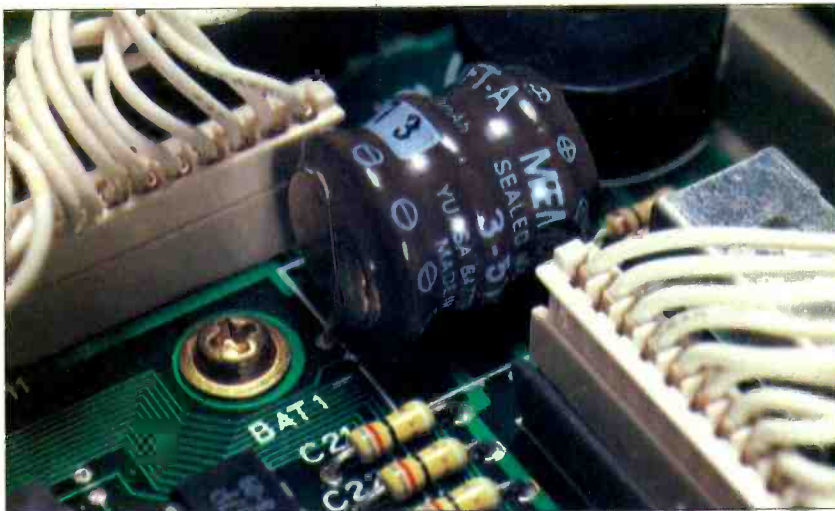

**Fig. 2. A small NiCd cell keeps the NEC 8201A's memory alive.**

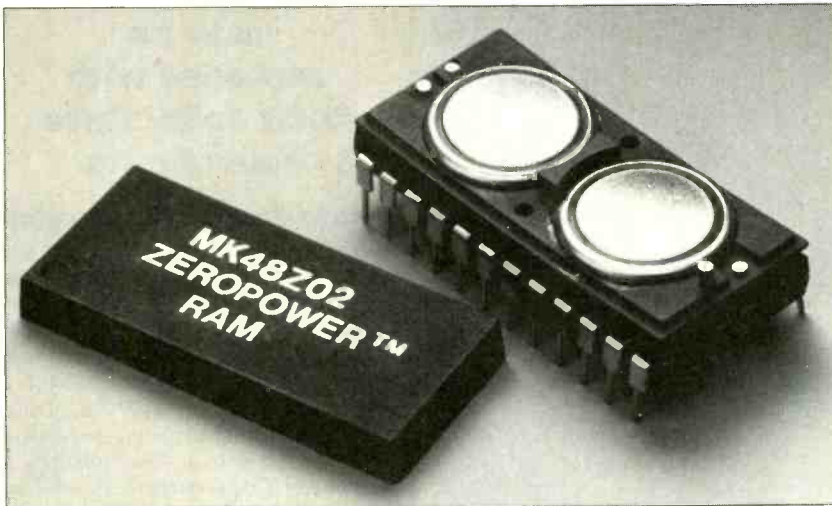

**Fig. 3. The Mostek MK48Z02 16K RAM has its own lithium cells.**

power up the computer and get the disk drives running. Next you search for the database program disk and insert it in a drive. Then you load the program into the computer. Only after you've done all that are you finally able to get the information you want.

And when you've finished and are

ready to go about your other business, you normally turn off the computer. That destroys any information that's been loaded into the system—which means that the next time you want to access the database, you have to go through the entire startup process once again. What a waste of valuable time!

If the computer has a battery-backed-up RAM, though, once the program (and data) has been loaded, powering down the system will not cause the contents of memory to be lost. The next time you wish to use the database, you simply turn on the system and go.

### Backing Up Portables

Battery backup for memory is not the exclusive province of the desktop computer, either. It has been carried to a logical extreme in a number of portable "lap" computers, like the Radio Shack Model 100 and the NEC 8201A. In fact, it is probably more important to have standby power in computers like this than in other types.

By its very nature, a portable computer of this type is apt to be used in situations where no external power (for use with an ac adapter, for example) is available. Its sole source of operating power is the penlight cells in its battery compartment. When those cells age and have to be replaced, the chances are that, not only will there be no external backup power, but there will also be no means for backing up the contents of RAM—a whole list of names and addresses, perhaps—on some external storage medium like tape or disk. Some means must be provided for keeping the main memory alive while the battery pack is replaced.

Radio Shack and NEC do this by using a small rechargeable nickel-cadmium (NiCd) battery, as shown in Fig. 2. This battery is trickle-charged from the main power source—the penlight cells or ac adapter—and maintained in a standby condition.

The computer has a low-power indicator that illuminates when the main battery voltage drops to the point where it can provide only about 15 minutes or so of reliable operation. At that time, the penlight cells should be replaced. With the NiCd cells providing backup power, this can be done without affecting what's stored in the computer's memory.

Even if the main batteries go dead, the memory is still protected by the nickel-cadmium cells. Depending on how much RAM is in the computer, its contents can be maintained for approximately seven days in the case of a 64K unit and for as long as 20 days in the case of an 8K one. As long as you realize that the main batteries need replacing, and replace them during the grace period granted by the NiCds, you will have lost nothing.



# SOFTWARE TO STIMULATE

Stimulate your mind every month with the #1 magazine of computer applications and software... CREATIVE COMPUTING! There is no other magazine like CREATIVE COMPUTING... WE TALK YOUR LANGUAGE!... Any make... any model... whether it's Apple, IBM, Radio Shack, TI, Mattel, Atari, Commodore... CREATIVE COMPUTING has monthly departments and articles you can use! You will receive a continuing education on *everything* related to personal computing with intriguing and useful applications for your personal computer. This is a magazine that will help you get more out of your computer—versatility, function and enjoyment—in easy-to-read and fully illustrated articles!

**Subscribe to CREATIVE COMPUTING today and save up to 33%!**

**YES**

**creative computing**

PO: Box 5214, Boulder, Colorado 80322

Please enter my subscription to CREATIVE COMPUTING for:

- |  |   |   |
|--|---|---|
| <input type="checkbox"/> One year (12 issues)<br>for \$19.97.<br>I SAVE 20%! | <input type="checkbox"/> Two years<br>for \$36.97.<br>I SAVE 26%! | <input type="checkbox"/> Three years<br>for \$49.97.<br>I SAVE 33%! |
|--|---|---|



Mr./Mrs./Ms. \_\_\_\_\_ (please print name in full) \_\_\_\_\_ 8H997

Company \_\_\_\_\_

Address \_\_\_\_\_

City \_\_\_\_\_ State \_\_\_\_\_ Zip \_\_\_\_\_

Check one:  Payment enclosed  Bill me later

Charge my:  American Express  Visa  MasterCard

Card No. \_\_\_\_\_ Exp. Date \_\_\_\_\_

Savings based on full one-year subscription price of \$24.97.  
Please add \$5 per year in Canada, \$10 per year in all foreign countries.  
Please allow 30 to 60 days for delivery of first issue.

# Memories

## Self-Supporting RAM

The Mostek Corporation of Carrollton, TX has taken memory support a step further. It has combined the low power requirements of CMOS technology and the long-lived energy of lithium batteries (see box) in a single package.

Unlike other battery-backup systems, which use separate lithium cells mounted on the board containing the memory chips, Mostek has built the standby bat-

teries (see box) in a single package. When the voltage on the supply line drops below 3 V, a switching circuit connects one of the two lithium cells to the RAM's internal power distribution bus and disconnects the external supply.

The two cells are never used at the same time. The voltage sensing circuit

prepares the memory chip to have data entered into it) from becoming active. This puts a lock on the chip's contents and prevents erroneous data changes, which could take place if the supply voltage were marginal.

When the voltage on the supply line drops below 3 V, a switching circuit connects one of the two lithium cells to the RAM's internal power distribution bus and disconnects the external supply. The two cells are never used at the same time. The voltage sensing circuit prepares the memory chip to have data entered into it) from becoming active. This puts a lock on the chip's contents and prevents erroneous data changes, which could take place if the supply voltage were marginal.

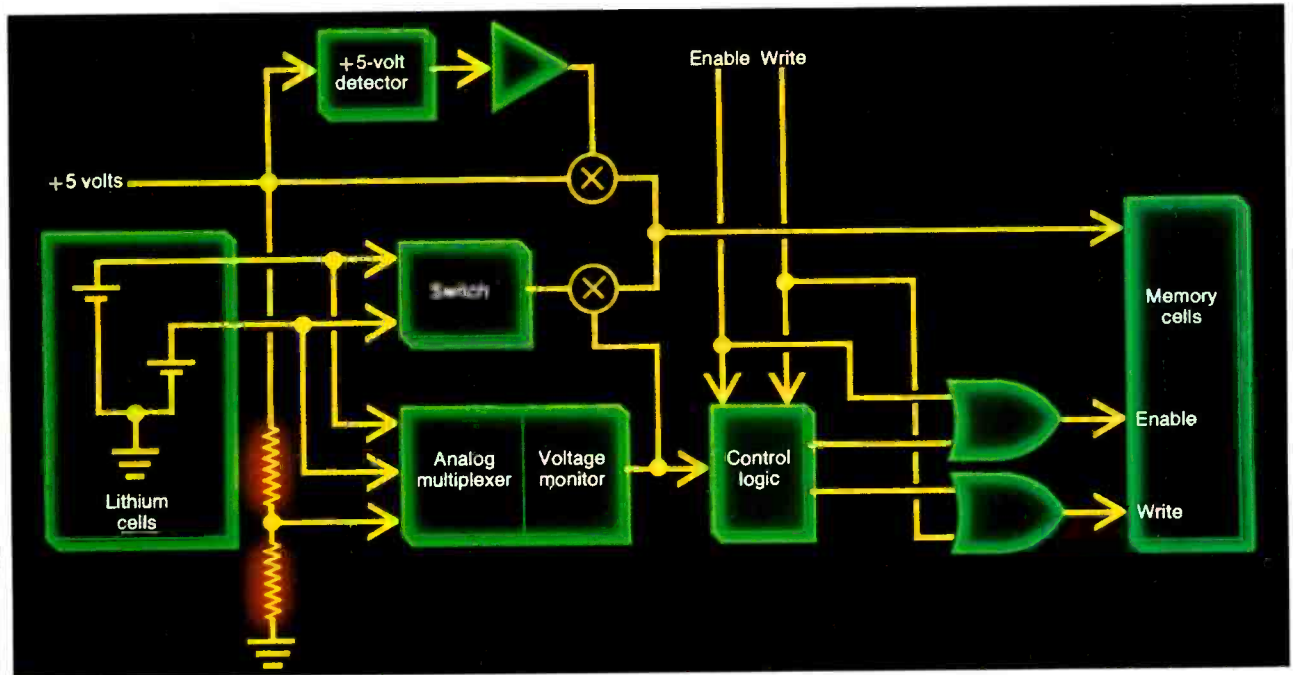

Fig. 4. A sensor switches in the cell with the highest voltage.

tery of its MK48Z02 RAM, shown in Fig. 3, directly into the device.

The memory portion of the chip is a 16K CMOS static RAM organized as 2K x 8 bits. Through the application of advanced CMOS technology, Mostek has been able to reduce the power consumption of the static device to an ultralow 5 nanoamperes. That's about as close to nothing as you can get. In normal operation, the memory chip functions like any other static RAM chip, and has an access time of under 200 nanoseconds.

Also in the package are two small lithium cells and an analog voltage-monitoring circuit that also requires very little power. This arrangement is shown in block form in Fig. 4. The precision voltage sensor continuously monitors the RAM's 5-V supply line. When the voltage there drops below 4.5 V, control logic within the monitor disables the RAM's write circuits and prevents the write-enable signal (which

monitors the voltage of each of the cells prior to disconnecting the chip from the main supply. Whichever cell has the higher voltage at the time is the one selected to power the chip. As soon as the sensing circuit determines that the normal supply voltage has been restored, the lithium cell is disconnected.

As the cells age, their voltage drops. This takes a long time, but eventually it happens. If the voltage of either cell falls below 2 V, a "flag" is set within the chip preventing the first write/read cycle attempted by the computer from being performed. This flag can be detected by having the computer perform a write, and then a read, cycle after power has been restored. If the flag has been set, the cycle will not be executed, thus providing a warning of impending battery failure.

The lithium cells, which are not replaceable—being welded into the IC's DIP package—have an expected lifetime of ten years. What happens af-

acquired its "mortal" status.

The MK48Z02 series of RAM chips is pin-for-pin compatible with all the popular 8-bit-wide RAMs now in use. You can, if the situation warrants, easily replace your existing 4016 chips with the battery-backed-up MK48Z02. It is quite possible that, as prices drop, the battery-powered RAM could someday make the EPROM obsolete.

## Things to Come

It is not inconceivable that within a short time you will see programs packaged in battery-powered RAM cartridges rather than on disks.

Putting programs in semiconductor memory is not something new. Video game cartridges are one example of software in ROM, and computers with built-in BASIC another. Unfortunately, ROM is expensive; RAM is not.

Some computers already use plug-in  
*(Continued on page 108)*



# We train specialists from the ground, up.

It takes a lot of special people to keep the Air Guard in the air. And not all are at the controls of a Phantom Jet.

Most serve in vital support positions. Positions requiring the very highest level of expertise. So when you join the Air Guard, you're trained by the best in the business. By top professionals in avionics, munitions loading, environmental support, and Tactical Air Command and Control. You can also get expert training in hundreds of other areas essential in defending America's skies. Training which can be just as important in launching your civilian career.

So if you're a special person looking for a specialty, check out the Air National Guard. For information, mail the attached coupon. Or call toll-free 800-638-0936.\*

\*In Alaska, Hawaii, New Jersey, Puerto Rico, Guam and the U.S. Virgin Islands, consult your local directory.

## We Guard America's Skies.



**Complete and mail to:**

Air National Guard, P.O. Box 6000, Clifton, N.J. 07015.

MALE  
 FEMALE

NAME (Please Print) \_\_\_\_\_

ADDRESS \_\_\_\_\_ APT \_\_\_\_\_

CITY \_\_\_\_\_ STATE \_\_\_\_\_ ZIP \_\_\_\_\_

AREA CODE: PHONE \_\_\_\_\_

OCCUPATION \_\_\_\_\_

BIRTH DATE \_\_\_\_\_

PRIOR MILITARY SERVICE YES NO

BRANCH \_\_\_\_\_ RANK \_\_\_\_\_ AFSC/MOS \_\_\_\_\_

Circle No. 15 on Free Information Card

A2CPTR\*\*044NP

## DEC 350

(Continued from page 46)

ment over the previous operating system. However, it too was in need of fine tuning. Finally, in October 1983, Digital released Version 1.7 of P/OS. Compared to the earlier releases, P/OS Version 1.7 "flies."

While P/OS Version 1.7 is essentially the same as the previous versions, it does offer faster execution times and an enhanced Prose editor. Unlike the previous editor, the new one allows you to

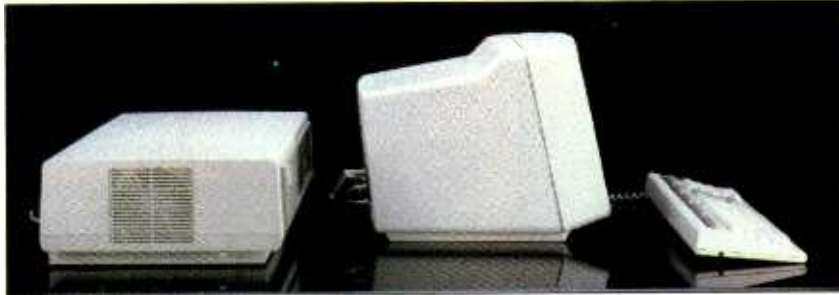

Standard on the Pro are 512K of RAM and a 5-Mb hard disk.

set tabs, use function keys to store and recall frequently used editing routines, and moves the cursor through a multiple-page document with fewer keystrokes.

With the addition of two optional memory boards (256K each), the Pro 350's memory can be increased to a megabyte. A 10-megabyte hard disk with half the access time of the 5-megabyte one is also available for \$2800. Although it's too soon to say when, larger capacity 5¼" hard disks will become available for the system in the near future.

At present, Digital doesn't offer a trade-in allowance on the 5-megabyte disk to Pro 350 owners seeking to upgrade their systems with 10-megabyte Winchester. They will . . . we hope.

In addition to faster access times and increased storage capacity, the 10-megabyte disk is a must for Pro 350 users desiring to create finished software products with Digital's Professional Developer's Tool Kit option. With that option, development of applications utilizing Digital's VMS and RSX-11 M/M PLUS (the operating systems used on Digital's PDP-11/23 minicomputers) is possible with a host computer. Programmers can also develop applications on the Pro 350 using language and development software such as BASIC-PLUS-2, DIBOL, COBOL-81, FORTRAN-77, Pascal, and Whitesmiths' C Cross Compiler. Prior to the introduction of P/OS Version 1.7, applications could not be developed on the Pro 350 without a host VAX or PDP-11 minicomputer.

### More Hardware

Now that Digital's CTI bus can be licensed by third-party hardware vendors, expect a number of add-on options for the Pro 350 to turn up in the market shortly. Peripheral options currently available for the computer include the Telephone Management System, Real-Time Interface, PRO CP/M-80 (part

hardware, part software), IVIS (Interactive Video Information System), Mini-Exchange, and a selection of printers.

With the Telephone Management System, you can send and receive data from host computers, and place calls automatically, via the built-in auto-dial modem and the TMS Voice Unit Option. [See the article "Now Let Your Computer Reach Out" in this issue. Ed] For computer control of test instruments, security devices, etc., Digital offers the Real-Time Interface. It features an IEEE-488 bus interface, two EIA RS-232C/423 asynchronous serial ports, and a 24-line bidirectional parallel I/O port. Software development for the RTI module is available with the Professional Developer's Tool Kit.

The CP/M-80 option enables Pro 350 users to run a wide range of CP/M-80 software. The CP/M option includes the CP/M-80 operating system, an 8-bit Z80 microprocessor, and 64K of memory. For interactive computer-based

training, Digital offers IVIS. When coupled with the optional 13" RGB color monitor and a CAV videodisc player, students can review programmed videodiscs, demonstrating complex procedures, with the convenience of random-access control. In addition, the Pro 350's graphics can be combined with screen images to produce charts, graphs, or special effects to enhance or highlight visual segments of the videodisc during playback.

With the Mini-Exchange, Pro 350 users have a cost-effective means of interfacing their computers with any RS-232/423 compatible device, or with other personal computers. A total of eight asynchronous devices can be connected to the Mini-Exchange, including printers, modems, multiplexers, and speech synthesizers. Devices connected to the Exchange can be accessed through manual switching or under software control.

To meet virtually any high-speed or letter-quality printing need, Digital offers the LA50, LA100, and LQP02 personal computer printers.

The LA50 is a dot-matrix printer featuring a 10" paper carriage and two print speeds—100 and 50 cps—for draft and memo-quality reproduction. For handling large forms and high-speed printing, the dot-matrix LA100 offers a 14.8" print carriage and 240 and 30 cps print speeds for draft and letter-quality reproduction, respectively. Also available is the LQP02 daisy-wheel printer for letter-quality reproduction at 32 cps.

### Comments

To appreciate the multi-tasking capability of the Pro 350's F-11 microprocessor, all one has to do is select a lengthy document and execute a "Print File" command. While the document is printed, it is possible to exit the print mode and return to the main menu to begin another application—without interrupting the document printout. I found this feature especially useful



The lightweight, low-profile keyboard has 105 keys in all.

when transmitting files to a host computer or remote database. It enabled me to review a document that I had just received while transmitting a data file in the background, simultaneously.

The Pro 350's lightweight low-profile keyboard features a full-size typewriter array, a host of function keys, an editing pad, cursor controls, and a numeric keypad—105 keys in all. Contrary to what you might expect, the keyboard's layout is simple and easy to use. The nonslip, matte-finish keycaps provide a positive "touch," and help reduce glare from overhead lighting. Touch typists, however, will have to get used to the left-hand region of the keyboard, in particular, the COMPOSE

CHARACTER and CONTROL keys.

Unlike many microcomputers that use the RETURN key to execute a command string, the Pro 350 has a DO key that serves this function. To the left of the DO key is a HELP key, which can be used to call on-line help documentation to the screen for reference at any time.

The black-and-white monochrome monitor delivers a sharp, jitter-free image for hours of continuous viewing without eye fatigue. The 11" (diagonally measured) screen is treated with a special nonreflective coating to reduce glare. For increased viewing ease, the monitor can be tilted over a range of 25°.

With a sticker price comparable to that of a two-door, front-wheel-drive

Honda, the Pro 350 is certainly not for first-time buyers looking to play video games or balance their checkbooks. On the other hand, the Pro 350 is a worthwhile investment for professionals who don't mind spending more for a computer backed by Digital's long-standing reputation for product excellence and a nation-wide service network. And you need not worry unduly about Digital, the world's second largest computer company, going under.

Anyone contemplating the purchase of a 16-bit microcomputer such as the IBM PC-XT or 3270-PC, Corvus Concept, Fortune 32:16, Victor 8000, or the TRS-80 Model 16B will want to take a close look at the DEC Pro 350 as well. ♦

## MORE SOFTWARE

Here's a sampling from the current catalog of over 50 DEC-designed and third-party software packages for the Pro 350.

### Programming and Development Languages

Digital offers a CP/M-80 Option Module and CP/M Version 2.2 operating system, enabling Pro users to run a long list of widely available CP/M programs on the market. Also available for the Pro are Unix, RT-11 (an operating system used on Digital's family of PDP-11 minicomputers), the UMD (Universal Microprocessor Development) System, SPSS-11 (Statistical Package for the Social Sciences), and microMAGIC—a development system that enables Pro users to create application programs to run on Digital LSI 11/2, 11/23, SBC-11/21 (FALCON), Intel 8086 and 8088, and Motorola 6809 and 68000 microprocessors.

### Information Management

Nonprogrammers can be up and running with two easy-to-use software packages developed for the Pro: The NPL Information Management System and RS/1. Developed as an information management tool for business, NPL enables users to develop applications to handle general ledger, payroll, inventory, mailing lists, form letters and more. For scientific and engineering applications, RS/1 transforms the Pro 350 into a notebook, enabling users to create tables and multi-dimensional graphs, and perform mathematical and statistical calculations, modeling, and more,

using simple English commands.

For spreadsheet calculations or equation solving there are Supercomp-Twenty and TK!Solver. With MAPS/Pro, financial models can be created for budgeting, profit and product planning and cash-flow analysis. You can convert financial, managerial, or operational data into visual aids for presentation or analysis with Fingraph and MAPS/Pro Graphics software.

### Word Processing

CT\*OS—Compu-Tome Office System and LEX-11 are third party word-processing packages developed for use on the Pro 350. CT\*OS is a comprehensive word-processing package featuring global search and replace, cut and paste, automatic pagination, list processing, page formatting and a host of other time-saving editing features. An optional 80,000-word spelling dictionary is also available.

Like CT\*OS, LEX-11 is a word- and list-processing package for Pro users who want full-feature text editing capability. LEX-11 offers a choice of command or menu-driven operation, multi-column and vertical text entry for creating graphs, and full-screen editing using the cursor keypad. Frequently used editing routines and text phrases can be conveniently stored and recalled with user-definable keys. Also available is an optional spelling dictionary and desk diary.

### Communications

IBM 3276/3278 Model 2 terminal emulation on the Pro 350 is now available with a new software package called Prism. This package uses a

subset of IBM's 3270 Binary Synchronous Communications protocols and provides 3287 printer emulation. With Digital's Pro-2780/3780 emulation software, you can send or receive data from a host computer using communications protocols of IBM 2780 or 3780RJE workstations.

With Protocol 350, Pro users with TMS or an auto-dial modem can dispense with their personal phone directories and manual telephone dialing. Load all your telephone and address files into the Pro and you're all set. Whenever you're ready to call someone, simply type the party's name—the Pro will automatically place the call. Even if you can't remember a particular name, you can quickly reference it by group or topic headings. ProtoCall 1000, an expanded version of ProtoCall 350, lets you create client profiles and call reports using a free-form information entry screen. When used in conjunction with the TMS Voice Unit Option, the Pro 350 becomes a powerful telephone management tool that can help eliminate desk clutter and make more productive use of phone time.

### Pro/Applications Starter Kit

Digital now offers a starter kit featuring four very useful applications for business and personal productivity, enabling new owners to put the computing power of the Pro 350 to immediate use. Featured in the starter kit are Pro/Spreadsheet for financial analysis, a graphics package for business called Pro/Graphics, Pro/Data-Manager for information storage and retrieval, and a text editor—Prose. Also included is a challenging computer game called DEClender. ♦

# NEW PRODUCTS

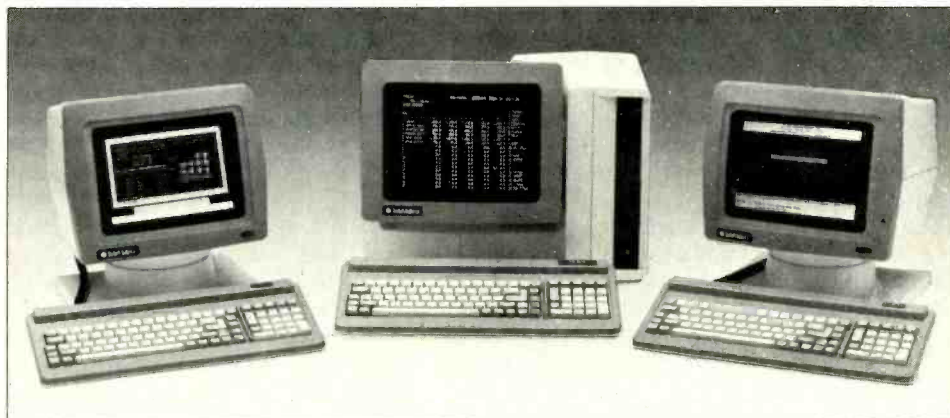

## Multiuser Computer System

A desktop multiuser micro-computer for business applications is available from Televideo. The Model TS-

804 computer supports up to four users through inexpensive video display terminals. The basic TS-804 is compatible with software written for the Altos Computer Series 5 systems and accepts up to

three additional ASCII terminals for multiuser operation. Features include: Z80A CPU; concurrent DMA; integral Televideo 914 display terminal; intelligent disk controllers; one Centronics par-

allel and three 19.5K-baud RS-232C serial ports; single-instruction memory mapping; 320K user RAM (includes 64K of disk cache memory); 737K 5 $\frac{1}{4}$ " floppy disk drive; 10M hard-disk system. Multiuser operating system is either MP/M-II or Oasis, while single-user system is standard CP/M. Available as options are a 15.04M hard-disk system and 14M tape cartridge unit for hard-disk backup. \$4495, includes TS-804 with choice of MP/M-II or Oasis operating system but less add-on terminals and printers; \$3600 for the TS-806H/40 hard-disk expansion unit; \$2995 for the TS-806C tape-cartridge unit; \$150 CP/M-80.

Circle No. 83 on Free Information Card

## SOFTWARE SOURCES

**Software for IBM PCjr.** Perfect Software has announced availability of Perfect packages for the IBM PCjr, including Perfect Writer word processor, Perfect Speller, Perfect Filer, and Perfect Calc electronic spreadsheet. To be able to fit into the PCjr's environment, the software programs have been limited in size to 128K, system calls have been minimized, and code portability has been maximized to quickly run on new versions of operating systems. Circle No. 86 on Free Information Card

**Personal Tax Planner.** "Personal Tax Planner" from Aardvark/McGraw-Hill is a software package designed for the home computer user who wishes to calculate and reduce personal Federal income tax. It increases accuracy and reduces the need for tables, booklets, and forms. It can even be used to instantly display the tax impact of any financial decision. The package consists of a program disk, program manual, registration card, and update coupon. Current versions are available for Apple II, II+, and IIe and the IBM PC and XT computers. \$99. Address: Aardvark/McGraw-Hill, 1020 N. Broadway, Milwaukee, WI 53202.

**Easy Database.** A new database, SeekEasy from Correlation Systems, can accept vague, incomplete, misspelled, or only partially correct inputs and still find the information you want. No fields, records, formats, or keywords have to be specified or are required—you simply type what you want to find and the program locates it, or the closest match(es). Entering data is just as uncomplicated. You just type in the information or thought in plain English (as words, phrases, or sentences) and press RETURN. Runs under CP/M 2.0 or 2.2 and is available on 8" and 5 $\frac{1}{4}$ " disks. \$235. Address: Correlation Systems, 81 Rockinghorse Road, Rancho Palos Verdes, CA 90274.



## Hi-Res Color Monitor

The Color IV from Amdek is a high-resolution color monitor that is compatible with the IBM PC and DEC rainbow computers. It is available in two versions, with either RGB analog or digital input. Using a separate interface, the monitor can display

the 16 colors presented by the IBM PC. It will also accept the RS-170A RGB signal of the Digital Equipment Corp.'s Rainbow to display this computer's colors. Resolution is rated at 720  $\times$  420 pixels in the graphics mode and 96  $\times$  24 characters in the text mode. \$995.

Circle No. 84 on Free Information Card



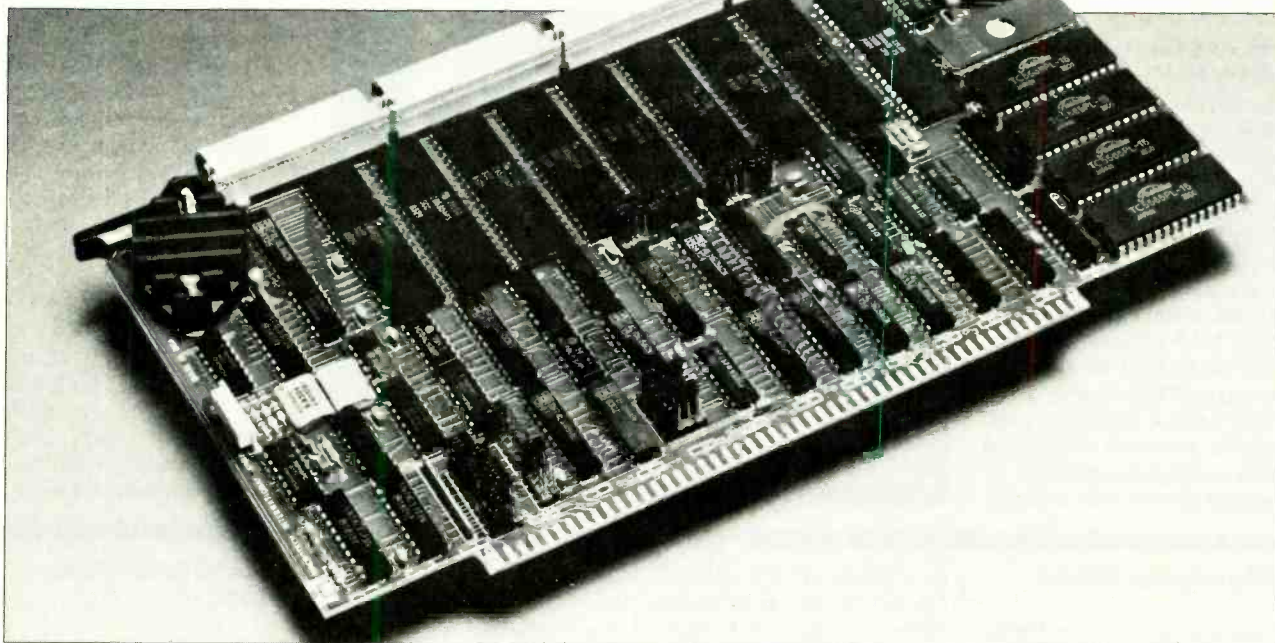

### 16-Channel Intelligent I/O Board

An intelligent I/O board that can extend an S-100 (IEEE/696) bus system to service as many as 16 additional terminals, modems, and printers and help create a fast multiuser system under Unix,

MP/M, or AMOS control is available from Macrotech International. The new 6-MHz Z80B Adit board's I/O channels can be synchronous or asynchronous and provide DMA operations to relieve overhead on the host CPU. The Adit board's up to 16K of EPROM contains the sys-

tem's real-time multitasking executive, resident virtual-disk firmware and a large array of commands. The fully arbitrated IEEE/696 DMA feature provides interleaved data transfers, block data transfers, and intermixed DMA or single-character transfers. Separate baud rates

are selectable for transmit and receive clocks on each channel. Four of the channels can support external clocks. On-board jumpers define default channel configurations. \$1075 to \$2125. **Address:** Macrotech International Corp., 20630 Lassen St., Chatsworth, CA 91311.

### Dot-Matrix Printers

Smith-Corona has now entered the dot-matrix printer market with three attractively priced models. The low-end Model D-100 offers bidirectional printing with short-line seeking; friction/tractor paper feed; parallel interface; six pitches; emphasized and elongated printing capability; true lower-case descenders; 96-character set, including six foreign-language fonts; 9 x 8 character matrix; bit graphics printing capability with 60 and 120 dpi horizontal resolution; 100-cps throughput; and 132-character buffer. An optional serial interface is available. The next model up is the D-200, with a throughput of 120 cps and proportional spacing;



italics; selectable super- and subscripting capability; near-letter-quality printing capability; and selectable

60/72/120 bit-graphics. The top-of-the-line Model D-300 is basically the same as the D-200, except that its through-

put is 140 cps. \$795 for D-300; \$595 for D-200; \$395 for D-100.

Circle No. 85 on Free Information Card

# NEW PRODUCTS

## Compatible Personal Computer

Micro Craft's Dimension 68000 Professional Personal Computer is touted to be the most hardware/software compatible such system on the market. With appropriate hardware options, it can emulate virtually any popular 8-, 16-, or 32-bit computer/software combination. Using an MC68000 CPU, it can access 16M of main memory and up to 50M of hard-disk storage. It comes with a microprocessor-controlled detached keyboard with separate numeric keypad and 10 user-programmable keys; 8K



operating system in ROM; two 5 1/4" double-sided, single/double-density floppy drives; drive controller that can handle four 5 1/4" and four 8" drives; 20/40/80/92 × 20-to-50-line text and 160 × 500-pixel (in 16 colors) or 640 × 500-pixel (in monochrome) graphics display formats; Centronics parallel, RS-232 serial, and game control interfaces; color controller; CP/M-68K; interpreter BASIC; assembler; and C. \$3995 with 128K RAM and two 400K drives; \$4245 with 256K RAM and two 400K drives; \$4545 with 256K RAM and two 800K drives.

Circle No. 87 on Free Information Card

## High-Speed Printer

Mannesmann Tally's Model MT-440 multi-function high-speed dot-matrix printer whizzes along at a speed of 400 cps and is capable of bursts of up to 650 cps when bypassing blank portions of a line. In the letter-quality mode, throughput is a speedy 100 cps. One model in the 440 series does bar-code printing

at a speed of 270 cps. All printers in the three-model series feature a unique paired-tractor paper-handling system for tighter paper handling and enhanced print quality. One set of tractors pulls paper from the rear-feed opening into the printing area; another set pulls the paper from the printing area into the output bin. Other standard features include sin-

gle-sheet and letterhead printing; bottom paper feed; 9 × 7 matrix for draft quality and 18 × 80 matrix for correspondence-quality printing; selectable 10, 12, and 16.7 cpi pitch; full dot-addressable graphics. \$2395 for MT-440I draft quality only; \$2695 for MT-440L letter-quality; \$2995 for MT-440D bar-code/OCR/text models.

Circle No. 88 on Free Information Card



## Color/Monochrome Board

The Multigraph board from Profit Systems permits IBM PC users to choose a color or monochrome video display. It offers monochrome graphics in two different modes, plus an inexpensive 132-column option in monochrome; optional soft scrolling; and increased operating speed made possible by a 32-bit internal architecture. In monochrome, Multigraph offers graphics with a 720 × 350-pixel resolution that is compatible with Lotus 1-2-3 and the ability to run standard software written for the IBM color board on the monochrome monitor. In color and monochrome, it offers 32K of on-board memory and flicker-free scrolling. Among the options available with Multigraph is a printer interface for any parallel printer. In color, the option is open to upgrade to 640 × 200- or 640 × 400-pixel resolution in 16 colors. In monochrome, it is possible to upgrade to 720 × 700-pixel graphics and 132 column resolution. A 128K on-board display buffer is an option for both color and monochrome. Address: Profit Systems, Inc., PO Box 1039, Berkeley, MI 48072.

# 80 COLUMN PRINTER SALE—\$149.00\*

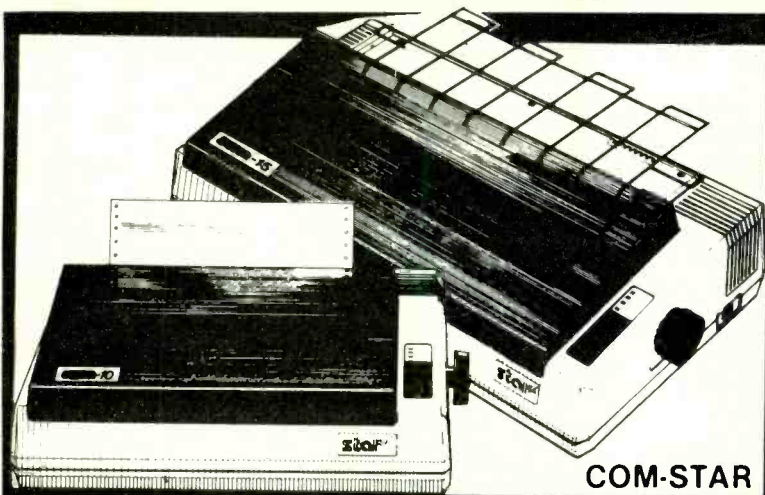

## COM-STAR T/F

Tractor  
Friction  
Printer

only **\$199\*\***

• 15 Day Free Trial - 180 Day Immediate Replacement Warranty

- Lowest Priced, Best Quality, Tractor-Friction Printers in the U.S.A.
- Fast 80-120-160 Characters Per Second • 40, 46, 66, 80, 96, 132 Characters Per Line Spacing
- Word Processing • Print Labels, Letters, Graphs and Tables • List Your Programs
- Print Out Data from Modem Services • "The Most Important Accessory for Your Computer"

### \*STX-80 COLUMN PRINTER—\$149.00

Prints full 80 columns. Super silent operation, 60 CPS, prints Hi-resolution graphics and block graphics, expanded character set, exceptionally clear characters, fantastic print quality, uses inexpensive thermal paper! Best thermal printer in the U.S.A.! (Centronics Parallel Interface).

### \*\*DELUXE COMSTAR T/F 80 CPS PRINTER—\$199.00

The COMSTAR T/F (Tractor Friction) PRINTER is exceptionally versatile. It prints 8½" x 11" standard size single sheet stationary or continuous feed computer paper. Bi-directional, impact dot matrix, 80 CPS, 224 characters. (Centronics Parallel Interface).

### Premium Quality—120 CPS COMSTAR T/F SUPER-10X PRINTER—\$289.00

COMSTAR T/F (Tractor Friction) SUPER-10X PRINTER gives you all the features of the COMSTAR T/F PRINTER plus a 10" carriage, 120 CPS, 9 x 9 dot matrix with double strike capability for 18 x 18 dot matrix (near letter quality), high resolution bit image (120 x 144 dot matrix), underlining, back spacing, left and right margin settings, true lower decenders with super and subscripts, prints standard, italic, block graphics

and special characters, plus 2K of user definable characters! The COMSTAR T/F SUPER-10X PRINTER was Rated No. 1 by "Popular Science Magazine." It gives you print quality and features found on printers costing twice as much!! (Centronics Parallel Interface) (Better than Epson FX 80).

### Premium Quality—120 CPS COMSTAR T/F SUPER-15½" PRINTER—\$379.00

COMSTAR T/F SUPER 15½" PRINTER has all the features of the COMSTAR T/F SUPER-10X PRINTER plus a 15½" carriage and more powerful electronics components to handle large ledger business forms! (Better than Epson FX 100).

### Superior Quality SUPER HIGH SPEED—160 CPS COMSTAR T/F 10" PRINTER—\$489.00

SUPER HIGH SPEED COMSTAR T/F (Tractor Friction) PRINTER has all the features of the COMSTAR SUPER-10X PRINTER plus SUPER HIGH SPEED PRINTING—160 CPS, 100% duty cycle, 8K buffer, diverse character fonts, special symbols and true decenders, vertical and horizontal tabs. RED HOT BUSINESS PRINTER at an unbelievable low price!! (Serial or Centronics Parallel Interface)

### Superior Quality SUPER HIGH SPEED—160 CPS COMSTAR T/F 15½" PRINTER—\$579.00

SUPER HIGH SPEED COMSTAR T/F 15½" PRINTER has all the features of the SUPER HIGH SPEED COMSTAR T/F 10" PRINTER plus a 15½" carriage and more powerful electronics to handle larger ledger business forms! Exclusive bottom paper feed!!

### PARALLEL INTERFACES

For VIC-20 and COM-64—\$49.00

For All Apple Computers—\$79.00

NOTE: Other printer interfaces are available at computer stores!

### Double Immediate Replacement Warranty

We have doubled the normal 90 day warranty to 180 days. Therefore if your printer fails within "180 days" from the date of purchase you simply send your printer to us via United Parcel Service, prepaid. We will IMMEDIATELY send you a replacement printer at no charge, prepaid. This warranty, once again, proves that WE LOVE OUR CUSTOMERS!

Add \$17.50 for shipping, handling and insurance. WE DO NOT EXPORT TO OTHER COUNTRIES EXCEPT CANADA.

Enclose Cashiers Check, Money Order or Personal Check. Allow 14 days for delivery, 2 to 7 days for phone orders, 1 day express mail! Canada orders must be in U.S. dollars. VISA — MASTER CARD ACCEPTED. We ship C.O.D.

SUPER-10"

ABCDEFGHIJKLMNOPQRSTUVWXYZ  
ABCDEFGHIJKLMNOPQRSTUVWXYZ 1234567890

Circle No. 40 on Free Information Card

**PROTECTO ENTERPRISES** (WE LOVE OUR CUSTOMERS)

BOX 550, BARRINGTON, ILLINOIS 60010  
Phone 312/382-5244 to order

# NEW PRODUCTS

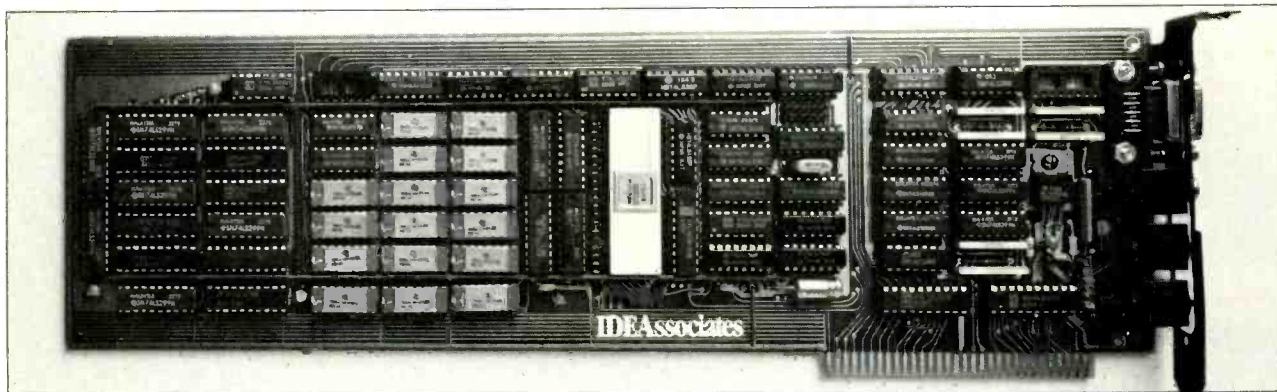

## Color Graphics Card

IDEAgraph from IDE Associates is a high-performance color graphics card for the IBM PC and XT computers. It is claimed to offer the greatest number of colors at the highest speed, using less memory than competing graphics boards. IDEAgraph

features the NEC 7220 chip and 128K of memory to generate four color planes (16 colors) at the standard  $640 \times 200$ -pixel resolution of an IBM PC monitor. The system's functions are hardware driven to operate 100 times faster than software-driven boards. Resolution and colors are software configured.

Available in 28- and 40-MHz versions, with 128K or 256K of memory, IDEAgraph is programmable to  $1024 \times 1024$  pixels. With 256K, eight color planes are programmable and 256 colors can be selected from a palette of 4096 colors. A hardware-controlled "zoom factor" of 1:16 can be used to highlight

specific areas of the display. Display blinking is through a software-controlled blink feature. Supplied with the board are IBM-compatible BIOS, IDE-extended BIOS, and virtual device interface (VDI) designed to link with GSX. \$895 to \$1895.

Circle No. 89 on Free Information Card

## 16/8-Bit Professional Computer

Xerox's new 16/8 Professional Computer has both 16- and 8-bit microprocessors with 128K (expandable to 256K) and 64K separate (not expandable) memories, respectively. A key feature of the computer is its concurrent processing ability that, because the processors each have their own separate memory blocks, permit operation under separate applica-



tions programs to be executed simultaneously. (Users of Xerox's Model 820-II 8-bit computer can upgrade to 16/8 status by adding an optional 16-bit processor card

kit and expansion modules.) The 16/8 has a 12" ( $24 \times 80$ -character) video display screen with high/low intensity, inverse video, and graphics. The keyboard has 18 function keys. Users can choose single- or double-sided  $5\frac{1}{4}$ " or 8" disk drives, and an optional 10M hard-disk drive is available. CP/M, CP/M-85, and MS-DOS are included at no extra cost. \$3395 to \$5295, depending on storage capacity.

Circle No. 90 on Free Information Card

## Host Computer Emulator

PCOX from CXI, Inc. is a high-performance interface that allows the IBM PC to emulate the IBM host 3278/3279 series mainframes. It interfaces with IBM 3274/3276 cluster controllers by way of a coaxial connection. It enables the IBM PC to emulate the IBM 3278 models 2, 3, and 4 with no performance degradation and, when equipped with a color monitor, is also able to emulate the IBM 3279 model 2A or 3A. The IBM PC and compatibles retain their stand-alone processing capabilities. PCOX is transparent to the operating system, access method, and application. A user-friendly file-transfer capability and PCOX's speed are claimed to be key advantages of the interface. The file transfer uses special PCOX interfacing subroutines that permit transferring files between the host computer and the PC by menu selection. \$1390; \$1195 without the file-transfer utility.

Circle No. 91 on Free Information Card

## Monochrome Monitor

Roland DG's Model MB-122 is an IBM PC-compatible monochrome monitor available with either green or amber phosphor. Features include a non-glare screen, 2000-character display capability,  $720 \times 350$ -pixel high-resolution graphics, and a brightness control on the front panel. The input to the terminal consists of a nine-pin TTL video jack, included with the monitor. \$225 green, \$240 amber. Address: Roland DG, 7200 Dominion Circle, Los Angeles, CA 90040.



# Which would YOU buy?

## Global Specialties QT-59S Socket

- 590 Tie Points
- 8-I.C. Capacity
- No Grid Labeling
- Horizontal Expansion only
- Screw-Down Mounting



**\$12.50**

## HANDY HB-1000 Socket

- 640 Tie Points
- 9-I.C. Capacity
- Alphanumeric Grid Labeling
- Both Horizontal and Vertical Expansion
- Self-Adhesive Mounting



**\$9.95**

**NEW!**

If you have two similar products, both designed for the same function... and one offers you MORE features for LESS money... which would YOU buy? The answer is obvious!

Just look at all these EXTRAS built into every HANDY test socket and buss strip...

- **Total contact labeling...** simplifies circuit design/layout
- **Self-adhesive backing...** for one-step simplified alignment and mounting
- **Full 9 14-Pin I.C. Capacity**
- **Expands both horizontally and vertically...** interlocks can't break or twist off
- **High temperature plastic housing...** to 80°C... no warping or melting ever!
- **Prices always up to 25% less than other leading brands**

To all these add: Long Life, low resistance and wide range contacts that accept combinations of resistors, capacitors, diodes, transistors, I.C.s, etc. with leads from .012 - .032" or 20 - 29 AWG. Clear, easy-to-read-and-identify contact markings simplify layout, wiring and documentation. Socket rows are labeled 1-to-64, and columns are marked A-to-E and F-to-J. Mating buss strip rows are labeled



A-to-D and consist of 25 contacts each. Bold red and blue lines show where contact strips begin and end.

Finally, we have a full line of breadboarding equipment, from discrete sockets and buss strips to multi-board assemblies, available at comparable lower-than-low prices.

**Here's how to order...**

### HANDY Sockets and Buss Strips

Part Number	Socket Strips	Buss Strips	Ground Plate	Tie Points	14 pin IC's	Price
HB-0100	N/A	1	no	100	N/A	2.25
HB-1000	1	N/A	no	640	9	9.95
HB-1110	1	1	yes	740	9	11.95
HB-1210	1	2	yes	840	9	13.95

### HANDY Breadboard Assemblies

Part Number	Socket Strips	Buss Strips	Binding Posts	Tie Points	14 pin IC's	Price
HB-2112	2	1	2	1380	18	25.95
HB-2312	2	3	2	1980	18	31.00
HB-3514	3	5	4	2420	27	47.95
HB-4714	4	7	4	3260	36	63.95

Mall Orders: Please add \$3 (Canada & Int'l add \$5) to cover cost of shipping/handling. Sorry! No C.O.D. orders.  
Charge Cards: (Min. \$15). Please include Acct. No., Exp. Date, Bank No. (M/C Only) and your signature.  
Checks: Drawn in U.S. Dollars on U.S. banks only. Connecticut Residents: Add 7% Sales Tax.

Let's face it. If you get all this... and the prices are ALWAYS to 25% less... there's no doubt which you'll buy. HANDY. It's our name... and it tells you what we do.

What are you waiting for? Order your HANDY breadboarding products today. A toll-free call is all it takes!



To order... call (203) 488-6603 Collect  
...charge with VISA, MasterCard or American Express.  
All items off-the-shelf for immediate shipment!

a division of RSP Electronics Corp.

7 Business Park Drive • P.O. Box 699 • Branford, CT 06405 • (203) 488-6603 • TWX: (710) 000-0000  
U.S. and Canadian Distributor inquiries welcomed.

# NEW PRODUCTS

## Intelligent Print Interface

Texprint has announced the Print-It! Model 2 full parallel printer interface for Apple II computers. It features 64K of ROM, 202 graphics modes, 25 text modes, seven format modes, compatibility with Apple IIe computers and more than 15 models of printers, including color models. The interface fully supports all the operating modes of the Apple II computer: 40- or 80-column text (even using the Videx card); standard and alternate font; color and monochrome; low-resolu-

tion, high-resolution, and double-high-resolution graphics; and automatic selection of proper print format to match the current screen in the Apple IIe. The same board is also compatible with Franklin and other Apple work-alike computers and has the ability to detect the type of computer in which it is installed to eliminate user set-up error. The self-contained device does not require a disk to load programs, nor are different program ROMs needed to obtain printer compatibility. \$174. **Address:** Texprint, Inc., 8 Blanchard Rd., Burlington, MA 01803.

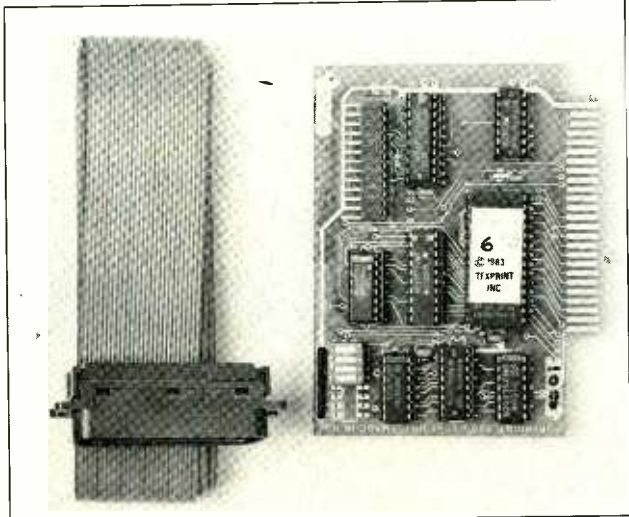

## SOFTWARE SOURCES

**Communications System.** Novation, Inc. has introduced its PC1200B smart modem and packaged it together with Crosstalk XVI from Microstuf, Inc. It is the first of a new family of customized communications systems called Access 1-2-3 that incorporate the LSI PC1200B 212 modem. The modem fits into a slot inside a number of IBM PC-compatible computers. It features an extensive set of commands and responses that provide telephone-line status. It has a built-in dialer (tone or pulse) with dial-tone and busy detect, which allows the modem to be preprogrammed to redial. The modem can also auto-answer and provide audio monitoring through the computer's internal speaker. It is capable of operating at either 300- or 1200-baud full duplex. Crosstalk XVI is an intelligent-terminal and file-transfer program configured to make full use of the modem's features. It can store up to 40 separate log-on passwords and IDs, allowing information utilities or mainframes to be accessed with a single keystroke. The program includes extensive error-checking and displays the transmission time for each file to be transferred. \$595.

Circle No. 92 on Free Information Card

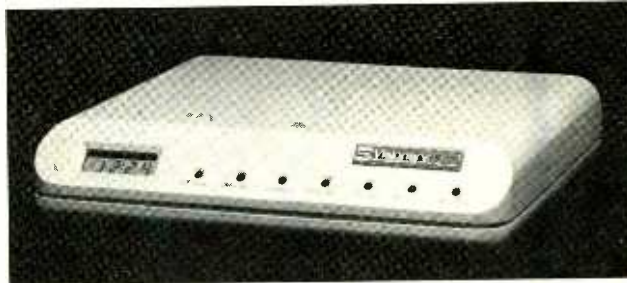

## Intelligent Stand-Alone Modem

Visionary Electronics is marketing the Visionary 1200 intelligent stand-alone 1200/300-baud modem. It contains up to 48K (24 pages) of battery-protected RAM for sending, receiving, and storing messages, including TEL-EX and TWX, and has its own internal clock/calendar. On-board software gives the modem the capability of sending and receiving messages automatically, even if the host computer is turned off. The Visionary is claimed to be the only modem on the market that contains all the features required, including internal answerback, to con-

veniently send/receive TEL-EX and TWX traffic directly to/from a computer's word processor. The Visionary 1200 contains a Bell 212A modem and two serial ports. It is 8085 microprocessor-controlled and includes such automatic features as: auto-answer; autodial; auto-redial on busy or no answer; answerback; automatic log-on; and data capture and retrieval. The system operates in originate or answer mode, communicates in either half or full duplex, and is RS-232C compatible. \$795 with 2K, \$895 with 32K, \$1095 with 48K of RAM. **Address:** Visionary Electronics Inc., 141 Parker Ave., San Francisco, CA 94118.

## Speech-Synthesizer Board

Street Electronics is currently offering three speech-synthesizer boards for use with personal computers. The

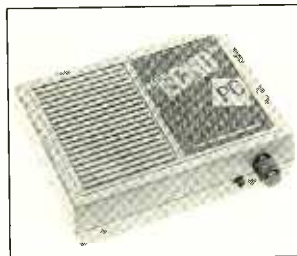

Echo II is for Apple, Echo-PC is for IBM-PC, and Echo GP is for virtually any other personal computer. All are capable of vocalizing in four different voice modes that range from a robotic machine sound to text-to-speech and phoneme modes to a natural voice in a fixed-word dictionary and custom-encoded

modes. (The fixed-word dictionary is currently available for the Echo II and Echo-PC only.) Echo II consists of a small board that plugs into any Apple slot, an 8-ohm speaker, diskette with demonstration and utility programs, and a comprehensive tutorial-style manual. Echo-PC comes with a diskette that contains a few demonstration programs and a sample of the natural-sounding fixed-word capability, in addition to an outboard hardware module with speaker. Like the Echo-PC, the Echo GP is a complete standalone speech synthesizer with on-board 6511 microprocessor, built-in speaker, text-to-speech firmware, wall-mount power supply, and serial interface. \$149.95 for Echo II; \$199.95 for Echo-PC and Echo GP. **Address:** Street Electronics Corp., 1140 Mark Ave., Carpinteria, CA 93013.



# The Computer Book Club®









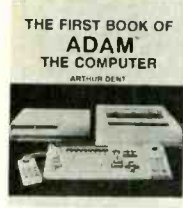

"The ONLY Book Club for Microcomputerists!"

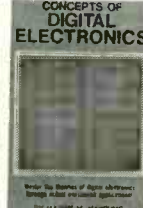
## Superior Performance! Practical Price!

More programs, projects, ways to use your micro for home, hobby, education, and business!

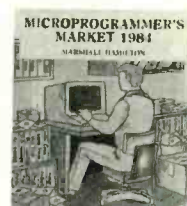
### Select 5 Books for Only \$2<sup>95</sup>

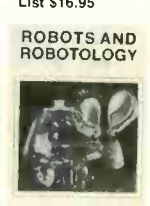
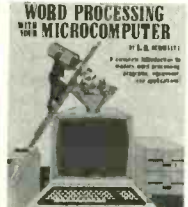

 1720 List \$14.95	 1473 List \$19.95	 1531 List \$17.95	 1479 List \$19.95	 1643 List \$19.95	 1539 List \$19.95	 1062 List \$14.95	 1743 List \$16.95
 1427 List \$21.95	 1700 List \$18.95	 1612 List \$15.95	 1398 List \$16.95	 1160 List \$14.95	 1607 List \$21.95	 1195 List \$13.95	 1673 List \$13.95
 1295 List \$16.95	 1478 List \$19.95	 1277 List \$19.95	 1620 List \$16.95	 1585 List \$21.95	 1111 List \$15.95		

## Plus FREE For Joining

### 7 very good reasons to join The Computer Book Club®

- **Big Savings.** Save 20% to 75% on books sure to increase your computer know-how
- **No-Risk Guarantee.** All books returnable within 10 days without obligation at Club expense
- **Club News Bulletins.** All about current selections—mains, alternates, extras—plus bonus offers. Comes 13 times a year with hundreds of up-to-the-minute titles you can pick from
- **"Automatic Order."** Do nothing, and the Main selection will be shipped automatically! But . . . if you want an Alternate selection—or no books at all—we'll follow the instructions you give on the reply form provided with every News Bulletin
- **Bonus Books.** Immediately get a Dividend Certificate with every book purchased and qualify for big discounts of 60% to 80%
- **Extra Bonuses.** Take advantage of added-value promotions, plus special discounts on software, games, and more
- **Exceptional Quality.** All books are first-rate publisher's editions selected by our Editorial Board and filled with useful, up-to-the-minute information

April 1984

### The Computer Book Club®

P.O. Box 80, Blue Ridge Summit, PA 17214

Please accept my membership in The Computer Book Club® and send the 5 volumes circled below, plus my FREE copy of *BASIC Statements, Commands and Functions*, billing me \$2.95 plus shipping and handling charges. If not satisfied, I may return the books within ten days without obligation and have my membership canceled. I agree to purchase 3 or more books at reduced Club prices (plus shipping/handling) during the next 12 months, and may resign any time thereafter.

1062 1111 1160 1195 1276 1277 1295 1333 1389  
 1398 1427 1466 1473 1478 1479 1531 1539 1585 1607  
 1612 1620 1633 1643 1673 1700 1720 1722 1743

Name \_\_\_\_\_ Phone \_\_\_\_\_  
 Address \_\_\_\_\_  
 City \_\_\_\_\_  
 State \_\_\_\_\_ Zip \_\_\_\_\_

Valid for new members only. (Foreign customers must pay in advance in U.S. currency.) This order subject to acceptance by The Computer Book Club®. PECC-484

Circle No. 39 on Free Information Card

# NEW PRODUCTS

## Color Computer Interface

The new TRS-80 Color Computer Multi-Pak Interface from Radio Shack permits up to four Program Pak cartridges to be connected to a TRS-80 color computer. Once game, educational, or business cartridges are inserted, programs can be selected by the flip of a single switch on the front panel of the interface module, eliminating the need to plug and unplug frequently used programs. The Multi-Pak interface attaches to the color computer's Program Pak slot. \$179.95.

Circle No. 93 on Free Information Card



## SOFTWARE SOURCES

**Writers' Tool.** A program for writers that integrates database management and word processing is available for the IBM PC and compatible computers from IdeaWare, Inc. Called The Idea Processor, it provides tools for information gathering and manuscript preparation. Notes, quotes, references and other source materials can be put freeform into a "cardfile" database system and assigned labels by which they can be recalled at a later time. The material can be transferred, in whole or in part, to the program's word-processing section where it can be modified, embellished, formatted for printing, footnoted, and more. The database system allows searching on multiple keys and allows the use of logical operators to specify how keys should be combined. The word processor offers a number of editing, printing, and formatting capabilities including automatic footnoting. A total of 18 help screens are available on demand. Minimum memory required is 192K. \$295. Address: IdeaWare, Inc., 225 Lafayette Street, Suite 712, New York, NY 10012; 212-334-8043.

**Spelling Checker.** Trigram Systems has announced a spelling correction program for the IBM PC and MS-DOS based machines designed to make full use of the extended memory addressing capability of 16-bit microprocessors. It will use up to 256K of RAM if available, although it can run in as little as 96K. MicroSpell V keeps its entire 58,795-word dictionary in memory, resulting in very fast word lookup and nearly instantaneous dictionary assistance. In addition to being able to look up words on request, the program suggests the correct spelling of suspect words automatically with virtually no time delay. A user can replace a misspelling with one of the alternatives displayed using a single keystroke. Twenty proofreading options can customize MicroSpell for particular tasks. For example, a user can choose to ignore formatter commands, check for repeated words, mark lines that change width after correction, automatically create auxiliary dictionaries, etc. The main dictionary is user modifiable. Entries can easily be deleted, and ten- to twenty-thousand new words can be added. \$139. Address: Trigram Systems, 3 Bayard Rd. #66, Pittsburgh, PA 15213.

## Joystick Interface

"Joy-Mouse" is a hardware interface from Micro-Labs, Inc., that allows TRS-80 Model III and 4 computers to use two proportional-control joysticks, trackballs, and/or mouse controls. It provides instantaneous hi-res X and Y position values ranging from 0 to 255, plus sound and music. The cassette cable plugs into a built-in amplifier that features a volume control and on/off switch. The device can be used with either BASIC or assembly language programs and is said to work with all

game programs written for joysticks. This new hardware device interfaces any device designed to be plugged into the TRS-80 Color Computer's joystick port with the Model III and 4 computers. Four A/D ports are available for monitoring any analog signals. Joy-Mouse comes in its own case and includes its own power supply. When plugged into the computer, the Joymouse allows other peripherals to be connected at the same time it is. \$99.95. Address: Micro-Labs, Inc., 902 Pinecrest, Richardson, TX 75080.



## Programmable Printer Interface

Advanced Interface Devices' Interfast-I is a 4K buffered programmable printer interface for Atari computers. It is hardware- and software-compatible with the Atari 850 Interface Module printer port and requires no modification to the computer. The device

can be user-programmed for advanced printing applications, such as graphics on printers with this capability. Translation of the ATASCII EOL character to ASCII carriage return is also user selectable. Address: Advanced Interface Devices, Inc., PO Box 2188, Melbourne, FL 32902.



# COMPUTER MAIL ORDER

**Commodore**

**SX-64 PORTABLE \$ 839<sup>00</sup>**



**HOME COMPUTERS**



CBM 8032.....	\$599
B128-80.....	\$769.00
CBM 64K Memory Board.....	\$269.00
8032 to 9000 Upgrade.....	\$269.00
2031 LP Disk Drive.....	\$299.00
8050 Disk Drive.....	\$949.00
8250 Disk Drive.....	\$1199.00
4023 Printer.....	\$379.00
8023 Printer.....	\$589.00
6400 Printer.....	\$1399.00
Z-RAM.....	\$499.00
Silicon Office.....	\$699.00
The Manager.....	\$199.00
Sort ROM.....	\$125.00
VisiCalc.....	\$159.00

**PROFESSIONAL SOFTWARE**

Word Pro 2 Plus.....	\$159.00
Word Pro 3 Plus.....	\$189.00
Word Pro 4 Plus/5 Plus.....each	\$279.00
InfoPro.....	\$179.00
Administrator.....	\$399.00
Power.....	\$79.00

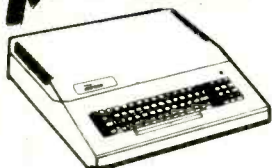

ACE 1000 Color Computer.....	CALL
ACE Family Pack System.....	CALL
ACE PRO PLUS System.....	CALL
ACE 1200 Office Mgmt. System.....	CALL
"NOT IIe EXPENSIVE"	

**MODEMS ANCHOR**

Mark I (RS-232).....	\$79.00
Mark II (Atari).....	\$79.00
Mark III (TI-99).....	\$109.00
Mark IV (CBM/PET).....	\$125.00
Mark V (Osborne).....	\$95.00
Mark VI (IBM-PC).....	\$169.00
Mark VII (Auto Ans/Auto Dial).....	\$119.00
Mark XII (1200 Baud).....	\$299.00
TRS-80 Color Computer.....	\$99.00
9 Volt Power Supply.....	\$9.00

**HAYES**

Smartmodem 300.....	\$219.00
Smartmodem 1200.....	\$509.00
Smartmodem 1200B.....	\$459.00
Micromodem II.....	\$265.00
Micromodem II Plus.....	\$299.00
Micromodem Iie.....	\$269.00
Micromodem 100.....	\$299.00
Smart Com II.....	\$89.00
Chronograph.....	\$199.00

**NOVATION**

J-Cat.....	\$99.99
Smart Cat 103.....	\$179.00
Smart Cat 103/212.....	\$399.00
Auto Cat.....	\$219.00
212 Apple Cat.....	\$569.00
Apple Cat 212 Upgrade.....	\$309.00
Cat.....	\$139.00
O-Cat.....	\$149.00
PC-Cat.....	\$399.00

**ZENITH**

ZT-1.....	\$309.00
ZT-10.....	\$339.00
ZT-11.....	\$369.00

**VIC 20..... CALL**

**C-64..... \$199**

MSD Disk Drive (C-64).....	\$349.00
C1541 Disk Drive.....	\$249.00
C1530 Datasette.....	\$69.00
C1520 Color Printer/Plotter.....	\$169.00
M-801 Dot Matrix/Parallel.....	\$219.00
C1526 Dot Matrix/Serial.....	\$279.00
C1702 Color Monitor.....	\$249.00
C1311 Joystick.....	\$4.99
C1312 Paddles.....	\$11.99
C1600 VIC Modem.....	\$59.00
C1650 Auto Modem.....	\$89.00
Logo 64.....	\$49.00
Pilot 64.....	\$39.00
Simon's BASIC.....	\$19.00
Word Pro 64 Plus.....	\$59.00
Parallel Printer Interface.....	\$49.00
Calc Result 64.....	\$129.00
Codewriter 64.....	\$75.00
Quick Brown Fox.....	\$49.00

**APPLE/FRANKLIN DISK DRIVES MICRO-8CI**

A2.....	\$219.00
A40.....	\$299.00
A70.....	\$319.00
C2 Controller.....	\$79.00
C47 Controller.....	\$89.00

**RANA**

Elite 1.....	\$279.00
Elite 2.....	\$389.00
Elite 3.....	\$569.00

**APPLE IIe STARTER PACK**

64K Apple IIe, Disk Drive & Controller, 80 Column Card, Monitor II & DOS 3.3 COMPLETE.....	CALL
--	------

**MONITORS AMDEK**

300 Green.....	\$149.00
300 Amber.....	\$159.00
310 Amber.....	\$169.00
Color 1.....	\$279.00
Color 1 Plus.....	\$299.00
Color 2.....	\$399.00
Color 2 Plus.....	\$419.00
Color 3.....	\$349.00
Color 4.....	\$699.00

**BMC**

12" Green.....	\$79.99
12" Green Hi-Res.....	\$119.99
9191-13" Color.....	\$249.99

**GORILLA**

12" Green.....	\$88.99
12" Amber.....	\$95.99

**NEC**

JB 1260 Green.....	\$109.99
JB 1201 Green.....	\$149.99
JB 1205 Amber.....	\$159.99
JC 1215 Color.....	\$299.99
JC 1216 RGB.....	\$429.99

**PRINCETON GRAPHICS**

HX-12.....	\$519.00
------------	----------

**TAXAN**

12" Green.....	\$119.00
12" Amber.....	\$129.00
Taxan 1 RGB.....	\$279.00

**UBI**

Pr 1, 9" Green.....	\$99.99
Pr 2, 12" Green.....	\$119.99
Pr 3, 12" Amber.....	\$149.99
Pr 4, 9" Amber.....	\$139.99
1400 Color.....	\$269.99

**ZENITH**

ZVM 122 Amber.....	\$109.00
ZVM 123 Green.....	\$89.99
ZVM 135 Color/RGB.....	\$469.99

1010 Recorder.....	\$74.00
1020 Color Printer.....	\$249.00
1025 Dot Matrix Printer.....	\$339.00
1027 Letter Quality.....	\$309.00
1030 DirectConnect Modem.....	\$119.00
1050 Disk Drive.....	\$339.00
CX30 Paddle.....	\$12.00
CX40 Joystick.....each	\$8.00
CX77 Touch Tablet.....	\$64.00
CX80 Trak Ball.....	\$48.00
CX85 Keypad.....	\$105.00
488 Communicator II.....	\$229.00
4003 Assorted Education.....	\$47.00
4011 Star Raiders.....	\$33.00
4012 Missile Command.....	\$29.00
4013 Asteroids.....	\$29.00
5049 VisiCalc.....	\$59.00
7097 Logo.....	\$79.00
7101 Entertainer.....	\$69.00
7102 Arcade Champ.....	\$75.00
8026 Dig Dug.....	\$33.00
8030 E. T. Phone Home.....	\$33.00
8031 Donkey Kong.....	\$39.00
8033 Robotron.....	\$35.00
8034 Pole Position.....	\$39.00
8036 Atari Writer.....	\$79.00
8040 Donkey Kong, Jr.....	\$39.00
8043 Ms. PacMan.....	\$39.00
8044 Joust.....	\$39.00

**MEMORY BOARDS**

Axlon 32K.....	\$59.00
Axlon 48K.....	\$99.00
Axlon 128K.....	\$299.00
Intec 32K.....	\$59.00
Intec 48K.....	\$85.00
Intec 64K.....	\$99.00
Intec Real Time Clock.....	\$29.00

**PRINTERS AXIOM**

AT-100 Atari Interface.....	\$239.00
CD-100 CBM 64/VIC 20.....	\$239.00
GP-100 Parallel Interface.....	\$199.00

**BMC**

401 Letter Quality.....	\$589.00
BX-80 Dot Matrix.....	\$269.00

**C.ITOH**

Gorilla Banana.....	\$209.00
Prowriter 8510P.....	\$379.00
Prowriter 1550P.....	\$599.00
A10 (18 cps).....	\$569.00
F10-40.....	\$999.00
F10-55.....	\$1499.00

**EPSON**

MX-80FT, MX-100, RX-80, RX-80FT, FX-80, FX-100.....	CALL
---	------

**OKIDATA**

82, 83, 84, 92, 93, 2350, 24" 0.....	CALL
--------------------------------------	------

**SMITH CORONA**

TP-2.....	\$399.00
Tractor Feed.....	\$119.00

**SILVER REED**

500 Letter Quality.....	\$469.00
550 Letter Quality.....	\$699.00

**STAR**

Gemini 10X.....	\$299.00
Gemini P15X.....	\$399.00
Delta 10.....	\$559.00
Serial Board.....	\$75.00

**600XL.....\$189**

**800XL.....\$299**

**1200XL .... CALL**

**1400XL .... CALL**



AT 88-S1.....	\$369.00
AT 88-A1.....	\$259.00
AT 88-S1PD.....	\$449.00
AT 88-DDA.....	\$119.00
RFD 40-S1.....	\$449.00
RFD 40-A.....	\$269.00
RFD 40-S2.....	\$699.00
RFD 44-S1.....	\$539.00
RFD 44-S2.....	\$869.00

**TEXAS INSTRUMENTS**

TX 99-S1.....	\$279.00
---------------	----------

**RANA**

1000.....	\$329.00
-----------	----------

**TRAK**

AT-D2.....	\$389.00
------------	----------

**KOALA PAD**

Atari(disk).....	\$75.00
Atari(rom).....	\$82.00
C64(rom).....	\$82.00
C64(disk).....	\$75.00
Apple.....	\$149.00
IBM.....	\$169.00

**WICO CONTROLLERS**

Joystick.....	\$21.99
3-way Joystick.....	\$22.99
Famous Red Ball.....	\$23.99
Power Grip.....	\$21.99
BOSS Joystick.....	\$17.99
ATARI/VIC Trak Ball.....	\$34.99
Apple Trak Ball.....	\$54.99
Apple Adapter.....	\$15.99
Apple Analog.....	\$37.99

**SOFTWARE FOR ATARI**

**ADV. INT.**

Preppie.....	\$19.99
Tutti Fruitti.....	\$11.99

**BRODERBUND**

Bank St. Writer.....	\$49.99
Chopliiffer.....	\$29.99
Track Attack.....	\$21.99

**BIG FIVE**

Miner 2049er.....	\$34.99
-------------------	---------

**DATASOFT**

Canyon Climber.....	\$23.99
Magneto Bugs.....	\$11.99
Pooyan.....	\$19.99
Zaxxon.....	\$27.99
Word Wizard.....	\$52.99
Spell Wizard.....	\$38.99

**ELECTRONIC ARTS**

Hard Hat Mack.....	\$29.99
M.U.L.E.....	\$29.99
Worms.....	\$29.99
Axis Assassin.....	\$29.99
Archon.....	\$29.99
Pinball Construction.....	\$29.99
Murder on the Zinderneuf.....	\$29.99

**EPYX**

Crush, Crumble & Chomp.....	\$21.99
Jumpman.....	\$28.99
Junior Jumpman.....	\$28.99

**THORN EMI**

River Rescue.....	\$28.99
Snooker Billards.....	\$26.99

**= WEST = = CANADA = = EAST =**

**1-800-648-3311**

**1-800-268-4559**

**1-800-233-8950**



In NV call (702)588-5654, Dept. 0407  
P.O. Box 6689, Stateline, NV 89449  
Order Status #: 588-5654

In Toronto call (416)828-0866, Dept. 0407  
2505 Dunwin Ct., Unit 18,  
Mississauga, Ontario, Canada L5L1T1  
Order Status #: 828-0866

In PA call (717)327-9575, Dept. 0407  
477 E. Third St. Williamsport, PA 17701  
Order Status #: 327-9576  
Customer Service Number 327 1450



No risk, no deposit on C. O. D. orders. Pre-paid orders receive free shipping within the UPS Continental United States with no waiting period for certified checks or money orders. Add 3% (minimum \$5.00) shipping and handling on all C. O. D. and credit card orders. Larger shipments may require additional charges. NV and PA residents add sales tax. All items subject to availability and price change. We stock manufacturer's and third party software for most all computers on the market. Call today for our new catalog.

CANADIAN ORDERS: All prices are subject to shipping, tax and currency exchange fluctuations. Call for exact pricing in Canada.

Circle No. 11 on Free Information Card

## VLSI

(Continued from page 67)

cell, is more costly and complex to design VLSI chips with, requiring 13 to 26 weeks time to prototype. However, it yields chips that can be manufactured with lower unit cost. Standard cells constitute a library of functions ranging from primitives like AND and OR gates to more complex functions like RAM and ROM. The designer who uses these devices composes his system from the predefined library of parts/functions to produce a pattern-generation (PG) tape that digitizes the layout of the chip. This tape is then used to generate a master mask that is ultimately used to fabricate the VLSI device (see "The Making of a Chip" box for more details on chip fabrication).

### Hierarchical Structured Design

The other main approach to simplifying the VLSI design process, Hierarchical Structured Design Methodology, has as its strategy the development of a "silicon compiler." Work on the methodology is going on at a large number of educational institutions and, commercially, at such companies as VTI, Silicon Compilers Inc., and Metalogic Inc.

The silicon compiler typically takes a high-level description of the system and converts it into a PG tape with a minimum of designer interaction. The high-level description of a system may, for example, be just an 8-bit BCD adder. This description is used as the input to the silicon compiler, whose output is a digitized layout of the adder in PG tape format. One of the silicon compiler's drawbacks is that the silicon area is not used very efficiently, resulting in higher chip manufacturing cost. However, the designer can improve area efficiency by interacting with the silicon compiler during the intermediate stages of floor planning and layout.

### VLSI Technologies

Bipolar and MOS (metal-oxide-semiconductor) are currently the two major technologies employed in the manufacture of ICs. MOS devices, unlike bipolar devices, have no junctions. Instead, they contain three layers of conducting material—metal, polysilicon (or "poly"), and diffusion. A transistor is created wherever the poly layer crosses over a diffusion layer. CMOS, or complementary metal-oxide-semiconductor, technology presently dominates in the IC marketplace. "Complementary," in this context, refers to the circuit building unit in which a pair of n- and p-channel insulated-gate field-effect tran-

sistors (IGFETs) are connected so that their input gates form a common input and their source electrodes are tied together to form a common output.

Low power consumption is perhaps the main reason for the popularity of CMOS technology. Beyond this, CMOS technology can meet a diverse set of circuit-design requirements, such as high input impedance, wide operating temperature range, and an ability to tolerate significant noise. In its original form, standard metal-gate CMOS technology suffered from slow speeds. However, development of high-speed CMOS, or HCMOS, technology has elevated CMOS gate speeds to be comparable to that achieved with bipolar TTL devices.

Technologies using materials other than silicon currently exist, of course, though at the present only in the design laboratory. The most prominent is gallium-arsenide (GaAs), which is being developed for very-high-speed circuit ap-

## VLSI technology has grown at a phenomenal rate, but there is a limit

plications. With GaAs devices, typical gate propagation delays are reduced to between 22.5 to 75 ps (1 ps = 1-billionth of a second). Another technology presently under development has major implications for the computer industry. Called wafer scale integration, or WSI, it allows an entire silicon wafer to be used to create a single IC, as opposed to the present techniques of obtaining many chips from the same wafer. WSI will make it possible to integrate more functions onto a single chip, with the immediate benefits of increased operating speed, and reduced systems cost. Presently, Trilogy, Inc. and a few other start-up companies are engaged in developing WSI technology.

### Limitations to Growth.

Though VLSI technology has grown at a phenomenal pace, there is a limit to further growth. The main problem areas are packaging, testability, design, and marketing of VLSI devices.

Unlike VLSI, packaging technology is still in its infancy. The dual-in-line package, or DIP, introduced in the midsixties and still being used today, is

already proving to be inadequate for VLSI devices. Having come from the original 14 pins on the early SSI devices, we already see that the current 64-pin DIP design has reached its limit of practicality. A number of packaging options (Fig. 4) are currently being considered. Among these are leaded plastic chip carriers, leadless ceramic chip carriers, pin-grid arrays, and tape automated bonding. While these options already exist, a clear industry standard or trend is not visible at the present time.

Testability and the issue of whether a system has been manufactured correctly remains an open question. In the VLSI era, test generation and verification have become critical issues. One approach that is finding increased popularity in the quest to address these issues is "design for testability." An example of a structured approach to design for testability is level-sensitive scan design (LSSD), developed by IBM. In LSSD, logic design is restricted to a set of design rules and specific cell library elements.

The economics of testability is also a major issue. As a rule-of-thumb, consider the following: If it cost 10¢ to detect a fault at the chip level, it will cost about \$100 to detect the same fault when the chip is in a system out in the field. Hence, detecting faults at the chip level, through a methodology of testability, must become a paramount goal of VLSI design.

The problem of designing with VLSI devices is a complex one. While hierarchical structured design software techniques, such as silicon compilers, are being created to simplify the IC design process, ASICs are permitting customized chips to be manufactured with shorter turnaround times.

As VLSI technology continues to grow, marketing will play an increasingly important role. Not only will marketing help make the technology choice for the designer confronted with an array of VLSI products and design tools, it will also help transmit system designers' needs to those who formulate development plans for VLSI technology.

### Summing Up

Assuming that VLSI technology continues to evolve and grow exponentially, will computer systems have any need for such advanced products? The answer is an emphatic "yes." VLSI will play a crucial and indispensable role in enhancing the power and performance of computers for some time to come. For example, use of VLSI chips should

# TO KEEP UP WITH TODAY'S TECHNOLOGY

# ...YOU HAVE TO KNOW WHERE TO TURN.



When you turn to *Computers & Electronics*, you're reading the world's foremost publication covering the microcomputer industry — where last night's discovery is today's technology. *Computers & Electronics* is your direct link to state-of-the-art information in:

### Microcomputer Developments

Whether you're investing \$300 or \$3000, turn to *Computers & Electronics* first. You'll find candid test reports of all major new microcomputers... from the Commodore 64 to the Apple™ IIe to the IBM-PCXT. And you'll discover which unit has the power, software and expansion capability to meet your specific needs. At your specific budget.

### New Peripherals and Software

Micro programs and add-ons are increasing almost geometrically. Let *Computers & Electronics* sort it all out for you.

You'll get features like a buyer's guide to printers. A preview of the first workable economical thesaurus program that runs on virtually any CP/M-based system. Advance looks at new products like a joystick for Visicalc®, disk drive assemblies... a color monitor for the IBM-PC.

### Increase Your Computer Science I.Q.

*Computers & Electronics* will enlighten you with easy-to-understand discussions of computer fundamentals. Such as the series on learning 16-bit microcomputer technology and an in-depth look at the structure of CP/M.

You'll also delve into the future with articles like Super Chip: next-generation personal computers with double the performance at a lower price.



### Plenty of Hands-On Action, Too

With expert input from *Computers & Electronics*, and your own electronics savvy, you'll find dozens of ways to experiment with... upgrade... and increase the versatility and performance of your system.

For example, with less than \$3 and very little time, you can add a feature to your keyboard that lets you automatically repeat a character by holding down a key. Or you might want to build a circuit that lets you match a 600-baud CoCo to a 300-baud printer.

Heard about the important new electrically-erasable PROMs? *Computers & Electronics* will keep you filled in on the improved memory chips as they're produced — how they work, how to wire them, what applications to use them for.

### Get Every Issue... PLUS Savings up to 37%!

If you're not getting every informative issue of *Computers & Electronics*, there's a gap in your knowledge — and enjoyment — of today's high-speed, high-tech revolution. And now's the best time to subscribe, while this *introductory offer* is in effect: One year (12 big issues) for just \$12.97, with long-term savings available up to 37%!

So keep up with what's happening. Turn to the special postpaid order card or the coupon below... now!

## Computers & Electronics

P.O. Box 2774, Boulder CO 80322

**YES!** Keep me tuned in with *Computers & Electronics* for the term I've checked below:

- One year (12 issues) just \$12.97 — **I save 24%!**
- Two years just \$22.97 — **I save 32%!**
- Three years just \$31.97 — **I save 37%!**

(Savings based on full one-year subscription price of \$16.97)

Mr. /Mrs. /Ms.

(please print full name)

4S135

Address

Apt.

City

State

Zip

CHECK ONE:  Payment enclosed.  Bill me later.

Please charge my credit card:  American Express  MasterCard  Visa

Card No.

Exp. Date

Add \$5 a year in Canada; all other foreign add \$8 a year. Please allow 30-60 days for delivery of first issue.



**DON'T MISS ONE  
INFORMATIVE ISSUE.  
SUBSCRIBE NOW AND  
SAVE UP TO 37%!**

# VLSI

increase large mainframe computer speeds from the present 10-million instructions per second (10 MIPS) to a projected 50 to 70 MIPS by 1990. Similar performance enhancements will also be required in personal, as well as super-mini, computers.

As artificial intelligence (AI) comes of age and database systems find increasing application, the demand for more on-board memory will undoubtedly grow by leaps and bounds. It will be the task of the VLSI designer to

evolve the 8M-bit DRAM to economically and practically meet these needs.

Another area that will depend heavily on VLSI design is the trend toward increasing user friendliness of computers. VLSI chips will have to be developed to serve the graphics needs of users. Among these needs will be higher resolution, faster Lisa-like clones, and more graphics capabilities. The demand for speech communications with computers will also create a requirement for VLSI chips for speech synthesis, analy-

sis, and reproduction. And evolution of user-friendly operating systems and programming languages will dictate that hardware adopt some of current software tasks, using VLSI devices.

Outside the computer industry, VLSI chips are being more and more widely used in computer-like applications. Microprocessors are found in motor vehicles for fuel control, electronic suspension, and on-board diagnosis. Machine tools have microprocessors to control their operations. And ICs have entered

## HOW VLSI EVOLVED

A full appreciation of VLSI requires a brief review of the developments that paved the way for modern VLSI technology. The triode (three-element) vacuum tube, shown schematically in Fig. A, contained a cathode from which electrons were emitted, a plate to which the electrons were attracted, and a grid that controlled the amount of electron flow. (The sole purpose of the filament, a fourth element, was to heat up the cathode to "boil" off electrons. It did not in itself enter into the tube's fundamental current-flow control process and, thus, was not considered a basic function element.) All elements—plate, grid, cathode, and filament—were housed in a vacuum in a bulky and fragile glass envelope which gave rise to the device's name.

The invention of the bipolar transistor, shown schematically in Fig. B, had a tremendous impact on electronics, particularly computers. This *solid-state* device permitted electrons to flow through *solids*, without the need for a vacuum in which to operate or a fila-

only three leads, as opposed to the minimum of five needed for a triode vacuum tube. Along with reduction in size, inherent physical ruggedness, and elimination of the filament, the transistor required fewer and less dangerous operating potentials. This made it possible for simplified power-supply designs and lower basic power consumption. With no filaments and more efficient power usage, transistor-designed computers could be operated in smaller-volume environments and with lighter-duty air-conditioning systems, lowering operating costs for the same computing power.

The transistor made it possible to reduce costs at all levels. Beginning at the manufacturing level, materials required for fabricating transistors were much less expensive than those required for tubes. The OEM user was also able to save considerably on the amount of space and materials required by using transistors, a particularly important consideration in the manufacture of computers.

### Transistor Design

The transistor is an analog of the triode vacuum tube. That is, it has elements that perform the same functions as in the vacuum tube. The counterpart of the vacuum tube's plate is the transistor's *collector*. Similarly, the counterparts of the tube's grid and cathode are the *base* and *emitter*, respectively, in the transistor.

The basic material from which a silicon transistor is fabricated is, of course, pure silicon. To obtain a transistor, a p-type impurity (dopant), such as boron, is added to a block of silicon to give it a deficiency of electrons. Similarly, an n-type impurity is added to another block of silicon to create an excess of electrons. Putting the two blocks of doped silicon together forms a pn junction.

When a voltage is applied across the

pn junction, current can flow through it in only one direction. A simple pn-junction device, therefore, has the characteristics of a diode. Indeed, solid-state diodes, in all their guises, are simple pn-junction devices. To make a bipolar transistor, another n-doped block of silicon must be added to the opposite side of the p material to create a second pn junction, as illustrated in Fig. B. (Shown is the npn transistor. For a pnp transistor, there would be a block of n material sandwiched between two blocks of p material.) The flow of electrical current through the dissimilar types of doped silicon blocks can be controlled by a potential applied to the base electrode (p material in our example).

### Beyond Bipolar Transistors

The next major development in transistors was the planar process created by Jean Hoerni of Fairchild. Previously, all transistors had to have raised areas. The planar process made it possible to

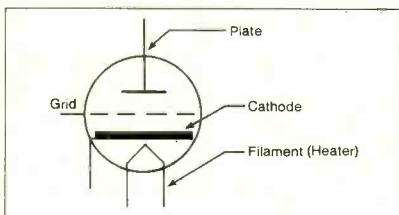

Fig. A. A conventional triode vacuum tube.

ment to provide electrons. Eliminating the need for a vacuum also did away with the need for the glass envelope. The transistor, then, occupied only a small fraction of the space required for even a compact vacuum tube.

Other benefits of transistors included cooler operating temperatures and reduced number of pins. The transistor has

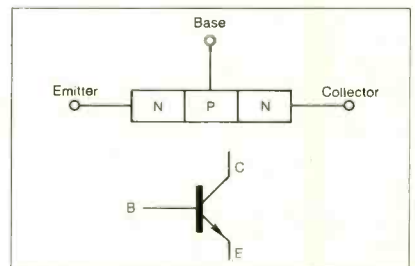

Fig. B. Schematic of the bipolar transistor.

mount many transistors on a single silicon wafer, paving the way for integrated circuits (ICs), which contained a number of components—transistors, diodes, resistors, and capacitors—on a single chip. (The manufacturing process for creating ICs, epitomized by VLSI devices, is described in another section of this article.)

the home environment in such products as automatic dishwashers and solid-state TV receivers. In a nutshell, we are in an era of ever-increasing complexity, electronically speaking. The most practical and economical means for dealing

with this complexity is through the use of VLSI devices. Consequently, we can expect to witness a growing use of and demand for VLSI devices of increasing complexity and capability for a long time to come.

John Nasbitt in his best-selling *Megatrends* book refers to the "mega-shift from an industrial to an information society." Are we perhaps "mega-evolving" now from an information society to a VLSI society? ◇

### THE MAKING OF A CHIP

The making of an IC—particularly a VLSI chip—is one of the most interesting and precise manufacturing processes in existence. Obviously, the details of every step of the manufacturing process cannot be presented here, but some of the important highlights will give a hint of the intricacies and complexities involved.

Preliminary to actual production steps, scientists and engineers painstakingly design the circuits that will go into the IC, a tremendously complex process that can take many months to accomplish. The fruits of this effort are recorded on a pattern-generation (PG) tape that goes to a mask house, where it is used to direct a precisely controlled sequence of exposures on a photographic plate (see Fig. A). The resulting photograph, called a "reticle," becomes the layout for one layer of the IC's circuitry. For each layer that is to be used in the fabrication of the IC, a separate reticle is required.

To make the layout designer's inspection task easier, the photographs might be enlarged up to 100 times for easy viewing. The reticle, however, is usually only a 10× magnification. From this

reticle, a 1× master mask, the exact size of the final chip, is generated by an extremely precise photorepeater camera. The mask is then sent to the fabrication line for photolithography.

The wafer fabrication process (Fig. B) begins with bare polished silicon wafers cut from an ingot of pure silicon. The wafer is placed in a furnace to produce a layer of silicon dioxide ( $\text{SiO}_2$ ), after which photolithography begins with application of a thin coating of photoresist to the  $\text{SiO}_2$  surface. The mask is then placed face down in intimate contact with the surface of the wafer to expose selected areas of the photoresist to ionizing radiation, such as ultraviolet light.

After exposure, the mask is removed and a developer solution is used to remove unwanted portions of resist from the wafer. The wafer is then sprayed with hydrofluoric acid to dissolve  $\text{SiO}_2$  from the resist-free areas of the  $\text{SiO}_2$  surface. Then whatever photoresist remains on the wafer is removed with a strong organic solvent or acid. The pattern that existed on the mask has now been transferred to the wafer's surface as areas of  $\text{SiO}_2$ .

If another layer is to be added to the wafer, the photolithography process is repeated. However, before the photoresist is applied, the wafer must be placed in a special type of furnace to diffuse impurities onto its exposed surfaces. The photolithography process is then repeated to etch oxide from the gate regions of MOS transistors (to be).

The wafer is once again subjected to a furnace for gate oxidation, followed with a third lithography process to remove the oxide layer according to the mask pattern. Next, the entire surface of the wafer is coated with a thin layer of metal by deposition and a fourth mask is used to remove unwanted metal. A fifth and final mask photolithography procedure opens up the bonding pads.

At this point, the wafer is probed and tested, following which a laser scribe or wafer saw separates the wafer into individual dies. Each good die is bonded into the cavity of its protective package and fine wires are bonded between the contact pads on the die and the leads (pins) of the IC package. Finally, a cover is cemented over the cavity. The chip, now a full-fledged IC, is ready for final testing and shipment to dealers. ◇

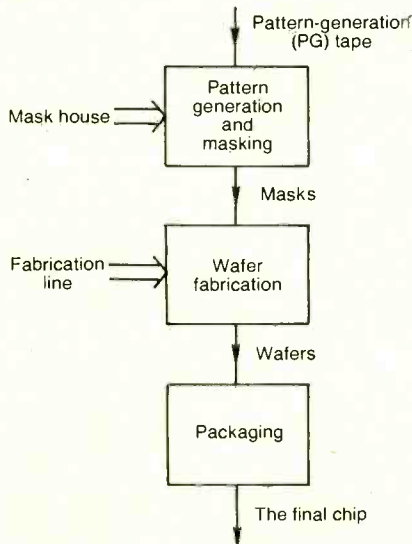

**Fig. A. Steps in the making of a wafer.**

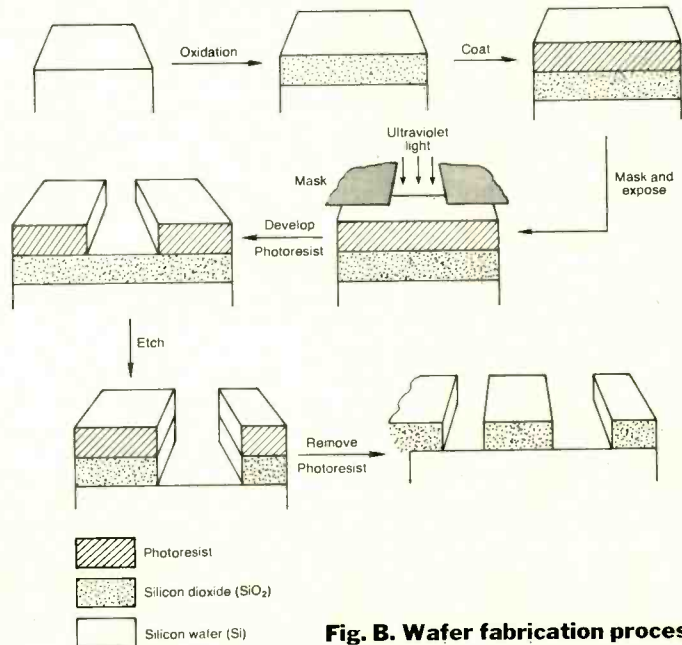

**Fig. B. Wafer fabrication process.**

## Avoiding Software Pitfalls

(Continued from page 54)

the conception stage.) The remaining unique product will do well, maybe spectacularly well, becoming the software equivalent of a classic novel.

Beyond this point it's very hard to quantify results, because our next stage is product evolution, and absolutely nobody knows what the future will bring.

### Evolution

Successful products evolve, or they cease being successful. The reason is that while stripped-down products can achieve remarkable early successes, those same successes draw in the "me too" products, and some of those are going to be done right from all viewpoints—product definition, promotion, advertising, etc.

So a leadership position can and will be lost unless the leader takes steps to maintain his advantages. Minor improvements aren't enough. The changes have to be radical enough to cause the product to appeal to the large numbers of people who didn't find the earlier version attractive enough to buy.

The same issues apply to the "me too" products that make it into volume distribution. They are not only fighting the leader, they are fighting among themselves, and only a fraction of them are going to survive the evolutionary stage.

In effect, a next-generation product is a new product. However, it starts off with the advantage of an already-developed marketplace—a base of satisfied customers, a familiar vendor and product name, and a trade press that is inherently favorably disposed toward it. Of course, some products are so well-done that the evolution to final form takes place quickly, leaving the competitors a "definitive" target to try to displace.

Again, WordStar can be considered such a product. There are plenty of text editors that are easier to learn, and people buy them for that reason. But, just as people learning to ride a bike outgrow their training wheels, people who must craft a lot of text usually turn to WordStar sooner or later.

And they usually stick with it, because for all its admittedly many faults,

WordStar has set a standard against which all other text editors must be compared: Fundamentally, it is *right*.

### Obsolescence

For products and companies, as for living creatures, death is inevitable. The cause of death? Usually it's a hardening of the corporate arteries.

It is often said in engineering that organizations tend to build products whose structure reflects that of the organization itself. Actually, it's the other way around, the organization fitting itself to the product structure.

Early in the game there's a close match between the product's function and the customer's need. This close match generates success in the marketplace, forcing the vendor to grow an organization to cope with the swelling tide of business.

As he learns, the vendor grows more efficient, setting up departments, and specialists within departments, all of whom are learning the "right" way to do whatever it is the vendor does.

## Context

(Continued from page 53)

\$185). Only, the managers of large corporations weren't doing their purchasing in computer stores. And the customers that did come in were often faced with salespeople who didn't understand the product.

CMS knew that no matter what the sales totals indicated, they had a good product. There were never any inherent problems with the product itself, and the company generously offered any backup assistance its customers required. What it lacked was development experience and the resources of a large company to handle the myriad tasks necessary to put a new product on the market. It was a small operation, starting from "square one."

CMS pulled Connector off the market in January 1982. Between answering questions ranging from the "fruit" in the name to how to set up a modem, CMS had had enough of its first foray into the software business. It was now ready to move on to its more sophisticated, and commercially viable product—Context MBA.

Launched in June 1982, MBA quickly found its niche in the management marketplace. The need for a fully integrated managerial software program

that was IBM-compatible was there. "The one thing we did exactly right was hit the things managers most often do," Gib explained. "Every manager has to do numbers. Every manager has to write memos, or draft letters. Every manager likes business graphs. And to a lesser extent, every manager needs some data management. Also, he would like to communicate."

The previous marketing plan was completely overhauled. Retail outlets for MBA are now concentrated in business-oriented computer stores whose salespeople also make onsite sales calls. CMS, also, now has field representatives located around the country calling on all the large corporations and making direct, volume-purchase deals (over 100 units).

MBA's packaging is an attention-getting blue box, with illustrated product information. Inside is a demo diskette along with a manual written to be understood by the nontechnical user. (The Connector manual had been written by programmers and was considered nothing less than a disaster.)

To overcome one last obstacle, the MIS directors of late have loosened their hold on their mainframes, and are actively helping users gain access to data from other information centers. Additionally, MBA's communications ability has been greatly improved. The user is now able to store and easily recall

the tedious and often complicated sign-on and query sequences for accessing multiple databases.

All this has made it easier for a manager using a personal computer to understand the need for the product and feel confident in using it. "We're finding that the users getting into the market now don't want to have to learn a lot of technology," Gib said. "They're more willing to buy a canned solution that's wrapped up in a bow."

Effective management, product reliability, the aid of a professional public relations firm, and a modest (by today's standards) advertising budget of around \$50,000 a month has gained CMS respect and desirability in the marketplace. About 20,000 units of MBA have been installed since its release.

Even though the struggle with Connector was planned for, many of the individual problems encountered with it in the field weren't. Gib Hoxie is the first to admit, however, that it was necessary to go through those growing pains in order to successfully market MBA and CMS's newest product, Corporate MBA.

MBA exists in a highly competitive environment including Lotus 1-2-3, Visi On, MS Windows, and Ovation. But at \$695, compared to a comparably equipped Visi On package for about \$2300, MBA has come out fighting and remained impressively unscarred. ♦

Procedures, rules and policies are introduced to help the organization avoid mistakes. Over time, the behavior of the organization becomes reflexive—and ultimately mindless—as the marketplace changes.

If a vendor is really successful, a point is reached where his organization becomes incapable of building any kind of product besides the one it's accustomed to building. ("We know we're right. Just look at how successful we are, and this is the way we've always done it.") At this point he is vulnerable—because he's asleep, in the corporate equivalent of a brain-death coma.

Competitors spring up, but they aren't seen as competitors. ("We make the best minicomputers in the world. Those microcomputer guys are just making toys.") Customers drift away, for reasons the organization can't quite fathom. ("Those folks at XYZ left us because they're always trying to get the best price and they think they can do better using those cheap micros. Who needs customers like that, anyway?") And employees drift away too. The best ones leave first, because Gresham's law applies as much to people as to money. ("He says this place isn't 'fun' anymore. Who needs him? We're running a business, not a summer camp.")

It always happens, the only question being how soon. You're not convinced? How about these companies, all early successes in their specialty markets: Remington-Rand (mainframes); Interdata (minicomputers); Osborne (microcomputers).

The software you are using on your computer today is a survivor, resting at the top of a pyramid of less successful efforts. It exists not because of luck or a middle-of-the-night inspiration, but because of intensive thought and planning. It is the result of months—or more probably years—of work and rework. A successful piece of software represents a tremendous creative investment.

It is easy to appreciate a piece of software for the features it offers. Understanding what went into providing those features can only foster a greater appreciation.

### Future Software

Where is the software business headed? No one has a clear idea, no matter what you read. Nevertheless, here are a prediction or two based on my observations on the trends of business and technology.

First, in business, in the last two years there has been a general (and much-

needed) improvement in software quality, both in terms of the product and the documentation and support that accompany it. Purchasers are learning to demand excellence, and are starting to get it. In the not-too-distant future, shoddy software simply will not appear on the market at all, and quality will be the norm.

Second, in addition to elevated quality, the *sophistication* of microcomputer software is increasing very rapidly. It is typical now for new microcomputer products to appear with capabilities that are simply unavailable to users of even minicomputers, much less mainframes.

Third, the marketplace is becoming increasingly competitive as new entrants flood in. In consequence, not only is solid development a prerequisite, good marketing has become an absolute must and, at least for the time being, overshadows everything else.

---

## This business has become like the rock music business

---

These three factors mean that the software business has become dollar-intensive, and there are now capital barriers to entry. Mass merchandising of better, more capable products takes money—lots of it—and only major publishing houses (or venture capital firms) are in a position to fund the big efforts.

Conventional wisdom has it that because of the dollar barriers to entry, the software business will become—*has become*—like the rock music business: publisher-driven, with publishers spotting talent and then manufacturing and packaging a product that goes to distributors who stock the stores that sell to the public.

This structure will not last long, because the distribution methods that publishers use today are those of the pre-computer era. In the age to come, software (and rock music?) will be distributed by telephone or over the airwaves. This is starting to happen now, and will be the dominant distribution method in ten years. All that's needed are high-bandwidth modems connected to every computer (mostly to receive HELP files) and a low-cost/high-bandwidth long-haul communications system (which will come about as a result of the breakup of the Bell System).

In the case of software, at least, we will swing away from mass-audience, magazine-oriented advertising and back to billboards and "bazaar" markets. Only the billboards of the future will be electronic, and visible to hundreds of thousands of people.

The "bazaars" will be specialty markets visited electronically by relatively small numbers of people from all over the world. They will sample software the way you sample cheese at a market.

And the giants of the 21st-century publishing business will be outfits like CompuServe and Tymshare, and other organizations of whom you may not even have heard, but who are already growing explosively. These companies will operate information warehouses.

Their game software will evolve into the interactive movie, which will be downloaded in seconds via satellite into your home entertainment system. Today's arcades will vanish like the nickelodeon.

And the revenue structure of the industry will change completely. Instead of advertisers paying for space in magazines that are low-cost or free to the consumer, it will be the other way around.

People will pay, heavily, for the privilege of connecting up to a multipurpose information/communications utility. They will purchase downloads of demo software. They will buy, or rent, the software itself. (When communications are cheap enough and fast enough, why bother to store software you don't use very often?) People will pay for the privilege of searching data bases to locate software they need. They will pay for the privilege of reading reviews. They will tell one another what's new, what's good and useful—and what isn't—and the information will spread rapidly through the user community by electronic mail, for which they will gladly pay.

In turn, the warehouse operators will pay developers to list their software with them, and they will pay royalties on each download. This will be feasible because the downloads will be customized to the recipient's computer, putting an end to large-scale theft of software.

And software companies will be able to develop and submit products electronically. Screens and menus will be done by graphic artists working out of their homes, as will the billboard advertising for the products themselves. Project teams will be spread all over the country (eventually the world), as will test sites and customers.

## Avoiding Software Pitfalls

You get the idea. The software business is going to go back to being a cottage industry in many respects, like the early days of the textile industry, with the software equivalent of weavers and spinners and seamstresses, all under subcontract to entrepreneurs.

And what software we are going to have! With 3 or 4 million children born each year in the USA alone, if only 1% of them have the talent and the will to develop high-caliber software, then each year will add 30,000 people to the talent pool.

The leading edge of that talent wave is in grammar school today. As those people and their colleagues enter positions of managerial responsibility they—and the programs they create—will start to remake the world in ways that we can't even begin to imagine. ◇

### Arktronics (Continued from page 54)

whole idea behind the entire industry that really sparked us. Not really any particular product, but just that we knew we wanted to be a part of it, and we knew that unlike other industries, there was a place for 19 and 20 year olds. Howard was into computers very heavily, ever since he was very young. He knew a significant amount, I did not. I had taken a BASIC class in high school but I didn't really have a particular interest in it. We had read an awful lot about people like Steve Jobs and Steve Wozniak (the founders of Apple). We sort of realized that school was relatively boring and that we had a lot to do there. At the same time it wasn't too time consuming and we thought maybe we could come up with some kind of product that we could call our own. That's when we set out on Jane—about 18 months ago.

**C&E:** Where did the idea for Jane come from?

**Kotick:** We did a significant amount of research before we came up with the idea. We spent a lot of time reading about educators like Alan Kay and Herb Simon and about Xerox's PARC and Smalltalk and some of the Smalltalk-type user interface concepts that existed at the time. This was way before there was ever a Lisa. We realized that the biggest problem was that people like us couldn't use these things yet because they were too difficult and time-consuming to learn.

Most of all, if a program was going to make my typing, or my spreadsheet analysis, or my list management easier, I would already have to know how to do it. There would always be problems for somebody who wanted to create a list or do word processing more efficiently. But they didn't have the time to learn how to use these things.

That was our biggest criticism of the industry, though frankly, if you had asked me then if I thought personal computers would permeate society the way they have—or the way they will—I would have said no. But that's how we came upon the idea of developing software that was so easy to use, so easy to

understand, that you more or less already knew how to use it. I guess the people at Apple were doing the same thing at the time.

**C&E:** How did you actually get started?

**Kotick:** Howard came in one day and said he'd heard about this great device called a "mouse." So we wrote this company in Switzerland and asked them to please send us one of the things. But since Howard used to work summers for Apple (in France) he brought a mouse back and we started playing around with it. There were no routines written for it, so he wrote some basic movement routines and tried to see what it could do.

**C&E:** What were your criteria?

**Kotick:** The biggest problem was that the mouse was too expensive. By that time we had made a wish list of things we would need to create the ultimate computer program. One of the first things was some kind of pointing device—whether it was a touch screen, a light pen, a mouse, or a joystick. It had to be something that was easy enough to use and at the same time very inexpensive and very standard.

The second thing on the wish list was memory constraint. Either computers had to have more memory, or we had to write a language with such a reduced instruction set that we could compress all of our code into a 64K environment, which, at the time, was more memory than most computers supported.

The third thing was some vehicle through which we could express all of the computer concepts so that people could understand them . . . which means essentially the actual user interface. Part of that was obviously the mouse. The other part ended up to be pictures. A lot of people criticized pictures, saying that hieroglyphics had gone out a long time ago, but we were going back to the beginning, so we said "Let's use a pictorial language that people can understand more easily."

We wanted the program to teach the user some of the fundamentals of computing, without creating a difficult environment, to accomplish the basic tasks that he set out to do.

We had to create a learning tool. Alan Kay once said "If you try to throw a ball

to somebody who can't catch a ball nine times out of ten he'll drop it. But if you throw the ball and tell him 'watch how many times the ball revolves in the air,' he'll catch it every time. You've taken his mind off the learning process and given him a simple task." We've tried to accomplish the same thing with Jane.

We had spec'd out the product and we knew exactly what we wanted, and we knew that, as much as we wanted to accomplish everything on the wish list, it would just not be feasible to have everything the way we wanted it. A good example is the mouse. In order to get the most cost-effective mouse, we had to settle for a lesser quality product (than the one we got from Switzerland). But it still accomplishes its purpose.

**C&E:** Quite an issue has been made over your youth, and the youth of your staff. Where did they come from?

**Kotick:** After Howard had done the specifications we set out to find people who could help us code. We got together a group of people to help (by this time we'd invested a lot of our own money). Some were under-graduate students; they're relatively inexpensive, but they have as good an understanding of coding as anybody else—and we had them sit down at a couple of Apples.

**C&E:** How did you find these students?

**Kotick:** Through bulletin boards, through friends, etc. But when we started to do some basic coding work, to try to figure out where it would take us, we realized that we had to really create our own language and our own compilers. So we decided the best approach was with graduate students and professors.

**C&E:** Do you really operate out of a dormitory room?

**Kotick:** No. We went out and rented office space—actually we'd been sharing offices with others for some time—but, about two weeks before we acquired a backer, we rented our own place. As much as we'd like to say it was, it never really was a dorm room operation. As much as anybody would like to think that you could take a group of students and create a company, that's a little bit unrealistic. Arktronics was formed—last July—to develop and market Jane.

**C&E:** Are the people who are part of Arktronics now the same graduate stu-



dents, etc. you started with.

**Kotick:** To a great extent, yes. We've even hired a couple of the professors away from their universities. We now have 31 designer/programmers working full time.

**C&E:** How did you finance the company?

**Kotick:** We started looking around for investors. Basically, the company was financed for the first three months of its existence by Howard's and my credit cards. We went from there and decided that my function was going to be to go out and find an investor. Fortunately I was invited to a party in Dallas last June, and the people who invited me told me there was someone coming who I'd be interested in meeting. By this time we were getting pretty desperate. We had a staggering overhead—14 people working, all for future salary. And we knew that, if we didn't keep the people working, we'd never get the product out in time.

Timing is crucial. We thought we had a product that would be at least a year ahead of anybody else who might be coming out with a product like this. I went out on the road and happened to meet somebody (Steven Wynn—Chairman of the Board of the Golden Nugget hotels in Las Vegas and Atlantic City—at the party in Dallas) and he realized how critical a period we were entering, and that we needed the money immediately.

**C&E:** What advice did Mr. Wynn give?

**Kotick:** To "put it in writing." So we wrote out for him our basic business plan, our business structure—where we were going, where we intended to be. We also gave him week-by-week descriptions and progress reports and we had a five-month calendar that we stuck to. That's when it really started.

**C&E:** What were some memorable moments in Jane's development?

**Kotick:** In addition to the money (supplied by Steve Wynn) we've been very lucky in making all the right moves.

The biggest disappointment for us was that we wanted to take orders for the product at Comdex (December 1983). We wanted to be the first company in the history of the microcomputer marketplace that went to a show, exhibited, and actually shipped. We basically had the product ready, but that was after only one month of beta testing, and nobody likes to ship a product after that little testing. So, based on comments we received from our beta testers, and from people who saw the product at the show, we went back and made some changes. We changed the packaging,

the mouse shape, some of the screen layouts, and other things so that it would really be a terrific first product.

**C&E:** You're still in college, aren't you. How do you manage both your schoolwork and Arktronic's?

**Kotick:** I'm a junior and Howard's a senior. Fortunately, my schedule is not too heavy and, as a matter of fact, I'm doing a study for school on the raising of venture capital.

**C&E:** Assuming that Jane is a success, what will happen next?

**Kotick:** We've positioned ourselves so that the product is at least a year in advance of other products of this type. So obviously, we're already working on other products that we'll be introducing in the latter part of 1984, as well as support products for Jane. We're also working with third-party software developers for new applications, and with existing applications to put them into the Jane environment. These would be applications that have a rather narrow appeal that we wouldn't undertake ourselves, but that already exist.

---

## "Howard heard about this great device called a mouse."

---

We're very particular about what we're using because the user interface is crucial, and it's foolish to take an application—like Multiplan or Visi-Calc—and make it mouse-oriented because it was never designed to be that. You've got to have an application that can either be wholly supported by the pointing device or the pictures, or be so independent of those things that it doesn't make a difference. But the key is ease of use. We're looking for applications that we can make easy to use, or that are already easy to use.

It's hard to say how long a life a product like Jane will have—we've have commitments from most of the major distributors. And a lot of the OEMs have said they'd like either to co-market or distribute the product—so we're excited about the success of Jane. But you can't have a company with just one product.

**C&E:** Where is Arktronic's going?

**Kotick:** We've been actively developing new types of programs incorporating even newer technology than has been used for Jane. By the end of 1985 we should have something like 125 employees.

**C&E:** If Jane does not make it, what's going to happen: Are you going to try again with something?

**Kotick:** Oh yeah! No question about that. If for any reason Jane isn't a success or isn't as successful as we expect it to be, we'll continue. We're actively developing new products and if Jane fails one of the new products should hit.

**C&E:** Do you make all the decisions yourself?

**Kotick:** Howard and I do. Steve (Wynn) is providing the financing and some terrific business insight. Whenever we feel hung up, he's there. He's probably the most perceptive person I've ever met and he's able to give us some insight so that we're getting a tremendous amount of experience.

**C&E:** You recently took on Jim Spillars (formerly of Microsoft) as President. What exactly will he be doing?

**Kotick:** Much as we'd like to think that we're industry veterans, he's been in it since the beginning. He took Micropro from 2 to 60 million dollars in sales, and he was the Vice President and General Manager of Operations for Microsoft. He's high power stuff. We felt that we needed somebody like that to run the company.

We're bringing in a lot of new talent from big software companies all over the place.

**C&E:** There are other windowing programs that are going to make their appearance shortly, hot on Jane's heels. Does this concern you?

**Kotick:** Our feeling is that, when other people start shipping, we'll see. In the meantime we're the first company to ship true windowing software and we're the only company that can do it in 64K. Everybody else needs a lot more. We have a unique product and we're in a good position. When there's more competition, we'll probably have a different attitude. We're not particularly worried—we know our product stands on its own merits.

**C&E:** Do you have any advice for someone who reads this and says, "Hey! I can do this too!"?

**Kotick:** I would encourage him. In fact, one of the things we're doing now, is to focus our advertising campaign on people like us who are between the ages of 10 and 30 and are software gurus in their own right, or programmers or designers or just conceptual thinkers who have an interesting idea. What we're looking for is other people like ourselves who would like to get involved in the software industry. We'll do everything we can to help them. Either to start up their own operations, or to come to us. ◇

## Laser Printers (Continued from page 75)

per minute that is the upper limit of mechanical printers. The high prices also reflected the use of expensive components, including lasers costing thousands of dollars each. The laser problems were serious enough that Xerox decided to build its own blue lasers especially for the printers. Updated versions of these fast laser printers remain on the market, though prices have come down somewhat. They were first used to generate large quantities of forms, such as insurance and mutual-fund statements. Then they were discovered by the junk-mail industry, and today laser printers churn forth vast quantities of "personalized" form letters at high speeds.

Slower and much less costly laser printers have also come on the market. Xerox has built a 43 page/min printer around a five-milliwatt helium-neon laser, which it markets for prices in the tens of thousands of dollars. The optics are similar to those in its higher-speed system, and the resolution is the same, 300 dots/in. Hewlett-Packard also uses a five-milliwatt helium-neon laser in its 45-page/min laser printer. The Hewlett-Packard printer's resolution is only 180 dots/in., the lowest of any laser printer, and coarse enough that the dot-matrix structure is visible in some of the graphics.

Low-power helium-neon lasers are also used in some much slower laser printers that offer sophisticated graphics as a major attraction. One example is the "Lasergrafix 1200" printer from Quality Micro Systems Inc. of Mobile, AL, which prints 12 pages/min with a resolution of 300 dots/in. The printer contains a sophisticated bit-mapping computer that creates graphic images for use in plotting and computer-aided design. The internal computer allows the laser printer to operate with large or small computers, although the system's \$25,000 price is several times that of most personal computers.

Although helium-neon laser printers are still being produced, many observers expect that semiconductor lasers will eventually dominate the printer scene because they are easier to modulate. Canon was the first to announce a semiconductor laser printer, which it sold to other companies that packaged it into systems purchased by end users. One example is a \$25,000 desktop printing system that Symbolics Inc. of Cambridge, MA, built around the Canon printer. Equipped with an internal computer and intended mainly for graphics, it prints 10 pages per minute with resolution of 480 dots/in. horizontally and 240 dots/in. vertically.

General Optronics uses a holographic scanner as well as a semiconductor laser in its "Holoscan" printer, which produces 28 pages/min with 300-dot/in. resolution. Ray Newstead of General Optronics says that over 100 of the printers are in use, largely as fast computer output printers at defense contractors and government agencies. The basic printer is priced at \$12,000, with an interface needed to generate characters an additional \$2000. An interface to provide graphic capabilities will cost about \$4000 when it comes on the market. After shipping over 10,000 of its first-generation semiconductor laser printers, Canon announced a high-resolution version, which records 480 dots/in. in both directions and prints five pages per minute. The basic "en-

---

### Laser printers can meet or beat the speed of dot-matrix printers

---

gine" sells to system makers for \$5,800 each in quantity, but does not include interfaces to generate type or graphics. No system packagers have their versions on the market yet; but, when they do, the price is likely to be \$12,000 or more, depending on the capabilities offered.

What has really gotten some industry observers excited is the new Canon "engine" designed to serve as the heart of laser printers for small computers. The starting point was a design used for Canon's inexpensive personal copier, where toner, developer, drum, and light receptor are housed in a replaceable cartridge. The same approach is used in the laser printer, which adds a semiconductor laser, a rotating polygon mirror, and inexpensive focusing optics made of molded plastic. The basic printer will have resolution of either 240 or 300 dots/in. and the same 8-page/min speed as Canon's model PC-10 personal copier, which retails for around \$1000. The cartridges for that copier cost about \$65 and have to be replaced after making about 2000 copies.

Companies buying the Canon printer assembly will have to supply their own interfaces. Opinions differ as to the cost and complexity of that task, but the result is likely to be a printer that retails for around \$3000 and up.

---

### Good News for Graphics

---

The anticipated arrival of inexpensive laser printers will be good news for computer users who have wanted the graphics and good-looking output of more costly laser printers. The projected \$3000 price makes the new generation of laser printers reasonable for use with desktop computers. It also makes them competitive with high-speed letter-quality printers for some printing jobs. It gives users a good excuse to consider other advantages of laser printers, including the ability to change typefaces almost instantly, and their much quieter operation than impact printers.

Despite a few claims to the contrary, laser printers cannot equal the sharpness of letter-quality printers or typesetters, but the best can come close. Characters and graphics printed at a resolution of 180 dots/in. are bumpy, and a close look shows that curved lines are really made up of zig-zag segments. Graphics look much better printed at 300 dots/in., although careful examination shows some spottiness. Characters are continuous but, like those on photocopies, aren't as sharp in outline as printed originals.

What are the prospects that laser printers will make today's dot-matrix and letter-quality impact printers obsolete? A few observers seem to think that might happen, but a more realistic view is that laser printers will find their own niche in the market.

One problem is that laser printer prices are not likely to drop too much farther. Laser prices have dropped to as little as \$10 each, and you can't get much cheaper than the plastic optics used in the Canon printers without severe sacrifices in beam quality. It would be nice to replace the rotating mirror with a solid-state scanner with no moving parts, but nobody knows how to make the solid-state devices both as good and as cheap. Nor is it clear how much farther the price of the photocopier components can come down.

Another problem could be performance and reliability. Office photocopiers have earned a reputation for unreliability because of problems ranging from perpetual paper jams to dirty-grey backgrounds. The sparkling-clean copies the salesman effortlessly produces on the first day from a brand-new machine may never be equalled again. Modular designs can help by assuring that key components are replaced and/or serviced regularly, but they can't solve all the problems.

Finally there's the matter of unrealistic expectations. The inexpensive Canon laser printer should be fine for producing a few thousand copies a month, but it could have trouble producing ten times that amount. Ray Newstead of General Optronics recalls with a shudder the potential customer who started calculating the capacity of a laser printer by multiplying pages per minute by 60 minutes an hour and 24 hours a day. That way he reached over a million pages a month, far beyond the 30,000 to 100,000 per month that Newstead says

the General Optronics printer is designed to produce. Many a light-duty office copier has died an early death from overwork.

But while the caution signals are real, so is the promise. Laser printers offer a unique combination of good speed, versatility, and decent-quality output. Thousands of expensive versions have already found a secure niche working with mainframe computers. Their smaller brothers should have little trouble establishing a similar role among personal computers. ♦

## Microwriter Printers (Continued from page 49)

### User Comment

If what you've read above sounds overwhelming, it is—but only at first. After reading through the excellent manuals and using the crib cards, I found that I was able to generate my first completely formatted letter with the Microwriter in just a couple of hours. The keyboard was surprisingly easy to use, with the help of the reference cards to begin with.

A sort of mental image mnemonic system was used to designate letter entry key combinations. You visualize the shape of most letters and press the appropriate keys. Some of these correlations stretch the point a bit, but they're easy to learn. The numbers mostly follow a finger count, while punctuation characters pick up, for the most part, the remaining combinations. The apostrophe is part of the alpha character set.

It takes considerable practice to become proficient and fast with the Microwriter, but initial progress is encouraging. I've never learned how to touch type, yet I found myself Microwriting in less than an hour—not fast, but I'm not fast at a typewriter keyboard, either. According to the manufacturer, any user who perseveres with the Microwriter should be exceeding his handwriting speed within a few weeks.

I experienced no trouble with record-operation. However, I found that the procedure must be followed closely to prevent prematurely cutting short a file during transfer. According to the manual, it takes "just under three minutes" to transfer an 8K file, which works out to a baud rate of about 500.

In my Microwriter-to-Star Micronics Delta-10 matrix printer setup, I found that I needed only the 2, 3, and 7 wires

for successful serial interfacing. I transferred text at 600 baud, since my printer happened to be set to that rate and it was easier to change the Microwriter's baud rate (110 to 4800) than to remove the printer's cover to get at the proper switch.

### Summary

The Microwriter is radically different in concept and operation from any device I have ever used. Even so, it appears to be compatible with the computing world. I'm amazed at its capabilities and potential. The unit I tested operated flawlessly.

I have one important observation to make, however. You must have a disciplined desire to learn the keyboard and operating system to use the Microwriter effectively. However, having made the commitment, you have at your command a number of capabilities that are lacking in a conventional typewriter keyboard. Business and professional people with limited or no access to secretarial help will benefit most from the Microwriter. Professional writers who have great familiarity with standard QWERTY keyboards, however, may have trouble disciplining themselves to learning how to use the Microwriter.

Will the Microwriter make it in the marketplace? It faces stiff competition from the more conventional lap-size portable computers that have built-in word processors. Most such computers have terminal software, a modem, and other programs and computing ability—none of which are included in the Microwriter. From my vantage point, it seems that the Microwriter will attract a select group of people who need its small size, special one-hand keyboard, or inherent operational flexibility. The Microwriter, obviously, isn't for everyone, but it's not claimed to be the answer to every input application, either. ♦

# CABLE TV

## CONVERTERS

**Largest Selection  
of Equipment Available**  
\$ Buy Warehouse Direct & Save \$



36 channel  
converter  
**\$4595**

36 channel  
wired remote  
converter  
only  
**\$8895**



Send \$2 for complete catalog  
of converters and equipment

Quantity Discounts • Visa • Master Charge  
Add 5% shipping—Mich. residents add 4% sales tax

**C&D Electronics, Inc.**  
P.O. Box 21, Jenison, MI 49428  
(616) 669-2440

## LEARN PROGRAMMING

**MASTER COMPUTERS  
IN YOUR OWN HOME!**

Now you can learn about computers, operations, programming, applications, software. Everything you always wanted to know. Write your own programs. Or customize pre-written programs. Make a computer do exactly what you want it to do. Benefit from becoming "computer-wise" today. It's all in this one educational package!

**A COURSE IN COMPUTERS  
AND BASIC PROGRAMMING**

**NO PREVIOUS COMPUTER EXPERIENCE NEEDED!** The entire course is "user friendly", written in simple language, that's easy for a beginner to understand. You will LEARN BY DOING—programming from the very first lesson using any computer: IBM, APPLE, ATARI, COMMODORE, TRS-80.

### A CONVENIENT WAY TO LEARN

Progress at your own speed, in your spare time, in your own home. Take the mystery out of word processing... computerized accounting... maintaining data files and much, much more.

Get started now in the fast-growing field of computers, and CATCH ON to the technology of the future... **COMPUTERS!**

Send today for your free information package. Or call toll-free (800) 624-7760, in California call toll-free (800) 824-8648. No obligation.

**HALIX INSTITUTE**  
1743 South Vermont Ave., Los Angeles, CA 90006

If you don't have a computer yet, don't buy one until you receive this free information.

**halix**  
INSTITUTE

An affiliate of Hemphill Schools and IPIG

THE INTERNATIONAL CHOICE SINCE 1920

HALIX INSTITUTE CENTER FOR COMPUTER EDUCATION  
1743 SO. VERMONT AVE  
LOS ANGELES, CA 90006

YES! Send me Catalog No. 44-C054 on how I can learn about computers and programming at home!

Name \_\_\_\_\_

Address \_\_\_\_\_

City \_\_\_\_\_ State/Zip \_\_\_\_\_

I already have a computer available.

Make \_\_\_\_\_ Model \_\_\_\_\_

# Bar Codes

(Continued from page 70)

meric data from 0 to 9, plus six special characters. Four different start/stop characters are available to allow the use of different data bases.

As its name suggests, this code uses seven binary bits of information encoded within the bars and spaces of each character. Two of these elements are binary 1s.

The 2-of-7 code can use a total of 18 different widths for bars and spaces. This structure was designed to account for printing errors, a problem common to early printers.

**Code 11.** This bidirectional bar code features 11 characters, including the ten numerics from 0 to 9, and the dash (—) symbol. A twelfth is used as a start/stop character. Each character is encoded in five binary bits formed from three bars and two spaces. However, not all characters have two wide elements out of the five. Instead, eight characters (1 through 8) have two wide elements while the other three (0, 9, and —) have only one wide element. This makes Code 11 non-self-checking.

**Universal Product Code (UPC).** The UPC bar code, the most commonly recognizable code, was designed for use with automatic checkout equipment to improve productivity in the grocery industry. Today, almost every grocery store item carries the code.

A 10-digit numbering system was adopted for product identification. Each participating supplier is issued a 5-digit manufacturer's identification number, with the remaining five digits assigned to generic product categories (tomato soup, canned peas, tissue paper, etc.). The 10-digit number, called UPC-A is combined with error-checking features and encoded. Certain small items, cigarette packs for example, use the UPC-E code which consists of only five characters without a checksum. With-



**Fig. 4. The most common code, the UPC, uses 10 digits.**

out the checksum, the E-version is less reliable than the A version.

The right and left ends of the UPC code (Fig. 4) contain a guard bar pattern (bar-space-bar) to prevent tampering. The first five encoded characters are separated from the second five by a tall space-bar-space-bar-space pattern. The numbers that have been encoded are seen under the bar code and are designed for use by an optical character-recognition system.

Unlike the other bar codes, the printed UPC bar code provides only *half* of the desired information. The parallel light and dark bar pattern is properly called the "bar code" to distinguish it from the "UPC code" that it represents. The data encoded in the bars include only the manufacturer's specifications. They do not include price or other store information. To complete the data, the 10-digit binary code is entered into a computer with a look-up table to append the required information.

The look-up table is created by the store management and can be updated for pricing or other information as needed.

### What's Available

Industrial bar-code readers have, for many years, been used for data capture in portable systems and as minicomputer and mainframe peripherals for warehouse inventory control. Some large-size (definitely not portable) bar-code readers have been installed at the checkout counters of large supermarket chains.

With the increasing popularity of microcomputers, several bar-code manufacturers are coming out with wands and software that can be used with popular microcomputers. Here is a look at some products now available.

The Bar Code Reader Wand and Decoder from Intertelephon USA (1200 Levin Ave., Mountain View, CA 94040; 415-969-3175) uses a LED and photo-detector to drive a microprocessor whose decoding algorithms are stored within an internal EPROM. Resolution is 0.3 mm width and the wand will resolve a line width or space as small as 0.2 mm. The preferred inclination of the wand to the printed bar code is plus or minus 15 degrees off the vertical.

Interface to the host computer is via the RS-232 port and software is provided to read most bar codes.

The decoder is available in two major configurations: stand alone, with a built-in speaker to alert the user that the code has been read and transmitted; and two pc-board arrangements, for use within a system.

The BarWand from Advanced Busi-

**TABLE 1—3-OF-9 CODE**

Data	Numeric Value	Data	Numeric Value
0	0	T	29
1	1	U	30
2	2	V	31
3	3	W	32
4	4	X	33
5	5	Y	34
6	6	Z	35
7	7	-	36
8	8	.	37
9	9	Space	38
A	10	\$	39
B	11	/	40
C	12	+	41
D	13	%	42
E	14		
F	15		
G	16		
H	17	Example of check digit technique:	
I	18	Data: ABC123\$	
J	19	Sum of values:	
K	20	10 + 11 + 12 + 1 +	
L	21	2 + 3 + 39 = 78	
M	22	78 / 43 = 1, remainder	
N	23	= 35	
O	24	Data for numeric	
P	25	35 is Z	
Q	26	Therefore: Data and	
R	27	check digit:	
S	28	ABC123\$Z	

## PRINTING YOUR OWN BARS

The value of bar codes to the small business is obvious. You have to have an inventory of what you have on hand, whether it's raw material, work in progress or finished goods. If you have a personal computer, you can print your own bar codes on your items in inventory. Here's what to do.

There are several commercial bar-code printers available. They and their software are relatively expensive. However, three bar-code wand manufacturers have developed software that works in conjunction with a dot-matrix printer. The three are Bi-Tech for the Epson HX-20, TRS-80 Model 100, and the NEC computer; ABT for the Apple II systems; and Caere for the IBM PC. Other wand manufacturers will undoubtedly be announcing their own software.

If you want to print your own bar codes, contact the manufacturer of the wand you are interested in. It is important to make sure that both the wand and printer software will work with your computer and the bar code you have in mind. Not all wands read all codes, and not all printer software prints all codes.

One other thing about printing your own bar codes. If you intend to pass a wand over the printed code only a couple of times, then a dot-matrix version printed on conventional paper will work fine. Too many wand passes across this type of label will cause ink smudges that lead to reading errors. For multiple passes across a label, commercial printing on heavy paper is recommended.

ness Technology, Inc. (1180 Coleman Ave., San Jose, CA 95110; 408-275-9880) uses the Hewlett-Packard HEDS-3000 Digital Bar Code Wand and interfaces with the Apple II, II+, and III computers. BarWand features 0.3-mm resolution, an integral push-to-read switch, and a seven-foot cable.

The Datawand from MSI Data Corporation (34 Fischer Ave., Costa Mesa, CA 92626; 714-549-6000) is a little different than the other bar-code readers. Measuring 6.25" long and 0.85" in diameter, the 1.8-oz wand is not cable-connected to the host computer and reads, decodes, and stores up to 4000 digits of UPC/EAN bar code in its battery-powered CMOS memory. Provisions are made for tone and LED indications of good scan, delete, memory near full, memory full, and transmission complete. It transmits the decoded information only when it is placed in its charger. The penlike Datawand, at \$265, can be carried in a shirt pocket.

The charger, called Datawell, not only serves as a recharger for Datawand's internal NiCd batteries, it also interfaces with the host computer (8-bit ASCII, even parity, asynchronous) via a telephone line or an RS-232 port at 1200 bps. Reading velocity is 5 to 30 ips.

The Digital Wand I.3 from Prodigital Systems, Inc. (1532 Elbridge St., Philadelphia, PA 19149; 215-744-5582) features a Hewlett-Packard HEDS-3000 wand, an interface and connector to piggyback with a parallel printer port, and software allowing control from BASIC, BASCOM, or dBase-II statements. Bar-code formats supported include Codabar, Code 39, and UPC-A/E. Versions are available for the IBM PC and CP/M. The complete package, including disk software, is \$399.95.

The PC-300 Bar Code Reader (\$695) (TPS Electronics, 4047 Transport, Palo Alto, CA 94303; 415-856-6833) for the IBM PC (and clones) features a built-in CPU within its 6" x 5" x 1 3/4" enclosure. It is connected between the keyboard and the computer and does not require an RS-232 port. It reads Codabar and 3-of-9 codes. The PC-350 Bar Code Reader (\$695) is similar, but for the DEC Rainbow computer.

The Series 200 Bar Code scanner (\$789) from Caere Corp. (100 Cooper St., Los Gatos, CA 95030; 408-395-7000) uses an RS-232 serial port or terminal. It reads 3-of-9, interleaved 2-of-5, and UPC A and E codes. The wand is stainless steel and has 0.010" resolution, although a 0.006" resolution wand is available. The wand emits an audible beep on successful read. Baud rate and

parity are switch selected. The PCS scanner (\$745) is for use with the IBM PC and XT. The Series 240 bar code scanner is the same as the Series 200 but uses an IBM plug-in board. The Series 220 (\$944) is for 3278-type displays for the IBM 3278, 3178, 5251, Memorex 2078, Telex 178, 278, Mohawk 2192, and ITT Currier 2700.

The Model 100 Bar Code Reader

from Bi-Tech (10 Carlough Rd., Bohemia, NY 11716; 516-567-8155) features 0.3-mm resolution, and has a digital output suitable for TTL or CMOS. It was designed for the TRS-80 Model 100 Computer. Bi-Tech also offers the Epson HX-20 Bar Code Reader, obviously designed for the Epson HX-20 machine and the PC-8201A Bar Code Reader, for the NEC computer. ◇

**INTERPOD . . .**  
**. . . A QUALITY, TRANSPARENT INTERFACE**  
**FOR THE COMMODORE 64™ OR VIC 20™**

**INTERPOD ALLOWS YOU TO ACCESS --**

- up to 30 IEEE 488 disk drives & printers
- other IEEE instruments, including volt meters, plotters and other analog/digital peripherals
- a wide range of inexpensive IEEE and RS232 matrix and quality printers

*Interpod is distributed in the United States by Limbic Systems, Inc. Dealer and school discounts are available. Ask about the new PASCAL COMPILER for the Commodore 64.*

**Limbic Systems Inc.**

560 San Antonio Road, Suite 202 Palo Alto, CA 94306  
 (415) 424-0168

Commodore 64 & VIC 20 are trademarks of Commodore Electronics, Inc.

**Circle No. 6 on Free Information Card**

**CALCULATOR SAVINGS**

<p>HP-11C Programmable . . . \$74.99</p> <p>HP-12C Financial . . . 99.99</p> <p>HP-15C Programmable . . . 99.99</p> <p>HP-16C Hexadecimal . . . 99.99</p> <p>HP-41C Alpha Progrmb . . . 149.99</p> <p>HP-41CV Full Memory . . . 209.99</p> <p>HP-41CX Extnd Functn . . . 259.99</p> <p>82104A Card Reader . . . 149.99</p> <p>82143A Printer . . . 299.99</p> <p>82153A Wand . . . 99.99</p> <p>HP-71B Computer . . . 419.99</p> <p>82400A Card Reader . . . Call</p> <p>82401A HP-IL Interface . . . 107.99</p> <p>82420A 4K Mem for 41B . . . 59.99</p> <p>71B Application Pats from 64.99</p> <p>HP-75C Computer . . . 739.99</p> <p>82700A 8K Mem for 75C . . . 149.99</p>	<p>82160A HP-IL Module . . . \$94.99</p> <p>82161A Cassette Drive . . . 347.99</p> <p>82162A HP-IL Printer . . . 347.99</p> <p>82164A RS-232 Interfc . . . 249.99</p> <p>92198A 80 col Video Int . . . 269.99</p> <p>7470A HP-IL Plotter . . . 899.99</p> <p>82180A Extnd Functns . . . 59.99</p> <p>82181A Extnd Memory . . . 59.99</p> <p>82182A Time Module . . . 59.99</p> <p>82183A Extnd I/O . . . 59.99</p> <p>HP-41 System Case . . . 49.99</p> <p>Port-X-Tender to 10 pts . . . 129.99</p>
--	---

Call for Low Prices on all Accessories and Software

<p>TI CC-40 Compact 6K Expandable Computer . . . \$199.99</p> <p>CC-40 Solid State Software . . . from 49.99</p> <p>TI-55-II Scientific Calculator w/ Statistics . . . 34.99</p> <p>LCD Programmer Hexadecimal Converter . . . 59.99</p> <p>BA-55 Advanced Handheld Financial . . . 49.99</p> <p>TI-5310 Desk Printing Financial . . . 109.99</p>	<p>Sharp EL-7050 Graphwriter . . . 69.99</p> <p>EL-7100 Memowriter . . . 59.99</p> <p>PC-1500 Advanced Handheld Computer . . . 139.99</p> <p>PC-1500A Advanced 8K Handheld Computer . . . 179.99</p> <p>CE-150 Cassette Intrfc/4-color Printer Plotter . . . 179.99</p> <p>CE-151 4K Memory for 1500/A . . . 39.99</p> <p>CE-155 8K Memory Expansion Box for 1500/A . . . 79.99</p> <p>CE-158 RS-232C &amp; Parallel Interface for 1500/A . . . 179.99</p> <p>CE-159 8K Memory Expan with Battery Back-up . . . 99.99</p> <p>CE-161 16K Memory Expan with Battery Back-up . . . 149.99</p> <p>PC-1500/A ROM Software Modules . . . 49.99</p>
---	--

<p>Caelo FX-700P Handheld Computer, 1568 steps . . . \$69.99</p> <p>FA-3 Cassette Adapter for FX-700P . . . 34.99</p> <p>FP-12 20-column printer for FX-700P . . . 59.99</p> <p>FX-98 Credit Card Salar Scientific Calculator . . . 24.99</p> <p>FX-450 Scientific Calculator with Hexadecimal . . . 29.99</p> <p>Fx-191 Scientific Scaler . . . 44.99</p> <p>PF-8000 Data Bank . . . 64.99</p> <p>SL-800 Film Card . . . 22.99</p>	<p>Use cashier's check, postal money order, VISA, or M/C. Print checks take five weeks to clear. Add shipping: 1% of your order (€3.99 minimum). East of Mississipp extra 1% 50. CA res add 6%. Subject to availability. USA prices.</p> <p><b>ORDER 800-421-5188</b> Outside  <b>TOLL-FREE Information line (213) 633-3282</b> CA, AK, HI</p> <p><b>tam's</b> Tam's Inc, Dept CE-4          INCORPORATED 14932 Garfield Ave.          (213) 633-3262 Paramount, CA 90723</p>
---	---

Circle No. 42 on Free Information Card

# FIREWORKS

FIRE CRACKERS    Rocket  
 Sparklers  
 FOUNTAINS

**MAJOR CREDIT CARDS ACCEPTED**

## THOUSANDS

OF ITEMS TO CHOOSE FROM

**Full Color Catalog Kit—\$2.00**  
 REFUNDABLE WITH YOUR FIRST ORDER

**Toll Free Nationwide**  
**1-800-321-6001**

Name \_\_\_\_\_

Address \_\_\_\_\_

City \_\_\_\_\_

State \_\_\_\_\_ Zip \_\_\_\_\_

PLEASE PRINT TO ASSURE PROMPT CATALOG DELIVERY!

**FIREWORKS UNLIMITED**

8550 ROUTE 224 ★ DEERFIELD, OHIO 44411

Circle No. 74 on Free Information Card

## Signal Processors (Continued from page 61)

case of the TMS320, the multiplier instruction (MPY) causes the multiplier to multiply a number stored in RAM by the multiplicand stored in the T register. The multiplier uses a hardware version of a multiplication algorithm called Booth's 2-bit algorithm. (For a really good refresher on how microcomputers work with numbers read Randy Carlstrom's *Number Systems for Microcomputers* in the December 1983 issue of COMPUTERS & ELECTRONICS.)

### Putting the Chip to Work

Finding work for a good DSP chip is easy. The very term "signal processing" describes a variety of jobs that computers already perform, at least to some extent, and others that are best left to machines. For signal processing is often a repetitious, mechanical task. In other words, ideally suited for automation.

Anytime you want to quickly match a set of known digital patterns with an unknown pattern, for example, the DSP has found a natural home. Consider the job of matching a single fingerprint to the set of fingerprints that the government has collected. If a camera records the prints and an analog-to-digital converter system makes them into digital signals, the DSP chip can be programmed to find the best possible match between one of the knowns and the unknown. The trick to the job is matching the prints quickly enough to do some one good.

This same pattern-matching capability is now being used in robotic vision systems, which inspect parts for defects. The set of stored patterns represent the digitized image of a freshly made part. The new patterns must match the stored pattern within certain tolerances or the part is considered bad.

If the matching takes too long, the vision system is worthless as part of an automated manufacturing system. A system based on a DSP chip can and does provide the computing power needed to do this job well.

A variation on the robot system is the optical character-recognition system. In such a system, the TMS320 takes digitized images from an optical scanner, finds the important features, and matches them to stored features (templates), as shown in Fig. 4.

Another application of this same pattern-matching strategy lets a computer recognize the words of a human speaker. The Texas Instruments Speech Command system (reviewed in the December 1983 issue of COMPUTERS &

ELECTRONICS) uses the TMS320 to compare spoken (and digitized) words with previously stored speech patterns. A digitizer converts the analog voice signals to digital signals that the DSP chip can match to other stored digital-signal patterns. In this case, the stored patterns represent the way the speaker says each word in the vocabulary. The input patterns (the ones to be matched) represent the unknown word. A close match between the input pattern and one of the reference patterns indicates which word was spoken.

The speed and accuracy with which a system can match patterns determines the practical limits to the size of the recognition system's vocabulary and the time it takes to accurately recognize any given word. Voice-recognition systems will allow workers to communicate with their computers (and other intelligent machines) and still keep their hands free. In a factory, this can mean that workers have greater safety and higher productivity than those who push buttons or keys on a keyboard to input data to a system.

**TABLE I—MULTIPLYING  
FLOATING-POINT  
NUMBERS**

DMPY:	LT	LSA	
	MPY	LSB	;least significant
	PAC		
	SACH	0,TMP	;temporary store
	LAC	1,TMP	;multiply
	MPY	MSB	;first middle product
	LTA	MSA	
	MPY	LSB	;second middle product
	SACH	0,TMP	
	LAC	1,TMP	
	MPY	MSB	;most significant
	APAC		

DSP chips are playing an increasing role in communications systems design, too. Digital modems can adapt to the changing conditions present on the telephone lines, making communications more efficient and reliable.

The DSP chip's ability to handle signals quickly simplifies digital filtering and modulation. Digital communications systems allow data to be processed more efficiently and make better use of the limited communications channels available. Speech data encoded with a DSP chip can reduce the data that has to be transmitted by a factor of 30, and it provides greater security. The data is encrypted through your own algorithm

to encode the signals. The growing importance of communications between people, between machines, and between people and machines indicates that this application of DSP chips may have great impact on our lives in the near future.

### The Chip Gains Sophistication

As DSP chips get faster and more capable, perhaps able to handle 32-bit data (with 64-bit precision), we will find even more uses for them. For one thing, they will play an increasing role in helping us locate and use all that data we've stored away in the bowels of our computers.

Pattern matching can help us sort, relate, and collate information in a way we have never had before; and it is the large scale of these particular tasks that we find so intimidating when using giant databases. But what specific improvements can we expect to see in DSP chips? What capabilities will grow?

Some experts would like to have DSP chips with analog-to-digital conversion circuitry. The drawback to this is that the A/D circuits would have to be general-purpose converters, and some of the flexibility that the TMS320 now offers would be lost. Texas Instruments has deliberately avoided this design, preferring to put the basic DSP chip with an analog input chip, such as TI's TMS32050, to provide an interface between the digital signal processor chip to the analog world.

Another possibility for DSP chips is floating-point arithmetic. Multiplying floating-point numbers isn't trivial. To get the TMS320 to do the job takes the code shown in Table I.

Adding hardware floating-point arithmetic would increase the chip's power tremendously and eliminate the need for external floating-point circuitry (such as a math coprocessor) in a design or the 12 machine cycles it now takes to multiply two floating-point numbers with software. Adding floating-point math to the DSP chip becomes a possibility as chip-fabrication technology improves.

You can also expect future versions of DSP chips to just plain run faster. New chip-fabrication technology (using smaller die sizes) will allow the same architecture to run 25% faster as explained in the sidebar. As a result, Texas Instruments expects a 150-ns version of the device to be available soon. And if faster performance is near, can improved and even brand-new applications be far behind? ◇

## Sinclair QL (Continued from page 63)

benchmarks, but from what we did see, SuperBASIC is fast—almost like a compiler rather than an interpreter.

The microdrives are quiet in operation, and faster than you would expect. The cassettes are easy to handle and install. Each QL package comes on its own microcassette, and loading these is both simple and fast. The keyboard has a smooth and comfortable "feel", not the least like the older Sinclair keyboards.

The alphanumeric and graphics are excellent, and comparable to any high-resolution display we have seen. The colors are crisp and clean (this may have been due to the use of an RGB color video monitor instead of a low-bandwidth color-TV receiver), and you can switch from 40 to 80 characters with a keystroke.

The QL packages were the only applications available, although I was told that several software houses (in England) were working on material that should be ready for the American unveiling. Other high-level languages including a Pascal compiler, a terminal emulator, and a 68000 assembler are

also in the offing according to a Sinclair spokesperson. Future hardware includes a 0.5-megabyte RAM expansion board, an A/D converter, a hard-disk interface, a modem, a parallel printer interface, and an IEEE-488 interface. However, a mouse is not planned.

### In addition to multitasking, QDOS allows up to twenty independent windows

There is no question that the Sinclair QL is an exceptional value. But there are problems that the machine faces on both the business and home fronts. For business purposes, it is an attractive package, but the business world is having a love affair with MS-DOS right

now. It doesn't seem likely that Sinclair can change its image of a "toy" computer manufacturer overnight. And where will support come from? Also, there's the question of using microcassette tapes rather than floppy disks. It appears that, in the business arena, Sinclair has much convincing to do.

Sinclair should have an easier time on the home front where it made its mark in the past. However, competition here is severe with Commodore, Apple, and IBM all having a strong foothold in the market at various price levels. And how is Sinclair going to distribute the QL? Right now they plan on selling it through mail order, which has its limitations. Also, for home purposes, some of the power of the machine will not be realized. For example, most consumers probably won't buy a high-quality RGB monitor for the QL since the cost could run twice as high as the QL itself.

Thus, although Sinclair has performed an extraordinary technological feat with the QL, the ultimate success of the machine may depend on factors that have more to do with market considerations than technology. ♦

# Addtrace I<sup>©</sup>

## A Low Cost

## Logic Analyzer



□ ADDTRACE I is a low-cost aid to microprocessor machine language programming and trouble shooting.

□ ADDTRACE I monitors the address bus, allowing the user to trace the path of his program. Hexadecimal thumbwheel switches and LED's indicate all coincident address lines. Programming errors can be located and corrected rapidly.

□ A personality module that plugs into ADDTRACE I adapts it to most popular micros.

□ Seven scope - probe points on the top panel allow observation of pulse duration and timing relationship for each digit selected.

□ Sixteen address input lines allow full 64K memory operation.

□ Self-contained, regulated power supply permits operation without drawing power from the system under test.

Phone or write today for full ADDTRACE I data, (702) 322-0429.



**BMH Company, Inc.**

224 Vassar Street  
Reno, Nevada 89502  
PH. (702) 322-0429

Circle No. 7 on Free Information Card

**"POWER  
FAILURE  
PROBLEMS"  
BLACKOUTS!  
BROWNOUTS!  
DIPS!  
YOUR  
SOLUTION...**

**LINE-SAVER™**

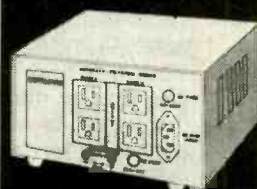

**STANDBY  
UNINTERRUPTABLE  
POWER  
SYSTEM**

**SAVE YOUR DATA** from power "blackouts," "brownouts" or line "dips."

**PROTECT YOUR DATA** from "transient voltages, spikes and EMI/RFI line noise."

**LINE-SAVER™** stands-by to switch 250VA, 150 watts of power to your micro-computer. Its heavy duty internal sealed battery provides up to 40 minutes of back-up power; more than enough to SAVE your data and shut down your system if line power does not return.

**LINE-SAVER™** provides constant protection for your system from damaging voltage surges, spikes and conducted line noise.

**LINE-SAVER™** constantly monitors the AC line and itself, with a unique visual and audible three staged ANNUNCIATOR that provides you at-a-glance status.

**LINE-SAVER™** is compact in size and utilizes the latest PWM technology to make it compatible with virtually every microcomputer system today.

**LINE-SAVER™** is low in cost... **\$395.00**

Call or write today for free literature

**AEGIS®**

Power Conditioning  
Equipment

**ORDER TODAY**

Out of State  
Toll Free Order Number  
1-800-523-9685

In-State Order No.  
215-837-0700



**KALGLO®**

6584 Ruch Rd., Dept. LCE  
Bethlehem, PA 18017

DEALER & OEM  
INQUIRIES INVITED

Add \$10.00 for shipping & handling = COD's add \$3.00  
PA Res. add 6% sales tax

Circle No. 58 on Free Information Card

## Memories

(Continued from page 80)

battery-backed-up RAM cartridges. The NEC 8201A is one. It can be expanded to 64K internally, and then to 96K through the use of a 32K cartridge that contains CMOS RAM backed up by a lithium cell. The RAM cartridge can be used to hold data you don't want to have on line (eating up your batteries) all the time, but that has to be available in the event it is needed. A series of such cartridges can be kept on hand, each containing a different set of data, and plugged in as required.

A logical extension of this is to replace floppy disks with their solid-state equivalents. Although disks are small

and portable, the drives required to read them are not. Not only are the drives awkward to transport, expensive, and power hungry; they are also prone to failure and extremely sensitive to dirt. This is especially important in the case of portable computers, which may find themselves in any kind of environment.

RAM cartridges, on the other hand, have no moving parts and require no external mechanism to make them work. A simple connection to the computer's bus is all the interface needed. The battery-backed-up RAM is virtually error-free; and, perhaps more important in the long run, the information it contains

can be accessed at electronic, not mechanical speeds.

The static RAM in the cartridge is reusable. When a program, or data, becomes dated or is no longer needed, it can be erased and the cartridge reused for another purpose.

With RAM capacities increasing by leaps and bounds, and power requirements and prices decreasing in similar fashion, the feasibility of a non-volatile solid-state "disk" is approaching. And we have only scratched the surface of what appears to be a new trend in mass-storage technology. No doubt, the future will hold more surprises. ◇

## BATTERY TYPES

**T**HERE are two types of batteries commonly used in standby power systems for memories. They are the nickel-cadmium (NiCd) cell and the lithium cell.

*Nickel-cadmium* cells were the first kind to be employed for memory protection. They are referred to as secondary cells, which means that, unlike primary cells, which we'll discuss below, they can be recharged. Primary cells cannot. Another, more familiar, type of secondary cell is the lead-acid battery used in automobiles. Both contain a mixture of chemicals that undergo a reversible electrochemical reaction.

When current is passed through a secondary cell, the electrical energy changes the chemical structure of the cell. The cell retains this new chemical identity and uses it to store power. When the charging current is removed and a load substituted across its terminals, the process reverses itself. The chemicals revert back to their original form, giving up the stored energy in the form of electricity.

This cycle can be repeated over and over many times. Any time there isn't enough power in the cell, or battery of cells, for the job, all that's necessary is a recharge.

Rather, though, than worry about when your standby battery is going to give up the ghost and cause the contents of your RAM to dissipate into thin air, it is better to keep it fully charged at all times.

This can be accomplished by putting the battery on a trickle charge. A trickle charge is a very small current (perhaps 5 mA, as opposed to the 50 mA or so normally used for charging) that isn't strong enough to cause the

cells to overcharge, but is sufficient to maintain them at 100% of capacity at all times.

The trickle charge comes from the main power supply. A charger circuit is placed between the main power source and the NiCd cells, as shown in the block diagram in Fig. 5. This charging circuit in no way interferes with the operation of the standby switch or the memory.

*Lithium* cells have been available for quite a while, but saw rather limited use until the advent of microelec-

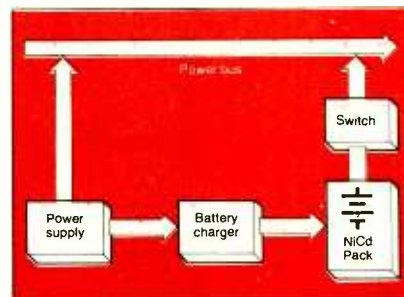

**Fig. 5. Trickle-charge circuit.**

tronics. They are not capable of delivering large amounts of current, but their useful life is long—as much as ten years. This has made them extremely popular in such devices as watches, calculators, and—of course—non-volatile memories.

Lithium cells are primary cells. That is, they do not have to be charged, but generate electricity through an irreversible chemical process. (The carbon-zinc and alkaline cells used in devices like flashlights and radios are also part of the primary-cell family.) Once a primary cell has been expended, it must be discarded. It cannot be recharged.

You may wonder why the more expensive lithium cell is used for computer support rather than the much cheaper carbon-zinc or alkaline type.

The answer is longevity.

Primary cells, by their own nature, suffer from a major problem. The chemical reaction that produces electricity goes on even when no current is being drawn. That means that from the moment it is manufactured a primary cell is already wearing out. (That's why carbon-zinc batteries leak. Eventually the chemical paste inside reacts enough with the zinc shell to eat a hole in it.) An ordinary carbon-zinc cell has a shelf life of only about a year.

Lithium cells, on the other hand, have a shelf life in excess of ten years. In the same standby application, you would have gone through at least ten carbon batteries instead of one lithium cell. Now which way is more expensive?

Lithium cells have another characteristic that makes them attractive for computer use. Most types of cells produce less than two volts. A carbon-zinc cell has an output of 1.5 V when fresh, and a NiCd's output is 1.2 V. A lithium cell, though, is rated at 3 V. That means that one lithium cell can do the work of two carbon-zinc cells or three NiCds.

When a lithium cell is used in conjunction with CMOS memory chips, a natural matchup occurs. The newer CMOS static RAM designs consume almost no power in the standby mode, and a lithium cell can last almost as long as its shelf life when used for backup purposes—even with constant use.

Consequently, many lithium cells come with solder tabs rather than button contacts. The cell can simply be soldered in place right along with the other memory components. The chances of the battery's going dead before the board is supplanted by a new one are slim. ◇



## Telephone Management (Continued from page 59)

can be exchanged with other computers, including DEC machines, at 1200 bps over ordinary telephone lines. Since TMS is integral to the DEC Professional and all set-up characteristics are selectable by the software, it eliminates the need for an external modem with the associated cables and setup buttons.

For voice recording and playback, speech can be stored directly into the computer's memory digitally. And it can be reconstructed and played back under computer control. This feature enables integration of voice with other computing tasks.

TMS uses the standard telephone network for both voice and data communications. Using one line, voice or data can be sent, with the mode selection under the control of the software application. If two lines are connected to the DEC Professional, simultaneous voice and data operation is possible. That provides the capability of reviewing data or graphics on the computer screen with another person at another computer in another city, while simultaneously talking to that person with an optional hands-free speakerphone.

TMS supports both tone and pulse dialing. Phone numbers can be up to 48 digits long, so it can easily handle long distance telephone services such as SPRINT or MCI. TMS has a "wait for dial tone" function that is useful on telephone services that require an access number to be dialed, followed by a second dial tone, then the completion of the dialing.

Automatic dialing or answering of both voice and data calls are possible; and using the Professional's built-in clock, TMS could be instructed to call another computer at a given time of day to automatically access information. It can understand touch-tone commands from a remote tone phone. That ability, together with the voice prompting feature, can effectively turn any remote tone phone into a computer terminal.

Hardware for TMS consists of three items: the Telephone Line Interface, the Controller Board, and the optional Voice Unit (a speakerphone). The Telephone Line Interface provides standard phone jack connectors with two telephone lines to a regular telephone handset. These jacks support both single and multi-line telephones. A jack is supplied also for connection to the optional Voice Unit. A special mounting slot on the back of the Professional system's unit provides space for the Telephone Line Interface. However, the interface unit does not use one of the Professional's option slots.

The Controller Board contains an integral modem, which transmits at 300 and 1200 baud with Bell 103J- and 212A- (asynchronous) compatible modes; voice digitizing circuitry, which converts analog voice signals from either one of the two telephone lines or the Voice Unit into digital signals for storage on the hard disk; a pushbutton telephone transceiver, which is a Dual-Tone Multi-Frequency (DTMF) transceiver that receives and transmits tones from standard pushbutton telephones for remote command and data entry; a Call Progress Tone Detector, for detecting a dial tone; and an analog switch, which connects any of the TMS devices to either of the telephone lines, the Voice Unit, or a telephone handset.

The package which has a suggested retail price of \$895, includes the Controller Board, Telephone Interface Board, a modular jack phone cord, an owner's guide, installation guide and maintenance diskette. A TMS software driver, also required, is packaged with P/OS Version 1.7. The optional speakerphone is available for \$295.

### Intelligent Technologies: PC Express

PC Express, from Intelligent Technologies International Corp., of Palo Alto, CA, is an integrated telecommunications package for the IBM Personal Computer. Similar in features to the Speech Command System and DEC TMS, the package transforms the IBM PC into a communications workstation providing PC-to-PC communications, electronic mail, direct access to mainframes, and a wide variety of automated telephone management capabilities.

There are two versions of PC Express. One provides a telephone management system and asynchronous communications support with DEC VT100/52 terminal emulation. The second version, PC Express with additional software called SNA (Systems Network Architecture), allows the IBM PC to emulate a 3274 Cluster Controller, and 327X and 3770 Remote Job Entry (RJE) terminals.

Both versions of the package include an integrated telephone management system that enhances both user and system communications productivity. Among the available features are: automatic answering; automatic dialing of numbers drawn from a database telephone directory; detection of busy, ringing, and voice on outgoing calls; and a full text editor for creating messages to be automatically routed to business as-

## PREVENT HI-TECH HEADACHES

Our Isolators  
eliminate  
equipment  
interaction,



clean up interference,  
curb damaging power line spikes and  
lightning bursts.

### ISO-1 Isolator

3 isolated sockets; quality spike  
suppression; basic protection. . . \$76.95

### ISO-3 Super-Isolator

3 dual isolated sockets; suppressor;  
commercial protection. . . . . 115.95

### ISO-17 Magnum Isolator

4 quad isolated sockets; suppressor;  
laboratory grade protection. . . 200.95

**ESP** Electronic Specialists, Inc.

171 S. Main St., Box 389, Natick, MA 01760

Toll Free Order Desk 1-800-225-4876  
MasterCard, VISA, American Express

Circle No. 51 on Free Information Card

For Home or Business  
WHAT...WHEN...HOW...

## LEARN HOW TO USE A COMPUTER



Train at home in spare time! No previous experience needed! Now you can learn it all! Computer programming...computer applications...computer games...everything you ever wanted to know about computer operations! Write your own computer programs or use hundreds of programs already available...budgeting, real estate, bookkeeping, expenses, investments, interest, taxes, shopping lists, vacation planning, addresses, phone numbers, routing...even foreign languages and graphics.

You'll know what really happens when you have a computer problem with a bank, store, loan company, oil company, utility or anyone else. You'll be able to talk their language...understand why and how things happen...to be able to take the offensive when you're the victim of a computer error. Experts explain everything in easy-to-understand language with step-by-step directions.

• **TIMEX COMPUTER INCLUDED WITH YOUR TRAINING** • **Free into any TV**  
• **SEND FOR FREE FACTS!**

**ICS** COMPUTER TRAINING, Dept. P2034  
SINCE 1991 Scranton, Pennsylvania 18515

Please rush me free facts and color brochure that tells how I can learn computer applications, programming and operation at home in spare time. No cost. No obligation.

Name \_\_\_\_\_ Age \_\_\_\_\_  
Address \_\_\_\_\_  
City/State/Zip \_\_\_\_\_

## Amazing DEVICES

PERSONAL DEFENSE AND PROPERTY PROTECTION  
UTILIZE SPACE AGE TECHNOLOGY.  
CAUTION THESE DEVICES CAN BE HAZARDOUS AND MAY SOON  
BE ILLEGAL.

<b>PHASORS</b>	<b>POCKET PAIN FIELD GENERATOR — IPG50</b>	
	Assembled	\$59.50
	IPG5 Plans	\$7.00 IPG5K Kit/Plans
	<b>PHASOR PAIN FIELD CROWD CONTROLLER — PPF10</b>	
	Assembled	\$250.00
	PPF1 Plans	\$15.00 PPF1K Kit/Plans
<b>LASERS</b>	<b>BLASTER</b> — Provides a plasma discharge capable of puncturing a can	
	Assembled	\$79.50
	BLS1 Plans	\$10.00 BLS1K Kit/Plans
	<b>SHOCKER/PARALYZING DEVICE</b> — Very intimidating and effective	
	SHG60 Assembled	\$99.50
	SHG6 Plans	\$10.00 SHG6 Kit/Plans

<b>SECURITY</b>	<b>RUBY LASER RAY GUN</b> — Intense visible red beam burns and welds hardest of metals. <b>MAY BE HAZARDOUS.</b>	
	<b>RUB3 All Parts Available for Completing Device</b> \$15.00	
	<b>CARBON DIOXIDE BURNING, CUTTING LASER</b> — Produces a continuous beam of high energy. <b>MAY BE HAZARDOUS.</b>	
	<b>LC5 All Parts Available for Completing Device</b> \$15.00	
	<b>VISIBLE LASER LIGHT GUN</b> — produces intense red beam for sighting, spotting, etc. Hand held complete	
	LGU3 Plans	\$10.00 (Kit & Assembled Units Available)
<b>SECURITY</b>	<b>IR PULSED LASER RIFLE</b> — Produces 15-30 watt Infra-red pulses at 200-2000 per sec	
	LRG3 All Parts & Diodes Available	\$10.00
	<b>BEGINNERS LOW POWER VISIBLE LASER</b> — Choice of red, yellow, green — provides an excellent source of monochromatic light	
	LHC2 Plans	\$5.00 LHC2K Kit
	<b>SNOOPERPHONE</b> — Allows user to call his premises and listen in without phone ever ringing	
	SNP20 Assembled	\$89.50

<b>SECURITY</b>	<b>SNP2</b> Plans \$9.00 <b>SNP2K</b> Plans/Kit \$59.50	
	<b>LONG RANGE WIRELESS MIKE</b> — Miniature device clearly transmits well over one mile. Super sensitive, powerful	
	MFT1 Plans	\$7.00 MFT1K Plans/Kit
	<b>WIRELESS TELEPHONE TRANSMITTER</b> — Transmits both sides of phone conversation over one mile, shuts off automatically.	
	VWPM5 Plans	\$8.00 VWPM5K Plans/Kit
	<b>TALK &amp; TELL AUTOMATIC TELEPHONE RECORDING DEVICE</b> — Great for monitoring telephone use	
TAT20 Assembled	\$24.50	
TAT2 Plans	\$5.00 TAT2K Plans/Kit	

Our phone is open for orders anytime. Technicians are available 9-11 a.m. Mon-Thurs for those needing assistance or information. Send for free catalog of hundreds more similar devices. Send check, cash, MO, Visa, MC. COD to: **INFORMATION UNLIMITED**  
DEPT Q1, P.O. Box 716, Amherst, N.H. 03031 Tel. 603-673-4730

Put Professional Knowledge and a  
**COLLEGE DEGREE**  
in your Electronics Career through

**HOME  
STUDY**

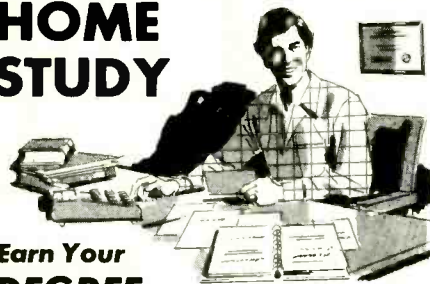

Earn Your  
**DEGREE**

No commuting to class. Study at your own pace, while you continue your present job. Learn from Grantham easy-to-understand lessons, with help from your home-study instructors.

You can earn your B. S. Degree in the Grantham electronics degree program, offered by independent home study and accredited by the NHSC Accrediting Commission.

Our free bulletin gives details. Write for *Bulletin E-84*.

**Grantham College of Engineering**  
2500 So. LaCienega Blvd.  
P. O. Box 35499  
Los Angeles, California 90035

## Telephone Management

sociates, clients and prospects. The package also incorporates a 300-baud modem chip and an RS-232 connector that can be used with an external modem with settings up to 19.2K baud.

PC-Express provides synchronous and asynchronous communications with IBM mainframes; and asynchronous communications with DEC mainframes, other microcomputers, and any of the more than 1400 on-line information services. (Synchronous transmissions are precisely timed with a clock signal and cannot use normal telephone lines; asynchronous transmissions are sent at random time intervals and are much slower than synchronous ones, typically ranging from 110 to 2400 bps.)

The package also supports electronic mail capabilities between PCs equipped with PC Express. This function provides mailbox facilities, and mail can be sent unattended, day or night. A "talk and send" mode permits two users to begin a conversation, transmit data to one another simultaneously, and then to resume their conversation after the transmission is completed. The data each machine receives is displayed on the monitor, stored on disk, or printed in hard-copy form.

A PC also can serve as a host to another local or remote PC, portable computer, or ASCII terminal. Any program stored on the host PC can be invoked, run and modified either locally or remotely.

PC Express enables users to extract information from the telephone database directory through multi-level servicing and sorting of files. Call lists can be created on the basis of area code, zip code, city, state, name, type of business, etc. Messages can be transmitted to all members of a list.

The telephone management software offers both a menu-driven and command-driven interface, and the PC keyboard's last four function keys enable the user to operate freely within the program by returning to the previous screen, accessing a selection of communications commands, obtaining help at any point during processing, or returning to the PC's normal operating system. Novice or occasional users can work easily with the package's menu options, while more sophisticated users can employ commands to directly invoke a communications task.

PC Express, including printed circuit board, software, and manuals for telephone management and asynchronous communications, is priced at \$895. With SNA, which augments the capabilities of PC Express, it is \$1295.

### Tecmar: ELAN (Extended Local Area Network)

The ELAN office communications system, marketed by Cleveland-based Tecmar, Inc., is a voice and data network designed for use with the IBM Personal Computer and the Ethernet local-area network. ELAN is available in three configurations—the Secretary, the Manager and the Executive.

ELAN uses an expansion board, the Tecmar Ethernet Companion, which converts voice to digital signals. The ability to digitize speech is crucial to many of ELAN's functions such as voice mail.

ELAN network users have a number of advantages. Through networking, printers, plotters, memory storage devices, or other peripherals can be used with any computer on the system.

The least expensive configuration of the ELAN system is the Secretary. It includes an Ethernet interface and functions as an electronic (data) mail station, a voice mail station, footpedal "dictation machine" control for either a real or simulated dictation recorder, and an interface that will later permit the attachment of an electronic mouse.

The Secretary adds voice to ELAN's data networking by converting voice into digital signals. Spoken messages are created via microphone from any station, then routed on command to any combination of other stations.

Digitized voice messages can be replayed for transcription as a dictating machine emulation. The system also works with the Pearlrecorder X-02 or XR Dictation Systems, through keyboard or footpedal control.

In the Manager configuration, ELAN offers a number of additional functions involving the interconnection of the voice/data network to telephone lines. A telephone handset is optional. The Manager adds either a 300-baud or 1200-baud (Bell 212A protocol, available at extra cost) direct-connect modem, which uses a standard modular connector for its link to the telephone line. The modems are equipped with special auxiliary voice circuits, which permit simultaneous passage of voice and data signals. The modems also offer auto-answer features, which permit unattended response to incoming calls. That allows the system to respond in the same way as an answering machine, delivering a spoken message and recording the incoming voice. Alternatively, this permits the reception of incoming files, including electronic mail.

Furthermore, the modems are equipped for automatic calling, including both DTMF tone and pulse (for telephone circuits not equipped for tone dialing) options. A virtually unlimited listing of telephone numbers can be stored in the computer's memory, permitting automatic dialing of any number of calls (at predetermined times for cost savings) for the exchange of voice or data. That feature also can operate unattended.

Another feature of the ELAN telephone interface is its ability to respond to dialing tones, which lets a caller issue commands to the system from any phone equipped for tone dialing (or, optionally, with a portable DTMF tone generator that is placed in the telephone mouthpiece). These commands can be used to retrieve voice messages or trigger any number of specified system activities.

A special output provides a signal when the phone is ringing, to be used for automatic power-on control. In addition, the telephone interface board enables terminal emulation, so the PC can be used with databases such as CompuServe, Dow Jones and the Source.

The third configuration is the Executive, which adds computer recognition of spoken commands to the capabilities of ELAN. The system will respond to oral commands just as it would to commands entered at the keyboard (or remotely entered from a telephone).

System requirements for ELAN include one disk storage location on the network (Tecmar hard disk recommended). Other participating IBM Personal Computers require neither floppy nor hard disk drives. And the only hardware requirement for ELAN participation beyond the ELAN and IBM PC systems is interconnecting coaxial cable.

Prices of the three configurations begin at \$1695 to \$1945 for the Secretary; \$1995 to \$2640 for the Manager; and \$2995 to \$3695 for The Executive. The systems are available at Tecmar dealers. (Price differences depend on available compatible software and optional modem).

#### Cygnnet Technologies: CoSystem

Cygnnet Technologies, Inc., of Sunnyvale, CA, has developed CoSystem, a

microprocessor-based voice and data communications system designed to work with the IBM PC, Compaq and other MS-DOS-based personal computers.

The CoSystem is a completely separate unit that is attached to the computer through an RS-232 compatible port. With this setup, the system can draw upon the full resources of the PC or function completely independently to streamline an entire range of telephone, information access, and data communications features. The total system integration offers complete menus and easy-to-understand simple entries and instructions in nontechnical language.

In addition to simultaneous voice and data capabilities, Cygnnet CoSystem features include electronic mail, intelligent telephone features, programmable function keys, automation of special PBX calling functions, automatic data base access, terminal emulation, detailed records of all communications activities and calendar/time management.

The CoSystem provides complete desk-to-desk teleconferencing capabilities over normal telephone lines with a 300-baud or 1200-baud modem (Bell

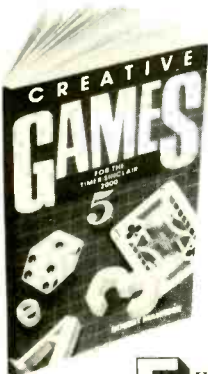

# INCREASE YOUR TIMEX-SINCLAIR ENJOYMENT

# CREATIVE GAMES FOR THE

# TIMEX-SINCLAIR

# 2068

## BY ROBERT MAUNDER

**E**ven the most seasoned computer professional will admit to enjoying computer games, and the selections in CREATIVE GAMES FOR THE TIMEX-SINCLAIR 2068 are a mix of completely original games as well as some old favorites for first timers and experienced users alike.

Over 21 games, including number, simulation, dice, card and grid games are included to allow you to use your Timex-Sinclair 2068 more fully, and have fun while expanding your use of the color computer.

For beginners, there is a simple guide to entering programs, and each program is clearly presented with detailed instructions.

Advanced users will find complete program design methods, with full explanations and documentation, including techniques and program notes.

CREATIVE GAMES FOR THE TIMEX-SINCLAIR 2068 will help you progress from just playing games to understanding their structures, modifying them and creating your own. Order your copy today!

### CREATIVE COMPUTING PRESS

Dept. NP4F, 39 East Hanover Avenue  
Morris Plains, NJ 07950

Please send me \_\_\_\_\_ CREATIVE GAMES FOR THE TIMEX-SINCLAIR 2068 at \$7.95\*, plus \$2.00 postage and handling each. Outside USA add \$3.00 per order. #2T.

Payment enclosed \$ \_\_\_\_\_ \*Residents of CA, WJ and NY State add applicable sales tax.

Charge my:  American Express  Visa  MasterCard  
(\$10. minimum for charge and phone orders.)

Card No. \_\_\_\_\_ Exp. Date \_\_\_\_\_

Signature \_\_\_\_\_

Mr. / Mrs. / Ms. \_\_\_\_\_ (please print name in full)

Address \_\_\_\_\_

City \_\_\_\_\_ State \_\_\_\_\_ Zip \_\_\_\_\_

Send me a FREE Creative Computing Press Catalog.

**For faster service, PHONE TOLL FREE 1-800-631-8112**

(In NJ only call 201-540-0445) Also available in your local bookstore or computer store.

Circle No. 1 on Free Information Card

# Telephone Management

System 212A compatible). Data can be sent, received and manipulated while permitting simultaneous discussion of the results.

Cygnit CoSystem enables sending and receiving unattended electronic mail 24 hours a day, even with the personal computer turned off or otherwise engaged. The CoSystem enables send-

ing confidential mail, mail to groups of people, and memoranda. Once mail is received, it can be filed, appended, re-transmitted, answered, or discarded.

The system provides a 400-name directory. A two-digit code can be used for speed dialing up to 30 frequently called numbers. If a number is busy, the CoSystem automatically calls it back.

CoSystem can easily group the steps required for a particular operation under a single key. Reprogramming any one of the 36 function keys is simple as requirements change. Twelve programmable keys make up the keyboard, and each one can have up to three distinct functions by using the alternate key shift.

In addition, by using the programmable function keys, a panorama of electronic information sources is available by pressing one button. CoSystem can be programmed to tie into Dow Jones News/Retrieval for stock quotes or CompuServe for travel and other information.

The Cygnit CoSystem can provide terminal emulation, which enables a workstation to communicate with mainframe computers, and other terminals. The system will store up to 15 different terminal profiles, accessible at the touch of a button. The CoSystem's calendar/clock can be utilized as a time and project recorder, or as a reminder calendar that keeps track of appointments and deadlines.

The minimum personal computer configuration required includes 192K RAM, an asynchronous serial port compatible with an RS-232 interface, two single- or double-sided disk drives, and an 80-column, 25-line monochrome display.

The Cygnit Communications CoSystem is available at computer retail outlets at prices ranging from \$1495 (300-baud modem) to \$1845 (1200-baud, 212A modem) plus an optional speakerphone for \$150.

## TMS MANUFACTURERS

### Speech Command System

Texas Instruments  
Data Systems Group  
PO Box 2909  
M/S 2201  
Austin, TX 78769  
800-527-3500

**TMS**  
Digital Equipment Corp.  
Maynard, MA 01754  
800-344-4825

**PC Express**  
Intelligence Technologies  
151 University Ave.  
Palo Alto, CA 94301  
415-328-2411

**ELAN**  
Teclar  
6225 Cochran Rd.  
Cleveland, OH 44139  
216-349-0600

**CoSystem**  
Cygnit Technologies, Inc.  
1296 Lawrence Station Rd.  
Sunnyvale, CA 94089  
800-331-9116

# We'll back you up!

## ATTENTION COMMODORE 64 OWNERS

If you own a disk drive then you'll need "The Clone Machine". Take control of your 1541 drive.

**NEW IMPROVED WITH UNGUARD.\***  
Package includes:

- 1.) Complete and thorough users manual
- 2.) Copy with one or two drives
- 3.) Investigate and back-up many "PROTECTED" disks
- 4.) Copy all file types including relative types
- 5.) Edit and view track/block in Hex or ASCII
- 6.) Display full contents of directory and print
- 7.) Change program names, add, delete files with single keystroke
- 8.) Easy disk initialization
- 9.) Supports up to four drives

**\$49.95**

\*UNGUARD Now allows you to read, write and verify bad sectors and errors on your disk making it easy to back-up most protected software.

Dealers & Distributors  
Inquiries Invited

CALL (201) 838-9027



Mr. Sad

P.O. Box 113  
Pompton Plains, N.J.  
07444

Circle No. 34 on Free Information Card

## RATED #1 FOR SERVICE & RELIABILITY

FOR INFORMATION OR ORDERING  
CALL TOLL FREE  
**800-221-8180**  
IN NEW YORK STATE  
(212) 732-8600



23 PARK ROW, N.Y.C.  
NEW YORK 10038

## THIS MONTH'S SUPER SPECIALS



**ATARI 800XL**  
• Home Computer  
• 64K RAM/256 Colors  
• Built-in High Level BASIC  
**\$289.95**

**ATARI 800XL HOME COMPUTER**  
• 16K RAM  
• Expandable to 64K  
**\$189.95**

**ATARI HARDWARE**  
ATARI 1027 Program Recorder \$74.95  
ATARI 1027 Letter Quality Printer \$289.95  
12 Print, 20 CPS  
ATARI 1025 80-Column Printer \$299.95  
ATARI 1030 Direct Con. Modem \$119.95  
ATARI 1050 Disc Drive \$249.95  
ATARI 850 Acoustic Modem \$139.95  
ATARI 850 Interface Module \$169.95

**ATARI SOFTWARE**  
ATARI AX2025 Microsoft Basic \$64.95  
ATARI CX2020 Centipede \$34.95  
ATARI CX2017 Invitation to Prog \$21.95  
ATARI CX2017 Inv to Prog II \$24.95  
ATARI CX2018 Pilot Home Package \$49.95  
DATA-SOFT ZAXXON Cassettes \$26.95  
**CX2050 CABINWARE**  
ATARI CX2699 Tar \$27.95  
ATARI CX2697 Ms Pac Man \$29.95  
ATARI CX2676 Centipede \$29.95  
ATARI CX2684 Galaxian \$29.95  
ATARI CX2691 Joust \$27.95  
ATARI CX2694 Pole Position \$24.95  
ATARI CX2688 Judge Dredd \$24.95  
ATARI CX2697 Mario Brothers \$26.95

**WE ALSO CARRY APPLE COMPUTER SOFTWARE**

**SANYO MBC555**  
• 128K Color Computer  
• Double Disk Drives  
• IBM Compatible  
**\$1199.95**

**SANYO MBC350 128K Single Drive \$819.95**  
**SANYO MBC1100 320K Dbl Drive \$1199.95**

**ATI 950/44 SOFTWARE**  
ATARI RX2550 Pro Hunt \$34.95  
ATARI RX2553 Centipede \$34.95  
ATARI RX2512 Donkey Kong \$34.95  
ATARI RX2516 Protector II \$29.95

**MONITORS**  
VIC C1702 14" Color \$249.95  
VIC C172024 12" Color \$259.95  
TALIAN 415 12" Super High Resolution \$299.95  
TALIAN 100 12" Green Screen \$129.95  
TALIAN 105 Amber Screen \$139.95  
TALIAN 210 12" Color Monitor \$289.95  
AMDEK 300A 12" Armor Screen \$159.95  
AMDEK 300E 12" Green Screen \$139.95  
AMDEK COLOR 13" Monitor \$259.95  
JANITZ DM122 12" Amber \$139.95  
PARASCREEN C180 10" Color \$269.95  
PARASCREEN DT1300D 13" Color \$449.95  
PARASCREEN DT1000 10" Color \$319.95



**TIMEX TS1000 \$449.95**

• Includes TS1016 16K RAM Expander Backgammon President and Stock Options.  
• Friendly Computer System  
**\$749.95**

**FREE GIANT CATALOGS**  
• 288 PAGE AUDIO/VIDEO/COMPUTER CATALOG  
• COMPLETE BUYING SOURCE OF OVER 10,000 PRODUCTS  
• 180 PAGE GIANT VIDEO MOVIES CATALOG  
WITH OVER 7,000 VIDEO CASSETTE CED & LASER DISC MOVIES  
• 64 PAGE GIANT RECORD & CASSETTE CATALOG  
10,000 LISTINGS OF THE MOST POPULAR ARTISTS & TITLES

**EAGLE PC2 PERSONAL COMPUTER \$2699.95**  
• 128K RAM  
• 2 Drives  
• 12" Screen  
• IBM Compatible

**FLOPPY DISCS**  
ELEPHANT 5 1/4" (Box of 10) \$29.90  
MAXELL MD70 (Box of 10) \$32.90  
SCOTCH 7450 (Box of 10) \$34.90  
VERBATIM MD525 (Box of 10) \$29.90  
DYSAN 104/1 5 1/4" (Box of 10) \$34.95  
WABASH 5 1/4" (Box of 10) \$27.95  
ULTRAMATECS 12326 5 1/4" (Box of 10) \$27.95



**COLECO ADAM \$479.95**

**VIDEO GAMES**  
COLLECTOR'S VIDEO Game \$109.95  
MATEL SE72 Intellivision \$59.95  
ATARI CX2600 Game Console \$99.95  
32K Manufacturer's Rebate \$84.95  
VICTREX Video Arcade System \$99.95  
ATARI 3200 Super Game System \$134.95  
(32K Manufacturer's Rebate)

**FRANKLIN ACE 1000**  
• 64K RAM  
• Apple II Software Compatible  
CALL OR WRITE FOR PRICE

**CANON PC20 PERSONAL CARTRIDGE COPIER W/FREE CARTRIDGE \$899.95**  
**EPSON HX20 NOTEBOOK COMPUTER \$15K RAM \$279.95**  
**EPSON C10 8-BIT COMPUTER SYSTEM \$279.95**  
CALL FOR PRICE



23 PARK ROW, DEPT. CE4, NYC, NY 10038

HOW TO ORDER BY MAIL: FOR PROMPT AND COURTEOUS SHIPMENT, SEND MONEY ORDER CERTIFIED CHECK, CASHIER'S CHECK, MASTER/AMERICAN EXPRESS CARD, PERSONAL INTERBANK NO. expiration date and signature. **DO NOT SEND CASH.** PERSONAL AND BUSINESS CHECKS MUST CLEAR OUR BANK BEFORE PROCESSING. \$25 MINIMUM. Handling, Shipping, Handling & Insurance Charge is 5% of Total order, with a \$3.95 minimum. WE SHIP TO CONTINENTAL U.S., ALASKA, HAWAII, PUERTO RICO AND CANADA ONLY. Canadian orders add 10% Shipping, with a \$7.95 minimum charge. For shipments by air, please double these charges. **SORRY NO C.O.D. NEW YORK RESIDENTS PLEASE ADD SALES TAX. ALL MICROBANDS ARE SHIPPED BRAND NEW, FACTORY FRESH, AND 100% GUARANTEED. WE ARE NOT RESPONSIBLE FOR ANY TYPOGRAPHICAL ERRORS.**

WRITE OR CALL FOR FREE 288 PAGE AUDIO/VIDEO/COMPUTER CATALOG

Circle No. 23 on Free Information Card

HOME COMPUTER ACCESSORIES

KEYBOARDS — POWER SUPPLIES

DISK DRIVES AND CABLE

VOICE SYNTHESIZER FOR APPLE AND COMMODORE

NEW!

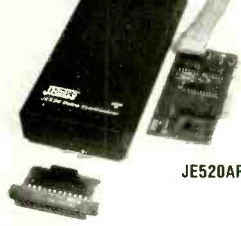

**JE520AP**  
• Over 250 word vocabulary - affixes allow the formation of more than 500 words • Built-in amplifier, speaker, volume control, and audio jack • Recreates a clear, natural male voice • Plug-in user ready with documentation and sample software • Case size: 7 1/4" L x 3 1/4" W x 1-3/8" H

**APPLICATIONS:**  
• Security Warning • Telecommunication  
• Teaching • Handicap Aid  
• Instrumentation • Games

The JE520 VOICE SYNTHESIZER will plug right into your computer and allow you to enhance almost any application. Utilizing National Semiconductor's DIGITAL KER™ Speech Processor IC (with four custom memory chips), the JE520 compresses natural speech into digital memory, including the original inflections and emphases. The result is an extremely clear, natural vocalization.

Part No.	Description	Price
JE520CM	For Commodore 64 & VIC-20	\$114.95
JE520AP	For Apple II, II+, and IIe	\$149.95



JE664 EPROM PROGRAMMER 8K to 64K EPROMS — 24 & 28 Pin Packages

Completely Self-Contained — Requires No Additional Systems for Operation — Programs and validates EPROMs — Checks for properly erased EPROMs — Emulates PROMs or EPROMs — RS232C Computer Interface for editing and program loading — Loads data into RAM by keyboard — Changes data in RAM by keyboard — Loads RAM from an EPROM — Compares EPROMs for content differences — Copies EPROMs — Power Input: 115VAC, 60Hz; less than 10W power consumption — Enclosure: Color-coordinated, light tan panels with milled end pieces in mocha brown — Size: 15 1/4" L x 8 3/4" D x 3 3/8" H — Weight: 5 1/2 lbs.

The JE664 EPROM Programmer emulates and programs various 8-Bit Word EPROMs from 8K to 64K bit memory capacity. Data can be entered into the JE664's internal 8K x 8-Bit RAM in three ways: (1) from a ROM EPROM, (2) from an external computer via the optional JE665 RS232C BUS, (3) from its panel keyboard. The JE664's RAMs may be accessed for emulation purposes from the panel's test socket to an external microprocessor. In programming and emulation, the JE664 allows for examination, change and validation of program content. The JE664's RAMs can be programmed quickly to all "1"s (or any value), allowing untested addresses in the EPROM to be programmed later without necessity of "UV" erasing. The JE664 displays the ADDRESS and content hexadecimal (alphanumeric) format. A "DISPLAY EPROM DATA" button changes the DATA register from RAM word to EPROM word and is displayed in both hexadecimal and binary code. The front panel features a convenient operating guide. The JE664 Programmer includes one JN16A Jumper Module (as listed below).

JE664-A EPROM Programmer . . . \$995.00

**JE665 — RS232C INTERFACE OPTION** — The RS232C interface Option implements computer access to the JE664-A RAM. This allows the computer to manipulate, store and transfer EPROM data to and from the JE664-A. A sample program listing is supplied in MIBASIC for CP/M computers. Documentation is provided to adapt the software to other computers with an RS232 port. \$900 (Base) for word, odd parity and 2 stop bits.

FOR A LIMITED TIME A SAMPLE OF SOFTWARE WRITTEN IN BASIC FOR THE TRS-80™ MODEL I LEVEL II COMPUTER WILL ALSO BE PROVIDED.

JE664-ARS EPROM Prog. w/ JE665 Option. . . \$1195.00

Assembled & Tested (includes JN16A Module)

**EPROM JUMPER MODULES** — The JE664's JUMPER MODULE (Personality Module) is a plug-in Module that pre-sets the JE664 for the proper programming output to the EPROM and configures the EPROM socket connections for that particular EPROM.

JE64 EPROM Jumper Part No.	Part No.	Programing Voltage	EPROM MANUFACTURER	PRICE
JM05A	2708	25V	AMD; Motorola; Nat. Inst. TI	\$14.95
JM16A	2716, 2M2516 (7)	25V	Intel; Motorola; Nat. Inst. TI; AMD; Hitachi; Mostek	\$14.95
JM15B	2M2517 (3 V <sub>16</sub> )	5V, +5V, +12V	Motorola, TI	\$14.95
JM24A	2M2522	25V	Motorola, TI, Hitachi, ONI	\$14.95
JM27B	2722	25V	AMD; Fujitsu; NEC; Hitachi; West. Mitsubishi; National	\$14.95
JM32C	2732A	21V	Fujitsu; Intel	\$14.95
JM36C	2M26875A	21V	Motorola	\$14.95
JM40A	2M26876A	21V	Motorola	\$14.95
JM48A	2764	21V	Intel; Fairchild; ONI	\$14.95
JM64C	2M2664	25V	TI	\$14.95

4-Digit Fluorescent Alarm Clock Kit

NEW!

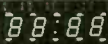

- Bright 4 digit 0.5" high display - 10 minute snooze alarm
- AMP/IMP indicator - Automatic display dimmer

The JE750 Alarm Clock Kit is a versatile 12-hour digital clock with 24-hour alarm. The clock has a bright 0.5" high blue-green fluorescent display. The display will automatically dim with changing light conditions. The 24-hour alarm allows the user to disable the alarm and immediately re-enable the alarm to activate 24 hours later. The kit includes all documentation, components, case and wall transformer. Size: 6 1/2" L x 3 1/4" W x 1 1/8" D.

JE750 Alarm Clock Kit. . . . . \$29.95



13 1/2" L x 4 1/4" W x 3/4" H

**Misumi 54-Key Unencoded Matrix All-Purpose Keyboard**  
• SPST keyswitches - 20 pin ribbon cable connector - Low profile keys • Features: cursor controls, control, Caps (lock), function, enter and shift keys • Color (keycaps): grey • Weight: 1 lb  
KB54. . . . . \$14.95



18" L x 7 7/8" W x 1 1/2" H

**71-Key ASCII Cherry Keyboard**  
• 7 bit parallel ASCII with strobe • 11 key numeric keypad • SPST mechanical keyswitches - #15/30 card-edge connector • Features: escape, control, cursor controls, plus ten additional function keys • Color: white • Weight: 2 lbs • Spec. included  
KB1801. . . . . \$29.95



21 1/2" L x 9 8/8" W x 3 3/8" H

**106-Key 8-Bit Serial ASCII Keyboard**  
• Numeric and cursor keypad • 10 user definable keys • 7 LED function displays • Security lock • N-key rollover • Uses Intel 8048/8748 • Color: white w/black panel • Documentation included • Weight: 6 1/2 lbs.  
KB139. . . . . \$59.95

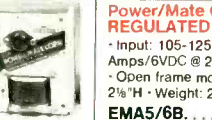

**Power/Mate Corporation REGULATED POWER SUPPLY** +5VDC @ 3 Amp / +6VDC @ 2.5 Amp  
• Input: 105-125/210-250VAC at 47-63 Hz • Output: 5VDC @ 3.0 Amps/6VDC @ 2.5 Amps • Line regulation: 0.05% • Load reg.: 0.1% • Open frame mounts on any 1 of 3 surfaces • Size: 4 1/2" L x 4" W x 2 1/2" H • Weight: 2 lbs.  
EMA5/6B. . . . . \$29.95

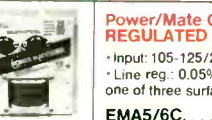

**Power/Mate Corporation REGULATED POWER SUPPLY** +5VDC @ 6 Amp / +6VDC @ 5 Amp  
• Input: 105-125/210-250VAC at 47-63 Hz • Output: 5V @ 6A/6V @ 5A • Line reg.: 0.05% • Load reg.: 0.1% • Open frame mounts on any one of three surfaces • Size: 5 1/2" L x 4 1/2" W x 2 1/2" H • Wt: 4 lbs.  
EMA5/6C. . . . . \$39.95



**POWER SUPPLY +5VDC @ 7.6 AMP 12VDC @ 1.5 AMP SWITCHING**  
• Input: 115VAC, 50-60Hz • 3 amp/230VAC, 50Hz @ 1.6 amp • Fan volt./power supply select switch (115/200VAC) • Output: 5VDC @ 7.6 amp, 12VDC @ 1.5 amp • 8 foot black power cord • Size: 11 1/8" W x 13 1/4" D x 3 3/8" H • Weight: 6 lbs  
Part No. PS94VOS. . . . . \$39.95



**POWER SUPPLY 4-Channel Switching**  
Microprocessor, mini-computer, terminal, medical equipment and process control applications. Input: 90-130VAC 47-60Hz. Output: +5VDC @ 5A, -5VDC @ 1A, +12VDC @ 1A, -12VDC @ 1A. Line reg.: ±0.2%, ripple 30mV p-p @ 120Hz. 0.1% overcurrent protection. Adj. 5V main output at 10A, 6-3/4" L x 17/8" W x 4-15/16" H. Wt. 1 1/2 lbs.  
Part No. FCS-604A . . . . . \$69.95 each



**Switching Power Supply for APPLE II, II+ & IIe™**  
• Can drive four floppy disk drives and up to eight expansion cards • Short circuit and overload protection • Fits inside Apple computer • Fully regulated +5V @ 5A, +12V @ 3A, -5V @ 5A, -12V @ 5A • Direct plug-in power cord included • Size: 9 1/2" L x 3 1/2" W x 2 1/4" H • Weight: 2 lbs.  
KHP4007. . . . . \$79.95

DISKETTES AND ACCESSORIES

5 1/4" and 8" Diskettes

Part No.	Description	Based	PRICE
UM1401	5 1/4" SDDO Soft Sector with Hub Ring and Envelope	100	\$24.95
UM0009	5 1/4" SDDO Soft Sector with Hub Ring (Bulk)	100	\$6.95
UM3261	5 1/4" DSDO Soft Sector with Hub Ring and Envelope	100	\$24.95
UM0014	5 1/4" DSDO Soft Sector with Hub Ring (Bulk)	100	\$28.95
UM1801	8" SDDO Soft Sector with Envelope (96PI)	10	\$4.95
UM0014	5 1/4" SDDO Soft Sector 80PI (Bulk)	100	\$19.95
UM1801	8" SDDO Soft Sector with Envelope (96PI)	10	\$4.95
UM0017	5 1/4" DSDO Soft Sector 80PI (Bulk)	100	\$26.95
<b>SK (ESKE) — 5 1/4" DISKETTES</b>			
SK10	5 1/4" SDDO Soft Sector with Hub Ring and Envelope	10	20.95
SK10B	5 1/4" SDDO Soft Sector with Hub Ring (Bulk)	100	149.05
SK20	5 1/4" DSDO Soft Sector with Hub Ring and Envelope	10	28.95
SK20B	5 1/4" DSDO Soft Sector with Hub Ring (Bulk)	100	189.95
<b>ULTRA MAGNETICS — 8" DISKETTES</b>			
UM1276	8" SDDO IBM Compatible 128 2B, 28 Sectors and Envelope	10	\$4.95
UM0015	8" SDDO IBM Compatible 128 2B, 28 Sectors Bulk	100	\$28.95
UM4278	8" DSDO Soft Sector Ultramagnetic with Envelope	10	\$9.95
UM0040	8" DSDO Soft Sector (ultramagnetic) Bulk	100	29.95

All prices listed above are \$100's selected. All have Hub Rings with the exception of the Quad Density and the 8" Diskette

**DISKETTE ACCESSORIES**

**Disk Minder**  
• Attractive, functional disk storage system • 50 (8") or 75 (5 1/4") disk storage capacity • Easy filling and retrieving • Protects disk from dust contamination • Made from durable smoked plastic with front carrying handle • Size: 7 1/4" x 6 1/4" H x 9 1/8" D • Weight: 2 lbs  
Part No. Description Price  
DM75 Stores 75 (5 1/4") Diskettes \$19.95 each  
DM50 Stores 50 (8") Diskettes \$29.95 each

**Diskette Envelopes**  
Sieves for Bulk-Purchased Diskettes  
Part No. Description Price  
MP5201 10 White 5 1/4" Envelopes 10 for \$ 1.49  
MP201-100 100 White 5 1/4" Envelopes 100 for \$10.95  
MP201-10 10 White 8" Envelopes 10 for \$ 1.95  
MP201-100 100 White 8" Envelopes 100 for \$17.95

**Vinyl Pages**  
For 3-Ring Binders  
Protects disks from dirt, scratches, dust, static, and other contaminants. Reduces the risk of getting dirty when your disk drive head sizes 8 1/4" x 11 1/2".  
Part No. Description Price  
PC001 2 Pocket 5 1/4" Vinyl Page 10 for \$7.95  
PC001-2 4 Pocket 5 1/4" Vinyl Page 10 for \$9.95  
PC014 1 Pocket 8" Vinyl Page 10 for \$7.95  
PC014-2 2 Pocket 8" Vinyl Page 10 for \$8.95

**Mail Pak™**  
• Holds up to 3 diskettes  
• Ideal for mailing and retail packaging  
• Dust proof and durable  
• Transparent sleeve allows easy identification  
Part No. Description Price  
MP05 Holds 3 ea. 5 1/4" Diskettes \$2.49 each  
MP08 Holds 3 ea. 8" Diskettes \$3.95 each

\$10.00 Minimum Order — U.S. Funds Only  
California Residents Add 6 1/2% Sales Tax  
Shipping — Add 5% plus \$1.50 Insurance  
Send S.A.S.E. for Monthly Sales Flyer!

Spec Sheets — 30c each  
Send \$1.00 Postage for your  
FREE 1984 JAMECO CATALOG  
Prices Subject to Change

Mail Order Electronics - Worldwide

**Jameco ELECTRONICS**

1355 SHOREWAY ROAD, BELMONT, CA 94002  
4/84 PHONE ORDERS WELCOME — (415) 592-8097 Telex: 176043

MasterCard VISA

8" FLOPPY DISK DRIVE



The FDD100-8 8" Floppy Disk Drive (Industry Standard) features single or double density. Recording mode: FM single, MFM double density. Transfer rate: 250K bits/sec. single density, 500K bits/sec. double density. The FDD100-8 is designed to work with the single-sided soft sector IBM Diskette I, or eq. disk cartridge. Power: 115VAC @ 50-60Hz, +24VDC @ 1.7 amps max. • 5VDC @ 1.2 amp max. Unit as pictured above (does not include case, power supply, or cables). Size: 8.55" W x 14" L x 4.5" H Weighs 12 lbs. Incl. 96-pg. manual.

- Single-Sided
- 77 Tracks
- 400/800K Bytes Capacity
- Industry Standard

FDD100-8 . . . \$169.95 ea.

**5 1/4" APPLE™ Direct Plug-In Compatible Disk Drive**  
• Uses Shugart SA330 mechanics • 14K formatted storage • 35 tracks — compatible with Apple controller • Complete with connector cable — just plug into your disk controller card • Size: 8 1/4" x 9 1/2" W x 8-9/16" D • Weight: 4 1/2 lbs.  
Part No. ADD-51A \$195.95

**5 1/4" TEAC DISK DRIVE**  
Single-Sided Half-Height 5 1/4" Drive  
• Single or double density • 48 TPI • 40 tracks • 6ms track to track • 5W power consumption • Brushless DC direct-drive motor • 16KB/bytes formatted storage • One year warranty parts and labor  
Double your work space with the TEAC 5 1/4" FLOPPY DISK DRIVE. Because the TEAC FD55A Drive is half the height of conventional drives, you can fit up to four TEAC drives in the same space where two conventional drives fit. Or, have room for two floppy disk drives and a hard disk drive. Includes operating manual. Requires: +5VDC @ .55A and +12VDC @ .3A. Size: 5 1/4" W x 1 1/4" H x 8" D Wt: 3 lbs.  
FD55A. . . . . \$249.95

**5 1/4" SHUGART DISK DRIVE**  
Double-Sided Half-Height 5 1/4" Drive  
• Single or double density • 48 TPI • 40 tracks • 4096Bytes formatted storage • 6ms track to track • Brushless DC direct-drive motor • One year warranty parts and labor • Media and interface compatible with the SA455  
Backed by the industry's largest and most experienced engineering sales and service organization, the SA455 is the smart solution for a wide range of desktop applications including operating manual. Requires: +5VDC @ .7A and +12VDC @ .75A. Size: 5 8/8" W x 1 6/8" H x 8" D Wt. 3.3 lbs.  
SA455. . . . . \$259.95

**5 1/4" PANASONIC DISK DRIVE**  
Double-Sided Half-Height 5 1/4" DRIVE  
Shugart SA455 Equivalent  
• Single or double density • 48 TPI • 40 tracks • 6ms track to track • 327KB/bytes formatted storage • One year warranty parts and labor  
The JAS51 is perfect for word processors, personal and portable computers, small business computers and terminal add-ons. Includes operating manual. Requires: +5VDC @ .3A and +12VDC @ 1 A. Size: 5.88" W x 1.63" H x 8" D. Wt: 3.55 lbs.  
JAS51-2 . . . . . \$239.95

DISK DRIVE CABLE CUSTOM

We stock a wide variety of signal cables and 3 power cable kits to meet your disk drive requirements. We also customize cable assemblies for many other applications. Call for a price quote.

IBM MEMORY EXPANSION KIT COMPACT COMPATIBILITY

SAVE HUNDREDS OF \$\$\$ BY UPGRADING MEMORY BOARDS YOURSELF!

Most of the popular memory boards allow you to add an additional 64K, 128K, 192K, or 256K. The IBM64K Kit will justify these boards in 64K byte increments. The kit is simple to install — just insert the nine 64K RAM chips in the provided sockets and set the two groups of switches. Directions are included.

IBM64K (Nine 200ns 64K RAMs) . . . . . \$49.95

EXPAND YOUR MEMORY

TRS-80 to 16K, 32K, or 48K  
\*\*Model 1 = From 4K to 16K Requires (1) One Kit  
Model 3 = From 4K to 48K Requires (3) Three Kits  
Color = From 4K to 16K Requires (1) One Kit  
\*\*Model I equipped with Expansion Board up to 48K Two Kits Required — One Kit Required for each 16K of Expansion

TRS-16K3 \*200ns for Color & Model III . . . . . \$12.95  
TRS-16K4 \*250ns for Model I . . . . . \$10.95

TRS-80 Color 32K or 64K Conversion Kit

Easy to install kits comes complete with 8 ea. 4164-2 (200ns) 64K dynamic RAMs and conversion documentation. Converts TRS-80 color computers with D, E, ET, F and NC circuit boards to 32K. Also converts TRS-80 color computer II to 64K. Flex DOS or OS-9 required to utilize full 64K RAM on all computers.  
TRS-64K2. . . . . \$44.95

UV-EPROM Eraser

8 Chips — 51 Minutes

Erases 2708, 2716, 2732, 2764, 2516, 2532, 2564. Erases up to 8 chips within 51 minutes (1 chip in 37 minutes). Maintains constant exposure distance of one inch. Special conductive foam liner eliminates static build-up. Built-in safety lock to prevent UV exposure. Compact — only 8.00" x 3.70" x 2.60". Complete with holding tray for 8 chips.  
1 Chip — 37 Minutes

DE-4 UV-EPROM Eraser . . . \$79.95  
UVS-11EL Replacement Bulb . . \$16.95

# 4164 64K DYNAMIC 200 NS \$595 TMM2016 2KX8 STATIC 200 NS \$415

## STATIC RAMS

2101	256 x 4 (450ns)	1.95
5101	256 x 4 (450ns) (cmos)	3.95
2102-1	1024 x 1 (450ns)	.89
2102L-4	1024 x 1 (450ns) (LP)	.99
2102L-2	1024 x 1 (250ns) (LP)	1.49
2111	256 x 4 (450ns)	2.49
2112	256 x 4 (450ns)	2.99
2114	1024 x 4 (450ns)	8/9.95
2114-25	1024 x 4 (250ns)	8/10.95
2114L-4	1024 x 4 (450ns) (LP)	8/12.95
2114L-3	1024 x 4 (300ns) (LP)	8/13.45
2114L-2	1024 x 4 (200ns) (LP)	8/13.95
TC5514	1024 x 4 (650ns) (cmos)	2.49
TC5516	2048 x 8 (250ns) (cmos)	9.95
2147	4096 x 1 (55ns)	4.49
TMS4044-4	4096 x 1 (450ns)	3.95
TMS4044-3	4096 x 1 (300ns)	3.99
TMS4044-2	4096 x 1 (200ns)	4.49
MK4118	1024 x 8 (250ns)	9.95
TMM2016-200	2048 x 8 (200ns)	4.15
TMM2016-150	2048 x 8 (150ns)	4.95
TMM2016-100	2048 x 8 (100ns)	6.15
HM6116-4	2048 x 8 (200ns) (cmos)	4.75
HM6116-3	2048 x 8 (150ns) (cmos)	4.95
HM6116-2	2048 x 8 (120ns) (cmos)	8.95
HM6116LP-4	2048 x 8 (200ns) (cmos)(LP)	5.95
HM6116LP-3	2048 x 8 (150ns) (cmos)(LP)	6.95
HM6116LP-2	2048 x 8 (120ns) (cmos)(LP)	10.95
Z-6132	4096 x 8 (300ns) (Qstat)	34.95
HM6264	8192 x 8 (250ns) (cmos)	49.95

LP - Low Power Qstat - Quasi-Static

## DYNAMIC RAMS

TMS4027	4096 x 1 (250ns)	1.99
UPD411	4096 x 1 (300ns)	3.00
MMS280	4096 x 1 (300ns)	3.00
MK4108	8192 x 1 (200ns)	1.95
MMS298	8192 x 1 (250ns)	1.85
4116-300	16384 x 1 (300ns)	8/11.75
4116-250	16384 x 1 (250ns)	8/7.95
4116-200	16384 x 1 (200ns)	8/12.95
4116-150	16384 x 1 (150ns)	8/14.95
4116-120	16384 x 1 (120ns)	8/29.95
2118	16384 x 1 (150ns) (5v)	4.95
MK4332	32768 x 1 (200ns)	9.95
4164-200	65536 x 1 (200ns) (5v)	5.95
4164-150	65536 x 1 (150ns) (5v)	6.95
MCM6665	65536 x 1 (200ns) (5v)	8.95
TMS4164-15	65536 x 1 (150ns) (5v)	8.95

5V - single 5 volt supply

## EPROMS

1702	256 x 8 (1us)	4.50
2708	1024 x 8 (450ns)	3.95
2758	1024 x 8 (450ns) (5v)	5.95
2716	2048 x 8 (450ns) (5v)	3.95
2716-1	2048 x 8 (350ns) (5v)	5.95
TMS2516	2048 x 8 (450ns) (5v)	5.50
TMS2716	2048 x 8 (450ns) (5v)	7.95
TMS2532	4096 x 8 (450ns) (5v)	5.95
2732	4096 x 8 (450ns) (5v)	4.95
2732-250	4096 x 8 (250ns) (5v)	8.95
2732-200	4096 x 8 (200ns) (5v)	11.95
2732A-4	4096 x 8 (450ns) (5v) (21vPGM)	6.95
2732A	4096 x 8 (250ns) (5v) (21vPGM)	9.95
2732A-2	4096 x 8 (200ns) (5v) (21vPGM)	13.95
2764	8192 x 8 (450ns) (5v)	6.95
2764-250	8192 x 8 (250ns) (5v)	7.95
2764-200	8192 x 8 (200ns) (5v)	19.95
TMS2564	8192 x 8 (450ns) (5v)	14.95
MCM68764	8192 x 8 (450ns) (5v) (24 pin)	39.95
MCM68766	8192 x 8 (450ns) (5v) (24 pin)(pwr dn.)	42.95
27128	16384 x 8 (300ns) (5v)	29.95

5v - Single 5 Volt Supply 21vPGM - Program at 21 Volts

## EPROM ERASERS

	Timer	Capacity Chip	Intensity (uW/Cm <sup>2</sup> )	
PE-14		9	8,000	83.00
PE-14T	X	9	8,000	119.00
PE-24T	X	12	9,600	175.00
PL-265T	X	30	9,600	255.00
PR-125T	X	25	17,000	349.00
PR-320T	X	42	17,000	595.00

- ★ Computer managed inventory — virtually no back orders!
- ★ Very competitive prices!
- ★ Friendly staff!
- ★ Fast service — most orders shipped within 24 hours!

## CRYSTALS

32.768 khz	1.95
1.0 mhz	3.95
1.8432	3.95
2.0	2.95
2.097152	2.95
2.4576	2.95
3.2768	2.95
3.579545	2.95
4.0	2.95
5.0	2.95
5.0688	2.95
5.185	2.95
5.7143	2.95
6.0	2.95
6.144	2.95
6.5536	2.95
8.0	2.95
10.0	2.95
10.738635	2.95
14.31818	2.95
15.0	2.95
16.0	2.95
17.430	2.95
18.0	2.95
18.432	2.95
20.0	2.95
22.1184	2.95
32.0	2.95

## CMOS

4000	.29	4528	1.19
4001	.25	4531	.95
4002	.25	4532	1.95
4006	.89	4538	1.95
4007	.29	4539	1.95
4008	.95	4541	2.64
4009	.39	4543	1.19
4010	.45	4553	5.79
4011	.25	4555	.95
4012	.25	4556	.95
4013	.38	4581	1.95
4014	.79	4582	1.95
4015	.39	4584	.75
4016	.39	4585	.75
4017	.69	4702	12.95
4018	.79	74C00	.35
4019	.39	74C02	.35
4020	.75	74C04	.35
4021	.79	74C08	.35
4022	.79	74C10	.35
4023	.29	74C14	.59
4024	.65	74C20	.35
4025	.29	74C30	.35
4026	1.65	74C32	.39
4027	.45	74C42	1.29
4028	.69	74C48	1.99
4029	.79	74C73	.65
4030	.39	74C74	.65
4034	1.95	74C76	.80
4035	.85	74C83	1.95
4040	.75	74C85	1.95
4041	.75	74C86	.39
4042	.69	74C89	4.50
4043	.85	74C90	1.19
4044	.79	74C93	1.75
4046	.85	74C95	.99
4047	.95	74C107	.89
4049	.35	74C150	5.75
4050	.35	74C151	2.25
4051	.79	74C154	3.25
4053	.79	74C157	1.75
4060	.89	74C160	1.19
4066	.39	74C161	1.19
4068	.39	74C162	1.19
4069	.29	74C163	1.19
4070	.35	74C164	1.39
4071	.29	74C165	2.00
4072	.29	74C173	.79
4073	.29	74C174	1.19
4075	.29	74C175	1.19
4076	.79	74C192	1.49
4078	.29	74C193	1.49
4081	.29	74C195	1.39
4082	.29	74C200	5.75
4085	.95	74C221	1.75
4086	.95	74C244	2.25
4093	.49	74C373	2.45
3341	4.95	74C374	2.45
MC3470	4.95	90C901	.39
MC3480	9.00	14409	12.95
11C90	13.95	14410	12.95
95H90	7.95	14411	11.95
2513-001 UP	9.95	14412	12.95
2513-002 LOW	9.95	14419	7.95
		14433	14.95
		4502	.95
		4503	.65
		4508	1.95
		4510	.85
		4511	.85
		4512	.85
		4514	1.25
		4515	1.79
		4516	1.55
		4518	.89
		4519	.39
		4520	.79
		4522	1.25
		4526	1.25
		4527	1.95

## UARTS

AY3-1014	6.95
AY5-1013	3.95
AY3-1015	6.95
PT1472	9.95
TR1602	3.95
2350	9.95
2651	8.95
IM6402	7.95
IM6403	8.95
INS8250	10.95

## GENERATORS

MC14411	11.95
BR1941	11.95
4702	12.95
COM5016	16.95
COM8116	10.95
MMS307	10.95

## BIT-RATE

MC4024	3.95
LM566	1.49
XR2206	3.75
8038	3.95

## MISC.

UPD7201	29.95
TMS99532	29.95
ULN2003	2.49
3242	7.95
3341	4.95
MC3470	4.95
MC3480	9.00
11C90	13.95
95H90	7.95
2513-001 UP	9.95
2513-002 LOW	9.95

## CLOCK

MMS5314	4.95
MMS369	3.95
MMS5375	4.95
MMS58167	12.95
MMS58174	11.95
MSM5832	3.95

## KEYBOARD

AY5-2376	11.95
AY5-3600	11.95
AY5-3600 PRO	11.95

## 6800

68000	49.95
6800	2.95
6802	7.95
6803	19.95
6808	13.95
6809E	14.95
6809	11.95
6810	2.95
6820	4.35
6821	2.95
6828	14.95
6840	12.95
6843	34.95
6844	25.95
6845	14.95
6847	11.95
6850	3.25
6852	5.75
6860	7.95
6875	6.95
6880	2.25
6883	22.95
68047	24.95
68488	19.95
6800 - 1MHZ	
68B00	10.95
68B02	22.25
68B09E	29.95
68B09	29.95
68B10	6.95
68B21	6.95
68B40	19.95
68B45	19.95
68B50	5.95
68B00 - 2 MHZ	

## 6500

6502	1 MHZ	4.95
6504	6.95	
6505	8.95	
6507	9.95	
6520	4.35	
6522	6.95	
6532	9.95	
6545	22.50	
6551	11.85	
6502A	2 MHZ	6.95
6522A	9.95	
6532A	11.95	
6545A	27.95	
6551A	11.95	
6502B	3 MHZ	9.95

## 8000

8035	5.95
8039	5.95
INS-8060	17.95
INS-8073	49.95
8080	3.95
8085	4.95
8085A-2	11.95
8086	24.95
8087	CALL
8088	29.95
8089	89.95
8155	6.95
8155-2	7.95
8156	6.95
8185	29.95
8185-2	39.95
8741	29.95
8748	24.95
8755	24.95

## 8200

8202	24.95
8203	39.95
8205	3.50
8212	1.80
8214	3.85
8216	1.75
8224	2.25
8226	1.80
8228	3.49
8237	19.95
8237-5	21.95
8238	4.49
8243	4.45
8250	10.95
8251	4.49
8253	6.95
8253-5	7.95
8255	4.49
8255-5	5.25
8257	7.95
8257-5	8.95
8259	6.90
8259-5	7.50
8271	79.95
8272	39.95
8275	29.95
8279	8.95
8279-5	10.00
8282	6.50
8283	6.50
8284	6.50
8286	5.50
8287	6.50
8288	25.00
8289	49.95

2114

450 NS

8/\$995

2114

250 NS

8/\$1095

74LS00

Table listing 74LS00 components with prices. Columns include part number, quantity, and price.

74S00

Table listing 74S00 components with prices. Columns include part number, quantity, and price.

VOLTAGE REGULATORS

Table listing voltage regulators with prices. Columns include part number and price.

C, T = TO-220 K = TO-3 L = TO-92

7400

Table listing 7400 components with prices. Columns include part number, quantity, and price.

SOUND CHIPS

Table listing sound chips with prices. Columns include part number and price.

DATA ACQUISITION

Table listing data acquisition components with prices. Columns include part number and price.

MICROCOMPUTER HARDWARE HANDBOOK

FROM ELCOMP - \$14.95. Over 800 pages of manufacturers data sheets on most commonly used IC's.

- Includes: \* TTL - 74/74LS and 74F \* CMOS \* Voltage Regulators \* Memory - RAM ROM, EPROM \* CPU's - 6800, 6500, Z80, 8080, 8085, 8086/8 \* MPU support & interface - 6800, 6500, Z80, 8200, etc.

INTERFACE

Table listing interface components with prices. Columns include part number and price.

CENTRONICS

Table listing Centronics components with prices. Columns include part number and price.



FEDERAL EXPRESS SERVICES AVAILABLE!

CONNECTORS

Table listing connectors with prices. Columns include part number and price.

EXAR

Table listing Exar components with prices. Columns include part number and price.

INTERSIL

Table listing Intersil components with prices. Columns include part number and price.

9000

Table listing 9000 components with prices. Columns include part number and price.

LINEAR

Large table listing linear components with prices. Columns include part number and price.

RCA

Table listing RCA components with prices. Columns include part number and price.

TI

Table listing TI components with prices. Columns include part number and price.

BI FET

Table listing Bi FET components with prices. Columns include part number and price.

LED DISPLAYS

Table listing LED displays with prices. Columns include part number, size, and price.

LED LAMPS

Table listing LED lamps with prices. Columns include type, quantity, and price.

BYPASS CAPS

Table listing bypass caps with prices. Columns include type and price.

DIP SWITCHES

Table listing DIP switches with prices. Columns include position and price.

ALL MERCHANDISE 100% GUARANTEED

Circle No. 22 on Free Information Card

Copyright 1984 JDR Microdevices







## Apricot (Continued from page 45)

execution of a software task, on an 8086 microcomputer to be much better than on an 8088 machine. However, this depends upon the task—we'll show you some "benchmarks" later on.

The clock rate of the 8086 is 5 MHz compared to the IBM PC's 4.77 MHz. (The clock rate directly influences instruction execution speed—the higher the clock rate, the faster BASIC and applications programs will execute.)

The Apricot "motherboard" comes "fully populated" with 256K bytes of RAM. This memory can be expanded to 768K bytes by adding a 512K RAM board to the basic system. The RAM board is added internally to one of the two expansion slots contained within the Apricot system.

The expansion slots can be used to add other options in addition to the 512K memory board. Other options include an alternative 128K or 256K RAM board, a hard disk drive that will plug into one slot and will replace one micro drive, and a modem board. The "bus" on the Apricot, by the way, is not a standard IBM PC bus because of the added signals required for the 16 bits of the 8086 over the 8088. This means that plug-in options available for the PC will not be available for the Apricot, but this is probably a blessing when you consider the compatibility problems encountered when plug-in boards created for one system are used on different systems.

### Bundled Software

The Apricot comes with "bundled" software, a marketing technique used ever since three popular packages were bun-

dled with the Osborne I. The advantage of bundled software is that you'll get applications programs included with the System that would normally cost hundreds of dollars. The disadvantage, of course, is that you'll have to take what the manufacturer provides, even though your first choice might be another type of "spreadsheet" or file manager.

Apricot applications software includes *SuperCalc I*, a "spreadsheet" applications program, and *Super Planner*, a data manager program that can be used to create calendars, address files, and scheduling files.

A big plus for many users will be the bundling of CP/M-86 and Concurrent CP/M-86. CP/M-86 is an offshoot of the "8-bit" CP/M-80 by Digital Research (CP/M was, and is, one of the most widely used 8-bit operating systems). Concurrent CP/M-86 is similar but is a "multi-tasking" operating system that allows you to run up to four tasks concurrently on the operating system. For example, printing a report, word processing, and data communications can be done concurrently.

Also included with the bundled software are many of the standard MS-DOS utilities and an asynchronous communications package for supporting data communications.

### The Apricot Manager

I've talked above about a piece of bundled software called the Apricot *Manager*. You might look on it as another "level" up from the operating system. It is supposed to relieve the user from the tedium of having to know MS-DOS commands to do such things as format and back up disks, set up the RS-232C parameters, and perform other system functions. The Manager here is really a binary tree of menus presented in graphics form (but without icons). Select the TOOLS menu item, for example, and you're brought down into a second level of options. Select DISK from this level and you're brought down to a third level, and so forth. The menus are presented as a series of boxes, selectable by cursor control or by function keys under the microscreen.

Although there are HELP screens to guide the user, I found the Manager tedious and confusing. It's also inordinately slow in cursor movement and in displaying the next menu of items. I believe the first-time computer user could do almost as well by working at the operating system level.

(Continued on page 126)

### BENCHMARK COMPARISON (Apricot, IBM PC, and Sanyo MBC-550)

**Benchmark 1:** Simple FOR TO NEXT loop (lower number is faster):

IBM PC: 37.8 seconds  
Apricot: 42.9 seconds  
Sanyo: 47.1 seconds

**Benchmark 2:** Computational and screen text display (lower number is faster):

Apricot: 38.7 seconds  
IBM PC: 45.8 seconds  
Sanyo: 56.3 seconds

**Benchmark 3:** BASIC sequential file writes with no pause (overall total; lower number is faster):

Sanyo: 104 seconds  
Apricot: 190 seconds  
IBM PC: 375 seconds

**Benchmark 4:** BASIC sequential file writes with random pause (overall total; lower number is faster):

Apricot: 289 seconds  
Sanyo: 353 seconds  
IBM PC: 591 seconds



**Active Electronics**  
NUMBER ONE IN  
QUALITY  
SERVICE  
AVAILABILITY  
THE WORLD'S MOST  
COMPLETE PROFESSIONAL  
AND HOME ELECTRONICS  
ENTHUSIAST INVENTORY

- Semiconductors + Memories
- Microprocessors + Support Circuits
- Microcomputer Systems + Peripherals
- Passive Electronic Components
- Hand Tools, Wire Wrapping, Soldering Equipment + Hardware

**NOW AVAILABLE — FREE**  
1983 80-page catalog  
A complete listing of products and specifications

Call, write or circle the inquiry card for your free copy today.

P.O. Box 8000, Westboro, Mass. 01581  
**CALL TOLL FREE: 1-800-343-0874**

Mass customers call (617) 366-0500

Circle No. 50 on Free Information Card

# Computers & Electronics Marketplace

## FOR SALE

GOVERNMENT and industrial surplus receivers, transmitters, snoopsopes, electronic parts, Picture Catalog 25 cents. Meshna, Nahant, Mass. 01908.

RECONDITIONED TEST EQUIPMENT \$1.00 for catalog. WALTER'S TEST EQUIPMENT, 2697 Nickel, San Pablo, CA 94806, (415) 724-0587.

ELECTRONIC CATALOG. Over 4,500 items. Parts, & components. Everything needed by the hobbyist or technician. \$2.00 postage & handling (United States Only), refundable with first \$15.00 order. T & M Electronics, 472 East Main St., Patchogue, NY 11772. (516) 289-2520.

PRINTED CIRCUIT BOARDS, your artwork. Quick delivery. Reasonable. Atlas Circuits, Box 892, Lincolnton, NC 28092. (704) 735-3943.

CABLE TV CONVERTERS & EQUIPMENT. Plans and parts. Build or buy. For more information send \$2.00: C & D ELECTRONICS INC., P.O. Box 21, Jenison, MI 49428.

FREE FLYER! IC's, resistors, capacitors, jacks, etc., plus SSM music synthesizer/audio IC's, power amp modules, analog delay IC's, computer books, and more. Also plans for analog delay/chorus unit! PGS Electronics, Route 25, Box 304 Terre Haute, IN 47802.

FREE CATALOG. Large selection of electronic kits and parts. Chaney Electronics, Box 27038, Denver, Colorado 80227. (303) 781-5750.

FREE Catalog of special function IC's and quality components. Goldsmith Scientific, Box 318M, Commack, New York 11725.

### MICROWAVE ANTENNA SYSTEMS

Freq 2.1 to 2.6 GHz • 34 db Gain • COMPLETE SYSTEMS (as pictured)

Commercial 40" Rod Style **\$89.95**  
Parabolic 20" Dish Style **\$79.95**

**TWO YEAR WARRANTY PARTS AND LABOR**

CALL OR WRITE FOR KITS • PARTS • INDIVIDUAL COMPONENTS

*We Repair All Types Down Converters & Power Supplies*

**Phillips-Tech Electronics**  
P.O. Box 34772  
Phoenix, AZ 85067  
(602) 265-8255

MasterCard  
VISA  
COD'S

Special Quantity Pricing • Dealers Wanted

## Telephone Listening Device

Record telephone conversations in your office or home. Connects between any cassette or tape recorder and your telephone or telephone LINE. Starts automatically when phone is answered. Records both sides of phone conversation. Stops recorder when phone is hung up. This device is not an answering service.



Each **\$19.95**  
Qty. Disc Avail.

## Super Powerful Wireless Mic

10 times more powerful than other mics. Transmits up to 1/4 mile to any FM radio. Easy to assemble kit. 15V battery (not incl.)  
Call (305) 725-1000 or send \$19.95 + \$1.00 shipping per item to USI Corp., P.O. Box CE-2052, Melbourne, FL 32901. COD's accept. For catalog of transmitters, voice scramblers and other specialty items, enclose \$2.00 to USI Corp.



CABLE TV SECRETS, the informative publication the cable companies are trying to ban. HBO, Movie Channel, Showtime converters, etc. Send \$8.95 to: CABLE FACTS, Box 711-PE, Pataskala, Ohio 43062.

GEARMOTORS \$35.00. 12VDC(6-36) 60 RPM. 1/6 HP. Instructions. Also speed controls. Drives robots, antenna doors, gates, carts. Sepac, 625 NW 41 Street, Seattle, WA 98107.

RF MODULATORS for SATELLITE TELEVISION, MICRO-COMPUTERS CCTV. Also monitors, cameras, kits. FREE VIDEO CATALOG. Phone (402) 987-3771. Dealers Welcomed. ATV RESEARCH, 13-P Broadway, Dakota City, NE 68731.

BURGLAR—FIRE—MEDICAL—ALARMS.—Home, office, factory, mobile, marine. Catalog information \$2.00. refundable \$3.00 coupon. Electronic Security Systems, POB 228, Elizaville, NY 12523.

12 SATELLITE DISH AND POLAR MOUNT. Total weight 125-lbs. For \$189.00. For information send \$4.95 (Refundable u.p.) to: Satellite Operational Systems, P.O. Box 2002, Titusville, FL 32781.

SAMS PHOTOFACT schematics 4.00 each folder. Cliff King, 342 E. Gladstone, San Dimas, CA 91773.

FREE CATALOG! UTILITIES, games, amateur radio software for VIC-20, Commodore 64, TI/99/4A. RAK Electronics, Box 1585, Orange Park, FL 32067.

OSCILLOSCOPE TEK 485, 350 MHz probes, manuals, \$5000.00, write Baker, 515 Hill Ave., Endicott, NY 13760.

## CABLE TV

**Buy Direct & Save**

### SUPER SPECIALS

40 CHANNEL CONVERTER  
**\$29.95**

Advanced Solid State design and circuitry allows you to receive mid & super band channels. Restores programming to Video Recorders.

36 CHANNEL REMOTE CONTROL CABLE CONVERTER  
**\$69.95**

JERROLD 400 THE ULTIMATE CABLE TV CONVERTER

60 CHANNEL INFRARED REMOTE CONTROL  
**\$129.95**

Send \$5 for Complete Catalog

**DIRECT VIDEO SALES**  
P.O. BOX 1329  
JEFFERSONVILLE, INDIANA 47130  
CALL  
1-812-282-4768

## NEW! MULTI-CHANNEL MICROWAVE

\*\*\*\*\*  
Complete Antenna Systems from \$69.95  
\*\*\*\*\*

Full 800 Mhz Range  
Tune 1.9-2.7 Ghz  
Includes all ITFS Channels

DEALERS WANTED

COD's and Credit Card Orders call TOLL FREE  
**1-800-247-1151**

GOLD STAR

SILVER STAR

TELE STAR

STAR II

**GALAXY ELECTRONICS**  
6009 N. 61 Avenue  
Glendale, AZ 85301  
**1-602-247-1151**

BUILD AND SAVE. TV EARTH STATION, DETECTIVE ELECTRONICS. Video Recorders, Color Cameras, advanced Telephone Projects. BROADCAST Electronics. 50 page color catalog of unusual electronic projects AIR MAILED \$3.00; with 3 hour audio cassette dramatization of our catalog \$5.00. Don Britton Enterprises, PO Drawer G, Waikiki, Hawaii 96815.

SEND FOR FREE DISCOUNT CATALOG: electronic components, parts. HORIZON SALES, P.O. Box 646, Framingham, MA 01701. (617) 875-4433.

FREE! 1984 CATALOGUE. 1001 bargains. Speakers-parts-tubes-video cassettes—record changers—tape recorders—kits. EVERYTHING IN ELECTRONICS. Write: MCGEE RADIO & ELECTRONICS, 1901 McGee Street, Kansas City, MO 64108-1891.

TV & RADIO TUBES, 59¢ each. Send for free catalog. Cornell, 4213 University, San Diego CA 92105.

PRINTED CIRCUIT BOARDS. QUICK PROTOTYPES production, design, reflow solder. Send print or description for quote to: KIT CIRCUITS, Box 235, Clawson, MI 48017.

SATELLITE TELEVISION COMPLETE SYSTEMS. Free catalog. Call: (612) 780-4088. Write: Sunspur Sales, P.O. Box 32245 A-7, Fridley, MN 55432.

CABLE TV CONVERTER PLANS \$2.98. Write to Stevens, Dept. CE, PO Box 20286, Bowling Green, KY 42102-6286.

## World's Most Remarkable Radar Jammer!

Causes speed radar guns and devices to read out your choice of either a percentage of your true speed when in automatic mode (example: Your speed: 78 mph, auto mode set for 75%, speed displayed — 57 mph), or the speed that you dial in when in manual mode. Operates on both X and K bands. WARNING: The device described in this literature is not legal for use against police radar, and is not FCC approved.

For complete literature and plan package, send \$14.95 to:  
**Phillips Instrument Design Co. Inc.**  
9560 S.W. Barbur Blvd., Suite #109 C  
Portland, Oregon 97219

POLICE CODE UNSCRABLERS, lets you hear the coded messages of Police, Fire and Medical channels; plus other scanner accessories, satisfaction guaranteed. DNE Inc., Rt. 7, Box 257-A, Hot Springs, AR 71901. (501) 623-6027.

WHOLESALE: MATV/CATV/VCR equipment, Antennas, Audio, Cables, Adapters, Original and Replacement Cartridges, Styli, Telephone Accessories, Radios, Cassette Recorders, Speakers, etc. Send letterhead for catalog, 212-897-0509, D&W.P. 68-12 110th St., Forest Hills, NY 11375.

## A SINGER'S DREAM!

### REMOVES VOCALS FROM RECORDS!

Our VOCAL ELIMINATOR can remove most or virtually all of a lead vocal from a standard stereo record and leave most of the background untouched! Record with your voice or perform live with the backgrounds. Used in Professional Performance yet connects easily to a home component stereo system. Not an equalizer! We can prove it works over the phone. Write or call for a free brochure and demo record.

Write to: **LT Sound, Dept. CE, PO Box 338**  
Stone Mountain, GA 30086  
In Georgia Call (404)493-1258  
**TOLL FREE: 1-800-241-3005 — Ext. 37**

PCB 15" sq-in. FREE DRILLING. Quantity Discounts. International Enterprise, 6452 Hazel Circle, Simi-Valley, CA 93063.

CABLE TV EQUIPMENT, Notch filters for "Beeping" Channels. Information \$1.00. Goldcoast, Box 63/6025 CE, Margate, Florida 33063 (305) 752-9202.

PAY-TV RECEPTION. HBO, Showtime, Cinemax. 'How-To' Book \$4.95. Diptronic, Box 80(D5), Lake Hiawatha, NJ 07034.

PRINTED CIRCUIT WORK. DESIGN/LAYOUT. Quality, prompt. SOMMER CIRCUIT DESIGN, P.O.B. 635, Wooster, OH 44691. VISA/MC (216) 263-6930.

**CABLE TV products.** Jerrold, Hamlin and Oak, send \$3.00 to **ADDITIONAL OUTLET CORP.**, 111 E. Commercial Blvd., Ft. Lauderdale, FL 33334.

**NEW! BUILD THESE EASY,** fascinating IC projects. Combination lock controls computers, stereos, etc! Programmable light show controller! Intelligent auto alarm. Logic probe. Vocal blaster! Digital dice! Most cost under \$20.00. \$8.95 U.S. for complete, full-size, glossy manual. Schematics, theory, troubleshooting, operation, sources, etc. Extra details \$1.00 (order credited). U.S. Inquiries, Stark Electronics, Box 11963, Edmonton, Alberta, T5J 3L1.

**ELECTRONIC test equipment.** Catalog 25<sup>+</sup>. EF Electronics, 10 Afton, Aurora, IL 60538.

**SATELLITE TELEVISION COMPLETE SYSTEMS.** Free catalog. Call: (612) 780-4088. Write: Sunspur Sales, P.O. Box 32245 A-4, Fridley, MN 55432.

## COMPUTER EQUIPMENT/PARTS

**SAVE 90% Build Your Own Minicomputer.** Free Details. Digatek, 2723 West Butler Dr., Suite 20C, Phoenix, AZ 85021.

**APPLE BUILDERS—**Send stamp for our flyer of Apple parts. IC sets, ROM sets, component packages. Shugart—Apple modification kits, Apple 9-track tape drives etc. Electrovalue, P.O. Box 376-P, Morris Plains, NJ 07950.

**COVERS—**Fabric, attractive quality custom fitted. All computing, stereo, ham, & video equipment. DecOtec, Box 24449, Dayton, OH 45424 (513) 236-9923.

**COMPUTER DUST COVERS, ANTI-STATIC MATS.** Acoustical cabinets. Com-Cov, 826 W. Laurel, Springfield, IL 62704. (217) 544-8824.

**WANT A PLEASANT SURPRISE?** Call or write for our quotes: Atari, Commodore, Timex, Franklin, TI, Okidata and more. ACCESSORIES, SOFTWARE. Factory sealed with full manufacturer warranty. **HARDWARE, SOFTWARE, ANYWARE.** 10 Coles Street, Brooklyn, NY 11231, (212) 596-3592.

**NOW! TRADE, BUY, OR SELL** used computer hardware. Fabulous results. **NATIONAL LISTING SERVICE** will match clients. Specify hardware. Send \$3.00 to: BIM Enterprises, 58B Nuthatch Knob, Glastonbury, CT 06003.

**APPLE-ATARI-INDUS DISK DRIVES NOW.** Word processor, data base, spreadsheet, double density. All for \$359.00 **TARI.** \$295.00 **APPLE.** **FREE SHIPPING.** Texas add 4%. Send certified check or money order to **STEWART ELECTRONICS,** PO Box 155, MULLIN, TX 76864.

**USED COMPUTER terminals, printers, modems, cables, surplus electronic parts.** Specials: CRT's \$20.00, Modems \$20.00, Modems \$35.00. Catalog \$1.00. Rondere Company, "The Computer Room" CE, 2522 Butler Street, Dallas, TX 75235. (214) 630-4621.

**FREE 64 PAGE COMPUTER CATALOG** crammed full of thousands of the best buys and lowest prices around! **A.P. COMPUTER PRODUCTS,** Dept. CC, 214A East Main, Patchogue, NY 11772. (516) 698-8636.

**48K APPLE COMPATIBLE COMPUTER:** US \$380.00 and hundreds of programs. Details US \$1.00. Reliant, P.O. Box 33610, Sheungwan, Hong Kong.

## COMPUTER SOFTWARE

**FREE VIC-20 and COMMODORE 64 USERS GROUP MEMBERSHIP** with software purchase. Why pay to belong to a users group when you don't have to? Benefits: Newsletter, extensive club library, discounts, contests, questions hot-line and more! Free details—(803) 797-1533. Lords of Basic, P.O. Box 459, Dept. 102 Ladson, SC 29456.

**DISKETTE FORMAT CONVERSIONS/DOWNLOADING,** from \$5.00. Port-A-Soft, 423 #800 N, Orem, UT 84057. 801/226-6704.

**VIC 20 40 COLUMN DISPLAY.** On tape, 8.95: NDPE, 102 Hickory Ct., Portland, IN 47371.

**HORSE RACE SOFTWARE-TRS-80, C64 VIC20. CALL OR WRITE** for free catalogue. Computer Research Tools, 725 South Evanwood Ave., West Covina, Calif. 91790 (213) 962-1688.

**TIMEX/SINCLAIR 16K, TI, VIC Owners.** 5 fun programs for \$1.00! Get Baseball, Etching-sketch, Blackjack, Dungeon, Galactic patrol. Specify your computer. Friendly Computer, 634 Littlecroft, Upper-Darby, PA 19082.

**COMMODORE 64/VIC 20 Games/educational software.** Over 400 titles! Write for FREE catalog! American Peripherals, 122 Bangor St., Lindenhurst, NY 11757.

**TI-99/4A PROGRAMMERS:** Affordable Software! Catalog, only \$1. **PROGRAMS SOFTWARE.** 1435 Burnley Square North, Columbus, Ohio 43229.

**TS 1000, TX81, TI 99/4A, VIC-20 SOFTWARE.** Send for FREE Catalog: Midwest Software, 9922 Harwich, Crestwood, MO 63126.

**SOFTWARE JUNKIE? RENT/buy** Apple, Atari, IBM games. Free brochure. Soft Source-R Inc., Dept. E., Box 2931, Joliet, IL 60434.

**HANDICAPPING PROGRAMS FOR MOST PERSONAL COMPUTERS.** Free Catalog. Gambler's Edge Computing, Dept. 88, 250 Richards Rd., Suite 254, Kansas City, MO 64116. 1-(800) 621-3343. 1-(800) 471-8660.

**COMMODORE-64 OWNERS.** Copy game cartridges to disk! Requires addition of switch (complete instructions). Also backup most copy protected disks on your 1541. Free software rental list. Send \$19.95 for both programs on disk to: GRANT SOFTWARE, P.O. Box 198, Stevensville, MI 49127.

**TI-99/4A SOFTWARE BARGAIN!** Complete library of 100 programs. Only 50¢ each! Free catalog. Exchange, PO Box 46, Sterling, VA 22170.

**FREE ATARI/COMMODORE-64/TI99-4A/Timex/TRS80-coco/VIC-20 programs!** Send stamps. Franchises! EZRAEZA, Box 5222-CM, San Diego, CA 92105.

**VIC 20/COMMODORE 64 SOFTWARE-FREE CATALOG!** Inexpensive, practical programs: Education/Home/Business. Over 50 titles! **FARTHEST FRINGE S.A.,** 101 Highway Blvd., N. Pekin, IL 61554.

**VIC 20. LEARN MORSE CODE** the easy way. Software \$10.00 + \$1.00 handling. RSCO, P.O. Box 11192, Cleveland, OH 44111.

**DISCOUNT SOFTWARE/HARDWARE/PRINTERS—30% MINIMUM BELOW RETAIL.** Available for Apple II/III/IV, Atari 400/800/XL, TI-99/4A, VIC-20, Commodore 64, IBM-PC, TRS-80/III, CP/M 8 inch. Example: blank disks. Elephant \$16.95. Maxell MD 1 \$25.00. Printers: Gemini 10x \$290. Okidata 92P \$440. Software, Flight Simulator \$137.50, Zork I/II/III \$28.50 each. Send \$1.00 for extensive software/hardware catalog. Specify computer system. Multi Video Services, P.O. Box 246, East Amherst, NY 14051.

**TI-99/4A CASSETTE CABLES** \$16.71 (Extended Basic, Logo, Mini-memory \$88.11 each!), PHP1250 Drive \$210.94. CSC, Box 1361, Bloomington, IL 61702-1361. (309) 828-3251.

**TI-99/4A owners.** Get your free catalog of new, exciting, low cost software. D.E. Box 690, Hicksville, NY 11801.

**COMMODORE 64/VIC 20 SOFTWARE.** 40 column display for VIC-20. Spread Sheet, Basic Compiler, and Adventure Generator. \$15.00 each. Free complete list. Software Solutions, PO Box 542, Sylvania, OH 43560.

**TI-99/4A SOFTWARE:** Programs for astronomy, Mathematics, Finance, Education. Send 40¢ for catalog Eastbench Software, 1290 Cliffside Drive, Logan, UT 84321.

**ADAM-OWNERS ACHIEVE THE FULL POTENTIAL OF YOUR SYSTEM.** Our interactive data pack tape explains capabilities not covered in your manual. Tape includes basic and word processing tutorial plus many business, game, and test programs. Act now! Send \$29.95 to **TapeWare Technology, P.O. Box 95691, Atlanta, Georgia 30347.**

## TIMEX/SINCLAIR

**KROK, STAR SEARCH, NOAH'S ARK,** finest programs available. Machine Language action, graphics. SASE Brown Cottage, 5486 Bright Hawk, Columbia, MD 21045.

**"MUST-HAVE" UTILITY SOFTWARE.** Cassettes-relocatable machine language. **SASE for BROCHURE—SIRIUS WARE,** 6 Turning Mill Rd., Lexington, MA. 02173.

**TREE FORTH** for the 2K+ Sinclair User—\$49.95. Multi-tasking forth for ZX81 and TS1000. Free information. Contact: Softmagic Corp., 1213 West High Street, Bryan, Ohio, 43506. (419) 636-4531.

**ONLY MONIXWARE HAS COMPUCAT!!!** You load this 16K catalog into your Timex/Sinclair computer—it's not on paper. Tape has 4 FREE sample programs also! Just \$4 p.p.d. from **MONIXWARE,** Box 318C, New Foundland, NJ 07435.

**CHALLENGING EDUCATIONAL SOFTWARE** written completely in BASIC to be easily understood. Send for free information. Tag Software, Box 688, Naugatuck, CT 06770.

**"HOW TO MARKET YOUR TIMEX/SINCLAIR SOFTWARE."** Informative guide for turning your programs into profits—\$14.95, money order, VISA, M.C. (incl. card no. & exp. date). Softmark Associates, Dept. CE2, 210 Fifth Ave., NY, NY 10010.

**FREE SOFTWARE/HARDWARE CATALOG** for your TS/ZX-81/16K; New programs. JPR SOFTWARE, Box 4156, Winter Park, FL 32793.

**SOLVE LOAD PROBLEMS!** Duplicate unSAVEable cassettes. **WINKY BOARD 2** cassette-TS1000, 1500/ZX81 interface. User-friendly, versatile! \$20.95 assembled, \$15.95 kit. PPD, Russell-Electronics, RD 1, Box 539C, Centre Hall, PA 16828. (814) 364-1325.

## COMPUTER GRAPHICS

**AVL computer graphics & programming systems.** Slide, Motion, Overhead, Video, & Audio equipment & supplies. Rentals & Staging. Custom Graphics, Slides & Presentations. **NEW ORIENT MEDIA-IL.** 1-(800) 223-9473. 1-(312) 428-6000.

## C.B. EQUIPMENT

**CB MODIFICATIONS,** conversions, books, plans, kits, repairs. Catalog \$2. CBCI, Box 31500PE, Phoenix, AZ 85046. (602) 996-8700.

## CABLE TV.

**CHANNEL 3—**60db notch filter. 66 5MHz \$32. Crosley, Dept. 607, Box 840, Champlain, NY 12919.

**DEALERS WANTED:** Channel 2, 3, & 4 notch filters. Send \$15 for sample and quantity price list. Specify channel(s). Lee Kurtz, P.O. Box 291394, Davie, FL 33329.

## PLANS AND KITS

**SCHEMATICS: OVER 2,000** early 1930's Radio Schematics. Send \$3.00 plus S.A.S.E. for Master list. Wayne Duke, Amateur Radio Operator, WA5-GQA, P.O. Box 433, Gilmer, TX 75644.

## COMPUTER HARDWARE

**5 MEGABYTE HARD DISK DRIVES,** new shugart SA1000 \$269. Controllers \$331. Digital Search, Greer, SC (801) 877-9444.

**DISCOUNT HARDWARE/SOFTWARE—30% MINIMUM BELOW RETAIL!** Educational, business, entertainment software for Apple II, Atari 400/800, TI 99/4A, Vic 20, Commodore 64, IBM-PC. **HARDWARE:** Gemini 10x—\$300. Okidata 82A—\$370.00 Microprism 480—\$490. RANA 1000—\$300. Send \$1 for complete hardware/software catalog. Specify make. **MULTI VIDEO SERVICES, P.O. BOX 246, East Amherst, NY 14051 (716) 688-0469.**

## MAILING LISTS

**COMPUTER SHOW ATTENDEES N.Y., N.J.:** 15,000 NAMES. \$30/M. P/S labels. For info, (201) 297-2526.

**FREE MAILING LIST analysis.** Details. GOC-1N, Box 1107, Stuart, FL 33494. (305) 334-5205.

## WANTED

**GOLD, electronic, circuit board scrap,** silver, platinum, tantalum, mercury, Ores, metals assayed. Samples evaluated. Wholesale Terminal, toll free 1-800-932-1010, (617) 326-3442 in Mass.

**AUTHORS!** Major publisher of popular how-to computer books seeks manuscripts. Send sample chapters, outline, to: Acquisitions Compusoft Publishing, 535 Broadway, El Cajon, CA 92021.

## TUBES

**TUBES: "Oldies",** Latest. Supplies, components, schematics. Catalog Free (stamp appreciated). Steinmetz, 7519-PE Maplewood, Hammond, Ind. 46324.

**HUGE INVENTORY!** Thousands of types. Wholesale prices. **FREE CATALOG!** ETCO Electronics, DEPT. 290, Plattsburgh, NY 12901.

**TUBES-RECEIVING,** Industrial and Semiconductors Factory Boxed. Free price sheet including TV, radio and audio parts list. **TRANSLATERONIC, INC.,** 1365 39th St., Brooklyn, NY 11218. Telephone: (212) 633-2800. Toll free: (800) 221-5802. Ask for Abe.

**7,000,000 TUBES.** World's largest inventory. Free catalog. **UNITY ELECTRONICS,** Dept. CE, P.O. Box 213, Elizabeth, NJ 07206.

## ALARMS

**HI-TECH SECURITY PRODUCTS.** Over 47 items from top quality hardware and plug in burglar & fire alarms to sophisticated glass break sensors and motion detectors. Name brand equipment at discount prices to protect your family, car and business. Free 45 page catalog. **Advanced Security, Box 156V, DeKalb, IL 60115.**

## PERSONALS

**UNIVERSITY DEGREES BY MAIL!** Bachelors, Masters, Ph.Ds. Free revealing details. Counseling, Box 317-EP4, Tustin, California 92680.

**SCANDINAVIAN SINGLES, ALL AGES,** seek correspondence, sincere friendships. Details: (send stamp). Scanclub CE, Box 4, Pittsford, NY 14534.

**MAKE FRIENDS WORLDWIDE** through international correspondence, illustrated brochure free. Hermes-Verlag, Box 110660/Z, D-1000 Berlin 11, W. Germany.

**FREE: WORLD'S LARGEST PARTNER PHOTO CATALOG** for friendship and marriage. Personalized introductions. **INTERCONTACT,** Box 12, Toronto, Canada M4A 2M8.

**INSTRUCTION**

**UNIVERSITY DEGREES BY SPECIAL EVALUATION of existing credits and Job Experience. Fast, inexpensive. Call (614) 863-1791. Or write: EVALUATION, Box 13151-A4, Columbus, Ohio 43213.**

**REPAIR ELECTRONIC ORGANS**—Revised home study course covers all current makes and models. Free booklet. Niles Bryant School, P.O. Box 20153, Sacramento, CA 95820.

**F.C.C. COMMERCIAL RADIOTELEPHONE LICENSE. Home Study. Fast, Inexpensive! Free details. COMMAND, D-100 Box 2223, San Francisco 94126.**

**UNIVERSITY DEGREES BY MAIL! Bachelors, Masters, Ph.D.s . . . Free revealing details. Counseling, Box 317-PE4, Tustin, California 92680.**

**LEARN WHILE ASLEEP! HYPNOTIZE!** Astonishing details. strange catalog free! Autosuggestion. Box 24-ZD, Olympia, Washington 98507.

**UNIVERSITY DEGREES without classes. Bachelors, Masters, Doctorates. Accredited, inexpensive, fast. Dr. John Bear, P.O. Box 11447-C12 Marina Del Rey, CA 90291.**

**TRAIN FOR A GREAT CAREER IN ELECTRONICS**

**LEARN AT HOME IN SPARE TIME . . .** The fast-growing Electronics field offers excellent career opportunities . . . even at the entry level. A knowledge of BASIC ELECTRONICS can help you get your foot in the door, qualify for good jobs like Inspector, Electronic Sales, Junior Technician/Tester and more. Easy-to-follow home-study course starts you at the very beginning . . . explains everything step by step with plenty of photos, charts, diagrams. Multimeter, parts kits, calculator, digital VOM included. Hands-on training lets you learn by doing. Get FREE FACTS. No salesman will call. MAIL COUPON TODAY!



**BASIC ELECTRONICS COURSE**  
Dept. PD824 Scranton, PA 18515

Name \_\_\_\_\_ Age \_\_\_\_\_  
Address \_\_\_\_\_  
City/State/Zip \_\_\_\_\_

**FOR INVENTORS**

**INVENTIONS, IDEAS, NEW PRODUCTS WANTED!** Industry presentation/national exposition. Call free 1-800-528-6050—Arizona, 1-800-352-0458. X831.

**PATENT AND DEVELOP your invention. FREE PATENT INFORMATION.** Richard L. Miller, P.E., 3612-E, Woolworth Building, New York, NY 10007, (212) 267-5252.

**BUSINESS OPPORTUNITIES**

**MECHANICALLY INCLINED individuals** desiring ownership of Small Electronics Manufacturing Business—without investment. Write: BUSINESSSES, 92-K11 Brighton 11th, Brooklyn, New York 11235.

**ONE MAN CRT FACTORY. T.V.'s, Business machines, Monitors, Scopes, VDT's. \$3.00 rebuilding nets \$100-\$500 each tube. Higher profits overseas. New/used. FACTORY, 1909 Louise, Crystal Lake, IL 60014. (815) 459-0666.**

**BORROW \$300-\$30,000 INTEREST FREE!** Keep indefinitely! Free Details. Write: American, 1601 Main, Plainfield, Indiana 46168.

**BUMPER STICKER PRINTING DEVICE.** Cheap, simple, portable. Free details. Bumper. POB 22791 (PE), Tampa, FL 33622.

**\$360 WEEKLY/UP, mailing circulars!** No quotas. Sincerely interested, rush reply envelope: Marketing International, Box 0197-E3, San Diego, CA 92115.

**"PROFESSIONAL" GIANT SCREEN PROJECTION TV . . .** "Don't be fooled by cheap imitations!" . . . "Build and sell the best with lenses and screens utilized by Sony, Zenith, Pioneer, and Magnavox!" . . . Simple Construction! . . . Unlimited profits! . . . Illustrated dealers information and complete parts catalog \$2.00 . . . Money back guarantee! . . . POLI-VISION, 187-C Cypress St., Throop, PA 18512.

**FREE CATALOGS.** Repair air conditioning, refrigeration. Tools, supplies, full instructions, Doolin, 2016 Canton, Dallas, Texas 75201.

**MAILORDER OPPORTUNITY!** Start profitable home business without experience or capital. Information free. Mail Order Associates, Inc., Dept. 648, Montvale, NJ 07645.

**ELECTRO MECHANICAL ASSEMBLERS ASSOCIATION** is looking for assemblers interested in working at home. Potential \$600 per week. Write for application. Enclose \$3.00 for processing. EMMA, Dept. CE, Box 9186, Columbus, MS 39705.

**BORROW \$30,000 without interest!** All eligible. Repay anytime. Free details! Infohouse-CE, 808 Post, San Francisco, CA 94109.

**PICTURE TUBE REBUILDING EQUIPMENT**—new and used. ATOLL TELEVISION, 6425 Irving Park, Chicago, Illinois 60634, (312) 545-6667.

**HOW TO MAKE MONEY WITH YOUR MICROCOMPUTER?** 92 page book. Send \$12.00. Front Room, Box 1541, Clifton, NJ 07013.

**PROJECTION TV . . . MAKE \$\$\$'s assembling Projectors . . . Easy . . . Results comparable to \$2,500 projectors. Your total cost less than \$20.00. PLANS, 8" LENS & Dealers information \$17.50. . . Illustrated information FREE. Macrocoma-CHX, Washington Crossing, Pennsylvania 18977. Creditcard orders 24 Hours (215) 736-2880.**

**EARN EXTRA INCOME** with your microcomputer. Super opportunities! Free details, Scitex, Box 02038, Columbus, OH 43202.

**ACQUIRE WEALTH!** Borrow \$30,000 interest free! Keep indefinitely. Erase debts with little-known law! Free details: Financial Technologies, Box 40434C4, Fayetteville, N.C. 28309.

**ERASE DEBTS** with little-known law—create wealth! Details FREE—Wealth Kit, No. EE4, Billings, NY 12510.

**EMPLOYMENT OPPORTUNITIES**

**JOBS OVERSEAS** - Big money fast. \$20,000 to \$50,000 plus per year. Call 1-216-453-3000, ext. 4605.

**GOVERNMENT JOBS**—Thousands of vacancies must be filled immediately. \$17,634 to \$50,112. Call 716-842-6000, Ext 3902.

**EXCELLENT INCOME FOR** part time home assembly work. For info. call (504) 641-8003, Ext. 9675.

**HANDLE YOUR OWN LEGAL AFFAIRS**—Be a Paralegal. Accredited Attorney Instruction. Home Study. FREE CATALOG. Southern Career Institute, Drawer 34CE-2158, Boca Raton, FL 33427. (305) 368-2522.

**ELECTRONICS/AVIONICS EMPLOYMENT OPPORTUNITIES.** Details FREE. Aviation Employment Information Service, Box 240E, Northport, New York 11768.

**OVERSEAS Positions.** Hundreds of top paying positions available. TAX free incomes. Attractive benefits. Opportunities for all occupations, skilled trades, professionals, management, technicians etc. Free details. Overseas Employment Services, Dept. CE, P.O. Box 460, Town of Mount Royal, Quebec, Canada H3P3C7.

**BOOKS & MAGAZINES**

**PUBLISHERS' OVERSTOCKS. BARGAIN BOOKS** 2,000 titles, all subjects! Free catalog: Hamilton's, 98-85 Clapboard, Danbury, CT 06810.

**SATELLITE TV VIEWERS**  
Get the most complete weekly listings  
Send \$1 for sample copy.

**Satellite TV Week**

P.O. Box 308, Fortuna, California 95540  
800-358-9997 (U.S.) • 800-556-8787 (Calif.)  
707-725-2476 (all others)

**COMPUTERS CLUBS**

**Commodore**—64 software 40% off, Free Programs, Newsletter, Rent Software, more! Membership \$12.00 yearly. CCAE, PO Box 784C, Bronx, NY 10473. (212) 409-0717.

**AMATEUR RADIO**

**MADISON**—RTTY, code copy: your computer with inter-face, software. Prices \$129.95 up. Madison Electronics, 1508 McKinney, Houston, TX 77010. 1-(713) 658-0268.

**MISCELLANEOUS**

**WE WON'T INSULT YOUR INTELLIGENCE. WE'LL WELCOME IT!** Learn more about Mensa, the international high I.Q. society. For a practice intelligence test you can take in the privacy of your home, send \$8 to Mensa, Dept. 111, 1701 West 3rd Street, Brooklyn, NY 11223. If you have already scored at or above the 98th percentile on a standard I.Q. test, you may qualify for Mensa without additional testing. Write for free brochure.

**Computer Mart**

**RATE: Ads are " by 3". 1 insertion: \$935.00. 6 insertions: \$900.00 ea. 12 insertions, \$865.00 ea.** Closing date: 1st of the 2nd mo. preceding cover date. Send order and remittance to Computer Mart, Computers & Electronics, 1 Park Ave., N.Y., N.Y. 10016. Direct inquiries to (212) 725-4215.

**Join the Click!**

**FOR FASTER & LARGER DATA ENTRY WITH YOUR E-Z KEYBOARD**

Not just a keyboard replacement but an enhancement that gives you more control over your computer.

**\$84.95** 30 day warranty

**E-Z HEY**

3670 79, Dept. CE  
711 Eastwood Factory  
Oakley, California 94621  
(415) 775-1187

**maxell**

**Floppy Discs**

**CALL NOW - TOLL FREE**  
1-800-328-DISC

Dealer inquiries invited. C.O.D.'s and charge cards accepted.

All orders shipped from stock, within 24 hours. Call toll FREE.

**North Hills Corporation**  
3564 Rolling View Dr.  
White Bear Lake, MN 55110  
1-800-328-DISC  
MN Call Collect 1-612-770-0485

**SPEECH SYNTHESIS** NEW! SAVE \$\$ ONLY \$59 KIT

**ZX81 TIMEX VIC20 APPLE II**

• UNLIMITED VOCABULARY \$69 BUILT  
• AMPLIFIER + SPEAKER BUILT  
• INPUT FOR TAPE - MUSIC UNITS

**SMART EARS! SPEECH RECOGNITION \$99**

**SPEECH INPUT FOR ABOVE LISTED COMPUTERS & OTHERS. CALL (SOME NEED I.O.)**

**MUSIC SYNTHESIS \$49 KIT**

**STEREO ISLINE CONTROL PORT PLAY 3PART MUSIC EFFECT DRUMS ETC. 1/0 PORT TO CONTROL PORT. BUILT \$59**

**AUDIO VISION** 1279 N. NORMANDIE LOS ANGELES, CA 90027

**SPEECH CHIP SX.01 \$36**  
ADD \$3 SHIPPING CHARGE  
(213) 8608217



# Vobrax SC-01A SPEECH SYNTHESIZER



**\$42 Each  
(\$32 in  
hundreds)**

**Order in Ones or Thousands**

The SC-01A Speech Synthesizer is a completely self-contained solid state device. This single chip phonetically synthesizes continuous speech of unlimited vocabulary.

Computer interfaces and text-to-speech algorithms also available for product development

Micromint is the largest U.S. distributor of the SC-01A. Call us for a price quote.

Call 1-800-645-3479, in N.Y. 1-516-374-6793

MICROMINT INC.  
561 Willow Avenue  
Cedarhurst, NY 11516



Add \$2.00 for shipping & handling



CIRCLE NO. 109 ON FREE INFORMATION CARD

# MICROSETTE

## 5 1/4-inch DISKETTES

- Single or double sided, all double density (SSDD, DSDD).
- Soft sector, reinforced hub.

## CASSETTES

- Error-free computer grade.

ITEM	10 PACK	50 PACK
SSDD	\$25.00	\$100.00
DSDD	35.00	150.00
C-10	7.50	32.50
C-20	9.00	39.00
C-60	11.00	50.00
C-90	15.00	70.00

UPS SHIPPING INCLUDED  
in Continental USA  
CA Customers add taxes

**MICROSETTE CO.**  
475 Ellis St., Mtn. View,  
CA 94043 (415) 968-1604

CIRCLE NO. 108 ON FREE INFORMATION CARD

**Now we can make any computer  
sing as well as talk, for only \$219.**



As featured in Garcia's  
Circuit Cellar:  
"BYTE" Magazine.  
September,  
October 1982.

## Microvox.

MICROVOX is a completely self contained professional voice quality text-to-speech synthesizer. MICROVOX may be easily interfaced to any computer modem RS-232C serial or parallel output device.

- 6502 Microprocessor based text-to-speech algorithm
- SC-01A phoneme based speech synthesizer
- 64 crystal controlled inflection levels
- 3000 character buffer
- RS-232C and parallel port interfaces
- On board power supply
- Music and sound effects capability

MV01 Microvox Assembled & Tested ..... \$299.00  
MV02 Microvox, complete kit ..... \$219.00



To Order: Call Toll Free  
1-800-645-3479

In N.Y. 1-516-374-6793

MICROMINT, INC.  
561 Willow Avenue  
Cedarhurst, NY 11516

CIRCLE NO. 115 ON FREE INFORMATION CARD

got a  
**COMMODORE 64**  
OR  
**TIMEX SINCLAIR**  
COMPUTER ?

GET STARTED WITH  
BOSS DISCOUNT  
SOFTWARE

GAMES, BUSINESS, EDUCATION, TUTORIAL

WRITE FOR  
FREE  
CATALOG

EULYN ENTERPRISES  
4N 650 RIDGEWOOD  
BENSENVILLE, IL., 60106

(312) 543-4225

CIRCLE NO. 118 ON FREE INFORMATION CARD

It's simple. . . .  
**CALL & SAVE MONEY**  
**1-800-841-0860**

**UP TO 20% DISCOUNT**  
COMPUTERS

MONITORS • PRINTERS  
**CALL FOR BEST PRICES**



## MICRO MANAGEMENT SYSTEMS

TELEMARKET DEPT. # 12  
2803 THOMASVILLE RD. EAST  
CAIRO, GEORGIA 31728  
GA. & INFO 912-377-7120

CIRCLE NO. 131 ON FREE INFORMATION CARD



LEO ELECTRONICS, INC.  
8921 S. Sepulveda # 208  
Los Angeles, CA. 90045  
(213) 641-3101 (800) 421-2418  
TLX: 664-688 Interline LSA

**PRICE !  
QUALITY !  
SERVICE !**

RAMS			
4116 (150ns)	1.35		
4116 (200ns)	1.25		16K UPGRADE
4164 (150ns)	4.95		
4164 (200ns)	4.75		64K UPGRADE
6116P-3	4.40		
EPROMS			
2708	3.00	2532	4.50
2716	3.20	2732	3.95
TMS2716	4.75	2764	7.00

TERMS: Check, Visa, Mastercard. Call for C.O.D. U.S. Funds only. California residents add 6% sales tax. SHIPPING: Add \$2.00 for Ground and \$5.00 for Air. ALL MAJOR MANUFACTURERS ALL PARTS 100% GUARANTEED Pricing subject to change without notice.



**Best Prices On  
TRS-80 Computers**

Our 6th year of discounts  
Ed or Joe McManus  
Fgt. Prepaid. Save Tax.  
Toll Free 800-231-3680

**Marymac Industries, Inc.**  
22511 Katy Fwy., Katy  
(Houston) Tx 77450  
1-713-392-0747  
Telex 774132

See us in the Wall Street  
Journal every Tues, Wed, Thurs.

**ICs PROMPT DELIVERY!!!**  
SAME DAY SHIPPING (USUALLY)

DYNAMIC RAM		
256K	150 ns	\$85.00
64K	200 ns	5.97
64K	150 ns	6.09
64K	120 ns	6.90
16K	200 ns	1.56
EPROM		
27128	300 ns	\$22.50
2764	250 ns	8.30
2732	450 ns	4.75
2716	450 ns	3.60
2532	450 ns	4.75
STATIC RAM		
6264P-15	150 ns	\$35.97
6264LP-15	150 ns	42.00
6116P-3	150 ns	5.75

MasterCard VISA or UPS CASH COD  
**Factory New, Prime Parts**  
MICROPROCESSORS UNLIMITED  
24,000 South Peoria Ave  
BEGGS, OK 74421 (918) 267-4961

Prices shown above are for Jan. 13, 1984.  
Please call for current & volume prices. Prices subject to change. Please expect higher prices on some parts due to world wide shortages. Shipping and Insurance extra. Cash discount prices shown. Federal Express Standard Air is \$5.99. Orders received by 6 PM CST can be delivered to you by the next morning.

# WE SELL TIME!

TIME FOR DECISIONS. TIME FOR LEISURE. YOUR TIME. ISA's software gives it back to you.

**SUPER™ DATABASE - \$199.00**

- EASY! FAST!
- General purpose business program DBMS

**ManageMint™ — \$395.00 & up.**

- PERT/CPM project control system

(Both menu driven for IBM PC, CPM & all TRS-80)

INSTITUTE FOR SCIENTIFIC ANALYSIS  
P.O. BOX 7186, DEPT. C-1  
WILMINGTON, DE. 19803

(215) 358-3735 / orders only (800) 441-7860  
M.C. & VISA accepted.

CIRCLE NO. 107 ON FREE INFORMATION CARD

## GET THE MOST FROM YOUR VIC-20/C64

### CASSETTE INTERFACE

• USE ANY STANDARD CASSETTE RECORDER  
• CONNECTS TO THE CASSETTE PORT  
• CONTROLS THE CASSETTE MOTOR  
• NEEDS NO BATTERIES  
• COPY FROM RECORDER TO RECORDER  
• THIS IS THE BEST ONE FOR LESS \$\$\$  
• ONLY \$34.95 POSTPAID. ADD \$2.50 FOR SHIPPING OUTSIDE US.  
CANADA, MEXICO



### THE MODEM INTERFACE

• CONNECTS TO THE USER I/O PORT  
• NEEDS NO BATTERIES, SOLDERING  
• CONNECTS ANY STANDARD MODEM  
• USE MODEM AUTODIAL ANSWER FEATURES  
• COMES WITH A FREE TYPE IN BASIC TERMINAL PROGRAM  
• ONLY \$24.95 POSTPAID. ADD \$2.50 FOR SHIPPING OUTSIDE US.  
CANADA, MEXICO



**CHARGE OR COD ORDERS CALL 1-800-227-3800**

ASK FOR OPERATOR 225

**BYTESIZE MICRO TECHNOLOGY** PO BOX 12309 DEPT C/J SEATTLE, WA 98111 (206) 236-BYTE

CALL OR WRITE FOR DEALER INFORMATION

CIRCLE NO. 117 ON FREE INFORMATION CARD

## DISCOUNT COMPUTER EQUIPMENT

LOWEST PRICES on Printers, Disk Drives, Software, and Other Computer Equipment! EPSON, Star Micronics, Okidata, Tandon, TEAC, & Many Others.

Call toll-free for a FREE catalog:

**800-331-3896**

In Oklahoma Call 918/825-4844



918 825-4844

Small Business COMPUTERS

## PRINTER STAND or DESK

- \*Size: 27h x 24d x 27" w.
- \*Black Painted Steel
- \*Sh. Wt. 75 Lbs.
- \*Shipped Freight Collect
- \*Use Order No. 2A70585



**\$39.95**



## FAN CONTROL

Controls Speed Of AC MOTORS!

ONLY **\$3.88** 3 for \$10.00

Muffin Fans, Caravel Fans, Blowers, ETC... Good for 115/220 VAC up to 6 amps stall current. Control rated at 1.6 amps. Size: 1 1/4 x 2 x 1" Shaft mounting. Use Order No. 3BS0269.

## BNF Enterprises

119r FOSTER St.  
Peabody MA 01960  
(617) 531-5774



40 Page Catalog  
Customer Pays All Shipping Charges.

CIRCLE NO. 125 ON FREE INFORMATION CARD

## MODULES FOR TIMEX-Sinclair

**\$149.95**  
MD-2B



## MODEM

- 2 FREE HOURS COMPUERVE NOW BOTH ORIGINATE AND ANSWER
- Send & Receive Programs by Phone
- Copy Information Into Memory. Print it. Review It. Save It On Tape. Send Text From Memory.
- Use Timex 2040 Printer or Any RS-232 Printer.
- RS-232 Printer Port Provided.
- No extra Memory Required. But with 64K Memory You Can Store Up To 60 Full Screens.
- ADAPTABLE TO THE NEW 2068

BYTE-BACK CO. Rt. 3 Box 147 Brodie Rd. Leesville, S.C. 29070 Ck. COD VISA M/C AM EXP Ph. 803-532-5812 Add \$4.95 shipping to all orders 10 day money back guarantee plus 90-day warranty

CIRCLE NO. 134 ON FREE INFORMATION CARD

## EPROM Eraser \$44.90 EPROM Programmer \$159



### ERASER

- contains same features as competitors' but cost less than one half their price
- erases up to 9 chips
- 6.4 mW/cm<sup>2</sup> on chips
- chip drawer prevents UV exposure to users
- long life UV tube
- erase time from 15 min

### PROGRAMMER

- ★ PROGRAMS & COPIES: 2516, 2532, 2716, 2732, 2732A.
- ★ 4K INTERNAL RAM BUFFER STORAGE CAPACITY.
- ★ NO PERSONALITY MODULE REQUIRED.
- ★ POWER CAN BE REMOVED FROM ZIF SOCKET WHEN LOADING EPROMS.
- ★ BINARY ADDRESS AND DATA DISPLAY.
- ★ INDEPENDENT UNIT - VERIFIES, PROGRAMS, INPUTS DATA FROM BINARY KEYBOARD, LOADS DATA FROM EPROM TO RAM, AND CHANGES ANY BIT OF DATA.
- ★ FULL 90-DAY GUARANTEE ON ALL PRODUCTS FOR ANY DEFECTS IN MATERIALS AND WORKMANSHIP.

ANGO ELECTRONICS CORP. 212-685-6336 P.O. BOX 112 HARRISON, NJ 07029 TLX.: 421531 ARTISIT

Mail orders: Please add \$3 handling charge N.J. residents: Please add 6% sales tax



CIRCLE NO. 134 ON FREE INFORMATION CARD

## COMMODORE 64-VIC TIMEX

We carry these and many other hard to find items

SINGLE and DUAL DISK DRIVES FOR C64/VIC IN STOCK

single ..... 399.95  
dual ..... 699.95



80 Col. Thermal Printer  
Commodore 64-VIC ..... \$199.95  
Extra Paper ..... \$10.95/2 Rolls

### 80 Col. Gorrilla Printer

Commodore 64-VIC ..... \$299.95  
TIMEX 1000 1500 ..... \$294.95  
Extra Paper ..... \$39.95/Case



To Order: Include \$6.95 Shipping in the U.S.A. Foreign customers call or write for shipping charges. VISA and Mastercard accepted. include exp. date. We carry a complete line of Commodore/TIMEX items. Write for our free brochure. Foreign, include \$2.00 postage.

Copyright 1983 by

**E. Arthur Brown Company**

Dept. #C3E 1702 Oak Knoll Drive  
Alexandria, MN 56308 812/762-8847

CIRCLE NO. 118 ON FREE INFORMATION CARD

## HAVING LOADING PROBLEMS ?

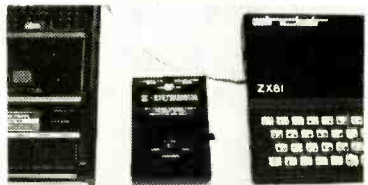

## GET A Z-DUBBER

Because of the great variation in cassette recorders used with the ZX80/81/TS1000 (some in very poor shape), you may be having a hard time loading cassette programs. The (Z-Dubber) connects between the cassette recorder and the computer, and its circuitry produces a much better signal for the computer to read. The (Z-Dubber) also allows you to connect two cassette recorders together to make perfect backup copies. The Z-Dubber can be yours for \$31.95 postpaid. Add \$2.50 for shipping outside the US, Canada or Mexico.

CHARGE OR COD ORDERS CALL

**1-800-227-3800**

ASK FOR OPERATOR 225

**BYTESIZE MICRO TECHNOLOGY** PO BOX 12309 DEPT C/J SEATTLE, WA 98111 (206) 236-BYTE

CALL OR WRITE FOR DEALER INFORMATION

CIRCLE NO. 120 ON FREE INFORMATION CARD

## SALES POWER

PC: Tech Journal not only sells itself at a nice profit, it helps sell the hardware and software in your store too. Because it goes home with customers and continues to influence buying decisions long after you're closed for the day. Let's talk now.

CALL COLLECT: (212) 725-7679

Or write:  
Ziff-Davis Publishing  
One Park Avenue  
New York, NY 10016



Minimum order. 10 copies. We pay all shipping costs.





# KCS

## ELECTRONICS CORPORATION

### SEMICONDUCTOR PARTS & PRODUCTS

**FACTORY PRIME DEVICES INCLUDE:**  
 Capacitors — all types & styles • Chokes & Coils • Connectors  
 Digital & Linear IC's  
 Hardware & Accessories  
 IC Sockets • Meinory Resistors — fixed & variable • Transformers  
 Transistors & More



**MANUFACTURERS SUCH AS:** Motorola, National, NEC, J.W. Miller, Texas Instruments and more!

**WE STOCK & SUPPLY DEVICES FOR:** OEM's, Distributors, Hobbyists, Magazine Projects, Engineers, Schools, Technicians & You!

**Send for FREE Catalog or Call:**  
**(602) 274-2885** P.O. Box 33205  
 Phoenix, AZ 85067

GENERAL INSTRUMENT SP0256-AL2

## Speech Synthesizer



UNLIMITED VOCABULARY **GI** EASY INTERFACED TO ANY COMPUTER

**\$25.00** each plus \$2.00 shipping

The General Instrument ALLOPHONE speech processor is a single chip LSI device that synthesizes continuous speech of unlimited vocabulary. Not to be confused with limited (stored) vocabulary speech chips like the SP0256-017. Documentation includes program listings, interfacing, etc., for use with Apple, VIC-20, Commodore 64 and TRS-80. Also general info for use with other systems!

**\*PARTIAL KIT, ALSO AVAILABLE\***  
 Includes CHIP, PC board, hard to find components, documentation, etc.:  
 Apple \$42. Commodore 64 \$40.  
 VIC-20 \$40. TRS-80 (1+111) \$40.  
 plus \$3.00 shipping

**SEND CHECK OR M.O. to:**  
 SILICON SCIENCES, INC.  
 4710 Wellington Blvd.  
 Alexandria, La. 71503

Call (318) 482-7733 for VISA or MC orders.

## ATTENTION APPLE LOVERS

### 100% APPLE COMPATIBLE

DISK DRIVE	\$199.
DUAL DISK CONTROLLER	\$ 49.
Z-80 BOARD	\$ 85.
80 COLUMN BOARD	\$159.

### MONITORS

ZENITH ZVM 121 12" Green Screen	\$ 89.
AMDEK COLOR I+ 13" Color	\$289.

FREE BROCHURE

## !!CALL US FOR LOWEST PRICES ON OTHER ACCESSORIES!!

XICOM COMPUTER PRODUCTS  
 414 B. West Fifth Street  
 Naperville, Illinois 60566  
 (312) 961-1616

MC, Visa

## A/D 8 channels + D/A 8 channels

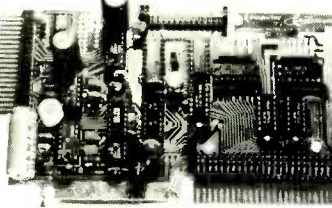

**APPLY YOUR MICRO TO ANALOG SIGNAL PROCESSING & CONTROL**

Connects to a processor buss of most Z80 & 6502 computers including Timex, TRS-80, Apple, CBM 64 Our pin rearrangement feature eases interfacing

**FAST:** 200,000 samples per sec with Z80A.

**EASY TO PROGRAM:** One PEEK chooses the channel, starts conversion & gets data. Routines provided

**SOFTWARE AVAILABLE:** FFT in Z80, 256 points in one second, storage scope for Timex.

**LOW COST:** Assembled & tested \$195. Cable \$15. Please call or write for free catalog

**Computer Continuum**  
 301 Sixteenth Avenue  
 San Francisco, CA 94118 (415) 752-6294

## CONVERT YOUR TV TO A HIGH QUALITY MONITOR



**USE WITH COMPUTERS, VCR's & CAMERAS**

Kit permits Dual Mode operation on B&W or Color sets

- Hi-resolution • Up to 80 characters per line • Wide bandwidth • Direct Video • Safe-Easy installation

**34<sup>95</sup>** ACVM

DVM-1 Hot Chassis kit with Audio available

**VAMP Inc.**  
 Box 411, Los Angeles, CA 90028  
 (213) 466-5533

## 20 PROGRAMS on 2 cassette tapes

for 16K TS1000, TS1500, & ZX81 only \$19.95

\*for TS2068 C-64, VIC 20, ATARI, TRS COLOR & MC-10 only \$29.95

Save money. Learn about the exciting world of home computing and have fun doing it with the new HOME-PAC™

The HOME-PAC with 21 page user manual covers educational, graphics, recreational, home-finance & utility applications.

**10 DAY MONEY BACK GUARANTEE**

Please add \$2.00 shipping and handling to order.

**SIMPLEX SOFTWARE**  
 220 N. Centre St., Dept. CEI  
 Merchantville, NJ 08109  
 MC, VISA & Checks Accepted  
 Orders & inquiries state computer type

## VIC-20

**NEW**

**VIC-20 INTERFACING BLUE BOOK**

Did you know that your VIC can be used to control a 99c motor so effectively that it runs like a precision machine? Or that you can build an accurate digital thermometer using the VIC and four parts costing less than \$5?

These and other interfacing projects selected for usefulness, ease of construction and low cost are detailed in the VIC-20 Interfacing Blue Book, a veritable gold mine of practical information on how to build a variety of interfaces for your computer.

Projects include: Connecting VIC to your stereo, Pickproof digital lock; Capacitance meter; Liquid level sensor; Telephone dialer; Voice output; 16K FAM/ROM expansion; 128K RAM expansion; 8-bit precision D/A; 8-bit A/D converter; MX-80 interface and more.

Written by a college professor in a friendly and informative style, the Blue Book gives you theory of operation, schematics, program listings, parts list, construction hints, and sources of materials for each one of the 30 projects.

If you want to get the most out of your VIC this book is a must. Cost is \$14.95 (less than 50¢ per project!). Price includes postage.

**microsignal Dept 9**  
 P.O. BOX 22  
 MILLWOOD NY 10548

VIC-20



## Scotch

### DISKETTES

Call Toll-Free  
 1-800-328-DISC for prices and information. Dealer inquiries invited. C.O.D. and charge cards accepted.

**All orders shipped from stock, within 24 hours. Call toll FREE.**



**North Hills Corporation**  
 3564 Rolling View Dr.  
 White Bear Lake, MN 55110  
 1-800-328-DISC  
 MN Call Collect 1-612-770-0485

## ATTENTION APPLE LOVERS

### 100% APPLE COMPATIBLE

DISK DRIVE	\$199.
DUAL DISK CONTROLLER	\$ 49.
Z-80 BOARD	\$ 85.
80 COLUMN BOARD	\$159.

### MONITORS

ZENITH ZVM 121 12" Green Screen	\$ 89.
AMDEK COLOR I+ 13" Color	\$289.

FREE BROCHURE

## !!CALL US FOR LOWEST PRICES ON OTHER ACCESSORIES!!

XICOM COMPUTER PRODUCTS  
 414 B. West Fifth Street  
 Naperville, Illinois 60566  
 (312) 961-1616

MC, Visa

# Apricot

(Continued from page 118)

## The Micro Diskettes

Now to the most interesting aspect of the Apricot. Are those tiny diskettes really viable data storage devices? I'll have to admit I went into this review being biased against micro diskettes. After having worked with the Apricot, though, I am favorably impressed. Through much testing, the disks were error free. Furthermore, I believe that the micro diskettes might actually be a better medium for use on computers than their 5 1/4" counterparts. Why? The 3 1/2" diskettes are not *floppies*. They come in rigid plastic cases that protect the disk surfaces until the diskette is loaded into the drive. Unlike floppies, you can throw them around without too much fear of having media problems caused by dust, grit, or fingerprints. Their small size makes them easier to store than floppies. And since they hold 315K bytes (on a single side), there's no loss in data storage capacity, either. The results of a benchmark test on their access speed under MS-DOS are shown in the next section.

## Benchmarks

It's hard to create an equitable benchmark. Never fearing to tread, however, I used four benchmarks to test the Apricot against an IBM PC and Sanyo PC. The results were somewhat surprising.

**Benchmark Number 1:** This is a simple FOR . . . NEXT loop that tests the general speed of each machine. The faster the count of 30,000 is reached, the faster the machine and BASIC interpretation is. The results are shown on page 118. The Apricot was midrange.

**Benchmark Number 2:** This is a test of both BASIC computational speed and the BASIC "display driver" speed. The Apricot won this test hands down.

**Benchmark Number 3:** This is a test of disk write operations. It consists of ten trials. For each trial, a disk file is opened and a series of 80-byte records of more or less random data is written out to disk in sequential file mode. The time that it takes to write out the complete disk file is then displayed. The file is then closed and killed. For the first trial, 100 80-byte records are written out to the file. The next trial writes out 200 80-byte records, and so forth, up to 1000 80-byte records, or about 80,000 bytes of data. Disk VERIFY is off in all cases. The Apricot fared much better than the IBM PC in this test, possibly a result of higher overhead in the PC BASIC code.

**Benchmark Number 4:** This is similar

to Benchmark Number 3, but introduces a random time of 0 to about 2/3 of a second between writes of each record, simulating processing time between records. The Apricot got highest marks again.

## Documentation

Documentation for the Apricot is similar to other PC compatible machines; it's not nearly as extensive as documentation for the IBM PC. Anyone using the system (or many other PC-compatible systems) will probably have to supplement the manufacturer's documentation with copies of the IBM manuals. There are four basic manuals with the system—an MS-DOS User Guide, covering MS-DOS and BASIC. A SuperCalc/SuperPlanner manual, a Configurator Guide, and an Owner's Handbook. Conspicuous by its absence is any really nitty-gritty technical information about the system.

## Final Considerations

In my opinion the Apricot is a well-designed, well-engineered microcomputer that is certainly comparable to other PC compatible machines. To answer the question about motivation for buying a system with micro disk drives, I would say that the use of micro diskettes should not dissuade the buyer from selecting this machine, as they appear as reliable as 5 1/4" diskettes, or perhaps even more reliable in practical situations. However, I can't see any clear-cut reasons for choosing a system with micro disk drives over one with the 5 1/4" drives.

With the bundled software described above, the Apricot is priced at \$3190. The problem, of course, is that there are many other MS-DOS systems for about the same price, all with the larger disk drives. Although I have no doubt that it's possible to download MS-DOS software to the Apricot via RS-232C (using an included utility program), the fact is that there is a great deal of available software on 5 1/4" diskettes, directly loadable into many IBM PC-compatible machines. My recommendations would be to look seriously at this machine if you want a transportable system, with some good bundled software, and if you don't expect to utilize a large number of applications programs or can take the time and trouble to "download" programs from another MS-DOS system. If it were priced under \$2000 the Apricot would be an excellent buy; at the current price it is less so. ♦

# Computers & Electronics

## ADVERTISERS INDEX

RS no.	ADVERTISER	PAGE no.
8	Acorn Computer Corp. . . . .	47
50	Active Electronics . . . . .	118
15	Air National Guard . . . . .	81
	Apple Computer . . . . .	24-25
7	BMH Co., Inc. . . . .	107
	C & D Electronics . . . . .	103
	Classified Advertising . . . . .	119-125
	Cleveland Institute of Electronics, Inc . . . . .	18-21
29	Commodore Computer . . . . .	5
60	CompuServe . . . . .	27
11	Computer Mail Order . . . . .	93
14	Digi-Key Corp. . . . .	116-117
10	Electra Corp. . . . .	17
51	Electronic Specialists . . . . .	109
74	Fireworks Unlimited . . . . .	105
	Grantham College of Engineering . . . . .	110
	Halix Institute . . . . .	103
24,28	Heath Co. . . . .	35, 7
41,2	IBM Corporation . . . . .	14-15, 42-43
	ICS . . . . .	109
	Information Unlimited/ Scientific Systems . . . . .	110
21	Jameco Electronics . . . . .	113
22	JDR Microdevices . . . . .	114-115
23	J & R Music World . . . . .	112
58	Kalglo Electronics Co., Inc. . . . .	107
20	Leading Edge . . . . .	Cover 4
6	Limbic Systems . . . . .	105
30	Maxell . . . . .	2
	Memotech Corp. . . . .	Cover 2, 1
5	Micro Craft Corp. . . . .	Cover 3
34	Micro-Ware . . . . .	112
	National Technical Schools . . . . .	28-31
	NRI Schools . . . . .	8-11
40	Protecto . . . . .	87
	Radio Shack . . . . .	23
4	RSP Electronics Corp./Handy Products . . . . .	89
39	Tab Books . . . . .	91
42	Tam's Inc. . . . .	105
	Tektronix . . . . .	33

# DIMENSION. THE MOST POWERFUL, MOST COMPATIBLE PERSONAL COMPUTER YOU CAN BUY.

Introducing the capability the world has been waiting for. A single personal computer able to handle Apple® IBM® TRS-80® UNIX™ and CP/M® based software.

The Dimension 68000 Professional Personal Computer does it all. It actually contains the microprocessors found in all of today's popular personal computers. And a dramatic innovation creates the environment that these systems function merely by plugging in the software.

Add to this the incredible power of a 32 bit MC68000 microprocessor with up to 16 megabytes of random access memory.

Dimension. At about the same price as the IBM® PC, it's obviously the best value you can find. For more information ask your dealer or call us at (214) 630-2562 for the name of your nearest dealer.

**dimension™**

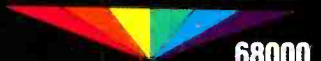

**68000**

A product of  
Micro Craft Corporation  
4747 Irving Blvd., Suite 241  
Dallas, Texas 75247. ©1983  
Circle No. 5 on Free Information Card



Apple is a registered trademark of Apple Computer, Inc.; IBM is a registered trademark of International Business Machines Corporation; TRS-80 is a registered trademark of Radio Shack, a Tandy Corporation company; UNIX is a trademark of Bell Laboratories, Inc.; CP/M is a registered trademark of Digital Research Corporation.

[www.americanradiohistory.com](http://www.americanradiohistory.com)

# THE DAY THE IBM® PC BECAME OBSOLETE.



It was a Monday in the autumn of '83:

The day they announced the Leading Edge® PC—a personal computer that's just plain better than the IBM® PC, at just about half the price.

The Leading Edge PC is faster (by more than 50%), more powerful, more flexible and more dependable (for example, our disk drives have a "mean time between failures" of 20,000 hours, versus an 8,000-hour MTBF for theirs). It's compatible with just about all the software and peripherals that the IBM is.

And unlike IBM's, ours comes complete with a high-resolution monitor, controller, seven expansion slots, serial port, parallel port, a time-of-day clock, double the standard memory (128K vs. 64K) plus hundreds of dollars worth of software to get you up and running immediately including MS™-DOS version 1.25, GW Basic, and Leading Edge Word Processing™ (the most powerful w.p. program ever created to run on an IBM-type personal computer). In short, the basic package comes to you complete and ready to work.

With IBM, on the other hand, you get charged extra for everything. Even for the PC DOS disk that makes it run (an extra \$40) ... and \$170 just for the time of day (a calendar/clock that's standard with Leading Edge). In short, the basic package comes to you as a very expensive paperweight.

It's this simple: The Leading Edge Personal Computer is the first and only serious alternative to the IBM PC ... and at only \$2895 for the Leading Edge PC ... Get serious.

Now at 500 Leading Edge Dealers across the country. For the one nearest you, call toll free 1-800-343-6833. In Mass., call collect (617) 828-8150.

LEADING EDGE PRODUCTS, INC., SYSTEM SALES DIVISION, 225 TURNPIKE STREET, CANTON, MA 02021

IBM is a registered trademark of International Business Machines Corp. MS is a trademark of Microsoft Corporation.

Circle No. 20 on Free Information Card



LEADING EDGE®