

WORLD'S LARGEST COMPUTER MAGAZINE

Computers & ELECTRONICS

FEBRUARY 1984

\$1.75

NEW LOW-COST INK-JET PRINTERS



0174142011
*****5-DIGIT 60506
390736 DHM 09976093 P4ID SEP84
MRS EDNA DAHM
957 GRAND AV
AURORA IL 60506
02ATP

REPORTS : ADAM & SHARP PC-5000

VIDEOTEX TAKES OFF

FLOPPIES ARE ON THE WAY!



You're traveling through 140° terrain at 300 rpm.

Only one disk guarantees safe passage through the torrid zone of drive heat. Maxell.

A lifetime warranty. And manufacturing standards that make it almost unnecessary.

Consider this: Every time you take your disk for a little spin, you expose it to drive heat that can sidetrack data. Worse, take it to the point of no return. Maxell's unique jacket construction defies heat of 140°F. And keeps your information on track.

And Maxell runs clean. A unique process impregnates lubricants throughout the oxide layer. Extending media and head life. How good is Gold?

Maxell's the disk that many drive manufacturers trust to put new equipment through its paces. It's that bug-free.

So you can drive a bargain. But in accelerated tests, Maxell floppys lead the industry in error-free performance and durability. Proving that if you can't stand the heat you don't stand a chance.



maxell®
IT'S WORTH IT.



Maxell Corporation of America, 60 Oxford Drive, Moonachie, N.J. 07074 201-440-8020
Circle No. 30 on Free Information Card

- **DISCOVER** how professionals upgrade their systems with affordable add-ons
- **LEARN** how not to over-invest in unnecessary software
- **EXPLORE** new uses for your computer

Get the most out of your computer with...

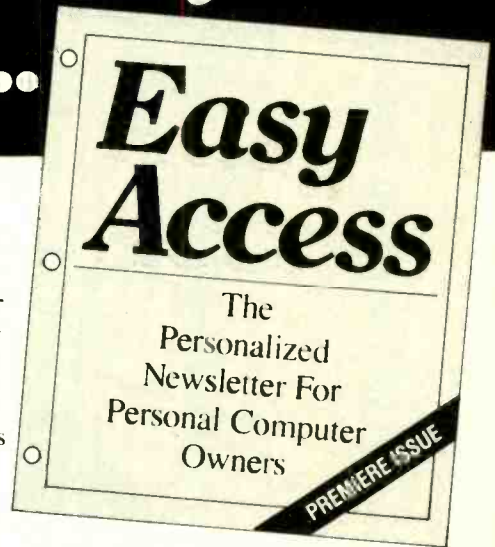

EASY ACCESS™ is the authoritative, easy to read, monthly newsletter that can save you money... save you time... and show you new ways to use your personal computer

In straightforward, non-technical language, EASY ACCESS answers the questions most often asked by computer users who want to get the most out of their systems. Computer magazines help, but they don't go far enough. And, retail sales people, who speak computerese, certainly aren't the answer.

EASY ACCESS is written especially for you and your system As a subscriber you'll read about software and hardware that are compatible with *your* system. Yes, there are multiple editions of EASY ACCESS—one for each major hardware system—You choose the edition that matches *your* system.

Plus, EASY ACCESS gives you behind-the-scenes input on what's happening in the industry (and what it means to you and your system), how specialists view new systems, and what's coming in the near future.

Sort through the software flood

Every month, EASY ACCESS reviews the best of the new software releases in *education, business, home management and entertainment*. You'll learn the important differences between programs that claim to do the same job... we'll tell you how long it will take to master a new, complex program, or if there's a simpler, less expensive program that will do almost as much.

Select only the extra hardware you really need Each issue of EASY ACCESS clearly assesses the avalanche of new add-ons and peripherals. For example, you'll be able to decide the most cost effective way to expand your computer's internal memory... or increase your external storage capacity... or add color or graphics without breaking your budget. And, if

you're not into data bases and networking, we'll show you how to get started.

Discover new ways to use your computer Get more value from your computer by letting EASY ACCESS introduce you to new applications you may never have considered. Research confirms that computer owners frequently fail to explore other uses for their system. EASY ACCESS will show you how your whole family can use the computer—for fun, for school, and for chores around the home, as well as for business uses. What's more, EASY ACCESS will tell how to get the most out of programs you already own.

Save money and be sure before you buy Subscribers may purchase selected products, often at significant savings, simply by dialing a TOLL-FREE number.

EASY ACCESS will also offer a TOLL-FREE INFORMATION LINE because we understand that no review, no matter how thorough, can answer everyone's ques-

tions. The INFORMATION LINE is there for your use before you buy.

Save money too—with your Charter Subscription Above all, EASY ACCESS can save you money. Savings when you avoid the wrong choices in software and hardware... savings when you buy. One year of EASY ACCESS (12 monthly issues) is only \$19.95 if you order now. One wise purchase can save you many times this amount.

CHARTER SUBSCRIPTION OFFER

YES, I want fast, useful information to help me get the most out of my personal computer. Enter my subscription to 1 year of EASY ACCESS (12 issues) at the low Charter Rate of \$19.95. I understand my 3-ring Binder will be sent as soon as payment is received.

Send the EASY ACCESS edition that's written for my computer:

- Apple Commodore TRS Other
 IBM Atari Coleco

My model is _____

- I use my computer for: Business Education
 Home Management Games/Entertainment
(You may check more than one)

YOURS FREE!

Permanent Reference Binder

A handsome 3-ring binder will be sent upon receipt of your payment. Use it to keep your issues for reference.

NO-RISK GUARANTEE

If you're ever dissatisfied, just let us know, and we'll send you a full refund on the unexpired portion of your subscription.

Name _____

Address _____

City _____ State _____ Zip _____

- Payment enclosed
 Bill me Later

- Charge my:** MasterCard Visa
 American Express credit card

Account No. _____ Exp. Date _____

*Send for your
Premiere Issue today!*

© MC 1983

MAIL TO: EASY ACCESS, 201 Lincoln Boulevard, Middlesex, N.J. 08846

053/2000

Great ideas in design: ours/yours

How many times have you looked at a clever piece of circuitry and thought "I could have designed that." Or... "I thought of that years ago, if only I had..."

Well now you can. Learn. Design. Create...your own electronic circuits. The new Heathkit/Zenith Engineering Design Series Experiment/Trainer and Courses makes it easy.



If you enjoy the challenge of creating your own circuits or have the desire to learn...then, the new ET-1000 Analog/Digital Circuit Design Experiment/Trainer is for you. Designed to be a multi-purpose lab for experimental circuit design, the ET-1000 makes it easy to design, develop and experiment with circuits of your own design.

Unit features large solderless plug-in breadboard, built-in power supplies, 1 Hz to 100 kHz signal generator, "no bounce" logic switches, LED indicators, logic probe and much, much more.

And if you need to learn circuit design before starting to create on your own, there are two self-study courses in passive and transistor circuits that will teach this exciting area to you right on the ET-1000.

Find out more about the new ET-1000 trainer and courses today. Complete specifications and details are in the new free Heathkit Catalog. The catalog also features more than 450 kit and educational products for your home, hobby and business. **Circle reader service number below.**

New Engineering Design Series

Heathkit®
Heathkit/Zenith
Educational Systems

Computers & ELECTRONICS

FEBRUARY 1984

VOLUME 22, NUMBER 2

FEATURE ARTICLES

42 ADAM ARRIVES
Charles Rubenstein/An exciting package for the beginner or the experienced.

50 DISKS AND DRIVES
Dawn Gordon/A look at the technology behind these mass storage devices.

53 MULTI-MEGABYTE MINIFLOPPIES
Alijandra Mogilner/A new recording medium provides up to 10-Mb storage on 5¼" floppies.

60 A FIRST PEEK AT THE SHARP PC-5000
Alex Marx/This unique versatile system has a plug-in bubble memory.

64 USE YOUR TRS-80 COLOR COMPUTER AS A STORAGE OSCILLOSCOPE
Forrest M. Mims, III/Develop your own test instrument.

67 AN 8-BIT COMPUTER GETS A NEW OPERATING SYSTEM
George Mitchell/Epson's QX-10 integrated package provides a variety of features.

72 VIDEOTEX AND YOU
John Helliwell/A clarification of videotex and its services.

78 JET SET PRINTERS
Mark S. Zachmann/The technology of ink-jet printers—Radio Shacks CGP-220 in particular.

COLUMNS

36 BITS & BYTES/Sol Libes

38 LES SOLOMON ON COMPUTER HARDWARE
The Ultimate Communicator.



COVER PHOTOGRAPH BY GARY HEERY

82 THE ELECTRONICS SCIENTIST
Forrest M. Mims, III/Analog Sensors for Personal Computers.

DEPARTMENTS

4 EDITORIAL
Seth R. Alpert/The Shot Heard 'Round the World.

6 LETTERS

12 NEW PRODUCTS

107 COMPUTER MART/ELECTRONICS CLASSIFIED

114 ADVERTISER'S INDEX

COPYRIGHT © 1984 BY ZIFF-DAVIS PUBLISHING COMPANY. All rights reserved. Computers & Electronics (ISSN 0032-4485) February 1984, Volume 22, Number 2. Published monthly by Ziff-Davis Publishing Co., at One Park Ave., New York, NY 10016. Richard P. Friesse, President; Selwyn Taubman, Treasurer; Bertram A. Abrams, Secretary. One year subscription rate for U.S. and Possessions, \$15.97; Canada, \$20.97; all other countries, \$23.97 (cash orders only, payable in U.S. currency). Second Class Postage Paid at Los Angeles, CA 90052 and at additional mailing offices. Authorized as second class mail by the Post Office Dept., Ottawa, Canada, and for payment of postage in cash. POPULAR ELECTRONICS including ELECTRONICS WORLD trademark registered. Indexed in the Reader's Guide to Periodical Literature. Ziff-Davis also publishes Boating, Car and Driver, Cycle, Flying, Popular Photography, Skiing, Stereo Review, Electronic Experimenter's Handbook, and Tape Recording & Buying Guide. **POSTMASTER:** Send address changes to COMPUTERS & ELECTRONICS, Circulation Dept. P.O. Box 2774, Boulder, CO 80302. Please allow at least eight weeks for change of address, enclosing, if possible, an address label from a recent issue. **Permissions.** Material in this publication may not be reproduced in any form without permission. Requests for permission should be directed to Elizabeth Amado, Rights and Permissions, Ziff-Davis Publishing Co., One Park Ave., New York, NY 10016.

EDITORIAL

THE SHOT HEARD 'ROUND THE WORLD

By **SETH R. ALPERT**

IN January, 1975, this magazine published a cover article that captured the imaginations of thousands of people across America.

It sparked new ideas and visions, it heralded a new world of technology, and it inspired a new technological subculture that now touches—or will soon—nearly every person in America.

That article revealed to the world the Altair 8800. It was the very first successful microcomputer.

The Altair and the microcomputer concept were so innovative, so resplendent with possibilities, so exciting, that some of the best and brightest of America's electronically oriented community saw the profound implications. Dreams were spawned in fertile minds. Lights burned late in garages and basements from Boston to San Francisco and a multi-billion-dollar a year industry was launched.

The revolution had begun.

The Minutemen. Now, I am new here, so it will not be immodest for me to boast a bit. Over the years, this magazine and its staff were more than mere reporters, chroniclers, or observers, for they, too, had a "vision." They were more than Paul Revere of the microcomputer revolution, riding the countryside by horseback heralding the coming of a new and important force. They were also the Minutemen of the age, pushing aside their typewriters to experiment, innovate, and implement new ideas.

In the few short years that followed, the staff and contributors to this magazine (then *Popular Electronics*) introduced low-cost versions for the personal computer marketplace of nearly a dozen major innovations in the microcomputer field, including modems, color graphics, speech I/O, remote control, logic analysis, and the cassette interface.

The results of this ongoing revolution are familiar to us all. The computational power available 10 years ago only to large, highly capitalized corporations and government is now within the grasp



of anyone who can afford a fancy color TV or used Volkswagen Beetle.

Microcomputers are now a product for the masses. Within years everyone who wants one will have his own.

Exciting New Direction. With this issue, *Computers & Electronics* assumes a new emphasis and direction, signalled by our new logo and format. You might well ask why?

The reason is simple. Alvin Toffler was right—the world is changing fast, very fast. And we must change, too, to keep pace with the needs of our readers. As a matter of fact, this change merely continues a process that has been part of the magazine's evolution since its inception in 1954.

Over the years, we have followed the currents of electronic technology. As the scope of microcomputing grew in the '70s and '80s, so did our coverage.

Since 1982, when we changed our name from *Popular Electronics* to *Computers & Electronics*, we have given our readers what we were always best at—and relied upon for—in-depth explanations and detailed descriptions of the latest advances in electronic technology, with an increased emphasis on microcomputers.

But now, new developments, technology, hardware, software, and new applications are bursting forth with ever-increasing speed.

In the months ahead, *C&E's* "reason for being" will be to keep readers abreast of up-to-the-minute developments in microcomputer technology, and inform them of the most significant advances in hardware, software, and applications affecting the field.

World's Largest Computer Magazine. Today, *Computers & Electronics* has a paid circulation of over 600,000, the largest of any computer magazine in the world!

The reason more people read us than any other computer magazine is simply because of our long and rich heritage. Over time, this publication has attracted an ever-growing number of individuals keenly—and viscerally—involved in the growing field of electronics. As that field has grown and changed, so have we.

Today, over 432,000 of our readers use microcomputers in their day-to-day lives. On average, our readers—you—use a microcomputer 16 hours a week. 390,000 of you use microcomputers on the job. And 306,000 of you personally own one or more microcomputers.

In our business, those are staggering numbers. In fact, more of our readers actually own and use microcomputers than the total circulations of many other magazines in the field.

The revolution continues.

If there is one thing we can all count on it is change. And as it happens we will bring to you authoritative, thorough, and exciting explanations about what is going on, why, its direct applications, and its meaning to you. Whether it be in new chip technology, or a new significant hardware introduction, a breakthrough in software or a novel application, *Computers & Electronics* will be at the forefront of the important innovations.

Join us for the ride to the exciting frontiers of microcomputer technology.

THE ULTIMATE SCANNER RADIO HAS ARRIVED.

Starting today, we're standing the scanner radio on its ear. Because we've forged ahead—way ahead—in radio frequency and digital technology.

Introducing the Bearcat® CompuScan™ 2100.

It's the first scanner radio designed to put the power of a personal computer to work for you. Now you can scan up to two hundred channels. Stack levels of priority so you'll hear vital calls in order of importance. Automatically search, store and count transmissions for accurate "pictures" of activity within frequency limits you select.

And with automatic video memos you'll know more than you've ever known before. The channel user, special codes, jurisdictions, phone numbers, alternate frequencies—any information you've programmed is automatically displayed when the channel is active.

With ten bands including 70-centimeter, 2, 6 and 10 meter FM Amateur, Military Land Mobile, AM Aircraft, plus Low, High, UHF and UHF-T bands.

For a real earful—and eyeful—see your Bearcat scanner dealer. For the name of the dealer nearest you, just call 1-800-S-C-A-N-N-E-R.

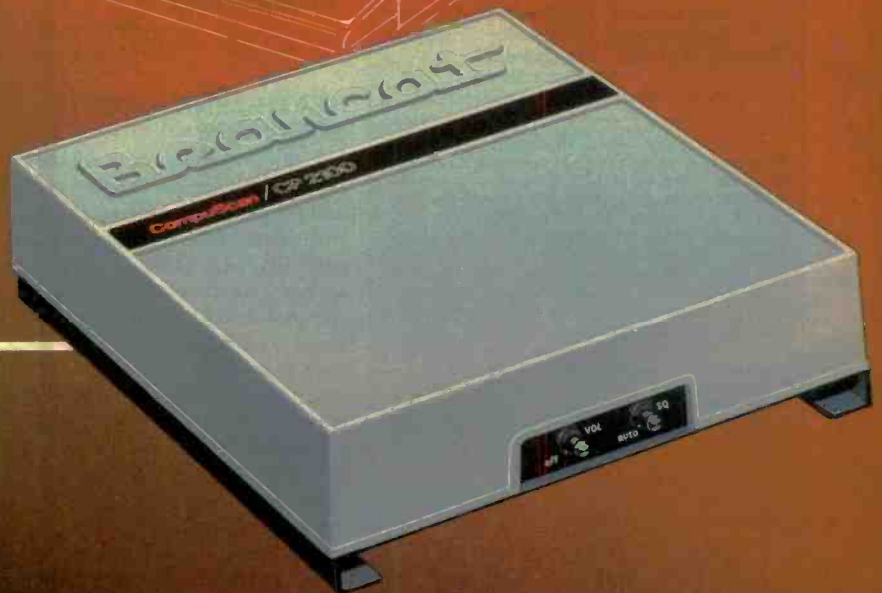
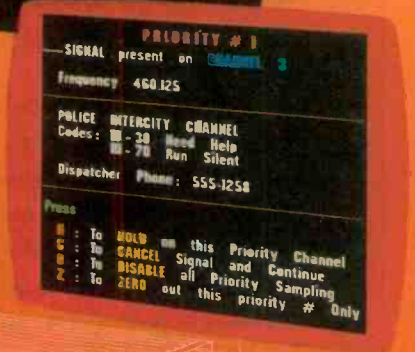

BEARCAT® SCANNERS

Electra
Division of Masco Corp. of Indiana
300 East County Line Road
Cumberland, Indiana 46229

© 1983 Masco Corp of Indiana
Circle No. 10 on Free Information Card

WILLIAM S. DAVID *Publisher*

SETH R. ALPERT *Editor in Chief*

ARTHUR P. SALSBERG *Editorial Director*

LESLIE SOLOMON *Technical Director*

JOHN R. RIGGS *Managing Editor*

JAMES KIEHLE *Art Director*

A. W. BURAWA *Senior Editor*

JOSEPH DESPOSITO *Technical Editor*

JOSEF BERNARD *Technical Editor*

ANDRE DUZANT *Technical Illustrator*

ROBERT LASCARO *Associate Art Director*

CARMEN VELAZQUEZ *Production Editor*

JEFF NEWMAN *Editorial Assistant*

Contributing Editors: Sol Libes, Forrest M. Minis, III

Editorial and Executive Offices
One Park Avenue, New York, N.Y. 10016. 212-725-3500

Advertising Sales Offices

New York

Tom Ballou 212-725-3578/Ken Lipka 212-725-3580

Midwestern

Robert Vanek, Suite 1400, 180 N. Michigan Ave., Chicago, IL 60601. 312-346-2600

Western

Joe Mesics, J.E.M. Associates, Francisco Bay Office Park, 1750 Montgomery Street, San Francisco, CA 94111. 415-989-4643

Southeastern

Mark Browning, PO Box 81306, 2511 Carroll Ave., Atlanta, GA 30366. 404-455-3430.

Representation in Japan

J.S. Yagi, Iwai Trading Co., Ltd. 603 Ginza Sky Heights Bldg., 18-13, Ginza 7-Chome, Tokyo, Japan 104

Consumer Computers & Electronics Magazine Division

Larry Sporn *President*

Jeff Hammond *Vice President, Marketing*

Carole Mandel *Vice President, Circulation*

Eileen G. Markowitz *Vice President,*

General Manager

Peter J. Blank *Creative Director*

Ziff-Davis Publishing

President Richard P. Fries; President Consumer Magazine Division Albert S. Traina; Executive Vice President, Marketing and Circulation Paul H. Chook; Senior Vice President Phillip T. Heffernan; Senior Vice President Sidney Holtz; Senior Vice President Edward D. Muhlfeld; Senior Vice President Philip Sine; Vice President Baird Davis; Vice President George Morrissey; Vice President Rory Parisi; Treasurer Selwyn Taubman; Secretary Bertram A. Abrams

Editorial correspondence: COMPUTERS & ELECTRONICS, 1 Park Ave., New York, NY 10016. Editorial contributions must be accompanied by return postage and will be handled with reasonable care; however, publisher assumes no responsibility for return or safety of manuscripts, art work, or models submitted.

The publisher has no knowledge of any proprietary rights which will be violated by the making or using of any items disclosed in this issue.

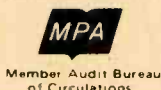

LETTERS

COMMODORE CP/M

The author of "Bits & Bytes" asked, in his November column, if anyone had seen (for sale) a Commodore Z80 cartridge to run CP/M on the C-64. I got one, accompanied by a 240-page User's Guide and one 5¼" CP/M system disk. The total cost was \$59.99, plus shipping, through the Sears catalog.

—W.H. ANTRIM
Tucson, AZ.

VIVA MATCHMAKER!

The story "Matchmaker, Matchmaker; Interfacing with Parallel and Serial Ports," in your November issue was excellent. How about a sequel on the IEEE-488 GPIB.

—R. REITER
McHenry, IL.

BAUDY HOUSE

I recently saw the following ad on BUY-PHONE, the Los Angeles "Computerized Yellow Pages."

ROOMMATE WANTED: I am looking for a roommate to share a two-bedroom apartment in San Gabriel. Rent is \$225/month.

You also may have partial use of my IBM PC computer. . . .

Is Los Angeles setting a trend toward "Room and Baud"?

—WILLIAM LAPPEN
Los Angeles, CA.

HEATH-ZENITH AND IBM SOFTWARE

I enjoyed the review of the Heath/Zenith 120 microcomputer in your October issue, but would like to take issue with some of the statements about compatibility with IBM PC software. The author said that IBM software is not compatible with the 100 series and vice-versa. This is not completely true. Here are a few points.

Zenith's ZDOS and IBM's PC-DOS are both customized versions of Microsoft's MS-DOS. They share a common set of BIOS calls that are accessed by software interrupt #21. In addition to these standard BIOS calls, both machines have advanced features that can be accessed through other interrupts or calls to routines in ROM. The point is

that programs that stick to the standard operating system calls will run on both machines.

With regard to disk formats, the Z-100 machines use the same disk format as the IBM PC. This is a double-density, 8-sector per track, 40 tracks per side, single- or double-density format. The IBM allows the user to extend the normal 8 sectors per track to 9. This boosts formatted capacity on double-sided disks from 320K to 360K. I think the Z-100 supports only the 320K format.

Regarding BASIC, the Zenith version, Z-BASIC, has a great deal in common with IBM's BASIC-A. Like ZDOS and PC-DOS, the BASIC systems were customized by Microsoft starting with the same source. The main difference is in the handling of graphics. The Zenith machines have a much higher degree of color resolution than IBM. Most BASIC-A programs can be converted to Z-BASIC without too much effort. One may have to store programs in ASCII if they are being moved via disk.

—G. F. ROBERTS
Knoxville, TN.

A POX ON HEX, ETC.

"Math with binary, octal, and hex. Sometimes, the best of us will vex. Especially when we are taught.

From pix with errors that are fraught."
—R. I. RUBY
Beverly Hills, CA.

Yes, in the December issue, in the article "Number Systems for Microcomputers," the illustrations wound up with the wrong captions. Obviously, Fig. 1 (octal) should have been the diagram based on 8's; Fig. 3 (hex) should have been based on 16's; and Fig. 4 (binary) should have had the 2's.—ED.

FAIL-SAFE, REAL-TIME CLOCK

In my article "Fail-Safe, Real-Time Clock for TRS-80" (December, p. 82), IC3 is incorrectly labelled on the schematic. It should be 74LS30, as given in the Parts List. Also, the address given for ordering parts from Appcomp, in the Parts List, should be 8578 W. 67th Pl., Arvada, CO 80004.

—JOHN C. MEIN
Arvada, CO.

 **commodore**  **64**

INDISPENSABLE SOFTWARE

For Your Most Important Computing Needs



EasyScript 64
Displays 764 lines x 240 characters. Prints to 130 columns. Works with EasySpell 64.



EasySpell 64
20,000 word Master Dictionary and automatic spelling checker. Works with EasyScript 64.

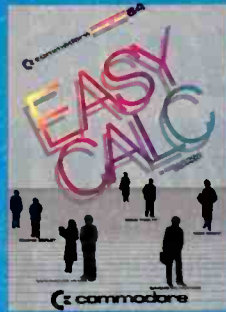

EasyCalc 64
Multiple electronic spreadsheet with color bar graph feature. 63 columns x 254 rows.



The Manager
Sophisticated database system with 4 built-in applications, or design your own. Text, formulas, graphics.



SuperExpander 64
21 special commands. Combine text with high resolution graphics. Music and game sounds.



Easy Finance I—Loan Analysis
12 loan functions. Bar graph forecasting as well as calculation.



Easy Finance II—Basic Investment Analysis
16 stock investment functions. Investment bar graph.



Easy Finance III—Advanced Investment Analysis
16 capital investment functions. Bar graphs.

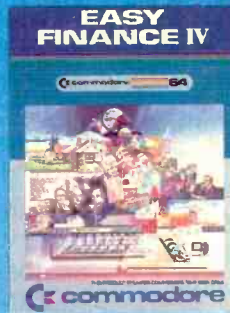

Easy Finance IV—Business Management
21 business management features. Bar graphs.



Easy Finance V—Statistics and Forecasting
Assess present/future sales trends with 9 statistics and forecasting functions.

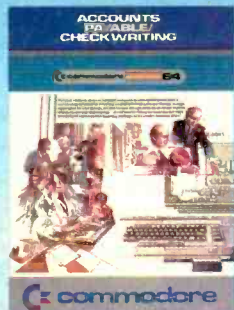

Accounts Payable/Checkwriting
11 functions. Automatic billing. 50 vendors/disk.

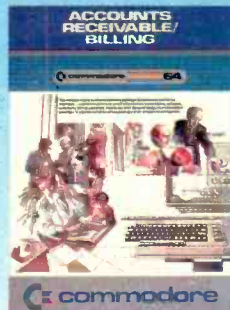

Accounts Receivable/Billing
11 billing functions. Printed statements.



General Ledger
8 general ledger options. Custom income statement, trial balances, reports.

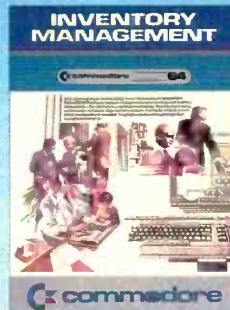

Inventory Management
1000 inventory items. Full reports.



Payroll
24 different payroll functions. Integrated with G/L system.

 **commodore**
COMPUTERS

First In Quality Software

Circle No. 29 on Free Information Card

Go on line in the world's fastest growing technology.

NEW! DATA COMMUNICATIONS TRAINING FROM NRI

Practical training includes computer, modem, test instruments, and access to exclusive NRI communications network

Satellites . . . microwave . . . fiber optics . . . dedicated land lines. Suddenly the world is communicating in a new and different way, via digital data systems. People talking to computers . . . computers to computers . . . information is stored, retrieved, and relayed in nanoseconds. And an entirely new kind of communications is born.

Industry, opportunities to triple

Data and telecommunications is already a \$150 billion industry and is expected to triple over the next five years. One typical company has grown from \$85 million to \$650 million . . . a 765% growth since 1978 alone. The need for qualified technicians to install, maintain, and service this enormous investment in high-tech equipment is tremendous even now. Opportunities and salaries can go nowhere but up and up.

Training includes all this equipment you keep . . . 16K computer, modem, breakout box, digital multimeter and the exclusive NRI Discovery Lab.

NRI will train you at home

You can learn at home in your spare time to become a data communications technician with NRI at-home training. NRI will start you with the basics, build upon your knowledge with easy-to-follow, bite size lessons to take you into the world of digital data communications. You'll learn what it takes to work on satellite, microwave, fiber optic, and telephone data links.

And you'll learn at your own comfortable pace, without classroom pressures or evenings away from your family. Over the past 70 years, NRI has taught the latest high-tech skills to almost 2 million

students to become the world's largest and most successful school of its kind.

Hands-on training includes computer, modem, breakout box and much more

NRI takes you far beyond "book learning." As part of your course, you receive plenty of practical



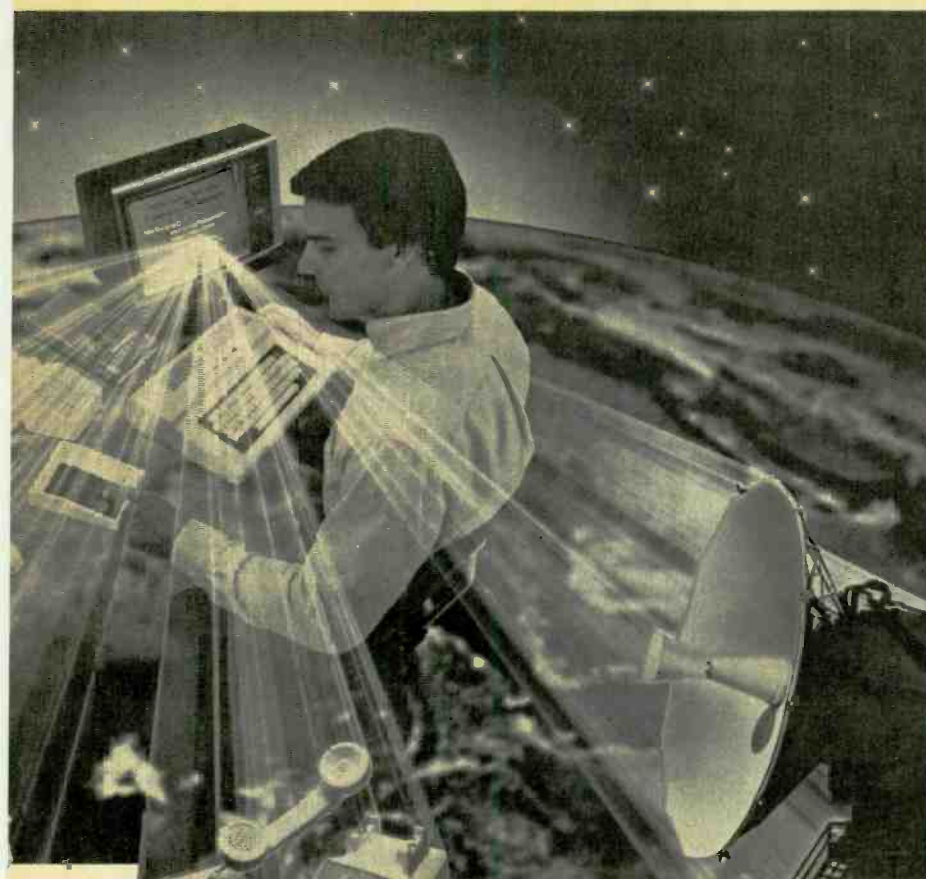

Tie into the NRI network using computer, software, and modem you get as part of your training.

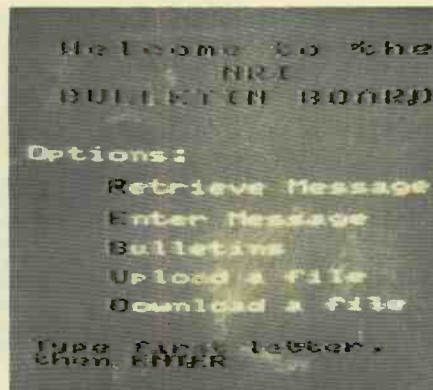

Move into the future, send for Free Catalog

You can't find training like this anywhere else. . . only NRI trains you at home for an exciting and rewarding career in the brilliant new world of Data Communications. Mail the postage-paid card right now for our big catalog of high-tech electronic careers showing all the equipment you get, detailed lesson descriptions, and career opportunities. Look it over and decide where you want your future to grow. Act now. There's a real need for trained data communications technicians.

You receive a professional digital multimeter and the NRI Discovery Lab, where you construct solid-state circuits and demonstrate practical applications of the theory you've learned.

Learn on-line with the exclusive NRI data network

You'll learn what data communications is all about by actually becoming part of an operating network. Using your computer, modem, and terminal software, you'll go on line to "talk" to your instructor, take your final exam by computer link, communicate with other NRI students and leave messages on the NRI "bulletin board."

As part of your course, you'll also receive membership in THE SOURCESM, a regular \$100 value. A phone call ties you into computers loaded with instant news, stock quotes, electronic mail, educational programs, games, even discount shopping and travel reservations.

NRI NRI SCHOOLS
McGraw-Hill Continuing Education Center
 3939 Wisconsin Ave.,
 Washington, DC 20016

WE GIVE YOU TOMORROW.

TRS-80 is a trademark of the Radio Shack division of Tandy Corp. SM a service mark of Source Telecomputing Corp., a subsidiary of the Reader's Digest Association, Inc.



hands-on training that gives you real-world skills. You get the Radio Shack Color Computer, with 16K memory to teach you the systems and language of data communications plus you get an operating modem to let you tie in with world-wide communications networks.

You build your own RS-232C interface breakout box, an indispensable installation and troubleshooting instrument you'll use throughout your career.

NEW PRODUCTS

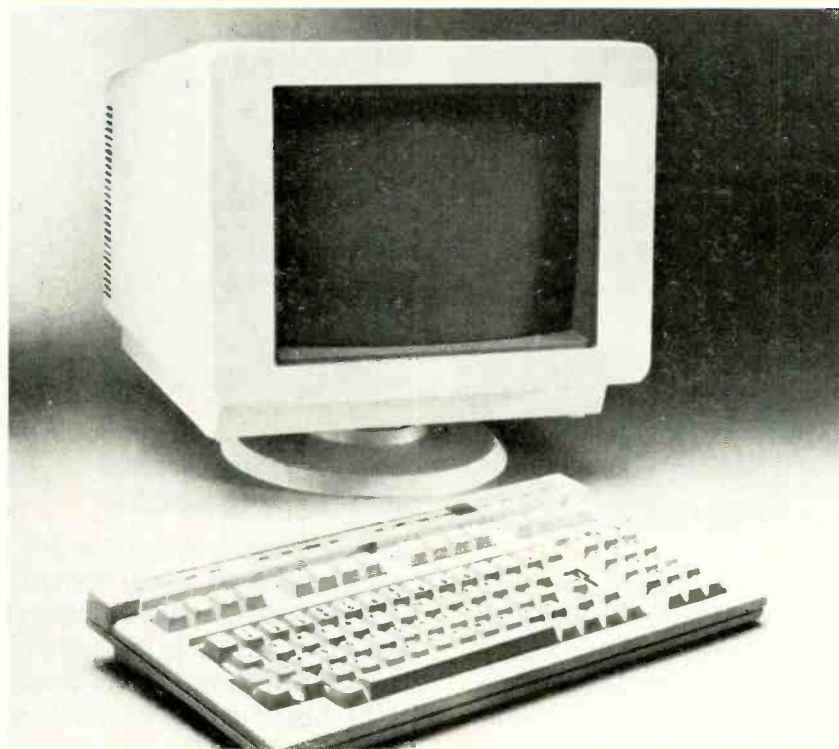

PC-COMPATIBLE WORKSTATION

Digital Microsystems Model DMS-816 workstation allows users to run MS-DOS or CP/M programs on the company's HiNet local area network. It duplicates the functions of IBM's ROM for I/O and has an IBM-compatible monochrome video display and keyboard with all the functions of the IBM PC. The company claims that 90% to 95% of the business applications programs that run on the IBM PC will run in the workstation. The DMS-816 has an integrated 12" video monitor and detachable low-profile keyboard; Z80A and 8088 processors; 256K (expandable to 512K) of RAM; 500K-baud RS-422 network port; 19.4K-baud RS-232 printer port; and parallel port. Software included with the computer consists of MS-DOS, Perfect Writer, Perfect Calc, Perfect Speller, and Perfect Filer. \$1695 for the DMS-816, \$500 for HiNet/PC system software to manage the network.

Circle No. 83 on Free Information Card

COMMUNICATIONS SYSTEM

Cygnets "CoSystem" is a microprocessor-based voice, data, and simultaneous voice/data communications system that functions independently and synergistically with personal computers. In addition to simultaneous interoffice voice and data teleconferencing, CoSystem offers such features as: electronic mail; speed dial; last-number memory; automatic redial from an extended directory; programmable function keys; automation of special PBX calling functions; automatic database access; terminal emulation; detailed records of all communications activities; and calendar/time management. The system is available in 300-baud (\$149⁹⁵) and 1200-baud, 212A (\$1845) modem versions. Current models are for use with IBM PC, Compaq, and other computers operating under MS-DOS. An optional speakerphone costs \$150. Address: Cygnets Technologies, Inc., 42C Lexington Ave., New York, NY 1017C.



LOW-COST BAR-CODE READER

A compact, low-cost optical scanner called "Oscar" (Optical SCanning Reader) from Databar Corp. can be used to scan bar-coded data for entry into popular makes of home computers like those from Atari, Commodore, Ra-

dio Shack, Texas Instruments, and Timex/Sinclair. Use of Oscar all but eliminates the need for tedious entry through the computer's keyboard. \$79.95, includes premier issue of a new monthly magazine with bar-coded programs written in BASIC. Subscription rate for the magazine is \$10 per month.

Circle No. 84 on Free Information Card



PLOTTER FOR PERSONAL COMPUTERS

The Model CR-1810 ComScriber I plotter from Comrex offers low-cost plotting on either paper or transparencies for personal computer users. Its pen produces high-resolution letters and graphics symbols with an accuracy of 0.00025" and a pen travel speed of up to 6" per second. Pen motion is user controllable via a 12-key touchpad. Though

the plotter is basically a single-pen device, multiple-color plots can be performed, using a built-in pause feature that makes it easy to change pens. The basic plotting area measures 8½" × 11", but the length can be extended to as much as 20". Character height can range from ⅛" to 20". The plotter uses standard pens, paper, and transparencies. It measures 14.3" W × 8.8" D × 2.9" H and weighs 7.25 lb. \$695.

Circle No. 85 on Free Information Card

COMPUTER COMMUNICATIONS TERMINAL

The Model RM1000 radio modem from Macrotronics is a hardware/software system that converts personal computers into communications terminals that support Morse, Baudot, and ASCII codes. It has multistage active filter demodulators with dual LED bargraph tuning displays for Morse code and RTTY reception and offers three RTTY shifts. A crystal-controlled AFSK tone generator provides stable RTTY keying, while relays are used for push-to-talk and Morse code transmitter keying. A hardware clock displays time, which can be inserted into the text. The software's multilevel split-screen format displays transmitted and received text in chronological order, and a review



window permits viewing and editing of text that has scrolled off-screen. Sixteen programmable messages can be linked and are dynamically allocated. A buffered ASCII parallel port permits printing of current text or text in the review window. Address: Macrotronics, Inc., 1125 N. Golden State Blvd., Suite G, Turlock, CA 95380.

SOFTWARE SOURCES

Financial Analysis Program. Profin from Business Software is an easy-to-use financial-analysis software package for use in personal computers. It is designed to assist users in evaluating all financial criteria involved in an investment before making a decision. It forecasts and budgets investment possibilities and analyzes discounted cash flows, returns on investments, and capital expenditures. The user does not have to set up mathematical calculations or lay out a spreadsheet. Profin is written in Microsoft BASIC V5.2 and runs under CP/M-80, MS-DOS, PC-DOS, and CP/M-86. It requires a minimum of 64K of RAM and 240K of disk storage. Available through software dealers.

Communications Utility. BLAST (Blocked ASynchronous Transmission) from Communications Research Group is now available for the IBM PC, Apple, CP/M, and MP/M computers, for transferring binary and text files between computers, with terminal emulation to mainframes. The programs employ a high-level SDLC/HDLC type protocol for reliable transfers in both directions simultaneously over the telephone lines. It converts text files to the format required by the other system and features text file uploading and downloading and supports auto-dial/auto-answer modems. \$250. Address: Communications Research Group, Inc., 8939 Jefferson Hwy., Baton Rouge, LA 70809.

Graphics for Pocket PCs. PocketGraph I from PocketInfo Corp. is designed for use in Radio Shack TRS-80 PC-2 and Sharp PC-1500 hand-held computers. It can be used to draw bar, line, pie, and scatter graphs with the computers' 4-color plotters. A user-defined function can be plotted for any range of values. Data is entered into a variable-size matrix ranging from 99 rows to 99 columns. Data can come from the PocketCalc IV spreadsheet program. \$29.95 cassette tape. Address: PocketInfo Corp., 7795 S.W. 184 St., Beaverton, OR 97007.

What's on the best-seller list in IBM Personal Computer software?

Games can make anyone
a winner while treating
you to hours of fun
and fantasy.



Payroll can boost your
productivity and make employee
deductions less taxing.



Electronic spreadsheets help
build financial models that
can shape your future.

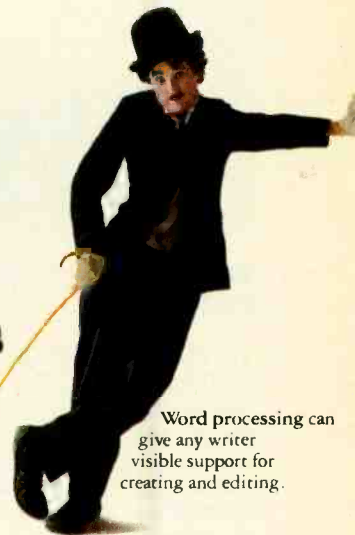

Word processing can
give any writer
visible support for
creating and editing.

Inventory control can help put you on top by keeping track of what's what and where.



Languages like BASIC can encourage students to write programs of their own.



Stock monitoring can help put you in the chips by tapping the world of Wall Street.



Data management can help tame your file of names, numbers, facts and figures.



Accounting can give you a leg up when balancing the books.



People prefer IBM Personal Computer software for a variety of reasons. And one of the best reasons is its variety.

Because, for just about anything you want the IBM Personal Computer to help you do, there's software to help you do it. Software to help improve productivity, efficiency and planning. To help teachers teach and students learn.

Or help you become an even more astute gamesplayer.

Every program in our software library makes the IBM Personal Computer a truly useful tool for modern times. That's why a lot of buyers like you have made them best sellers. And the library is still growing.

So the best may well be yet to come.

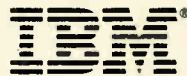

For more information on where to buy IBM Personal Computer software and hardware, call 800-447-4700. In Alaska or Hawaii, 800-447-0890.

CIRCLE NO. 41 ON FREE INFORMATION CARD

NEW PRODUCTS



"FAMILY PACK" COMPUTER

Franklin has combined a number of items with its Apple II work-alike ACE 1000 personal computer to produce its new "Family Pack" aimed at the home

user. The Family Pack includes a selection of educational and recreational software, a home finance software package, joystick, and BASIC programming manual. \$1495.

Circle No. 86 on Free Information Card

ELECTRONIC TYPEWRITER INTERFACE

Selectone's Model AR-180 Micro-Type is designed to interface Adler 1010/1011 and Royal 5050/5011 electronic typewriters with personal computers. Using Intel's 8031 microprocessor, it provides an RS-232C and a Centronics parallel interface on a single circuit board that easily installs inside the typewriter. Readily accessible DIP switch programming allows the user to configure the typewriter to most computers and word-processing packages. Other features include: 4K buffer; computer control of tabs, margins, underlining, boldfacing, superscripting, subscripting, and linefeeding; and compatibility with most common baud rates and handshaking protocols. **Address:** Selectone, Computer Prods. Div., 28301 Industrial Blvd., Hayward, CA 94545.

SOFTWARE SOURCES

Word-Processing System. AlphaBit's Lazy Writer word-processing system is now tailored for use in the Radio Shack TRS-80 Model 4 computer. This version makes use of the better screen display on the Model 4 by displaying text in 80 x 24 format and is fully compatible with text created on the 64 x 16 version used in the Model I and III computers. The Model 4 version consists of two sets of programs, one to use in any Model III DOS, the other with Radio Shack's new TRSDOS V6. Another version of Lazy Writer is available for use in the Lobo MAX-80 computer operating under LDOS. \$175 for both versions. Current Lazy Writer users can obtain upgraded versions for \$39.95. **Address:** AlphaBit Communications, Inc., 11349 Michigan Ave., Dearborn, MI 48126.

Speedy Basic. APCBASIC from American Planning is now available for the IBM PC computer, virtually all S-100 systems, and most other personal computers running under CP/M-80 and CP/M-86. The language provides unique functions and capabilities while reportedly retaining the friendliness

and ease of use of a limited BASIC for beginners. Among APCBASIC's features are: 50 functions, 18 commands, and 42 statements; exact BCD arithmetic that eliminates rounding errors; and multiple buffers that maximize disk throughput. An included Runtime version further speeds execution by up to 50%. **Address:** American Planning Corp., Suite 243, 4600 Duke St., Alexandria, VA 22304.

Advisor. Three programs that enable a personal computer to act as an advisor to its human operator during difficult moments in dealing with other people are offered by Human Edge Software Corp. The three products, The Management Edge, The Negotiation Edge, and The Sales Edge elicit from the user, in conversational English, information about himself, the situation, the goal, and the opponent or employee. The information is combined and analyzed by the program, and the user is provided with an easy-to-read printout that "walks" him through the proper scenario to achieve the optimum resolution to the situation. Each program, \$250.

Circle No. 88 on Free Information Card

GIVE SIGHT TO YOUR COMPUTER

Micromint's Micro D-CAM digital image sensor gives the gift of sight to personal computers. It uses a 256 x 128 silicon array and menu-driven software to interpret, enhance, and store images in a computer. Applications include creating graphics, recognizing patterns and characters, robotics, process control, and security. The device features



continuous exposure control and is claimed to be easy to incorporate into any user application. Supplied software includes utilities for automatic exposure, multilevel greyscale generation, screen dumps, picture storage, and image enhancement. It comes with interface card, extension cable, optic RAM, lens, remote housing, manual, and utility software. Versions are currently available for the IBM PC and Apple II and can be specially ordered for RS-232 interfaces. \$295.

Circle No. 87 on Free Information Card

Now 60 MHz or 100 MHz Tek quality is just a free phone call away!

**New lower price!
100 MHz 2235
now just \$1650.**



Tek has expanded its best-selling 2200 scope line up to 100 MHz. And brought it all as close as your phone. Tek's revolutionary, reduced-component architecture brings unprecedented quality, reliability and affordability to the 60 MHz 2213 and 2215, and now, the 100 MHz 2235.

All three of these lightweight (13.5 lb.) scopes feature 2 mV/div vertical sensitivity and 5 ns/div sweep speeds, plus a complete trigger system for stable triggering on digital, analog or video waveforms.

Scopes with a comprehensive 3-year warranty*... probes... and expert advice. One free call gets it all! You can order, or obtain literature, through the Tek National

	2213	2215	2235
Bandwidth	60 MHz	60 MHz	100 MHz
No. of Channels	2	2	2 + Trigger View
Alternate Sweep	—	Yes	Yes
Vert/Trig B/W Limit	—	—	Yes—20 MHz
Single Sweep	—	—	Yes
Accuracy: Vert/Horz	3%	3%	2%
Delay Jitter	1:5,000	1:10,000	1:20,000
Trigger'g Sensitivity	0.4 div at 2 MHz	0.4 div at 2 MHz	0.3 div at 10 MHz
Input R-C	1M Ω - 30pf	1M Ω - 30pf	1M Ω - 20pf
Variable Holdoff	4:1	4:1	10:1
Price	\$1200†	\$1450†	\$1950 Now \$1650 †

Marketing Center. Technical personnel, expert in scope applications, will answer your questions and expedite delivery. Direct orders include operating and service manuals, two 10X probes, 15-day return policy, and worldwide service back-up.

**Call toll-free:
1-800-426-2200,
Extension 128.**

In Oregon, call collect:
(503) 627-9000, Ext. 128.

†Price F.O.B. Beaverton, OR.
*3-year warranty includes CRT and applies to 2000 family oscilloscopes purchased after 1/1/83.
Scopes are UL Listed, CSA and VDE approved.

Tektronix
COMMITTED TO EXCELLENCE

MASTER THE "NEW ELECTRONICS" WITH MCGRAW-HILL'S

Contemporary



Now you can meet the challenges of today's incredibly rapid changes in electronics quickly and easily. This professional level electronics learning series is as innovative as the circuitry it explains and as fascinating as the experiments you build and explore!

From digital logic to the latest 16-bit microprocessor, you master one subject at a time with McGraw-Hill Concept Modules sent to you one at a time, once a month, to make up the complete CONTEMPORARY ELECTRONICS SERIES. Each module of the fifteen in the Series is a unique blend of "hands-on" experience, interactive audio cassettes, and vividly illustrated printed support materials. Together

they will prepare you for tomorrow's better jobs or advancement in your present position by staying current with today's electronics revolution.

Understand Digital Logic... Microprocessors... Optoelectronics

Here's an extraordinary opportunity to update your understanding of today's most important technological changes in electronics. You can start from scratch or use the Series to update yourself. You cover the latest integrated circuits, including TTL, CMOS, and ECL digital circuits; op-amps; phase-locked loops; microprocessors; and opto devices such as LEDs and LCDs.

Perform Electronic Experiments

With your first module you'll use the latest digital integrated circuits to build an oscillator circuit that demonstrates digital signals—verified visually by the flash of light emitting diodes (LEDs).

You'll learn concepts applicable to all electronic circuits. With the first module, you will be able to identify the major passive components, like resistors, capacitors, inductors, diodes and transformers, and active components such as transistors and integrated circuits.

Electronics Series

Each Concept Module goes right to the heart of the matter. You waste no time on extraneous material or outdated history. It's a fast, efficient, and lively learning experience, a nontraditional approach to the most modern of subject matter.

Construct And Use New Explorer Design Lab

What's more, laboratory experiments you perform as you expand your Explorer Design Lab system reinforce every significant point. All projects are designed to enhance and support your interaction with the cassettes and special text materials.

This essential hands-on experience with actual electronic components gives you a clear and simplified understanding of contemporary electronics. Every module will include additional components that you mount on your expanding Explorer Lab system. You'll use your Lab throughout the Series and later to design, build, and test your own circuits.

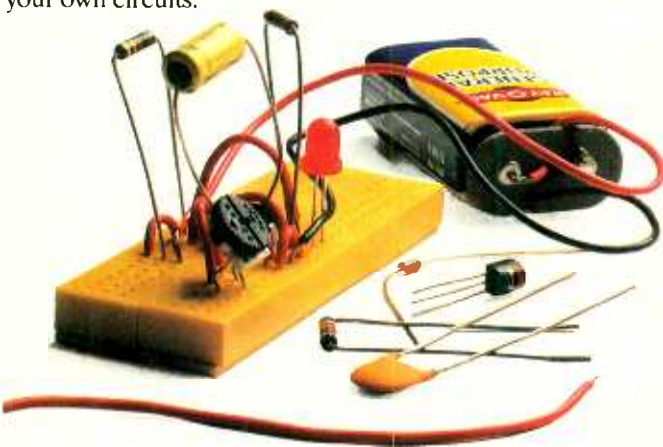

With your first module you'll use this solderless breadboarding system. As you add additional boards to create your Explorer Design Lab you retain the ability to connect and build increasingly complex circuits easily and quickly.

When you have received Module 15, you also have a wide variety of contemporary components you can continue to use for your own design projects. The principles you will have mastered in your Series will apply to all contemporary electronic circuits, right up to tomorrow's latest VLSI's (Very Large Scale Integrated) circuitry.

Unique Interactive Instruction Makes Learning Easy

With each new module you will receive a McGraw-Hill Action-Audio Cassette, a remarkable technique of interactive instruction. Each tape creates a dynamic discussion that not only quickly communicates the facts, but makes you feel that you are participating in a lively dialogue with experts in contemporary electronics who provide you with first-hand information in a warm and provocative way.

Your ability to rapidly make this knowledge your own

is further aided by a strikingly original method using diagrams, explanations, illustrations, and schematics to drive home and reinforce the meaning of all important points. Carefully indexed binders contain this material as well as the instructions to guide you through your "hands-on" lab experiments. Finally, having completed the Series, you can be awarded a Certificate of Achievement from McGraw-Hill upon passing an optional final examination.

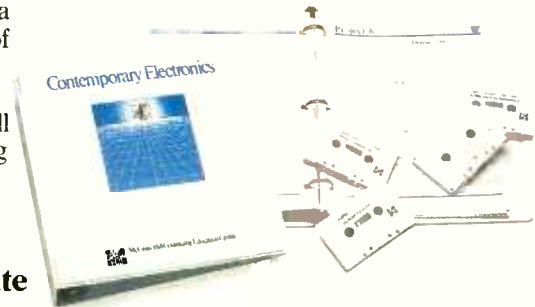

Update Your Knowledge of the New Electronics

This program is for anyone who has an interest in electronics. It's designed for you whether you are someone looking to find new directions in this wide open field... or the kind of person who wants to understand what's going on in the world around you... you could be a teacher who would benefit from a refresher course in contemporary circuits, components, and applications... a manager or supervisor in an electronics related business or industry... an engineer in another field who finds electronics playing an ever more important role in your work. It's even for the

electronics engineers and technicians, or people with similar backgrounds who feel their training is out-of-date.

McGraw-Hill's Contemporary Electronics Series offers you the quickest and probably least expensive learning method available today, and the only one with "hands-on" experience.

15-Day Trial

To order your first module under our 15-day trial examination, simply complete the card and send today! If card is missing, write us for ordering information.

YOU COVER EVERY SUBJECT IN CONTEMPORARY ELECTRONICS

- Digital logic
- Digital gates (TTL, CMOS, ECL, NMOS)
- Flip flops
- Counters and Registers
- Op-amps and Applications
- Combinational logic circuits (ROMs, PLAs, decoders, etc.)
- Circuit analysis, LCR networks
- Transistors (bipolar and FETs), diodes and thyristors
- Integrated circuits (linear and digital)
- Oscillators
- Optoelectronics
- Microprocessors
- Voltage Regulation
- Advanced Digital Concepts

McGraw-Hill
Continuing Education Center
3939 Wisconsin Avenue
Washington, DC 20016.



NEW PRODUCTS

VERSATILE DISK-READING COMPUTER

Vector Graphic's Model 4-S computer can read a range of soft-sectored floppy-disk formats. It automatically detects if a disk was created under MS-DOS or CP/M-86 and reads 8- and 9-sector single- and double-sided disks with 48- and 96-tpi formatting. It also offers 737K formatted storage capacity. The included CP/M-86 (MS-DOS 2.0 is optional) allows CP/M-86 and MS-DOS to reside on the same hard disk. Other software included with the 4-S consists of a GSX-85 graphics package, 8-bit CP/M simulator and MBASIC, and software development tools. Hardware consists of Z80B and 8088 processors; 128K (expandable to 256K) of RAM; detached keyboard; 12" hi-res graphics display; two modified S-100 expansion slots; tone generator; and one serial and two parallel ports. The 4-S system is available with different drive configurations, ranging from single and dual mini-floppy drives to a single minifloppy drive with 5M, 10M, or 36M hard-disk systems. \$3295 to \$9995.

Circle No. 89 on Free Information Card



IBM PC-COMPATIBLE DESKTOPPER

TeleVideo's Model TS 1605 16-bit personal computer is claimed to be fully hardware and software compatible with the IBM PC. The 8088-based computer comes with 128K (expandable on-board to 256K) of RAM; two half-height

368.6K floppy disk drives; RS-232 asynchronous serial port; IBM-style DP-25S parallel printer port; detached IBM-style keyboard; and 14" green video display monitor. It can display up to 80 characters by 24 lines and hi-res graphics of 640 x 200 pixels.

Circle No. 90 on Free Information Card

SOFTWARE SOURCES

Information Processor. The Concentric Information Processor (C.I.P) is a database/information-management and report-writing program for the IBM PC and PC compatibles. It allows users to do their work directly on the screen, just as it will appear in final reports. The program, from Concentric Data Systems, Inc., is distinguished from other products in the database category not only by its broad application of visual techniques, but also by an extensive on-line help system that allows even first-time computer users to become productive quickly. C.I.P. is operated using single keystrokes, and requires no command language. Features include: horizontal scrolling for 132-column capability with an 80-column display, built-in calculation facility, and in-place file reorganization that accommodates the changing needs of a user without adversely affecting the information within a file. C.I.P. can be used with other products such as VisiCalc or Lotus 1-2-3. Address: Concentric Data Systems, Inc., 18 Lyman Street, Westboro, MA 01581; 617-366-1122.

We don't care which computer you own. We'll help you get the most out of it.

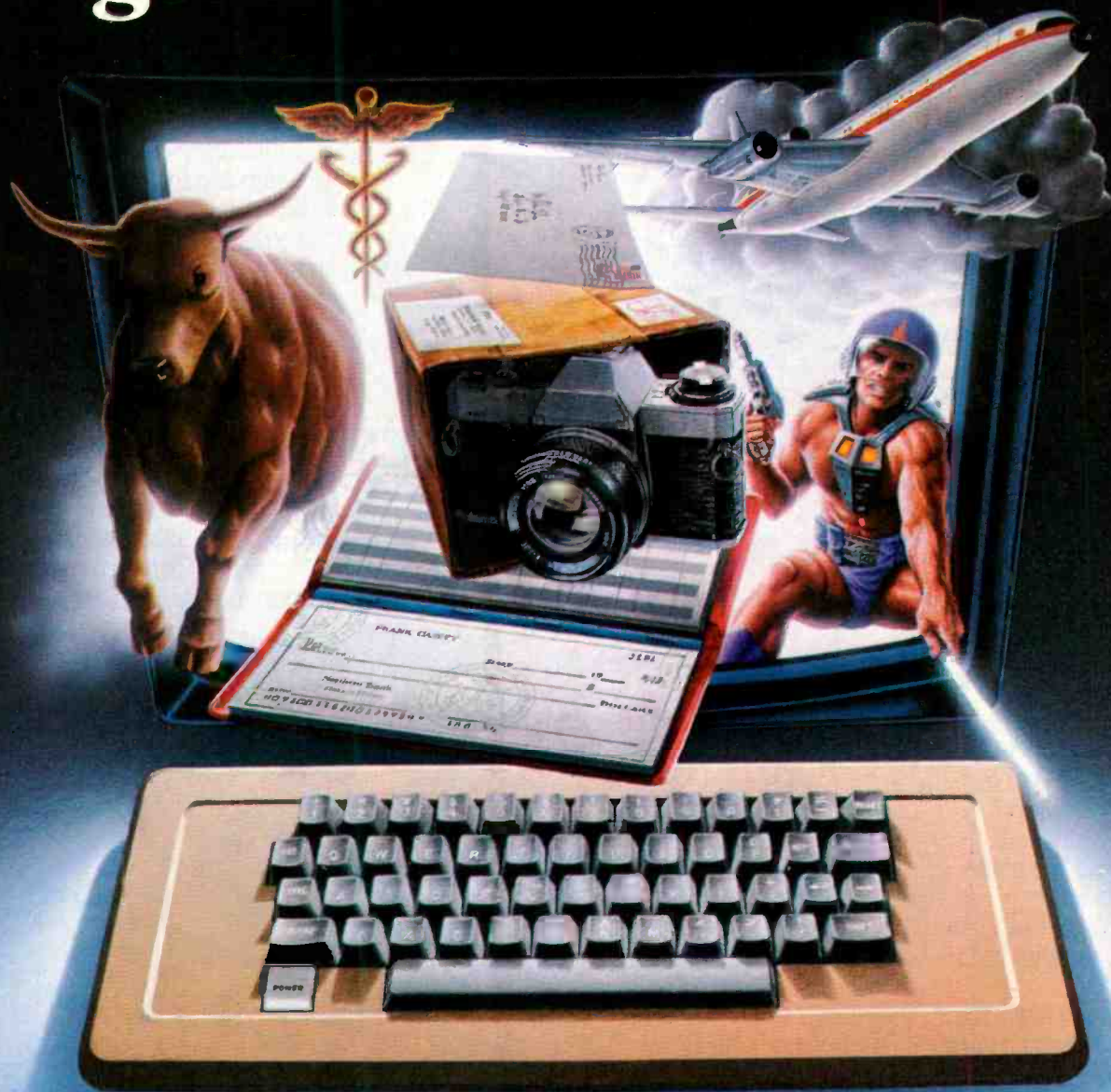

CompuServe puts a world of information, communications, and entertainment at your fingertips.

CompuServe is the easy to use videotex service designed for the personal computer user and managed by the communications professionals who provide business information services to over one fourth of the FORTUNE 500 companies.

Subscribers get a wealth of useful, profitable, or just plain interesting information like national news wires, electronic banking and shop at home services, and

sophisticated financial data. Plus, a communications network for electronic mail, a bulletin board for selling, swapping, and personal notices and a multi-channel CB simulator.

You get games on CompuServe, too. Classic puzzlers, educational, sports and adventure games and fantastic space games featuring MegaWars, the "ultimate computer conflict."

Circle No. 60 on Free Information Card

To learn more about CompuServe, call toll-free, 800-848-8199, for an illustrated guide to the CompuServe Information Service. The videotex service for you, no matter which computer you own.

CompuServe

Consumer Information Service, P. O. Box 20212
5000 Arlington Centre Blvd., Columbus, OH 43220
800-848-8199 In Ohio Call 614-457-0802
An H&R Block Company



Inside Apple

Vol. 1, No. 4

A dot matrix printer that will improve your image.

Meet the Apple® Imagewriter, the newest dot matrix printer for your Apple Personal Computer.

And with all that it has going for it, just maybe the best dot matrix printer on the market.

Take legibility, for instance.

The Imagewriter crams 140 x 160 dots into each square inch. So you get text that's highly readable and high resolution graphics, besides.

And is it fast.

The Imagewriter cruises at an unbelievable 120 characters per second. And that's just in the text mode. It's even faster printing graphics. 180 characters per second, to be exact.

What's more, the graphics dump is up to 60% faster than other comparably priced dot matrix printers. And that makes the Imagewriter fast enough to handle the Lisa™

Yet it's just as at home with an Apple III or Apple IIe. Thanks to Apple software experts who designed the control electronics to give the Imagewriter perfect compatibility. Not to mention some special capabilities

like superscript and subscript, to name just two.

Now, with all this high-speed performance, you'd expect the Imagewriter to make the Devil's Own Noise. It doesn't. In fact, the Imagewriter is specially constructed — with overlaid seams and special sound-deadening materials — to achieve a remarkable 53 dB. How loud is a remarkable 53 dB? You'd make more noise if you read this aloud.

The Imagewriter even has quiet good looks, since we designed it to look like the rest of the Apple Family.

Yet even with all its improvements, the Imagewriter is a better deal than any other dot matrix printer with comparable performance. And you can print that.

**APPLE PRESENTS THE
IMAGewriter APPLE PR
SENTS THE IMAGewriter APPLE PRESEN
S THE IMAGewriter APPLE PRESENTS THE IMAGewriter APPLI**

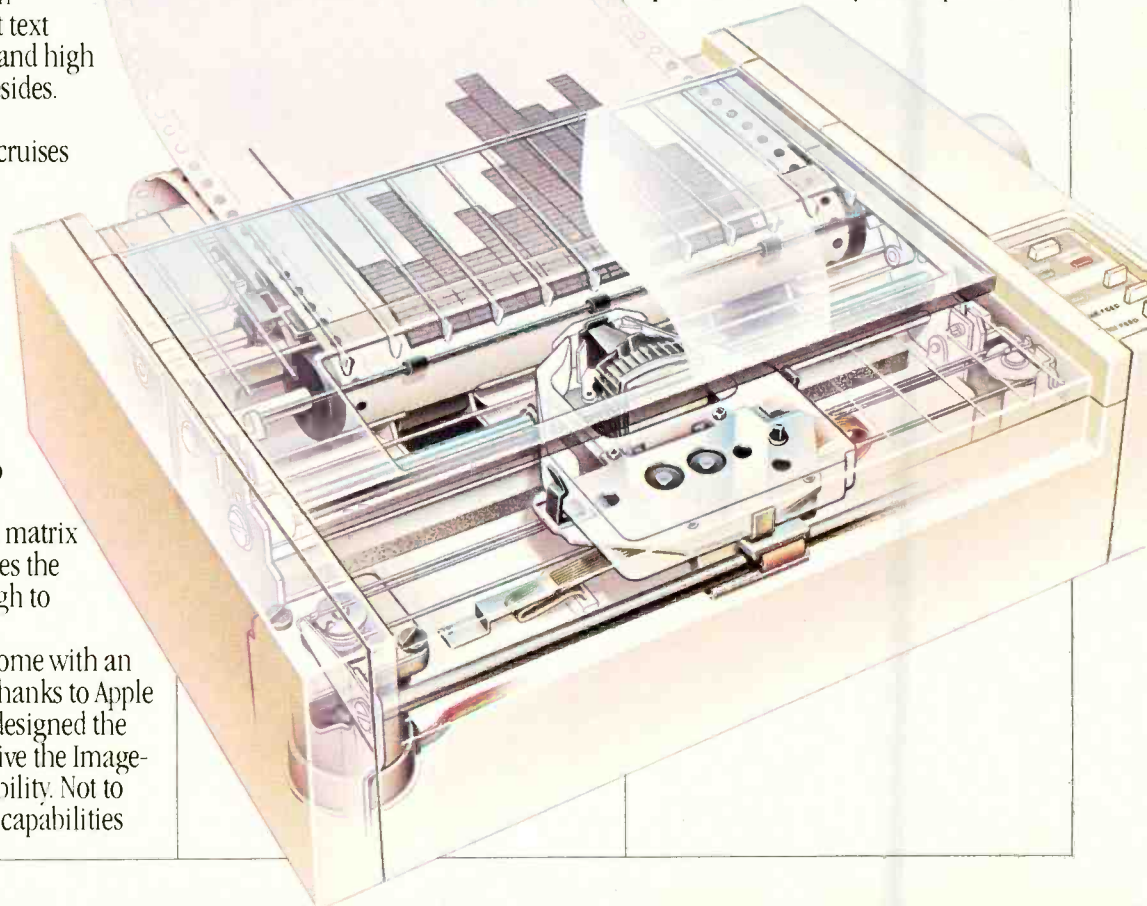

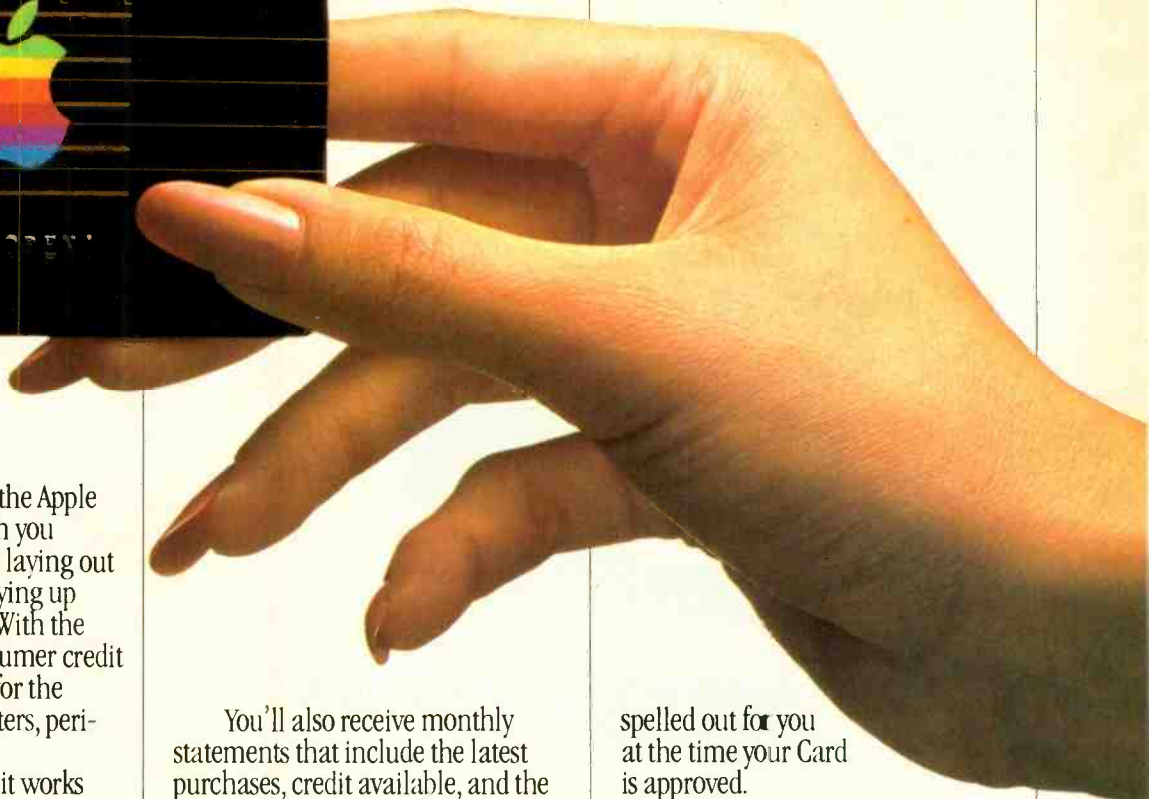
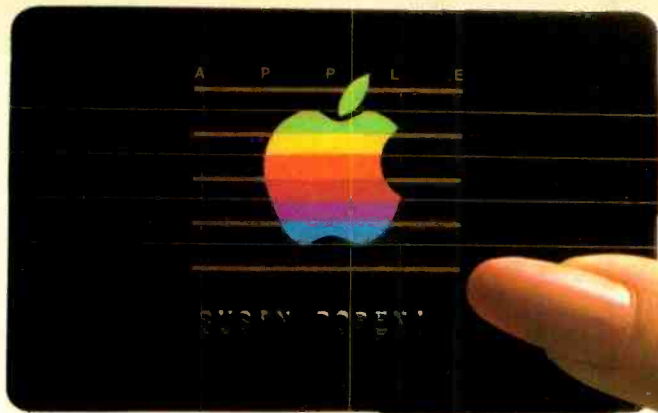

Charge!

Go out there and get the Apple Personal Computer System you really want. Now. Without laying out your extra cash. Without tying up your other lines of credit. With the Apple Card. The only consumer credit card reserved exclusively for the purchase of Apple Computers, peripherals and software.

Like all our products, it works simply:

Fill out an application (short, to the point and annotated in English) at an authorized Apple dealer honoring the Card. Your salesperson will call in the application and in most cases get an approval for you right on the spot.

You can then take your Apple system home. You don't even have to wait for the Card; we'll mail it out to you. And by the time you get it, you'll probably be well into doing whatever you bought your Apple system to do.

There is no annual fee for the Card, although a couple of restrictions do apply. The first purchase must include an Apple Personal Computer and you have to put 10% down. And subsequent purchases need to be at least \$100 if made with the Card. Oh, yes — you'll also have a credit limit.

When you use the Apple Card to make additional purchases, all you have to do is show the Card and sign the invoice. As long as it's within your credit limit, of course. Our dealers get a little nervous when someone signs for half their inventory. You understand.

You'll also receive monthly statements that include the latest purchases, credit available, and the minimum payment due. You'll also be happy to know Apple Card credit terms are affordable and the payments can be spread out. It's all

spelled out for you at the time your Card is approved.

So stop by a participating authorized Apple dealer and get an Apple Card. Just think of it as credit where credit is due.

Give your floppy disks the boot.

We call it the "floppy disk shuffle." It happens when you have two or more software programs on floppies and you need to work with both. What do you do? You put one disk in, boot it, do your work, take it out, put the other disk in, boot it, do your work — you get the idea.

Well, you can stop shuffling any time now.

Thanks to a unique new software program called Catalyst™ from Quark, Inc. Specially designed for your Apple III and ProFile™ hard disk.

Catalyst allows you to take a wide variety of software programs and store them on your ProFile. Once they're on your ProFile, you just select the program you want from the Catalyst menu that appears on your monitor — then Catalyst does the rest. You'll never have to boot those programs again.

What kinds of programs will work with ProFile and Catalyst?

Almost anything written for the Apple III including copy-protected programs like VisiCalc®, Quick File™ and Apple Writer III. Or languages like Pascal, BASIC, or COBOL.

And once you've loaded these programs into your ProFile, the only diskette you may ever need is the Catalyst.

So if you have an Apple III and a ProFile and more floppies than you care to flip through, get yourself a Catalyst. And boot those disks for good.

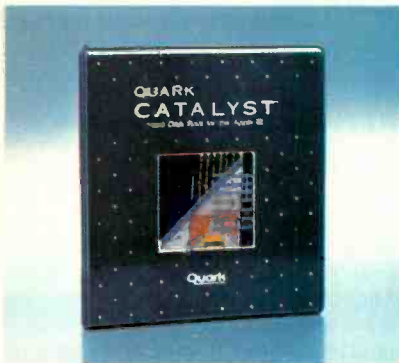

NEW PRODUCTS



IBM COMPATIBLE PORTABLE

The Model RL-H7000 Senior Partner from Panasonic is an IBM-compatible computer bundled with a wide range of software. The 8088-based computer comes with 128K (expandable to 512K) of RAM and a 320K floppy-disk drive, with room for an optional second drive. It features a built-in 80/132-column thermal printer; 9" 80 x 25-character green video display; color graphics capability with RGB output; Centronics

parallel and RS-232 serial ports; and a slot for an optional IBM-compatible expansion card. Software included with the Senior Partner includes: MS-DOS, Wordstar, VisiCalc, PFS File, PFS Graph, PFS Report, and GW BASIC. The computer is claimed to be able to run virtually all IBM software without modification, and its keyboard accepts IBM overlays. The 28.7-lb Senior Partner measures 18 $\frac{1}{4}$ " x 13 $\frac{3}{16}$ " x 8 $\frac{1}{4}$ ". \$2495.

Circle No. 91 on Free Information Card

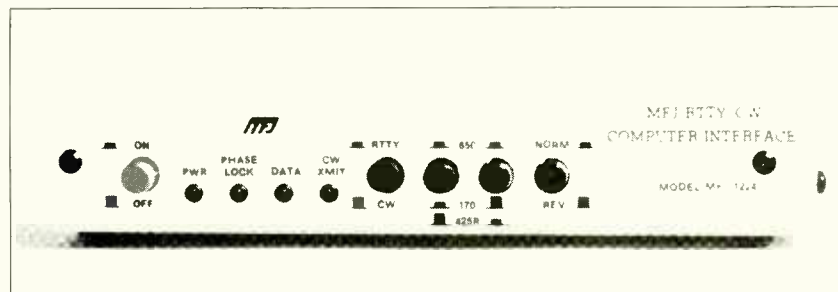

RTTY/ASCII/CW INTERFACE

The Model MFJ-1224 Computer Interface from MFJ Enterprises, Inc. lets radio operators use a personal computer as a full-feature RTTY/ASCII/CW send/receive communications station. The device copies on both mark and space and contains an automatic noise limiter and an eight-pole active filter for 170-Hz shifts to assure good copying

under varying signal conditions. It uses Kantronics software that features split-screen display; 1024-character type-ahead buffer; 10 message ports of 255 characters each; status display; CW-ID from keyboard; Centronics-type printer compatibility; and send/receive speeds of 5 to 99 wpm on CW, 60/67/75/100 wpm on RTTY, and 110/300 baud on ASCII. \$99.95 plus \$4.00 for shipping.

Circle No. 92 on Free Information Card

SOFTWARE SOURCES

Data Transfer. The Copylink communications package from U.S. Digital Corporation allows high-speed transfer of text and program code between dissimilar computers and operating systems, as well as providing access to public database services, Telex and TWX capability, unattended data transfer, and emulation of both smart and dumb terminals. Other features include: manual- and smart-modem support, advanced dialing features and null-modem (direct wire) transfers to 19,200 baud. Documentation includes a manual and a 334-page book, "The Complete Handbook of Personal Computer Communications." \$99.

IBM PC Tutorials. Cdex Corporation has released two comprehensive training tutorials for users of the IBM PC and PC-compatible computers. The two products, "How to Use Your IBM PC with PC-DOS" and "How to Use Your IBM PC with CP/M-86 and Concurrent CP/M," each include four diskettes of interactive instruction and a reference guide of important keystroke sequences and operating system commands. The programs are menu driven, and users can choose depth and pace at which they learn. \$69.96. Address: Cdex Corp., 5050 El Camino Real, Suite 200, Los Altos, CA 94022.

Idea Processor. "Docupower!" from Computing! is an idea organizer that works with any word processor. The product assembles your random paragraphs, sections, pages, or any other word-processor texts into a master indexed resource file of usable ideas. There's no need to retype anything you've already typed; just pick the sections you want from the master index to automatically create new texts, reports, letters, proposals, school themes, articles, etc. After you mark any sections, paragraphs, or groups of pages of text you think you may use again, Docupower! adds the material selected to a master resource file and automatically makes an index, sorted by category. The program is available in 20 disk formats for all CP/M, CP/M-86 and IBM PC-compatible computers. \$149. Address: Computing!, 2519 Greenwich, San Francisco, CA 94123.

TRS-80® Ultra-High Performance MS™-DOS System

The New Tandy Model 2000 Personal Computer

Radio Shack Heralds the Dawn of a New Era in Microcomputer Technology

This remarkable system delivers much more than other 16-bit MS-DOS-based computers. More speed. More disk storage. More expansion. Higher resolution graphics. And a modular design that advances the science of ergonomics.

Use the Hottest Names In Software

Like dBase II™ relational data base. Microsoft-Multiplan™ spreadsheet analysis. PFS®.File electronic filing. MultiMate™ word processing. And many more already acclaimed by the entire microcomputer industry.

Increased Speed, Storage and Expansion

A "next-generation" 16-bit CPU makes Model 2000 almost three times faster than the IBM® PC and faster than other MS-DOS computers, so you get the job done quicker. With 1.4 megabytes of storage, you can set up massive data bases. And you can add more memory, high-resolution color and monochrome graphics, our new Digi™-Mouse and much more.

Complete Support

The TRS-80 Model 2000 is backed with the quality and support that have kept Tandy Corporation in the forefront of the microcomputer industry. See it today at over 1000 Radio Shack Computer Centers nationwide.

TRS-80 Model 2000 With Two Disk Drives

2750⁰⁰

26-5103

Commercial Lease Available For Only \$95 Per Month (Plus Applicable Use/Sales Tax)

TRS-80 Model 2000 HD With Built-in 10-Megabyte Hard Disk

4250⁰⁰

26-5104

Commercial Lease Available For Only \$150 Per Month (Plus Applicable Use/Sales Tax)

Monitor, graphics and Digi-Mouse not included



Compare the Tandy TRS-80 Model 2000 to the IBM® Personal Computer

Price Comparison ¹	Tandy Model 2000	IBM Personal Computer
Base Unit	\$2750	\$2104
2nd Drive	Included (720K)	\$529 (320K)
Monochrome Monitor	\$249	\$345
Display/Printer Adapter	Included	\$335
128K RAM	Included	\$165
RS-232 ²	Included	\$120
MS-DOS 2.0	Included	\$60
Total Cost*	\$2999	\$3658
Feature Description	Tandy Model 2000	IBM Personal Computer
Internal Memory	128K Standard	64K Standard
Disk Capacity Per Drive	720K	160K or 320K (optional)
Microprocessor Clock Speed	8 MHz	4.7 MHz
True 16-Bit Microprocessor	Yes (80186) 16-bit/16-bit data path	No (8088) 16-bit/8-bit data path
User-Available Expansion Slots*	4	2
Graphics Options		
Color Resolution	640 x 400	320 x 200
Number of Colors	8	4
Monochrome Resolution	640 x 400	640 x 200

¹Comparable IBM configuration with monochrome adapter and display, communications adapter, two 320K disk drives and 128K RAM. ²Manufacturer's pricing as of 9/1/83.

Radio Shack®

The biggest name in little computers®

A DIVISION OF TANDY CORPORATION

Send me the Tandy Model 2000 brochure.

Mail To: Radio Shack, Dept. 84-A-681
300 One Tandy Center, Fort Worth, Texas 76102

NAME _____
COMPANY _____
ADDRESS _____
CITY _____ STATE _____ ZIP _____
TELEPHONE _____

Prices apply at participating Radio Shack stores and dealers. IBM is a registered trademark of International Business Machines Corp. PFS is a registered trademark of Software Publishing. MS and Multiplan are trademarks of Microsoft Corp. MultiMate is a trademark of Softword Systems Inc. dBase II is a trademark of Ashton-Tate.

NTS Electronics

Learn Robotics, Microcomputers, Microprocessors, Digital Video, Test Equipment and more with NTS INTRONIC™ home training. Courses include state-of-the-art equipment, lessons and texts to make your hands-on programs exciting and down-to-earth practical.

HERO 1 is included in two courses, one basic and one advanced. You'll cover principles of industrial electronics, microprocessor troubleshooting, fundamentals of mechanics, and robotic applications in industry. You'll learn analog and digital skills, radio control, fluidic, pneumatic and servo-mechanisms, as well as computer interfacing and robotic programming. HERO 1, complete with arm, gripper and speech synthesis board, is a fully self-contained electro-mechanical robot—the featured unit in the most exciting training programs ever offered in home study.

NTS Intronic Training is a carefully developed and tested learning system providing a thorough intergration of advanced electronic hardware with modern lesson texts. The relationship between theory and practical applications is made clear through the hands-on experience of building and assembling kits of state-of-the-art equipment. Courses include a wide variety of test instruments, both digital and analog, as well as other units not shown here. And, depending on the NTS program you select, you can earn up to 30 CEU credits for successful completion. Our full-color catalog has complete details. NTS has taught industrial skills for over 78 years—a record that has no equal.



Training.....

FIRST WITH TOMORROW'S TECHNOLOGY

1. **Advanced "Z Chassis" NTS/HEATH "Smart Set"** with computer space command remote control and space phone. Originate or receive telephone calls through this set and the number appears on the screen-store your police and other emergency numbers into memory which may be recalled and auto-dialed at any time. Traditional and incomparable picture quality. Unit has Quartz Controlled Tuning, 178 channel capacity, remote antenna switch accessory for reception of VCR, VDR, Broadcast, Cable, Video Games, and Personal Computer Input (no cable change) plus computer-controlled color. Featured in all-new Video Technology Course.

2. **NTS/HEATH HN89A Microcomputer** is included in two programs. This famous and reliable unit features Floppy Disc Drive, 48K Memory on Board, CRT Terminal with its own Z-80 Processor, and standard keyboard as well as Numerical Input Keyboard. The growing importance of computer knowledge and skills have made these programs increasingly significant. The experience gained in assembling these kits is invaluable in the understanding of computer troubleshooting skills.

3. **NTS Microprocessor Trainer** is included in our Industrial and Microprocessor Technology Course. It is a portable unit, contained in a convenient high-impact carrying case. Hardware/Firmware includes Monitor Operating System-Expandable User Memory-User Experimental On-Board Section-Breakpoint Editor-Single Step Trace-Cassette I/O.

NO OBLIGATION NO SALESMAN WILL CALL



TECHNICAL TRADE TRAINING SINCE 1905
Resident and Home-Study Schools
4000 So. Figueroa St., Los Angeles, CA 90037

Simulated TV Reception



Use the mail-in card or fill out and mail the coupon. Indicate the field of your choice. (One, only please.) FREE full color catalog will be sent to you by return mail.

NATIONAL TECHNICAL SCHOOLS Dept. 205-024
4000 South Figueroa Street, Los Angeles, CA 90037

Please send FREE color catalog on course checked below:

- | | |
|---|---|
| <input type="checkbox"/> Robotics | <input type="checkbox"/> Computer Electronics |
| <input type="checkbox"/> Digital Electronics | <input type="checkbox"/> Video Technology |
| <input type="checkbox"/> Auto Mechanics | <input type="checkbox"/> Home Appliances |
| <input type="checkbox"/> Air Conditioning/Solar Heating | |

Name _____ Age _____

Address _____

Apt. _____ City _____

State _____ Zip _____

- Check if interested in G.I. information.
 Check if interested ONLY in classroom training in Los Angeles

NEW PRODUCTS

DUAL SERIAL CARD

STM Electronics has a dual RS-232C serial card for its CP/M-based Pied Piper portable computer. The card provides two 110-to-9600-baud asynchronous/synchronous serial ports and is software controlled to eliminate the need for setting DIP switches. Users can readily configure the two ports to be either synchronous or asynchronous and adjust baud rate to meet different requirements. \$120. Address: STM Electronics Corp., 525 Middlefield Rd., Suite 130, Menlo Park, CA 94025.



RGB/COMPOSITE-VIDEO COLOR MONITOR

Taxan's new RGBvision Model 210 is an RGB and composite-video color monitor for the Apple II+ and IIe computers. Its medium-resolution display capability offers 380 lines resolution with 0.63-mm slit pitch, and a 15-MHz bandwidth. The composite-video mode is NTSC standard and offers 2 watts of audio output power. It features on/off-volume and contrast controls up front and brightness, sharpness, color, and hue controls on the rear. A removable antiglare screen is provided. \$399.

Circle No. 94 on Free Information Card

COMPUTER/VIDEO INTERFACE

A new computer/VCR interactive interface and authoring system for the Commodore VIC-20 and C-64 computers has been announced by Videobook Corp. The Prometheus interface connects the computers to any Panasonic 5000, 6500, or 8500, Canon, or Hitachi VCR. A retrofit modification kit for solenoid VCRs that lack the required input plug will soon be available. \$49.95. Address: Videobook Corp., PO Box 19597, Seattle, WA 98109.



COLOR PLOTTER

A multi-color plotter, Model 410, that produces presentation-quality graphs and charts on paper and transparencies has been introduced by Apple. The plotter is compatible with Apple Business Graphics and many other software programs that utilize the high-resolution, multi-color graphics capabilities of the Apple II and Apple III. It features four color pens that can be automatically interchanged during graphics software execution. Plotting speed is specified at

3.94I per second, with 0.004I resolution and 0.008I repeatability. Media size can be up to 11" x 17". The plotter uses a standard RS-232C serial interface to connect directly to the Apple III's built-in serial port, while Apple's Super Serial Interface Card is required to connect the plotter to Apple II, II Plus, and IIe. Supplied with the plotter are: connector cables; 50-sheet package of 8½" x 11" plotter paper; eight different color pens for paper printouts; and operating and installation manuals. \$995.

Circle No. 93 on Free Information Card

HIGH-PERFORMANCE DESKTOP COMPUTER

Tandy's new TRS-80 Model 2000 Personal Computer is an MS-DOS-based system that offers a high-performance, next-generation processor for the pro-



fessional microcomputer user. It uses the Intel 80186 16-bit, 8-MHz microprocessor with full 16-bit data path to give it almost three times faster speed than MS-DOS systems built around the 8088 processor. Included with the computer are two thin-line 5¼" floppy-disk drives with 720K capacity per drive; 640 x 400-pixel display resolution with capability of displaying up to eight colors; 128K of RAM (expandable to a system total of 768K); detached keyboard with 12 function keys and separate numeric keypad; display/printer adapter; RS-232 serial I/O port; and four expansion slots. Supplied at no extra cost with the computer are MS-DOS and BASIC. Available as options are monochrome and color video displays. The Tandy 2000 System retails for \$2750. The Tandy 2000 HD System, which replaces one floppy drive with a 10M hard disk and 256K of RAM, is \$4250.

Circle No. 95 on Free Information Card

Complete WORD PROCESSING SYSTEM \$995

(Featuring: "THE SCRIPT 64" 80 COLUMN EXECUTIVE WORD PROCESSOR)

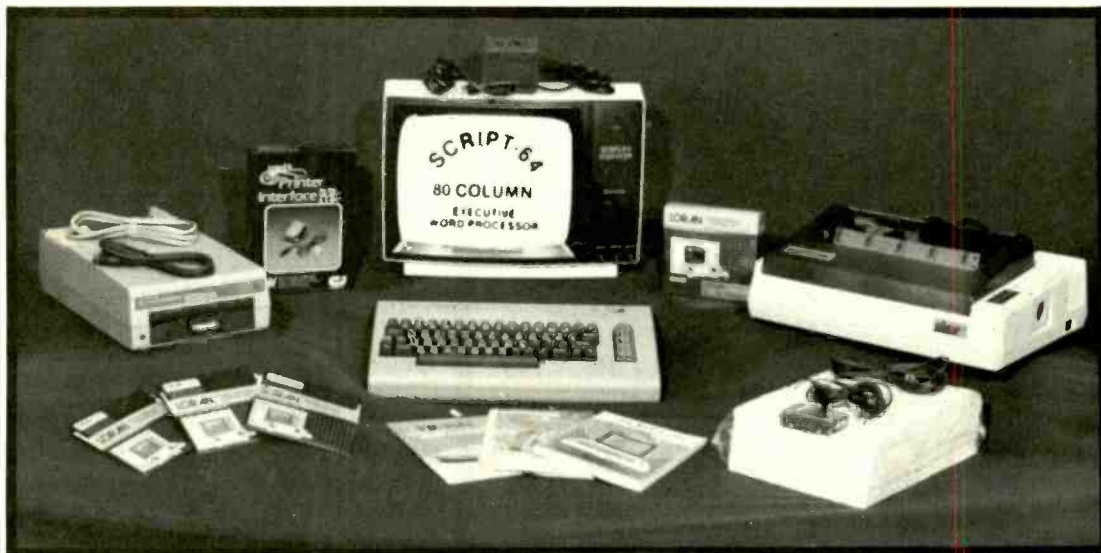

LOOK AT WHAT YOU GET FOR ONLY \$995.00

1. "THE SCRIPT 64" Executive Word Processor, 80 column in color or black and white, 20,000 word dictionary, data base, mail merge and labels! Developed by Richvale Telecommunications Ltd. 2. The powerful 84K Commodore 64 Computer! (more features than Apple II) 3. 170K Commodore 64 Disk Drive! 4. Box of 10 "Loran" Disks! 5. Gemini 10X Starmicronics, 10" Carriage Deluxe, 120 CPS, Dot Bit Addressable, Tractor-Friction Printer! 6. Deluxe Cardco Printer Interface! 7. Box of Printer Paper! 8. 12" Green or Amber Screen "Sanyo" Monitor! 9. Monitor Interface Cable! 10. "Special Software Coupon" that allows \$100 to \$300 savings!

PLUS! THE  **Olympia** OPTION!!



You can add the  **Olympia** Electronic Typewriter/Computer Printer for **Superb Letter Quality** correspondence and documents! Now you can have the best **Electronic Typewriter** made and used by the world's largest corporations (better than IBM Selectric) plus — a **Professional Computer Printer** (two machines in one) for only \$395.00 additional cost!! List Price \$799.00. (Competitive word processing systems sell for \$3000 to \$5000 without the electronic typewriter feature!!!)

15 DAY FREE TRIAL We give you 15 days to try out these SUPER SYSTEM PACKAGES!! If it doesn't meet your expectations, just send it back to us prepaid and we will refund your purchase price!!

90 DAY IMMEDIATE REPLACEMENT WARRANTY If any of the SUPER SYSTEM PACKAGE equipment or programs fail due to faulty workmanship or material we will replace it IMMEDIATELY at no charge!

Add \$50.00 for shipping and handling!!

Enclose Cashiers Check, Money Order or Personal Check. Allow 14 days for delivery, 2 to 7 days for phone orders, 1 day express mail! Canada orders must be in U.S. dollars. We accept Visa and MasterCard. We ship C.O.D.

**PROTECTO
ENTERPRIZES** (WE LOVE OUR CUSTOMERS)

BOX 550, BARRINGTON, ILLINOIS 60010
Phone 312/382-5244 to order



Timex turns your home into a bank, a library, a shopping center, an airline reservation office, a schoolroom, an electronic post office and a whole lot more.

The remarkable new Timex Sinclair 2068 computer system brings a fascinating world of telecommunications into your home.

With the addition of the TS 2050 Telecommunications Modem, the new Timex Sinclair 2068 computer can be linked with telephone lines, allowing you access to other computers around the world.

A new world of opportunities.

You can shop at home for thousands of items and charge them to your credit cards. Call on specialized data banks for information. Pay your bills. Look up airline schedules and reserve your seat. Tie into Dow Jones News/Retrieval® for the latest quotes on stocks.

You can also use your Timex computer and modem to send mail. Overnight, you can have a paper letter delivered for less than half the price of air express.

It's all possible when you tie into telecommunications services like CompuServe, Dow Jones News/Retrieval®, MCI Mail and THE SOURCESM.

Timex even makes that easier.

\$169 Telecommunications bonus.

When you buy a TS 2068 computer and TS 2050 modem, you'll also receive membership to THE SOURCESM America's information utility. Plus free use of the CompuServe demonstration area. And if you subscribe to CompuServe, two free hours of standard service connect time. Plus an introductory offer when you register with MCI Mail lets you send your first letter free.

And registering for MCI Mail automatically gives you a complimentary subscription to Dow Jones News/Retrieval®.

Behind it all, a great computer.

72K. Color. Sound. Under \$200.

The heart of the Timex Telecommunications system is the Timex Sinclair 2068, a second-generation home computer designed with one purpose in mind—to be useful. With 72K on-board memory, it's powerful enough to entertain you with brilliant color graphics and 8-octave sound. Plus do word processing as well as spread sheet functions.



Its unique one-touch entry requires no typing skills. And the new Timex Sinclair Command Cartridges can be used without any knowledge of programming.

For your personal records, you can add the TS 2040 printer. For game playing, the Timex Sinclair Command Stick is designed for fast-action firing. And the TS 2020 Program Recorder makes loading programs fast and easy.

So whether you use the Timex Sinclair 2068 for telecommunications, or simply as a great home computer, you've got a powerful performance package. To purchase it, see your local dealer or mail the coupon.

Touch more of the world, with Timex.

Mail to: Timex Computer Corporation, P.O. Box 3138, Dept. CE, Wallingford, Conn. 06492. Or call: 1-800-24-T-I-M-E-X.

Item	Price	Qty.	Total
Timex Sinclair 2068 Computer	\$199.95		
Timex Sinclair 2040 Printer	\$ 99.95		
Timex Sinclair 2050 Modem	\$119.95		
Timex Sinclair 2020 Recorder	\$ 49.95		
Timex Sinclair 2090 Command Sticks	\$ 14.95 ea.		
Offer good only in U.S.A.		Please add \$5 handling charge.	\$5.00
		Connecticut residents please add 7½% State tax.	
I enclose a check/money order for \$ _____			Total
Please charge my VISA®/MasterCard™ account no. _____			
Exp. date _____			

Name _____

Address _____

City _____

State _____

Zip _____

TIMEX **sinclair 2068**

RUMORS & GOSSIP

► Apple is rumored switching to Sony microfloppy in its forthcoming Macintosh microcomputer, a less-pricey version of the Lisa. . . . Adam Osborne is reportedly about to start a new venture based on software publishing. . . . Commodore is expected to shortly announce a new disk drive for the C-64 which employs the user port rather than the 488 serial bus interface. This would speed disk I/O, the slowness of which has long been a complaint of C-64 owners. . . . Videobook Corp., Seattle, WA, is rumored readying a personal computer that runs Apple, Commodore 64, and IBM PC software and sells for under \$500. . . . MicroOffice Systems Technology, which introduced the "RoadRunner" knee-top computer last fall (with an 8-line by 80-character LCD display, running CP/M) is promising to introduce units with 16- and 25-line displays by mid-year. . . . At least six IBM PC clones are expected from Taiwan during the first quarter of this year. . . . Morrow Designs is expected to announce transportable and portable machines compatible with the IBM PC. . . . Mattel Inc., maker of the Aquarius home computer, is rumored getting ready to follow in TI's footsteps and exit the home computer business.

OSBORNE NEWS

► Don't count Osborne Computer Corp. out of the game yet. Despite the fact that the company is operating under Chapter 11, there are signs that Osborne computers may live on. The Osborne I and Executive models are still selling well in England where IBM PC only recently went on sale, and portables such as the Compaq, Corona and KayPro are either not yet available or have very limited distribution. In fact Osborne is selling so well in England that the British distributor is considering starting production there. The Osborne machines are also still doing well in Canada and several other foreign countries, too.

Here in the U.S., many dealers who have healthy stocks of Osborne units are holding "close-out" sales offering the Osborne I for as little as \$800 and the Executive for under \$1500. These prices offer buyers real bargains since Xerox has gone on record as promising to provide service support for these units for at least another two years and purchase

\$1 million in spare parts from Osborne.

There are rumors that several companies are interested in buying the company. It still has several thousand Osborne I and Executive models in inventory and the parts to build many more. The company also has reportedly completed development of an IBM PC compatible version of the Executive and a true portable, and is ready to go into production on the units.

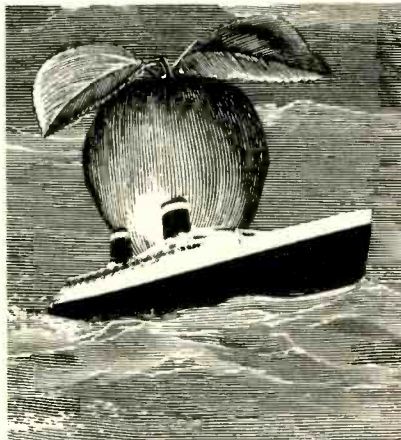

APPLE NEWS

► If you have been to a local computer flea market lately, you are aware that Apple has not yet won the battle of stopping the importing of Apple II clones from the Far East. Although Apple has been successful in having the U.S. customs service impound Apple copies, it has not been able to stop importing of parts to build Apple IIs. Thus, at computer flea markets one sees printed circuit boards and assembly instructions for the Apple II being sold for as little as \$25. And there are Apple II keyboard copies, ROMs, and a bag of parts, power supply, and even cases. So a copy of the Apple II can be put together by a hobbyist in a few hours for under \$300.

Further, dealers, despite Apple's attempts at preventing discounting of units, are offering discounts on the IIs. Most dealers attempt to conceal them by bundling the unit with peripherals and software. However, there are dealers selling the basic unit unbundled for well under \$1000. Apple is expected to shortly reduce the suggested retail price of the IIs to just under \$1000.

Apple Computer and Rana Systems Inc. have entered into an agreement to provide a disk add-on system for the

Apple II that will provide IBM PC compatibility. The add-on will provide two 360K drives, 8088 processor, 256K of RAM, and the MS-DOS operating system for just under \$2000. The success of this product is uncertain since it costs more than the Apple itself.

Apple's "Elf" transportable computer (rumored in this column previously) should be announced by the time this appears in print. The unit is expected to use a 6500-type processor and hence have a high level of Apple II compatibility. It should have 64K of RAM expandable to 128K with some expansion slots on the motherboard. It will use a microfloppy drive and, thus, the overall unit will be physically much smaller than the Apple II. RS-232 and Centronix ports are expected to be standard. A true battery-operated, portable CMOS version is expected before year-end.

BAD TIMES IN THE HOME COMPUTER BIZ

► Atari, which had expected to ship at least a half million of its new XL series of computers by the end of last year, is rumored to have actually shipped only a little over 100,000 units. Shipments, which were supposed to begin in September, did not begin until mid-October.

Atari is rumored readying a new high-end computer that is IBM PC compatible. If true, it may signal a move by Atari away from the low-end home computer business in which it has as yet to show a profit.

Warner Communications, Atari's parent, reported a loss for the first 9 months of '83 of almost \$425 million. While the company's profits from other businesses rose by 32%, the Atari video game and computer divisions produced a loss of over \$536 million on sales that dropped from \$1.41 billion to \$753.6 million.

Texas Instruments exited the home computer business after losing half-a-billion dollars on its 99/4 computer. It held a "fire sale" during the Christmas season to sell off over 100,000 units in stock. And Coleco Industries, which promised to start shipping its Adam system by the end of last August, did not actually begin shipments until the end of October. Thus it expects to ship

BITS & BYTES

far less than the half-million units promised by the end of '83.

Interestingly, Atari and Coleco reacted to the introduction of the IBM PCjr home computer by raising their home computer prices. The PCjr, which is tagged for \$669 base price for its entry model, may signal a leveling off in the pricing battle that has laid waste to the home computer market.

MORE BAD NEWS IN THE COMPUTER BIZ

► Digital Equipment Corporation disclosed that it had sold about 19,000 micros in the last quarter, about 30% less than it had expected.

Apple Computer revealed that earnings for the last quarter dropped by 73% despite an increase in sales of 55%. Expenses for research and development and marketing and distribution soared.

NATIONAL SAMPLING 32-BIT MICRO

► National Semiconductor started shipping samples of its new NS32032 32-bit microprocessor last October, fully two months before its promised shipment date. National claims that the 32032 is the first microprocessor to break the 1-MIPS (Million Instructions Per Second) barrier and that it will have a 7-MIPS unit by 1987. The unit is said to be upward compatible with the National Semiconductor 16000 line of 16-bit microprocessors and it operates at 6 MHz (a 10-MHz unit is expected shortly). The 32032 is expected to find wide use in applications such as CAD/CAM, telecommunications, robotics, and military and space applications.

NCR is also sampling a 32-bit microprocessor and Intel is expected to begin sampling its 80386 micro (upward compatible with the 8088 and 8086) this spring.

FIRST OPTICAL STORAGE DEVICES

► Shugart has released its Optimem 1000 1-gigabyte optical disk drive, priced at \$6000. The device uses a laser to write indelible information on a preformatted 12" removable cartridge optical disk. This is now the second such unit to become available, the first

being from Panasonic. Panasonic is also shipping a 7" video disk that some customers are using for data storage. An erasable version is expected next year.

Storage Technology is expected to introduce a 4-gigabyte optical unit using a 14" medium and a technology similar to that used by Shugart. The unit will be compatible with IBM mainframes.

NEC and 3M Co. are cooperatively developing a unit with 12" disks and a



technique using a laser to burst preformed blisters. NEC is expected to start shipping units shortly. Phillips, Sharp and Sony are also known to be working on systems even though no formal announcements have been made. Hitachi, Toshiba, and Sanyo are all currently beta testing small low-cost units and announcements are expected shortly.

THE SOFTWARE SHAKEOUT

► Sale of software is approaching that of the record business (\$3.5 billion) and the number of new programs issued last year exceeded the number of new record albums introduced. PC Telemart, Fairfax, VA, a computerized catalog, already lists 15,000 titles and 40,000 products (many titles come in different versions for different computers). The number of software products doubled last year and will probably double this year again.

The explosive growth in the number of software products has made the role of the software distributor more important than the developer. Thus, Softsel Computer Products, a distributor, did an \$8-million business last year, while the leading developers such as

Microsoft, VisiCorp, MicroPro and Digital Research did \$70, 53, 51, and 46 million, respectively.

All of the leading software developers businesses are based primarily on one product and they are striving to broaden their product lines. About 50% of Microsoft's revenues came from its Basic interpreter, for example.

Some companies have already begun to offer inducements to salesmen to push their products. So far the software market has not seen a price war, but new products being introduced are carrying lower prices and price declines are inevitable.

RANDOM NEWS BITS

► Xerox, which only two months ago boasted that it planned to open 50 computer stores a year for the next few years, has sold off 43 of its current stores and shut the remaining 10. Rumors are that they always operated in the red. . . Intel has introduced a nonvolatile byte-wide 4K RAM. Its secret is an EEPROM shadow memory that retains data when power is turned off. . . Docutel/Olivetti has introduced a kneetop computer. What is interesting about the unit is that it is the third such machine (the other two are from Tandy and NEC) designed and made by Kyocera in Korea. . . Bank of America announced a "Personal Computer Account" for owners of home computers who wish to do bank transactions using their systems and the phone lines. . . Fujitsu Ltd. is the first company to introduce a personal computer using the Microsoft MSX operating system. Sales of the unit are currently being limited to Japan.

QUOTATION OF THE MONTH

► "The iAPX432, although not a business success, is a technical triumph in that it blazed a lot of computer architecture territory. We developed a number of capabilities and functionality that we have since adapted to products like the 286 and 386. We do believe in the architectural direction of the 432 and are currently very intensely developing the next 432 product."

David House
Vice President & General Manager
Microcomputer Group
Intel Corp.

LES SOLOMON ON

COMPUTER HARDWARE

THE ULTIMATE COMMUNICATOR

DURING the past several years, I have been reading about the latest communication techniques using satellites and physically small, low-power transmitters that enable scientists to keep track of the movements of small creatures wandering about the surface, or in the seas, of this planet. It appears that constant monitoring can take place whether the small animal is scurrying around the polar icepacks, creeping through tropical jungles, or swimming around in some lagoon.

The thought struck me the other day that this monitoring technique could form the basis for what I call the "1984 Ultimate Communicator," a technique that combines computer technology, digital devices, and a little r-f technology.

Consider the digital watch that most of you have on your wrists. The complexity of even "el cheapo" model is the equal of that used in large-scale digital computers only a few years old. They have seven-segment LCD readouts, multi-functions (some include a calculator), and even a liquid-crystal screen capable of resolving TV images. And the power source for all this digital activity? A cell so small that it can be easily lost in a pocket or purse—yet so powerful that the watch can run for a couple of years before battery replacement.

Now let us look at a couple of recent developments. First is a new technique that allows an LCD screen that is the equivalent of an 8" diagonal CRT to display 25 lines at 80 characters (the same as most terminals). The second is the development of "software on a chip" (in this case CP/M), while the third is new CMOS deposition techniques that allow a 256K-bit RAM or a CPU to have a mere 10- μ A standby power. In fact, as the deposition goes under a 1- μ m line, even greater chip densities can be reached.

The r-f and telemetry devices have

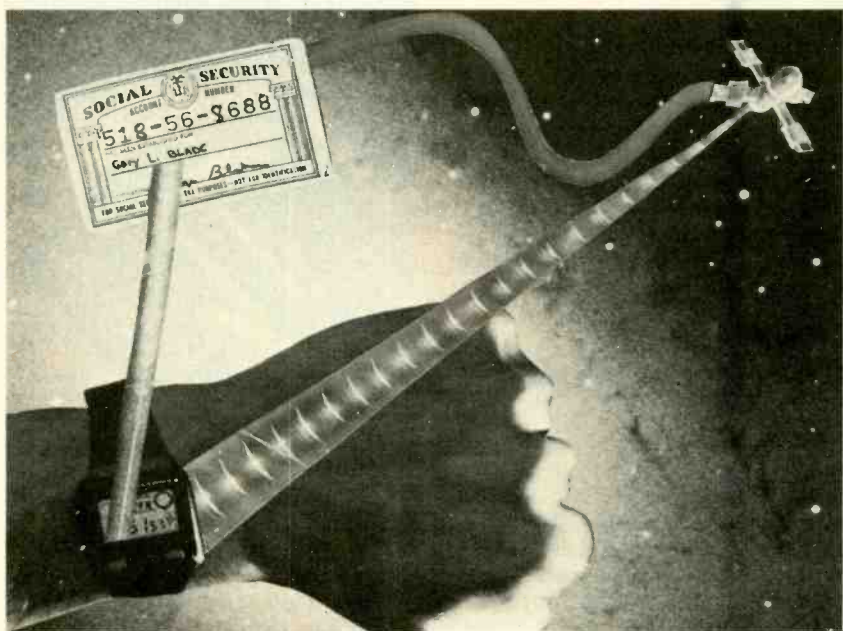

An ever-watchful satellite will have your number.

also reached new highs (or is it smallness) in physical size and required operating power. If the package is small enough not to bother a small animal, then it will not bother a larger animal—man.

Now let's put the items together.

Even with only a slight knowledge of electronics, you can see that it is now possible to build a digital device that will act for all intents and purposes like a conventional computer terminal, but instead of being tied to a telephone line so that data can be passed back and forth, it is coupled via a radio link to a satellite somewhere up there.

Since any given satellite can cover a good portion of this planet, and since satellites can communicate with each other, this allows two-way communications between an earth station and a personal communicator to take place no matter where on the planet the user is.

But that is not all. Since the introduction of digital computers, methods for maintaining data integrity have been at the forefront. In the area of personal computers alone, software "piracy" has cost the fledgling industry millions of dollars. In industrial, scientific, banking, and military areas, data integrity is paramount. This has given birth to a new set of chips called "data encryption" devices that will allow data communication only when a unique user code is employed. (One out of 2 to the 57th power in the case of one chip.)

Thus, it is possible for each person to be given a unique number (Social Security?) at birth, and use this number for all data communications. Since this is a unique set of personal digits, and since satellite transmissions even now cover the planet, if anyone called your number, and you didn't answer, you would be among the missing. \diamond

"I built this 16-bit computer and saved money. Learned a lot, too."

Save now by building the Heathkit H-100 yourself. Save later because your computer investment won't become obsolete for many years to come.

Save by building it yourself. You can save hundreds of dollars over assembled prices when you choose the new H-100 16-Bit/8-Bit Computer Kit - money you can use to buy the peripherals and software of your choice.

The H-100 is easy to build - the step-by-step Heathkit manual shows you how. And every step of the way, you have our pledge - "We won't let you fail." Help is as close as your phone, or the nearest Heathkit Electronic Center.†

And what better way to learn state-of-the-art computing techniques than to build the world's only 16-bit/8-bit computer kit? To run today's higher-speed, higher-performance 16-bit software, you need an H-100. It makes a big difference by processing more data faster.

Dual microprocessors for power and compatibility. The H-100 handles both high-performance 16-bit software and most current Heath/Zenith 8-bit software.

Want room to grow? The H-100's standard 192K byte Random Access Memory complement can be expanded to 768K bytes - compared to a 64K standard for many desktop computers.

And the industry-standard S-100 card slots support memory expansion and additional peripheral devices, allowing your investment to grow.

High-capacity disk storage, too. The H-100's 5.25" floppy disk drive can store 320K bytes on a single disk. The computer also supports an optional second 5.25" and external 8" floppy disk drives. For maximum storage, an optional internal Winchester disk drive is also available.

For more information, circle the reader service number below. Better yet, visit your Heathkit Electronic Center for a demonstration!

H-100 SERIES COMPUTER SPECIFICATIONS:

USER MEMORY:

192K-768K bytes*

MICROPROCESSORS:

16-bit: 8088

8-bit: 8085

DISK STORAGE:

5.25" disk drive,

8" disk drive

Winchester drive

KEYBOARD:

Typewriter style, 95 keys,

13 function keys,

18-key numeric pad

GRAPHICS:

Always in graphics mode.

640h/225v resolution; up to eight colors are available**

COMMUNICATIONS:

Two RS-232C Serial

Interface Ports and

one parallel port

DIAGNOSTICS:

Memory self-test

on power-up

AVAILABLE SOFTWARE:

Z-DOS (MS-DOS)

CP/M®

Z-BASIC Language

Microsoft BASIC

Multiplan

SuperCalc

WordStar

MailMerge

Data Base Manager

File Manager

General Ledger

Accounts Receivable

Accounts Payable

Inventory Control

Sales Invoicing

Lotus 1, 2, 3

PeachText 5000

Fortran-86

Cobol-86

Pascal

Basic Compiler

Most standard

8-bit CP/M

Software

*192K bytes standard.

**Optional.

CP/M is a registered trademark of Digital Research.



The H-100 gives me the most for my computer dollar!

Heathkit®

Heath
Company

A subsidiary of Zenith Radio Corporation

†Heathkit Electronic Centers are units of Veritechnology Electronics Corporation.

Circle No. 28 on Free Information Card

ADAM ARRIVES



Useful as soon as it's uncrated, Adam is an exciting package for the beginner or experienced computerist

By Charles P. Rubenstein

THOUGH almost too long ago to remember, Coleco's introduction of the Adam Family Computer System last summer had the same kind of impact as a 90%-off sale at a department store. After all, Coleco was offering an 80K computer with a high-speed digital tape drive, a daisy-wheel printer, and bundled software for the unheard of price of \$600! Normally, that amount could only buy the printer. And with the reputation that the company had built up with its enormously successful ColecoVision video game machine (whose cartridges are compatible with the computer), you just knew that Adam was something special. Now, after months of waiting and a couple of price increases (the latest suggested retail figure is \$750), Adam has emerged. Here's a hard look at this exciting package.

The Basic System. The Adam Family Computer System consists of a keyboard, a memory console with built-in digital data drive and ColecoVision cartridge port, a SmartWriter daisy-wheel (letter-quality) printer, connecting cables, adapters, and a pair of multi-function ColecoVision controllers. Also included in the basic package are three digital data packs (C-250 tape cassettes): SmartBASIC, "Buck Rogers Planet of Zoom," and a preformatted blank tape.

When you turn Adam on, it comes up as an electric typewriter. Press a key and it becomes a word processor. Load a tape and you can learn and use BASIC



The keyboard and two multi-function ColecoVision controllers.

or play true-to-life arcade games.

A Look Inside. The recipe for Adam's "central nervous system" goes something like this: take one Z80 microprocessor and 64K RAM, add a ColecoVision video controller and 16K of video RAM, and stir gently. Then fold in a "master" Motorola MC6801 single-chip microcomputer as a network controller. Finally, add three more MC6801s to govern the operation of the digital data drives, the printer, and the keyboard.

The MC6801s operate at a 1-MHz clock rate in a network arrangement that treats each of the peripherals (printer, tape drive, and keyboard) as a separate self-contained computer system.

Identification and communication among these intelligent peripherals is accomplished through the "master" network controller in communication with each unit's National LM339 quad comparator used as a port decoder. All

of this is orchestrated, as necessary, under the control of the Z80 microprocessor.

Adam's memory allocation is shown in Table I. There is the basic 64K RAM and an additional 16K of video RAM. The built-in word processor is contained in a 24K ROM and a general-purpose operating system takes up another 8K ROM. There is also 8K of ROM dedicated to peripheral control. Adding up the pieces, the basic system comes with 80K RAM and 40K ROM.

The Memory Console. Adam's memory console contains the Z80 microprocessor; a Coleco video controller; the master and tape-drive MC6801s; 80K of RAM; the 24K word-processor ROMs; a ColecoVision game-cartridge socket; an "Adamnet" 6-pin modular telephone plug connector; a 60-conductor edge-card expansion bus; an r-f modulator; and three card sockets (two 30-pin and one 44-pin edge-card connectors) for whatever the Coleco wizards decide

It achieves its operating goals and nothing is near it for the price

they want to come up with next.

The 19" × 13.75" × 4.25" memory console weighs in at about 9.5 lb with a single data drive. Unseen by the user is the completely r-f shielded computer and video-signal generator boards inside the console. Adam provides for a variety of audio/video outputs at the rear of the console. There is a standard (r-f) TV output through a phono plug which can be switched to channel 3 or 4 as desired. Another phono plug supplies video output signals for standard monitors, and a third yields both audio and video signals on a 7-pin DIN plug. On the right side of the console are two ports for the ColecoVision hand controllers, and an expansion slot. On the left side are a power and printer-output connector as well as the Adamnet connector. The keyboard cable connects to a 6-pin modular telephone plug on the front in the lower right-hand corner.

The digital data drives are conveniently poised for operation on the front left side of the console. One drive comes with the basic system while a second optional drive can be easily installed by the family user in about 10 minutes with a Phillips screwdriver. The drives are reasonably designed except that it is easy to insert a data pack in backwards due to inadequate labelling of the pack front. However, Adam "knows" that the pack is not in properly, and says so; but I perceive that the life of the drive may be reduced somewhat due to forcing the pack in. The doors seem a bit too flimsy and actually bow out when properly inserted data packs are in use. This is caused by spring-operated safety features that assure good data transfer. The drive is on whenever a tape is in it since the tape is constantly being stretched to keep it taut. This tends to heat the drive, and thus the pack. There is no indicator to tell you when the drive is running nor any mechanism to prevent the door from being opened while the pack is in use.

The C-250 digital data pack cassette tapes are preformatted to hold about 500K (253 2K blocks) of data or, as advertised, about 250 double-spaced pages of text. To give some feel for what this means, the complete four-level "Buck



Memory console with data drives and game cartridge socket.

Rogers Planet of Zoom" program is about 144K long. There are no true specifications for the drives or pack other than the supposed access time of 19.2 kilobytes/second. I found that this number is of no great consequence since a considerably longer time is spent checking the directory, finding and loading the program, and then executing it (i.e., 56K of SmartBASIC loads in about 68 seconds).

The Keyboard. Adam's keyboard is networked and controlled, as are all of its peripheral devices, by an r-f-shielded, Motorola MC6801 single-chip microcomputer and LM339 quad comparator device decoder. The keyboard unit is housed in a rugged beige and brown plastic case, and attached to the memory console by means of a 6-wire, modular telephone-type connector. Its 75 keys are the full-travel, tactile-feedback type designed for both the more brutal among us, and our young children. The keys are ruggedly built, yet they let you

know when you have pressed them properly. Their initial feel, to individuals familiar with more conventional typewriter and terminal keys, leaves something to be desired. In fact, they feel quite tinny. However, after using the keyboard a while, you become accustomed to it.

The keyboard is composed of a 54-key standard alphanumeric keyboard (includes TAB, CONTROL, SHIFT, and LOCK keys); a set of 6 "smart keys" labelled I, II, III, IV, V, and VI above the standard area; a set of 10 function keys for use with the word processor; and five cursor-control keys.

The SmartWriter Printer. Another peripheral means yet another MC6801 networked into Adam's central nervous system. However, the printer is more than just another smart peripheral. For beating inside the bowels of this cleverly designed daisy-wheel is the system power supply.

The SmartWriter constitutes, at the

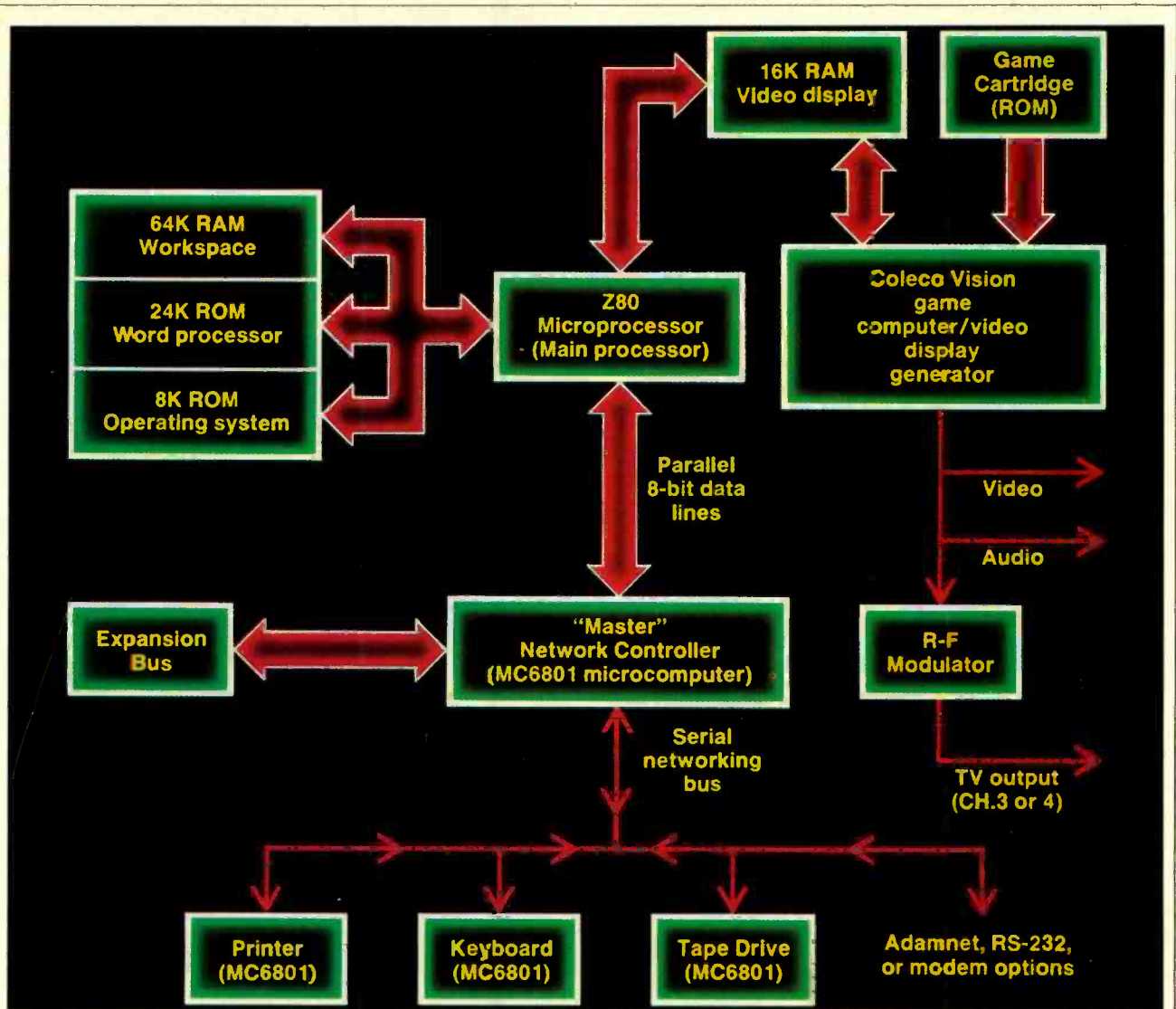

Block diagram of Adam's "central nervous system."

very least, a major breakthrough in cost-effective packaging. Here, included with the complete Adam computer system is a 10-character-per-second letter-quality, bidirectional daisy-wheel printer whose cost should be what the entire system is being sold for. Yes, it is a bit noisier than the dot-matrix printers that retail around \$400; yes, the construction is not as rugged as you might want; and yes, it is a bit difficult to insert and adjust paper in the platen. But—the sound level of this printer is only slightly higher than an IBM Selectric, or other daisy-wheel printer (probably because of its plastic shell construction); And its cost, if available separately, would probably be under \$200!

Of course, when compared with printers costing much more, there are some problems with the design of the printer. The line cord and power cable both are connected in the center rear of the printer making the use of fan-fold paper a bit sloppy. The daisy-wheel mechanism is exposed to little hands

and inquisitive fingers. And, as a result of the internal *system* power supply, the printer "hums," the left side of the paper platen (above the power transformer) gets warm (about 3°C above room temperature), and the rear upper-right-hand corner of the top of the printer gets hot (about 15°C above room temperature).

As is often the case with inexpensive daisy-wheel printers, the letters often get printed on an ever-so-slight angle. On testing the printer speed and word-processor abilities, I found an even greater problem which may be related only to fan-fold paper. The printer sometimes inserts a space(s) between lines. I printed out 53 lines of copy, and the printer inserted seven random line spaces! Repeating this test four times resulted in a total of 24 random line spaces. The speed at which this was accomplished was a respectable 10.73 characters/second. A 9-line screen, printing from within the word processor, was printed in about a minute, at a

rate of 9.79 cps. As an aside, built into Adam is an irreversible CTRL P command which will attempt to print everything currently on the screen. This can be helpful when writing BASIC programs when you do not wish to have only a listing of the program, but rather the results, etc., as well.

The ColecoVision Controllers. There are two multi-function ColecoVision controllers. One can be placed in a cradle on the right side of the keyboard and serve as a joystick cursor controller and as a number pad. This is not as nice a feature as it may seem because the number pad is an exposed membrane type, which I found harder to use than the standard number keys on the regular keyboard.

Each controller has a disk-topped joystick handle that needs a full 0.25" travel to turn on the internal switch elements. This tends to make for slower, sloppier, and more tiresome game playing, yet allows even the heavy handed

Adam's ability to do more than one thing at a time is called multitasking

person to play without destroying the unit. The two pushbuttons on either side of the controller are used for speed, fire, etc. control. In addition to being used as an accessory number pad, the diode-matrix encoded touch-tone number keypad can be used with games.

Resident Software. About five seconds after the system power is turned on, Adam awakes, ready for use as an electronic typewriter with video display. The user receives an immediate response to a keypress. Short notes, letters, or whatever can be typed with the ease of using any electronic typewriter.

To use the SmartWriter word processor, you merely press the WP "smart key" in the upper left-hand corner. This brings you to the resident (24K ROM) line-editing WP mode. The basic screen format is the same, but this time there is a scale on the left side of the screen that indicates where you are on a page. There is no indication of what line you are on other than this, although the top horizontal scale shows what column you are in. The WP has a large number of features. Perhaps the most dramatic and user-friendly aspect of it is Coleco's use of definable keys. These six keys with Roman numerals are double-size and are defined for the user interactively at the bottom of the word-processor screen.

The word-processor screen is divided into two distinct areas: a display of the last 8 lines and the line that is being edited or entered. Each line is composed of a 35-character first "line" and a 25-character second "line" for a total of 60 characters (default) per full printed line (72 characters maximum). If you want to print out the nine lines displayed, you press the PRINT button in the upper right-hand corner of the keyboard. You will be "asked" to press one of the smart keys. You can print an underlined (highlighted) section of the screen, the work space (entire file), or the screen only on either fan-fold or individual sheets of paper. Once you decide, you press smart-key v to do the printing. When the printing is done, Adam returns automatically to the primary screen for more work.



The daisy-wheel printer houses the system power supply.

Cassette Software. Nearly anytime you wish, you may insert a digital data pack into drive 1 and push the reset switch located atop the memory console to load in software. Included with Adam are two software cassettes: SmartBASIC (an Applesoft BASIC-like high-level language), and "Buck Rogers Planet of Zoom," a multilevel, multiscreen, arcade extravaganza.

SmartBASIC. Coleco SmartBASIC, which takes about 68 seconds to load, is compatible with Applesoft BASIC.

What this means is that the standard commands used for Applesoft generally can be used with Adam. For example, to list a program on the printer, you would type PR #1 and LIST, rather than using a command such as LLIST. However, PEEKS and POKES of memory locations are not the same between Adam and Apple. Thus, if you were to copy a program written for an Apple computer that included these particular commands, it wouldn't necessarily work with Adam.

I calculate the SmartBASIC program, which claims to have 225 blocks of memory left in the directory, to be 28 blocks, or about 56 kilobytes long! This seems to be rather large for a cassette-based program, so I guess the Z80 machine language requires quite a bit of code to duplicate the 6502-coded Applesoft BASIC. However, since most disk-based BASICs are 16K or smaller, I suspect that SmartBASIC includes much of the RAM space for video mapping in the graphics mode.

TABLE I—COLECO ADAM MEMORY ALLOCATION

64K	Open Work Space
16K	Video Memory
24K	Word Processor ROMs
8K	Operating System ROM
2K	Keyboard Computer ROM
2K	Tape Drive Computer ROM
2K	Printer Computer ROM
2K	(Master) Network Computer ROM
64K	(Optional memory expansion)

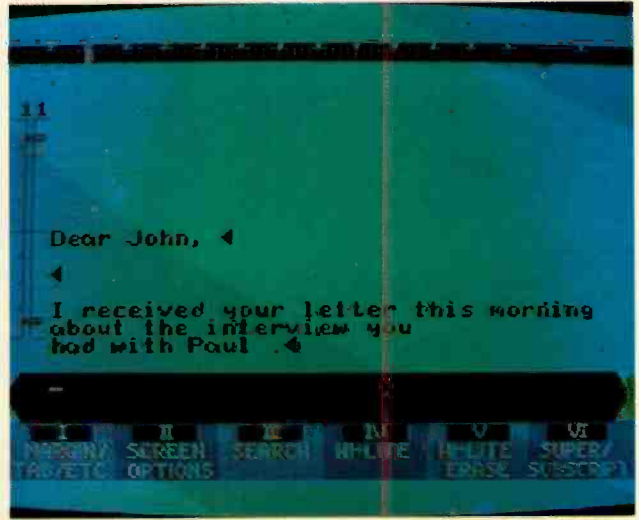

Adam's electronic typewriter mode (left) and word-processor mode (right).



"Buck Rogers Planet of Zoom" takes advantage of Adam's excellent graphics.

Most standard BASIC commands are usually parsed (decoded) in an area rather low in memory. Adam uses the area between 288 and 1152 decimal for these. Again, as is customary, Adam uses the area on top of the BASIC command listing (between 1152 and 1504 decimal) for the error message listing.

Adam's SmartBASIC graphics comes in four varieties, pure Text (24 lines of 36 characters) low-resolution (GR) graphics (40 × 40), hi-resolution (HGR) graphics (256 × 160) with four lines of text, or pure hi-resolution (HGR2) graphics (280 × 192). In its hi-resolution mode, the screen memory alone requires over 52 kilobytes of infor-

mation for each display screen.

Since no memory map is supplied with any of the manuals, you will have to wait for information analyzing the memory contents, BASIC pointers, etc. For example, the Apple uses a PEEK (-16336) to initiate sound.

We all hear the pretty music and fun sounds of the Buck Rogers game. But how do we create our own sounds? And where are the collision and graphics registers? Also, there is no information on creating those beautiful background screens. Is there a simpler (other than byte-by-byte memory mapping) technique to create HiRes screens? How can we enter our own Z80 machine lan-

guage programs? How can we hook up the outside world to Adam's network of computers? These questions cannot be answered without proper support material.

"Buck Rogers Planet of Zoom." Included with the basic system is the arcade game, "Buck Rogers Planet of Zoom." The game takes about one minute to load, but it should be noted that this is not just a one-shot cassette loading. All during play, the cassette loads and the screens are changed. This ability to do more than one thing at a time is called multitasking. While the interactive arcade game plays, the tape

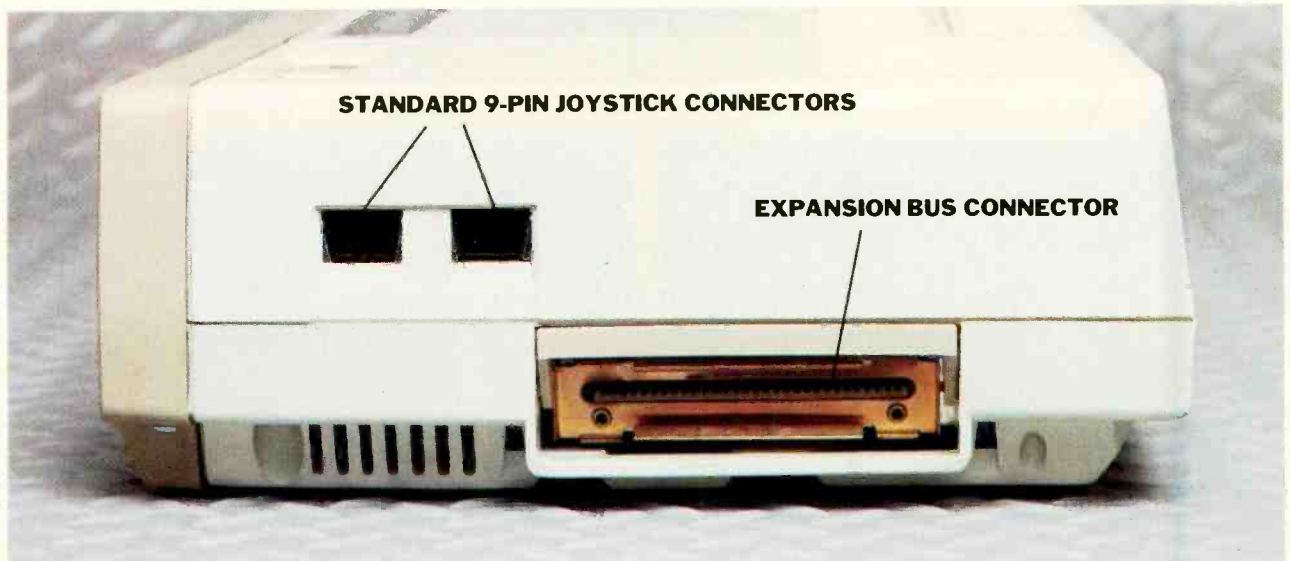

Right side of memory console with two joystick connectors and an expansion slot.

drive feeds information into the memory banks to describe the game's next screens and moves.

Adam's graphics are excellent and game play is realistic (even at the easier-than-arcade difficulty levels) and very challenging. The only disappointment is the game controller. It is relatively slow to respond, and it is quite difficult to keep controlling speed with the left button (how about a speed lock?) and fire with right button.

Comments. I found the Adam Family Computer system to be very satisfactory for its intended use. The word processor is adequate, although not comparable to professional packages such as WordStar. Though the SmartWriter printer is not meant for heavy-duty work, it does offer letter-quality print. One strong point of the system is its compatibility with ColecoVision video game cartridges. This assures quality entertainment for video-game enthusiasts. In fact, the system itself may be purchased as an add-on to the ColecoVision video game console for a suggested retail price of about \$600.

Coleco intends to support Adam with additional peripheral devices. These will include a telephone modem, an RS-232 adapter, an additional 64K of RAM, and even a 3.25" CP/M-compatible floppy-disk system with 80-column converter card. Also in the works is an Adamnet, which will allow the interconnection of several Adam's for

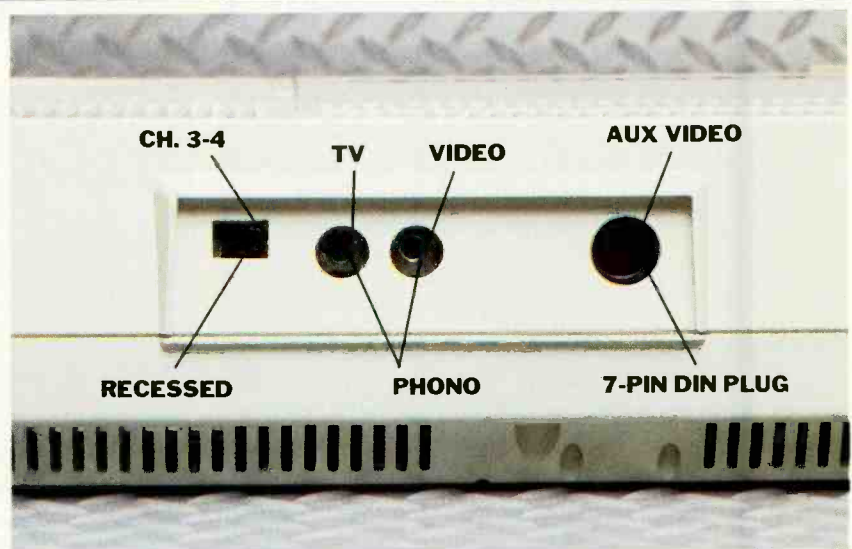

Rear of memory console showing display outputs.

networking the already networked Adam.

Conclusion. Coleco has finally arrived with Adam. Adam is designed to be as familiar to the first-time user, as it is powerful enough for the experienced computerist for home applications. It is conceived as a complete system with nothing (other than a TV set) necessary for immediate and long-term use. It is user-gentle and user-friendly. It is useful from the moment it is uncrated and begins its life as an electric typewriter, through to word processing as a serious

application, and the Planet of Zoom arcade game for family entertainment. It seems to have the upward compatibility necessary to entice the experienced hacker, and the ruggedness to resist the inquisitive 2-year-old. The machine appears to have more than satisfied its "English" language operation goals, and nothing is near it for the price. I do think that a few design and programming bugs need to be fixed, and more powerful and technical manuals are needed. But, overall, I recommend Adam—for your family, your kids, and you. ◇

"MADAM, I'M ADAM"

A novice's first experience with the Adam family computer

By Lois Cantwell

I AM the kind of consumer that Coleco likely had in mind when it developed Adam—someone who is ready to make a computer-system purchase if the price is modest and confusing options are eliminated. The rumors alone of an 80K computer with built-in word-processing software (no expensive WordStar or Perfect Writer to buy), game playing, and a daisy-wheel printer that all together cost about the same as a printer alone, were attractive enough for me to postpone buying a computer until Adam was on the market. And now that I've met Adam and have had several hours to get to know him well, he seems to be very easy to get along with.

Adam comes packed, unassembled, in a gigantic box along with instruction manuals on SmartWriter, SmartBasic, Buck Rogers video-game instructions, SmartWriter Easy Reference Guide, and a set-up manual which instructs "Read Me First." Since a great part of Adam's charm lies in everything being "built-in," I panicked slightly when faced with connecting the various sections.

My fears were unfounded, though, since it took only about a half hour to get the computer to work. Not bad, I thought, for a technically disinclined person. One time I had to rearrange all the modules after I had everything all plugged because I had wires crisscrossing the keyboard, which made the computer impossible to use. Finally, after assembling Adam perfectly and turning on the separate color TV that doesn't come with the system, the computer refused to operate. A major problem, I thought. But, no, I had forgotten to turn the computer on! It's equally easy to forget to turn Adam off, which makes the printer get very hot. These problems were not, of course, Adam's fault.

A nice design touch is that all the cords have a "this side up" label and all the cord outlets are labeled. Without this touch, I might still be looking for the keyboard outlet. Assembly might have been a little easier if the manual supplied a large numbered



diagram of the entire system that showed where to set things up and plug them in, instead of the small close-ups of where the various plugs should be attached. When you're nervously trying to fit all the right cords into their right slots, each section of computer shown in the close-ups resembles any other section. Since the modules and tabletop TV spread out over a large area that's at least 4' wide by 3' deep, the system isn't especially compact. This is not an unimportant consideration if Adam is being brought into a small apartment or crowded child's room, or if you are planning to use the family television as a monitor.

In many ways I fell in love with Adam. The Smart Keys were terrific! They make changing margins and tabs as simple (literally) as pressing a button until the exact numbers you want appear on the screen. I was able to change the screen color to one I liked better, or was easier on my eyes, or matched my sweater. My options were blue, green, white, black, and gray. And the type appeared in various rainbow hues. I was impressed with the actual prettiness of the type on the screen, too.

As a longtime typewriter user, it was somewhat distracting to use Adam as a word processor whose type appeared on a screen instead of a page in front of me, but that is something I could very easily get used to. Another option that Adam offered me was how much noise I wanted with my typing. If I wanted a collection of beeps and boops as I pressed keys, I could have that; a more attractive option was com-

plete silence. I did wish I had a noise option on the Adam printer, which emitted a grinding noise when turned on and an irritating "whap-whap" when keys hit the paper. I would try placing Adam on a typewriter mat to try and muffle the noise, while keeping my eye peeled for some kind of low-cost printer cover to reduce noise further. This aside, I thought it was neat to see the printer speeding through my text unassisted, typing sentences backwards.

As Coleco claims, I found storing, filing and retrieving text on Adam to be a simple task, handled by its STORE/GET key. When I was ready to call back my text, Adam displayed a clear directory in a file-folder format. It was a simple operation to point to the file I wanted with one of the arrow keys and to ask for it. I found it was easy to clear the screen and begin a new project, too.

Not having had much hands-on experience with computers, I was a little surprised at the complexity of SmartBASIC (which I'm told is no more complex than plain BASIC). Adam is supposed to be super simple, so I was disappointed that I would have to enter intricate strings of numbers and letters, at least one time for storage, before I could do any computing. This was frustrating, even with the built-in prompts and self-corrections. I knew, therefore, that I would be combing the market for ready-to-run software very soon. Coleco's promised SmartFiler series would therefore appeal to me very much.

Now that I've had a "new owner's" exposure to Adam, I think that it lives up to the hype preceding its introduction. ◇

DISKS & DRIVES

A look at the technology behind the most popular mass storage devices for microcomputers

By Dawn Gordon

THE 5¼" floppy diskette, and the drive that uses it, have contributed enormously toward making personal computing the popular pastime it is today. Without this method of information storage, we would have to rely on such primitive mechanisms as punched cards and paper tape; inexpensive, but slow and often fallible, cassette recorders; or relatively expensive 8" disks.

The 5¼" disk is a happy medium, as it offers the speed and random-access capabilities of its 8" big brother, but at a price nearer that of cassettes. Mini-floppy technology brought the speed and flexibility of professional systems into the home, and personal computing hasn't been the same since. A little polyester-and-iron-oxide disk can make a big difference, and it's about time you found out why.

In the Beginning. In the very earliest days of personal computing, programs were stored—if they were saved at all—on punched paper tape. You may have seen it used with Telex or Teletype machines. However, though it was great for throwing out of windows during parades, it did little to advance the cause of personal computing.

It was quickly realized that a better way of storing data was needed, and a system (actually a number of similar systems) was devised for turning digital information into audio tones and storing them on ordinary audio cassettes. While better than paper tape, and fairly inexpensive, this system was incredibly slow. In the days before BASIC was built into computers in ROM, it could take minutes to load even a small version of the language into a machine. Furthermore, since the tapes were used with inexpensive off-the-shelf recorders, there was no way to randomly access individual files. Unless you knew exactly where on a tape a file was stored, you had to start at the beginning and just keep going until you (or your computer) found it.

For a while, though, cassettes were the storage medium; there was just no

other reasonable option. There was the possibility of using the professional 8" disk technology developed by IBM, but its cost was very high, and definitely not conducive to personal use. Fortunately, an innovative company by the name of Shugart Associates solved the problem in 1976, and offered the first convenient and affordable random-access mass-storage medium. Its small disk drive, and accompanying 5¼" disk (or mini-

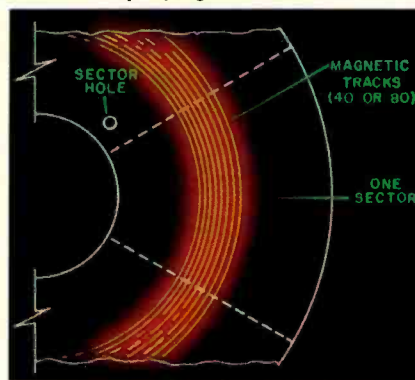

Fig. 1. Disks are formatted into tracks and sectors.

diskette), finally offered many of the advantages of the 8" disk at a price the consumer could afford. For \$595 you could buy a disk drive for your Apple II, along with everything you needed to make it run. For another \$495 you could get a second one.

Disk Makeup. Like audio cassette tapes, floppy disks store information magnetically. There are, though, considerable differences between the two. The magnetic-oxide particles that coat recording tape are aligned in the direction of the tape's travel to receive the highest degree of magnetization from the recording head. Those on the surface of a disk are oriented randomly. This is due both to the way in which disks are manufactured, and to various factors involved in disk-recording technology.

For durability's sake, the base film, or substrate, of a floppy disk is about six times thicker than that of cassette tape, at a hefty 3 mils (3/1000"). That makes

it floppy, but not droopy. Unlike cassette tape, though, its magnetic-oxide coating is very much thinner. At only 2½ microns (90-millionths of an inch) the coating found on the average floppy is three times thinner than that on standard recording tape. The reason for this is simple: The thicker the coating, the greater the chance for spillover and overwrite of digital information. A thick coating also increases the chances that enough traces of old data still persist to cause trouble even when new data has been written over it. Interestingly enough, the magnetic material is a simple form of ferric oxide, very similar to what's used on Type I audio tape. It appears that the really good stuff isn't necessary for digital recording.

The digital information is recorded on a series of tracks. These tracks have often been compared to the grooves on a phonograph record, but about the only similarity that really exists between the two is the name (if you consider a "groove" a "track").

When you buy a blank disk, its surface is truly blank—there are no tracks on it. This is because almost every microcomputer system uses a different method for *formatting* the tracks, which are actually concentric magnetic rings created on the disk's surface by the disk drive's read/write head. When you run your system's formatting, or initialization, program, you are creating the tracks on the disk at that time. Most disks are rated to contain 48 tracks per inch (tpi), but the actual area used usually contains only 40 tracks. Some high-density 5¼" diskettes requiring special drives are rated at 96 tpi formatted to contain 80 tracks.

When a disk is formatted, not only track information but also *sector* information is written to the disk. By dividing each track into a number of sectors, it is possible to store and locate information easily. A section of the disk called the directory stores the file name (the name assigned to a particular group of information) along with the track and sector numbers indicating where the information is to be found. Those areas

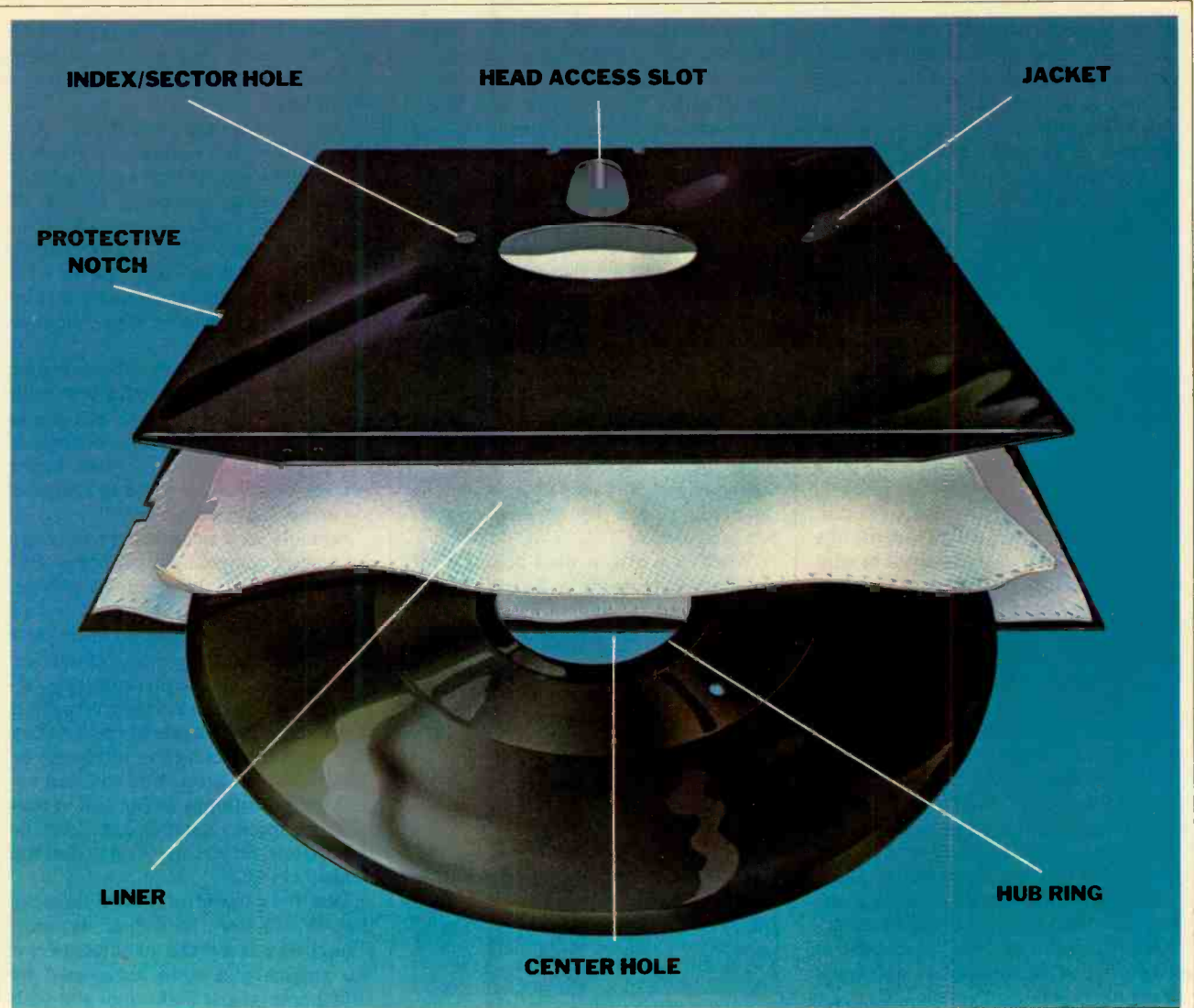

Fig. 2. The principal parts of a diskette and its jacket.

may or may not be contiguous, depending on how often the files have been altered, and the amount of contiguous free space available on the disk. The track-and-sector information stored in the directory allows you to access any file at random, almost instantaneously. The process is quite different from the serial storage method used with cassettes.

How Disks are Made. As is the case with any other high-tech product, the manufacture of floppy disks isn't as simple as you might think. As BASF Product Manager of Flexible Media, Terence Kelly, points out, "The process is a painstakingly careful and complicated one." The following is a description of the complete step-by-step manufacturing procedure at BASF's Bedford, Massachusetts facility. The end result is a finished and lifetime-certified 5¼" floppy diskette.

The process begins as a continuous sheet of plastic film called a "web" is

run through a coating machine for the deposit of a liquid slurry made up of 40% magnetic oxide and 60% binders, resins and lubricants. The coated sheets are dried in large and very hot ovens and then calendered to compress and polish the surface. The finished material is rolled up into what's called a "butt roll" and the process repeated for the other side. To stabilize the disk's polyester base, the film then goes into curing ovens where it remains for 24 hours. After that time, the material is put through a stamping machine for cutting into "cookies" or "donuts." The stamping process cuts out the disk shape, as well as the center hole, index hole, and sector holes (if any are required). Then, another chemical is added to give the disk durability.

In another part of the factory, the jackets that house and protect the diskettes are being formed. The jacket material, PVC, is cured for 24 hours in heat chambers. A synthetic, nonwoven liner material is then welded into place as a

bearing surface and cleaner for the disk. After the jacket is cut to size, it is folded into shape and the flaps are sonically welded. Centering and indexing holes for the disk are punched out, along with the write-protect notch and head-access slot, and the magnetic disk is slipped inside. The finished diskette is finally loaded into a certifying machine, which fills the entire surface of the disk with data and checks that data for errors to certify that the disk is good.

If an error is found on only one side of a disk, it will be classified and sold as single-sided. The results of the certification test also determine whether the disk will be sold as single- or double-density. (A single-density disk is one that is usable at low data-packing levels, but cannot meet the rigid requirements of high-capacity, double-density recording techniques.) Diskettes that do not pass inspection are "trashed," and the jackets reused.

Finally, after a disk passes inspection by the certifying machine, the final flap

of the jacket is sonically sealed, and a hub-reinforcing ring is added. Labelling and packaging follow, and the product is ready to be shipped.

BASF quality control consists of inspection of samples of disks at every step of the manufacturing process, and between 85 and 90% of the disks pass that inspection.

Inside a Drive. The disk drive itself is a marvel of miniaturization. Very much like a super-high-speed linear-tracking phonograph turntable, the drive is a highly accurate device. The main spindle that spins the disk at 300 revolutions per minute is belt-driven from the drive motor. A tachometer and special servo system keep the spindle rotating at a constant speed.

In drives for single-sided diskettes, the read/write head, which is made of a ceramic material, is maintained in contact with the disk by a pressure pad similar to those found in audio cassettes. In drives for double-sided diskettes, the two heads, one for each side of the disk, usually act as pressure pads for one another.

When a diskette is inserted into the drive and the door closed, a hub clamps it tightly against the spindle, and it starts to spin inside its protective jacket. When the computer commands it to, the drive's read/write head moves in or out from track to track along radial guide-rails, contacting the disk through the head-access slot in the disk jacket. Extreme precision of head placement is necessary, as the width of a single track is only $12/1000''$.

After the correct track has been located, the next step is to locate the appropriate sector. This is achieved by an index/sector detector, which is an assembly consisting of a light-emitting diode and a photocell. The index hole cut in the disk jacket allows light from the LED to strike the disk, or to pass through an index hole when one goes by it. If the light passes through an index hole, it strikes the photocell, and an electrical pulse is generated that tells the computer the position of the disk (and thus the sector over which the read/write head is) at that instant.

Disk Types. Disks are available in either "hard" sector or "soft" sector configurations. Most computers use soft-sectored disks, which have only one index hole. A few though, like the Apple II family, use hard-sectored disks with one index hole, and ten sector holes, arranged in a ring around the disk's center hole.

Each time the index hole in a soft-sectored disk passes over the index/sector detector, the pulse generated in-

forms the computer that it is at sector one and keeps things in synchronization. The formatting procedure mentioned earlier writes information to the disk indicating the number, size, and address of every track and sector, and this information is read by the read/write head and conveyed to the computer.

In the case of hard-sectored disks, the sector divisions are determined by the numerous sector holes, with the index hole supplying synchronizing information. The hard-sectoring scheme leaves more room on the disk for actual data storage since the sector information is determined by the holes and not by information written on the disk. It is, however, less flexible to use since the size and number of the sectors cannot be changed, as can be done with soft-sectored media.

Whether a disk is used in single- or double-density mode is determined by the drive and the electronics that gener-

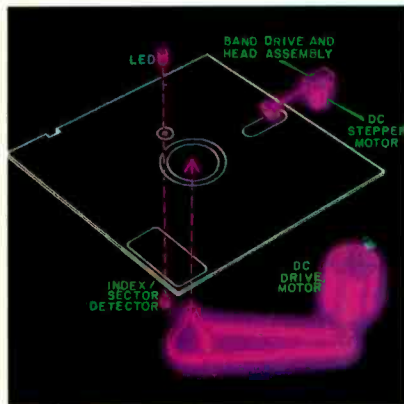

Fig. 3. Parts of a disk drive.

ate the signal that is written to the disk. (Just remember that, while you can safely use a double-density disk as a single-density one, doing the reverse can be asking for trouble.) A single-density system records using a frequency modulation (FM) system of recording binary ones and zeroes on the disk. A clock pulse plus a standard amount of space for every 8-bit word, or byte, is used.

For double-density operation, a modified FM (MFM) system was developed to reduce the number of clock pulses by actually incorporating them in the bytes directly. Of course, more complex circuitry is required for double-density encoding and decoding, but the end result is that you can get twice as much information on the disk as you can with a single-density system.

Other Types of Disks. Disk technology is constantly moving forward (see the article on "Multi-Megabyte Mini-floppies" elsewhere in this issue). New types of drive systems have been appear-

ing over the years, and the good old $8''$ and $5\frac{1}{4}''$ disks that we're now using may become obsolete in the not too distant future.

One variety of the present $5\frac{1}{4}''$ diskette that is slowly building up steam is the 96-tpi format. It requires very-high-precision drives and disks. Instead of containing 40 tracks on each side, a 96-tpi disk contains 80. A double-sided, double-density disk of this type can hold nearly as much information as a double-sided, double-density $8''$ disk—close to a megabyte.

One of the latest developments in disk technology centers around a reduction in disk size together with an increase in storage capacity. The new *microflop-pies*, as they are called, can hold, in the laboratory at least, as much as 1 Mb and are under $3\frac{1}{2}''$ in diameter.

Actually, as is so often the case, there are several competing microfloppy formats. Three of them, to be precise: Sony's $3\frac{1}{2}''$, Tabor's $3\frac{1}{4}''$, and Hitachi's $3''$. These disks get their great capacities by using a very-high-density cobalt ferric oxide magnetic coating rated at 135 tpi. Because of their very small size, and improvements in the circuitry they use, these units can conceivably be powered by batteries. You can well expect the microfloppy to flourish in portable computer systems, but don't be surprised when you see them in desktop models as well.

Last, but certainly not least, there are the Winchester hard-disk systems. (Winchester is not the manufacturer; it was originally a code name used by IBM.) Spinning at 3600 rpm, and with read/write heads that fly over the highly polished disk surface—they are literally airborne—Winchesters allow you to lay down data in extremely dense form. It's the speed that does it, and many hard-disk systems incorporate multiple disks (called "platters") and heads in single units with staggering capacities of 60 megabytes or more. The magnetic coating used on the platters is made up of the same iron oxide particles that coat $5\frac{1}{4}''$ floppies, but is far thinner. It's this thin structure, though, that allows for very high data resolution.

As hard-disk technology advances and the cost of producing these complex drives continues to come down, expect to see much less expensive hard-disk systems. Prices of under \$1000 for a 10-megabyte drive are not far off.

Disk systems offer flexibility, reliability, convenience and, most important, speed. Reading and writing programs is no longer an anxiety-ridden 15-minute affair. If you've stored a piece of information on a disk, you can retrieve it in a matter of seconds. We've come a long way from the days of cassette tapes. ◇

MULTI-MEGABYTE MINIFLOPPIES

*How a new magnetic recording medium
allows for up to 10-Mb storage on 5¼" floppies*

By Alijandra Mogilner

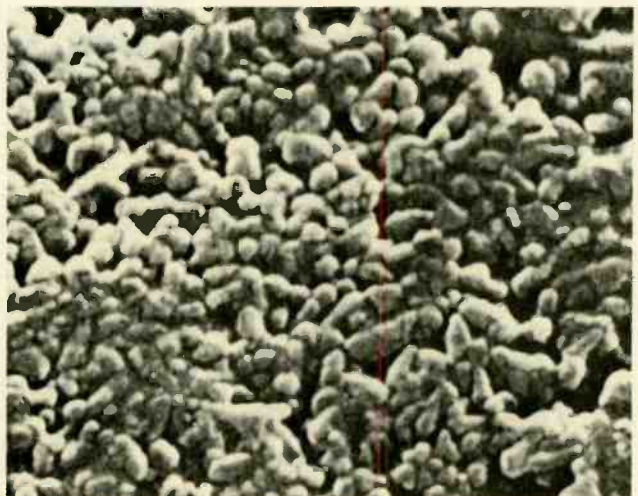

Scanning-electron micrographs of a conventional disk coating (left) and an isotropic one (right).

MASS information storage devices have been a focal point of computer hardware research and development almost since the beginning of the "computer age." The object of all this research has been to provide information storage in such a way that it can be accessed by a computer rapidly, with enough storage space to make use easy and practical. If there weren't some form of mass storage, you would have to reinput information into your system every time you turned on your computer, or even just changed from one program to another.

For years, mass storage for most home and small business applications has meant the use of 5¼" or 8" floppy disks. Hard (Winchester) disk systems have the advantage of offering greater reliability and—probably of more importance to many users—the ability to provide a large, multi-megabyte, storage area. However, until recently, they have been, for the most part, both costly and incompatible with most microcomputer systems.

Conventional 5¼" floppy disks are generally formatted with either 40 or 80 tracks and can hold from as little as about 50K of data to as much as about 700K. Lately, though, the new Japanese high-coercivity 600-oersted vertical-write emulsions capable of putting 200 tracks or more on a 5¼" floppy disk have offered small-system users an exciting breakthrough. This kind of new technology has meant that a microcomputer user could begin to approach the sort of mass information storage that was previously available only with hard-disk systems.

The Japanese, though, have been gone one better by a subsidiary of Eastman Kodak, called Spin Physics, based in San Diego, CA. It has recently announced an almost unbelievable breakthrough in mass-storage technology. Briefly, says Spin Physics spokesman Ken Thompson, its new Isomax 5¼" floppy disk offers 10 to 20 times the storage capacity of any disk the same size, using any current technology. That includes the Japanese vertical-write

mass-storage systems.

However, the breakthrough has not been due to Spin Physics, or Americans, alone. Development has been quietly under way for several years. The active particle that makes the technology so revolutionary was developed by Kodak Pathe in France seven or eight years ago. Spin Physics has had the job of making that particle practical to use and has spent about six years developing it for use as a disk coating at its San Diego facility.

Isotropic Medium. Spin Physics' development is described in its patents as a "read/write isotropic 800-oersted emulsion." What that means in practical terms is that a double-sided 5¼" disk will be able to hold ten megabytes and will cost less per byte to use than any disk-storage medium currently available. Not only that, the product is far more real than many already announced "coming attractions" in the computer field. Engineering samples of 5¼" floppy disks are now being used by

systems engineers and designers throughout the country.

The material of which the cobalt-doped Isomax recording medium is composed is essentially the same as that used in the fabrication of conventional disks. What is different is that it is the first to act in an isotropic (from the Greek *iso* = same + *tropos* = turn, direction) manner. The individual elements of the magnetic medium are truly isotropic in nature. In crystallographic terms, that means the magnetic structure of each particle is exactly the same in all directions. The scanning-electron micrographs on page 53 show the differences between a conventional disk coating and an isotropic one. The isotropic elements, and thus the entire recording surface, can be read from and written to both horizontally and vertically. Like Willy Wonka's magic elevator, the information can go up and down, and sideways, and backways and frontways, and *anyways*.

The new disks will be manufactured by the web-coat technology which is in widespread use today. Spin Physics will supply webs (sheet plastic coated with isotropic material) from which disks can be stamped to be sold under disk manufacturers' own brand names. The isotropic medium is also adaptable to tape and ribbon mass-storage methods, and Spin Physics has been talking with manufacturers in those areas. Users of those types of systems can expect to see isotropic media in use shortly.

Some engineers and manufacturers were hoping that the Spin Physics breakthrough could be used to create read-only disks, which would be protected against unauthorized copying. Unfortunately (depending on your point of view, of course), this was not the case, and the isotropic disks are read/write.

New Drives Required. While Isomax disks can be used in conventional drives, making the most of them will require a new type. The new drives will have to have closer head tolerances, and be more accurate in finding information. The heads will also need to maintain better physical contact with the disk surface than standard drives permit.

Spin Physics is working with all the major drive manufacturers to develop new drives that will accommodate its media. (And, at the time of writing, Eastman Kodak had just licensed a San Jose, California disk-drive manufacturer, Drivetec, Inc., to take advantage of the Spin Physics technology.) Most of the large drive-manufacturing companies have been working on programs to develop new techniques for use with vertical-write 600-oersted media prior

to the announcement of the Spin Physics breakthrough. That technology already used 200 tracks or more, and had to accommodate itself to a more densely packed information surface. In a very real way, the needs of the new 800-oersted media will be met by just an extension of that same technology. The executives at Spin Physics and Eastman Kodak see their product as simply the next generation in a fast-moving field.

Not only will the drives be different, but there may be changes in the appearance of the floppy disks themselves.

Information goes up, down . . . any way . . . just like Willy Wonka's magic elevator

Disk manufacturers feel that the new emulsion may require some different "cosmetics." An 800-oersted medium is a very dense surface. That means that the tracks on an isotropic-surfaced disk will be narrower and closer together, and more tightly packed with the changes in magnetic flux that serve to store digital information. Because of this higher packing density, the disks will be very delicate and much more susceptible to damage from mishandling. They will need more protection than is currently provided. The manufacturers with whom Spin Physics is

talking feel that the new floppy disks will require some kind of rigid or semi-rigid jacket, or other protective measures, to safeguard the disk media because the surfaces will be more sensitive.

These changes are considered cosmetic in nature because, while their capacities will be significantly greater than what is available at present, the disks will still use what is considered a standard format.

Capacity. Of course, the really big difference between magnetic media manufactured using Spin Physics' development and any other is how many kilobytes a 5¼" floppy disk, or other mass-storage system, will be able to hold. As a point of comparison, a current-technology 5¼" double-sided, double-density disk records at a density of 5000-6000 bits-per-inch (bpi). Disks using an isotropic medium can record up to 40,000 bpi. That means that a single-sided, double-density Isomax disk will be able to hold as much as 5 megabytes and a double-sided one as much as 10 megabytes. Compare that to the approximately 720 kilobytes available on a few current double-sided, double-density 5¼" disks.

The formats that will actually be available to the end user will be up to the manufacturers of the disk drives and of the computers that use them. There aren't any specific limitations built into the isotropic technology as far as formatting is concerned.

Actually, the new media all allow a greater flexibility in size, format, and use than do traditional ones. A good example can be seen in the mushrooming

ISOMAX UHD 800 DISK SPECIFICATIONS

Physical:

Diameter:	5.125" (130.17 mm)
Jacket size:	5.25" square
Substrate:	Polyethylene terephthalate
Coating:	Isotropic, modified iron oxide
Thickness:	5 microns (200 ± 10 microinches)
Surface Finish:	0.08 micron (3.0 microinches)

Magnetic:

Squareness:	0.85 (nominal)
Remanence:	1500 gauss (nominal)
Coercivity:	790 oersteds (nominal)

Functional:

Packing density:	To 40,000 bpi
Track density:	To 140 tpi without servo assist To 300 tpi with servo assist
Media life:	Greater than 5 million revolutions with less than 20% reduction in track amplitude
S/N ratio:	Greater than 35 dB
Overwrite:	Greater than 24 dB

popularity of the new sub-5¼" disk sizes, like Sony's 3½" microdisk. Almost all of them are already using a 600-oersted emulsion. It is really the only thing that makes such small sizes practical.

Who and When. Spin Physics has already been talking to all of the major manufacturers, and the general feeling is that the next generation of sub-5¼" disks will use its product. Whether those manufacturers will be licensees and manufacture the isotropic coating themselves, or will purchase it from Spin Physics, is still unknown. The decision is in the process of being made by Eastman Kodak marketing executives. Breaking away from its usual practice of

automatically making and marketing its own products, the company has begun talking to other companies already in the disk business about licensing the technology.

However, no licenses have yet been issued, and Eastman may still decide to make the formulation itself. As Ken Thompson of Spin Physics says, "Eastman Kodak has traditionally sub-licensed to itself, but this isn't 35-mm film. This is a whole new area, so it is still under discussion."

The new technology will be available for mass marketing by the time you read this. Even as this is being written, Isomax disks are being advertised to the trade and Spin Physics is manufacturing webs and making available engi-

neering samples. Drive manufacturers have said that drives tailored to the 800-oersted medium's particular needs will be available by the middle of this year or in early 1985.

The first disks are expected to retail at about a 25% premium over what the 600-oersted-medium disks currently sell for. Spin Physics is already selling engineering samples at a price of \$125 for a box of ten 5¼" disks. The company is quick to point out, though, that the cost of use per byte is significantly less than for standard disks. Its marketing personnel expect the initial retail price to be lower than the present \$12.50/disk, with price erosion to occur as the product makes itself known in the marketplace. ◇

LONGITUDINAL AND VERTICAL

Conventional floppy disks are made for longitudinal recording. That is, the magnetic fields created in the disk surface's needle-shaped magnetic particles by the disk drive's read/write head are parallel to the plane of the disk. This makes it necessary for the magnetic domains (the magnetized regions) to be fairly extensive, as can be seen at A. The size of these domains necessarily limits the number of magnetic-flux reversals, which ultimately works out to bits per inch, that can exist in a given area. Thus the capacity of longitudinally recorded disks is relatively low.

The particles coating Spin Physics' disks, however, due to their isotropic properties, can be magnetized equally well in any direction. The figure at B illustrates how both longitudinal and vertical magnetization can be supported. And, again because of isotropism, the "smearing" effect encountered in recording on disks intended only for longitudinal recording does not exist. (Even though the isotropic particles may look elongated, magnetically they are perfectly spherical.)

Longitudinal media cannot retain vertical magnetization. Isotropic media can. And because magnetic fields in the vertical direction are "self-sharpening"—the isotropic medium tends to concentrate them—their resolution is much greater than in a longitudinal medium. In the end, that means that the number of bits per inch that can be recorded is significantly higher. ◇

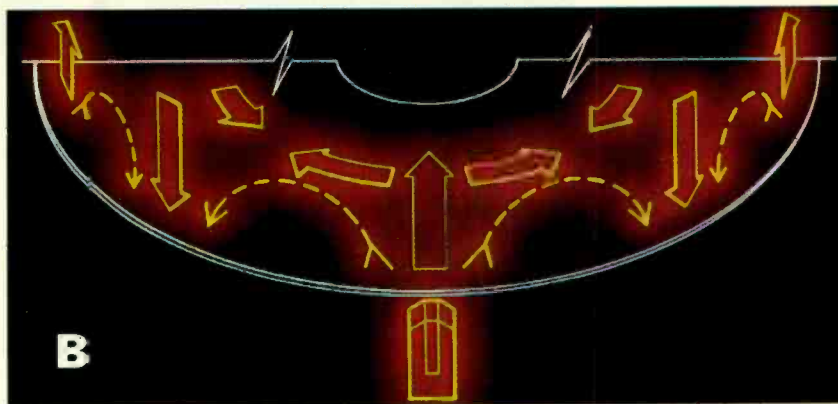
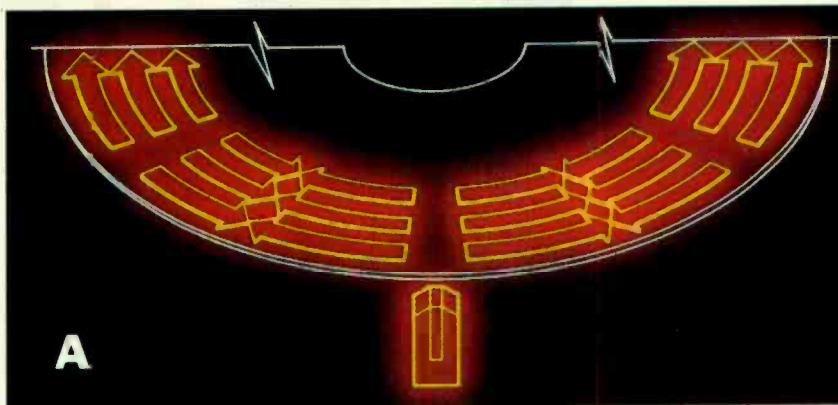

COERCIVITY, REMANENCE AND SQUARENESS

The qualities of magnetic media are measured in several ways, and those qualities bear unfamiliar names like coercivity, remanence, and squareness. Knowing what they mean will help you understand some of the factors of how effective a disk is at storing and retaining data.

The **remanence** of a material tells us how well it can be magnetized. Remanence is the flux density (the "number" of lines of magnetic force), expressed in **gauss**, of a material after it has been mag-

netized to saturation and the magnetizing field removed. The greater the remanence of a disk, the more strongly data can be recorded on it.

Coercivity is a measure of the attachment of a magnetic field to the particles that make up the recording surface of a disk. Its value is given in **oersteds**, an absolute measure of magnetic strength. Coercivity is defined as the value of the magnetic field (in oersteds) required to reduce the flux density of a fully saturated material

to zero. The greater the coercivity of a material, the more difficult it is to demagnetize it, and, in the case of a floppy disk, the better the disk will hold onto its data.

Squareness has nothing to do with the shape of the magnetic particles making up a disk's surface. Rather, it is the ratio between the remanence of a material and its flux density at saturation. The higher the squareness ratio, the more accurately the magnetizing field is "mirrored" by the material it has magnetized. ◇

**Learning electronics
is no picnic.**

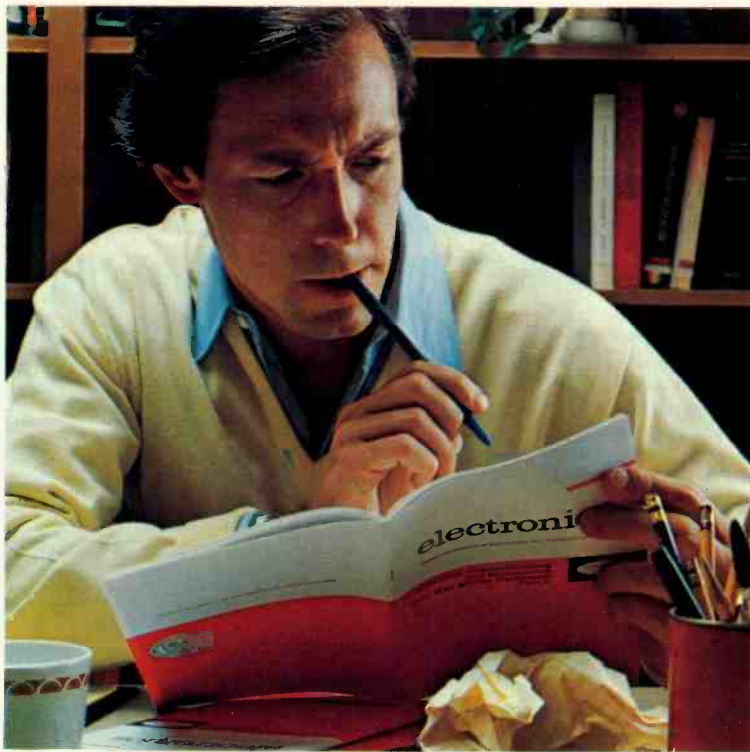

**At any level it takes
work and a few
sacrifices. But with
CIE, it's worth it.**

Whoever said, "The best things in life are free," was writing a song, not living a life. Life is not just a bowl of cherries, and we all know it.

You fight for what you get. You get what you fight for. If you want a thorough, practical, working knowledge of electronics, come to CIE.

You can learn electronics by spending some hard-working time at home. Or, would you rather go bowling? Your success is up to you.

At CIE, you *earn* your diploma. It is not handed to you simply for putting in hours. But the hours you do put in will be on your schedule, not ours. You don't have to go to a classroom. The classroom comes to you.

Why electronics training?

Today the world depends on technology. And the "brain" of technology is electronics. Every year, companies the world over are finding new ways to apply the wonders of electronics to control and program manufacturing, processing...even to create new leisure-time products and services. And the more electronics applications there are, the greater the need will be for trained technicians to keep sophisticated equipment finely tuned and operating efficiently. That means career opportunities in the eighties and beyond.

Which CIE training fits you?

Beginner? Intermediate? Advanced? CIE home study courses are designed for ambitious people at all entry levels. People who may have:

1. No previous electronics knowledge, but do have an interest in it;
2. Some basic knowledge or experience in electronics;
3. In-depth working experience or prior training in electronics.

You can start where you fit and fit where you start, then go on from there to your Diploma, an Associate Degree if you want it, and career.

Many people can be taught electronics.

There is no mystery to learning electronics. At CIE you simply start with what you know and build on it to develop the knowledge and techniques that make you a specialist. Thousands of CIE graduates have learned to master the simple principles of electronics and operate or maintain even the most sophisticated electronics equipment.

CIE specializes in electronics.

Why CIE? CIE is one of the largest independent home study schools that specializes in electronics. Nothing else. CIE has the elec-

tronics course that's right for you.

Learning electronics is a lot more than memorizing a laundry list of facts about circuits and transistors. Electronics is interesting! It is based on recent developments in the industry. It's built on ideas. So, look for a program that starts with ideas and builds on them. Look to CIE.

Programmed learning.

That's exactly what happens with CIE's Auto-Programmed[®] Lessons. Each lesson uses famous "programmed learning" methods to teach you important principles. You explore them, master them completely, before you start to apply them. You thoroughly understand each step before you go on to the next. You learn at your own pace.

And, beyond theory, some courses come fully equipped with electronics gear (the things you see in technical magazines) to actually let you perform hundreds of checking, testing, and analyzing projects.

Experienced specialists work closely with you.

Even though you study at home, you are not alone! Each time you return a completed lesson, you can be sure it will be reviewed, graded, and returned with appropriate instructional help. When you need additional individual help, you get it fast and in writing from the faculty technical specialist best qualified to answer your question in terms you can understand.

CIE offers you an Associate Degree.

One of the best credentials you can have in electronics — or any other career field — is a college degree. That's why CIE gives you the opportunity to earn an Associate in Applied Science in Electronics Engineering Technology. Any CIE career course can offer you credit toward the degree...more than half of the number needed in some cases.

You can also prepare for the government-administered FCC (Federal Communications Commission) Radiotelephone License, General Class. It can be a real mark in your favor...government-certified proof of your specific knowledge and skills.

Today is the day. Send now.

Fill in and return the postage-free card attached. If some ambitious person has removed it, cut out and mail the coupon. You'll get a FREE school catalog plus complete information on independent home study. For your convenience, we'll try to have a CIE representative contact you to answer any questions you may have.

Mail the card or the coupon or write CIE (mentioning the name and date of this magazine) at:
1776 East 17th
Street, Cleveland,
Ohio 44114.

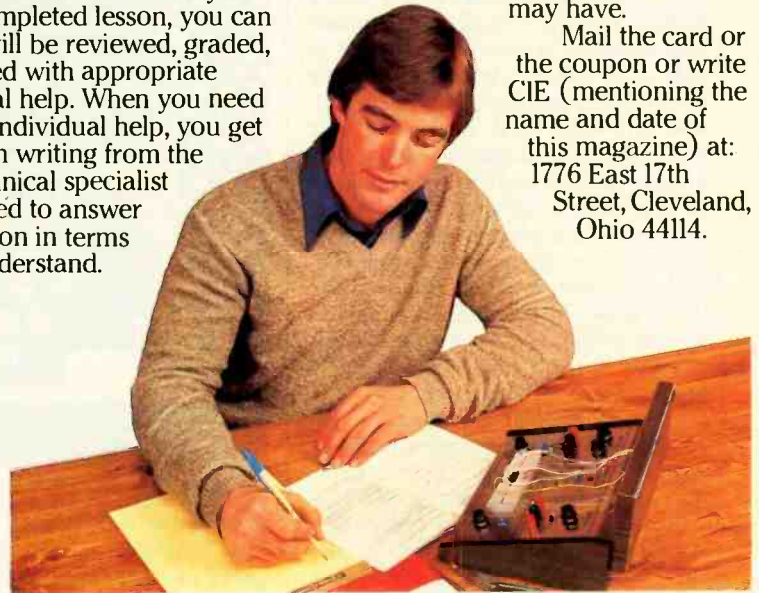

CIE Cleveland Institute of Electronics, Inc.
1776 East 17th Street, Cleveland, Ohio 44114
Accredited Member National Home Study Council

YES...I want to learn from the specialists in electronics — CIE. Send me my FREE CIE school catalog...including details about the Associate Degree program... plus my FREE package of home study information.

Print Name _____

Address _____ Apt. _____

City _____ State _____ Zip _____

Age _____ Area Code/Phone No. _____ / _____

Check box for G.I. Bill bulletin on Educational Benefits: Veteran Active Duty

MAIL TODAY!

PE-05

First Peek at the SHARP PC-5000

A true portable with many features normally found on more expensive systems—and a plug-in bubble memory

By Alex Marx

TRUE portable computers like the Epson HX-20, Radio Shack TRS-80 Model 100, and Workslate have been in the marketplace for just a short time. But they've already made a significant impact on the buying public. What makes these computers true portables is that they conform to user expectations. Aside from having powerful computing capabilities, full-size typewriter-style keyboards, and reasonably large display windows, they are also compact and light in weight and have self-contained power sources that make them completely independent of ac line power. Any computer that conforms to these criteria is almost a sure bet to pique the potential buyer's interest. One of the newest contenders in this category is the Sharp Model PC-5000 briefcase-size portable computer.

Sharp's PC-5000 isn't just another computer like its predecessors, however. Like the portables from Epson, Radio Shack, and Workslate, the PC-5000 has a relatively large display window and a full-size keyboard. However, it also shares some of the features of the much more expensive Gavilan Computer, such as a swing-up and back display module that snaps closed to protect display and keyboard when not in use. And the PC-5000 has its own unique feature that sets it apart from all the other contenders—a plug-in bubble-memory cartridge that acts for all the world like a disk system but consumes a lot less power. Add to this a bundled software package and some interesting optional peripherals, and Sharp has a potential winner.

The System. I recently had the pleasure of testing the Sharp PC-5000. First impressions made it evident to me that Sharp has paid careful attention to its



The PC-5000 has a large display window and full keyboard.

forerunners with this 12-lb (with battery installed) marvel. The PC-5000 packs a lot of hardware (and some software) into the PC-5000's 12¹³/₁₆" × 12" × 3⁷/₁₆" case.

The PC-5000 has several standard features that will appeal to the serious computer user. One of these is a large 80-column by 8-line liquid-crystal display (LCD) window, which is actually a bit-addressable array consisting of 640 × 80 dots capable of displaying graphics. Another is its full-size typewriter-style keyboard with sculpted keytops. In addition to the standard character keys on the main keyboard, there are eight function keys, four cursor-control keys, and two special-feature keys in a row along the top.

The operating system chosen for the

PC-5000 is Version 2.0 of MS-DOS, which makes the computer somewhat software compatible with the IBM PC. For the programmer, Sharp includes GWBASIC. The "GW," I'm told stands for "Gee Whiz," which labels this as an enhanced version of the famous Microsoft BASIC interpreter. Both MS-DOS and GWBASIC reside in a 192K internal ROM. Fleshing out the standard memory resident in the PC-5000 is 128K of RAM, which can be optionally expanded on-board, via two plug-in RAM cartridges, to a system total of 256K.

Following the tradition of other portable computers, the PC-5000 comes with bundled software. My understanding is that Sorcim's "SuperWriter" and "SuperComm" word processor and

communications packages will be supplied as standard items.

Rather than going the route of a disk drive, as was done in the Gavilan computer, Sharp has chosen a 128K removable, nonvolatile bubble-memory cartridge, which is also supplied standard with the PC-5000. Measuring only $2\frac{3}{4}$ " \times $2\frac{1}{4}$ " \times $\frac{7}{16}$ ", this cartridge offers all the features of a disk system and, in fact, is designated by the system as drive A. One of the nice things about the bubble memory cartridge is that it can be removed from its slot without having to power-down the computer—as long as the BUBBLE indicator on the top of the computer isn't on, of course. Just as with a floppy disk, the bubble cartridge can be write-protected.

The PC-5000 appears to have a virtual-drive option, which lets you plug a different bubble-memory cartridge into the slot and have it appear to the system as another drive. Hence, you get the same convenience provided with disk drives, of being able to swap program packs without confusing the system.

One bubble-memory cartridge is supplied standard with the computer. Additional cartridges are optionally available at \$269 each.

Cassette mass-storage is supported through a built-in cassette interface. This may appear to be a throwback to a bygone era, considering that disk drive prices are at an all-time low and in light of the fact that the PC-5000 uses a sophisticated high-technology bubble-memory "drive," but it really makes good sense. It makes a reliable, sturdy backup system for valuable disks. And when your bubble cartridge fills to capacity when you're far from your disk drives, you'll appreciate this additional feature.

The price for the PC-5000's basic computing power is \$1995, which isn't really excessive for a portable machine that can be expanded with optional peripherals. One such option is a \$399 printer that nests inside the PC-5000's case without making the computer any larger, though it does add about 3 lbs to the weight.

An unusual feature of this printer is that it can be operated as either a thermal printer with thermal paper, or a standard printer with a ribbon cartridge and ordinary bond paper. This gives you the flexibility of using whatever type of paper happens to be available when it comes time to generate hard copy of a document or file. Being thermal, the printer is almost quiet enough to use in an office, classroom, or library, without disturbing anyone nearby. Try to do that with your run-of-the-mill impact dot-matrix printer!

Bubble memory acts like a disk system but takes a lot less power

Print quality is officially termed "correspondence," but it was very close to being "letter" quality. This is amazing, when you consider that only a few years ago thermal printers at their best were almost worse than an ordinary impact dot-matrix printer operated in the draft mode.

A plug-in modem also fits inside the PC-5000. This \$349 option is compatible with both pulse and tone telephone

PC-5000, it's nice to know that you *can* expand the system if and when other peripherals do become available.

The final option now available for the PC-5000 is a 64K RAM cartridge, two of which can be plugged into slots on the bottom of the computer. Adding the two 64K RAM cartridges to the 128K supplied standard with the computer brings the system up to its maximum of 256K. Each RAM cartridge carries a list price of \$169.

Currently, there are just a few software packages available for the PC-5000: SuperWriter word processor, SuperComm communications package, and SuperCalc² spreadsheet, all from Sorcim. Sharp informs me that it's negotiating with several large software houses for additional programs for the PC-5000. My guess is that a database

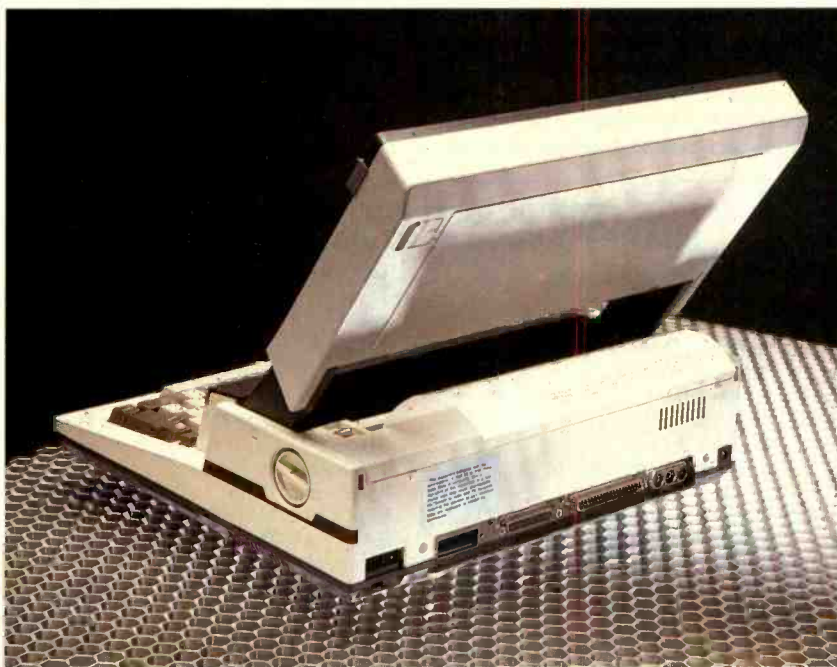

Rear view shows how the display swings up and back.

lines and includes a 10-button dial pad. Unrealistically, you get communications software free when you buy the computer, but you must buy the modem separately.

For nonportable work you'll almost certainly want Sharp's optional dual $5\frac{1}{4}$ " floppy-disk drives for \$999, anyway. Each disk has a storage capacity of 360K, and the drives will read standard IBM PC-format disks. The drives plug into a 37-pin D-type connector located on the rear panel of the PC-5000. Since this is the computer's normal expansion device, an identical connector is available on the rear panel of the disk-drive unit to permit further expansion.

Though at the present time, and for the near future, I've been informed that no other peripherals are planned for the

program and maybe another spreadsheet package like VisiCalc or 1-2-3 will soon be in the offing. And since the PC-5000 uses MS-DOS, I feel safe in speculating that much other software will be forthcoming, from Sharp and outside vendors.

The Details. The PC-5000 I tested was a preproduction model, which gave me an opportunity to get a sneak preview of Sharp's new computer product. Sharp informs me that the unit I had was the same as the one that will be in full production, although the test unit I had hadn't been optimized as the full production models will be. In fact, my test unit had been pulled out of Sharp's service department, where it had been to fix the printer.

The PC-5000 is physically small, no larger, in fact, than a portable typewriter, though it's a bit heavier. It's designed to fit into a large attache case. By the time this appears in print, however, Sharp should have ready an optional carrying case for the computer. I'm also told that an American Tourister hardcase, which I haven't seen, will be tailored to fit the PC-5000. From its description, I get the impression that the hard case is designed for shipping the computer, rather than for typical carry/use applications.

On the rear panel of the PC-5000 are several connectors and a pair of switches. From right to left, viewed from the rear, there are an ac adaptor jack, cassette interface connector, 37-pin D connector for floppy-disk drives, standard 25-pin D connector for the RS-232 serial output, and connector for the optional modem. The two switches, one rocker and the other a slide type to avoid confusion, are mounted one above the other at the far left. The rocker switch is used to apply and disable power to the com-

If Sharp supports it, the PC-5000 should be a real winner

puter. The slide switch is for connecting the system's ac adapter as either a power source for the computer or as a recharger for the battery pack.

ule can be set to any of a number of click-stop positions for most comfortable display viewing. Built into the top surface of the module is a shallow well that accommodates the optional modem and has a removable protective cover.

Moving toward the rear of the computer, the next section contains a flip-up cover that protects the bubble-memory cartridge slot. (Inside the slot is a plastic lever for ejecting the cartridge.) Also on this section are three LED status indicators arranged in a vertical column like a traffic light. The top (red) LED lights when the battery needs charging; the middle (yellow) LED lights when power

volts. This is enough power to keep the computer going for eight hours or to provide 2 hours of nonstop printing. (Additional battery packs will be optionally available.)

On the right side of the computer are thumb controls for adjusting the volume of the internal speaker and display contrast. On both sides of the computer are locking latches for releasing the hinged display/modem assembly so that it can be swung into operating position and expose the keyboard.

The main keyboard features the standard typewriter layout and automatic repeat when a key is held down for more than a second. Happily, the RETURN key is located in the correct place. An ALT key is located to the right of the space bar, far enough out of the way that it won't be accidentally pressed. Just below the RETURN key is the CAPS lock key, which, unfortunately, offers no visible means of telling you whether it's in the released or locked mode. A locking push-on/push-off key or a LED indicator would be a definite improvement here.

Arranged in a single row across the top of the main keyboard are 15 rectangular keys. At the far left are two orange-colored keys labeled ON/BRK and OFF. They control a unique "sleep" feature (*not* power to the computer) that partially powers down the PC-5000. This feature lets you turn on the computer at a preset time via the internal clock or the modem. This makes the system usable even if unattended, with minimum drain on the battery.

Using the sleep feature, you can, for example, have the computer turn on by itself and dial your office, via the modem, and download data to or upload data from your office computer, all automatically. Since a timer is involved in this function, you can set the system to take advantage of less-expensive nighttime telephone rates. You could even have your office computer call the PC-5000 and have it turn on to accept or send data. Now that's a really nice feature!

The eight function keys that follow the OFF key are used by software to activate different functions in one-key operations. To the right of the function keys are the four cursor-control arrow keys. Being arranged in a row, rather than in a diamond shape, the cursor-control keys tend, at first, to be a little inconvenient to use. Once I became accustomed to their placement, however, I had no trouble at all using them.

The last key in the top row is labeled CLR/INS. Operated in the shifted mode, it clears the screen and homes the cursor in the display window. The unshifted

TECHNICAL SPECIFICATIONS SHARP PC-5000 PORTABLE COMPUTER

Central processor unit:	16-bit 8088
ROM memory:	192K
RAM memory:	128K
Bubble memory:	128K
LCD display	80 char. × 8 lines
Graphics:	650 × 80 dots
Keyboard:	Standard QWERTY
Serial I/O:	RS-232
Audio cassette:	1600 bps
External bus driver:	8 bits handshake
Operating system:	MS-DOS 2.0 in ROM
Program language:	BASIC in ROM
Extra functions:	Clock, sound generator
Power source:	Rechargeable battery with adapter
Dimensions:	12 ³ / ₁₆ "W × 12"D × 3 ⁷ / ₁₆ "H
Weight:	11 lb

puter. The slide switch is for connecting the system's ac adapter as either a power source for the computer or as a recharger for the battery pack.

On the bottom panel of the computer is a recessed CLOCK switch that apparently connects and disconnects a separate internal clock battery. Setting this switch to off prevents the PC-5000 from functioning at all. This position is used whenever the computer isn't to be used for a long period of time, to prevent the internal clock battery from running down. Also on the bottom panel are two covers that protect the slots used for RAM memory expansion.

The top of the computer is divided into several distinct sections, the most forward of which is actually a hinged module that swings up and back and contains the display window. This mod-

is turned on; and the bottom (green) LED lights whenever the bubble memory is being accessed.

Continuing toward the rear, there's a hinged plastic cover that protects the optional printer mechanism. My test unit came with the printer installed, so I can only guess that some sort of dummy plastic panel comes with the computer with no printer installed. Behind and to the right of the printer well is the paper-release lever for the printer, and behind this is the final section that has a narrow slot for loading paper into and unloading it from the printer.

The rear-most section is removable to provide access to the battery compartment. The battery itself is a sealed lead-acid module that measures 5" × 2" × 1" and weighs less than 8 oz but packs a powerful 1.6-ampere-hour charge at 6

mode lets this key change the cursor from a blinking underline to a blinking block and permits nondestructive insertion of characters in a line.

Use Tests. How does the PC-5000 perform? The answer is, very well, even with my nonoptimized preproduction test unit. Though the screen on my test unit updated slowly, but smoothly, Sharp informs me that the production version will be optimized for greater speed. Characters displayed in the LCD window were small but very sharp. They appear to be constructed in a limited 5 × 7 matrix that doesn't support true lower-case descenders. The dots are so small that you get smooth, solid characters that aren't broken into difficult-to-read individual dots alternating with blank spaces. In addition to being able to adjust contrast for best readability, you can control the apparent "brightness" of displayed characters through software to obtain different effects.

imagine that eyestrain is likely to set in. The solution to the problem might be to use a slightly less polished plastic window or even an antiglare filter.

The keyboard was a joy to use. An experienced typist would have no problem with it. However, the drawback to making the computer as compact as possible is that something had to be sacrificed, in this case, a separate numeric keypad cluster (an omission common to all portable computers to date).

The optional printer was *very* quiet in operation, even though my unit was pulled from the repair bin with a bad printer. The quality of the printouts on both thermal paper and standard bond was excellent; you would have to look very closely to see that the print is generated with a dot-matrix printhead and not a formed-character element. The ribbon used for printing on bond paper is contained in a compact cassette-like case that simply snaps into place. I've never seen such an easy-to-install ribbon!

applications packages weren't yet implemented for the PC-5000. This situation will be cleared up in the production models, but it was frustrating not to be able to perform in-depth tests to find out what I could do with the hardware and software.

The bubble-memory cartridge I had was too full to permit any large files to be created for either SuperCalc² or SuperWriter. However, I was able to test some BASIC programs and found the language to be very fast, the only exception being when it displayed to the screen. Again, I'm assured by Sharp that this will be corrected in production models.

From the abbreviated testing I did perform, the limited number of lines that can be displayed on the LCD screen presented no problems. With SuperCalc², I was able to scroll through a large model very quickly, which made viewing somewhat less inconvenient than it might have been with the limited-size display window. I was also able



The optional printer nests neatly into the computer to make a complete package.

The only problem I had with the display was a case of glare that tended to make the display unreadable. To deal with this problem, I adjusted both the tilt angle and the contrast of the display, but neither was very effective. With normal overhead fluorescent lighting, I experienced difficulty in obtaining an acceptable pair of adjustments. The problem appears to be with the transparent plastic insert that protects the LCD panel from damage. Putting an incandescent table lamp above the display made a positive difference.

The glare proved to be a serious problem for me, but other people who used the computer weren't as adversely affected by it. They were aware of the glare but were able to work around it. Over a long period of time, though, I

The printer can accommodate paper up to 8½" wide, a single sheet at a time. It hums along at a print speed of 37 characters per second, which isn't exactly fast. Keep in mind, though, that we're talking here about near-letter-quality print, however. The printer is also capable of printing out dot graphics, with a resolution of 1197 dots per line and at a speed of 555 dots per second. Furthermore, print intensity can be controlled via software to create shading effects.

Software received with the PC-5000 consisted of SuperCalc², SuperWriter, and GWBASIC. Unfortunately, since mine was a preproduction model, I couldn't fully test all the packages because SuperWriter was missing several overlay files and several features of both

to perform some split-screen operations that let me view two different portions of the model on the same screen.

Working with SuperWriter, I noted that the word processor used the function keys very effectively. I had no problem using the program for simple word processing, even without having to refer to the manual. Both SuperWriter and SuperCalc² have built into them extensive help screens that can be called at any time to aid you in what you're attempting to do. I don't hesitate to state that these are two great applications programs.

In theory, the bubble memory is a great idea for a portable computer. In practice in the PC-5000, it worked very well. Because it functions like a disk sys-

(Continued on page 101)

USE YOUR TRS-80 COLOR COMPUTER AS A STORAGE OSCILLOSCOPE

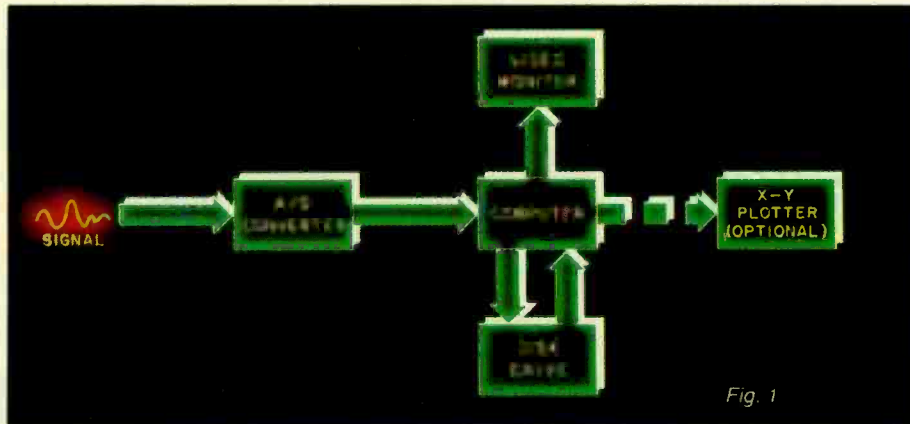

Fig. 1

With an analog-to-digital converter on your TRS-80 Color Computer, you have the makings of a low-cost storage oscilloscope

By Forrest M. Mims, III

OF the many kinds of electronic test instruments, the oscilloscope is by far the most important. Only the oscilloscope provides a graph-like electronic picture showing how a voltage (the *signal*) varies with time. You might say the oscilloscope combines the functions of a voltmeter and frequency counter into a single but more powerful instrument. Borrowing from the old adage, you might also say a single oscilloscope trace is worth a thousand data points.

In the simplest oscilloscopes, a thin

beam of electrons is repeatedly swept across the phosphor screen of a cathode ray tube (CRT) much like those in television sets. The beam can be deflected vertically by a signal applied to a sensitive amplifier whose output is connected to electrodes within, or an electromagnetic coil outside, the CRT. This provides a brightly illuminated graph that neatly displays the time-dependent variations in the amplitude of a signal. Simply by speeding up the time required for the beam to sweep across its screen, an oscilloscope can provide a look at sig-

nals whose amplitude fluctuates many millions or even billions of times in a single second.

Often an oscilloscope user would like to be able to "freeze" the trace on an oscilloscope screen for more detailed study. This is especially true when the sweep speed is very slow or when a signal with a very brief duration (such as that produced by a switching logic gate) is being monitored.

One way to preserve a trace is to photograph the oscilloscope's screen. Another is to use a sophisticated instrument called a *storage oscilloscope*. Unfortunately, storage oscilloscopes are quite costly.

A little more than a year ago, a small company called Northwest Instrument Systems (PO Box 1309, Beaverton, OR 97075) revolutionized oscilloscope technology when it introduced a sophisticated computer peripheral that brought the capabilities of a storage oscilloscope to anyone with an Apple II computer and \$995. Dubbed the Model 85 aScope™, the device is a module containing a fast analog-to-digital converter. When plugged into an Apple II, the aScope provides the capabilities of a laboratory storage oscilloscope costing as much as \$10,000.

Fig. 2. Three circuits whose outputs can be monitored.

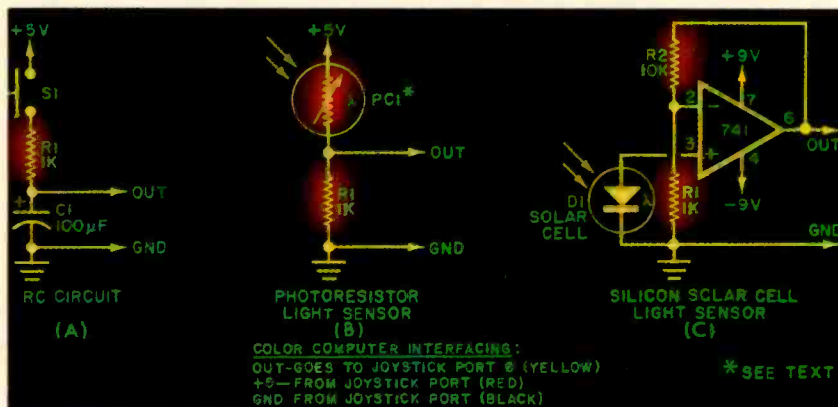

The aScope is supplied with appropriate software (on disk) to place labels and a graticule on the screen of the computer's monitor. The software also permits traces to be saved on disk and printed on paper.

The aScope is merely the first of an expected flood of peripherals that will allow personal computers to function as many kinds of sophisticated, programmable test instruments. Concerned about this new development, traditional makers of oscilloscopes and other test instruments have already begun to develop new systems designed around personal computers.

If you own or have access to a personal computer equipped with an analog-to-digital converter, you can develop your own test instruments. You can even convert your system into a slow-scan, storage oscilloscope. In the remainder of this article we will explain how.

If you own a personal computer with an analog-to-digital converter, you have the essential ingredients for a slow-scan oscilloscope. And if you have access to an x-y plotter, you can transform traces displayed on the computer's display into publication-quality images.

Best of all, you can assemble a computer-simulated oscilloscope from surprisingly economical components. While many different computers can be used, I have had excellent results with Radio Shack's Color Computer. Using a system equipped with Extended Color BASIC, I developed software to transform the computer's display into a very useful large-screen, slow-scan oscilloscope with both single-sweep (storage mode) and continuous-sweep operation. The software includes an optional graticule complete with tick marks, and the ability to store traces on a floppy disk for later retrieval and display. A second software package directs an optional plotter to draw a high-resolution rendition of a trace stored on a disk.

Getting Started. If you've ever tried to use a standard oscilloscope to observe a slowly changing signal, you can readily appreciate the advantage of a storage scope that freezes the display for later viewing and interpretation. The only other way to preserve the trace is to photograph the display.

A simple block diagram showing how a personal computer can be configured as a slow-scan storage oscilloscope is shown in Fig. 1. While any of a number of computers can be used, excellent results can be attained with a 32K Color Computer with Extended Color BASIC.

The original machine has been re-

placed by the 16K Extended Color Computer 2 and the 64K Extended Color Computer. Like the original product, these new machines are equipped with two analog joystick ports for a total of four A/D converter inputs. The software given here, although developed for the original Color Computer, should run on both new machines.

Operation of the Color Computer joystick ports is described in detail in "The Electronic's Scientist" column elsewhere in this magazine. Briefly,

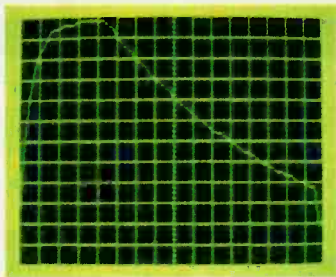

Fig. 3. Charge-discharge cycle for circuit shown in Fig. 2A.

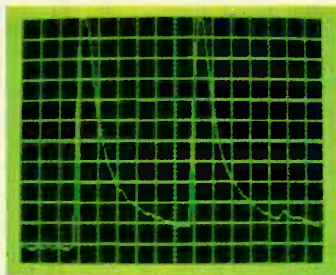

Fig. 4. Two spikes produced when flashlight is blinked twice.

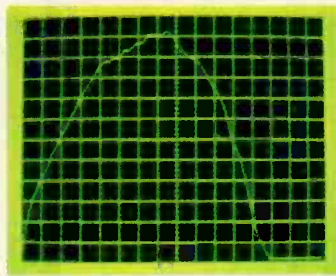

Fig. 5. Slow scan of flashlight across circuit in Fig. 2C.

when the joystick feature is selected, the computer generates a decimal number directly proportional to the voltage at the selected joystick port. These numbers range from 0 to 63 (6-bit accuracy) when the voltage varies from about 0.3 to 4.75 volts.

Normally the voltage is derived from the two potentiometers in each joystick.

Each potentiometer is connected as a voltage divider across a 5-volt supply from the computer with the wiper terminal providing a variable output voltage as the potentiometer shaft is rotated.

Of course any other voltage source can be connected to the joystick ports if its excursions fall within a 0-to-5-volt window. In any case, the digitized representation of the voltage can be summoned by the simple command JOYSTK(*n*) where *n* is the port number (0-3).

Knowing this and taking advantage of the Color Computer's powerful graphics capabilities, it is easy to develop a rudimentary oscilloscope program. Here's one possibility:

```
10 PCLS:PMODE 4,1:SCREEN
   1,0
20 FOR X=0 TO 255
30 Y=JOYSTK(0)
40 PSET(X,Y)
50 NEXT X
60 GOTO 10
```

This very simple program transforms the screen of the monitor into a black square surrounded by a green border. A moving green dot traces a solid line from left to right across the black square.

If the wiper of the potentiometer representing JOYSTK(0) (horizontal, right joystick) is rotated, the green dot will move up (or down), leaving behind a trail of dots. When the dot reaches the right side of the square, the line and dot pattern it has traced is instantly erased and a new sweep is begun.

The simple oscilloscope program can be converted to emulate a storage scope merely by changing the last line to:

```
60 GOTO 60
```

The green dot will now form a single trace which will be displayed on the monitor until the BREAK key is pressed.

Other enhancements can be easily added to the basic program. For example, the following BASIC line will add a trigger feature to initiate a trace only when the incoming voltage exceeds 0.3 volt:

```
15 IF JOYSTK(0) > 0 THEN 20
   ELSE 15
```

The trigger feature can be further enhanced by changing 0 [not JOYSTK(0)] to a variable. Many other features can also be added. For example, a graticule can be drawn on the monitor's screen. And, traces can be saved on disk for later retrieval and viewing.

Comscope. The simple program just discussed has been enlarged into a menu-driven computerized oscilloscope program called Comscope shown in Listing 1. While the joystick and graphics commands in Comscope are unique to the Extended Color BASIC of the Color Computer, the program can be used as a guide to develop similar software for other computers.

When entered and run, the monitor displays Comscope's menu:

```

COLOR COMPUTER
OSCILLOSCOPE
A. SINGLE SWEEP STORAGE
SCOPE .
B. CONTINUOUS SWEEP SCOPE .
C. RETRIEVE TRACE FROM
DISK .
FOR GRATICULE ADD G TO
SELECTION
PRESS M TO RETURN TO MAIN
MENU
SELECTION?
  
```

The menu provides a total of six options. If a G is appended to the selection, the graticule subroutine (line 2000-2160) is executed. The graticule provides a grid of 16 horizontal and 12 vertical divisions. The center horizontal and vertical lines are given short tick marks.

If single or continuous sweep modes are selected, the sweep subroutine (lines 4000-4700) is executed. In both cases, the program first asks for the desired sweep time in seconds-per-division

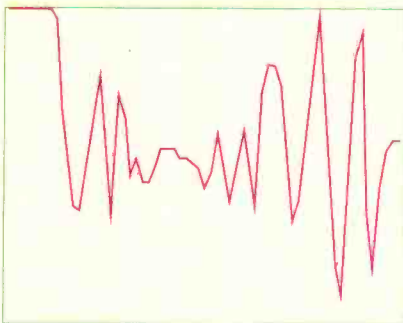

Fig. 7. Plot of joystick output.

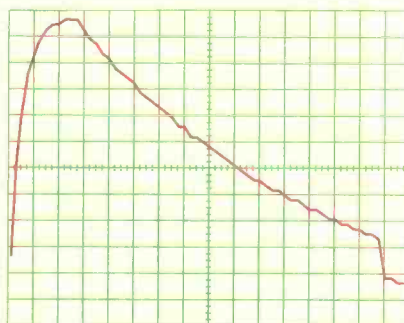

Fig. 8. Plot same as Fig. 3.

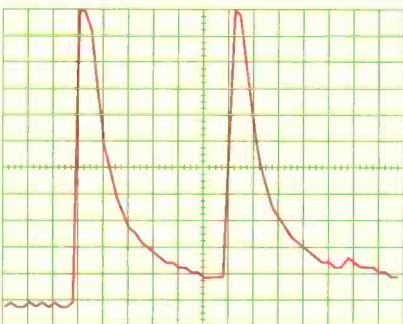

Fig. 9. Plot same as Fig. 4.

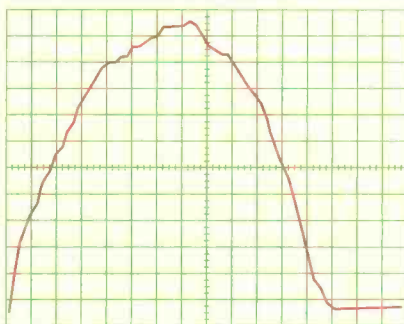

Fig. 10. Plot same as Fig. 5.

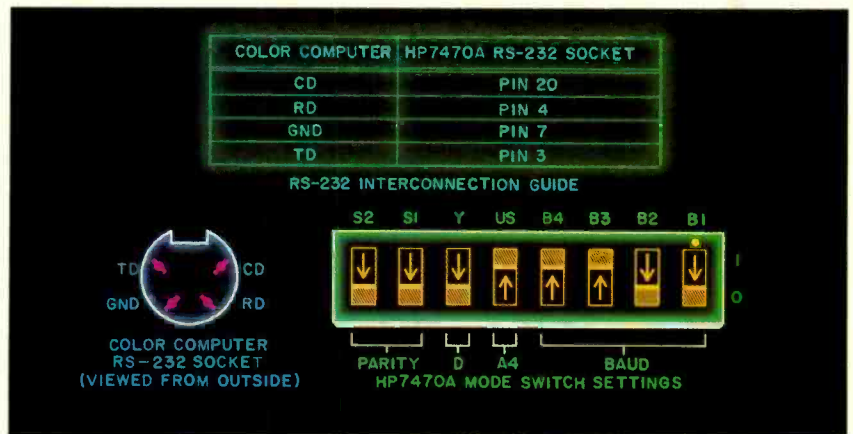

Fig. 6. How to connect a plotter to the Color Computer.

(0.35 second minimum) and assigns it to variable SD (see lines 340-360).

The program subtracts 0.34 second from the time entered. The 0.34 s is the approximate time required for the program to execute the steps that retrieve joystick values and draw the trace on the monitor (lines 4300-4350). The result after the subtraction is multiplied by 460, the number that, when used in a one line timer loop (FOR T=0 TO 460:NEXT T), produces a delay of 1 second.

If the trace is *not* to be saved on disk, the product is then divided by 16, the number of pixels in a single graticule division, and designated SW (line 360). If the trace is to be saved on disk, the product is divided by 4. This is because traces to be saved on disk must be made at 1/4 the resolution of ordinary traces

to prevent the disk buffer from filling before all or at least most of the trace has been completed.

High resolution traces *can* be saved, but since the disk drive will turn on and momentarily interrupt program execution several times during a single trace, the resultant traces will contain undesirable artifacts. This is particularly true when fast sweep speeds are selected and when the input voltage varies rapidly.

The processed seconds-per-division variable (SW) is held until needed by the sweep subroutine. It is then used in the timer loop at line 4340.

In the simple demonstration program given earlier, the trace was formed by a stream of dots. When superimposed on a graticule, however, the dots lack the visibility a solid line would provide.

For this reason the sweep subroutine forms a continuous line trace. Line 4100 establishes a starting point for the LINE command. Line 4330 then extends a line from the starting point to the first pair of coordinates designated by a FOR . . . NEXT loop (x values) and the data retrieved from the disk data file (y values).

Incidentally, line 4200 in the sweep subroutine provides a trigger that prevents the sweep from beginning until the voltage at the joystick port exceeds about 0.3 volt. This feature can be omitted by dropping line 4200. Or you can alter the condition so that the sweep begins at any joystick value you select (0-63).

A particularly important option in the single-sweep storage scope mode is whether or not you wish to save a trace on disk. Comscope assigns your answer (Y or N) to a string variable called D\$. and at various points in the program queries D\$ to determine whether or not data is to be saved on disk.

At line 370, a disk data file assigned a name you specify (see N\$, lines 330 and 370) is opened if D\$ is Y. At line 4320 in

(Continued on page 98)

AN 8-BIT COMPUTER GETS A NEW OPERATING SYSTEM

Epson's QX-10, using new Valdocs software, offers an integrated package that provides word processing, communications, and many other features

By George Mitchell



EIGHT-BIT microcomputers have multiplied like rabbits during the last few years and most are fairly similar. Every so often, though, a manufacturer takes a common product like this and adds a new dimension to it. Such is the case with Epson America. Known primarily for its highly successful line of printers, Epson has developed the QX-10 microcomputer using the latest version of the Valdocs software running under the TPM (Transient Program Manager) operating system. This 8-bitter does such uncommon things as power up as a word processor and react to keys marked "insert," "bold," and

"italic." With one keystroke, you can switch the QX-10 to communications and dial another computer. When the call is completed, another keystroke will return you to the document you just left.

But this innovative product has not been without difficulties. The Valdocs software has paid for its expansive, integrated approach by being slow and full of bugs when first introduced more than a year ago. A series of revisions has cleared up most of the problems, however.

The QX-10 not only runs Valdocs, but also CP/M software. Epson is mar-

keting the QX-10 as a package that includes Valdocs 1.18, CP/M 2.21, a five-pack of Peachtree software (text, calc, proofreader, thesaurus, and mailing list), and an RX-80 FT printer and interface for a suggested retail price of \$2995. This review concentrates on the QX-10 computer and the implementation of the new Valdocs software.

Anything But Modest. In design, the QX-10 is unusually sophisticated for an 8-bit machine. The system is bus-oriented and uses a modular concept to maximize system resources (Fig. 1).

The QX-10 uses a Z-80 microproces-

In design, the Epson QX-10 is unusually sophisticated for an 8-bit machine.

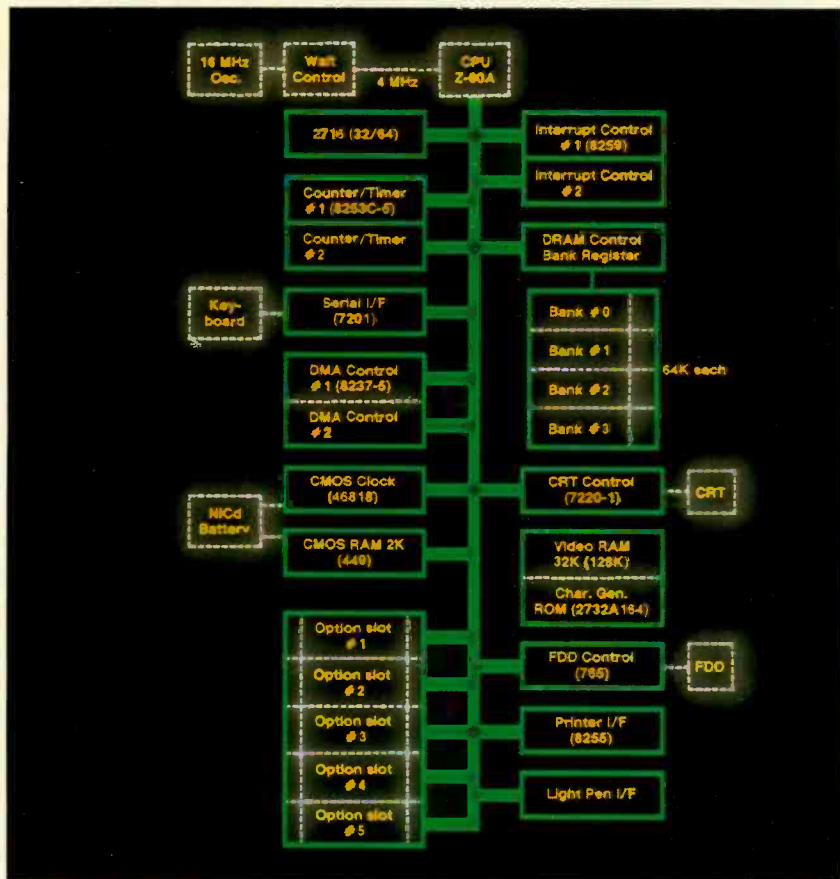

Fig. 1. The system is bus-oriented, with a modular concept.

sor, specifically the NEC PD780C-1 operating at 4 MHz (I clocked it at 4.67 MHz), driven by a 16-MHz oscillator through a divide-by-4 circuit. The CPU fills two roles in the QX-10: data processor and system manager.

The NEC PD8237 DMA controllers and PD8259 interrupt controllers work in concert with the CPU to establish a priority of devices along the bus (Fig. 2). Notice that the disk and monitor have the highest priorities, with the options acting as slaves with their own priority and interrupt scheme.

The QX-10 comes standard with 256K RAM that is divided into four banks of 64K each. Besides this, there is 2K of battery-backed CMOS RAM, located between 8000 and 8800 hex, which is used to store system information such as data needed by the HD46818P real-time clock. In addition, about 50 bytes can be used for holding other information, either supplied by you, or later by Epson.

Dual Disk Drives. The standard system includes dual disk drives. They are 1/3-height double-sided, double-density, 48-tpi models with a capacity of 320K bytes for actual usage on a diskette formatted for data and about 290K for a system diskette.

The drives feature a positive loading mechanism that prevents accidental damage to a diskette by action of the door and also ensures proper spindle mounting and head loading. Moreover, the drive has sensors that are used to advise the system that a diskette is in or out, or has been changed. Unfortunately, CP/M hasn't been modified to take advantage of this feature; but TPM does.

The NEC PD765A programmable disk controller is a stack device. This means that it can be set up to operate in a much more efficient manner in an interrupt-driven system with DMA than can a register device. Moreover, the NEC controller permits the creation of large buffers and the use of "least-frequently-used" methods for speeding up access. Surprisingly, neither CP/M nor TPM makes use of this fact. The disk system, therefore, is slower than you would expect or, for that matter, want. For example, it takes 45 seconds to load in Valdocs from either a cold or warm boot.

Based on the way the memory is laid out as shown in Fig. 3 and considering specifically the area for the floppy disk, one would expect that multiple track buffers would be used, but they're not.

There are five expansion slots on the main motherboard for adding such options as a GP-IB (IEEE-488) interface, an optical-fiber interface, a color CRT interface, and a pulse transformer interface. Pin numbers and corresponding signals for the expansion slot are given in Table I. You can also add a 10M-byte Winchester to boost storage.

In addition, the system has tucked away under its low-profile (20" x 13" x 4") covers 8K of system ROM, a speaker, 7 channels of DMA, 15 interrupt levels, and 6 channels of counter/timer circuitry.

A Capable Screen. Another feature of the QX-10 is the screen display. The



Fig. 2. Priority of devices along the bus.

system employs a 12" green-phosphor CRT capable of displaying 640 x 400 dots. The screen is controlled by the NEC-7220 display controller, and has 128K bytes of RAM dedicated to it. This provides a continuous scrolling screen, thus allowing a page-like system ideal for word processing.

The display is worthy of a review all its own simply because of the capability it offers. You can, for example, expand a figure 16 times, develop line-clipping mechanisms, and rotate figures in real-time. That is, you can if you have the software. Epson has supplied some with Valdocs, and I have found that the system works well with Fox and Geller's "dGraph."

Working in concert with the screen is the printer. The system I evaluated included an Epson FX-80 dot-matrix printer, which can achieve a dot-for-dot resolution with the screen.

A New Keyboard Design. One of the touted features of the QX-10 is the so-called HASCII—Human engineered ASCII—keyboard. It uses function keys that are predefined for a variety of purposes such as HELP, MENU, MAIL, DRAW, and even an UNDO to let you fix goofs.

This 105-key detached keyboard includes an alphanumeric set of keys, a numeric keypad, function keys, and



The QX-10 uses 1/3-height 5 1/4" disk drives.

dedicated word-processing keys. The keys are the full-travel type, which have an excellent feel to them. The layout of the keyboard is similar to one you might find on a dedicated word processor. In other words, functions such as INSERT, TAB SET, ITALICS, etc. can not only be accessed with one keypress, but are labelled as such.

To Epson's credit, it did carry the layout design further and built in functions that take advantage of Valdocs. But the operation codes were redefined also,

thus making it tricky to use the function keys with other software. The system can respond to either Televideo 920 sequences, which you can establish through the SETUP.SYS file available on the Valdocs system disk, or what they term Valdocs standard, which is the same as a Lear Siegler ADM3A. Both implementations are only partial, however, and you might find that not all things work the way you would expect.

Valdocs. The Valdocs software is designed to work in concert with the hardware. It runs under the TPM operating system and takes advantage of the HASCII keyboard. Valdocs is an integrated software package that offers word processing, graphics, communications, mail list/database, document locator, time scheduler, and calculator. It is a menu-driven system with four experience levels: beginner, novice, advanced, and expert. In operation, you boot up using the Valdocs system diskette. I was supplied with the latest 1.18 version. (Valdocs has gone through many revisions and has many to go. Each time, it does get better.)

Word Processor. The system comes up in the word-processor mode, which acts exactly like a typewriter. You can set the page any way you want. The word processor uses a window approach with the text window at the top and the menus in a window at the bottom. Tapping the HELP key brings up a menu that allows you access to six other menus, plus offers a tutorial on the basics of using the word processor. The menu is shown in Fig. 4.

Choosing the On-Screen menu enables you to center text, set margins, etc. The Miscellaneous menu permits changing wordwrap, justification, etc. Margin settings are displayed on a sta-

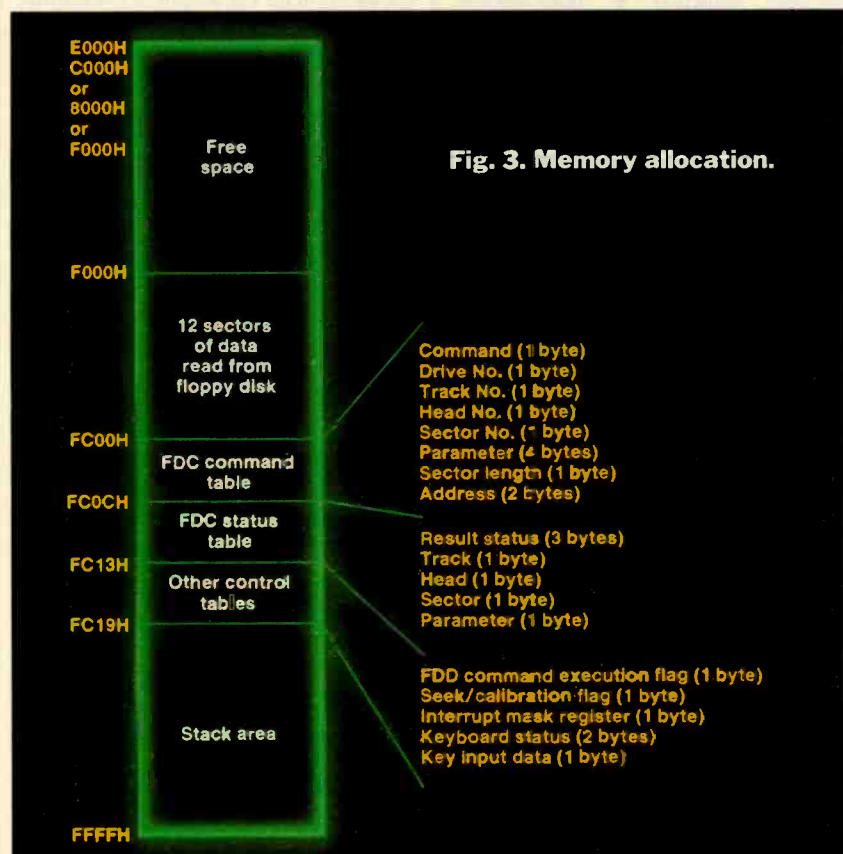

tus line at the bottom of the text window, as are your present page and line numbers. The wordwrap and justification information isn't shown on the status line, however, so you don't know if they are on or off.

Other menus offer typical word-processing features such as block move and search. The Quirks menu, which is reserved for the expert level, allows a variety of file-management options as well as two interesting features. One of them, called "Cursor locked in center," keeps the cursor on a horizontal line at midscreen at all times. The text scrolls past it, just as with a typewriter. The menu option allows you to toggle between this mode and normal cursor.

The other feature is called "Quick display." It is intended to alleviate a problem that you may find with the word processor. Since the normal operating mode uses the graphics functions to generate characters, you can get ahead of the system while you're typing, thus producing misspelled words. Although the system corrects itself, there is a slight delay which can be unnerving. Choosing the "Quick display" option turns the screen from a bit-mapped to a character display. This enables Valdocs to keep up with a very fast typist, although graphics-dependent features such as bold and italics can no longer be viewed on the screen (the codes can only be sent to a printer).

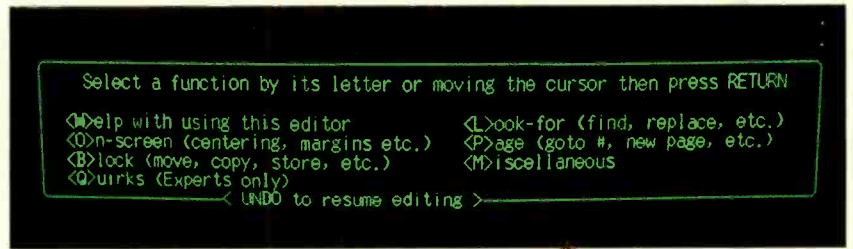

Fig. 4. HELP menu.

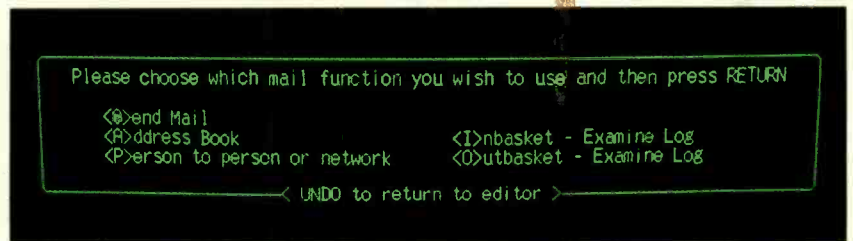

Fig. 5. MAIL menu.

Each time you switch to another function the text is automatically saved in a temporary file, which can cause a delay of about 15-20 seconds. Retrieval of the text is automatic, too. Pressing UNDO while in another area returns you to the word processor with the cursor in the same spot in the text that you left it! If, while in the editor, you erase a word accidentally, you can restore it by tapping UNDO. While using the word processor, I found that every so often I would overrun the right margin and it wouldn't reformat in the normal

Valdocs operating mode. A remedy I quickly found was to set the system to the expert level and choose "Reformat" under the "Quirks" menu. This set the margins correctly.

Within the editor, you can change print styles with the press of a key. For example, you can choose BOLD, ITALIC, and underline. The last function is handled by tapping the STYLE key. This key will later have its own menu to allow you to choose a variety of type styles and sizes. All font and style changes are shown right on the screen in the normal

AN IDEA BORN IN PHILLY

Have you ever wondered where designs for the latest computers come from? Well, most come from a lot of head scratching and reinvention of the wheel. Such is not the case with the Epson QX-10.

This tidy little machine was the brainchild, born as early as 1976, of a group of inventive entrepreneurs. The group called itself Technical Design Labs, then later Xitan before it disappeared into the edge of yonder. The TDL/Xitan group had the idea for a truly integrated machine that was easy to use; but in 1976 that seemed like something that was a long way off.

With an eye to the future, however, they developed what was then, and still is, considered one of the better system monitors known as Zapple, plus a powerful editor/text processor known as Z-Tel. All of this formed the basis for a series of powerful S-100 bus machines called the Alpha series. The Zapple monitor was to form the basis of the QX-10, and the data-handling functions of Z-Tel defined the basis of Valdocs.

In 1979, at the final John Dilks East Coast Computer Fair in Philadelphia, the group unveiled its newest machine, called the General. It was claimed that

the General not only offered more processing power and greater memory than any of the 8-bit systems being shown; but sported an innovative word-processing and database management system with communications all rolled into one.

Unfortunately, Xitan was finding itself in a less than comfortable financial position and the General never led the battle. Fortunately, the idea wasn't forgotten. In late 1980, Epson America was formulating plans to enter the desktop computer market. Its design strategy was based on those defined for the General. Now, however, it appeared that, by using the latest in peripheral IC technology, and support devices such as 1/2-height floppies, the easy-to-use integrated system could be built.

By November of 1981, at Comdex in Las Vegas, Epson was ready to tempt the market in a modest way. It exhibited the first prototype of a machine that very closely resembled the General, except it had 1/2-height floppy drives and a high-resolution screen.

Interest was high, and Epson officials gave the go-ahead for development of the real product. Most of 1982, and a good portion of 1983, was spent in readying the hardware and software.

Thus was born the QX-10 and Valdocs software system.

Unlike its precursor, the General (which reportedly operated off two Xitan Alpha systems hidden under the table that week in Philadelphia), the QX-10 not only works but is shipping at a volume of about 5000/month.

Unfortunately, though, the Valdocs software isn't as exciting as first imagined. Currently, version 1.18 (reviewed in this article) does combine word processing, database management, communications, and graphics; but a great deal still needs to be done. Specifically, the word processing is slow. The graphics, although fairly good, still aren't as flexible as those found on an IBM PC, for example. And the communications package has an excellent concept for adding phone numbers, but still needs work on the protocols.

It is an idea that was picked up from the scrap heap and made workable. And it does represent the best in the state of 8-bit architecture.

Although Valdocs can't be classified as a grade-A product yet, the designers are making headway, and, by the time you read this article, version 2.0 should be ready for release. ◇

(graphics) operating mode.

I was surprised to find that no convenient method existed in Valdocs to take advantage of the FX-80 printer's functions of condensed print, or super and subscripting. I was able to do this in Wordstar by modifying the printer drivers.

One of the nice features about Valdocs is that you will never lose files due to a full diskette. Valdocs keeps you notified and allows you to change diskettes midstream.

Once you have created a file, you can store it by pressing STORE. Valdocs allows you to store (and retrieve) documents using meaningful names up to 16 words long. After you've used Valdocs for a while you'll notice another useful feature. Suppose you have stored 50 or so documents on a disk. Pressing INDEX allows you to look at your list files in several different ways: alphabetically, sequentially, or cross-referenced.

Alphabetic filing is obvious. Sequential filing displays the files in the order that they were created with a date and number assigned to each file. The cross-index display takes the key words that appear in the index and lists them alphabetically with the particular files that pertain to them. You can retrieve a file by taking advantage of this cross-index feature. Just select a key word associated with the file name and you'll be presented with a list of files that use that key word in their names.

You can print a document by first storing it to disk and then hitting the PRINT key. The document won't start printing out immediately—instead you will have to go through a series of menus before you get hard copy. Once you start printing, you may continue on with your work since the system has a print spooler. If you just want a dump of what's on the screen, you need only press CTRL PRINT. Normal copy is printed with the screen dump only if

ZAPPLE SEES INSIDE

When doing development work on a microcomputer, it's often necessary to have some method of digging into the internal operation of the processor and associated circuits. This is usually accomplished using a utility such as Digital Research's Dynamic Debugging Tool (DDT) or, in the case of the QX-10 operating under the Transient Program Manager (TPM), Zapple.

This powerful tool was originally designed for use on TDL/Xitan systems to enable users to load programs, modify memory, and perform various and other sundry system level tasks.

Zapple was, and I believe still is, the only utility written to take advantage of all the power a Z-80 has to offer rather than being an 8080-based program. It is relocatable and can be moved around at will in memory.

Zapple serves as a powerful development tool on the QX-10, and is a basis for

the operation of TPM. Unlike early versions that were loaded off paper or magnetic cassette tape, Zapple is loaded immediately on boot up from the TPM/Valdocs system diskette. Getting to it, however, isn't via a direct route. You have to set up the QX-10 to permit trapping to Zapple. This is accomplished by using the Valdocs SETUP program, changing the Experience level to EXPERT and turning on the Control \ (backslash) function.

Once this is accomplished, and you've saved the new setup parameters by simply tapping the UNDO function key, you can trap to Zapple at any time by doing the CONTROL backslash function.

You are greeted with an breakpoint @EA26 and a greater-than sign. Now you can use Zapple. Once you're through, you can trap back to Valdocs by entering a GO100, which causes a reboot. ◊

you are in the "Quick display" mode. Otherwise, larger graphics text is printed.

Prior to any printing, you have to inform the system of the type of printer you're using. If you have an Epson printer, it's just a matter of choosing the printer by name from a list that's found in the SETUP.SYS file. If not, you must insert the characteristics of the printer you're using.

Communications. The communication function, entered by pressing the MAIL key, is designed to work off a card-file system. Here you enter name, address, phone numbers (voice and modem), and modem speed of correspondents. Plus you set up yourself with your area code, which the computer automatically checks when you make a call. If the area code is not required, it isn't used. This is great if you ever move since you only change one record in-

stead of many. You can then send someone a document or have a person-to-person exchange by simply selecting that particular option from the MAIL function menu (Fig. 5).

You are then prompted through the various alternatives. You can set up to receive mail or schedule it to send later. The system real-time clock will turn the system on. Interestingly, you have to be in MAIL for this function to work. I thought this should have been a background function and work much like the print spooling function.

Graphics. One of the more exciting functions of Valdocs, is the DRAW capability. This allows you to enter data and create a pie chart, bar chart, scatter chart, or scientific chart. It is accurate, as can be seen in Fig. 6. The data was taken from an article in the Feb, 1982 issue of *Mini-Micro Systems* on printers.

(Continued on page 87)

Fig. 6. The DRAW capability permits entering of data and creation of charts.

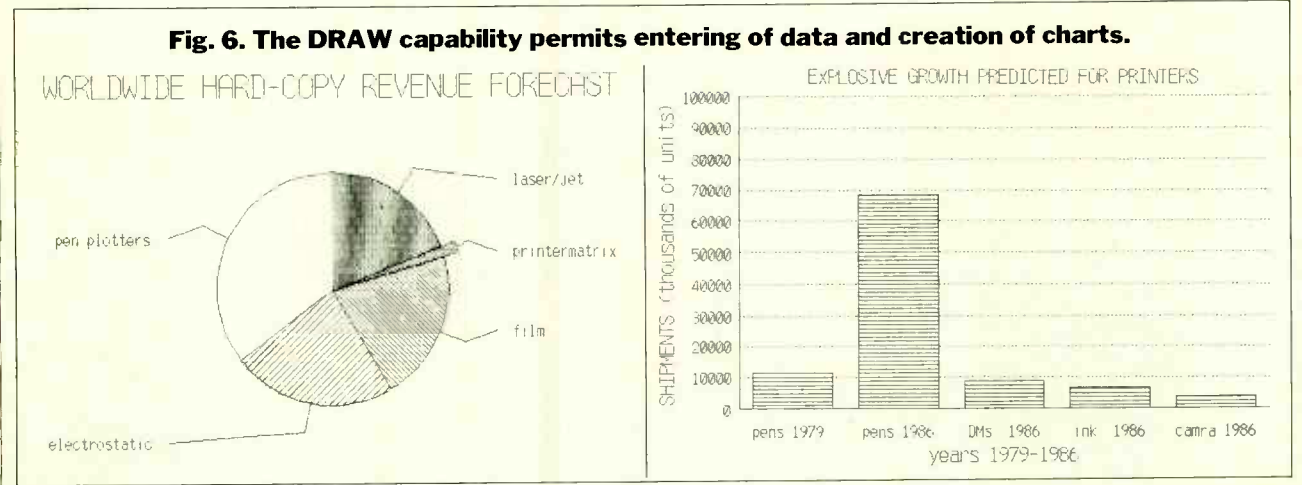

**Let's clear up some
of the confusion
about what
videotex is—
and the services
it can provide**



VIDEOTEX AND YOU

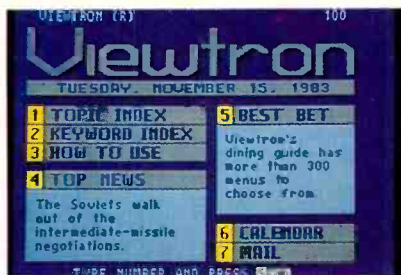

By John Helliwell

IF you are confused about what videotex is, you're not alone. Much of the cause of this confusion lies in the fact that different people have different ideas about what the service is.

Some people will tell you that videotex has something to do with television, frequently citing "two-way TV" as the basic reason for the existence of the service. Others will tell you that it has something to do with home computers. Adding to the confusion, companies like Radio Shack and RCA offer boxes they call "videotex terminals" that bear a strong resemblance to home computers. The confusion is further compounded by the fact that the companies are selling business terminals under the name "videotex."

Nor is hardware the only area in which the term "videotex" is applied from different viewpoints. The very definition of the term depends on who's doing the defining. A number of people contend that this type of service is videotex only if it's aimed at the home market. No wonder people are confused!

The object of this article is to clear the air about what videotex is and, just as importantly, what it isn't. We'll then go on to tell you in very general terms how it works and how and when you can get in on the action.

Start at the Beginning. In an attempt to clarify the issue, you have to start at square one. Clear your mind of anything you may have heard about videotex, particularly of any notion that videotex has something to do with television. Now you're ready to learn what videotex is with an unbiased mind.

A good way to understand what videotex is is to take a look at the typical

airlines reservations counter. Every airlines office in the country is equipped with one or more computer terminals that look something like a TV receiver to which has been added a typewriter-like keyboard. Instructions to the computer are typed in from the terminal's keyboard. The computer may be in the same room as the terminal or halfway across the continent. The computer displays on the screen of the video monitor the information requested, such as the number of seats available and their locations on a given flight, the state of a customer's credit balance, and any other data. Interacting with the computer through the video terminal, the reservations agent has the ability to perform such transactions as reserving seats on a flight or recording a bank deposit.

One gets the impression when using the terminal that he's the only one accessing the computer. Actually, though, hundreds of reservations agents

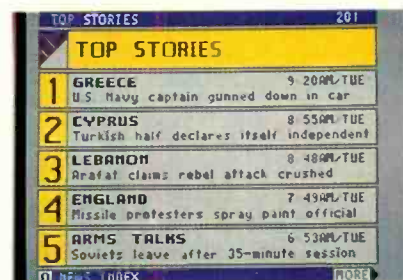

may be using the computer at the same time. This technology has been fairly common for the past 10 years or so.

In theory, there's nothing to prevent you from buying a terminal for \$1500 or so and contracting with a number of services to gain access to their computers over the telephone line. There are dozens of "time-sharing" computers in the country that you can use in this manner, though, in most cases, the data available to you would be terribly specialized and virtually useless.

The roots of videotex are varied. We start with computer data banks with enough information in them that's of

Announcing A Major New Innovation From The Publishers Of 

Now, Get Up To 72 Programs For As Little As \$2.00 Each.

Introducing PC DISK MAGAZINE. The Only Magazine On Disk That Gives You A Library Of Software Programs For Your IBM Personal Computer ... At A Fraction Of The Price!

Imagine building a library of software programs with amazing ease...adding utilities, subroutines, games and data files to your system...for as little as \$2 per program! Introducing PC DISK MAGAZINE—a totally new concept for your microcomputer that gives you all this and more! You get thoroughly tested, ready-to-run programs on a floppy disk—complete with a comprehensive, illustrated User Manual—for the ultimate in ease, efficiency and economy. With your subscription to PC DISK MAGAZINE you'll receive a floppy disk containing up to 12 varied ready-to-use programs and files. Developed by experts and tested by the editors, you'll be able to expand the use of your IBM personal computer.

Business and Finance Aids: Create advanced pie, bar and line chart graphics. Compute loan payment tables. Calculate the Present Value and Internal Rate of Return for your investments. VisiCalc[®] templates for

Real Estate, Lease/Purchase and Tax Shelter analysis.

Programming Tools: Create cross-reference listings for your BASIC programs. Convert MBASIC[™] program files to CBASIC[™] format or reverse. Use your text editor on your BASIC programs. Convert data between BASIC and VISICALC[®] or Supercalc[®] formats.

Home/Personal Applications: Whether you need your own income tax return helper...proven ways to maintain a mailing list...a personal cash flow analyzer...a speed reading trainer...or SAT test preparation aids, you'll get it from PC DISK MAGAZINE.

Utilities and Diagnostics: Print graphics, screen images on your printer...backup, copy, delete, un-delete or type files with simple menu commands. Use your computer to simulate a conversational terminal with function key control of disk or printer logging...and more.

Data Files: Tax tables, population statistics, dictionaries and economic times series.

Games: Adventures! Strategies! Test your skills, intelligence and your luck!



Everything Is Ready For You

PC DISK MAGAZINE has everything you need. The accompanying 60-page User Manual is written clearly, concisely, in easy-to-understand terms. You'll be able to try the programs immediately...there's no need to type listings into your computer. Just insert the disk and go! That simply, all the latest software developments are at your fingertips!

A LIBRARY OF SOFTWARE PROGRAMS FOR THE IBM PERSONAL COMPUTER

PC DISK MAGAZINE

BUSINESS & FINANCE

LOAN ANALYZER
AUTOMATIC BAR CHARTER
WORDSTAR CONFIGURATOR

PROGRAMMING TOOLS

BASIC PROGRAM EDITOR
PERPETUAL CALENDAR

HOME/PERSONAL

PERSONAL CASH FLOW MANAGER
(PART I OF III)

UTILITIES & DIAGNOSTICS

DISK MAP
IBM MATRIX PRINTER
CONTROL

DATA FILES

DEMOGRAPHIC DATA FILE

GAMES

HIDE AND SINK
PYRAMID WATCH

COPYRIGHT © 1983 BY ZIFF-DAVIS PUBLISHING COMPANY. ALL RIGHTS RESERVED



Date	Page	Item	Description	Debit	Credit	Balance	Total
12/2		General	Working 6 Item	4.25		254.25	
12/10		United	Farm Truck	125.00		129.25	
12/15		International	Supermarket	50.50		78.75	
12/20		Hardware	Hardware	30.00		48.75	
12/25		Stock	Dividend		15.00	63.75	
12/31		Salary		6.18		57.57	

UNIVERSAL FILE PRINT UTILITY

File: Print: Print/Variable/Document:

Start Page: Record: Column/Field:

Stop Page: Record: Column/Field:

Line Numbers: Page Numbers: Print in Hex?

Spacing: Suppress Control? Truncate?

Upper Case? Print Control? Print Control?

Page Heading:

Page Footing:

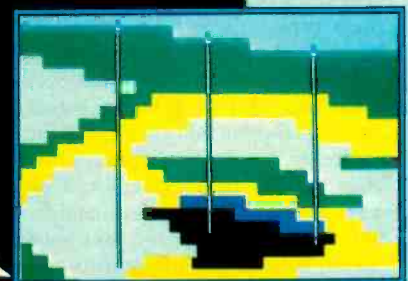

PRODUCT SPECIFICATIONS

- Programs will run on IBM personal computers under PC-DOS and MS-DOS versions 1.1 and 2.0 and require a minimum of 64K.
- Most programs will be written to run on both monochrome and color displays; however, some games and utilities may be specifically developed for color display.
- Most programs will be written in advanced Basic; however, some machine language and compiled code may be used.
- Programs and documentation are copyrighted by Ziff-Davis Publishing Company. All rights of reproduction in all forms and media strictly reserved.

PROGRAM SUBMISSIONS

If you wish to submit a program for inclusion in future issues, please write to: PC DISK MAGAZINE, Attn: Editor, One Park Avenue—Dept. 732, New York, N.Y. 10016.

GUARANTEE

- All programs are fully tested and guaranteed to run. Damaged or faulty disks will be replaced at no charge.
- If you wish to cancel a subscription, simply return the most recent disk in its sealed package and you will receive a full refund for this copy and on all unmailed issues.

Save \$60 With This Introductory Savings Offer. Get 6 Big Issues of PC DISK MAGAZINE And Save 34%.



P.O. Box 2462, Boulder, CO 80322

8H294

YES, Please accept my subscription to PC DISK MAGAZINE for 6 issues at the Special Introductory Price of just \$119 (less than \$20 per issue, as little as \$2 per program). I save \$60—34% off the full price of \$179.

Check one: Please bill me. Payment enclosed.
 Please charge to my credit card.

American Express Visa
 MasterCard

Credit Card No. _____ Exp. Date _____

Name _____

Address _____

City _____

State _____ Zip _____

MAIL NO-RISK COUPON TODAY — AND SAVE 34%!

Forget the idea that videotex has something to do with television

general interest to the public and that can be presented attractively with color graphics. The cost of the terminal to access such services, of course, must be relatively inexpensive, and access must be made very simple so that the user doesn't have to learn computer programming or complicated codes. Given these criteria, every household would want—and need—a terminal.

Different companies have moved toward this goal in different ways, frequently stopping short of providing all the features mentioned above, while still claiming the name videotex. CompuServe and The Source, for example, often claim to provide videotex services, mainly because the information and services they offer are of "general interest" and their customers are individuals instead of companies. What this statement implies is that it's the user who decides whether the service is or isn't videotex.

Companies that offer business information in a graphics format—graphs of stock quotations, for example—sometimes name their services videotex. One such company is General Motors' Buick division, which is putting together a "videotex" system that will link together all its dealerships to provide information about its products, using a lot of graphics. The people who are putting together these systems are saying that it's graphics that establish the service as videotex.

Clearing the Air. People who are deep into technology feel that true videotex has two fundamental and immutable characteristics. First, it's aimed at the individual (normally home) user. Second, it must use both text and graphics to display information. We may not get away with imposing this definition, but in the interest of having everyone understand what everyone else is talking about, it's worth a try.

The technical base of videotex isn't difficult to understand. At the center of the videotex system is an expensive, large, and powerful mainframe "host"



A typical screen for a "Top News" story.

computer. It is linked to the telephone network through a number of "ports." A videotex decoder in your home is also linked to the telephone system to give it access to the host computer.

The decoder is similar to a microcomputer. It has one or more microprocessors inside it and the necessary circuitry to produce a TV-like signal to drive a video display monitor. And, like some home computers, a modem that translates the decoder's digital signals into audio-tone signals to be carried over the telephone network is built into the decoder. Another similarity to the home computer is that you communicate with the decoder using a keyboard.

The videotex decoder is unlike the typical home computer in that there are limitations to what you can do with it. Even though it might be smart enough to, say, play games or do word processing, the intelligence that makes this possible usually won't be accessible to you. On the other hand, there are areas in which the videotex decoder is actually better than a home computer. For example, its modem is likely to be considerably more sophisticated than anything you'll find for a Commodore VIC-20 or Atari computer.

The videotex decoder is designed to

work with some kind of video display monitor. The most likely candidate, mainly because almost every household has at least one, is the ordinary TV receiver, preferably a color unit. But don't jump to the conclusion that using a TV receiver means that videotex has something to do with television! The TV receiver is required only as a display; all videotex decoding is accomplished separately from the TV receiver. In fact, you don't even need a receiver per se. If you had one of the new component TV systems in which the tuner and amplifier are separate items from the CRT display monitor, you'd connect the decoder directly to the monitor itself. The rest of the TV system isn't even needed, except to be able to receive normal broadcast TV programs when you're not using the video monitor for viewing videotex information.

Currently, and for the next few years at least, most videotex services will use the telephone network for communications. But any two-way medium that can carry signals from your home to a host computer and from the computer to your home could work. So, as two-way cable-TV (CATV) networks emerge, we're likely to see a new medium for transmitting videotex informa-

It's a new medium of communication that has yet to be exploited

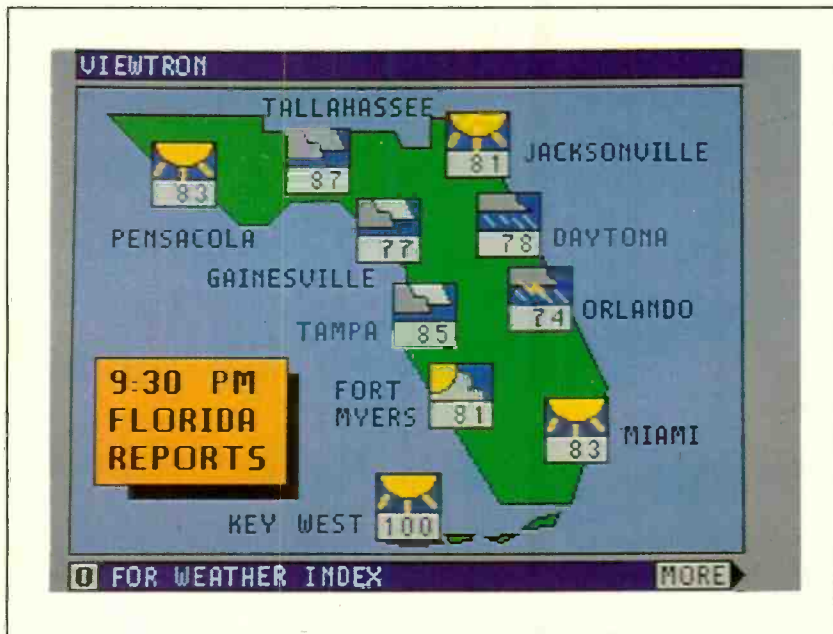

The screen for the weather forecast might look like this.

standard impelled those planning videotex systems to a common graphics standard. If everyone involved in the videotex industry agreed on a standard for encoding graphics, there would be more expertise, more software, more competition to supply the hardware, and more marketability of acquired experience. Indeed, there is an emerging North American standard for encoding graphics information, called the North American Presentation Level Protocol Syntax, abbreviated NAPLPS.

Drawing the Lines. NAPLPS is the forerunner, but it didn't emerge without a battle. In the beginning, were two proposals for encoding videotex graphics. One was the British *alphamosaic* scheme called Prestel, while the other was the Canadian *alphanumeric* scheme called Telidon. The battleground for both was the United States, which was clearly seen from the outset as the most lucrative market for videotex.

To understand the difference between the two standards, you might consider the problem of having to describe, without visual aids, a simple picture to someone over the telephone. Imagine also that the person at the other end of the line has only a limited knowledge of the English language.

Your first step would be to lay a grid over the picture (see illustration) to establish a frame of reference. In our example, the grid represents only a small fraction of the picture that can be displayed on the TV screen. The entire picture would consist of tens of thousands of such squares.

Notice the small rectangle in the upper left of the grid and the letter Z in the lower right. Let's assume you're trying to convey this picture to your non-English-speaking friend at the far end of the telephone line. If your friend's English vocabulary is *very* limited, you might try to name the color in each grid square.

Beginning at the far left of the first
(Continued on page 92)

tion. Current CATV networks are capable of single-direction-only information transfers, and they are only to your home. This situation will almost certainly change in the near future.

The Videotex System. Most of the hardware required in videotex systems is analogous to the hardware used in airlines reservations systems. That is, it consists of terminals, displays, communications lines, and a central computer. One more essential element is needed, however. This is a common code that will allow all subscribers to the system to communicate with the host computer.

The airlines reservations computer and the computers at The Source and CompuServe can communicate with subscribers only if they agree on how to present the information that's being transmitted. Fortunately, most of the world some years ago agreed to use ASCII (American Standard Code for Information Interchange) coding for communication of alphabetic and numeric information. The 7-bit code assigns a unique pattern of seven 1s and/or 0s for each letter and number and such common punctuation characters as the question mark, comma, and

parentheses. The code for *A* is 1000001, *m* is 1101101, *** is 0101010, and so on. Computers, terminals, communications links, and most software use the same ASCII codes.

ASCII codes cover only alphabetic and numeric information. However, one of the characteristics we've decided must be part of the true videotex system is that available information must include graphics. We'll take this demand a step further and add that the graphics must be in color.

Every computer system that uses color graphics, from Apples to Ataris to IBM mainframes, has to devise an encoding scheme for graphics. Unfortunately, manufacturers of different computers take different approaches to achieving this goal. This is the problem. Apple solved the color-encoding problem differently from Atari, and IBM has its own approach that's different from the other two. While this wouldn't be a problem for the videotex system, it would have to be guaranteed that everyone involved, including the host computer and all subscriber terminals, were going to use equipment and software from a single source.

Naturally, the forces that brought the computer industry to the ASCII stan-

Jet Set Printers



THE other day I did something I would never have considered doing—or even been able to do at all—a month earlier. I walked into a Radio Shack store and, for \$699 and change, took home an ink-jet printer. Ink-jet printers have been around for a while, but their prices—thousands of dollars—made their use with microcomputers prohibitive. Times and technology have changed, though, and there are now several printers of this type available at a price comparable to that of a dot-matrix or formed-character

Recent advances in technology have made ink-jet printers competitive pricewise with other types—as exemplified by the Radio Shack CGP-220

By Mark S. Zachmann

printer. One such is Radio Shack's CGP-220.

How They Work. Inexpensive ink-jet printers of this type use a technique called *drop-on-demand* printing. Instead of shooting out a continuous jet of ink and using electrical fields to deflect it to form characters on the target paper (much the same way as the electron beam in a TV picture tube is deflected to paint an image on the screen), drop-on-demand printers use a technique similar to that found in dot-matrix printers.

The print head contains a linear array of orifices through which ink is squirted by a piezoelectric mechanism that generates a "squeeze" when commanded by the printer's 6809 microprocessor and character-generator ROM.

When the squeeze is applied, a drop of ink spurts out of the print-head nozzle and hurls through the air to impact on the paper. There it forms a dot that dries almost instantaneously. By using a head with several nozzles, different-colored inks can be applied to the paper. If the actions of the nozzles are sequenced correctly, a number of different colors can be produced by the mixing of the inks on the paper.

The ink for the CGP-220 comes in flattish plug-in plastic cartridges. The printer has two receptacles into which those cartridges can be inserted—one for black ink and the other for the tri-color pack containing yellow, magenta, and cyan inks. The ink itself is contained in what appear to be metallized plastic pouches within the cartridges. The tri-color cartridge contains three such pouches stacked vertically and supported by plastic separators. Changing a cartridge is easy since it is merely a matter of unplugging the old one and inserting the new one.

Print-head nozzles in ink-jet printers can be arranged either vertically or side-by-side. The CGP-220 uses a horizontal array of four nozzles, one for each color ink. The head traverses a metal rod as it moves from one side of the paper to the other. The mechanism is shown on page 81. By combining the inks from different nozzles, seven colors can be produced: black, red, green, yellow, blue, magenta, and violet.

Ink-jet printers have several significant advantages over dot-matrix printers, their nearest rivals. For one thing, they are better at color printing. Color dot-matrix printers use a ribbon with several color bands impregnated in it. Not only is the printing process with this type of mechanism noisy and time consuming, but the quality of reproduction leaves something to be desired. The inks used by ink-jet printers can actually be mixed on the paper, giving a result superior to that produced by depositing the colors separately by making several passes across a ribbon.

A second advantage ink-jet printers have over the dot-matrix type is their reliability. There are fewer moving parts and they are forced to operate much less strenuously than those in the matrix

printers. There are no solenoids and no wires or pins to wear out.

Ink-jet printers are relatively fast—comparable in speed to dot-matrix

printers. What primarily makes them this way is the lack of mass of the print head. It has no heavy solenoids and bearings to carry, and all it has to do is

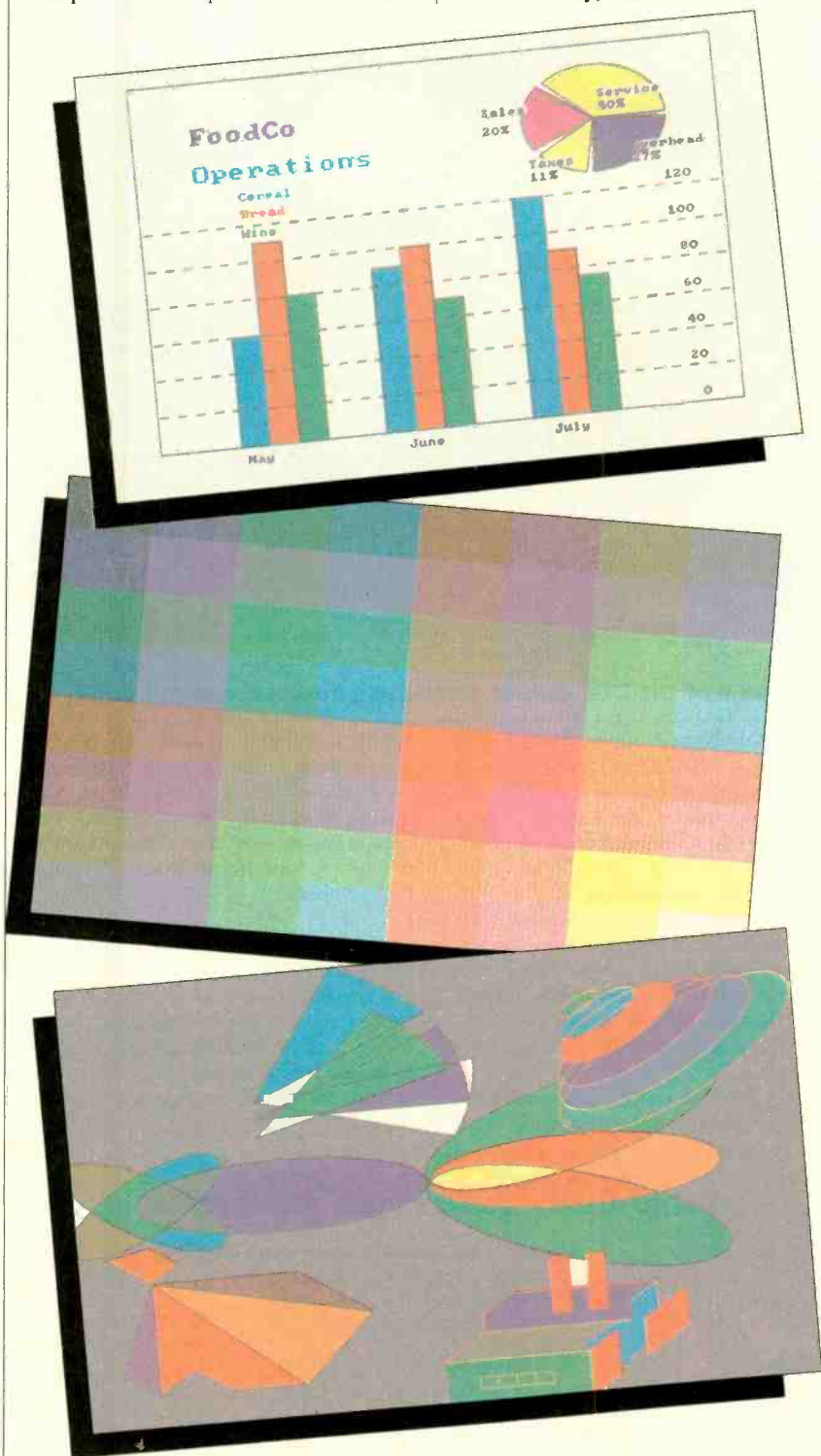

Many interesting effects can be achieved with an ink-jet printer.



Design of the CGP-220 is simple and inexpensive, but good.

spray lightweight droplets of ink. Finally, there is the lack of noise. Ink-jet printers don't whine, buzz, or screech. The noisiest part of the CGP-220's operation is when the head changes direction and you hear a sort of "click" as it does so. The rest is silence.

For all their advantages, ink-jet printers do have a few shortcomings. Unless proper care is taken, the ink in the nozzles can dry out and clog. (A printer from Olivetti, though, uses a dry-powder ink that presumably avoids this problem.)

Also, for best results, a special plastic-impregnated paper should be used.

While acceptable results can be obtained with ordinary bond paper, the ink has a tendency to soak into it, producing sometimes fuzzy results. The special papers, available in both roll and sheet form from Radio Shack, eliminate that problem.

The CGP-220. Operation of the Radio Shack CGP-220 ink-jet printer is based on a mechanism that is produced by Canon and used in several other printers such as the Quadram Corporation's Quadjet. It is a simple and inexpensive design, but a good one into which much thought has gone.

TECHNICAL SPECIFICATIONS RADIO SHACK CGP-220 INK JET PRINTER

Resolution:	640 dots × 8 columns (color scan graphics mode) 560 dots × 7 columns (bit image mode) 12 cpi, 5 × 7 dot-matrix (text mode)
Speed:	2600 dots/second (graphics) 37 cpi (text)
Ink cartridge:	Black (4,000,000 char.) Tri-color (3,000,000 char.)
Interfaces:	Centronics parallel Serial (600/2400 baud, 4-pin DIN connector, connects directly to TRS-80 Color Computer)
Size:	15¾" × 11⅝" × 4¼"
Weight:	12.3 lb

The bidirectional printer has two modes: graphics and text. In the graphics mode, it prints at the rate of 2600 dots per second and provides a monochrome resolution of 560 dot-columns (with 7 dots per column) per line. In its multi-color graphics mode, the resolution becomes 640 dot-columns per line (80 dots per inch), with 8 dots per column. To fill an 8½" square page with graphics takes approximately 5 minutes. Direct screen dumps can be done from the TRS-80 Color Computer.

The text mode produces 5 × 7 characters—in black or in color—at approximately 37 cps. A 5 × 7 dot array does not produce very attractive characters; but, for a device that will be used principally for color graphics, this is not a particularly harmful drawback.

Radio Shack has overcome the nozzle clogging problem with what the user's manual terms the "Green Lever." The green lever actually serves several purposes. When the printer is not in use or is to be transported, it caps the nozzles of the print head and locks the mechanism to keep it from being damaged. In addition, the lever can be used to "pump" the ink supply to make the colors printed more saturated (sometimes the output of the printer looks a little on the pastel side).

The CGP-220 supports elongated character sets, variable pitch, character repetition (256 repetitions maximum), and provides some special characters such as those used in European languages.

Radio Shack should have included a method in hardware or software to tell the printer not to advance a line when a carriage return is sent, or to ignore linefeeds. As it is, when you send a CR-LF pair to the printer you get double-spaced text, whether you want it or not.

Unfortunately, some features common in similarly priced dot-matrix printers are absent. They include underlining, bold face, italics, partial line feeds, and proportional spacing. Since the device is programmable from BASIC, it is possible that some of these features *are* available under program control, but they do not seem to be readily callable from, say, a word processor.

Remember, though, that this printer is primarily a graphics device; and, for its price, it does an awful lot. If you want a near-letter-quality printer, there are plenty around—but they can't produce pretty colored pictures. ♦

TYPES OF PRINTERS

The printers used with microcomputers can be separated into two different categories. *Fully-formed character* printers, sometimes referred to as "letter-quality" printers, give the best results. They generally use Electric-type print elements—commonly known as "golf balls"—or daisy wheels. Daisy wheels have the characters embossed on the ends of spokes that are attached to a central hub, and the appearance of this configuration is what gives them their name. As the wheel, which is attached to the print-head mechanism, moves back and forth across the paper, it is rotated to bring the proper character into a position where it can be hit by a small solenoid-driven hammer. The character strikes a ribbon, producing printed characters just like a typewriter.

The quality of the print is excellent, but the massive head assembly keeps speed down (to about 55 cps maximum, and usually less) and the noise level is high. Still, daisy-wheel printers are faster and quieter than "golf-ball" types. Those usually print no faster than 14 cps and, in addition, are mechanical nightmares, usually having over 600 moving parts.

The other type of printer is the *dot-matrix* type. Dot-matrix printers, which include the ink-jet family, use a variety of techniques for producing a pattern of dots on a piece of paper to form a character. The higher the resolution of the printer—expressed in dots per inch or in terms of the matrix (5 × 7, 7 × 9)—the better the characters will look. Most dot-matrix printers have the ability to produce some graphics, and to generate different character sets and sizes. At present there are five principal types of dot-matrix printers.

The most expensive, and fastest, dot-matrix technology is *laser printing*. Laser printers work much like wet-process photocopiers. The paper rotates on a drum, as first the paper goes through a sensitization process. Then the laser, pulsed on and off at a very high rate, sweeps over the paper, energizing portions of the paper where its light falls. The paper is then dipped in a developing

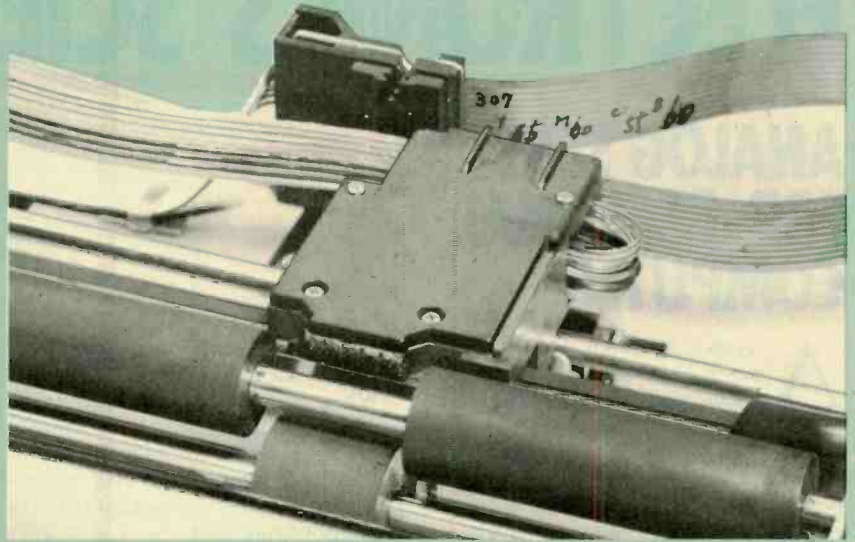

A horizontal array of four ink nozzles moves across the paper.

solution and stabilized. One advantage of using a laser is that the light beam can be focused very tightly, which gives excellent resolution and results in distinct, well-formed, characters. Another advantage is speed.

The most prevalent dot-matrix technology is *impact* printing, which is usually what is meant when the term *dot matrix* is used. The print head of a dot-matrix printer contains a number of vertically mounted stiff wires, or pins, pointed at the paper. As the head travels across the paper, the solenoids push the wires out against an inked ribbon. This technique can produce *near-letter-quality* results, depending on the size, shape and number of wires in the print head. Sometimes to achieve near-letter (or *correspondence*) quality printing, several passes over the same line must be made, with the print head offset slightly each time. That causes the spaces between the dots to be filled in. Since wires are so much lighter than print wheels, impact printers are faster than formed-character printers, sometimes operating at several hundred characters per second. Impact dot-matrix printers tend to be noisy.

Another type of dot-matrix printer is

the *thermal* printer. It requires a special kind of paper. Its head has wires arranged like those in the impact type; but as the head passes over the paper, the wires don't move, heating up instead. This causes a chemical change in a coating on the paper, causing it to turn blue or black.

The paper is somewhat unstable and if kept in a warm place, or exposed to high heat, discolors, making it difficult (and sometimes impossible) to read what's on it. Thermal printers are, however, extremely quiet and are inexpensive compared to the other types.

A relative of the thermal printer is the *electrostatic*, or *electrosensitive* printer. It too uses a special paper, but this type has had an ultra-thin layer of metal deposited on it. The wires in the print head "zap" dot-sized portions of the metallic coating by passing an electrical current through the paper to an electrode behind it, exposing the black surface of the paper beneath. The paper used by this sort of printer is also very delicate, and great care must be taken in handling it. Electrostatic printers, while not costly, are rare today.

Finally there is the *ink-jet* printer, the subject of the body of this report. ◇

PRINTER SAMPLER

	HP 2688A	NEC 3550	Epson FX-80	Radio Shack CGP-220
DPI (vert.)	300	N/A	150	80
DPI (horiz.)	300	N/A	80	80
Speed (rated)	6 pages/min.	33 cps	160 cps	37 cps
Noise	Quiet	Very loud	Noisy	Quiet
Colors	1	1	1	7
Character quality	Letter	Let. er	Good	Fair
Graphics quality	Great	—	Good	Good
Price	\$29,000	\$2000	\$600	\$699

ELECTRONICS SCIENTIST

ANALOG SENSORS FOR PERSONAL COMPUTERS

ANYONE who has built a fair number of electronic circuits knows the frustration of not being able to make quick changes to an assembled project. But if you own a personal computer, you may already possess the key ingredient for solving this common circuit builder's malady.

Thanks to its programmability, a computer allows you to change the operation of many kinds of circuits simply by entering a revised program. Often changes can be made just by altering a few numbers in an existing program.

In this column we'll explore how a personal computer equipped with an analog-to-digital converter can greatly expand the capabilities of a very simple circuit. While the emphasis will be on analog sensors, you'll quickly see many other possibilities for adding "intelligence" to other relatively simple circuits to monitor light, temperature, barometric pressure, and various other parameters.

Of course, there are circuits that can accomplish these same functions without using a computer. And these circuits would probably be less expensive to build and more compact than a computerized sensing system. However, the computer provides an easy-to-use, yet highly sophisticated, means for storing and displaying measured data.

For example, an accurate and reliable light meter can be made by connecting a silicon solar cell to an operational amplifier as shown in Fig. 1. When connected to either an analog or digital voltmeter, this circuit can be used to manually monitor the intensity of sunlight and artificial lights. In either case, measurements have to be manually recorded.

When connected to the A/D input of a computer, the light level measured by the circuit in Fig. 1 can be automatically stored in the computer's memory for later readout. Moreover, a simple program will allow the computer to sample, at any time interval specified, the output from the sensor circuit. Another program can then be used to display or

print out the samples as a function of time on a line or bar graph.

When used in this role, a computer can be considered a "smart" data logger or, perhaps, chart recorder. The computer is so "smart" it can even be programmed to correct for nonlinearities in the sensor being used.

Furthermore, the computer can be programmed to prepare publication-quality graphics on an x-y plotter and can even be programmed to send control signals to various output devices when the input signal falls below, or exceeds, any specified level.

Selecting a Computer. Any computer that can be equipped with an analog-to-digital converter board can be used to monitor an analog sensor. Such boards are available from various sources for personal computers made by Apple, IBM, Radio Shack, Timex, and others.

Some computers include a built-in A/D converter. For example, the two joystick inputs on Radio Shack's Color Computer are actually four separate inputs to a built-in 6-bit digital-to-analog (D/A) converter.

Each Color Computer joystick contains a pair of 100-kilohm potentiometers connected as voltage dividers across a 5-V supply. As the rotor of each pot is turned, the output voltage varies from 0 to +5 V.

Within the computer, an analog multiplexer (MC14529B) selects, under program control, one of the four joystick voltages. The selected voltage is then applied to one input of one of the comparators within an LM339 quad comparator. The other comparator input is connected to the output of a simple 6-bit D/A converter made from the network of six resistors and six buffers (MC14050B) shown in Fig. 2. A machine-language successive approximation routine is then used to determine, to the 6-bit accuracy of the D/A converter, the analog equivalent of the joystick position.

Evaluating Computer A/D Systems. Before selecting an A/D board or system for your computer, collect as much information about the available boards as possible. Talk to someone who has actually added an A/D capability to a

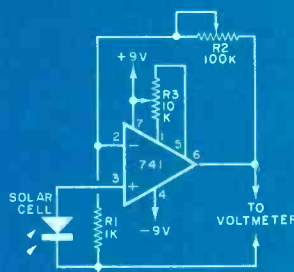

Fig. 1. Light meter circuit.

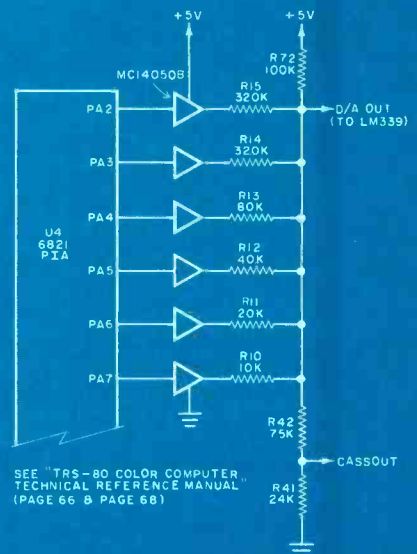
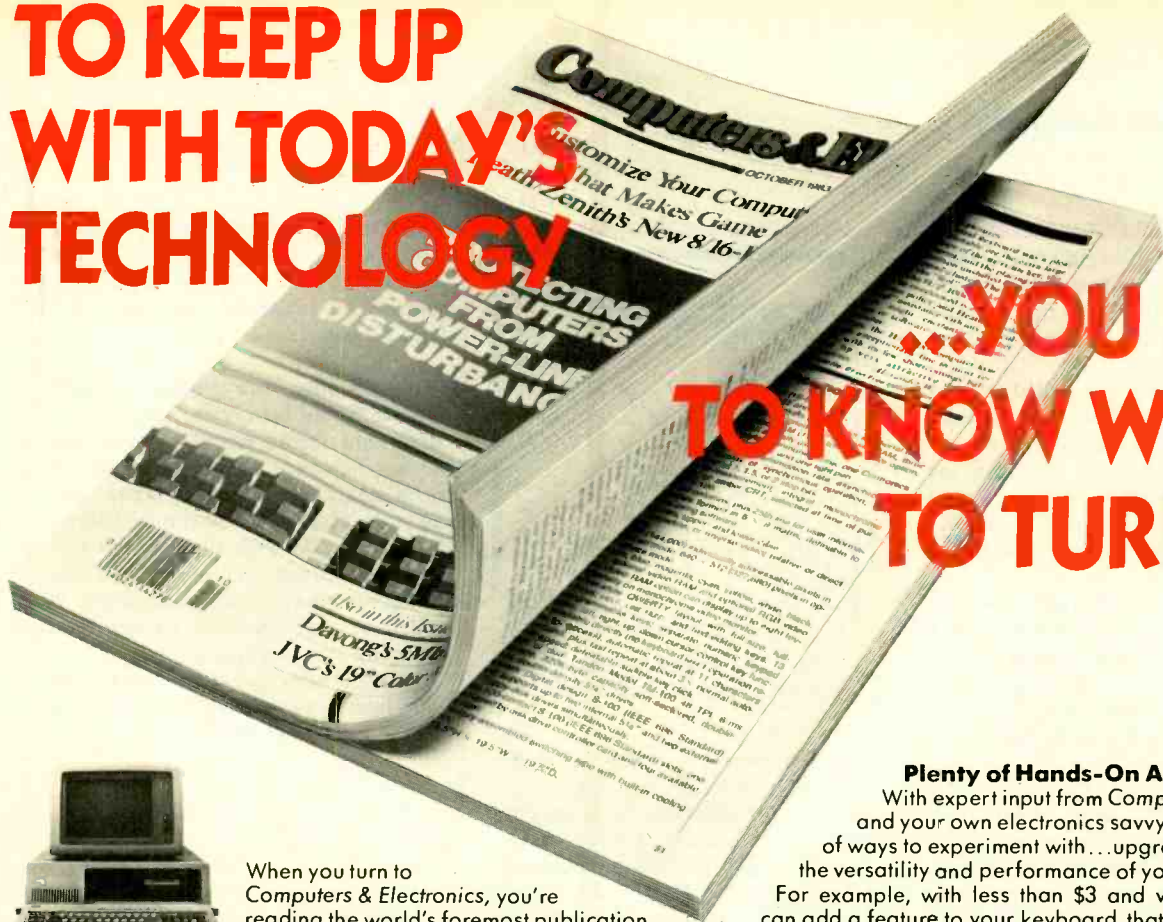

Fig. 2. D/A converter circuit.

TO KEEP UP WITH TODAY'S TECHNOLOGY

...YOU HAVE TO KNOW WHERE TO TURN.



When you turn to *Computers & Electronics*, you're reading the world's foremost publication covering the microcomputer industry — where last night's discovery is today's technology. *Computers & Electronics* is your direct link to state-of-the-art information in:

Microcomputer Developments

Whether you're investing \$300 or \$3000, turn to *Computers & Electronics* first. You'll find candid test reports of all major new microcomputers... from the Commodore 64 to the Apple™ IIe to the IBM-PCXT. And you'll discover which unit has the power, software and expansion capability to meet your specific needs. At your specific budget.

New Peripherals and Software

Micro programs and add-ons are increasing almost geometrically. Let *Computers & Electronics* sort it all out for you.

You'll get features like a buyer's guide to printers. A preview of the first workable economical thesaurus program that runs on virtually any CP/M-based system. Advance looks at new products like a joystick for Visicalc®... disk drive assemblies... a color monitor for the IBM-PC.

Increase Your Computer Science I.Q.

Computers & Electronics will enlighten you with easy-to-understand discussions of computer fundamentals. Such as the series on learning 16-bit microcomputer technology and an in-depth look at the structure of CP/M.

You'll also delve into the future with articles like Super Chip: next-generation personal computers with double the performance at a lower price.



Plenty of Hands-On Action, Too

With expert input from *Computers & Electronics*, and your own electronics savvy, you'll find dozens of ways to experiment with... upgrade... and increase the versatility and performance of your system.

For example, with less than \$3 and very little time, you can add a feature to your keyboard that lets you automatically repeat a character by holding down a key. Or you might want to build a circuit that lets you match a 600-baud CoCo to a 300-baud printer.

Heard about the important new electrically-erasable PROMs? *Computers & Electronics* will keep you filled in on the improved memory chips as they're produced — how they work, how to wire them, what applications to use them for.

Get Every Issue... PLUS Savings up to 37%!

If you're not getting every informative issue of *Computers & Electronics*, there's a gap in your knowledge — and enjoyment — of today's high-speed, high-tech revolution. And now's the best time to subscribe, while this introductory offer is in effect: One year (12 big issues) for just \$12.97, with long-term savings available up to 37%!

So keep up with what's happening. Turn to the special postpaid order card or the coupon below... now!



Computers & Electronics

P.O. Box 2774, Boulder CO 80322

YES! Keep me tuned in with *Computers & Electronics* for the term I've checked below:

- One year (12 issues) just \$12.97 — **I save 24%! (Savings based on full one-year subscription price of \$16.97)**
- Two years just \$22.97 — **I save 32%! (Savings based on full one-year subscription price of \$16.97)**
- Three years just \$31.97 — **I save 37%! (Savings based on full one-year subscription price of \$16.97)**

Mr. /Mrs. /Ms. _____ (please print full name) 45119

Address _____ Apt. _____

City _____ State _____ Zip _____

CHECK ONE: Payment enclosed. Bill me later.
Please charge my credit card: American Express MasterCard Visa

Card No. _____ Exp. Date _____

Add \$5 a year in Canada; all other foreign add \$8 a year. Please allow 30-60 days for delivery of first issue.



DON'T MISS ONE INFORMATIVE ISSUE. SUBSCRIBE NOW AND SAVE UP TO 37%!

personal computer, to find out if using the board requires a knowledge of machine language. If so, you may want to make sure the board is supplied with at least some software.

When the board is installed in your computer, perform a calibration check to make sure its output is linear with respect to its input. For example, the graph of Fig. 3 plots the joystick values displayed on a Color Computer (0 to 63) versus the input voltage provided by the joystick.

Thanks to the 1% tolerance precision resistors in the Color Computer's D/A converter network, the graph in Fig. 3 is almost perfectly linear. Broad-tolerance resistors would have almost certainly caused at least a few perturbations in the curve.

Note, however, that the plot does *not* extend all the way from ground to +5 V as implied in the description of the Color Computer joystick interface. Instead, it extends from approximately 0.3 to 4.81 V, very close to the design specification of 0.25 to 4.75 V.

Refer back to Fig. 2 and you'll see why the Color Computer joystick inputs don't extend to ground and +5 V. Resistors *R72*, *R42* and *R41* are included at either end of the D/A resistor network to intentionally limit the minimum and maximum excursions of its output voltage. Although not checked, it is assumed that shorting these resistors would allow the output of the D/A to extend from ground to +5 V.

A Computerized "Smart" Light Meter. The simple light meter circuit in Fig. 1 works quite well and is adequate for many light measurement purposes. However, by connecting the basic circuit to the A/D input of a personal computer, a "smart" light meter having capabilities not available in commercial light meters will be produced. This computerized "smart" light meter is so sophisticated it can even be used in a low-budget scientific laboratory.

Figure 4 shows one way to connect the basic light meter to one of the joystick ports on a Color Computer. The interface cable can be made from insulated hookup wire and a 6-pin DIN connector plug. Or, you can simply unsolder the yellow wire connected to the rotor of one of the pots in a Color Computer joystick. Solder 10" lengths of color-coded wrapping wire to the yellow lead and the ground (black) and +5-V (red) connections and thread the leads

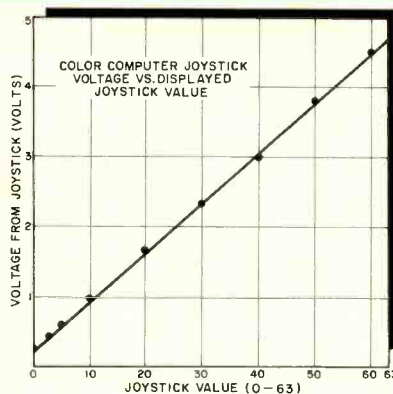

Fig. 3. Graph showing linearity of the computer's A/D circuit.

through a small hole drilled in the joystick case near the FIRE button.

Keep in mind that the basic circuit in Fig. 1 can be connected to other computers having A/D conversion capability. Just be sure to follow the instructions regarding analog-to-digital interfacing.

Before connecting the light-meter circuit to a computer, it's a good idea to adjust its offset and gain using a dc voltmeter connected across its output (as in Fig. 1). First, isolate the solar cell so that no light can fall upon its sensitive surface, then adjust offset potentiometer *R3* until the dc output is as close as possible to 0 (or 0.25 V for the Color Computer).

Next, allow full sunlight to illuminate the solar cell and adjust gain potentiometer *R2* until the output reaches the maximum voltage input for your computer's A/D converter (4.75 V for the Color Computer).

The light meter circuit will now output a range of voltages compatible with your system. Incidentally, to keep readjustments to a minimum and to protect

your circuit from unauthorized control "tiddling," it's a good idea to use screwdriver-adjustable trimmers for both *R2* and *R3*.

Programming the "Smart" Light Meter. If your computer permits and if your light measurement requirements do not require ultra-fast response, it's surprisingly easy to develop simple BASIC programs for a customized smart light meter. Though the routines that follow are intended for use with a Color Computer, they illustrate the kinds of programs that can easily be developed for many other computers.

The following program displays the light intensity at the surface of the solar cell on a scale of 0 to 63:

```
10 CLS
20 PRINT @ 0, JOYSTK(0)
30 GOTO 20
```

When this program is run, a number ranging between 0 and 63 will be displayed at the upper left corner of the video monitor. The number will fall to 0 when the solar cell is dark and rise to 63 when the solar cell is brightly illuminated.

It's easy to dress up the program to provide a fancier readout. First, we can add some text to explain exactly what the flickering number means. And we can insert a correction factor to change the 0 to 63 scale to a more convenient scale of 0 to 100. The correction factor is determined by dividing 100 by 63. The result is multiplied by the joystick value to provide a readout scale of from 0 to 100 (1.5873). While this procedure is intended for the Color Computer, a similar method can be used with other computers.

Here's one possible version of the im-

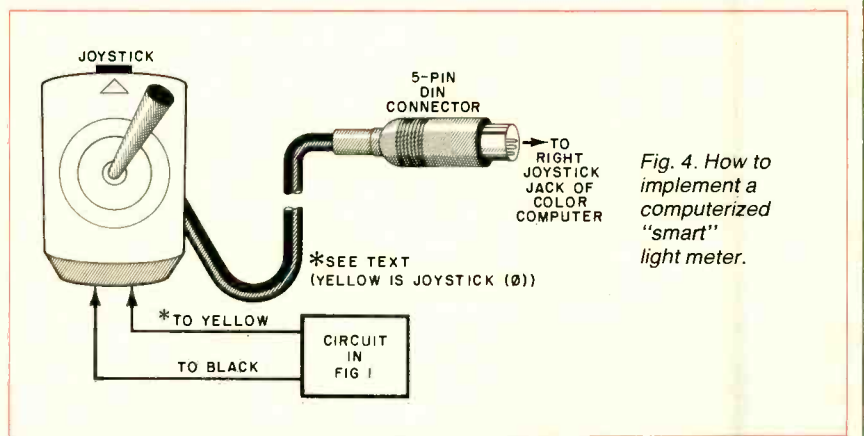

Fig. 4. How to implement a computerized "smart" light meter.

proved program:

```
10 CLS
20 PRINT @ 0, "SMART
  LIGHT METER"
30 PRINT @ 64, "LIGHT
  INTENSITY (0-100):"
40 PRINT USING "##";
  1.5873* JOYSTK(0)
50 GOTO 30
```

When this program is run, the screen displays:

```
SMART LIGHT METER
LIGHT INTENSITY
(0-100):
nn
```

with the light intensity level denoted by "nn." Note the use of the PRINT USING statement in line 40 to round off the corrected value of nn. PRINT USING is available with Extended Color BASIC. If your computer does not have PRINT USING, check the operator's manual to see if alternative statements are available. For example, INT will print only the integer portion of a number, but no rounding will occur.

If you're still not impressed by the capabilities of the "smart" light meter, perhaps adding an analog display capability will convince you. Here's one of many ways the graphics capabilities of the Color Computer can be used to provide an analog output:

```
10 CLS(0)
20 PRINT @ 8, "SMART
  LIGHT METER";
30 PRINT @ 256,
  "0.....5
  .....1";
40 PRINT @ 99, "LIGHT
  INTENSITY
  (0-100):";
50 PRINT USING "##";
  1.5873*
  JOYSTK(0);
60 X=JOYSTK(0)
70 SET (X, 15, 3)
80 FOR T=1 TO 50:
  NEXT T
90 RESET (X, 15)
100 GOTO 30
```

When this program is run, the screen displays three horizontal, text-filled yellow bars across a black background as shown in Fig. 5. The right end of the center bar provides the light meter's digital readout. The bottom bar is the



PREVENT THE DISASTER OF HEAD CRASH AND DROPOUT.

The war against dust and dirt never ends. So before you boot-up your equipment, and everytime you replace a cassette, disk or drive filter, be sure to use Dust-Off II; it counteracts dust, grit and lint. Otherwise you're flirting with costly dropouts, head crashes and downtime.

Dust-Off II is most effective when used with Stat-Off II. Stat-Off II neutralizes dust-holding static electricity while Dust-Off II blasts loose dust away. There's also the Dual Extender and Mini-Vac for vacuuming dust out of hard-to-reach places.

Photographic professionals have used Dust-Off brand products consistently on their delicate lenses and expensive cameras for over ten years. They know it's the safe, dry, efficient way to contaminant-free cleaning.



Cleaning not provided by liquid cleaners.

Dust-Off II's remarkable pinpoint accuracy zeroes in on the precise area being dusted. And you have total control—everything from a gentle breeze for



Stat-Off II neutralizes dust-holding static electricity from media and machines.

delicate computer mechanisms to a heavy blast for grimy dirt.

Don't let contamination disrupt your computer operation. Stock up on Dust-Off II—the ad-

vanced dry cleaning system, at your local computer or office supply dealer.

Or send \$1.00 (for postage and handling) for a 3 oz. trial size and literature today.



Dust-Off II

The safe dry cleaning system

Falcon Safety Products, Inc., 1065 Bristol Road, Mountainside, NJ 07092

Circle No. 25 on Free Information Card

scale for the analog output. As the light intensity is varied, a blue dot slides back and forth along the upper side of the analog scale. This provides a highly visible moving-dot analog readout.

Still another capability of the smart light meter is *data logging*. When suitably programmed, the computer will sample the output from the solar-cell circuit at any desired interval and display the readings on the screen or print them on a printer as a list of numerical entries. The readout can be embellished with explanatory text. Some computers can even provide a readout of the time at which each sample was made for future reference information.

This program shows one of many ways to use the Color Computer as a data logger for the smart light meter:

```

10 CLS
20 INPUT "SAMPLE
   INTERVAL
   IN SECONDS"; S;
25 INPUT "NUMBER OF
   SAMPLES"; N
30 CF=(S - .35) * 460
40 CLS
45 PRINT "SMART LIGHT
   METER"
50 PRINT "SAMPLE
   INTERVAL: "; S;
   "SECONDS ."
60 PRINT ""
70 FOR S=1 TO N
80 Q=Q + S;
90 D=INT(1.5873 * JOYSTK
   (0))
100 PRINT S; " "; Q; " "; D
110 FOR T=1 TO CF;
   NEXT T
120 NEXT S
130 PRINT "TEST
   COMPLETE ."
140 END
    
```

When this program is run, the computer will ask you to enter the interval in seconds at which you wish samples to be made and the total number of samples you wish the computer to record. Let's assume we want the computerized smart light meter to record ten samples of sunlight intensity separated by intervals of 10 seconds. On a day when the sky is filled with clouds, a typical post-test display might look like this:

```

SMART LIGHT METER
SAMPLE INTERVAL : 10
SECONDS
1. 10 : 94
    
```

```

2. 20 : 94
3. 30 : 89
4. 40 : 71
5. 50 : 63
6. 60 : 59
7. 70 : 82
8. 80 : 91
9. 90 : 95
10. 100 : 94
TEST COMPLETE.
OK
    
```

The first column gives the sample number. The second column gives the accumulated time in seconds when the sample was made. The third column gives the light intensity on a scale of 0 to 100.

Adding Set Points to the Smart Light Meter. Any of the preceding programs can be supplemented with *set points* that might trigger a sound or even close (or open) an external relay when specified conditions are met. Here's an example of a simple set point program for our smart light-meter:

```

10 A=JOYSTK(0)
20 IF A<20 THEN SOUND
   150,5
30 GOTO 10
    
```

When run on a Color Computer, this program instructs the computer to emit an audible tone when the light level falls below 20 (on a scale of 0 to 63). If you've done much electronics experimenting, you'll recognize the comparator-like operation of the program.

Of course the programmability of the smart light meter makes the set-point option far more powerful than a hard-wired comparator. With a few key-strokes we can quickly change the system's set point and both the frequency and duration of the output tone. We can also add additional set points; and we can even establish one or more programmed windows into which (or outside of which) the data must fall if a tone

is to sound (or cease sounding).

Going Further. As you can see, interfacing a personal computer to an analog sensor can greatly expand the capabilities of the circuit. The programs given here are merely a few examples of what can be done.

If you want to further embellish the capabilities of the smart light meter, you might wish to combine a series of programs into a single program. You can then use a menu routine to call up the data presentation options you want.

You can easily add provisions for converting the data into hard copy. And you can even write routines that will perform numerical analysis of the data. For example, add these lines to the data-logging program:

```

92 X=1.5873 * JOYSTK(0)
94 Y=Y+X
123 Z=Y/N
125 PRINT "AVERAGE
   LIGHT LEVEL : "; Z
    
```

Now the data-logging program will automatically sum the sampled light levels and display their average when the sampling is complete. (The displayed average will be slightly higher than the average of the displayed samples since the samples are truncated to simplify the display.)

The smart light meter can even control external devices with no modifications or external hardware if the computer includes a cassette port. For example, the Color Computer includes an internal relay that is accessible via the cassette jack and that is closed or opened by the statements **MOTOR ON** and **MOTOR OFF**.

Actually, the possibilities are almost endless. Replace the light-sensor circuit with a simple voltage divider and a couple of probes and you can assemble what computer pundits have been writing about for years: an automatic lawn and garden watering system. ♦

Fig. 5. Light meter's digital and moving-dot display.

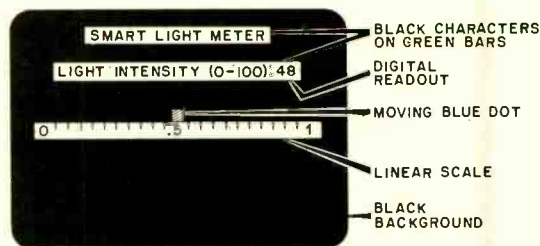

Epson QX-10

(Continued from page 71)

The data was entered and Valdocs calculated the pie segments. They were exactly the same as those that appeared in the original article. After creating a graph you can edit it, save it to disk, display it on the screen, or print it out.

I found some difficulties with the graphics program. Firstly, DRAW is inflexible. I'd like to place labels where I want them. In addition, I'd like to enter the data once and use it to produce a variety of graphs. Secondly, in printing, the Valdocs package does a one-for-one dot representation of the screen. This is OK, except that, for graphs with a high-resolution (i.e. many segments), the screen presentation is run together, and so is the hardcopy (Fig. 7). Often, the resolution of the graph can be as important as the data being represented. It appears that the current intent is to provide a quick method of taking a snapshot of data, thus resolution is sacrificed.

Other Applications. There are two fur-

ther applications that are standard features of Valdocs. One is an appointment book and the other is a calculator.

When you press SCHED, the screen displays a page that looks just like the left-hand side of a standard desk calendar

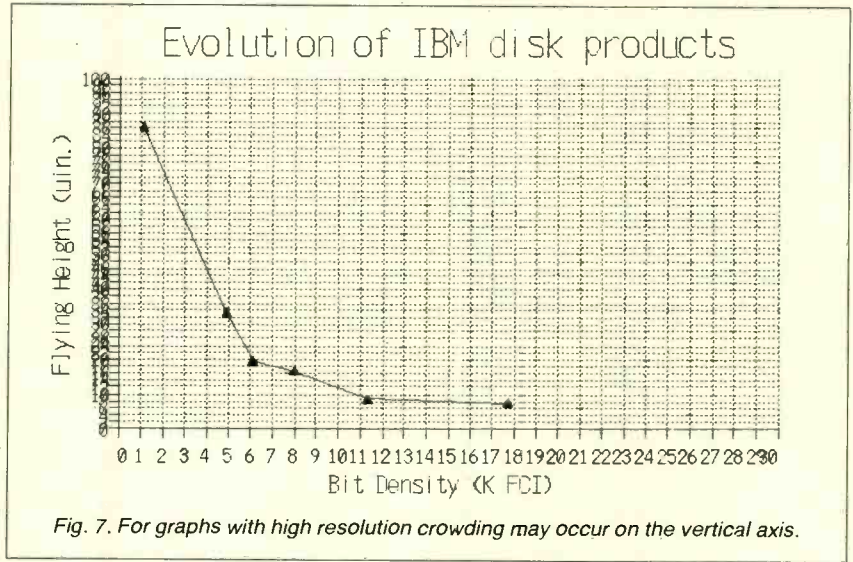

PROFESSIONAL SOFTWARE FOR MICRO'S



- * Insurance Agency Management
- * Medical Office Management
- * Dental Office Management
- * Property Management
- * Legal Time Accounting
- * Professional Time Accounting



On-Line Order Entry
 Super Ledger Accounting
 General Ledger Accounting
 Accounts Receivable
 Accounts Payable

Data Base Management

Runs On CP/M, CP/M-86 & MS-DOS

UNIVAIR SYSTEMS

UNIVAIR INTERNATIONAL
 9024 ST. CHARLES ROCK ROAD
 ST. LOUIS, MISSOURI U.S.A. 63114

(314) 426-1099

Dealers Welcome

MS-DOS is a registered trademark of MicroSoft.
 CP/M and CP/M-86 are registered trademarks of Digital Research

Circle No. 79 on Free Information Card



Active Electronics

**NUMBER ONE IN
 QUALITY
 SERVICE
 AVAILABILITY**

**THE WORLD'S MOST
 COMPLETE PROFESSIONAL
 AND HOME ELECTRONICS
 ENTHUSIAST INVENTORY**

- * Semiconductors + Memories
- * Microprocessors + Support Circuits
- * Microcomputer Systems + Peripherals
- * Passive Electronic Components
- * Hand Tools, Wire Wrapping, Soldering Equipment + Hardware

**NOW AVAILABLE — FREE
 1983 80-page catalog**

A complete listing of products and specifications

Call, write or circle the inquiry card for your free copy today.

P.O. Box 8000, Westboro, Mass. 01581
CALL TOLL FREE: 1-800-343-0874

Mass customers call (617) 366-0500

Circle No. 50 on Free Information Card

CALCULATOR SAVINGS

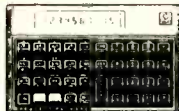

HP-10C Scientific	\$57.99	
HP-11C Programmable	74.99	
HP-12C Financial	99.99	
HP-15C Programmable	99.99	
HP-16C Hexadecimal	99.99	
HP-32E Scientific	29.99	82160A HP-IL Module . . . 94.99
HP-34C Programmable	54.99	82161A Cassette Drive . . . 347.99
HP-38C Financial	69.99	82162A HP-IL Printer . . . 347.99
HP-97 Programmable	599.99	82164A RS-232 Interf. . . 249.99
HP-41C Alpha Program	149.99	92198A 80 col Video Int . . . 269.99
HP-41CV Full Memory	207.99	7470A HP-IL Plotter . . . 899.99
HP-41CX Extnd Functn	259.99	82180A Extnd Functns . . . 59.99
82104A Card Reader	149.99	82181A Extnd Memory . . . 59.99
82143A Printer	289.99	82182A Time Module . . . 59.99
82153A Wand	99.99	82183A Extnd I/O . . . 59.99
HP-75C Computer	739.99	HP-41 System Case . . . 49.99
82700A 8K Mem for 75C	149.99	Port-X-Tender to 10 pts . . . 129.99

Call for Low Prices on all Accessories and Software

TI	CC-40 Compact 6K Expandable Computer	\$199.99
	CC-40 Solid State Software	from 49.99
	TI-55-II Scientific Calculator w/ Statistics	34.99
	LCD Programmer Hexadecimal Converter	59.99
	BA-55 Advanced Handheld Financial	49.99
	TI-5310 Desk Printing Financial	109.99

Sharp	PC-1250 Pocket Extended BASIC Computer	469.99
	CE-125 Printer/Microcassette for PC-1250	149.99
	PC-1500 Advanced Handheld Computer	139.99
	PC-1500A Advanced 8K Handheld Computer	179.99
	CE-150 Cassette Interf./4-color Printer Plotter	179.99
	CE-151 4K Memory for 1500/A	39.99
	CE-155 8K Memory Expansion Box for 1500/A	79.99
	CE-158 RS-232C & Parallel Interface for 1500/A	179.99
	CE-159 8K Memory Expan with Battery Back-up	99.99
	CE-161 16K Memory Expan with Battery Back-up	149.99
	PC-1500/A ROM Software Modules	49.99

Casio	FX-700P Handheld Computer, 1568 steps	469.99
	FA-3 Cassette Adapter for FX-700P	34.99
	FP-12 20-column printer for FX-700P	59.99
	FX-98 Credit card Solar Scientific Calculator	24.99
	FX-450 Scientific Calculator with Hexadecimal	29.99
	TE-2500 Spanish Translator Watch	69.99
	TC-500 Touch Sensor Calculator Watch	59.99
	CFX-20 Scientific Calculator Watch	34.99

Use cashier's check, postal money order, VISA, or M/C. Personal checks take five weeks to clear. Add shipping, 1% of your order (\$3.95 minimum). East of Missp. extra \$1.50. CA res. add 6%. Subject to availability. USA prices.

ORDER **800-421-5188** Outside
TOLL-FREE Information line (213) 633-3262 CA, AK, HI



Tam's Inc, Dept CE-1
14932 Garfield Ave.
Paramount, CA 90723
(213) 633-3262

Circle No. 42 on Free Information Card

Epson QX-10

for the current date. Through various menu functions, you can display a note page, go to a specific date on the calendar, set a timer, and print out one or more pages of the book, among other things.

The CALC function gives you access to a general-purpose calculator that interacts with the word processor so you can perform calculations and insert them anywhere in a document. The calculator will total columns or rows that appear in a document automatically!

Documentation. A "Valdocs User's Guide" is provided with the system. It's written with the non-computerist in mind and makes liberal use of screen shots, diagrams, and cartoon illustrations. When describing key-press operations, the key legends are shown in reverse in the copy, which helps provide clarity when reading.

This light-and-easy treatment has some drawbacks, however. One particular part of the manual that was disconcerting was the description of the setup

of the DIP-switches located on the rear panel. The manual says that, if you plan to use the machine with Valdocs, be sure to flip switch 1 down and leave the others up.

No explanation is given as to the function of the other switches. However, I discovered after trial and error and deciphering the schematics found in the optional technical manual, which incidentally is well done and complete, that the switch settings are more important than you are led to believe.

Should you want to do a great deal of development work, you might want to set switch 2 down to automatically enter Zapple, the machine language monitor, on bootup.

Switches 5, 6, 7 control the memory switching and should be in the down position to get the full advantage of the bank-switching function. If you follow the manual, bank select doesn't work as well. Switch number 8 provides the capability of downloading fonts to the printer if in the down or off position. I turned it on to let the FX-80 handle all

Be a MICROCOMPUTER SERVICE TECHNICIAN

Train at home in spare time... No previous experience needed

Sales of small computers are running over a billion dollars a year. That's why a whole new business is starting up—devoted entirely to small computer repair. And right now is the time to get in on the ground floor—either working for someone else or in your own computer repair business.

Start making money in electronics

No need to quit your job, change your daily routine or take time from family responsibilities. And you don't waste time going to and from class because you train at home in spare time. The ICS Microcomputer Repair Course is designed for beginners—people with no previous experience who want to get started fast. And you should be ready for an entry-level job repairing small computers even before you finish this course.

Experts show you what to do...

how to do it! We start you fast with the basics, and everything is explained in easy-to-understand language complete with plenty of diagrams and drawings

GET INTO SMALL COMPUTER REPAIR

SEND FOR FREE FACTS!



School of Computer Repair, Dept. P2014
Scranton, Pennsylvania 18515

Send free facts and color brochure telling how I can get into computer repair at home in my spare time. No obligation. No salesman will call.

Name _____ Age _____

Address _____

City/State/Zip _____

TABLE I—EXPANSION SLOT SIGNALS

Pin No.	Signal Symbol	Signal Direction	Description of Signal
1-2	GND	-	Ground
3-10	DTBO-7	In/Out	Databus
11-12	-12 V	-	-12 V
13-28	ADRO-15	Out	Address bus
29-30	GND	-	Ground
31	CLK	Out	System clock
32	GND	-	Ground
33	BSAK	Out	Bus acknowledge
34	MEMX	Out	External memory select
35	IRD	Out	I/O read
36	IWR	Out	I/O write
37	MWD	Out	Memory read
38	MWR	Out	Memory write
39	RSIN	In	Reset input
40	INT(H)1	In	High-priority external interrupt
41	INT(H)2	In	High-priority external interrupt
42	INT(L)	In	Low-priority external interrupt
43	+5 V	-	+5 V
44	RSET	Out	Reset output
45-46	+5 V	-	+5 V
47	DRQ(F)	In	DMA request
48	DRQ(S)	In	DMA request
49	RDY(F)	In	DMA ready
50	RDE(S)	In	DMA ready
51	WAIT	In	Wait
52	IWS	Out	I/O write short
53	DAK(F)	Out	DMA acknowledge
54	DAK(S)	Out	DMA acknowledge
55	EOP(F)	Out	End of process
56	EOP(S)	Out	End of process
57-58	+12 V	-	+12 V
59-60	GND	-	Ground

1984 Business Activity Planner

Imagine! A complete Appointment Book, Financial Record Keeping System, Travel Information Guide, Health and Fitness Aid and Directory... All in one book!

No matter how organized and successful you are today, our Planner will make you even better in the future... or your money back!



IT'S A GREAT GIFT IDEA, TOO!

IT'S AN APPOINTMENT BOOK! SEE-A-WEEK CALENDAR

■ A full week... at a glance! Time planning becomes easy when your appointments, meetings, luncheon and dinner engagements and special activities are in front of you.

HALF-HOUR TIME SCHEDULING

■ Convenient scheduling... seven days a week.

THINGS TO DO TODAY

■ Keep track of important follow-ups, telephone calls and correspondence.

SEVEN SNAP-LOCK RINGS

■ The seven ring format insures that your pages won't pull out... unless you want them to!

BEAUTIFUL, SOFT, LEATHER-LIKE BINDER

■ Padded front and back, your 9½ x 11½ Planner is comfortable to carry. You can take it with you wherever you go. The sturdy, permanent bookmark always keeps you in the right week and the two inside pockets enable you to keep all your important papers in your **1984 Activity Planner.**

YOUR CHOICE OF IMPRINTS

■ Order the 1984 Business Activity Planner for everyone in your office... and select the cover imprint for

each person! Available with Business Activity Planner, Chairman of the Board Activity Planner, Executive Woman Activity Planner, or Executive Activity Planner.

IT'S MUCH MORE!

■ Each Section is Index-Tabbed for Instant Retrieval of Information.

FINANCIAL RECORD KEEPER

- 12 Income and Expense Reports
- 1984 Business Tax Calendar
- Executive Compensation Checklist
- Personal Investment Portfolio

HEALTH AND FITNESS AID

- Fat - Cholesterol - Calorie Charts
- Value of Various Exercises

- Substitution Chart for Better Health
- First Aid Tips

TRAVEL INFORMATION

- Average Temperatures for Most Major Cities
- Rank and Population of the Top 100 U.S. Cities
- Traveling Distances
- Toll-Free Telephone Numbers for Major Airlines, Auto Rentals, Hotels, Motels and much more!

MISCELLANEOUS

This section is filled with valuable information including Principal Holidays, French and California Wine Vintage Charts and more.

DIRECTORY

Places all emergency and important telephone numbers at your fingertips.

ZIFF-DAVIS ACTIVITY PLANNER P.O. Box 16-2354, Miami, FL 33116
Please send me the following 1984 Activity Planners at \$38.95* each plus \$5 per copy postage and handling. Outside U.S.A. add \$10 per copy postage and handling.

Specify quantity for each cover imprint ordered:

- ___ Business Activity Planner(s)
- ___ Chairman of the Board Activity Planner(s)
- ___ Executive Woman Activity Planner(s)
- ___ Executive Activity Planner(s)

QUANTITY DISCOUNTS

(On total number of Planners)

6-20	10% off	(\$4 P&H each)
21-50	15% off	(\$3 P&H each)
51-or more	20% off	(\$2 P&H each)

Payment enclosed. American Express Visa MasterCard Purchase Order enclosed.

Card No. _____ Exp. Date _____

Signature _____ CE02

Name _____

Company _____ (please print)

Address _____

City/State/Zip _____

*Florida residents add 5% sales tax.
SATISFACTION GUARANTEED or return
within 10 days for a prompt refund!

FOR FASTER SERVICE CALL TOLL FREE
800-327-1969
(In Fla. and Canada call (305) 595-8744)

RATED #1 for SERVICE and RELIABILITY

FOR INFORMATION OR ORDERING,
CALL TOLL FREE
800-221-8180
IN NEW YORK STATE
(212) 732-8600



23 PARK ROW, N.Y.C.
NEW YORK 10038

**THIS MONTH'S
SUPER
SPECIALS!**

ATARI 600XL
• Home Computer
• 16K RAM
Expandable to 64K
\$159.95

ATARI 800XL HOME COMPUTER
• 64K RAM 256 Colors
• Built-in High Level BASIC
\$269.95

ATARI HARDWARE
ATARI 1010 Program Recorder \$74.95
ATARI 1050 Disc Drive \$159.95
ATARI 850 Acoustic Modem \$139.95
ATARI 1550 Interface Module \$159.95
ATARI SOFTWARE
ATARI AX225 Microbot Basic II \$64.95
ATARI CX4005 Assembler Editor \$48.95
ATARI CX4045 Word Processor \$89.95
DATA-SOFT ZAXXON Speller \$74.95
THORN SUBMARINE COMMANDER \$44.95
ATARI PROC. EASTERN FRONT Disk \$24.95
CX2600 GAMEWARE
STREET BATTLE AT NORMANDY \$24.95
COLECO Zaxxon \$24.95
ATARI CX2675 M3 Pac Man \$23.95
ATARI CX2676 Centipede \$24.95
ATARI CX2681 Battle Zone \$22.95
ATARI CX2689 Kingrider \$23.95
ATARI CX2686 Pole Position \$23.95
ACTIVISION AC28 Robot Tank \$24.95
PARKER S360 DBert \$29.95
M NETWORK Lock n Chase \$17.95
COLECO Mr. Do! \$24.95
COLECO Smurfs \$24.95

WE ALSO CARRY
APPLE COMPUTER SOFTWARE
TEXAS INSTRUMENTS T199/4A
• Home Computer
• 16K RAM
\$59.95

T1 99/4A HARDWARE
TI PMP1210 8622 Card \$119.95
TI PMP1250 Internal Disk Drive \$279.95
TI PMP1260 12K RAM Card \$209.95
TI PMP1600 Modem \$159.95
TI PMP1850 Disk Memory Drive \$349.95
T1 99/4A SOFTWARE
TI PHT6003 Pers Finance Aids \$12.95
TI PHT6004 Programming Aids \$12.95
TI PHT6005 Trek (w/ram screen) \$13.95
TI PHT6006 Number Magic \$17.95
TI PHT6007 Household Budget \$29.95
TI PHT6023 Hunt The Wumpus \$19.95

MONITORS
VIC C1702 16" Color \$249.95
NEC C12202A 17" Color \$249.95
TI DHA1100 10" Color \$19.95
SONY KV1351 13" Color
• Game Comp. Ready \$309.95
TAXI 100 12" Green Screen
• 64K RAM \$129.95
TAXI 105 12" Amber Screen
• 64K RAM \$139.95
TAXI 210 12" Color Monitor
• 64K RAM \$289.95
AMDEK 300A 12" Amber Screen
• 64K RAM \$159.95
AMDEK 300C 12" Green Screen
• 64K RAM \$159.95
AMDEK COLOR 13" Monitor
• 64K RAM \$299.95
ZENITH ZM122 12" Amber
• 64K RAM \$109.95

TIMEX SINCLAIR TS1000
includes:
TS1016 16K RAM Expander
Background
Resident and
Soft Options
\$39.95

TIMEX HARDWARE
TIMEX TS1500 16K Computer \$64.95
TIMEX 1016 16K RAM Expander \$79.95
TIMEX 7040 DDP Matrix Printer \$79.95
MEMOTECH Keyboard for TS1000 \$69.95
MEMOTECH 16K Ram for TS1000 \$64.95
MEMOTECH 32K Ram for TS1000 \$74.95
MEMOTECH 64K Ram for TS1000 \$99.95
MEMOTECH Keyboard \$74.95

FREE GIANT CATALOGS
• 300 PAGE AUDIO/VIDEO/COMPUTER CATALOG
• GIANT VIDEO MOVIE CATALOG
• GIANT RECORD AND CASSETTE CATALOG
Filled with over 10,000 different listings of the most popular artists and titles!
1000 Rock Jazz Country & Western!

MATTEL COMPUTER KEYBOARD
• For use with Intellivision II
\$99.95

MATTEL Intellivision II
• 16K RAM Expandable to 64K
• 5 1/4" Disk
\$119.95

MATTEL 8021 Voice Synthesizer
• 16K RAM Expandable to 64K
• 5 1/4" Disk
\$44.95

MATTEL 8022 Data Recorder
• 16K RAM Expandable to 64K
• 5 1/4" Disk
\$44.95

MATTEL 8023 Joy Stick
• 16K RAM Expandable to 64K
• 5 1/4" Disk
\$19.95

MATTEL 8024 TV Software Adapter
• 16K RAM Expandable to 64K
• 5 1/4" Disk
\$19.95

MATTEL 8025 Joy Stick
• 16K RAM Expandable to 64K
• 5 1/4" Disk
\$19.95

MATTEL 8026 Joy Stick
• 16K RAM Expandable to 64K
• 5 1/4" Disk
\$19.95

MATTEL 8027 Mail Train
• 16K RAM Expandable to 64K
• 5 1/4" Disk
\$19.95

COLECO ADAM
• Friendly Computer System
• Call For Information
PLEASE CALL

VIDEO GAMES
COLECOVISION Expandable Video Game Console \$149.95
COLECO MOO 1 (for Atari Carts) \$59.95
COLECO Gemini Video Game \$74.95
ATARI CX2600 Game Console \$79.95
VICTREX Video Arcade System \$99.95
ODYSSEY Master Computer \$79.95
ATARI 5200 Super Game System \$159.95

COMMODORE 64
• 64K RAM
• Home Computer
\$199.95

COMMODORE 64 HARDWARE
VIC V1541 Disk Drive \$229.95
VIC V1512 Paddle Controller \$19.95
VIC 1650 (Auto-Dial) Modem \$79.95
VIC CPM Card (Version 2.1) \$59.95
COMMODORE 64 SOFTWARE
V64 EASY LESSON/QUIZ \$12.95
V64 FOR LIT RATE \$9.95
EVENT 64 Sorcerer's Apprentice \$29.95
NES supervisor \$49.95
MICRO 64 Data Base Mng (Disk) \$49.95
MIDWEST 64 Terminal Program \$24.95
RAINBOW 64 Personal Finance \$24.95
SOFTSYNVC 64 Personal Account \$24.95
LMI 64 Checkbook \$19.95
VERSA 64 Business Pack \$64.95

VIC 20 HARDWARE
VIC V1101 8K RAM Expander \$89.95
VIC V1110 8K RAM Expander \$59.95
VIC V1111 16K RAM Expander \$69.95
VIC V1111 JoyStick \$7.95 ea
VIC V1130 Data Set \$19.95
VIC V1525 Graphic Printer \$199.95
VIC V1600 Telephone Modem \$49.95
VIC V1650 Auto-Dial Modem \$79.95
CARDBOARD 6 EXPANDED user port IO-Rtd & cartridge \$59.95

VIC 20 SOFTWARE
VIC V1103 Intro to Basic int. 2 \$19.95
VIC V1110 Context Microprog \$17.95
VIC V1111 Microprog \$16.95
VIC V1112 Microprog \$16.95
VIC V1113 Microprog \$16.95
VIC V1114 Microprog \$16.95
VIC V1115 Microprog \$16.95
VIC V1116 Microprog \$16.95
VIC V1117 Microprog \$16.95
VIC V1118 Microprog \$16.95
VIC V1119 Microprog \$16.95
VIC V1120 Microprog \$16.95
VIC V1121 Microprog \$16.95
VIC V1122 Microprog \$16.95
VIC V1123 Microprog \$16.95
VIC V1124 Microprog \$16.95
VIC V1125 Microprog \$16.95
VIC V1126 Microprog \$16.95
VIC V1127 Microprog \$16.95
VIC V1128 Microprog \$16.95
VIC V1129 Microprog \$16.95
VIC V1130 Microprog \$16.95
VIC V1131 Microprog \$16.95
VIC V1132 Microprog \$16.95
VIC V1133 Microprog \$16.95
VIC V1134 Microprog \$16.95
VIC V1135 Microprog \$16.95
VIC V1136 Microprog \$16.95
VIC V1137 Microprog \$16.95
VIC V1138 Microprog \$16.95
VIC V1139 Microprog \$16.95
VIC V1140 Microprog \$16.95
VIC V1141 Microprog \$16.95
VIC V1142 Microprog \$16.95
VIC V1143 Microprog \$16.95
VIC V1144 Microprog \$16.95
VIC V1145 Microprog \$16.95
VIC V1146 Microprog \$16.95
VIC V1147 Microprog \$16.95
VIC V1148 Microprog \$16.95
VIC V1149 Microprog \$16.95
VIC V1150 Microprog \$16.95
VIC V1151 Microprog \$16.95
VIC V1152 Microprog \$16.95
VIC V1153 Microprog \$16.95
VIC V1154 Microprog \$16.95
VIC V1155 Microprog \$16.95
VIC V1156 Microprog \$16.95
VIC V1157 Microprog \$16.95
VIC V1158 Microprog \$16.95
VIC V1159 Microprog \$16.95
VIC V1160 Microprog \$16.95
VIC V1161 Microprog \$16.95
VIC V1162 Microprog \$16.95
VIC V1163 Microprog \$16.95
VIC V1164 Microprog \$16.95
VIC V1165 Microprog \$16.95
VIC V1166 Microprog \$16.95
VIC V1167 Microprog \$16.95
VIC V1168 Microprog \$16.95
VIC V1169 Microprog \$16.95
VIC V1170 Microprog \$16.95
VIC V1171 Microprog \$16.95
VIC V1172 Microprog \$16.95
VIC V1173 Microprog \$16.95
VIC V1174 Microprog \$16.95
VIC V1175 Microprog \$16.95
VIC V1176 Microprog \$16.95
VIC V1177 Microprog \$16.95
VIC V1178 Microprog \$16.95
VIC V1179 Microprog \$16.95
VIC V1180 Microprog \$16.95
VIC V1181 Microprog \$16.95
VIC V1182 Microprog \$16.95
VIC V1183 Microprog \$16.95
VIC V1184 Microprog \$16.95
VIC V1185 Microprog \$16.95
VIC V1186 Microprog \$16.95
VIC V1187 Microprog \$16.95
VIC V1188 Microprog \$16.95
VIC V1189 Microprog \$16.95
VIC V1190 Microprog \$16.95
VIC V1191 Microprog \$16.95
VIC V1192 Microprog \$16.95
VIC V1193 Microprog \$16.95
VIC V1194 Microprog \$16.95
VIC V1195 Microprog \$16.95
VIC V1196 Microprog \$16.95
VIC V1197 Microprog \$16.95
VIC V1198 Microprog \$16.95
VIC V1199 Microprog \$16.95
VIC V1200 Microprog \$16.95
VIC V1201 Microprog \$16.95
VIC V1202 Microprog \$16.95
VIC V1203 Microprog \$16.95
VIC V1204 Microprog \$16.95
VIC V1205 Microprog \$16.95
VIC V1206 Microprog \$16.95
VIC V1207 Microprog \$16.95
VIC V1208 Microprog \$16.95
VIC V1209 Microprog \$16.95
VIC V1210 Microprog \$16.95
VIC V1211 Microprog \$16.95
VIC V1212 Microprog \$16.95
VIC V1213 Microprog \$16.95
VIC V1214 Microprog \$16.95
VIC V1215 Microprog \$16.95
VIC V1216 Microprog \$16.95
VIC V1217 Microprog \$16.95
VIC V1218 Microprog \$16.95
VIC V1219 Microprog \$16.95
VIC V1220 Microprog \$16.95
VIC V1221 Microprog \$16.95
VIC V1222 Microprog \$16.95
VIC V1223 Microprog \$16.95
VIC V1224 Microprog \$16.95
VIC V1225 Microprog \$16.95
VIC V1226 Microprog \$16.95
VIC V1227 Microprog \$16.95
VIC V1228 Microprog \$16.95
VIC V1229 Microprog \$16.95
VIC V1230 Microprog \$16.95
VIC V1231 Microprog \$16.95
VIC V1232 Microprog \$16.95
VIC V1233 Microprog \$16.95
VIC V1234 Microprog \$16.95
VIC V1235 Microprog \$16.95
VIC V1236 Microprog \$16.95
VIC V1237 Microprog \$16.95
VIC V1238 Microprog \$16.95
VIC V1239 Microprog \$16.95
VIC V1240 Microprog \$16.95
VIC V1241 Microprog \$16.95
VIC V1242 Microprog \$16.95
VIC V1243 Microprog \$16.95
VIC V1244 Microprog \$16.95
VIC V1245 Microprog \$16.95
VIC V1246 Microprog \$16.95
VIC V1247 Microprog \$16.95
VIC V1248 Microprog \$16.95
VIC V1249 Microprog \$16.95
VIC V1250 Microprog \$16.95
VIC V1251 Microprog \$16.95
VIC V1252 Microprog \$16.95
VIC V1253 Microprog \$16.95
VIC V1254 Microprog \$16.95
VIC V1255 Microprog \$16.95
VIC V1256 Microprog \$16.95
VIC V1257 Microprog \$16.95
VIC V1258 Microprog \$16.95
VIC V1259 Microprog \$16.95
VIC V1260 Microprog \$16.95
VIC V1261 Microprog \$16.95
VIC V1262 Microprog \$16.95
VIC V1263 Microprog \$16.95
VIC V1264 Microprog \$16.95
VIC V1265 Microprog \$16.95
VIC V1266 Microprog \$16.95
VIC V1267 Microprog \$16.95
VIC V1268 Microprog \$16.95
VIC V1269 Microprog \$16.95
VIC V1270 Microprog \$16.95
VIC V1271 Microprog \$16.95
VIC V1272 Microprog \$16.95
VIC V1273 Microprog \$16.95
VIC V1274 Microprog \$16.95
VIC V1275 Microprog \$16.95
VIC V1276 Microprog \$16.95
VIC V1277 Microprog \$16.95
VIC V1278 Microprog \$16.95
VIC V1279 Microprog \$16.95
VIC V1280 Microprog \$16.95
VIC V1281 Microprog \$16.95
VIC V1282 Microprog \$16.95
VIC V1283 Microprog \$16.95
VIC V1284 Microprog \$16.95
VIC V1285 Microprog \$16.95
VIC V1286 Microprog \$16.95
VIC V1287 Microprog \$16.95
VIC V1288 Microprog \$16.95
VIC V1289 Microprog \$16.95
VIC V1290 Microprog \$16.95
VIC V1291 Microprog \$16.95
VIC V1292 Microprog \$16.95
VIC V1293 Microprog \$16.95
VIC V1294 Microprog \$16.95
VIC V1295 Microprog \$16.95
VIC V1296 Microprog \$16.95
VIC V1297 Microprog \$16.95
VIC V1298 Microprog \$16.95
VIC V1299 Microprog \$16.95
VIC V1300 Microprog \$16.95
VIC V1301 Microprog \$16.95
VIC V1302 Microprog \$16.95
VIC V1303 Microprog \$16.95
VIC V1304 Microprog \$16.95
VIC V1305 Microprog \$16.95
VIC V1306 Microprog \$16.95
VIC V1307 Microprog \$16.95
VIC V1308 Microprog \$16.95
VIC V1309 Microprog \$16.95
VIC V1310 Microprog \$16.95
VIC V1311 Microprog \$16.95
VIC V1312 Microprog \$16.95
VIC V1313 Microprog \$16.95
VIC V1314 Microprog \$16.95
VIC V1315 Microprog \$16.95
VIC V1316 Microprog \$16.95
VIC V1317 Microprog \$16.95
VIC V1318 Microprog \$16.95
VIC V1319 Microprog \$16.95
VIC V1320 Microprog \$16.95
VIC V1321 Microprog \$16.95
VIC V1322 Microprog \$16.95
VIC V1323 Microprog \$16.95
VIC V1324 Microprog \$16.95
VIC V1325 Microprog \$16.95
VIC V1326 Microprog \$16.95
VIC V1327 Microprog \$16.95
VIC V1328 Microprog \$16.95
VIC V1329 Microprog \$16.95
VIC V1330 Microprog \$16.95
VIC V1331 Microprog \$16.95
VIC V1332 Microprog \$16.95
VIC V1333 Microprog \$16.95
VIC V1334 Microprog \$16.95
VIC V1335 Microprog \$16.95
VIC V1336 Microprog \$16.95
VIC V1337 Microprog \$16.95
VIC V1338 Microprog \$16.95
VIC V1339 Microprog \$16.95
VIC V1340 Microprog \$16.95
VIC V1341 Microprog \$16.95
VIC V1342 Microprog \$16.95
VIC V1343 Microprog \$16.95
VIC V1344 Microprog \$16.95
VIC V1345 Microprog \$16.95
VIC V1346 Microprog \$16.95
VIC V1347 Microprog \$16.95
VIC V1348 Microprog \$16.95
VIC V1349 Microprog \$16.95
VIC V1350 Microprog \$16.95
VIC V1351 Microprog \$16.95
VIC V1352 Microprog \$16.95
VIC V1353 Microprog \$16.95
VIC V1354 Microprog \$16.95
VIC V1355 Microprog \$16.95
VIC V1356 Microprog \$16.95
VIC V1357 Microprog \$16.95
VIC V1358 Microprog \$16.95
VIC V1359 Microprog \$16.95
VIC V1360 Microprog \$16.95
VIC V1361 Microprog \$16.95
VIC V1362 Microprog \$16.95
VIC V1363 Microprog \$16.95
VIC V1364 Microprog \$16.95
VIC V1365 Microprog \$16.95
VIC V1366 Microprog \$16.95
VIC V1367 Microprog \$16.95
VIC V1368 Microprog \$16.95
VIC V1369 Microprog \$16.95
VIC V1370 Microprog \$16.95
VIC V1371 Microprog \$16.95
VIC V1372 Microprog \$16.95
VIC V1373 Microprog \$16.95
VIC V1374 Microprog \$16.95
VIC V1375 Microprog \$16.95
VIC V1376 Microprog \$16.95
VIC V1377 Microprog \$16.95
VIC V1378 Microprog \$16.95
VIC V1379 Microprog \$16.95
VIC V1380 Microprog \$16.95
VIC V1381 Microprog \$16.95
VIC V1382 Microprog \$16.95
VIC V1383 Microprog \$16.95
VIC V1384 Microprog \$16.95
VIC V1385 Microprog \$16.95
VIC V1386 Microprog \$16.95
VIC V1387 Microprog \$16.95
VIC V1388 Microprog \$16.95
VIC V1389 Microprog \$16.95
VIC V1390 Microprog \$16.95
VIC V1391 Microprog \$16.95
VIC V1392 Microprog \$16.95
VIC V1393 Microprog \$16.95
VIC V1394 Microprog \$16.95
VIC V1395 Microprog \$16.95
VIC V1396 Microprog \$16.95
VIC V1397 Microprog \$16.95
VIC V1398 Microprog \$16.95
VIC V1399 Microprog \$16.95
VIC V1400 Microprog \$16.95
VIC V1401 Microprog \$16.95
VIC V1402 Microprog \$16.95
VIC V1403 Microprog \$16.95
VIC V1404 Microprog \$16.95
VIC V1405 Microprog \$16.95
VIC V1406 Microprog \$16.95
VIC V1407 Microprog \$16.95
VIC V1408 Microprog \$16.95
VIC V1409 Microprog \$16.95
VIC V1410 Microprog \$16.95
VIC V1411 Microprog \$16.95
VIC V1412 Microprog \$16.95
VIC V1413 Microprog \$16.95
VIC V1414 Microprog \$16.95
VIC V1415 Microprog \$16.95
VIC V1416 Microprog \$16.95
VIC V1417 Microprog \$16.95
VIC V1418 Microprog \$16.95
VIC V1419 Microprog \$16.95
VIC V1420 Microprog \$16.95
VIC V1421 Microprog \$16.95
VIC V1422 Microprog \$16.95
VIC V1423 Microprog \$16.95
VIC V1424 Microprog \$16.95
VIC V1425 Microprog \$16.95
VIC V1426 Microprog \$16.95
VIC V1427 Microprog \$16.95
VIC V1428 Microprog \$16.95
VIC V1429 Microprog \$16.95
VIC V1430 Microprog \$16.95
VIC V1431 Microprog \$16.95
VIC V1432 Microprog \$16.95
VIC V1433 Microprog \$16.95
VIC V1434 Microprog \$16.95
VIC V1435 Microprog \$16.95
VIC V1436 Microprog \$16.95
VIC V1437 Microprog \$16.95
VIC V1438 Microprog \$16.95
VIC V1439 Microprog \$16.95
VIC V1440 Microprog \$16.95
VIC V1441 Microprog \$16.95
VIC V1442 Microprog \$16.95
VIC V1443 Microprog \$16.95
VIC V1444 Microprog \$16.95
VIC V1445 Microprog \$16.95
VIC V1446 Microprog \$16.95
VIC V1447 Microprog \$16.95
VIC V1448 Microprog \$16.95
VIC V1449 Microprog \$16.95
VIC V1450 Microprog \$16.95
VIC V1451 Microprog \$16.95
VIC V1452 Microprog \$16.95
VIC V1453 Microprog \$16.95
VIC V1454 Microprog \$16.95
VIC V1455 Microprog \$16.95
VIC V1456 Microprog \$16.95
VIC V1457 Microprog \$16.95
VIC V1458 Microprog \$16.95
VIC V1459 Microprog \$16.95
VIC V1460 Microprog \$16.95
VIC V1461 Microprog \$16.95
VIC V1462 Microprog \$16.95
VIC V1463 Microprog \$16.95
VIC V1464 Microprog \$16.95
VIC V1465 Microprog \$16.95
VIC V1466 Microprog \$16.95
VIC V1467 Microprog \$16.95
VIC V1468 Microprog \$16.95
VIC V1469 Microprog \$16.95
VIC V1470 Microprog \$16.95
VIC V1471 Microprog \$16.95
VIC V1472 Microprog \$16.95
VIC V1473 Microprog \$16.95
VIC V1474 Microprog \$16.95
VIC V1475 Microprog \$16.95
VIC V1476 Microprog \$16.95
VIC V1477 Microprog \$16.95
VIC V1478 Microprog \$16.95
VIC V1479 Microprog \$16.95
VIC V1480 Microprog \$16.95
VIC V1481 Microprog \$16.95
VIC V1482 Microprog \$16.95
VIC V1483 Microprog \$16.95
VIC V1484 Microprog \$16.95
VIC V1485 Microprog \$16.95
VIC V1486 Microprog \$16.95
VIC V1487 Microprog \$16.95
VIC V1488 Microprog \$16.95
VIC V1489 Microprog \$16.95
VIC V1490 Microprog \$16.95
VIC V1491 Microprog \$16.95
VIC V1492 Microprog \$16.95
VIC V1493 Microprog \$16.95
VIC V1494 Microprog \$16.95
VIC V1495 Microprog \$16.95
VIC V1496 Microprog \$16.95
VIC V1497 Microprog \$16.95
VIC V1498 Microprog \$16.95
VIC V1499 Microprog \$16.95
VIC V1500 Microprog \$16.95
VIC V1501 Microprog \$16.95
VIC V1502 Microprog \$16.95
VIC V1503 Microprog \$16.95
VIC V1504 Microprog \$16.95
VIC V1505 Microprog \$16.95
VIC V1506 Microprog \$16.95
VIC V1507 Microprog \$16.95
VIC V1508 Microprog \$16.95
VIC V1509 Microprog \$16.95
VIC V1510 Microprog \$16.95
VIC V1511 Microprog \$16.95
VIC V1512 Microprog \$16.95
VIC V1513 Microprog \$16.95
VIC V1514 Microprog \$16.95
VIC V1515 Microprog \$16.95
VIC V1516 Microprog \$16.95
VIC V1517 Microprog \$16.95
VIC V1518 Microprog \$16.95
VIC V1519 Microprog \$16.95
VIC V1520 Microprog \$16.95
VIC V1521 Microprog \$16.95
VIC V1522 Microprog \$16.95
VIC V1523 Microprog \$16.95
VIC V1524 Microprog \$16.95
VIC V1525 Microprog \$16.95
VIC V1526 Microprog \$16.95
VIC V1527 Microprog \$16.95
VIC V1528 Microprog \$16.95
VIC V1529 Microprog \$16.95
VIC V1530 Microprog \$16.95
VIC V1531 Microprog \$16.95
VIC V1532 Microprog \$16.95
VIC V1533 Microprog \$16.95
VIC V1534 Microprog \$16.95
VIC V1535 Microprog \$16.95
VIC V1536 Microprog \$16.95
VIC V1537 Microprog \$16.95
VIC V1538 Microprog \$16.95
VIC V1539 Microprog \$16.95
VIC V1540 Microprog \$16.95
VIC V1541 Microprog \$16.95
VIC V1542 Microprog \$16.95
VIC V1543 Microprog \$16.95
VIC V1544 Microprog \$16.95
VIC V1545 Microprog \$16.95
VIC V1546 Microprog \$16.95
VIC V1547 Microprog \$16.95
VIC V1548 Microprog \$16.95
VIC V1549 Microprog \$16.95
VIC V1550 Microprog \$16.95
VIC V1551 Microprog \$16.95
VIC V1552 Microprog \$16.95
VIC V1553 Microprog \$16.95
VIC V1554 Microprog \$16.95
VIC V1555 Microprog \$16.95
VIC V1556 Microprog \$16.95
VIC V1557 Microprog \$16.95
VIC V1558 Microprog \$16.95
VIC V1559 Microprog \$16.95
VIC V1560 Microprog \$16.95
VIC V1561 Microprog \$16.95
VIC V1562 Microprog \$16.95
VIC V1563 Microprog \$16.95
VIC V1564 Microprog \$16.95
VIC V1565 Microprog \$16.95
VIC V1566 Microprog \$16.95
VIC V1567 Microprog \$16.95
VIC V1568 Microprog \$16.95
VIC V1569 Microprog \$16.95
VIC V1570 Microprog \$16.95
VIC V1571 Microprog \$16.95
VIC V1572 Microprog \$16.95
VIC V1573 Microprog \$16.95
VIC V1574 Microprog \$16.95
VIC V1575 Microprog \$16.95
VIC V1576 Microprog \$16.95
VIC V1577 Microprog \$16.95
VIC V1578 Microprog \$16.95
VIC V1579 Microprog \$16.95
VIC V1580 Microprog \$16.95
VIC V1581 Microprog \$16.95
VIC V1582 Microprog \$16.95
VIC V1583 Microprog \$16.95
VIC V1584 Microprog \$16.95
VIC V1585 Microprog \$16.95
VIC V1586 Microprog \$16.95
VIC V1587 Microprog \$16.95
VIC V1588 Microprog \$16.95
VIC V1589 Microprog \$16.95
VIC V1590 Microprog \$16.95
VIC V1591 Microprog \$16.95
VIC V1592 Microprog \$16.95
VIC V1593 Microprog \$16.95
VIC V1594 Microprog \$16.95
VIC V1595 Microprog \$16.95
VIC V1596 Microprog \$16.95
VIC V1597 Microprog \$16.95
VIC V1598 Microprog \$16.95
VIC V1599 Microprog \$16.95
VIC V1600 Microprog \$16.95
VIC V1601 Microprog \$16.95
VIC V1602 Microprog \$16.95
VIC V1603 Microprog \$16.95
VIC V1604 Microprog \$16.95
VIC V1605 Microprog \$16.95
VIC V1606 Microprog \$16.95
VIC V1607 Microprog \$16.95
VIC V1608 Microprog \$16.95
VIC V1609 Microprog \$16.95
VIC V1610 Microprog \$16.95
VIC V1611 Microprog \$16.95
VIC V1612 Microprog \$16.95
VIC V1613 Microprog \$16.95
VIC V1614 Microprog \$16.95
VIC V1615 Microprog \$16.95
VIC V1616 Microprog \$16.95
VIC V1617 Microprog \$16.95
VIC V1618 Microprog \$16.95
VIC V1619 Microprog \$16.95
VIC V1620 Microprog \$16.95
VIC V1621 Microprog \$16.95
VIC V1622 Microprog \$16.95
VIC V1623 Microprog \$16.95
VIC V1624 Microprog \$16.95
VIC V1625 Microprog \$16.95
VIC V1626 Microprog \$16.95
VIC V1627 Microprog \$16.95
VIC V1628 Microprog \$16.95
VIC V1629 Microprog \$16.95
VIC V1630 Microprog \$16.95
VIC V1631 Microprog \$16.95
VIC V1632 Microprog \$16.95
VIC V1633 Microprog \$16.95
VIC V1634 Microprog \$16.95
VIC V1635 Microprog \$16.95
VIC V1636 Microprog \$16.95
VIC V1637 Microprog \$16.95
VIC V1638 Microprog \$16.95
VIC V1639 Microprog \$16.95
VIC V1640 Microprog \$16.95
VIC V1641 Microprog \$16.95
VIC V1642 Microprog \$16.95
VIC V1643 Microprog \$16.95
VIC V1644 Microprog \$16.95
VIC V1645 Microprog \$16.95
VIC V1646 Microprog \$16.95
VIC V1647 Microprog \$16.95
VIC V1648 Microprog \$16.95
VIC V1649 Microprog \$16.95
VIC V1650 Microprog \$16.95
VIC V1651 Microprog \$16.95
VIC V

Move up to Microsystems

**THE JOURNAL FOR SOPHISTICATED
MICROCOMPUTER USERS.**

Microsystems is not, in any sense, for beginners. Unlike "personal computer" magazines, *Microsystems* is written *exclusively* for expert users and designers in the software and support hardware field.

If you need a reliable, high-level, up-to-date journal devoted to CP/M,[®] MP/M,[®] MS-DOS,[™] UNIX,[®] XENIX,[™] OASIS and other operating systems, then *Microsystems* is for you. We feature tutorials on the modification and special use of systems, offer short-cut routines, show you debugging procedures, techniques for interfacing, and much more. Our one purpose is to keep the advanced microcomputer professional at the leading edge of DOS development and use.

In a few recent issues of Microsystems you would have seen:

- Reviews of four C compilers: BDS C, Small C, tiny c TWO[™] and Whitesmiths C.
- A programming style comparison: Digital Research PL/I-80[™] vs. Microsoft BASIC.
- Twenty-seven 16-Bit DOS compared.
- Virtual segment procedures under UCSD Pascal.
- An in-depth look at MP/M-80 II.[™]
- A simple 6-byte hexadecimal ASCII conversion routine.
- Using CP/M's undocumented "Autoload" feature.
- An explanation of double density disk controllers.

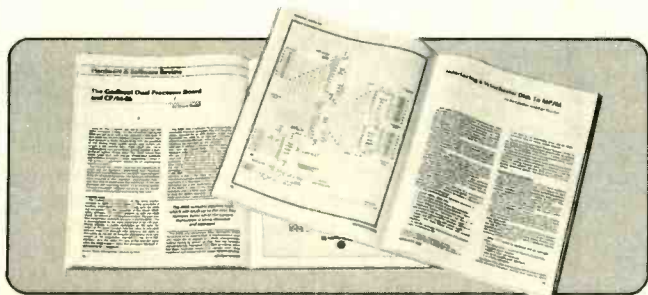

- A comparison of five popular S-100 disk controller cards.
- OS-1—a UNIX-like DOS with a CP/M adapter.

Every issue of *Microsystems* keeps you at the forefront of the industry in customizing software and adapting hardware to meet new requirements and standards. You'll also find industry news, book and new product reviews, plus our regular *Software Directory* listing newly available programs.

To get the high-level systems information you want, join the club of serious microcomputer professionals who subscribe to *Microsystems*. Use the coupon below to order, and save up to 33%!

PROFESSIONALS PLEASE NOTE:

*Your subscription to Microsystems
may be tax deductible. Check
with your accountant.*

Trademarks:

XENIX: Microsoft; tiny c TWO: tiny c assoc.;
PL/I-80, MS-DOS, MP/M-80 II: Digital Research.
Registered Trademarks:
CP/M, MP/M: Digital Research; UNIX: Bell
Laboratories.

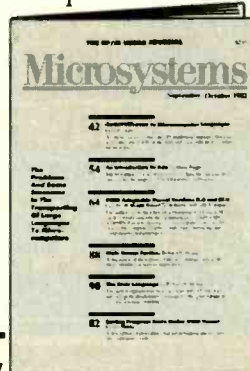

Microsystems CN 1987
Morristown, New Jersey 07960

YES, enter my subscription to *Microsystems* for:

- 12 issues at \$21.97—I save 19%
- 24 issues at \$40.97—I save 24%
- 36 issues at \$55.97—I save 31%

Savings based on full 12-issue subscription price of \$ 26.97

Mr.
Ms.

(please print full name)

8H534

Company

Address

City

State

Zip

CHECK ONE: Payment enclosed. Bill me later.

Offer valid in U.S. and possessions only. Please allow 30 to 60 days for delivery of first issue. Satisfaction guaranteed or a prompt refund for unmailed issues.

NEW SUBSCRIBERS ONLY

Videotex
(Continued from page 77)

row, and working horizontally, you would say "blank" for a1, "blank" for b1, "color" for c1, "color" for d1, "color" for e1, and continue to say "blank" for all remaining cells in the row. Then you would drop down to row 2 and repeat the procedure. You would contin-

ue dropping down, row by row, until you've finished describing the entire grid matrix. In this fashion, you could convey the entire picture with a minimum of vocabulary, but it would be very time-consuming. More to the point, your listener would have no idea

that you were describing a rectangle and the letter Z until he filled in the squares.

The procedure we've just described is basically what occurs in the alphamosaic scheme proposed by the British.

Let's assume now that your friend has a slightly greater command of English. Then you could describe your picture more efficiently as follows: "color rectangle, 3 squares by 5 squares, starting at c1" and "color letter Z, 5 squares tall, starting at n9, ending at q13." This is the alpheometric approach, which directly describes the *geometry* of the figure in a much more concise and efficient manner than with the alphamosaic approach. The drawback of the alpheometric approach, however, is that it requires more interpretative ability on the part of your listener.

The strength of the alphamosaic scheme is that it can be decoded with very simple and, therefore, relatively inexpensive equipment. While this was an important consideration when Prestel was invented several years ago, it has recently become an only marginal advantage in light of the recent drop in prices for electronic parts. The result is that, by the time there was a reason to look for an American standard, the Canadian Telidon scheme's superior graphics and sophistication made it the natural choice.

The Telidon standard was adopted in 1982 by AT&T and is currently working its way through the various North American standards committees under the name NAPLPS.

NAPLPS Standard. The NAPLPS standard takes up where the ASCII standard leaves off. It starts with the ASCII codes to represent letters and numbers; and, in keeping with the ASCII standard, it is a 7-bit code (though there's also an 8-bit version), so that any equipment that can send and receive ASCII can do the same with NAPLPS-encoded graphics. The result is that graphics information can be moved about as easily as text, and any host computer can be used to manipulate the graphics.

With only 128 possible combinations available in a 7-bit code, and ASCII code characters taking up most of them for numbers and letters, it might appear that there's no room for graphics character codes. However, NAPLPS makes it possible for graphics codes to overlay the numbers and letters codes. To be

We'll back you up!

ATTENTION COMMODORE 64 OWNERS

If you own a disk drive then you'll need "The Clone Machine". Take control of your 1541 with this package that includes:

- 1.) Complete and thorough users manual
- 2.) Copy with one or two drives
- 3.) Investigate and back-up many "PROTECTED" disks
- 4.) Copy all file types including relative types
- 5.) Edit and view track/block in Hex or ASCII
- 6.) Display full contents of directory and print
- 7.) Change program names, add, delete files with single keystroke
- 8.) Easy disk initialization
- 9.) Supports up to four drives

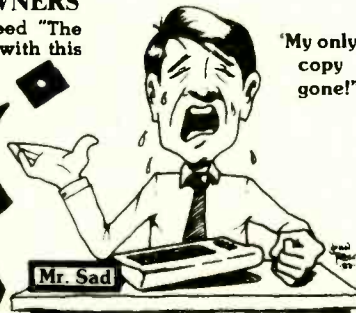

List # 495

Special intro \$39.95

Dealers & Distributors
Inquiries Invited

CALL (201) 838-9027

MICRO WARE

P.O. Box 113
Pompton Plains, N.J.
07444

Circle No. 34 on Free Information Card

CABLE TV

CONVERTERS

Largest Selection
of Equipment Available
\$ Buy Warehouse Direct & Save \$

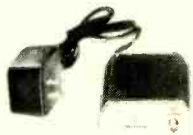

36 channel
converter
\$45.95

36 channel
wired remote
converter
only
\$88.95



Send \$2 for complete catalog
of converters and equipment

Quantity Discounts • Visa • Master Charge
Add 5% shipping—Mich. residents add 4% sales tax

C&D Electronics, Inc.
P.O. Box 21, Jenison, MI 49428
(616) 669-2440

AMAZING DEVICES

- LASERS**
- RUBY LASER RAY GUN** — Intense visible red beam, burns and welds the hardest metals. HAZARDOUS device. Kits available. RUB3 PLANS includes part sources \$15.00
 - CARBON DIOXIDE BURNING AND CUTTING LASER** — produces a continuous beam of energy. HAZARDOUS device — Kits available. LC5 PLANS includes part sources \$15.00
 - VISIBLE LASER LIGHT GUN** — produces intense red beam for special effects and other various optical applications. Hand-held enclosure houses batteries. LGU3 PLANS \$10.00 LGU3K KIT/PLANS (minus tube) \$99.50
 - IR PULSED LASER RIFLE** — produces 15-30 watt pulses at 9000A at 200-2000 per second. LRG3 PLANS \$10.00 LRG3K KIT/PLANS (minus diode) \$119.50
 - BEGINNER POCKET LASER** — visible red simulated device produces an excellent monochromatic source of light. LHC2 PLANS \$5.00 LHC2K KIT/PLANS \$24.50
- PHASORS**
- HIGH ENERGY VARIABLE AND PROGRAMMABLE PAIN FIELD GENERATORS. REQUIRE NO CONTACT** — Recently developed device produces directional fields of moderate to high SPL capable of producing intense pain and discomfort. HAZARDOUS IF NOT USED WITH DISCRETION. SOLD FOR ANIMAL CONTROL — MAY BE USED IN CERTAIN INSTANCES TO DISCOURAGE UNWANTED ENCOUNTERS. PPF1 PROG/VAR PLANS \$15.00 PPF1K KIT/PLANS \$175.00
 - PSP3 VAR HAND-HELD PLANS \$7.00 PSP3K KIT/PLANS \$44.50**
 - PHASOR BURNING WAND** — capable of burning flesh, generates 3500 volts of continuous DC power. PSW3 PLANS \$8.00 PSW3K KIT/PLANS \$59.50
 - PARALYZING SHOCKING WAND** — produces 100,000 watt pulses of stunning power. PG1W PLANS \$10.00 PG1WK KIT/PLANS \$79.50
- SECURITY**
- Above electrical devices are hand-held and may be used for **PERSONAL DEFENSE**.
 - SNOOPER PHONE** — allows user to call his premises and listen in without the phone ever ringing. SNP2 PLANS \$7.00 SNP2K KIT/PLANS \$49.50
 - LONG RANGE WIRELESS MIKE** — miniature device clearly transmits over 1 mile. FBT9 PLANS \$7.00 FBT9K KIT/PLANS \$34.50
 - WIRELESS TELEPHONE TRANSMITTER** — long range all automatic, undetectable. VWP5 PLANS \$7.00 VWP5K KIT/PLANS \$34.50
 - TALK AND TELL** — clearly and automatically records both sides of a telephone conversation when phone is being used. TAT2K KIT/PLANS \$14.50 TAT20 READY TO USE \$24.50
- Our order phone is available 24 HOURS, 7 DAYS A WEEK.
Write for **FREE** catalog of our many products.
We accept Master Charge or Visa. Please allow 10% for shipping. On orders OVER \$50.00 WE PAY freight.
SEND TO: SCIENTIFIC SYSTEMS
DEPT. 01, P.O. BOX 716 AMHERST, NH 03031
OR CALL FOR ORDERING ONLY 1-603-673-4730

COMPUTER MAIL ORDER



ACE 1000 Color Computer... CALL
 ACE Family Pack System... CALL
 ACE PRO PLUS System... CALL
 ACE 1200 Office Mgmt. System... CALL
 "NOT IIE EXPENSIVE"



C 64 \$ 199

- B128-80.....\$769.00
- CBM 64K Memory Board...\$269.00
- 8032 to 9000 Upgrade...\$269.00
- 2031 LP Disk Drive...\$299.00
- 8050 Disk Drive...\$949.00
- 8250 Disk Drive...\$1199.00
- 4023 Printer...\$379.00
- 8023 Printer...\$569.00
- 6400 Printer...\$1399.00
- Z-RAM...\$499.00
- Silicon Office...\$699.00
- The Manager...\$199.00
- Soft ROM...\$125.00
- VisiCalc...\$159.00

PROFESSIONAL SOFTWARE

- Word Pro 2 Plus...\$159.00
- Word Pro 3 Plus...\$189.00
- Word Pro 4 Plus/5 Plus...each \$279.00
- InfoPro...\$179.00
- Administrator...\$399.00
- Power...\$79.00

MODEMS ANCHOR

- Mark I (RS-232)...\$79.00
- Mark II (Atari)...\$79.00
- Mark III (TI-99)...\$109.00
- Mark IV (CBM/PET)...\$125.00
- Mark V (Osborne)...\$95.00
- Mark VI (IBM-PC)...\$169.00
- Mark VII (Auto Ans./Auto Dial)...\$119.00
- Mark XII (1200 Baud)...\$299.00
- TRS-80 Color Computer...\$99.00
- 9 Volt Power Supply...\$9.00

HAYES

- Smartmodem 300...\$219.00
- Smartmodem 1200...\$509.00
- Smartmodem 1200B...\$459.00
- Micromodem II...\$265.00
- Micromodem II Plus...\$299.00
- Micromodem IIE...\$269.00
- Micromodem 100...\$299.00
- Smart Com II...\$89.00
- Chronograph...\$199.00

NOVATION

- J-Cat...\$99.99
- Smart Cat 103...\$179.00
- Smart Cat 103/212...\$399.00
- Auto Cat...\$219.00
- 212 Apple Cat...\$549.00
- Apple Cat 212 Upgrade...\$309.00
- Cat...\$139.99
- D-Cat...\$149.00
- PC-Cat...\$339.00

ZENITH

- ZT-10...\$339.00
- ZT-11...\$369.00

APPLE/FRANKLIN DISK DRIVES MICRO-SCI

- A2.....\$219.00
- A40.....\$299.00
- A70.....\$319.00
- C2 Controller...\$79.00
- C47 Controller...\$89.00

RANA

- Elite 1...\$279.00
- Elite 2...\$389.00
- Elite 3...\$569.00

APPLE IIE STARTER PACK
 64K Apple IIE, Disk Drive & Controller,
 80 Column Card, Monitor II & DOS 3.3
 COMPLETE...\$1399



MSO

- SD1 Disk Drive...\$349.00

VIC 20.....CALL CBM 8032.....\$599

- C1541 Disk Drive...\$249.00
- C1530 Datasette...\$69.00
- C1520 Color Printer/Plotter...\$169.00
- M-80 Dot Matrix/Parallel...\$219.00
- C1526 Dot Matrix/Serial...\$279.00
- C1702 Color Monitor...\$249.00
- C1311 Joystick...\$4.99
- C1312 Paddles...\$11.99
- C1600 VIC Modem...\$59.00
- C1650 Auto Modem...\$89.00
- Logo 64...\$49.00
- Pilot 64...\$39.00
- Simon's BASIC...\$19.00
- Word Pro 64 Plus...\$59.00
- Parallel Printer Interface...\$49.00
- Calc Result 64...\$129.00
- Codewriter 64...\$75.00
- Quick Brown Fox...\$49.00

MONITORS AMOEK

- 300 Green...\$149.00
- 300 Amber...\$159.00
- 310 Amber...\$169.00
- Color 1...\$279.00
- Color 1 Plus...\$299.00
- Color 2...\$399.00
- Color 2 Plus...\$419.00
- Color 3...\$349.00
- Color 4...\$699.00

BMC

- 12" Green...\$79.99
- 12" Green Hi-Res...\$119.99
- 9191-13" Color...\$249.99

GORILLA

- 12" Green...\$88.99
- 12" Amber...\$95.99

NEC

- JB 1260 Green...\$109.99
- JB 1201 Green...\$149.99
- JB 1205 Amber...\$159.99
- JC 1215 Color...\$299.99
- JC 1216 RGB...\$429.99

PRINCETON GRAPHICS

- HX-12...\$519.00

TAXAN

- 12" Green...\$119.00
- 12" Amber...\$129.00
- Taxan 1 RGB...\$279.00

USI

- Pi 1, 9" Green...\$99.99
- Pi 2, 12" Green...\$119.99
- Pi 3, 12" Amber...\$149.99
- Pi 4, 9" Amber...\$139.99
- 1400 Color...\$269.99

ZENITH

- ZVM 123 Amber...\$99.99
- ZVM 123 Green...\$89.99
- ZVM 135 Color/RGB...\$489.99



**600XL.....\$189
 800XL.....\$299**

- 1010 Recorder...\$74.00
- 1020 Color Printer...\$249.00
- 1025 Dot Matrix Printer...\$449.00
- 1027 Letter Quality...\$299.00
- 1030 Direct Connect Modem...CALL
- 1050 Disk Drive...\$379.00
- CX30 Paddle...\$12.00
- CX40 Joystick...each...\$8.00
- CX77 Touch Tablet...\$64.00
- CX80 Trak Ball...\$48.00
- CX85 Keypad...\$105.00
- 4003 Assorted Education...\$47.00
- 4011 Star Raiders...\$33.00
- 4012 Missile Command...\$29.00
- 4013 Asteroids...\$29.00
- 5049 VisiCalc...\$159.00
- 7097 Logo...\$79.00
- 7101 Entertainer...\$69.00
- 7102 Arcade Champ...\$75.00
- 8026 Dig Dug...\$33.00
- 8030 E.T. Phone Home...\$33.00
- 8031 Donkey Kong...\$39.00
- 8036 Atari Writer...\$79.00
- 8040 Donkey Kong, Jr...\$39.00
- 8043 Ms. PacMan...\$39.00
- 8044 Joust...\$39.00

PRINTERS AXIOM

- AT-100 Atari Interface...\$239.00
- CD-100 CBM 64/VIC 20...\$239.00
- GP-100 Parallel Interface...\$199.00

BMC

- 401 Letter Quality...\$589.00
- BX-80 Dot Matrix...\$269.00

C.I.TOH

- Gorilla Banana...\$209.00
- Prowriter 8510P...\$379.00
- Prowriter 1550P...\$679.00
- A10 (18 cps)...\$69.00
- F10-40...\$999.00
- F10-55...\$1499.00

EPSON

- MX-80FT, MX-100, RX-80, RX-80FT,
 FX-80, FX-100...CALL

OKIDATA

- 82, 83, 84, 92, 93, 2350, 2410...CALL

SMITH CORONA

- TP-2...\$449.00
- Tractor Feed...\$149.00

SILVER REED

- 500 Letter Quality...\$439.00
- 550 Letter Quality...\$639.00

STAR

- Gemini 10X...\$239.00
- Gemini P15...\$449.00
- Delta 10...\$559.00
- Serial Board...\$75.00

CONTROLLERS & JOYSTICKS WICO

- Joystick...\$21.99
- 3-way Joystick...\$22.99
- Famous Red Ball...\$23.99
- Power Grip...\$21.99
- BOSS Joystick...\$17.99

**1200XL....CALL
 1400XL....CALL**



- AT 88-S1...\$329.00
- AT 88-A2...\$259.00
- AT 88-S2...\$529.00
- AT 88-S1PD...\$429.00
- AT 88-DDA...\$119.00
- RFD 40-S1...\$449.00
- RFD 40-A1...\$269.00
- RFD 40-S2...\$699.00
- RFD 44-S1...\$539.00
- RFD 44-S2...\$869.00

TEXAS INSTRUMENTS

- TX 99-S1...\$279.00

RANA

- 1000...\$319.00

TRAK

- AT-D2...\$389.00

MEMORY BOARDS

- Axlon 32K...\$59.00
- Axlon 46K...\$99.00
- Axlon 128K...\$299.00
- Intec 32K...\$59.00
- Intec 46K...\$85.00
- Intec 64K...\$99.00
- Intec Real Time Clock...\$29.00

SOFTWARE FOR ATARI

BRODERBUND

- Bank Street Writer...\$49.99
- Chopflifer...\$29.99
- Track Attack...\$21.99

BIG FIVE

- Miner 2049er...\$34.99

DATASOFT

- Canyon Climber...\$23.99
- Magnet Bugs...\$11.99
- Pooyan...\$19.99
- Zaxxon...\$27.00
- Word Wizard...\$52.99
- Spell Wizard...\$38.99

ON-LINE

- Crossfire...\$29.99
- Frogger...\$26.99
- Threshld...\$24.99

PARKER BROTHERS

- Frogger...\$38.99
- Popeye...\$38.99
- Q*Bert...\$38.99

SPINNAKER

- Alphabet Zoo...\$23.99
- Facemaker...\$23.99
- Rhymes & Riddles...\$19.99
- Snoope: Troops: 1 or 2...\$29.99

SYNAPSE

- Bluemax...\$24.99
- Claim Jumper...\$29.99
- File Manager 800 Plus...\$69.99
- Slime...\$29.99
- Shadow World...\$25.99
- Zeppelin...\$26.99

= WEST = = CANADA = = EAST =

1-800-648-3311 1-800-268-4559 1-800-233-8950



In NV call (702)588-5654, Dept. 0207
 P.O. Box 6689, Stateline, NV 89449
 Order Status #: 588-5654

In Toronto call (416)828-0866, Dept. 0207
 2505 Dunwin Ct., Unit 1B,
 Mississauga, Ontario, Canada L5L1T1
 Order Status #: 828-0866

In PA call (717)327-9575, Dept. 0207
 477 E. Third St. Williamsport, PA 17701
 Order Status #: 327-9576
 Customer Service Number: 327-1450



No risk, no deposit on C.O.D. orders. Pre-paid orders receive free shipping within the UPS Continental United States with no waiting period for certified checks or money orders. Add 3% (minimum \$5.00) shipping and handling on all C.O.D. and credit card orders. Larger shipments may require additional charges. NV and PA residents add sales tax. All items subject to availability and price change. We stock manufacturer's and third party software for most all computers on the market. Call today for our new catalog.

CANADIAN ORDERS: All prices are subject to shipping, tax and currency exchange fluctuations. Call for exact pricing in Canada.

Circle No. 11 on Free Information Card

Videotex

able to do this, NAPLPS redefines a couple of ASCII's 32 nonprinting codes, which represent such things as "carriage return" and "go to top of next page." The new definitions can be used to tell the system that what's coming next is either letters and numbers or graphics information. Consequently, the same 7-bit ASCII code does double duty, representing a letter in one context and a graphics element in another.

The NAPLPS standard describes all graphics images as combinations of points, arcs, lines, rectangles, and polygons. The graphics can be solid or outlines, and they can be any color desired.

The coding scheme cleverly permits colors and locations to be described to almost any degree of precision. So even if it's not yet worth having 64,000 colors available, because current video monitors can't distinguish among them anyway, or even if there's no point in describing a shape with a precision of

0.001", the standard can handle it. If, in the future, better monitors or faster decoders become available, the standard and any graphics already encoded un-

der it, won't have to be altered. Hence, NAPLPS offers the same type of backward and forward compatibility for computer-stored graphics information

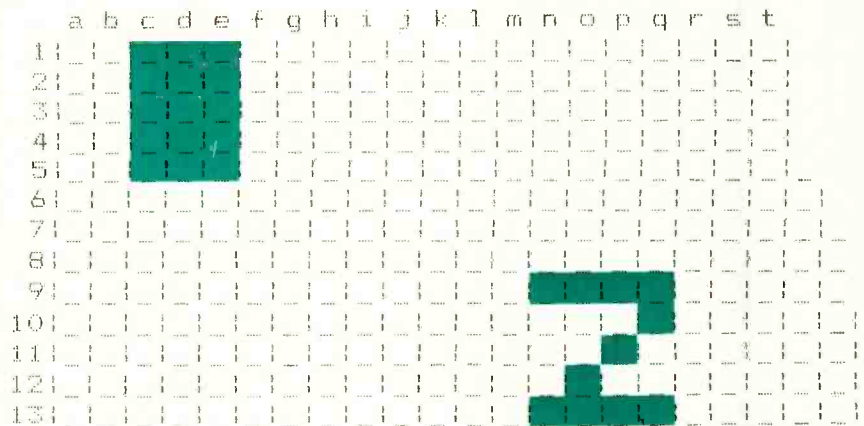

The alphasosaic approach to conveying picture information.



MASTER COMPUTERS IN YOUR OWN HOME!

**LEARN PROGRAMING
AND APPLICATIONS**

Now you can learn about computers... operations... programming... applications... software. Everything you always wanted to know. Write your own programs. Or customize pre-written programs. Make a computer do exactly what you want it to do. Benefit from becoming "computer-wise" today. It's all in this one educational package!

**A COURSE IN COMPUTERS
AND BASIC PROGRAMMING**

NO PREVIOUS COMPUTER EXPERIENCE NEEDED. The entire course is "user friendly", written in simple language, that's easy for a beginner to understand. You will LEARN BY DOING - programming from the very first lesson using any computer, IBM, APPLE, ATARI, COMMODORE, TRS, TI... even the tiny Timex-Sinclair!

A CONVENIENT WAY TO LEARN

Progress at your own speed, in your spare time, in your own home. Take the mystery out of word processing... computerized accounting... maintaining data files and much, much more.

Get started now in the fast-growing field of computers, and **CATCH ON** to the technology of the future... **COMPUTERS!**

Send today for your free information package.

HALIX INSTITUTE CENTER
FOR COMPUTER EDUCATION
1743 So. Vermont Ave., Los Angeles, CA 90006
...if you don't have a computer yet, don't buy one until you receive this free information.

halix An affiliate of Hemphill Schools and IPIG
INSTITUTE ...The International Choice Since 1920

YES! Send me information on how I can learn about computers and programming at home!

Name _____ Age _____

Address _____

City _____ State/Zip _____

I already have a computer available.

Make _____ Model _____

HALIX INSTITUTE CENTER FOR COMPUTER EDUCATION
DEPT. 44H-AO302
1743 So. Vermont Ave.
Los Angeles, CA 90006
44H-AO302

Circle No. 4 on Free Information Card

"POWER FAILURE PROBLEMS"

**BLACKOUTS!
BROWNOUTS!
DIPS!**

**YOUR
SOLUTION...**

LINE-SAVER™

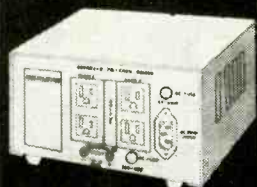
**STANDBY
UNINTERRUPTABLE
POWER
SYSTEM**

SAVE YOUR DATA from power "blackouts," "brownouts" or line "dips."

PROTECT YOUR DATA from "transient voltages, spikes and EMI/RFI line noise."

LINE-SAVER™ stands-by to switch 250VA, 150 watts of power to your micro-computer. Its heavy duty internal sealed battery provides up to 40 minutes of back-up power; more than enough to **SAVE** your data and shut down your system if line power does not return.

LINE-SAVER™ provides constant protection for your system from damaging voltage surges, spikes and conducted line noise.

LINE-SAVER™ constantly monitors the AC line and itself, with a unique visual and audible three staged **ANNUNCIATOR** that provides you at-a-glance status.



LINE-SAVER™ is compact in size and utilizes the latest PWM technology to make it compatible with virtually every microcomputer system today.

LINE-SAVER™ is low in cost... **\$395.00**

Call or write today for free literature

AEGIS®
Power Conditioning
Equipment

ORDER TODAY
Out of State
Toll Free Order Number
1-800-524-0400
In-State Order No.
215-837-0700

KALGLO®

**6584 Ruch Rd., Dept.
Bethlehem, PA 18017**

DEALER & OEM
INQUIRIES INVITED

Add \$10.00 for shipping & handling • COD's add \$3.00
PA Res. add 6% sales tax

Circle No. 58 on Free Information Card

INCREASE YOUR KNOWLEDGE AND CONFIDENCE WITH THREE GREAT IDEABOOKS FOR YOUR HOME COMPUTER SYSTEM!

Imagine harnessing the full potential of your home computer system! CREATIVE COMPUTING's IDEABOOKs give you a wealth of information to help you discover your computer's hidden strengths and overcome its weaknesses!

Beginning with chapter one, you will start getting more out of your system...for example:

- 50 ready-to-run tested programs that will help you solve practical everyday problems in math, science and business.
- Solve problems with formulas and repetitive trials, convergence, recursion, compounding, probability, geometry, science, simulations and drill and practice.

• Tap into the *true* capabilities of your home system! And identify the shortcomings and recognize the types of jobs and applications best suited for your system!

Your IDEABOOK will supplement the user manual giving you the confidence and knowledge to make the most out of your home system, at an affordable price of only \$8.95!

Don't go another day without your copy of CREATIVE COMPUTING's IDEABOOK!

**For faster service,
phone Toll Free:
1-800-631-8112**
(in New Jersey call 201-540-0445)

IDEABOOKS are available at your local bookstore or computer store.

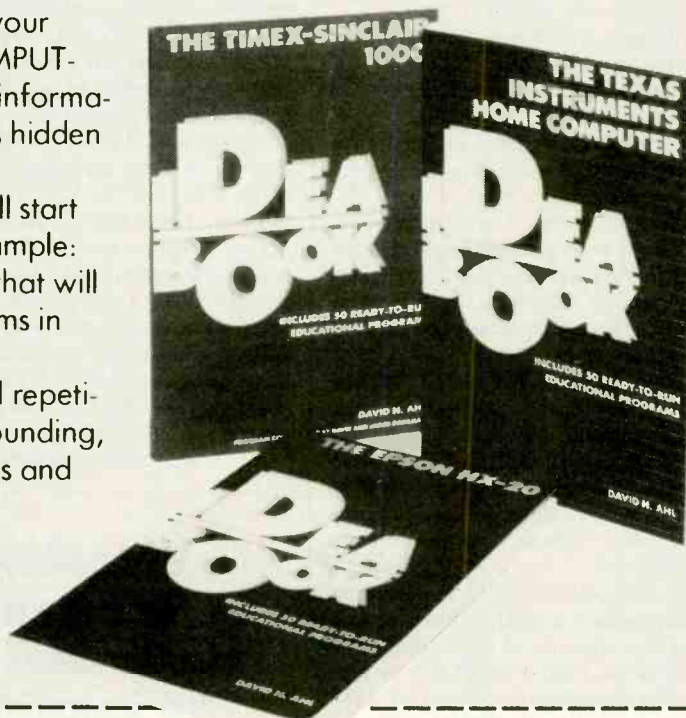

Creative Computing Press

Dept. NL3F
39 E. Hanover Avenue
Morris Plains, NJ 07950

Please send the following books:

TITLE	BOOK NO	QTY	PRICE EACH*	\$2.00 POSTAGE HANDLING EACH	TOTAL
Epson HX-20 Ideabook	3S		\$8.95		
TI Ideabook	3R		\$8.95		
TS1000 Ideabook	3P		\$8.95		
				TOTAL AMOUNT DUE	

CA, NJ & NY State residents add applicable sales tax.*
Outside U.S.A. add \$3.00 per order.

- Payment Enclosed
 CHARGE MY: American Express Visa MasterCard

Card No. _____ Exp. Date _____

Mr./Mrs./Ms. _____
please print name in full

Address _____ Apt. _____

City _____ State _____ Zip _____

Please send me a Free Creative Computing Press Catalog.

Videotex

that was established when color broadcasts became possible for television.

The Services. Now that you know that the technology for videotex exists and is quite refined, what about services? Does a videotex service actually exist to which you can subscribe? For most of the U.S.—and the rest of the world, for that matter—the answer is “no.”

In Britain, the Prestel service has a few tens of thousands of subscribers, which gives it the largest subscriber base for any videotex system currently in existence. Most subscribers to Prestel are businesses that use the service for professional purposes.

Across the Channel in France, a system similar to Prestel is being tested for the ultimate purpose of replacing traditional printed telephone directories. It will also be used to provide other consumer services.

In Canada, a service called “Grassroots” offers both consumer-oriented and agricultural information in a rural area in southern Manitoba. Farther to the east, in Toronto, a couple of hundred terminals in hotel lobbies and other public places offer tourist information.

The only place in the U.S. where you can subscribe to a local videotex service is in three counties in and around Miami, Florida. Called Viewtron, the service was launched in November 1983 and is operated by the Viewdata Corp., a subsidiary of Knight-Ridder Newspapers, Inc. The Viewtron service is based on a Tandem Non Stop II computer located in Miami Beach. A subscriber reaches the computer with a local telephone call from anywhere in the three-county area. Cost for this service is \$12 per month plus \$1 per connected hour. Since in addition to subscribing to the Viewtron service, you need a videotex decoder, Viewdata is selling, through retail chains in its marketing area, the AT&T Sceptre videotex terminal for \$600.

The Viewtron service offers both specialized and general-interest information, including stock quotations, local-area restaurant menus, and the American Academic Encyclopedia. It also offers services like electronic banking and shopping, and subscriber-to-subscriber electronic messaging. Some services simply use Viewtron's computer to access other computers. You can tell the system you want to order some-

thing from, say, J.C. Penney, and Viewtron's computer connects you to Penney's computer.

Another videotex service should be in operation by the middle of this year in Orange County, California. Called Gateway, it will be operated by Times-Mirror Videotex Services, a subsidiary of the *Los Angeles Times*. The range of services and the configuration of the hardware isn't very different from what Viewtron offers. The major difference is that Gateway plans to rent, rather than sell, decoders to subscribers.

If Gateway is successful, this service may be in your area sooner than you think. Through its Videotex America affiliate, Times-Mirror proposes to set up partnerships with local newspapers across the country for local videotex services. Each local service would run its own computer, rent out its own decoders, and do its own selling, both of advertising and of the service itself. Like network TV, some nationwide Gateway services would also be provided, as would some national advertising.

Videotex is often described as “a solution in search of a problem”

It's not necessary for you to be within the local marketing area of any of these services to be able to use them. All you need are a subscriber ID, a telephone line, and a videotex decoder. Of course, if you live outside the area the system is designed to service, you may not want to subscribe, since most of the information available on it will be of a local nature. Just how local the videotex service is has a lot more to do with marketing and the people who are launching the services (usually local newspapers), than it does with technology. Subscribers outside the service area will have to pay for toll calls to the computer.

Subscribers outside a given local area wouldn't have to use the prescribed terminal, at least not if terminals aren't in-

cluded in the monthly subscription fee. This means you can use a personal computer, modem, and communication software as a videotex decoder. Canadian software developers, who have been working with the NAPLPS standard the longest, already have software for micros as inexpensive as the Commodore C-64 computer. And several software packages exist for Apples and the IBM PC. (Really inexpensive computers, like the Commodore VIC-20, aren't fast enough to be used as practical videotex decoders.)

Down the Road. You might want to keep on the alert for new developments in the near future. In particular, watch for AT&T to bring to your local area its Sceptre terminal and for really good decoding software to become available for the IBM PCjr computer.

Like the IBM PC and PCjr and a number of other very powerful 16-bit computers currently available, the Sceptre is an 8088-based system. If it were available right now, you couldn't use a Sceptre as a computer, since no way exists to permit you to load the necessary software into it. However, AT&T is likely to reveal a few hidden pathways into the Sceptre at about the time it wants to get into the home computer market.

If you live in the southern Florida area, watch for the stores selling the IBM PCjr to start stocking videotex decoding software. Since it already exists for the IBM PC, it will almost certainly be made available for the PCjr just about the time this new computer from IBM is delivered to dealers. Anyone who purchases an IBM PCjr could turn it into the equivalent of the Sceptre terminal, for a nominal cost of perhaps \$200, and still have the PCjr for its computing power.

In Closing. Videotex is frequently described as a “solution in search of a problem.” It's a new medium of communication that no one is quite sure what to do with and, consequently, has yet to be fully exploited. This situation is destined to change rapidly in the near future.

As paying, commercial videotex systems appear, with commitments from solid companies like AT&T and major newspaper chains, we may see videotex emerge as a truly useful home service. ◇



The Computer Book Club®

"The ONLY Book Club for Microcomputerists!"

Superior Performance! Practical Price!

More programs, projects, ways to use your micro for home, hobby, education, and business!

Select 6 Books for Only \$2⁹⁵



1533 List \$17.95 473 List \$19.95 1607 List \$21.95

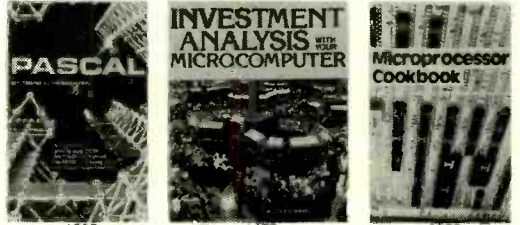

1205 List \$16.95 1479 List \$19.95 1053 List \$13.95



1633 List \$19.95 1050 List \$13.95 1241 List \$15.95 1062 List \$14.95 1478 List \$19.95 1521 List \$17.95 1556 List \$21.95 1428 List \$17.95

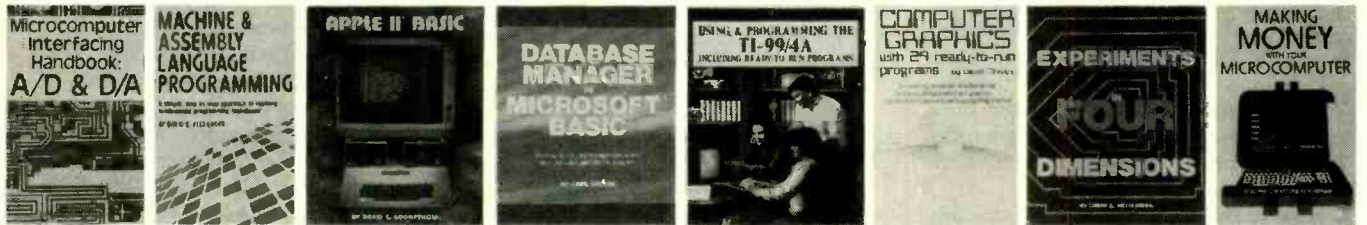

1271 List \$18.95 1389 List \$15.95 1513 List \$19.95 1567 List \$18.95 1620 List \$16.95 1276 List \$15.95 1541 List \$24.95 1506 List \$13.95

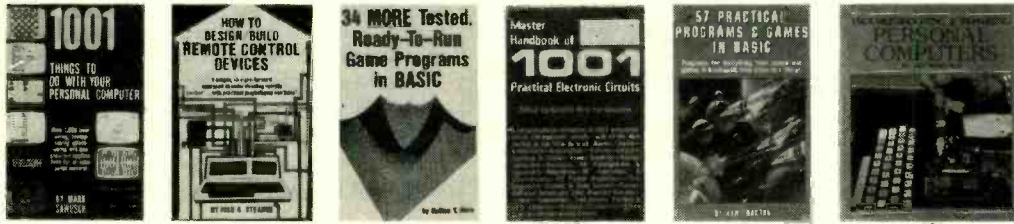

1160 List \$14.95 1277 List \$19.95 1228 List \$14.95 800 List \$18.95 (paper) 1000 List \$13.95 1539 List \$19.95

Free guide to BASIC Statements & Commands



Plus FREE For Joining →

7 very good reasons to join The Computer Book Club®

- **Big Savings.** Save 20% to 75% on books sure to increase your computer know-how
- **No-Risk Guarantee.** All books returnable within 10 days without obligation at Club expense
- **Club News Bulletins.** All about current selections—mains, alternates, extras—plus bonus offers. Comes 13 times a year with hundreds of up-to-the-minute titles you can pick from
- **"Automatic Order."** Do nothing, and the Main selection will be shipped automatically! But . . . if you want an Alternate selection—or no books at all—we'll follow the instructions you give on the reply form provided with every News Bulletin
- **Bonus Books.** Immediately get a Dividend Certificate with every book purchased and qualify for big discounts of 60% to 80%
- **Extra Bonuses.** Take advantage of added-value promotions, plus special discounts on software, games, and more
- **Exceptional Quality.** All books are first-rate publisher's editions selected by our Editorial Board and filled with useful, up-to-the-minute information

The Computer Book Club®

P.O. Box 80, Blue Ridge Summit, PA 17214

Please accept my membership in The Computer Book Club® and send the 6 volumes circled below, plus my FREE copy of *BASIC Statements, Commands and Functions*, billing me \$2.95 plus shipping and handling charges. If not satisfied, I may return the books within ten days without obligation and have my membership canceled. I agree to purchase 3 or more books at reduced Club prices (plus shipping/handling) during the next 12 months, and may resign any time thereafter.

800 1000 1050 1053 1062 1160 1205 1228 1241
1271 1276 1277 1389 1428 1473 1478 1479 1506 1513
1521 1533 1539 1541 1556 1567 1607 1620 1633

Name _____
 Phone _____
 Address _____
 City _____
 State _____ Zip _____

Valid for new members only. (Foreign customers must pay in advance in U.S. currency.) This order subject to acceptance by The Computer Book Club®. PECC-284

Circle No. 39 on Free Information Card

Storage Oscilloscope (Continued from page 66)

the sweep subroutine, y-axis (vertical) trace data is written into the data file if D\$ is Y. The sweep delay per division (SD) is saved after the trace has been saved (line 4500). This allows a suitable plotter program to correctly annotate a hard copy version of the retrieved trace. (Omit line 4500 if you don't plan to use the plotter option described below.) Finally, the disk file is closed (line 4600) after the sweep is completed and saved.

Traces which have been saved on disk can be retrieved and displayed with or without a graticule. This function is accomplished by the routine in lines 1000-1400. Line 1020 requests the name of the trace (N\$) and line 1030 opens an input buffer (#1) for the disk. The remainder of the routine retrieves data from the disk and paints the trace on the monitor's screen. The retrieved trace is drawn using the sweep subroutine's method for painting a real-time trace. (See lines 4300-4350 and 1310-1340.) Saved traces can also be drawn on a plotter using the Scopeplt program described later.

How to Use Comscope. After loading the program (and saving it on disk if you have a disk drive), verify operation by moving the joystick handle during the display sweep phase. If the trace does not move up and down in response to joystick movements, check to make sure that the program was entered correctly.

Be sure to check all the menu options for proper operation. A displayed trace can be exited (while it's being painted or after it's frozen on the monitor) by pressing M. The screen will immediately clear and the main menu will be displayed. You can exit at other points in the program by pressing BREAK and restart by typing RUN.

Many different signal sources can be connected to the Color Computer's joystick ports as long as their output levels fall within the 0.5-volt "window." When no external amplifier is used, Comscope provides a sensitivity of about 0.4 volt per vertical division.

Low-level signals will require amplification and this is easily accomplished with a simple operational amplifier circuit such as the one described in this month's "The Electronics Scientist" column. This column also describes how to gain access to the Color Computer's joystick ports by soldering a pair of wires to terminals inside a joystick.

Three simple circuits whose outputs

can be monitored with the Comscope program are shown in Fig. 2. Figure 2A shows an RC circuit that outputs a rapidly rising voltage followed by a slowly falling voltage as *C1* is charged through *R1* and then self-discharged through natural leakage paths within the circuit.

A photograph of the actual trace of the charge-discharge cycle as displayed on the computer's monitor (0.4 volt per vertical division and 0.35 second per horizontal division) is shown in Fig. 3. The trace begins automatically as soon as *S1* is closed. The switch was opened when the charge of *C1* approached maximum amplitude.

The circuit in Fig. 2B is a very simple, yet ultra-sensitive, light sensor. The cadmium sulfide photoresistor, *PCI*, has a high dark resistance and a low light resistance (Radio Shack 276-116 or similar). The circuit's output voltage

Even economical printers have higher resolution than video monitors

rises as the light level at the photoresistor increases.

A photograph of the monitor's screen showing two spikes produced by the light sensor when a flashlight was blinked twice in quick succession (0.4 volt per vertical division) is shown in Fig. 4. The spikes, which are easier to discern without the graticule, exhibit the very slow fall times characteristic of photoresistors. This is the so-called *memory effect*. While a small part of the delay is caused by the thermal lag of the lamp filament, note that the output from the sensor is still 0.4 volt when the second flash arrives about 2.5 seconds after the first.

A linear-response light sensor using a silicon solar cell and an op amp is shown in Fig. 2C. Using the values of *R1* and *R2* as shown, the gain of the op amp is 10. This can be increased (decreased) by increasing (decreasing) the value of *R2*.

A photograph of the monitor's screen showing the trace produced when the

beam from a flashlight is slowly scanned past the solar cell is shown in Fig. 5. The horizontal sweep is 1 second per division. Thanks to the X10 gain of the amplifier, the vertical scale is a sensitive 0.04 volt per division.

Earlier it was explained that traces saved on disk must have reduced resolution to avoid interruptions from the disk drive when the output buffer is filled. The display photograph in Fig. 3 clearly shows an artifact resultant from a disk-drive interruption near the right end of the trace. Depending upon the signal, a similar artifact may appear at the same location on other traces.

Modifying Comscope. In using Comscope for serious applications, you may want to consider modifying or expanding the program to include custom features. Since the time per horizontal division is only approximate, you can refine the timing calibration. One possibility is to use the TIMER function.

If you can program in assembly language, you can greatly increase Comscope's sweep speed. This is done by substituting an assembly language subroutine for the sweep subroutine.

You may also wish to add sound effects, particularly if you intend to record traces over a period of minutes or hours. A simple BASIC line such as SOUND 200,50 appropriately placed will generate a tone to notify that the trace is complete or any other desired event has occurred.

Using an X-Y Plotter. It's possible to use some dot-matrix printers to produce a hard-copy version of graphics displayed on a computer's monitor. This procedure is called a *screen dump*.

A better approach is to employ an x-y plotter. Even economical plotters have much higher resolution than the best available video monitors. This means very precise graticules and calibration marks can be superimposed on a plotted trace.

A program called Scopeplt that converts Comscope traces saved on disk into publication-quality hard copy is given in Listing 2. The program is designed for use with Hewlett-Packard's HP-7470A plotter and a Color Computer. With minor modifications it can also be used with other computers and any of the various plotters that understand HPGL (Hewlett-Packard Graphics Language).

Storage Oscilloscope

LISTING 1—COMSCOPE

```
10 'COMSCOPE
20 'COPYRIGHT 1984 BY FORREST M. MIMS III
30 CLS
50 PRINT @ 34, "COLOR COMPUTER OSCILLOSCOPE"
100 PRINT @ 96, "A.SINGLE SWEEP STORAGE SCOPE."
110 PRINT @ 160, "B.CONTINUOUS SWEEP SCOPE."
120 PRINT @ 224, "C.RETRIEVE TRACE FROM DISK."
150 PRINT @ 320, "FOR GRATICULE ADD G TO SELECTION"
160 PRINT @ 384, "PRESS M TO RETURN TO MAIN MENU"
165 PRINT " ":PRINT ""
170 INPUT "SELECTION";SE$
200 IF SE$="B" OR SE$="BG" THEN 340
210 IF SE$="C" OR SE$="CG" THEN 1000
300 CLS
310 INPUT "SAVE TRACE ON DISK (Y OR N)";D$
320 IF D$="Y" OR D$="N" THEN 330 ELSE 300
330 IF D$="Y" THEN INPUT "NAME OF TRACE";N$
340 INPUT "SECONDS PER DIVISION (0.35 MINIMUM)";SD
350 IF D$="Y" THEN M=4 ELSE M=16
360 SW=((SD-.34)*460)/M
370 IF D$="Y" THEN OPEN "O",#1,N$
380 PMODE 4,1:PCLS:SCREEN 1,0
400 IF SE$="AG" OR SE$="BG" THEN GOSUB 2000
450 GOSUB 4000
500 IF SE$="B" OR SE$="BG" THEN 380
1000 CLS
1020 INPUT "NAME OF COMSCOPE TRACE ON DISK";N$
1030 OPEN "I",#1,N$
1100 PMODE 4,1:PCLS:SCREEN 1,0
1200 IF SE$="CG" THEN GOSUB 2000
1300 LINE (0,191)-(0,191),PSET
1310 FOR X=0 TO 255 STEP 4
1320 INPUT #1,Y
1330 LINE -(X,Y),PSET
1340 NEXT X
1350 CLOSE #1
1400 IF INKEY$="M" THEN 30 ELSE 1400
2000 'DRAW GRATICULE
2010 FOR H=0 TO 255 STEP 16
2020 LINE (H,0)-(H,191),PSET
2030 NEXT H
2040 FOR T=0 TO 191 STEP 4
2050 PSET (127,T):PSET (129,T)
2060 NEXT T
2100 FOR V=16 TO 191 STEP 16
2110 LINE (0,V)-(255,V),PSET
2120 NEXT V
2130 FOR T=0 TO 255 STEP 4
2140 PSET (T,95):PSET (T,97)
2150 NEXT T
2160 RETURN
4000 IF D$="Y" THEN Q=4 ELSE Q=1
4100 LINE (0,191)-(0,191),PSET
4200 IF JOYSTK(0) > 0 THEN 4300 ELSE 4200
4300 FOR X=0 TO 255 STEP Q
4305 IF INKEY$="M" THEN 30
4310 Y=189-3*JOYSTK(0)
4320 IF D$="Y" THEN WRITE #1,Y
4330 LINE -(X,Y),PSET
4340 FOR T=1 TO SW:NEXT T
4350 NEXT X
4500 IF D$="Y" THEN WRITE #1, SD
4600 IF SE$="A" OR SE$="AG"
    THEN CLOSE #1 ELSE RETURN
4700 IF INKEY$="M" THEN 30 ELSE 4700
```

LISTING 2—SCOPEPLT

```
10 'SCOPEPLT
15 'COPYRIGHT 1984 BY FORREST M. MIMS III
20 PRINT #-2, "SP0;":CLS
25 PRINT @ 34, "COLOR COMPUTER OSCILLOSCOPE"
30 PRINT @ 69, "HP7470 PLOTTER DRIVER"
35 PRINT @ 288, "PRESS ANY KEY TO START..."
40 IF INKEY$="" THEN 40 ELSE CLS
45 PRINT "SCOPE DATA FILE MUST BE ON DISK."
47 PRINT "PRESS R TO RESTART PROGRAM.":PRINT ""
50 INPUT "SCOPE DATA FILE NAME";N$
60 INPUT "DO YOU WANT A GRATICULE (Y OR N)";G$
70 IF G$="N" THEN INPUT "DO YOU WANT
    BORDER TICK MARKS (Y OR N)";TS
80 OPEN "I",#1,N$
90 PRINT#-2, "SC0,255,0,191;SP2;"
110 PMODE 4,1:PCLS:SCREEN 1,0
120 IF G$="N" THEN 3000
230 FOR H=0 TO 271 STEP 16
240 LINE (H,0)-(H,191),PSET
250 PRINT#-2, "PA"H",0,PD,"H",191,PU;"
255 IF INKEY$="R" THEN 5000
260 NEXT H
270 PRINT#-2, "PA128,0;"
280 FOR T=0 TO 191 STEP 4
290 PRINT#-2, "PA128,"T";YT;"
295 IF INKEY$="R" THEN 5000
300 NEXT T
310 FOR Q=1 TO 1000:NEXT Q
320 FOR V=0 TO 207 STEP 16
330 LINE (0,V)-(255,V),PSET
340 PRINT#-2, "PA0,"V",PD,255,"V",PU;"
345 IF INKEY$="R" THEN 5000
350 NEXT V
360 PRINT#-2, "PA0,96;"
370 FOR T=0 TO 255 STEP 4
380 PRINT#-2, "PA"T",96;XT;"
385 IF INKEY$="R" THEN 5000
390 NEXT T
400 FOR Q=1 TO 1000:NEXT Q
420 FOR T=0 TO 191 STEP 4
430 PSET (127,T):PSET (129,T)
440 NEXT T
450 FOR T=0 TO 255 STEP 4
460 PSET (T,95):PSET (T,97)
470 NEXT T
480 PRINT #-2, "SP1;"
500 FOR X=0 TO 255 STEP 4
600 INPUT #1, Y
700 PSET (X,Y)
720 PRINT#-2, "PA"X,Y";PD;"
750 IF INKEY$="R" THEN 5000
800 NEXT X
900 PRINT#-2, "PU;SP2;"
910 PRINT#-2, "DR-1,0;SR5,-7;"
920 PRINT#-2, "PA0,220;LB"N$;CHR$(3)
925 PRINT #-2, "SR2.5,-4
927 INPUT#1, SD
930 PRINT #-2, "PA0,250;LB0.4 VOLT/DIV
    "SD"SEC/DIV"CHR$(3)
950 PRINT#-2, "PU;SP;"
990 CLOSE #1
1000 IF INKEY$="R" THEN 20 ELSE 1000
3000 PRINT#-2, "PA0,0,PD,0,191,
    255,191,255,0,0,0,PU;"
3100 IF TS="N" THEN 500
3200 FOR T=0 TO 191 STEP 16
3300 PRINT#-2, "PA0,"T";TL1,0;YT;"
3350 IF INKEY$="R" THEN 5000
3400 NEXT T
3500 FOR D=1 TO 1000:NEXT D
3600 FOR T=0 TO 191 STEP 16
3700 PRINT#-2, "PA255,"T";TL0,1;YT"
3750 IF INKEY$="R" THEN 5000
3800 NEXT T
3900 FOR D=1 TO 1000:NEXT D
4000 FOR T=0 TO 255 STEP 16
4100 PRINT#-2, "PA"T",0;TL1,0;XT;"
4150 IF INKEY$="R" THEN 5000
4200 NEXT T
4300 FOR D=1 TO 1000:NEXT D
4400 FOR T=0 TO 255 STEP 16
4500 PRINT#-2, "PA"T",191;TL0,1;XT;"
4550 IF INKEY$="R" THEN 5000
4600 NEXT T
4700 FOR D=1 TO 1000:NEXT D
4800 GOTO 500
5000 CLOSE #1;GOTO 20
```

Storage Oscilloscope

The program combines instructions for the computer's video monitor and the plotter so that both form graticules (if so instructed by the user) before plotting the retrieved trace.

The program probably seems very complicated if you're not familiar with HPGL. Actually, HPGL is very easy to use, as you can readily see by referring to the keystone of the program, lines 500-800. These five short lines form a loop that plots the saved trace a point at a time on both the computer's monitor and the plotter. Here's what happens:

Line 500 establishes a loop of 256/4 events, 256 being the number of pixels across the screen of the monitor. The loop is stepped through each fourth pixel since the disk data is stored at 1/4 resolution.

Line 600 retrieves y-axis data (voltage) from the disk.

Line 700 moves the plotter pen to the appropriate position (PA or Plot Abs-

olute) and places the pen tip on the paper (PD or Pen Down).

Line 800 repeats the cycle started at line 500.

As the loop executes, a stream of dots is "painted" on the video monitor, while simultaneously, the plotter pen draws a continuous line plot identical to the displayed trace.

While Scopeplt, like all graphics programs, is very meticulous in its detail, it's actually a relatively simple program. Look, for instance, at line 90. This line uses the plotter's SC (Scale) instruction to establish a grid of 192 x 256 plotter units. This gives the plotter the same resolution as the Color Computer and allows the x and y values used for the computer to be used by the plotter.

The HPGL commands between lines 230 and 390 draw the graticule and insert tick marks. The HPGL commands between lines 3000 and 4800 draw a simulated CRT screen *without* a grati-

cule and with or without border tick marks if either of these options is selected.

You may be wondering about the sprinkling of seemingly functionless time-wasting loops such as those in lines 310, 400, 3000, 3900, 4300, and 4700. These are included to prevent the buffer in the HP-7470A plotter from being filled by too rapid a stream of incoming instructions from the Color Computer.

To reduce execution time, experiment with the values in these timer loops.

How to Use Scopeplt. An HP-7470A (RS-232 version) plotter is connected to the serial port of a Color Computer as shown in Fig. 6. While this arrangement does not permit the plotter to send data to the computer, it is satisfactory for most common plotting applications. Other computers offer better interfacing via "handshake" signals.



FREE SOCKETS!

Send **\$1.00** postage and handling

for DIP Socket Deal!

One each of 8, 14, 16, 24 and 40 pin tin low profile DIP Sockets

plus

we will send you FREE our 56 page catalog with \$1.00 OFF Coupon on any purchase.

How can you lose?

SINTEC COMPANY
28 8th Street
Box 410
Frenchtown, NJ 08825
(201) 996-4093

We Carry Over 1500 Parts in Stock!!

Fill in below for Socket Deal

I want the Socket Deal Enclosed is my \$1.00 cash.

Name _____

Address _____

City _____ State _____ Zip _____

For Home or Business: WHAT...WHEN...HOW...



LEARN HOW TO USE A COMPUTER

Now at Home in Spare Time, you can learn everything you always wanted to know about personal computers. How to program in BASIC. How to understand and use more than 80 BASIC commands and functions. How to write and run your own programs... for both personal and business applications. How to use pre-packaged software and change it to meet your special needs. How to make sense of the overwhelming maze of books, information and advice available at your local computer store.

More Than Just A Computer Manual

This is more than just another programming manual...it's an entire comprehensive course written by experts. Yet, because it was especially developed for home study, you learn everything right in your own home, without changing your job or lifestyle, without attending a single class.

Plus You Get Your Own Computer

To give you practical hands-on experience, this course includes your own personal computer—the Timex Sinclair 1500 with built in 16K memory—plus a cassette recorder that lets you save your programs on tape.



Get all the facts. MAIL COUPON TODAY!

ICS COMPUTER TRAINING, Dept. P2014
SINCE 1991 Scranton, PA 18515

Name _____ Age _____

Address _____

City/State/Zip _____

For more information on advertised products, equipment tested, etc., circle appropriate number on postpaid Free Information Card.

Circle No. 36 on Free Information Card

Storage Oscilloscope

Prior to running Scopeplt, the plotter's scaling points should be manually entered into the plotter. This is accomplished from the plotter's control panel by first directing the pen to the desired upper *left* corner of the plot and entering P1. Next, move the pen to the desired lower *right* corner of the plot and enter P2. Be sure to leave room for the label which will be drawn under the plot.

Next, select the pens you wish the plotter to use. A fine tip (0.3 mm) black pen is excellent for the graticule or border (right stall) while a broad tip (0.7 mm) red, green or blue pen provides a highly visible trace (left stall).

Make sure the plotter is placed so the paper has an unimpeded path as it moves back and forth across the bed. Then place a sheet of paper in the plotter. (White typing bond is okay, but plotter paper provides publication-quality results.)

Now run Scopeplt. The program will ask you to enter the name of the trace you want to plot. (You'll get an NE error if the data file for the trace is not on the disk inserted in the drive.) The program will then ask if you want a graticule. If not, it will ask if you want tick marks inserted around the rectangle which will surround the plot.

After you have responded to the program, Scopeplt will take over and rapidly commence drawing the plot. After completing the graticule (or border) and trace, it will label the plot and insert the calibration factors. The program uses a fixed value of 0.4 volt per vertical division, with the value for the sweep speed retrieved from the disk file.

Be sure to keep your fingers away from the fast moving pen! Depending upon where you set P1 and P2, you can enter new locations for P1 and P2 and make additional plots on the same sheet.

A sample test plot showing voltage fluctuations generated by one axis of an analog (potentiometer voltage divider) joystick is shown in Fig. 7. The data for this oscillogram, which illustrates the border with tick marks option, was retrieved from a disk data file called JOYSTK-1.

Figures 8, 9, and 10 are plotter-generated oscillograms corresponding to the computer monitor photographs in, respectively, Figs. 3, 4 and 5. All three oscillograms illustrate the graticule option.

Various combinations of pen colors

and widths can be used to dress up the oscillograms. You can plot an oscillogram anywhere you please on a sheet of paper simply by setting new P1 and P2 locations. You may wish to make light pencil marks for the new locations. Enter them after first moving a pen directly over each mark. Remember that you'll have to reenter the P1 and P2 points if you turn off the plotter.

Modifying Scopeplt. Experienced HPGL programmers will have little trouble revising Scopeplt to include additional features. With a little practice, even novice HPGL programmers can soon learn to expand the program.

The most obvious revision would be a menu of options to permit such a frill as keyboard control of the location, size, and orientation of the oscillograms. Other options might include user-selectable label size and graticule configuration. A text feature could also be included.

The programs can be revised to drive other computers and plotters

Incidentally, normally P1 and P2 are set, respectively, at the upper *left* and lower *right* corners of the paper. Scopeplt alters this arrangement in order to match the Color Computer coordinate system. Therefore, the labels are *reverse* printed so they will appear normal (see line 910). Keep this in mind if you revise the program.

Going Further. Both Comscope and Scopeplt illustrate the use of moderately priced computer hardware to provide capabilities previously unavailable to engineers, technicians, and experimenters unable to afford expensive storage oscilloscopes and data loggers. Remember that, while these programs were developed for the Color Computer and HP-7470, they can both be revised to drive *other* computers and plotters. ◇

Sharp PC-5000 (Continued from page 63)

tem, no special procedure is required for using the bubble memory. Bubble cartridges are small enough to tuck into a shirt pocket and are quite a bit more rugged than floppy disks and data cassettes.

As I see it, the only drawbacks to the bubble-memory system are its limited 128K storage capacity and the relatively high price of additional cartridges. However, with a combination of disks and bubble memory, the one cartridge supplied with the computer should be sufficient for most users.

Closing Comment. Sharp has done a great job in designing the PC-5000. My main regret is that I didn't have a production model, complete with software and all options, to test. The fact that the computer uses MS-DOS as its operating system should mean that there will be many fine software packages available for the PC-5000 in a short time. If Sharp supports and services the computer, the PC-5000 should be a real winner. ◇



ISOBAR...cleans up your line power! The most complete computer protection available!

More features to prevent errors, false printout, disc skips! *Only ISOBAR has 3-way spike protection, noise suppression for RFI PLUS isolated filter banks!* Individual filter banks isolate each load from other loads minimizing data errors of any kind. MOV surge suppressors arrest both common mode and differential mode surges. L/C filter network rejects radio frequency noise at any amplitude. Toroidal coils for greatest efficiency!

Model IBAR 2-6 (2 outlets, 6 ft. cord) Only \$54.95	Model IBAR 4-6 (4 outlets, 6 ft. cord) Only \$79.95
Model IBAR 8-15 (8 outlets, 15 ft. cord) Only \$97.95	

**Indus-Tool, 325 W. Huron, Dept. CE
Chicago, IL 60610 • Call 1-312-642-6871**

Enclosed is \$ _____ or bill us open account...we are Dun & Brad rated.
Send model # _____

Name _____
Company _____
Address _____
City _____ State _____ Zip _____

4164

64K DYNAMIC 200 NS

\$595

TMM2016

2KX8 STATIC 200 NS

\$415

STATIC RAMS

2101	256 x 4 (450ns)	1.95
5101	256 x 4 (450ns) (cmos)	3.95
2102-1	1024 x 1 (450ns)	.89
2102L-4	1024 x 1 (450ns) (LP)	.99
2102L-2	1024 x 1 (250ns) (LP)	1.49
2111	256 x 4 (450ns)	2.49
2112	256 x 4 (450ns)	2.99
2114	1024 x 4 (450ns)	8/9.95
2114-25	1024 x 4 (250ns)	8/10.95
2114L-4	1024 x 4 (450ns) (LP)	8/12.95
2114L-3	1024 x 4 (300ns) (LP)	8/13.45
2114L-2	1024 x 4 (200ns) (LP)	8/13.95
TC5514	1024 x 4 (650ns) (cmos)	2.49
TC5516	2048 x 8 (250ns) (cmos)	9.95
2147	4096 x 1 (55ns)	4.95
TMS4044-4	4096 x 1 (450ns)	3.49
TMS4044-3	4096 x 1 (300ns)	3.99
TMS4044-2	4096 x 1 (200ns)	4.49
MK4118	1024 x 8 (250ns)	9.95
TMM2016-200	2048 x 8 (200ns)	4.15
TMM2016-150	2048 x 8 (150ns)	4.95
TMM2016-100	2048 x 8 (100ns)	6.15
HM6116-4	2048 x 8 (200ns) (cmos)	4.75
HM6116-3	2048 x 8 (150ns) (cmos)	4.95
HM6116-2	2048 x 8 (120ns) (cmos)	8.95
HM6116LP-4	2048 x 8 (200ns) (cmos)(LP)	5.95
HM6116LP-3	2048 x 8 (150ns) (cmos)(LP)	6.95
HM6116LP-2	2048 x 8 (120ns) (cmos)(LP)	10.95
Z-6132	4096 x 8 (300ns) (Qstat)	34.95
HM6264	8192 x 8 (150ns) (cmos)	49.95

LP = Low Power Qstat = Quasi-Static

DYNAMIC RAMS

TMS4027	4096 x 1 (250ns)	1.99
UPD411	4096 x 1 (300ns)	3.00
MM5280	4096 x 1 (300ns)	3.00
MK4108	8192 x 1 (200ns)	1.95
MM5298	8192 x 1 (250ns)	1.85
4116-300	16384 x 1 (300ns)	8/11.75
4116-250	16384 x 1 (250ns)	8/7.95
4116-200	16384 x 1 (200ns)	8/12.95
4116-150	16384 x 1 (150ns)	8/14.95
4116-120	16384 x 1 (120ns)	8/29.95
2118	16384 x 1 (150ns) (5v)	4.95
MK4332	32768 x 1 (200ns)	9.95
4164-200	65536 x 1 (200ns) (5v)	5.95
4164-150	65536 x 1 (150ns) (5v)	6.95
MCM6665	65536 x 1 (200ns) (5v)	8.95
TMS4164-15	65536 x 1 (150ns) (5v)	8.95

5V = single 5 volt supply

EPROMS

1702	256 x 8 (1us)	4.50
2708	1024 x 8 (450ns)	3.95
2758	1024 x 8 (450ns) (5v)	5.95
2716	2048 x 8 (450ns) (5v)	3.95
2716-1	2048 x 8 (350ns) (5v)	5.95
TMS2516	2048 x 8 (450ns) (5v)	5.50
TMS2716	2048 x 8 (450ns)	7.95
TMS2532	4096 x 8 (450ns) (5v)	5.95
2732	4096 x 8 (450ns) (5v)	4.95
2732-250	4096 x 8 (250ns) (5v)	8.95
2732-200	4096 x 8 (200ns) (5v)	11.95
2732A-4	4096 x 8 (450ns) (5v) (21vPGM)	6.95
2732A	4096 x 8 (250ns) (5v) (21vPGM)	9.95
2732A-2	4096 x 8 (200ns) (5v) (21vPGM)	13.95
2764	8192 x 8 (450ns) (5v)	6.95
2764-250	8192 x 8 (250ns) (5v)	7.95
2764-200	8192 x 8 (200ns) (5v)	19.95
TMS2564	8192 x 8 (450ns) (5v)	14.95
MCM68764	8192 x 8 (450ns) (5v) (24 pin)	39.95
MCM68766	8192 x 8 (350ns) (5v) (24 pin)(pwr dn.)	42.95
27128	16384 x 8 (300ns) (5v)	29.95

5v = Single 5 Volt Supply 21vPGM = Program at 21 Volts

EPROM ERASERS

	Timer	Capacity Chip	Intensity (uW/Cm ²)	
PE-14		9	8,000	83.00
PE-14T	X	9	8,000	119.00
PE-24T	X	12	9,600	175.00
PL-265T	X	30	9,600	255.00
PR-125T	X	25	17,000	349.00
PR-320T	X	42	17,000	595.00

- ★ Computer managed inventory — virtually no back orders!
- ★ Very competitive prices!
- ★ Friendly staff!
- ★ Fast service — most orders shipped within 24 hours!

CRYSTALS

32.768 khz	1.95
1.0 mhz	3.95
1.8432	3.95
2.0	2.95
2.097152	2.95
2.4576	2.95
3.2768	2.95
3.579545	2.95
4.0	2.95
5.0	2.95
5.0688	2.95
5.185	2.95
5.7143	2.95
6.0	2.95
6.144	2.95
6.5536	2.95
8.0	2.95
10.0	2.95
10.738635	2.95
14.31818	2.95
15.0	2.95
16.0	2.95
17.430	2.95
18.0	2.95
18.432	2.95
20.0	2.95
22.1184	2.95
32.0	2.95

CMOS

4000	.29	4528	1.19
4001	.25	4531	.95
4002	.25	4532	1.95
4006	.89	4538	1.95
4007	.29	4539	1.95
4008	.95	4541	2.64
4009	.39	4543	1.19
4010	.45	4553	5.79
4011	.25	4555	.95
4012	.25	4556	.95
4013	.38	4581	1.95
4014	.79	4582	1.95
4015	.39	4584	.75
4016	.39	4585	.75
4017	.69	4702	12.95
4018	.79	74C00	.35
4019	.39	74C02	.35
4020	.75	74C04	.35
4021	.79	74C08	.35
4022	.79	74C10	.35
4023	.29	74C14	.59
4024	.65	74C20	.35
4025	.29	74C30	.35
4026	1.65	74C32	.39
4027	.45	74C42	1.29
4028	.69	74C48	1.99
4029	.79	74C73	.65
4030	.39	74C74	.65
4034	1.95	74C76	.80
4035	.85	74C83	1.95
4040	.75	74C85	1.95
4041	.75	74C86	.39
4042	.69	74C89	4.50
4043	.85	74C90	1.19
4044	.79	74C93	1.75
4046	.85	74C95	.99
4047	.95	74C107	.89
4049	.35	74C150	5.75
4050	.35	74C151	2.25
4051	.79	74C154	3.25
4053	.79	74C157	1.75
4060	.89	74C160	1.19
4066	.39	74C161	1.19
4068	.39	74C162	1.19
4069	.29	74C163	1.19
4070	.35	74C164	1.39
4071	.29	74C165	2.00
4072	.29	74C173	.79
4073	.29	74C174	1.19
4075	.29	74C175	1.19
4076	.79	74C192	1.49
4078	.29	74C193	1.49
4081	.29	74C195	1.39
4082	.29	74C200	5.75
4085	.95	74C221	1.75
4086	.95	74C244	2.25
4093	.49	74C373	2.45
4098	2.49	74C374	2.45
4099	1.95	74C901	.39
14409	12.95	74C902	.85
14410	12.95	74C903	.85
14411	11.95	74C905	10.95
14412	12.95	74C906	.95
14419	7.95	74C907	1.00
14433	14.95	74C908	2.00
4502	.95	74C909	2.75
4503	.65	74C910	9.95
4508	1.95	74C911	8.95
4510	.85	74C912	8.95
4511	.85	74C914	1.95
4512	.85	74C915	1.19
4514	1.25	74C918	2.75
4515	1.79	74C920	17.95
4516	1.55	74C921	15.95
4518	.89	74C922	4.49
4519	.39	74C923	4.95
4520	.79	74C925	5.95
4522	1.25	74C926	7.95
4526	1.25	74C928	7.95
4527	1.95	74C929	19.95

UARTS

AY3-1014	6.95
AY5-1013	3.95
AY3-1015	6.95
PT1472	9.95
TR1602	3.95
2350	9.95
2651	8.95
IM6402	7.95
IM6403	8.95
INS8250	10.95

GENERATORS

BIT-RATE

MC14411	11.95
BR1941	11.95
4702	12.95
COM5016	16.95
COM8116	10.95
MM5307	10.95

FUNCTION

MC4024	3.95
LM566	1.49
XR2206	3.75
8038	3.95

MISC.

UPD7201	29.95
TMS99532	29.95
ULN2003	2.49
3242	7.95
3341	4.95
MC3470	4.95
MC3480	9.00
11C90	13.95
95H90	7.95
2513-001 UP	9.95
2513-002 LOW	9.95

CLOCK CIRCUITS

MM5314	4.95
MM5369	3.95
MM5375	4.95
MM58167	12.95
MM58174	11.95
MSM5832	3.95

KEYBOARD CHIPS

AY5-2376	11.95
AY5-3600	11.95
AY5-3600 PRO	11.95

6800

68000	49.95
6800	2.95
6802	7.95
6803	19.95
6808	13.90
6809E	14.95
6809	11.95
6810	2.95
6820	4.35
6821	2.95
6828	14.95
6840	12.95
6843	34.95
6844	25.95
6845	14.95
6847	11.95
6850	3.25
6852	5.75
6860	7.95
6875	6.95
6880	2.25
6883	22.95
68047	24.95
68488	19.95
6800 = 1MHZ	
68B00	10.95
68B02	22.25
68B09E	29.95
68B09	29.95
68B10	6.95
68B21	6.95
68B40	19.95
68B45	19.95
68B50	5.95
68B00 = 2 MHZ	

6500

6502	4.95
6504	6.95
6505	8.95
6507	9.95
6520	4.35
6522	6.95
6532	9.95
6545	22.50
6551	11.85
6502A	6.95
6522A	9.95
6532A	11.95
6545A	27.95
6551A	11.95
6502B	9.95

DISC CONTROLLERS

1771	16.95
1791	24.95
1793	26.95
1795	29.95
1797	49.95
2791	54.95
2793	54.95
2795	59.95
2797	59.95
6843	34.95
8272	39.95
UPD765	39.95
MB8876	29.95
MB8877	34.95
1691	17.95
2143	18.95

8000

8035	5.95
8039	5.95
INS-8060	17.95
INS-8073	49.95
8080	3.95
8085	4.95
8085A-2	11.95
8086	24.95
8087	CALL
8088	29.95
8089	89.95
8155	6.95
8155-2	7.95
8156	6.95
8185	29.95
8185-2	39.95
8741	29.95
8748	24.95
8755	24.95

CRT CONTROLLERS

6845	14.95
68B45	19.95
HD46505SP	15.95
6847	11.95
MC1372	6.95
68047	24.95
8275	29.95
7220	99.95
CRT5027	19.95
CRT5037	24.95
TMS9918A	

2114 450 NS **8/\$995**

2114 250 NS **8/\$1095**

74LS00

74LS00	.24	74LS173	.69
74LS01	.25	74LS174	.55
74LS02	.25	74LS175	.55
74LS03	.25	74LS181	2.15
74LS04	.24	74LS189	8.95
74LS05	.25	74LS190	.89
74LS08	.28	74LS191	.89
74LS09	.29	74LS192	.79
74LS10	.25	74LS193	.79
74LS11	.35	74LS194	.69
74LS12	.35	74LS195	.69
74LS13	.45	74LS196	.79
74LS14	.59	74LS197	.79
74LS15	.35	74LS221	.89
74LS20	.25	74LS240	.95
74LS21	.29	74LS241	.99
74LS22	.25	74LS242	.99
74LS26	.29	74LS243	.99
74LS27	.29	74LS244	1.29
74LS28	.35	74LS245	1.49
74LS30	.25	74LS247	.75
74LS32	.29	74LS248	.99
74LS33	.55	74LS249	.99
74LS37	.35	74LS251	.59
74LS38	.35	74LS253	.59
74LS40	.25	74LS257	.59
74LS42	.49	74LS258	.59
74LS47	.75	74LS259	2.75
74LS48	.75	74LS260	.59
74LS49	.75	74LS266	.55
74LS51	.25	74LS273	1.49
74LS54	.29	74LS275	3.35
74LS55	.29	74LS279	.49
74LS63	1.25	74LS280	1.98
74LS73	.39	74LS283	.69
74LS74	.35	74LS290	.89
74LS75	.39	74LS293	.89
74LS76	.39	74LS295	.99
74LS78	.49	74LS298	.89
74LS83	.60	74LS299	1.75
74LS85	.69	74LS323	3.50
74LS86	.39	74LS324	1.75
74LS90	.55	74LS352	1.29
74LS91	.89	74LS353	1.29
74LS92	.55	74LS363	1.35
74LS93	.55	74LS364	1.95
74LS95	.75	74LS365	.49
74LS96	.89	74LS366	.49
74LS107	.39	74LS367	.45
74LS109	.39	74LS368	.45
74LS112	.39	74LS373	1.39
74LS113	.39	74LS374	1.39
74LS114	.39	74LS375	.95
74LS122	.45	74LS377	1.39
74LS123	.79	74LS378	1.18
74LS124	2.90	74LS379	1.35
74LS125	.49	74LS385	3.90
74LS126	.49	74LS386	.45
74LS132	.59	74LS390	1.19
74LS133	.59	74LS393	1.19
74LS136	.39	74LS395	1.19
74LS137	.99	74LS399	1.49
74LS138	.55	74LS424	2.95
74LS139	.55	74LS447	.95
74LS145	1.20	74LS490	1.95
74LS147	2.49	74LS624	3.99
74LS148	1.35	74LS640	2.20
74LS151	.55	74LS645	2.20
74LS153	.55	74LS668	1.69
74LS154	1.90	74LS669	1.89
74LS155	.69	74LS670	1.49
74LS156	.69	74LS674	14.95
74LS157	.65	74LS682	3.20
74LS158	.59	74LS683	3.20
74LS160	.69	74LS684	3.20
74LS161	.65	74LS685	3.20
74LS162	.69	74LS688	2.40
74LS163	.65	74LS689	3.20
74LS164	.69	81LS95	1.49
74LS165	.95	81LS96	1.49
74LS166	1.95	81LS97	1.49
74LS168	1.75	81LS98	1.49
74LS169	1.75	25LS2521	2.80
74LS170	1.49	25LS2569	4.25

74S00

74S00	.32	74S132	1.24	74S225	7.95
74S02	.35	74S133	.45	74S240	2.20
74S03	.35	74S134	.50	74S241	2.20
74S04	.35	74S135	.89	74S244	2.20
74S05	.35	74S138	.85	74S251	.95
74S08	.35	74S139	.85	74S253	.95
74S09	.40	74S140	.55	74S257	.95
74S10	.35	74S151	.95	74S258	.95
74S11	.35	74S153	.95	74S260	.79
74S15	.35	74S157	.95	74S273	2.45
74S20	.35	74S158	.95	74S274	19.95
74S22	.35	74S161	1.95	74S275	19.95
74S30	.35	74S162	1.95	74S280	1.95
74S32	.40	74S163	1.95	74S287	1.90
74S37	.88	74S168	3.95	74S288	1.90
74S38	.85	74S169	3.95	74S289	6.89
74S40	.35	74S174	.95	74S301	6.95
74S51	.35	74S175	.95	74S373	2.45
74S64	.40	74S181	3.95	74S374	2.45
74S65	.40	74S182	2.95	74S381	7.95
74S74	.50	74S188	1.95	74S387	1.95
74S85	1.99	74S189	6.95	74S412	2.98
74S86	.50	74S194	1.49	74S471	4.95
74S112	.50	74S195	1.49	74S472	4.95
74S113	.50	74S196	1.49	74S474	4.95
74S114	.55	74S197	1.49	74S482	15.25
74S124	2.75	74S201	6.95	74S570	2.95
				74S571	2.95

VOLTAGE REGULATORS

7805T	.75	7905T	.85
78M05C	.35	7908T	.85
7808T	.75	7912T	.85
7812T	.75	7915T	.85
7815T	.75	7924T	.85
7824T	.75		
7805K	1.39	7905K	1.49
7812K	1.39	7912K	1.49
7815K	1.39	7915K	1.49
7824K	1.39	7924K	1.49
78L05	.69	79L05	.79
78L12	.69	79L12	.79
78L15	.69	79L15	.79
78H05K	9.95	LM323K	4.95
78H12K	9.95	UA78S40	1.95

7400

7400	.19	74123	.49
7401	.19	74125	.45
7402	.19	74126	.45
7403	.19	74132	.45
7404	.19	74136	.50
7405	.25	74143	4.95
7406	.29	74145	.60
7407	.29	74147	1.75
7408	.24	74148	1.20
7409	.19	74150	1.35
7410	.19	74151	.55
7411	.25	74153	.55
7413	.35	74154	1.25
7414	.49	74155	.75
7416	.25	74157	.55
7417	.25	74159	1.65
7420	.19	74160	.85
7421	.35	74161	.69
7425	.29	74163	.69
7427	.29	74164	.85
7430	.19	74165	.85
7432	.29	74166	1.00
7437	.29	74167	2.95
7438	.29	74170	1.65
7442	.49	74173	.75
7445	.69	74174	.89
7446	.69	74175	.89
7447	.69	74177	.75
7448	.69	74181	2.25
7451	.23	74184	2.00
7473	.34	74185	2.00
7474	.33	74191	1.15
7475	.45	74192	.79
7476	.35	74193	.79
7482	.95	74194	.85
7483	.50	74195	.85
7485	.59	74197	.75
7486	.35	74198	1.35
7489	2.15	74221	1.35
7490	.35	74246	1.35
7492	.50	74247	1.25
7493	.35	74259	2.25
7495	.55	74273	1.95
7497	2.75	74276	1.25
74100	1.75	74279	.75
74107	.30	74366	.65
74109	.45	74367	.65
74116	1.55	74368	.65
74121	.29	74393	1.35
74122	.45		

INTERFACE

8T26	1.59
8T28	1.89
8T95	.89
8T96	.89
8T97	.89
8T98	.89
DM8131	2.95
DP8304	2.29
DS8833	2.25
DS8835	1.99
DS8836	.99
DS8837	1.65
DS8838	1.30

FEDERAL EXPRESS SERVICES AVAILABLE!



CENTRONICS

IDCEN36 Ribbon Cable	36 Pin Male	8.95
IDCEN36/F Ribbon Cable	36 Pin Female	8.95
CEN36 Solder Cup	36 Pin Male	7.95

SOUND CHIPS

76477	3.95
76488	5.95
76489	8.95
AY3-8910	12.95
AY3-8912	12.95
MC3340	1.49

BYPASS CAPS

.01 UF DISC	100/6.00
.01 UF MONOLITHIC	100/12.00
.1 UF DISC	100/8.00
.1 UF MONOLITHIC	100/15.00

IC SOCKETS

8 pin ST	1.99	100
14 pin ST	.13	.11
16 pin ST	.17	.13
18 pin ST	.20	.18
20 pin ST	.29	.27
22 pin ST	.30	.27
24 pin ST	.30	.27
28 pin ST	.40	.32
40 pin ST	.49	.39
64 pin ST	4.25	call
ST = SOLDERTAIL		
8 pin WW	.59	.49
14 pin WW	.69	.52
16 pin WW	.69	.58
18 pin WW	.99	.90
20 pin WW	1.09	.98
22 pin WW	1.39	1.28
24 pin WW	1.49	1.35
28 pin WW	1.69	1.49
40 pin WW	1.99	1.80
WW = WIREWRAP		
16 pin ZIF	5.95	call
24 pin ZIF	7.95	call
28 pin ZIF	8.95	call
ZIF = TEXTOCL		
(Zero Insertion Force)		

CONNECTORS

RS232 Male	2.50
RS232 Female	3.25
RS232 Hood	1.25
S-100 ST	3.95

EXAR

XR 2206	3.75
XR 2207	3.75
XR 2208	3.75
XR 2211	5.25
XR 2240	3.25

INTERSIL

ICL7106	9.95
ICL7107	12.95
ICL7660	2.95
ICL8038	3.95
ICM7207A	5.59
ICM7208	15.95

9000

9316	1.00
9334	2.50
9368	3.95
9401	9.95
9601	.75
9602	1.50
96S02	1.95

LINEAR

LM301	.34	LM340 (see 7800)		LM565	.99
LM301H	.79	LM348	.99	LM566	1.49
LM307	.45	LM350K	4.95	LM567	.89
LM308	.69	LM350T	4.60	NE570	3.95
LM308H	1.15	LM358	.69	NE571	2.95
LM309H	1.95	LM359	1.79	NE590	2.50
LM309K	1.25	LM376	3.75	NE592	2.75
LM310	1.75	LM377	1.95	LM709	.59
LM311	.64	LM378	2.50	LM710	.75
LM311H	.89	LM379	4.50	LM711	.79
LM312H	1.75	LM380	.89	LM723	.49
LM317K	3.95	LM380N-8	1.10	LM723H	.55
LM317T	1.19	LM381	1.60	LM733	.98
LM318	1.49	LM382	1.60	LM741	.35
LM318H	1.59	LM383	1.95	LM741N-14	.35
LM319H	1.90	LM384	1.95	LM741H	.40
LM319	1.25	LM386	.89	LM747	.69
LM320 (see 7900)		LM387	1.40	LM748	.59
LM322	1.65	LM388	1.35	LM1014	1.19
LM323K	4.95	LM390	1.95	LM1303	1.95
LM324	.59	LM392	.69	LM1310	1.49
LM329	.65	LM393	1.29	MC1330	1.69

QUALITY - Name brand products from nationally recognized manufacturers.
SERVICE - Computerized order processing and inventory control.
SAVINGS - Volume Discounts • OEM Quantity Pricing • Toll Free 800 Number

VISA
DIGI-KEY
DIGI-KEY

TEXAS INSTRUMENTS
I.C. SOCKETS

NEW! KIT
DISC CAPACITORS

7400 TTL
7400 TTL
7400 TTL

4000 CMOS
Linear
Linear

NEW! KIT
DISC CAPACITORS
NEW! KIT
DISC CAPACITORS

Part	Price	Part	Price
7400N	41	7400N	48
7400N	41	7400N	48
7400N	41	7400N	48
7400N	41	7400N	48
7400N	41	7400N	48

Part	Price	Part	Price
4000N	48	4000N	48
4000N	48	4000N	48
4000N	48	4000N	48
4000N	48	4000N	48
4000N	48	4000N	48

Part	Price	Part	Price
NEW! KIT	2495	NEW! KIT	5495
NEW! KIT	2495	NEW! KIT	5495
NEW! KIT	2495	NEW! KIT	5495
NEW! KIT	2495	NEW! KIT	5495
NEW! KIT	2495	NEW! KIT	5495

Part	Price	Part	Price
7400N	41	7400N	48
7400N	41	7400N	48
7400N	41	7400N	48
7400N	41	7400N	48
7400N	41	7400N	48

Part	Price	Part	Price
4000N	48	4000N	48
4000N	48	4000N	48
4000N	48	4000N	48
4000N	48	4000N	48
4000N	48	4000N	48

Part	Price	Part	Price
NEW! KIT	2495	NEW! KIT	5495
NEW! KIT	2495	NEW! KIT	5495
NEW! KIT	2495	NEW! KIT	5495
NEW! KIT	2495	NEW! KIT	5495
NEW! KIT	2495	NEW! KIT	5495

Part	Price	Part	Price
7400N	41	7400N	48
7400N	41	7400N	48
7400N	41	7400N	48
7400N	41	7400N	48
7400N	41	7400N	48

Part	Price	Part	Price
4000N	48	4000N	48
4000N	48	4000N	48
4000N	48	4000N	48
4000N	48	4000N	48
4000N	48	4000N	48

Part	Price	Part	Price
NEW! KIT	2495	NEW! KIT	5495
NEW! KIT	2495	NEW! KIT	5495
NEW! KIT	2495	NEW! KIT	5495
NEW! KIT	2495	NEW! KIT	5495
NEW! KIT	2495	NEW! KIT	5495

Part	Price	Part	Price
7400N	41	7400N	48
7400N	41	7400N	48
7400N	41	7400N	48
7400N	41	7400N	48
7400N	41	7400N	48

Part	Price	Part	Price
4000N	48	4000N	48
4000N	48	4000N	48
4000N	48	4000N	48
4000N	48	4000N	48
4000N	48	4000N	48

Part	Price	Part	Price
NEW! KIT	2495	NEW! KIT	5495
NEW! KIT	2495	NEW! KIT	5495
NEW! KIT	2495	NEW! KIT	5495
NEW! KIT	2495	NEW! KIT	5495
NEW! KIT	2495	NEW! KIT	5495

Part	Price	Part	Price
7400N	41	7400N	48
7400N	41	7400N	48
7400N	41	7400N	48
7400N	41	7400N	48
7400N	41	7400N	48

Part	Price	Part	Price
4000N	48	4000N	48
4000N	48	4000N	48
4000N	48	4000N	48
4000N	48	4000N	48
4000N	48	4000N	48

Part	Price	Part	Price
NEW! KIT	2495	NEW! KIT	5495
NEW! KIT	2495	NEW! KIT	5495
NEW! KIT	2495	NEW! KIT	5495
NEW! KIT	2495	NEW! KIT	5495
NEW! KIT	2495	NEW! KIT	5495

Part	Price	Part	Price
7400N	41	7400N	48
7400N	41	7400N	48
7400N	41	7400N	48
7400N	41	7400N	48
7400N	41	7400N	48

Part	Price	Part	Price
4000N	48	4000N	48
4000N	48	4000N	48
4000N	48	4000N	48
4000N	48	4000N	48
4000N	48	4000N	48

Part	Price	Part	Price
NEW! KIT	2495	NEW! KIT	5495
NEW! KIT	2495	NEW! KIT	5495
NEW! KIT	2495	NEW! KIT	5495
NEW! KIT	2495	NEW! KIT	5495
NEW! KIT	2495	NEW! KIT	5495

Part	Price	Part	Price
7400N	41	7400N	48
7400N	41	7400N	48
7400N	41	7400N	48
7400N	41	7400N	48
7400N	41	7400N	48

Part	Price	Part	Price
4000N	48	4000N	48
4000N	48	4000N	48
4000N	48	4000N	48
4000N	48	4000N	48
4000N	48	4000N	48

Part	Price	Part	Price
NEW! KIT	2495	NEW! KIT	5495
NEW! KIT	2495	NEW! KIT	5495
NEW! KIT	2495	NEW! KIT	5495
NEW! KIT	2495	NEW! KIT	5495
NEW! KIT	2495	NEW! KIT	5495

DIGI-KEY compares the lowest prices with competing prices. **DIGI-KEY** stocks most A.P. Products.

Volume Discount: **10% off** on orders over \$1000. **15% off** on orders over \$2000. **20% off** on orders over \$5000. **25% off** on orders over \$10000.

NATIONAL SEMICONDUCTOR • PANASONIC • QUALITY - Name brand products from nationally recognized manufacturers. SERVICE - Computerized order processing and inventory control. CHEMICALS • ARIES • PLESSEY • MOLEX • E. MACHINE • DIAMOND TOOL • UNGAR • GC CH. AS INSTRUMENTS • D • K • A • P PRODUCTS • D • K • A • P PRODUCTS • UNGAR • GC CHEMICALS • ARIES • PLESSEY • MOLEX • E.

SILICON RECTIFIERS ZENER DIODES 3 AMP SILICON RECTIFIER. Includes circuit diagram and specifications for various diode types.

Silicon Transistors. Table listing various transistor models (e.g., 2N3638, 2N3639) with their specifications and prices.

alpha wire. Hookup Wire, Stranded PVC Insulated. Table listing wire types and prices.

National Semiconductor MA1026 Time-Temp. Clock Module. Includes circuit diagram and specifications for the clock module.

IP Jumper Cable Assembly Standard Assembly Styles. Diagrams showing different cable assembly configurations and their dimensions.

IP Jumper Cable Assembly Standard Assembly Styles. Table listing cable assembly specifications and prices.

Littelfuse 3AG "NORMAL-BLO" FUSES. Table listing fuse models and prices.

1% Metal Film Resistors. Table listing resistor models and prices.

1% Carbon Film Resistors. Table listing resistor models and prices.

DIGI-CLOCK Kit. Includes circuit diagram and specifications for the digital clock kit.

3AG SLO-BLO™ FUSES. Table listing fuse models and prices.

3AG Panel Fuseholder. Table listing fuseholder models and prices.

Handling Charges. Value Discount. Shipping and handling charges information.

Circle No. 14 on Free Information Card. American Radiohistory.com

7400

*Number of Pins of each IC for easy Socket purchase

Part No.	**Pins	Price	Part No.	**Pins	Price	Part No.	**Pins	Price
SN7400N	14	25	SN7472N	14	29	SN74156N	16	59
SN7401N	14	25	SN7473N	14	35	SN74161N	16	59
SN7402N	14	25	SN7474N	14	35	SN74162N	16	59
SN7403N	14	25	SN7475N	14	35	SN74163N	16	59
SN7404N	14	25	SN7476N	16	59	SN74164N	16	59
SN7405N	14	25	SN7477N	16	59	SN74165N	16	59
SN7406N	14	25	SN7478N	14	35	SN74166N	16	59
SN7407N	14	25	SN7479N	16	59	SN74167N	16	59
SN7408N	14	25	SN7480N	14	35	SN74168N	16	59
SN7409N	14	25	SN7481N	14	35	SN74169N	16	59
SN7410N	14	25	SN7482N	14	35	SN74170N	16	59
SN7411N	14	25	SN7483N	14	35	SN74171N	16	59
SN7412N	14	25	SN7484N	14	35	SN74172N	16	59
SN7413N	14	25	SN7485N	14	35	SN74173N	16	59
SN7414N	14	25	SN7486N	14	35	SN74174N	16	59
SN7415N	14	25	SN7487N	14	35	SN74175N	16	59
SN7416N	14	25	SN7488N	14	35	SN74176N	16	59
SN7417N	14	25	SN7489N	14	35	SN74177N	16	59
SN7418N	14	25	SN7490N	14	35	SN74178N	16	59
SN7419N	14	25	SN7491N	14	35	SN74179N	16	59
SN7420N	14	25	SN7492N	14	35	SN74180N	16	59
SN7421N	14	25	SN7493N	14	35	SN74181N	16	59
SN7422N	14	25	SN7494N	14	35	SN74182N	16	59
SN7423N	14	25	SN7495N	14	35	SN74183N	16	59
SN7424N	14	25	SN7496N	14	35	SN74184N	16	59
SN7425N	14	25	SN7497N	14	35	SN74185N	16	59
SN7426N	14	25	SN7498N	14	35	SN74186N	16	59
SN7427N	14	25	SN7499N	14	35	SN74187N	16	59
SN7428N	14	25	SN7500N	14	35	SN74188N	16	59
SN7429N	14	25			SN74189N	16	59	
SN7430N	14	25			SN74190N	16	59	
SN7431N	14	25			SN74191N	16	59	
SN7432N	14	25			SN74192N	16	59	
SN7433N	14	25			SN74193N	16	59	
SN7434N	14	25			SN74194N	16	59	
SN7435N	14	25			SN74195N	16	59	
SN7436N	14	25			SN74196N	16	59	
SN7437N	14	25			SN74197N	16	59	
SN7438N	14	25			SN74198N	16	59	
SN7439N	14	25			SN74199N	16	59	
SN7440N	14	25			SN74200N	16	59	
SN7441N	14	25			SN74201N	16	59	
SN7442N	14	25			SN74202N	16	59	
SN7443N	14	25			SN74203N	16	59	
SN7444N	14	25			SN74204N	16	59	
SN7445N	14	25			SN74205N	16	59	
SN7446N	14	25			SN74206N	16	59	
SN7447N	14	25			SN74207N	16	59	
SN7448N	14	25			SN74208N	16	59	
SN7449N	14	25			SN74209N	16	59	
SN7450N	14	25			SN74210N	16	59	
SN7451N	14	25			SN74211N	16	59	
SN7452N	14	25			SN74212N	16	59	
SN7453N	14	25			SN74213N	16	59	
SN7454N	14	25			SN74214N	16	59	
SN7455N	14	25			SN74215N	16	59	
SN7456N	14	25			SN74216N	16	59	
SN7457N	14	25			SN74217N	16	59	
SN7458N	14	25			SN74218N	16	59	
SN7459N	14	25			SN74219N	16	59	
SN7460N	14	25			SN74220N	16	59	
SN7470N	14	25			SN74221N	16	59	

74LS

Part No.	**Pins	Price	Part No.	**Pins	Price	Part No.	**Pins	Price
74LS00	14	25	74LS192	16	79	74LS390	14	49
74LS01	14	25	74LS193	16	79	74LS391	14	49
74LS02	14	25	74LS194	16	79	74LS392	14	49
74LS03	14	25	74LS195	16	79	74LS393	14	49
74LS04	14	25	74LS196	16	79			
74LS05	14	25	74LS197	16	79			
74LS06	14	25	74LS198	16	79			
74LS07	14	25	74LS199	16	79			
74LS08	14	25	74LS200	16	79			
74LS09	14	25	74LS201	16	79			
74LS10	14	25	74LS202	16	79			
74LS11	14	25	74LS203	16	79			
74LS12	14	25	74LS204	16	79			
74LS13	14	25	74LS205	16	79			
74LS14	14	25	74LS206	16	79			
74LS15	14	25	74LS207	16	79			
74LS16	14	25	74LS208	16	79			
74LS17	14	25	74LS209	16	79			
74LS18	14	25	74LS210	16	79			
74LS19	14	25	74LS211	16	79			
74LS20	14	25	74LS212	16	79			
74LS21	14	25	74LS213	16	79			
74LS22	14	25	74LS214	16	79			
74LS23	14	25	74LS215	16	79			
74LS24	14	25	74LS216	16	79			
74LS25	14	25	74LS217	16	79			
74LS26	14	25	74LS218	16	79			
74LS27	14	25	74LS219	16	79			
74LS28	14	25	74LS220	16	79			
74LS29	14	25	74LS221	16	79			
74LS30	14	25	74LS222	16	79			
74LS31	14	25	74LS223	16	79			
74LS32	14	25	74LS224	16	79			
74LS33	14	25	74LS225	16	79			
74LS34	14	25	74LS226	16	79			
74LS35	14	25	74LS227	16	79			
74LS36	14	25	74LS228	16	79			
74LS37	14	25	74LS229	16	79			
74LS38	14	25	74LS230	16	79			
74LS39	14	25	74LS231	16	79			
74LS40	14	25	74LS232	16	79			
74LS41	14	25	74LS233	16	79			
74LS42	14	25	74LS234	16	79			
74LS43	14	25	74LS235	16	79			
74LS44	14	25	74LS236	16	79			
74LS45	14	25	74LS237	16	79			
74LS46	14	25	74LS238	16	79			
74LS47	14	25	74LS239	16	79			
74LS48	14	25	74LS240	16	79			
74LS49	14	25	74LS241	16	79			
74LS50	14	25	74LS242	16	79			
74LS51	14	25	74LS243	16	79			
74LS52	14	25	74LS244	16	79			
74LS53	14	25	74LS245	16	79			
74LS54	14	25	74LS246	16	79			
74LS55	14	25	74LS247	16	79			
74LS56	14	25	74LS248	16	79			
74LS57	14	25	74LS249	16	79			
74LS58	14	25	74LS250	16	79			
74LS59	14	25	74LS251	16	79			
74LS60	14	25	74LS252	16	79			
74LS61	14	25	74LS253	16	79			
74LS62	14	25	74LS254	16	79			
74LS63	14	25	74LS255	16	79			
74LS64	14	25	74LS256	16	79			
74LS65	14	25	74LS257	16	79			
74LS66	14	25	74LS258	16	79			
74LS67	14	25	74LS259	16	79			
74LS68	14	25	74LS260	16	79			
74LS69	14	25	74LS261	16	79			
74LS70	14	25	74LS262	16	79			
74LS71	14	25	74LS263	16	79			
74LS72	14	25	74LS264	16	79			
74LS73	14	25	74LS265	16	79			
74LS74	14	25	74LS266	16	79			
74LS75	14	25	74LS267	16	79			
74LS76	14	25	74LS268	16	79			
74LS77	14	25	74LS269	16	79			
74LS78	14	25	74LS270	16	79			
74LS79	14	25	74LS271	16	79			
74LS80	14	25	74LS272	16	79			
74LS81	14	25	74LS273	16	79			
74LS82	14	25	74LS274	16	79			
74LS83	14	25	74LS275	16	79			
74LS84	14	25	74LS276	16	79			
74LS85	14	25	74LS277	16	79			
74LS86	14	25	74LS278	16	79			
74LS87	14	25	74LS279	16	79			
74LS88	14	25	74LS280	16	79			
74LS89	14	25	74LS281	16	79			
74LS90	14	25	74LS282	16	79			
74LS91	14	25	74LS283	16	79			
74LS92	14	25	74LS284	16	79			
74LS93	14	25	74LS285	16	79			
74LS94	14	25	74LS286	16	79			
74LS95	14	25	74LS287	16	79			
74LS96	14	25	74LS288	16	79			
74LS97	14	25	74LS289	16	79			
74LS98	14	25	74LS290	16	79			
74LS99	14	25	74LS291	16	79			
74LS100	14	25	74LS292	16	79			

74S/PROMS*

Part No.	**Pins	Price	Part No.	**Pins	Price	Part No.	**Pins	Price
74S02	14	35	74S243	14	29	74S244	14	29
74S03	14	35	74S245	14	29	74S246	14	29
74S04	14	35	74S247	14	29	74S248	14	29
74S05	14	35	74S249	14	29	74S250	14	29
74S06	14	35	74S251	14	29	74S252	14	29
74S07	14	35	74S253	14	29	74S254	14	29
74S08	14	35	74S255	14	29	74S256	14	29
74S09	14	35	74S257	14	29	74S258	14	29
74S10	14							

Computers & Electronics Marketplace

CLASSIFIED RATES: Per Word, 15 Word Minimum. **COMMERCIAL:** \$5.00. **PERSONAL:** \$3.00. **EXPAND-AD®:** \$7.50. Ads set in all bold type @ 20% premium. Ads set with background screen @ 25% premium. **DISPLAY:** 1" x 2 1/4", \$605.00. 2" x 2 1/4", \$1,165.00. 3" x 2 1/4", \$1,675.00. **GENERAL INFORMATION:** Frequency rates and prepayment discounts available. Payment must accompany order except credit card—Am. Ex., Diners, MC, VISA (include exp. date)—or accredited ad agency insertions. Copy subject to publisher's approval; must be typewritten or printed. First word set in caps. Advertisers using P.O. Boxes MUST supply permanent address and telephone number. Orders not acknowledged. They will appear in next available issue after receipt. Closing date: 1st of the 2nd month preceding cover date (e.g., Mar. issue closes Jan. 1). Send order & remittance to: Classified Advertising, **COMPUTERS & ELECTRONICS** Magazine, 1 Park Avenue, New York, NY 10016. To Charge your ad to a major credit card, call Lois Price at (212) 725-4312.

FOR SALE

GOVERNMENT and industrial surplus receivers, transmitters, snooper scopes, electronic parts, Picture Catalog 25 cents. Meshna, Nahant, Mass. 01908.

ELECTRONIC PARTS, semiconductors, kits. FREE FLYER. Large catalog \$1.00 deposit. **BIGELOW ELECTRONICS**, Bluffton, Ohio 45817.

RECONDITIONED TEST EQUIPMENT \$1.00 for catalog. **WALTER'S TEST EQUIPMENT**, 2697 Nickel, San Pablo, CA 94806, (415) 724-0587.

ELECTRONIC CATALOG. Over 4,500 items. Parts, & components. Everything needed by the hobbyist or technician. \$2.00 postage & handling (United States Only), refundable with first \$15.00 order. **T & M Electronics**, 472 East Main St., Patchogue, NY 11772. (516) 289-2520.

PRINTED CIRCUIT BOARDS, your artwork. Quick delivery. Reasonable. **Atlas Circuits**, Box 892, Lincolnton, NC 28092. (704) 735-3943.

SATELLITE TELEVISION... HOWARD/COLEMAN boards to build your own receiver. For more information write... **ROBERT COLEMAN**, Rt. 3, Box 58-APE, Travelers Rest, S.C. 29690.

CABLE TV CONVERTERS & EQUIPMENT. Plans and parts. Build or buy. For more information send \$2.00: **C & D ELECTRONICS INC.**, P.O. Box 21, Jenison, MI 49428.

FREE FLYER! IC's, resistors, capacitors, jacks, etc., plus SSM music synthesizer/audio IC's, power amp modules, analog delay IC's, computer books, and more. Also plans for analog delay/chorus unit! **PGS Electronics**, Route 25, Box 304 Terre Haute, IN 47802.

CABLE TV

Buy Direct & Save

SUPER SPECIALS



40 CHANNEL CONVERTER
\$29⁹⁵



36 CHANNEL REMOTE CONTROL CABLE CONVERTER
\$69⁹⁵

Advanced Solid State design and circuitry allows you to receive mid & super band channels. Restores programming to Video Recorders.



JERROLD 400 THE ULTIMATE CABLE TV CONVERTER



60 CHANNEL INFRARED REMOTE CONTROL
\$129⁹⁵

Send \$5 for Complete Catalog

DIRECT VIDEO SALES
P.O. BOX 1229
JEFFERSONVILLE, INDIANA 47130
CALL
1-812-282-4786

POLICE CODE UNSCRAMBLERS, lets you hear the coded messages of Police, Fire and Medical channels; plus other scanner accessories, satisfaction guaranteed. **DNE Inc.**, Rt. 7, Box 257-A, Hot Springs, AR 71901. (501) 623-6027.

IF YOU ARE READY TO BUY OR SELL COMPUTER EQUIPMENT, YOU NEED...

COMPUTER SHOPPER

Over 100 pages each month. Deal with individuals nationwide. Low ad rate, only 12¢ a word. Subscription: \$15/year. MC & VISA. Money back guarantee. 407 S. Washington, P.O. Box F596, Titusville, FL 32781. (305) 269-3211.

CABLE TV

CONVERTERS & EQUIPMENT

We have the largest selection of **JERROLD** and **OAK** cable converters and equipment. Such as: Jerrold SB-3, Oak N12 and Jerrold 61 channel remote control converter with FULL features DRX3-DIC-105. Plus others.

CABLE TV KITS

Cable TV Kit (Jerrold gated pulse) 39.95.

We also have a large selection of cable TV and kits including all parts, silk screen, PC board and complete instructions.

Send for informative catalogue \$2.00

J & W ELECTRONICS, INC.
P.O. BOX 61-K
CUMBERLAND, RI. 02864

WHOLESALE: MATV/CATV/VCR equipment, Antennas, Audio, Cables, Adapters, Original and Replacement Cartridges, Stylis, Telephone Accessories, Radios, Cassette Recorders, Speakers, etc. Send letterhead for catalog, 212-897-0509, D&WP 68-12 110th St., Forest Hills, NY 11375.

FREE Catalog of special function IC's and quality components. **Goldsmith Scientific**, Box 318M, Commack, New York 11725.

World's Most Remarkable Radar Jammer!



Causes speed radar guns and devices to read out your choice of either a percentage of your true speed when in automatic mode (example: Your speed; 76 mph, auto mode set for 75%, speed displayed — 57 mph), or the speed that you dial in when in manual mode. Transmits only in the presence of speed radar, or by manual override. Operates on both **K** and **K** bands. **WARNING:** The device described in this literature is not legal for use against police radar, and is not FCC approved.

For complete literature and plan package, send \$14.95 to:

Phillips Instrument Design Co. Inc.
8135 S.W. Nimbus, Building #11, Suite #114 C
Beaverton, Oregon 97005

MICROWAVE ANTENNA SYSTEMS

Freq. 2.1 to 2.6 GHz • 34 db Gain+

COMPLETE SYSTEMS (as pictured)	
Commercial 40" Rod Style	\$89.95
Parabolic 20" Dish Style	\$79.95

TWO YEAR WARRANTY PARTS AND LABOR

CALL OR WRITE FOR KITS + PARTS • INDIVIDUAL COMPONENTS

We Repair All Types Down Converters & Power Supplies

Phillips-Tech Electronics
P.O. Box 34772
Phoenix, AZ 85067
(602) 265-8255

Special Quantity Pricing • Dealers Wanted

SEND FOR FREE DISCOUNT CATALOG: electronic components, parts. **HORIZON SALES**, P.O. Box 646, Framingham, MA 01701. (617) 875-4433.

NEW! MULTI-CHANNEL MICROWAVE

Complete Antenna Systems from \$69⁹⁵

Full 800 Mhz Range
Tune 1.9-2.7 Ghz
Includes all ITFS Channels



GOLD STAR



SILVER STAR



TELE STAR

DEALERS WANTED

COD's and Credit Card Orders call TOLL FREE
1-800-247-1151



GALAXY ELECTRONICS
6009 N. 61 Avenue
Glendale, AZ 85301
1-602-247-1151

PRINTED CIRCUIT ARTWORK, DESIGN/LAYOUT. Quality, professional, prompt. **SOMMER CIRCUIT DESIGN**, P.O. B. 635, Wooster, OH 44691. (216) 263-6930.

DIGITAL TRAINERS AND POWERED BREADBOARDS... The most complete selection available... at the lowest prices. For free catalog write, **C-Systems**, Box 2482, Evergreen, CO 80439.

PRINTED CIRCUIT BOARDS... Projects this issue. Also custom boards, your artwork or ours. Quality. Competitive prices, **Century Instruments**, 400 Macey Court, #4, Yukon, Oklahoma 73099. (405) 354-0347.

LOWEST POSSIBLE PRICES ANYWHERE! Computers Hardware—Software—Printers, Audio, Video, Car Stereo. **ELECTRIFIED DISCOUNTERS**, 996 Orange Ave., West Haven, CT 06516. MC/VISA. (203) 937-0106.

CABLE TV EQUIPMENT. Channel 3 or 4 notch filter \$20.00. Information \$1.00. **Goldcost**, P.O. Box 63/6025A, Margate, FL 33063. (305) 752-9202.

FREE! 1984 CATALOGUE. 1001 bargains. Speakers-parts-tubes-video cassettes—record changers—tape recorders—kits. **EVERYTHING IN ELECTRONICS**. Write: **McGEE RADIO & ELECTRONICS**, 1901 McGee Street, Kansas City, MO 64108-1891.

U-FIX-M Oak CA TV converters—M-26 Buy one get one free 19.95. **Cable Sales** 3868 Trade Ctr. Dr. Ann Arbor Mich. 48104. C.O.D. or Certified Funds Other Converters Available.

30 CHANNEL WIRED remote CA TV converter kits. Complete with everything 39.95. **Cable Sales** 3868 Trade Ctr. Dr. Ann Arbor MI 48104. C.O.D. or Certified Funds Other Cvtvs. Available (313) 971-7501.

LCD PEN WATCH, excellent for everyone. Special, 2 for \$7.00. Calculator alarm wristwatch \$14.00. Wireless telephones. Water purification system—plans \$5.00. Guaranteed, fantastic, unusual gift items available. Send \$1.00 for catalog. Next day shipment. **Visa/Master card.** Starburst Industries, 6354 Van Nuys Blvd., Suite 161, Van Nuys, CA 91401. (213) 994-5671.

TV & RADIO TUBES, 59¢ each. Send for free catalog. **Cornell**, 4213 University, San Diego CA 92105.

PRINTED CIRCUIT BOARDS. QUICK PROTOTYPES production, design, reflow solder. Send print or description for quote to: **KIT CIRCUITS**, Box 235, Clawson, MI 48017.

PCB 15¢ sq-in. FREE DRILLING. Quantity Discounts. **International Enterprise**, 6452 Hazel Circle, Simi-Valley, CA 93063.



A SINGER'S DREAM!

REMOVES VOCALS FROM RECORDS!

Our **VOCAL ELIMINATOR** can remove most or virtually all of a lead vocal from a standard stereo record and leave most of the background untouched! Record with your voice or perform live with the backgrounds. Used in Professional Performance yet connects easily to a home component stereo system. Not an equalizer! We can prove it works over the phone. Write or call for a free brochure and demo record.

Write to: **LT Sound, Dept. CE, P.O. Box 338 Stone Mountain, GA 30086**
In Georgia Call (404)493-1258
TOLL FREE: 1-800-241-3005 — Ext. 37

Earn Big Money - REPAIR GAMES/COMPUTERS

- Atari 2600, 2600a
- Atari 400, 800 computers
- Intellivision
- ColecoVision

Each of these Comprehensive EIB courses contains signature charts, schematics, technical data and complete video tape instructions! Virtually anyone familiar with basic electronics and the use of a digital meter can troubleshoot and repair the most complex digital equipment and with the use of the Signature Analysis Method most repairs can be completed in 15 minutes or less! Imagine all Atari, Intellivision and ColecoVision parts available from one supplier. Send \$1.00 for parts lists and additional information, refundable with order.

ELECTRONICS WAREHOUSE CORP.
1910 Coney Island Ave., Dept. CE-10, Brooklyn, N.Y. 11230
(212) 375-2700

CABLE TV CONVERTER PLANS \$2.98. Write to Stevens, Dept. CE, PO Box 20286, Bowling Green, KY 42102-6286.

FREE details! Build electronic combination lock, alarm, logic probe, more! Each under \$20.00. Project dept., Stark Electronics, Box 11963, Edmonton, Alta., T5J 3L1

Telephone Listening Device

Record telephone conversations in your office or home. Connects between any cassette or tape recorder and your telephone or telephone LINE. Starts automatically when phone is answered. Records both sides of phone conversation. Stops recorder when phone is hung up. This device is not an answering service.



size 10"
Each
\$19.95
Dry Disc Avail

Super Powerful

Wireless Mic

10 times more powerful than other mics. Transmits up to 1/4 mile to any FM radio. Easy to assemble kit. 15V battery (not incl.)

Call (305) 725-1000 or send \$19.95 + \$1.00 shipping per item to USI Corp., P.O. Box CE-2052, Melbourne, FL 32901. COD's accept. For catalog of transmitters, voice scramblers and other specialty items, enclose \$2.00 to USI Corp.



size 2" x 3" x 1/2"

QUALITY MICROWAVE ANTENNAS

Frequency 1.9 to 2.6 GHz

Complete System (Pictured) Aluminum Parabolic Dish, Pre-Assembled Probe with Down Converter, Power Supply and Tuner Switch, 63' of RG59/U Coax with Connectors, 75 to 300 Ohm Transformer. All Mounting Hardware for Fast and Easy Installation. Add \$9.50 Shipping & Handling Each.

- 24" 48db gain • Special \$74.95
- 33" 75db gain • Special \$249.00

SUNSET GIFTS

P.O. Box 521076, SLC, UT 84152

(801) 483-1504

(801) 487-6269

Order Six and Deduct 10%

Special \$74.95

VISA/MasterCard/COD



LEARN THE SECRETS OF YOUR COMPUTER—facts never before published for the public. "COMPUTEL," the complete SOURCE for every hobbyist and enthusiast everywhere. You can now do the things you've only heard about, right in the privacy of your own home. Indispensable reference to preteens and hackers. Learn how to receive thousands of free programs, computer secrets, numbers, access codes. Published monthly. One year subscription \$12.00. Sample copy \$2.00. STARBURST INDUSTRIES OF AMERICA, P.O. Box 7719, Van Nuys, CA 91409.

SATELLITE TELEVISION COMPLETE SYSTEMS. Free catalog. Call: (612) 780-4088. Write: Sunspur Sales, P.O. Box 32245 A-7, Fridley, MN 55432.



MAGIC COMPUTER "INPUT/OUTPUT" MUGS

When hot liquid is poured in, one message disappears and another takes its place on the computer screen. Fascinating to watch. Big 10 oz. size. Fine quality white English porcelain. **MUG "B"** — "Computer Expert on/off duty."

*\$95 ea. Plus \$2 ea. for ship. & handling.

Fla. residents add 5% sales tax.

Visa or MasterCard accepted. Include card #, Expiration date and signature with order.

Send for our free **COMPUTERMANIA** Catalog of other unique items for the computer buff.

Call Toll-Free Mon.-Fri. 9am-6pm
1-800-B-E-S-W-E-E-T • In Fla. (305) 687-9338

sweet gum inc.

15490 NW 7th Ave., Dept. CE014, N. Miami, FL 33169

COMPUTER EQUIPMENT/PARTS

SAVE 90% Build Your Own Minicomputer. Free Details. Digatek, 2723 West Butler Dr., Suite 20C, Phoenix, AZ 85021.

APPLE BUILDERS—Send stamp for our flyer of Apple parts. IC sets, ROM sets, component packages. Shugart—Apple modification kits, Apple 9-track tape drives etc. Electrovalue, P.O. Box 376-P, Morris Plains, NJ 07950.

FREE DISCOUNT CATALOG OF SYSTEMS, PERIPHERALS AND SOFTWARE. Most major brands. Descriptions complete with options and accessories. Please indicate your specific interest and application. **MICRO TREND INC.**, 2001 Kirby Drive, Suite #906, Houston, TX 77019 (713) 520-0107.

FREE! Computer supplies catalog—Low prices—Satisfaction guaranteed—**DATA SYSTEMS**, Box 99, Fern Park, Florida 32730. (305) 788-2145.

48K computer U.S. \$380.00 or hundreds Apple compatible software details U.S. \$1.00. Reliant P.O. Box 33610, Sheungwan Hong Kong.

USED COMPUTER terminals, printers, modems, cables, surplus electronic parts. Specials: CRT's \$20.00, Modems \$20.00, Modems \$35.00. Catalog \$1.00. Rondure Company, "The Computer Room" CE, 2522 Butler Street, Dallas, TX 75235. (214) 630-4621.

FREE 56-PAGE COMPUTER CATALOG crammed full of thousands of the best buys and lowest prices around! **A.P. Computer Products**, 8 Division St., Holtville, NY 11742, (516) 698-8636.

COVERS—Fabric, attractive quality custom fitted. All computing, stereo, ham, & video equipment. **DecOtec**, Box 24449, Dayton, OH 45424 (513) 236-9923.

COMPUTER DUST COVERS, ANTI-STATIC MATS, Acoustical cabinets. Com-Cov, 826 W. Laurel, Springfield, IL 62704. (217) 544-8824.

COMPUTER SOFTWARE

DISCOUNT SOFTWARE—Available for Apple, TRS-80, IBM/PC and TI 99/4 personal computers. Professional applications for the doctor, dentist, attorney, school administrator, teacher, contractor and general office personnel. Catalog \$1.00. Write for **MONTHLY SPECIAL OFFERS!** Creative Discount Software, 256 S. Robertson Blvd., Suite 2156, Beverly Hills, CA 90211.

COMPUTER PAPER—SAVE\$\$\$; Top quality. Low single carton prices. Free shipping via UPS. Call A-1, 405 Third, Long Beach, Ca., (800) 628-8736 or (213) 804-1270.

FREE VIC-20 and COMMODORE 64 USERS GROUP MEMBERSHIP with software purchase. Why pay to belong to a users group when you don't have to? Benefits: Newsletter, extensive club library, discounts, contests, questions hot-line and more! Free details—(803) 797-1533. Lords of Basic, P.O. Box 459, Dept. 102 Ladson, SC 29456.

DISKETTE FORMAT CONVERSIONS/DOWNLOADING, from \$500. Port-A-Soft, 423 #800 N, Orem, UT 84057. 801/226-6704.

VIC 20 40 COLUMN DISPLAY. On tape. 8.95: NDPE, 102 Hickory Ct., Portland, IN 47371.

MONEY BACK GUARANTEE. Easy to install circuit adds Intercom/Hold capability to phones for under \$10. Plans \$5.00. Information SASE dB Enterprises, Box 8, Oradell, NJ 07649.

HORSE RACE SOFTWARE-TRS-80, C64 VIC20, CALL OR WRITE for free catalogue, Computer Research Tools, 725 South Evanwood Ave., West Covina, Calif. 91790 (213) 962-1688.

VIC 20/s64—WHOLESALE PRICES ON ALL PRODUCTS! Send SASE: Omni Micronics, 404 Auburn Road, Waynesville, NC 28786.

FREE CATALOG OF DISCOUNT SOFTWARE. Specify computer. The Floppy Disk, Box 5392C, North Hollywood CA 91616.

TAX-HELP PROGRAM FOR ATARI, 1040, 1040A, 1040EZ. \$7.95 cassette. Krause & Son, P.O. Box 624, Severna Park, MD 21146.

FREE Atari/Commodore-64/TI99-4A/Timex/VIC-20 programs! Send Stamps. Dealers welcome. Lists, EZRA-EZRA, Box 5222-CF, San Diego, CA 92105.

TI-99/4A owners. Send for free catalog of new and exciting, low cost software. D.E., Box 690, Hicksville, NY 11801.

TIMEX/SINCLAIR 16K, TI, VIC Owners. 5 fun programs for \$1.00! Get Baseball, Etching-sketch, Blackjack, Dungeon, Galactic patrol. Specify your computer. Friendly Computer, 634 Littlecroft, Upper-Darby, PA 19082.

COMMODORE 64/VIC 20 Games/educational software. Over 400 titles! Write for FREE catalog! American Peripherals, 122 Bangor St., Lindenhurst, NY 11757.

TS/1000, ZX/81, TI99/4A, VIC-20 Software. Send for FREE catalog: Midwest Software, 9922 Harwich, Crestwood, MO 63126.

COMMODORE 64/VIC-20 SOFTWARE. 40 column display for VIC-20, Spread Sheet, Basic Compiler, and Adventure Generator. \$15.00 each. Free complete list. Software Solutions, PO Box 542, Sylvania, OH 43560.

SUPERIOR VIC-20 SOFTWARE! Educational programs and Adventure games. FREE program summaries with price list. Creative Workshop, P.O. Box 2725, Dept. 22 Spring Valley, CA 92077

COMPUTER PUBLICATIONS

"HOW to Debug BASIC Programs." \$6 PP. MBG. TIS. Box 921, Dept. CE 12, Los Alamos, NM 87544.

TIMEX SINCLAIR owners—get monthly news, tips, programs, projects to expand 1000/1500/ZX81, \$29 per year. Back issues available. SYNTAX, RD2 Box 457, Harvard, MA 01451.

BOOKS & MAGAZINES

PUBLISHERS' OVERSTOCKS. BARGAIN BOOKS 2,000 titles, all subjects! Free catalog: Hamilton's, 98-85 Clapboard, Danbury, CT 06810.

FREE CATALOG!

Just let us know and we'll mail you a FREE *Creative Computing* Catalog—16 pages filled with books, buyer's guides, magazines, and more!

To get your FREE catalog, write to: *Creative Computing* Catalog, Dept NA1X 39 East Hanover Ave., Morris Plains, NJ 07950.

TIMEX/SINCLAIR

KROK., STAR SEARCH, NOAH'S ARK, finest programs available. Machine Language action, graphics. SASE Brown Cottage, 5486 Bright Hawk, Columbia, MD 21045.

5 TS/1000 PROGRAMS FOR \$5. Send SASE for details: Programs 3763 W. Crocus, Phoenix, AZ 85023.

"MUST-HAVE!" UTILITY SOFTWARE. Cassettes-relocatable machine language. SASE for BROCHURE—SIR-UIABLE WARE, 6 Turning Mill Rd., Lexington, MA. 02173.

TIMEX/SINCLAIR VIC-20 Bible pack design build any peripheral imaginable includes cassettes \$39.95. Info. \$6.00 refundable. Jorge Sampson, Box 38663, Houston, TX 77288.

ARTIFICIAL INTELLIGENCE PROGRAM. Converse with ZX-81/TS 1000. 16K. Cassette, \$10. Dynabyte, Box 2021 Michigan City, IN 46360.

TS/1000—Great values on home/finance software. Free information: Ace Software, 2 E. Oak Ave., Moorestown, NJ 08057.

BIO-RHYTHMS PLOTTED. Know your critical days and your good days—30 day plots-cass. Tape \$6.75, listing \$2.50, both 16K and 2K included, LAKAR, 36 Western Ave., Morristown, NJ 07960.

MR. BARTENDER—lists over 200 drinks alphabetically and by liquor, cass tape—\$6.75, listing \$2.50, 16K, LAKAR, 36 Western Ave., Morristown, NJ 07960.

TREE FORTH for the 2K+ Sinclair User—\$49.95. Multi-tasking forth for ZX81 and TS1000. Free information. Contact: Softmagic Corp., 1213 West High Street, Bryan, Ohio, 43306. (419) 636-4531.

C.B. EQUIPMENT

CB MODIFICATIONS, conversions, books, plans, kits, repairs. Catalog \$2. CBCI, Box 31500PE, Phoenix, AZ 85046. (602) 996-8700.

CABLE T.V.

CHANNEL 3—60db notch filter, 66 5MHz \$32. Crosley, Dept. 607, Box 840, Champlain, NY 12919.

PLANS AND KITS

FREE KIT CATALOG contains test equipment. Phone (209) 772-2076. DAGE SCIENTIFIC, Box 144, Valley Springs, CA 95252.

ROBOTICS—BOOKS—build your own robot. Write now for FREE catalog! Kohn Co./CE11, Box 16265, Alexandria, VA 22302.

MICROPROCESSOR CONTROLLED. Six voice polyphonic synthesizer plans. \$15.00. Syntron 1075 1/2 Mill Rd., Helena, Mt 59601.

PROJECTION TV... CONVERT your TV to project 7 foot picture... Results comparable to \$2,500 projectors... Total Cost less than \$30.00... PLANS AND 8" LENS \$19.95... Illustrated information FREE. Macrocoma-CF, Washington Crossing, Pennsylvania 18977. Creditcard orders 24 Hours. (215) 736-3979.

MAILING LISTS

COMPUTER SHOW ATTENDEES N.Y., N.J.: 15,000 NAMES. \$30/M. P/S labels. For info, (201) 297-2526.

ALARMS

BURGLAR-FIRE ALARMS for home, business, auto. Install yourself and save. Installation manual/catalog shows how. Shows latest equipment, accessories. Lowest prices. Send \$1.00 (refundable). BURDEX SECURITY, Box 82802-CEL, Lincoln, NE 68501.

ALARMS: BURGLAR AND FIRE, high-tech security products to protect your family and business. Name brands at discount prices. Free brochure. 45 page catalog \$1.00 (refundable). Advanced Security, Box 156, Dept. 78, Dekalb, IL 60115.

WANTED

GOLD, electronic, circuit board scrap, silver, platinum, tantalum, mercury. Ores, metals assayed. Samples evaluated. Wholesale Terminal, toll free 1-800-932-1010, (617) 326-3442 in Mass.

TUBES

TUBES: "Oldies". Latest. Supplies, components, schematics. Catalog Free (stamp appreciated). Steinmetz, 7519-PE Maplewood, Hammond, Ind. 46324.

HUGE INVENTORY! Thousands of types. Wholesale prices. FREE CATALOG! ETCO Electronics, DEPT. 290, Plattsburgh, NY 12901.

PERSONALS

UNIVERSITY DEGREES BY MAIL! Bachelors, Masters, Ph.Ds. Free revealing details. Counseling, Box 317-EP2, Tustin, California 92680.

SCANDINAVIAN SINGLES, ALL AGES, seek correspondence, sincere friendships. Details: (send stamp). Scanclub CE, Box 4, Pittsford, NY 14534.

INSTRUCTION

UNIVERSITY DEGREES BY SPECIAL EVALUATION of existing credits and Job Experience. Fast, inexpensive. Call (614) 863-1791. Or write: EVALUATION, Box 13151-A2, Columbus, Ohio 43213.

REPAIR ELECTRONIC ORGANS—Revised home study course covers all current makes and models. Free booklet. Niles Bryant School, P.O. Box 20153, Sacramento, CA 95820.

F.C.C. COMMERCIAL RADIOTELEPHONE LICENSE. Home Study. Fast, Inexpensive! Free details. COMMAND, D-100 Box 2223, San Francisco 94126.

UNIVERSITY DEGREES BY MAIL! Bachelors, Masters, Ph.Ds... Free revealing details. Counseling, Box 317-PE2, Tustin, California 92680.

LEARN WHILE ASLEEP! HYPNOTIZE! Astonishing details, strange catalog free! Autosuggestion, Box 24-ZD, Olympia, Washington 98507.

FOR INVENTORS

INVENTORS! IDEAS HAVE VALUE!

Ever think of an idea, forget it and see it later on the market? Many people don't forget, act quickly and are rewarded by American Industry. Write down your idea! We offer free disclosure registration and initial consultation regarding your idea's potential value. Call or write without delay for your free information package.

AMERICAN INVENTORS CORPORATION
82 Broad St., Dept. CE
Westfield, MA 01086
413-568-3753

A fee Based Marketing Company
Offices Coast to Coast

INVENTIONS, IDEAS, NEW PRODUCTS WANTED! Industry presentation/national exposition. Call free 1-800-528-6050—Arizona, 1-800-352-0458 X831.

PATENT AND DEVELOP your invention. FREE PATENT INFORMATION. Richard L. Miller, P.E., 3612-E, Woolworth Building, New York, NY 10007, (212) 267-5252.

WANTED! Microcomputer Products, Peripherals, Software. We manufacture, market, finance your designs. Large royalties. Write for Free confidential information kit. CO-GEN TECHNOLOGIES, 1 Pennsylvania Plaza, Suite 100, N.Y., NY 10119. (212) 408-1770.

BUSINESS OPPORTUNITIES

MECHANICALLY INCLINED individuals desiring ownership of Small Electronics Manufacturing Business—without investment. Write: BUSINESSES, 92-K11 Brighton 11th, Brooklyn, New York 11235.

ERASE DEBTS with little-known law—create wealth!! Details FREE—Wealth Kit, No. EE1, Billings, NY 12510.

ONE MAN CRT FACTORY. T.V.'s, Business machines, Monitors, Scopes, VDT's. \$3.00 rebuilding nets \$100-\$500 each tube. Higher profits overseas. New/used. FACTORY, 1909 Louise, Crystal Lake, IL 60014. (815) 459-0666.

BORROW \$300-\$30,000 INTEREST FREE! Keep indefinitely! Free Details. Write: American, 1601 Main, Plainfield, Indiana 46168.

LCD WATCH \$2.50, Penwatch \$2.00, catalogue \$1.00. Reliant Engineering Company, P.O. Box 33610, Sheungwan, Hong Kong.

MOONLIGHT WITH YOUR MICRO! Handbook describes 25 proven money-making ideas! \$5, Microbucks, PO Box B, Southfields, NY 10975.

BUMPER STICKER PRINTING DEVICE. Cheap, simple, portable. Free details. Bumper, POB 22791 (PE), Tampa, FL 33622.

SMALL COMPUTER BUSINESSES... Over 100 you can start anywhere-anytime. Unique 40 pg. catalogue—\$1. C.B.I.E.L., P.O. Box 4759, Santa Barbara, CA 93103.

ACQUIRE WEALTH! Borrow \$30,000 interest free! Keep indefinitely. Erase debts with little-known law! Free details: Financial Technologies, Box 40434CZ, Fayetteville, N.C. 28309.

PICTURE TUBE REBUILDING EQUIPMENT—new and used. ATOLL TELEVISION, 6425 Irving Park, Chicago, Illinois 60634, (312) 545-6667.

"PROFESSIONAL" GIANT SCREEN PROJECTION TV... "Don't be fooled by cheap imitations!"... "Build and sell the best with lenses and screens utilized by Sony, Zenith, Pioneer, and Magnavox!"... Simple Construction!... Unlimited profits!... Illustrated dealers information and complete parts catalog \$2.00... Money back guarantee!... POLI-VISION, 187-C Cypress St., Throop, PA 18512.

\$360 WEEKLY/UP, mailing circulars! No quotas. Sincerely interested, rush reply envelope: Marketing International, Box 0197-E2, San Diego, CA 92115.

BORROW \$30,000 without interest! All eligible. Repay anytime. Free details! Infohouse—CE, 808 Post, San Francisco, CA 94109.

PROJECTION TV... MAKE \$\$\$'s assembling Projectors... Easy... Results comparable to \$2,500 projectors. Your total cost less than \$20.00. PLANS, 8" LENS & Dealers information \$17.50... Illustrated information FREE... Macrocoma-CFX, Washington Crossing, Pennsylvania 18977. Creditcard orders 24 Hours (215) 736-2880.

MAILORDER OPPORTUNITY! Start profitable home business without experience or capital. Information free. Mail Order Associates, Inc., Dept. 591, Montvale, NJ 07645.

EMPLOYMENT OPPORTUNITIES

ELECTRONICS/AVIONICS EMPLOYMENT OPPORTUNITIES. Report on jobs now open. Details FREE. Aviation Employment Information Service, Box 240E, Northport, New York 11768.

JOBS OVERSEAS - Big money fast. \$20,000 to \$50,000 plus per year. Call 1-216-453-3000, ext. 4603.

GOVERNMENT JOBS—Thousands of vacancies must be filled immediately. \$17,634 to \$50,112. Call 716-842-6000, Ext 3900.

OVERSEAS Positions. Hundreds of top paying positions available. TAX free incomes. Attractive benefits. Opportunities for all occupations, skilled trades, professionals, management, technicians etc. Free details. Overseas Employment Services, Dept. CE, P.O. Box 460, Town of Mount Royal, Quebec, Canada H3P3C7.

ELECTRONIC TECHNICIANS: Journeymen to \$40,000+. Apprentices to \$32,000. Report on opportunities throughout U.S. O&M, 879, Shingle Springs, CA 95682.

COMPUTER REPAIR

COMPUTER REPAIRS—SIX MONTH WARRANTY. Our highly qualified technicians will diagnose and repair all makes of computers and peripherals including OSI, Osborne, Apple, Diablo, Hazeltine, and TeleVideo. Computer Development Systems Inc., 18 Matthews St., Terryville, Conn. 06786. (203) 583-5993.

RUBBER STAMPS

RUBBER STAMPS, BUSINESS CARDS. Free catalog 1-800-851-4945. Jackson's, E-100, Brownsville Rd., Mt. Vernon, Ill. 62864.

GAMES

ATTENTION—VIC-20 SOFTWARE! Write for a free catalog! ORA, (P.O.) Box 2149, Providence, RI 02905.

MISCELLANEOUS

LASER DISPLAYS. Worldwide sources reveal 2-3D effects, equipment. RENAISSANCE! Box 687, Mercer Island, WA 98040. (206) 232-6256.

RETAIL ROSTER

CONNECTICUT

C&E DISTRIBUTING—Edgewood Drive, Jewett City 06351 (203) 423-0657. Retail outlet and wholesaling for dealers.

MICROSETTE

5 1/4-Inch DISKETTES

- Single or double sided, all double density (SSDD, DSDD).
- Soft sector, reinforced hub.

CASSETTES

- Error-free computer grade.

ITEM	10 PACK	50 PACK
SSDD	\$25.00	\$100.00
DSDD	35.00	150.00
C-10	7.50	32.50
C-20	9.00	39.00
C-60	11.00	53.00
C-90	15.00	70.00

UPS SHIPPING INCLUDED
in Continental USA
CA Customers add taxes

MICROSETTE CO.
475 Ellis St., Mtn. View,
CA 94043 (415) 968-1604

CIRCLE NO. 122 ON FREE INFORMATION CARD

TRS-80 COMPUTER DISCOUNTS

- Factory Direct
- Best Prices Anywhere
- No Out-of-State Taxes
- 100% Radio Shack Warranty
- Free Price List
- Authorized TRS-80

SCOTT TASSO ASSOCIATES

175 North Delsea Drive
Vineland, N.J. 08360

800-257-0426

NJ 609-691-7100

CIRCLE NO. 134 ON FREE INFORMATION CARD

ATTENTION APPLE LOVERS 100% APPLE COMPATIBLE

DISK DRIVE	\$199.
DUAL DISK CONTROLLER	\$ 49.
Z-80 BOARD	\$ 85.
80 COLUMN BOARD	\$159.

MONITORS

ZENITH ZVM 121 12" Green Screen	\$ 89.
AMDEK COLOR I+ 13" Color	\$289.

FREE BROCHURE

**!!CALL US FOR
LOWEST PRICES ON
OTHER ACCESSORIES!!**

XICOM COMPUTER PRODUCTS
414 B. West Fifth Street
Naperville, Illinois 60566
(312) 961-1616

MC, Visa

CIRCLE NO. 131 ON FREE INFORMATION CARD

R.I.S.T. Inc. ANNOUNCES SPEECH SYNTHESIZER

ORDER NOW **SALE** ORDER NOW

\$59.95 plus \$4.00 sh/hd

Phrase Finder Program
Speech Synthesis Manual **FREE**

TRS80 Models I, II, III
Apple II, II+
ZX80/81 TS1000
Com 64, VIC 20

Regularly \$89.95
Now Only \$59.95

Complete or Starter
Kits Available

10 Day Money-Back Guarantee
Send check or M.O. COD add \$1.50 to R.I.S.T. Inc.
Dept. GZ1083, P.O. Box 499 Ft. Hamilton Station
Brooklyn NY 11209 212-259-4934
N.Y.S. RESIDENTS ADD 8.75% TAX

TOROIDAL POWER TRANSFORMERS

Small size • Low noise • Easy mounting



Ideal for audio amps, CRT monitors and computers where low hum is required.

Includes mounting washer with center hole for screw.

A wide selection of toroidal power transformers for 117V-60Hz available from stock. Included are transformers in sizes below with dual secondaries 2 x 8.5V or 2 x 15V or 2 x 18V, your choice. (Rated current = Power/2 x Volts)

Power	Size OD x H	Net wt. lbs.	Price 1	Price ea. 2-4
20VA	2.4" x 1.2"	.7	\$24.30	\$20.40
40VA	2.8" x 1.3"	1.1	\$26.10	\$22.00
70VA	3.2" x 1.4"	1.5	\$27.90	\$24.20
100VA	3.7" x 1.4"	2.2	\$30.00	\$25.70
150VA	3.7" x 1.8"	2.9	\$34.60	\$29.30

Call to place order, or write for complete listing of US made off-the-shelf toroidal power transformers in sizes 20VA-800VA.

We custom make toroids 20VA-3,600VA.
Terms: C.O.D., VISA, MASTERCARD or Money Order.
Shipping: Add \$1.00/lbs for UPS I. - \$1.50 for C.O.D.I.

(410) 450-8898 **TOROID CORPORATION OF MARYLAND**
4720 Q Boston Way, Lanham, MD 20706

CIRCLE NO. 129 ON FREE INFORMATION CARD

ICs PROMPT DELIVERY!!

SAME DAY SHIPPING (USUALLY)

DYNAMIC RAM

64K	200 ns	\$ 5.97
64K	150 ns	6.09
64K	120 ns	6.95
16K	200 ns	1.56

EPROM

27128	300 ns	\$19.20
2764	250 ns	5.99
2732	450 ns	4.25
2716	450 ns	3.60
2532	450 ns	4.75

STATIC RAM

6264P-15	150 ns	\$38.00
6116P-3	150 ns	5.62

MasterCard VISA or UPS CASH COD
Factory New, Prime Parts
MICROPROCESSORS UNLIMITED
24 000 South Peoria Ave
BEGGS OK 74421 (918) 267-4961

Prices in US \$
Prices subject to change. Please expect higher prices on some parts due to world wide shortages. Call for volume prices. Subject to available quantities. Shipping & insurance extra. Cash discount prices shown. Federal Express Standard Air - \$5.99. Orders received by 6 PM CST can be delivered to you by the next morning. We try harder.

CIRCLE NO. 108 ON FREE INFORMATION CARD

Put 64K CP/M 2.2 in your TRS-80 Model III.

Our plug-in Shuffleboard III comes with 15K and gives you the full power of 64K CP/M 2.2, the industry standard operating system.

Tap into over 2,000 off-the-shelf business programs such as dBASE II, SuperCalc, WordStar, etc. READ/WRITE and RUN software from Osborne, Xerox, Superbrain, Keypro II, HP 125 and TeleVideo. You can even READ/WRITE IBM PC software for CP/M 86.

Simple to install! Shuffleboard III plugs into two existing sockets inside your Model III. No permanent modifications, no cut traces, no soldering. You'll be up and running in minutes. For only \$299. Includes MBASIC Interpreter, a software manual and a first class user's manual. Coming soon, an 80 x 24 Video Board and a Floppy Disk Controller.

See the Shuffleboard at your local computer store or order directly from us. Credit card orders shipped directly from stock. Sorry, no COD's. Free 12 page brochure. Call (415) 786-9685

\$299.
Memory Merchant
24219 Clawiter Rd. Hayward, CA. 94545

CIRCLE NO. 120 ON FREE INFORMATION CARD

"CONTROL YOUR WORLD" WITH YOUR VIC-20

With simple circuits using low cost parts and our program supplied on cassette tape, we'll show you how to use your COMMODORE VIC-20 for:

- Digital Thermometers
- Digital Clock
- Burglar Alarm - 2 Zone, Time Controlled
- Fire Alarm - 2 Zone, Time Controlled
- Dusk to Dawn Lighting with Photo Cell
- Furnace and Air Cond., Clock and Thermostat
- Clock Controlled Appliance Switches

Simple program variations in basic can operate lights, motors, furnaces, machines, heat pumps, radios, sound systems, test equipment, swimming pools, garden watering, and more.

Your video screen will display simultaneously:
• Two Digital Temperatures • Digital Time • Two Analog Inputs • Five Input Ports Status • Eight Output Ports Status.

GET A LOW COST EDUCATION IN COMPUTER CONTROL.
ORDER YOUR CASSETTE AND INSTRUCTION BOOK NOW!
\$39.90 PRICE INCLUDES POSTAGE.

Terms: MASTER CARD/VISA

The Continental Press, Inc., Elizabethtown, PA 17022
Toll free: 800-233-0759 Collect in PA: (717) 367-1836

CIRCLE NO. 126 ON FREE INFORMATION CARD

YORK 10 CASSETTES

DATA TRAC
BLANK CASSETTES

C-05, C-06, C-10, C-12, C-20, C-24, C-30

From the leading supplier of Computer Cassettes, new, longer length C-12's (6 minutes per side) provide the extra few feet needed for some 16K programs.

BASF-LHD (DPS) world standard tape.
Premium 5 screw shell with leader.
Error Free • Money back guarantee.

ITEM	1 DOZEN	1 DOZEN
C-05	7.00	13.00
C-06	7.00	13.00
C-10	7.50	14.00
C-12	9.50	14.00
C-20	9.00	17.00
C-24	9.00	17.00
C-30	11.00	21.00
Hard Box	2.50	4.00

FOR IMMEDIATE SHIPMENT
USE YOUR VISA OR MASTERCARD
Call: 213-700-0330
9525 Vassar Ave., #P1
Chatsworth, CA 91311

1983 TAX RETURN HELPER

Fast and easy income tax preparation.

- Form 1040 and Schedules A B C D E
- Enter and modify data on a screen copy of the form
- Works like a spreadsheet - all the lines affected by a change are instantly updated
- Form 1040 and Schedule A are automatically correlated
- Price is tax deductible.

Cassette VIC 20 (16K RAM) or C64	\$23
TIMEX 1000 (16K RAM)	\$14
TIMEX 2068	\$18
Disc. VIC 20 (16K RAM) or C64	\$33

(Add \$1.50 S & H). Check, MO or credit card.

KSOFT CO.
845 WELLNER RD
NAPERVILLE, IL 60540
(312) 961-1250



Dealer inquiries welcome



SAVE MORE THAN EVER ON 3M Scotch® DISKETTES!

\$1.95 ea 5 1/4" SSDD (744) **\$2.70** ea
Qty. 20 5 1/4" DSDD (745) Qty. 20

5 1/4" SSDD-96TPI (746)	\$2.89 ea
5 1/4" DSDD-96TPI (747)	\$3.95 ea
(Specify soft, 10 or 16 sector.)	
8" SSSD (740)	\$2.07 ea
8" SSDD (741)	\$2.54 ea
8" DSDD (743)	\$3.30 ea
(Specify soft or 32 sector.)	

Save even more on quantity orders!
Minimum Order: 20 diskettes. Add \$3.00 shipping per 200 diskettes. C.O.D. charge \$1.65 additional.
Visa • Mastercard • Checks

For fast service, call **DISK WORLD!**

Nationwide: 1-800-621-6827
In Illinois: 312-944-2788

Suite 4806 • 30 East Huron Street • Chicago, Illinois 60611

Authorized Distributor
Information Processing Products



COMPUTER FURNITURE

CD 3624

PS 3024



Genuine Oak Veneer \$89.95 Each

Completely Finished - Ready for Use
Excellent for Student, Home or Office

Send name and address with check or money order for \$89.95 per unit. Specify model no. Add \$15.00 for castors. Include \$10.95 for prompt shipping. Mail to: C.F.M.

P.O. Box 520652 • Salt Lake City, UT 84152



MONEY BACK GUARANTEE
A Division of
Timeless Computer Furniture Manufacturers

64K for VIC 20 SELECT-A-RAM™



SELECT-A-RAM

- STANDARD FEATURES
- RAM BLOCKS SELECTABLE FROM THE KEYBOARD OR BY SOFTWARE COMMAND
 - TWO EXPANSION SLOTS
 - WRITE PROTECTION
 - RESET SWITCH
 - EXPANDABLE TO 192K WITH ADDITION OF 84K EXPANSION MODULES
 - COMPATIBLE WITH ROM CARTRIDGES
 - ONE YEAR WARRANTY ON PARTS AND LABOR

APS-52A
52K MEMORY FOR ATARI 400/800 \$119.00

SELECT-A-RAM \$189
84K EXPANSION MODULE \$145
TRADE INS ACCEPTED
3K 550 \$85.00 16K 520
VIC 20 IS A TRADEMARK OF COMMODORE ELECTRONICS LIMITED

The APS-52A memory expansion boards come assembled and tested with a 90 day warranty covering materials and workmanship. Boards come with complete documentation including operation and installation instructions and a memory test program.

ATARI 400 AND 800 ARE TRADEMARKS OF ATARI INC.

512-441-3202 PO BOX 43006 Austin, Tx. 78745-0001



CIRCLE NO. 99 ON FREE INFORMATION CARD

PRINTER STAND or DESK

- * Size: 27h x 24d x 27" w.
- * Black Painted Steel
- * Sh. Wt. 75 Lbs.
- * Shipped Freight Collect
- * Use Order No. 2A70585



\$39.95



FAN CONTROL

Controls Speed Of AC MOTORS!

ONLY **\$3.88** 3 for \$10.00

Muffin Fans, Caravel Fans, Blowers, ETC... Good for 115/220 VAC up to 6 amps stall current. Control rated at 1.6 amps. Size: 1 1/4 x 2 x 1" Shaft mounting. Use Order No. 3BS0269.

BNF Enterprises

119r FOSTER St.
Peabody MA 01960
(617) 531-5774

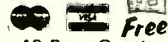

Free! 40 Page Catalog

Customer Pays All Shipping Charges.

CIRCLE NO. 101 ON FREE INFORMATION CARD

VIC-20

NEW

VIC-20 INTERFACING BLUE BOOK
Did you know that your VIC can be used to control a 99c toy motor so effectively that it runs like a precision machine? Or that you can build an accurate digital thermometer using the VIC and four parts costing less than \$5?

These and other 20 interfacing projects selected for usefulness, ease of construction and low cost are detailed in the VIC-20 Interfacing Blue Book, a veritable gold mine of practical information on how to build a variety of interfaces for your computer.

Projects include: Connecting VIC to your stereo; Pickup digital lock; Capacitance meter; Liquid level sensor; Telephone dialer; Voice output; 8K/16K RAM/ROM expansion; 128K RAM expansion; 8-bit precision D/A; 8-bit A/D converter; MX-80 interface and more.

Written by a college professor in a friendly and informative style, the Blue Book gives you theory of operation, schematics, program listings, parts list, construction hints and sources of materials for each one of the 30 projects.

If you want to get the most out of your VIC this book is a must. Cost is \$14.95 (less than 50¢ per project!). Price includes postage.

microsignal Dept 9
P.O. BOX 22
MILLWOOD NY 10546

VIC-20

VIC-20 VIC-20 VIC-20 VIC-20 VIC-20 VIC-20 VIC-20 VIC-20 VIC-20 VIC-20

VIC-20 VIC-20 VIC-20 VIC-20 VIC-20 VIC-20 VIC-20 VIC-20 VIC-20 VIC-20

A/D 8 channels + D/A 8 channels

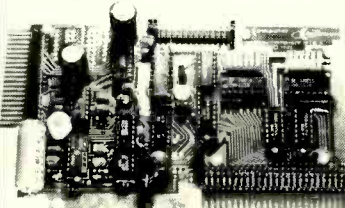

APPLY YOUR MICRO TO ANALOG SIGNAL PROCESSING & CONTROL

Connects to a processor bus of most Z80 & 6502 computers including Timex TRS-80, Apple CBM 64. On chip reprogramming feature eases interfacing.

FAST: 200,000 samples per sec. with Z80A.

EASY TO PROGRAM: One PEEK chooses the channel, starts conversion & gets data. Routines provided.

SOFTWARE AVAILABLE: FFT in Z80 256 points in one second, storage scope for Timex.

LOW COST: Assembled & tested \$195. Cable \$15. Please call or write for free catalog.

Computer Continuum
301 Sixteenth Avenue
San Francisco, CA 94118 (415) 752-6294



Scotch® DISKETTES

Call Toll-Free 1-800-328-DISC for prices and information. Dealer inquiries invited. C.O.D. and charge cards accepted. All orders shipped from stock, within 24 hours. Call toll FREE



North Hills Corporation
3564 Rolling View Dr.
White Bear Lake, MN 55110
1-800-328-DISC
MN Call Collect 1-612-770-0485

GENERAL INSTRUMENT SP0256-AL2

Speech Synthesizer

UNLIMITED VOCABULARY **\$25.00** each plus \$2.00 shipping

The General Instrument ALLOPHONE speech processor is a single chip LSI device that synthesizes continuous speech of unlimited vocabulary. Not to be confused with limited (stored) vocabulary speech chips like the SP0256-017. Documentation includes program listings, interfacing, etc., for use with Apple, VIC-20, Commodore 64 and TRS-80. Also general info for use with other systems!!

PARTIAL KIT; ALSO AVAILABLE

Includes CHIP, PC board, hard to find components, documentation, etc.
Apple \$42. Commodore 64 \$40.
VIC-20 \$40. TRS-80 (I, II) \$40.
plus \$3.00 shipping

SEND CHECK OR M.O. TO:

SILICON SYSTEMS, INC.
4710 Wellington Blvd.
Alexandria, La. 71303

Call (318) 442-7753 for VISA or MC orders.



MODULES FOR
TIMEX-Sinclair
NEW MD-2 DIRECT CONNECT
MODEM

\$119.⁹⁵ Kit
\$149.⁹⁵ W&T

with New **SMART** Menu Driven,
SOFTWARE Included FREE

- Send & Receive Programs by Phone
- Copy Information Into Memory, Print It, Review It, Save It On Tape, Send Text From Memory.
- Use Timex 2040 Printer or Any RS-232 Printer.
- RS-232 Printer Port Provided.
- No Extra Memory Required, But With 64K Memory You Can Store Up To 60 Full Screens.

RS-232 Printer Interface \$59.⁹⁵ Kit \$69.⁹⁵ Ass.
BB-1 Control Module, 8 Relays, 8 TTL Inputs \$69.⁹⁵

UM-64 64K Memory

Battery Backup, Prom/Rom Socket, Reset Sw. Plus Exclusive Feature: Copy the Timex Rom into the 0-8K Area of Ram, flip a Sw & operate out of RAM. MODIFY it to suit your needs. Add new commands.
\$119.⁹⁵ Kit \$129.⁹⁵ Assembled

Gorilla/Banana Printer Discounted to only \$239.⁹⁵
See "Leading Edge" Ad in this magazine

BYTE-BACK CO. Rt. 3 Box 147 Brodie Rd.
Leesville, S.C. 29070 Ck. COD VISA M/C AM EXP
Ph. 803-532-5812 Add \$4.95 shipping to all orders
10 day money back guarantee plus 90-day warranty

CIRCLE NO. 114 ON FREE INFORMATION CARD

**WE SELL
TIME!**

TIME FOR DECISIONS. TIME FOR LEISURE. YOUR TIME. **ISA's** software gives it back to you.

SUPER™ DATABASE - \$199.00

- EASY! FAST!
- General purpose business program DBMS

ManageMint™ — \$395.00 & up.

- PERT/CPM project control system

(Both menu driven for IBM PC, CPM & all TRS-80)

INSTITUTE FOR SCIENTIFIC ANALYSIS
P.O. BOX 7186, OEPT. C-1
WILMINGTON, OE. 19803

(215) 358-3735 / orders only (800) 441-7860
M.C. & VISA accepted.

CIRCLE NO. 117 ON FREE INFORMATION CARD



**Best Prices On
TRS-80 Computers**

Our 6th year of discounts
Ed or Joe McManus
Fgt. Prepaid. Save Tax.
Toll Free 800-231-3680

Marymac Industries, Inc.
22511 Katy Fwy., Katy
(Houston) Tx 77450
1-713-392-0747
Telex 774132

See us in the Wall Street
Journal every Tues. Wed. Thurs.

It's simple. . . .
CALL & SAVE MONEY

1-800-841-0860

UP TO 20% DISCOUNT
DRIVES • PRINTERS
MONITORS • SOFTWARE
CALL FOR BEST PRICES



MICRO MANAGEMENT SYSTEMS
TELEMARKET DEPT. # 12
2803 THOMASVILLE RD. EAST
CAIRO, GEORGIA 31728
GA. & INFO 912-377-7120

CIRCLE NO. 107 ON FREE INFORMATION CARD

Now we can make any computer
sing as well as talk, for only \$219.



As featured in Garcia's
Circuit Cellar,
"BYTE" Magazine,
September,
October 1982.

Microvox.

MICROVOX is a completely self contained professional voice quality text-to-speech synthesizer. MICROVOX may be easily interfaced to any computer modem RS-232C serial or parallel output device

- 6502 Microprocessor based text-to-speech algorithm
- SC-01A phoneme based speech synthesizer
- 64 crystal controlled inflection levels
- 3000 character buffer
- RS-232C and parallel port interfaces
- On board power supply
- Music and sound effects capability

MV01 Microvox Assembled & Tested \$299.00
MV02 Microvox, complete kit \$219.00



To Order: Call Toll Free
1-800-645-3479
In N.Y. 1-516-374-6793
MICROMINT INC.
561 Willow Avenue
Cedarhurst, NY 11516



LEO ELECTRONICS, INC.
8921 S. Sepulveda # 208
Los Angeles, CA. 90045
(213) 641-3101 (800) 421-2418
TLX: 664-688 Interline LSA

**PRICE!
QUALITY!
SERVICE!**

RAMS		
4116 (150ns)	1.35)	
4116 (200ns)	1.25)	16K UPGRADE
4164 (150ns)	4.95)	
4164 (200ns)	4.75)	64K UPGRADE
6116P-3	4.40	
EPROMS		
2708	3.00	2532 4.50
2716	3.20	2732 3.95
TMS2716	4.75	2764 7.00

TERMS: Check, Visa, Mastercard. Call for C.O.D.
U.S. Funds only. California residents add 6% sales tax
SHIPPING: Add \$2.00 for Ground and \$5.00 for Air.
**ALL MAJOR MANUFACTURERS
ALL PARTS 100% GUARANTEED**
Pricing subject to change without notice.

CIRCLE NO. 118 ON FREE INFORMATION CARD

TIMEX
SINCLAIR ZX81
\$99.95

64K RAM PACK
No Ram Pack Wobble
TEDEX
INTERNATIONAL

48945 VAN DYKE, UTICA MI 48087
Check or Money Order add \$5.00 s/h
Michigan residents add 4% tax



**EXTENSIVE
CATALOG
AVAILABLE**

CIRCLE NO. 125 ON FREE INFORMATION CARD

maxell®

Floppy Discs
CALL NOW - TOLL FREE
1-800-328-DISC

Dealer inquiries invited. C.O.D.'s and charge cards accepted.

All orders shipped from stock, within 24 hours. Call toll FREE.



North Hills Corporation
3564 Rolling View Dr.
White Bear Lake, MN 55110
1-800-328-DISC
MN Call Collect 1-612-770-0485

**Votrax™ SC-01A
SPEECH SYNTHESIZER**



**\$42 Each
(\$32 in
hundreds)**

Order in Ones or Thousands

The SC-01A Speech Synthesizer is a completely self-contained solid state device. This single chip phonetically synthesizes continuous speech of unlimited vocabulary.

Computer interfaces and text-to-speech algorithms also available for product development.

MicroMint is the largest U.S. distributor of the SC-01A. Call us for a price quote.

Call 1-800-645-3479, in N.Y. 1-516-374-6793

MICROMINT INC.

561 Willow Avenue
Cedarhurst, NY 11516



Add \$2.00 for shipping & handling.

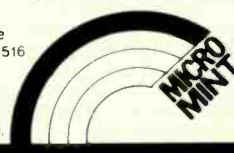



Predictable.

A flawless future is in sight with 3M diskettes.

When it comes to keeping track of precious data, predictable means reliable. Being able to count on every diskette, every time. At 3M, reliability is built into every diskette. We've been in the computer media business for over 30 years. And we've never settled in. We're constantly improving and perfecting our product line, from computer tape and data cartridges to floppy disks.

3M diskettes are made at 3M. That way, we have complete control over the entire manufacturing process. And you can have complete confidence in the reliability of every 3M diskette you buy.

Look in the Yellow Pages under Computer Supplies and Parts for the 3M distributor nearest you. In Canada, write 3M Canada, Inc., London, Ontario. If it's worth remembering, it's worth 3M diskettes.



3M hears you...

3M

Circle No. 48 on Free Information Card

www.americanradiohistory.com

▲ THE DAY THE IBM® PERSONAL COMPUTER BECAME OBSOLETE.



It was a Monday in the autumn of '83.

The day they announced the Leading Edge® PC—a personal computer that's just plain better than the IBM® PC, at just about half the price.

The Leading Edge PC is faster (by more than 50%), more powerful, more flexible and more dependable (for example, our disk drives have a "mean time between failures" of 20,000 hours, versus an 8,000-hour MTBF for theirs). It's compatible with just about all the software and peripherals that the IBM is.

And unlike IBM's, ours comes complete with a high-resolution monitor, controller, seven expansion slots, serial port, parallel port, a time-of-day clock, double the standard memory (128K vs. 64K), plus hundreds of dollars worth of software to get you up and running immediately including MS®-DOS version 1.25, GW Basic, and Leading Edge Word Processing (the most powerful w.p. program ever created to run on an IBM-type personal computer). In short, the basic package comes to you complete and ready to work.

With IBM, on the other hand, you get charged extra for everything. Even for the PC DOS disk that makes

it run (an extra \$40) ... and \$170 just for the time of day (a calendar/clock that's standard with Leading Edge). In short, the basic package comes to you as a very expensive paperweight.

It's this simple. The Leading Edge Personal Computer is the first and only serious alternative to the IBM PC ... and at only \$2895 for the Leading Edge PC ...

Get serious.

In the age of the personal computer, Leading Edge, means what it says.



LEADING EDGE PRODUCTS, INC., 225 TURNPIKE STREET, CANTON, MA 02021, 1-800-343-6833, IN MASSACHUSETTS, (617) 828-8150

IBM is a registered trademark of International Business Machines Corporation.

Circle No. 20 on Free Information Card